

# AUDIO ENGINEERING

NOVEMBER  
1950  
35c

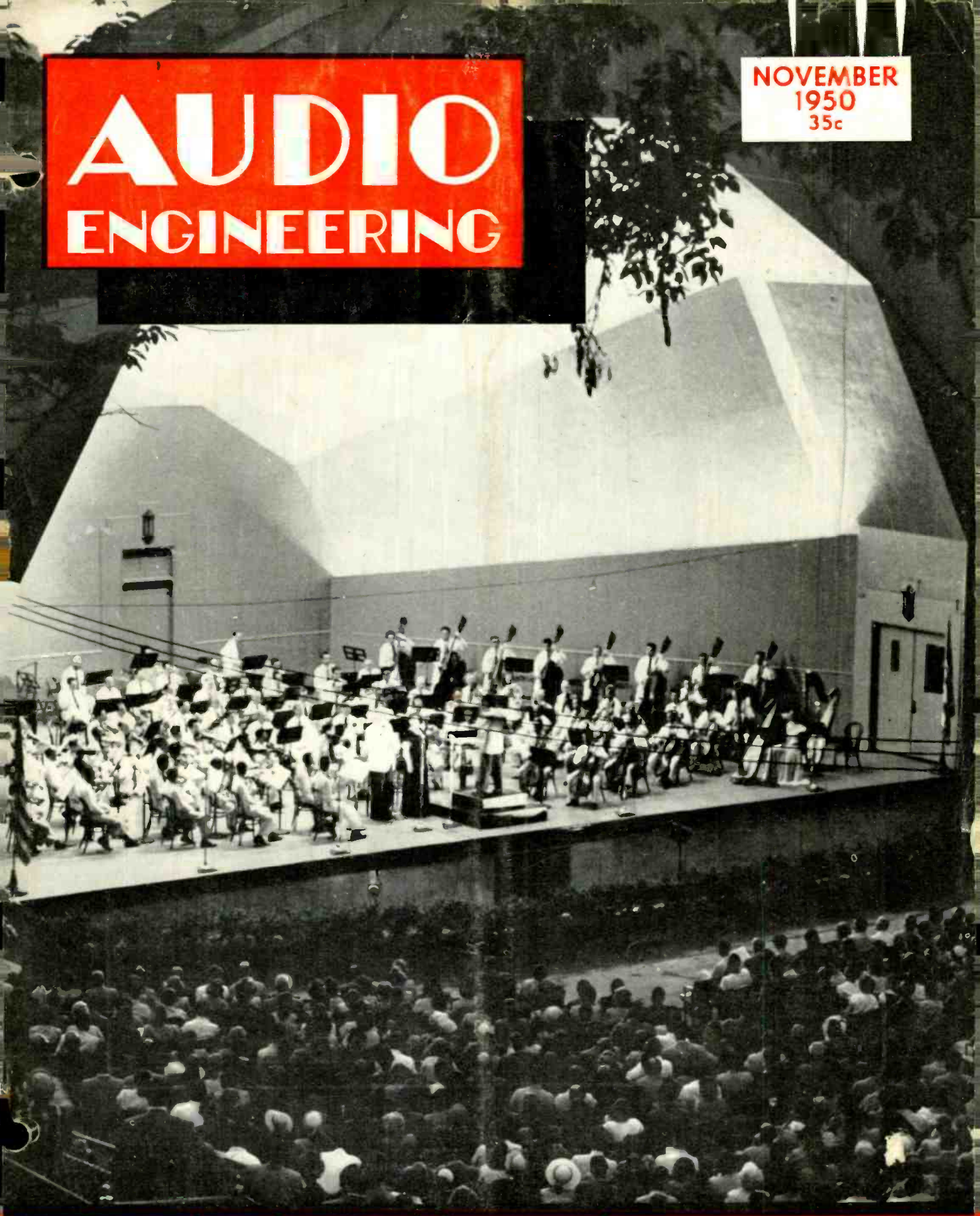

Published by RADIO MAGAZINES, INC.

[www.americanradiohistory.com](http://www.americanradiohistory.com)



# Look at the new audiotape\*

Yes, you can actually see the difference. The way it tracks and winds absolutely flat, due to superior, straight-line slitting. Its smooth, non-curling flexibility — and the way it rides snugly over the heads without humping away in the middle. And,

compared under a microscope, you can see Audiotape's superior dispersion of the oxide particles—free from "clumping" which tends to increase background noise. You can tell a lot just by looking at Audiotape, but...



# Listen to its matchless reproduction

That's the real test. Audiotape actually does "speak for itself." Hear its brilliant high-frequency response — freedom from annoying background noise and distortion. There's no friction squeal—no rasping hum

from low-frequency modulation noise. And a sensitive ear can appreciate the remarkable uniformity of output volume, varying not more than  $\pm 1/4$ db for an entire 2500 foot reel.

*Original recordings for phonograph records of America's leading artists are made on Audiotape. There must be a reason!*



And see how Audio's **IMPROVED PACKAGING** simplifies handling and storage

All 2500 and 5000 foot rolls of Audiotape are individually boxed in specially designed containers (Pat. Pending) that make handling and storage safer and easier than ever before. Tape can be transferred from container to turntable (and vice versa) without danger of slipping from the hub or becoming unwound. Reel side flanges can be attached to hub without removing it from container. In storage, tape hangs from hub core — does not rest on edge of roll.

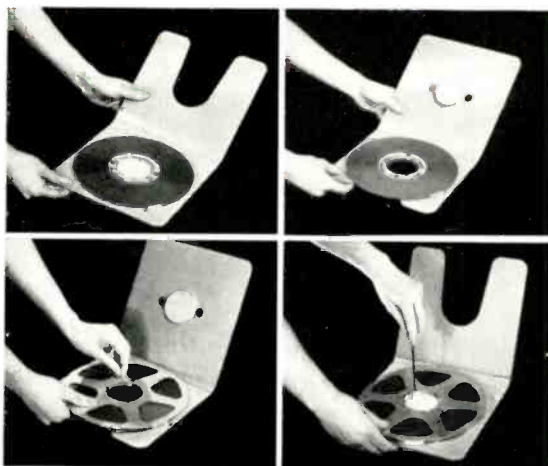

SEND FOR FREE  
100 FOOT SAMPLE  
of plastic espaper base  
Audiotape today

## AUDIO DEVICES, INC.

444 MADISON AVE., NEW YORK 22, N. Y.  
Export Dept.: ROCKE INTERNATIONAL, 13 East 40th St., New York 16, N. Y.



Makers of **audiodiscs\***

... the standard of disc recording quality for more than a decade

\*Trade Mark:



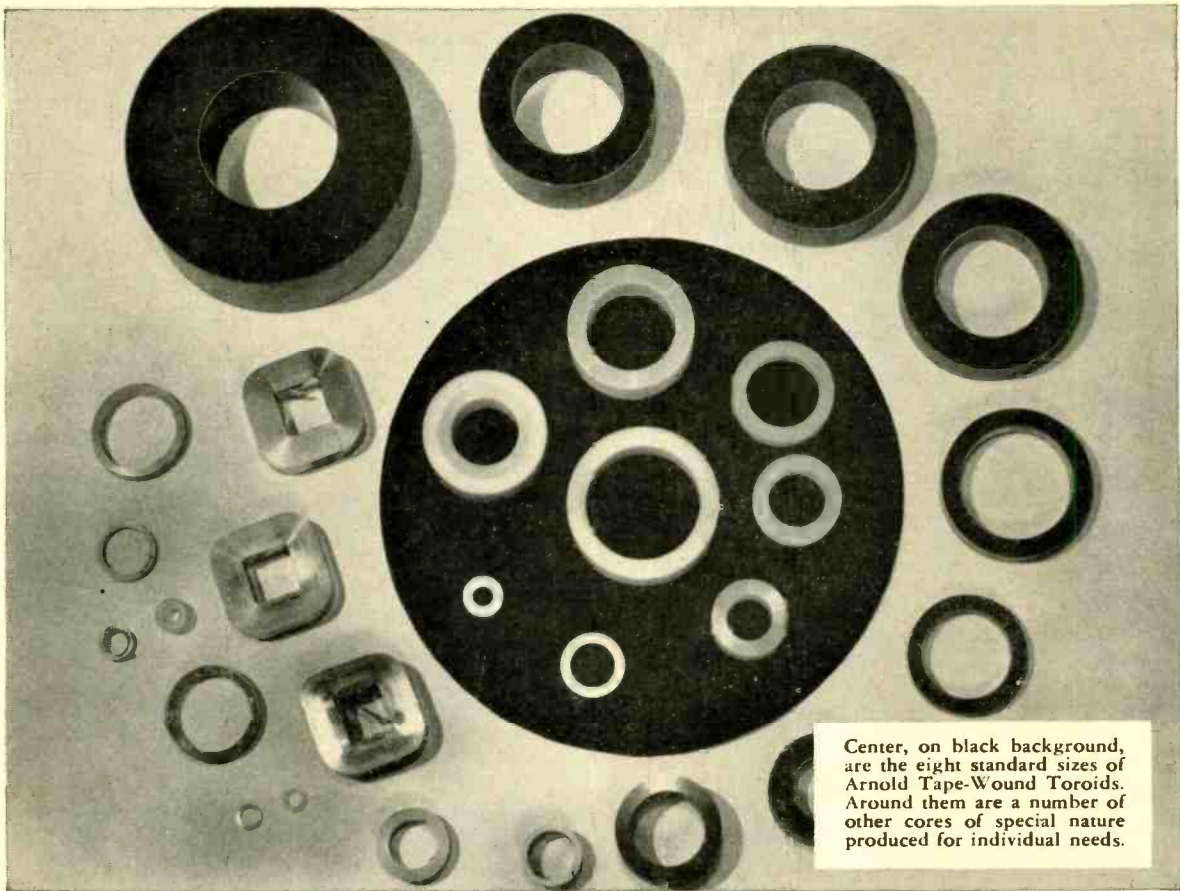

Center, on black background, are the eight standard sizes of Arnold Tape-Wound Toroids. Around them are a number of other cores of special nature produced for individual needs.

# ARNOLD TAPE-WOUND TOROIDAL CORES

of DELTAMAX  
4-79 MO-PERMALLOY  
SUPERMALLOY\*

## APPLICATIONS

MAGNETIC AMPLIFIERS  
PULSE TRANSFORMERS  
NON-LINEAR RETARD COILS  
and TRANSFORMERS  
PEAKING STRIPS, and many other  
specialized applications.

## RANGE OF SIZES

Arnold Tape-Wound Toroids are available in eight sizes of standard cores—all furnished encased in molded nylon containers, and ranging in size from 1/2" to 2 1/2" I.D., 3/4" to 3" O.D., and 1/8" to 1/2" high.

## RANGE OF TYPES

These standard core sizes are available in each of the three magnetic materials named, made from either .004", .002" or .001" tape, as required.

In addition to the standard toroids described at left, Arnold Tape-Wound Cores are available in special sizes manufactured to meet your requirements—toroidal, rectangular or square. Toroidal cores are supplied in protective cases.

\* Manufactured under licensing arrangements with Western Electric Company.

W&O 3182

## THE ARNOLD ENGINEERING COMPANY



SUBSIDIARY OF ALLEGHENY LUDLUM STEEL CORPORATION

General Office & Plant: Marengo, Illinois

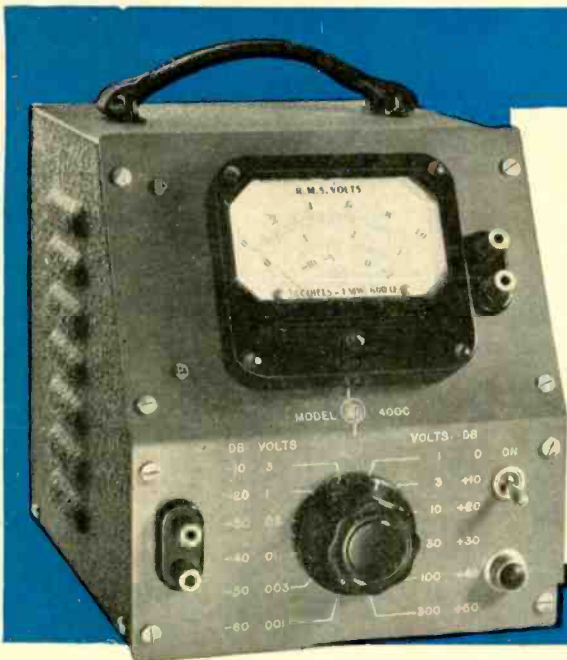

VOLTAGE RANGE:

**3,000,000 to 1**

READINGS:

**.1 mv to 300 v**

FREQUENCIES:

**20 cps to 2 mc**

## **-hp- MODEL 400C VACUUM TUBE VOLTMETER**

**High sensitivity... Wider range... Easy-to-read linear scale... Space-saving, time-saving versatility!**

30 times more sensitive than the *-hp-* 400A voltmeter, the new *-hp-* 400C accurately determines voltages from .1 mv to 300 v. Its measuring range is broad and new—3,000,000 to 1. And with it you can make split-hair measurements all the way from 20 cps to 2 mc!

The big, clearly-calibrated linear scale reads directly in RMS volts or db based on 1 mw into 600 ohms. Generous overlap makes possible more readings at mid or maximum scale, where accuracy is highest. A new output terminal lets you use the *-hp-* 400C as a wide-band stabilized amplifier, for increasing gain of oscilloscopes, recorders and measuring devices. As a voltmeter, the new instrument has still wider applicability—for direct hum or noise readings, transmitter and receiver voltages, audio, carrier or supersonic voltages, power gain or network response.

Naturally the new *-hp-* 400C includes the familiar advantages of the *-hp-* 400A voltmeter. Range switch is calibrated in 10 db inter-

vals providing direct readings from -70 dbm to +52 dbm. Overall accuracy is  $\pm 3\%$  full scale to 100 kc. High input impedance of 1 megohm means circuits under test are not disturbed. And the rugged meter movement is built to safely withstand occasional overloads 100 times normal.

In every respect, the convenient, durable *-hp-* 400C is the ideal new voltmeter for precision work in laboratory, plant or repair shop.

### **Hewlett-Packard Company**

1556L Page Mill Road, Palo Alto, California

### **CHECK THESE SPECIFICATIONS**

#### VOLTAGE RANGES:

12 ranges. Full-scale readings.

.001 v	.100 v	10.0 v
.003 v	.300 v	30.0 v
.010 v	1.00 v	100 v
.030 v	3.00 v	300 v

FREQUENCY RANGE: 20 cps to 2 mc

#### ACCURACY:

$\pm 3\%$  full scale 20 cps to 100 kc  
 $\pm 5\%$  full scale 100 kc to 2 mc

#### INPUT IMPEDANCE:

10 megohms shunted by 15 uufd on the 1.0 v to 300 v ranges, 25 uufd on the .001 v to .300 v ranges.

#### METER SCALE:

3" linear. Voltage ranges related by 10 db steps. Db calibrated -12 to +2 db. Zero level 1 mw into 600 ohms.

#### OUTPUT CIRCUIT:

Maximum 0.5 v full scale. Internal Impedance 1000 ohms.

#### POWER SUPPLY:

115 v, 50/60 cps, 45 watts.

#### CABINET SIZE:

8" high, 7½" wide, 9" deep.

**hp laboratory instruments**  
 FOR SPEED AND ACCURACY

Power Supplies    Frequency Standards    Amplifiers    Electronic Tachometers    Frequency Meter  
 UHF Signal Generators    Square Wave Generators    Audio Frequency Oscillators    Attenuators  
 Audio Signal Generators    Noise and Distortion Analyzers    Wave Analyzers    Vacuum Tube Voltmeter



# AUDIO ENGINEERING

Successor to **RADIO**

Established 1917



**C. G. McProud, Editor**  
Luci Turner, Production Manager  
Lucille Carty, Circulation Manager

**D. S. Potts, Publisher**  
S. L. Cahn, Advertising Director  
H. N. Reizes, Advertising Manager

#### Editorial Advisory Board

Howard A. Chinn  
John D. Colvin  
C. J. LeBel  
J. P. Maxfield  
George M. Nixon

#### Representatives

Sanford R. Cowan, Mid-West Sales  
342 Madison Ave., New York 17, N. Y.  
James C. Galloway, Pacific Coast Sales  
816 W. 5th St., Los Angeles 17, Calif.  
Technical Book & Magazine Co.  
297 Swanston St., Melbourne, C. I.  
Victoria, Australia

## CONTENTS NOVEMBER, 1950 Vol. 34, No. 11

Audio Patents—Richard H. Dorf .....	4
Letters .....	8
Editor's Report .....	12
The Flewelling Audio System—Edmund T. Flewelling .....	15
Performance and Operation of a New Limiting Amplifier—C. A. Singer ..	18
Performance Plus Economy Tape Recorder—Jay Blakesley .....	20
The Impact of Acoustics on Music—Robert H. Tanner .....	21
Fixed-Filter Type Distortion and Noise Meter—J. P. Smith .....	22
Simplified Intermodulation Measurements—John M. van Beuren .....	24
Acoustics of London's New Concert Hall .....	26
<b>AUDIO engineering society SECTION</b>	
Sound Reinforcing Systems—Arthur W. Schneider .....	27
Employment Register .....	28
Loudspeaker Damping as a Function of the Plate Resistance of the Power Output Tube—Donovan V. Geppert .....	30
Audiana—High Fidelity—Lewis S. Goodfriend .....	32
Record Revue—Edward Tatnall Canby .....	34
Pops—Rudo S. Globus .....	34
Audio in England—H. A. Hartley .....	36
New Products .....	60
New Literature .....	71
Advertising Index .....	72

#### COVER

Night scene of concert at Robin Hood Dell, Philadelphia. Entire sound reinforcement system installed and maintained by Air-Tone Sound and Recording Co. using Electro-Voice High Fidelity Broadcast Microphones and University Loudspeakers. Amplifiers designed and constructed by Gene Hessel of Air-Tone.

AUDIO ENGINEERING (title registered U. S. Pat. Off.) is published monthly at 10 McGovern Ave., Lancaster, Pa., by Radio Magazines, Inc., D. S. Potts, President; Henry A. Schober, Vice-President. Executive and Editorial Offices; 342 Madison Avenue, New York 17, N. Y. Subscription rates—United States, U. S. Possessions and Canada, \$3.00 for 1 year, \$5.00 for 2 years; elsewhere \$4.00 per year. Single copies 35c. Printed in U. S. A. All rights reserved. Entire contents copyright 1950 by Radio Magazines, Inc. Entered as Second Class Matter February 9, 1950 at the Post Office, Lancaster, Pa. under the Act of March 3, 1879.

# One Pickup

## PLAYS ALL DISKS

New Fairchild Turret-Head 3-Way Transcription Arm Plays Standard Laterals, Microgrooves, and Verticals Without Plug-ins . . .

#### WHAT IT IS:

A revolutionary new pickup with provision for 3 separate cartridges—All in ONE arm



#### WHAT IT DOES:

Obsoletes plug-in cartridges. Eliminates extra pickups on turntable. Performs functions of 3 separate pickups.

#### RESULTS:

- Lateral, Vertical, Microgroove in 1 Arm
- Any combination of cartridges in 1 Arm
- Simply turn knob to select cartridge
- Pressure changes automatically
- Optimum performance — separate cartridge for each function
- No arm resonance — new viscous damping
- Fits all transcription turntables.

Write for  
Illustrated Details



154TH STREET AND 7TH AVENUE  
WHITESTONE, N. Y.

FR-113

**FOR  
ABSOLUTE TOP QUALITY  
... at Popular Prices!  
REK-O-KUT  
TURNTABLES**



**CONTINUOUSLY VARIABLE SPEED  
RECORD PLAYER**

Plays without "wow" at any setting within its speed range of 25-100 R.P.M. The indispensable turntable for TV, AM, FM broadcast stations, dance studios, musicians, singers, record collectors and wherever audio-visual methods are employed. Plays through any amplifier, radio, TV set, or phonograph. Operates on 50 or 60 cycles. The only turntable to use in areas of varying voltages and frequencies or with portable power plants.

CVS-12 (illustrated) ..... \$84.95 NET  
CVS-12P in portable case with 16" Dual-Stylus Pickup ..... \$124.95 NET



**Famous  
Models  
T-12H and  
T-43H**

\* Recommended for use with Hi-Fi amplifiers and speaker systems because of low noise and rumble level, which is maximum-50 db. The only 11" dual speed turntables equipped with Hysteresis synchronous motors, thereby meeting standards for speed regulation and "wow" content specified by the N.A.B. Instantaneous speed shift engages either 78 or 33 1/3 R.P.M. Idler without stopping turntable or removing disc.

T-12H ..... 78-33 1/3 ..... \$119.95 NET  
T-43H ..... 45-33 1/3 ..... \$119.95 NET

Interchangeable idlers for third speed optional



**Model LP-743  
Three-Speed  
12" Transcription  
Turntable**

Designed to meet the growing demand for a good turntable which is priced between the deluxe models and ordinary phono motors and dimensioned for easy replacement of obsolete motors in average consoles. Instantaneous speed changes—78, 45, 33 1/3 R.P.M. without stopping turntable or removing disc. \$54.95 net.

\* As attested to by America's top authorities on sound equipment. Reprints on request.

See these and other REK-O-KUT instruments at the Audio Fair, Hotel New Yorker, Room 636.

Ask to see REK-O-KUT Products at Music Stores, Radio Parts Distributors and Audio-Visual Dealers, or Write for Literature.

**REK-O-KUT CO., Inc.**  
38-01 QUEENS BOULEVARD  
LONG ISLAND CITY 1, N. Y.



# AUDIO PATENTS

RICHARD H. DORF\*

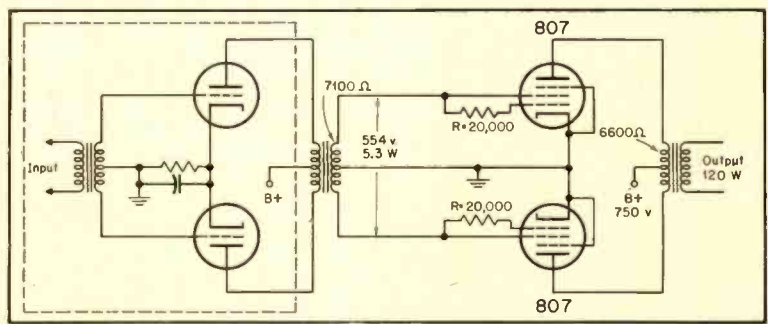

Figure 1

**T**HE 807 and its smaller counterpart, the 6L6, have excellent class-AB<sub>2</sub> characteristics, and they are very attractive for high-power work—such as in high-power PA systems and in transmitter modulators—because of their small size and price, the unipotential cathode, and the ability to deliver a great deal of power at comparatively low plate voltage. They are not used to a great extent for these jobs, however, probably because furnishing screen and grid-bias voltages with the necessary regulation is neither easy nor economical.

The necessity for screen and grid supplies has been entirely eliminated by Arthur Mack Seybold in his patent No. 2,494,317 (assigned to RCA). Despite this, the full 120-watt output specified in the ICAS handbook ratings for the 807 may be had. The price paid is a requirement for greater grid drive, but at 5.3 watts that is hardly a king's ransom.

The circuit of the 807 output stage appears in Fig. 1. The driver, within the dashed box, is merely a pair of push-pull 2A3's (or 6B4's or 6A3's etc.) in an en-

tirely standard circuit. The "gimmick" is the resistor *R* between each 807 screen and control grid, and the fact that the screen is directly connected to the secondary of the driver transformer. There is no screen supply, no bias supply; the stage is as easy to construct as a zero-bias class-B stage.

Figure 2 shows some plate-family curves taken under various conditions, illustrating the effect of resistors *R*. *E<sub>c</sub>* in each case is

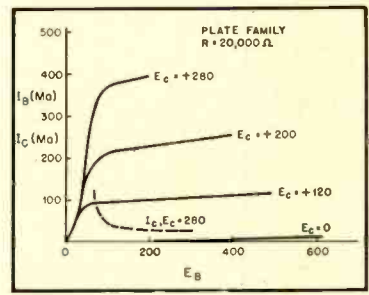

Figure 3

the voltage applied to the screen grid. The *R*=0 curve indicates what would happen if the tubes were operated simply as triodes with screen and control grids tied together. The knee is poor because the control grid draws too much current. The same is true of the lower resistance values when *R* is inserted. The optimum condition is reached when *R* is about 20,000 ohms. Higher values are not advisable because the grid and screen then require higher driver voltages than the ratings permit. Figure 3 is a complete plate family with *R* equal to 20,000 ohms. Grid and screen current combined are indicated by the dashed curve labelled *I<sub>c</sub>*.

Actually, the only important difference between this circuit and regular zero-bias class-B triodes is in the effective grid re-

\* Audio Consultant, 255 West 84th Street, New York, N. Y.

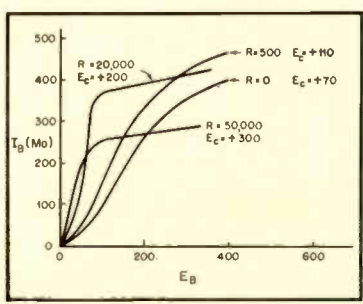

Figure 2



# A-F OUTPUT POWER MEASUREMENTS

## from 0.2 mw to 100 Watts

**T**HIS direct-reading meter is invaluable for measurements of the power output of audio-frequency circuits. Essentially it is equivalent to an adjustable load impedance across which is connected a voltmeter calibrated directly in watts dissipated in the load. Its features include:

### VERY WIDE RANGES

**POWER:** 0.2 milliwatt to 100 watts, in 5 ranges

**IMPEDANCE:** 2.5 to 20,000 ohms

### GOOD ACCURACIES

**IMPEDANCE:** Within  $\pm 2\%$ , except at higher audio frequencies where error for higher impedance settings may be greater. At 15,000 cycles, input impedance error is about 5% for impedances from 10,000 to 20,000 ohms

**POWER:** Over-all frequency characteristic of power indication is flat within  $\pm 0.5$  db from 20 to 10,000 cycles; within  $\pm 0.75$  db to 15,000 cycles

**WAVEFORM ERROR:** A copper-oxide rectifier meter is used, calibrated in r-m-s values for sinusoidal applied voltage. When non-sinusoidal voltages are used, error in indication can occur. Error will depend upon magnitude and phase of harmonics present; it will not be serious with waveforms normally encountered in communication-frequency circuits

For testing amplifiers, transformers, telephone lines and other networks, the Type 783-A meter is a very handy, useful and accurate instrument. Considerable overloads, for a short time, can be handled by the rectifier-type voltmeter. The indicating meter is equipped with an auxiliary decibel scale, useful in many types of measurements.

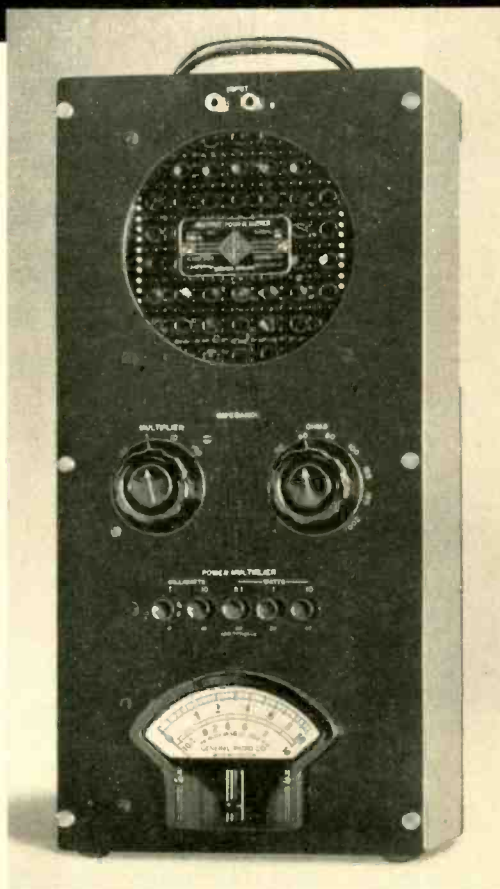

**TYPE 783-A OUTPUT-POWER METER . . . . \$310.00**



# GENERAL RADIO COMPANY

Cambridge 39,  
Massachusetts

90 West St., New York 6 920 S. Michigan Ave., Chicago 5 1000 N. Seward St., Los Angeles 38

sistance. Most of the high- $\mu$  zero-bias triodes require low-voltage, high-current excitation. Here, a high-voltage signal—554 volts peak—is used, with low current. The 807 grids present a fairly constant load with an equivalent resistance of 7,100 ohms. Other values and ratings are noted in the drawing of Fig. 1.

### Tone-Control Circuits

Here are a couple of tone-control circuits which have been patented recently. Tone controls are among the commoner audio inventions these days.

The first, diagrammed in Fig. 4, is intended for small receivers. Its purpose is to act as rudimentary loudness control to boost the bass as volume gets lower. It has the advantage of not causing an overall

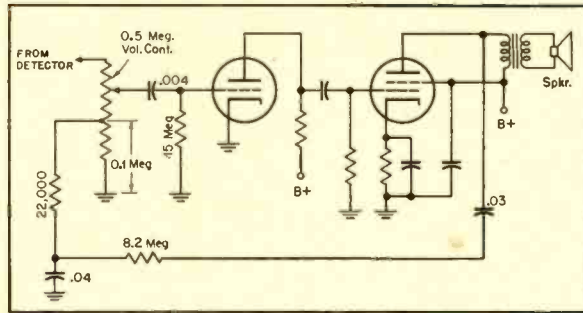

Figure 4

drop in amplifier gain such as is the price of most tone controls for this purpose. The inventor is D. C. Knight and the assignee

of patent No. 2,506,365 is Zenith.

The diagram shows the audio section of a receiver. It is conventional in every way except that it has regenerative feedback at the lower frequencies—and an auxiliary bass booster besides. Starting with the latter, note the .04- $\mu$ f capacitor (in series with a 22,000-ohm resistor) across the lower 100,000 ohms of the 500,000-ohm volume control. So far, it is standard—the old tapped-volume-control system.

Next, however, note that there is a feedback line originating at the plate of the output tube and going back to the volume control tap. Since the output tube plate is in phase with the triode grid, this is positive feedback. Since the feedback line runs into a .04- $\mu$ f shunt capacitor, it emphasizes the low frequencies. The feedback is applied to the volume control tap, so that as the control is moved down toward the tap, bass gets stronger and—unlike other “boosters”—gain actually increases over what it would be without the tone control. The .03- $\mu$ f capacitor in series with the feedback loop keeps the very low frequencies out of the circuit so that the amplifier does not start imitating an outboard motor. The 8.2-megohm series resistor adjusts the degree of feedback and would need changing in different amplifiers.

There is, of course, a fairly sharp dropoff in the bass boost as the control is moved below the tap, for then the feedback is subject to voltage-divider action. For that reason, the tap should be as close to ground as possible without destroying the boosting action.

The second in our duo of tone controls is the invention of M. H. Mesner. The patent is numbered 2,505,254 and is assigned to RCA. The circuit is diagrammed in Fig. 5.

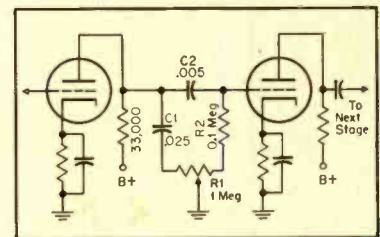

Figure 5

This is a single-control network whose purpose is to attenuate either bass or treble. With the knob in the center position, all is normal; at one end treble drops and at the other end bass fades away. The design is attacked as follows:

With  $R_1$  at its center setting, the grid of the second triode has a grid leak amounting to the 0.1 meg of  $R_1$  plus 0.5 meg of  $R_2$ .  $C_2$  is big enough so that under those

[Continued on page 45]

**new**

# Permoflux

## ROYAL EIGHT™

### compares with any 12" speaker!

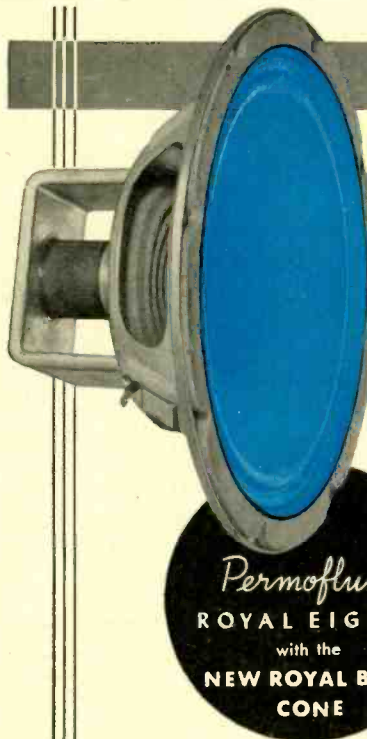

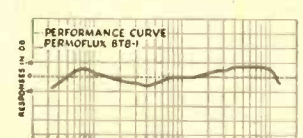

*This averaged laboratory response curve of the Permoflux 8TB-1 proves that it compares with the finest speakers regardless of size or price.*

**It's Your "Springboard" to Extra Sales with Customers who want 12" performance but don't want to pay a 40% higher price.**

Permoflux  
**ROYAL EIGHT™**  
with the  
**NEW ROYAL BLUE CONE**

From the resonant boom of jungle drums to the light warble of the flute, this new 8" speaker reproduces sound with superior sensitivity and fidelity. The tonal qualities of this magnificent speaker can only add to the excellence of any audio equipment.

Special processing provides extra-strong cone; allows cone to be soft-suspended from basket and held at coil-end by extra-large spider. Permits more faithful reproduction at lower frequencies. Deeper, curvilinear cone greatly extends high-frequency response.

Permoflux Royal Eight™ (Model 8TB-1) is ruggedly-built, and simple to install. Provides big speaker performance in a small frame—uses smaller, more economical baffle. List Price \$15.00.

Send for Catalog No. J201—Dept. AE

See us at the Audio Fair

Rm 640



**PERMOFLUX CORPORATION**  
4900 W. GRAND AVE., CHICAGO 39, ILL. • 236 S. VERDUGO RD., GLENDALE 5, CALIF.



8740

8743

8734

8735

8738

8739

8747

8433

8799

8752

# INTERCOMMUNICATION AND SOUND SYSTEM CABLES

*Every Type for Every Service*

Sold Exclusively Through Recognized Wholesale Distributors

## **Belden** *Radio* WIRE

# AMPERITE

## STUDIO MICROPHONES at P.A. PRICES!



at **CLOSE TALKING**



and **DISTANT PICK-UP**

**YOU CAN SHOUT RIGHT INTO IT, or STAND AWAY**  
... In either case, Quality will be perfectly natural. Output charge reduced to a minimum by the Automatic Volume Control effect achieved by special construction.

**AMPERITE  
Ribbon Mike  
LEADS 7 WAYS**

- 1 BLASTPROOF:** No "boom." or stand 12" away, response is always perfect. Shout into it, less
- 2 LOWEST FEEDBACK:** much than any diaphragm type mike with equal frequency response.
- 3 LESS DISTORTION;** below 1%.
- 4 FLAT RESPONSE** without peaks over frequency range of 50-11,000 cps.
- 5 OUTPUT** (-62 db); automatic volume control effect achieved with special construction.
- 6 COMPACT** and RUGGED.
- 7 UNAFFECTED** by CHANGES in climatic conditions, wind, etc.



Models:  
RBLG-200 ohms  
RBHG-Hi-imp.  
List \$42.00



Amperite "Kontak" Mikes  
Model SKH, hi-imp ..... List \$12.00  
Model KKH, with hand volume control ..... List \$18.00

**AMPERITE CARDIOID  
DYNAMIC MICROPHONE**

Models PGH-PGL ..... List \$32.00



**SPECIAL OFFER:**  
Write for Introductory Offer, and  
4-page Microphone Folder 53-M

**AMPERITE Company, Inc.**

561 Broadway • New York 12, N. Y.

In Canada: Atlas Radio Corp., Ltd., 560 King St., W., Toronto 2B

## LETTERS

"Hot Stylus" Technique

Sir:

Mr. Bachman's article in your June issue under the title "The Columbia Hot Stylus Recording Technique" adds much detail to this very interesting and supposedly new advancement in recording.

As pointed out by H. E. Roys in the RCA Review of June 1949, "Tracing distortion might be eliminated by forming the groove with a stylus similar to the playback stylus, but this amounts to adopting the embossing system of recording. No satisfactory high-quality embossing means has so far been found." Perhaps Mr. Roys was not familiar with the hot-needle technique.

Just to add another splash of color to this picture, it may be of interest to note that I used this very same heated-stylus recording technique in 1921 while developing electric recording for the Brunswick Company in Chicago. I was using wax and conventional non-burnishing cutters at that time, of course, but the results were very good indeed as to low noise output. The only fly in the ointment was that the appearance of the record pressings was not so good, due to the irregular-height ridge of wax pushed up by the hot cutter. So, the sales department vetoed its use for commercial pressings.

The needle was heated by a high-voltage arc with a series resistance to limit the current. The arc was between the needle and an adjacent electrode about 10 mils distant. A high-voltage r.f. arc could also be used. The needle was not a normal cutter, but a regular steel reproducing needle, so that the usual problems of tracking a groove, cut by a triangular cutting tool, with a conventional needle was not present. The surface noise was very low and the high-frequency response exceedingly good.

Another heating method which was tried out consisted of a wax coated metal plate. A heating current was passed between the needle and the grounded metal backing

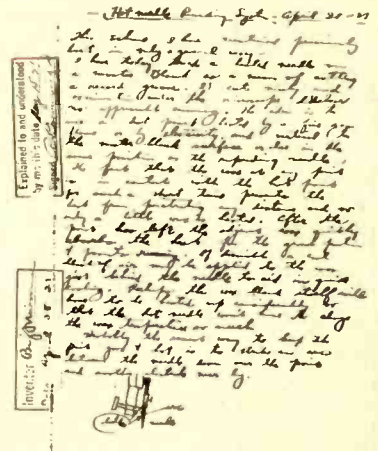

Figure 1



6" x 9" PM



5" PM



4" PM



5" x 7" PM



# Announcing~

**A new advance in popularly priced  
high-fidelity speaker design—The RCA-515S2**

4" x 6" Field Coil



4" x 6" PM

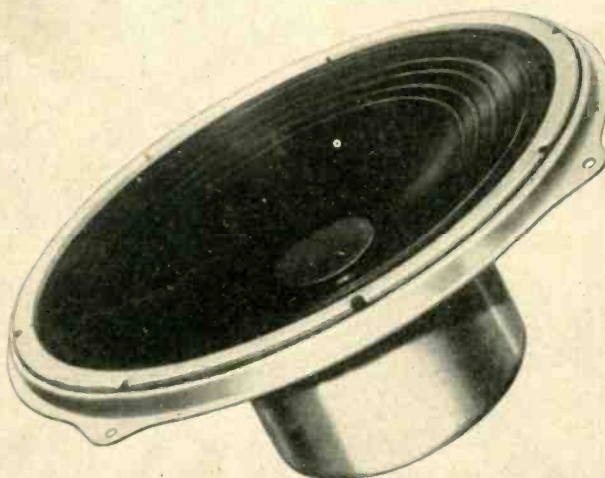

8" PM



12" PM



✓ Requires no cross-over network ✓ Has uniform directivity pattern  
✓ Minimum cross-over interference ✓ Designed for either rim or flange mounting  
✓ Wide-angle radiation over entire frequency range ✓ Low non-linear distortion  
✓ Sound pressure radiates from one plane.

A NEW SPEAKER . . . embracing a new approach to audio quality standards . . . the RCA-515S2 employs the "duo-cone" principle originated by Dr. H. F. Olson, world renowned acoustical authority of RCA Laboratories.

Featuring high sensitivity over a useful response range of 40 to 12000 cycles per second, the 515S2 has a power-handling capability of 25 watts of audio power.

The unique vibrating system and magnet structure utilized in the 515S2 consist of a duo-cone, and two voice coils operating in two separate air gaps excited by a single, 2-pound Alnico V magnet. The duo-cone is constructed with large "woofer" cone and small "tweeter" cone each so mounted in its

individual housing that the large cone is effectively a continuation of the small cone. The large cone is driven by a 2-inch voice coil to produce the low frequencies, and the small cone is driven by a ¾-inch voice coil to produce the high frequencies.

RCA has a complete line of quality speakers designed to RTMA rim-mount standards. From the miniature 2" x 3" to the superb new 15" duo-cone—each RCA speaker is skillfully designed, fabricated from the finest materials, and produced under rigid quality-control methods. For complete details on the RCA-515S2 duo-cone speaker, see your RCA Distributor, or write RCA, Commercial Engineering, Section K64V, Harrison, N. J.



**RADIO CORPORATION of AMERICA**  
ELECTRONIC COMPONENTS

HARRISON, N. J.

New 1951 • • MODEL V-4A

# Heathkit VTVM KIT

HAS EVERY EXPENSIVE *Feature*

- ★ Higher AC input impedance, (greater than 1 megohm at 1000 cycles).
- ★ New AC voltmeter flat within 1 db 20 cycles to 2 megacycles (600 ohm source).
- ★ New accessory probe (extra) extends DC range to 30,000 Volts.
- ★ New high quality Simpson 200 microampere meter.
- ★ New ½% voltage divider resistors (finest available).
- ★ 24 Complete ranges.
- ★ Low voltage range 3 Volts full scale (½ of scale per volt).
- ★ Crystal probe (extra) extends RF range to 250 megacycles.
- ★ Modern push-pull electronic voltmeter on both AC and DC.
- ★ Completely transformer operated isolated from line for safety.
- ★ Largest scale available on streamline 4½ inch meter.
- ★ Burn-out proof meter circuit.
- ★ Isolated probe for dynamic testing no circuit loading.
- ★ New simplified switches for easy assembly.

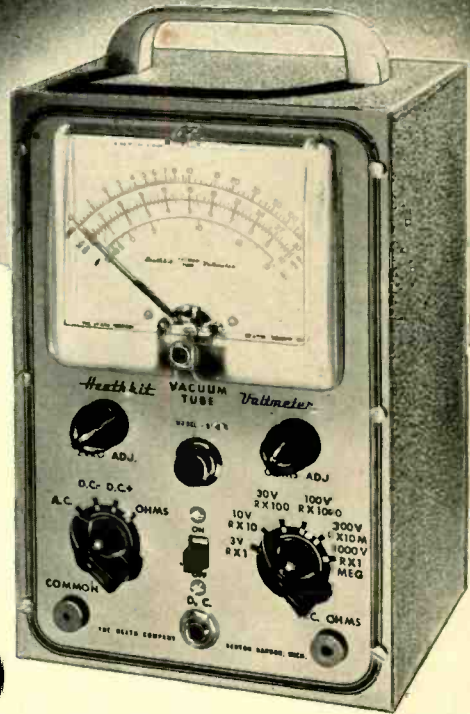

*New*  
**LOW PRICE \$23.50**

The new Heathkit Model V-4A VTVM Kit measures to 30,000 Volts DC and 250 megacycles with accessory probes — think of it, all in one electronic instrument more useful than ever before. The AC voltmeter is so flat and extended in its response it eliminates the need for separate expensive AC VTVM's. + or - db from 20 cycles to 2 megacycles. Meter has decibel ranges for direct reading. New zero center on meter scale for quick FM alignment.

There are six complete ranges for each function. Four functions give total of 24 ranges. The 3 Volt range allows 33⅓% of the scale for reading one volt as against only 20% of the scale on 5 Volt types.

The ranges decade for quick reading.

New ½% ceramic precision are the most accurate commercial resistors available — you find the same make and quality in the finest laboratory equipment selling for thousands of dollars. The entire voltage divider decade uses these ½% resistors.

New 200 microampere 4½" streamline meter with Simpson quality movement. Five times as sensitive as commonly used 1 MA meters.

Shatterproof plastic meter face for maximum protection.

Both AC and DC voltmeter use push-pull electronic voltmeter circuit with *burn-out* proof meter circuit.

Electronic ohmmeter circuit measures resistance over the amazing range of 1/10 ohm to one billion ohms all with internal 3 Volt battery. Ohmmeter batteries mount on the chassis in snap-in mounting for easy replacement.

Voltage ranges are full scale 3 Volts, 10 Volts, 30 Volts, 100 Volts, 300 Volts, 1000 Volts. Complete decading coverage without gaps.

The DC probe is isolated for dynamic measurements. Negligible circuit loading. Gets the accurate reading without disturbing the operation of the instrument under test. Kit comes complete, cabinet, transformer, Simpson meter, test leads, complete assembly and instruction manual. Compare it with all others and you will buy a Heathkit. Model V-4A. Shipping Wt., 8 lbs. Note new low price, \$23.50.



## New 30,000 VOLT DC PROBE KIT

Beautiful new red and black plastic high voltage probe. Increases input resistance to 1100 megohms, reads 30,000 Volts on 300 Volt range. High input impedance for minimum loading of weak television voltages. Has large plastic insulator rings between handle and point for maximum safety. Comes complete with PL55 type plug.

No. 3366 High Voltage  
Probe Kit.  
Shipping Wt.,  
2 pounds.

**\$550**

## Heathkit RF PROBE KIT

Crystal diode probe kit extends range to 250 megacycles = 10% comes complete with all parts, crystal, cable and PL55 type plug.

No. 309 RF Probe Kit.  
Shipping Wt., 1 lb.

**\$550**



EXPORT AGENT  
ROCKE INTERNATIONAL CORP.  
13 E. 40th ST.  
NEW YORK CITY (16)  
CABLE: ARAB-10-L

**The HEATH COMPANY**

**... BENTON HARBOR 25, MICHIGAN**



plate. This maintained constant groove depth and confined the heating pretty much to the tip end of the needle.

I am enclosing photostatic copies of my laboratory note book records for April 28 and 29, 1921 (Figs. 1 and 2) which explain

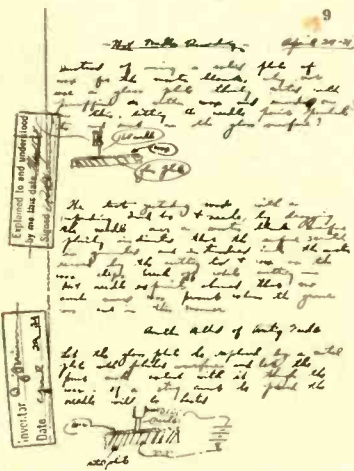

Figure 2

and sketch this hot-needle recording technique. Included also is an invention note on a resurfacing technique for master wax blanks which gives a perfectly flat, highly polished surface with no shaving cutter marks and with no loss of wax.

This resurfacing method, combined with the hot-needle recording method, causes no loss of wax in either operation, so that a wax master could be used as long as desired.

Benjamin F. Miessner,  
Van Beuren Road, RFD 2,  
Morristown, N. J.

**Picture tube-Speaker Separation**

Sir:

In the New Products section of the August issue, you mention a TV loudspeaker permitting reduction of distance from picture tube, stating: "Reduction in required distance between the picture tube and the loudspeaker in TV receivers is made possible in a new line of models by means of a magnetically enclosed motor structure."

What is supposed to be the "required distance" between the picture tube and the speaker? I am about to assemble various components for a high-fidelity TV receiver, to be housed in the same cabinet with the speaker, and I am very eager to avoid any pitfalls. Kindly advise me what is the minimal distance.

M. E. Chernowitz,  
91 Payson Ave.,  
New York 34, N. Y.

(Good question. Many speakers have considerable external field. Minimal distance is that at which the stray field of the speaker no longer causes any deflection of the picture on the screen of the tube. This can readily be determined by experiment with the TV set operating. Bring the speaker closer gradually, and notice the point at which deformation of the picture occurs.)



**THE FIRST CHOICE OF RADIO ENGINEERS**

More radio engineers use Magnecorders than all other professional tape recorders combined. Here's why:

**HIGH FIDELITY, LOW COST**

Stations are enthusiastic about the life-like tone quality and low distortion of Magnecorder recordings. Magnecorder frequency response: 50 — 15kc ± 2 db. Signal-noise ratio: 50 db. Harmonic distortion less than 2%. Meets N.A.B. standards. No other recorder offers such fidelity at such a moderate price.

**GREATEST FLEXIBILITY**

Mount a Magnecorder in a rack or console cabinet for delayed studio and network shows. Slip it into its really portable cases for remotes. Add to your Magnecorder equipment as you need it—combine Magnecorders to suit every purpose.

**MORE FEATURES**

Your Magnecorder, new or old, can now have 3 heads (separate erase, record, and playback) to permit monitoring from tape. Three speeds (15" — 7½" — 3¾" — up to an hour on a 7" reel) available on both PT6 and PT63 equipment. Dual track heads also available if desired.

**Write for NEW CATALOG**

MAGNECORDER, INC., Dept. A-11  
360 North Michigan Avenue, Chicago 1, Ill.  
Send me latest catalog of Magnecorder Equipment.

Name.....  
Company.....  
Address.....  
City..... Zone..... State.....

**MAGNECORDER**

For every purpose . . .  
every purse!



PT6 SERIES  
Most widely used professional tape recorder in the world.



PT63 SERIES  
Three heads to erase, record, and monitor from the tape.



PT7 SERIES  
A complete console for only \$950.00. Outstanding features and flexibility. Models for portable or rack mount also available.

# EDITOR'S REPORT

## THE FLEWELLING AUDIO SYSTEM

**B**ALLYHOOD as the greatest advancement in the field of audio in many years, the Flewelling Audio System is described by its inventor in the article starting on page 15 of this issue. Any well informed audio engineer or hobbyist will find it of some interest, and *Æ* is pleased to be able to bring this subject to the attention of its readers for its newsworthiness.

To a large extent, *Æ* has espoused the idea of arranging the main amplifier so that a "flat" signal applied at its input would be reproduced as an acoustic signal from the loudspeaker with "flat" characteristics. Thus the combination of power amplifier and speaker complement each other and the result—to the ear—is a signal which is a reasonably exact facsimile of the original. This is apparently a fundamental idea of the Flewelling system.

While the description of the new system is presented in these pages, *Æ* does not guarantee the claims of the inventor, nor does it, in fact, agree with many of them. *Æ* does not believe that there is any compromise with quality—whether it be in pickups, amplifiers, speakers, or other components.

The amplifier—which is claimed to be superior to others in many respects—is one of the two major elements of the system which differ from conventional practice. A check of the characteristics of the amplifier will indicate a probable maximum feedback of approximately 10 db. Most authorities do not consider this sufficient for 6L6's. In addition, it will be noted that the high-pass filter in the feedback loop decreases the feedback at the lower frequencies, and the capacitor across the cathode resistor of the 6SQ7 decreases the feedback at the high frequencies. The response resulting from this arrangement is apparent to anyone who has done much work with feedback, and may roughly be expected to have a dip of the order of 8 db at around 800 cps. In other words, both the lows and the highs will be boosted about 8 db over the middle register. Since this boost is the result of a decrease of feedback at these frequencies, the circuit is questioned because it is usually considered that the feedback is more necessary at the extremes of the spectrum than at mid-frequencies. Thus it is felt that the performance of the amplifier can not possibly compare with the standards maintained by reputable amplifier manufacturers in presently available units.

As to the speaker system, a simple analysis of the combination of units will permit a comparison between the suggested arrangement and a more conventional type of speaker system. The large cabinet can be described essentially as a reflexed enclosure having a volume of four cubic feet. The mounting of the cone—on the outside of the back of the cabinet—is acoustically identical with a similar mounting on the inside, except for a slight reduction of enclosure volume in the latter case. The

radiation from the port is directed to the listener, so that the sound level due to direct radiation from the cone is relatively lower than the radiation of low frequencies from the port. This amounts to a type of equalization where one band of frequencies is suppressed in order to boost another band. Naturally the low frequencies will be more pronounced. The use of ordinary cone speakers for the middle- and high-frequency range is questionable, and can only be offered as a substitute for components of higher quality.

While it is agreed that the listener is not particular whether the crossover frequency for a two-way speaker system falls at 400 cps or at 427 cps, *Æ* still does not recommend the use of electrolytic capacitors in this network because the capacitance will probably not remain constant with time, and it is believed that once a system is set up all components must retain their values indefinitely.

Aside from these points, it is possible that the suggested system may have some advantages in providing a quality of reproduction which is a definite improvement over that usually encountered in home radio receivers, and may thus warrant the application of these methods to improve the quality of such equipment with a small increase in cost. The inventor of this system indicates that sufficient bass is available at all times, regardless of the volume of sound output. He makes no provision for adapting the frequency response of the amplifier to compensate for the Fletcher-Munson characteristics of the ear, but maintains that the response is ideal at all listening levels.

In presenting this article, *Æ* is not recommending the system to its readers, but is only performing a reportorial function to keep them informed of developments in the field—good, bad, or indifferent.

## TO FIRST-TIME READERS

Because of the distribution of *Æ* at the Audio Fair, many readers of this issue will be seeing their first copy of this magazine. We trust that they will find a few interesting articles which may possibly answer questions invariably arising in the pursuance of any hobby. Over the past three and a half years, readers have come to look upon *Æ* as reasonably reliable, and as covering the audio field thoroughly—both for the professional and for the hobbyist. Good audio is not a matter of differentiation between the professional and the music lover who strives to get the best possible sounds from his loudspeaker. The same principles of design apply to groups, and it is the aim of *Æ* to serve both equally.

If you are a new reader this month, and if you find something that especially interests you, *Æ* would be pleased to know of it. Similarly, if you find nothing of interest let us know. By your comments and suggestions we may serve everyone better as time goes on.

We are pleased to welcome you as a new reader.



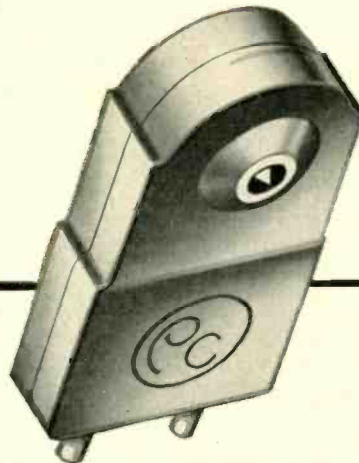

## PICKERING PICKUP CARTRIDGES FOR THE FINEST AUDIO QUALITY

No other Pickup will reproduce LP records with the fidelity of Pickering Cartridges . . . they are the most widely used by record manufacturers, recording studios, broadcasters and music enthusiasts who demand the effect of a live performance from their records.

The nearest approach to a live performance is a recording played by a system equipped with Pickering High Fidelity Audio Components . . . Speaker, Cartridge, Arm, Preamplifier, Record Compensator, etc.

Pickering Cartridges Series 120 and 150 are for standard records . . . Series 140 are for micro-groove records . . . They track with phenomenally low record wear and virtually eliminate harmonic and intermodulation distortion as well as frequency discrimination . . . all Pickering Cartridges available with either sapphire or diamond stylus.



### LOUDSPEAKER MODEL 180L

Designed to satisfy the musical ear. A low-cost high quality loudspeaker with smooth wide-range response (within 5 db, 45 to 12000 cycles) and low distortion . . . the only loudspeaker with acoustically adjustable bass response . . . occupies less floor space than any other high quality loudspeaker — less than one square foot.



### PREAMPLIFIER MODEL 130H

This preamplifier represents the most advanced design ever achieved in phonograph preamplifiers . . . it equalizes the bass response of records and transcriptions and provides the necessary gain for high quality magnetic pickups . . . its intermodulation and harmonic distortion is exceptionally low — better than most professional equipment.



### RECORD COMPENSATOR MODEL 132E

This compensator, with 6 positions of equalization, provides the flexibility required to properly equalize for the different recording characteristics used by various record manufacturers . . . it is a most important addition to record playing systems using magnetic pickups.

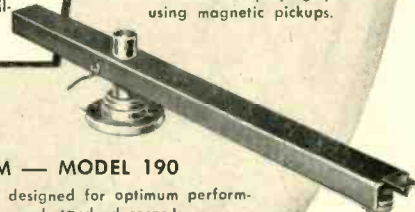

### PICKUP ARM — MODEL 190

The only arm specifically designed for optimum performance on both microgroove and standard records.

- Statically balanced to eliminate tendency to skip when jarred.
- Minimum vertical mass to track any record without imposing extra vertical load on grooves.
- Sensitive tracking force adjustment.
- Magnetic arm rest.
- Rugged frictionless bearings.
- Plug-in cartridge holder.
- One-hole mounting — self-contained levelling screws.

Cartridges used with this arm require 50% less vertical tracking force than when used in conventional arms.



**For the finest audio quality specify Pickering Components**

**Oceanside, N. Y.**

Pickering High Fidelity Components are available through leading jobbers and distributors everywhere . . . detailed literature will be sent upon request.



## How a whiff of stibine led toward lower telephone costs

*At the New York Telephone Company's Triangle exchange in Brooklyn, emergency batteries stand ready to deliver 3000 amperes for several hours.*

In the Bell System there are a million lead storage battery cells connected to telephone circuits in the central offices. Current seldom flows in or out of these cells beyond the trickle which keeps them charged. In the rare event of power failure, however, they stand ready to supply the current for your telephone service.

Even in this stand-by service, cells require water to make up for electrolysis. And they consume power and eventually wear out. But Bell Laboratories chemists discovered how to make a battery which lasts many more years and requires less attention — by changing a single ingredient, the clue to

which came unexpectedly from another line of their research.

The clue was a minute trace of stibine gas in battery rooms which electrochemists detected while on the lookout for atmospheric causes of relay contact corrosion. In small traces the gas wasn't harmful but to battery chemists it offered a powerful hint.

For stibine is a compound of antimony—and antimony is used to harden the lead grids which serve as mechanical supports for a battery's active materials. Tracing the stibine, the chemists discovered that antimony is leached out of the positive grid and enters into chemical reactions which

hasten self-discharge and shorten battery life.

Meanwhile, in the field of cable sheath research Bell metallurgists had discovered that calcium could be used instead of antimony to harden lead. And theory showed that calcium would not react destructively in a battery. The result is the new long-life calcium-lead battery which cuts battery replacement costs, goes for months without additional water, and needs but  $\frac{1}{5}$  the trickle current to keep its charge.

It demonstrates again how diverse lines of research come together at Bell Telephone Laboratories to keep down the cost of telephone service.

## BELL TELEPHONE LABORATORIES

*Working continually to keep your telephone service big in value and low in cost.*





# The Flewelling Audio System \*

EDMUND T. FLEWELLING \*\*

This is the system about which so many rumors have been current during the past few months—an authentic description by the inventor.

This description of the author's unconventional system is presented to AE readers because of the wide interest already engendered. Since the material is somewhat controversial, it is carried on the following pages exactly as written by its author. AE's opinion is carried on page twelve in the Editor's Report.

I CANNOT BEGIN TO COVER my entire subject in one article, but I am going to describe in that space, as completely as I can, a system of sound reproduction that comes closer to being a musical instrument than anything you have yet heard. Some of the best engineers in the country have said so, and, if you build one, you can prove to your own satisfaction that it is capable of real performance by the following simple test:

Connect a good signal generator that will produce a clean sine wave at 25 to 50 cps into the input circuit of the amplifier. Then with a good mike, a clean amplifier, and a 'scope, you should be able to pick up *out of the air* a clean 25 to 50 cps sine wave such as you put into the outfit. How low, in frequency response, you can go will depend upon factors that we are not yet sure of. We have seen outfits that would go down to 20-25 cps without any trouble at all.

\* Copyright, 1950, by E. T. Flewelling  
\*\* Ashburnham, Massachusetts

Chassis of amplifier used in the Flewelling System.



This system will give the experimenter plenty of opportunity. Later on I shall cover this in more detail.

The above statement points out, vaguely perhaps, that you are not at all interested now in the linearity or the intermodulation of the amplifier, or whether you use triodes, pentodes, magnetic, or by-roads. We've had all we need of this bunk for 20 years. It's very necessary in its place and time, but 20 years is a long time. We are fed up on it for "one". What we want is a musical instrument that will sing to us and not blast our ears off while we kid ourselves with "that bass is good". Remember, remember—the bass range is the very foundation upon which music is built.

Let's stop talking about high fidelity

because it has not yet been achieved. Let's stop raving about magnetic, reluctance, or crystal pick-ups. Let's not be foolish about FM reception. The point is to be stressed and stressed again is that if your reproducing system—note that I said system not amplifier—is good, bad, or indifferent, what comes out in the air will be good, bad, or indifferent, exactly as your system is able to handle what is put into it. It's what comes out of the hat that counts, not that he says he'll produce a rabbit. Imagine the beautiful FM reception that you would get, with the finest reproducing system in the world, if you tuned in an FM station whose program was a transcription, received over a few miles

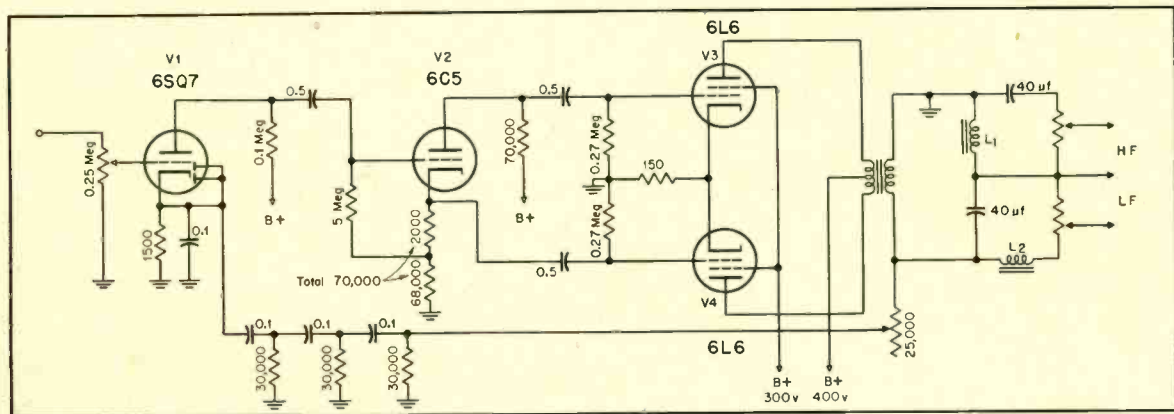
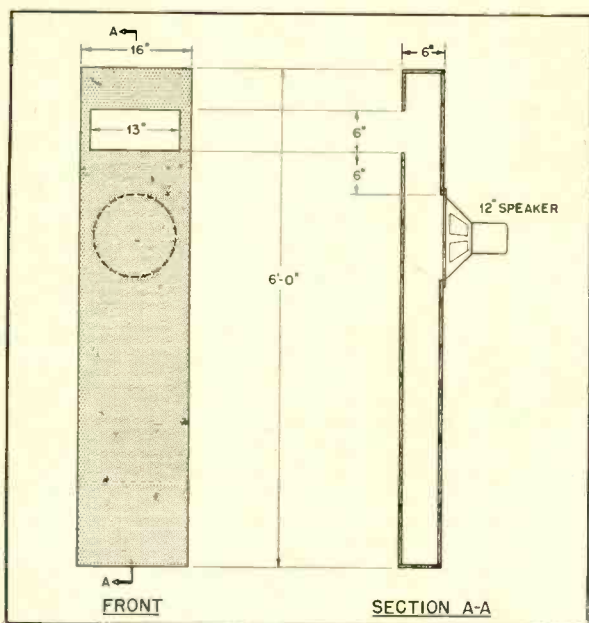

Fig. 1. Schematic of two-stage amplifier which is the electrical section of the Flewelling system. Note the use of large coupling capacitors, and the unique feedback circuit. Other than this, the circuit is reasonably conventional.



**Fig. 2. Elevation and section of the low-frequency reproducer unit, which differs appreciably from standard types of reflexed cabinets, infinite baffles, or exponential horns.**

of 5000-cps line, and then put through—well, what's the use? You get the point, there's no use in getting childish about it.

The outfit to be described has been designed for residence music only. It is not a dance hall instrument. The circuit diagram shown in Fig. 1 is a standard two-stage amplifier, with the addition of a trick feedback circuit. We will leave it to the "X square Y square" boys to prove that this is wrong. We haven't the time and besides we've been told that we were wrong so many times, that we are fed up on this; "two".

#### Circuit Description

We have two stages because as you know (or do you?) the phase inverter produces no gain. This phase inverter is a cathode follower, and really does a job. Be *sure* to put your scope on both outputs, the plate and the cathode, and check for distortion. When the stage is right, both outputs will be clean and equal. You should have no trouble here, for it is not at all hard to set up. 6SN7 or double-triode phase inverters are absolutely out. To use such a phase inverter generally means three stages of amplification and distortion. Feedback over three stages is something one had best stay far away from. We want only two stages and we want feedback that we can control. The more amplification we have, the more chances we have for distortion, and the less chance we have for decent control of our feedback.

The feedback control shown in the diagram is a variable only because no two amplifiers or speaker systems are exactly alike. You'll come close enough, unless you are fussy, if you use a fixed

15,000-ohm resistor. Now remember, many times an audio amplifier can oscillate without making an audible sound. Of course, oscillation will mean distortion that you might not be aware of. If you doubt this statement, hook up the outfit strictly according to direction. Then watch the output with a 'scope while you listen to the speakers and do things to the volume control. Maybe you'll be surprised.

I am tempted many times, as I write this article, to branch out with a dissertation on sound reproduction. I feel that I could easily write a book on the subject. May I, while I am off the track a bit, say that years ago when I was writing about my super-regenerative circuit, I formed a habit that, as far as I know, I seldom break. I formed the habit of being able to prove practically any statement that I make. Not being a saint, I'm not claiming perfection.

To go on—that 0.1- $\mu$ f capacitor across the cathode of the 6SQ7 had better not be changed, and of course you know that the feedback take-off will have to be taken from the right side of the voice coil. I can't show the right side in a diagram.

The output transformer must be the best obtainable. The taps used on the secondary should give you a correct impedance match through your dividing network and speakers.

#### Dividing Network

In the dividing network, the choke coils are wound on the core of old transformers such as are used as output transformers for 50L6's in table models. It is preferable to use slightly larger cores, but we are not trying to show how accurate we can be because we have had

so much experience over the years with this system that we know where accuracy is or is not needed. You may wind these coils in one, two, or three layers, putting on 100 turns of wire and using a piece of wrapping paper for an air gap. If you want to know if they are working, start up the system leaving the laminations a bit loose. You'll see.

Before we leave the network, we must not forget to speak about the capacitors. If you make the mistake about these condensers that several \$10,000-\$15,000 a year engineers have made and have had to retract, you'll just be out of pocket, gained nothing, and kidded yourself. The statement that these capacitors cannot be used, is something else that I am fed up on: "three". The capacitors, without any further beating around the bush, are common ordinary 20-20  $\mu$ f 150-volt electrolytics such as are used in table model a.c. d.c. jobs, although any of the small electrolytic capacitors may be used if their rated capacitance is in the 20- $\mu$ f class, and the voltage rating is not exceeded by the peak output voltage of your outfit. Your dividing point will be around 400 cps. Do you care if it is 350 or 450 cps? Certainly not, unless you have a specific reason. Put a d.c. meter with a rectifier across this network, run an oscillator over the range, and you'll see that you have hit it in about that frequency.

#### The Speaker System

It seems that 10,000 years ago (more or less) Confucius kept goats, and, of course, daily had occasion to call them home. As the goats wandered farther away, old Con soon found that he could be heard at a greater distance if he made a sort of horn out of his cupped hands, or by rolling up a copy of AUDIO ENGINEERING. Con was a pretty wise old duck, you remember, and he at once saw that the thing was getting over his head, so he called in all the audio experts in his realm and told them to get busy, be-

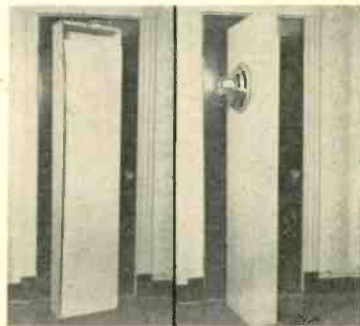

**External appearance of low-frequency speaker cabinet used with this system.**





Left, the author at the controls of an early version of his home reproducing system. Right, later model of the system, with three changers for 78, 45, and 33 1/3 r.p.m. records.

cause it looked to him as if he had stumbled onto something pretty big.

Well, the engineers went to work on it, and they tried out everything they could think of. They even tried out the goat pen in the corner of Con's living room, and after yahs and yahs, they came up with what we now call the exponential horn. It wasn't just what Con wanted because he found that while he could attract the attention of his goats at great distances, they often just looked up and went back to cropping his neighbors corn. Thus he discovered that while the goats heard him, they did not recognize his voice. Today horn distortion is still with us, children.

Let us refer to pages 104-107 of *Motion Picture Sound Engineering*.<sup>1</sup> Here we have the horn that the motion picture boys came up with in an effort to give us the best. It is one of the reasons why so many raving maniacs are created by listening to musical movies. Confucius found it out 10,000 years ago. I wouldn't dare say that I can improve upon it. You use your own judgment, but in the meantime, note that the response curve of the thing gives up at 50 cps, evidently in disgust. The unit has a mouth area of 50 square feet, an axial length of 40 inches. The mouth is also mounted on a flat baffle 10 feet by 12 feet. You'd look well trying to get down to 50-cps with anything less than this movie horn, for those boys knew what they were doing. In horns it's the horn. Your wife would also, no doubt, be pleased with such a horn in the living room.

In laying out my system of reproduction I tried to reason the thing out and finally came up with this answer. No matter what the job was, whether a \$300

combination record player or a so-called high-fidelity outfit, there was, generally speaking, no substantial difference in the quality of the output. All reproducing jobs ran smack up against what might be called "the state of the art." There has been no basic improvement for years. What one man knew was certainly available to the other. What difference there was, it seemed to me, depended almost entirely upon the output transformer or upon the space that was available for the outfit. In other words, what size horn or baffle could be used. This led me to wondering if we were connecting our speakers to the air in an acoustically correct manner.

The answer is a bit involved, but it seems evident that our greatest weakness is in the speaker end of our outfits. To go into the matter in more detail, we must point out that a loudspeaker, of the type in ordinary use, is not only a motor, but it is a generator. I think the "brains" will agree with me that its performance as a generator might very well exceed its performance as a motor. This is because as a motor, it cannot be properly loaded at low frequencies (acoustically coupled to the air) and hence under a varying drive it is bound to "fly wheel" and go off on excursions of its own. There are bound to be small high-frequency voltages generated, which, if we desire, we can feed back, and to some extent affect with our feedback circuit.

An infinite baffle has a limited use, and a horn cannot properly load a loudspeaker. The more we try to load our speakers, the larger our speaker and horn become, and we run up against the law of diminishing returns. We cannot do it with \$300 or \$400 precision speakers or with horns, but if it is done correctly—that is, if we could succeed

in coupling our low-frequency speakers to the air in an acoustically correct manner—we should be able to use the 10- or 12-inch speakers of the common garden variety which cost around \$8 or \$10. We might even be able to do it with 6-inch speakers, although I've not seen it done. Furthermore we would succeed in producing lower frequencies, in generating less fly-wheel excursions, in clarifying the very apparent distortion that is evident in the high-frequency end of all systems, due to the generation of these fly-wheel parasites, and should, to top it off, increase the speaker efficiency many fold.

A horn seems to offer much better performance than just the air in front of a speaker. A horn is a form of air column, so the question naturally comes up—what is the best form of air column, and how should it be used? Is the exponential horn, after all, the best manner in which we can use an air column? I finally came up with a type of air column that seems to help considerably. Instead of playing a speaker *through* an air column, as in a horn, the idea is to build a non-resonant air column and play the speaker *across* the air column. See Fig. 2. It is made of plain pine boards 3/4 inch thick, and must be assembled with screws.

Space does not allow me to do more than give the inside dimensions of an air column that we have used successfully. There is much promise in this approach to air columns. We know very little about it except that over five-hundred lay persons, musicians, and top flight engineers have said that they have never heard such reproduction as that given by this system. We know too, that it created enough interest in the indus-

[Continued on page 46]

<sup>1</sup> D. Van Nostrand Co., Inc. New York.

## Performance and Operation of a

# New Limiting Amplifier

G. A. SINGER\*

A description of a recently developed broadcast-type limiting amplifier and its characteristics under various input-signal conditions.

**S**INCE EVERY SYSTEM for the transmission, recording or reproduction of sound is capable of delivering only a limited amount of power, there will be a level at which the system or a unit of the system becomes overloaded or overmodulated. Under these conditions, the output level is no longer a linear function of the input level and non-linear distortion takes place. To the ear, this is one of the most annoying forms of distortion and for this reason alone, overloading or overmodulation must be prevented if good reproduction is to be maintained.

Economic reasons and the desire for a high signal-to-noise ratio dictate that the system be operated as near maximum output or full modulation as possible. Speech and music, however, vary widely and often suddenly in level. Therefore, manual means of adjusting output cannot be relied upon entirely to prevent overloading or overmodulation at sudden peaks in the program. An automatic means of limiting output to a safe maximum value is therefore essential for the successful operation of every broadcasting station and recording studio.

In order to obtain distortionless limiting, a limiting amplifier is inserted at an appropriate point of the system. Its primary function is to reduce the system gain by nearly the same amount as the signal level is increased above a pre-

determined value while at the same time preserving the waveform.

A limiting amplifier must not only meet all of the specifications required of other audio amplifiers—such as frequency response, gain, power output, distortion, noise, and stability—but many special specifications which are peculiar to its operation as a limiting amplifier.

Foremost of these is the compression characteristic. Up to a certain level, called the verge of limiting, the gain is constant and the output is therefore proportional to the input. Above the verge of limiting, the amplifier gain is progressively reduced. The difference between what the output would be at constant gain and what it is with reduced gain (due to limiting) is the gain reduction. The ratio of the increase in input level in db to the increase in output in db is the compression ratio.

Another important rating is the time required for a change in gain to take effect. The attack time (which is the time required for the gain to be reduced) should be as short as possible in order that compression be effective on a sudden peak. Listening tests, however, indicate no appreciable change in sound quality by making the attack time even shorter than 1 millisecond. The recovery time, which is the time required for the gain to return to normal after the signal level has dropped below the verge of limiting, must be fairly long in order to avoid distortion at low frequencies and

to prevent rapid change in gain from becoming noticeable. The optimum recovery time depends on the type of program material.

Usually the operating point of a tube is shifted to change the gain of a limiting amplifier. The resulting change in plate current, unless balanced out, will cause a "thump" (a low-frequency transient) to appear in the output of the amplifier. The ratio of signal to thump should be maintained as high as possible over a wide range of gain reduction.

### Amplifier Design and Operation

The operating principles of a modern limiting amplifier may be studied in greater detail by examining the BA-6A Limiting Amplifier which is newly designed for use in broadcast stations and recording studios. The BA-6A, shown externally in Figs. 1 and 2, is a balanced, three-stage amplifier which uses commonly available tube types as shown by the simplified schematic diagram of Fig. 3.

The input transformer matches both 600-ohm or 150-ohm lines. A dual attenuator controls the input signal which is applied to the control grids of the two 6SK7 remote cutoff pentodes of the variable-gain stage. To minimize thump over a wide range of gain reduction, both the screen and cathode voltages of these tubes are adjustable. Thus any pair of tubes may be balanced over the entire operating range.

The balancing operation is simple. By setting a selector switch to the BALANCE A position, an in-phase signal is applied to the control grids of the 6SK7 tubes. The output voltage is indicated by a meter. The BALANCE A control, which adjusts the cathode voltage of the two tubes, is then adjusted for minimum output indication. By setting the selector switch to the BALANCE B position, a larger signal is applied to the control grids and the cathode bias is increased. The BALANCE B control, which sets the screen grid voltage of one of the 6SK7 tubes, is then adjusted for minimum output signal. This process is repeated until no output is indicated in both the BALANCE A and BALANCE B positions. The characteristics of the tubes are then very

\* Audio Engineering Section, Radio Corporation of America, Camden, N. J.

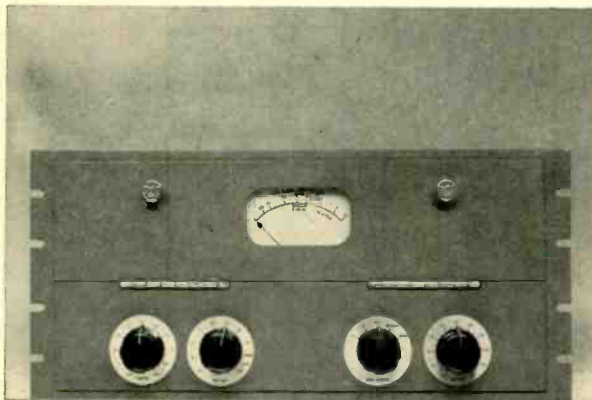

Fig. 1. Front panel view of the new BA-6A Limiting Amplifier.



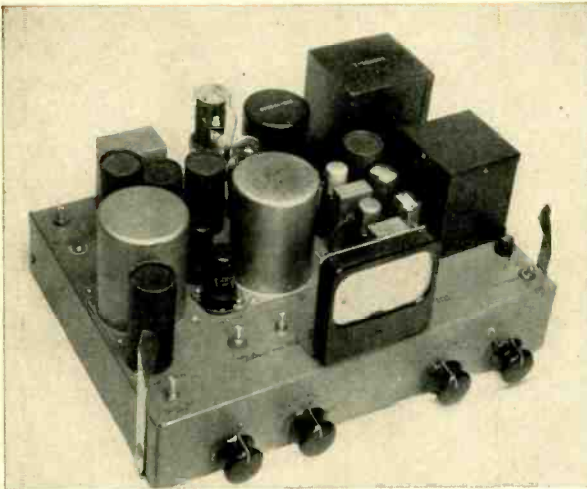

Fig. 2. Chassis view of the amplifier. Note plug-in design for shelf mounting, allowing quick and easy removal.

closely matched over a wide range of gain reduction resulting in a high signal-to-thump ratio. This arrangement also permits periodic checks of tube balance and compensation for tube aging.

The screen supply voltage of the variable gain stage is held constant by means of a voltage regulator tube and negative feedback is applied over the other two

stages in order to obtain high stability of gain and output over wide variations in line voltage. To minimize hum, the heater current for the first stage is derived through a filter from a full-wave selenium rectifier.

As an additional means of maintaining balance, the first stage is transformer coupled to the second stage. The output stage is capable of delivering 10 watts

to a 600-ohm output attenuator which is calibrated in 1-db steps. A continuous fine output adjustment is also provided to set the output level exactly. This is as important a feature as stability of output because a fraction of a db change in output level may result in a large increase of distortion in certain types of equipment, as for example, a transmitter.

A full-wave rectifier, connected to the output stage through coupling capacitors and isolating resistors, provides the gain-control voltage. The cathodes of the rectifier tube are biased positive with respect to the plates and the tube will not conduct until the output signal exceeds the limiting level. The rectified voltage is filtered by capacitor *C*, and applied to the control grids of the tubes in the variable gain stage. The higher the output level tends to become, the more the gain is reduced. The compression ratio thus obtained is greater than 10 to 1.

The LIMIT-OFF position on the selector switch is provided to turn the limiting action off when no compression is desired. The single-limit and dual-limit positions of the selector switch deter-

[Continued on page 69]

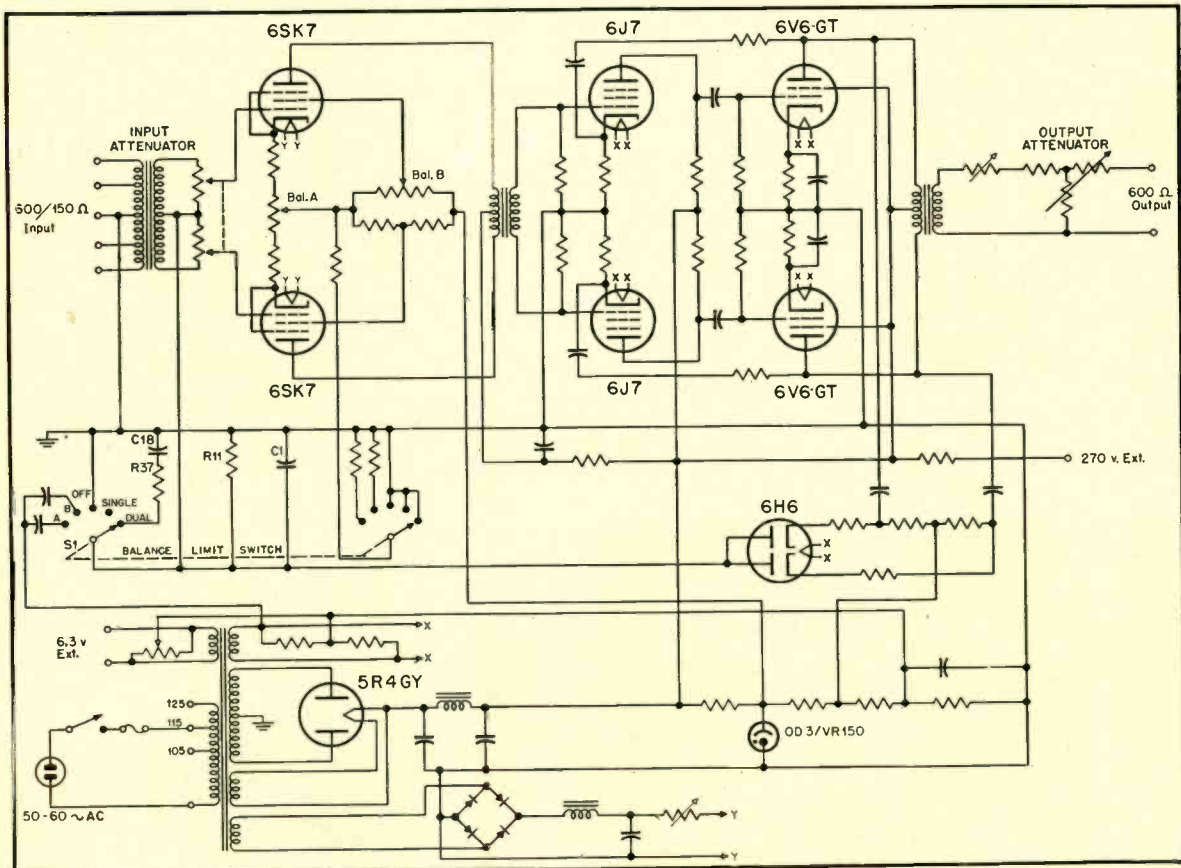

Fig. 3. Simplified schematic of the BA-6A Limiting Amplifier.

# Performance Plus Economy Tape Recorder



JAY BLAKESLEY\*

The description of a unique modification to existing equipment to provide a tape recorder of suitable quality for broadcast use and with a minimum of expenditure for new material.

Tape recorders differ from audio amplifiers in that it is necessary to consider the mechanical as well as the electronic aspects. A tape recorder may have excellent frequency response and low distortion, but unless the playback time is within three seconds of the recording time for a 30-minute program, it is unsatisfactory for the broadcast industry where time is all important.

Many stations have an extra turntable that has been outmoded because of filter design or appearance and yet possesses a speed regulation of around 0.4 per cent. With such good speed regulation in mind, the author set out to build a tape recorder utilizing the turntable as a constant speed capstan. Making use of existing equipment, the total

cost of the entire recorder was under fifteen dollars.

The turntable on hand was an RCA 70-A, and the amplifier parts were taken from a Brush BK-401 tape recorder. A square wooden box with a 1/8-inch steel top was constructed to fit flush with the top dimensions of the turntable cabinet. Holes were punched in the steel top to accommodate the supply and take-up motors, one erase head, one record-playback head, and one monitor head.

A large hole was punched in the center for the capstan which extends from the turntable shaft. The front panel of the box was made removable in order that the 78/33 speed-change switch

[Continued on page 47]

**M**ANY BROADCASTING STATIONS have purchased low priced tape recorders because of their limited budget. These recorders have been unsatisfactory for broadcasting use because of poor speed regulation, wow, or flutter.

\*214 W. 4th St., North Platte, Nebr.

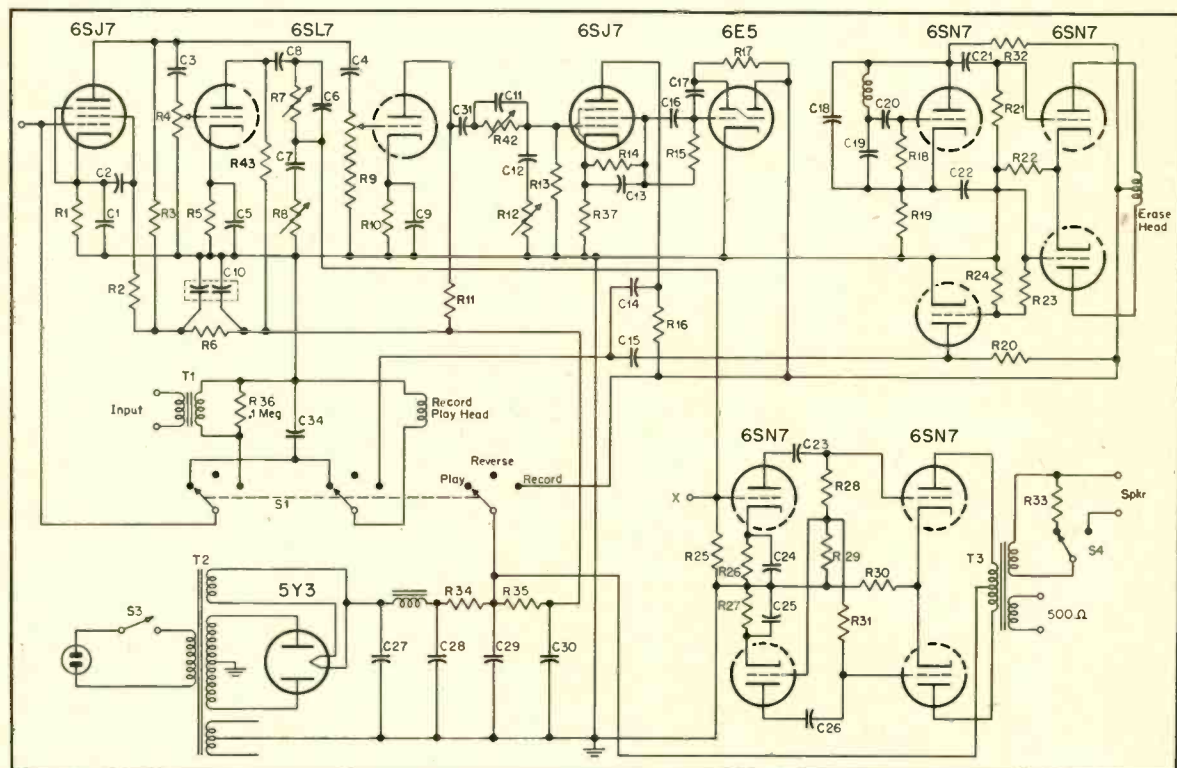

Fig. 1. Complete schematic of the modified Brush amplifier for use with the machine described.



# The Impact of Acoustics on Music

ROBERT H. TANNER\*

In which the author compares the live-end-dead-end technique of recording with early acoustical practices, and offers a promising design for studios.

THE SUBJECT OF ARCHITECTURAL ACOUSTICS is one which man has dealt with, consciously or unconsciously, for many centuries, first as an art and only in very recent years as a science, striving sometimes almost desperately to find reasons for, and attach meanings to, the vast collection of practical data which has been accumulating for centuries. Students of Acoustics work in a kind of no-man's-land between the physical realm of measurable quantities and ascertainable facts, and the aesthetic world of artistic opinions and prejudices (not to mention temperaments), under conditions which present a very sharp contrast with those experienced, for example, by researchers in the field of atomic physics. These latter work (often literally as well as figuratively) in the desert of a completely new subject, scattered with cases of knowledge which are being steadily enlarged. Acoustics workers, on the other hand, often feel that they are hacking their way continually through a thick jungle of preconceived ideas and empirical results, in an attempt to clear away an undergrowth of misconceptions. Under such circumstances, therefore, it may well be worth while trying to step

\* Audio Equipment Engineer, Northern Electric Company Limited, Belleville, Ont.

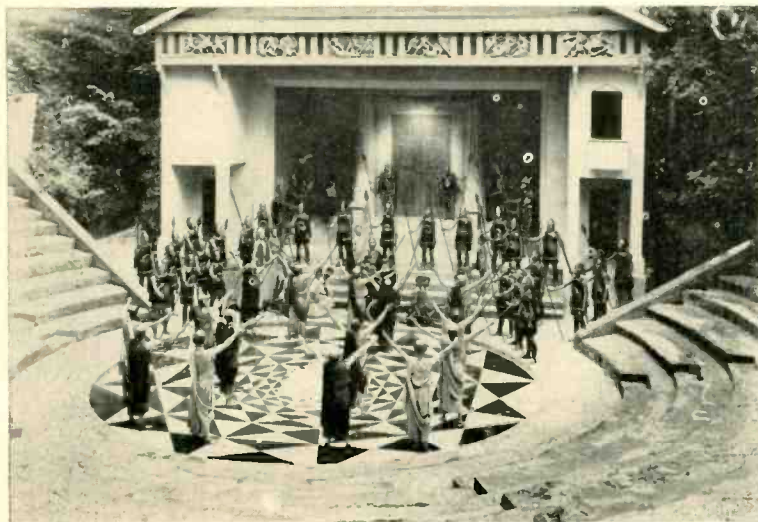
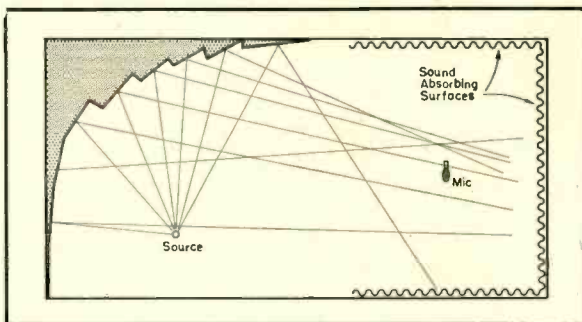

Fig. 1. Modern reconstruction of early Greek theatre type of "auditorium" for presentation of plays.

Fig. 3. Diagrammatic elevation of "bandshell" studio.



outside our subject in an effort to discover some of the real fundamentals of

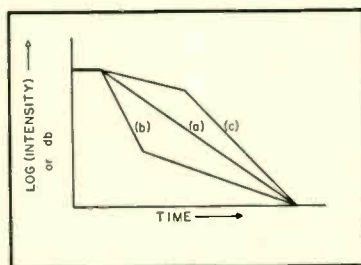

Fig. 2. Idealized sound decay curves for types of acoustical structures.

acoustics, to see the wood rather than the trees.

For the roots of Acoustics, we must go back in history at least to the time of Ancient Greece, where the plays of the great Greek authors formed the world's first public entertainment depending for their success on the audience *hearing* what was happening rather than merely seeing it, for until then public entertainments had been purely visual. These plays at first took place in natural amphitheatres, usually around an altar to the Greek God Dionysius (who like his Roman counterpart, Bacchus, was god of wine and other entertainment), but it was not long before two important changes were made. The soft grass around the altar was replaced by a circle of paving called the "orchestra," and a stone building or "skene" was erected on the side of this away from the audience. The "skene" had pillars in place of the wall facing the spectators, with broad stone steps leading up the raised floor. Figure 1 shows a modern reconstruction of such a theater at a boys' school in England, and may help to make the general arrangement clear. Now both of these changes, although they were not made solely for acoustical reasons, had a decided effect on the audibility of both the actors in the "skene" and the chorus on the "orchestra," for in both cases the hard reflecting surfaces gave much-needed reinforcement to the voices. At the same time, the absence of any large enclosure surrounding the audience avoided trouble from prolonged reverberation. It seems clear that the Greeks realized that the shape of their theaters helped the actors to make themselves understood and as new theaters were built they incorporated acoustical improvements.

[Continued on page 49]

# Fixed-Filter Type Distortion and Noise Meter

J. P. SMITH\*

A description of an instrument which brings the measurement of distortion, noise, and hum into the realm of accurate, dependable, and repeatable results.

**A** FILTER-TYPE Distortion Measuring Set offers several distinct advantages over the conventional Null-Bridge type. These advantages are: (a) Wide pass band, so no precise frequency or phase adjustments are required; (b) Wide level range, for inputs from +40 dbm to -50 dbm or less; (c) Quick frequency change and single dial control for determining distortion; (d) Direct reading of levels in db; (e) Accurate and reliable indication of distortion, noise, and hum.

Filter-type distortion measuring sets have been available in simplified forms for many years. Because of the price of the filters, the frequency selection has

\*Chief Engineer, The Daven Co., Newark, N. J.



Fig. 1. Panel appearance of Daven Type 35-A Noise and Distortion Measuring Set.

been restricted to a few predetermined frequencies. The set herein described has eight frequencies available: 50, 100, 400, 1000, 5000, 7500, 10,000, and 15,000 cps. The width of each band eliminated is approximately  $\pm 3$  per cent so that the oscillator does not need to be adjusted accurately.

In the development of this distortion measuring equipment, it was found that

no tube circuit—including cathode couplers or followers—could be depended upon to retain, over a long period of time, low enough inherent distortion to be used between the input and the filter network. Only resistive networks with their accompanying high losses could be depended upon to provide stable and dependable results. All amplification is done after the filter, with only the harmonics (and the portion of the fundamental 70 db down) being amplified.

## Filter Problems

Before discussion of the circuit of the distortion and noise set the problems surrounding the filter should be considered. The prime problem is to eliminate the fundamental and hum and leave all the harmonics of the signal; in addition to

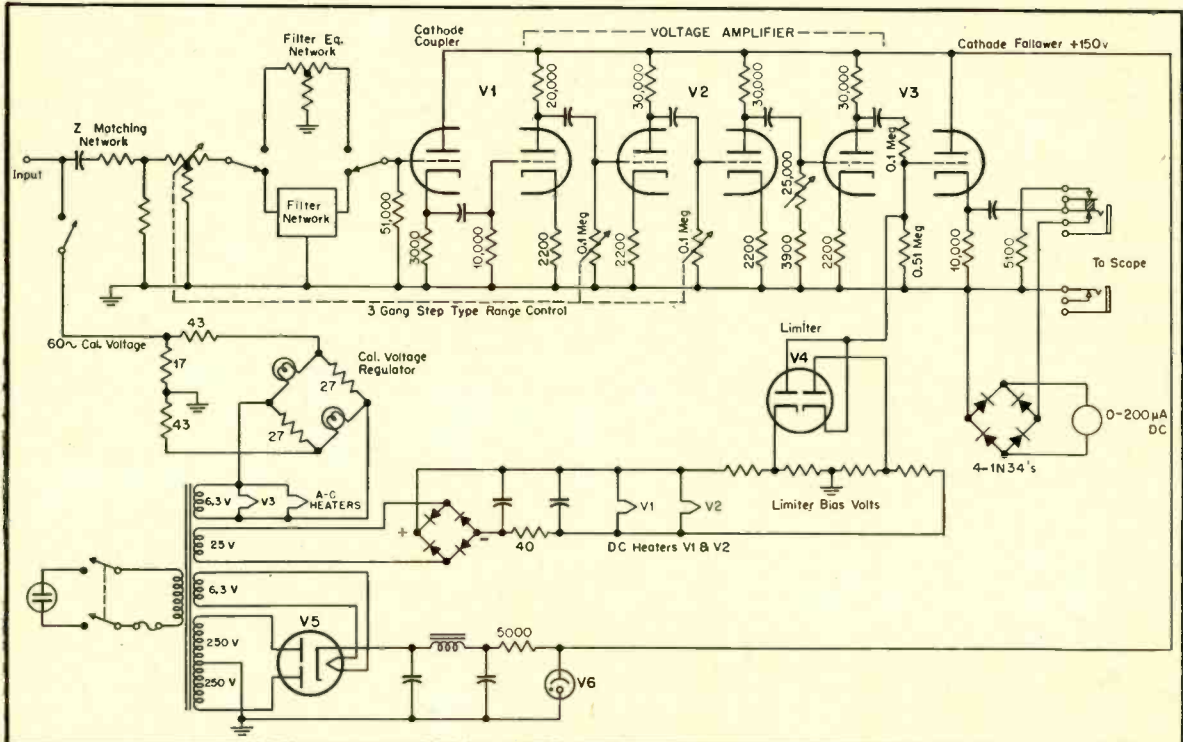

Fig. 2. Simplified schematic of instrument used in making harmonic distortion measurements, as well as those of hum and noise.



this, the load on the source being investigated should not be altered. That is, the distortion measuring device should not tend to short out or discriminate against the fundamental or exaggerate any of the harmonics due to impedance changes. In order to function properly, the filter should operate from a resistive generator and into a resistive load—both equal to the input and output impedance of the network. To accomplish the requirements of constant or no loading on the source being investigated and yet have the filter work from a resistive source equal to its own impedance even when bridging a low impedance, loss networks are inserted between the input and the filter networks. Any loss inserted in the input will restrict the lower-level range of the instrument since there are well known limitations in the amount of amplification that can be utilized. As pointed out later, the amplifier utilizes 12AY7 tubes with d.c. on the heaters. The filter networks employed are of the high-pass type with a cut-off of 70 db. For example, the frequencies below cut-off are also attenuated at least 40 db at 60, 120, and 180 cps for the 400-cps filter. This is also true for the remaining 1000, 5000, etc. The reason for this is to separate out the hum components from the distortion as indicated on the meter. The hum component can be read on the noise measuring position of the set or observed on a scope. In the study of distortion and noise it was found that this method of separating the distortion from the hum was extremely useful. The hum components can be separated from tube and circuit noises by using the 100 or 400 cps filter with no signal input. This restricts the noise band somewhat.

Figure 1 shows a front view of the equipment. A three-gang push-button switch is provided for selecting either a 0.1 meg input or a 10,000-ohm input or a calibrating voltage for adjusting the gain of the amplifier. A nine-gang push-button switch is provided for selecting any of the eight frequencies or for measuring noise. Two gain controls are provided—one in steps of 10 db calibrated from +40 to -60, the other continuously variable over a range of  $\pm 10$  db. The indicating meter—a self illuminated type—is calibrated from 0 to -15 db.

Figure 2 is a simplified schematic of the distortion and noise measuring set. In order to cover the level range from +4 to -50 dbm, it was necessary to use a ganged control—50,000-ohm "T" network ahead of the filter—and potentiometers in the grid of the second and third audio stages. The third deck of the potentiometer attenuates at input levels -60, -50, and -40; the second deck attenuates at -30, -20, and -10, and the first deck "T" attenuates at 0, +10, +20,

Fig. 3. Attenuation characteristics of 400-cps high-pass filter used to eliminate fundamental and hum voltages.

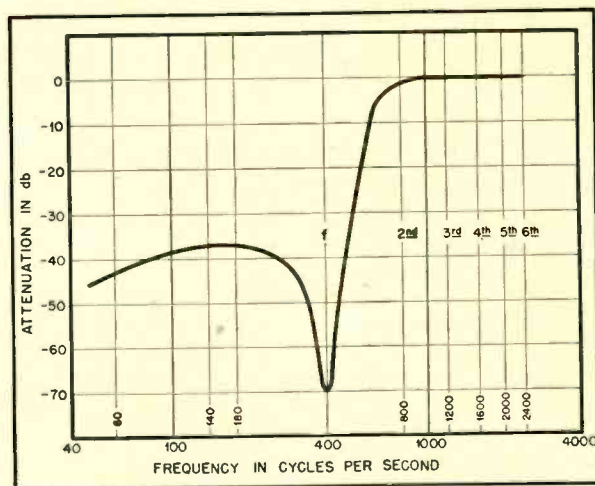

+30 and +40 dbm. Thus the level into the filter and first grid is never greater than 0 dbm, nor does it exceed 0 dbm at the second and third grids. When measuring at -60 dbm, the ganged gain control is "all out" and maximum circuit noise is indicated by a slight movement of the meter pointer with zero input signal; however, above -50 dbm the circuit noise is attenuated and cannot be detected on the indicating meter.

The filter equalization network is a symmetrical 50,000-ohm "T" network equal to the filter impedance and having an insertion loss at the harmonic frequencies equal to that of the filter.

The purpose of the input cathode coupler is to remove any appreciable capacitance across the output of the 50,000-ohm filters. At 45,000 cps, a few micromicrofarads will upset the filter characteristics.

Four stages of amplification—each of comparatively low gain—are employed. No feedback is used since a multiple gain control is utilized to extend the range. A flat frequency response from 50 to 45,000 cps is required, and because of using low noise level triodes the gain per stage is necessarily limited.

The output cathode coupler serves two purposes: it steps down the impedance to match that of the indicating meter, and offers a high input voltage which enables the limiter to cut off sharply just above full-scale meter pointer swings. A 200  $\mu$ -amp d.c. meter is utilized in a full-wave bridge circuit employing 1N34 germanium crystals. Since the frequency response of the meter must be flat to above 45,000 cps, the conventional VU-meter rectifier could not be used.

#### Calibrating Voltage

Calibrating voltage for adjusting the amplifier to indicate VU is obtained from the 6.3-volt heater winding by using a bridge-type regulator utilizing two standard type 44 pilot lamps. By proper selection of resistor values the a.c. output of the calibrating circuit remains

constant for line voltage variations from 105 to 125 volts.

Figure 3 illustrates the typical filter attenuation characteristics. This particular filter is for 400 cps; however, the same general type of characteristic holds for all eight bands. Note that the maximum attenuation of 70 db occurs at the fundamental frequency. All harmonics of the fundamental are equally passed. Most equipment to be tested, if usable, has a hum level at least 40 db down. For this reason, no attempt was made to hold the attenuation at 60, 120, or 180 cps below this value.

The meter indicates the average sum of the harmonics, but does not show which harmonic is present. By using a 'scope in conjunction with the distortion set, harmonics and their relative amplitudes can readily be determined at a glance. For example, when using a 'scope the sweep is generally set for the fundamental frequency—one complete cycle. When the filters are switched in, the gain is increased until the harmonics appear on the screen. Actual harmonics present and their relative amplitudes can be determined easily by counting the number of complete cycles (above one) appearing and noting the amplitudes. For example, second harmonics appear as two cycles, thirds as three, etc. A combination of second and third harmonics appear as an unsymmetrically shaped third with every other crest indicating a greater amplitude.

#### Hum and Noise Measurement

In addition to the measurement of distortion as discussed above, the Noise and Distortion Set may be used to measure hum and noise in audio systems. Noise can be separated easily from the hum by utilizing the characteristics of the filters employed in the set. For example, with no input signal except noise and hum from the equipment under test, the noise can be separated from the hum by util-

[Continued on page 55]

# Simplified Intermodulation Measurements



JOHN M. van BEUREN\*

A discussion of the methods employed in making intermodulation measurements, together with a description of two instruments designed for this purpose.

**I**NTERMODULATION MEASUREMENTS are rapidly gaining their rightful place along with frequency-response checks and square-wave analysis in evaluating the overall performance of modern audio-frequency systems. Formerly, much emphasis was placed on harmonic distortion measurements as a criterion of the quality of a given system, and there are still those who do not recognize the necessity for intermodulation testing. It is now generally accepted that intermodulation measurements, due to their dynamic character, will show up non-linearity not detected by steady state analysis. Dynamic measurements of the intermodulation type will readily and quickly detect such serious and often unrecognized sources of distortion as saturation in iron-core transformers, poor tracking capabilities of phonograph pickups, worn or damaged recording and reproducing styli, and overpolishing of phonograph record matrices. Originally adopted by the film industry as a dynamic check on the linearity of recording and reproduction, it is also ideally suited as a quick and easy means of

\*Chief Research Engineer, Measurements Corporation, Boonton, New Jersey.

Fig. 3. Attenuation vs. frequency curves for the filters employed in the instrument of Fig. 2.

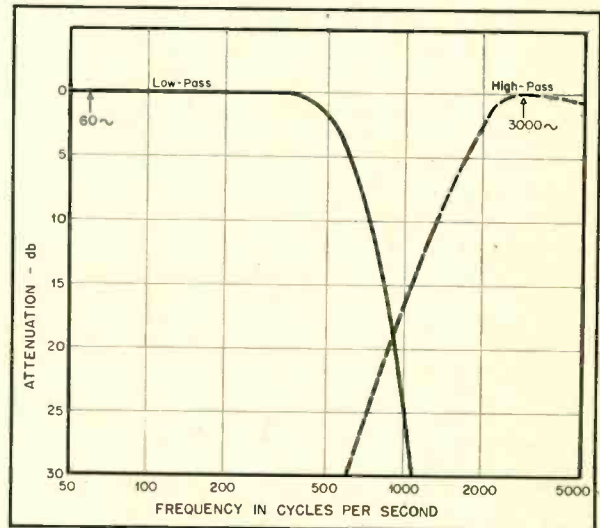

balancing push-pull audio amplifiers, and for determining the correct adjustment and alignment of AM and FM transmitters and receivers. A relatively new and increasingly popular use of intermodulation testing is in rapidly determining the proper high-frequency bias in tape recording, a rather tedious process by

conventional means and one which should be performed often, due to uncontrollable variations even between individual rolls of tape from the same manufacturer.

It is not to be construed from the above that intermodulation testing is the final answer to all audio measurement problems. However, in conjunction with proper frequency-response and phase-distortion (square-wave) measurements, it provides the engineer with a more complete and reliable evaluation of the performance of an audio system than was previously available.

## Fundamentals of IM Testing

Most engineers are by now familiar with the fundamentals of intermodulation testing by the system most commonly adopted by the audio industry, in which a low and a high frequency are mixed together and applied to the apparatus under test. Non-linearity in the apparatus will result in modulation (of the high frequency by the low frequency) which may be measured by filtering out the low frequency from the output signal and determining the per-

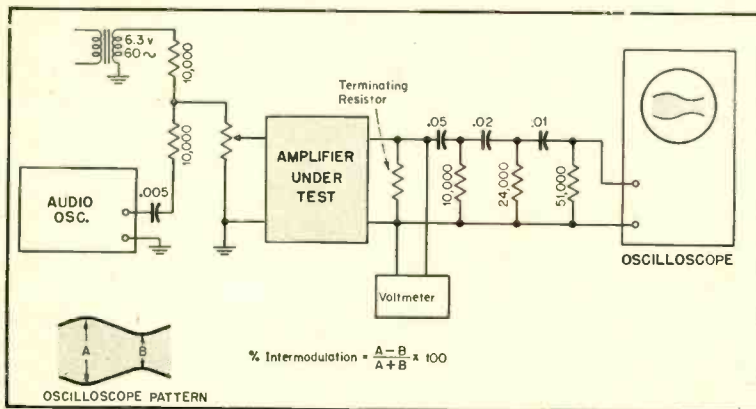

Fig. 1. Arrangement of apparatus for making IM measurements of a qualitative nature, using a 'scope as the indicator.



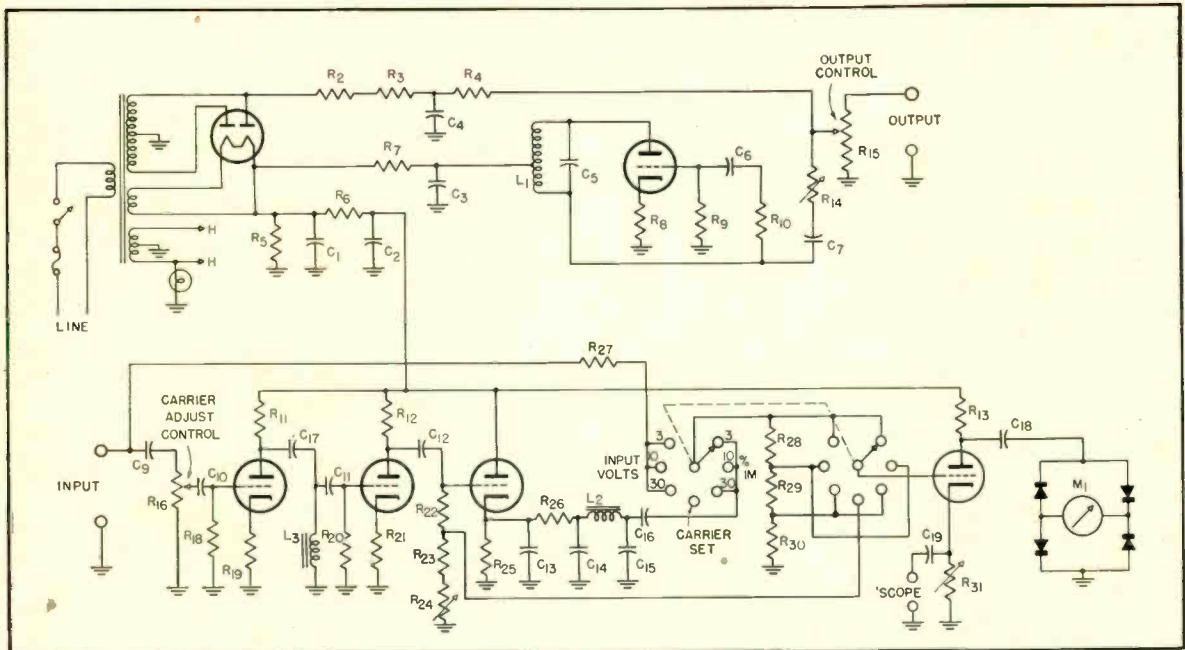

Fig. 2. Complete schematic of instrument designed to provide the test signal and the output filtering required by the method shown in Fig. 1. Refinements in the filtering circuits have been added to give better operation.

centage modulation of the remaining high-frequency "carrier." Most commercially available intermodulation analyzers use this system in a greater or less degree of complexity. However, it is possible for the average engineer or enthusiastic amateur to make simple intermodulation measurements with no more complicated apparatus than an audio oscillator and an oscilloscope. This is done, as shown in Fig. 1, by using 60 cps as the low frequency, and 3,000 cps or higher from the audio oscillator as the high frequency. The frequencies are mixed in the resistance network and applied to the input of the amplifier under test; an input gain control being used, if necessary, to avoid overloading the input stages. The l.f./h.f. voltage ratio should be adjusted to approximately 4/1 by varying the output of the audio oscillator. The output of the amplifier under test should be terminated in its proper impedance, and if anything but a true peak-reading voltmeter is used to determine output power, the output voltage should be multiplied by a factor of 1.25, since most r.m.s. meters will almost ignore the presence of the high-frequency signal.

To measure the percentage of intermodulation, the low frequency is removed in the simple RC filter, shown in Fig. 1. This filter is flat above 3,000 cps, but has adequate attenuation at 60 cps for this type of measurement. The oscilloscope used in conjunction with it should have an input impedance of at least 0.1 meg. The percentage inter-

modulation is determined by measuring the maximum and minimum on the oscilloscope pattern.

While such simple techniques will suffice for occasional measurements, they are rather tedious to perform and are more qualitative than quantitative, due to the complex waveforms usually encountered in intermodulation. If the user possesses a wave analyzer, quantitative measurements can be made, but the calculation of r.m.s. values from the various sidebands is again a tedious process. With these limitations in mind it was decided to undertake the development of a complete Intermodulation Meter with the primary aims of keep-

ing it low in cost, making it completely self-contained, light, compact, and simple to operate, and at the same time sensitive and accurate enough for general laboratory measurements, daily maintenance, and production line tests. The external appearance of this instrument is shown in the photograph.

#### Design of IM Tester

Low cost dictated the use of the power line frequency as the low frequency and a single high frequency with a fixed l.f./h.f. ratio of 4/1. 3000 cps was chosen as the high frequency since it is well within the pass-band of even limited-frequency-

[Continued on page 56]

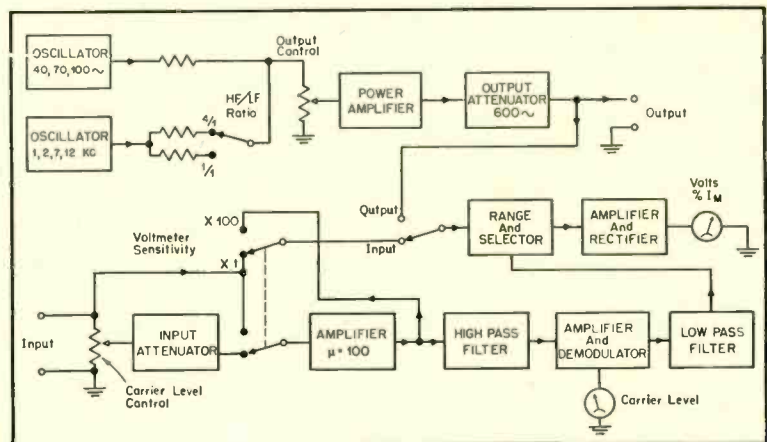

Fig. 4. Block diagram of laboratory-standard type of Intermodulation Analyzer.

# Acoustics of London's New Concert Hall

**T**HE MAJOR QUESTION in modern acoustic design is how to ensure, not merely a reasonable hall, but one which has high acoustic quality. This problem confronted the architects and expert advisers for the important new concert hall now being built in London for the 1951 festival of Britain.

The primary aim of this Royal Festival Hall is to create not merely a London hall, but a concert hall to which Europe and the world may look for an outstanding example of contemporary architecture; and to provide in this a worthy setting for the conductors, soloists, and orchestras of international repute who will be seen and heard there. The latest building technique has been employed, and every effort made to secure comfort both for players and audiences.

The building is being built in two stages, the first of which, to be completed by the time the Festival opens next year, will include the concert hall, a restaurant, and additional accommodation. The second stage, to be finished by 1953, will, with the addition of a small theatre, exhibition galleries, etc., complete a building which will give to London a center of the arts, where music, drama, opera, ballet, paintings, and sculpture may all be presented, and which is within easy reach of all.

On all matters of acoustics and sound transmission, Mr. Hope Bagenal, D.C.M., F.R.I.B.A., assisted the architects. Sir Malcolm Sargent is also advising about special musical arrangements.

## Acoustics Of The Main Concert Hall

To some extent the attempt to produce good acoustic conditions depends upon the definition of quality. Unfortunately, there is not yet sufficient common ground between scientific work and music for the criteria of good quality to be defined in physical terms in such a way that it becomes possible to design with exactness for prescribed acoustic conditions. Perhaps the outstanding instance of this is our inability to tie down the meaning of string tone and singing tone for this purpose. Very considerable efforts

*This article was prepared by authorities on the London County Council.*

have been made to advance scientifically into this field, however, and it is believed that the new concert hall will provide conditions which will be found very acceptable musically.

In the circumstances, it seemed wise not to depart from those traditions of build-

clearly and in proper balance by the whole audience, it was essential that all instruments should be visible from every position. Consequently, in place of the common arrangement of a fore-stage with raked tiers behind, the whole orchestra is stepped. There is no fore-stage in the accepted sense.

The division between the main floor level and the orchestra is marked by a rise of only one foot and, from this level, the platform rises in steps generally wide enough to receive only one bench of players. At the same time, the seating area is also sloped quite steeply from the main floor level. In this way an exceptionally good view, both aural and visual, will be had by the audience.

This orchestral platform needs a little further discussion. In the opinion of the acoustics advisers, the disadvantage of the common fore-stage arrangement is that a

large number of fiddles and the wood-wind, all of which are relatively weak acoustically, are screened by other players or by being behind the piano, because they are all on the same level. The brass and percussion, on the other hand, which are acoustically powerful, are set in very exposed positions on the stepped tiers behind. This seems to be the cause of the lack of balance which prevails in many halls, except in balcony seat positions. In effect, therefore, the attempt in the new London County Council hall has been to secure for all seats the balanced acoustical picture which in many halls is obtained only from the balcony.

There is one other aspect to be noted. String tone or singing tone, however it may eventually be defined, is almost certain to be linked to a fairly long reverberation time. This may easily interfere with clarity and intelligibility, largely dependent on hearing the high frequencies of the initial sounds and the high partials coming from the individual instrument. These are readily screened by other nearby players and big objects, such as pianos, and the arrangement whereby the whole audience is able to see every instrument seems to be the surest way of making every instrument clearly heard for what it is.

The plan-size of the orchestra was also closely studied. Orchestras are often set  
[Continued on page 63]

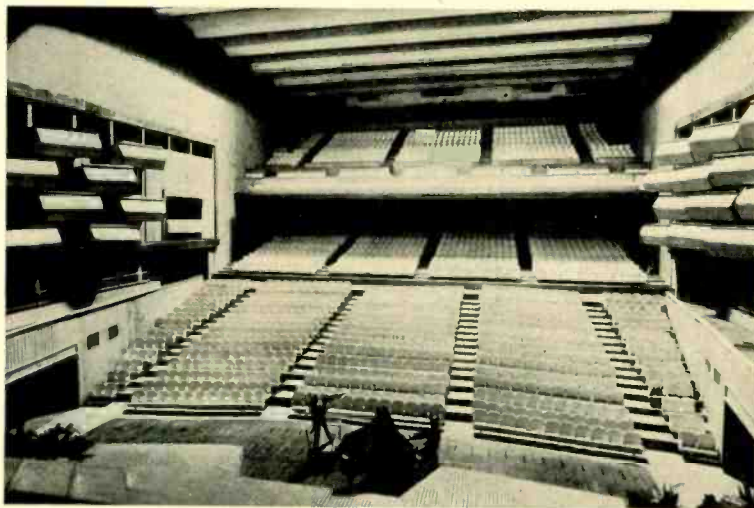

Interior view of London's new Concert Hall which is being constructed on the South Bank of the River Thames in the heart of the metropolis. This view was made from a model, looking from the choir staging above the orchestra.

ing and design which appear to be associated with good acoustics and, so far as these are understood, they have been accepted. The most important, from the point of view of design, was the decision to adhere to a plan with parallel sides, on the grounds that this had apparently been successful in halls that were known to be good, and that the wedge-shaped plans so frequently used today had not yet given us any auditoria with outstanding acoustics.

A remark should perhaps be made about horseshoe-shaped halls, such as the characteristic opera houses of the 18th-19th centuries, which frequently had good acoustic characteristics. Frequently, however, they have a short reverberation time, which is associated with high intelligibility for speech sounds, rather than the musical quality of "singing" tone, and for this reason it was not put forward as a plan type to use in this case. It should not be assumed that the wedge-shaped plan is necessarily bad musically; the point is that it could not be relied upon in the present state of knowledge.

Apart from the plan form, the most important design decision concerned the orchestra platform in relation to the main seating area. Broadly, the arrangement put before the architects ran somewhat as follows, that, if the orchestra was to be heard





Audio Engineering Society,  
Box F, Oceanside, N. Y.

# AUDIO engineering society

Containing the Activities and Papers of the Society, and published monthly as a part of AUDIO ENGINEERING Magazine

## OFFICERS

John D. Colvin . . . . . President	Bob Hugh Smith Western Vice.-Pres.
C. C. McProud Executive Vice-Pres.	Lawrence Shipley Central Vice.-Pres.
Norman C. Pickering . . . . . Secretary	Ralph A. Schlegel . . . . . Treasurer

## Sound Reinforcing Systems

ARTHUR W. SCHNEIDER\*

A discussion of a variety of problems that arise in the installation of these systems in large halls.

**S**OUND REINFORCING is not, in the strict sense of the word, public address. It is an electro-acoustic system of amplifying and converting sounds into acoustic energy in such a fashion as to aid the original sound and to permit comfortable listening. A sound reinforcing system is not a reproducer of sound, nor is it a producer of sound. Fundamentally, the approach to a sound reinforcing system and the analysis of a sound reinforcing problem depends on sound reproducers and sound producers.

A sound reproducer is something which picks up a sound, amplifies it, and reproduces it so that the sound is as near to the original as possible. In this process no latitude should be taken by the engineer or the user to modify the original sound, even though this modification may make the sound more pleasing. In a case where latitude is taken to modify the nature of the original sound, then the instrument is no longer a reproducer of sound but becomes a producer of sound. For instance, Hammond organs and electric guitars are essentially producers of sound, whereas broadcast studios, transmitters, and radio receivers are essentially reproducing networks.

A sound reinforcing system, however, is neither one of these, but a combination of both in view of the fact that it is necessary to add to the original sound so that the original sound plus the amplified sound will make it sound to the auditor as if it were all original sound. Therefore, in the perfect sound reinforcing system, this blending of the amplified sound plus the original sound gives the auditor a feeling of comfortable listening without his realizing that amplification is being made.

From these statements it is readily

\*General Manager, Commercial Radio-Sound Corp., 231 E. 47th St., New York 17, N. Y.

seen that the art of sound reinforcing is applicable primarily to large halls and outdoor places of entertainment. It is also interesting to note that the art of sound reinforcing is relatively young. It has originated since the advent of the microphone, loudspeaker, and amplifier. As a matter of fact, to the writer's knowledge, no outstanding installations of sound reinforcing systems were in use prior to 1931. Our forefathers were able to get around this fact by developing people with high acoustic output, and we cherish the memories of such producers of sound as Caruso and William Jennings Bryan. Now, through the efforts of sound engineers, we have developed a crop of singers who croon and politicians who whisper into KB2C's.

### System Requirements

Let us now consider the requirements of the so-called perfect sound reinforcing system, or at least the requirements of a system that would fill all the desired and ideal functions. The first requirement is for a system to amplify all sounds on the stage regardless of where these sounds originate, and to amplify them with sufficient intensity for the audience to hear comfortably before feedback occurs. Feedback, of course, occurs when the sound returning to the microphone from the loudspeaker is equal to the original sounds. The second requirement of the perfect sound reinforcing system is that all sounds be amplified and reproduced equally insofar as the frequency response is concerned. The third requirement is that the wave form characteristics of the sound be preserved, that is, that the reproduced sounds be relatively free from distortion. The fourth requirement is that the illusion be preserved. This, of course, is a most important factor when it comes to show business. The basic reason for people going to theaters is to lose them-

selves in the illusion of what is going on, and surely the illusion would not be preserved if the sounds appeared to come from any spot other than where they are produced. The last requirement of a sound reinforcing system—one without which an otherwise good system will cease to be good—concerns the acoustics of the hall in which the system is to be installed and the attention of the design engineer to these acoustic problems.

It is not possible to install a perfect sound reinforcing system for many reasons, and numerous compromises must be effected. In order to get sufficient amplification before feedback, the characteristics of the microphones should be such as to limit their range of pickup to the area in which the sounds are being produced. In general, directional microphones are needed with normal pickup from the stage side and little from the audience side. These go a long way toward increasing the maximum usable gain.

### Loudspeakers

On the speaker side, a directional unit is required so that the sounds produced can be directed into the audience area with a minimum of sound being returned to the microphone. However, a directional horn to cover the low end of the spectrum is impractical because of its size. Fortunately, this limitation is not serious in view of the fact that most sounds below 150 cps produced in the theater are of a sufficient intensity as not to require much sound reinforcing. Therefore, you will find that in most sound reinforcing systems the emphasis is laid on those frequencies extending upward from the fundamental of the male voice. At the high-frequency end of the spectrum, some compromises have to be effected in the loudspeaker design. Selection is limited, in view of the fact

that best-known over-all reproducers of sound are of the cone type, which is not readily adaptable to a directional loud-speaker. The loudspeakers on the high end should be of the cellular type, giving a uniform distribution to the high-frequency sounds. The microphones should have a directional characteristic pattern that limits the pickup to the area in which the sounds are being produced. However, in a good sound reinforcing system it is best that the microphone be concealed, inasmuch as it is not desirable to advertise the fact that the sound is being amplified, because this in turn would spoil the illusion. Therefore, it is necessary to conceal microphones in footlights and similar places, which results in a compromise in quality, directional characteristics, and scope of pickup.

If microphones are concealed for reasons of illusion, it is necessary that the speakers be concealed also if a good illusion is to be preserved from an audience standpoint. However, in connection with the speakers, their concealment is not the only consideration when it comes to illusion. It is necessary to have the speaker within a reasonable distance of the sound-producing source and located in such a manner as to make it appear to the auditor that the sound is actually coming from the sound-producing device and not from the loud-speaker. In general, the difference in the path length between the actual sound and the sound coming from the loud-speaker should not be greater than 60 to 80 feet. If this distance is greater than 80 feet, the auditor perceives that the sound is not actually coming from the producer of the sound, but from another spot. As this distance is increased, this realization becomes more acute. Compromises have to be affected in this particular category to a much greater degree than in any phase of sound reinforcing.

It is only with the distinct help of the architect in connection with the design that illusion can be preserved. Complete cooperation between the sound engineer and the architect is a matter of great importance. To date, too few architects have realized the problems of the sound engineer and have given too much attention to the appearance of the halls rather than to utilitarian value. After all, if a room is designed so that it is impossible to see or to hear properly, then it has little use as a meeting hall or a theater. The two fundamentals of a good auditorium are good vision and good hearing. Once these two objectives are obtained, then specification for fancy chandeliers, paintings, and other decorative elements lose their importance.

One example of a wonderful illusion was in the "Great Waltz," a show at the Center Theater back in 1933. The size of the proscenium was cut down considerably, and in the center of this there was a large emblem of the double eagle. It was behind this emblem that the sound reinforcing horns were placed. In all parts of the theater, it appeared as though the sound were coming from the actual singers and orchestra.

The frequency response of the amplifier, microphones, and speaker is an important phase of sound reinforcing. Too much emphasis has been laid on the range of the system rather than the smoothness of response. It is much better to have a system with a limited range and a close tolerance of the output over this range than one with an extended range and large variation in the output over the range.

When feedback occurs, it occurs at the frequency at which the system peaks. If there is a large peak at some particular point, feedback will occur even though the average energy content over the entire frequency range is relatively small. Therefore, you can see that if amplifiers, speakers, and microphones were absolutely flat in their response, all portions of the spectrum would be reproducing equally before feedback would occur. The integrated energy over the spectrum, which is the sensation we actually hear, would be far greater; therefore, a compromise is necessary to pick equipment which will give maximum response and a balance between gain and response.

In the realm of distortion, compromises for economical reasons are generally the limiting factor, but the amplifier capacity required to take care of peak conditions should be possibly ten times the average power required. For example, if a sound system requires an average power of 50 watts, its peak capacity should be 500 watts. From an economical standpoint, it is not always practical to install an amplifier of this capacity.

#### Typical Examples

One of the larger and more recent sound reinforcing systems is installed at the Lewisohn Stadium of the C.C.N.Y. During the summer, the New York Philharmonic Orchestra—through Stadium Concerts, Inc.—gives concerts to audiences ranging up to twenty thousand people. The stage is approximately 100 ft. wide and 60 ft. deep, and the roof is about 60 ft. above the stage. In the roof, along the leading edge, are installed five RCA twin-power speakers, each of them directed in such a manner

[Continued on page 53]



## Employment Register

EMPLOYMENT OPPORTUNITIES may be listed here at no charge to industry or to members of the Society. For insertion in this column, brief announcements should be in the hands of the Secretary, Audio Engineering Society, Box F, Oceanside, N. Y. before the first of the month preceding the date of issue. Replies to box numbers should be addressed to AUDIO ENGINEERING, 342 Madison Ave., New York 17, N. Y.

#### ★ Positions Open

#### ● Positions Wanted

★ **Radio and Television engineers.** Experienced in design of high frequency circuits such as FM tuners, TV boosters, and TV antennae. Salary commensurate with ability. Write giving full details. Mr Stone, Talk-A-Phone Company, 1512 South Pulaski Road, Chicago 23, Illinois, Lawndale 1-8414.

★ **Wireman,** Instrument, capable of building models and occasional short production runs of precision electronic devices. Must be able to work with minimum of supervision. Permanent; write giving salary expected, family status, availability. Box 1002.

★ **WANTED:** Signal Corps Center, Fort Monmouth, N. J. has openings in the following Civil Service positions:

**Military Instructors**—Microwave relay, radar, radio electronics, fixed station radio, central office techniques, teletype installation and maintenance, repeater and carrier, dial central office maintenance, theory of electricity. \$3100-4600.

**Electronic Engineers**—Participate in design, development, modification, construction, and testing of electronic equipment—radio, radar, wire communications, instrumentation, sonar, etc. Responsibility depending upon experience and ability. \$3100-6400.

**Technical Writers**—Write, edit, prepare technical publications, handbooks, circulars, instruction books, etc. Edit and revise scientific manuscripts on radio, radar, electronics, communications, and photography. Write instruction manuals on theory, operation, and maintenance of Signal Corps equipment; determine media and method of presentation of material; prepare charts, graphs, schematic diagrams etc. \$3100-5400.

Applicants for any of these positions should write Chief, Civilian Personnel Branch, Signal Corps Center, Fort Monmouth, N. J., submitting a completed Standard Form 57, "Application for Federal Employment" (obtainable at any first or second class post office) for review before going to Fort Monmouth for a personal interview.



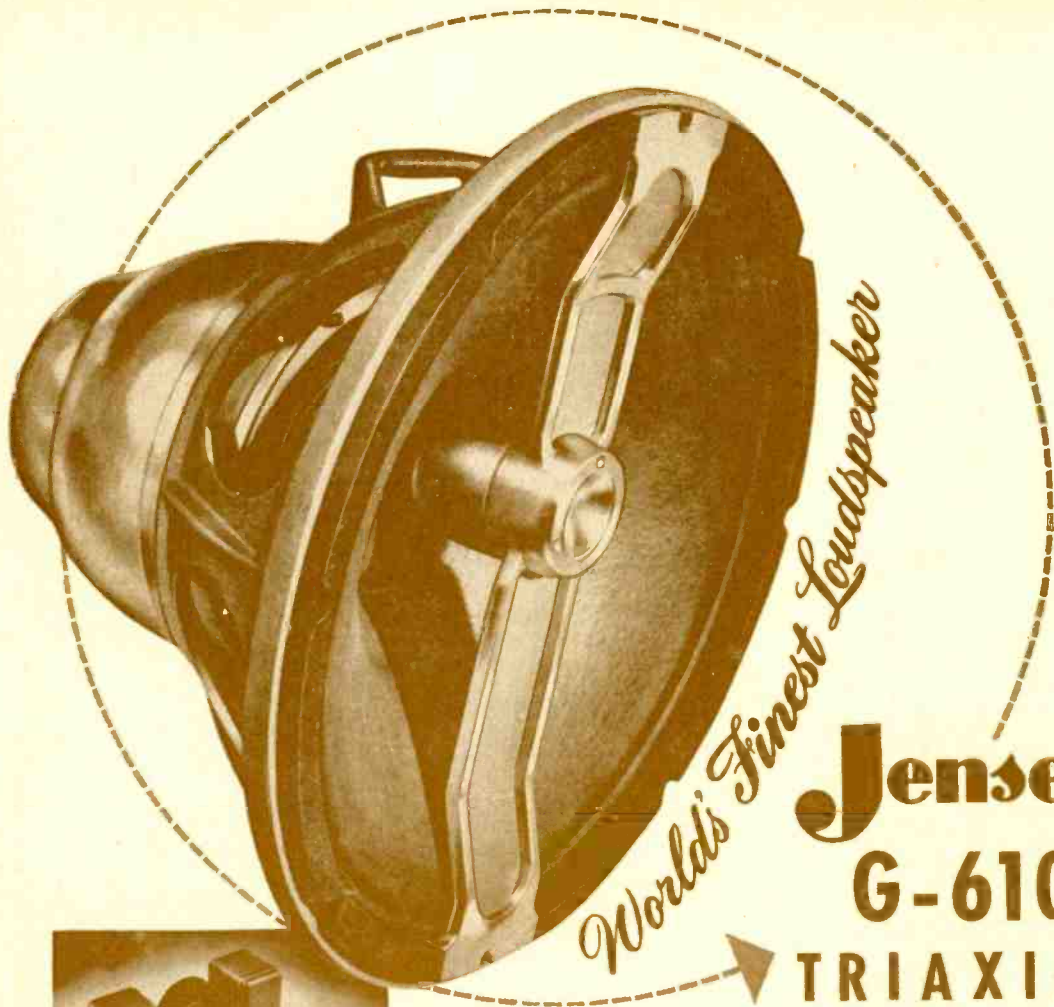

*World's Finest Loudspeaker*

# Jensen

## G-610

### TRIAxIAL

LOUDSPEAKER SYSTEM

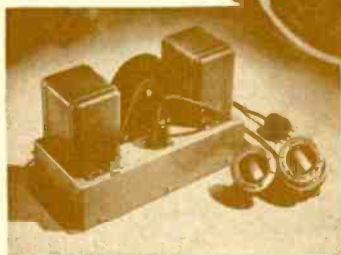

### Never Before Reproduction Like This!

The G-610 brings a totally new meaning to high fidelity sound reproduction. Not only does this new 3-channel system reproduce the widest frequency range ever attained by a loudspeaker, but it also sets new high standards with its incomparably smooth response characteristic and very low distortion. The result is clear, clean, life-like quality, with thrilling *transport to the original* such as you have never heard before. The G-610, complete with Speaker Unit and Crossover and Control network is priced at \$365.00 list. Ask for Data Sheet 160.

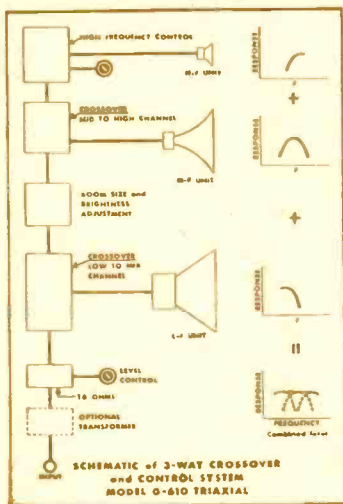

# Jensen

Manufacturing Company

Division of the Muter Company

6633 SOUTH LARAMIE AVENUE, CHICAGO 38, ILLINOIS

# Loudspeaker Damping as a Function of the Plate Resistance of the Power Output Tube

DONOVAN V. GEPPERT\*

Logical reasoning is applied to the problem of choosing between triodes and pentodes or tetrodes to obtain low output impedance and the resulting high damping factor.

**A** MISCONCEPTION appears to be common with regard to the effect of the dynamic plate resistance of a tube driving a loudspeaker on the "damping" properties of the tube. It is apparently considered a general rule that the lower the plate resistance of the output tube the greater the amount of speaker damping. The 2A3, with a relatively low plate resistance of 800 ohms, has long been considered the tube *par excellence* for driving a loudspeaker. Recently the 6AS7, with a plate resistance of only 200 ohms, has made its appearance in the output stage of amplifiers designed to feed loudspeakers. Carried to its logical end, we would eventually use output tubes having zero plate resistance, and, naturally, zero amplification, since

$$\mu = r_p g_m$$

Is there any real justification for this apparent race towards an infinitesimal plate resistance? It will be shown that there actually does exist a practical advantage in using triodes over beam tetrodes or pentodes, as far as speaker damping is concerned, but there is practically *no* advantage of one triode over another. Also it will be shown that the advantage of triodes over beam tetrodes and pentodes does not lie in the fact that they have lower values of plate resistance as such, but that for the values of load impedance commonly chosen on

\*University of Arkansas, Fayetteville, Ark.

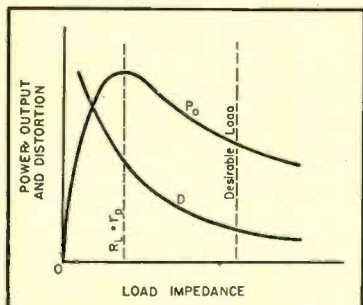

Fig. 1. Power output and distortion vs. load impedance for a typical single-ended triode power amplifier.

the basis of allowable distortion, the impedance reflected into the secondary of the output transformer is inherently lower for triodes than for pentodes or beam tetrodes.

Consider the curves in Fig. 1 which show the variation in power output and harmonic distortion for a single-ended triode amplifier. For Class A linear operation, maximum power output occurs when the equivalent load impedance reflected into the primary of the output transformer equals the dynamic plate resistance of the tube. This is shown by the dotted line marked  $R_L = r_p$  in Fig. 1. However, a more desirable load from the

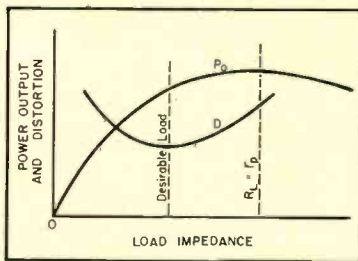

Fig. 2. Power output and distortion vs. load impedance for a typical single-ended pentode power amplifier.

standpoint of distortion is a value somewhat higher than the plate resistance of the tube. A load impedance equal to twice the plate resistance of the tube is frequently stated as being an optimum value. In actual practice, values between two and four times the plate resistance are used to advantage.

## Pentode Curves

The corresponding curves for a pentode or beam tetrode are given in Fig. 2. In this case a desirable load is one giving a minimum harmonic distortion which inevitably occurs at a load impedance lower than the plate resistance of the tube. Hence, for typical triodes, loads *greater* than the plate resistance are used, whereas for typical pentodes or beam tetrodes, loads *less* than the plate resistance are used.

Refer now to Fig. 3. For operation over the linear portion of the tube's

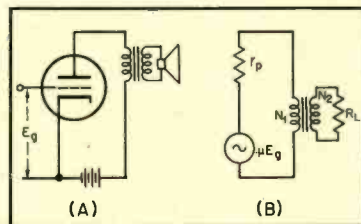

Fig. 3. (A), left, actual circuit and (B), right, equivalent circuit for Class A linear single-ended power amplifier.

characteristics, the series equivalent circuit can be used to replace the tube as far as a.c. computations are concerned. If the output transformer has a turns ratio of  $N_1/N_2$  and is considered to be perfect, the impedance reflected into the primary is  $(\frac{N_1}{N_2})^2 R_L$  and the impedance

reflected into the secondary is  $(\frac{N_2}{N_1})^2 r_p$ .

In other words the impedances can be referred to either side. The ratio of load impedance to plate resistance is the same on either side. In the case of triodes, it has been shown that the ratio of load impedance to plate resistance is always made *greater* than one and generally two or three to one. Therefore the equivalent generator internal impedance is about one-half or one-third of the load impedance. But for pentodes, the ratio of load impedance to plate resistance is always made *less* than one, and the equivalent generator internal impedance is therefore greater than the load impedance. Consequently, triodes reflect a lower impedance into the secondary than tetrodes or beam pentodes, not because of their lower plate resistance, but because the values of load impedance dictated by distortion considerations make it so.

As to the relative merit of different triode tubes, it should be obvious that as long as the same ratio of load impedance to plate resistance is used, there is no difference whatever in the amount of speaker damping. As an example, con-

[Continued on page 59]



# Intermodulation can be measured quickly and accurately with MEASUREMENTS' new, portable **MODEL 31** INTERMODULATION METER



**COMPLETELY SELF-CONTAINED**

- TEST SIGNAL GENERATOR
- ANALYZER
- VOLTMETER
- POWER SUPPLY

To insure peak performance from all audio systems; for correct adjustment and maintenance of AM and FM receivers and transmitters; checking linearity of film and disc recordings and reproductions; checking phonograph pickups and recording styli; checking record matrices; adjusting bias in tape recordings, etc.

MEASUREMENTS CORPORATION meets the demand for compact, easily-operated intermodulation equipment! The MODEL 31 is moderately priced, yet extremely accurate and built to the same rigid specifications of all "LABORATORY STANDARDS".

One section of the MODEL 31 supplies mixed audio frequencies to the apparatus under test; the resultant signal from the apparatus is then applied to the analyzer section of the MODEL 31 to be filtered, amplified, demodulated and metered. The meter is direct-reading in percentage of intermodulation and input volts.

## **MODEL 30 INTERMODULATION METER**

This model has a test generator providing, a low frequency range of 40, 70 and 100 cycles, a high frequency range of 2000, 7000 and 12,000 cycles, either separate or mixed in a 1/1 or 4/1 ratio.

The analyzer will operate from 20 cycles to 200 cycles and from 2000 cycles to 20,000 cycles.

A direct-reading meter measures intermodulation percentages from 0.1% to 30%; test generator output voltages from .01 to 100 v. (-30 to +20 DBM); analyzer input voltages from .0001 to 100 v. (-70 to +40 DBM).

*Detailed circular on request*

### Specifications:

#### GENERATOR

LOW FREQUENCY: 60 cycles.  
 HIGH FREQUENCY: 3000 cycles.  
 LF/HF VOLTAGE RATIO: Fixed 4/1.  
 OUTPUT VOLTAGE: 10 v. max. into high impedance or +5 DBM matched to 600 ohms.  
 OUTPUT IMPEDANCE: 2000 ohms.  
 RESIDUAL INTERMODULATION: 0.2% max.

#### ANALYZER

INPUT VOLTAGE: Full scale ranges of 3, 10 and 30 volts RMS. Less than one volt of mixed signal is sufficient for operation.  
 INPUT IMPEDANCE: Greater than 400 K ohms.  
 INTERMODULATION: Full scale ranges of 3, 10 and 30%.  
 ACCURACY:  $\pm 10\%$  of full scale.  
 OSCILLOSCOPE connection at meter.

Power supply: 117 volts, 50/60 cycles, 30 watts. Dimensions: 8" high x 19" wide x 9" deep. May be mounted in standard 7" relay rack panel space. Weight: 16 lbs.

**MEASUREMENTS CORPORATION**

**BOONTON NEW JERSEY**

# AUDIANA

LEWIS S. GOODFRIEND

## High Fidelity

**H**IGH FIDELITY, as an important factor in the recording and reproduction of sound, has been discussed from many points of view during the past few years. Today more and more emphasis is being placed on equipment design by both engineers and hobbyists. It is the purpose here to analyze the various aspects of the problem, and to determine the present status of high fidelity reproduction.

Webster's New International Dictionary, Second Edition, Unabridged, defines fidelity, in its application to electricity as, "The degree to which an electrical device, as a radio receiving set, accurately reproduces at its output end the signal or wave form received at its input end." This definition is preceded by the general definition which is, "Faithfulness: . . . exactness as in a copy, accuracy." These two sections of Webster's definition carry all the ideas involved in the high-fidelity devotee's requirements, and if money and space were no object, this article could stop here. On a number of occasions the Bell Telephone Laboratories have demonstrated their stereophonic sound transmission systems, using both direct wire lines and film recording. The basic stereophonic system, Fig. 1, as shown by the tests, is capable of reproducing sound that is such an accurate facsimile of the original that it meets the approval of the most critical listener. The amount of space required and the cost prohibit the use of such a system in the home. However the tests do show that high-fidelity reproduction is feasible, and that the definition is a good one.

According to W. B. Snow<sup>1</sup> the ultimate goal is an acoustic facsimile, and that in the stereophonic tests the sound pressure at the stage opening in front of the reproducing loudspeakers was made the same as that at the stage opening in the originating concert hall. This is fine for special purposes, but the problem remains of approximating this acoustic facsimile under practical conditions. It is at this point that opinion and personal

preference become factors in designing high-fidelity systems. The next factor to consider is the objective of the modified aim, that is, how can we come closest to the acoustic facsimile within the limits of space and cost. Again work done by

rectors, have developed techniques for microphone placement, the most plausible being that developed by Maxfield and Albersheim. If used with good judgment, their method will provide an excellent program signal.<sup>2</sup> Many studio engineers

Fig. 1. The stereophonic system, in which both perspective and quality are maintained.

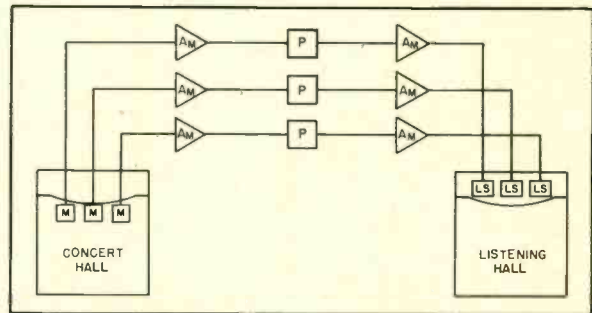

the Bell Telephone Laboratories gives a key to the problem.

### The Perfect System

The change from a multichannel to a single-channel system, using perfect transducers and amplifiers, still causes many changes in the characters of the transmitted sound. Factors influencing these changes are microphone placement, microphone directional response, acoustics of the pickup studio or hall and of the listening room, and the placement of the loudspeaker and listener. Taking the first of these, microphone placement, where can we put one or more microphones to pick up the sound from an entire orchestra in a manner that closely approximates the sound pickup of the ear? The answer is, "No place." First of all the microphone will pick up some of the reverberant energy from the surrounding space, if only one is used, and when this sound is reproduced in another room it will be further modified by the reverberation characteristic of that room. If several microphones are used to pick up an orchestra, how should they be spaced, and how should their outputs be mixed in order to approximate the sound that a listener would hear if sitting in the studio. Again the answer cannot be given. Therefore, over the years of development of broadcasting and recording, engineers, musicians, and di-

rectors have developed methods which result in the same microphone position on a cut and try basis. However it must be remembered that this is still an approximation. The directional response determines the amount of reverberant energy added to the incident sound, and changing it affects the listener's appreciation of the signal. Loudspeakers, for reasons of efficiency, are frequently placed in the corners of rooms. Again the ratio of the incident energy to re-

[Continued on page 64]

<sup>2</sup> J. P. Maxfield and W. J. Albersheim, "Acoustic constant of enclosed spaces correlatable with their apparent liveness." *J. Acous. Soc. Am.* Jan. 1947, p. 71.

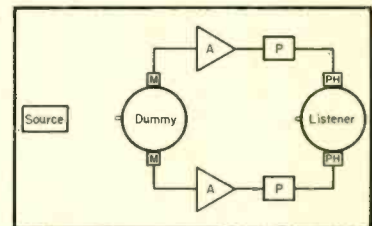

Fig. 2. The binaural system uses microphones at the side of a dummy head to account for the diffraction by the listener's head, and dual channels to maintain perspective. Apparent quality is good even with narrow range transmission.

<sup>1</sup> W. B. Snow, "The acoustic facsimile as a goal." *Acous. Soc. Am. meeting* Nov. 6, 1948, paper 31.



## Something New



### NEW OVAL SELECTOR SWITCHES

Several new oval rotary selector switches are described in Bulletin L13 just issued by the Shallcross Manufacturing Co., Collingdale, Pa. Six basic plates and three rotor types produce switches having from one to three poles per deck or gang and with other desired mechanical and electrical details. As many as 18, 9 or 6 positions may be obtained in single-, double-, or triple-pole types respectively. These may be single-, double-, or triple-pole decks exclusively or a combination of different types.

### VERTICAL STYLE PRECISION RESISTORS FOR JAN USES

Improved vertical style precision wire-wound resistors for use where mounting requirements make it desirable to have both terminals at the same end of the resistor have been introduced by the Shallcross Manufacturing Co., Collingdale, Pa. These units provide a longer leakage path from the mounting screws to the terminals. Known as Shallcross Types BX120, BX140, and BX160, they are designed to meet JAN requirements for styles RB40B, RB41B and RB42B respectively. For commercial uses, the resistors carry somewhat higher ratings than for JAN applications. Wire leads instead of terminals can be furnished if desired. Complete details will gladly be sent on request to the manufacturer.



### FLAT, METAL-ENCASED WIRE-WOUND RESISTORS

A new flat, metal-encased, wire wound power resistor introduced by the Shallcross Manufacturing Company, Collingdale, Penna. is specifically designed for business machines and other exacting equipment where the call is for real dependability in minimum size. Known as the Shallcross Type 265A, the resistor is space wound, has mica rather than phenolic insulation, and is encased in aluminum for mounting flat against a metal chassis to assure maximum heat dissipation. At 175° C. continuous operating temperature these units are conservatively rated for 7½ watts in still air and 15 watts when mounted on a metal chassis. Actually, the resistor has safely dissipated as much as 35 watts over long periods when mounted flat against a heavy metal plate, although such extreme loading is, of course, not recommended for normal use. Shallcross Bulletin No. 122 giving full details is available from the manufacturer.

*Advertisement*

Really Smooth—Outstandingly Quiet—Fully Dependable

MANY TYPES  
AVAILABLE FROM  
STOCK  
and through  
Shallcross  
parts distributors



# Shallcross *Precision* ATTENUATORS

ALL STANDARD FIXED AND  
VARIABLE TYPES

- LADDER AND BALANCED  
LADDER CONTROLS
- "T" CONTROLS
- BALANCED "H" CONTROLS
- POTENTIOMETERS
- VARIABLE IMPEDANCE  
MATCHING NETWORKS
- V.U. METER RANGE  
EXTENDING ATTENUATORS
- STANDARD AND SPECIAL  
FIXED PADS
- SPECIAL NETWORKS

Perhaps you've noticed how frequently Shallcross attenuators now appear in the finest audio or communications equipment? Or how often they are chosen for replacement purposes?

There's a reason! Improved design, materials and production techniques have resulted in a line that sets new, higher standards of attenuation performance for practically every audio and communications use.

Shallcross Attenuation Engineering Bulletin 4 gladly sent on request.

Shallcross Manufacturing Co.  
Dept. A-110 Collingdale, Pa.

RESISTORS — INSTRUMENTS — SWITCHES — ATTENUATORS



# RECORD REVUE

EDWARD TATNALL CANBY\*

## New Speeds—Why?

**A**S WAS NOTED recently in the Editor's Report, the addition of more new speeds to the repertory of recorded music is hardly an appetizing idea, even to the professional engineer. To a record reviewer of the usual brand who is quite thoroughly removed from technical matters, the thing seems unutterably sinful, if not downright nutty. *Now—of all times!* That will be the general reaction, I am quite sure. And with condemnation of the strongest sort most comment will end.

This column, however, is not inclined to let the matter drop—whether theoretical, or whether (by the time this gets read) a matter of practicality, with new speeds actually announced. There are some interesting angles, I'd say, from the bird's eye viewpoint. For the sake of argument, if you wish.

### What Reasoning?

The titillatingest aspect right now is that I have no official information whatsoever as to just why anyone should even so much as wish to bring out a new speed, commercially—and yet it would seem to be a common sense deduction to assume that there are good reasons. Reasons worth a large cash gamble, a lot of development, engineering, publicity, distribution setting-up, and all the other enormous headaches that go into the production of any new product. People don't bring out new speeds just for the heck of it. Perhaps most of us might disagree with the idea, but obviously the persons who might be back of such a venture would believe in its potentialities themselves. How come? What kind of reasoning would theirs be? That's what interests me at this point.

Not that I have any intention of going out on a shaky limb by trying to forecast the shape and the system of a 16-rpm speed, though I have certain unscientific ideas or hunches or rumors that have been passed along to me which it will be interesting to verify—or kill—when the time comes (if it does). Let's take the broad viewpoint (it's much safer).

### Stored up Progress

My feeling is that the revolution of the

\* 279 West 4th Street, New York 14, N. Y.

last two and a half years in the phonograph industry was anything but a self-contained entity, before which there was virtually no change, *after which* there will be virtually no change. Outwardly, there was in truth no more than a minor set of improvements in the 78-rpm record between the early electrics in the late twenties and the birth of LP in 1948. Tonal range (in some cases) was improved, distortion (in some cases) was lowered; greatly improved electronic equipment made things generally easier all around for the record maker. But none of this was fundamental. The fundamental things, I'd say, occurred pretty much behind the scenes. Electronics as a field grew tremendously, but the 78-rpm record didn't much benefit. Progress was, so to speak, stored up. Vested interest in the old acoustical groove (large-sized in order to transmit a maximum of energy from groove to needle) kept it in use long after it might have been possible to make it smaller, given ideal conditions without the necessary incubus of existing standards. It took the war, with it greatly expanded and accelerated development, plus the fact that actual applications to the phonograph were delayed completely, to bring on the sudden revolution.

Indeed, the use of a small groove and fine-gauge stylus was in the cards in the 1920's when the electrical process first appeared. Delay was inevitable, quite aside from vested interest; technological bottlenecks such as pickup weight, the need for low-distortion copying techniques, silent and smooth record material, wider range cartridges and speakers, held things up endlessly. At the war's end we saw the cashing-in, though, of a lot of accumulated progress—twenty years' worth. The final break with 78-rpm, to LP, was bound to come. (And in this sense, the 45 is a rival and concomitant development of basically similar nature—small groove and stylus, lightweight pickup, unbreakable, silent, economical record material.) The war itself with its accelerated activity brought to a head so many basic developments in the phonograph area (brought them to the point of practicable, direct application) that pressure away from the 78-rpm record was very much greater than in the immediate pre-war days. If it hadn't been "LP" or 45, it would have been

[Continued on page 41]

## Pops

RUDO S. CLOBUS\*

**O**NE of the few remaining great men of jazz (if not the greatest), old "Satchmo" Louis Armstrong, recently made the final eulogy for the musical freak called "bop." A master of the precise phrase, the great man merely said, "Bop is finally gone." The word "gone" has a double meaning in this connection, only one of which was involved in Armstrong's terse comment. What he failed to say was that the same thing applies to almost every other aspect of the jazz universe. His own case is a significant one, because it points up some of the tragic aspects of the period we live in. Louis has been touring the United States and Europe with what would ordinarily be one of the most majestic aggregations of jazz heroes ever assembled in one spot at one time—"Faddah" Hines, Jack Teagarden, Barney Bigard, Cosy Cole—a group which makes the blood tingle. Playing to full houses, Mr. Armstrong's symphony is a sad reminder of what we've lost and what we will continue to lose in the future. The terms are hackneyed and clichéd, but they are real and significant nevertheless. We've lost sincerity, and with it one of the great motives for the major experiences in jazz. The creative experience has gone, and the mere museum-piece repetition of the wonders of the past has replaced it.

Last month, I pointed out the extraordinary fact that we are facing the slow death of live music, both classical and otherwise. We are undoubtedly going through the revolution which in an extreme way justifies the invention of the radio, the phonograph record, and TV. As a result, musical responsibility has shifted and is still shifting to a new group. The night club owner, the concert manager, the orchestra patron, all the groups who were the arbiters of the music business in all its aspects up to the present time, are increasingly having less and less to do with the promulgation and fulfillment of musical possibilities. They

[Continued on page 66]

\* 960 Park Ave., New York 28, N. Y.



GOODMAN SPEAKERS • HALLICRAFTERS • HOLL • JENSEN • LEAK • LIVINGSTON • MARKEL • MASCO • NATIONAL • NEWCOMB • PENTRON

APPROVED • ASTATIC • ATLAS • AUDAX • AUDIO DEVELOPMENT • BELL • BOGEN • BOZAK • BROOKS • BROWNING • BRUSH • CHALLENGER • ELECTRONIC WORKSHOP • ELECTRO-VOICE • ESPEY • GARRARD

# ONCE AGAIN LEONARD SETS THE PACE

*and how!*



## SOUND STUDIO "A"

*Hear music reproduced with a sensation of "concert-hall presence"*

Twelve floors stocked to the brim with tuners, amplifiers, speakers, tape recorders, disc players—all arranged so that the flick of a switch demonstrates any desired combination of audio equipment.

Here, in any one of three sound studios, you will hear music played with such faithful reproduction as to amaze even the most discriminating artist.

*or . . . . .*

Wander through our many Furniture Rooms. Is your preference "Period"? We have it. . . . . Or perhaps you fancy "Modern". . . . . We have that, too. Literally hundreds of designs to suit the most critical taste are at your disposal.

Of course, we shall continue to give our customers the type of SERVICE that spells SATISFACTION.

## AUDIO FAIR DEMONSTRATION HEADQUARTERS

Hotel New Yorker—Suite 536

Ask to hear the new Goodman Industries, Ltd. speaker—Just arrived from England

# LEONARD RADIO, INC.

69 Cortlandt Street, New York 7, N. Y.

• ALTEC-LANSING

WESTERN ELECTRIC •

PERMOFLUX • PICKERING • PROCTOR • RACON • RADIO CRAFTSMEN • REK-O-KUT • REVERE • H. H. SCOTT • SHURE • TURNER • UNI-MODE • UNIVERSITY • V.M. WEBSTER • CHICAGO • WEBSTER ELECTRIC

# Audio in England

H. A. HARTLEY

ONE OF THE DIFFICULTIES in reporting on audio practice over here is apparatus which will amplify and reproduce audio frequencies without distortion, and as I said in my last report, musical acceptance cannot be completely defined in terms of response curves, distortion measurements, and acoustic conditions of the auditorium. It seems to me that until some further development in measuring has been achieved the judgment must be made by a trained musical ear, and that trained musical ear must not allow itself to be carried away by the perfection of the performance. Over and over again I have seen musicians listening to phonograph reproduction which was ludicrous in its badness, but they have been so lost to reality by a superb artistic execution as to be stone deaf to the actual noises they were supposed to be hearing. Perhaps they find some occult link with the original performance which makes the intermediate steps superfluous. All I can say as an engineer, with a strong liking for good music, is that if there is distortion in the reproduction, then I get no pleasure from the performance however superb it may be.

As I want to report on the whole audio chain from the beginning to the end, I am starting with pick-ups and records. What is the datum line here? Quite obviously every pick-up and record has some distortion in it and some distortion is unavoidable. But I think it would be safe to say that the frequency response should be flat, so far as the pick-up is concerned. Once we have stated recording characteristics we can design our amplifiers to compensate exactly for the characteristics of the records, but I find it extremely difficult to compensate for defective pick-up performance.

## Response Measurements

I have recently come into possession of a three-speed record-changer with a turret-head pick-up made by an eminent American manufacturer. It is a marvel of mechanical ingenuity. We, whose main contribution to civilization is original thinking, are not anything like so good as you in design for production. A purist might criticize some of the "chances" the designer of this changer has taken, but it works and seems likely to go on working for a long time. But then I tried it on the discs, and—like Queen Victoria—I was not amused. In terms of frequency response I found a considerable top boost was necessary to get any life into the reproduction, but what was worse, the non-musical noise content was considerable, even when top boost was not used. As a matter of interest I took a curve of the pick-up which is given in the accompanying diagram. Curve A shows the response of the American record changer with a crystal head using 78-r.p.m. constant-frequency records. As a basis of comparison I give two other superimposed curves, B and C, taken from two English changers also with crystal heads. The loss of bass in the case of curve A may be due to the fact that the American unit, which also has to play microgroove, has a very much lighter pick-up arm, and so cannot generate a very prominent tone-arm resonance. The loss can be partially compensated by bass boost, of course, and is not serious. It will be seen, however, that except for a somewhat poorer high-note response, the performance is not

very different from an English crystal pick-up.

Curve D is from a magnetic pick-up such as is used on the mass-produced cheap radio-phonograph, and is of no interest to high-fidelity men. But curve E is from a so-called high-fidelity magnetic pick-up sufficiently robust to be used on a record changer, and of this more anon.

The point I wish to make clear is that over here we are not very much interested in crystal pick-ups for the highest class of reproduction. At least one manufacturer has done a considerable amount of work in trying to perfect them, and I notice that he is now stressing the importance of a very carefully designed super-trailer stylus. It would seem that a crystal can be designed to give a flat output over a certain band of frequencies, but the width of that band is not great enough for really wide-range reproduction. For good top it appears that the stiffness is too great for good tracking at low frequencies, or if this latter is achieved, the response at the top end is deficient. This may be nonsense, for I am not a crystal expert, but that is how it seems to work out in practice. If, therefore, one chooses a crystal which will give good top, then a long trailed stylus is necessary to avoid record damage. And that is the snag. I would not care to undertake the mathematical analysis of a trailer stylus mounting under load at all frequencies between, say, 30 and 13,000 cps. but I am quite sure in my own mind that the modulation of the record groove will not be transferred to the crystal without distortion. I have found that trailers do introduce a degree of distortion which is quite painful with wide-range equipment, and others in this country have too. That is why we don't like the crystal pick-up.

## Early Magnetic Pickups

Our first breakthrough from the heavy magnetic and the crystal was some years before the war. The German Telefunken people started selling moving-coil pick-ups in this country, and they were fitted with sapphires. To our ears of the late 1930's they sounded pretty good, and a host of people started copying them. I think it fair to say that, by 1939, the Telefunken was still the best that

could be bought. But then our moving-coil complex was shattered by the introduction of a lightweight magnetic pick-up by E.M.I. (owners of H.M.V., Columbia and Parlophone records). This delightful device was cheap, simple and certainly worked well, but it had one drawback—the miniature needle was not clamped (to maintain top) and this caused buzzes at high frequencies—in the 10,000-cps region. We used match-sticks to plug the hole up, but the answer came when we could get sapphires and cement them into place.

In radio and audio, as in everything else, there are always plenty of people ready to step in with copies of a new idea, and before long we were assailed with a host of lightweight magnetic pickups, but some of them were pretty poor. There must be some tricky work in designing a good magnetic pick-up, for it was noticed that the excellent E.M.I. when subsequently put into mass-production, did not perform so well as the earlier models. It was certainly far better than the usual run of pick-ups fitted to inexpensive radio-phonographs, but not up to the standard insisted on by the real high-fidelity man. The steel needle, too, has a resonance at 9,000 cps which tends to emphasize surface noise unduly. It may be of interest to note that the British Columbia people offer a sapphire stylus which is all sapphire; this avoids the steel resonance and also the bugbear of changing needles.

Now, the pick-up whose response is given in curve E is a better pick-up than the E.M.I., at least in the opinion of the writer, and on paper it should perform very well. Yet its design is such that it will not sit down in the low-frequency grooves with a counterbalanced arm; the recommended pressure is 28 gms. and this is, I think, much too high for assured freedom from record wear on the "pinches." The Decca company, by using an ingenious method of bonding the stylus to a rubber disc, have achieved a relatively free suspension in a simple but effective magnetic design, and offer the alternatives of round or oval sapphires. But as it is now becoming generally recognized that sapphires are dangerous things to use in a give-and-take household, because of their tendency to chip if dropped, Decca also offer a diamond stylus for the man who really cares.

A number of magnetics can be dismissed because they are mainly inspired by one or other of those already mentioned, but I might say that I have been much pleased with an entirely different type of magnetic in which the stylus is used as the armature. This not only has a very fine frequency response, but it can be counterbalanced down to 5 grams and so is entirely suitable for use with microgroove, which it repro-

Pickup response curves.

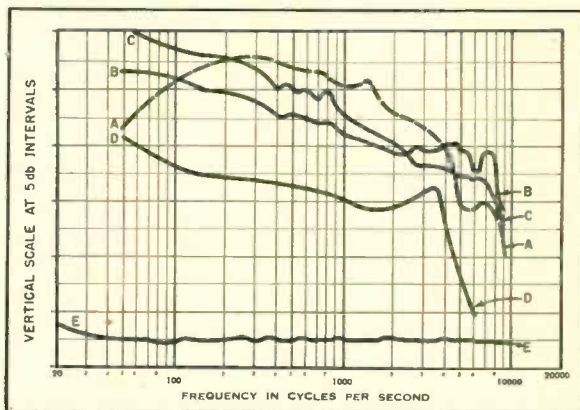



# Audax

## POLYPHASE REPRODUCERS

*"The Standard by Which Others Are Judged and Valued"*

## We...the People

When POLYPHASE was first introduced, a few months ago, we could give you only our own observations that this new reproducer delivers a finer, smoother, cleaner performance, by far, than any yet devised. Since then, however, thousands of delighted POLYPHASE users—fairly amazed by its unprecedented realism—are acclaiming POLYPHASE, reinforcing our own findings. The public has spoken practically in unanimity:

"Never before such EAR-QUALITY, such FAITHFUL  
REPRODUCTION . . . . that is POLYPHASE"

## but...

ONLY YOU can decide what sounds best and most pleasing to your ears. . . . Therefore . . . . see it, HEAR it and compare it with any reproducer at any price . . . . then, YOU be the judge.

### Specifications

One single high quality magnetic unit assuring the same point pressure—6 to 8 grams—for ALL discs ● Employs either sapphire or diamond styli—replaceable AT HOME—as simply as steel needles ● Output about 20 m.v. ● Response 20 to over 10,000 cps ● Needle talk practically NIL ● Phenomenal tracking ● High or low impedance ● Flexible plug-in connectors ● Available for Garrard, Webster and other changers ● Facsimile reproduction at all speeds ● Costs less than ordinary magnetic units

Send for editorial reprint on POLYPHASE principles

## The Audax ARM SIMPLICITY itself!

- Only 3 parts
- Highest tracking efficiency
- No restraint to stylus travel
- Frontal oscillations nil
- No springs
- No fatigue
- Maintains original point-pressure permanently—regardless of climatic changes
- Unquestionably the simplest and most efficient arm yet devised

\* refer to August issue cover

3 models available in  
12 inch and 16 inch

—and Audax arms  
cost less —

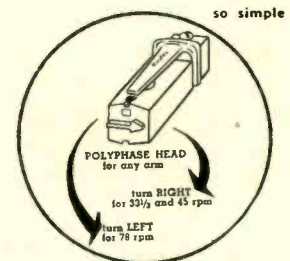

## AUDAK COMPANY

500 Fifth Avenue,

New York 18, N. Y.

*"Creators of Fine Electro-acoustical Apparatus for over 30 years"*

# 70 db. Dynamic Range\* on Disks

now made possible with the

## FAIRCHILD Thermo-Stylus Kit

\*Measured in accordance with NAB Recording and Reproducing Standards: Section 1, paragraph 1.85.

### WHAT IT IS:

A kit of special styli with miniature heating elements, a cutterhead adaptor and a heat control with calibrated meter.

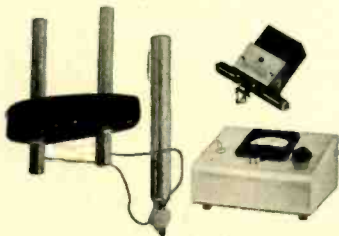

### WHAT IT DOES:

Applies thermoplastic principles to disk recording; eliminates mechanical loading of the cutter by the disk material.

### RESULTS:

- Reduces basic surface noise at least 20 db.
- Minimizes frequency discrimination at innermost diameters
- Eliminates most difficulties due to production differences in blank disks.

Recordings made with the Fairchild Thermo-Stylus Kit retain the esthetic listening appeal of original sound.

WRITE FOR ILLUSTRATED DETAILS  
SPECIFY YOUR CUTTERHEAD



154TH STREET AND 7TH AVENUE  
WHITESTONE, N. Y. FR. 118

duces very nicely indeed. Twenty years ago the B.T.H.\* needle armature pick-up was much admired as compared with its contemporary magnetics of more complicated design, but it weighed a colossal amount, as did the others. It does seem, therefore, that the utmost simplicity of armature design is needed for the cleanest results, and I am banking on this lightweight needle-armature job as a cheap and efficient way of dealing with the problems involved.

Our moving-coil pick-ups vary in price from £6 to £20, and as in most other things

\* British-Thompson-Houston.

you get what you pay for in precision of workmanship. They are all of low output, they all require input transformers, and those transformers must be properly screened, preferably in streamlined high-permeability boxes, to avoid hum pick-up. I have yet to be convinced that the output is any freer from distortion than that of a really well-designed magnetic, and the introduction of metal in the shape of transformer cores seems to me to be all wrong. Over here we try and get rid of all the transformers we can. The output transformer must always be with us, apparently, [Continued on page 39]

## THE BEST BRITISH RECORDS OF 1949

The records in this list have been selected because they are well performed and well recorded. It seems futile to recommend a good recording if the musical interpretation is unsatisfactory, and an excellent performance badly recorded is a constant irritation, as well as a reminder of what might have been. In assessing the performance my own opinion has necessarily been modified by heeding the opinions of established musical critics who must be listened to with respect. The list could be considerably lengthened by listing discs which are nearly very good, but a line has to be drawn some-

where, and the following may be considered good buys in every way.

Catalog numbers are British ones, and some titles may be available with American labels. The experts of The Gramophone Shop should be able to give the cross references, but a note of the performers and conductors will probably provide the clue in most cases. One or two American productions will be noted and may provide a standard of reference, but there is no guarantee that a given performance will sound the same on a British disc as on an American. All records are on shellac and run at 78 r.p.m.

### Contractions Used

H.M.V.: His Master's Voice. Col.: Columbia. Parlo.: Parlophone.  
L.P.O.: London Philharmonic Orchestra. L.S.O.: London Symphony Orchestra.  
Ph.O.: Philharmonic Orchestra. C.O.A.: Concertgebouw Orchestra of Amsterdam.  
O.S.C.C.: L'Orchestre de la Société des Concerts du Conservatoire.  
O.N.R.F.: Orchestre National de la Radiodiffusion Française.  
V.P.O.: Vienna Philharmonic Orchestra. Orch.: Orchestra.  
c.: Conductor.  
(Records listed Decca may be available in the U. S. on the London label, with different numbers, and some may be available as LP's.)

### ORCHESTRAL

Bartok	Concerto for Orchestra. C.O.A. c. van Beinum.	Decca K2042-6
Beethoven	Symphony No. 3. V.P.O. c. Furtwängler.	H.M.V. DB6741-6; DB86747
	Symphony No. 9. Choral Soc. of the Friends of Music and V.P.O. c. Furtwängler.	Col. LX8612-20
	Overture: Coriolan. V.P.O. c. Furtwängler.	H.M.V. DB6625
	Overture: Coriolan. L.P.O. c. Schuricht.	Decca K2079
Brahms	Hungarian Dances Nos. 2 & 3, and Variations on a theme by Haydn. V.P.O. c. Furtwängler.	H.M.V. DB6982-4
Chernblin	Overture: The Water Carrier. Bournemouth Municipal Orch. c. Schwarz.	H.M.V. C3865
Dvorak	Carnaval Overture Op. 92. L.P.O. c. Kleiber.	Decca K2079
Grieg	Symphonic Dances Op. 64. L.S.O. c. Coppola.	Decca K1869-70
Haydn	Symphony No. 100. L.P.O. c. van Beinum.	Decca K1808-10
	Symphony No. 104. L.P.O. c. Krips.	Decca X287-9
Liszt	Hungarian Fantasia. Solomon & Ph.O. c. Süßkind.	H.M.V. C3761-2
Mozart	Masonic Funeral Music, K.477. V.P.O. c. Karajan.	Col. LX1155
Prokofiev	Symphony No. 5. Philharmonic Symphony Orch. of New York. c. Rodinski.	Col. LX1147-51
Ravel	Bolero. O.N.R.F. c. Klitzki.	Col. LX1193-4
	La Valse. O.S.C.C. c. Ansermet.	Decca K1867-8
	L'Enfant et les Sortilèges. Vocalists and O.N.R.F. c. Bour. Sheherazade. O.S.C.C. c. Ansermet.	Col. LX1124-8 and LX81129
		Decca K1966-7
Rimsky-Korsakov	Sheherazade. O.S.C.C. c. Ansermet.	Decca K1980-5
Saint-Saens	Danse Macabre. C.O.A. c. Münch.	Decca K2069
Sibelius	Symphony No. 5. c. Leinsdorf.	Decca K2193-6
Strauss, J.	Emperor Waltz. New Symphony Orch. c. Krips.	Decca K1874
	The Blue Danube. V.P.O. c. von Karajan.	Col. LX1118
Strauss, R.	Metamorphosen. V.P.O. c. von Karajan.	Col. LX1082-4; LX81085
Stravinsky	Concerto in D for Strings. Halle Orch. c. Barbirolli.	H.M.V. C3733-4

[Continued on page 62]



#85 ("La Reine"); #82 ("The Bear").  
HSLP 1008  
#83 ("La Poule"); #84 in E flat.  
HSLP 1015

Here are eight of the remarkable "new" Haydn symphonies that the Haydn Society has dug up, edited and corrected for performance, and recorded in Vienna on tape, and if you have any taste at all for the Haydn-Mozart kind of music (which most of us do) you can't help but be pleased by the flood of music herewith loosed on LP! For years the 104 Haydn symphonies have been "represented" in true democratic manner by about a half-dozen of the later works, played and recorded over and over; those dim and unheard dozens of symphonies were the ones that, as they say, had "failed to hold a place in the repertory."

Whose repertory? Not the Haydn Society's and not mine! This music is a revelation—it'll give you an idea how first rate stuff can sit around in libraries unheard, while people move about muttering about how only the best music "survives." Poppycock. It's usually the worst that survives, I'd say, if you'll pardon my slight cynicism.

Not much use describing individual symphonies here—all the above are from wide-range tape, all but the last done, with excellent acoustics and very good performance, by the Vienna Symphony under Jonathan Sternberg. The last (1015) uses a different group, the Vienna Collegium Musicum under Anton Heiller—excellent playing if a bit rough sometimes, with acoustics somewhat thin and dry compared to the Vienna Symphony. There are many other Haydn items also available in this expanding series, including choral works for them as likes 'em (the "Lord Nelson" Mass, for instance).

Note that the humorous nick-names of the above symphonies were attached according to the then current taste for such whimsies. The musical passages that occasioned them are unimportant and not intended to be taken seriously as program music—the "Hen," for instance ("La Poule") is one of the more thoughtful, dissonant works except for the brief little twitter in the oboe that someone imagined as a chicken! Profound music under an outwardly whimsical surface.

Glazounoff, Violin Concerto in A minor.  
Mozart, Adagio in E, K.261, Rondo in C, K.373, for violin and Orch.  
Milstein; RCA Victor Symphony, Steinberg.

RCA Victor LP:  
LM 1064

Wagner, Tannhauser Overture and Venusberg Music.

Leopold Stokowski & His Orch.,  
Women's Chorus, LM 1066

Wagner, Five Wesendonck Songs.  
Eileen Farrell; Leopold Stokowski & His Orch.

Franck, Symphony in D Minor  
San Francisco Symphony, Monteux.  
LM 1065

Offenbach, Helen of Troy (La Belle Héléne) excerpts.  
Minneapolis Symphony, Dorati,  
LM 22 (10")

A couple of hours of quiet perplexing ear work with the above records preceded the following remarks. Equipment for listening included two separate equalizer-preamplifier systems, one with flat treble, and with 300, 500, and 800-cps bass turnover; the other with variable treble roll-off (to NAB), fixed 500-cps turnover. Question: what is RCA's LP pre-emphasis as revealed by the records... and what is the turnover?

# HARVEY DELIVERS... PROMPTLY EFFICIENTLY... AND AT LOWEST PRICES!

## THE FAMOUS WESTERN ELECTRIC 728B LOUDSPEAKER — AT AN AMAZINGLY LOW PRICE!

Originally \$113.50 Only \$31.20

Designed by Bell Laboratories to meet those requirements where only a relatively small baffle can be utilized. The 728B has a voice coil impedance of 4 ohms and continuous power handling rating of 30 watts. A completely enclosed baffle of only 3 cubic feet is recommended for optimum reproduction. Splendid for home reproducing or P.A. systems. Many broadcast stations use the 728B for critical monitoring. (Model 755-8", Only \$22.35)



**FREQUENCY RANGE:** 88 to 108 megacycles.  
**SENSITIVITY:** Receiver limits on input circuit noise at any frequency in the 88 to 108 megacycle band. For all input signals of four microvolts or more applied to the input terminals, the receiver output signal-to-noise ratio in a band from 50 to 15,000 cycles is within three db of the optimum obtainable at the present state of the art where the limiting noise is

### REL FM RECEIVER

random. **FREQUENCY RESPONSE:** Plus or minus 1 db 30 to 15,000 cycles, including de-emphasis of 75 micro-second time constant. **NOISE SUPPRESSION:** Receiver noise is 70 db or more below output of ten watts for any quieting carrier. **WAVEFORM DISTORTION:** Receiver distortion up through the detector is less than 1% for 100% modulation. The ten watt audio amplifier associated with Model 646-B Receiver has less than 1.5% distortion at full output. **IMAGE REJECTION:** Better than 45 db. **I. F. REJECTION:** Better than 65 db. **OUTPUT:** 10 watts, 500 and 8 ohms. **CONTROLS:** Tuning, Audio input switch, Audio frequency gain, Radio frequency gain, Power switch. **POWER SUPPLY:** 115 volts, 60 cycles, 125 watts.

Price, complete . . . \$345.00

### WILLIAMSON HR-15 AMPLIFIER KIT

The famous Williamson HR-15 amplifier circuit... now available with the original Partridge transformers built to Williamson's specifications. Build this kit in 3 hours or less, and enjoy sound of a quality you never heard before.

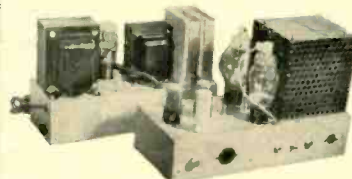

The HR-15 is a 2-Chassis power amplifier for use with tuners or other front ends having own volume and tone controls. All American triodes, 2-6SN7GY, 2-807, or 6BG6G in PP output, 5V4G rectifier. Response ± .5db, 10-100,000 cycles. Output impedances 1.7 to 109 ohms in 8 steps. Absolute gain 70.8 db. 20 db. of feedback around 4 stages and the output transformers. Kit is Complete with Tubes, Punched Chassis, Pre-wired Resistor Board, Sockets, Genuine Partridge Output Transformer, and All Necessary Parts... \$75.00.

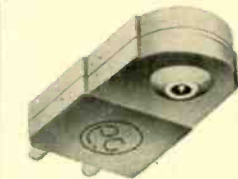

### THE PICKERING CARTRIDGE

Models D-120M, S-120M, D-140S and S-140S, with diamond or sapphire stylus, produce the finest quality reproduction of lateral recordings.

Models D-120M and S-120M are for standard playing records and transcriptions requiring 2.5 mil styli. Models D-140S and S-140S are for long playing, microgroove records, 33 1/3 and 45 RPM.

- Model S-120 M, with .0027" Sapphire stylus, List Price . . . . . \$ 9.90
- Model D-120 M, with .0025" Diamond stylus, List Price . . . . . \$24.90
- Model S-140 S, with .001" Sapphire stylus for long playing Microgroove records, List Price . . . . . \$15.00
- Model D-140 S, with .001" Diamond stylus for long playing Microgroove recordings, List Price . . . . . \$36.00
- Model R-150, less stylus for home phonographs, List Price . . . . . \$ 9.90

VISIT THE AUDIO-TORIUM

Come in and visit our new sound department... all these items and many more on working display at all times.

Telephone: 7-LUXemburg 2-1500

**HARVEY RADIO COMPANY INC.**

103 West 43rd St., New York 18, N. Y.

NOTE: In view of the rapidly changing market conditions, all prices shown are subject to change without notice and are Net, F.O.B., N.Y.C.

# SUPERIOR REPRODUCTION WITH

# Gray

RESEARCH

## TRANSCRIPTION ARMS

### NEW VISCOUS-DAMPED 108-B ARM

For all records—33 1/3, 45 and 78 r.p.m. Radically new suspension development on the viscous damping principle for perfect tracking of records and elimination of tone arm resonances. Instant cartridge change with automatic correct stylus pressure. Solves all transcription problems. Ideal for LP records. For Pickering, new GE (short), old GE (long) cartridges. Write for bulletin. Price, less cartridges, \$56.00 (effective Sept. 1st). Cartridge slides for both GE and Pickering are furnished.



### MODEL 106-SP ARM

Designed to meet strictest requirements of modern highly compliant pick-up cartridges. 3 cartridge slides furnished enable GE 1-mil, 2 1/2-mil or 3-mil cartridges or Pickering cartridge to be slipped into position in a jiffy. No tools or solder! Superb reproduction of 33 1/3, 45 or 78 r.p.m. records. Low vertical inertia, precisely adjustable stylus pressure. Write for bulletin. Price, less cartridges, \$45.15



## EQUALIZERS

### MODEL 603 EQUALIZER

Latest of the universally adopted Gray Equalizers used, with Gray Tone Arms, as standard professional equipment by broadcast stations. High-frequency characteristics obtainable comprise 5 steps — flat, high roll-off, NAB, good records, poor records. For both GE and Pickering cartridges. Price, \$50.70



### MODEL 602 EQUALIZER

Has 4 control positions, highly accurate response curves. Price, \$49.50

Write for bulletins on Gray Equalizers.

**GRAY RESEARCH** and Development Co., Inc.

18 Arbor St., Hartford 1, Conn.

Division of The GRAY MANUFACTURING COMPANY

Originators of the Gray Telephone Pay Station and the Gray Audograph



Answer: it all depends. At least so comparison indicates!

In spite of receipt of much proffered info on the subject (not from RCA) this column remains doubtful—that is, unconvinced of any consistency among the various sections of this company's recording facilities. Where records of most companies now are fairly uniform in sound and general technical characteristics, this batch of records doesn't indicate any such thing.

Briefly, I find that some of the above are noticeably weak in the lower end (as in RCA's of the past) as compared, AB style, with records of other companies. But got all of them. Similarly, the high ends vary—though we must remember that the apparent highs are directly affected by the amount of bass present. These are well known laws of hearing.

The RCA Victor Symphony Orchestra recordings, of Mozart and Glazounoff, sound reasonably wide range, with fine, deep perspective, solid, weakish but adequate bass on 500-cps turnover, highs bright, if not brilliant. But the Wagner records with Stokowski, the Franck with the San Francisco and the Offenbach with the Minneapolis seem still weaker in the bass, when AB-ed. Mike placement and/or acoustics? Perhaps. But note this. With an 800-cps turnover these records come alive, sound on a par with others from other companies at 500 cps. Try it yourself—but make it an AB test.

Let's mention, too, the Toscanini LP's with the NBC Symphony—dead, thin-toned, minus bass to an appalling degree, with indifferently high, and compare them with the contemporary RCA LP of the Beethoven 7th with the Boston Symphony, the extreme opposite is just about all of these respects. An unaccountable difference in which apparent difference in both turnover point and range on the high end may—or may not—be merely a difference in actual recording set-up.

Finally, take the following new LP:  
**The Heart of the Ballet** (Orchestral excerpts).

LM 1083

Leopold Stokowski & His Symphony Orch.

We have all heard the superb, wide-range recordings of this orchestra a year or so back on 45 and 78. This record has a nice, well-bred sound (it is, of course, beautifully played) and it is a shock to find that apparently there is nothing at all in the way of highs on it above 4000 or 5000 cps. Waggle the cut-off switch back and forth—nothing happens. Don't ask me what gives, but again, try it for yourself. Sounds fine on the usual small home machine.

And all of these come from one company. Anybody any information—RCA, for instance?

**Beethoven, Fidelio** (Complete opera)  
Symphony Orch., Chorus, Soloists  
Mitteldeutsche Rundfunk, Leipsic,  
G. Pflüger.

Oceanic LP  
OCLP 301 (3)

**Purcell, The Fairy Queen** (excerpts)  
Cambridge (Mass.) Festival Orch. &  
Chorus, soloists, Pinkham.

Allegro LP  
AL 60 (2 10")

**Wagner, The Flying Dutchman**  
(complete opera)  
Chorus, Orch., Soloists Bavarian State  
Opera, Klemens Krauss.

Mercury LP  
MGL 2 (4)

'Twas about 1900, my dear children, that the operatic excerpt—maximum time, 4



minutes—became popular, thanks to the fact that the human voice, *genus opera*, was the only instrument with the frequency characteristic and the sheer power to manufacture drama and excitement via the acoustical record! If LP has its way, the operatic excerpt is a dead duck. Now, it's whole operas or almost, and these are merely samples from the huge list already available, with lots more coming.

The Fidelio is perhaps the most welcome—an opera that is very seldom heard complete, by the biggest of composers; here it is done, via tape, with a good cast (not tops), an excellent spirit and teamwork, with the original German dialogue included—adding much to the recorded value.

The Wagner Flying Dutchman is of less value musically, being an early opus of Wagner's, and it is relatively more often heard; still, in this full-length portrait the opera comes out stunningly—if only because of the enormous gain in continuity afforded by LP. Wagner never did adjust well to the slice method.

The Fairy Queen was a masque—a sort of 17th century stage show not unlike our musicals today, with plenty of music and dancing. This is the first example of an extensive recording of the music of Purcell, England's top composer since the 16th century, and if you like Bach and Handel you'll find this a new and wonderful variant, in an earlier style, of that sort of music. Good performance, tape recorded with fair-to-good acoustics. Poor surfaces, for LP.

**Bizet, The Fair Maid of Perth.**  
**Delius, Over the Hills and Far Away.**  
Royal Philharmonic, Beecham.

Columbia LP  
ML 2133 (10")

**Bizet, L'Arlésienne Suites #1 and #2.**  
Berlin Philharmonic, Schuricht.

Capitol LP  
1-8098 (10")

Bizet from two very different sources—British and German, though B. was a Frenchman. Beecham's Bizet is fine in the softer parts, with excellent detail work; but the louder parts take on the typical Beecham solidity; which, in French, means "too-heavy." The same approach is ideal for the Delius number, with all its atmospheric, romantic quality. The German Bizet, unexpectedly, is peppy and very much wide awake, and the Telefunken recording merely adds a touch of perfection to the playing. Surfaces aren't perfect.

## AUDIO PATENTS

[from page 6]

conditions bass response is good down to the lowest frequency desired. At the same time, there is a shunt across the output of the first triode consisting of half of  $R_1$  and  $C_1$  in series. Here  $C_1$  is small enough not to cause a loss of highs at the maximum frequency to be transmitted.

Now when the tap on  $R_1$  is moved toward  $C_1$ , the reactance of  $C_1$  becomes a greater part of the shunt, so highs begin to deteriorate. If the tap on  $R_1$  is moved toward  $R_2$ , the reactance of  $C_2$  becomes a more important part of the voltage divider consisting of  $C_2$ ,  $R_2$ , and part of  $R_1$ .  $C_2$  is no longer large enough in comparison to the resistors to pass all the lows, so the bass is attenuated.

The values shown in the diagram were given by the inventor. The tube types were

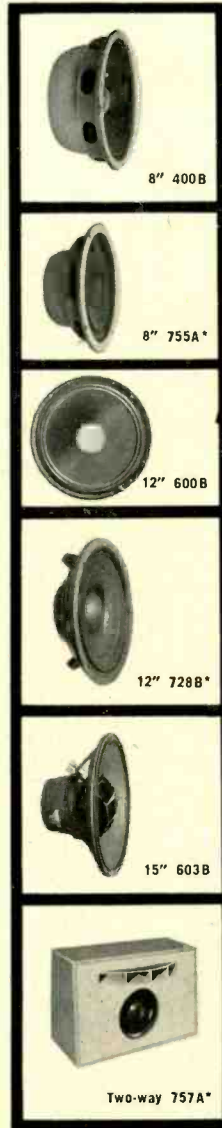

\*Formerly manufactured  
by Western Electric Co., Inc.

It's

**ALTEC**

...for every speaker need

Regardless of stringent restrictions or special requirements, ALTEC can provide a speaker that does the job better . . . and more economically. In every instance ALTEC speakers prove themselves superior with their smooth extended frequency response, efficiency, ruggedness and trouble-free operation. 8, 12 and 15 inch single and diaphone speakers . . . the famous 15 inch two-way "Duplex" . . . complete two-way systems suitable for the largest installations . . . and horns for every conceivable application.

**ALTEC**

...always the finest

Next time you purchase a speaker don't just compare price unit for unit. Instead, compare the truthful way, result for result. If you study what you really get for your investment . . . in quality, efficiency and trouble-free service, you will find that ALTEC is always the best and most economical investment for your audio dollar.

DEALERS EVERYWHERE

9356 Santa Monica Blvd., Beverly Hills, Calif.  
161 Sixth Avenue, New York 13, New York





LIST PRICE  
**\$69.50**



Multi-Impedance Switch  
for Low, Medium or High  
Impedance.

**RICH SATIN-CHROME CASE**

*Each* OF THESE MICROPHONES  
HAS THE **SUPER-CARDIOID**  
PICKUP PATTERN THAT REDUCES  
RANDOM SOUND PICKUP  
BY **73%**

## THE FAMOUS "55" UNIDYNE DYNAMIC

**Unidirectional Microphone.** This superlative dynamic microphone is a Multi-Impedance Microphone—you can have either High, Medium, or Low Impedance simply by turning a switch! Because it is a Super-Cardioid, the "Unidyne" kills Feedback energy by 73%—making it possible to use under the most difficult acoustic conditions. The "Unidyne" is probably the most widely used microphone throughout the world. Recommended for all highest quality general-purpose uses.



LIST PRICE  
**\$3975**

## THE NEW "737A" MONOPLEX CRYSTAL

**Unidirectional Microphone.** The "Monoplex" is the *ONLY* Super-Cardioid Crystal Microphone made. As such, it is undoubtedly the finest of all crystal microphones. (A comparative test will prove this statement convincingly.) The "Monoplex" employs the same type of acoustic phase-shifting network used in the highest cost Shure Broadcast Microphones. Has "Metal Seal" crystal—will withstand adverse climatic conditions. Can be used in those applications where severe background noise would make conventional microphones practically useless!

**RICH SATIN-CHROME CASE**

Licensed under patents of Brush Development Company. Shure patents pending.

**SHURE BROTHERS, Inc.**

*Microphones and Acoustic Devices*



225 West Huron Street, Chicago 10, Illinois • Cable Address: SHUREMICRO

not, but he specifies that the first triode have a plate resistance of 8,000 ohms, which, unless we miss our guess, points straight to our old friends the 6J5 and 6SN7-GT. Figure 6 shows what you can do with this

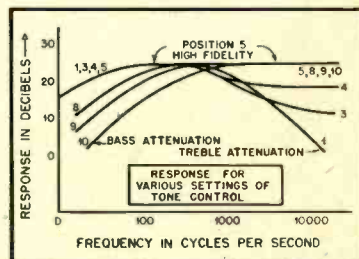

Figure 6

circuit. The numbers identifying the curves refer to a dial plate linearly calibrated from 1 to 10, assuming that the .05-meg potentiometer has a linear "taper." Complete counterclockwise rotation (1) gives maximum treble attenuation.

A copy of any U. S. patent may be obtained for 25¢ from the Commissioner of Patents, Washington 25, D. C.

## FLEWELLING SYSTEM

[from page 17]

try for one of the big companies to part with many, many bucks.

### Conclusions

To sum up: The system consists of the amplifier as described, the air column, and six loud speakers. These speakers are to be of the cheap or garden variety, and are to be placed as follows. In the high side of the dividing network use a tweeter, a 6-inch, and a 12-inch speaker; most anything will do as a baffle for these speakers. In the low side of the network use a 12-inch speaker in the air column, hide the column behind a divan or such, and connect with it two 8-inch speakers mounted on any convenient baffle. All speakers are standard 6- or 8-ohm speakers, and must make some sort of an impedance match with the output circuit.

In the low side we run afoul of our theory, but, as I have said, we know very little about the air column. It is well known that the impedance of a loaded speaker is quite different from that of a free wheeling speaker, and that these columns do load the speaker. We need to know lots more about the columns.

All of the speakers are concealed, for the psychological effect of a speaker opening is bad. Remember, of course, that the high-frequency speakers will show directional effects, and should be placed with that in mind.

It may well be that another article could be written on the subject of pitfalls in sound reproduction, with particular reference to this system.



## TAPE RECORDER

[from page 20]

could be accessible. At 33 1/3 r.p.m. over one and one-quarter hours of recording is possible. This slow speed is entirely satisfactory for transcribing long speeches and sports broadcasts.

The capstan was turned out of steel to the tolerance of one-thousandth of an inch. The capstan, which has a diameter of 1.865 inches, is large enough so that flutter will be negligible, but unless it is carefully machined, "wow" will be of sufficient magnitude that the performance of the recorder will be seriously impaired. The capstan was bolted to the turntable platter utilizing the four existing bolts. It should be kept in mind that the capstan as described above, is one of the two most important parts of the completed recorder. A chair caster fastened to a hinge underneath the steel top was used as a pressure roller. A steel spring keeps the proper tension on the tape.

### Amplifier Section

For the amplifier section, the basic Brush amplifier was used with a few modifications and improvements. The modified circuit is shown in Fig. 1. The push buttons on the Brush machine were replaced by a three-position rotary switch that selects the record or play circuits. This switch also operates the reverse motor for rewind purposes. The amplifier and speaker were mounted inside of the turntable cabinet so that tubes and components could be reached easily. The turntable power switch was left on the side of the cabinet and also wired to operate the take-up motor. The mechanical fingers were discarded, and the play heads were positioned to give the desired tape pressure. Adjustments of these heads is done from the top of the cabinet by individual bolts that allow both horizontal and vertical movement.

By installing an additional playback head following the recording head, and using with a simple two-stage pre-amplifier such as shown in Fig. 2, it is possible to monitor the tape during recording.

Since the amplifier is located in the turntable cabinet, and is some distance from the high-impedance heads, crystal microphone cable is used for wiring. Wiring of the amplifier is the same as for any high-gain amplifier. Care should be taken to position the power transformer as far as possible from the recording head. In this particular machine, the input transformer is of the bridging type. When using the slow speed, considerably more high-frequency boost will be needed than for 7.5 inches per second: this is done by adjusting  $R_{42}$  for flat re-

## Newest AMPEX

### HIGH FIDELITY MAGNETIC TAPE RECORDER Model 400

**T**ERMINAL brings you this new incomparable 15,000 cycle performance at 7 1/2 inches per second that equals the performance of 15 IPS full-track recorders and gives 4 to 1 savings in tape cost.



**\$795<sup>00</sup>**

### 2 FULL HOURS OF PROGRAM MATERIAL CAN BE COMBINED ON ONE 10" REEL

**METER & OUTPUT SWITCH** — Position "B" (Level), connects meter "Line Output" plug, and "Phones" monitor plug to the output of the playback for monitoring of playback, while recording or playing back tapes. Position "A" connects "Line Output" plug, and "Phones" monitor plug to the record amplifier for direct monitor of the incoming program. Under position "A" there are three switch positions designated: LEVEL — which connects the meter to measure record volume level.

**BIAS**—which connects the meter to indicate proper record bias.

**ERASE**—which connects the meter to indicate proper erase current.

**SPEED CHANGE** — Toggle switch permits quick choice of 7 1/2 or 15 i.p.s. tape drive speeds.

**RECORD BIAS ADJUSTMENT** — Biased for maximum output of 1000 cycle tone (factory adjusted).

**7 1/2"-15" EQUALIZATION** — Adjusts electronics for proper operation at 7 1/2 or 15 i.p.s.

**INPUT TRANSFER SWITCH** — Properly connects input plug for: I) 200 ohm microphones such as R.C.A., 44BX, KB-2C, etc. II) Balanced bridge for bridging telephone lines or balanced studio lines. III) Unbalanced bridge 100,000 ohm input for radio tuner, phono pre-amp, bridging public address equipment or unbalanced studio lines.

**FOUR-INCH "VU" METER** — Volume level meter used to indicate proper record volume level. This instrument can be switched for several functions as listed under "Meter & Output Switch."

**OUTPUT LINE TERMINATION SWITCH** — Places 600 ohm terminator across amplifier when same is not externally loaded (This is necessary for proper meter calibration).

**OPERATION SELECTOR** — Switch provides for normal forward or fast forward or fast rewind.



## FREE WRITE FOR YOUR PORTFOLIO OF 15 IDEAS FOR CUSTOM RADIO-PHONOGRAPH INSTALLATIONS.

This profusely illustrated booklet gives you actual photos of installations in typical room settings.

VISIT US IN ROOM No. 622  
AT THE AUDIO FAIR OCT. 26-28

# TERMINAL RADIO CORPORATION

Distributors of Radio & Electronic Equipment

85 CORTLANDT ST., NEW YORK 7, N. Y. • WOrth 4-3311 • Cable: TERMRADIO

# "Have some pudding?"

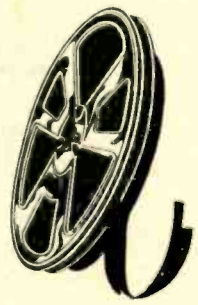

You have to try it before you can appreciate the taste—until then—you can't prove it's good.

"The proof of the pudding is in the eating" is a time-worn adage—and, if it's been around so long, there's a chance that there is a lot of common sense packed in those few words.

We don't mean to suggest that Soundcraft discs taste good. What we would like to get over is that, until you try Soundcraft products, we can talk our heads off about how good they are.

Use Soundcraft products in your operations—you'll prove for yourself that all Soundcraft recording media will guarantee you the one thing they are designed for -- the best possible performance in recording sound.

**SOUNDCRAFT'S ONLY CLAIM IS ITS PROOF OF PERFORMANCE**

REEVES — "20 YEARS WITH SOUND RECORDING MEDIA."

**REEVES Soundcraft CORP.**  
35-54 36th STREET, LONG ISLAND CITY 6, N. Y.

EXPORT—REEVES EQUIPMENT CORP. • 10 E. 52ND, N. Y. 22, N. Y.

sponse at slow speed and then using  $R_p$  for the high-frequency roll off at the 7.5-inch speed.

This tape recorder has been in operation several months and has proven itself

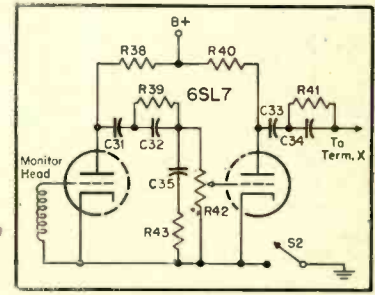

Fig. 2. Schematic of simple preamplifier stage used with a monitor head and a speaker amplifier of the original Brush unit.

to be as good as many on the market costing several times as much. No claim is made by the author as to the originality of the recorder, nor that it is necessarily the answer to all tape recorder problems, but if care is used in building a recorder similar to the one described, the result will be a recorder of broadcast quality plus economy.

**PARTS LIST**

- R<sub>1</sub>, R<sub>6</sub>, R<sub>10</sub> 1000 ohms
- R<sub>2</sub>, R<sub>13</sub>, R<sub>15</sub>, R<sub>17</sub>, R<sub>25</sub>, R<sub>30</sub> 1.0 meg.
- R<sub>3</sub> 0.3 meg.
- R<sub>4</sub> 1.0 meg. playback volume
- R<sub>5</sub>, R<sub>16</sub> 50,000 ohms
- R<sub>7</sub> 0.5 meg. screwdriver set
- R<sub>8</sub>, R<sub>12</sub> 50,000 ohms, screwdriver set
- R<sub>9</sub> 1.0 meg. record volume
- R<sub>11</sub>, R<sub>34</sub> 10,000 ohms
- R<sub>14</sub>, R<sub>19</sub> 25,000 ohms
- R<sub>18</sub> 33,000 ohms
- R<sub>18</sub>, R<sub>31</sub>, R<sub>32</sub>, R<sub>20</sub>, R<sub>30</sub> 0.1 meg.
- R<sub>20</sub>, R<sub>30</sub> 15,000 ohms
- R<sub>22</sub> 500 ohms
- R<sub>34</sub> 60,000 ohms
- R<sub>35</sub>, R<sub>37</sub> 2000 ohms
- R<sub>38</sub>, R<sub>41</sub> 0.47 meg.
- R<sub>39</sub> 700 ohms
- R<sub>40</sub>, R<sub>42</sub>, R<sub>43</sub> 30,000 ohms
- R<sub>44</sub> 4 ohms
- R<sub>45</sub> 300 ohms
- R<sub>46</sub> 0.5 meg.
- R<sub>47</sub> 1.0 meg. monitor volume
- C<sub>1</sub>, C<sub>5</sub>, C<sub>9</sub>, C<sub>24</sub>, C<sub>25</sub>, C<sub>27</sub>, C<sub>28</sub>, C<sub>29</sub>, C<sub>30</sub> 20 μf, electrolytic
- C<sub>2</sub>, C<sub>14</sub> 0.25 μf
- C<sub>3</sub>, C<sub>13</sub> .02 μf
- C<sub>4</sub>, C<sub>6</sub>, C<sub>23</sub>, C<sub>26</sub>, C<sub>31</sub> .05 μf
- C<sub>8</sub>, C<sub>11</sub>, C<sub>32</sub> .0005 μf
- C<sub>7</sub>, C<sub>12</sub>, C<sub>19</sub>, C<sub>30</sub>, C<sub>33</sub> .01 μf
- C<sub>10</sub> 40-40 μf, electrolytic
- C<sub>15</sub>, C<sub>18</sub>, C<sub>21</sub>, C<sub>22</sub> .001 μf
- C<sub>16</sub> 0.1 μf
- C<sub>17</sub> .0001 μf
- C<sub>34</sub> .01 to .03 μf, depending upon head
- S<sub>1</sub> 3-gang, 3-pos. rotary switch
- S<sub>2</sub> SPST, mounted on R<sub>45</sub>
- S<sub>3</sub>, S<sub>4</sub> SPST toggle switch



## ACOUSTICS IMPACT ON MUSIC

[from page 21]

Thus it appears that the Greeks appreciated the main acoustical function of any building used for the dissemination of entertainment or information. In modern terms, such a building is a transmission system whose fundamental object is to convey sound from the source to the listener with as little loss or distortion as possible. This, of course, is the same objective as that of a broadcasting system, and we can now explore an interesting analogy. Throughout the existence of radio, it has been an acknowledged fact that the average domestic receiver has distorted the transmission by introducing a considerable loss in the higher audible frequencies, and in a matter of some twenty-five years or less, this state of affairs appears to have produced a considerable number of people who actually prefer their music (and maybe their speech) distorted in this way. If, by a stretch of the imagination, we can picture the passing of several centuries during which music could be heard only with such a top cut, it is reasonable to assume that a reversion to "wide-band" reproduction would be extremely unpopular, especially as by then the great mass of music would have been composed to suit the restricted conditions. By this time, what we would now call distortion would have become desirable reproduction.

### Distortion in Architectural Acoustics

Since the time of the Greeks, something similar has been happening in the realm of architectural acoustics, so that we have come to accept as actively desirable a condition which in the strict sense is a distortion, so let us elaborate on this apparently rather sweeping statement. As civilization and culture spread northwards throughout Europe, although even in Shakespearian England only the best seats were under cover. But in course of time, almost all places where music and plays were performed acquired four walls and a roof enclosing both players and audience, and, of course, introducing reverberation or the prolonging of each sound beyond its original duration, undeniably a distortion in the strict sense of the word. But here the complications set in: the musicians of the day, probably without realizing it, set to work to make use of this unavoidable reverberation by suiting their music to the conditions under which it was most usually played, with such success that, for example, the organ works of Bach played in a dead studio rather than

# Air-Tone

## HEADQUARTERS FOR MAGNACORD.



**MAGNACORD PT6-JA  
RECORDER &  
AMPLIFIER**

Portable rig for superb professional sound reproduction. Easy operating, exceptional high fidelity, the finest in Magnetic recording. 10 watts output.

Complete Systems from \$548

### MCINTOSH AMPLIFIERS

Highest quality, efficiency. Full dynamic range. Frequency range—20 to 20,000 plus or minus 0.2 db; 10 to 200,000 plus or minus 2 db. Lowest phase shift distortion; lowest noise level.

50W-2 for less than 1% distortion  
 • Continuous single freq. rating  
 • 50 watts RMS—Peak 100  
**\$249.50 net**

20W-2 for less than 1% distortion  
 • Continuous single freq. rating  
 • 20 watts RMS—Peak 40  
**\$149.50 net**

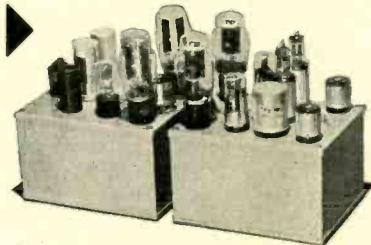

### PROCTOR SOUNDEX PLAYBACK UNIT FLOATING DISC DRIVE MULTI- SPEED TURNTABLE

20 to 120 R.P.M. Instantly shifts to 33 1/3, 45, 78 R.P.M. Eliminates speed variations. Uses faster lightweight components. 16" turntable.

Turntable . . . \$159.50 net

### NEW SOUNDEX PICKUP ARM

Interchangeable cartridge carriers. Instant substitution of standard or microgroove cartridges. Self-contained stylus pressure scale. Precise pressure adjustment in grams.

Arm . . . . . \$39.60 net

### ELECTRO-VOICE MICROPHONE #650

Response  $\pm 2.5$  db, 40-15,000 cps. Extremely high output level—46 db. Impedance selector. External shock mount. Non-metallic Acoustalloy diaphragm. Individually laboratory calibrated.

**\$90 net**

*Electro-Voice Microphones used exclusively at Robin Hood Dell concerts.*

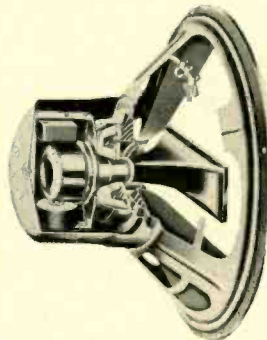

### UNIVERSITY CO-AXIAL LOUDSPEAKER #6201

Response 50-15,000 cps. 25 watts, continuous. Impedance 8 ohms. Dual range principle. Wide angle dispersion. Easily, quickly installed. 12 5/8" dia., 8" deep. Universal application.

**\$45.00 net**

# Air-Tone

**SOUND & RECORDING COMPANY**

1527 CHESTNUT ST., PHILA. 2, PA. — RI. 6-8388

# SONOCRAFT

Headquarters for  
**SOUND - RECORDING  
EQUIPMENT**



*...invites you to visit  
our new sound display studio  
for demonstration of the following equipment  
and accessories:*

- ALTEC-LANSING
- AUDIO DEVICES
- ATLAS
- BELL
- CALIFONE
- CAPPS STYLI
- CARTER
- ELECTRO VOICE
- GRAY
- MAGNECORD
- MINNESOTA MINING
- PENTRON
- PICKERING
- PRESTO
- PROCTOR
- RADIO CRAFTSMEN
- RECOTON
- REK-O-KUT
- REVERE
- SHURE
- SOUNDCRAFT
- WEBSTER ELECTRIC
- WESTERN ELECTRIC
- WILCOX-GAY  
AND OTHERS

## SONOCRAFT

CORPORATION

**3rd floor** • 115 West 45th Street, New York 19, N. Y.  
Next to Times Square LUXemburg 2-1750

a live church would be quite intolerable.

Thus the theoretical distortion has become in course of time a desirable condition and designers of new concert halls and studios have to give a great deal of thought to the amount of reverberation which their buildings shall introduce at various frequencies. But at once they run up against a serious difficulty, because since the days of the earliest composers, the conditions for which music was written have been continually changing. Worse still, one composer might write in two or more completely different styles depending on where the music was to be performed. To take Bach as an example again, his choral and organ works were written to suit comparatively live stone churches (many of them for the Thomaskirche in Leipzig), while his chamber music, Brandenburg Concertos and the famous 48 Preludes and Fugues were designed for the music rooms and drawing rooms of various German Princes.

The music room played a large part too in the life of Haydn, but by the time of Mozart, the opera house, with quite different acoustical characteristics, was influencing more and more composers. In the history of music, however, nothing stands still: the opera house itself developed until by the 1870's we find Wagner designing his own at Bayreuth and incorporating in it many original acoustical features, which he considered his music demanded. To name only one, the orchestra pit at Bayreuth, large enough to accommodate a full Wagnerian symphony orchestra, is mainly underneath the stage, instead of between it and the audience, with quite a narrow gap through which the music emerges. This was done to overcome the effect of the orchestra interposing itself between the singers and the listeners, and at the same time it allowed the composer to indulge in much fuller and richer accompaniments, without drowning the vocal parts, than would be tolerable if the orchestra were in the open. Acoustically, however, the Bayreuth pit provides an example of coupled enclosures having two different reverberation times, so that it is difficult, if not impossible, to reproduce in a concert hall or studio the effect that Wagner himself desired.

In the same way that styles of composing developed along several different lines at once, we find that standards and conditions of performance changed too. The small orchestras of Bach and Haydn gave place to bigger and bigger combinations, until by the time of Hector Berlioz, we reach the complement of approximately one hundred players which has lasted until today. This change, of course, demanded a corresponding enlargement of the Concert halls (accompanied by inevitable changes



in acoustical properties) giving us such places as the Carnegie Hall in New York, or the Royal Albert Hall in London, where Bach and Haydn would probably have felt completely out of place.

From all this, it would seem that the job of the present day acoustical designer is a difficult, if not an impossible one; but fortunately human taste and human ears both have wide tolerances, and especially in the concert hall field the skilled designer is able to effect a compromise which is reasonably satisfactory to all but the most extreme purists. After all, most lovers of Bach's organ music are quite content to hear it played on a good modern instrument and do not insist on the use of a Baroque organ such as exists at Harvard, while Mozart symphonies are regularly played by orchestras which would have seemed fantastically large to the composer himself. So, by analogy, it is unreasonable to demand that present day listening conditions shall exactly reproduce those for which the composer wrote, although naturally the more nearly we approach them, the closer will we be to complete harmony with, and appreciation of, the composer's ideas and thoughts.

The case of the broadcast studio is admittedly even more complicated, mainly owing to the interpolation of a monaural transmission system between the studio and the listener at home, but this subject has been extensively dealt with in a number of recent articles, and there is therefore no need to enlarge upon it here. However, there is an added problem for the designer that for economic reasons he can seldom if ever provide for as many different sizes and types of studio in any one radio station as purely acoustical reasoning would require. Thus further compromise is necessary, although in some cases a greater variety of acoustic conditions is achieved by the use of variable wall treatment. In practice, however, studios with variable acoustics normally demand from the operating staff a degree of knowledge and skill that is often lacking. In short, few people would dispute the statement that a great deal of work remains to be done on this subject, and, to return to the metaphor of the first paragraph, the undergrowth is still very thick.

#### A New Approach

In conclusion, we may examine in some detail an entirely new approach to the problem, the results of which have aroused considerable interest in acoustical circles. Paradoxically enough, this approach is derived almost directly from the theaters of Ancient Greece. The great mass of modern acoustical theory has been built up around the assumption made by Sabine that sound in an enclosed space dies away logarithmically,



## CHICAGO FULL FREQUENCY OUTPUT TRANSFORMERS

**.2db** 30-20,000 CPS

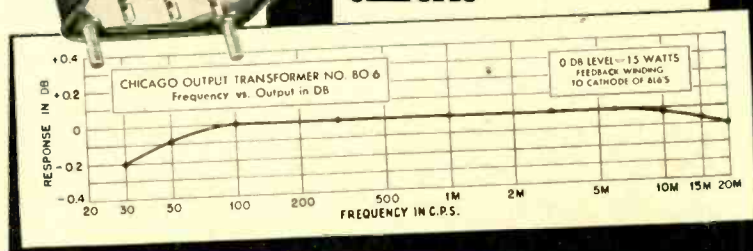

**No. BO-6.** For use in high fidelity amplifiers. Couples push-pull 6L6's (7500 ohms, C-T) to 6/8 or 16/20-ohm voice coil. Center-tapped tertiary winding provides 15% inverse feedback to reduce harmonic distortion to a minimum. In drawn steel case, 4 $\frac{1}{16}$ " x 3 $\frac{7}{8}$ " x 3 $\frac{11}{16}$ ", with mounting studs and convenient pin-type terminals.

**No. BO-7.** For matching 600 or 150-ohm line to a 6/8 or 16/20-ohm voice coil. Frequency response within plus or minus 1db. at full rated output—maximum power level, 30 watts. Mounted in compound-filled drawn steel case, 4 $\frac{1}{16}$ " x 3 $\frac{7}{8}$ " x 3 $\frac{11}{16}$ ". Mounting studs and pin-type terminals same as No. BO-6 illustrated above.

There's a CHICAGO Output Transformer for Every Full Frequency Use

Cat. No.	Application	Impedance	Max. Power
BO-1	Single Plate to Line	Pri.—15,000 ohms at 0 to 10 ma d-c *Sec.—600/150 ohms CT	+20 dbm
BO-2	P.P. Plates to Line	*Pri.—20,000 ohms CT *Sec.—600/150 ohms CT	+30 dbm
BO-3	P.P. Plates to Line	Pri.—5,000 ohms CT *Sec.—600/150 ohms CT	+40 dbm
BO-4	P.P. Plates to Line	Pri.—7,500 ohms CT *Sec.—600/150 ohms CT	+43 dbm
BO-5	P.P. Plates to Line	Pri.—10,000 ohms CT *Sec.—600/150 ohms CT; 16/8/4 ohms.	+37 dbm

‡Tertiary winding provides 15% inverse feedback. \*Split and balanced windings.

### HIGH Q CHOKES

for Dynamic Noise Suppression Circuits



Two precision-built chokes with inductance values of .8 and 2.4 henrys respectively—accurate to within  $\pm 5\%$  with up to 15 ma d-c. Units have a minimum Q of 20. Remarkably compact, 1 $\frac{1}{4}$ " x 2 $\frac{3}{8}$ " x 1 $\frac{3}{16}$ ".

No.	Inductance
NSI-1	.8 h
NSI-2	2.4 h

### Famous "Sealed in Steel" New Equipment Line

The units described above are typical of CT's New Equipment Line featuring transformer engineering that's ahead of the trends in circuit design. Get the full facts on the complete line now. Check the features, and you'll see why CT is called the "Engineer's Transformer." Check the prices: see how little more these advanced units cost over ordinary transformers.

Write for Complete "New Equipment" Catalog Today



## CHICAGO TRANSFORMER

DIVISION OF ESSEX WIRE CORPORATION

3501 ADDISON STREET • CHICAGO 18, ILLINOIS

**CABINETS • CHASSIS • PANELS • RACKS**

**Planning ELECTRONIC EQUIPMENT ?  
Investigate the ECONOMIES  
of PAR-METAL HOUSINGS !**

We manufacture Metal Housings for every purpose — from a small receiver to a deluxe broadcast transmitter. And the cost is low!

Because we specialize in the Electronics field, Par-Metal Products excel in functional streamlined design, rugged construction, beautiful finish, and economy.

Remember, Par-Metal equipment is made by electronic specialists, not just a sheet metal shop.

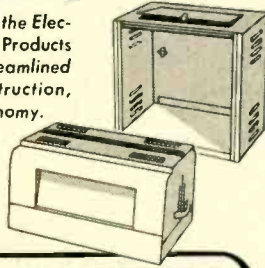

**PAR-METAL**  
PRODUCTS CORPORATION  
32-62 — 49th ST., LONG ISLAND CITY 3, N. Y.  
Export Dept.: Roche International Corp.  
13 East 40 Street, New York 16, N. Y.



**WRITE FOR CATALOG !**

**AUDIO ENGINEERING SUPPLIES • KEYS  
PANELS • PLUGS • POWER SUPPLIES**

**GAIN SETS • TRANSFORMERS  
EQUALIZERS • KNOBS • DIALS**

**WRITE FOR  
FREE  
1950 CATALOG**

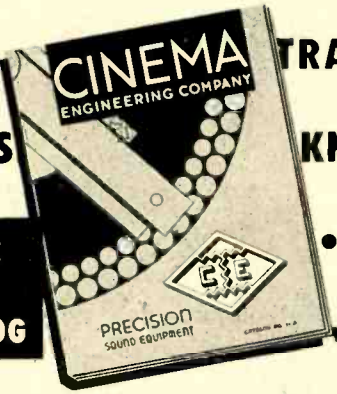

**• VU METERS  
• DB METERS**

**TRANSMISSION LINE • TERMINAL BLOCKS  
AMPLIFIERS • PATCH CORDS • FILTERS**

See us at The Audio Fair, Room 516

**CINEMA ENGINEERING COMPANY**  
1510 WEST VERDUGO AVENUE, BURBANK, CALIFORNIA

Export Agents: Frazer & Hansen, Ltd. • 301 Clay Street • San Francisco, Calif., U. S. A.

as at (a) of Fig. 2. Yet, as anyone who has measured decay curves knows, cases often arise when this does not hold even approximately, the usual departure being a fairly quick drop at the beginning of the decay followed by a much slower tail, as in curve (b) of Fig. 2. If this state of affairs is found to occur in many positions in a hall or studio, it represents a definite fault, since a little thought will show that it corresponds to comparatively little reinforcement of the sound, but plenty of muddling due to prolonged reverberation at fairly low level. This at once suggests that decay curve which displays a slow initial drop, followed by a quick cut-off as in curve (c) might correspond to even better listening conditions than the theoretical ideal of (a), since it would indicate maximum reinforcement with a minimum of muddling. It has already been pointed out that this is just what occurred in the theaters of Ancient Greece, where the "skene" and "orchestra" gave reinforcement, while the absence of any enclosure avoided reverberation. And, much more recently it would seem that the same principle has been applied, perhaps without too clear an appreciation of the underlying logic. One example is the "live-end, dead-end" technique of studio construction, the name being self-explanatory. In a studio of this type, the performers occupy the live end, while the microphone is placed in the end which is acoustically dead, the analogy with the Greek theater being obvious. However, this is not an ideal application of the principle under discussion, since the live end itself will have a definite reverberation time, unless its walls are very carefully arranged. An elaboration of the idea brings us to the famous Disney bandshell used for the recording of Fantasia, which created quite a sensation in the Acoustics world. Here, the live end of the studio (or the skene of the Greeks) was replaced by a bandshell, the polycylindrical walls of which were so shaped as to direct as many reflections as possible of the original sound through the open front into the dead sound stage, the main function of which had been reduced to keeping rain and extraneous sound away from the microphone. Of course, this particular arrangement is hardly suitable for broadcast use, but if the arguments which have been put forward to explain the acoustical excellence of the Disney bandshell are correct, it remains to apply them to the design of studios. This would involve a construction similar to that of the live-end dead-end type, except that the design of the walls and ceiling in the live end would be directed mainly to delivering as much reflected sound as possible into the dead end, where it would be



absorbed as completely as possible. This is illustrated diagrammatically in Fig. 3. A studio of this type, it is felt, ought to act as a very efficient transmission system, giving the illusion of reverberation owing to the slow initial drop of its decay curve, but giving increased clarity due to the quick cut-off.

These last conclusions are so far entirely theoretical, and would need to be confirmed by experiment. Unfortunately, while an audio designer can so readily try out new ideas in amplifiers at almost negligible cost, the acoustical designer nearly always requires a large construction job to test any new theories, and the cost of failure is very high. Doubtless this is one of the main reasons why progress in the field of acoustics is often so painfully slow.

## SOUND REINFORCING SYSTEMS

[from page 28]

as to give optimum coverage over the entire seating area, which extends over a radius of 140 deg. with a maximum projection distance of approximately 250 feet. Into this system is fed a total of 400 watts of audio energy, divided 100 watts into each of the three center speakers and 50 watts into each of the two outside speakers. Controls are provided on each loudspeaker amplifier to proportion the amount of energy into the speakers to give uniform distribution over the seating area. The average power required in this system is approximately 75 watts.

The input system is made up of 15 to 17 microphones arranged in six groups. A remote control is located some 250 feet from the stage, directly in audience area. The operator blends the amplified sound with the actual sound for the best results, which, in this case, means adding just enough of the amplified sound to permit comfortable listening without the audience realizing that the concert is being reinforced.

In this particular installation—as in many others—sounds from the orchestra are picked up with multiple microphones, and the results are mixed electrically to get a combined signal. This results in an electrical mix which, when added to the acoustic energy of the orchestra, makes it sound as though the whole orchestra were playing sufficiently loud so as not to require a sound reinforcing system. That, of course, is ideal. It was accomplished to a very high degree in this installation.

Another installation of note is located at the same college in the Great Hall. This installation was a most difficult one in view of the fact that the large, curved rear wall of the hall is a perfect

reflector for sound originating on the stage, and when attempts are made to boost the acoustic output to the point where people can hear throughout the hall, the reflecting sounds cause loss of intelligibility. In this hall, the problem was corrected by installing a sound reinforcing system with a loudspeaker suspended on a single pendant support from the ceiling. Sounds originating from a relatively weak source are amplified through the loudspeaker, and its output is directed into the audience area with a minimum amount falling on the rear and side walls. In this way the intelligibility has been improved so that

it is possible to hear and understand throughout the entire seating area. In the Great Hall the path-length difference between the orator and the loudspeaker is never greater than 60 feet in any part of the auditorium where amplified sound is received. Therefore, the illusion is remarkably good.

### Multiple-Speaker Problems

One large reinforcing system, which for a while was almost a failure, was that part of the official World's Fair sound system at the Court of Peace. Approximately ninety thousand people were assembled in a "U" shaped area,

## leading audio engineers choose BROWNING FM-AM TUNERS for discriminating listeners

MODEL  
RJ-20A

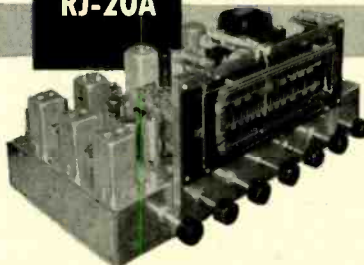

### MODEL RJ-20A FM-AM TUNER

- Armstrong FM circuit; 20 db quieting with  $6\frac{1}{2}$  microvolts
- Separate r.f. and i.f. on both bands
- AFC on FM with ON/OFF switch
- AM bandwidth selection, 9 kc. and 4 kc.
- Drift-compensated
- FM audio 15-15,000 cycles  $\pm 1\frac{1}{2}$  db
- 20 db treble and bass boost
- self-contained power supply.

### MODEL RJ-12B FM-AM TUNER

- Armstrong FM circuit; 20 db quieting with less than 10 microvolts
- Separate r.f. and i.f. on both bands
- AFC on FM with ON/OFF switch
- Drift-compensated
- FM audio 15-15,000 cycles  $\pm 1\frac{1}{2}$  db
- AM audio 20-6600 cycles  $\pm 3$  db
- Triple-tuned i.f.

MODEL  
RV-10A

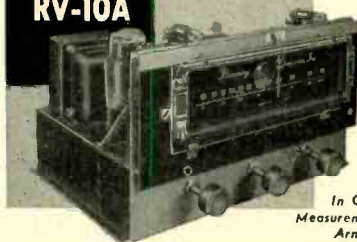

### MODEL RV-10A FM TUNER

- Armstrong FM circuit; less than 10 microvolts for complete limiting
- AFC with ON/OFF switch
- 2-stage cascade limiter
- Tuned r.f. stage
- Drift-compensated
- High impedance output.

Learn the full specifications for Browning high-fidelity — write for complete performance curves and data on these models.

In Canada, address:  
Measurements Engineering Ltd.  
Auriprior, Ontario.

**BROWNING**  
Laboratories, Inc.  
Winchester, Mass.



ENGINEERED  
FOR  
ENGINEERS

surrounded on two sides by the exhibits of various nations and the tremendously large Federal Building which was the exhibit of the United States. The podium was erected on the steps of the Federal Building, and loudspeakers were at a level of about 150 ft., built behind grilles in the front of the building. Two RCA twin-power speakers were used, each being supplied with 100 watts of audio. At the last minute, just before the dedication, the radio director insisted that we install additional horns along the sides of the Court of Peace because he was afraid the people would not be able to hear distinctly. During the first part of the

ceremony the people heard many confusing sounds, first from the nearest speaker and then from other speakers that covered the same area. After we were advised at the master control desk that this was happening, we cut off the side speakers and projected the sound only from the top of the Federal Building, and with far better results. This setup was never designed as a sound reinforcing system, but it was used that way on the opening day.

A makeshift and compromise sound reinforcing system is now in use at the General Assembly of the United Nations out at Flushing Meadow.<sup>1</sup> The term "compromise" is used in view of

the fact that the nature of the room does not lend itself to a true sound reinforcing system. The room is fairly large but has a balcony which overhangs the first floor to a considerable degree. This overhang prevents any possibility of feeding sound from the main cluster of cellular horns which are directly over the podium. It was therefore necessary to put a number of small speakers on the ceiling underneath the balcony. In this area, which covers a depth of 20 to 30 rows of seats, there is a total of 66 loudspeakers because the ceiling is low and the area must be blanketed with low-level sound. Thus the auditors are not too conscious that the speaker is in their immediate vicinity. One other compromise was effected by putting an additional loudspeaker half way back from the podium, towards the rear wall, to cover the balcony exclusively. This speaker could be dispensed with if the delegates and press were attentive. However, the compromise, insofar as illusion is concerned, was made to permit those in the balcony area to hear all of the proceedings.

It must be borne in mind that these compromises are acceptable because it is not the prime intent of the United Nations to put on a show. The main purpose is to have the spoken word of the delegate heard by all in the seating area with 100 per cent intelligibility. To reach this condition, some compromises are acceptable.

Sound reinforcing systems for the ordinary broadcast are relatively simple. All that is necessary is to install one or two high-quality commercial loudspeakers in the approximate center of the proscenium and directed to cover the audience area. Very little trouble with feedback is encountered because the microphones are in close proximity to the sound to be picked up. For an orchestra, of course, no amplification is required because most broadcasts take place in relatively small halls.

In a television studio, the actor or the sound producing device is no longer relatively close to the microphone, because the latter must be kept out of the field of the camera. Consequently, it is not possible to locate loudspeakers where they previously were because of the feedback problem. The solution is to put a number of high-quality loudspeakers throughout the seating area. These speakers are connected to their own amplifier with separate gain control, and the amplifiers bridge the output of the audio system picking, being cut off only when the applause microphones are used. Experience by NBC at the International Theater has indicated that the type of



## THE MOST ENJOYABLE QUALITY AMPLIFIER for MUSIC REPRODUCTION

A Twelve-Watt Full-Range High-Fidelity Amplifier with three distinctive SOMERSET developments.

1. The Somerset Dynamic Noise Suppressor which eliminates substantially all surface noise without loss of desired high frequencies.
2. A unique multiple feedback circuit which accomplishes extraordinarily effective loudspeaker damping and substantial improvement in bass tone response without distortion or intermodulation.
3. The new Somerset cathode-follower remote control circuit and 15-foot control extension; all controls mounted in small separate case, containing no tubes or high voltages, and all without loss in quality reproduction.

**Somerset** LABORATORIES, INC.  
1701 PALISADE AVENUE, UNION CITY, N. J.

<sup>1</sup> A. W. Schneider, "Broadcast and Public Address Systems," AUDIO ENGINEERING, Aug. 1947.



speaker used is most important. It has been found impossible and impractical to get by with an inexpensive speaker. One is required which has an excellent and smooth high-frequency response so that the audience can understand every word. Part of the reaction upon the radio or television audience, as well as the sponsor, is the reaction of the audience in the theater. If the audience cannot understand what the actor is saying, a gag may be missed and the audience does not laugh when it is supposed to. Sponsors are prone to blame the sound reinforcing system for many an "egg" laid on a television program.

In the International Theater, a total of six twin-cone speakers are used to cover the balcony, and approximately four cover the orchestra floor. Illusion is compromised in this case, but illusion is not the primary intent. A compromise is possible because the programs are not intended primarily to entertain the people in the theater, but to entertain millions in their homes so they will go out and buy the products advertised by the sponsor.

## DISTORTION AND NOISE METER

[from page 23]

izing the high-pass characteristics of the low-frequency filters. Using the 400-cps filter will effectively eliminate the hum but will leave the bulk of the noise. In turn, the frequency distribution of the remaining noise can be studied by using the other high pass filters and noting the remaining noise. With no filters in the circuit, viewing the hum and noise output on a scope with the sweep in sync with the 60- or 120-cps hum, the random noise will appear as a high-frequency modulation on the low-frequency hum. Inserting the 400-cps filter will remove the low frequencies and leave only the random noise on the screen.

In addition to the measurement of distortion, noise, and hum in audio systems, this type of meter can be readily calibrated to measure levels from +40 to -75 dbm across a 600-ohm load. This is done by placing the step-type attenuator on CAL, depressing the CAL button, and adjusting the meter for full-scale deflection with the  $\pm 10$ -db control. When bridged across 600 ohms the meter and range control indicate power directly in dbm.

Although not indicated in the circuit of Fig. 2, an input isolation transformer is included to provide a 10,000-ohm balanced or unbalanced input as well as the

0.1-meg. unbalanced input as shown. For simplicity, Fig. 2 does not include cathode by-pass capacitors or high- and low-frequency compensation to provide flat frequency response from 50 to 45,000 cps. By-pass capacitors and frequency compensation are both employed in the actual set but the basic circuit is as outlined in the schematic.

In use this Distortion and Noise Meter is connected and read in the same manner as any conventional set; however, the back and forth adjustments usually

required with conventional sets are not needed and no frequency, balance, or phasing controls are available on the instrument. Indications are the same, but can be taken in a fraction of the time because no adjustments are necessary. The results obtained can be readily duplicated day after day and do not depend upon the skill of the operator in balancing the circuit. The Noise and Distortion Meter described in this paper is available commercially as Type 35B, manufactured by The Daven Company.

# Floating Action!

## for all TV Cameras

### "BALANCED" TV TRIPOD

Pat. Pending

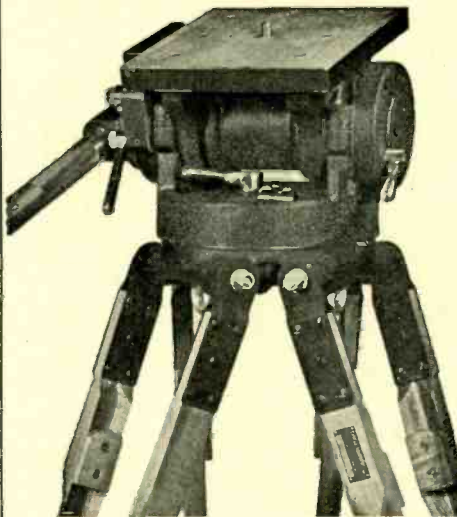

This tripod was engineered and designed expressly to meet all video camera requirements.

Previous concepts of gyro and friction type design have been discarded to achieve absolute balance, effortless operation, super-smooth tilt and pan action, dependability, ruggedness & efficiency.

Below:

3 wheel portable dolly with balanced TV Tripod mounted.

Complete 360° pan without ragged or jerky movement is accomplished with effortless control. It is impossible to get anything but perfectly smooth pan and tilt action with the "BALANCED" TV Tripod.

Quick-release pan handle adjustment locks into position desired by operator with no "play" between pan handle and tripod head. Tripod head mechanism is rustproof, completely enclosed, never requires adjustments cleaning or lubrication. Built-in spirit level. Telescoping extension pan handle.

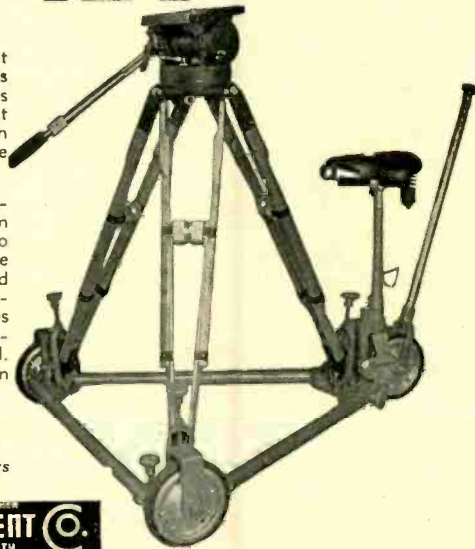

Write for further particulars

**CAMERA EQUIPMENT CO.**  
1600 BROADWAY NEW YORK CITY

# SUPERIOR RECORD REPRODUCTION ASSURED with SMOOTH RUNNING, NOISELESS —

## "SOUNDEX FLOATING DISC-DRIVE" PLAYBACK UNIT

For every type of recording, a continuously variable speed, from 30 to 110 RPM can be accurately set and regulated manually. Precision settings for 33 1/3, 45 and 78 RPM are easily attained.

Using 33 1/3 RPM on a 15 minute run, with a line voltage change of 10 volts, the change in speed remained so constant, that the variation was only 2 RPM in 500. On constant voltage, the speed variation was only 1/4 RPM or 0.05 per cent.

"Floating Disc-Drive" completely isolates the motor from the turntable; minimizing mechanical vibration, rumble and other harmful effects of direct drive systems—such as rim, gear train etc.



16" turntable—Model No's. TT12 and TT16—\$159.50 less pickup arm

### PICKUP ARM

... with "finger-tip" pressure control

Non-resonant arm assures perfect tracking and less record wear. Scale pressure ranges, 0 to 25 grams. Models are available for every type of cartridge:

No. SS16—single stylus } \$39.60 net  
No. DS16 double stylus }

103 LAFAYETTE ST. • NEW YORK 13, N. Y.



## INTERMODULATION MEASUREMENTS

[from page 25]

range equipment, and is yet high enough to simplify filter and oscillator requirements.

As a compromise with cost and complexity, it was decided to limit the intermodulation range to 3, 10, and 30 per cent full scale. This would allow readings of as low as 0.5 per cent and as high as 30 per cent, a range adequate for all but the most extreme measurements.

A circuit diagram of the complete instrument is shown in Fig. 2. The low frequency is obtained directly from the high-voltage winding of the power transformer through a dropping resistor, and a capacitance filter is used to remove some of the higher harmonics often found present in the line voltage. The high frequency is obtained from a simple LC oscillator and applied with the low frequency across the 2,000-ohm output control which is connected in such a way as to provide an almost constant output impedance. The open circuit mixed output voltage is approximately 10 volts, sufficient to drive most driver-power amplifier combinations direct. When shunted for 600-ohm use, the output is more than +5 dbm.

The analyzer section of the Intermodulation Meter employs RC filters to remove most of the low frequency, with a resultant saving of relatively high cost inductors. A simple LC filter is used between the amplifier stages to obtain the sharp low-frequency cutoff required. The input impedance of the analyzer varies from approximately 0.4 meg. up, depending on frequency. Sensitivity is such that less than 0.2 volt of mixed signal is sufficient for operation. After being filtered and amplified, the high-frequency signal is passed to the demodulator which consists of a high  $G_m$  triode connected as an infinite-impedance detector. A combination RC-LC filter removes the residual high frequency, leaving only the intermodulation products. Curves for the high-pass and low-pass filters are shown in Fig. 3.

A seven-position switch selects any one of the 3, 10, or 30 per cent intermodulation ranges, and a CARRIER SET position for setting the proper high-frequency carrier level, or any of three input voltage ranges of 3, 10, and 30 volts r.m.s. full scale. The provision of a built-in metering circuit for measuring input voltage to the analyzer without a separate external voltmeter is extremely convenient for portable operation. The meter is of the r.m.s. type; consequently, for mixed signal voltages the reading should be multiplied by a factor of 1.25, as ex-

## Acmetape

Lowest priced recording tape on the market  
Save 30 to 40 per cent on your tape costs

BROWN OXIDE

STRONG ACETATE BASE

600-ft. reels ..... \$1.45 each  
(1 to 3 reel lots)

1200-ft. reels ..... \$1.95 each  
(3 reel lots)

"Reel Your Own"—3900-ft. roll .. \$3.95

*Best Christmas gift possible for your recording enthusiast friends*

**SOLD ONLY BY MAIL**

Orders accompanied by check or money order mailed prepaid  
You pay postage if we ship C.O.D.

Acme

Agents' inquiries invited

98 Jay Street,

Brooklyn 1, N. Y.

## NEED BACK ISSUES?

- August 1948
- September 1948
- June 1949
- September 1949
- November 1949
- December 1949
- January 1950

- February 1950
- March 1950
- June 1950
- July 1950
- August 1950
- September 1950
- October 1950

1948, 1949—50¢ each      1950—35¢ each

Payment must accompany order.

Circulation Dept., Audio Engineering, 342 Madison Ave., N. Y. 17, N. Y.



plained above. Since the same meter is used to measure both the carrier level and the intermodulation products, variations in sensitivity of the copper oxide meter rectifier do not effect the accuracy of the percentage intermodulation measurements. An oscilloscope connection is provided for visual observation of wave shapes. The instrument is extremely simple to operate, all functions being controlled by two potentiometers and a single selector switch. This, plus its accuracy and portability, make it ideally suited for daily maintenance checks as well as production line and general laboratory measurements. The front panel is a standard rack type allowing for fixed mounting, if desired.

#### Laboratory-type Instrument

The above-described instrument was developed to satisfy the demand for a simple, low cost Intermodulation Meter. To fill the need for a laboratory standard Intermodulation Meter incorporating the ultimate in accuracy and flexibility without sacrificing simplicity of operation, a parallel development was carried on resulting in the instrument shown in Fig. 4. Again every effort was made to keep the unit compact and reasonable in cost, although in this case, performance and flexibility were the prime objectives. The generator section contains two stable RC tuned oscillators, with selector switches for obtaining 40, 60, or 100 cps as the low frequency, and 2,000, 7,000, and 12,000 cps as the high frequency. These are available separately or mixed in a 1/1 or 4/1 ratio. 1,000 cps is also available as a standard reference signal. An output power amplifier with a gain control and step attenuator provides a maximum output of 15 volts mixed signal into a high impedance, or + 15 dbm matched to a 600-ohm line. Residual intermodulation in the generator is well below 0.1 per cent at maximum output.

The analyzer section has an input impedance of approximately 80,000 ohms. An input step attenuator and gain control provide for easy setting of the carrier level for an input range from less than 0.1 volt to 100 volts. The input signal is amplified, the low frequency is filtered out, and the high frequency is demodulated in a full-wave rectifier. A separate meter is provided for constant monitoring of the carrier level. After demodulation, the carrier frequency is filtered out in a low-pass filter, and the low-frequency resultant passes to the voltmeter section.

The voltmeter section consists of an accurate, stable vacuum tube voltmeter with a sensitivity of 0.1 volt full scale. A single, eleven-position range and selector switch permits selecting any one of seven voltage ranges from 0.1 to 100

**NOW AT LAST**

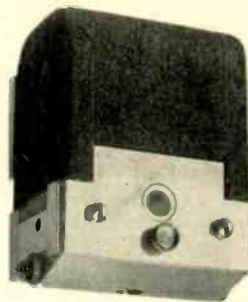

▶ IMMEDIATE DELIVERY ON FAMOUS  
**OLSON** DISC RECORDING HEAD

HIGHLY PRECISION, CUSTOM MADE UNIT. FLAT RESPONSE 50 TO 10,000 CYCLES ( $\pm 1$  DB). LESS THAN 2% IM DISTORTION. WIDELY USED BY MAJOR RECORDING STUDIOS IN THE WEST. ALSO ARMY AND NAVY. LOW MAINTENANCE OVER A LONG PERIOD OF TIME. STANDARD MOUNTING. WRITE FOR LITERATURE.

EDWIN A. LIPPS  
1781 RIMPAU BLVD., LOS ANGELES 6, CALIF.



**TWO NAMES YOU CAN ALWAYS DEPEND UPON**  
For Quality and Service!

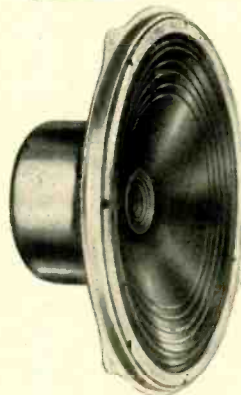

- ★ RCA for Top Quality Equipment!
- ★ HUDSON for Best Value — Dependable Service!

Order by Mail or Phone, or Shop In Person at New York's Newest Radio, TV and Sound Equipment Supply House . . . 3 Great Floors featuring a Complete Line of RCA Tubes, Parts, Batteries, Test Equipment and Speakers!

#### NEW! RCA 515S2 15" Duo-Cone SPEAKER

Sensational development of Dr. H. F. Olson, famous RCA speaker authority. This new 15" Dual-Cone Loudspeaker provides amazing life-like reproduction at a moderate price! Delivers 25 watts of high fidelity audio from 40-12,000 cps over 60° angle. Has 2 voice coils, each driving one of the duo-cones, which vibrate as a single cone, at crossover frequencies (around 2,000 cps), avoiding "crossover" interference. Requires no cross-over network. 16 ohms. 2 lb. Alnico V magnet. Resonance (with baffle) 40:55 cps. 18 lbs.

No. A53, RCA 515S2 Speaker.....Net **\$48.50**  
This price includes 2% discount.  
RCA Model 515S1, No. A52, 15" Duo-Cone Speaker. 18 lbs. Net \$35.57

#### RCA TELEVISION COMPONENTS

All RCA Television Components are "originals," designed with characteristics which are correct both electrically and mechanically for the tubes and circuits. They are "performance" proved and competively priced!



#### RCA INDUSTRIAL TUBES — Value Beyond Price!

RCA's unparalleled research facilities, engineering background, and manufacturing experience contribute to the quality, dependability, and operating economy of EVERY RCA tube you buy. The Quality of RCA tubes is Unquestioned!



**FREE!**  
SEND FOR OUR  
NEW 1951  
CATALOG



212 FULTON ST.  
NEW YORK 7, N.Y.  
Olgy 9-1192

Hudson Radio & Television Corp. Dept. 11A  
212 Fulton St., New York 7, N. Y.

- Please send:  515S2 Speaker  
 Full Payment Enclosed  
 Down Payment (10%)  
 SEND FREE HUDSON CATALOG—Just Out!

Name.....  
Address.....  
City..... Zone..... State.....

Most Complete Stock of Radio, Television,  
Electronic and Sound Equipment in the East!



# University HIGH FIDELITY COAXIAL SPEAKER Model WLC

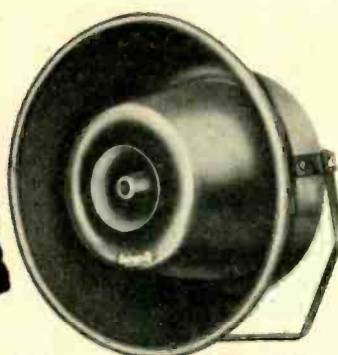

## -Voice of the Robin Hood Dell!

### MODEL 6201 HI-FI COAXIAL SPEAKER

Superb reproduction at a sensible price. Features wide angle cobra-shaped tweeter. Handles 25 watts with flat response from 45 to 15,000 cycles. Built-in LC frequency dividing network with attenuator.

### MODEL 6200 WIDE RANGE CONE SPEAKER

For the discriminating listener—hi-fi at a budget price. Concert hall quality to all frequencies—45 to over 10,000 cycles. Will handle 30 watts of power. Standard RMA mounting facilitates replacement of any standard speaker.

The WLC features essentially flat full range response plus design that handles the full volume range of the finest symphonic music without distortion. Its triple purpose reflexed horn affords maximum air column length in minimum space, provides excellent acoustic baffling, protects the woofer and tweeter against severest exposure.

Without question, the WLC provides an entirely new standard of comparison in all-weather high fidelity speaker performance . . . a good reason why it's the first choice in the finest installations—such as Philadelphia's Robin Hood Dell.

**University**  
LOUDSPEAKERS • INC.  
80 South Kensico Avenue  
White Plains, New York

### ACCEPT THIS INVITATION!

Come to  
ROOM 611  
at the  
AUDIO FAIR

and hear the matchless tone and fidelity of these fine reproducers.

IT'S UNIVERSITY WHEREVER GOOD LISTENING IS A MUST!



## look to ALLIED for your high-fidelity custom sound components

WORLD'S LARGEST STOCKS  
OF ALL FAMOUS MAKES

### ON HAND FOR IMMEDIATE DELIVERY

Aller-Lansing • Audio Development • Bell • Bogen  
Brook • Brownling • Collins  
Clarkstan • Electro-Voice  
General Electric • Jensen  
Jim Lansing • Knight  
Livingston • Magnecord  
Market • Masco • Meissner  
McIntosh • National  
Pickering • Presto  
RCA • Rek-O-Kut  
Radio Craftsmen • Scott  
Stephens • Thordarson  
University • V-M Corp.  
Webster-Chicago  
Western Electric

IF IT'S HI-FI . . .  
**ALLIED HAS IT!**

Just name your need in high-fidelity audio components—ALLIED will deliver *immediately* from the country's largest in-stock supplies. Make your selections of tuners, amplifiers, speakers, baffles, cabinets, record changers, transcription and phono equipment, wire and tape recorders, pre-amps—all the equipment you want, with the exact specifications required—at the price you want to pay. For *everything* in high-fidelity sound, depend on ALLIED.

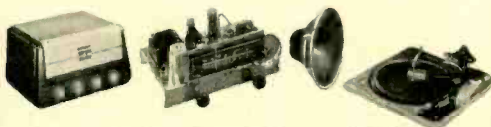

### FREE 1951 CATALOG

Write today for our complete Buying Guide. (Custom Installers . . . ask to be put on our special mailing list.) WE STOCK EVERYTHING—FOR IMMEDIATE SHIPMENT—ANYTIME—ANYWHERE.

### ALLIED RADIO

833 W. Jackson Blvd., Dept. 17-L-0  
CHICAGO 7, ILLINOIS



volts full scale or any of four ranges of intermodulation from 1 to 30 per cent full scale. The meter scale is calibrated directly in per cent intermodulation, volts r.m.s., and dbm 600 ohms. A separate switch enables the meter to read either output voltage from the generator or input voltage to the analyzer without interfering with intermodulation measurements.

An additional position on the input step attenuator throws the input amplifier in ahead of the voltmeter increasing its sensitivity by 100 times and allowing hum and noise measurements down to below -70 dbm or 100 microvolts. Oscilloscope connections are provided at the detector and at the meter for visual observations of carrier and intermodulation.

Despite its flexibility and sensitivity, the unit is extremely compact, the panel space required being a standard rack size, 8 $\frac{3}{4}$ " x 19". Like its smaller and simpler counterpart, it is extremely simple to operate and accurate measurements are rapidly made. Both of the above-described instruments were developed to fill a need for accurate, simple intermodulation test equipment at a reasonable cost and to promote the use of intermodulation measurements by the industry as a whole.

### PARTS LIST

R <sub>2</sub> , R <sub>5</sub> , R <sub>1</sub> , R <sub>7</sub>	22,000 ohms
R <sub>5</sub>	0.15 meg.
R <sub>6</sub> , R <sub>14</sub> , R <sub>24</sub>	20,000 ohms
R <sub>8</sub> , R <sub>18</sub>	2000 ohms
R <sub>9</sub> , R <sub>20</sub> , R <sub>25</sub>	0.1 meg.
R <sub>10</sub> , R <sub>21</sub>	10,000 ohms
R <sub>11</sub>	51,000 ohms
R <sub>12</sub> , R <sub>13</sub>	1.0 meg.
R <sub>13</sub>	0.2 meg.
R <sub>16</sub>	0.5 meg.
R <sub>19</sub>	1500 ohms
R <sub>22</sub> , R <sub>27</sub>	3.0 meg.
R <sub>23</sub> , R <sub>30</sub>	60,000 ohms
R <sub>26</sub>	18,000 ohms
R <sub>28</sub>	0.42 meg.
R <sub>29</sub>	0.12 meg.
R <sub>31</sub>	3000 ohms
C <sub>1</sub> , C <sub>2</sub> , C <sub>3</sub>	10 $\mu$ f
C <sub>4</sub> , C <sub>18</sub>	.05 $\mu$ f
C <sub>5</sub>	.02 $\mu$ f
C <sub>6</sub> , C <sub>14</sub>	.005 $\mu$ f
C <sub>7</sub> , C <sub>15</sub> , C <sub>16</sub> , C <sub>19</sub>	.01 $\mu$ f
C <sub>9</sub> , C <sub>23</sub>	.001 $\mu$ f
C <sub>10</sub> , C <sub>17</sub>	.0005 $\mu$ f
C <sub>12</sub>	.0001 $\mu$ f
C <sub>18</sub>	0.25 $\mu$ f
L <sub>1</sub>	3000-cps oscillator coil
L <sub>2</sub>	10 henries
L <sub>3</sub>	5 henries



## LOUDSPEAKER DAMPING

[from page 30]

sider a hypothetical tube having a plate resistance of 1000 ohms and a desirable load of 2500 ohms. To feed a 10-ohm loudspeaker requires a turns ratio of

$$\sqrt{\frac{2500}{10}} = 15.8 \text{ to } 1. \text{ The impedance reflected into the secondary becomes } (1/15.8)^2 \times 1000 = 4 \text{ ohms. Consider another tube having a plate resistance of 5000 ohms and a desirable load of 12,500 ohms (2\frac{1}{2} \text{ times the plate resistance as for the first tube). To feed a 10 ohm loudspeaker requires a turns ratio of } \sqrt{\frac{12,500}{10}} = 35.3 \text{ to } 1. \text{ The impedance reflected into the secondary becomes } (1/35.3)^2 \times 5000 = 4 \text{ ohms, the same as for the first tube.}$$

ratio of  $\sqrt{\frac{12,500}{10}} = 35.3$  to 1. The impedance reflected into the secondary becomes  $(1/35.3)^2 \times 5000 = 4$  ohms, the same as for the first tube.

ratio of  $\sqrt{\frac{12,500}{10}} = 35.3$  to 1. The impedance reflected into the secondary becomes  $(1/35.3)^2 \times 5000 = 4$  ohms, the same as for the first tube.

### Comparisons

This does not mean of course that all triodes *as actually used* have the same damping properties. What it does show is that if the choice of load impedance is governed by allowable distortion for each tube type, one type may give better speaker damping than the other *for the particular load impedances chosen*. Clearly the higher the ratio of load impedance to plate resistance, the greater the amount of speaker damping. Fortunately, in the case of triodes, the higher the ratio of load to plate resistance the lower the distortion, so that one does not have to sacrifice speaker damping for distortion or vice versa.

To summarize, when using triodes, the ratio of load impedance to plate resistance, (sometimes called the damping factor), is always greater than one because this relationship produces low distortion. When using pentodes or beam tetrodes, the damping factor is always less than one because such a condition gives lower distortion. Hence, triodes are superior to tetrodes or pentodes, but as far as speaker damping only is concerned all triodes must be considered about equally as effective.

## New! BELL Custom HIGH FIDELITY AMPLIFIER with complete Remote Control

EXPRESSLY DESIGNED FOR MUSIC LOVERS . . .  
FOR ANY TYPE BUILT-IN OR CUSTOM JOB

For extra value—without extra cost—in built-in or custom audio systems, install this unique, new Bell High Fidelity Amplifier. Its remote controls, in attractive unit for table or console mounting, are amazingly selective. Single selector for phono-AM, FM radio (or TV), all domestic and foreign records, 78, 45 and 33-1/3 rpm. Smooth, continuously variable bass and treble with boost and cut. Amplifier applies 100% negative feedback; reproduces sound at all levels naturally clear and life-like. Amplifier and remote control unit can be separated 5 to 25 feet with only .1 db loss at 20 kc. All inputs (3 phono, 1 mike, 2 radio) connect directly to main amplifier. For more details, write.

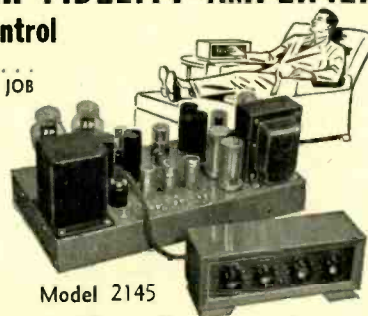

Model 2145

- Extremely wide power pass band
- Total distortion .5% or less at 10 watts
- All triode 30 watts maximum
- Compensated volume control



### BELL SOUND SYSTEMS, INC.

559 MARION ROAD, COLUMBUS 7, OHIO

Export Office: 4900 EUCLID AVENUE, CLEVELAND 3, OHIO

## Now Available! audio anthology

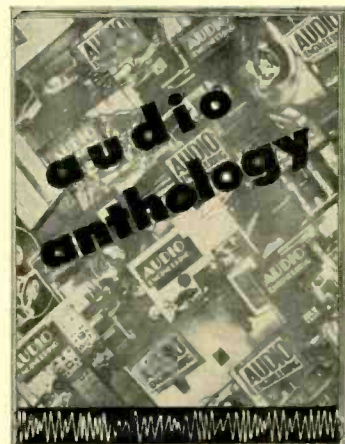

Paper cover . . . \$2.00

Board cover . . . \$3.00

Distributors write for quantity discount

The long awaited compilation of reprints from early issues of AUDIO ENGINEERING, most of which are unobtainable.

Contains 37 articles on the following subjects:

- Amplifiers
- Speakers
- Noise Suppressors
- Phonograph Equipment
- Tone and Loudness Controls
- Dividing Networks

These articles have been of great interest to readers of AUDIO ENGINEERING over the past three years. Assembled in one volume, they comprise the most authoritative reference work for the audio hobbyist.

---CUT OUT---MAIL TODAY---

Book Division, Dept. A9  
Radio Magazines, Inc.  
342 Madison Ave., New York 17, N. Y.

Sirs: Enclosed is my  check  money order for \_\_\_\_\_ copies of the Audio Anthology.

(Please check one)  Paper cover  Board cover

Name (print carefully) .....

Address .....

City ..... Zone ..... State .....

# NEW PRODUCTS

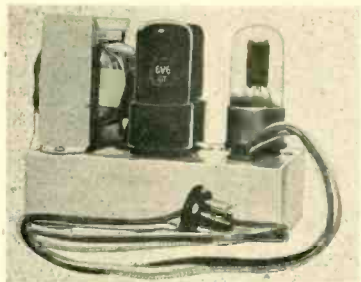

● **TV Audio Amplifier.** Answering the long felt need for improved sound quality from production-model TV receivers, the NJR Model 10MT amplifier measures only 3 x 5 in. and may easily be incorporated in most any TV chassis. It is equipped to plug in to an existing single-ended amplifier such as is found in average TV receivers. Using two 6V6's and a 6J5 driver, the 10MT has a frequency range of 100-13,000 cps  $\pm$  one db and delivers 6 to 8 watts output with less than 3 per cent harmonic distortion. Current consumption is 45 ma. Further details may be obtained by writing to Milo Sound, 200 Greenwich St., New York 7, N. Y., exclusive distributor.

● **Duo-Cone Speaker.** Newest addition to the high-quality speaker field is the RCA Type 515S2, a low-cost adaptation of the famous model LC-1-A speaker developed by Dr. Harry Olson. A 15-in. unit of the permanent magnet type, the 515S2 is capable of handling up to 25 watts input and is intended essentially for use in

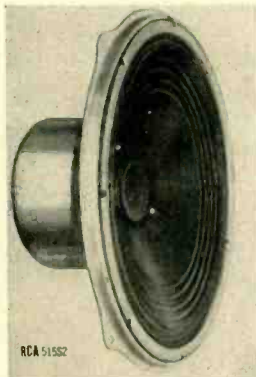

high-quality radio-phonographs and in monitoring equipment. Design of the new speaker is similar to that of the LC-1-A, employing a large and a small cone mounted so that, practically speaking, the large cone is a continuation of the small one. The small cone is driven by a  $\frac{3}{4}$ -in. voice coil; the large one by a 2-in. voice coil. The 515S2 is designed for standard RTMA rim mounting and can be used as a direct replacement for existing 15-in. rim-mounted speakers. Now available from RCA parts distributors.

● **High Quality Tape Recorder.** Higher performance standards in the field of tape recording are realized with the new Ampex Model 400 magnetic recorder. Offering 30-15,000 cps frequency range on

half-track tape at a recording speed of  $1\frac{1}{2}$  in. per second, the Model 400 permits substantial savings in tape requirements with no lowering of program quality. Normally supplied in a single portable case weighing approximately 62 pounds, the unit is also available in console cabinets and for standard rack mounting. Model 400 includes among its unique features simultaneous erase, record, and playback by means of three magnetic heads shielded in a single housing. A built-in VU meter is included as standard as is a single control switch for fast forward, fast rewind, and record. The machine also provides 15 in. per second tape speed. At  $7\frac{1}{2}$  in. per second flutter and



wow is less than one-quarter of one per cent and frequency response is 30-15,000 cps  $\pm$  4 db. Additional information may be obtained by writing Ampex Electric Corporation, San Carlos, Calif.

● **Stylus Shadowgraph.** Adaptation of laboratory equipment to the field of merchandising is evidenced in the use of a modified shadowgraph for determining stylus contour in the Sound department of Sun Radio and Electronics Co., Inc., 122 Duane St., New York City. Customers are invited to bring in their reproducer cartridges and are given the opportunity of inspecting the units on the shadowgraph's ground glass screen. Outline of the stylus is magnified 500 times. It is thus possible to note how much the stylus is worn and to determine how greatly it varies in contour from the original. Customers are shown a special card which permits comparison of an unworn stylus with the one under inspection. The stylus checking service is offered free.

● **Magnetic Recording Tape.** Adding to its line of recording accessories, Duotone Company, Keyport, N. J. is now producing a complete selection of magnetic recording tapes. Included in the Duotone tape line are both plastic and kraft paper

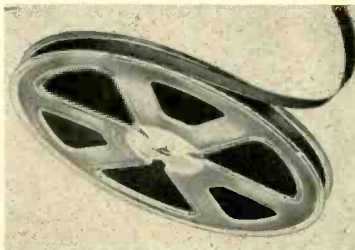

bases. Both types are manufactured to meet the exacting requirements of professional application, and are supplied with low-inertia plastic reels which are warp proof and shatterproof. Requests for further information should be addressed to the manufacturer.



● **High-Quality Preamplifier.** Said to exceed broadcast requirements in frequency response and in accuracy of equalization, the new Pickering Model 230H preamplifier for magnetic pickups is self-powered and may be used with any high-impedance amplifier input. Both intermodulation and harmonic distortion are claimed to be remarkably low.

● **Record Changer.** Versatility is carried out to a high degree in the Lincoln record changer which plays records of all standard speeds—78,  $33\frac{1}{2}$  and 45 rpm—and 7, 8, 10 and 12-in. sizes intermixed in any sequence of the same speed. Records

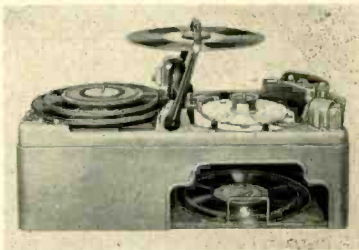

may be played automatically on one or both sides as desired. Handling of records is by means of suction cups with no metal except the stylus touching the record surface. Only one record is on the turntable at a time, thus eliminating slippage and assuring proper stylus angle. Special selections can be put on record table for immediate playing without removing other records or waiting until all previous records have been played. Lincoln changers are available in two models—a standard unit for custom installation, and a special unit for replacement in Capehart radio-phonographs. Additional information will be supplied by Lincoln Engineering Co., Record Changer Division, 5701 Natural Bridge Drive, St. Louis 20, Mo.

● **Microphone System.** Unique in many respects, the new Tru-Sonic microphone system is essentially non-directional throughout the entire audio range, and is said to be the only microphone on the market making use of a condenser type diaphragm in a circuit which does not require vacuum-tube circuits adjacent to



the head. The microphone head contains only a tiny cell, and all auxiliary equipment may be located up to 400 feet away. Interconnection is accomplished by a standard single-conductor microphone cable which does not carry high voltage. There is no conventional pre-amplifier. High efficiency claimed for the system is accomplished by a one-tube amplifier circuit incorporated in an oscillator/demodulator unit. Specifications and prices



may be obtained by writing for Bulletin M-1, Stephens Manufacturing Corporation, 8538 Warner Drive, Culver City, Calif.

● **Compact L-Pad.** Designed primarily for use in outdoor drive-in theaters and other p.a. applications where dependability and low cost are necessary factors, the new Clarostat Type CM8727 8-ohm L-pad is a single unit with two separate wire windings for maintaining constant impedance. It is identical in size to the compact Clarostat Type 43 control, measuring 1 1/4-in. diameter x 9/16-in. deep.

● **Capacitance Bridge.** Notwithstanding unusually small size and light weight, Simpson's new Model 381 capacitance bridge offers measurements ranging from 20 mmfd to 500 mfd. Ideally suited for application wherever capacitance measurements are required, the unit is so simple in operation that even the inexperienced can use it with ease and confidence. Bakelite-housed with panel of etched aluminum, Model 381 measures



3 1/2 x 5 1/2 x 2 3/8 in. and weighs 1 1/4 lbs. Complete technical description may be obtained by writing Simpson Electric Company, Chicago, Ill.

● **Special LP Cartridge.** Designed by Astatic engineers working in conjunction

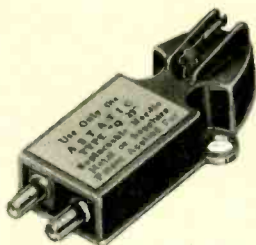

with the Engineering and Development department of the Columbia Broadcasting System, the new Astatic Type CAC-J crystal cartridge is said by the manufacturer to be internally equalized for providing ideal frequency response from Columbia LP recordings. The new unit is housed in lightweight aluminum and contains standard 1/2-in. mounting holes to fit most tone arms. An adapter plate is furnished to permit mounting in RCA and similar 45-rpm changers. Output of the CAC-J is approximately 0.6 volts at 1000 cps on Columbia No. 103 test record, and one volt on RCA 12-5-31-V test record. Full technical details may be obtained by writing The Astatic Corporation, Conneaut, Ohio.

MAGNETIC  
RECORDING  
TAPES TO  
THE HIGHEST  
PROFESSIONAL  
STANDARDS

Now the well-known Duotone super-quality is available in magnetic recording tapes for commercial and home recorders. The six Duotone quality features assure finest sound reproduction for professional programming and the ultimate in home entertainment. For finest performance on any tape recorder, use Duotone professional quality magnetic tapes!

- Interchanges with Other Tapes
- Constant Tracking and Winding
- No Snarls or Backlash
- Low Inertia Plastic Wheel
- Low Friction—Long Life
- High Output—Minimum Background

DUOTONE SUPER QUALITY IS AVAILABLE  
IN TAPES FOR EVERY RECORDING NEED

Made with plastic or kraft paper base in extra long 625 or 1250 foot lengths. Plastic base is tough with high tear strength and special smooth finish for uniform coating. All kraft bases are super-calendered for perfect surfacing without fillers. For complete data on Duotone standard and special tapes, call or write for illustrated catalog.



Canadian Representative: CHARLES W. POINTON, TORONTO, CANADA  
Export Division: AD. AURIEMA, INC., NEW YORK CITY, N. Y.

*Now-famous*  
**DUOTONE**  
*quality...*



— IN A  
**RECORDING  
TAPE**  
FOR EVERY  
PURPOSE

*6 WAYS  
to better  
Recordings*

# FREE

## New Edition



now 100 pages.

### Sun Radio's "Audio Equipment"

Our first edition of this FREE AUDIO EQUIPMENT HANDBOOK was gobbled up immediately by sound enthusiasts who soon made it the standard guide for understanding and choosing high fidelity music components.

Now, here's our new 1951 edition, completely revised and enlarged.

Again it contains an easy-to-read layman's guide to the understanding of high fidelity music systems written by an authority in the field.

In the catalog section you'll find a complete, logical, easy-to-find listing of tuners, amplifiers, arms, pickups, speakers, record playing mechanisms and cabinets by every important manufacturer.

Write or come in for your copy.

### Our Famed Sound Studio

Push a few buttons on our famous selector panel and try various combinations of tuners, amplifiers, speakers, pickups. Let your ears be the judge and select the system you like from 2600 possible combinations. When you're in New York, stop in and visit our Sound Studio.

### Free Stylus Check

Another new service at SUN! Our shadowgraph quickly checks contour of stylus for wear. You actually see your stylus magnified 500 times. Comparison with an unused stylus of the same make shows the difference. No obligation, of course.

### At the Audio Fair

Visit us in Room 601, Hotel New Yorker, Oct. 25, 26, 27 . . . see the Shadowgraph in operation, pick up your free copy of "Audio Equipment".



Hours: 9-6 Daily, 9-4:30 Saturdays.

Tchalkovsky	Symphony of Psalms. L.P.O. & Choir. c. Ansermet.	Decca K1753-5
Wagner	Symphony No. 4. Ph.O. c. Dobrowen. Flying Dutchman Overture. Ph.O. c. Kletzki.	H.M.V. C3809-13 Col. LX1160-1
<b>CONCERTOS</b>		
Bach, J. S.	Violin Concerto in E. de Vito & London Chamber Orch. c. Coppola. Violin Concerto in A minor. Varga & Ph.O. c. Bernard.	H.M.V. DB6884-6 Col. DX1586-7
Bruch	Violin Concerto No. 1. Haendel & Ph.O. c. Kubelik.	H.M.V. C3802-4
Dvorak	Cello Concerto in D minor. Fournier & Ph.O. c. Kubelik.	H.M.V. DB6887-91
Haydn	Violin Concerto in C. Goldberg & Ph.O. c. Süsskind.	Parlo. R20558-60
Mendelssohn	Violin Concerto in E minor. Campoli & L.P.O. c. van Beinum.	Decca X290-92
Mozart	Piano Concerto in C. K503. Fischer & Ph.O. c. Krips. Violin Concerto in D. K218. Heifetz & Royal Philharmonic Orch. c. Beecham.	H.M.V. DB6604-7 & H.M.V. DB6678-80
<b>CHAMBER MUSIC</b>		
Beethoven	Septet in E flat Op.20. Soloists of the Danish State Broadcasting Orch.	Col. LDX7006-10
Geminiani	Concerto Grosso in C minor. Boyd Neel String Orch. c. Boyd Neel.	Decca K2124
Haydn	The Seven Last Words from the Cross Griller Quartet.	Decca K2139-47
Schubert	Trio in B flat Op.99. Trio di Trieste.	H.M.V. C3792-5
Wolf	Italian Serenade in G. Schneiderhan Quartet.	Col. LX1168
<b>OPERATIC</b>		
Moussorgsky	Boris Godounov. Monologue and Farewell. Christoff & Ph.O. c. Dobrowen.	H.M.V. 6948 & 6935
Mozart	Die Entführung. "Martern aller Arten." Erna Bergner & Ph.O. c. Krips. Il Re Pastore (Act 2) "L'Amoro sarò costante." Schwartzkopf & V.P.O. c. Krips.	H.M.V. DB6616 Col. LX1096
Tchalkovsky	Eugene Onegin Tatiana's Letter Scene. Weltsch & Ph.O. c. Süsskind.	Col. LX1108-9
Verdi	Macbeth Sleepwalking scene & "La luce langue." Marguerita Grandi & Royal Phil. Orch. c. Beecham. Otello Act 4. Sc. 1 & 2. Gatti & L.S.O. c. Belleza & Frede.	H.M.V. 6739-40 H.M.V. DB6712-8
Wagner	Flying Dutchman. "Die Frist ist um." Berglund & orch. c. Blech.	H.M.V. DB6378
<b>CHORAL</b>		
Bach, J. S.	St. Matthew Passion. Bach Choir & Jacques Orch. c. Jacques.	Decca K2001-21
<b>VOCAL AND ORCHESTRA</b>		
Handel	Messiah. "I know that my redeemer liveth." Ada Alsop & L.S.O. c. Sargent.	Decca K2137
Strauss, R.	Ariadne auf Naxos. "Es gibt ein Reich." Cebotari & V. P. O.	H.M.V. DB6914
<b>VOCAL AND PIANO</b>		
Brahms	Liebeslieder Waltzer Op.52 & Waltzes Op.39. Nos. 2, 6 & 15. Seefried, Höngen, Meyer-Welfing, Hotter Piano: Wührer & Von Nordberg.	Col. LX1114-7
Faure	L'hiver & Debussy Green. Maggie Teyte.	H.M.V. DA1893
<b>PIANO</b>		
Beethoven	Sonata in E. Op.109. Denis Matthews.	Col. DX1509-11
Chopin	Nocturne Op.48 No. 1. Mazurka Op.41 No. 2. Malcuzymsky.	Col. LX1228
Liszt	Funeralles. Gina Bachauer.	H.M.V. C3872
Ravel	Ondine. Monique Haas.	Decca K1888
<b>VIOLIN AND PIANO</b>		
Handel	Violin Sonata No. 4 in D. Goldberg & Merre.	Parlo. R20568-9
<b>ORGAN</b>		
Mendelssohn	Sonata in A. 1st. movement. Demiseieux.	Decca K1700



## LONDON CONCERT HALL

[from page 26]

out so that their depth from front to back is as great as 30 or 35 feet. This approaches the point at which the sounds from the front instruments and those from the back will reach the audience sufficiently far apart to make the orchestra appear to be badly synchronized. Added to this is the occasional tendency of percussion to lag slightly behind other parts of the orchestra, especially if they are partly playing by ear, as sometimes is said to happen. Consequently there are limits to the size of an orchestra if it is to sound well in quick passages, and in the new concert hall the dimension from front to back is not only limited, but care has been taken to reduce the area available for each player to the minimum consistent with good playing.

The reflections from surfaces around the orchestra are important. Those that are placed to reflect back to the orchestra must reflect back so quickly that the orchestra is supported and not confused, and the same applies to the reflections sent out to the seating area. The critical areas are those above the orchestra, and there has been a conflict in this respect between organ requirements and those for orchestral reflections.

The organ was just behind the orchestra, and it was desired to have an adequate opening, so that it would be heard well. This meant that the reflector had to be raised high enough not to interfere. It might easily have become too high, but it is thought that the compromise finally worked out will be satisfactory from both points of view.

The common trouble in halls is that echos are heard in the front seats. This often arises from instruments on the same side of the orchestra as the listeners who hear the echos, the sounds being reflected from the opposite sides of the hall. In order to minimize this risk, special absorbents have been located at the danger points on each side of the hall, just in front of the orchestra.

Apart from this absorbent area, and some other areas used to avoid echos from the cornice region of the hall, every effort has been made to avoid absorbents which would absorb the high-frequency sounds on which musical quality seems largely to depend. The ceiling is to be a hard surface not absorbing at any particular frequency. The walls are to be lined with wood panelling which is carefully designed in terms of its weight and the depth of air space behind it to absorb only low-frequency sounds. This is important, because the present hall is designed to exclude low-frequency noises from traffic and the nearby railway, and the construction should, therefore, also retain the low frequencies generated in the hall. Calculations showed that there was a serious risk of long, low rumbles, and the panelling has been adjusted to absorb only in this frequency range. At the same time, the panelling has been made so that it can be adjusted after the hall is in use, and a period for tuning the hall is being provided before it is finally opened.

One of the main factors for good listening

## NEW LABORATORY INSTRUMENTS custom-designed for AUDIO SPECIALISTS!

### Negligible loading with the BRIDGER

In bridging measuring instruments across high-Z circuits, lowest possible circuit loading is vital. Model 100's improved cathode follower and special double-shielded cable reduce cable capacitance and circuit leakage to the insignificant. Input Z: 70 megohms, 5mmf, with 3-ft cable. Output Z: 200 ohms. Output/input voltage ratio: 0.99 up to 55 kc. Price \$72.50.



### Easier, faster, low cost Distortion Testing with INTERMODULATION SET

For the first time—here's a quality IM set at a truly low cost! With Model 162, and your own audio oscillator and oscilloscope, you read per cent of IM in any pickup, amplifier or system directly on your scope image—in just seconds. Identify such faults as: wrong bias, wrong load impedance, tube unbalance, regeneration and insufficient drive capacity. Complete with graphic instructions for adjusting equipment for best performance. Price \$88.50.

Coming next month:  
Models 165, 169  
Intermodulation Meters

WRITE NOW FOR CATALOG A

**Audio** INSTRUMENT COMPANY  
Dept. π 133 WEST 14th ST. NEW YORK 11, N. Y.

AMAZING . . . EXCLUSIVE

True, Full-Range Fidelity

**BOZAK**  
Kettle Drum Speaker

CLEAN, PLEASING TREBLE  
ROBUST, LIVE BASS  
Acclaimed By Musicians, Engineers!



With or Without This  
Handsome, New Cabinet

An entirely new experience in music and voice reproduction awaits you in this unique Kettle Drum Speaker . . . a Bozak exclusive! Truly, you'll be moved by the live, undistorted tone—the unparalleled listening ease at any level, achieved by this fine Bozak instrument. And you'll be amazed at the low price.

If you have high quality sound sources . . . if you appreciate and demand highest quality reproduction, the Bozak Kettle Drum is your speaker . . . your only speaker.

And now, if you prefer, it's available in a handsome mahogany cabinet at a modest, additional cost.

Write for descriptive literature, and the name of your local dealer.

**R. T. BOZAK CO.**  
90 Montrose Ave. Buffalo 14, N. Y.

WRITE

FOR

JOB

IN

SAN  
DIEGO

NOW

# ELECTRONICS ENGINEERS

We need engineers for electronics research development and production. Real opportunity for graduate engineers with 5 or more years experience in basic circuit design, pulse, micro-wave, system analysis, electronic project coordination and administration. Openings for project leaders, senior designers, assistant project leaders and staff specialists.

Congenial associates, and superior living conditions in wonderful San Diego. Write today to H. T. Brooks, Engineering Personnel Office,

## CONVAIR

(Consolidated Vultee Aircraft Corporation)  
3302 PACIFIC HIWAY, SAN DIEGO, CALIFORNIA

### STATEMENT OF THE OWNERSHIP, MANAGEMENT AND CIRCULATION, REQUIRED BY THE ACT OF CONGRESS OF AUGUST 24, 1912, AS AMENDED BY THE ACTS OF MARCH 3, 1933, AND JULY 2, 1946.

of AUDIO ENGINEERING, published monthly at New York, N. Y., for October 1, 1950.  
State of New York }  
County of New York } ss.:

Before me, a Notary Public in and for the State and county aforesaid, personally appeared Dorothy S. Potts, who, having been duly sworn according to law, deposes and says that she is the publisher of AUDIO ENGINEERING, and that the following is, to the best of her knowledge and belief, a true statement of the ownership, management, etc., of the aforesaid publication for the date shown in the above caption, required by the Act of August 24, 1912, as amended by the Act of March 3, 1933, and July 2, 1946 embodied in Sec. 34.38, Postal Laws and Regulations, to wit:

1. That the names and addresses of the publisher, editor, managing editor and business manager are: Publisher: Dorothy S. Potts, 1737 York Avenue, New York 28, N. Y.; Editor: Charles G. McFroud, 7 Peter Cooper Road, New York 10, N. Y.; Managing Editor: None; Business Manager: Henry A. Schober, 35 Daill Street, New Hyde Park, N. Y.

2. That the owners are: Radio Magazines, Inc., 342 Madison Ave., New York 17, N. Y.; Dorothy S. Potts, 1737 York Avenue, New York 28, N. Y.

3. That the known bondholders, mortgages, and other security holders owning or holding 1 per cent or more of total amount of bonds, mortgages, or other securities, are: None.

4. That the two paragraphs next above, giving the names of the owners, stockholders and security holders, if any, contain not only the list of stockholders or security holders as they appear upon the books of the company, but also, in cases where the stockholders or security holder appears upon the books of the company as trustee or in any other fiduciary relation, the name of the person or corporation for whom such trustee is acting, is given; also that the said two paragraphs contain statements embracing affiant's full knowledge and belief as to the circumstances and conditions under which stockholders and security holders who do not appear upon the books of the company as trustees, hold stock, and securities in a capacity other than that of a bona fide owner; and this affiant has no reason to believe that any other person, association, or corporation has any interest direct or indirect in the said stock, bonds, or other securities than as so stated by him.

(Signed) DOROTHY S. POTTS, Publisher.

Sworn to and subscribed before me, this 26th day of September, 1950.

(Seal) HARRY N. REIZES, Notary Public.

State of New York, No. 24-3249550, Qualified in Kings County, Certs filed with Kings & N. Y. Co. Clk. Off. & Kings Co. Reg. Off. Commission expires March 30, 1951.

in a hall is a low level of background noise. This noise comes largely from external traffic, through walls which have inadequate insulation, and many halls suffer excessively from it without full realization. Much care has been devoted in this design to the exclusion of railway and ordinary traffic noises. The chief features of the insulation are heavy double walls and roof, absorbent linings to the intake ducts for the ventilation plant and special types of doors with limited sound transmission.

## AUDIANA

[from page 32]

verberant energy in the room changes the sound as heard by the listener, and this ratio varies with the position of the listener in the room. With all these modifications to the sound, it is not surprising—even though using a good but not electronically perfect system—that acceptance of the program is not universal. The methods of overcoming the problem are costly and bulky and involve dual or binaural channels, as shown in Fig. 2. Since it is obvious that we have further modified the quality of the program, we must look further for our most convincing approximation of the acoustic facsimile, within these limits.

### The Practical System

If, in addition to the deviations from the studio conditions introduced by the use of a single channel, we now add the noise and distortion characteristics and limited dynamic range of the amplifiers, the uneven polar response of the microphone and loudspeaker, the limited output of each, and the distortion introduced by the loudspeaker, we can see the full scope of the problem. It is at this point that many manufacturers and engineers claim that with all the other factors modifying the original signal, a little distortion or high-frequency droop will never show up. Again tests conducted by the Bell Telephone Laboratories and RCA indicate that in a single channel system when there is a minimum of or no distortion present and the overall system response is flat, the system is more acceptable.<sup>3-4-5</sup> No transmission system is satisfactory that does not have a wide-band frequency response and very little distortion over its entire frequency range. In addition, noise and hum should be at least 60 db below full output and the transient response should be good, as measured by any of the accepted meth-

<sup>3</sup> W. B. Snow, "Audible frequency ranges of music, speech, and noise." *J. Acous. Soc. Am.* 3, 1, p. 155, 1931.

<sup>4</sup> H. Fletcher, "Speech and Hearing." p. 28. D. Van Nostrand Company, 1929.

<sup>5</sup> H. F. Olson, "Elements of Acoustical Engineering." Second edition, pp. 488-497, D. Van Nostrand Company, 1947.



# ATLAS "Multi-Cellular" TWEETER

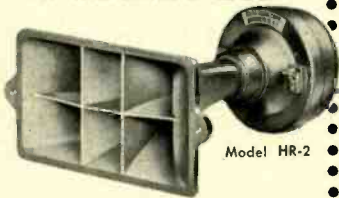

Model HR-2

SIX CELL WIDE ANGLE  
DISTRIBUTION: 100° x 50°  
Clean and efficient to 15,000 cycles  
25 watts of program material above  
1000 cycles

"Alnico-V-Plus" super  
efficient magnetic cir-  
cuit. Heavy die cast  
sectorial horn, flush  
mounting 6 3/4" wide,  
3 1/2" high, 8" deep. A  
new high in realism—  
smooth and clean  
musical brilliance.  
Perfect articulation  
and Sibilance in  
voice reproduction.

Variable  
High Pass  
Filter  
Model FN-1



WRITE FOR COMPLETE  
DESCRIPTIVE CATALOGUE

**ATLAS SOUND CORPORATION**  
1448 39th St. Bkn, 18, N. Y.

In Canada, Atlas Radio Corp., Ltd.,  
Toronto, Ontario

"HAVE YOU HEARD  
THE SOUND OF QUALITY?"



## NEWCOMB SOUND IS BETTER

Manufacturers of public address, mobile,  
phonograph, musical instrument and wired  
music amplifiers • Portable systems • Port-  
able phonographs and radios • Transcription  
players • Rack and panel equipment.

Write today! Circle items of interest and  
indicate whether you are a Dealer, Parts  
Jobber or Sound Specialist.

**NEWCOMB AUDIO PRODUCTS CO.**  
DEPT. T, 6824 LEXINGTON AVE.  
HOLLYWOOD 38, CALIFORNIA

ods. These broad requirements can be met by much of the available audio equipment marketed or described in current literature, with two major exceptions—phonograph equipment and loudspeakers. This fact has been evidenced on numerous occasions in the installation of industrial and home music systems. The place where personal preference is most exercised in the selection of such equipment is in the loudspeaker with the phonograph and its associated equipment a close second.

The reason for this is that even the wide-range transducers in these two classes contain numerous distortion-producing elements, and it is the effect of the resulting distortion on each listener that determines his particular preference. The most important fact that all this shows is that *quality degradation must be held to a minimum* if high fidelity is desired. There is some degradation of the signal caused by every element of the system through which it passes, and it doesn't add up, it multiplies.<sup>6</sup>

After writing the specifications of the amplifiers and other components of the transmission system, it occurs that even with an almost perfect system we must do something to compensate for the differences in level between the sound at the source and the sound as reproduced. That is, there should be some attempt made to reconcile the loss of low-frequency sensitivity, a product of the Fletcher-Munson effect, with the experience of the listener when hearing concert music or speech at its normal concert hall or conversational levels respectively. Also, there will be considerable modification of the high-frequency characteristic caused by the acoustics of the room and the pickup and reproducing transducers. In both cases flexible equalizers may be used to provide the necessary compensation.

### How Much Compensation

For many years the Fletcher-Munson curves have been used as a standard for response characteristics of the ear, and have recently been supplemented by the Worlds Fair Hearing Test Results, and the San Diego Fair Tests.<sup>7,8,9</sup> One of the frequent errors made in the use of these tests is that they indicate an

<sup>6</sup> H. J. Reich, "Theory and Application of Electron Tubes." New York: McGraw-Hill Book Co., 1944, pp. 74-79.

<sup>7</sup> H. Fletcher and W. A. Munson, "Loudness, its definition, measurement, and calculation." *J. Acous. Soc. Am.* 5, 2, p. 82, 1933.

<sup>8</sup> J. C. Steinberg, H. C. Montgomery, and M. B. Gardner, "Results of the Worlds Fair Hearing Tests." *J. Acous. Soc. Am.* 12, 2, p. 291, 1940.

<sup>9</sup> J. C. Webster, Malcolm Lichtenstein, and Robert S. Gales, "San Diego County Fair Hearing Survey." *J. Acous. Soc. Am.* 22, 4, 1950.

A  
TIME-TESTED  
DEPENDABLE  
SOURCE  
FOR

HIGH-PRECISION FRACTIONAL  
H. P. INSTRUMENT-TYPE  
MOTORS & GENERATORS  
PRODUCED TO ORDER

GOVERNOR CONTROLLED  
SELF SYNCHRONOUS  
DRAG CUP  
VELOCITY & ACCELERATION  
DC & AC TACHOMETER  
SERIES  
COMPOUND  
PERMANENT-MAGNET  
SPLIT-FIELD  
SEPARATELY EXCITED  
UNIVERSAL  
INDUCTION  
RELUCTANCE  
HYSTERESIS  
ONE, TWO & THREE PHASE  
DC & AC SERVO  
TOTALLY ENCLOSED  
AC DYNAMICALLY BRAKED  
REELMOTORS  
ONE, TWO, THREE & FIVE SPEED  
SYNCHRONOUS MOTORS

Experienced for years in meeting customers' exacting requirements for high-precision instruments designed by engineers of ability and ingenuity, and manufactured with extreme care and skill. Over 500 different basic types may be varied to meet your own unique requirements of use, either electrically or physically.

**ELECTRIC INDICATOR CO.**

PARKER AVENUE  
STAMFORD, CONNECTICUT

## Only One

National Magazine in the consumer field gives complete treatment of  
**ELECTRONICS**

## SATURDAY REVIEW of Literature

has won a large nation-wide following among the more than 100,000 families who have come to respect it as a dependable guide in all phases of sound reproduction

**ATTEND OUR EXHIBIT at New York's AUDIO FAIR**

Use the handy order form for entering your subscription

**SATURDAY REVIEW OF LITERATURE**  
25 West 45th Street, New York 19, N. Y.

Please enter my subscription for:  
 1 yr. - \$6.00  2 yrs. - \$10.00  3 yrs. - \$14.00  
 Remittance enclosed  Bill me

Name .....

Address .....

City ..... Zone ..... State .....

Note: These rates apply in U. S. and Possessions, and Pan-American Union. Add \$1.00 per subscription year for foreign addresses.

## CLASSIFIED

Rates: 10c per word per insertion for noncommercial advertisements; 25c per word for commercial advertisements. Rates are net, and no discounts will be allowed. Copy must be accompanied by remittance in full, and must reach the New York office by the first of the month preceding the date of issue.

### Equipment

FOR SALE: Barker 150 speaker, unused original carton, cost \$60, sacrifice \$45; Also GE 3-way cartridge in arm, \$5; Univesity twin tweeter with crossover network, \$12. Box CV-2, Audio Engineering.

FOR SALE: Used Western Electric 9A Re-producer group, UTC 3A equalizer, QRK 16-inch turntable, Presto PT900 tape recorder, dual potentiometers, top quality ladder and fixed T-pads. Voltage regulated power supply, top quality meters, also quality audio transformers and ham gear. Write for list. M. E. Boyd, 903 Salmon Drive, Dallas, Texas.

FOR SALE: Rek-O-Kut disc assembly (originally \$500); includes M-5 16-in. overhead mechanism, 8 cutter, V-deluxe dual-speed turntable, R-8A Amplifier (2 mike, 2 phono inputs), 12 sapphire styli bonus. Best offer over \$175. Excellent condition. Jack Hartley, 88 Diamond Bridge, Hawthorne, N. J.

FOR SALE: Gray arm 103SL-LP, RMC professional 16" transcription turntable, hysteresis synchronous motor, \$80. S. Leen, Hyannis, Mass.

WESTERN ELECTRIC 19C Audio Oscillator, \$75; type 124 amplifier, \$70; 109-9A equalizer \$10; 170B repeat coil \$8; 285L input trans \$8; Weston 571 constant-impedance voltmeter, \$10; Jensen A15, PM12H speakers and 8-in. reflex cabinet, \$6 each; EV 731 Cardyne-2 mike, \$30; RCA Architects Sound Manual, Lorenzen's "AC Calculation Charts," all issues A and Proc IRE 6/47 on. Charles Bensen, FL 3-5427 (N. Y.) after 5 p.m., or Box CV-3, Audio Engineering.

PICKERING DIAMOND pickup cartridge, standard .0025 stylus, played only one hour, \$20. Gordon Blackwell, 406 E. 54th St., New York 22, N. Y. Phone MU 3-4498.

PRESTO 90-A amplifier, three mike inputs 30-15,000 cps, \$250; Brush 3-hour wire recorder with extras \$195; (orig. cost \$800) sell both as unit \$395. 2 Presto 1-D heads \$60 each. 2 transcription arms \$8 each. Presto AM tuner and FM Pilotuner \$50. Reco-Art Sound Recording Co., 1305 Market St., Philadelphia 7, Penna.

PILOT FM tuner, Webster changer, GE cartridges and preamplifier, 10-in. speaker, \$35; New Federal 269 enlarger, \$25; Bolex B camera with new flashgun, filters, etc., \$45. Norman Tetelman, 225 Roebling St., Brooklyn, N. Y.

FOR SALE: Heathkit 'scope, latest model, perfect operating condition, \$32.50 (reason—too large for present apt.); Thordarson Tru-Fidelity transformers—T-90A00 line-to-grid, T-90A02 plate-to-line, and T-87R85 power with bias tap, \$7 each, all three for \$15. Precision Model 954 tube tester multi-meter, just rechecked by mfr, \$30; 2 Aitec 15-in electrodynamic woofers, new, perfect, \$22.50 each. All f.o.b., New York. Box CV-1 Audio Engineering.

FOR SALE: Amplifier Corp. Twin-Trax recorders, Model 810-B, new; Model 710-B portable; \$150 each. Ely Recording Studios, Mt. Holly Springs, Penna.

### WANTED

#### ACOUSTIC OR AUDIO ENGINEER

Position available in research and development on loudspeakers and microphones. College training plus several years practical experience required. Applicant should be fairly well grounded in the physics of vibrating systems, audio reproduction and laboratory technique pertaining to audio and acoustic measurements. Engineer who has had employment with a loudspeaker manufacturer would be most desirable. A progressive concern with extensive and up-to-date research facilities located in New York suburban area. Salary liberal and open depending upon qualifications of applicant.

Box DP1 AUDIO ENGINEERING

average for the samples taken, and that the average characteristic does change over a period of time. Therefore it is not possible to build fixed equalization for this purpose into any system. However, a minimum requirement of high- and low-frequency equalization provides gain or loss at the rate of 6 db per octave and has variable turnover points at both ends. The range of equalization that will satisfy one listener is extremely limited and anyone who is forced to listen to an unsuitable equalization characteristic will be subject to auditory fatigue, and in turn will not like the equipment.<sup>10</sup> Equalizer settings are best determined after a period of trial and, as pointed out by LeBel, it is often impossible to satisfy some people because of certain subjective problems including partial deafness.

As has been indicated, even using live program material, a single-channel system makes several compromises with high fidelity and ideal transmission. When remote radio broadcasts or old records are reproduced on a single-channel system, the system cannot be held at fault. Further reduction of bandwidth is necessary to obtain any enjoyment from material of this type. This leads to the conclusion that we are now giving the listener *pleasing* instead of *faithful* reproduction.

Although the means for providing the acoustic facsimile are available, their cost and size prevents their use by the public as high-fidelity systems. It is therefore necessary to take practical systems and modify the quality of the signal as passed by the system, to produce an acoustical result which the listener will compare favorably with the original signal, or with his idea of what the original signal would have sounded like.

<sup>10</sup>C. J. LeBel, "Psycho-acoustic aspects of higher quality reproduction." *AUDIO ENGINEERING*, 33, 1, p. 9, Jan. 1949.

## POPS

[from page 34]

have lost their public, and with it, their influence in setting the standards for musical experience. They have been replaced by a new group that will shortly determine the history of music in this country more powerfully than ever before. In place of the concert hall, the theatre stage, the night club, bar, cafe, and community auditorium, the major scene of musical activity is (and will continue to be) the recording studio, the TV studio, and (as long as it lasts) the turntable (both AM and FM). The new leaders are responsible to an entirely new audience, an audience which is not only enormous, but also capable of getting its kicks without leaving its homes.

But there is still another problem. Assuming the importance of FM, will there

## PROFESSIONAL DIRECTORY

### C. J. LeBEL

AUDIO CONSULTANT

Sound Recording • Instrumentation

370 RIVERSIDE DRIVE  
NEW YORK 25, N. Y.

### Custom-Built Equipment

## U. S. Recording Co.

1121 Vermont Ave., Washington 5, D. C.

STerling 3626

Consultation • Design • Fabrication

## Audio Facilities Corporation

133 West 14th Street,

New York 11, N. Y.

## HERMAN LEWIS GORDON

Registered Patent Attorney

Patent Investigations and Opinions

Warner Building 100 Normandy Drive  
Washington 4, D. C. Silver Spring, Md.  
National 2497 Shephard 2433

## RICHARD H. DORF AUDIO CONSULTANT

Sound Systems Recording Installations  
Product Design Technical Literature

255 W. 84th Street Phone  
New York 24, N. Y. Schuyler 4-1928

### AUDIO ENGINEERING SCHOOL

Practical engineering training in Audio fundamentals, Disc, Film, Magnetic Recording, and Audio frequency measurements. Studio training simulates Broadcast, Motion Pictures, Television, and Commercial Recording work. Approved for Veterans.

Hollywood Sound Institute, Inc.  
1040-A North Kenmore, Hollywood 27, Calif.

Specify if Veteran or Non-Veteran



**AVAILABLE FOR THE FIRST TIME**  
**ELEMENTS of SINGLE and**  
**DUAL TRACK TAPE RECORDING**  
**and 1001 APPLICATIONS**

by A.C. Shoney

A completely new 112 page booklet for recording technicians, experimenters and recordists. Over 100 illustrations, circuit diagrams, parts lists and construction hints. Latest elementary and advanced theory and design. Order your copy today.

**Only \$1.00**  
 postpaid

To: Amplifier Corp. of America  
 398-4 Broadway, N. Y. C.

Rush.....copies of A. C. Shoney's Book "Elements" I enclose herewith \$..... @ \$1 per copy.

Rush free literature on your complete tape recorder line.

NAME.....  
 ADDRESS.....  
 CITY..... STATE.....

**AMPLIFIER CORP. of AMERICA**  
 398-4 Broadway, New York 13, N. Y.

**ELECTRONICS TECHNICIANS WANTED**

The RCA Service Company, Inc., a Radio Corporation of America subsidiary, needs qualified electronics technicians for U. S. and overseas assignments. Candidates must be of good character and qualified in the installation or maintenance of RADAR or COMMUNICATIONS equipment or TELEVISION receivers. No age limits, but must have at least three years of practical experience.

RCA Service Company offers comprehensive Company-paid hospitalization, accident and life insurance programs; paid vacations and holidays; periodic review for salary increases; and opportunity to obtain permanent position in our national and international service organization, engaged in the installation and maintenance of AM, FM and TV transmitters, electronic inspection devices, electron microscopes, theatre and home television, r-f heating equipment, mobile and microwave communications systems, and similar electronic equipment.

Base pay, overseas bonus, payments for actual living and other expenses, and benefits mentioned above add up to \$7,000 per year to start for overseas assignments, with periodic review of base salary thereafter. Openings also available at proportionately higher salaries for specially qualified technicians with supervisory ability.

Qualified technicians seeking an advantageous connection with a well-established company, having a broad-based, permanent peacetime and wartime service program, write to

Mr. G. H. Metz,  
 Personnel Manager,  
 RCA Service Company, Inc.,  
 Camden 2, New Jersey

be any live music or simply the present practice of playing records? From all indications, the latter will be the case. As a matter of fact, the primary source of music in the not-too-distant future will probably be the revolving disc. Despite what we said last month about the creation of the record not as a replacement for live music, but merely a supplement, the technological wheel has ground and theoretical pre-suppositions can be tossed out the window. Musicians can no longer be criticized or judged at the time they perform, but only under the conditions of reproduction. Pop vocalists and novelty groups will probably persist, thanks to TV, but purely instrumental stuff will be heard, not seen.

**Record Critic's Obligations**

Therefore, the entire problem has changed radically. The record critic has been pretty insignificant so far. His readership was limited, in terms of the full range of musical activities, to a comparatively small group of record collectors. He has not been taken seriously, for the most part, by the trade and even his readers glanced at him only as a source of information about new releases. But, from the looks of things now, the record critic will have to be in the future (and should be now) the new music critic... plus. He must be not only a musicologist, an individual with well defined musical tastes and a moderate theoretical background to back up the tastes, but he is now responsible for technical information as well. By all rights, a record critic should review on the basis of a two-fold experience. He should be present at the recording session itself, and then should be able to make a comparison between the original performance and the recorded version. He is also prey to the evil that befalls those whose only sound values are those derived from hearing recorded performances. Believe it or not, there is a large group of so-called music lovers who have never (or rarely) heard a live performance and whose judgments concerning sound and balance are limited to what can be heard via recordings. If any of my dire predictions are correct, even partially, there is more need than ever for responsible criticism and responsible judgment on all fronts. The music-lover-via-records must develop a tremendously conscientious outlook and refuse to accept the kind of mediocrity which is now current. Since the powers that be are the leaders of the record industry, they can only be controlled by the display of purchase power, both negatively and positively.

But what about jazz and pops? The prediction at this point is the most dire one of them all. I am seriously of the opinion that the right conditions for good jazz no longer exist. Even assuming the innovations of the future, jazz as we know it is finished. It cannot subsist merely on a recording level (as should be clear from the column of two months ago). Whether this is good or bad, a completely new type of basic popular music will have to replace it. The popular music will have to replace the subjectivity and spontaneity of jazz with deliberate scoring for deliberate effects. Bop was obviously not the replacement and it is even questionable whether anything like "swing" with be the thing. We are probably going through a transitional period until some popular form on an instrumental level is finally evolved which can appeal to a popular taste on a substantial level. What it will be, I don't know.

So far, we are talking about professional music and professional musicians. Even with the expected enormous cut-down in the business, there will continue to be

**An Invitation to see and hear BRITAIN'S FINEST AUDIO PRODUCTS**

**AT THE AUDIO FAIR**  
 Hotel New Yorker Room 650



**GARRARD**

"The world's finest automatic record changer. Competitively priced! Plays all speeds. Automatic stop. Heavier turntable. Quieter motor. Muting switch eliminates noise between records. Accurate tuning resonance.



**LEAK "POINT ONE"**

A new model of Britain's best audio amplifier. Distortion: 0.1%. Triple loop power amplifier and pre-amplifier certified by British Nat'l Physical Lab. (equiv. U. S. Nat'l Bureau of Standards) to exceed manufacturer's performance claims. Pure, undistorted musical reproduction... the ultimate in clarity and frequency response.



**WHARFEDALE**

Magnificent speakers, yet inexpensive, with remarkable response. Built by Wharfedale Wireless Works under the direction of world-famous engineer, G. A. Briggs. Brilliant performance approaching living sound. Endorsed by B.B.C.



**BOOKS by G. A. BRIGGS**

"Loudspeakers" and "Sound Reproduction" written by renowned authority on sound, G. A. Briggs. The only such books written expressly for the layman. A "must" for those interested in finest musical reproduction.

At your dealer or write to  
**BRITISH INDUSTRIES CORP.**  
 164 Duane St., New York 13, N. Y.



TWIN-TRAX\* TAPE RECORDERS

designed... **ENGINEER** in mind  
with the

A COMPLETE SERIES

... of high-fidelity, dependable tape recorders — from transport mechanisms to highly specialized instruments, including the one YOU want. Write today for catalog 5101. Includes ALL technical specifications and direct factory prices.

**AMPLIFIER CORP. of AMERICA**  
398-4 Broadway New York 13, N. Y.

\*Trademark Reg.



HOW LEADING NETWORKS  
USE **Carter CONVERTERS**

Photo above shows NBC's Tommy Bartlett and Universal Recording Company engineers making transcriptions from STORAGE BATTERY POWER by means of Carter Frequency Controlled Converter.

Wherever 115v. line voltage is not available, or hard to get, Carter Converters supply dependable AC power to make on location recordings. Operates from storage batteries. . . . Used by leading networks, broadcast stations, and program producers.

Recommended by Brush and Magnecord

One model operates both Brush and Magnecord equipment. Delivers clean 60 cycle AC power. Requires no filtering. Frequency control feature compensates for 10% input voltage variation. Available for 6, 12, 24, 28, 32, 64, and 115v. DC input voltage. Size 8 1/4" x 5 3/8" x 7 1/2" high. Weight only 15 3/4 lbs. Performance Guaranteed!

MAIL COUPON FOR  
FREE CATALOG

New Converter catalog illustrates entire line of Carter Rotary Converters for recording, TV, sound collection and transcription players. **SELECTOR CHART** included tells model to suit your purpose. Mail Coupon now for your copy and name of nearest Carter distributor.

**Carter**

MOTOR CO.

2648 N. MAPLEWOOD AVE., CHICAGO 47

Carter Motor Co.  
2648 N. Maplewood Ave.,  
Chicago 47, Ill.

Please send catalog #349 with information on Frequency Control Converters, and name of nearest distributor.

Name .....

Station or Company .....

Address .....

those who call themselves amateur musicians. They will continue to play jazz and will be the primary source for any continuation of the tradition. Jazz will have to be a spare time affair, with no occupational dependency placed on it. But this spare time affair could be a tremendous thing. It is still my contention that somebody can make a big bundle of dough by correctly recording jazz at this stage of the game, and some of these groups, completely detached from the sordid needs of making a living, can do magnificent things. If allowed to play live under their own conditions, on-the-spot tapes should make it possible to continue supplying the jazz-loving public with a moderately acceptable replacement for the real thing. Since jazz cannot be evolved in a recording studio, the recording studio will have to become portable and simply move from spot to spot across the country and across the world, discretely listening in on the experience of jazz being made under the best conditions. Big names on a professional level will be unimportant. Something of this sort has happened in other fields during the past fifty years (sic the case of poetry, by the writing of which one cannot make a living).

But to sum it all up, the major requirement is a completely new attitude on the part of audio engineers. Now, more than ever, the primary objective is the creation of equipment which will make possible the so-far impossible theoretical optimum. Up to this point, it was merely an idle dream which didn't have to be fulfilled. Now it has to be. Stereophonic systems of the highest possible efficiency, the creation of acoustical systems suitable for even the worst possible locations, the manufacture of equipment which is both compact and inexpensive. It's a tall order, but it will have to come to pass. Perfect response all the way up and down the line has not been realized to date. There are many who believe it impossible. There are many who have abused the perfectionists . . . but the perfectionists are now the only realists. The problem now has nothing to do with LP's, 78's, tape, or what have you. It is the creation of a means of record reproduction which will replace the live thing. The original factor is the record itself. It has to perform for FM as well as for home reproduction. The next crisis in the record industry will have to result from this because ultimately, the LP versus 78 versus 45 controversy is completely immaterial.

Well . . . there's the gist of the matter. The above may appear to be fantastic, unbelievable, unreal, etc. It is far from it. It is a presentation of imminent reality. The enormous switch from second-rate reproduction system to expensive, high quality units during the past ten years, the enormous increase in the sale of records and the concomitant decrease in the need for live concert attendance, the complete death of the dance business and the reduction of pop participation to radio, records, and movies all point to it. The recent discovery that the major cities of the United States are going through complete decentralization, with the middle class—whose shekels make musical activity possible—moving out of the cities into suburban areas is partial corroboration. The people who have left the cities live too far away to participate in live music activities and will have to depend, like rural communities, on records and radio. The switch to records on radio proves the point again. Now comes the time to make standards as high as possible. As I said once before, the power of the buck is tremendous. You can destroy an entire industry and build another with your bucks. You destroyed one and are building another. Build it well, please!

More Pleasure...for Less

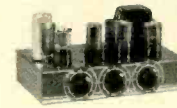

MUSIC LOVERS  
AMPLIFIER

\$2950

Especially designed by CONCORD engineers to give the Hi-Fi Fan an inexpensive yet good quality unit. Normal rated output 8 watts (harmonic distortion only 2%). Three inputs for magnetic, and crystal cartridges, and radio tuner; built-in pre-amp for reluctance pickups; separate bass and treble controls with flat position—bass gives 10db boost, treble gives 12db boost and 14db attenuation. Freq. resp. at rated output 40-15,000 cps ±1db. Tubes: (2)6X6, 6SL7, 6SC7, and 6X5 rect. For 117V, 60 cycle AC. Brown hammered finish. Size: 10-1/2 x 6 x 5-1/4". With tubes. 2-295A -- Shpg. wt. 10 lbs. . . . . **29.50**

ATTENTION HI-FI CUSTOM INSTALLERS

Write on business letterhead for information on Concord's Dealer Plan and Technical Advisory Service designed especially for custom installation men. Write now for FREE information.

CONCORD RADIO CORP.

Mall Order Center and Showroom  
901 West Jackson Blvd. Chicago 7, Ill.

CONCORD RADIO CORP. Dept AL50  
901 W. Jackson Blvd., Chicago 7, Ill.

Enclosed \$ . . . . (include shipping charge. Any excess will be refunded.)  
Rush \_\_\_\_\_ Music Lovers Amplifiers @ \$29.50  
 Send FREE latest Bargain Bulletin  
Name .....

MUSICORNER



CORNER HORN-SPEAKER

FREQUENCY RESPONSE: 30-15,000 cps. LOW FREQUENCY ACOUSTIC GAIN: 3 DECIBELS over ANY conventional enclosure. This is done WITHOUT the use of resonant sections. This gain is due to the 4-foot long exponential horn loading of the rear of the speaker cone which permits 30 cycle FUNDAMENTAL response from 12" speaker. Medium and high frequencies are radiated from front of the speaker cone, permitting use of coaxial type of speaker in this enclosure. Available with or without coaxial speaker in either utility or quality furniture finish, which is appropriate for the finest home surroundings.

WRITE FOR DESCRIPTIVE  
BULLETIN AND PRICES

ELECTRONICS OF STATEN ISLAND, N. Y.

363 Victory Blvd.  
Staten Island 1, N. Y.

Hear it at the Audio Fair—Room 537



IN - BUILT  
TWIN DRIVE  
with  
CROSS OVER  
and  
FEED - BACK



The idea of crossovers and twin units seems to have got such a grip that some U. S. friends ask us why we don't make such things. Well, of course we do, only we do it better and build the whole lot into one, plus a dose of self adjusting feed back which no other speaker, single, twin or triplet, possesses. Our drive is patented in U. S. A. as elsewhere and only genuine Barker speakers have its resultant quality of full audio frequency range plus freedom from slantant resonances plus dead beat motion which pin-points transients and detail, plus an overall smoothness making highs, middles and lows equally clear-cut and true. You may ask: Ah! but what about that large cone? If our cone was normal that might hit home, but again it is a patented special with perfectly graded compliance from apex to rim, making it comparable with a whole series of matched cones covering the needs of efficient radiation from below 40 to over 15,000 cps. Back to the driver: It is a very thin, light metal tube fixed to the cone apex. On it is a coil of fine wire over a skin of long life stabilised latex. Up to the middles the latex won't flex so the coil drives, but as the frequency rises the latex gives and the metal tube takes over by induced currents, giving efficient drive to beyond audio limits. A simple but true dual action with in-built, truly matched cross-over. And how the feed-back? Send for details of the Barker Model 150, 12 ins. unit with 17,500 gauss magnet. \$60 post and insurance paid to your home.

BARKER NATURAL SOUND REPRODUCERS  
BCM/AADU, LONDON, W.C.1, ENGLAND.

## TWIN LEAD, TELEVISION LIGHTNING ARRESTER

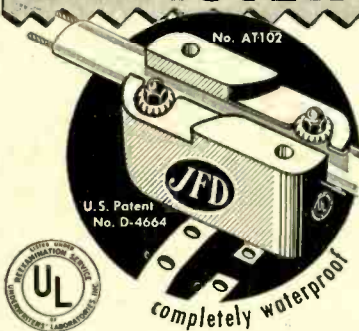

APPROVED for OUTDOOR-INDOOR Use \$2.25  
Protects Television Sets  
Against Lightning and Static  
Charges

**JFD SAFE TV GUARD**

Simple to install everywhere and anywhere  
...no stripping, cutting or spreading of  
wires. More than 300,000 in use today!

SEE YOUR JOBBER OR WRITE TO

**JFD MANUFACTURING CO., Inc.**  
6127 16th Avenue, Brooklyn 4, N. Y.  
First in Television Antennas & Accessories

## A NEW LIMITING AMPLIFIER

[from page 19]

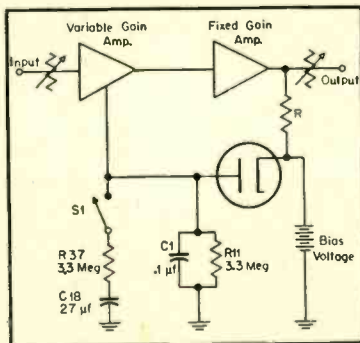

Fig. 4. Block diagram of the limiting amplifier.

mine the recovery time constants of the gain reduction circuit.

The single time constant is formed by  $C_1 R_{11}$ . The capacitance of  $C_1$  and the resistance of  $R_{11}$  are such that the capacitor will charge very rapidly (0.0006 sec) and discharge more slowly (0.33 sec). The dual time constant is obtained by connecting  $C_{18}$  and  $R_{37}$  in series across  $C_1$ .  $C_{18}$  is charged slowly through  $R_{37}$  (0.9 sec) and even more slowly discharged (2.0 sec) through  $R_{37}$  and  $R_{11}$ . The difference between the results obtained when using the single- or dual-time-constant circuits is illustrated in the following:

### Examples of Operation

Consider an input waveform as shown at A in Fig. 5. From  $t_0$  to  $t_1$  the level corresponds to the verge of limiting. At

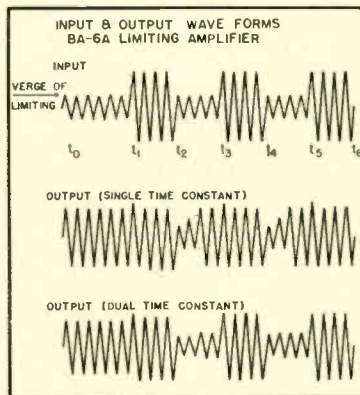

Fig. 5. Input and output waveforms showing effect of different time constants.

## MILO SOUND has all the best lines!

Take your choice of the world leaders in audio equipment. Here's just a partial list—from MILO SOUND'S great warehouse of complete stocks:

ALTEC	LIVINGSTON
APPROVED	MASCO
ASTATIC	MEISSNER
ATLAS	MINNESOTA
AUDAK	MINING
AUDIO DEVICES	NEWCOMB
BELL	PENTRON
BOCEN	PERMOFLUX
BROOK	PICKERING
BROWNING	PRESTO
BRUSH	RACON
CLARKSTAN	RADIO
COLLINS AUDIO	CRAFTSMEN
ELECTRONIC	RAULAND
WORKSHOP	REK-O-KUT
ELECTRO-VOICE	SCOTT
ESPEY	SHURE
GARRARD	SOMERSET
GE	STEPHENS
GRAY	TURNER
HOLL	UNIVERSITY
JENSEN	UTC
LEAK	VM
	WEBSTER

Visit our Showroom.

Write for Literature



## FOR THE "GOLDEN EAR" CROWD

### THE STRAIN-SENSITIVE PHONOGRAPH PICKUP

Here's why this truly faithful reproducer appeals to people gifted with the "Golden Ear" . . . why the STRAIN-SENSITIVE PICKUP developed by the PFANSTIEHL CHEMICAL COMPANY brings out the brilliance of great voices and orchestras . . . the latent music on your records that other pickups leave untouched.

- The STRAIN-SENSITIVE PICKUP is an amplitude transducer with a CONSTANT RESISTANCE of about 250,000 ohms.
- Signal output is at a practically CONSTANT IMPEDANCE level.
- Excellent transient response.
- NO DISTORTION, phase shift or evidence of intermodulation is audible.
- LINEAR RESPONSE free from peaks or resonances.

Cartridges are available for both standard and micro-groove, and can be had with Famous PFANSTIEHL M47B Precious Metal Alloy or diamond tipped styli.

A special preamplifier is necessary to provide the correct D.C. voltage for the pickup element and to provide the first stages of signal gain. Four styles are ready, or, if you prefer, you can build your own from the circuit in the literature.

Ask your radio supply man, or write today for complete FREE INFORMATION.

**PFANSTIEHL  
CHEMICAL COMPANY**

105 Lake View Avenue, Waukegan, Illinois

AT THE FAIR

NEW L.S. BAFFLE

**DUOPHASE**  
ACOUSTICAL COUPLER

PRESENTATION BY

RADIO-MUSIC CORPORATION

122 E. 42nd St., N. Y. 17, N. Y.

**DEMONSTRABLY BEST  
BY EVERY TEST!**

*Acrosound\**

QUALITY OUTPUT TRANSFORMERS\*

- Widest Frequency Response
  - Unexcelled Transient Response
  - Lowest Intermodulation and Harmonic Distortion
  - Highest Power Capacity
  - Professional Quality at a Practical Price
- Write for FREE descriptive literature, performance data, and suggested amplifier circuits for high fidelity applications  
★ Pat. Pending

Acro Products Co. 215 Arch St., Phila. 6, Pa.

## BOUND VOLUMES 1950

Enter your order now for your copy of the 1950 bound volume of AUDIO ENGINEERING. For permanent reference, the bound volume is easier to store, easier to find things in, and it keeps your copies in mint condition throughout the years. The ideal way to keep these valuable issues.

1950 Bound Volumes . . . \$8.95

## FOR 1951

A new offer, made now for the first time entitles you to subscribe or to renew your present subscription for one year at the cost of \$10.00, which includes a bound volume delivered to you around January 1, 1952. Each month you will receive AUDIO ENGINEERING—read it, cut out coupons to your heart's content, mark on the pages as much as you want. At the end of the year, you receive a fresh, new bound volume of 1951 issues which you can keep as a permanent record. Stop trying to keep each issue neat and clean—use it. Then, at the end of the year, you'll receive a completely new set—no creases, no dog-eared pages.

Dept. SV

**AUDIO ENGINEERING**

342 Madison Ave., New York 17, N.Y.

$t_1$ , the level is suddenly increased. At  $t_2$ , the level is again decreased to what it was at  $t_0$ , and the cycle repeats.

With the switch  $S_1$  in the single-limit position, the output waveform will be approximately that shown at B in Fig. 5. Assuming the charging time of  $C_1$  to be much shorter than the period of the signal, the output signal will increase only slightly since the amplifier gain is reduced as  $C_1$  is charged. At  $C_2$  the output drops suddenly as the input level is reduced, but increases rapidly as the charge leaks off  $C_1$ , and the gain is restored to normal.

With  $S_1$  in the dual-limit position, the output waveform is the same as with  $S_1$  in the single-limit position up to  $t_2$ .

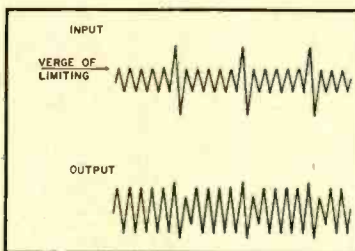

Fig. 6. Input and output waveforms where signal consists of a series of short peaks.

During the time interval from  $t_1$  to  $t_2$ , however,  $C_{1a}$  is charged. As the input level drops at  $t_2$ , the output level drops as in the first case, but increases much more slowly since the discharge time of  $C_{1a}$  is longer than that of  $C_1$ . The output waveform is indicated by C in Fig. 5.

On an input waveform containing short peaks such as shown at A in Fig. 6, there is not sufficient time for  $C_{1a}$  to charge appreciably and the circuit acts as though the  $S_1$  were in the single-limit position. The corresponding output waveform is shown at B in Fig. 6.

Thus with the dual timing circuit, the recovery time is shorter after a single peak

and long after a series of peaks. This means that the reduction of gain following a short peak is held to a minimum and does not cause a noticeable "hole" in the program. After a prolonged series of peaks, the recovery time is long, and rapid changes in gain often referred to as "breathing" or "pumping" are avoided.

In order to obtain the desired system performance, the input and output attenuators of the limiting amplifier have to be set properly. With a given maximum input level, the setting of the input attenuator determines the gain reduction obtained. The maximum gain reduction which should be used is a compromise between the increase in average power output and the loss of dynamic range.

Listening tests indicate that as much as 15 to 20 db of gain reduction can be used on program material where the loudness range is not of primary importance. The output attenuator and fine output adjustment must be set for the desired output level or percentage modulation at maximum gain reduction.

The BA-6A Limiting Amplifier also incorporates those features which are found in other high-quality broadcast audio amplifiers. The amplifier with its self-contained power supply is constructed on a plug-in chassis for shelf mounting and is therefore readily removable for inspection and service. All controls, tubes, and plug-in capacitors are accessible from the front. A selector switch permits use of the four-inch illuminated gain reduction meter for measuring the cathode current of all amplifier tubes, tube balance, and d.c. filament voltage. Plate and heater power are available for operating a pre-amplifier in applications where additional gain is required.

The use of high-quality components and the straightforwardness of design, employing only nine tubes including rectifier and voltage regulator, insure a maximum degree of reliability.

Fig. 7 Curve of the limiting characteristics of the BA-6A. This unit provides an automatic means of limiting program output to a safe maximum value.

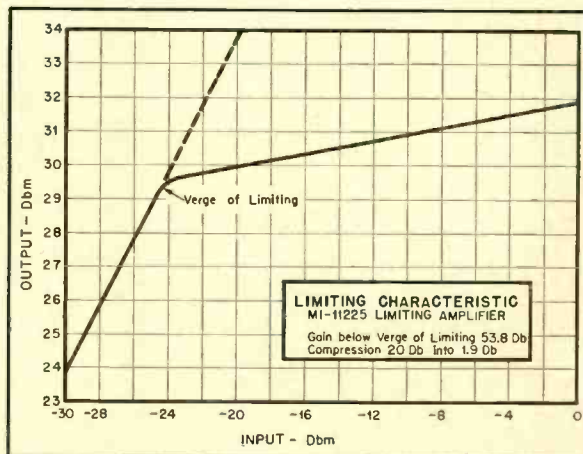



The Improved 1951

# Concertone RECORDER



Model 1401

"just like  
being there"

• Equalization conforms to NAB recommended standards • Extended frequency response—40 to 15,000 c.p.s.  $\pm$  2db • Tape noise down to random level • More powerful drive motor • Improved braking system • Monitors directly from tape while recording • Plays up to 10½" NAB reels • Write for Bulletin No. 101.

MODEL NO. 1401—Complete for console installation, with dual track heads..... **\$345.00**

Manufactured by **USER'S NET COST**

## Berlant Associates

4917 W. Jefferson Boulevard  
Los Angeles 16, California



## Ready NOW ULTRASONIC FUNDAMENTALS

By S. YOUNG WHITE

The rapid increase in the use of ultrasonics during the last few years makes it natural that the well-informed sound engineer should want to learn something of the applications and potentialities of this amazing new field. But interest in ultrasonics is not confined to the sound engineer—it is of still greater importance to the industrial engineer for he is the one who will visualize its uses in his own processes.

Elementary in character, **ULTRASONIC FUNDAMENTALS** was written originally as a series of magazine articles just for the purpose of acquainting the novice in this field with the enormous possibilities of a new tool for industry. It serves the double purpose of introducing ultrasonics to both sound and industrial engineers. The list of chapter headings will indicate how it can help you.

### CHAPTER HEADLINES

Too Much Audio. Opportunities in Ultrasonics. Elements of Ultrasonics. Experimental Ultrasonics. Coupling Ultrasonic Energy to a Load. Ultrasonics in Liquids. Ultrasonics in Solids. Testing by Ultrasonics. High-Power Ultrasonics. Notes on Using High-Power Ultrasonics. Applications of Ultrasonics to Biology. Economics of Industrial Ultrasonics.

The applications of ultrasonics have already extended to many industries, and as its possibilities are explored they will increase a hundredfold. To keep abreast of its growth, engineers in all fields must know what they may expect from ultrasonics, how it is used, how the energy is generated, and the techniques of applying ultrasonic treatment to many processes.

**ULTRASONIC FUNDAMENTALS** is not a big book—it does not cover the entire field of ultrasonics with hundreds of pages of dull reading. But in the three hours it will take you to read it, you will get a down-to-earth glimpse into the far-reaching possibilities of a new art.

**ULTRASONIC FUNDAMENTALS**  
By S. YOUNG WHITE

36 pages, 40 Ill., 8½ x 11, paper cover  
\$1.75

Book Division, Dept. A  
**RADIO MAGAZINES, INC.**  
342 Madison Avenue New York 17, N. Y.

## NEW LITERATURE

• **Mark Simpson Mfg. Co.**, 32-28 49th St., Long Island City 3, N. Y. is using its new catalog No. E-351 to introduce a new line of economy sound equipment. Included in the equipment described are amplifiers and complete sound systems ranging in power from 8 to 52 watts for fixed, portable and mobile operation.

• **RCA Victor Division of Radio Corporation of America**, Camden, N. J. announces a new edition of the "RCA Receiving Tube Manual." Designated RC-16, the new manual incorporates many features reflecting new developments in electronics. Completely revised and expanded, RC-16 contains over 300 pages and is 25 per cent larger than the RC-15 edition it supercedes. Available through RCA parts and tube distributors.

• **Bakelite Division, Union Carbide and Carbon Corporation**, 300 Madison Ave., New York 17, N. Y. has available a newly published 24-page booklet summarizing the characteristics, development and latest applications of Bakelite polyethylene resins. Both domestic and industrial applications of the material are described as are methods of processing for various functions.

• **Radio Shack Corporation**, 167 Washington St., Boston 8, Mass. is now mailing free upon written request the largest catalog in the company's history. Major sections of the 172-page 1951 catalog include: Test and Service Instruments, P.A. and High-Fidelity Music Systems, Ham Equipment, Tubes, and Component Parts.

• **D. W. Onan & Sons Inc.**, Minneapolis 5, Minn. is now distributing a folder titled "When Power's Off . . . You're Safe"—telling how businesses, farms, and homes can be protected against property damage and danger to life which are the frequent results of electric power failure. The folder describes the Onan standby generator. When writing ask for Folder A-277.

• **Allied Radio Corporation**, 833 West Jackson Blvd., Chicago 7, Ill. announces publication of its new 1951 212-page catalog. In addition to covering the field of radio, television and industrial electronics, the new Allied catalog has an expanded section on Geiger counters for X-ray and radioactive ore detection. Copy available without charge.

• **Society of Motion Picture and Television Engineers**, 342 Madison Ave., New York 17, N. Y. is now accepting orders for "Principles of Color Sensitometry," a 72-page text dealing with instruments available for use in color research and for quality control in practical use of commercial color processes. Authored by a group of outstanding figures in the motion picture and kindred fields, the book is expected to help guide industry in the standardization of many aspects of color sensitometry. Price is \$1.00.

• **Trilane Associates, Inc.**, 1 Hudson St., New York 13, N. Y. has recently published a 16-page "United States Government Procurement Brochure" to aid manufacturers in obtaining government business. Various aspects of the government procurement process are covered in the book, a free copy of which may be obtained by writing the publishers.

## SENSATIONALLY NEW!

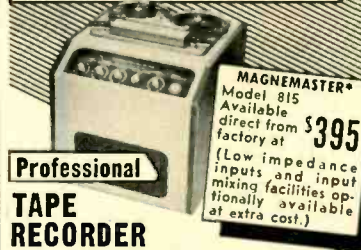

**MAGMASTER®**  
Model 815  
Available direct from factory at **\$395**  
(Low impedance inputs and input mixing facilities optionally available at extra cost.)

Professional

**TAPE RECORDER**

The **MAGMASTER®** Console

Featuring

- Two-speed two-direction operation! 50 to 15,000 cycles at 15 in. per sec. 50 to 10,000 cycles at 7½ in. per sec.
- Dynamic range better than 50 db!
- Single or dual track recording without changing heads!
- Simultaneous monitoring off tape while recording (optional)!

Other Magmaster features include: Separate heads for erase, record and monitor • Guaranteed lifetime head alignment • Shuttle speed in both directions • Synchronized brakes for instantaneous stop • No overshoot or tape spillage during play or shuttle • Flutter  $\pm$  0.05% at 15 in. per sec.;  $\pm$  0.1% at 7½ in. per sec. • Lifetime self-adjusting spring clutches • Gentle non-slip non-pinching drive system.

Write today for complete literature.

\*Trade Mark Reg.

**AMPLIFIER CORP. of AMERICA**  
398-4 Broadway, New York 13, N. Y.

## Langevin

### AMPLIFIERS



For broadcast, public address, recording, and music services — custom designs for special applications.

## Langevin

### TRANSFORMERS



Open-core, enclosed, hermetically sealed, high-temperature. Built to your own or MIL-T-27 specifications.

## Langevin

### ENGINEERING



Available for the development and manufacture of special electronic devices.

For detailed information on our products and services, write to

# Langevin

MANUFACTURING CORPORATION  
37 W. 65th St., New York 23, N. Y.



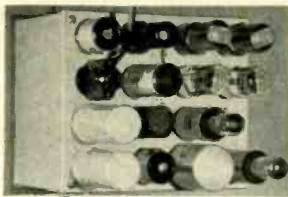

20 W-2 Amplifier \$149.50



AE-2 Equalizer PreAmp \$74.50

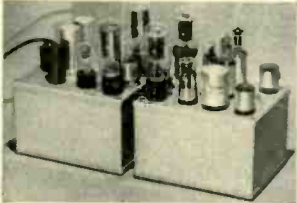

50 W-2 Amplifier \$249.50

# McIntosh

Engineering Laboratory, Inc.  
910 King St. Silver Spring, Md.  
Prices Subject to Change Without Notice.

## MORE INFORMATION FOR YOUR DOLLAR

We have just completed mailing further technical data to all those on our mailing list. In addition every subscriber to "New Notes in Radio" has received a copy of our short treatise on "Reproducing L.P. Records".

We have had many letters complimenting us on the information we send out. Many have told us they have learned things they never knew before, although they thought they were well-informed. We accept the implied compliment gracefully, not because we think we are clever, but because it suggests we have been working on original lines.

The name Hartley-Turner has always been associated with an ardent desire to achieve perfection in audio reproduction, and in that never-ending quest we have picked up a lot of useful knowledge which is yours for the nominal sum of one dollar.

Achievement of nearly perfect reproduction rests on your choice of speaker. The 215 is the result of twenty years' specialisation in high-fidelity work, and the 215 is so highly specialized that we have no other model; if we had, one or other would not be so good. The cost is \$40.00, post and insurance paid by us; but if you are a member of a Hartley-Turner Speakeasy the cost will be even less.

Why not send that dollar today? Even if you can't feel inclined to risk a dollar you can have our catalogue free for the asking.

**H. A. HARTLEY Co. Ltd.,**  
152 HAMMERSMITH ROAD  
LONDON W.6, ENGLAND

## ADVERTISING INDEX

Acme	56
Acro Products Co.	70
Air-Tone Sound & Recording Co.	49
Allied Radio Corp.	58
Altec Lansing Corp.	45
Amperite Co., Inc.	8
Ampex Electric Corp.	72
Amplifier Corp. of America	67, 68, 71
Arnold Engineering Co., The	1
Astatic Corp., The	42
Atlas Sound Corp.	65
Audak Co.	37
Audio Devices, Inc.	Cover 2
Audio Facilities Corp.	66
Audio Instrument Co.	63
Barker Sound Reproducers	69
Belden Radio Wire	7
Bell Sound Systems, Inc.	59
Bell Telephone Laboratories	14
Berlant Associates	71
Bozak, R. T.	63
British Industries Corp.	67
Browning Laboratories, Inc.	53
Camera Equipment Co.	55
Carter Motor Co.	63
Chicago Transformer Div.	51
Cinema Engineering Co.	52
Classified Ads	66
Concord Radio	68
Consolidated Vultee Aircraft Corp.	64
Dorf, Richard H.	65
Duotone Co.	61
Electric Indicator Co.	65
Electronics of Staten Island	68
Electro-Voice, Inc.	39
Fairchild Recording Equipment Corp.	3, 38
General Radio Co.	5
Gordon, Herman Lewis	66
Gray Research & Development Co., Inc.	44
Hartley, H. A. Co., Ltd.	72
Harvey Radio Co., Inc.	43
Heath Co.	10
Hewlett-Packard Co.	2
Hollywood Sound Institute, Inc.	66
Hudson Radio & Television Corp.	57
Jensen Manufacturing Co.	23
JFD Manufacturing Co., Inc.	69
Langevin Manufacturing Corp.	71
C. J. LeBel	66
Leonard Radio	35
Edwin A. Lipps Co.	57
Magnecord, Inc.	11, 41
McIntosh Engineering Laboratory, Inc.	72
Measurements Corp.	31
Milo Radio & Electronics Corp.	69
Newcomb Audio Products Co.	65
Par-Metal Products Corp.	52
Partridge Transformers, Ltd.	72
Permoflux Corp.	6
Pfanstiel Chemical Co.	69
Pickering & Co., Inc.	13
Proctor Soundex Corp.	56
Professional Directory	66
Radio Corp. of America	9, Cover 4
RCA Service Company, Inc.	67
Radio-Music Corp.	70
Reeves Soundcraft Corp.	48
Rek-O-Kut Co., Inc.	4
Saturday Review of Literature	65
Shallcross Manufacturing Co.	33
Shure Brothers, Inc.	46
Somerset Laboratories, Inc.	54
Sonocraft Corp.	50
Sun Radio & Electronics Co., Inc.	62
Terminal Radio Corp.	47
U. S. Recording Co.	66
United Transformer Co.	Cover 3
University Loudspeakers, Inc.	58



## Partridge News

Individually tested  
**AUDIO TRANSFORMERS**  
to the 'WILLIAMSON'  
Specification

This range of 20 watt push-pull output transformers is intended for use in equipment reproducing the full audio frequency range with the lowest distortion. The design and measured performance is exactly as specified by Williamson in the "Wireless World" August 1949 (see also Audio Engineering November 1949). The transformer is available in a varied range (separate models suitable for KT86, 807 tubes, etc.) Performance assured by comprehensive testing procedure applied to each unit. Close limits set on shunt reactance at 50 cps., series reactance at 5 Kc/sec., d.c. resistances and interwinding insulation resistances at 2 K.V. This is the best possible transformer of its type (weight 14 lbs.) Our new technical data sheet is available and will be rushed to you by airmail upon application. The price of the potted model is \$19.50. Postage, packing and insurance \$1.50 extra. We can guarantee immediate despatch.



## PARTRIDGE TRANSFORMERS LTD

Roebuck Road, Tolworth, Surrey, England



... highest known  
**Recording Efficiency**  
for Instrumentation Applications

Ampex Magnetic Tape Recorders offer the only proved means of making electrically reproducible recordings up to 40,000 cps! Such critical recording permits detailed study of particular phenomena from tape loops, or other automatic data reducing systems. Up to 14 channels of data recorded simultaneously on separate tracks where required. Special systems record down to 0 cycles with no phase shift or wave form distortion. Write for analysis of your specific problem.



Ampex Magnetic Tape Recorders are available in console, rack or portable types.

### UNLIMITED USES INCLUDE:

- Recording-Broadcasting
- Industrial Recording
- Laboratory Research
- Telemetering
- Aerophysical Research
- Multi-Channel Recording
- Portable Half-Track Recording

STANDARD OF THE GREAT RADIO SHOWS  
**AMPEX**  
MAGNETIC TAPE RECORDERS

AMPEX ELECTRIC CORP.  
San Carlos, Calif.





# Linear Standard Units...

## THE ULTIMATE IN QUALITY...

UTC Linear Standard Audio Transformers represent the closest approach to the ideal component from the standpoint of uniform frequency response, low wave form distortion, high efficiency, thorough shielding and utmost dependability.

### UTC Linear Standard Transformers feature...

- **True Hum Balancing Coil Structure** ... maximum neutralization of stray fields.
- **Balanced Variable Impedance Line** ... permits highest fidelity on every top of a universal unit ... no line reflections or transverse coupling.
- **Reversible Mounting** ... permits above chassis or sub-chassis wiring.
- **Alloy Shields** ... maximum shielding from inductive pickup.
- **Hiperam-Alloy** ... a stable, high permeability nickel-iron core material.
- **Semi-Toroidal Multiple Coil Structure** ... minimum distributed capacity and leakage reactance.
- **Precision Winding** ... accuracy of winding .1%, perfect balance of inductance and capacity; exact impedance reflection.
- **High Fidelity** ... UTC Linear Standard Transformers are the only audio units with a guaranteed uniform response of  $\pm 1$  DB from 20-20,000 cycles.



## TYPICAL LS LOW LEVEL TRANSFORMERS

Type No.	Application	Primary Impedance	Secondary Impedance	$\pm 1$ db from	Max. Level	Relative hum-pickup reduction	Max. Unbalanced DC in primary	List Price
LS-10	Low impedance mike, pickup, or multiple line to grid	50, 125, 200, 250, 333, 500/600 ohms	60,000 ohms in two sections	20-20,000	+15 DB	-74 DB	5 MA	\$25.00
LS-10X	As Above	As above	50,000 ohms	20-20,000	+14 DB	-92 DB	5 MA	32.00
LS-12	Low impedance mike, pickup, or multiple line to push pull grids	50, 125, 200, 250, 333, 500/600 ohms	120,000 ohms overall, in two sections	20-20,000	+15 DB	-74 DB	5 MA	28.00
LS-12X	As above	As above	80,000 ohms overall, in two sections	20-20,000	+14 DB	-92 DB	5 MA	35.00
LS-26	Bridging line to single or push pull grids	5,000 ohms	60,000 ohms in two sections	15-20,000	+20 DB	-74 DB	0 MA	25.00
LS-19	Single plate to push pull grids like 2A3, 6L6, 300A, Split secondary	15,000 ohms	95,000 ohms; 1.25:1 each side	20-20,000	+17 DB	-50 DB	0 MA	24.00
LS-21	Single plate to push pull grids, Split primary and secondary	15,000 ohms	135,000 ohms; turn ratio 3:1 overall	20-20,000	+14 DB	-74 DB	0 MA	24.00
LS-22	Push pull plates to push pull grids, Split primary and secondary	30,000 ohms plate to plate	80,000 ohms; turn ratio 1.6:1 overall	20-20,000	+26 DB	-50 DB	.25 MA	31.00
LS-30	Mixing, low impedance mike, pickup, or multiple line to multiple line	50, 125, 200, 250, 333, 500/600 ohms	50, 125, 200, 250, 333, 500/600 ohms	20-20,000	+17 DB	-74 DB	5 MA	25.00
LS-30X	As above	As above	As above	20-20,000	+15 DB	-92 DB	3 MA	32.00
LS-27	Single plate to multiple line	15,000 ohms	50, 125, 200, 250, 333, 500/600 ohms cycles	30-12,000	+20 DB	-74 DB	8 MA	24.00
LS-50	Single plate to multiple line	15,000 ohms	50, 125, 200, 250, 333, 500/600 ohms	20-20,000	+17 DB	-74 DB	0 MA	24.00
LS-51	Push pull low level plates to multiple line	30,000 ohms plate to plate	50, 125, 200, 250, 333, 500/600 ohms	20-20,000	+20 DB	-74 DB	1 MA	24.00
LS-141	Three sets of balanced windings for hybrid service, center-tapped	500/600 ohms	500/600 ohms	30-12,000	+10 DB	-74 DB	0 MA	28.00

## TYPICAL LS OUTPUT TRANSFORMERS

Type No.	Primary will match following typical tubes	Primary Impedance	Secondary Impedance	$\pm 1$ db from	Max. Level	List Price
LS-52	Push pull 2A5, 250, 6Y6, 42 or 2A5 A triode	8,000 ohms	500, 333, 250, 200, 125, 50, 30, 20, 15, 10, 7.5, 5, 2.5, 1.2	25-20,000	15 watts	\$28.00
LS-55	Push pull 2A3's, 6A5G's, 300A's, 275A's, 6A3's, 6L6's	5,000 ohms plate to plate and 3,000 ohms plate to plate	500, 333, 250, 200, 125, 50, 30, 20, 15, 10, 7.5, 5, 2.5, 1.2	25-20,000	20 watts	28.00
LS-57	Same as above	5,000 ohms plate to plate and 3,000 ohms plate to plate	30, 20, 15, 10, 7.5, 5, 2.5, 1.2	25-20,000	20 watts	20.00
LS-58	Push pull parallel 2A3's, 6A5G's, 300A's, 6A3's	2,500 ohms plate to plate and 1,500 ohms plate to plate	500, 333, 250, 200, 125, 50, 30, 20, 15, 10, 7.5, 5, 2.5, 1.2	25-20,000	40 watts	50.00
LS-6L1	Push pull 6L6's self bias	9,000 ohms plate to plate	500, 333, 250, 200, 125, 50, 30, 20, 15, 10, 7.5, 5, 2.5, 1.2	25-20,000	30 watts	42.00

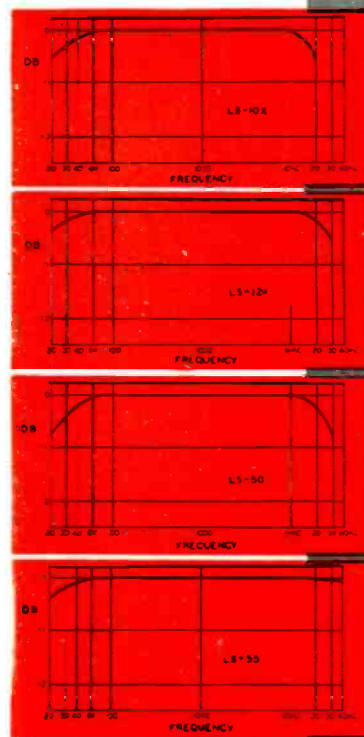

Write for our Catalog PS-409

*United Transformer Co.*

150 VARICK STREET NEW YORK 13, N. Y.  
EXPORT DIVISION: 13 EAST 40th STREET, NEW YORK 16, N. Y., CABLES: "ARLAB"



IT'S UNOBTUSIVE. Umber gray coloring blends it right into the TV picture. Minimum reflection.

In the show . . .  
 without stealing the act  
 RCA's new ribbon-pressure **"STARMAKER"\***

SO SLIM YOU MUST LOOK sharply to see it . . . so skillfully styled its shape and coloring fade right into the scene . . . this tubular microphone has won the favor of entertainers and announcers wherever it has been shown.

Designed By RCA Laboratories after more than three years of painstaking research, the STARMAKER meets the long need of broadcasting, television, and show business for a high-fidelity microphone that—will not hide the features of performers—is easier to handle—and yet retains all the high-quality features of RCA professional microphones. Pick-up is non-directional. Frequency response is uniform, 50 to 15,000 cps.

Here is a "carry-around" microphone free from wind blast and air rumble. It contains no tubes, no condensers, no high-impedance circuits, no special amplifiers, or power supplies—is virtually impervious to mechanical shock.

The STARMAKER fits any standard microphone stand . . . and can be substituted for any professional high-quality RCA microphone. *No extra attachments needed!*

For price and delivery, call your RCA Broadcast Sales Engineer. Or write Dept. 7K, RCA Engineering Products, Camden, N. J.

*\*Selected from entries submitted by Broadcast Stations in national contest.*



IT'S COMFORTABLE TO HANDLE . . . weighs only 1 lb.



IT'S SMALL. Diameter of body is only 1¼ inches. Diameter of pick-up point is only ⅜ inch!



**AUDIO BROADCAST EQUIPMENT**  
**RADIO CORPORATION of AMERICA**  
**ENGINEERING PRODUCTS DEPARTMENT, CAMDEN, N. J.**

In Canada: RCA VICTOR Company Limited, Montreal