

# AUDIO ENGINEERING

MAY  
1950  
35c

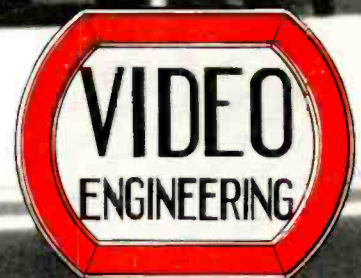

INCLUDING



SECTION

Published by RADIO MAGAZINES, INC.

[www.americanradiohistory.com](http://www.americanradiohistory.com)



## HERE'S WHAT THEY SAY ABOUT **audiotape**

From all parts of the country—from users in every branch of the recording art—hundreds of reports have come in, commenting on the performance of Audiotape. The typical comments quoted below speak for themselves.

If you haven't tried Audiotape yet, why not see for yourself just what it can do to improve the quality of your tape recordings? Your local Audiotape and Audiodisc dealer will be glad to fill your requirements. Or, write to Audio Devices for a free 200-foot sample reel of either paper or plastic base Audiotape. It will speak for itself.

### *A Recording Service*

"We find that your plastic Audiotape meets our requirements far better than the others we were using. We were bothered with flutter before, but now it seems that our discs we duplicate from tape are of much better tonal quality."

### *A Sound Consultant*

"I have tested the samples on several recorders under various conditions. Both paper and plastic base proved to be as fine as any I have yet used--good frequency range and especially low noise level (inherent)."

### *A Radio Station*

"We find Audiotape to be the best so far obtainable. There is less dust, dirt, and grit accumulation from this tape compared to others--as a result our machine runs at more constant speed."

### *A University*

"We are using No. 1251 to record sound tracks for our educational films. We find the product very satisfactory and particularly appreciate the flat tape that does not hump away from the head in the middle."

### *A Research Laboratory*

"Have found your tape the best for my recorder. Very low noise level and very uniform characteristics are its outstanding qualities. Price is also attractive."

### *A Home Recordist*

"We've compared Audiotape with the tape we've been using and were impressed with the fidelity and low noise level. The output for a constant level 1000 cycle input is remarkably good, showing uniform coating."

### *A Broadcasting School*

"I am happy to report that of several brands of tape tried, Audiotape has the lowest consistent noise level. Over-all response is remarkably consistent for all parts of each reel."

### *An Industrial Firm*

"I find that this tape excels all other makes now on the market in quietness, range, and ease of handling. On the strength of the test sample, have disposed of all other makes and am now using only Audiotape."

### *A Grammar School*

"We have used various tapes in our school work here and really know that yours is second to none. You can expect an order from us shortly."

### *A Radio Station*

"We are very pleased with your Audiotape samples. Noise level very low and quality excellent. We use it whenever a good reproduction is desired. We find your tape and your discs best in the field."

### *A University*

"We are delighted with the plastic base sample and in the future plan to order it exclusively. In speech work fidelity is very important, and we feel that the plastic Audiotape is the best we have tried."

### *A Radio Station*

"Results from tapes tested--excellent. Low noise levels--low distortion. Seems to be less capstan slippage than other tapes. Attractive prices. All future purchases by us will include Audiotape."

### *A College*

"Thanks for the Audiotape samples. We are using your plastic base tape exclusively for the original recording of our radio programs. We find that there is practically no loss dubbing from tape to discs."

### *A Radio Station*

"Excellent tape--much less flutter due to its ability to fit head contours better. All of our new tapes will be Audiotapes."

\* Trade Mark

## AUDIO DEVICES, INC.

444 MADISON AVE., NEW YORK 22, N. Y.

Export Dept.: ROCKE INTERNATIONAL, 13 East 40th St., New York 16, N. Y.



# AUDIO ENGINEERING

Successor to **RADIO**

Established 1917



**C. G. McProud, Editor**  
 Luci Turner, Edit. Prod. Mgr.  
 David Saltman, Production Manager  
 E. E. Newman, Circulation Manager

**D. S. Potts, Publisher**  
 S. L. Cahn, General Manager  
 H. N. Relzes, Adv. Mgr.  
 Harold Weisner, Asst. Circ. Mgr.

### Editorial Advisory Board

Howard A. Chinn  
 John D. Colvin  
 C. J. LeBel  
 J. P. Maxfield  
 George M. Nixon

### Representatives

Sanford R. Cowan, Mid-West Sales,  
 342 Madison Ave., New York 17, N. Y.  
 James C. Galloway, Pacific Coast Sales  
 816 W. 5th St., Los Angeles 17, Calif.  
 Technical Book & Magazine Co.  
 297 Swanston St., Melbourne, C. I.  
 Victoria, Australia

## CONTENTS MAY, 1950 Vol. 34, No. 5

Letters .....	4
Editor's Report .....	6
Audio Patents .....	8
Determining the Tracking Capabilities of a Pickup— <i>H. E. Roys</i> .....	11
The Art of Tape Recording—1— <i>Joel Toll</i> .....	13
Considerations in the Design of Feedback Amplifiers— <i>Herbert I. Keroes</i> ..	14
A White-Noise Generator for Audio Frequencies— <i>J. M. Gottschalk</i> .....	16
Audiana—Construction Practice—2 .....	19
Simplified Reverberation-Time Calculation— <i>Lewis S. Goodfriend</i> .....	20
New Products .....	22
Record Revue— <i>Edvard Tatnall Canby</i> .....	24
Pops— <i>Rudo S. Globus</i> .....	24
Additional Test Records .....	40
Employment Register .....	47
Advertising Index .....	48

### COVER

Most of the newscasts, chain-break commercials, and personal interviews originating in KSD's new studios go out from Studio C, which is shown as it appears from the control room. The studio is directly adjacent to the newsroom for maximum convenience of the station's news staff and newscasters. It is faced on four sides with perforated cement board and has a ceiling of the same material. Photo courtesy The Austin Co., Engineers and Builders.

AUDIO ENGINEERING (title registered U. S. Pat. Off.) is published monthly at 10 McGovern Ave., Lancaster Pa., by Radio Magazines, Inc., D. S. Potts, President; Henry A. Schober, Vice-President. Executive and Editorial Offices: 342 Madison Avenue, New York 17, N. Y. Subscription rates—United States, U. S. Possessions and Canada, \$3.00 for 1 year, \$5.00 for 2 years; elsewhere \$4.00 per year. Single copies 35c. Printed in U. S. A. All rights reserved. Entire contents copyright 1950 by Radio Magazines, Inc. Entered as Second Class Matter February 9, 1950 at the Post Office, Lancaster, Pa. under the Act of March 3, 1879.

## "UA" SERIES CONNECTORS FOR AUDIO CIRCUITS

MANY NEW FEATURES TO RMA SPECIFICATIONS AND STANDARDS



UA-3-32 Receptacle

UA-3-11 Plug



UA-3-31 Receptacle

UA-3-12 Plug



UA-3-13 Receptacle

UA-3-14 Receptacle



UA-3-42

Receptacle

### First in the Field with the Latest and the Best!

This achievement of Cannon Electric applies to this new series of audio connectors for the radio industry as well as to other developments such as steel firewall connectors and guided missile plugs, etc.

The UA Series has all of the superior features of the Type P and XL Series and in addition the following: (1) Gold plated contacts for long life; (2) double-protection rubber relief collar and bushing; (3) stronger and better latchlock; (4) flat-top polarization for finger-touch action; (5) steel plug shell and steel insert barrel.

Three 15-amp. contacts; 1500 volts min. flashover; 1/2" cable entry.

Sold through Cannon Electric Franchised Jobbers. Ask for UA-1 Bulletin.

Address Cannon Electric Development Company, Division of Cannon Manufacturing Corporation, 3209 Humboldt Street, Los Angeles 31, California. Canadian offices and plant: Toronto, Ontario. World Export: Frazer & Hansen, San Francisco.



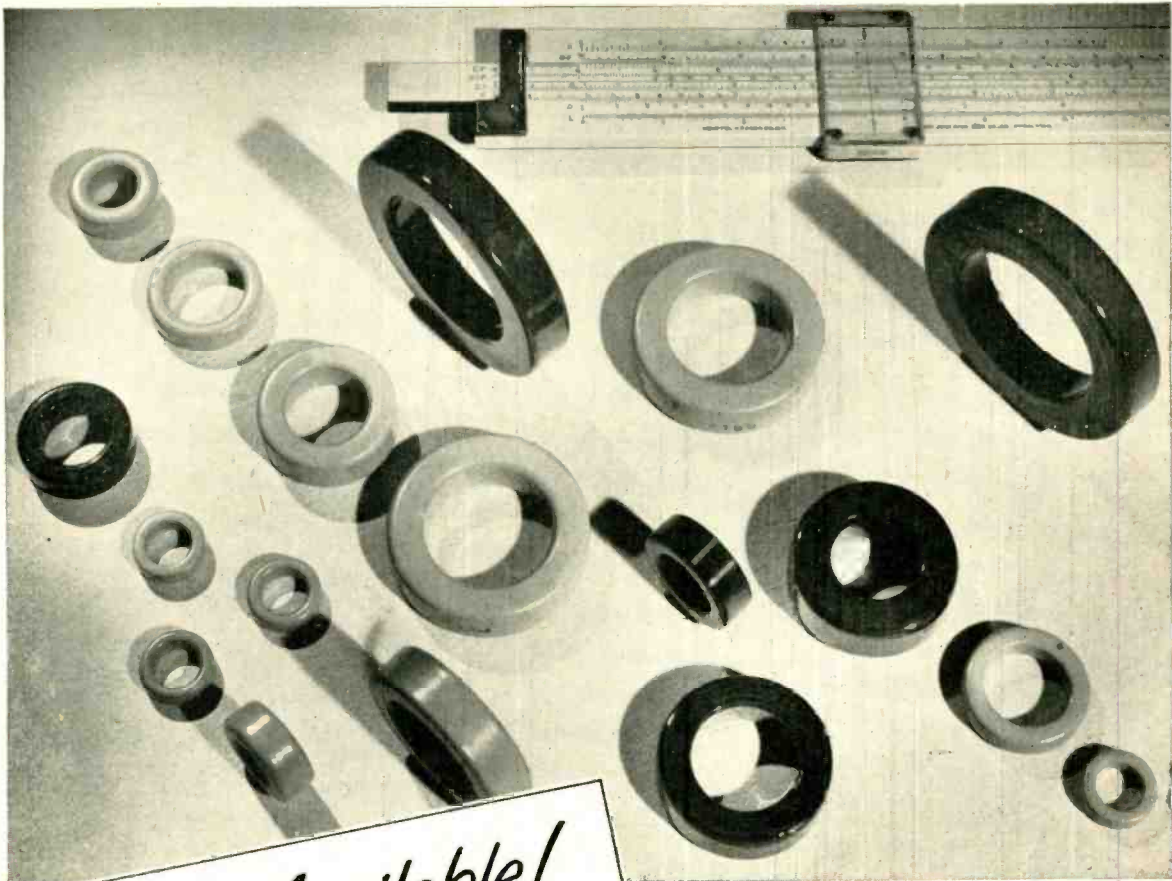

*Now Available!*  
**MOLYBDENUM PERMALLOY  
 POWDER CORES\***

**HIGH Q TOROIDS** for use in  
 Loading Coils, Filters, Broadband  
 Carrier Systems and Networks—  
 for frequencies up to 200 K C

**COMPLETE LINE OF CORES  
 TO MEET YOUR NEEDS**

- ★ Furnished in four standard permeabilities—125, 60, 26 and 14.
- ★ Available in a wide range of sizes to obtain nominal inductances as high as 281 mh/1000 turns.
- ★ These toroidal cores are given various types of enamel and varnish finishes, some of which permit winding with heavy Formex insulated wire without supplementary insulation over the core.

For high Q in a small volume, characterized by low eddy current and hysteresis losses, ARNOLD Moly Permalloy Powder Toroidal Cores are commercially available to meet high standards of physical and electrical requirements. They provide constant permeability over a wide range of flux density. The 125 Mu cores are recommended for use up to 15 kc, 60 Mu at 10 to 50 kc, 26 Mu at 30 to 75 kc, and 14 Mu at 50 to 200 kc. Many of these cores may be furnished stabilized to provide constant permeability ( $\pm 0.1\%$ ) over a specific temperature range.

\* Manufactured under licensing arrangements with Western Electric Company.

W&O 2030

**THE ARNOLD ENGINEERING COMPANY**  
 SUBSIDIARY OF ALLEGHENY LUDLUM STEEL CORPORATION  
 147 EAST ONTARIO STREET, CHICAGO 11, ILLINOIS



# Jensen Model H-510

**COAXIAL 2-WAY SPEAKER**

For thrilling life-like reproduction . . . For truly satisfying listening pleasure . . . For a host of history-making features that mean higher performance . . . new flexibility and convenience—be sure to hear and see the Jensen H-510. You'll know why wise listeners tell us it's the best at any price!

\*The Genuine Jensen Wide-Range Series includes a distinguished group of new coaxial and single-unit speakers—a complete range of sizes, ratings and prices. Ask for Data Sheet 152.

*“best at any Price!”*

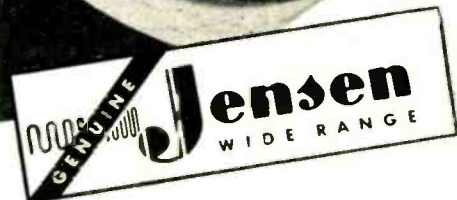
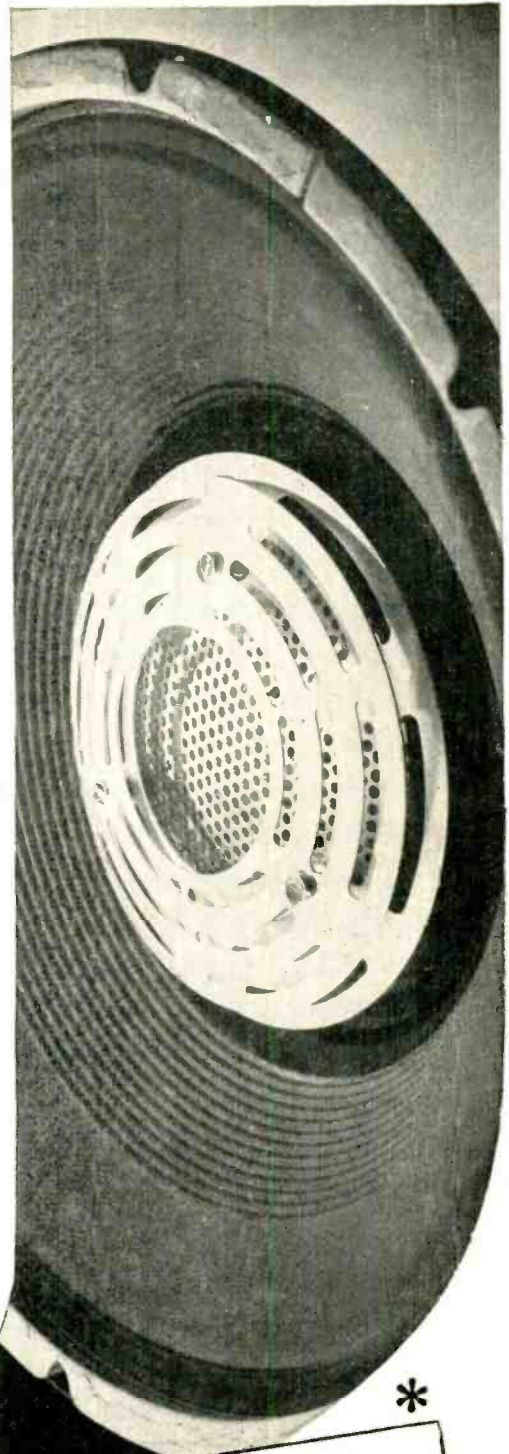
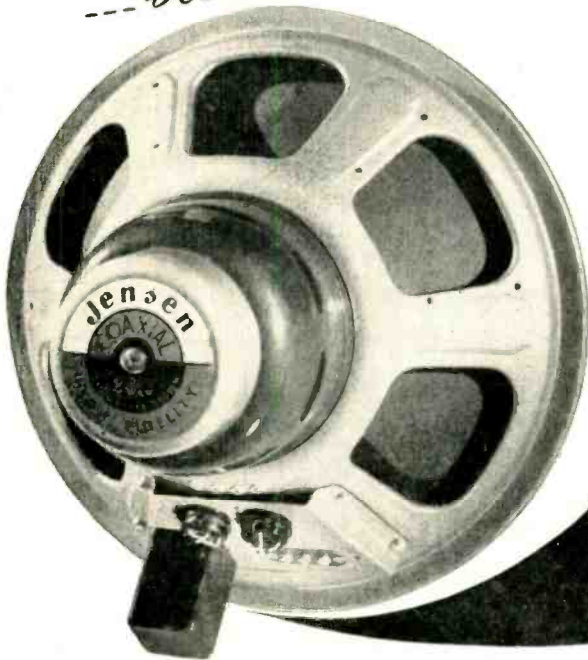

**JENSEN MANUFACTURING COMPANY** DIVISION OF THE MUTER COMPANY

6633 South Laramie Avenue, Chicago 38, Illinois • In Canada: Copper Wire Products, Ltd., 351 Carlaw, Toronto  
AUDIO ENGINEERING • MAY, 1950

# LETTERS

## Golden Ears

Sir:

I note with interest the article "For Golden Ears Only," by Joseph Marshall, in which he states that the amplifier represents the nearest approach to perfection achieved in three years of experimentation. I further note "with the exception of a few elements, which may lift eyebrows slightly," that my eyebrows were lifted more than slightly. Upon reading the article with care and studying the schematic, I discovered to my amazement that the circuit is *very* similar to one published by the writer in the January 1946 issue of *Electronics* in which the circuit appears on page 155. My design utilized essentially the same basic feedback circuits, the identical transformers, and the center-tapped choke to maintain the driver output in Class A. I should like to congratulate Mr. Marshall on doing a fine bit of test work and on applying to my original circuit the cross neutralization as described by Paul W. Klipsch in the same magazine some sixteen years ago.

George E. Beggs, Jr.,  
Warrenton, Penna.

## Even Errata Have Errata

Sir:

Without meaning to rub salt into your wounds, I believe you have an erratum in your errata on page 8 of the April issue. No doubt you mean: "on page 24 of the March issue . . ." (not page 18). Your confirmation would be appreciated, for I frequently study the back issues and Mr. Fleming's article is one I get my teeth into. Will you please tell me the date of the first issue of *Æ*?

Charles F. Erwood,  
28 Marine Avenue,  
Brooklyn 9, N. Y.

(Well, salt is justly deserved. Page 24 is the correct location. Again we offer regrets. The first issue of *Æ* was May 1947. Ed.)

## Audio in South Africa

Sir:

In the March issue, you inquired: "as an afterthought—is there no audio activity in other countries?"

You may be interested to hear that there certainly is audio activity in South Africa amongst high-fidelity enthusiasts.





The English Williamson circuit has long been popular, both in its original form and with various modifications. It has become almost a point of honour to use power amplifiers producing a total harmonic distortion not exceeding 0.1 per cent. The pre-war standard of push-pull Class A triodes *without* negative feedback is, nowadays, viewed somewhat cavalierly!

Probably the proportion of British to American high-fidelity equipment in use here is about 50-50. In Pretoria, there is a tendency to favour British output valves such as the KT66, EL37, PX25, DO24, DA30, DO30, etc. We feel that probably the most serious obstacles to realistic *domestic* reproduction are the unavoidable bogies of room acoustics, "scale" distortion, and lack of *true* binaurality in recording and reproduction. May I suggest that Domestic Room Acoustics be made the subject of an article in your periodical?

M. R. H. MacNamara,  
1251. Prospect Street,  
Hatfield, Pretoria,  
South Africa

# Only SOUNDEX MULTI-SPEED TURNTABLE HAS THE NEW "FLOATING DISC DRIVE"



-  **READY TO MOUNT:** Complete with shielded mounting board.
-  **CONSTANT SPEED:** Using 33 1/3 RPM on a 15 minute run, with a line voltage change of 10 volts, the change in speed was only 2 RPM in 500 or 0.4 percent. On constant voltage, the speed variation was 1/4 RPM or 0.05 percent.
-  **INSTANT STARTING:** With the switch advanced to the motor threshold of acceptance, the motor was rotating at full speed in less than 1/4 turn when the switch was advanced further.
-  **PRECISION SETTINGS** for speeds of 33 1/3, 45 and 78 and any speeds from 30-110 RPM may be accurately set. The speed can be continuously controlled manually between 30-110 RPM.
-  **COMPLETE ISOLATION** between turntable and motor eliminates mechanical vibration, rumble as well as other ill effects of rim, gear train and other direct drive systems.

 Proctor designed units of comparable quality are selling in the \$500.00 range. **\$138.00**  
Trade price less pickup arm

**CONSOLETTÉ**—for table, bench, or cabinet. Dimensions—  
22 7/8" x 18 7/8" x 8 1/4"  
**\$18.00 net.**

**PROCTOR SOUNDEX**  
CORP.

Write for bulletin

133 NORTH SIXTH AVENUE MOUNT VERNON, N. Y.

## REPRESENTATIVES

Walter Berggren & Asso.  
2005 S. Michigan Ave.  
Chicago 16, Ill.

Burlingame Asso.  
103 Lafayette St.  
New York 13, N. Y.

Campion Sales Co.  
Republic Nat. Life Bldg.  
Dallas 8, Texas

Erlanger Sales Co.  
925 South Grand Ave.  
Los Angeles 13, Calif.

R. W. Farris Co.  
406 West 34th St.  
Kansas City 2, Mo.

Dave M. Lee Co.  
819 Thomas St.  
Seattle 9, Wash.

Massey Associates, Inc.  
1124 Vermont St., N.  
Washington 5, D. C.

Stanley K. Wallace  
P. O. Box 744  
Lutz, Florida

Gerald Wilson  
403 Second St.  
Jackson, Mich.

**MEASURE TOTAL DISTORTION**  
Between 20 cps and 20 kc



# 330B DISTORTION ANALYZER

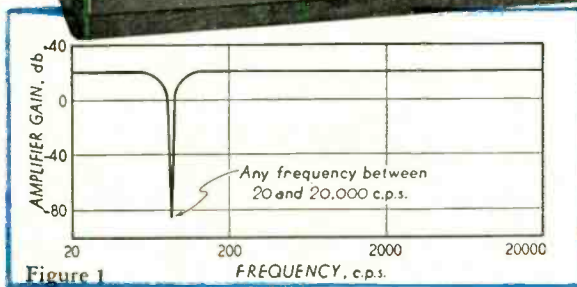

Figure 1

## CHECK THESE SEVEN IMPORTANT FUNCTIONS:

1. Measures total audio distortion.
2. Checks distortion of modulated r-f carrier.
3. Determines voltage level, power output.
4. Measures amplifier gain and response.
5. Directly measures audio noise and hum.
6. Determines unknown audio frequencies.
7. Serves as high-gain, wide-band stabilized amplifier.

This fast, versatile *hp*-330B Analyzer measures distortion at *any* frequency from 20 cps to 20 kc. Measurements are made by eliminating the fundamental and comparing the ratio of the original wave with the total of remaining harmonic components. This comparison is made with a built-in vacuum tube voltmeter.

The unique *hp*-resistance-tuned circuit used in this instrument is adapted from the famous *hp*-200 series oscillators. It provides almost infinite attenuation at one chosen frequency. All other frequencies are passed at the normal 20 db gain of the amplifier. Figure 1 shows how attenuation of approximately 80 db is achieved at any pre-selected point between 20 cps and 20 kc. Rejection is so sharp that second and higher harmonics are attenuated less than 10%.

### Full-Fledged Voltmeter

As a high-impedance, wide-range, high-sensitivity vacuum tube voltmeter, this *hp*-330B gives precision response flat at any frequency from 10 cps to 100 kc. Nine full-scale

ranges are provided: .03, .1, .3, 1.0, 3.0, 10, 30, 100 and 300. Calibration from +2 to -12 db is provided, and ranges are related in 10 db steps.

The amplifier of the instrument can be used in cascade with the vacuum tube voltmeter to increase its sensitivity 100 times for noise and hum measurements.

Accuracy throughout is approximately  $\pm 3\%$  and is unaffected by changing of tubes or line voltage variations. Output of the voltmeter has terminals for connection to an oscilloscope, to permit visual presentation of wave under measurement.

### FM and AM-FM MODELS

For FM broadcast measurements, *hp*-330C Model 330C Analyzer. This instrument includes a vacuum tube voltmeter with special characteristics meeting F.C.C. requirements.

For both AM and FM measurements, *hp*-330D Model 330D is provided. This model includes an AM detector to rectify the transmitted carrier and the special vacuum tube voltmeter described above.

*Write for complete details.*

### HEWLETT-PACKARD CO.

1437L Page Mill Road • Palo Alto, California

Export: Frazar & Hansen, Ltd., 301 Clay St., San Francisco, Calif., U. S. A.

Offices: New York, N. Y., and Los Angeles, Calif.



Attenuators  
Electronic Tachometers  
Microwave Power Meters  
Tunable Balometer Mounts  
Slotted Lines  
Standing Wave Indicators  
Low Pass Filters

**-hp- PRODUCTS**  
VHF & UHF Signal Generators  
Voltage Dividers, Multipliers and Shunts  
Electronic Frequency Meters  
FM & TV Broadcast Monitors  
Regulated Power Supplies  
Audio Frequency Oscillators

Audio Signal Generators  
Vacuum Tube Voltmeters  
Frequency Standards  
Square Wave Generators  
Wave Analyzers  
Distortion Analyzers  
Amplifiers

# EDITOR'S REPORT

## THE FOURTH YEAR

**W**ith this issue, *AUDIO ENGINEERING* enters its fourth year of publication. Pioneering a field which had been almost completely neglected before, *Æ* has become the most sought after magazine in the technical field, and copies of the first issue are just short of being traded on curb exchanges.

We hope that we have conducted this magazine primarily for the interests of its readers. Fortunately, we are not concerned with national or local politics, and can thus devote our pages to important matters. Our campaigns (see page V3) are normally directed to something our readers are all striving for—high quality sound reproduction.

We hope we have not strayed from our original intention that *Æ* should be devoted solely to audio, in spite of the V- pages, and we again reiterate that creed. To our many enthusiastic readers we express our appreciation of their support, and we hope that we may continually improve month by month, with a bigger and better *Æ* our guiding ambition.

## IDENTIFICATION

One of the most insistent comments that we have heard from advertisers in recent months is something we have been unable to fathom. Until recently, we are told, those who write requesting information about the products described in our advertising columns have habitually identified themselves by writing on their company letterheads or by mentioning their company affiliations. But more and more, it appears that correspondence requesting information arrives on penny postcards, without a single word as to the work in which the inquirer is engaged or the company that employs him.

This may not be a bad sign. It may only indicate that our readers who are not engaged in audio work professionally are becoming more interested in the products that make *Æ* possible from month to month. But, on the other hand, it seems possible that readers are expecting advertisers to be more prodigal in distributing their circulars and catalogs.

Advertising literature, assuredly, is prepared with a view to selling merchandise, and its cost is legitimately one of the expenses that any manufacturer must incur in order to familiarize potential users with his products. But if for no other reason, inquirers should state their occupation so as to help the manufacturer in furnishing information which would be of real service.

No manufacturer will turn down a legitimate inquiry as to his products, and in most instances he will do

everything possible to acquaint a possible customer with the extent and nature of his services. But it must be remembered that catalogs are expensive to produce, and an indiscriminate distribution of those catalogs would ultimately be reflected as a price increase for the merchandise involved.

We, too, receive many inquiries for information—many of them asking for data, circuits, advice. We try to answer them all as fairly as possible, even those which border on a consulting service. One thing we cannot do, however, is to express a preference for one manufacturer's product over another's. We have, for example, been asked as to the "results" of the speaker demonstration at the Audio Fair—even after it was publicly announced that no ballot would be taken. Such questions we cannot answer.

We do try to reply to all letters with information which we consider reliable, but we cannot express preferences, even if we were to admit having any. Advice as to the selection of different makes of equipment must necessarily come from consultants.

## HIGH (?) FIDELITY

One correspondent has brought up a question which deserves a comment—even though his own answer to the same question will be published next month. This correspondent has a friend who has spent considerable time and money in assembling a high-quality system, only to find that he hears harsh and strident music from his records. The friend questions the advisability of buying high-fidelity equipment and then "deliberately impairing its range by setting it back into the category of mediocre equipment."

It has often been stressed in these pages that the possession of tweeters should not necessarily demand that the highs must be heard beyond their natural balance, or that a bass boost control need not make the drums shake the floor. These facilities permit the user to adjust the response to correct for deficiencies in recording, microphone technique, or even in his own equipment.

It is desirable, though, that flexibility in controls be provided so as to make these corrections possible if they are necessary. The presence of the controls does not obligate the listener to adjust them for unrealistic reproduction just because he has the facilities for doing so.

In the final analysis, equipment should be selected to provide the best possible reproduction from a perfect program source. Since few sources are perfect, let the controls be adjusted to make the reproduction optimum for the practical conditions which do exist.



## Outstanding Music and Record Critics Acclaim Pickering Cartridge Reproducers as Unequaled for LP Record Playing

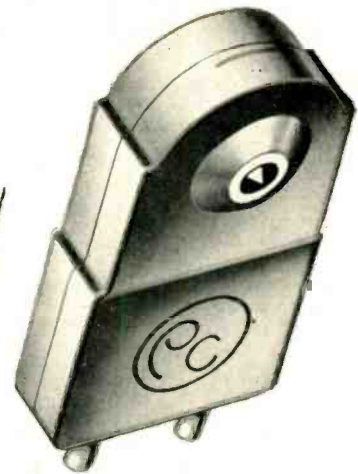

In the February 18th Saturday Review of Literature, E. T. CANBY says: "... For pure top-quality sound, Pickering is unbeatable on LP's" ... and in the January American Record Guide PETER HUGH REED says: "... using the Pickering we heard the best of the 45's in a manner which made for the greatest enjoyment of music."

**YES,** Pickering Pickup Cartridges are without equal ... no other Pickup can equal the performance of Pickering Cartridges on LP's ... they are widely used by the leading record manufacturers, recording studios, broadcasters and by music enthusiasts who demand the effect of a live performance from their records.

The nearest approach to a live performance is a recording played by a system equipped with Pickering High Quality Audio Components ... Cartridge, Speaker, Arm, Preamplifier, Record Compensator, etc.

### RECORD COMPENSATOR MODEL 132E



This compensator, with 6 positions of equalization, provides the flexibility required to properly equalize for the different recording characteristics used by various record manufacturers ... it is a most important addition to record playing systems using magnetic pickups.

### LOUDSPEAKER — MODEL 180L



Designed to satisfy the musical ear. A low-cost high quality loudspeaker with smooth wide-range response (within 5 db, 45 to 12000 cycles) and low distortion ... the only loudspeaker with acoustically adjustable bass response ... occupies less floor space than any other high quality loudspeaker — less than one square foot.



### PREAMPLIFIER MODEL 130H

This preamplifier represents the most advanced design ever achieved in phonograph preamplifiers.

It equalizes the bass response of records and transcriptions and provides the necessary gain for high quality magnetic pickups ... its intermodulation and harmonic distortion is exceptionally low — better than most professional equipment.

**Pickering  
& Company, Inc.  
Oceanside, N. Y.**

### PICKUP ARM — MODEL 190

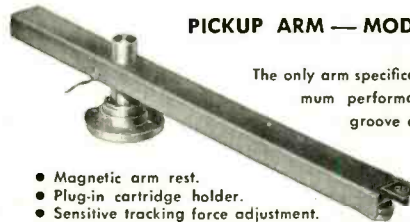

The only arm specifically designed for optimum performance on both micro-groove and standard records.

- Magnetic arm rest.
- Plug-in cartridge holder.
- Sensitive tracking force adjustment.
- Statically balanced to eliminate tendency to skip when jarred.
- One-hole mounting — self-contained levelling screws.
- Minimum vertical mass to track any record without imposing extra vertical load on grooves.
- Rugged frictionless bearings.

Cartridges used with this arm require 50% less vertical tracking force than when used in conventional arms.

For the finest audio quality specify Pickering Components

Pickering High Fidelity Components are available through leading jobbers and distributors everywhere ... detailed literature will be sent upon request.

# MR. ENGINEER..

TRIAD TRANSFORMERS  
will meet and maintain the most exacting requirements of your equipment



## AVAILABLE FROM STOCK

Triad "HS" Series Transformers are engineered to meet precisely and maintain indefinitely the most exacting requirements of any industrial electronic application. Maximum protection against failure of your product is assured through:

- Hermetic Sealing
- "Climate" Treatment (the improved and exclusive vacuum impregnation process used on all Triad transformers)
- Conservative Ratings
- Strong Mechanical Construction
- Exceptional Electrical Characteristics
- Long, trouble-free life

Triad "HS" Series Transformers are carried in stock for immediate delivery by Triad distributors or at the factory. Write for Catalog TR-49A.

Also readily available in standard designs for most used circuits are Triad Geoformers (Geophysical Transformers). Write for Catalog GP-49.

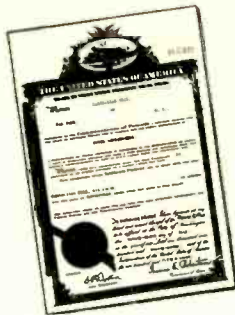

# AUDIO PATENTS

RICHARD H. DORF

THE UNITED STATES patent laws require that every patent must contain enough information so that those "skilled in the art" will be able to reproduce the invention. The inventions disclosed include almost every interesting advance in audio engineering, many of which, though not available to the average engineer for commercial exploitation, can be used by anyone with a profit in results, but not in cash. This column will review each month interesting and useful new audio patents.

### Voltage Amplifier

H. L. Daniels is the inventor of a pentode voltage-amplifier circuit (Patent No. 2,489,272) in which a feedback

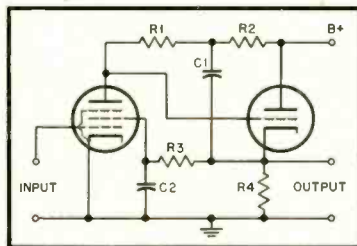

system effectively increases the value of the pentode load impedance and makes for very high stage gain. Figure 1 gives the basic circuit.

The pentode output appears across  $R_1$  and  $R_2$  in series. The triode is a cathode follower with a gain of less than 1. Its audio cathode voltage follows its audio grid voltage very closely, as in all cathode followers, the cathode voltage being always somewhat less due to the loss in gain.

The grid is tied to the pentode plate and the cathode, through  $C_1$ , to the other end of  $R_1$ . This applies the grid-cathode

difference in a.c. potential across  $R_1$ , with the lower voltage at the same end of  $R_1$  at which the lower pentode signal output voltage appears, thus accentuating the effect of the pentode signal drop across  $R_1$ . When the output of the pentode increases, so does the difference between triode grid and cathode voltage, which, added across  $R_1$ , adds to the pentode output. (The triode grid-cathode difference is a matter of percentage, not a constant voltage.) The increased effective pentode output adds still more to the triode grid-cathode difference, and the net effect is cumulative.

Pentode screen voltage is maintained at the right level automatically by deriving it from the triode cathode through isolating resistor  $R_2$  and bypass capacitor  $C_2$ .  $R_2$  need only be large enough to isolate the cathode feedback connection from the triode plate.  $C_1$ , the feedback impedance, can be an electrolytic capacitor for good low-frequency response, as leakage currents from the B-supply are unimportant. The gain of the stage, the inventor claims, can be made to approach the amplification factor of the pentode, which would put it in the order of the high hundreds. Output could be taken from the pentode plate, but taking it from the triode cathode instead avoids any effect the following stages might have on feedback operation.

### Single-Ended Power Amplifier

The amount of negative feedback pos-  
(Continued on page 41)

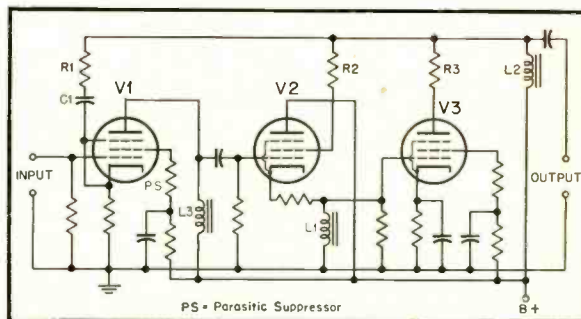

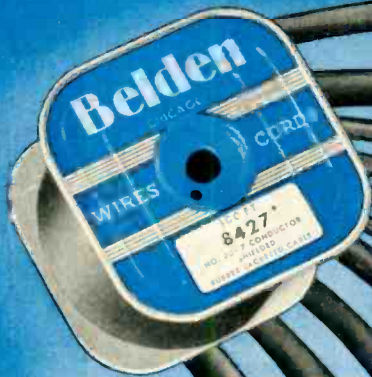

# MULTIPLE CONDUCTOR CABLES

*Every Type for Every Service*

Sold Exclusively Through Recognized Wholesale Distributors

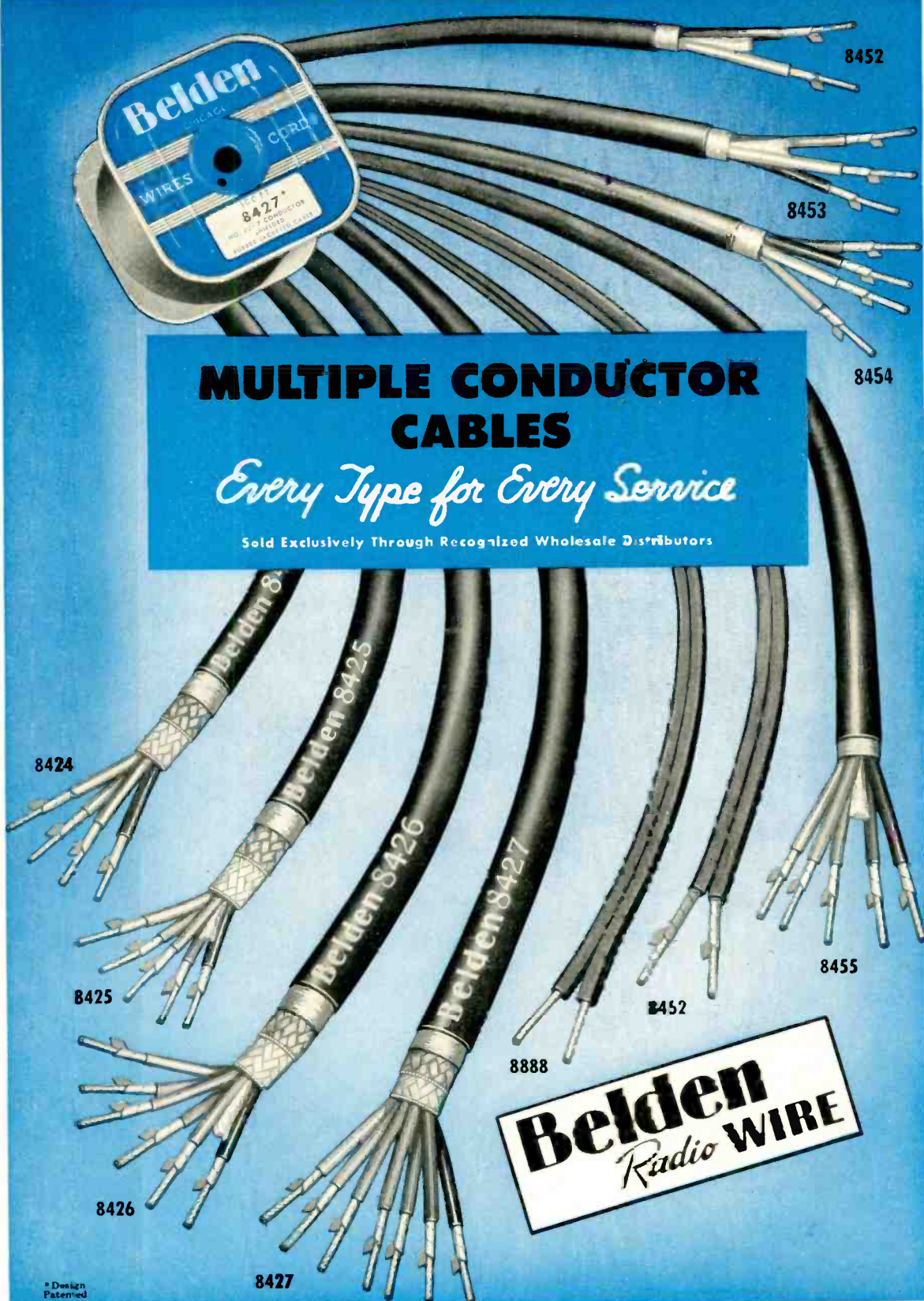

**Belden**  
*Radio WIRE*

\* Design Patented

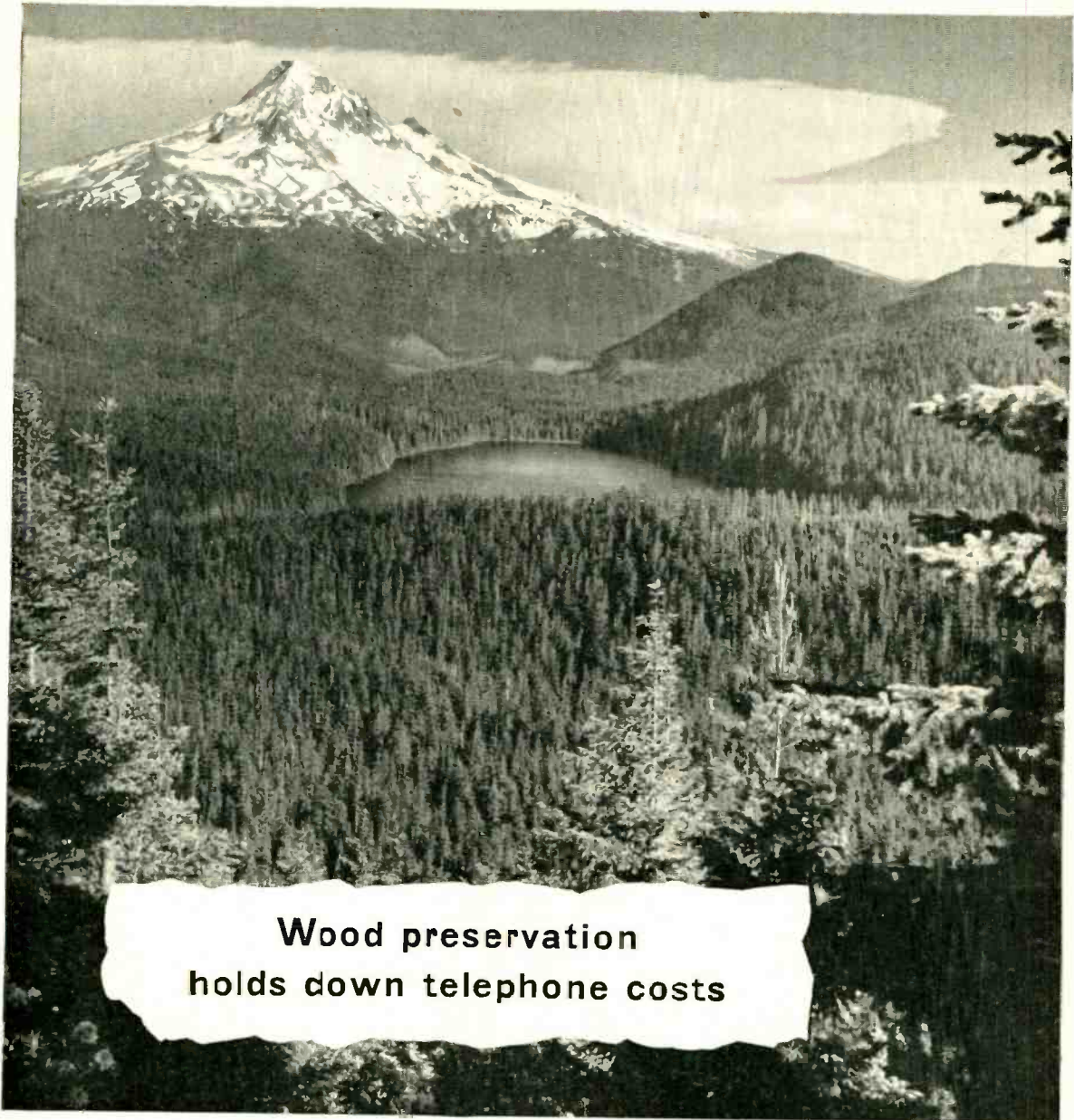

## Wood preservation holds down telephone costs

Poles are a substantial part of the plant that serves your telephone; making them last longer keeps down repairs and renewals that are part of telephone costs. So Bell Laboratories have long been active in the attack on wood-destroying fungi, the worst enemies of telephone poles.

Better, cleaner creosotes and other preservatives have been developed in co-operation with the wood-preserving industry. Research is now being carried out on greensalt—a new, clean, odorless

preservative. Even the products of atomic energy research have been pressed into service—radioactive isotopes are used to measure penetration of fluids into wood.

Treated poles last from three to five times as long as untreated poles. This has saved enough timber during the last quarter century to equal a forest of 25,000,000 trees. More than that, wood preservation has enabled the use of cheaper, quickly growing timber instead of the scarcer varieties.

This and other savings in pole-line

costs, such as stronger wires which need fewer poles, are some of the reasons why America's high-quality telephone service can be given at so reasonable a cost. It is one of today's best bargains.

**BELL TELEPHONE  
LABORATORIES**



*Exploring and Inventing, Devising and Perfecting, for Continued  
Improvements and Economies in Telephone Service.*

# Determining the Tracking Capabilities of a Pickup

H. E. ROYS\*

Measurement of intermodulation distortion is shown to be a reliable method for evaluating pickups as to one important characteristic which is not readily measureable otherwise.

**A** PICKUP that is used for the purpose of reproducing disk records relies upon the mechanical contact between groove and stylus tip for actuation of the stylus. For in order to obtain faithful reproduction, it is necessary that the stylus "track" or maintain good mechanical contact with, and exactly follow, the undulations of the recorded groove. Where we are dealing with lateral recordings—and these form the bulk of the records in use today—we are primarily concerned with the contact between stylus and groove side walls as illustrated at (A) in Fig. 1. When the groove changes laterally from a mean position, due to the modulation, it is the side walls of the groove that exert a side thrust upon the stylus to make it follow. If the vertical force is low, the stylus will climb the side wall, as illustrated at (B), and then the effectiveness of the pinch of the "V" shaped record groove is lost, and poor tracking and distortion result.

Tracking has been a problem from the beginning of disk recording, even when the vertical force was half a pound instead of half an ounce. It is only by

\*Engineering Products Department, RCA Victor Division, Camden, N. J.

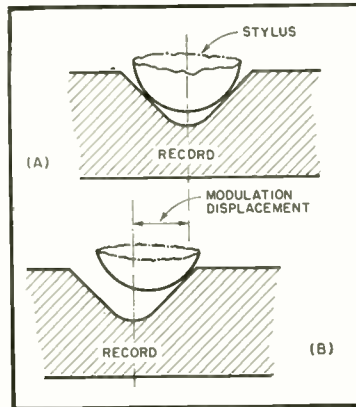

Fig. 1, (A) An ideal "fit" between stylus and groove side walls. (B) When the groove is displaced laterally from the mean position due to modulation, the tip will climb the side wall of the groove if the mechanical impedance of the pickup is high.

using adequate vertical force that the stylus can be held in the groove and so maintain good mechanical contact with the side walls. The tracking problem still exists today, even though vast strides have been made in the reduction

of pickup mechanical impedance with a resulting improvement in tracking. Fine groove reproduction with a small stylus tip requires low vertical force if a minimum of record and stylus wear is wanted.

## Method of Measurement

Since the tracking capabilities of a pickup depend upon its mechanical impedance, a measure of the mechanical impedance is also a measure of its ability to follow the recorded groove.

Determining the mechanical impedance is not a simple measurement, nor is it completely adequate. For example, practically all of the pickup and tone arm combinations tend to climb the groove side walls, rattle, and even skip out of the groove at tone arm resonance, and although skipping is not common at the high-frequency resonance, changes in response at resonance can be noted unless sufficient vertical force is used, as shown in Fig. 2. The mechanical impedance is high at the two resonant points, and usually the vertical force has to be increased several times over its normal value in order to keep the pickup stylus firmly in the groove. Yet listening tests indicate that the quality of re-

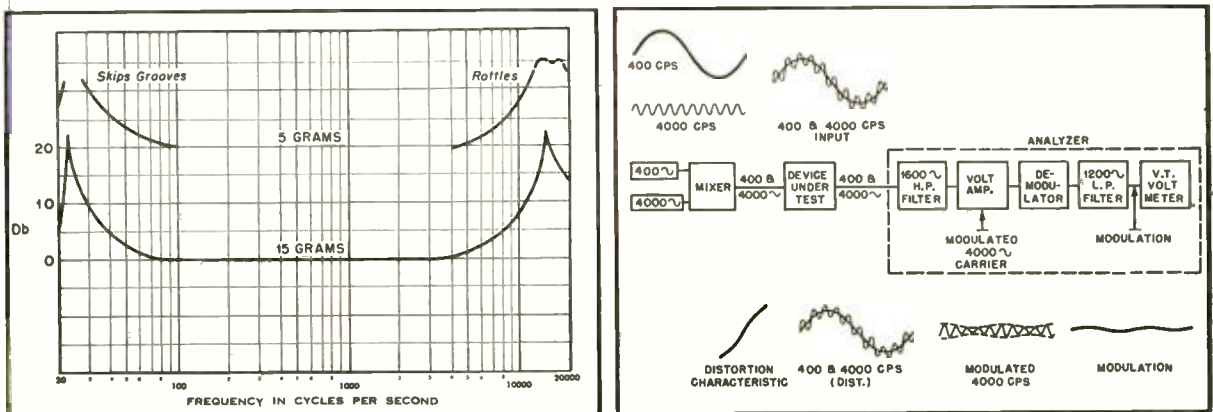

Fig. 2, left. This is a frequency response characteristic taken by the variable speed method. The peak at the low-frequency end is due to tone arm resonance, and the one at the high-frequency end is due to pickup resonance. The mechanical impedance characteristic is similar to this in shape. If the vertical force is too low, the pickup will skip grooves. Fig. 3, right, Block diagram showing the function of the components of the equipment. The sine-wave figures illustrate the appearance of the test signal, and how distortion shows up as amplitude modulation of the 4000-cps test tone.

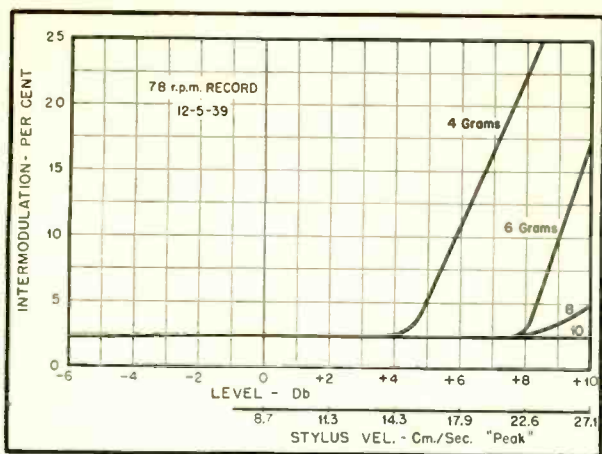

Fig. 4. Distortion curves obtained with experimental RCA magnetic pickup, illustrating its tracking capabilities and the improvement obtained as the vertical force is increased.

production is acceptable with the lighter force. This may be due to the fact that the mechanical impedance between the resonance frequencies is low, and it is throughout this region that the peak energies of speech and music are encountered so that, although the tracking requirements may be severe, the vertical force requirement is not great.

The intermodulation method of distortion analysis appears to be a good method of studying the tracking capabilities of a pickup, especially when using frequencies of 400 and 4000 cps. These frequencies lie between the two resonant frequencies of the pickup system and are located in the region where high peak energies of speech and music are normally encountered. The method is sensitive, and yet the measurements are simple and easy to make. In addition, measurement equipment is not absolutely necessary, as a great deal of useful information can be obtained by simply listening to the reproduction of the test record. In fact, the test record is probably the most valuable item of the test.

#### The Test Records

For tracking studies, 78 and 45 r.p.m. records cut by Mr. R. C. Moyer of the Indianapolis plant are used. These were cut at different levels up to 10 db above an assumed normal recording value. Levels as low as a -6 db were also recorded so that an over-all range in 2-db steps from -6 to +10 db is available when using the 78-r.p.m. record and from -4 to +10 db with the 45-r.p.m. record.

The two frequencies were combined in the normal manner for the intermodulation signal, 400 cps for the low frequency and 4000 cps for the high with the 4000-cps tone 12 db below the 400-cps signal in level. The 0 db or normal level for the 45-r.p.m. record was made approximately 3 db lower than the 78-r.p.m. value in accordance with the general practice of cutting fine

groove records at a reduced level in order to avoid cutting into adjacent grooves and also to minimize tracing distortion. The peak value of the 0 db or normal levels as measured by the optical pattern method while the pressings were being rotated (a necessity where two frequencies are combined in order to obtain an accurate evaluation of the pattern width) was measured to be 6 cm./sec. for the 45-r.p.m. record and 8.7 cm./sec. for the 78. The maximum peak recorded levels attained is about 27 and 18 cm./sec. for the 78 and 45 r.p.m. records respectively. It is difficult to determine just what peak levels are encountered in phonograph records, but it is believed that the levels on the test records are adequate for pickup tracking studies. The RCA 45-r.p.m. record system design is based upon a maximum recording level of approximately 14 cm./sec.

Both records were cut with a stylus having a tip radius of less than 0.0005 inch, so a fine groove pickup having a tip radius of 0.001 inch can be used with either record. The 78-r.p.m., record 12-5-39, has a groove wide and deep enough to accommodate pickups that have a tip radius of 0.003 inch, such as normally used with 78's. The 45-

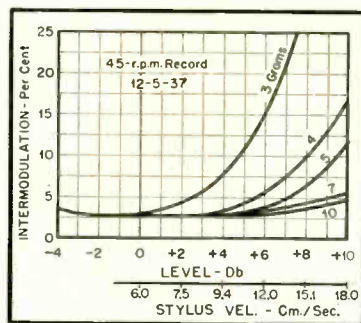

Fig. 5. Characteristic obtained with the pickup of Fig. 4 when using the 45-r.p.m. test record.

r.p.m. record, 12-5-37, has a narrow groove suitable only for reproduction with a pickup having a 0.001 inch tip radius.<sup>1</sup>

#### Test Procedure

Intermodulation test frequencies of 400 and 4000 cps have been found to be particularly useful for studies of distortion in disk recording and reproducing systems.<sup>2,3</sup> Figure 3 shows a block diagram of the equipment used and also illustrates what the test signal, a combination of two frequencies, looks like on an oscilloscope and also how the distortion appears as modulation of the 4000-cps carrier.

In determining the tracking capabilities of a pickup, either of the intermodulation records is played while using various vertical forces, and the distortion is measured for each different recorded level. The results when plotted give a set of curves such as illustrated in Fig. 4. In general, the distortion is low for the low values of recorded signal, but at some higher level an abrupt change is encountered, and the distortion increases rapidly as the recorded level is raised. Increasing the vertical force shifts the breaking point to a higher recorded level, and by using sufficient vertical force, good tracking can be obtained at the highest levels available on the record.

Where the distortion appears abruptly and increases so rapidly with recorded level, it appears permissible to define good tracking in terms of vertical force and the recorded level where the break occurs.

Figure 5, however, gives the results obtained with the 45-r.p.m. record and shows the breaking point with resulting rise in distortion to be less abrupt than obtained with the 78. This makes it difficult to determine good tracking as defined above, and it may be necessary to establish some value of intermodulation, such as 10 per cent, for example, as the limiting value. Then for the pickup illustrated in Fig. 5 with a vertical force of 5 grams, good tracking can be expected for recorded levels up to about 17 cm./sec.

Ten per cent intermodulation when using test frequencies of 400 and 4000

[Continued on page 38]

<sup>1</sup> Both of these records can be obtained from the Custom Record Sales Section, RCA Victor Division, 155 E. 24th St., New York 10, New York.

<sup>2</sup> H. E. Roys, "Intermodulation Distortion Analysis as Applied to Disk Recording and Reproducing Equipment," *Proc. I.R.E.*, October, 1947.

<sup>3</sup> H. E. Roys, "Analysis by the Two-Frequency Intermodulation Method of Tracing Distortion Encountered in Phonograph Reproduction," *RCA Review*, June, 1949.

# The Art of Tape Recording—1

JOEL TOLL\*

The first of a series of articles on the practical aspects of magnetic tape recording and editing.

**T**HREE BASIC METHODS of recording and reproducing sound are now in use—the mechanical or phonographic, the photographic or sound-on-film, and the magnetic. Of these, the last has now come into general use and promises to outstrip the other two in fidelity.

The first tidings of the advent of successful magnetic recording were recorded in the patent offices of Europe and America in 1899 when Valdemar Poulsen, a Danish inventor and engineer, applied for original patents on "methods of and apparatus effecting the storing up of speech or signals by magnetically influencing magnetizable bodies." Poulsen's unique machine attracted the attention of the scientific world at the Paris Exhibition in 1900. The Telegraphone, as his machine was called, could have many uses, but in his patent application, Poulsen noted only three: as a substitute and improvement on the phonograph; for recording and imparting communications over telephone wires with no human assistance; for telegraphic purposes, to record code messages at high speeds and play them back at much lower speeds so that the messages could easily be transcribed.

Within a few years several different types of Telegraphones had been developed, one using a solid steel disc, another steel tape, still another, wire. But no further development, except the addition of d.c. bias by Poulsen, was noted for about two whole decades. One possible reason for this stalemate in the development of magnetic recording may have rested in the lack of appropriate means for amplifying the reproduced sound with any great fidelity. Not until 1912 was DeForest's audion being manufactured in quantity and, before Dr. DeForest's invention of the three element tube, electronic amplification of sound was not possible.

Further improvements in the art of magnetic recording were developed in 1924, this time by Dr. Kurt Stille in Berlin. Influenced by Stille, the Ludwig Blattner Picture Corp. Ltd., of London, together with the Telegraphic Patent Syndikat, of Berlin, jointly announced a new system of magnetic recording on steel tape in 1929. Talking motion pic-

tures, using steel tape for the accompanying sound, were exhibited and the "Blattnerphone," it was hoped, would speedily supplant the phonograph discs which were so difficult to synchronize with the pictures. The Blattner Corp. also noted that its machine could be used to record telephone conversations, a purpose for which Poulsen had, almost expressly, designed his Telegraphone.

In 1930, Dr. Kurt Stille brought out his "Dailygraph," a dictating machine which could record either on steel tape or steel wire. The steel tape used on the Dailygraph was a highly-developed steel alloy about one quarter of an inch in width and approximately three thousandths of an inch (.003) in thickness.

#### First Tape Broadcast—on BBC

That same year, 1930, the British Broadcasting Corporation began using the "Blattnerphone," and its first broadcast using steel tape occurred when King George V's New Year's Day address was re-broadcast from a Blattnerphone recording. This same year, a patent was issued to Dr. Pfeumer covering the use of paper or plastic tape coated with iron dust. This innovation was immediately taken up by the Allgemeine Electricitäts-Gesellschaft (AEG) and I. G. Farben with the idea of producing a recorder for general use less expensive to operate.

Radio broadcasting companies both in Germany and in England were continuing to experiment with magnetic recording. By 1934, the BBC, in collaboration with Dr. Heising of Stille Laboratories, Ltd. had developed a recorder of good broadcast quality, incorporating frequency-correcting circuits.

The Marconi Company predicted a great future for tape recording in broadcasting and, by the pen of N. M. Rust, notes that "a continuous-band machine is being developed, which will have several interesting and useful applications for broadcasting. By its use in conjunction with special circuit arrangements, artificial echo effects can be produced simply, and with relatively little apparatus, as compared with methods ordinarily in use." By the end of 1936 the AEG in Germany had put a recorder on the market using a coated film tape and the Lorenz Company was marketing a machine using a special steel tape. Both machines were being used by the Ger-

man Broadcasting Company, and several were made for portable use in automobiles and sound trucks.

#### Supersonic Bias

Except for refinements in quality of reproduction, in mechanical drives, and in the use of d.c. bias, the basic principles laid down by Poulsen in the 1900's still governed magnetic recording. The AEG and I. G. Farben, who had merged their magnetic recording activities in the Magnetophon Co., had, it is true, made use of film coated with iron dust or oxides as the recording medium, but Poulsen's direct current method of magnetizing was still in universal use. Because of this, there was always a great deal of noise in the reproduction of a magnetic record. In 1921 W. L. Carlson and G. W. Carpenter of the General Electric Co had designed a "Radio Telegraph System" in which recording was accomplished by means of high-frequency bias current, (the Carlson patent was granted in 1927) but it was not used in commercial equipment until 1941 when Dr. Braunmuhl and Dr. Weber rediscovered a.c. bias. They observed, while testing a Magnetophon, that the use of high-frequency magnetizing currents improved the signal to noise ratio. The magnetophon immediately began to use this "supersonic" method of recording and so did, and still do, all other magnetic recorders in general use.

After World War II, tape recording utilized the technical knowledge gained during the war. Copies of the German Magnetophon were produced in Europe and the United States. This country is now far in the lead in both quality and quantity of recorders manufactured. Refinements are being added and machines are being designed for special purposes.

In tracing the progress of magnetic recording since its invention at the beginning of the twentieth century, we have followed the development of the art from the first unique machine of Poulsen up to present day recorders capable of almost exact reproduction of sound. The increasing use of tape recorders—by the public, by industry as a whole, and by broadcasters—points to its great value in any situation where sound must be faithfully recorded and easily edited. With developments yet to come, there

[Continued on page 31]

\* Columbia Broadcasting System, New York.

# Considerations in the Design of Feedback Amplifiers

HERBERT I. KEROES\*

## Part I. A study of the practical application of feedback to both triode and tetrode amplifiers, and of some of the pitfalls which must be avoided.

**A**N ENDLESS SUBJECT of debate in the audio field—one which has taken place with varying degrees of intensity over more than a decade—is that concerning the relative merits of amplifiers which use triode output tubes as contrasted with beam tetrodes. In recent years the argument has waxed as hot as ever, and even with lack of substantial evidence to the contrary, there is a group that supports the use of triodes not only in the output stage but in every amplifier stage.

This argument is likely to continue for some time to come, for every attempt to resolve its differences has led to engineering achievements which have produced great improvements in amplifiers as a whole. The point of diminishing returns has apparently not been reached where it might be said that each type is close to perfection. The trained ear is a hypercritical observer, and as fidelity is increasingly improved, for example, by the reduction of harmonic distortion to a negligible amount, other faults are unmasked which glare in the absence of distortion. After harmonic distortion—and it by-product, intermodulation—have been removed, the fidelity of transient reproduction is critically examined by the ear. All music and speech is basically transient by nature, and no method of measurement has been devised that will give an over-all figure of merit in terms of aural fidelity.

With these facts firmly in mind, the author has concluded that the triode-beam tetrode argument lacks substance when subjected to both theoretical and aural comparisons. Well designed amplifiers of both types have been heard which lack "character" of their own and do only the job intended—namely, magnify the power of the input signal with nothing added or removed in the process. However, it is true that the beam tetrode power stage has a bad reputation based upon the number of poorly designed amplifiers in service. In order to attain the high performance that the tetrode is capable of giving, inverse feedback must be used, and a poor amplifier is usually

defective because of faults in the feedback loop.

A faulty feedback circuit causes not only inferior tetrode performance, but when applied to triodes, also produces the same disturbing results. Aurally speaking, these are experienced as transient hash, ringing, and a general blurring of tones. The disturbance is truly of a transient nature and does not show up on steady tone laboratory tests.

### Effects of Feedback

The facts relating to the application of feedback and its effects on frequency response, distortion, and so on, are generally appreciated. It is also generally accepted that the benefits of inverse feedback increase proportionally according to the amount of feedback used.

To summarize, these effects are:

1. The output impedance of the amplifier is reduced.
2. Non-linear distortion, intermodulation, and noise, generated within the amplifier itself, are reduced.
3. Variation of gain due to aging of tubes and drift of circuit elements is reduced.
4. The apparent bandwidth of the amplifier is extended.

The reduction of output impedance is effected by the application of feedback of the voltage or shunt type. This is the form almost always used in connection with power amplifier design.

The limitations imposed on performance by increasing feedback indefinitely are not as well understood, and the idea seems prevalent that feedback is a cure-all for any amplifier deficiency. For example, the erroneous proposal has often been made that an output transformer having a poor frequency-response characteristic can be made to show a much better one in a circuit in which feedback is taken around the transformer. This is true at low levels only and to the minor extent that a relatively small amount of feedback may be used before the amplifier loses stability and sings. If the amount of feedback is reduced slightly below the point of self oscillation, the circuit conditions are still not favorable for good transient reproduction, and quality suffers. There is, moreover, practically no improvement in the power handling capacity of the transformer. It is there-

fore seen that the gain in frequency response is accompanied by a loss in overall fidelity, and the benefits of applying feedback indiscriminately are questionable.

It is not to be inferred, however, that properly applied feedback will result in doubtful improvement. Amplifiers of high performance standards owe their performance to a correctly designed feedback loop. In general, the maximum benefits of feedback will be realized in a specific design only by first maximizing the performance of the amplifier alone, and by then applying feedback with judicious understanding. Near perfection in the amplifier proper allows a greater amount of feedback to be used before the ultimate point of instability is reached. The excellence of the design depends greatly upon the feedback margin between the actual amount of feedback used and the maximum feedback possible. The realization of the greatest amount of margin will permit the highest degree of transient stability to be obtained with a consequent faithfulness of transient reproduction.

### The Feedback Loop

Inverse feedback, by definition, consists of the introduction to the input circuit of a voltage which is proportional to the output of the amplifier, with this voltage applied in opposite sense to that of the input voltage. At any one level of input voltage, this procedure reduces the output of the amplifier and results in a loss of gain. The numerical value of the loss expressed in decibels provides a measure of the amount of inverse feedback.

There are many ways in which inverse feedback can be taken around an amplifier. Some circuits make use of feedback on the individual stages only, and these circuits are said to employ local feedback. More commonly, feedback is carried in a single circuit from output to input, and the path is termed a single-loop type. Combinations of feedback may be employed, for example, from the output to each of two earlier cascaded stages. Such circuits are said to use a multiple-loop feedback system.

The choice of the type of feedback

\* Acro Products Company, 5328-30 Baltimore Ave., Phila., Pa.



system is governed by many considerations. Feedback is most beneficial on stages that operate at a high level. This includes the driver stage and the output stage. While local feedback could be employed on each of these stages, it is usually better to take feedback over the two stages as a group for the reason that application of feedback to the output stage alone would require a prohibitively high voltage to be delivered by the driver. Moreover, if taken over just the output stage, the feedback circuit would have to be of a balanced form, and it is most difficult to secure good balance and stability in this type of circuit. For these reasons, it is more usual to use a single-loop circuit in which the feedback voltage is taken from the secondary of the output transformer to an earlier single-ended stage. The use of a multiple-loop feedback system is governed by stability considerations rather than by the improvement effected in each additional loop; i.e., it is sometimes necessary to use secondary paths to obtain stable operation at the required feedback level.

It is well to recognize that the feedback loop encompasses the portion of the amplifier circuit over which it is taken, as well as the return circuit alone. Therefore, any defect in the main circuit of the amplifier will show up as a defect in the feedback loop. To obtain the maximum benefits of feedback, it is first necessary to maximize the performance of the amplifier with the feedback system removed. This statement is open to question on the grounds that feedback supposedly takes care of circuit imperfections and consequent performance deficiencies. While this is true within the useful bandwidth of the amplifier, it does not hold at the upper and lower extremes of frequency. At these limits, every defect will be multiplied many times when applied through the feedback system.

The process of this multiplication is readily understood when it is recalled that the amount of inverse feedback is proportional to the product of the amplifier gain and the vector fraction of output voltage reintroduced in the input circuit. The phase of the feedback voltage will be an accumulation of the phase shift in the amplifier circuit itself, plus any additional phase shift in the return path. There is a certain amount of phase shift which it is necessary to accept due to the fact that a practical amplifier has a restricted bandwidth. The numerical amount of phase shift is based on the rate and manner in which the gain drops outside the useful band. There may be other undesirable effects present that will cause a phase shift and yet produce no changes in the gain-frequency curve. These are caused by spurious feedback paths which may arise from insufficient decoupling and from parasitic capaci-

ties between various sections of the circuit.

#### Phase Shift Effects

The effects of phase shift in a feedback amplifier may best be understood by reference to Fig. 1 (A), which shows the normal gain-frequency curve of an amplifier. Points A, B, C, and D marked along the curve are transposed to the phase diagram of the feedback voltage Fig. 1(B). Point X represents the phase and magnitude of the input signal. Two conditions are shown on Fig. 1 which represent a possible high-frequency cut-off condition. These result in the corresponding curves of (B). It is seen that

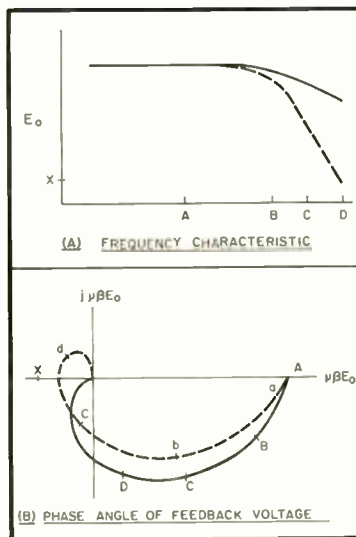

Fig. 1. Amplitude and phase of the feedback voltage.

the solid line curve of (A) produces a phase characteristic that shows a small amount of displacement within the useful frequency range and a uniformly diminishing feedback voltage outside the band that falls to zero at 180 degrees.

The dashed characteristic of (A) gives a phase characteristic again small within the useful band, but with a greater amount of phase shift at points outside. In fact, a sizeable amount of signal is returned to the input circuit in phase with the input signal. This constitutes a positive feedback voltage, and while it occurs at a remote frequency, nevertheless if great enough to enclose the input voltage, X would cause oscillation<sup>1</sup>. The particular value of voltage as shown is not strong enough to cause the circuit to break into continuous oscillation, but since this condition is favorable to the production of damped oscillations, it causes ringing—a transient disturbance and a sign of transient instability.

<sup>1</sup> Bode, "Network Analysis and Feedback Amplifier Design." Chap. VIII.

Another commonly experienced fault occurs in some designs which may be traced to the relation between phase shift and feedback. Oftentimes, an amplifier which shows up as good on steady tone laboratory tests will exhibit poor transient fidelity when operating into a speaker load. The nature of the load itself is reflected into the feedback loop and represents a possible cause of additional phase shift. Moreover, the gain of the amplifier changes because of the presence of the load, and the magnitude of the feedback voltage is altered in accordance with the load. This is not an undesirable condition that should be eliminated, since it is the same condition responsible for the reduction of apparent source impedance due to feedback. However, the fact that speaker loads are variable should be taken into account in design, and the problem of stability referred to a variable load as a basis.

It is a difficult task to make measurements of stability under all conditions of load. A simple criterion has been adopted which seems to work well in practice, and which is based on the following proposition. If the amplifier is stable with the output terminals open circuited, short circuited, or operated into rated resistive load, then it is stable under all load conditions. The measurements of stability at open circuit and under rated load can be made with an oscilloscope across the output terminals to check for the presence of supersonic oscillations. A check on the short-circuit condition can best be made using a high-frequency ammeter across the output terminals. An oscilloscope of very high input impedance might also be used by connecting it across the input of one of the stages in the feedback loop.

Finally, the overload characteristic of the amplifier enters into the problem of stability. Musical transients occur with a suddenness that causes a high dissipation of power in a short time interval. A normal flattening of the peak of a transient represents distorted reproduction of the transient, but is not nearly as serious as the presence of supersonic oscillation on the peak. A simple check which is not altogether conclusive consists of feeding a sine wave input to the amplifier with the gain full up, and examining the resultant clipped output. The waveform should appear to be square with no ripple or hash on the leading and trailing portions of the wave. A better check consists of feeding "slugs" or bursts of sine-wave signal to the input, with each slug separated from the next by a time interval that can be seen on the scope. In this manner the overload recovery time of the amplifier can also be examined.

(To be concluded)

# A White-Noise Generator for Audio Frequencies

J. M. GOTTSCHALK<sup>2</sup>

The author describes a circuit arrangement for producing a "white-noise" signal over the audio band with a relatively constant amplitude throughout.

**T**HIS ARTICLE deals with the development of a noise generator whose output power is uniformly distributed over the audio-frequency region of the spectrum. Noise theory indicates that this uniform spectrum is to be expected from the so-called "shot effect" in thermionic diodes and photoelectric tubes. By measurement of the audio-frequency noise output of a specific noise source, considerable disagreement was found between the actual output and that indicated by theory. It was found that over limited regions of the radio-frequency spectrum the noise energy is uniformly distributed and that by heterodyning a selected portion of the r.f. spectrum, audio-frequency noise can be generated which has practically uniform frequency components.

The development of a noise generator with this characteristic was prompted by its possible application as a sound source in reverberation time measurements. If single-frequency sound is used in such measurements, the decay in the sound after its source is cut off is often very irregular. This lack of a smooth decay has been attributed to standing-wave phenomena and can be combatted to some extent by warbling the sound through a portion of an octave.

The idea has been proposed that a device generating noise with power uniformly distributed over, say, a third of an octave might constitute a more suitable sound source for reverberation time measurements. With this possible application in mind, the investigation was undertaken to study first the possible means for generating noise with uniform frequency components in the audio range. With proper filters a portion of the spectrum of such "white" noise (as it is called by analogy to white light)

<sup>2</sup> Washington University, St. Louis, Mo.

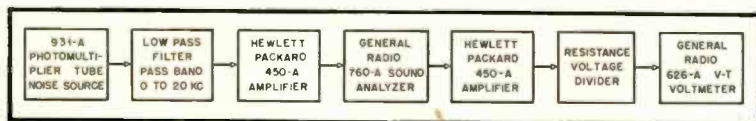

Fig. 1. System used to measure a.f. spectrum of direct noise output of 931-A photomultiplier tube.

could be used for the desired sound source.

## Theoretical Noise Spectrum

In most applications noise is undesirable. The effort to minimize noise has led to considerable theoretical and experimental studies of the phenomenon. This work turns out to be equally useful when the problem being considered is that of generating noise of particular characteristics.

Among the causes of noise which have attracted considerable attention is the *shot effect*. This term refers to the fluctuation of the plate current in a vacuum tube which results from the random arrival of electrons at the plate. Discussions of the theory underlying this phenomenon may be found in many places in the periodical literature and in some of the standard textbooks on radio and electronics.<sup>1</sup> Among the situations usually considered is that in which the emission is temperature limited, i.e., where all emitted electrons are drawn to the plate. The theoretical analysis of this phenomenon shows that the fluctuating component of the plate current in a diode with temperature limited emission has an r.m.s value of<sup>2</sup>

$$I_{rms} = \sqrt{2kI_0\Delta f}$$

where  $k = 1.602 \times 10^{-19}$  coulomb,  $I_0 =$  emission current, and  $\Delta f =$  band width over which the noise is observed. This equation shows that the power involved in the noise components lying within a band of a specified width  $\Delta f$  is proportional to  $\Delta f$ , but is independent of where that band is located. This is the characteristic desired in white noise. It would

<sup>1</sup> For example, S. Goldman, "Frequency Analysis, Modulation, and Noise," New York: McGraw-Hill Book Co., Inc., 1948.

<sup>2</sup> *op. cit.* p. 356.

appear then that, theoretically at least, a diode with temperature-limited emission would be well suited for use as the desired noise generator. Actually, as will be brought out later, this is not borne out by experiment with a particular noise source.

Another important outcome of the theoretical considerations is the fact that for a given emission current  $I_0$ , the noise current is independent of the plate load

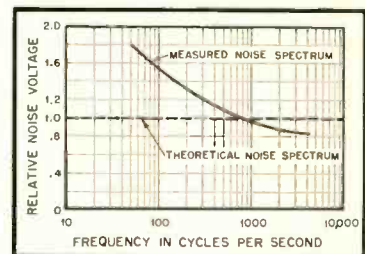

Fig. 2. Direct a.f. noise spectrum of 931-A photomultiplier tube.

resistance, that is, the diode represents a constant-current noise source.<sup>3</sup> Consequently, the greater the load resistance, the greater will be the noise voltage developed across it. Practical limit is placed on the value of plate load resistance in this case because to maintain a particular emission current, the plate supply voltage must be increased if the load resistance is increased.

Although usually developed by considering temperature limited emission in a thermionic diode, the shot-effect theory is equally applicable where emission is photoelectric. The only requirement is that all emitted electrons are drawn to the anode. In devising a noise generator an advantage is found in using photoelectric tubes which incorporate secondary emission multipliers. These multipliers are intended, of course, to amplify changes in emission current resulting from changes in illumination of the cathode, but they amplify also the shot effect fluctuation in the current arriving at the first multiplying electrode. This allevi-

<sup>3</sup> K. R. Spangenberg, "Vacuum Tubes," pp. 307, 308. New York: McGraw-Hill Book Co., Inc., 1948.

**VIDEO  
ENGINEERING**

YANKEE  
NETWORK

**WNAC**  
THE YANKEE

129347

FIRST

SLIM TRIM  
DYNAMIC for TV



- RESPONSE:  
40-15,000 C.P.S.  
± 2.5 DB
- POWER RATING: -53
- OMNIDIRECTIONAL
- ACOUSTALLOY  
DIAPHRAGM
- POP-PROOF HEAD
- CHANGEABLE  
LOW IMPEDANCE
- REMOVABLE SWIVEL
- 1/2" OR 3/4"-27  
THREAD MOUNTING
- CANNON XL-3  
CONNECTOR
- ALL PARTS  
PRECISION GROUND



Shows TV 655 suspended on a boom. Omnidirectional polar pattern and firm swivel permits easy, diverse use.



Shows the popular Patsy Lee with the TV 655. Note how swivel permits aiming at sound source without hiding face.



Shows TV 655 in the hand with swivel removed. Note how convenient it is to handle for announcing or interviewing.

- New '655' Microphone Provides Ultra-Wide-Range, High Fidelity Response
- More Rugged, More Versatile
- Stops Wind and Breath Blasts
- Individually Laboratory Calibrated

Here, for the first time, you have a slim, trim microphone with all the advantages of dynamic performance and utility! Only because of the ingenious *Acoustalloy* diaphragm and other E-V developments has it become a reality! Meets the highest standards of TV, FM and AM.

You can use the TV 655 on a stand, in the hand, or on a boom...or you can easily conceal it in studio props. *No additional closely-associated auxiliary equipment is required!* Provides effective individual or group pick-up. Reproduces voice and music with remarkable accuracy.

New E-V Blast Filter makes the 655 *pop-proof*. Acoustically-treated, strong wire-mesh grille head stops wind and breath blasts. Eliminates wind rumble in outdoor pick-up. *Fully field tested and proved!* Ideal, too, for recording and high quality sound amplification.

*See for yourself! Write today for Bulletin No. 156 and full information on how you can try this amazing new microphone.*

Model 655. List Price.....\$200

NEW PRODUCTS



• **Standoff Capacitor.** Of interest to television manufacturers is this new metal-clad capacitor recently placed in production by Electrical Reactance Cor-

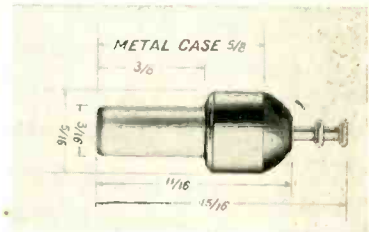

poration, Franklinville, N. Y. Known as Type MCS, the new unit is supplied with a capacity rating of 1500 mmf, and is equipped with a unique end seal to resist the effects of temperature and humidity changes. Full technical description may be obtained from the manufacturer.

• **American Structural Products Company,** Box 1035, Toledo 1, Ohio, is offering an elaborately-illustrated twelve-page book containing scale drawings which depict the relative dimensions of rectangular TV tubes and their round counterparts. The drawings are complete in detail and may be used by designers and manufacturers in working out problems of chassis and cabinet design.

• **Variable If-V Power Supply.** Designers and research engineers will find many uses for the new Model 99 high-voltage r.f. power supply recently presented to the trade by Inductograph Products. Variable potentials ranging from 1 kv to 40 kv may be obtained by means of a single control knob. In addition, the new unit supplies 6.3-volt heater potential and low-voltage d.c. for various types of external equipment which may be used in conjunction with the power supply.



Provision is made for varying focus voltage when the unit is used in conjunction with a projection television system. Simplicity is the keynote in construction of Model 99, output voltage being from an r.f. transformer and rectified by a half-wave voltage-tripler rectifier system. No electrolytic capacitors are used. Technical brochure may be obtained by writing Inductograph Products, 236 West 55th street, New York 19, N. Y.

[Continued on page V14]

**Electro-Voice** INC.

401 CARROLL STREET • BUCHANAN, MICHIGAN

Export: 13 East 40th Street • New York 16, N. Y., U. S. A. • Cables: Arlab



SECTION OF



**C. G. McProud, Editor**

Luci Turner, Edit. Prod. Mgr.  
David Saltman, Production Manager  
E. E. Newman, Circulation Manager

**D. S. Potts, Publisher**

S. L. Cahn, General Manager  
H. N. Reizes, Adv. Mgr.  
Harold J. Weisner, Asst. Circ. Mgr.

**Editorial Advisory Board**

Howard A. Chinn  
Rodney D. Chipp  
Robert M. Morris  
Chester A. Rackey

**Representatives**

Sanford R. Cowan, Mid-West Sales  
342 Madison Ave., New York 17, N. Y.  
James C. Galloway, Pacific Coast Sales  
816 W. 5th St., Los Angeles 17, Calif.  
Technical Book & Magazine Co.  
297 Swanston St., Melbourne, C. I.  
Victoria, Australia

**CONTENTS**

**MAY, 1950**

New Products .....	V2
The Mechanics of TV Recording— <i>Skipwith W. Athey</i> .....	V4
Audio Systems for TV Service— <i>W. L. Lyndon</i> .....	V9
CBS-TV Sound Effects Console—2— <i>R. B. Monroe and P. E. Fish</i> ....	V12

**COVER**

A familiar sight to Bostonians is the red, white, and blue Televan used in telecasting baseball, football, and basketball games, and all special events of remote broadcast.

**Advertising Index**

Camera Equipment Company <i>TV camera tripods and dollies</i>	V15
Electro-Voice, Inc. <i>Microphones</i>	V2
JFD Manufacturing Company, Inc. <i>TV antennas and lightning arresters</i>	V14
Maurer, J. A., Inc. <i>16-mm camera equipment</i>	V16

**VIDEO VIEWS**

**A**FTER SOME THREE YEARS OF growth, television entertainment is now undeniably established, and is beyond the slings and arrows of outraged editors. Seeing and hearing many of the year's crop of sets, however, creates a spark of curiosity as to how long the consumer will hold still for sound quality which would just barely be acceptable in a five-tube table model.

We, personally, think we are fortunate in living with a modified early-model TV set which has an audio system above average, and which uses a speaker system that does credit to the best of recorded music. We have no complaint about the sound quality as it leaves the studio and transmitter—with the possible exception of the herd of cattle that seems to cavort just behind the cameras—though 99 per cent of the viewers probably can't hear them.

Three years ago—or even two—there was some excuse for poor audio quality. The picture was the important thing. Larger picture tubes needed more cabinet front, so the speakers were put on the side—or top—or bottom—anywhere room could be found. Would that be acceptable in any sound receiver today? Would a single, small pentode or beam tetrode be acceptable in a set costing over fifty dollars? Would a four-inch speaker be acceptable in anything but a battery portable?

TV sound quality—as transmitted—compares favorably with the best that FM has to offer; this can be proved by any program that is simulcast. Customers certainly would not sit through a sound movie if the picture were shown on a screen only 3 ft. by 4 ft. Why must they sit in their own home-theatre with sound of equivalent dimensions?

It can be argued—and rightly—that cost is a controlling factor. But there should be some means of obtaining better sound quality without doubling the price to the consumer. The big sets *do* have good sound. The viewer who gets the most good from TV because he can't afford to go out every night for entertainment is similarly unable to afford the super-special consoles.

Thus campaign No. 1: Better sound in the average TV receiver.

# The Mechanics of TV Recording

TELEVISION RECORDING is widely used at present as a means of programming television network stations and of storing television programs for audition or reference purposes. It is probable that more than 60 million feet of 16-mm film are used per year for television recordings at the present rate of operation by the television networks.

The general method of making television recordings has been described previously by several writers.<sup>1</sup> Television recording entails photography of the television picture and recording of the accompanying sound. This paper does not cover the latter subject, but concerns itself entirely with the operation of the cameras used for recording the television image from a special picture-tube. A great many factors are involved in achieving proper operation of such cameras, and many of the effects of improper operation are mystifying in the extreme. The television recording camera is required to operate for longer periods of time, with less opportunity for maintenance, under conditions requiring greater precision of exposure with highly accelerated film motion than any motion picture camera in the past. This article attempts to describe the action of the TV recording camera in relation to the TV system in sufficient detail to permit a systematic approach to camera adjustment and operation. Since only two types of TV recording cameras are currently in extensive use, the discussion will be limited to these cameras in specific detail. Although both may be used with "electronic shutters" involving electronic blanking of the recording kinescope, they are currently in wide use only with mechanical shutters. The discussion is

accordingly limited to operation with mechanical shutters.

No attempt will be made to discuss the photographic processes involved in TV Recording as they apply to rendition of tone values. The tone rendition of TV Recording in the present state of the art admittedly leaves something to be desired. There is little agreement as to the

motion picture frame lasts for 1/24 second. By photographing one television frame onto each film frame (1/24) - (1/30) = 1/120 second is left for film pulldown. These figures ignore television blanking times, but the difference is unimportant in this part of the discussion. The method of operation is as follows:

Assume the camera shutter is just being opened as the kinescope beam begins to trace the odd lines of the television picture. The shutter stays open during the scanning of one odd and one even field, and closes just before the next odd field is about to be scanned. During the next 1/120 second, the film is being pulled down in the camera. Meanwhile, the beam has scanned down to the middle of the next television field (1/120 second is one-half field). The shutter opens, and the film records the lower half of that field (odd), the whole next (even) field, and the top half of the next (odd) field. The shutter stays open for 1/30 second, which is just two television fields, and then closes again. Again the film is pulled down, taking 1/120 second, and the beam meanwhile scans the rest of the odd field. As the shutter opens again, the beam is just beginning to scan the next field (even) and the process is back where it started. During two cycles of the camera, ( $2 \times 1/24 = 1/12$  second), five television fields ( $5 \times 1/60 = 1/12$  second) have been scanned, three odd and two even. The process then repeats itself, however, this time three even and two odd fields are being scanned, (every two film frames, the first field scanned changes from odd to even and back again).

From the above it is seen that two half fields are lost for every five scanned, that is, the information in them is not recorded. It is a little hard to say what happens to this one-fifth of the information and how its loss affects the final pictures. It is probable that the effect of the loss is to increase the noise and lower the resolution in proportion, but this has never been established in any specific way.

## The Picture Splice

Although this is a very neat method of getting 24 from 30 frames per second, it raises the difficult question of making a "splice" between two halves of a picture in the middle of the picture. Ideally, it would seem to be best if the shutter could wait until the television line next above the middle of the picture had been

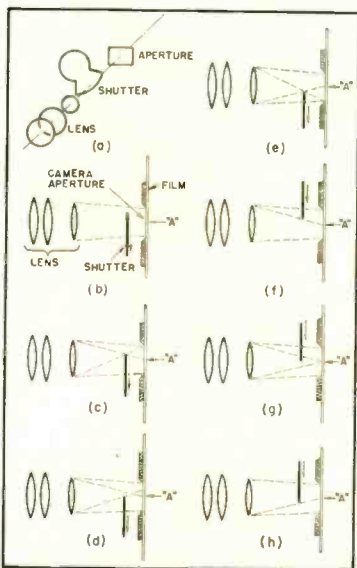

Fig. 1. Conditions existing during the opening and closing of the camera shutter.

proper methods of achieving better tone rendition, and the subject is still too fluid to warrant discussion here.

## General

In the standard motion picture camera, the shutter is closed at intervals to permit the pulling down of new frames of film. To apply such a camera to the photography of television images immediately raises the problem of finding time for the film pulldown, since the successive frames of the TV picture follow each other with a spacing of about 1 millisecond. Fortunately, it is necessary at the same time to convert from the 30 frames per second of television to the 24 frames per second of motion pictures. The 6-frame difference between the two processes can be utilized to provide pulldown time in the TV recording camera.

One television field lasts for 1/60 second, a frame for 1/30 second, while a

<sup>1</sup>R. M. Fraser, "Motion Picture Photography of Television Images," *RCA Review*, vol. IX, pp. 202-217; June 1948.  
 Thomas T. Goldsmith, Jr., and Harry Milholland, "Television Transcription by Motion Picture Film," *J. Soc. Mot. Pic. Eng.*, vol. 51, pp. 107-116; August 1948.  
 J. T. Boon, W. Feldman, and J. Stoiber, "Television Recording Camera," *J. Soc. Mot. Pic. Eng.*, vol. 51, pp. 117-127; August 1948.  
 F. G. Albin, "Sensitometric Aspects of Television Monitor-Tube Photography," *J. Soc. Mot. Pic. Eng.*, vol. 51, pp. 595-613; December 1948.  
 George Gordon, "Video Recording Techniques," *Tele-Tech*, vol. 8, no. 6, p. 31, May 1949; no. 7, p. 29, June 1949.  
 F. N. Gillette, "The Picture Splice as a Problem of Video Recording," *J. Soc. Mot. Pic. Eng.*, vol. 53, pp. 245-256; September 1949.

**An analysis of the operation of a TV recording camera to obtain a minimum of flicker between succeeding picture frames as a result of the shutter movement.**

scanned and then could open instantaneously, so that the first line recorded was the one just below the middle of the picture. At the end of the exposure, the shutter should then close instantaneously after recording the line above the middle. Thus each film frame would record 525 television lines (less blanking), and the top and bottom halves of the picture would match perfectly.

Unfortunately, no practical shutter exists which will open and close fast enough for the ideal situation described above. Motion picture cameras have rotating disc shutters, and these shutters require a finite time to open and close. The larger the shutter diameter, the smaller the fraction of its time of rotation is necessary to open or close, but there is a practical limit to shutter size. In the cameras used for TV recording, the shutter requires about 7 deg. of its rotational cycle to cover or uncover the film frame. The shutter revolves at 1440 r.p.m. or once every  $1/24$  second. The time for a movement of 7 deg. at that speed is  $7/360 \times 1/24 = 1/1224$  second or about 0.8 milliseconds. The television lines are scanned at a rate of 15,750 per second so that during the time the shutter is closing,  $15,750 \times 1/1224$  or about 12 television lines are scanned. The same number are scanned while the shutter is opening. The result is a kind of overlapping fadeout and fadein of the lines over an area which is  $12/262\frac{1}{2}$  or approximately  $1/22$  of the picture height. At first glance it would appear that such a process couldn't make a good "splice." Fortunately, it does work, but the dissolve must be made with extreme precision, and all the mechanical and photographic factors must be just right to make an invisible splice. *The effective time* of making the splice is considerably shorter than 12 television lines, as will be seen from the discussion below.

As the process has been described, there is just one splice in the middle of the picture. Actually there are two splices separated by a half a field, but in the situation described one of them occurs during vertical blanking. If the phasing of the shutter with respect to the television system is other than as assumed, two splices would be visible. However, the phasing of the camera can

be so adjusted that one of the splices is hidden.

Figure 1 illustrates what happens during shutter opening and closing. "Line A" is any specific television line in the picture area.

(a) illustrates the relative positions of the camera elements referred to.

At (b) the shutter is just beginning to admit light to the top of the film frame (bottom of TV picture).

At (c) the top of the film frame is completely illuminated, and light is just being admitted to line A, but most of the film frame is still dark.

At (d) Line A is partially illuminated but the lower part of the frame is still dark.

At (e) Line A is fully illuminated, as is all but the lower part of the frame.

At (f) the shutter is just beginning to cut light off from Line A.

At (g) the shutter is cutting off part of the light from Line A.

At (h) Line A is completely covered.

The time lapse between these various stages of opening and closing and the corresponding number of television lines or shutter revolution degrees are dependent on a number of factors of camera construction:

Focal length of lens.

Lens to kinescope tube distance (hence lens to film distance).

Relative stop opening of lens.

Position of shutter relative to lens and film.

Diameter of shutter (affects only relationship between shutter degrees and time or television lines).

The relationship of the above factors is obviously complex. It can be seen that the fuzzy nature of the shutter shadow or "penumbra" is the determining factor in shutter operation. Practical considerations in making the "splice" perfect require a realization of the effect of all the factors on the penumbra. The nature of the penumbra, the actual shutter size, the phosphor decay time and the kind of film used all combine to determine the perfection of the picture splice.

**Decay of Kinescope Phosphor**

Consider a television line in the middle of the exposure period. As the beam scans the line, the phosphor fluoresces to a certain brilliance, and then the

brightness decays to effective blackness. The P11 phosphor decays in brightness in a peculiar manner which is neither linear nor exponential. Theoretically it takes an infinitely long time for the phosphor to decay to extinction, no matter how fast the initial decay is, since the decay becomes exponential after a short period of time. However, for a given film and a given initial brightness, there is a certain time after the excitation of the phosphor beyond which the phosphor adds no further measurable exposure.

For example, suppose a given area of the kinescope phosphor is excited and photographed, and with the same initial excitation, a test film is exposed first for a very short time (say 0.1 millisecond), and then for progressively longer times. The shortest exposure would give a certain density on the film after development. The longer exposures would give progressively greater densities, up to a



Dr. Athey was born in Baltimore, Maryland on March 14, 1917. He graduated from Yale University in 1938 with the degree of B.S. in Chemistry. For the next two years he did research in stereophotography and in 1940 went to Stanford University as a graduate student in Electrical Engineering. He was at Stanford, dividing his time between teaching and study until 1948, except for a period of one and a half years in 1944 and 1945 when he was in charge of the Motion Picture Department of the Radio Research Laboratory (sponsored by the Office of Scientific Research and Development) at Harvard University. He received the degree of E.E. from Stanford in 1943, and the Ph.D. in Electrical Engineering, also from Stanford, in 1947. From 1948 to 1950, he was a Project Engineer in the General Engineering Department of the Columbia Broadcasting System, primarily working on problems of television recording. In March 1950, he returned to Stanford University where he is Assistant Professor of Electrical Engineering and Speech and Drama.

# The Mechanics of TV Recording

certain point at which increased exposure time no longer increased the density. This time would be slightly different for different initial brightness.

The actual amount of exposure of a given TV line in the splice region is dependent on a complicated combination of the phosphor decay process and the gradual cutoff and buildup of light as the fuzzy shutter shadow (penumbra) passes the line.

## The Penumbra

The penumbra or "fuzzy" edge of the shutter shadow is caused by the lens aperture appearing as an extended source of light when viewed from the film. From a point on the film, the shutter is seen to cover progressively more of the lens aperture as it passes, and there is a corresponding progressive cut-off of light, with no sharp transition from light to dark.

In the TV Recording cameras currently available, the penumbra of the shutter shadow is about 1/5 of the picture height and therefore about two or three TV lines are scanned while it passes a given point. (1/5 picture height = .06-in., which at the edge of the 3-in. radius shutter, is about  $.06/3 \times 57^\circ = 1.14^\circ$ ). In time, this represents  $1.14/360 \times 1/24 \times 15,750 = 2+$  lines.

## Making the Picture Splice

Assume the lines of the television picture are numbered as shown in Fig. 2. Note that reference to "odd" and "even" fields are only for convenience in description, and that "odd" and "even" line numbers are not used in the diagram to distinguish between alternate fields. The lines of the two fields are distinguished by making one set shorter in the diagram. Line 1 is in the middle of the splice area.

Assume the picture on the tube is static during the period described. Starting 40 total lines before the splice, let us say the beam is scanning lines 505, 506, 507, 508, etc. of a given television frame. The shutter completely cuts off the light from these lines as they are scanned.

Now as the shutter begins to open, the first part of the penumbra starts down across the film frame. The image on the film frame is being scanned upward because of the inversion in the lens. As the shadow moves past the upper part of the film frame, no exposure takes place as there is no image being scanned in this part of the picture. Finally, the shutter shadow gets to a point where it just admits a little light from a line that is being scanned, say line number 524. The

phosphor is fully excited by the scanning beam and then decays in brightness. At the same time the shutter shadow progressively admits a little larger portion of the light output of the line as it crosses the line. However, as this is occurring in the darkest part of the shutter shadow, little total light reaches the film. The beam then scans line 525, and quite a bit more light reaches the film from this line, since it is displaced toward the

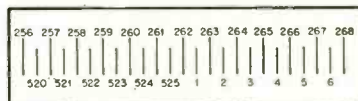

Fig. 2. Scanning lines of the TV picture during the "splice" caused by the shutter movement.

bright edge of the approaching shadow, and it is scanned later so that the shadow has progressed a little. Even more light is admitted from line 1. The penumbra of the shutter shadow takes the time of scanning two or three TV lines to pass a point, and therefore has almost completely uncovered line 524 by the time line 1 is scanned. Line 1 is displaced so that the shadow has completely uncovered it by the time it is being scanned. Line 2 is recorded on the film with no shutter shadow in the way, and the net exposure it receives is dependent only on the initial brightness of the line and the decay time. All subsequent lines are fully exposed, including the lines of the next field which are recorded between those already scanned.

As the end of the exposed TV frame approaches, the penumbra of the closing edge of the shutter shadow begins to approach the top of the film frame. As the penumbra reaches the top of the frame, lines 520 and 521 are being scanned. As line 524 is scanned, the shutter shadow is just reaching it. The shadow only cuts off a little of the light, and the line has time to decay through almost the whole useful range before the shutter completely cuts off light to it. This line therefore makes almost its full normal exposure on the film. Line 525 is already in the shadow when scanned and has its effective light output considerably reduced. Line 1 puts out even less light. Line 2 is completely blacked out by the shutter. If everything is working right, the combination of the small first and large second exposure on line 524 will produce a net exposure which is equal to a full exposure of the line. The same will occur with subsequent lines up to line 1, with the relative amount of first and second exposure

being reversed as the lines progress. Under these conditions the splice is perfect.

Two physical factors which affect the perfectness of the splice are:

The lines numbered 259, 260, 261, 262, etc. of the alternate field are recorded without any shutter interference and therefore add a perfectly uniform exposure which tends to smooth out any uneven exposure at the splice.

The effect of two successive exposures on a film is not the same as a single exposure containing the same total photographic energy as the two. This is termed the "intermittency effect," and undoubtedly plays a part in the mechanism of the splice, but no information is available on the subject.

If the lens aperture were square and the edge of the shutter blade were on the lens axis at the moment considered, the lens would act as a light source which would produce a shutter penumbra extending symmetrically on each side of the edge of the shutter, with a straight-line gradation of brightness from one edge of the penumbra to the other. The brightness would be just 50 per cent of maximum directly opposite the edge of the shutter. Since the lens is round, the gradation of brightness is not straight-line, and since the edge of the shutter blade is not usually exactly on the lens axis at the time of making the splice, the penumbra is not symmetrical, and the adding of the two exposures is rather complicated. This, together with the intermittency effect, plus the differences in effective decay time for different films, probably explains why slightly different shutter sizes are necessary for different films to produce an invisible splice.

So far it has been assumed that the shutter closes at exactly the right time to admit from the last few lines the correct amount of additional exposure to build their images on the film up to the correct total exposure. This requires that the length of the opened and closed parts of the shutter cycle be exactly correct. Put another way, this means that the angular size of the shutter blade must be just right.

At first glance it would seem that the shutter blade should be of such length as to take just 1/2 a television field or 1/120 second to pass a given point. This would make it  $\frac{1/120}{1/24} \times 360$ , or  $72^\circ$  in width. Considering the complex matter of unsymmetrical and non-uniformly graded penumbra plus phosphor decay time, a second glance makes this seem a little too easy. In practice, the correct shutter size turns out to be very close to  $72^\circ$  ( $72^\circ 6'$  or  $72^\circ 20'$  in two common cases), and the final size is determined experimentally. As is shown below, the shutter size has to be very accurate.

It will be noted the statement was



made above that the shutter required twelve television lines to cover the picture area, but the process of forming the splice was described as taking only about two to three television lines. This difference is explained by the absence of any picture information at the time of making the splice anywhere in the film frame except in the vicinity of the splice. The time of three lines is required for the shutter *penumbra* to pass a *given point*, while the time of twelve lines is required for the edge of the shutter to go from *one side (or edge) of the picture area to the other*. Since the splice may in general be anywhere in the picture area, this last factor is important in determining shutter and pulldown phasing and timing tolerances to assure covering up the film motion.

The size of the penumbra is determined by the physical factors of the camera optical system mentioned above. As a result, if the lens stop is changed, the penumbra size changes in proportion to stop diameter. Or, if the lens to kinescope tube distance is increased (lens to film distance decreased) and shutter to film distance is the same, the penumbra increases in size. Similar relations hold for other optical system changes. Since the width of the penumbra adds to the actual shutter size in producing an effective shutter size, it is usually found that a change in one of the optical factors mentioned may make the splice imperfect, and the cure for this is found in trimming the shutter size.

It is of interest to note just how perfect the splice has to be to be invisible. Since the splice only appears in every other film plane, it flickers at the slow rate of twelve times a second, and hence is easy to see. From a rough calculation of brightness-differences detectable under such flicker conditions, considering the contrast of the positive film, it appears that if there is a change in the density in the negative of more than .01 at the splice, the splice will be visible. Assuming the presence of the uniformly exposed interlace lines smooths out the bump to the extent of dividing the effect by two, an error of density of .02 is allowable in the lines of the splice. Assuming the splice occurs at a density which lies on the straight-line portion of the negative film curve, with a gamma of 0.70, the exposure error must be less than 1.5 per cent.

Since the shutter completely opens or closes during only about 1.2 deg. of rotation for a given TV line, one can roughly say the error in shutter size and position must be less than 1.5 per cent of 1.2 deg. or 1.08 minutes of arc. With a shutter 3 in. in radius, this means an error in position of the shutter edge of less than .001 in.

### Timing

So far we have been concerned only with the point-to-point mechanical and optical relationships necessary for a perfect splice. We now must consider the fact that this whole process is going on at a high rate of speed and that extremely close tolerances must be held at this rate of speed. The various timing requirements will be discussed in order of increasing complexity:

### Synchronism

It has been assumed so far that the camera and television system are in perfect instantaneous synchronism, that is, that the shutter is in exactly the same position every time a given line of the TV picture is being scanned. Roughly speaking, this will be true if the camera is driven synchronously off the same a.c. power system as that to which the TV system is locked. If different a.c. systems are used by the camera and the TV system, as is apt to be the case when recording a network or distant remote program, one a.c. system may drift slowly with respect to the other. The effect of this is twofold: The splice will drift in position in the TV picture, and, if the drift is at a high enough rate, i.e., a.c. frequencies are sufficiently different, there will be a gap or pileup at the splice. For example, if the TV a.c. supply is one part in 525 lower in frequency than the camera a.c. supply, and the shutter has opened at its normal time, the shutter will start to close one TV line early and the splice will be poor, being lower in density than it should be on the negative, producing a "white" splice on the negative and a "black" one on the positive. With this much error, the splice would be seen to "drift through" the picture from bottom to top in about four seconds ( $262\frac{1}{2}/60 \approx 4$ ).

If the frequency difference is in the other direction, the splice will have a "pileup" instead of a "gap" and the splice will drift down in the picture.

### Time Constant

The above discussion of synchronism dealt with average relative frequencies and did not consider small instantaneous disturbances of synchronism. Such instantaneous disturbances actually cause much more design and operating trouble than slow frequency differences or drifts.

The TV system is never actually synchronous with the a.c. system it is locked into. A common method of locking the sync generator with the a.c. line is as follows:

A high-frequency oscillator runs at a frequency of 31,500 cps, which is the frequency of the TV equalizing pulses. The output of this oscillator synchronizes a system of pulse-counter frequency dividers which eventually produce 60-

cps pulses, as well as other frequencies used in the TV system (15,750 cps and 30 cps). These 60-cps pulses are compared with the 60-cps sine waves of the a.c. power system. The comparison involves applying the pulses and the sine waves to a diode bridge. If the pulse is timed so that exactly one half of it occurs before the sine wave crosses its axis and the other half occurs after the axis crossing, the output of the bridge is zero. Essentially, the bridge determines if the pulse is symmetrical in time with respect to the axis crossing. If the pulse is not symmetrical, the bridge produces an output of a polarity corresponding to the direction of asymmetry. The output of the bridge is applied through a filter to a reactance tube a.f.c. circuit which controls the frequency of the 31,500-cps oscillator. If the pulse is early, the oscillator is slowed down, if it is late, the oscillator is speeded up. In normal operation, this correction is going on all the time, so that the frequency of the oscillator, and hence the 15,750-cps line frequency, is changing around its average value all the time. The changes are small (about one part in 10,000).

Some sync generators are equipped with an "A.F.C. Time Constant" switch with several steps. This switch changes the amount of filtering between the comparison bridge and the reactance tube. In effect, it changes the time-constant or speed with which the frequency is readjusted when an error occurs. This time constant has an important bearing on the perfection of the splice in a TV recording.

If the time constant is "too fast" the effect is to cause jittering of the line frequency at a high speed. This causes one TV frame to differ in duration from the next one. The camera is grinding out exposures at a very uniform rate, but the TV frames are jumping around in time duration. This has the effect of making the splice "white" on one frame and "black" on another at an irregular rate. If the time constant is slow enough ("slowest" switch position is usually slow enough), the frequency changes are slower, and the change in frame duration is spread over ten or twenty frames, making the splice changes invisible. In addition, the effect of the slow time constant is to make the total frequency change, and hence the frame duration change, smaller than for a short time constant, thus reducing the splice error.

### Shutter Timing

In order for the shutter to repeat each cycle with sufficient precision to make consistently perfect splices, something rather special is needed in the way of mechanical drives. In addition, the fast pull-down time required in a TV recording camera puts a large intermittent

load on the camera drive system and further complicates attaining uniform shutter motion.

Fortunately, a solution to this problem is simply to drive the shutter from its own synchronous motor. Proper initial phase between shutter and pull-down is assured by connecting the two through a loose coupling which floats free when the camera is up to speed. Especially good gears and a stable motor are necessary for the shutter drive. Continual checkup is necessary to assure that all gears and shafts are securely fastened and that the floating coupling is running free, as mechanical irregularities introduced at these points produce the same kind of flickering splice as does short time constant in the sync generator.

#### Film Positioning

In any kind of motion picture photography, it is essential that the successive frames of film be positioned in a mechanically precise way and that the shutter be fully closed long enough to allow pulldown and registration to take place. In TV recording these requirements must of course be met, with the additional complication of the very limited time allowed for pulldown and registration.

If 7 deg. is considered the amount of time necessary for the shutter to cover the film completely, and if the shutter has a 72 deg. blade, 72-14, or 58 deg. is available for pulling down and registering the film. 58 deg. of the camera cycle is 1/150 seconds or 6.7 milliseconds.

The film must be given a terrific yank, and then stopped dead during this 6.7

milliseconds. Since the currently available cameras use basically different methods to achieve this result, they will be discussed separately:

#### Eastman TV Recording Camera, Model 2

The Eastman camera uses a sprocket intermittent to pull down and register the film. The star and cam geneva movement is relatively slow acting, requiring 135 deg. of its drive shaft to accomplish the pulldown cycle. The drive shaft is accelerated 3 to 1 temporarily during the pulldown, so that the actual number of camera degrees required for the operation is 57 deg. This leaves 1 deg. of leeway within the 58 deg. shutter closed time, some of which is to ease the required precision of shutter to pulldown phasing, and some of which is undoubtedly to permit shock waves set up in the film to die out.

The use of a sprocket intermittent requires that the angular displacement of the sprocket teeth which position successive frames of film be very precise. The star and cam which turn the sprocket must be equally precise. In addition, it is extremely important that the film not coast past the position to which it is pulled by the sprocket. Actually, only the front of one tooth of the sprocket is in contact with one film sprocket hole at the end of the pulldown, and this contact is the only means of registration. The nylon gate and pressure pad used in the Eastman camera undoubtedly help in the sudden stopping process, but they both must be scrupulously clean and the pressure on the pressure pad exactly right for proper operation. In addition, the accuracy of

the sprocket teeth is completely lost if dirt or emulsion pileup occurs on them.

In the Eastman camera it is possible to cover up the pulldown cycle completely with time to spare. It is, however, necessary that the phase of shutter and intermittent be correct in order that the beginning or ending of the pulldown cycle be completely covered.

#### RCA TMK75B TV Recording Camera

The RCA camera (manufactured by the J. M. Wall Co.) uses a more conventional claw and register pin intermittent movement to pulldown and register the film. The actual mechanism requires about 120 or 130 deg. to operate, but it is given an accelerated drive through a spline and block mechanism. The actual pulldown time is about 48 deg., with another 10 to 16 deg. used for registration, leaving no tolerance or a negative tolerance within the shutter closing period. The action of the intermittent mechanism is as follows:

The register pin is a jam fit in a film perforation, and is assumed to be fully engaged at the start of the cycle. The register pin is withdrawn while the claw is being carried up inside the mechanism. Just before the register pin leaves the perforation, the claw enters the next perforation below it. The claw is .002 in. smaller in vertical dimension than the perforation, and considerably narrower. The claw enters with .001 in. clearance top and bottom, thus not disturbing the film. The register pin leaves the perforation and the claw starts down, moving .001 in. before moving the film. The claw carries the film down to within .001 in. of its final position, and as it stops, the register pin enters the next film perforation. The register pin has a slightly tapered nose, and, as it enters, it pushes the film down an additional .001 in. and holds it there firmly. This moves the film away from the claw, which can now leave the film without disturbance. The cycle is now ready to be repeated.

Because of the lack of tolerance between pulldown cycle and shutter cycle, it is not practical to cover the pulldown and registration completely in the RCA camera. Since the register pin actually moves the film on entering, but should not on leaving, the leaving end of the cycle is chosen to be uncovered. This means that the shutter completely covers the end of the pulldown cycle, but does not close entirely before the beginning of the cycle. Critical shutter phasing is necessary to assure the correct order of events and avoid film motion during exposure.

#### Overall Flicker

An effect which is still only partly understood is a peculiar kind of overall

[Continued on page V15]

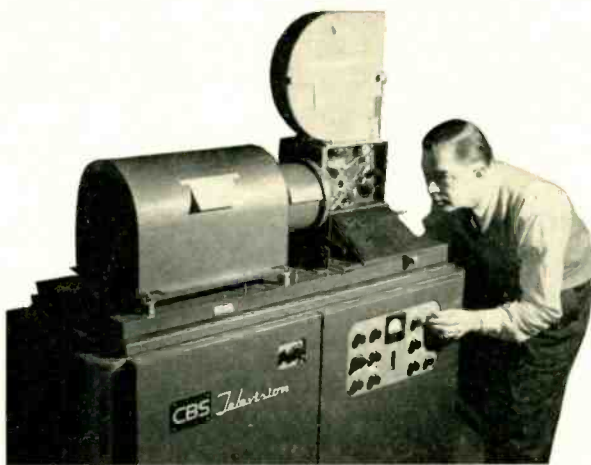

One of a group of six television recording equipments in service at the Columbia Broadcasting System's New York studios. The housing at the left contains the high-intensity picture tube that is photographed by the special 16mm motion-picture camera shown with its door open at the right. The lower portion of the assembly contains video amplifiers, control circuits, power supplies and other auxiliary equipment.

# Audio Systems for TV Service

W. L. LYNDON

Beginning a discussion of the studio, control, and transmitter facilities to handle the audio and video signals composing a complete television program.



Fig. 1. TTC-3A console—a basic unit for handling both audio and video signals.

**T**HE ABILITY TO TRANSLATE and transmit sound waves by means of electrical energy has been possible for several decades, but only within the last few years has equipment been available that would transmit and reproduce sound with life-like fidelity. This great achievement was not due to any one master stroke or any one particular piece of equipment, but rather to the over-all results obtained from improvements in microphones, vacuum tubes, amplifier components, circuit and transformer design, loudspeaker development, and, above all, a better understanding and interpretation of the science of acoustics.

Each branch has gone through its own cycle of evolution. Broadcasting made its debut with the carbon type of microphone, which was superseded by an era of condenser microphones, which in turn were superseded by the dynamic and ribbon or velocity types. Each type as it appeared possessed certain advantages over its predecessor, in such features as increased sensitivity, more uniform response, ruggedness, reliability, and improvement in signal-to-noise ratio.

All early audio systems were operated from storage battery supplies. The only type of tubes available would not permit their filaments to be operated directly

from a.c. because of the resultant high hum level. The introduction of the cathode type of tube eliminated large storage batteries and charging equipment which effected a material reduction in the over-all cost of an audio system. The use of a.c. necessitated the development of a new type of audio transformer shielding and the demand for lower distortion, and a wider frequency range called for better transformer core materials and improved methods of coupling transformer windings.

The early broadcast studios were generally existing rooms that were converted at the minimum of expense for this service. The improvements in microphones, reproducers, and amplifiers having lower inherent noise levels clearly pointed out the shortcomings of such makeshift arrangements, and it was at this point that serious thought was given to the designing of spaces that would be acoustically correct for broadcast purposes. Knowing the results that were desired, the problem was approached in a scientific manner and preferred studio dimensions were arrived at, based on studio occupancy. Many acoustic materials for studio interior treatment were developed, and in addition to designing studios for acoustic correctness, methods of construction were adopted that permitted a high degree of isolation between studios and between studios and the building framework. At this high point of broadcast audio development, the science of transmitting light waves, commonly known as television, entered the field as a medium of entertainment.

## TV Increases Complexity

The translation and transmission of light waves is considerably more complicated than that of sound waves. A quick examination of a comparable audio and picture channel clearly demonstrates the extensive complexities of the latter. This complexity results in a picture channel costing many times that of a comparable audio channel.

In the early period of AM broadcasting, stations were placed on the air with a minimum outlay of capital. Many of our present day popular and high-

powered stations had just such a humble beginning. Television, with its more complicated circuits, must of necessity start out with a much greater capital investment and contend with a higher operating cost. But the path has been partly paved by the pioneering work carried on by standard broadcasting. The ability to receive entertainment by radio has been firmly established as a part of our way of life; the ability to be able to add sight to that medium is a natural sequence of normal events.

In broadcasting, the transcription equipment rates second to studio programming; in telecasting, motion picture reproduction ranks next to studio programming, thus placing transcriptions in a minor role. In broadcasting there are many stations where a high per-



W. L. Lyndon was born 1899 at Lyndon, Alberta, Canada. In 1925 he graduated from Montana State College with a B.Sc. degree in Electrical Engineering. He entered the Radio Test Course at General Electric Co., Schenectady, N. Y., and was soon transferred to the engineering division, where he did development work on broadcast antennas and later on speech input equipment.

In 1930 he joined the Radio Corporation of America at Camden, N. J. From 1930 to 1938 he was project engineer for speech input equipment and low powered transmitters for broadcast and police service.

He served as sales engineer for speech input and television equipment from 1939 to 1941, when he became product design engineer on high-powered conventional frequency and short-wave broadcast transmitters. He supervised the construction and installation of the high powered transmitter tube testing facilities for the RCA tube plant at Lancaster, Penna. From 1948 to date, he has been doing audio systems engineering for television service.

Mr. Lyndon is a senior member of the I.R.E.

## Audio Systems for TV Service

centage of the programs are transcribed, and there will also be the type of television station that is desirous of starting with a minimum of equipment using film and slides as the only source of programs. This plan is particularly attractive to isolated areas that will have no immediate access to coaxial cable or possible relay service. In such locations, each TV broadcasting system installed is, in its own right, a pioneer, because there will be no receivers until the station becomes an actuality. The station must of necessity continue to function until such a time that its viewing audience has been built up to the point that advertising rates can be charged which will permit operation on an efficient commercial basis.

### The Audio-Video Control System for Small TV Stations

The basic system described here deals only with equipment that will handle film or remote programs, and does not cover the audio equipment necessary for producing studio shows. With this basic type of TV station in mind, the TTC-3A1 Audio-Video Control Console as shown in Fig. 1 was developed. Stepping beyond the realm of being merely an audio control unit, the TTC-3A1 control console provides a compact and efficient control that places a television system on the air with the minimum of equipment and operating personnel. Additional built-in features provide a certain degree of expansion. If a TV station makes its debut showing only motion picture film and opaque and transparent slides, the additional audio and video facilities provided in the console permit the system to be expanded for use with either a relay

circuit or coaxial cable service, or both, whenever they become available.

The control circuits and a few of the associated components are housed in a self-contained console having a turret with a hinged sloping-front panel. The basic console is one of a standard RCA design that will permit it to be mounted adjacent to such units as the TK-20A film camera control unit, and a TM-5B master monitor. Such a combination of units is shown in Fig. 2, and a finished appearance is achieved by adding end sections.

The essential controls are located on the hinged front panel of the turret. The auxiliary units, such as relays, audio monitor-level equalizer potentiometers, isolation transformer, pre-emphasis network and chopper circuit, are located within the turret. The base of the unit houses a dry rectifier for relay and pilot-light power supply, as well as the audio, video, and power-control circuit terminations. A close-up view of the control panel is shown in Fig. 3. In order to simplify the operation of this panel, the various controls have been functionally grouped.

The upper left corner contains the controls for a transparent slide projector. These controls consist of an ON-OFF power switch with associated indicating pilot light, a variable unit which permits control of the projector lamp supply, and a push button switch designated as OPERATE. This switch may be used as a means of controlling remotely operated slide changing devices.

The top center of the panel contains a standard VU meter. The multiplier for this meter is a semi-adjustable type and

can be set for any level from +4 to +31 VU by reconnecting the control unit.

### Projector Controls

Normally, TV stations whose programming is devoted almost entirely to the showing of motion picture films will require the services of two picture projectors, preferably of the 16-mm type because of the wide variety of film that is available. In the upper right corner of the control panel are located the controls and indicator lights for two 16-mm motion picture projectors. After the projectors themselves have been placed in an operating condition, their controls are thrown to the remote position. This arrangement makes it possible to start-stop and change over from one projector to the other from the console. The audio outputs of the two projectors terminate in a relay, which in turn is controlled by the projector change-over switch. The output of this relay is connected to the film position of a four-position audio selector switch designated as FILM, NET, REMOTE, SPARE. The picture outputs of the two projectors feed into one film camera and its control unit. The video output of the film camera control unit, which would be mounted adjacent to the console, would feed by means of coaxial cable to the film position of the picture program switch designated as FILM, NET, RELAY, SPARE 1, and SPARE 2. This switch is mechanically interlocked so that it is possible to obtain only one source of picture on the outgoing video program bus. Each projector is provided with a dowsing unit mounted in front of the projector lens, and, whenever either machine is placed in operation, the sound and picture are transferred simultaneously.

Below the projector control switch is a pushbutton designated as CHOPPER. This button controls a vibrator which is operated from an a.c. power supply. The armature of this vibrator is connected to the picture monitor output position of the video transmitter, and is adjusted so that it intermittently shorts the monitor line. This monitoring circuit is switched to the input of the master monitor. It provides a means of locating and adjusting the zero per cent of modulation.

Directly below the CHOPPER switch is a mechanically interlocked pushbutton switch used for the termination of four incoming audio sources referred to above. The output of this switch feeds into an audio attenuator designated as PROGRAM which regulates the level feeding the program bus. Adjacent to this switch is located a lever key which, when operated, feeds an announce circuit into an associated attenuator. The output of this announce and program circuit is combined to feed the program bus. The announce key also controls a speaker

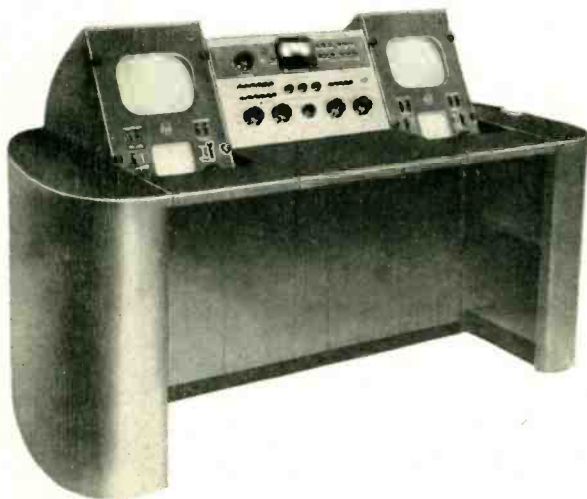

Fig. 2. The basic console, with the addition of a camera control unit and a master monitor.

relay which opens the speaker circuit to prevent acoustic feedback.

Directly below the VU meter are three controls which provide the essential adjustments of a Type TA-5C Stabilizing Amplifier. This amplifier is a highly desirable piece of equipment and adds much to the reproduction of pictures of high quality, especially if the pictures are received over relay or coaxial circuits. The three controls regulate the picture gain, picture clipper circuit, and the sync level. If the input of the stabilizing amplifier is terminated on a coaxial jack panel, its usefulness is expanded because it may be patched to any of a number of program circuits.

A video gain control for the picture transmitter is provided and is located directly below the three stabilizing amplifier units. This control is associated with a motor-driven video volume control located within the transmitter. By switching the monitor output position of the picture transmitter to the input of the master monitor, it is possible to observe and adjust the picture being transmitted for the correct depth of modulation. No control unit would be complete without having monitoring facilities for the essential audio and video circuits.

#### Audio Facilities

The audio monitoring consists of a seven-position selector switch and a monitor volume control. It is possible to

Fig. 3. Panel view of basic console unit.

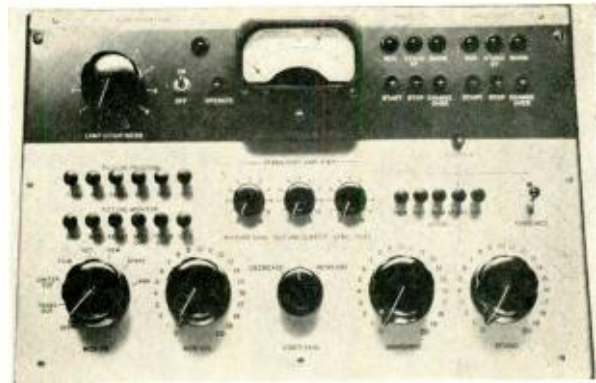

monitor the transmitter output, line amplifier, or limiter amplifier output, film network, remote, spare line, and announce position. On the input of each one of these monitor positions is a semi-adjustable volume control, thus permitting the levels feeding the monitor switch to be equalized.

The video monitoring consists of a six-position mechanically interlocked switch, the output of which is fed by means of coaxial cable to the input of the master monitor, located adjacent to the TTC-3A1 control console. In addition to two spare positions on this switch, there are positions for monitoring such circuits as network, relay, modulator output, and transmitter output. The inputs for both the picture program and moni-

tor switches are terminated in coaxial cable plugs mounted within the base of the control unit. Three of the positions are provided with semi-adjustable terminations, thus making it possible to switch between these positions without any apparent change in video monitor level.

A block diagram of the TTC-3A1 is shown in Fig. 4. The circuits and components that are physically part of the desk are shown in solid lines. All external circuits and associated units are indicated by dotted lines. The upper half of the block diagram is devoted to the picture part of the system, while the lower half covers the audio system and the 16-mm projector controls.

The video equipment consists of one transparent slide projector and two 16-mm motion picture projectors feeding into a film camera unit and its monitor. Two type WP-33B power supplies are associated with this camera and control chain. The sync generator, which would normally be of the rack mounted type, supplies the drive and sync voltages for TK-20A film camera unit. The output of the camera control unit feeds to the input of the video program switch, which in turn is connected directly to the input of the picture transmitter. The picture transmitter may be an RCA 500-watt type 500A or 500-B, or a 5KW unit type TT-5A. The r.f. output of the transmitter is terminated in a vestigial sideband filter before it is fed into an antenna system. Two monitoring positions are indicated: (1) the output of the transmitter modulator, and (2) the rectified carrier output from an r.f. diode unit. The chopper action is applied to this latter circuit.

The master monitor is connected to the output of the video monitor switch. The input for all video program and monitoring circuits are provided with a 75-ohm termination. The type WF-49A and WF-50A are frequency monitor units for the picture transmitter. Directly below are the remote control units for the stabilizing amplifier.

[Continued on page V14]

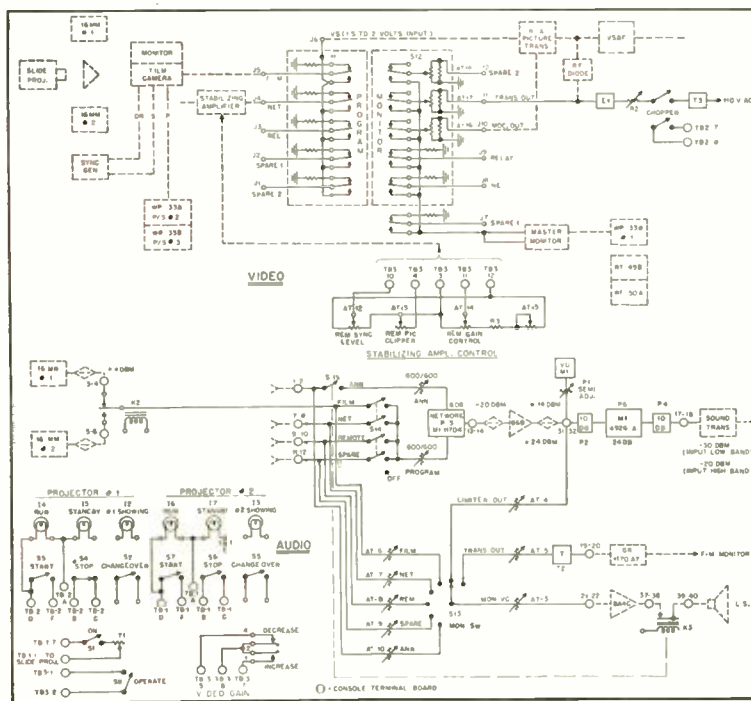

Fig. 4. Block diagram of the TTC-3A1 console. Solid lines indicate equipment which is physically a part of the unit; dotted lines indicate external circuits and units.

# CBS-TV Sound Effects Console—2



Robert B. Monroe, Project Engineer  
CBS General Engineering Department

Born in Brooklyn, New York on October 17, 1908, Mr. Monroe attended Pratt Institute from 1937 to 1942 while being employed by Columbia Broadcasting System, Inc., where he went in 1934 and where he has since been continuously employed except for the war years.

From 1942 to 1945 he was associated with the Radio Research Laboratory, Harvard University (sponsored by the Office of Scientific Research and Development). He served successively as head of the Planning Department, head of the Standards Laboratory, and assistant to the Executive Engineer.

Mr. Monroe is a senior member of the Institute of Radio Engineers.

**V**ARIABLE-SPEED turntables extend the scope of sound effects recordings to a considerable degree. Let us assume that a recording of the sound of a cruising airliner is available. If the rotational speed of the turntable is increased, this same recording produces a sound resembling that of a speeding fighter or racing plane. Reproducing this same recording at a slower-than-normal rotational speed produces a sound like that of a large dirigible. Similarly, a recording of an idling automobile engine may serve to create the effect of an automobile operating at many different speeds. This same record may be used to produce the effect of an automobile accelerating or decelerating by changing the turntable speed while the record is playing. Thus, the variable-speed turntable is valuable to the sound effects man in creating new sounds from standard sound effects recordings. The units employed in this console, illustrated in Fig. 1, are continuously variable over the range from 10 to 130 rpm.

## Sound-Effects Filter

The sound-effects filter in the main program channel is a standard CBS device incorporated in all studio audio facilities. It acquired its name because, in this particular form, it was originally proposed<sup>1</sup> and used for radio sound-

effects. The filter consists of a low-pass section and a high-pass section connected in cascade. The cut-off frequency of each section is independently adjustable, a choice of any of eight frequencies (100, 250, 500, 1000, 2000, 3000, 4000, and 5000 cps) being available. In addition, the individual sections may be removed entirely from the circuit, permitting the unit to be used as a high-pass, a low-pass, or a band-pass filter. To insure against switching noises during operation of the range switches, the capacitors in the various sections are shunted with suitable resistors to provide a continuous discharge path. Furthermore, the switching arrangement is such that in passing from one set of contacts to the next continuity of the signal through the filter is maintained. The filter unit can be switched in or out of the circuit whenever desired by means of a twist-type key located immediately above the range selector controls.

## Headphone Cue

In CBS television operation, the sound-effects operator wears split headphones. One of the two receiver units is connected at all times to a bus from the program director's microphone, and through this circuit the director gives instructions and directions to all technical and production personnel. The second receiver unit can be connected by means of a front panel key switch to any of the following circuits: (1) the record cueing circuit, (2) the audio output of

<sup>1</sup> H. A. Chinn and R. A. Bradley "CBS Hollywood Studios," *Proc. I.R.E.*, July, 1939.

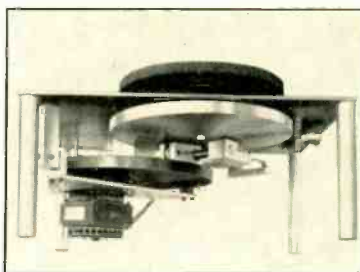

Fig. 1. Internal construction of Gray variable-speed transcription turntable. Change of speed is accomplished by varying the diameter at which coupling takes place between driver and driven discs, and covers the range from 10 and 130 r.p.m.

the sound effects console, or (3) the over-all audio program output of the studio. Panel-mounted volume controls permit the level of each headphone unit to be independently controlled.

## Physical Construction

Careful attention was given to all physical design details of the CBS 4-A sound effects console to produce a compact and readily movable unit. The entire housing is fabricated of aluminum to keep the weight as low as possible. Four large ball-bearing casters make the unit easy to move. A sturdy bar-type handle is provided at each end of the unit and is recessed to avoid any out-board obstruction and to keep the overall dimensions as small as possible. The controls on the front of the unit also are recessed to avoid damaged knobs and switches when the unit is moved through a door or other narrow passageway.

To protect the equipment when it is not in use, a roll-top cover not unlike those employed on roll-top desks has been employed. This cover differs from its predecessors, however, in that it is constructed of lightweight aluminum tubing. When closed, it may be locked in place, keeping the equipment protected from dust and from use by unauthorized persons.

A rack for holding program script as well as records is provided, and is constructed of clear plastic to increase the visibility of the operator in the forward direction. The general construction can be seen in Fig. 1. The rack extends across the entire length of the console at eye level. A felt-lined aluminum channel fastened across the lower edge of the plastic panel serves not only as a ledge to hold the records and script in place, but also serves to strengthen the entire assembly. The plastic rack hinges down under the roll-top cover when the console is closed.

To facilitate identification, the knobs on the four transcription mixer positions are colored green, blue, red, and white respectively, and the four transcription arm heads are colored correspondingly. This eliminates any confusion on the part of the operator regarding the mixer position associated with each of the transcription arms.

All amplifier units, as well as the power supply, are of the plug-in type and, in the case of the CBS Grand Central television studios, are identical to the units employed in the control room

## Part 2. Production of television programs with optimum sound effects and a minimum of confusion demands flexible audio facilities designed for the purpose.

audio consoles<sup>2</sup> and master control room. To further simplify maintenance, only two tube types are employed in the entire console, the rectifier in the power supply unit being of the dry-disc type.

The ten amplifier units are mounted in two rows of five amplifiers each, and the entire mounting assembly is shock mounted. Access to the amplifiers and power supply is through the large door in the front of the console. All connections to external circuits are made to the receptacles grouped on the lower left side of the console.

### Operation in Television Studios

In radio broadcasting studios, the usual method of mixing sound effects from recordings into the over-all studio program is to reproduce the sounds on a studio loudspeaker, where they are

<sup>2</sup> R. B. Monroe and C. A. Palmquist, "Modern Design Features of CBS Studio Audio Facilities," *Proc. I.R.E.*, June, 1948.

picked up on one or more of the studio microphones. It is, of course, necessary to give careful consideration to the relative positioning of loudspeaker and microphones in order that a satisfactory microphone pickup will be obtained. Sounds from direct sources, such as doors opening and closing, footsteps, etc., are picked up on a regular studio microphone placed at the sound effects operating location.

The above method of operation, although entirely satisfactory in radio broadcasting, has not proven entirely adequate in television operations because microphone booms replace the fixed microphones ordinarily used in radio broadcasting. Due to the constantly changing relationship between the moving microphone booms and the fixed sound-effects loudspeakers, the pick-up becomes unpredictable. As a result, a new method of operation is employed in CBS television studios. It has been noted already that the sound effects console de-



Price E. Fish, Project Engineer  
CBS General Engineering Department

Mr. Fish was born in Fort Worth, Texas, on September 18, 1911. He received the B.A. degree in mathematics from William Penn College in 1935. From 1938 to 1942 he was employed by the United Broadcasting Co. in Cleveland, Ohio, and in 1942 joined the scientific staff of the U. S. Navy Underwater Sound Laboratory (sponsored by the Office of Scientific Research and Development) at New London, Conn., where he was engaged in the development of submarine underwater sound devices. In 1945 he joined Columbia Broadcasting System, Inc.

Mr. Fish is a senior member of the Institute of Radio Engineers.

livers two different outputs—one a line level output of +10 VU and the other a loudspeaker output level. The sound effects operator mixes together all sound-effects material—whether from recordings, sound effects microphones, or other sources—and transmits the complete sound effects material at line level to the studio control room, where it is mixed with audio from all other sources. Performers on the set are permitted to hear the sound effects from a loudspeaker unit driven by the sound effects console high-level output. This method of operation has proven quite successful in CBS television studio operation.

The panel-mounted VU meter on the sound-effects console permits the operator to maintain the line output level of the console at a standard transmission level of +10 VU. The volume indicator also makes it possible for the operator to reproduce an effect at exactly the same level used during rehearsal or on a previous program. A twist-type key switch immediately beneath the volume indicator removes it from the circuit, if desired.

It is the usual practice in television studios to arrange several different sets in a single studio. These sets may be associated with a single large production or may be associated with several smaller, single set, productions. In any event, as the programming progresses, the studio cameras and microphones are moved from one set to the next. It is,

[Continued on page V15]



Fig. 1. A close-up of the operating controls of the CBS 4-A sound effects console. Immediately below the clear plastic script and record rack is the turntable platform upon which is mounted the three variable-speed turntables and four transcription arms. Lever arms controlling the turntable speed are to the right and forward of each turntable.

The six-position mixer and associated master gain control are arranged across the center portion of the control panel. Above the four color-coded mixer controls associated with the four transcription arms may be seen the low- and high-frequency equalizer controls. To the right of the mixer is the volume indicator with its associated on-off switch and, at the extreme right, the "sound-effects" filter. To the left of the mixer is the five-position loudspeaker push-button selector with its associated volume control and, at the extreme left, the selector key switch and volume controls associated with the headphone cue circuits.

The over-all dimensions of this console are 64 inches long, 28½ inches deep, and 50 inches high. The weight, ready for operation, is approximately 575 pounds.

## MORE NEW PRODUCTS

● **TV Stabilizing Amplifier.** Correction of faults which may be introduced in video signals during their transmission from the television camera to the transmitter is an accomplished fact with RCA's new Type TA-5C amplifier. Among the many common disturbances which the new amplifier will offset are random signals originating in long cable sheaths, hum or surges originating in power supplies, switching surges, and low-frequency

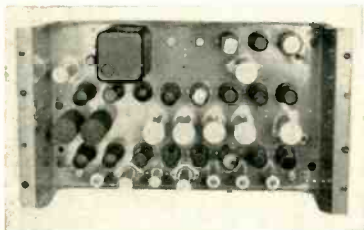

distortion caused by coupling circuits with inadequate time constants. In addition, the new amplifier may be employed to remove sync from a remote signal so that it may be switched, faded, or dissolved with local signals in either television or microwave relay systems. The amplifier is provided with built-in filament supply, but plate voltage must be obtained from an external regulated power source. It is built on a standard bathtub chassis for rack mounting. Complete technical description may be obtained from RCA Victor Division of Radio Corporation of America, Camden, N. J.

**The ORIGINAL and Still the BEST LIGHTNING ARRESTER**

for all weather conditions

will not absorb moisture

completely waterproof



**APPROVED for OUTDOOR-Indoor Use!**  
Protects Television Sets Against Lightning and Static Charges

**JFD SAFE TV GUARD**

Fits Any Type of Twin Lead

No. AT102 for Regular Twin Lead  
No. AT103 for Oval Jumbo Twin Lead  
No. AT103 Also for Tubular Twin Lead  
BOTH Models Conform With Fire Underwriters and National Electrical Code Requirements for OUTDOOR installations.

**\$2.25**  
EACH

**SIMPLE TO INSTALL . . .** can be mounted directly on mast by strap fastening arrangement . . . or attached to any grounded object, at any position between antenna and set, outdoors or indoors. No stripping, cutting or spreading of wires necessary. Hardware furnished.

Look for the JFD Trademark

**JFD MANUFACTURING CO., Inc.**  
6127 16th Avenue, Brooklyn 4, N. Y.  
First in Television Antennas & Accessories

## TV RECORDING

[from page V8]

flicker in which the halves of the picture above and below the splice seem to flicker alternately light and dark. The best present explanation relates this effect to the variability of decay time of the P-11 phosphor with brightness as follows:

Silver-activated ZnS phosphors (the P-11 falls in this general class) have a two-part decay curve. The portion of the brightness decay near extinction is identical in shape for any initial phosphor brightness. However, there is a very fast initial decay (decreases in intensity as great as 100 to 1 in 0.1 millisecond) which appears above a given initial brightness and which varies in depth with brightness. Because of this sudden decay, the exposure of the film to such a phosphor may be considered to be in two parts, an initial short (0.1 millisecond) very bright exposure, followed by a much less intense exposure during the tail of the decay curve, lasting perhaps several milliseconds.

This particular combination of exposures is just right for the production of the Clayden effect<sup>2</sup>. This effect consists in the reduction of the effectiveness of the initial high-intensity exposure by the second low-intensity one. If two identical high-intensity exposures are made, one followed by a relatively long low-intensity exposure, and the other not, the first may produce less density on the developed film than the second, although the film has actually received more light energy in the first case. The exact relative amounts of exposure and the processing of the film can cause the effect to appear or not. To produce the Clayden effect, the order of exposures must be: "short-intense—long-dim", not the reverse.

The way in which the Clayden effect can produce the overall flicker mentioned above comes from the shutter action at the splice. Lines just below the splice have the tail of the decay curve extended out to effective extinction as it is about 1/30 second after they are scanned before the shutter cuts off the light from the film. Lines directly above the splice are scanned before the shutter opens, and the tail of the decay from that scanning produces a small exposure on the film as soon as the shutter opens. On top of this exposure the film later receives an initial intense exposure, plus an abbreviated "tail" exposure, which

is cut off by the shutter before it has a chance to decay fully. Therefore, the Clayden effect causes the exposure in the region below the splice to have its effect on the film reduced, while the secondary exposure is not permitted to last long enough to inhibit the effect of the initial exposure on the film in the region just above the splice. This produces an apparent step in density at the splice, with the lower portion of the picture darker, and since the splice itself is alternately in the center of the picture and hidden at top or bottom, the step seems to flicker in and out.

This over-all flicker makes it very difficult to correct shutter-size and timing errors in the TV recording camera, since it masks them. Changing picture brightness affects the flicker, since it changes the difference between the initial flash and the tail exposure. Often the flicker is seen only in very bright or over-exposed scenes, being invisible at other times. The negative film processing can also be adjusted so as to remove this flicker essentially completely.

### Conclusion

The proper operation of the TV recording camera has been shown to involve the precise interaction of many factors. However, it is possible to produce TV recordings on a routine basis which are entirely satisfactory from the point of view of camera operation. Although at present such results require care and vigilance in searching out irregularities, it is to be expected that the large amount of operating experience being acquired in daily operation of TV recording equipment will result in even greater improvements of techniques and equipment. It is perhaps not too optimistic to anticipate that the operation of TV recording equipment will soon be as simple and routine as the operation of present-day disc and tape recording equipment for sound.

## AUDIO SYSTEMS

[from page V11]

The audio diagram indicates the sound output of the two 16-mm projectors as being connected directly to the program switch. Circuit losses and required amplifier gain are indicated. In the case of the type TT-5A low-band transmitter, it requires an input level of -30 dbm, whereas for the TT-5A high-band transmitter, the input level required is -20 dbm. The inputs for the announce, network, remote, and spare positions are indicated as being terminated on jacks, and no reference is made to any preceding audio amplifying units. This has been left in this manner because the type

<sup>2</sup> C. E. Kenneth Mees, *The Theory of the Photographic Process*, The Macmillan Co., New York, 1945, p. 254 ff.



and quantity of units required depend upon the type of service to be provided. The input level required for each of these three positions is +4 dbm, which has been established by the normal audio output supplied by the projectors.

For the announce circuit, a portable amplifier such as the BN-2A can be used to advantage, since it has additional inputs which could be used for transcription service. Amplification for the network and remote lines can be conveniently provided by the use of a type BA-13A program amplifier. The addition of a 33-A jack panel, a line equalizer, and an MI-11265 VU meter panel will provide a flexible arrangement for equalizing, amplifying and determining the correct audio level to be fed into the audio program switching circuit. An MI-26313 film equalizer has not been indicated. It would normally be connected into the common lead feeding the program switch. This equalizer has an adjustable high- and low-frequency response and can be of considerable assistance in correcting the variable recording characteristics which may be encountered in 16-mm film.

The facilities incorporated in the TTC-3A1 audio video control console are sufficient to permit a television station to be placed in service with the minimum of equipment and operating personnel, and it contains additional facilities which will permit a certain degree of facility expansion. However, should the station expand to the point of adding a television studio, where direct pickup will be made, the audio system must, of course, be reconsidered on the basis of the type of programs that are expected to be reproduced.

## SOUND EFFECTS

[from page V13]

of course, desirable that the sound effects loudspeaker be directly at the set in use, but as moving the loudspeaker is impractical because of the limited time available, it has been found convenient to place a loudspeaker unit at each of the sets. When this is done, it is merely necessary to switch the audio output of the sound effects console to the desired loudspeaker. A push-button type selector switch permits the audio power to be transmitted to any one of five sound effects loudspeakers; this switch has an OFF position which terminates the output of the studio loudspeaker units is being operated.

These sound effects consoles have been in operation in the CBS Grand Central television studios for a period

of approximately a year. During this time, they have been employed in conjunction with all types of television programs and have proven themselves entirely capable of meeting all of the exacting demands made on sound-effects facilities by large-scale television productions.

The basic design of the CBS 4-A sound effects console is not new, but has evolved over a period of more than fifteen years to meet the ever-increasing problems with which the sound-effects operator is faced. Pioneer work in this field was undertaken by Walter Pierson,

past Manager of CBS-New York Sound Effects Division. More recently, this work has been carried on by Davidson Vorhes, present Manager of the division, to whom an outstanding acknowledgment is due for his many contributions and suggestions.

Acknowledgments are also made to Howard A. Chinn, CBS Chief Audio-Video Engineer, under whose direction this project was undertaken, and to the Gray Research and Development Company of Hartford, Conn., for their many contributions to the design and manufacture of these consoles.

# Floating Action!

## for all TV Cameras "BALANCED" TV TRIPOD

Pat. Pending

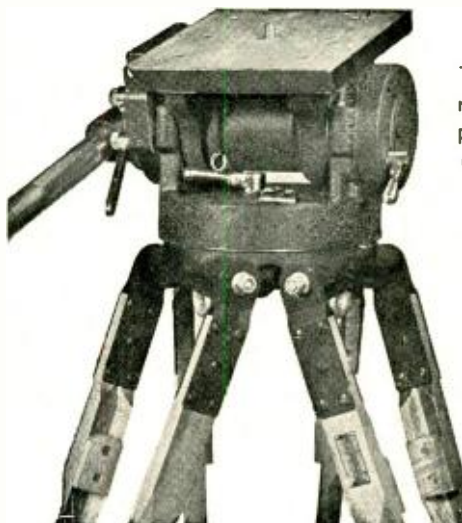

This tripod was engineered and designed expressly to meet all video camera requirements.

Previous concepts of gyro and friction type design have been discarded to achieve absolute balance, effortless operation, super-smooth tilt and pan action, dependability, ruggedness & efficiency.

Below:

3 wheel portable dolly with balanced TV Tripod mounted.

Complete 360° pan without ragged or jerky movement is accomplished with effortless control. It is impossible to get anything but perfectly smooth pan and tilt action with the "BALANCED" TV Tripod.

Quick-release pan handle adjustment locks into position desired by operator with no "play" between pan handle and tripod head. Tripod head mechanism is rustproof, completely enclosed, never requires adjustments cleaning or lubrication. Built-in spirit level. Telescoping extension pan handle.

Write for further particulars



FRANK S. JONES  
**CAMERA EQUIPMENT CO.**  
1600 BROADWAY NEW YORK CITY

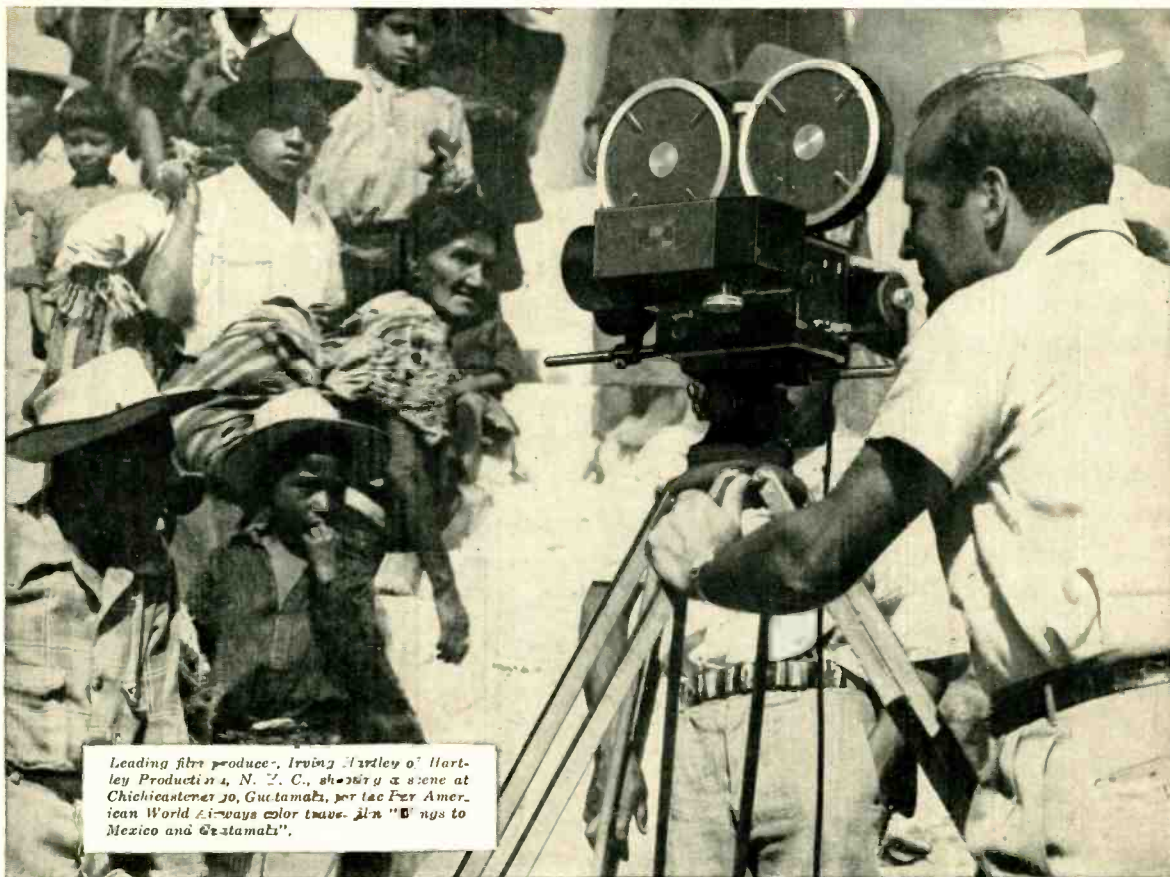

Leading film producer, Irving Hartley of Hartley Productions, N. Y. C., showing a scene at Chichicastenango, Guatemala, for the Fox American World Airways color travel film "Flights to Mexico and Guatemala".

## Here is the Maurer 16 mm. at Chichicastenango!

Mr. Irving Hartley, top-flight cinematographer and producer—like dozens of others in the field—knows, uses and recommends the Maurer 16 mm. camera wherever and whenever excellent color photography is required, for the following reasons:

- Its **VERSATILITY** first of all, makes it ideal for all sorts of color work, its accuracy, precision high power focusing system and its large clear glass direct-through-the-lens viewing system insure excellent results at all times.
- Its **DEPENDABILITY**, the result of years of rigid testing and improvement have made it ideal for below freezing or torrid conditions—the dependable camera for all field work.
- Its **UNIQUE FEATURES**, such as the 235° dissolving shutter, allows you to shoot with one-third less light, and with automatic fades and smooth lap dissolves made right in the camera.

These are some of the many reasons why more and more of the best professional cameramen today pick the Maurer—the 16 mm. camera designed specifically for professional use!

For details on these and other exclusive Maurer features, write Dept. E

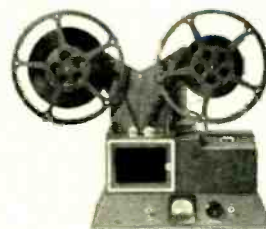

The 16 mm. Film Phonograph unit provides the finest quality in high fidelity re-recording and playback. Its unique optical system reduces photo-cell hiss—resulting in excellent quality reproduction.

# J. A. Maurer, INC.

37-01 31st Street, Long Island City 1, N. Y.  
850 South Robertson Blvd., Los Angeles 35, California

16mm  
maurer

CABLE ADDRESS:  
JAMAURER

ates to a great extent the need for subsequent amplification of the noise.

A photomultiplier tube which seemed suitable as a noise source is the type 931-A. The calculated radio frequency spectrum for this tube has been published,<sup>4</sup> and the calculations show its noise output to have uniform frequency components from 10 to 1000 megacycles. But no information was found other than the basic theory of shot-effect noise to indicate what noise output could be expected in the audio-frequency region. Actual measurements show that the noise

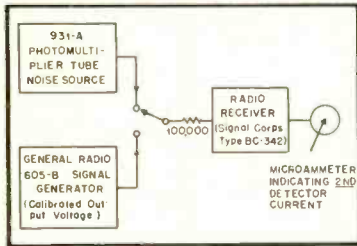

Fig. 3. Block diagram showing method used for r.f. noise measurements.

energy is not uniformly distributed over the audio-frequency region of the spectrum.

#### Experimental Determination of the Noise Spectrum of a 931-A Photomultiplier Tube

##### a. At audio frequencies.

For these measurements the 931-A photomultiplier tube was supplied with a total accelerating potential of 800 volts, and illumination of its cathode was provided by a 6-volt pilot lamp. Measurements in the audio portion of the spectrum places severe requirements as to ripple in the accelerating voltage. Rather than undertake an elaborate power supply design for these preliminary experiments, this potential was obtained from batteries.

It was anticipated that some hum would be introduced if the exciter lamp were lighted from a 60-cycle a.c. source. Actually, no trouble was encountered in this regard, and no difference was noted whether the power for the lamp was a.c. or d.c.

Another issue to be decided in establishing the operating conditions for the photomultiplier tube is the value of load resistance to be used. The advantages of a high-resistance load were discussed in the preceding section. However, the value of load resistance is limited by other considerations. In a secondary-emission multiplier, the amplification depends to a great extent on the potential difference between the last multiplier electrode and the collector anode. Usually the potentials on the various multi-

<sup>4</sup>R. D. Sard, "Calculated Frequency Spectrum of Shot Noise from a Photo-Multiplier Tube," *J. App. Phys.*, vol. 17, pp. 768-777, 1946.

plier electrodes are supplied from a voltage divider across an appropriate voltage source. The anode potential, however, is applied through the load resistor. If the load resistance is high, the anode potential will vary considerably with small variations in cathode emission, making the gain unstable. A good compromise between the desire for large output and the desire for stable gain is obtained with a load resistance of 1500 ohms.

The method by which these measurements were made is shown in Fig. 1. The General Radio 626-A v-t voltmeter is a square-law meter and, therefore, indicates the root-mean-square of all frequency components of the noise voltage which lie within the pass band of the GR 760-A Sound Analyzer.

It is customary to represent the distribution of noise energy over the spectrum in terms of the root-mean-square voltage of the components within the fixed band width  $\Delta f$ . In the case of the 760-A Sound Analyzer, the band width is a fixed percentage of the center frequency of the pass band and is therefore proportional to the center frequency. The equation given earlier shows that the r.m.s. noise current (and therefore the r.m.s. noise voltage across the load resistor) is proportional to  $\sqrt{\Delta f}$ . To express the results in terms of what noise would have been passed had the band width  $\Delta f$  been constant, the readings were in each case divided by the square root of the center frequency of the pass band. The results, which are shown in Fig. 2, then indicate the relative voltage of the various frequency components in the noise output of the 931-A photomultiplier tube. Since the absolute magnitude of the noise output was immaterial in this investigation, it was sufficient to simply find the relative noise output as a function of frequency.

In Fig. 2 the theoretical uniform distribution of noise energy is indicated by a broken line. It is plain to see that the measurements show a considerably different distribution than that of the desired white noise. Because of this non-uniform distribution found by actual measurement, a somewhat different method for obtaining audio-frequency noise was undertaken. This method consists of selecting a small portion of the radio-frequency noise spectrum and by heterodyning, generating noise which

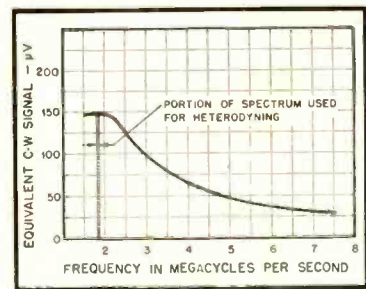

Fig. 4. R.f. noise spectrum of 931-A photomultiplier tube.

has essentially uniform frequency components in the audio-frequency region.

##### b. At radio frequencies.

In considering the feasibility of obtaining audio-frequency noise by heterodyning of portions of the r.f. spectrum, it was necessary to know the distribution of noise energy at these frequencies. Measurements for this purpose were made using a system represented diagrammatically in Fig. 3. The effective voltage of all frequency components of the noise lying within the response band of the receiver gives rise to a particular second detector current in the receiver. Having noted the value of this current, the noise source was replaced by a signal generator whose output frequency was that to which the receiver was tuned. The output voltage of the signal generator was then adjusted to give the same second detector current as did the noise source. This signal generator voltage was then an indication of the noise within the band width to which the receiver responded. Taking such readings with the receiver tuned to various frequencies, the noise spectrum shown in Fig. 4 was obtained.

As was the case in the audio-frequency data, it was desired that the curve showing spectral distribution of the noise energy be based on a constant band width. The matter of variations of the band width of the receiver as a function of frequency to which the receiver was tuned was therefore investigated. Actual measurement showed that the response band width of the receiver used (a superheterodyne) did not vary sufficiently over the frequency range of the receiver to affect the results significantly.

The findings presented in Fig. 4 show that the actual distribution of energy

Fig. 5. Block diagram of system used to produce a.f. noise by heterodyning a selected portion of the r.f. noise spectrum.

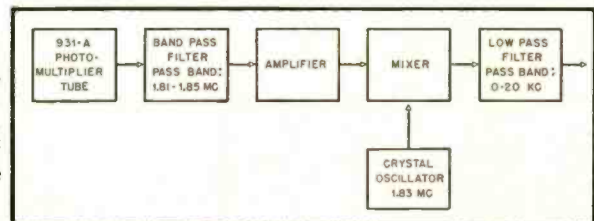



## Construction Practice—2

**T**HE FIRST ARTICLE of this series discussed a number of the major components used in audio equipment. We shall now examine some of the smaller items which are equally essential to the design of audio apparatus, and which are often overlooked. In addition some elements of chassis layout will be discussed.

Variable potentiometers are commonly used in audio work for gain and tone compensation controls. They are available in three general groups, carbon, molded carbon, and wire-wound. The most popular before the war was the carbon element potentiometer in which a rotating contact arm carried a sliding contact over a circular card on which a layer of carbon had been deposited. Since the end of the war, the molded carbon element used in the same mechanical case, but having a ring of plastic into which the carbon has been molded, has become extremely popular. These two types find application in the grid circuit of vacuum tube equipment where little or no current passes through the unit. For low level use the molded element gives more satisfactory service because it introduces less noise. Wire-wound potentiometers are used in plate, cathode, and screen circuits where they are required to dissipate up to four or five watts of power. Under these conditions, the carbon elements would either burn out or generate excessive amounts of noise. The rating of the molded element is two watts, and that of the usual, small carbon element is one watt. Where a potentiometer is required to fit into a small space, a special series may be obtained from most manufacturers as stock items, but they have reduced power and life ratings. Large quantities of the molded element and wire-wound potentiometers have been available since the end of the war, on the surplus market.

### Variable Capacitors

The use of variable capacitors in audio work is becoming more frequent, and they bear some discussion. They are used in variable-frequency oscillators and tunable filters. Capacitors for this service must be precision built on rigid

metal or ceramic frames and should have the plates soldered into carefully machined slots, or assembled on the shaft with precision spacers and locked in place. Among the better capacitors for this service are the National PW series and the Cardwell PL 24,050. Also these capacitors must have a drive system with a minimum of backlash, and the dial or scale should be carefully hand engraved or machine divided.

With the advent of magnetic recording equipment the audio man is often faced with the selection of small trimmer capacitors. These should be of the mica spaced, ceramic mounted type because they have lower losses and less tendency to change value under varying conditions of temperature and humidity. Care must be used when soldering to mica trimmers to prevent solder or flux from flowing between the plates and causing erratic operation. It is not good practice to reuse trimmers; in fact it is economically unsound.

### Inductors

Inductors are not commonly thought of as being an audio component. However from the earliest days of audio they have been used in impedance-coupled amplifiers and as components in loading, equalizing, and filter circuits. Both the core style and inductance determine the case size and shape, but where expense is not a primary consideration, toroid coils are available in a wide range of values and in small cases. The toroid coil has several advantages over the conventional laminated, rectangular-core inductor in that it provides greater coupling between turns and between separate windings, and since there are no corners or gaps in the core, the flux distribution outside of the core is extremely small. Another desirable feature is the low sensitivity of the toroid to stray hum and noise fields which recommend its use in low-level equalizers and filters. These last two considerations make it possible to put two toroid coils in close proximity on a chassis without the danger of interaction or, when used on different signal circuits, of crosstalk.

Care should be exercised in the mounting of air or iron core inductors, so that they will not be within the strong fields that surround power supply chokes, transformers, and tubes. When used in low-level circuits such as an input playback equalizer, it is best to mount them as far from the power supply as possible, and where practicable the equalizer should be mounted on a separate chassis. In some cases it may be necessary to determine the best mounting position for inductors, to obtain minimum pickup, after the rest of the unit is built. The approximate position may then be explored with the coil connected to an oscilloscope.

### Switching Devices

Switches, outside of the a.c. power switch, are used to change circuit conditions in a positive-acting manner. This covers changes in input source and output transducer, and changes in equalization, operating impedance, and gain when it is desired to go from one fixed known value or condition to another. The most common switches for these applications are the wafer-type rotary switches with laminated plastic decks and silvered contacts. High-power switching requires mica-filled or plastic decks and for applications where leakage is important, ceramic decks may be used. In cases where only two or three switch positions are needed, lever-type switches can be used. They are particularly useful where the operating conditions must be known without reference to small dial indications, since their position may be seen at a glance. These switches are also made with an anti-capacitance feature where low switch capacitance is necessary, but these are more expensive. When more than three positions are to be used and rapid visual indication of the operating point is necessary, pushbutton types, with interlocking buttons that release any depressed button when another is pressed, are similar in electrical characteristics to the laminated decked rotary switches. For broadcast and long life service, pushbutton switches using jack leaf springs are preferred. All of these switches are self

[Continued on page 35]

# Simplified Reverberation-Time Calculation

LEWIS S. GOODFRIEND\*

A graphical presentation of the Eyring formula for determination of the reverberation time of enclosures.

**R**EVERBERATION TIME is one of the most important indices of the acoustical properties of buildings. W. C. Sabine in *Collected Papers on Acoustics* defined reverberation time as the time required for the intensity of a sound to fall to one one millionth of its original intensity, after the source is shut off. This definition is still used today, although the method of computing the value of the absorption coefficients and reverberation time have changed during the past few years and are still under careful scrutiny. The use of reverberation time as an indication of the usefulness of a building as an auditorium, theatre, or studio is now being studied. However, the continued use of this index, either by itself or as a factor in other indices such as the Maxfield-

Albersheim liveness constant<sup>1</sup>, makes the development of a simplified method for its calculation a desirable aim.

The formula for reverberation time developed by Sabine by empirical methods was later derived in an analysis by W. S. Franklin in the *Physical Review*, June 1903. It is:  $T = kV/A$  where  $k = .049$  for normal conditions of sound distribution, temperature, and pressure;  $V$  is the volume of the room under study in cubic feet; and  $A$  is the total absorption of all the exposed surfaces,  $A = a_1S_1 + a_2S_2 + a_3S_3 + a_4S_4 + \dots + a_nS_n$ . If  $S$  is the total area of all the absorbing surfaces in the room, then the average absorption,  $\bar{a}$ , is  $A/S$ . In cases where the average absorption is high (for example unity, which is closely approached in modern anechoic chambers), the com-

<sup>1</sup>J. P. Maxfield and W. J. Albersheim, "Acoustic Constant of Enclosed Spaces Correlatable with Their Apparent Liveness." *J. Acous. Soc. Am.* Jan. 1947, p. 71.

puted reverberation time is:  $T = kV/S$  which is an absurdity, since when no sound is reflected, the reverberation time is zero.

## Eyring Formula

C. F. Eyring in the *J. Acous. Soc. Am.* in 1930 gave a new analysis which appears to be closer to the actual case. He arrives at the formula:

$$T = \frac{kV}{-S \times \ln(1 - \bar{a})}$$

in which the symbols have the same definitions as above. There have been other approaches to the computation of reverberation time, but this expression is the one in most common use today.

One of the difficulties in the use of the Eyring formula is the necessity of referring to a table of natural logarithms. In addition, it is difficult to visualize what change in  $\bar{a}$  would be required to change the reverberation time of a room after its existing characteristics have been determined. These considerations suggest the use of a chart or graph. By rewriting the Eyring equation in the

form  $T = \frac{k}{[-\ln(1 - \bar{a})]} \times \frac{V}{S}$ , we can get for any fixed value of  $\bar{a}$  the expression

$$T = C \times \frac{V}{S}$$

in which the numerical value of the brackets has been replaced by  $C$ . This is the equation of a straight line starting at the origin and having a slope of  $C$ . It is then possible to plot a family of straight lines for  $T$  vs.  $V/S$  for different values of  $\bar{a}$ . This has been done and appears at Fig. 2. The range of values for both  $T$  and  $V/S$  exceeds the most extreme cases. The small outlined section in the lower left corner covers the range most encountered in studios and living facilities, and has been expanded for greater accuracy in Fig. 1.

To use the charts, the values of  $V$ ,  $S$ , and  $\bar{a}$  are found in the conventional manner, and the ratio  $V/S$  determined. The charts immediately give the reverberation time. The charts are also useful when it is desired to find the amount of acoustical material required to correct the acoustical properties of a room to

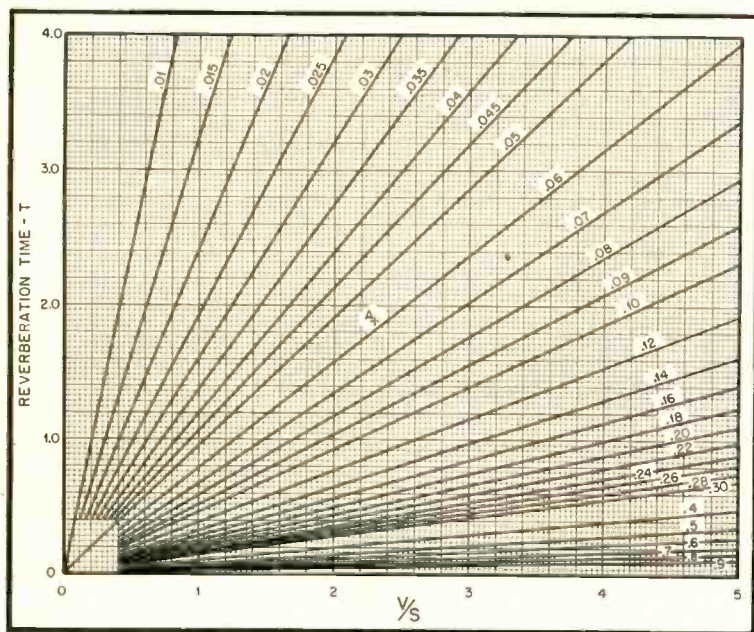

Fig. 1. Reverberation time chart for values of  $V/S$  from 0 to 5.

achieve a characteristic within the optimum range.

Since it may be argued that the use of charts reduces the accuracy of the result, two types of check were made. The methods recommended in the current literature were examined and found to give results varying over a range of six per cent. Then a group of thirteen rooms having volumes from 700 to 420,000 ft<sup>3</sup> were analyzed and the reverberation time computed by the formula and, independently, found from the charts. The spread of the deviation of the chart values from the computed values was -1.05 to +3.8 per cent with an rms. deviation of 1.2 per cent. This variation is within the limits of deviation of the various methods presently in use. It should also be noted that laboratory measurements on the same panel give absorption coefficients that may vary

by as much as seven per cent, and the assignment to a surface of a given value with an accuracy greater than this seems impracticable. An illustrative example is given below. Several of the absorption coefficients are from the author's own notes.

In cases where it is desirable to achieve an exact reverberation time at a given frequency, actual measurements should be made during the construction and correction of the enclosure and compared to the computed values.<sup>2</sup> It is not within the scope of this article to discuss methods of making the measurements, but it is hoped that the charts will simplify the work of those who consistently work with the Eyring formula.

<sup>2</sup>W. W. Carruthers and D. P. Loye, "Building to the Acoustical Optimum New Mutual-Don Lee Broadcasting Studios," *J. Acous. Soc. Am.* July 1949, p. 428.

### EXAMPLE

Residence Living Room, 14 × 26 × 15. Volume 5460 ft<sup>3</sup>

Material	Area ft <sup>2</sup>	Absorption Coefficient	Absorption
	<i>S</i>	<i>a</i>	<i>aS</i>
Linoleum	268.5	.03	8.1
Hard wood (Interior trim and furniture)	180.5	.03	5.4
Soft wood	75.0	.04	3.0
Leather furniture	141.0	.03	4.2
Cloth drapes	112.0	.25	28.0
Glass	84.0	.027	2.3
Open doors	56.0	.25	14.0
Plaster	1467.0	.05	73.4
	<i>S</i> = 2384.0		138.4

$$\begin{aligned} \bar{a} &= \frac{138.4}{2384} = 0.058 \\ V &= 5460 \\ \bar{S} &= \frac{.049 \times 5460}{2384} = 2.3 \\ T &= \frac{-2384 \times \ln(1 - 0.058)}{.049 \times 5460} \\ &= \frac{-2384 \times (-0.0597)}{2684} \\ &= 1.88 \text{ sec.} \end{aligned}$$

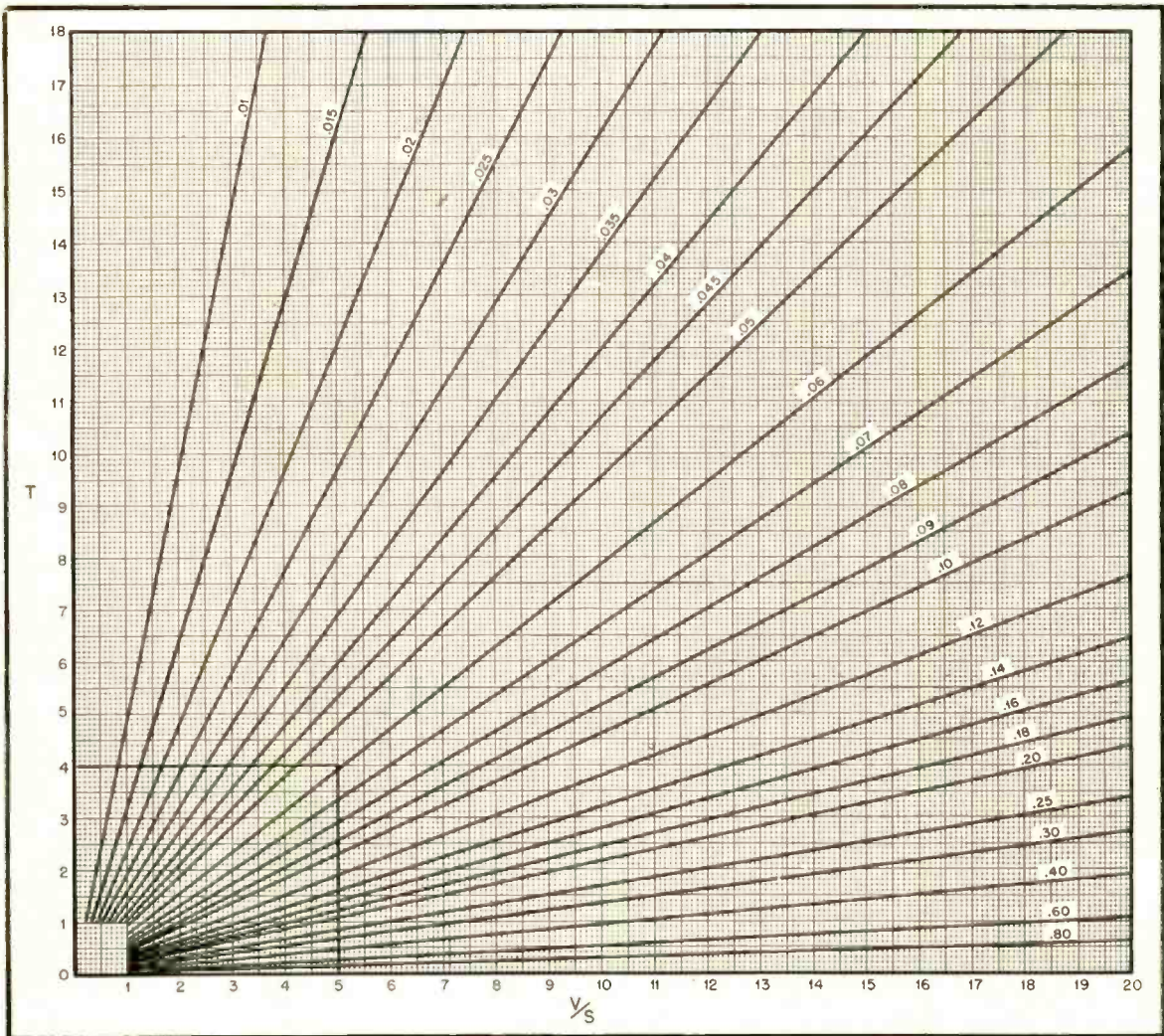

Fig. 2. Reverberation time chart for values of  $V/S$  from 0 to 20. Corner section enclosed in dotted lines is shown enlarged in Fig. 2.

# NEW PRODUCTS

● **Power Amplifier.** Designed primarily for use in commercial and industrial sound systems, the recently-announced RCA power amplifier Type MI-12188 supplies 70 watts to any of several load impedances when bridged across a line of 3.3 volts rms. Frequency response is 30 to 15,000 cps and distortion is low. The



amplifier comprises two stages, makes use of feedback control, and contains a regulated power supply. Provision is made for adding a relay to control plate voltages, and the amplifier also is equipped for supplying filtered d.c. and 6.3 volts a.c. to external equipment. Further technical details may be obtained from RCA Victor Division of Radio Corporation of America, Camden, N. J.

● **Tape Splicer.** Operating in a manner similar to an 8-mm film splicer, the new Jiffy Splice is a saver of both time and tape. Splices are hardly visible and are not



detectable audibly during playback. Descriptive literature may be obtained from the manufacturer, Rason Manufacturing Company, 61 Myrtle Avenue, Brooklyn, N. Y.

● **TV-Tuner-Phono Cabinet.** A boon to custom builders is the new "Californian" model cabinet recently placed in production by Electronic Decorators of New York. Reflecting highest quality construction throughout, the "Californian" is unique in the fact that it is designed essentially as a container for custom-built radio-TV-phono components, and thus overcomes the usual shortcomings which exist when a piece of conventional



furniture is adapted to this purpose. The speaker compartment, for example, is acoustically treated and is suitable for any standard 12" or 15" driver unit. Remaining compartments are designed to accommodate a tuner-amplifier combination, record changer, and a 630-type television chassis with 16" rectangular tube. Adjustable shelves permit individual design of storage space. The "Californian" is available in practically any modern finish on standard order, or will be supplied in finish to match customer's sample at slight extra charge. Full description will be supplied by Electronic Decorators, 121 Seaman Avenue, New York 34, N. Y.

● **Decade Inductor.** Announced as companion instruments to the company's well-known decade resistance and capacitor units, General Radio's new decade inductor units provide precise decade steps of inductance ranging from 1 mh to 1 h per step. Intended primarily for use at audio and lower ultrasonic frequencies, the new Type 940's are available in single-decade units for incorporation in other



equipment, and in three- and four-decade cabinet assemblies for laboratory application. Accuracies range from 2 per cent for the 1-mh steps to 0.25 per cent for 1-h steps. Technical description may be obtained from General Radio Company, Cambridge, Mass.

● **Tube Sockets.** Further expanding its position in the radio and television parts

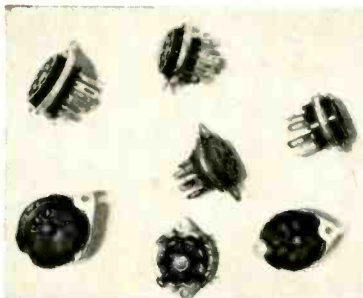

field, Sylvania Electric Products, Inc., Warren, Pennsylvania, is now supplying to the trade a wide variety of miniature and GT type sockets meeting RMA and UL standards. Types presently available include T5 1/2, T6 1/2 and octal with 7, 8 and 9 cadmium plated brass contacts, for top or bottom chassis mounting.

● **Turret-Head Arm.** Combining the advantages of viscous damping with those of turret-type construction, this new Fairchild product permits playing any

type of disc recording currently available with a single pickup-arm assembly. Vertical, standard lateral and microgroove cartridges are all mounted within the head. Cartridge selection is afforded by



means of a protruding knob. Stylus pressure changes automatically to conform with requirements of the unit in use. Specifications will be supplied by Fairchild Recording Equipment Corporation, Whitestone, L. I., N. Y.

● **Microphone Support.** Flexibility is the keynote in the new Boom Bracket, recently introduced by Atlas Sound Corporation, Brooklyn 18, N. Y. Suitable for mounting on pulpits, desks, ceiling or wall surfaces, the device offers a maximum boom length of 23 inches. Unique set-screw construction makes it

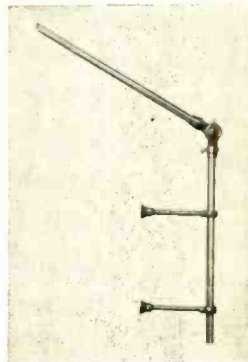

possible to adjust the length of any tubular section so that the bracket assembly can be made to custom fit most any given requirement. Technical sheet is available from the manufacturer.

● **Plug-In Chassis.** New addition to the line of audio equipment manufactured by Cinema Engineering Company, Burbank, Calif., is the Type 8862 plug-in amplifier chassis. Following telephone equipment practice in design, the new unit can be mounted in a variety of positions. Companion mounting frames are available for accommodating either horizontal or ver-

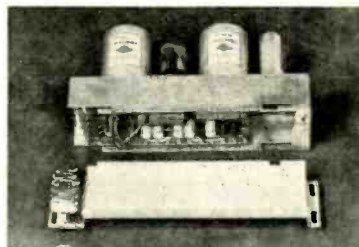

tical positioning. Type 8862 may be had in a variety of widths, listings of which are shown in Bulletin C-1011 available without charge from the manufacturer.



# No MORE!

## No MORE PLUG-IN CARTRIDGES! No MORE EXTRA PICK-UP ARMS!

with the new. . . . .

*Fairchild*  
**TURRET-HEAD ARM**

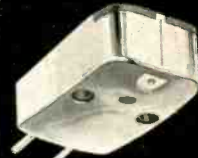

### NOW. All 3 CARTRIDGES in ONE ARM

lateral, vertical and microgroove - or any other combination desired

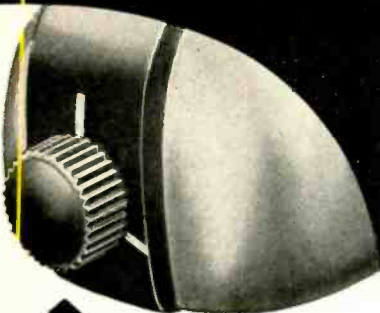

**SIMPLY TURN KNOB  
to select cartridge...**

**Pressure Changes Automatically**

New miniature version of the Fairchild moving coil cartridge permits this revolutionary advance.

- OPTIMUM PERFORMANCE ASSURED by separate cartridge for each function. Mount any 3 of four cartridges listed at right in one arm.
- OPTIMUM GROOVE TANGENCY—offset design.
- NEW VISCOUS DAMPING—NO ARM RESONANCE.
- FITS ALL TRANSCRIPTION TABLES—mounting radius, 13 3/8"; height above record surface, 1 7/8"; base height adjustable.
- 3 WAY TURRET-HEAD ARM . . . . . \$65.

**MINIATURE DYNAMIC CARTRIDGE**, shown above, fits all arms and record changers—standard RMA mountings—Diamond Styli mounted perpendicular for back cuing.

- LINEAR FREQUENCY RESPONSE—constant velocity device—moving coil design for low mass moving parts and freedom from distortion.
- NO HUM PICKUP—extremely small coil winding keeps induced hum at least 15db below other professional type cartridges.
- HIGH LATERAL COMPLIANCE in conformance with good pickup design.
- CONNECTS TO MICROPHONE CHANNEL—low impedance—feeds through equalizer directly to the input of console at microphone level.

CARTRIDGES WITH DIAMOND STYLI	LOW PRICED
Unit 212—Lateral 2.8 mil . . . . .	\$42.50
Unit 211—Lateral 2.2 mil . . . . .	42.50
Unit 210—Lateral 1.0 mil . . . . .	47.50
Unit 213—Vertical . . . . .	50.00



*Fairchild* RECORDING  
EQUIPMENT CORPORATION

154 St. & 7th Avenue

Whitestone, New York



EDWARD TATNALL CANBY\*

Continued Anguish

**J**UDGING FROM the continued letters of anguish, fuzziness (?) in LP records will never end as far as this department's mail is concerned. In a good many cases the trouble seems to be the same old business—compliance trouble, with one or another of the old-model GE removable styli or with some of the other styli now in use (though the writers of most letters tend to forget to mention the equipment they use, putting all of the blame on the records themselves). Since writing the assorted effusions on this subject last fall (*AUDIO ENGINEERING*, Nov. and Dec. 1949), I have learned much—as I always manage to do when I stick my neck out far enough. What has become most clear is that in addition to the quite definite troubles with compliance, the LP record falls heir to a multitude of arm resonance problems. Let the experts decide what arm is best—for the rest of us it is enough to say that any old arm, especially a heavy one with lots of counterbalancing, will *not* do a job on LP. Belatedly, it seems to be admitted that extremely careful arm design, specifically for LP, can make or break the sound, not to mention the gross tracking ability, of your LP equipment. The lay audio enthusiast may be somewhat surprised to learn that he has one more headache to groan about—for the same cartridge, in different arms, may give him quite different results from his records. Alas, a good deal of trouble with the widely used cheap LP player attachments is to be found in the cartridge, but in the arm. It looks to me as though the recent "fluid clutch" arms—i.e. those with oily or viscose connecting links to damp out vibration—are the arms of the future. The audio trade itself is well onto the necessity for a correct LP arm, but the wider areas in the LP world are scarcely beginning to see this bit of heavenly light.

#### AC and CAC

Speaking of LP—readers may note with considerable confusion the ads in this very sheet for a crystal cartridge from Astatic named the "AC" which does not seem to correspond to the cartridge mentioned in this column last season in any reasonable

\* 279 West 4th Street, New York 14, N. Y.

way. It does not, in fact; for it is a quite different cartridge, developed for an altogether different purpose.

The CAC, under design last fall in collaboration with CBS, was and is to be a wide-range crystal similar to the CQ, but pre-equalized, mechanically, to give a very close approximation of the Columbia LP curve (NAB) when fed into a flat amplifier. At this writing, the CAC is still not finally approved, but this writer, for one, hopes it will be forthcoming. The samples I got last fall are still sounding forth with quality very close to that of a well equalized magnetic. The AC cartridge, as advertised, is a double-header model, turnover type, no relative of CAC. Funny coincidence.

#### Grist for the Transient Men

One leftover item concerning LP fuzziness continued to have me somewhat bothered long after the most immediate problems seemed to have sorted themselves out into reasonably clear cause-and-effect: the unaccountable fact that, given a poor stylus, there were still some LP records that would play beautifully without a bit of "breaking up," and others, not seemingly any louder or heavier in texture, that would throw the equipment for a dead loss. Last November I even went so far as to name a few of those LP's which seemed to play well, even with an unsatisfactory stylus. In presenting a group of recorded "concerts" last summer, I was terribly aware of these strange differences; for one record would delight the listeners with its clean quality, the next would produce such blasts of fuzziness in its louder parts that drastic cut-off treatment was the only way out. (And yet, played on "other" equipment—i.e. on what I didn't then realize was a properly compliant stylus, in a crystal cartridge—they all sounded OK.)

I offer at least a workable hypothesis, hereby, to explain why some types of sound, as I see it, make more trouble in stylus tracking than others. Not that there is anything radical or new in what follows—I haven't seen it written out in so many words before.

For a moment, lay aside the question of other forms of distortion, and consider only

[Continued on page 42]

## Pops

RUDO S. GLOBUS\*

Recording Criteria—Part 3

**T**HIS MONTH'S piece will serve to complete, conclude and re-emphasize the sum total of thoughts contained in my last two columns. Before jumping into the soup, I want to reiterate "my" position with regard to the general attitude to be taken in this column. Therefore, in a more serious vein this time...

What have I been doing and what do I intend to do in this column? I could beat around the bush, rationalize in a considerable amount of space, and simply call myself a reviewer. But what is a reviewer? Simply and to the point, a record reviewer is merely one who lists the total number of releases each month, mentions the band and says a few vague, meaningless words about what is on each disc. The value of a "reviewer" is questionable. His only function appeals to the lazy ones who won't take the trouble to walk down to their favorite record shop and pick up the releases so kindly distributed by the record companies. He further condenses a lot of material into a small amount of space, saving the time and trouble of going through dozens of throw-aways. At any rate, what has been said above applies to the standardized reviewer.

We (or I) will not be so pretentious as to call for the epithet "critic". But my function is to pass judgment on all recordings which fall under the category of "pops." There is no point in passing judgment unless the reader is explicitly informed as to what the criteria involved are. Many of the criteria are intangible; they are certainly not expressible verbally. Some of the criteria are open to doubt, question, argument, and what have you. It is not simply a question of my taste versus yours. Our tastes need not necessarily, and actually should not, agree. But unless you are per-

[Continued on page 26]

\* 960 Park Ave., New York 28, N. Y.

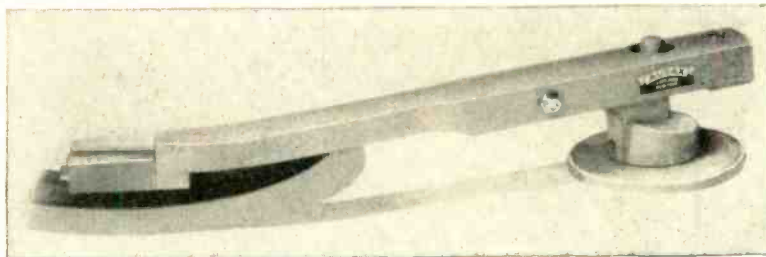

# \* **HANGOVER**

Answering a common query, and citing one of the reasons why, with the superlative **POLYPHASE**, music no longer sounds "REPRODUCED"

Writes a POLYPHASE owner:—"Have had your L-6 Polyphase in operation for over three weeks now. I have the needed instruments for testing. Polyphase certainly has the wide range claimed. But I have every other magnetic pick-up available in the market, and some of these also have wide-range. Now, I would like to ask you, what else can there be in this Polyphase that makes it sound SO VASTLY CLEANER, SMOOTHER THAN ANYTHING ELSE I HAVE EVER HEARD"

As long as ten years ago, Audax stated:—"By now, wide-range has been mastered so thoroughly that today most any pick-up can be fixed for wide-range. BUT, wide-range is actually detrimental if without QUALITY. Thus,—of two singers, each capable of reaching high "C", one's voice may be pleasing, the other's just the opposite. To achieve EAR-QUALITY, all other factors must be satisfied . . . and of these, the most important is VIBRATORY MOMENTUM. The nearer the vibrating mass approaches the zero ideal, the less the "hangover" and the finer the finished performance."

*The vibrating mass in POLYPHASE is tinier by far than in any pick-up hitherto created. VIBRATORY MOMENTUM at last approaches the vanishing point. The result is a facsimile of the original performance.*

*There's an Audax pick-up for every purpose . . . Record Changers, Studios, etc. including high output types*

*"an ugly form of distortion"*

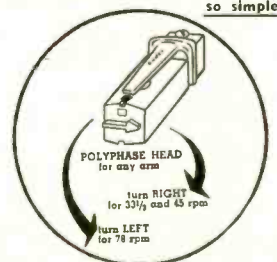

- \* One single unit, and same point pressure for all discs, 6-8 grams
- \* Response 20 to over 10,000
- \* POLYPHASE available for any arm
- \* Sapphire Styli (or diamond) replaceable individually, as simply as you replaced steel needles
- \* Output about 25 m.v.
- \* High or low impedance
- \* Needle-talk very low
- \* Ear-quality par excellence
- \* Special highly sensitized arms

See and hear POLYPHASE at the R M A show Room 529 Hotel Stevens and then YOU be the judge!

# Audax

**POLYPHASE REPRODUCERS**

*"The Standard by Which Others Are Judged and Valued"*

a distinguished product of

**Audax Company, 500 Fifth Avenue, New York 18, N. Y.**

**"Creators of Fine Electro-acoustical Products over 35 years"**



## keep with it!

Be sure you get that famous ALTEC 21B quality from over-active announcers and recording artists by using the new 155A Chestplate. Because of the microphone's perfect positioning, you may readily obtain the sound separation you desire from vocalists working with an orchestra... without false bass! With this new adaptation of the 21B, sports announcers can always override even the noisiest crowds, for the 21B does not limit at audio peaks. Its smooth frequency response permits use in high-level sound fields which would ordinarily cause acoustic feedback.

The 155A Chestplate is compact, lightweight and contains a matching unit which permits its use up to 400 feet away from associated equipment.

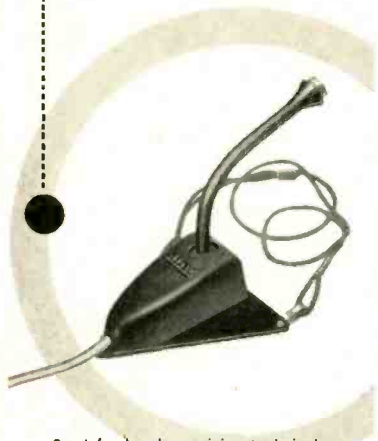

Send for brochure giving technical information on ALTEC 21B Miniature Microphone adaptations.



1161 N. VINE ST., HOLLYWOOD 38, CALIF.  
161 SIXTH AVE., NEW YORK 13, NEW YORK

## POPS

[from page 24]

fectly aware of my taste, my criteria, my standards, you will not be able to judge what ideas, records, etc., conform to your own. To those of you who disagree violently with me . . . you know what to do. When I rave about a record, don't buy it. Within certain reasonable bounds, when I turn thumbs down on certain records, you know that you've just added several new discs to your collection.

But how does this apply to the series on "Recording Criteria?" The first two columns in the series made clear that there is no final word, no perfect judgment, no absolute standard in this business. Further, and it can be said now, there are no such animals as "recording criteria." As long as 50,000 people buy a record which I consider a foul, disgusting, untouchable addition to the chamber of horrors called the "pop" industry, what I have to say is pretty meaningless. Therefore, what right do I have to attack certain policies, both technical and musical, in the business? I have gone through the trouble, the effort, the brood, swat, and terrors of deciding what I like and acquiring sufficient information and training to justify my taste. I strongly believe (otherwise, I'd have a lot of gall writing a column like this) that my taste is good, my judgment accurate and valid, and my suggestions constructive. I emphatically do not believe that the old dictum to the effect that the buying of the record consumer accurately reflects his ultimate demands and needs. The record consumer can buy only within the range of commodity choice supplied him by the record manufacturer. There isn't a human animal alive who will buy a "tin-box" record player when a superb reproduction unit is available at the same price. The consumer does not set the standards for the industry in the broad sense. His limited knowledge and his cash capital are deciding factors.

I am not in any sense stating that a hillbilly addict is a natural for some of the recent Bartok releases, despite the fact that I believe that remarkable things can happen under the proper conditions, namely satisfactory musical education, etc. But there are good and bad performances of hillbilly music, good and bad recordings, in the technical sense, of hillbilly music, and good and bad instruments for playing hillbilly music.

Therefore, our function will and has been, in part, to campaign as strenuously as possible for the optimum musically and technically on records. If you will overlook the slightly smug look of the above, I will also continue to suggest and propagandize for areas within the pop field that have been overlooked and are unknown to you, my patient readers. A few months from now, I will run a list of "pop" recordings, all available, recorded here, elsewhere, etc., which should be boosted and heard. This list, which has already been begun, represents, from my point of view, a good, substantial, basic core to the pop collection. It will serve the same function as the numerous classical lists, and will cover the whole range. Therefore, preparatory to such a list, my concluding remarks on "recording criteria" . . .

Further along, you will find my "recent releases" section. I am devoting it to only one recording this month, and for good reason. It is an important disc from both the technical and musical points of view. To a great extent, it represents the full expression of my "technical-acoustical-sensational" demands. It does not meet with my musical

approval, and for reasons to be found in the review itself.

On the basis of the analysis contained in last month's piece, it should now be seen that basic responsibility falls on the shoulders of the musical director or producer. His taste, or his conception of "popular taste," determines, with some notable exceptions, how a given performance will be recorded. I have pointed out, again with some notable exceptions, that the engineer on the recording date merely fulfills the demands of the musical director, and therefore the finished recording can be judged only on two grounds:

1. Approval or disapproval of the musical director's taste.

2. Recognition and judgment (on the basis of inside information or actual presence at the recording date itself) of the adequacy of the recording engineer in fulfilling the wishes of the musical director.

To all intents and purposes, therefore, we can overlook the recording engineer as a responsible factor. The basic taste categories of the musical director fall into three major divisions.

1. The "I don't care how . . . just cut it as it comes out because its a piece of junk anyhow and I was meant to do better things because I should handle the classical date that that jerk who married the boss' daughter does and he doesn't know anyhow . . . etc."

2. The technical wizard who saw a copy of a technical magazine once and heard something somewhere about some exquisite technique for covering the mystic range of -15,000 to +15,000 cps and insists on not only one mike for every man on the date, but a special job that fits into the frontal sinuses and picks up the overtones that are lost by natural breathing through the nose or mouth.

3. The guy who knows what he wants, musically, and asks for it. This guy has a good, substantial, basic training musically; he understands the finer points of orchestration, the objectives of the given piece of music, and hopes to achieve a good representation on records. He knows something about orchestral balance and therefore investigates and familiarizes himself with the mysteries of a properly balanced recording. His taste may be utterly contrary to yours or mine, but at least it's founded on a responsible and substantial decision.

Let's I forget, there's still one more category . . . this referring to the phony (a typical phenomenon in all businesses, but in greater abundance in this one) who leaves the whole date up to the engineering staff after fulsome proclamations as to what he wants which doesn't amount to anything, and is properly prepared to disavow a job that gets panned and to point his little pinky in his own direction (proudly, no less) when the date works out well.

Type 3, above, is of course not in great abundance. He generally tries to do the best he can when he can. This best, from our point of view, consists in disregarding the category "pops." But further, and leave us not mince words, there is the problem of deciding what to record. Everybody knows, at this point, what the condition of the music business has been for the last ten years. There has been a steady down-hill trend. We have been overwhelmed of late with a plethora of mediocre vocalists, novelty fads, and simple, inept, musical production. All of this stuff has been recorded, of course. We can still remember the days when we looked forward to each new Goodman release . . . but why limit it to Goodman. The amount of material that was good musically was overwhelming. I now have the pleasure to report that the day of the musically worthwhile "pop" release is gradually coming

Now There's a *Magnecorder*  
for Every Tape Recording Need

**NEW!** PT63-A Offers 3 Heads

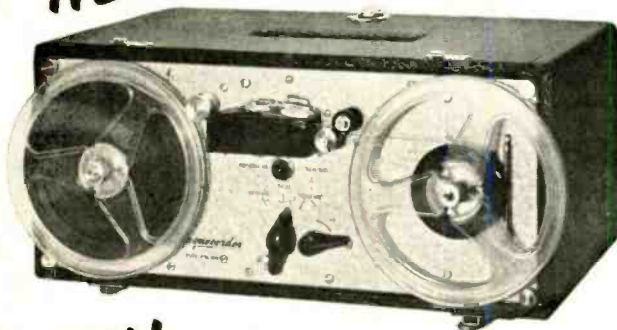

**Monitor from the tape!**

A new professional tape recorder with three separate heads: erase, record, playback for monitoring from the tape. This PT63-A Magnecorder incorporates all other fine features of the PT6-A. The new PT63-J Amplifier for single microphone recording includes separate playback amplifier.

**NEW!**

*the Talk  
of the Shows*

**Magnecorder  
PT7 Console**

**3 Heads** In a single housing. Separate heads for erase, record, playback or monitoring from the tape. Separately alignable, replaceable.

**New Features** New positive drive eliminates timing errors. Push-button controls can be remotely operated. Accommodates 10½" N.A.B. reels on all models including portable.

**Also Available As  
PORTABLE or RACK MOUNT**

Same features included. Separate amplifier for each purpose. Portable amplifier has high-level mixing for three microphones.



**NEW!**



**Three Heads and Amplifier Kit**

**Converts Your PT6-A  
To Monitor From Tape**

Complete conversion kit includes new three-head unit, additional monitor amplifier and power supply. Three-head unit simply plugs into receptacle for present two heads on your PT6-A Magnecorder.

**SPECIFICATIONS JUST RELEASED**

Write for detailed information on these latest Magnecorder developments.

*Magnecord*, INC., CHICAGO 1, ILL.  
360 NORTH MICHIGAN AVENUE

World's Largest and Oldest Manufacturers of Professional Magnetic Recorders

# 5 TO COUNT ON

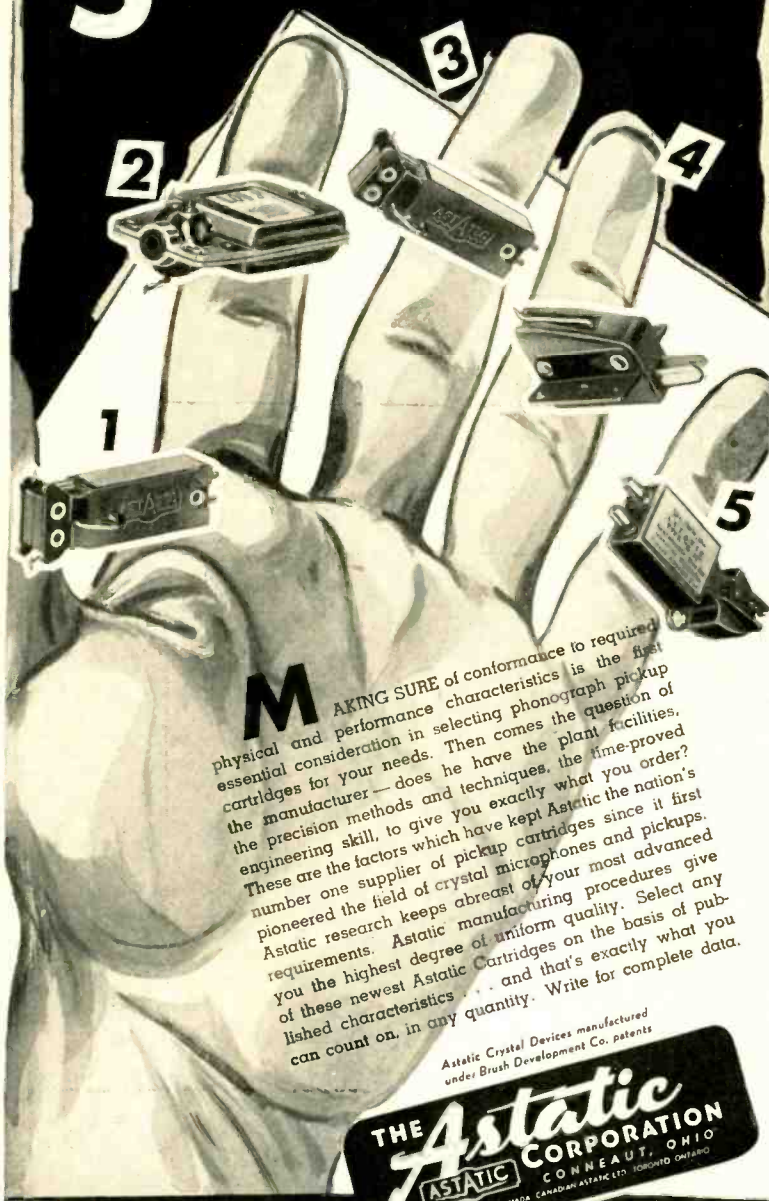

**M**AKING SURE of conformance to required physical and performance characteristics is the first essential consideration in selecting phonograph pickup cartridges for your needs. Then comes the question of the manufacturer—does he have the plant facilities, the precision methods and techniques, the time-proved engineering skill, to give you exactly what you order? These are the factors which have kept Astatic the nation's number one supplier of pickup cartridges since it first pioneered the field of crystal microphones and pickups. Astatic research keeps abreast of your most advanced requirements. Astatic manufacturing procedures give you the highest degree of uniform quality. Select any of these newest Astatic Cartridges on the basis of published characteristics . . . and that's exactly what you can count on, in any quantity. Write for complete data.

Astatic Crystal Devices manufactured under Brush Development Co. patents

**THE Astatic CORPORATION**  
 CONNEAUT, OHIO  
IN CANADA: CANADIAN Astatic LTD. TORONTO, ONTARIO

#### ACD Double-Needle Crystal Cartridge

1 Newest Astatic miniature turnover model featuring mechanical drive system with new low in inertia. Result—sensationally smooth response, new tracking excellence, low needle talk. Output 1.0 volt at 1,000 c.p.s. Needle pressure six grams.

#### AC Crystal Cartridge

3 Tiny, single-needle version of the new ACD, with same unparalleled smooth response. AC-J for slow speed records has five gram needle pressure; AC-AG-J, with special All-Groove needle tip for all record types, has six gram needle pressure; AC-78-J for 78 RPM records has six gram needle pressure. Output of each is 1.0 volt at 1,000 c.p.s.

#### CQ Crystal Cartridge

5 Features miniature size and five-gram weight. Models CO-J and CO-AG-J fit standard 1/2" mounting and RCA 45 RPM record changers. Model CO-J fits RMA No. 2 Specifications for top mounting. 453" mounting centers. Output 0.7 volt at 1,000 c.p.s. Employ one-mil tip radius "Q" Needle, or special All-Groove tip (Model CO-AG-J).

#### LQD Double-Needle Crystal Cartridge

2 The PROVED TOP PERFORMER for turnover type pickups today. Outstanding for excellence of frequency response, particularly at low frequencies. Output 1.2 volts on slow speed side, needle pressure six grams, 0.9 volt on 78 RPM side, eight grams. Available with or without needle guards.

#### GC Ceramic Cartridge

4 The first ceramic cartridge with replaceable needle. Takes the "Type G" needle—with either one, three-mil or special All-Groove tip, precious metal or sapphire—which slips from its rubber chuck with a quarter turn sideways. Output has been increased over that of any other ceramic cartridge available. Light weight and low minimum needle pressure.

back. The major four, Capitol, Decca, Victor, and Columbia, are all recording worthwhile stuff again, along with the hang-over junk. From all indications, the next year will be exciting discally. Because good things are coming, it is now of the moment to insist as strenuously as possible that they be rationally recorded. The pains that have been taken with classical recording must be taken with the new crop of pops. This means, as far as we're concerned, an emphasis on good sound quality on all levels, rational orchestral balance, wide range with a spacious but logical acoustical pattern. We have already granted, and will admit it again, that the greater percentage of the record-buying public cannot do justice to quality releases on the type of equipment standard to the pop buyer. But first things first. Quality recordings and some soul searching on the part of the manufacturers of record playing equipment might have happy results . . . maybe!

### NEW RELEASES:

Liberian Suite

Columbia CL 6073

Duke Ellington

Its about time that somebody did some serious thinking and talking about Ellington at this stage of the game, and this release on LP by Columbia gives sufficient cause. First, a word about the recording proper. Last month we reviewed another Ellington LP, a six-inch job, and waxed enthusiastic about its quality. This is another case for enthusiastic waxing. The quality of this job is superb from beginning to end. The spaciousness of the recording is breath-taking . . . and talk about sound purity! Actually, to these ears, the sax and brass sounds on this job are the best heard, so far, on a pop recording. The heaviness of the orchestration, as well as the complexity, make for innumerable difficulties . . . but its all there. A bold bravo to Columbia.

But now on to something else. The musical issue is a horse of a different color. There is something a little tragic in this recording. We heard the Liberian Suite at its Carnegie Hall premiere, and a re-listen further substantiates our judgment. There is somewhat of a controversy about Ellington, a controversy surrounding a myth which goes something like this. Ellington cannot be considered as a jazz artist per se. He is something more . . . an amalgam of primitive African and Negro musical origins blending into a sophisticated amalgam partially impressionistic and partially classical in feeling and spirit.

There is no need to go through the various myth symbols . . . the importance of trains to Ellington, the conditions surrounding individual creation involving the participation of each member of his virtuoso orchestra. There is even an absurd myth crediting Billy Strayhorn with the injection of everything from twelve-tone system to lost Incan melodic patterns, etc., etc. . . . Everytime a change has occurred in the Ellington combination, rumors of every shade and type spread through the underworld (note what happened when Cootie Williams switched to Calv . . . I mean Goodman).

Despite the changes, the rumors, the myths, we will have to look elsewhere for an explanation for the tiredness and the essential mediocrity and banality of the recent Ellington output . . . and by recent we mean the last six years. A good listen to this recording will reveal the standard virtuosity of the typical Ellington combo. Johnny Hodges, of course, Ray Nance on violin, Al Killian on trumpet, Tyree Glenn on trombone, Harry Carney on baritone

# COMPARE...



## Design... Construction... Performance...



MODEL 401  
mechanism and electronics — ready  
for custom installation

# 295<sup>00</sup>

user net

berlant

# CONCERTONE

magnetic tape recorder

Sound reproduction to satisfy the most critical "golden ear" is combined with the ultimate in tape handling ability, compactness, simplicity, and economy in this new recorder. It is ideal for studio, school, industrial and home use.

Simultaneous monitoring *from the tape* while recording.  
Exceptionally smooth motion — *less than 0.1% flutter.*  
Full range frequency response, *50 to 12,500 cycles ± 2 db.*  
Outstanding dynamic range — *full 50 db signal to noise ratio.*  
High speed *forward and reverse* rewind — 2500 feet in 60 secs.  
*Instantaneous choice* of 7.5 or 15 inch tape speeds.  
Plays *both* RMA 7 inch and NAB 10½ inch reels.  
*All controls interlocked* to prevent spilling or tearing tape.



for FREE brochure write  
**berlant associates**

4917 W. JEFFERSON BOULEVARD  
LOS ANGELES 16, CALIFORNIA

### Available Through

<p>Eastern Wholesale Distributor <b>FISHER RADIO CORP.</b> 41 East 47th Street New York, N. Y. MUrray Hill 8-1520</p>	<p>Los Angeles Distributors <b>MAGNETIC RECORDERS CO.</b> 7120 Melrose Avenue Los Angeles 46, Calif. Telephone: WYoming 9600</p> <p><b>AUDIO PACIFIC CO.</b> 6110 Santa Monica Blvd. Hollywood 38, Calif. Telephone: GLadstone 7186</p>	<p>San Francisco Area <b>R. M. BECK COMPANY</b> 90 Ninth Avenue San Francisco, Calif. Telephone: MARket 1-3350</p> <p><b>AUDIO DISTRIBUTORS</b> 2876 Telegraph Avenue Oakland 9, Calif. Telephone Twin Oaks 3-6403</p>	<p>San Diego Distributor <b>McBRIDE ENGINEERING CO.</b> 723 Bank of America Bldg. San Diego, Calif. Telephone: FRanklin 9-8248</p> <p><b>AND OTHER LEADING AUDIO EQUIPMENT DISTRIBUTORS</b></p>
---	---	--	---

# COMPARISON CONVINCES

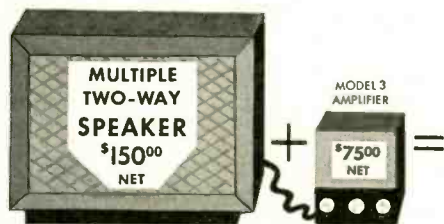
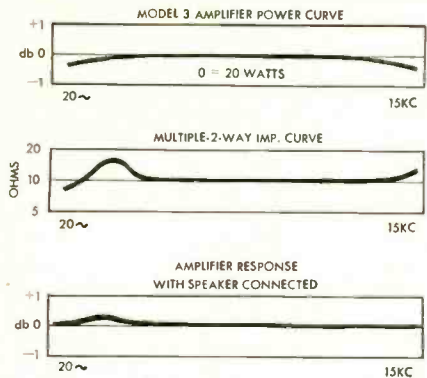

it's an  
engineer's dream  
a musician's delight  
a scotchman's brag  
an end to your plight

the cleanest,  
flattest, most  
NATURAL—

best buy  
-yet!

PERFORMANCE  
PLUS  
Enjoyment

"YOU CAN FEEL THE DIFFERENCE"

audio pacific co.

6110 SANTA MONICA BLVD.  
HOLLYWOOD 38  
CALIFORNIA

Masterpiece IN CABINETRY!

THE "CALIFORNIAN"

FEATURED AT  
TERMINAL  
RADIO CORPORATION  
85 CORTLANDT STREET  
NEW YORK 7, N. Y. — Phone: WOrth 4-3311

Matching record & bookcases also available

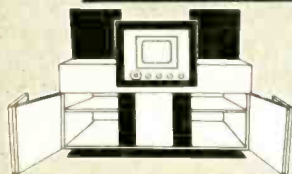

Write for complete technical specification data describing materials used, dimensions, construction and finishes, etc.

Terminal Radio Corp. proudly introduces "The Californian", a new conception of custom built radio furniture created by Electronic Decorators Co. Here is a magnificent modern cabinet engineered for performance, built for everlasting eye appeal and designed to house your entire home entertainment center.

If you seek the kind of a cabinet that can never be mass produced, a furniture gem constructed of the finest materials obtainable, and finished in your choice of any of the more beautiful hand rubbed modern finishes — this is it!

If your technical background demands a cabinet designed by engineers completely familiar with the requirements of a fine home music and TV system and built by cabinet craftsmen, we believe this to be the ultimate answer to your individual tastes. The various cabinet compartment dimensions are individually designed for each customer, so that any combination of TV chassis, FM-AM tuner, Amplifier, Record Changer and Speaker can be accommodated.

ELECTRONIC Decorators

Mailing Address:  
121 SEAMAN AVENUE  
NEW YORK 34, NEW YORK

CREATORS OF SUPERB TELEVISION - RADIO - PHONOGRAPHS IN CUSTOM FURNITURE

sax, Jimmy Hamilton on clarinet, Al Sears on tenor sax, and so on . . . all resplendent on this date. The playing is awe-inspiring, but . . . something is missing behind it. The suite opens with a vocal solo by Al Hibbler of a banal, tired, unfortunate thing called "I Like the Sunrise." The recording of voice is nothing short of magnificent . . . almost frightening in its liveness . . . with beautiful balance of voice and orchestra. But to what effect. The song, like the two reviewed last week, cannot even be described as poor Ellington.

Leave us go further. Everybody knows what Ellington could do with primitive rhythm patterns. The second side of this disc contains three dances, aptly titled Dances No. 3, 4, and 5. No. 3 is rumbaesque, featuring a solo by Ray Nance on fiddle. This is real, real, real bad stuff. It is a hodgepodge of every tired rumba in the books . . . a little Frenesi, etc. The other two are played agitato, to no effect whatsoever. There is murderous jumble of sound . . . a blasting morass which doesn't even veil the basic absence of a good idea. Of course, occasionally the real (whatever that means) Ellington leaks through. But not often enough to make up for the depressing banality and, frankly, the utter boredom of the Suite.

Therefore, we have a superb recording, superbly played. What is our diagnosis? Hard to say. This is a period characterized by many, many musicians who just shoot their bolt and that's that. But this is an inadequate explanation for Ellington. There is too much evidence to the effect that the Duke has plenty more to say and a lot more basic brilliance to compensate for occasional periods of barrenness. Overshooting the mark? Possible. The highly ambitious, pretentious, and metaphysically gownned jazz suites generally don't work out. Witness the recent Stan Kenton album (to be reviewed next month). We also remember some of great man Fats Waller's more pretentious moments of Mozart which were slightly ludicrous.

Basically, I have no reason and I don't know. I have always been and will continue to be one of the excited followers of everything the Duke does. But this kind of stuff just doesn't pass muster. There has been too much of it lately. I have been approached by too many of the so-called jazz "intelligentsia" with words of fulsome praise for the "Liberian Suite." My answer to them is simply "nuts!" It is . . . barren, weak, banal, and even mildly vulgar in its pretentiousness.

But . . . to Columbia . . . my head off. A beautiful recording job and an LP anybody could be proud of. I have rarely heard a clarinet such as Jimmy Hamilton's come through on a recording the way this one does.

Words of Apology:

I had meant to keep my mouth shut . . . but too much mail is coming in on this point . . . so I'll answer you all *en masse*. Two months ago I reviewed the Jimmy Dorsey recording of "That's a Plenty." As all you kind people have pointed out, I put Teagarden on trombone. WELL . . . I didn't. Charlie Teagarden was on trumpet . . . and I put him where he belonged. But somebody did me dirt. Since I once shared a long beer with Jack Teagarden, the trombone man, I feel in all fairness the Teagarden's should play what they want to play. Therefore . . . we can all now rest quietly. The T's are where they belong, all's well with the world.

Further, there has been some question as to where CIRCA records are available. As far as I know, there may be a few in Rome, around the second century B. C. To those



of you who can't get there, may I point out that I used CIRCA as a show of erudition, inasmuch as a Latin word will always do better where an English word would do as well. From now on, when I refer to old jazz recordings, and wish to date them, CIRCA will be used to refer to the long English phrase . . . recorded round or about such and such a date.

For all my sins . . . an apology . . . and thanks for the mail.

## TAPE RECORDING

[from page 13]

is reason to believe that tape will become the universal method for recording sound in every kind of application.

This new art opens up such a vista of possibilities in all directions that we should recognize it as another step forward in man's struggle to preserve his works and ideas; the struggle that began in civilization's dawn when the first of our literate ancestors made his own unique mark of ownership upon his first clay pot. The marking on a clay pot became more or less permanent when the clay dried; the magnetic marks on wire or tape can be visualized along the same general line of reasoning.

### How A Tape Recorder Works

When Valdemar Poulsen, in 1899, applied for his patent on magnetic recording he used the following words:

"To all whom it may concern:—

Be it known that I, Valdemar Poulsen, have invented certain new and useful improvements in methods of and apparatus for effecting the storing up of speech or signals by magnetically influencing magnetizable bodies." etc.

From the above we can readily understand that in order to picture the action taking place when a magnetic record is being made, or when the same or a similar record is being played back through an amplifier and loudspeaker, it is necessary to know a few facts about "magnetism."

Everyone, at one time or another, has noticed how a magnet attracts a needle or other small bit of iron or steel. But, if you were to take two magnets and place their ends together, if the ends were both "north poles" or "south poles" they would push apart from each other. But if they were not alike in "polarity" they would attract each other. If two unlike magnetic poles were forcibly kept separated, a force would be exerted that would try to bring them together. The area in which this force is exerted is called the "magnetic field." Any magnetic material that is placed in or near this magnetic field will tend to become magnetized itself. The ease with which such a material (iron or steel, for example) becomes magnetized determines its permeability. (The property of

# HARVEY presents

## MAGNECORD SERIES 6 RECORDERS AND AMPLIFIERS

PT6-JA Recorder and Amplifier...the only combination on the market today that offers such high professional quality at such a low price. Includes PT6-A Recorder plus Amplifier with low impedance microphone and bridging inputs, 10-watt audio amplifier with monitor, speaker and jack for external speaker, 600 ohms balanced line output terminal.

PT6-JA—Magnecord combination . . . . .	\$499.50
With high speed forward for cueing. . . . .	515.50
PT6-A—Recorder . . . . .	278.00
PT6-AH—Recorder with high speed forward for cueing. . . . .	294.00
PT6-J—Amplifier . . . . .	221.50

### NOW — ACROSOUND, the finest in transformers

Power capacity is rated at 20 cps and all units deliver full rated power over the 20 to 20000 cps band. The rating is very conservative. Phase shift is sufficiently low to permit over 30 db of degenerative feedback to be carried around the transformer without instability. Transient response is excellent. All units have push-pull primaries, — secondaries tapped for 4, 8 and 16-ohm voice coils. Other primary impedances, secondaries for 600-ohm line and different power ratings can be furnished to special order. All units are in standard end bells. For \$2.00 additional transformers can be furnished fully potted in seamless steel case in silver gray hammer tone finish. Write for FREE literature.

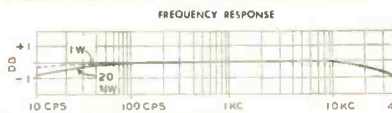

12.5-WATT MODELS		20-WATT MODELS	
TO-240	4,000 ohms . . . . . \$8.75	TO-280	9,000 ohms, for 615. . . . . \$10.75
TO-250	5,000 ohms . . . . . 8.75	TO-290	12,000 ohms . . . . . 13.25
TO-260	6,000 ohms, for 6A57. . . . . 8.75	TO-290	12,000 ohms for Williamson cct. . . . . 15.25
TO-270	10,000 ohms, for 6V6. . . . . 8.75		(Shpg. Wt. 7 lbs. Prices subject to change without notice.)
	(Shipping Wt. 6 lbs.)		

### REL FM RECEIVER



**FREQUENCY RANGE:** 88 to 108 megacycles.  
**SENSITIVITY:** Receiver limits on input circuit noise at any frequency in the 88 to 108 megacycle band. For all input signals of four microvolts or more applied to the input terminals, the receiver output signal-to-noise ratio in a band from 50 to 15,000 cycles is within three db of the optimum obtainable at the

present state of the art where the limiting noise is random. **FREQUENCY RESPONSE:** Plus or minus 1 db 30 to 15,000 cycles, including de-emphasis of 75 micro-second time constant. **NOISE SUPPRESSION:** Receiver noise is 70 db or more below output or ten watts for any quieting carrier. **WAVEFORM DISTORTION:** Receiver distortion up through the detector is less than 1% for 100% modulation. The ten watt audio amplifier associated with Model 646-B Receiver has less than 1.5% distortion at full output. **IMAGE REJECTION:** Better than 45 db. **I. F. REJECTION:** Better than 65 db. **OUTPUT:** 10 watts, 500 and 8 ohms. **CONTROLS:** Tuning, Audio input switch, Audio frequency gain, Radio frequency gain, Power switch. **POWER SUPPLY:** 115 volts, 60 cycles, 125 watts.

Price, complete . . \$345.00

### WESTERN ELECTRIC SPEAKERS

Here's another good buy from Harvey's. Genuine Western Electric speakers at a new low price, every one brand new in factory sealed cartons. These are the genuine article from our regular stock.

12" — 728-B . . . . \$31.20 8" — 755-A . . . . \$20.60

Telephone: Luxemburg 2-1500

All in stock for immediate delivery.

**HARVEY**  
RADIO COMPANY INC.

103 West 43rd St., New York 18, N. Y.

NOTE: All prices are Net, F. O. B. N. Y. C. and are subject to change without notice.

**NATURAL TREBLE**  
**kettle drum**  
**SPEAKERS**  
 by **BOZAK**  
**TRUE TYMPANY BASS**



For *On-stage Realism* of tone, the Bozak "Kettle Drum" loudspeaker is unmatched in price, unsurpassed in listening pleasure. Critical listeners—those interested in complete musical enjoyment, in recording, broadcast monitoring or speech training—agree that the "Kettle Drum" adds new dimensions to high fidelity sound reproduction.

Years of electronic and acoustical research have combined to develop these unprecedented features:

- ▶ Bozak "Kettle Drum" 32" spun steel baffle for true pitch bass
- ▶ Bozak 12" free-moving cone woofer for outstanding, low resonance bass response
- ▶ Bozak damped-cone dual tweeter for distinctly natural treble and broad, smooth response

Response: 40–13,000 cycles with useful response to 16,000; Input: 12 watts, peaks to 18 watts; Impedance: 8 ohms; Coverage: 120° at 10 kc; Woofer magnet: 22 oz. Alnico V

For all applications demanding highest quality sound reproduction at moderate power levels, hear the Bozak "Kettle Drum", model B-201 (patents pending) at your dealer's, or write

Speakers by  
**R. T. BOZAK CO.**

90 Montrose Ave. • Buffalo 14, N. Y.

permeability is one of the factors considered in the making of magnetic tape coatings.) Figure 1 shows a source of direct current electricity, a switch, a bar of iron, and a coil of wire surrounding the iron bar. When the switch is closed,

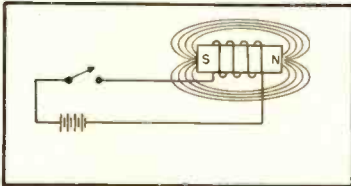

Fig. 1. Simple d.c. magnetizing circuit. The magnetic field is established when the switch is closed, and collapses when the switch is opened.

the iron becomes a magnet and a magnetic force is exerted from one pole to the other. If a strip of magnetic material passed across either pole, this force would magnetize the nearest end of the strip to an *opposite polarity*. That is, if the material were magnetized in passing a north pole, it would try to take on a south polarity and vice versa. It is possible to make a magnetic record on tape just by opening and closing the switch in Fig 1. Then, if the same coil were disconnected from the battery and switch and connected to the input of an amplifier, by moving the tape along the end of the iron bar you would hear a "click" every time the switch had previously been opened or closed.

A method similar to the above, in essence, was used by Poulsen in his Telegraphone. One coil of wire, through which direct current flowed, was the magnetizing coil. Another coil of wire was connected to the source of sound (telephone wire, for example) and, while the steel wire or tape was being magnetized, influenced the magnetism so that it varied in both magnitude and frequency in accordance with the original sound.

At the present time tape recording is effected in much the same manner as in the Telegraphone, with the exception that an alternating magnetizing current, commonly called bias current, is used. The frequency of the bias current, its strength, the width of the magnetic gap of the recording head—these and many other points are questions of the design of the tape-recorder and of the type of tape used.

**The Physics of Recording**

Since this article is designed for the guidance of the operating technician who is confronted with a new medium, nothing will be gained by repeating in detail the whole theory of magnetic recording. Adequate descriptions of the complete process will be found in AUDIO ENGI-

**It's here!**  
 The World's Finest  
**3-SPEED**  
**RECORD CHANGER**  
 Model RC-80  
**GARRARD**  
*"Triumph"*

**PLAYS ALL 3 SPEEDS**  
 —fully automatic with automatic stop

Priced lower than any previous Garrard changer!

A triumph of engineering, with every feature tested for finest performance

<b>PUSHER TYPE PLATFORM:</b>  It always works	<b>TWO INTERCHANGEABLE SPINDLES</b>  Plays records as intended	<b>HEAVY DRIVE SHAFT:</b>  No wows, no wavers
<b>JEWEL MOUNTED TONE ARM:</b>  Disturbing resonance eliminated	<b>AUTOMATIC STOP:</b>  At end of any type record	<b>TRIPLE SPEED SWITCH:</b>  Simple and easy settings
<b>INTERCHANGEABLE PLUG-IN HEADS:</b>  Your choice of cartridge	<b>HEAVY DUTY SILENT MOTOR:</b>  Absolutely no rumble	<b>WEIGHTED TURNTABLE:</b>  Gives flywheel action
<b>MUTING SWITCH:</b>  Silence between records	<b>SIMPLE INSTALLATION:</b>  Fits former Garrard cut-outs	<b>START-STOP-REJECT LEVER:</b>  Combined and conveniently located

At Your Radio Parts Jobber  
**GARRARD SALES CORP.**  
 164 Duane Street New York 13, N. Y.

NEERING<sup>1</sup> and in Dr. S. J. Begun's book "Magnetic Recording." In essence magnetic recording is a method of "storing up speech or signals by magnetically influencing magnetizable bodies." The modern tape recorder uses iron oxide coated tape as the "magnetizable" body and uses a.c. bias instead of d.c. bias. The remaining differences are due to improvements in drives, amplifiers, heads, and so on.

The first unit that the tape encounters in its recording cycle is the "erase" head, as indicated in Fig. 2. All authorities

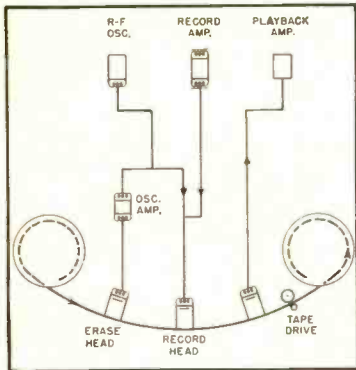

Fig. 2. Normal arrangement of erase, recording, and playback heads in a modern tape recorder.

agree that thorough demagnetization is necessary before tape can be properly recorded. The demagnetization is accomplished by subjecting the tape to a strong saturating supersonic field which is created by the erase head. Of course, erasing by means of a series of ordinary permanent magnets of alternate polarity is also effective in some degree. But at best the permanent magnets, besides wiping out any previously recorded magnetization in the tape, leave some slight noise on the tape. For this reason professional tape recorders make use of the supersonic erase method. The erase head coils, which are energized by an r.f. amplifier that follows a supersonic oscillator, must be sturdy enough to withstand possibly 5 watts of power. The erase field must be able to wipe out any previous signal completely, otherwise the cross talk and noise on the tape will be quite obnoxious. Indeed, recording engineers have found that tape that has been erased properly is often appreciably quieter than brand new tape.

The second head the tape passes is the recording head, Fig. 3. What occurs magnetically at this point determines how faithfully the tape will "store" sound. The tape has already been thor-

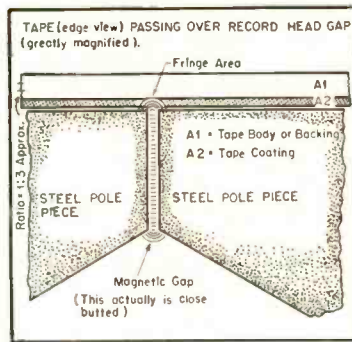

Fig. 3. Edge view of magnetic tape passing over recording-head gap, greatly enlarged.

oughly demagnetized by the action of the erase head. The record head is also energized, in part, by the same kind of supersonic current that actuated the erase coils. This head is connected to the output of the same oscillator that feeds the erase r.f. amplifier, or to a separate oscillator at a different frequency. The strength of the magnetic field emanating from the poles of the recording head is only a fraction of that of the erase field. The audio signal that will be recorded on the tape mixes with the supersonic current at the record head.

Most recorders employ supersonic oscillators that operate frequencies from 30 kc to over 100 kc. The majority em-

THE FAMOUS

# Western Electric

## 728B Loudspeaker

# 24<sup>95</sup>

F. O. B. N. Y.

### another terrific Terminal value...

<p><b>FREQUENCY RESPONSE</b> Essentially uniform from 60 to 10,000 cycles, with negligible distortion.</p> <p><b>VOICE COIL IMPEDANCE</b> 4 ohms</p> <p><b>COVERAGE ANGLE</b> 50°</p> <p><b>POWER HANDLING CAPACITY</b> 30 watts continuous</p>	<p><b>DIAMETER (overall)</b> 12-11/32"</p> <p><b>DEPTH (overall)</b> 3-25/32"</p> <p><b>WEIGHT</b> 17 pounds (approximate)</p> <p><b>BAFFLE HOLE DIAMETER</b> 10-15/16"</p> <p><b>MOUNTING HOLES</b> Four equally spaced on 11-9/16" diam.</p>
---	--

At a distance of 30 feet on axis the 728B will produce a level of 93.5 db. above 10<sup>-16</sup> watt per sq. cm. at 30 watts. This level is on a basis of a warble frequency covering a range from 500 to 2,500 cycles per second.

**Speaker Enclosure**  
provides 3 cubic feet completely enclosed as recommended by Western Electric for best results with the 728B. Constructed of 5/8" plywood throughout, supplied unfinished ready for painting or spraying to desired finish.

**16<sup>95</sup>**  
F. O. B. N. Y.

Write for our New Sound Catalog

# TERMINAL

RADIO CORPORATION

Distributors of Radio & Electronic Equipment

85 CORTLANDT ST. NEW YORK 7, N. Y. • Phone-WORgh 4-3311 • Cable-TERMRADIO

<sup>1</sup> W. W. Wetzel, "Review of Present Status of Magnetic Recording Theory," Parts 1, 2, and 3; Nov. and Dec. 1947 and Jan. 1948.

A  
MASTERPIECE  
OF  
SOUND  
PRESENTATION

the  
**LOWTHER-VOIGT speaker**

the world's  
finest speaker  
in a most unique  
corner cabinet  
price \$284.50



... makes the music  
of the immortals your living-  
room companion. Years ahead of the  
present conventional equipment, this  
new speaker-cabinet combination is the  
ultimate in sound-engineering design.

Bass or treble, voice or symphonic  
orchestration, all are produced  
with equal unbelievable tonal  
perfection. For those who  
know and appreciate  
the finest in sound  
reproduction.

**SPECIFICATIONS:**

HEIGHT 5' 4"  
WIDTH 36"  
DEPTH 24"  
Basic Lowther unit with  
Voigt exponential horn  
in appealing mahogany,  
walnut, or oak cabinet.  
Impedance 15 ohms.  
Frequency response 18-  
18,000.

Made by the Lowther Mfg. Co.,  
Bramley, Kent, England  
N. Y. office: 11 W. 42nd St.

**ARROW** *Beauty in Sound*  
**ELECTRONICS INC** 82 Cortlandt St., New York 7, N. Y.

**IN ORDER TO FIND IT—  
WHY NOT BIND IT?**



Your reference library of AUDIO ENGINEERING can be up-to-the-minute by keeping your copies in an AUDIO Binder.

**APPEARANCE** . . . Your den, workshop . . . or wherever you do your experimentation can be kept in "apple-pie" order when all your copies of AUDIO ENGINEERING are within easy reach. The deep, blue cover will harmonize with any color scheme and . . . in addition, the backbone will be gold-stamped with AUDIO ENGINEERING and any year you specify.

**CONVENIENCE** . . . No more wondering what happened to last month's issue . . . or the month before . . . Just reach for your Binder and no time is lost finding the information you need . . . AT ONCE.

**WORKMANSHIP** . . . DuPont Fabricord . . . stainproof and washable . . . rigid backbone with bound-in metal support . . . center channel to keep magazines securely in position.

**COST** . . . For only \$2.50 you can have this handsome binder for your ready reference.\*

\*(Foreign orders add 50¢ per binder)

**Audio Engineering**  
342 Madison Ave., New York 17, N. Y.

Enclosed find \$ . . . . . for . . . . . Binders

Name . . . . .

Address . . . . .

City . . . . . Zone . . . . . State . . . . .

Year Wanted  1947  1948  1949  1950.

play a frequency near 60 kc. The higher the frequency the less possibility of "beat frequencies" between bias and audio signal that, of course, introduce a kind of distortion. The rule followed in designing tape recorders requires the use of a supersonic frequency at least five times the top frequency of audio to be recorded. A still higher frequency would produce less beats but, unfortunately, r.f. losses increase with frequency and economy dictates a compromise.

If the wave shape of the erase field or of the bias field is not symmetrical there will be induction remaining in the tape that is proportional to the degree of non-symmetry. The record field is designed to be symmetrical and so, if it does not contain an audio component, should leave the tape "unmodulated" so to speak. But, if audio is mixed with the r.f. bias current in the head, it will cause differences in the peak values of flux in the recording field that correspond to the audio frequencies introduced. Thus there is remanent induction in the tape that varies exactly the same as the audio frequencies applied to the recording field.

The playing of a recorded tape again brings into action the magnetic forces we have already described. The actual record in the iron coating of the tape may be visualized in the form of very small magnetic structures. The maxima and minima of these infinitesimal magnets are spaced according to the frequency of the sound that was impressed on them by the audio component of the magnetizing current, and they will stay in that position until subjected to a strong magnetic field. When we play a recorded tape back, these tiny magnets, moving against the steel pole-piece of the playing-head, cause minute currents of electricity to rise and fall within the coil of wire wound around the steel pole-piece. After they have been sufficiently amplified, these currents produce the exact sound that was originally recorded on the tape.

From now on we will be concerned solely with techniques of recording, editing and mixing tape recordings, with the maintenance of the machines, and with ideas for making use of tape recordings in radio production.

Part II of this series will deal with recording "lay-outs" and methods and will contain a detailed discussion of the factors making for good magnetic tape recording.

The writer wishes to acknowledge the continued assistance of Howard A. Chinn and Price E. Fish for their assistance in the preparation and editing of this material.

**BIBLIOGRAPHY**

U. S. Patent 661,619, Nov. 13, 1900; Valdemar Poulsen.

U. S. Patent 1,640,881—Aug. 30, 1927—W. L. Carlson.  
*The Electrician*, Oct. 18, 1929; p. 472 ("Blattnerphone").  
*Elektrotechnische Zeitschrift*, Mar. 27, 1930; pp. 450-451.  
*Wireless World*, Jan. 5, 1934; Vol. 34, pp. 8-10.  
*Marconi Review*, Jan.-Feb. 1934, (N. M. Rust).  
*Wireless World*, June, 1946; Vol. 52, (R. A. Power).  
 W. W. Wetzel, *AUDIO ENGINEERING*—Nov. and Dec. 1947, Jan., 1948—"Review of the Present Status of Magnetic Recording Theory."  
 Dr. S. J. Begun, "Magnetic Recording," 1949. New York: Murray Hill Books, Inc.

## AUDIANA

[from page 19]

cleaning and may be had with either shorting (make-before-break) or non-shortening (break-before-make) contacts, and with up to twelve positions in stock styles.

For a.c. power control, toggle switches are suitable and are made with both laminated and plastic cases. The latter are more desirable but are higher in price. In addition to all of the above considerations in selecting switches, no switch should be used in a circuit where its rated current-carrying capacity will be exceeded. Disregarding this practice leads to burned contacts, poor connections, and sometimes causes the switch contacts to weld.

Relays are electrically operated switches, and have been popular in audio equipment for remote operation by switch, clock, voice, and photocell actuation. In general the considerations governing the selection of switches also apply to relays, with a few additional features found only in relays. Among them are their operate and release time, bounce characteristic, and coil characteristics. It is necessary when specifying a relay to give its resistance and its operating and release currents or the operating voltage and power consumption. These will be determined by the circuit in which it is to be used. Relays can be provided with latching and release mechanisms for use where it is undesirable to have the actuating current flowing continuously, or where there is only a short pulse of energy to actuate the relay. Mechanically looking relays come with a variety of contact and frame arrangements, but the electrical switching capabilities are the same as the switches already discussed. The stepping relay, so common in telephone work, provides the same type of contact arrangements as the multideck rotary or pushbutton switch.

A practice often suitable with other components—the purchase of a unit at a reduced price and the redesign of the cir-

cuit to make it possible to use the unit—is not too sound when applied to relays. They should be selected to fit the simplest conventional circuit which may be used or adapted for the purpose. When extreme sensitivity is needed for differential current or battery operation, "sensitive relays" can be obtained from several manufacturers as stock items.

In mounting both relays and switches, consideration should be given to lead lengths and the relation to adjacent parts. For convenience in mounting and locating relays many are now packaged in octal-based cans providing for easy installation and maintenance. Where practical they should be mounted close to the

other components which they control, and when used in low-level circuits they should be mounted away from power supply components. Both of these conditions are particularly important when the application is to low-level audio stages.

### Plugs and Connectors

Interconnecting plugs and sockets are available to the audio engineer and hobbyist from a wide variety of sources, and their selection is governed by the general service application as well as the electrical characteristics. For broadcast type equipment, it is necessary that the microphone and other low level input

## Here's Hi-fidelity FM and AM to Please the Experts

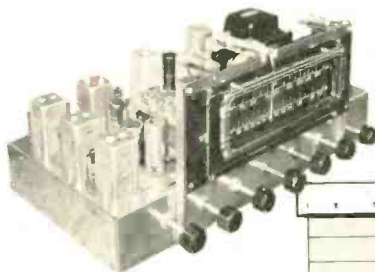

- The man who knows radio
  - The discriminating listener
- will recognize the superior performance of Browning FM and FM-AM without any shadow of doubt.

These are the performance curves which, to the man who knows radio, mean high-fidelity reception, flawless and noise-free.

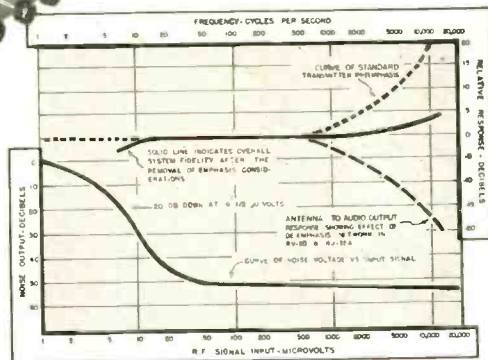

And the non-technical listener who demands the best — brilliant music, clear speech, with lifelike "presence" — will know he has it just the instant he hears Browning FM and AM.

### MODEL RJ-20 AM-FM TUNER

- Armstrong FM circuit; 20 db quieting with 6 1/2 microvolts.
- FM response 15-15,000 c.p.s. ± 1 1/2 db.
- Separate RF and IF for FM and AM.
- 20 db treble and bass boost.
- Variable AM bandwidth, 9 kc. and 4 kc.
- Tuning drift-free, precise.
- Self-contained power supply.

### MODEL RJ-12A FM-AM TUNER

High-sensitivity tuner for distortion-free FM and quality AM. Armstrong FM circuit. Drift compensated. FM audio flat 15-15,000 c.p.s. ± 1 1/2 db. AM audio flat 20-6,600 c.p.s. ± 3 db. Triple-tuned i.f. Easy to install.

### MODEL RV-10 FM TUNER

Small, compact, easily mounted. Armstrong circuit. Drift compensated. High-impedance output to feed any high-fidelity amplifier. Self-contained power supply. Audio flat 15-15,000 c.p.s. ± 1 1/2 db.

Write for a complete set of characteristic curves and performance data for any or all of these Browning Tuners.



**BROWNING**  
 Laboratories, Inc.  
 Winchester, Mass.  
 ENGINEERED FOR ENGINEERS

# Tape Recorders

## Sonar



**R.P.A.-1**

Compare this unit with those costing 2 to 3 times as much. R.P.A.-1 net price **\$275.00**. Dual speed—7.5" and 15" per sec. \$50.00 extra.

The R.P.A.-1 is a broadcast, high fidelity tape recorder especially suited to small FM-AM Broadcast stations. Ideally suited for remote recording and feeding a phone line simultaneously, the R.P.A.-1 is equipped with two inputs, one for a low impedance microphone and one for bridging. The output level is 0 db to a balanced 600 ohm line. The frequency response at 7.5" p.s.—40 cycles to 9.5 kc.  $\pm 2.75$  db. Built-in earphone monitoring facility. Loud speaker monitoring with a 5" dynamic speaker having its own gain control. The master gain control is calibrated in steps of 2 db. The R.P.A.-1 has a built-in RF filter enabling operation along side high power transmitters and so simple to operate, the personnel need not be an engineer or technically inclined.



**R.P.A.**

The RPA amplifier will work with any radio or high fidelity amplifier, to record, play back, or erase tape, using any tape mechanism. Complete **\$45.00**



**T-10**

The T-10 has 5 inputs—2 low gain and 3 high gain—for microphone and radio inputs. Amplifier response 20 to 20,000 CPS  $\pm 1$  db. Tape response (7.5" per sec.) 35 to 9,500 CPS. WOW and FLUTTER less than 0.3%. The T-10 recorder is available in separate units so that duplication of present equipment is not necessary.

Complete with speaker and power supply (in separate cabinet) and 1200 ft. roll of tape. **\$395.00**  
RPA 10 amp. only \$175.00.

**WRITE FOR DESCRIPTIVE LITERATURE**

SONAR

RADIO CORPORATION

General Offices & Factory: 59 MYRTLE AVE., B'KLYN 1, N. Y.

connectors have small physical size combined with positive electrical contact, low contact resistance, cable clamping, and plug locking devices that still permit quick disconnect. Another important feature of the connector is its pin and socket insert style. The best connectors use solid pins and split cylindrical tubes or rings as the mating pieces, each with a small "solder pot" as the wiring facility. Most AN type plugs are of this construction, as are the connectors manufactured by Cannon Electric Development Co. and Winchester Electronic Co. In addition to these features the latter may be obtained with spring loaded pins making it possible to separate a twenty or thirty pin connector with almost no effort.

For transferring power from one unit to another a different set of requirements must be met. The usual contact resistance and noise requirements should be met, but most important is the size of the contact area. This determines the current handling capacity, which affects the transmission in filament and low-impedance power circuits. Plugs for this service may be of the tube-base-and-socket variety, knife blade style, or in the same style as the microphone connectors.

The first of the styles mentioned above is typified by the Amphenol series 86 and 78 having from four to eleven contacts. An often used knife blade connector is the Cinch-Jones series 300, 400, or 500 with up to 33 contacts and with a variety of shells and chassis mounting brackets. Pin-style connectors for power use are made by Cannon and Winchester, and, in addition to the regular power transfer pins may be equipped with pairs of signal connectors inside a shield for use with two-conductor shielded wire or twinax cable. Connectors of this type are the Cannon DP series. Miniature and battery connectors are not recommended for audio design because of their poor electrical and mechanical characteristics, except for the very expensive military series. For very high current carrying capacity both Hubbell and Russel & Stoll make suitable connectors in a variety of cases and mountings including waterproof assemblies.

Contact arrangement for a particular application is dependent on the selection of arrangements listed by the manufacturer. Microphone connectors are made with one to four contacts, and some styles of low-level signal connectors—although not specifically designed for microphone service—have more. Among them are the Cannon types K and P. It is seldom advisable to use single-pin connectors except at the chassis end of a microphone line. Otherwise it will be impossible to avoid capacitive or magnetic hum pick-

## World-Wide Popularity

Since the inception of AUDIO ENGINEERING in May 1947, engineers and audio hobbyists have subscribed in ever-increasing numbers, not only in the 48 states and in all of the major foreign countries but in such places as Tasmania, Transvaal and Trinidad.

Each month AUDIO ENGINEERING covers the latest developments and practices in recording, reproduction and instrumentation for the entire audio field.

**Subscribe Now—Don't Miss an Issue! Back numbers are hard to get!**

AUDIO ENGINEERING  
342 Madison Avenue, New York 17, N. Y.

Sirs: Here is my  check (or  money order) for \$..... Enter my subscription order to AUDIO ENGINEERING for the next ..... issues. Subscription Price: In U.S.A., Canada and Pan American Union—12 issues \$3—24 issues \$5. All others \$4.00 per year. Please check one:  New Subscription  Renewal.

Name (please print) .....

Address .....

City ..... Zone ..... State .....

Occupation (give title and department) .....

Firm Name .....

up or ground loops. In general the three-circuit connector is best for this service since it carries not only the signal leads through on the pins but can also carry the ground lead or shield without depending on the dubious electrical capabilities of the shell assembly. For interconnection of plug-in chassis assemblies, either the knife blade connectors or the Cannon DP series may be used. They should have sufficient contacts to provide several spares for future modification without having to be changed and the mounting hole enlarged. Also they must be mounted "floating" so that the guide pins will pick up the mating connector and carry out their guide function. If rigidly fastened it is easy to break off the pins. When it is necessary to provide isolation, shielded pins may be used or a ring of pins may be grounded. For low leakage a ring or row of pins can usually be removed.

Although most manufacturers number the pins on plugs and sockets, there is as yet no industry standard. It has been common practice on microphone connectors to have pin #1 as ground and pin #3 as the hot lead, and some manufacturers make the circuit of pin #1 close before the other two in order that the shield or ground connection is completed before the signal circuit. On larger connectors it is almost impossible to follow any consistent system, and the designer should choose his own system and stick with it. At least be consistent within any given group of units designed to work together. Where all pins are of the same size an acceptable numbering method is to use the numbers in relation to increasing potential. However, even this method is not completely satisfactory.

The rules governing the use of male and female connectors is simple. In low-level circuits the male is placed on the source side of the line and the female on the load side or amplifier input. This protects the amplifier from overload caused by hum, clicks and pops which occur when open input terminals are touched. In all other applications the male should be placed on the load side of the line and the female on the source. The reason is obvious. Nobody wants to pick up a pair of high voltage contacts or to have a good transformer ruined by being shorted at the connector terminals.

Input plugs should, if space permits, be placed close to the input circuit elements and as far away from the power supply components as possible. Where a single plug carries all input, power, and output leads the input leads should be kept as far from the a.c. and output leads as possible or brought through on a twinax pair. Otherwise a.c. and output leads should be placed for the operator's convenience. In rack mounted units this

would usually be along the rear edge of the chassis. In some home audio systems, the amplifier is on the floor of a cabinet in which case the plugs are brought out on the top of the chassis.

Wherever possible, connectors should be mounted on the chassis in a position that is clear of tube sockets and terminal boards. Otherwise whenever maintenance is required the connector will have to be dismantled from the chassis to get at the parts that are hidden.

A beginning has been made on the discussion of chassis layout and in the next article this will be covered more thoroughly along with a discussion of unit styling and appearance.

## WHITE NOISE

[from page 17]

applied. The plate current of the mixer contains noise components in the range from 0 to 20 kc, as well as r.f. components. All but the audio components are eliminated by the low pass filter. This filter, of the constant-k type, has a pass band up to about 15 kilocycles with about 1 decibel attenuation at 20 kilocycles increasing roughly linearly to about 30 decibels at 100 kilocycles.

### Conclusions

The noise generator which is de-



new

# Permoflux

## ROYAL EIGHT"

### compares with any 12" speaker!



This averaged laboratory response curve of the Permoflux 8T8-1 proves that it compares with the finest speakers regardless of size or price.

It's Your "Springboard" to Extra Sales with Customers who want 12" performance but don't want to pay a 40% higher price.

From the resonant boom of jungle drums to the light warble of the flute, this new 8" speaker reproduces sound with superior sensitivity and fidelity. The tonal qualities of this magnificent speaker can only add to the excellence of any audio equipment.

Special processing provides extra-strong cone; allows cone to be soft-suspended from basket and held at coil-end by extra-large spider. Permits more faithful reproduction at lower frequencies. Deeper, curvical cone greatly extends high-frequency response.

Permoflux Royal Eight" (Model 8T8-1) is ruggedly-built and simple to install. Provides big speaker performance in a small frame—uses smaller, more economical baffle. List Price \$15.00.

See New Complete Line of Permoflux Products at Booth 603, Radio Parts Show.

Send for Catalog No. J201. Write—Dept. AE

  
**PERMOFLUX CORPORATION**
  
 "SOUND IN DESIGN"

4900 W. GRAND AVE., CHICAGO 39, ILL. • 236 S. VERDUGO RD., GLENDALE 5, CALIF.

# EQUALIZERS

## PROGRAM EQUALIZER—TYPE 4031-B



Most flexible tool ever offered Audio Engineering Trade. Has over 1400 curve combinations. Write for catalogue.



**CINEMA ENGINEERING COMPANY**

1510 WEST VERDUGO AVENUE, BURBANK, CALIFORNIA

Export Agents: Frazar & Hansen, Ltd. • 301 Clay Street • San Francisco, Calif., U. S. A.

## TWIN-TRAX\* TAPE RECORDERS *feature*

- WIDER FREQUENCY RESPONSE
- LONGER PLAYING TIME
- GREATER DYNAMIC RANGE
- *and lower price!*



For the Home  
\$285



Wired Music  
System \$495

Professional-type specifications that mean professional quality, operating ease, and trouble-free construction that you would normally associate with recorders selling at \$1000 and more. Yet the Twin-Trax Recorder series is available to you direct from the factory at low factory prices, starting at \$285 for complete high-fidelity recorders, and \$89.50 for precision-built basic tape transport mechanisms.

If you are thinking of buying a tape recorder, or if you use recorded sound for any purpose—for personal enjoyment or in your business, there is a Twin-Trax instrument for you. There are more than 30 standard and special Twin-Trax models available, including continuous-playing instruments, two-speed models, 24-hour recorder, etc.

\*TRADE MARK REG. U.S. PAT. OFF.



Experimenter  
\$89.50



Educational  
Institution \$335

Learn why Twin-Trax is the only professional recorder in the popular-price field. Save many dollars by dealing direct with the factory. Write

**AMPLIFIER CORP. OF AMERICA**  
398-4 Broadway • New York 13, N. Y.

today for illustrated 16 page catalog, including complete technical data.

## Ready June 15th! audio anthology

The long awaited compilation of reprints from early issues of AUDIO ENGINEERING, most of which are out of print and unobtainable.

Contains 37 articles on the following subjects:

- Amplifiers
- Speakers
- Noise Suppressors
- Phonograph Equipment
- Tone and Loudness Controls
- Dividing Networks

These articles have been of great interest to readers of AUDIO ENGINEERING over the past three years. Assembled in one volume, they comprise the most authoritative reference work yet available to the audio hobbyist.

Paper Cover \$2.00

Board Cover \$3.00

**Radio Magazines, Inc. Dept. A**

342 Madison Avenue

New York 17, N. Y.

scribed in this paper is undoubtedly not the only possible device which will provide a.f. noise of substantially uniform spectral distribution. It is possible that a noise source may be found by some search which will provide this type of spectrum with less equipment. In the absence of such a device, the method of heterodyning a selected portion of the r.f. spectrum provides a practical means of generating a.f. noise with the desired characteristics.

It seems that, if it were desired, considerable reduction in the apparatus could be effected by further development. For example, the 6AC7 tubes in the amplifier stages could supply considerably more gain than called for in the circuit described here. One or possibly two of the amplification stages might thus be eliminated. A somewhat more elaborate band-pass filter might result in greater output from the phototube, decreasing the gain required of the amplifier. The oscillator and mixer might advantageously be combined in a single 6K8 tube. The work reported here proves the practicability of the method and shows the results obtainable from such a system. A need for further compactness did not warrant further refinement of the design by the author at the present time.

## PICKUP TRACKING

[from page 12]

cps, is a figure that has been arrived at after many careful listening tests over a wide-range system as the value at which tracing distortion becomes perceptible. It is the value that has been used to establish the inner recorded diameter of RCA's 45-r.p.m. records. Good correlation has been obtained between measurements and listening tests, and more recent tests indicate that the intermodulation method is equally useful in determining the tracking capabilities of pickups.

When making tracking measurements, it is often advisable to listen to the output of the test record in order to detect any irregularities that may occur due to record eccentricity or wobble causing a once-around variation in distortion at turntable speed (due perhaps to excessive friction in the tone arm bearings). Such variation may be so slight that it does not register on the meter, especially if the meter is sluggish in action, and therefore may be overlooked unless listening tests are made.

When making comparison tests with records containing music, the pickup will usually appear to track better than indicated by the intermodulation test records. In such cases, it is possible that the peak velocity on the music record is not as high as expected, or



that its duration is so short that tracking distortion is not readily apparent. If several tests are made, especially while using a wide-range system so that tracking distortion can be more readily detected, it is believed that on the average, the agreement will be found to be good between measurements and listening tests.

#### Effect of Damping

It is the usual practice in pickup design to incorporate some mechanical resistance to smooth out the resonant peak of the pickup. The effect of the damper is usually judged by frequency-response measurements. During tracking studies it was noted that the damping material can have a detrimental effect on tracking. A sliver of viscoloid between the stylus and case of the pickup, used for the tracking tests of Fig. 4, gave the results shown in Fig. 6. The sliver was

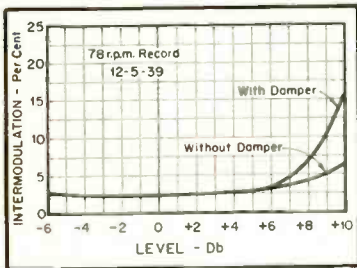

Fig. 6. A small piece of viscoloid applied for mechanical damping caused this change in tracking capabilities.

small and had little effect upon the response characteristic, but the effect on the tracking capabilities was such that the intermodulation increased from about 6 to 16 per cent at a recorded level of 27 cm./sec.

A large stiff block of viscoloid was tried in the same location with another pickup, and the results with and without the damper are shown in Fig. 7. In this

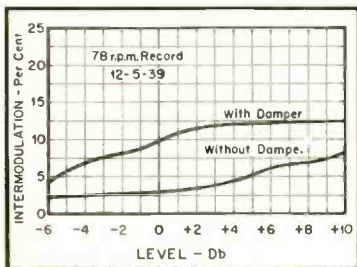

Fig. 7. A larger piece of viscoloid had a detrimental effect on tracking throughout the entire recorded range.

case, the damper block was so stiff that it affected the tracking capabilities even at the lowest recorded levels. This is an unusual example, but it serves to illustrate that the damper block should be

## Build YOUR OWN TEST EQUIPMENT

# Heathkit

**Heathkit**  
AUD. O. GEN. KIT  
\$34.50

**Heathkit**  
TELEVISION GENERATOR KIT  
\$39.50

**Heathkit**  
SIGNAL TRACER KIT  
\$19.50

**Heathkit**  
CONDENSER CHECKER KIT  
\$19.50

**NEW Heathkit**  
IMPEDANCE BRIDGE SET  
\$69.50

**NEW Heathkit**  
HANDITESTER KIT  
\$13.50

**Heathkit**  
TUBE CHECKER KIT  
\$29.50

**Heathkit**  
5" OSCILLOSCOPE KIT  
\$39.50

**Heathkit**  
BATTERY ELIMINATOR KIT  
\$22.50

**Heathkit**  
ELECTRONIC SWITCH KIT  
\$34.50

**Heathkit**  
R.F. SIGNAL GEN. KIT  
\$19.50

**Heathkit**  
VACUUM TUBE VOLTMETER KIT  
\$24.50

Heathkits are beautiful factory-engineered quality service instruments supplied unassembled. The builder not only saves the assembly labor cost but learns a great deal about the construction and features of the instrument. This knowledge aids materially in the use and maintenance of the equipment. Heathkits are ideal for and used by leading universities and schools throughout the United States. Each kit is complete with cabinet, 110V 50 cycle transformer (except Handi-Tester), all tubes, coils assembled and calibrated, panel already printed, chassis all punched, formed and plated, every part supplied. Each kit is provided with detailed instruction manual for assembly and use. Heathkits provide the perfect solution to the problem of affording complete service equipment on a limited budget. Write for complete catalog.

### HEATH COMPANY

BENTON HARBOR, 10 MICHIGAN

REPORT DEPARTMENT  
15 EAST 40th STREET  
NEW YORK 18, N.Y.  
CABLE - ARIAS - N.Y.

## takes the "ACK" out of PLAYBACK



#### REK-O-KUT'S

new 3-Speed Player, Model P-43C, is the quality instrument of the playback field. No ackaty-acks, no rumbles, no wows... just a continuous flow of smooth, true sound.

#### EXTRA! EXTRA!

With the Model P-43C you can DUB everything you have on your record into ANY TYPE of recording mechanism... wire, tape or disc... and the only "wow" you'll hear will be that of your own pleased amazement.

#### REK-O-KUT 3-Speed Player, Model P-43C

**\$84<sup>95</sup>**  
NET

Sold by leading  
radio parts  
distributors

#### FEATURES

- **TURNTABLE**... cast aluminum, lathe turned with shaft hardened and ground to micro finish.
- **MOTOR**... constant speed, 4-pole, fitted with REK-O-KUT'S exclusive lamitex motor pulley ground concentric to the rotor.
- **SPEEDS**... 78, 45 and 33½ with instantaneous selection, controlled by adjustable stops for extra fine regulation.
- **DRIVE**... inside rim type. Idlers completely disengaged from motor and turntable when in neutral position. Idlers engage as built-in switch starts motor.
- **PICKUP**... 16" with wide range dual stylus cartridge for playing 16" transcriptions, standard and long-playing records.
- **CASE**... finished in enriched grey leatherette.

For Complete Information About ALL REK-O-KUT Products Write...

**REK-O-KUT CO., Inc.** 38-01 QUEENS BOULEVARD  
LONG ISLAND CITY 1, N. Y.

# SEE THE *American* EXHIBIT AT THE RADIO PARTS SHOW

CHICAGO, MAY 22 - 25

## FULL VISION



**NEW!**

*Dynamic*

## MICROPHONE

MODEL D33 - Latest addition to America's line of quality microphones. Full vision for artist and audience. Omnidirectional pickup.

Output: -52 db with transformer. Easily detachable from stand or suspension mounting by raising small lever lock. • Weight: seven ounces. • Plug: Cannon "Latch lock." • No pre-amplifier required.

*American*  
**MICROPHONE COMPANY**  
370 SOUTH FAIR OAKS AVENUE  
PASADENA 1, CALIFORNIA

added with care, and the effect upon tracking as well as frequency response should be investigated.

Several pickups of different design were investigated for tracking capabilities. The same vertical force was used, and the results are shown in Fig. 8. Two of the pickups were of the same type with minor changes in construction but considerable difference in the amount of damping material used. One pickup

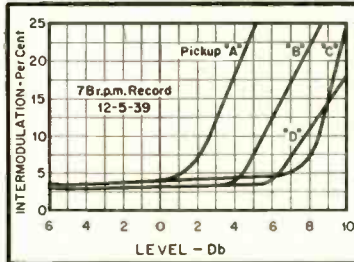

Fig. 8. Comparison of pickups of different types and construction.

used no damping material, and another used a moderate amount. The pickup that used the greatest amount of damping material exhibited the poorest tracking capabilities, confirming the results of our tests as given above.

### Conclusions

The intermodulation method of distortion analysis appears to be valuable in determining the tracking capabilities of a pickup. By reproducing intermodulation frequencies that have been recorded at different levels, the necessary value of vertical force needed to insure proper tracking can be determined easily.

Measurement equivalent, although needed for a careful analysis, is not essential, as much useful information can be obtained by listening to the output of the test record.

Damping material so commonly used in pickup construction to obtain smooth response characteristics may adversely affect the tracking capabilities of the pickup and therefore should be investigated carefully and used judiciously.

## Additional Test Records

Several new test records have been announced which will facilitate measurements and tests such as those described in Mr. Roys' article. Information regarding these and other Test and Technical Purpose Records may be obtained from Custom Record Sales Section, RCA Victor Division, 120 E. 23rd St., New York 10, N. Y. The following listing is in addition to the one appearing in the September and November issues, 1949:

## CONCERTONE



**\$295.00**

Net FOB Los Angeles

The magnetic tape recorder that invites competition—for living sound and high fidelity. Compare CONCERTONE quality and performance with any other recorder on the market. **THREE HEADS** for simultaneous monitoring and playback.

### SPECIFICATIONS

Size: 22" x 14" x 5" mounting depth.  
Recording Speeds: 7.5" and 15" per second.  
Frequency response: 2 db from 50 to 12,500 cycles at 15"/sec.  
2 db from 50 to 7,500 cycles at 7.5"/sec.  
Flutter: Less than 0.1% at 15"/sec.; 0.2% at 7.5"/sec.  
Signal to noise ratio: 35 db for single track recording; 50 db for dual track.  
Total harmonic distortion: Less than 2% at normal maximum signal level.  
Input and output impedances: 0.5 meghm.  
Minimum input signal: 5 millivolts.  
Output signal: 2.0 volt.  
Playing time, single track: 7" reel: 16 min. at 15"/sec.; 32 min. at 7.5"/sec.  
10 1/2" reels: 33 min. at 15"/sec.; 66 min. at 7.5"/sec.  
Double above times for dual track recording.  
Power requirement: 117V. 60 cycle single phase.

Complete descriptive brochure available upon request. For the ultimate in all types of tape and wire recording apparatus, supplies, and service, call, write or wire.

DISTRIBUTED IN THE WEST BY

*Magnetic Recorders Company*  
7170 MELROSE AVENUE  
LOS ANGELES 46, CALIF.  
Telephone Wyoming 9600

## BRITAIN'S FINEST SPEAKER COMES TO YOU



Much as we hate repeating ourselves we respect those experienced advertising kings who tell us that we must do it to be believed. Therefore we say once again that the BARKER SPEAKER is the most NATURAL, satisfying and perennially pleasing sound reproducer for home use, bar none. This repetition of a truth now well known to many hundreds in Britain and a goodly number elsewhere is put before you not so much in the hope that if you did not believe us last time you will now, but that if you did not see our previous advertisements at all, you will see this one and write to us for details of how we do it! Or, of course you can look up your last four numbers of A. E. and get the outlines that way before you write. But any way we shall be glad to hear from you.

Barker Speakers are based on two simple ideas which seem to us to be right in principle and proved in practice. Our Patent dual drive with its aluminium former, latex compliance and light coil not only covers the full audio frequency range but is self controlled to a unique degree by its inherent feedback, giving remarkably clean, clear-cut transients and smooth, resonance free output. Our cone, made of strong woven material impregnated with special dope and moulded with a graded compliance from apex to rim, is equally smooth and free from peaks or colouration.

Two models, both 12 in. frame, 14,000 or 17,500 lines/sq. cm. Prices \$45.00 or \$80.00 by insured post to your home.

**BARKER NATURAL SOUND REPRODUCERS  
BCM/AADU, LONDON, W.C.I., ENGLAND.**

12-5-35 7-inch, 45 rpm. Unfilled Vinyl DF. For checking landing and tripping action of changer mechanisms; for checking pick-up sensitivity, turntable flutter and rumble. The last music groove is at 4 1/4-inch diameter with the concentric stopping groove at 3 7/8-inch diameter.

12-5-37 7-inch, 45 rpm. Unfilled Vinyl DF. Bands of 400 and 4000 cps signals combined with the 4000 cps 12 db below the 400-cps level. Peak velocities run from 3.5 to 18 cm/sec in approximately 2 db steps. Distortion in the record is less than 4%. For testing pick-up "tracking" at various levels and stylus forces. Measurements with an analyser are recommended, but listening tests usually reveal the useful information.

12-5-39 12-inch, 78 rpm. Unfilled Vinyl DF. Bands of 400 and 4000-cps signals combined with the 4000-cps level. Peak recorded velocities run from 27.1 to 4.3 cm/sec in approximately 2 db steps. Distortion in the record is less than 3%. Groove has small bottom radius suitable for testing with 1.0 or 3.0 mil styli. Same use as 12-5-37.

12-5-41 12-inch, 33.3 or 78 rpm. Unfilled Vinyl DF. Designed for routine testing of record changer operation at either 33.3 or 78 rpm with 1.0 or 3.0 mil styli. Standard RMA landing areas for 10- and 12-inch records are defined by short interrupted tones. Short bands of 400 cps and 1000 cps tones at both 33.3 and 78 rpm are included for routine pick-up sensitivity measurements.

## PATENTS

[from page 8]

sible in a recording or loudspeaker amplifier with push-pull output is limited by phase shift at high audio frequencies, caused by leakage reactance between the two halves of the output transformer primary. Norman D. Webster, in Patent No. 2,488,357 (assigned to McClatchy Broadcasting Co.), presents a single-ended system with very high feedback, which extends the frequency response considerably and probably has less distortion than the more usual push-pull circuits. It is diagrammed in Fig. 2.

Three tubes are used.  $V_1$  is a voltage-amplifier pentode;  $V_2$ , which operates as a cathode follower, and  $V_3$ , the output stage, are beam tubes, chosen for high efficiency. For greater power output several tubes may be used in parallel for  $V_3$ .

$V_1$  operates in the usual way, feeding the grid of cathode-follower  $V_2$ , the output of which is taken from across load choke  $L_1$ .  $V_3$  operates in Class A. At high levels, a single-ended stage of this kind produces a smaller plate-current change for a given negative grid-voltage excursion than for a positive grid-current excursion of the same value. The result, of course, is even-harmonic distortion, which is what push-pull outputs are designed to avoid.

That is compensated for in Fig. 2 by connecting the screen of  $V_2$  (through  $R_2$  and  $R_3$  to the plate of  $V_3$ . Now, when

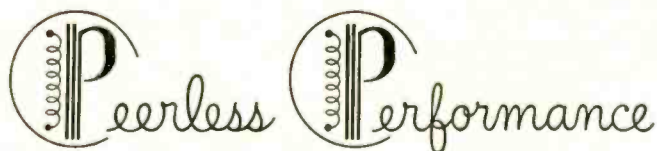

## RMA 70 Volt Line Matching Transformers

Complete coverage from 1/4 to 64 watts, with an insertion loss less than 0.6 db at full power, makes the Peerless 70 volt line the best buy for RMA-standardized sound distribution systems! Available in three sizes (1/4, 3-24, 8-64 watts), each provides five primary taps for overlapping coverage through entire power range in steps never greater than 3 db. Five secondary impedances match speakers of 2 to 16 ohms, singly or in combination. Because efficiency is high, these transformers will stand considerable abuse and may be safely up-rated with only a slight reduction in frequency range and efficiency. Furnished potted or in open frames. Mounting flanges provided.

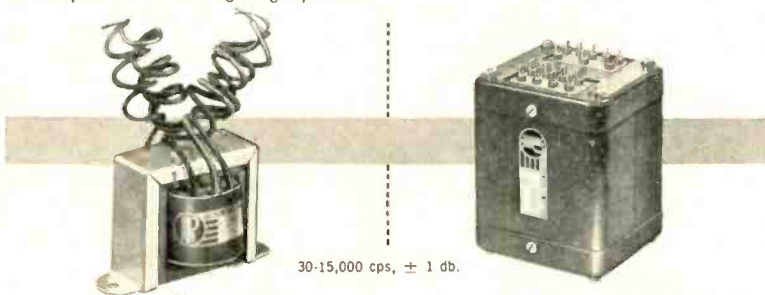

30-15,000 cps,  $\pm 1$  db.



PEERLESS ELECTRICAL PRODUCTS  
DIVISION

1161 N. VINE ST., HOLLYWOOD 38, CALIF. • 161 SIXTH AVE., NEW YORK 13, N. Y.



## Here's Your Complete Kit -- PEERLESS High-Efficiency Triode Amplifier



### FEATURES

Response: 20-20,000 cps  $\pm 0.5$ db. 15W output at 4% intermodulation distortion. 7db of feedback around 5 stages & output transformer. Cathodyne phase inverter. Cathode follower driver. Fixed bias. 8 tubes: 2 - 6J7, 1 - 6J5, 2 - 6SN7, 2 - 6A5G, 1 - 5V4G. Equalized for GE, Pickering pickups. Terminal strip for easy construction, servicing. Peerless transformers.

This great amplifier, featuring high efficiency triode design and described in an article by Mr. Melvin C. Sprinkle in the current issue of Radio & Television News is supplied in complete kit form by Sun Radio & Electronics Co., Inc. -- since 1922 one of America's favorite parts supply houses, renowned for its friendly, square-dealing service.

PEERLESS KIT: contains 4 Peerless transformers, chassis, bottom plates, RC mounting board, all instructions and diagrams . . . . . \$46.80

SUN ACCESSORY COMPONENT KIT: contains all additional parts needed -- sockets, switches, plastic case capacitors, tubes, knobs, connectors, everything . . . . . \$34.75

TOTAL COST, both kits complete \$81.55 (Either kit sold separately)

FAST MAIL ORDER SERVICE TO ANY PART OF THE UNITED STATES. Send full amount to speed handling, 25% required with COD's.

We are exclusive distributors in the New York area for Peerless transformers -- not only for this kit but for the complete line of high-fidelity audio, power and other types of transformers and chokes. Write us for the Peerless catalog.



# Unequaled

GREAT RADIO SHOWS... STANDARD OF THE

instantaneous start and stop  
ease of operation and editing  
WOW-proof performance  
true-to-life fidelity  
installation assistance  
for scientific research  
mechanical ruggedness  
critical user satisfaction

## AMPEX

magnetic tape recorder

Models to \$3800  
Shown model 300-C \$1575  
(control panel \$105 extra)



AMPEX ELECTRIC CORP., San Carlos, California

Without obligation please send 16-page illustrated booklet containing technical specifications of Ampex Magnetic Tape Recorders.

NAME \_\_\_\_\_  
ADDRESS \_\_\_\_\_  
CITY \_\_\_\_\_ STATE \_\_\_\_\_

Our need is for:

- Laboratory Research       Telemetering  
 Multi-Channel Recording     Industrial Recording  
 Recording-Broadcasting     Aerophysical Research

Distributed by...

BING CROSBY ENTERPRISES (Hollywood)  
AUDIO & VIDEO PRODUCTS CORP. (New York City)  
GRAYBAR ELECTRIC COMPANY (Everywhere)  
EXPORT: WESTREX (New York City)

## Aerosound

### QUALITY OUTPUT TRANSFORMERS

The outstanding performance of these units is demonstrated in the characteristics of the famous WILLIAMSON amplifier using the TO-290 (12,000 ohms for optimum match with triode 807's). In this rigorous usage, half-power points are 8 cps and 50 kc; intermodulation distortion is less than 1% at 10 watts output with 40 cps carrier, 4 to 1 ratio, with frequencies of 2.7, or 12 kc with 400 volt plate supply.

ALL ACROSOUND transformers conform to equally high standards, with the following performance specifications:

- Response  $\pm 1$  db 10 cps to 40 kc
- Full power from 20 cps to 20 kc
- Low phase shift permitting over 30 db of stable feedback
- Superior transient response measured by 20 kc square wave

12.5 WATTS		
TO-240	4,000 ohms	@\$8.75 net
TO-250	5,000 ohms	@\$8.75 net
TO-260	6,000 ohms	@\$8.75 net
TO-270	10,000 ohms	@\$8.75 net

20 WATTS		
TO-280	9,000 ohms	@\$10.75 net
TO-290	12,000 ohms	@\$13.25 net

Also available fully potted in seamless steel case with silver grey hammerstone finish at \$2.00 extra

All units have pushpull primaries and 4, 8 and 16 ohm secondaries

Descriptive literature, suggested circuitry and performance data on Williamson circuit available on request.

Prices F.O.B. Phila. 25% deposit  
\* Pat. Pend. with C.O.D.'s

### ACRO PRODUCTS COMPANY

5328-30 Baltimore Ave. Philadelphia 43, Pa.

the  $V_3$  grid swings positive, some of the resulting negative plate voltage is applied to the screen of  $V_2$ , reducing its gain and reducing the positive grid voltage available to  $V_3$ . Careful selection of resistors makes the positive and negative output peaks of  $V_3$  equal and removes one source of distortion. On the next alternation, the screen of  $V_2$  is driven positive, but the gain of a cathode follower cannot exceed a certain value less than 1, so there is no effect on the negative swing applied to  $V_3$ , though it does help to reduce any negative peak clipping in  $V_2$ . The arrangement makes it possible to drive  $V_3$  much harder than usual while maintaining excellent linearity.

It also makes possible much larger amounts of feedback than usual. Ordinarily, to obtain large output from a beam tube, the grid must be driven positive enough to approach plate-current saturation, which produces a flat top on negative peaks. Negative feedback hinders rather than helps the situation because further positive grid swing after the plate reaches saturation gives no additional plate-voltage drop, and the negative half wave is made more flat-topped than ever. But because positive  $V_3$  grid signals are controlled by the  $V_2$  screen coupling,  $V_3$  may operate to plate-current cutoff on negative grid swings and to the point where the  $E_g-I_p$  curve becomes nonlinear on positive ones. That eliminates one of the factors limiting feedback.

The other is avoided by the method of output coupling, where the output is taken from across  $L_2$ , a comparatively low impedance. The feedback is taken from the junction of  $R_3$  and  $L_2$ , through  $R_1$  and  $C_1$ , to the cathode of  $V_1$ . With large feedback, the output impedance of the amplifier is effectively extremely low, with consequent lack of loudspeaker "overshoot" and insensitivity to change of load impedance with frequency.

A slight improvement given by the inventor consists of replacing  $V_1$  load choke  $L_3$  with two bucking windings to cancel objectionable hum.

A copy of any patent may be obtained for 25¢ from the Commissioner of Patents, Washington 25, D. C.

## RECORD REVUE

[from page 24]

the problem of tracking a record which is, let's say, arbitrarily perfect and entirely free of distortion in the actual wave track. With an unsatisfactory stylus there still may be some passages that "blast" and others that do not. It is clearly a particular combination of sound waves that sets off the poor tracking which results in blast or "buzz"—rather than a mere matter of volume level. This most of us will have long since discovered. Some very high-level

## Laboratory Standards



### SQUARE WAVE GENERATOR

Model 71. Frequency Range: Continuously variable from 5 to 100,000 cycles. Wave Shape: Rise time less than 0.2 microsecond. Output Voltage: 75, 50, 25, 15, 10, 5 peak volts fixed; 0-2.5 volts continuously variable.

### MEASUREMENTS CORPORATION

BOONTON NEW JERSEY



## ATLAS "Multi-Cellular" TWEETER

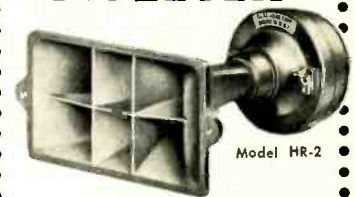

Model HR-2

### SIX CELL WIDE ANGLE

DISTRIBUTION: 100° x 50°  
Clean and efficient to 15,000 cycles  
25 watts of program material above 1000 cycles

"Alnico-V-Plus" super efficient magnetic circuit. Heavy die cast sectoral horn, flush mounting 6 3/4" wide, 3 1/2" high, 8" deep. A new high in realism—smooth and clean musical brilliance. Perfect articulation and Sibilance in voice reproduction.

WRITE FOR COMPLETE DESCRIPTIVE CATALOGUE

### ATLAS SOUND CORPORATION

1448 39th St. Bkn. 18, N. Y.

Variable High Pass Filter  
Model FN-1



## PROFESSIONAL DIRECTORY

### C. J. LEBEL

AUDIO CONSULTANT

Sound Recording • Instrumentation

370 RIVERSIDE DRIVE  
NEW YORK 25, N. Y.

Custom-Built Equipment

### U. S. Recording Co.

1121 Vermont Ave., Washington 5, D. C.

STerling 3626

Consultation • Design • Fabrication

### Audio Facilities Corporation

608 Fifth Avenue

New York 20, N. Y.

### HERMAN LEWIS GORDON

Registered Patent Attorney

Patent Investigations and Opinions

Warner Building Washington 4, D. C. National 2497	100 Normandy Drive Silver Spring, Md. Shepherd 2433
---	---

### Albert E. Hayes, Jr.

CONSULTING RADIO PHYSICIST

8 East Sampson St. Bay Park, L.I., N.Y.

### RATES FOR PROFESSIONAL CARDS IN THIS DIRECTORY

\$10 Per Month.  
Orders Are Accepted  
for 12 Insertions Only

passages may offer no difficulty in the tracking, others that do not seem particularly heavy nevertheless cause a fine breaking up.

The differences (in musical recording) must depend, then, on musical differences in the actual sound recorded. You will find, I think, that, with any stylus that is susceptible to "buzz", the worst fuzziness comes with loudly recorded, high string passages and similar highly complex sounds. Choral music is particularly apt to cause breaking up in loud passages. This would seem quite reasonable, for a passage for high violins may be played by as many as thirty or so different instruments simultaneously, each one dynamically out of tune by very small degrees with the others, each one producing a vibrato version of the supposed pitch being played, according to standard violin technique. The transient complications and the intermodulation effects in a sound like this are fantastic. The same is true for a chorus of voices. Enormous transient peaks of ultra-short duration are bound to occur in such situations. Trouble in stylus tracking is, it can be seen at once, only one of the headaches that this sort of musical sound is likely to promote—but let's keep off the electrical side for a moment.

The sound of a trumpet is one of the more powerful bits of tone in the musical repertoire, and trumpet blasts make the biggest peaks in most symphonic recordings. But look at the difference. A trumpet usually is a solo instrument (paradoxically, due to its very power); at most there are a handful of them in the fanciest trumpet explosions. Moreover, the trumpet blast is a clean, non-vibrato sound in itself, with relatively simple overtone structures.

Is it then surprising that a trumpet passage at top recording level may track gracefully, whereas a considerably weaker-powered string passage—as the ear hears it—may throw a stylus into a tizzy? A bit of study, especially if you have been experiencing tracking difficulties, will turn up a lot of illuminating evidence of this sort. Music by different composers varies tremendously in its effect on a sensitive stylus, and if you take careful note of the offending passages, you'll see, I think, that—other things being equal—there will always be some sort of complex, transient-producing wave form at that point. Clearly, stylus behavior and musical structure are very intimately related, to put it mildly. More grist for the transient-and-intermodulation men—for this is strictly in their realm, even though we speak entirely of actual sound wave transients, for the moment.

Put it another way. Two identically made recordings, same studio, same equipment throughout, from mike to stylus to speaker, may—for purely musical reasons—give utterly different results as to faithfulness in stylus tracking. We can all imagine a frantic engineer checking and re-checking his equipment to find what had caused the difference! The audio man who forgets the music he's working with is as bad as the pilot who can't be bothered with the weather.

### The Unfaithful VU Meter

All of which brings up a related point, concerning the recording of choral music. Long before I had heard of a transient, I ran into what seemed to be a series of examples of careless recording technique that had me much annoyed—especially when a set of four privately pressed 78 recordings for which I was directly responsible musically turned out to be duds. The trouble was blasting—not merely poor tracking this time, but just plain ordinary over-cutting. Rabid over-cutting. How a respectable

## Investigate The Sound of Quality NEWCOMB AMPLIFIERS

If you haven't heard a Newcomb you haven't heard the best. Because in the business of sound reproduction a Newcomb amplifier has no equal. We invite you to investigate... let us tell you why each Newcomb amplifier is the best available in its particular field of operation. We ask you to listen to our claims... and listen to our amplifiers... then judge for yourself by our standards you choose. We know you'll agree that for technical perfection, for faithful sound reproduction, for actual listening pleasure... **THEY CANNOT BE SURPASSED!**

There's a Newcomb amplifier for every purse and purpose, from the low cost Standard Series, through the superb Deluxe Series, to the incomparable Custom Models.



Check equipment below  
for complete information

- Public Address Amplifiers
- Mobile Amplifiers
- Phonograph Amplifiers
- Musical Instrument Amplifiers
- Wired Music Amplifiers
- Portable Systems
- Portable Phonographs
- Transcription Players
- Rack and Panel Equipment

### NEWCOMB AUDIO PRODUCTS CO.

Dept. T, 6824 Lexington Ave.,  
Hollywood 38, California

Please send information on equipment checked above.

Name \_\_\_\_\_  
Address \_\_\_\_\_  
Firm \_\_\_\_\_

Dealer  Jobber  Sound Specialist

**NOW AVAILABLE**

At your RCA Distributor

**MODEL  
515S1**



**PRICED RIGHT!**  
**ONLY \$55**

Suggested List

The sensational RCA  
**15" Duo-Cone Speaker**  
... proud offspring of the  
famous RCA LC-1A

**SONOCRAFT**  
**RECORDING**  
**HEADQUARTERS**

for professional  
sound recording  
equipment and  
accessories  
is Proud to Present

the  
**SENSATIONAL**  
**NEW**

**7-SERIES**  
*Magnecorders*

Write or Phone for Demonstration

**SONOCRAFT**  
CORPORATION  
45 W. 45 St., New York 19, N. Y.  
LUXemburg 2-1750

sound engineer could cut eight masters from a fairly low-level original, every one of which was unplayable in the louder passages, was beyond me. It seemed to me, at that time, that I had heard a remarkable number of overly-loud choral recordings. Why didn't the engineers cut them at the right level? All you had to do was watch your meter.

Came tape, and I ran smack into this little problem myself. "Run the level about at the zero point for most recording," they told me. It worked fine for single voice recording, for instruments, radio recording of symphonic music and the like. But then I tried my first choral recording (being a choral singer myself). The entire first tapes I made were grossly overloaded! Yet I knew—at least I thought so—that I had kept the level properly low, on the meter. A bit of further experimenting convinced me—shakily, I admit—that the rule was to run the level way down for choral music. Didn't make much sense, but it worked, and worked well.

Perhaps, my line of reasoning went, it was something of the same sort—whatever it may be—that accounted for the overcut discs. Maybe the engineers were cutting at "normal" levels, according to their meters—not knowing that choral music, music for many voices, was a law unto itself? (Of course I didn't breathe a word to my engineer friends about my own special law. It wasn't very scientific and it didn't make any sense.)

By last spring, a year ago, I was quite definite about it, however. *When a choral recording is made, run your level so low that you think nothing is being cut or taped at all.* My chorus gave a concert in New York, and I hauled my recorder into the hall, asked an engineer to man the controls, and got into the gang to sing. But not until I had argued for a good long while to persuade the dear boy (he's younger than I) that I didn't want that needle to climb more than halfway up to zero, no matter how loud we hollered! He did it, but reluctantly.

The resulting tapes, while no models for acoustics, were perfect as to level. Not a trace of over "cutting," with 200 voices and an echo-to-end-all-echoes. The recordings were sold, and will be available on LP from a commercial company before this is printed—provided the LP cutting engineer doesn't run the level too high in his re-recording. I'll work on him, you may be sure.

The moral is clear enough, but I frankly don't understand just what goes on in the average meter in these choral recording situations. You professional readers will be able to explain that. Obviously, we have once more a problem of enormously complex wave forms, with tremendous transient peaks, with the most involved instantaneous intermodulations as 200-odd (or even a lot fewer) separate voices beat and clash and cross each other in a million ways. It is clear enough that any such sound entering an amplifier will overload it at the drop of a sibilant, and this even though perhaps the average electrical level is relatively far lower; that, in any case, would roughly account for the fact that the overloading fails entirely to show up on the VU meter. Am I right? If you doubt all this—just try for yourself next time you have a hefty choral group back of your mikes.

**Epilogue**

No doubt all of these effects, having to do with complex sound waves and transient conditions, are significant in the "new" area of transient performance that seems to be much in the wind these days when one speaks of the latest in amplifier design. I

**AMPERITE**

Studio Microphones  
at P.A. Prices

Ideal for  
**BROADCASTING  
RECORDING  
PUBLIC ADDRESS**

"The ultimate in microphone quality," says Evan Rushing, sound engineer of the Hotel New Yorker.

- Shout right into the new Amperite Microphone—or stand 2 feet away—reproduction is always perfect.
- Not affected by any climatic conditions.
- Guaranteed to withstand severe "knocking around."



Models  
RBLG—200 ohms  
RBHG—Hi-imp.  
List \$42.00



"Kontak" Mikes  
Model SKH, list \$12.00  
Model KKH, list \$18.00

**Special Offer:** Write for Special Introductory Offer and 4-page illustrated folder.

**AMPERITE Company, Inc.**

561 BROADWAY • NEW YORK 12, N. Y.

Canada: Atlas Radio Corp., Ltd., 560 King St. W., Toronto

**Ready NOW**  
**ULTRASONIC FUNDAMENTALS**

By S. YOUNG WHITE

The rapid increase in the use of ultrasonics during the last few years makes it natural that the well-informed sound engineer should want to learn something of the applications and potentialities of this amazing new field. But interest in ultrasonics is not confined to the sound engineer—it is of still greater importance to the industrial engineer for he is the one who will visualize its uses in his own process.

Elementary in character, **ULTRASONIC FUNDAMENTALS** was written originally as a series of magazine articles just for the purpose of acquainting the novice in this field with the enormous possibilities of a new tool for industry. It serves the double purpose of introducing ultrasonics to both sound and industrial engineers. The list of chapter headings will indicate how it can help you.

**CHAPTER HEADLINES**

Too Much Audio. Opportunities In Ultrasonics. Elements of Ultrasonics. Experimental Ultrasonics. Coupling Ultrasonic Energy to a Load. Ultrasonics in Liquids. Ultrasonics in Solids. Testing by Ultrasonics. High-Power Ultrasonics. Notes on Using High-Power Ultrasonics. Applications of Ultrasonics to Biology. Economics of Industrial Ultrasonics.

The applications of ultrasonics have already extended to many industries, and as its possibilities are explored they will increase a hundredfold. To keep abreast of its growth, engineers in all fields must know what they may expect from ultrasonics, how it is used, how the energy is generated, and the techniques or applying ultrasonic treatment to many processes.

**ULTRASONIC FUNDAMENTALS** is not a big book—it does not cover the entire field of ultrasonics with hundreds of pages of dull reading. But in the three hours it will take you to read it, you will get a down-to-earth glimpse into the far-reaching possibilities of a new art.

**ULTRASONIC FUNDAMENTALS**

By S. YOUNG WHITE

36 pages, 40 ill., 8 1/2 x 11, paper cover \$1.75

Book Division, Dept. A  
**RADIO MAGAZINES, INC.**  
342 Madison Avenue New York 17, N. Y.

am much interested in the way that attention in the audio field moves on from one phase of the reproductive set-up to another: a couple of years ago all the talk was of intermodulation distortion in amplifiers; last year there was a considerable period of active discussion on transients in speaker performance (including an Audio Engineering Society lecture with highly illuminating "animated" performance graphs which I will not soon forget—the transients were so incredibly fouled up!). Now, the talk is of electrical transient response measurements—see, for example, the "white noise" article by Mr. Cook in the March issue. My general feeling is, at this point, that maybe if we get the stylus and arm problems of LP straightened out, we can then begin to blame a lot of LP playing troubles on the amplifier again. Poor transient response. Audio sure is fun.

**Bartok, Divertimento for Strings.**  
String Orchestra conducted by Tibor Serly.

**Bartok LP**  
BRS 005

**Poulenc, Le Bal Masqué.**  
Instrumental group conducted by Edvard Fendler; Warren Galjour, baritone.

**Esoteric LP:**  
2000 (10")

Back in ye olde days, before World War II and Microgroove had hit the recording industry, it was always assumed by us musicians that the more esoteric the music, the worse the recording, and the rule almost never failed. Indeed, the real recordphiles were proud of those faint, raspy bits of music that managed to penetrate the roaring, whirling noise of old fashioned low-grade shellac! It was considered a point of honor not to complain about small-company recording because, after all, the biggies had a monopoly of sorts on recording know-how and matériel; small-company recording was a labor of love.

And just look. The above two items are merely two of dozens and dozens, as this department will repeatedly point out, that in pre-LP days would have never made contact with a mike. Both of the two are herewith presented on the excuse, not of good music (which they are), but of good recording. With tape, quality processing and pressing, you can do a first class job these days on a sub-microscopic basis (Esoteric has, at this point, I think, made three records) and stay in business, too.

The Bartok item is one more in a continuing fresher of highly professional Bartok recordings (B. is delightfully susceptible to good wide-range treatment) from numerous sources. This source is the composer's son who is in a rather unique position, an electrical engineer by trade, with his own recording studio, and an unprecedented wealth of musical connections (plus as one might guess, a useful musical ear, inherited!). Bartok recorded by Bartok, then, will always be worth watching and hearing. My only criticism of this recording is acoustical: what seems to have been a one-mike pickup has missed the psychologically perfect spot by a bit, giving a slightly narrow, distant effect instead of a broad, deep perspective. Otherwise, a first class LP of string playing, and a lot of it you'll find not at all harsh or difficult in the listening.

Poulenc is another of those snazzy "bumtuous musical upstarts" (see last month's mention of Francaix) that France produced after World War I. Poulenc's music, though it is always clever, witty, technically accomplished, can be downright annoying—one feels he could have done so much more. However, the present "cantata" for solo voice and a rich collection of highly

# Air-Tone HEADQUARTERS FOR Magnecord.

Air-Tone offers Magnecord recording equipment for radio stations, motion pictures, business, recording studios. Easy operating, Magnecord provides unusually high fidelity, plus great flexibility in use, for outstanding realism in tone.



**PT6-JA Recorder & Amplifier**  
Portable rig for professional, superb reproduction of all types of program material. 10-Watts output. Highest Quality. Greatest Value. \$499.50



**PROCTOR SOUNDEX PLAYBACK UNIT**  
Floating Disc Drive Multi-speed Turntable. 20 to 120 R.P.M. Instantly shifts to 33 1/3-45-78 R.P.M. Eliminates speed variations. 16" turntable.

Turntable . . . . . \$138 net

**NEW SOUNDEX PICKUP ARM**  
Interchangeable cartridge carriers. Instant substitution of standard or microgroove cartridges. Self-contained stylus pressure scale. Precise pressure adjustment in grams. Arm . . . . . \$39.60 net

# Air-Tone

**SOUND & RECORDING COMPANY**

1527 CHESTNUT ST., PHILA. 2, PA. — RI. 6-8388

## INTERMODULATION SET For . . . . . DISTORTION TESTING and ANALYSIS at LOW COST

WITH MODEL 162, using charts like these you can measure and analyze the performance of an amplifier or a complete system at a glance. Significant distortion is shown much more clearly by the intermodulation method than by trying to see directly the distortion of a single frequency wave on an oscilloscope screen.

Use your own audio oscillator and oscilloscope with MODEL 162 to identify these faults: wrong bias, wrong load impedance, tube unbalance, regeneration, insufficient drive capacity. For the first time phonograph pick-up distortion can be tested at low cost with an intermodulation record.

Curves and pictures in instruction book tell how to read intermodulation percentage directly, how to determine harmonic distortion, how to adjust an amplifier for best performance quickly by using the screen images as a guide.

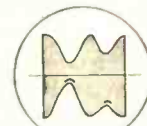

INCORRECT ADJUSTMENT

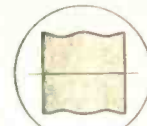

CORRECT ADJUSTMENT

Experience shows that an amplifier adjusted for low IM will also have low harmonic distortion, but the reverse is not true. Low harmonic distortion does not assure low IM.

This unit tests over a wide frequency range and at 1:1 or 4:1 voltage ratio of the two frequencies. It permits separate testing of low and high frequency overload.

It uses basic relation between total notch depth and percent of intermodulation. Using special screen supplied with unit, you can read percent of IM directly on the oscilloscope image.

### TEST FREQUENCIES

Low: Any frequency from 10 to 250 cps. from external oscillator or 60 cps. from power line via internal transformer.

High: Any frequency above 2000 cps. from external oscillator.

Price \$88.50

COMPLETE INFORMATION ON REQUEST

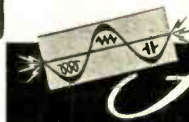

**Audio INSTRUMENT COMPANY**  
1947 BROADWAY NEW YORK 23, N. Y.

**WANTED**

**Business Opportunity**

Graduate Engineer, member AIEE, IRE, Acoustical Society of America, registered professional engineer, experienced in management and operation of business, wants responsible position in established radio, television, electronics or acoustical manufacturing enterprise. Willing to make substantial five-figure investment if opportunity warrants. Write Box 357, Audio Engineering.



**HOW LEADING NETWORKS USE Carter CONVERTERS**

Photo above shows NBC's Tommy Bartlett and Universal Recording Company engineers making transcriptions from STORAGE BATTERY POWER by means of Carter Frequency Controlled Converter.

Wherever 115v. line voltage is not available, or hard to get, Carter Converters supply dependable AC power to make on location recordings. Operates from storage batteries. . . . Used by leading networks, broadcast stations, and program producers.

Recommended by Brush and Magnecord

One model operates both Brush and Magnecord equipment. Delivers clean 60 cycle AC power. Requires no filtering. Frequency control feature compensates for 10% input voltage variation. Available for 6, 12, 24, 28, 32, 64, and 115v. DC input voltage. Size 8 1/2" x 5 3/4" x 7 1/2" high. Weight only 15 3/4 lbs. Performance Guaranteed!

**MAIL COUPON FOR FREE CATALOG**

New Converter catalog illustrates entire line of Carter Rotary Converters for recording, TV, sound projection and transcription players. **SELECTOR CHART** included tells model to suit your purpose. Mail Coupon now for your copy and name of nearest Carter distributor.



**Carter**

MOTOR CO.

2648 N. MAPLEWOOD AVE., CHICAGO 47

Carter Motor Co.  
2648 N. Maplewood Ave.,  
Chicago 47, Ill.

Please send catalog #349 with information on Frequency Control Converters, and name of nearest distributor.

Name .....

Station or .....

Company .....

Address .....

colored solo instruments, while as crazy as a coot in its French text, has a lot of stuffing to it, behind the slightly decadent *décor*. Whether you like it or not will depend on your taste for the esoteric—this is *really* esoteric. (If you liked the Walton-Sitwell "Facade" recording of last year, You'll find this in a similar vein.) I can highly recommend it on the basis of excellent, wide-range recording, rather dry and sharp, well suited to the slightly acid music. Same tape job as Esoteric's recent Schoenberg "Serenade," which this column passed over with eyes slightly averted in the interests of peace and quite among engineers. (Well . . . now that it's out, let's say no more than that the "Serenade," beautifully recorded, with mandolin and guitar effects, is musically just a bit troublesome to the untrained ear—it's likely to suggest back fence cats, though I can assure you it is quite unrelated to any feline variety of ululation. Actually it is an important and rewarding work when you get your ears used to it.)

**Schubert, Songs for Unaccompanied Male chorus.**

RCA Victor Chorale, Shaw.  
RCA Victor 45:  
WDM 1353 (3)

**Britten, A Ceremony of Carols (Women's voices).**

RCA Victor Chorale, Shaw.  
RCA Victor 45:  
WDM 1324 (3)

Here is music, both old and modern, that is infinitely removed from the brassy, witty Poulenc. Here you have romance, mysticism, sweetness and light. The RCA Victor chorale, split into its opposite sexes, does a fine job on both of these, and the recording is top quality. (Note—believe it or not, there *are* a couple of overloaded loud passages here—not serious: but could it be the phenomenon noted in the disquisition at the head of this column?)

The Schubert songs are the profoundly beautiful ancestors of today's German beer garden singing, and for that matter, of all of our familiar men's glee club stuff. It is sentimental, sweet music, that almost sings itself—it brings tears to any bass or tenor who lets himself loose in it. But in Schubert, sentiment never gets out of hand at the expense of musical values—these are priceless songs, ranking with the great Schubert *lieder* for solo voice and piano.

Britten's "Ceremony of Carols," originally intended for boys' voices, is a continuous work based on a whole group of English carols, many of them the beautiful ones that have come down from the Middle Ages. Britten is a top choral composer, and these slightly mystic, slightly acid choral settings, unaccompanied, are vocal naturals—the voices "sound like angels," as the old saying goes. These albums make a wonderful bit of contrast to mix in with your all-instrumental record collection. Available on 78, too, but not LP.

**Sibelius, Symphony #2.**

Royal Philharmonic, Beecham.  
RCA Victor 45:  
WDM 1334 (5)

Funny—at this point I feel the need (after Poulenc, Schoenberg, Bloch, et al) of a slightly more standard item of repertory, and it seems that actually there haven't been too many such, relatively speaking, in the last month or so. (A batch of conventional items is soon due from RCA and Columbia, though.) This is the best I can do for the moment—and it surely is as standard as you can get. The only difficulty here is the usual one with RCA re-pressings

**HENRY J. GEIST**

&  
**ASSOCIATES**

REPRESENTING:

**RAYTHEON**

**ANDREW**

**WINCHARGER**



Cinema Engineering Co.  
Hughey & Phillips Co.  
Weston Instrument Co.  
Stancil-Hoffman Corp.  
Minnesota Mining & Mfg. Co.

Everything for  
**The Broadcaster**

60 EAST 42<sup>ND</sup> STREET  
NEW YORK 17, N.Y.  
MURRAY HILL 7-1550

STRIKE BACK

**Give**  
TO CONQUER CANCER



AMERICAN CANCER SOCIETY

**AUDIO ENGINEERING SCHOOL**

Practical engineering training in Audio fundamentals, Disc, Film, Magnetic Recordings, and Audio frequency measurements.

Studio training simulates Broadcast, Motion Pictures, Television, and Commercial Recording work.

Approved for Veterans

Hollywood Sound Institute, Inc.

1040-A North Kenmore, Hollywood 27, Calif.

Correspondence Courses Available

Specify if Veteran or Non-Veteran



## HIGH "Q" DECADE-INDUCTORS



**HYCOR DECADE**—Inductor units are indispensable for design and experimentation work on audio filters.

The units are available in four ranges up to 10 henries. Units may be used individually or all four may be connected in series to obtain 11.11 henries in 1 millihenry steps.

Toroid coils are used to obtain high "Q", stability and low pickup from external fields. Inductance accuracy is 2%.

The units are economically priced to bring them within the reach of all audio experimenters. Send for Bulletin D.

**THE HYCOR COMPANY**  
11423 VANOWEN ST.  
NORTH HOLLYWOOD, CALIF.



**FM**   
NC 108T  
**TUNER-RECEIVER**

"... the only FM tuner that can accomplish satisfactory separation."

An audio fan, living in Connecticut, wrote us that the National 108T was the only FM tuner he had tried that could separate New York's WQXR and WNYC from two powerful local FM stations—AND at no sacrifice in fidelity (40—15,000 c.p.s.,  $\pm 2$ db). The NC-108T can also be used as a complete receiver, with built-in monitoring speaker. Write for details.



of the Royal Philharmonic: beautiful acoustics, fine playing, everything, indeed, excellent, except the upper tonal range, which is just plain missing. It's missing on the 45's as well as the 78's. The originals are supposedly in the new E.M.I. series that is cut to 20,000 cps. Maybe I'm wrong—but my ear still hears no highs. Judge for yourself—if you enjoy Sibelius and if you appreciate beautifully slick, juicy mike pickup in the best British manner, you won't miss the highs a bit.



## Employment Register

POSITIONS OPEN and AVAILABLE PERSONNEL may be listed here at no charge to industry or to members of the Society. For insertion in this column, brief announcements should be in the hands of the Secretary, Audio Engineering Society, Box F, Oceanside, N. Y., before the fifth of the month preceding the date of issue.

● **Electrical Design Engineer Wanted:** By large, modern, Eastern manufacturing firm for experimental development work in industrial electronics. Applicant must have degree in electrical engineering with communications or electronic option or equivalent in 10-15 years practical experience. Give details, including age, education, experience, references, availability, and salary expected. Box 401.

● **Audio Engineer.** BS in radio from NYU, 26, married. Well versed all phases comm'l disc and tape rec'dg. Presently employed large NYC studio, but not happy. A "future position" more desirable than a "present job." 9 yrs audio exp; available immediately, NYC metropolitan area. Box 501.

● **Audio and Electrical Engineer:** MS in physics; MS in EE. 10 yrs research, development, and design experience with magnetic and disc sound recording, acoustic measurements, and transducers. Also experienced in magnetic recording systems for computer applications. In present position for 10 years, but desire change to smaller company or consulting firm. Box 402.

● **Audio Engineer.** BEE from CCNY, 25, married. Superior knowledge of music; some informal experience with magnetic recording. Desire position in audio. Salary and location secondary. Box 301.

● **Audio Engineer:** M.S. Physics, Electrical Engr; ten years research, development, design experience with sound recording, acoustic measurements, and transducers. Thorough bkgnd in magnetic and mechanical recording including magnetic recording systems for computer applications. Presently employed, prefer firm in which could invest capital, small city or suburban location. Box 201.

● **Graduate VTI:** employed at present. Desires position in audio field. Some experience. Age 20, single, and in good health. Willing to learn, and will go anywhere. Box 202.

● **Audio Engineer:** experienced man with family desires position in recording, broadcasting, film, or TV sound. Excellent operator, troubleshooter, and maintenance man. Superior knowledge of classical music. Studio and equipment design and construction experience. Fluent English, French, and German. Willing to relocate. Box 203.

# ALTEC'S..

# #1

where quality counts!



Altec speakers remain the first choice of quality-conscious engineers and music lovers everywhere. The Diacone speakers, using a metal high frequency diaphragm plus a low frequency cone combine wide frequency range, exceptional fidelity and efficiency with moderate cost. They are ideal for multiple installations where quality is a must but where cost is still an important factor. Music lovers acclaim their smoothness of response... engineers their wide application.

15" 603B Diacone has multicellular horn-dispersion of "highs," power capacity of 25 watts. 12" 600B is ideal for smaller rooms where quality is required at lower power. Handles 20 watts. 8" 400B gives large speaker performance with small size. Handles 12 watts.

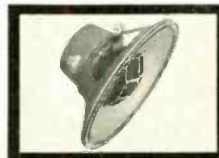

603B



600B



400B

Send for brochure giving complete technical data on all Altec speakers.



1161 N. VINE ST., HOLLYWOOD 38, CALIF.  
161 SIXTH AVE., NEW YORK 13, NEW YORK

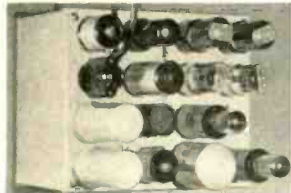

20 W-2 Amplifier \$149.50



AE-2 Equalizer PreAmp \$74.50

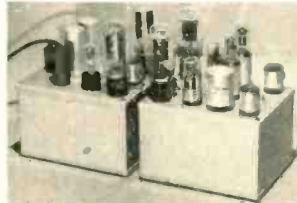

50 W-2 Amplifier \$249.50

# McIntosh

Engineering Laboratory, Inc.  
910 King St. Silver Spring, Md.  
Prices Subject to Change Without Notice.

## MORE HARTLEY-TURNER HI-FIDELITY DEVELOPMENTS.

A recent letter from N. J. says, about the 215, "I have heard several of these units in operation and being a true high fidelity enthusiast, must admit the results were amazing - all I can say is that if you people have more products like this, I sure will use them".

We have designed two new amplifiers, of 14 and 20 watts output, having practically no distortion at full output, and exceptional stability on transients. Unlike our kit type amplifiers these are completely assembled with the power supply on a single 12" x 8" chassis, and are not sold as kits of parts. Full details of these are being posted to everyone on our mailing list.

With this comes a new pre-amplifier and tone-control unit giving complete tone-correction for all requirements including microgroove records. It can be used remote from the main amplifier and should be included with the playing desk for complete control "at your elbow".

Our new lightweight pick-up is nearly ready (we are sorry about the delay, but we wanted to make sure it was a good job) and this will be suitable with interchangeable styluses for standard and microgroove. And we are working hard on that 3-speed motor.

All this equipment will ensure that you can feed undistorted signals into your 215 speaker, but we do not claim for it the same exceptional merits as the speaker. We are fundamentally speaker designers but we have never been free from insistent demands from users of our speakers that we build equipment of like performance. In producing it, therefore, we are not starting competition with other equipment manufacturers, but merely trying to satisfy a demand from music lovers who say they cannot get the results they want elsewhere.

Meanwhile your best buy today is the Hartley-Turner 215 Speaker.

Price only \$40.00, postage and insurance paid. Don't forget that, other best buy in high-fidelity technique "New Notes in Radio", which, together with a continuing supply of technical data sheets, costs you only a dollar bill. Descriptive literature is free.

**H. A. HARTLEY Co. Ltd.**  
152 HAMMERSMITH ROAD,  
LONDON W.6, ENGLAND.

## ADVERTISING INDEX

Acro Products Company	42
Air-Tone Sound & Recording Co.	45
Altec Lansing Corp.	26, 41, 47
American Microphone Co.	40
Amperite Co., Inc.	44
Ampex Electric Corp.	42
Amplifier Corp. of America	38
Arnold Engineering Company	2
Arrow Electronics Company	34
Astatic Corporation, The	28
Atlas Sound Corp.	42
Audak Company	25
Audio Devices, Inc.	Cover 2
Audio Facilities Corp.	43
Audio Instrument Company	45
Audio Pacific Company	30
Barker Natural Sound Reproducers	40
Belden Manufacturing Company	9
Bell Telephone Laboratories	10
Berlant Associates	29
Bozak, R. T.	32
Browning Laboratories, Inc.	35
Camera Equipment Co.	V15
Cannon Electric Dev. Co.	1
Carter Motor Company	46
Cinema Engineering Company	38
Electronic Decorators	30
Electro-Voice, Inc.	V2
Fairchild Recording Equip. Corp.	23
Freed Transformer Co., Inc.	Cover 3
Garrard Sales Corp.	32
Geist, Henry J. & Assoc.	46
Gordon, Herman Lewis	43
Hartley, H. A. Co., Ltd.	48
Harvey Radio Company, Inc.	31
Hayes, Albert E., Jr.	43
Heath Company	39
Hewlett-Packard Co.	5
Hollywood Sound Institute	46
Hycor Company, The	47
Jensen Manufacturing Co.	3
JFD Manufacturing Co., Inc.	V14
LeBel, C. J.	43
Lowther Mfg. Co., The	34
Magnecord, Inc.	27
Magnetic Recorders Co.	40
Maurer, J. A., Inc.	V16
McIntosh Engineering Lab, Inc.	48
Measurements Corp.	42
National Company, Inc.	47
Newcomb Audio Products	43
Partridge Transformers, Ltd.	48
Permoflux Corporation	37
Pickering & Co., Inc.	7
Proctor Soundex Corp.	4
Professional Directory	43
Radio Corp. of America (Tube Dept.)	44
Rek-O-Kut Company, Inc.	39
Sonar Radio Corp.	36
Sonocraft Corporation	44
Sun Radio & Electronics Co., Inc.	41
Terminal Radio Corp.	33
Triad Transformer Mfg. Co.	8
United Transformer Corp.	Cover 4
U. S. Recording Co.	43
Wireless World	48



## Partridge News

Individuality tested  
**AUDIO TRANSFORMERS**  
to the 'WILLIAMSON'  
Specification

This range of 20 watt push-pull output transformers is intended for use in equipment reproducing the full audio frequency range with the lowest distortion. The design and measured performance is exactly as specified by Williamson in the "Wireless World" August 1949 (see also Audio Engineering November 1948). The transformer is available in a varied range (separate models suitable for KT66, 807 tubes, etc.) Performance assured by comprehensive testing procedure applied to each unit. Close limits set on shunt reactance at 50 cps., series reactance at 5 Kc/sec., d.c. resistances and interwinding insulation resistances at 2 K.V. This is the best possible transformer of its type (weight 14 lbs.) Our new technical data sheet is available and will be rushed to you by airmail upon application. The price of the potted model is \$19.50 post free to your door. Immediate from our stocks.



**PARTRIDGE**  
**TRANSFORMERS LTD**  
Roebuck Road, Tolworth, Surrey, England

## Wireless World keeps you up-to-date on all British developments in radio and television

WIRELESS WORLD is Britain's leading technical magazine in the radio, television and electronic fields. For 39 years it has consistently provided a complete and accurate survey of the newest British techniques in design and manufacture. Articles of a high standard include reviews of equipment, broadcast and television receivers and components, while theoretical articles deal with design data and circuits for every application.

★ Readers of "Audio Engineering" will recall the recent article "Musician's Amplifier" describing an adaptation of the Williamson high-fidelity amplifier originally published in "Wireless World." A 32-page booklet on the 15-watt Williamson amplifier, which has achieved a wide-world reputation for high-quality reproduction, is now obtainable price 75c. from "Wireless World," Dorset House, Stamford Street, London, S.E.1, England.

## Wireless World

Britain's Leading Technical Magazine  
on Radio, Television and Electronics  
**PUBLISHED MONTHLY**

Single Copies 50c. 12 months Subscription \$4.50

Write for free sample copy to :-  
BRITISH PUBLICATIONS INC.,  
150 EAST 35th STREET, NEW YORK 16, N.Y.

# FREED

## Instruments & Components

*Famous for*

• **QUALITY**

• **ACCURACY**

• **DEPENDABILITY**

**"PRODUCTS of  
EXTENSIVE RESEARCH"**



### "Q" INDICATOR

No. 1030 **FREQUENCY RANGE:** From 20 cycles to 50 kilocycles. **"Q" RANGE:** From 0.5 to 500. "Q" of inductors can be measured with up to 50 volts across the coil. Indispensable instrument for measurement of "Q" and inductance of coils, "Q" and capacitance of capacitors, dielectric losses, and power factor of insulating materials.

### INCREMENTAL INDUCTANCE BRIDGE

No. 11.0 **IMPEDANCE RANGE:** One mh. to 1000 h. in five ranges. Inductance values are read directly from a four dial decade and multiplier switch. This range can be extended to 10,000 henries by the use of an external resistance.

**INDUCTANCE ACCURACY:** Within plus or minus 1% through the frequency range from 60 to 1000 cycles.



**NOW AVAILABLE**  
SUB-MINIATURE HERMETICALLY SEALED J.A.N. COMPONENTS FOR SPACE SAVING APPLICATIONS.



Sub-miniature HI- $\Omega$  inductors featuring toroid coils — Diameter:  $\frac{7}{8}$ " x 1" high. Hermetically sealed. Compression type terminals.



Sub-miniature hermetically sealed transformers — Diameter:  $\frac{13}{16}$ " x 1" high . . . Glass type terminals.



Sub-miniature transformers with octal sockets.

**ALSO** . . . **MAGNETIC AMPLIFIERS DISCRIMINATORS AND NARROW BAND PASS FILTERS FOR TELEMETERING APPLICATIONS.** Send us your requirements.

## A NEW LINE OF HIGH FIDELITY OUTPUT TRANSFORMERS



High quality output transformer combines unusually wide frequency range together with very low phase shift and harmonic distortion. Frequency range  $\frac{1}{2}$  Db  $\pm$  30,000 cycles.

Type No.	Primary matches following typical tubes	Primary Impedance	Secondary Impedance	$\pm$ 1/2db from	Maximum level
F1950	Push pull 2A3's, 6A5G8's, 300A's, 275A's, 6AZ's, 5L6's.	5000 ohms	500, 333, 250, 200, 125, 50	20-30000 cycles	15 watts
F1951	Push pull 2A3's, 6A5G8's, 300A's, 275A's, 6AZ's, 5L6's.	5000 ohms	30, 20, 15, 10, 7.5, 5, 2.5, 1.2	20-30000 cycles	15 watts
F1954	Push pull 2A5, 250, 6V6, 42 or 2A5 A prime	8000 ohms	500, 333, 250, 200, 125, 50	20-30000 cycles	15 watts
F1955	Push pull 2A5, 250, 6V6, 42 or 2A5 A prime	8000 ohms	30, 20, 15, 10, 7.5, 5, 2.5, 1.2	20-30000 cycles	15 watts
F1958	Push pull 685 6A6, 53, 6F6, 59, 79, 89, 6V6, Coss 3 46, 59	10,000 ohms	500, 333, 250, 200, 125, 50	20-30000 cycles	15 watts
F1959	Push pull 685 6A6, 53, 6F6, 59, 79, 89, 6V6, Coss 3 46, 59	10,000 ohms	30, 20, 15, 10, 7.5, 5, 2.5, 1.2	20-30000 cycles	15 watts
F1962	Push pull parallel 2A3's, 6A5G's, 300A's, 6AZ's, 6L6	2500 ohms	500, 333, 250, 200, 125, 50	20-30000 cycles	36 watts
F1963	Push pull parallel 2A3's, 6A5G's, 300A's, 6AZ's, 6L6	2500 ohms	30, 20, 15, 10, 7.5, 5, 2.5, 1.2	20-30000 cycles	36 watts
F1966	Push pull 5L6 or Push pull parallel 6L6	3800 ohms	500, 333, 250, 200, 125, 50	20-30000 cycles	50 watts
F1967	Push pull 6L6 or Push pull parallel 6L6	3800 ohms	30, 20, 15, 10, 7.5, 5, 2.5, 1.2	20-30000 cycles	50 watts

**SEND FOR LATEST CATALOG!**

**FREED TRANSFORMER CO., Inc.**  
DEPT. MA 1718-36 WEIRFIELD ST., (RIDGWOOD) BROOKLYN 27, NEW YORK



# COMPONENTS FOR EVERY APPLICATION



**LINEAR STANDARD**  
High Fidelity Ideal



**HIPERM ALLOY**  
High Fidelity . . . Compact



**ULTRA COMPACT**  
Portable . . . High Fidelity



**OUNCER**  
Wide Range . . . 1 ounce

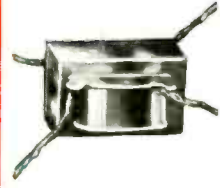

**SUB OUNCER**  
Weight 1/2 ounce



**COMMERCIAL GRADE**  
Industrial Dependability



**SPECIAL SERIES**  
Quality for the "Ham"



**POWER COMPONENTS**  
Rugged . . . Dependable



**VARITRAN**  
Voltage Adjustors



**MODULATION UNITS**  
One watt to 100KW



**VARIABLE INDUCTOR**  
Adjust like a Trimmer



**TOROID HIGH Q COILS**  
Accuracy . . . Stability



**TOROID FILTERS**  
Any type to 300KC



**MU-CORE FILTERS**  
Any type 1/2 - 10,000 cyc.



**EQUALIZERS**  
Broadcast & Sound



**PULSE TRANSFORMERS**  
For all Services



**HERMETIC COMPONENTS**  
Ceramic Terminals



**PLUG IN ADAPTER**  
Impedance Matching



**FOSTERITE**  
Grade 3 JAN Components



**CABLE TYPE**  
For mike cable line

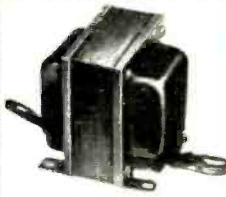

**VERTICAL SHELLS**  
Husky . . . Inexpensive



**REPLACEMENT**  
Universal Mounting



**STEP-DOWN**  
Up to 2500W . . . Stock



**LINE ADJUSTORS**  
Match any line voltage

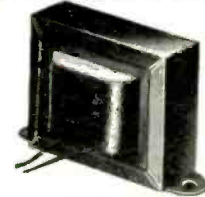

**CHANNEL FRAME**  
Simple . . . Low cost

*United Transformer Co.*  
 150 VARICK STREET NEW YORK 13, N. Y.  
 EXPORT DIVISION: 13 EAST 40th STREET, NEW YORK 16, N. Y. CABLES: "ARLAB"