

# AUDIO ENGINEERING

FEBRUARY

1950

*Conlon*

35c

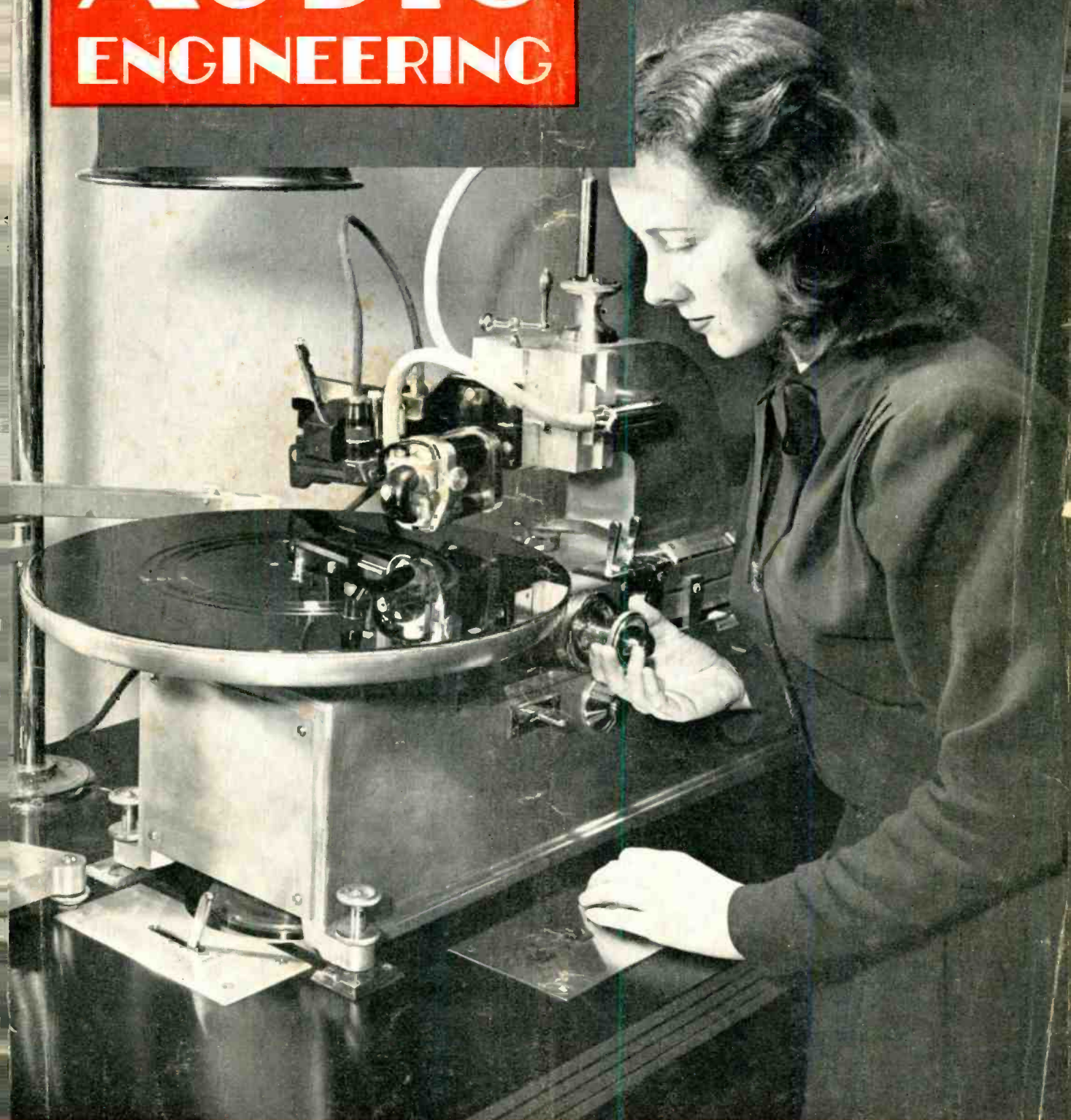

Published by RADIO MAGAZINES, INC.

# 12 Reasons Why **audiotape**\* can help you get the most out of your tape recorder!

1. AUDIOTAPE is wound on precision, all-aluminum reels.

2. AUDIOTAPE is cut by a superior straight-line slitting process which makes it track and wind absolutely flat.

3. AUDIOTAPE has no curl — lies flat on the magnetic head without increased tension, giving better frequency response and more uniform motion.

4. AUDIOTAPE has exceptionally low surface friction—reduces wear on heads.

5. AUDIOTAPE has definitely superior dispersion of oxide particles—no lumps, no bumps. This can be checked with any good microscope.

6. AUDIOTAPE is completely free from any tendency to stick, layer to layer.

7. AUDIOTAPE coating is specially formulated to give strong adherence of the oxide to the base.

8. AUDIOTAPE is designed to give maximum signal to noise ratio.

9. AUDIOTAPE has a wider bias range for optimum results — less sensitive to bias changes.

10. AUDIOTAPE has excellent high frequency response.

11. AUDIOTAPE has low distortion.

12. AUDIOTAPE has unequalled uniformity — within the reel, and from reel to reel. No magnetic weak spots that can cause fluctuations in output.

We know that every reel of AUDIOTAPE offers you all of these plus values — because all AUDIOTAPE is made in our own plant, under our own supervision and control, on machines designed by our own engineers. AUDIOTAPE is backed by over ten years of experience in producing professional quality recording discs. What's more, every foot of AUDIOTAPE is monitored for output, distortion and uniformity — your assurance of

the same consistent, uniform quality that has characterized AUDIODISCS for the past decade.

But why not try out a reel and let AUDIOTAPE speak for itself? Your AUDIODISC and AUDIOTAPE distributor will be glad to fill your requirements. And you're sure to be pleased with the professional discounts available. Or — we will be pleased to send you a 200 ft. sample reel of plastic or paper base AUDIOTAPE.

\*Reg. U. S. Pat. Off.



## AUDIO DEVICES, INC.

444 Madison Ave., New York 22, N. Y.

Export Dept. — Rocke International, 13 East 40th St., New York 16, N. Y.



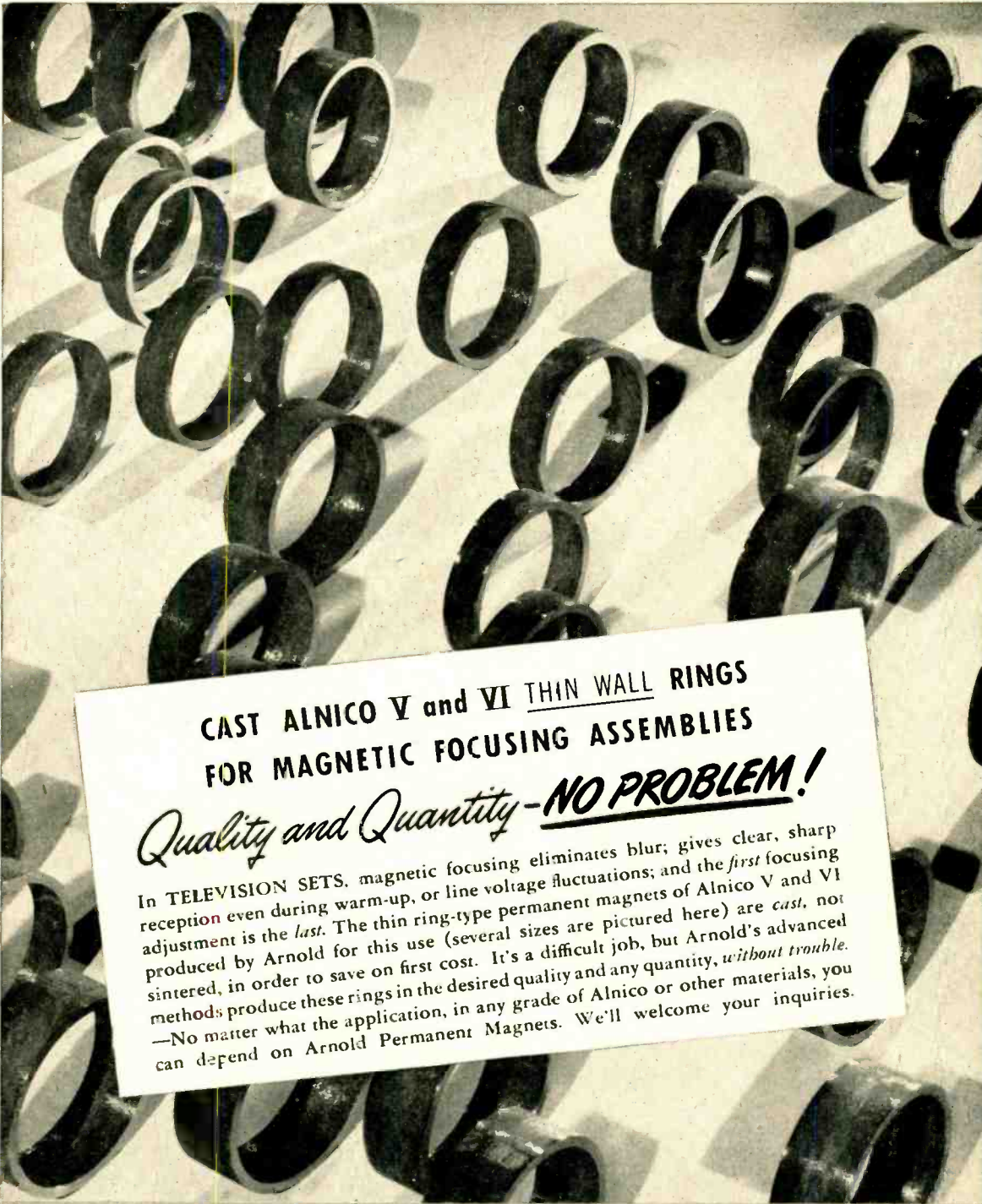

CAST ALNICO V and VI THIN WALL RINGS  
FOR MAGNETIC FOCUSING ASSEMBLIES

*Quality and Quantity - NO PROBLEM!*

In TELEVISION SETS, magnetic focusing eliminates blur; gives clear, sharp reception even during warm-up, or line voltage fluctuations; and the *first* focusing adjustment is the *last*. The thin ring-type permanent magnets of Alnico V and VI produced by Arnold for this use (several sizes are pictured here) are *cast*, not sintered, in order to save on first cost. It's a difficult job, but Arnold's advanced methods produce these rings in the desired quality and any quantity, *without trouble*. —No matter what the application, in any grade of Alnico or other materials, you can depend on Arnold Permanent Magnets. We'll welcome your inquiries.

**THE ARNOLD ENGINEERING COMPANY**



Subsidiary of

ALLEGHENY LUDLUM STEEL CORPORATION

147 East Ontario Street, Chicago 11, Illinois

*Specialists and Leaders in the Design, Engineering and Manufacture of PERMANENT MAGNETS*

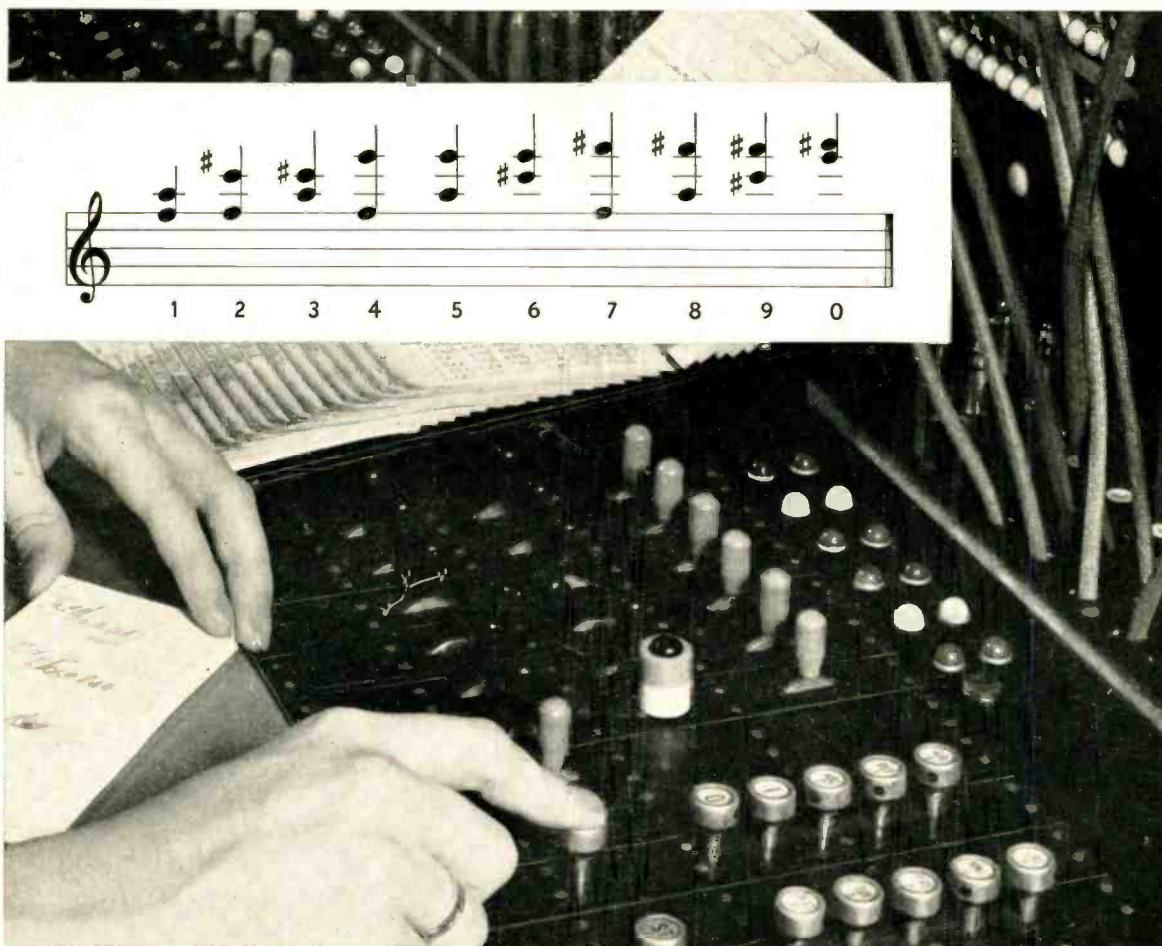

Above is the Bell System's new "musical keyboard." Insert shows the digits of telephone numbers in musical notation, just as they are sent across country.

## ***Playing a tune for a telephone number***

Before you talk over some of the new Bell System long distance circuits, your operator presses keys like those shown above, one for each digit in the number of the telephone you are calling. Each key sends out a pair of tones, literally setting the number to music.

In the community you are calling, these tones activate the dial telephone system, to give you the number you want. It is as though the operator reached clear across the country and dialed the number for you.

This system, one of the newest developments of Bell Telephone Laboratories, is already in use on hundreds of long distance lines radiating from Chicago, Cleveland, New York, Oakland and Philadelphia, and between a number of other communities.

It will be extended steadily in other parts of the country — a growing example of the way Bell Telephone Laboratories are ever finding new ways to give you better, faster telephone service.

**BELL TELEPHONE LABORATORIES**

Exploring and inventing, devising and perfecting, for continued improvements and economies in telephone service



# AUDIO ENGINEERING

Successor to **RADIO**

Established 1917



**C. G. McProud, Editor**  
 Luci Turner, Edit. Prod. Mgr.  
 David Saltman, Production Manager  
 E. E. Newman, Circulation Manager

**D. S. Potts, Publisher**  
 S. L. Cahn, General Manager  
 H. N. Reizes, Adv. Mgr.  
 Harold Weisner, Asst. Circ. Mgr.

**Editorial Advisory Board**

Howard A. Chinn  
 John D. Colvin  
 C. J. LeBel  
 J. P. Maxfield  
 George M. Nixon

**Representatives**

Sanford R. Cowan, Mid-West Sales  
 342 Madison Ave., New York 17, N. Y.  
 James C. Galloway, Pacific Coast Sales  
 816 W. 5th St., Los Angeles 13, Calif.  
 Technical Book & Magazine Co.  
 297 Swanston St., Melbourne, C. I.  
 Victoria, Australia

**CONTENTS FEBRUARY, 1950 Vol. 34, No. 2**

Editor's Report .....	4
Letters .....	6
An Improved Audio Frequency Phasemeter— <i>O. E. Kruse and R. B. Watson</i> .....	9
The Cathode Follower Output Stage— <i>Robert M. Mitchell</i> .....	12
Measurement of H-P Filter Characteristics— <i>Werner E. Neuman</i> .....	14
Magnetic Recording of Meter Data— <i>R. E. Zenner</i> .....	16
Audio Engineering Society Section Longitudinal Noise in Audio Circuits— <i>H. W. Augustadt and W. F. Kammberg</i> .....	18
Employment Register .....	21
Record Revue— <i>Edward Tatall Canby</i> .....	22
Pops— <i>Rudo S. Globus</i> .....	22
Audio Design Notes— <i>Willard F. Meeker</i> .....	23
Audiana—Phonograph Reproduction I .....	24
New Products .....	36
New Literature .....	47
Advertising Index .....	48

**COVER**

The Western Electric 2A disc recorder was developed to provide the same high quality in lateral recording for which the 1A recorder is known in vertical disc recording. Like the 1A, the 2A operates on the feedback principle in association with the Western Electric 115B amplifier.

AUDIO ENGINEERING (title registered U. S. Pat. Off.) is published monthly at Lancaster, Pa., by Radio Magazines, Inc., D. S. Potts, President; Henry A. Schober, Vice-President. Executive and Editorial Offices at 342 Madison Avenue, New York 17, N. Y. Subscription rates—United States, U. S. Possessions and Canada, \$3.00 for 1 year, \$5.00 for 2 years; elsewhere \$4.00 per year. Single copies 35c. Printed in U. S. A. All rights reserved. Entire contents copyright 1950 by Radio Magazines, Inc. Entered as Second Class Matter Dec. 29, 1949 at the Post Office, Lancaster, Pa. under the Act of March 3, 1879.

when you use  
 the **Audax**  
**POLYPHASE...**  
**ONE** single unit  
 plays **ALL**  
 your records  
**SUPERBLY...**  
 and at less  
 than the cost  
 of ordinary  
 magnetic pick-ups



Microgroove,  
 78 r.p.m., etc.

Only **\$11.70**  
 net cost to you—  
 believe it or not!

**"The Standard by which Others  
 Are Judged and Valued"**

Enjoyment of today's discs demands a single pick-up unit that yields such quality performance as you'd expect from two or more high grade magnetic units, each made expressly for a given type of recording.

Not only does Audax POLYPHASE accomplish just that . . . exciting admiration when you hear it, and performing vital functions that no other pick-up does . . . but it refutes the traditional idea that because Audax is so GOOD it costs more.

Wide range performance with any disc and only one point pressure for all (6 to 8 grams); sapphire styli (or diamond) each replaceable independently of the other by the user himself; output about 30 mv.; needle talk very low; ear quality, par excellence.

—See it at your local dealer—

Models also available for radio stations

**Write for Editorial  
 Reprint on  
 POLYPHASE Principles**

to Dept. 44

**AUDAK COMPANY**  
 500 5th Ave., New York 18  
*Fine Electro-Acoustical Units Since 1915*

# EDITOR'S REPORT

## UNANIMOUS LP's

**B**EFORE the January issue was in the hands of subscribers, RCA announced that sometime in March the Victor catalog would begin to become available on 33 $\frac{1}{3}$  r.p.m. Long Playing records, thus marking the end of the 78-45-33 "war" which has hamstrung the record industry for the last year and a half. Consumers have been sitting on the fence between three pastures, not knowing which way to jump. Now it seems that they will have to make the decision. In this column last month, we ourselves got off the fence, believing that the 78 is obsolescent, and that the 45 with its remarkable and well-designed changer would take over the field for short selections—with LP remaining the favorite for longer selections such as symphonies, concertos, and chamber music.

Without question, the Victor catalog is sufficiently important to the music lover that he could not afford to ignore it, even though it meant that it was necessary to complicate the reproducing facilities. Since most of the smaller companies—who are often responsible for the real gems of recorded music—are pressing exclusively on LP, and since *all* of the major companies are now on LP, there is no longer any need for indecision.

## DIMINISHING RETURNS

The question is often raised as to just how far it is possible to go in the search for perfection in sound reproduction. Admittedly, true perfection can never be reached in phonograph or radio reproduction because of the number of factors which are beyond the control of the individual. Regardless of how good a reproducing system may be, there are always possibilities that the record or the radio program or the intervening transmission medium may introduce distortions of one kind or another.

Consider, for example, the question of eliminating the output transformer from an amplifier used to reproduce radio programs. This seems a waste of time, for any radio station will have used dozens of them between the microphone's ribbon or voice coil and the modulator stage. Hundreds will be used in a transcontinental line. Will the elimination of one single transformer improve the over-all quality appreciably?

Good transformers are available, and in general they are trouble-free components—much more so than tubes, or even capacitors and resistors. A good output transformer may be costly, but it will continue to be reliable for many years, and in an experimenter's hands may do yeoman service in a number of different amplifiers.

Considerable attention is being placed, in recent years, on assemblies of tuners, phonograph turntables and pickups, amplifiers, and speakers. For a given amount of money, it is possible to put together a complete system

which is appreciably better than a complete commercially available radio-phonograph combination. Some of the better components are in themselves relatively expensive, but the principal factor in an assembly of this sort is that each separate unit may be replaced without disturbing the remainder of the system.

When a comparatively good system is so assembled, it is just possible that some corners may have to be cut to fit the pocketbook. A good amplifier will sound reasonably good with almost any speaker, even though the latter is not of the finest quality. It seems advisable, therefore, to select an amplifier which the user would consider as the ultimate if he were unlimited as to cost. The remainder of the equipment may be of somewhat lower quality, if necessary, as long as the end planning is based on the idea of gradual upgrading.

In making later improvements by replacing individual components, it would appear that the next item to change would be the loudspeaker, and this can be followed by the tuner or the phonograph equipment, whichever is the most used as a program source.

After arriving at near perfection by this process, additional expenditures may seem to produce only small improvements in reproduction. This is normal, and the time will come sooner or later when it does not seem possible to make any further improvement, although the true experimenter will certainly continue to try. The law of diminishing returns works with audio equipment as with practically any other, and the additional units of cost will make increasingly smaller increments in quality, so a decision regarding further changes must involve a consideration of economic as well as technical questions.

## NEXT MONTH

The March issue will be larger—by sixteen pages—than is normal for *AUDIO ENGINEERING*, for it marks the first appearance of a new quarterly supplement in the television field, under the title *VIDEO ENGINEERING*. Its content will be directed primarily to the engineers of TV broadcasting stations, and is planned to cover design, operation, and maintenance of studio equipment.

As a word of reassurance, Video will not encroach on Audio, and there will be as many audio articles as usual. Among them is a novel method of transient testing which may be employed by anyone with comparatively little trouble, and which will evaluate an entire system, from pickup to speaker.

Also scheduled is an informative paper, "Outline of Magnetic Tape Recording for Motion Pictures," by M. Rettinger, who has been closely associated with movie sound recording since its beginning. A radical new type of corner speaker will be described, and the issue will contain a number of other interesting articles.

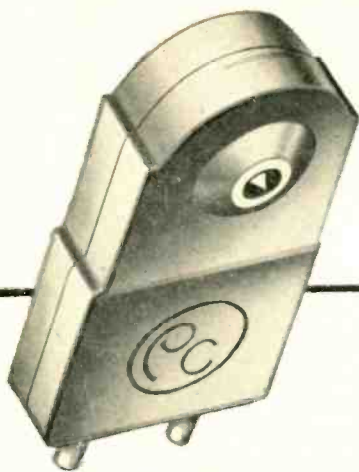

### PICKERING PICKUP CARTRIDGES FOR THE FINEST AUDIO QUALITY

No other Pickup will reproduce LP records with the fidelity of Pickering Cartridges . . . they are the most widely used by record manufacturers, recording studios, broadcasters and music enthusiasts who demand the effect of a live performance from their records.

The nearest approach to a live performance is a recording played by a system equipped with Pickering High Fidelity Audio Components . . . Speaker, Cartridge, Arm, Preamplifier, Record Compensator, etc.

Pickering Cartridges Series 120 and 150 are for standard records . . . Series 140 are for microgroove records . . . They track with phenomenally low record wear and virtually eliminate harmonic and intermodulation distortion as well as frequency discrimination . . . all Pickering Cartridges available with either sapphire or diamond stylus.



### RECORD COMPENSATOR MODEL 132E

This compensator, with 6 positions of equalization, provides the flexibility required to properly equalize for the different recording characteristics used by various record manufacturers . . . it is a most important addition to record playing systems using magnetic pickups.



### LOUDSPEAKER MODEL 180L

Designed to satisfy the musical ear. A low-cost high quality loudspeaker with smooth wide-range response (within 5 db, 45 to 12000 cycles) and low distortion . . . the only loudspeaker with acoustically adjustable bass response . . . occupies less floor space than any other high quality loudspeaker — less than one square foot.

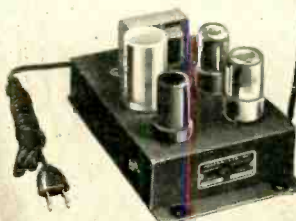

### PREAMPLIFIER MODEL 130H

This preamplifier represents the most advanced design ever achieved in phonograph preamplifiers . . . it equalizes the bass response of records and transcriptions and provides the necessary gain for high quality magnetic pickups . . . its intermodulation and harmonic distortion is exceptionally low — better than most professional equipment.

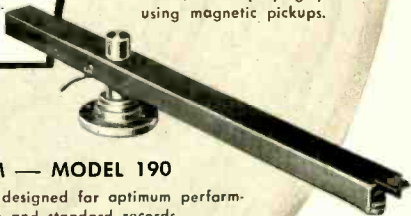

### PICKUP ARM — MODEL 190

The only arm specifically designed for optimum performance on both microgroove and standard records.

- Statically balanced to eliminate tendency to skip when jarred.
- Minimum vertical mass to track any record without imposing extra vertical load on grooves.
- Sensitive tracking force adjustment.
- Magnetic arm rest.
- Rugged frictionless bearings.
- Plug-in cartridge holder.
- One-hole mounting — self-contained levelling screws.

Cartridges used with this arm require 50% less vertical tracking force than when used in conventional arms.



For the finest audio quality specify Pickering Components

Oceanside, N. Y.

Pickering High Fidelity Components are available through leading jobbers and distributors everywhere . . . detailed literature will be sent upon request.

# LETTERS

## FM Quality

Sir:

The recent announcement by station WMCA (New York) that it was suspending operation of its FM affiliate should be of vital interest to readers of *AUDIO ENGINEERING*. Since the beginning of 1949, more than two hundred authorizations for FM stations have been returned voluntarily to the FCC by people who have no faith in the economic future of the medium.

I believe that one item that has contributed to this condition is the fact that the audio quality of FM broadcasts has not lived up to what audio enthusiasts have expected.

In my opinion, the average regular metropolitan pickup from such places as Carnegie Hall, Town Hall, the Brooklyn Museum, and other auditoriums from which a number of broadcasts originate, is superior in quality to programs emanating from regular broadcast studios. Most studio programs usually sound excessively brilliant on high frequencies and heavy on bass. Program quality varies greatly on the same station. It is also to be noted that in many instances solo instruments sound better than a full orchestra. These opinions are derived from listening with high-quality equipment.

In my experience I have found only one program of such high quality that the pres-

ence of a loudspeaker is completely eliminated, from a psychological concept.

Do readers agree with me in this matter? If so, can we do something about it?

C. Robert Schwartz,  
1975 Sedgwick Ave.,  
The Bronx, N. Y.

## Mathematics

Sir:

I wonder if anyone but perhaps RCA-Victor knows the true reason for the choice of 45 rpm for their seven-inch records?

Existing records were recorded at 78.26 rpm and 33.33 rpm—what was left? The difference, 78.26 - 33.33 = 44.93 rpm.

Alfred Thiele,  
1990 Eden Ave.,  
Glendale 6, California

## Bandwidth

Sir:

In a lecture before the Royal Arts Society not so long ago, Sir Malcolm Sargent, internationally known orchestra conductor, stated that one reason why a reproduced program never sounds exactly the same as the original is that musical instruments generate ultrasonic overtones which cross-modulate to produce audible sonic beat tones. Some of this cross-modulation may take place within the human auditory system, hence an audio reproduction system

must have an ultrasonic band-width to provide realistic reproduction.

Where sharply percussive signals with steep rise-times are concerned, fundamental repetition frequencies are of less significance than the leading wave-front which might be considered to be  $\frac{1}{2}$  of a high-frequency sine wave. Suppose, for instance, that a water tumbler shatters on a tile flooring within  $\frac{1}{150,000}$  of a second and the crash signal has a leading wave front with an equivalent rise-time. If this leading pulse is considered to be  $\frac{1}{2}$  of a sine-wave, then a sound reproducing system bandwidth of about 37 kc is required to pass it faithfully.

Applying this simple pulse-circuit analysis to musical instruments, we have an explanation for the puzzling strike-tone of percussion instruments. The striking hammer dents the string, bell, etc. in a tiny area, which then propagates along the instrument body as a high-frequency wave modulating the fundamental tone.

For these reasons, one must qualify the statement that "30 to 15,000 cps is the audible bandwidth" by inserting the words "sine-wave signal" ahead of the word "bandwidth"—just as one must include the word harmonic or non-linear when one speaks of so-called total distortion.

Ted Powell,  
5719 69th Lane,  
Maspeth, L. I., N. Y.

*When seconds count*  
**YOU'RE THERE WITH...**

**SAVES UP TO 500%  
ON HANDLING TIME**

**Handle up to 400 feet of mike cord with short cord ease**

Here's one of the handiest tools ever made for the Radio-Audio Engineer—for either in studio or outside use. Rugged... light weight... Saves time... gets the job done easier... faster... with less confusion... fewer jangled nerves. A must for every special events and remote crew.

**MAKES CORD LAST 5 TIMES AS LONG!**

PORT-O-REEL pays for itself in cord saved. Cord size governs capacity. Some stations and networks use over 400-ft. of 2-wire shielded mike lead, other units equip for 120-volt power transmission. Unwind cord needed... set brake.

Reel turns with operator as cord is drawn off. Non-slipping... non-tipping. Re-wind 400 ft. of cord in only 40 seconds!

- Weighs only 9-lbs. without cord... Low, level-wind cord guide prevents kinks and knots.
- Available without cord or equipped with any standard cable and plugs to your specifications.
- Handy screw binding posts permit quick attachment or change of cord on unit.
- Available with receptacle in frame for plug-in of feeder cord or for attachment of feeder cord to screw binding posts.
- Moisture-proof running constant collector ring... reel out or wind while broadcasting... no audible sound through transmitter.

Patents and Patent Pending

Send for literature, prices and name of nearby distributor.

**INDUSTRIAL ELECTRICAL WORKS, 1505 CHICAGO ST., OMAHA 2, NEBR.**

**PORT O REEL**  
CORD SAVER

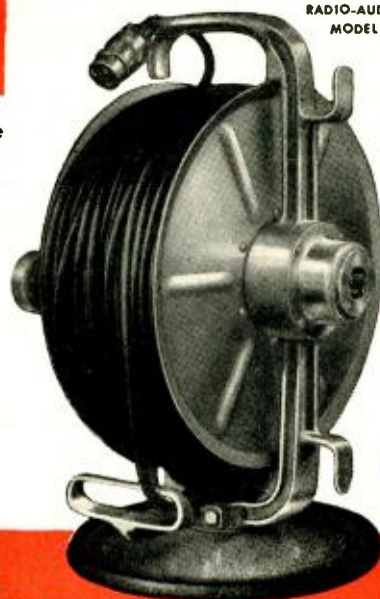

RADIO-AUDIO  
MODEL



**TV Engineers:**  
Ask about the  
3-phase  
Heavy Duty  
POWEREEL



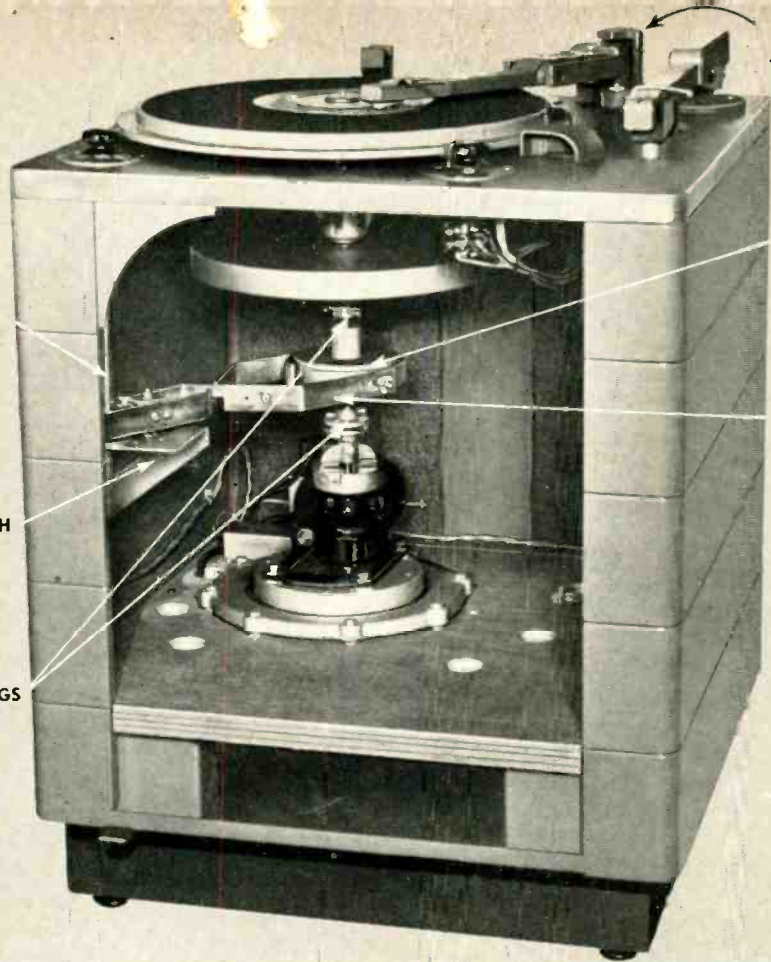

"45" RPM  
TONE ARM

CLUTCH  
ASSEMBLY

"BRAKE ARM"  
ASSEMBLY

SWITCH  
AND CAM SHAFT  
ASSEMBLY

MICROSWITCH

COUPLINGS

The new RCA 45 RPM Conversion Kit, MI-11883—installed. The kit is complete with (a) clutch assembly (speed changer); (b) brake-arm assembly; (c) switch and cam shaft assembly; (d) microswitch; (e) dial plate; (f) shaft coupling; and (g) adapter hub.

The fine-groove tone arm and pick-up for "45 RPM" are available extra.

# Play 45 RPM's on 70-series Turntables— with RCA Kit MI-11883

NOW you can handle 45's, 78's or 33-1/3's—fine-groove or standard—  
—with this kit, and a second tone arm (available extra).

#### Easy to install

You install the single-unit, ball-type speed reducer between the two flexible couplings in the main drive shaft of your turntable. You transfer the motor switch leads to the micro-switch—included with the kit. That's all there is.

#### Easy to operate

A motor-control knob on the deck of the turntable controls the speed. Position No. 1 stops the motor. No. 2 shifts the speed control to the 78-33 1/2

rpm speed-change lever (on turntable deck). No. 3 shifts to "45 rpm" position (speed lever set at 78 rpm). *You can shift speeds instantly in either direction while turntable is running.*

#### Same RCA broadcast dependability

Sturdy construction and accurate mechanical alignment assures you the same quiet, trouble-free service for which more than five thousand RCA turntables are famous.



**AUDIO BROADCAST EQUIPMENT**  
**RADIO CORPORATION of AMERICA**  
ENGINEERING PRODUCTS DEPARTMENT, CAMDEN, N. J.

In Canada: RCA VICTOR Company Limited, Montreal

### Order your kit (s) today

**RCA ENGINEERING PRODUCTS**  
**DEPT. 7 B, CAMDEN, N. J.**

- Send me \_\_\_\_\_ 45 RPM Conversion Kit (s) MI-11883 at once. Price each, \$70.00\*.
- Send me \_\_\_\_\_ fine-groove tone arm and pick-up (s), MI-11884. Price each, \$70.00\*.
- Remittance enclosed  Ship C.O.D.

NAME \_\_\_\_\_

ADDRESS \_\_\_\_\_

CITY \_\_\_\_\_ STATE \_\_\_\_\_

STATION \_\_\_\_\_ \*Price applies only in continental U. S. A.

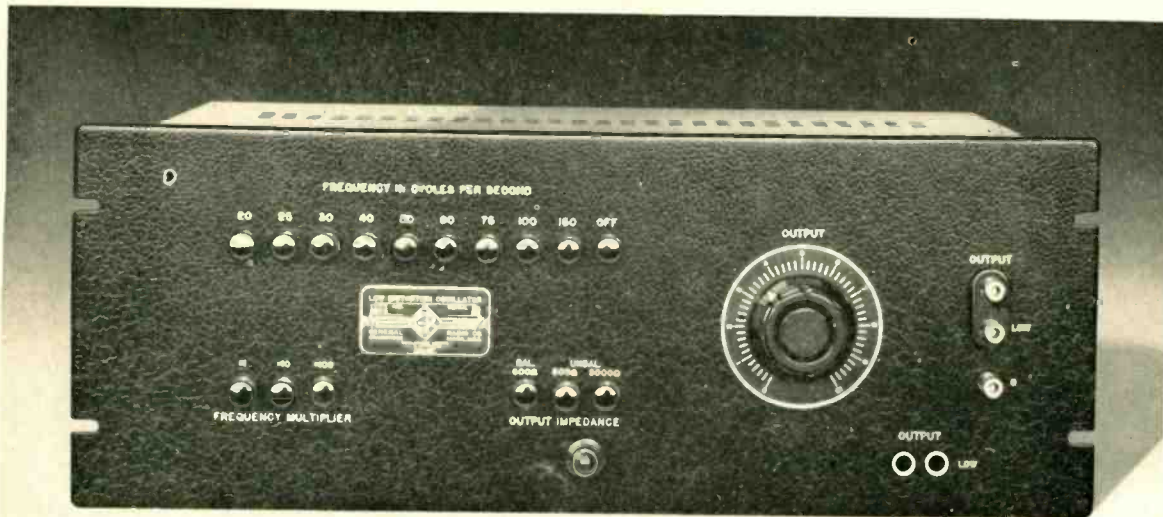

## for DISTORTION and BRIDGE MEASUREMENTS 2 to 15,000 CYCLES

This highly stable oscillator with unusually low distortion is of the resistance-tuned type and operates on the inverse feedback principle developed by General Radio.

The Type 1301-A Low-Distortion Oscillator is especially suitable as an a-f power source for bridge use, for general distortion measurements, to obtain frequency characteristics and to make rapid measurements of distortion in broadcast transmitter systems.

### FEATURES

- **Wide Frequency Range** — 20 to 15,000 cycles (with Range Extension Unit, 2 to 15,000 cycles).
- **Convenience** — 27 fixed frequencies, selected by two push-button switches in logarithmic steps — any desired frequency between steps obtained by plugging in external resistors.
- **Three Output Impedances** — 600-ohm balanced to ground; 600-ohm unbalanced; 5,000 ohm unbalanced.
- **Exceptionally Pure Waveform** — Distortion not more than the following percentages: with 5,000-ohm output 0.1% from 40 to 7,500 cycles; 0.15% at other frequencies. With 600-ohm output 0.1% from 40 to 7,500 cycles; 0.25% from 20 to 40 cycles and 0.15% above 7,500 cycles.
- **High Stability** — Frequency is not affected by changes in load or plate supply voltage. Drift less than 0.02% per hour, after a few minutes operation.
- **Accurate Frequency Calibration** — Adjusted to within  $\pm(1\frac{1}{2}\% + 0.1 \text{ cycle})$ .
- **No Temperature or Humidity Effects** — In ordinary climatic changes, operation is unaffected.

TYPE 1301-A LOW-DISTORTION OSCILLATOR \$395.00

• The normal range of this oscillator is 20 to 15,000 cycles. This Range Extension Unit lowers the range by a full decade to 2 to 15 cycles, greatly extending the oscillator's usefulness to frequencies considerably below those heretofore practicable.

With its very high stability, unusually low distortion and many operating conveniences, these two instruments fill a long-felt need in distortion and bridge measurements.

TYPE 1301-P1 RANGE EXTENSION UNIT . . . . . \$70.00



# GENERAL RADIO COMPANY

Cambridge 39,  
Massachusetts

90 West St., New York 6 920 S. Michigan Ave., Chicago 5 1000 N. Seward St., Los Angeles 38

An Improved

# Audio Frequency Phasemeter

O. E. KRUSE\* and R. B. WATSON\*

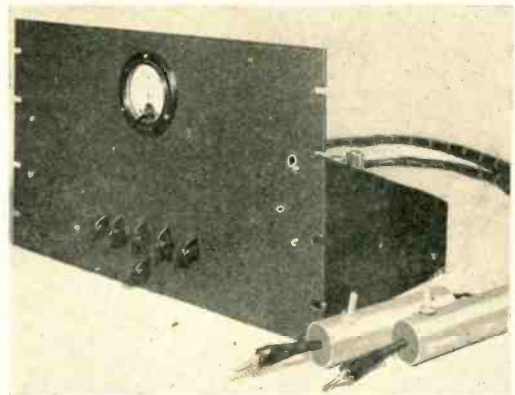

Description of an instrument designed to measure accurately the phase difference between two audio signals of equal or differing magnitude.

**E**LECTRONIC PHASEMETERS of the general type, which includes the phasemeter described herein, have been made in a variety of forms.<sup>1-4</sup> All of these phasemeters are based on the measurement of the time difference between points of zero voltage (or current) of two sinusoidal signals of the same frequency. One of the difficulties encountered in these phasemeters is the instability of reading which occurs when the phase angle is very near 0 deg. or 360 deg. or multiples thereof. The phasemeter to be described includes an alternate circuit arrangement which overcomes this instability. Another difficulty encountered in such phasemeters is the

requirement that each channel be exactly matched in phase. The calibration procedure used for this phasemeter is so arranged as to allow compensation for small phase differences between the two channels.

The various portions of the phasemeter are shown by the block diagram in Fig. 1. Two identical amplifier channels are used, including a cathode follower probe at each input. The amplifiers act as limiters in part, so that the outputs are in the form of square waves. A resistance-capacitance peaking circuit produces positive and negative pulses at the times corresponding to the axis crossings of the square waves. The pulse inverter in Channel B is assumed disconnected from the circuit for the moment. Each set of pulses is next clipped to remove the positive pulses; in each channel the resultant negative pulses are separated in time by a period of the input signal. The time interval between a pulse from Channel A and a pulse from Channel B is a measure of the phase angle between the two input signals, provided that the channels are identical. The outputs from the two channels are applied to a comparison circuit in the form of a two-tube trigger circuit. The negative pulses trigger this

circuit, so that one tube conducts for a portion of the period of the input signal proportional to the angle by which one input voltage leads the other and the other tube conducts for the remainder of the period. The indicating voltmeter is connected to these two tubes in a symmetrical manner, and its reading is proportional to the phase difference between the input voltages.

When the phase difference is nearly 0 deg. or 360 deg., the negative pulses arrive at the comparison circuit at nearly the same time. The trigger circuit may or may not operate, and hence, the voltmeter indication swings violently between 0 deg. and 360 deg. To avoid this difficulty, the pulse inverter is inserted in Channel B by means of the switch *S*. The inverter is arranged to produce pulses identical to those normally present at the input to the clipping circuit, except for the phase reversal. The clipping circuit operates as before to remove the positive pulses. The time interval between corresponding pulses in Channel A and Channel B is now approximately a half period, so that the trigger circuit operates dependably. The meter reading of 180 deg. must, of course, be interpreted as 0 deg. (or 360 deg.) under these circumstances.

\* Department of Physics, University of Texas, Austin, Texas.

<sup>1</sup> Edwin F. Florman and Andrew Tait, "An Electronic Phasemeter," *Proc. I.R.E.*, February, 1949, pp 207-210.

<sup>2</sup> E. R. Haberland, "Direct Reading Electronic Phase Meter," Naval Ordnance Laboratory Memorandum No. 7900.

<sup>3</sup> *Electronic Circuits and Tubes*, by the Electronics Training Staff of the Cruft Laboratory, Harvard University. McGraw-Hill Book Co., Inc., New York, 1947. pp 854-5.

<sup>4</sup> Edward L. Ginzton, "Electronic Phase-Angle Meter," *Electronics*, May, 1942, p. 60.

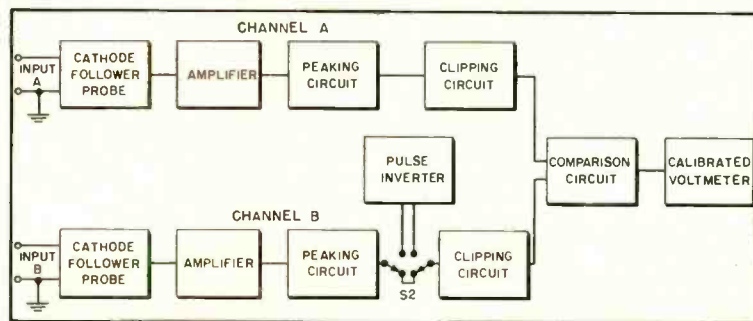

Fig. 1. Block diagram of phase measuring instrument employing two identical channels and a comparison circuit.

## Circuit Description

The cathode follower input probe (see Fig. 2) includes a voltage divider which may be set to produce a desirable voltage level at the input to the amplifier proper. A high resistance in series with this divider prevents any appreciable change in loading on the external source of voltage. The minimum input signal for satisfactory operation of the phasemeter is 1.5 volts, which produces a signal of 0.05 volts at the output of the cathode follower; in most of the testing of the meter an input signal of 4.5 volts was used. Overloading for higher voltages

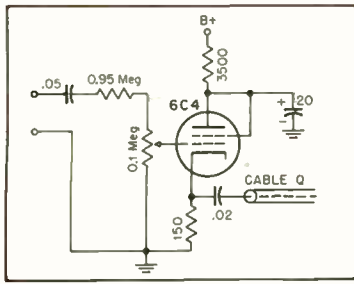

Fig. 2. Input probe with signal level adjustment built into the tube housing.

may be avoided by use of the input voltage divider so that the high voltage limit is set only by insulation requirements for the components used. It was found that with the particular circuit used the maximum allowable difference in voltage at the outputs of the two cathode follower probes was about 20 per cent.

The amplifier stages in the two channels are identical, there being five stages in each. A typical stage is shown in Fig. 3, together with the switching arrangement provided at the input to allow measurement of the input voltage with a vacuum tube voltmeter. To provide suitable bandwidth in frequency response, a small inductance is placed in series with each plate load resistance. A resistance is included in series with the input grid lead of each stage to provide for the necessary limiting to produce square waves at the output of each channel. The upper half-power frequency of each amplifier is of the order of several megacycles; the lower half-power frequency, determined by the coupling capacitor of 0.1  $\mu\text{f}$ , together with the grid resistor in the following stage, is about 2.5 cps. Each cathode bias resistor is made variable to allow proper alignment of these amplifiers.

The square wave output from each channel is applied to a peaking circuit consisting of a small capacitor (135  $\mu\text{f}$ ) in series with a resistor (39,000 ohms), as shown in Fig. 4. The output of the peaking circuit takes the form of a succession of positive and negative pulses through the resistor; these pulses correspond in time to the instants the original sinusoidally varying voltage passes through zero with negative and positive slopes respectively. The switch  $S_1$  allows these pulses to be removed during calibration. The pulse output from the peaking circuit is applied to a tube biased below cutoff to remove the negative pulses; the positive pulses cause the appearance of negative pulses at the output of this clipping circuit (see Fig. 4).

The two sets of negative pulses, one set from each channel, are then applied

to the comparison circuit Fig. 4, which is an Eccles-Jordan trigger circuit. If all the preceding circuits are identical in the two channels, and the pulse inverter circuit is disconnected, the pulses from the two channels arrive at the grids of the tubes in the trigger circuit separated in time by an amount directly proportional to the difference in phase of the two input voltages. Since the trigger circuit is stable in the absence of signals, one tube in this circuit will conduct for a portion of the period of the input voltage proportional to the phase angle between the two input voltages; the other tube will conduct for the remainder of the period. Assuming

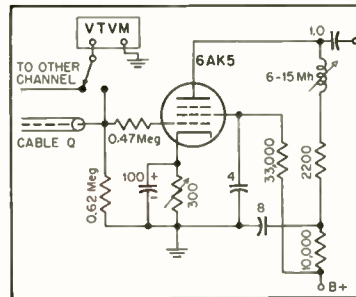

Fig. 3. Schematic of amplifier stage. Each channel employs five identical stages.

perfect symmetry in the trigger circuit, a zero-centered voltmeter may then be connected across points *A* and *B* (see Fig. 4) and may be calibrated in degrees phase difference. Continuous conduction by one tube will cause full deflection of the meter in one direction, corresponding to no phase shift between the input voltages; continuous conduction by the other tube will cause full-scale deflection in the opposite sense, corresponding to a 360 deg. phase angle between input voltages. The central position of the meter, on zero, indicates equal conduction on the average by both tubes and a phase shift, therefore, of 180 deg.

When the pulses arrive at the comparison circuit at almost the same time from both channels, that is, near 0 deg. or 360 deg. phase shift, the operation of the comparison circuit becomes somewhat unstable. The switch  $S_2$  is then thrown to its alternate position (see Fig. 4), which inserts the pulse inverting circuit in Channel B. This circuit is designed to supply to the clipping circuit inverted pulses of the same magnitude as before. Assuming perfect inversion, pulses arriving at the comparison circuit from Channel B are now displaced in time by an amount of half the period. Accordingly, when the two input signals are in phase, each tube in the comparison circuit conducts during alternate half cycles, producing a zero deflection of the voltmeter so that the

zero center now corresponds to 0 deg. (or 360 deg.) phase angle. Under these conditions, no instability occurs for signals which are in phase.

The power supply for these units is a conventional full-wave rectifier with a single pi-section filter, including an 8  $\mu\text{f}$  input capacitor protected against surges with a 100-ohm series resistor.

#### Alignment and Calibration

Prior to operation, certain alignment and calibration procedures are necessary. The alignment procedure is the semi-permanent process necessary to bring the two channels into approximate electrical equivalence. The calibration procedure is the relatively temporary adjustment of certain circuit elements each time the phasemeter is used.

For alignment, the input cathode followers and the amplifier stages in the two channels are checked pair by pair, using an electronic switch and an oscilloscope, to be sure that approximately the same phase shift is introduced by each channel, and that pulses of nearly the same amplitude are applied to both inputs of the comparison circuit. This procedure is somewhat laborious, and any deviations require careful checking of circuit components and careful placement of parts on the chassis. Final adjustment of each amplifier stage is made by varying the cathode bias resistor. It is not necessary that exact phase equality be obtained between Channels A and B. As will be shown, a difference of the order of 20 deg., for example, can be compensated for by the calibration procedure.

Two steps are involved in the calibration procedure. Switches  $S_1$  are opened first, thereby removing the pulses from the comparison circuit and leaving only one tube conducting in this circuit. The two 200-ohm resistors are set at their midpoints. The 30,000-ohm common cathode resistor is set at about half its total value, and the 1000-ohm resistor in the conducting stage is adjusted to produce full-scale indication of the voltmeter. The grid terminal of the conducting stage is now momentarily grounded, causing the other tube to become conducting. The 1000-ohm cathode resistor in this stage is now adjusted to give full-scale indication of the voltmeter in the opposite direction. Since these adjustments are not entirely independent, the procedure is repeated once or twice to obtain proper calibration.

The second step requires (when the pulse inverter is not in use) two input signals which are 180 deg. out of phase. Switches  $S_1$  are now closed. The voltmeter should indicate zero at the center of its scale. If this condition is not met exactly, due to unbalance between the

two amplifier chains, the two 200-ohm resistors should be adjusted by simultaneously increasing one and decreasing the other by an equal amount until the zero indication is obtained. When the pulse inverter is in use, this part of the calibration should be repeated with two input signals which are in phase and with switches  $S_1$  closed. The voltmeter again should indicate zero, and if it does not, the two 200-ohm resistors should again be adjusted to produce the zero reading. Since the phase shift introduced by the pulse inverter is a function of frequency, this adjustment should be made for every value of frequency used.

Following these adjustments, the phasemeter is ready for operation. The presence of small phase discrepancies between the two channels of the phasemeter is compensated for by this calibration procedure. During calibration, application of signals out of phase by 180 deg. causes each tube in the comparison circuit to conduct for approximately half of each cycle; if there is a phase discrepancy between channels, one tube will conduct a fraction  $h$  of a cycle more

where  $R$  is the initial cathode resistance for each tube measured from the cathode to point  $C$ . For this value to vanish,

$$I(2hR - D) = 0 \quad (3)$$

that is,

$$D = 2hR \quad (4)$$

is required to satisfy the experimental calibration condition. Of course the zero indication of the voltmeter is interpreted to mean 180 deg. phase difference between the input signals. When signals are applied to the phasemeter, which are removed  $\theta$  deg. from 180 deg., or a fraction  $g$  of the period from 180 deg., then the average voltage indicated by the voltmeter becomes:

$$V = I(R - D)(\frac{1}{2} + h + g) - I(R + D)(\frac{1}{2} - h - g) \quad (5)$$

which reduces by application of the calibration condition to

$$V = 2IRg = 2IR(\theta/360^\circ) \quad (6)$$

The initial part of the calibration required that  $IR$  represent full-scale deflection of the voltmeter; so the calibration of the voltmeter is proper in degrees with full-scale being 360 deg.,

nected to both input terminals during the calibration procedure. The requisite 180 deg. phase shift required for the calibration procedure is now provided through the pulse inverter circuit. Of course, the indication of the voltmeter must now be reinterpreted, with zero center corresponding to 0 deg. (or 360 deg.) phase difference between the input signals, the right half of the scale corresponding to the range from 0 deg. to 180 deg. and the left half of the scale corresponding to the range from 180 deg. to 360 deg.

#### Performance

Two important factors in evaluating the performance of the phasemeter are the useful frequency range and the accuracy of the reading. It was found by experiment that the useful frequency range was from 40 to 29,000 cps, allowing a maximum error in reading of two per cent. If the error is limited to one per cent, which is about as closely as the voltmeter (a standard three-inch d'Arsonval movement) can be read, the useful upper limit is decreased from 29,000 to 20,000 cps. The lower frequency limit is set by the coupling capacitors in the amplifiers, so that inclusion of the lower frequencies would require larger values. The upper frequency limit is set largely by the width of the triggering pulses delivered to the comparison circuit. These pulses have an effective width of seven  $\mu$ -seconds when measured at the voltage point corresponding to cutoff of the comparison circuit tubes. It is essential to proper operation that at least seven  $\mu$ -seconds elapse after one tube of the comparison circuit is triggered before a pulse arrives at the grid of the other tube. Otherwise, the overlapping of pulses may cause faulty operation, causing the meter to indicate low. When such overlapping occurs, the pulse inverter may be used, as described earlier. The minimum phase angle which may be measured without employing the pulse inverter is given by the fraction of the period of the wave represented by the pulse width, or in degrees:

[Continued on page 46]

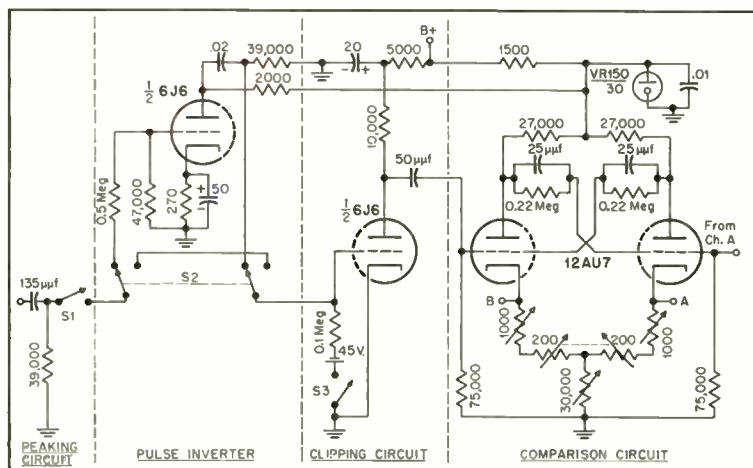

Fig. 4. Schematic of inverter, clipper, and comparison circuit.

than one half cycle, and the other will conduct a fraction  $h$  less. It is required that the difference in voltage ( $V'$ ) between the two cathodes be zero:

$$V = V_{ac} - V'_{bc} = 0 \quad (1)$$

where  $V_{ac}$  is the potential difference between points  $A$  and  $C$  and  $V'_{bc}$  is the potential difference between points  $B$  and  $C$  (see Fig. 4). To accomplish this equality, the 200-ohm resistors are changed from their common value by amounts  $-D$  and  $+D$ . Assuming both trigger tubes have the same value of plate current on conduction, the average value of  $V$  is:

$$V = I(R - D)(\frac{1}{2} + h) - I(R + D)(\frac{1}{2} - h) \quad (2)$$

mid-scale (zero center) being 180 deg., and full-scale oppositely being 0 deg. Note the reading of the phasemeter is independent of the phase discrepancy  $h$ .

In the course of the above analysis, it was assumed that the currents in the two tubes of the comparison circuit were exactly equal during conduction. The presence of a small unbalance between these currents leads to a second order correction term to Eq. (6), of the form  $(I_2 - I_1)Dg$ , where  $I_2$  and  $I_1$  are the two current values. If great accuracy is desired, selected tubes could be used to reduce this difference to a completely negligible value.

The same analysis stated above also applies when the pulse inverter is in use, provided that the same signal is con-

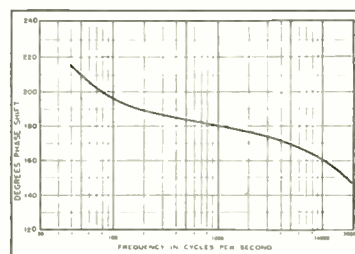

Fig. 5. Typical phase-shift curve for a conventional pentode amplifier stage.

# The Cathode Follower Output Stage

ROBERT M. MITCHELL\*

Summarizing the advantages and disadvantages of a much discussed circuit arrangement which has many zealous adherents.

**A**LTHOUGH THE ADVANTAGES and method of operation of the cathode follower have been known for years and covered thoroughly in the literature, there has been relatively little material devoted to the use of the circuit as an audio power output stage.<sup>1</sup> As a result, there are widespread misconceptions regarding this use of the cathode follower, even among otherwise well-informed engineers. These misconceptions involve: (1) the relation between the static and the dynamic characteristics, i.e., between d.c. and a.c. conditions; (2) impedance matching; and (3) damping effects. These three concepts are those usually misunderstood in treating negative voltage feedback amplifiers in general, and consequently, the conclusions obtained here for the cathode follower will be directly applicable to other voltage feedback circuits.

The simple general negative voltage feedback circuit, its equivalent, and the simple cathode follower circuit are shown in Fig. 1 at (A), (B), and (C) respectively. The fraction of the output voltage that is fed back out of phase with the input voltage is denoted by  $\beta$ . For the cathode follower,  $\beta$  is 1, and consequently there is 100 per cent inverse feedback. From (B) it may be seen that since the equivalent generator magnitude is  $\mu/(\mu\beta + 1)$  times the input, the cathode follower can never give a voltage gain, but must always result in a loss, the value of which depends directly on the amplification factor of the tube. There can be, however, a considerable power gain, and it is this fact that makes the circuit useful as a power output stage.

## D-C versus A-C Conditions

The equation of the output voltage  $e_o$  of a negative voltage feedback amplifier is

$$e_o = e_i \left( \frac{\mu}{\mu\beta + 1} \right) \left( \frac{Z_i}{Z_i + r_p/(\mu\beta + 1)} \right) \quad (1)$$

Comparison of this formula with that for an ordinary voltage amplification stage

\*25-46 89th St., Jackson Heights, N. Y.

<sup>1</sup>C. J. Mitchell, the Cathode Follower Output Stage, *Wireless World*, April 1944, pp 108-110.

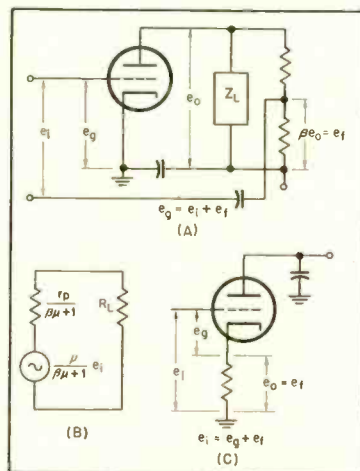

Fig. 1. (A) General schematic of voltage feedback circuit, and (B) its equivalent. (C) Simple cathode follower circuit.

$$e_o' = e_i(-\mu) \left( \frac{Z_i}{r_p + Z_i} \right) \quad (2)$$

shows that the magnitudes of both the amplification factor and the plate resistance have been effectively reduced by the factor  $1/(\mu\beta + 1)$ . Since the amplification factor and the plate resistance are shown to have been changed when feedback is present, it is possible to construct an equivalent characteristic for the tube under feedback conditions.

Figure 2 shows the plate characteristic for a rather high  $r_p$  power triode—the 807 triode connected. For cathode follower operation the value of  $\beta$  is unity. Then for any cathode voltage  $e_o$  the feedback voltage  $e_f$  equals  $\beta e_o$ , which is  $e_o$ . A voltage of 300 on the cathode represents a feedback voltage of 300. Reference to (C) of Fig. 1 will show that the voltage polarity is defined as positive in the direction from ground to cathode and that the plate of the tube is at ground potential for a.c. voltages. The plate-to-cathode voltage is therefore negative as far as the defined voltages are concerned. If the plate voltages on the plate family characteristics (which are, of course, plate-to-cathode voltages) are taken as negative for the feedback conditions of the cathode follower, these characteristics can be used to create a new set of curves valid for cathode follower operation.

The grid to cathode voltage,  $e_g$ , is the difference between the input voltage  $e_i$  and the feedback or cathode voltage  $e_f = e_o$ .

$$e_g = e_i - e_o$$

From this relation it is seen that at  $e_g = 0$  the value of  $e_i$  must be equal to that of  $e_o$ . If points along the  $e_g = 0$  curve are taken at different values of  $e_o$  (which are the plate voltage ordinates on the graph) the value of  $e_i$  at each point will be exactly equal to the plate voltage ordinate at that point. For example, at the intersection of the  $e_g = 0$  curve and "plate volts" = 300 volts on the 807 characteristic (Point A) the value of  $e_i$  is -300 volts (negative since  $e_o$  values were defined as negative). In like fashion, the value of  $e_i$  at the intersection of the  $e_g = 0$  curve and the 200 volts ordinate is -200 volts (Point B). Similarly, the intersection of  $e_g = -10$  volts and the 300 volts ordinate represents -310 volts (Point C), since

$$e_i = e_g + e_o \\ -310 = -10 + (-300)$$

If a number of points thus plotted representing a fixed value of  $e_i$  (such as  $e_i = -300$  volts) are connected, a curve for this value of input voltage is constructed. Continuation of this process for different values of  $e_i$  permits the construction of the equivalent cathode follower characteristic for the tube. Although this may appear a lengthy process, it is actually the work of only five minutes or so to construct an equivalent cathode follower characteristic, depending upon the number of curves desired. The 807 cathode follower characteristics are shown in dotted lines on the original graph. Note that (1) the lines are much steeper, representing a tube of much lower plate resistance, and (2) the distance that represented an input of 5 volts on the original characteristic represents an input of approximately 50 volts on the cathode follower characteristic, showing a reduction in  $\mu$  to one tenth of the original value. Construction for other percentages of feedback in plate-loaded amplifiers can be made in a similar manner.<sup>2</sup> Note that the figures on the parameter curves represent values

<sup>2</sup>Albert Preisman, "Graphical Constructions for Vacuum Tube Circuits," New York: McGraw-Hill Book Co., 1943, pp 226-231.



# The Measurement of H-P Filter Characteristics

WERNER E. NEUMAN\*

Methods employed in making measurements on filters may introduce errors unless the signal source is a pure sine wave. The author shows how to make allowances for these errors.

**H**ARMONIC DISTORTION present in most laboratory oscillators can be a serious source of error in test results of high-pass filter characteristics. A brief discussion of the quantitative effects of harmonic distortion on the attenuation properties of the filter with a description of two methods used to eliminate this source of error is presented here.

High-pass filters are used extensively in communications circuits to suppress

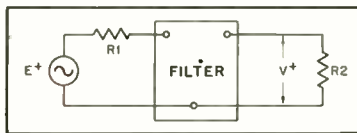

Fig. 1. Test circuit for measuring filter characteristics.  $R_1$  and  $R_2$  represent source and load impedances respectively.

all frequencies from zero cycles per second to any specified frequency, and to pass all frequencies above this with a minimum of power loss. Most filters work satisfactorily only with given source and load impedances and have practically constant impedance characteristics in the pass band. In the attenuation region, however, the transfer impedance—i.e. the impedance measured at the input terminals of the filter when the filter is terminated in its design impedance—will change rapidly, increasing or decreasing depending upon the circuit configuration. Because of the many characteristics obtainable through proper design and the wide range of possible applications, filters are usually designed to meet only the specifications required by the equipment in which they are to work.

## Test Circuits

After the unit is designed, it is assembled and tested under the same or similar conditions that it will undergo in its particular application. The standard test circuit for measuring filter characteristics is shown in Fig. 1,

where  $R_s$  and  $R_l$  represent the source and load impedances respectively. The voltage  $E$ , which is usually supplied by an oscillator that covers the required frequency range, is held constant throughout the test, while the output voltage  $V$  is read as the frequency of  $E$  is varied over the range of the operating conditions. Typical high-pass filter specifications specify the following:

1. A maximum permissible value of insertion loss (i.e. the power loss or voltage drop at the load due to the insertion of the filter into the circuit).
2. A maximum permissible value of attenuation at the cut-off frequency.
3. A minimum permissible value of attenuation at all frequencies below 0.9 or less of the cut-off frequency.

This last part of the specifications depends on the service requirements and will usually be specified between 20 and 60 db. A typical attenuation vs frequency curve of a high-pass filter is shown in Fig. 2. This curve represents the attenuation of the fundamental frequency voltage of a filter with a 5,500 cps cut-off frequency. It should be noted that the vertical coordinates in this graph are in units of attenuation, not response, which is the convention in amplifier work. Decibels of attenuation are defined by the equation

$$\text{Attenuation in db} = 20 \log_{10} \frac{V'}{V} \quad (1)$$

where  $V'$  = the voltage across  $R_2$

Fig. 2. Fundamental frequency attenuation characteristics of a high-pass filter as measured with a wave analyzer. Attenuation at the cutoff frequency, 5.5 kc, equals 6.0 db.

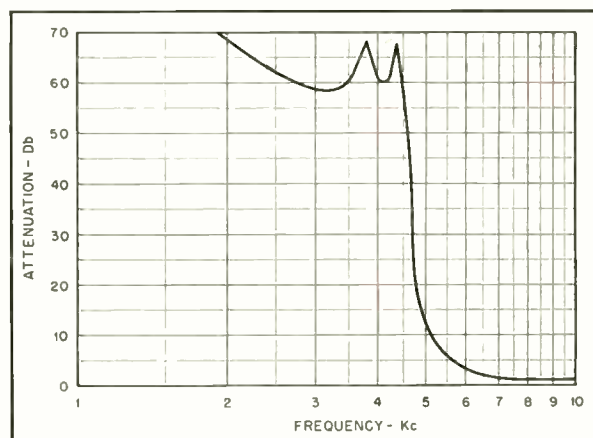

without the filter in the circuit.  $V$  = the voltage across  $R_2$  with the filter in the circuit.

Due to the fact that no two assembled units will have exactly the same attenuation characteristics, all production line units must be tested in a circuit such as the one in Fig. 1 to assure that they meet the specifications.

Measuring the filter characteristics in the circuit of Fig. 1 is relatively straightforward; however, as in all electrical measurements, the limitations of the equipment must be well known for an accurate interpretation of the results. In this circuit the greatest error is usually introduced by the voltage source, since even the best of the modern laboratory oscillators produce signals with some harmonic content. Examination of Fig. 2 (high-pass filter-curve, attenuation vs frequency) shows an attenuation of all fundamental components of  $E$  at frequencies below the cut-off frequency  $f_c$ , and above  $\frac{1}{2} f_c$ , but no attenuation of the harmonics of these frequencies which fall within the pass band, as measured at  $R_2$ . Below  $\frac{1}{2} f_c$  the second harmonic is attenuated, while below  $\frac{1}{3} f_c$  the third harmonic is also suppressed.

## Effect of Distortion

The quantitative effect of distortion in the signal on high-pass filter attenuation characteristics is plotted in Fig. 3 for various fundamental frequency attenua-

\* Engineering Dept., Audio Development Co., 2851 13th Ave. South, Minneapolis 7, Minn.



tion levels. The points on these curves were computed by means of equation (2).

Apparent attenuation in db

$$= 20 \log_{10} \frac{V}{\sqrt{(V')^2 + (V'')^2}} \quad (2)$$

where  $V'$  = unattenuated fundamental voltage at  $R_2$ , i.e. the voltage measured at  $R_2$  without the filter in the circuit.

$V''$  = attenuated fundamental voltage at  $R_2$ .

$V'''$  = unattenuated harmonic voltage at  $R_2$ .

As indicated by these curves, the effect of even a slight amount of harmonics on the apparent attenuation characteristics of the filter is very great for high levels of fundamental frequency attenuation

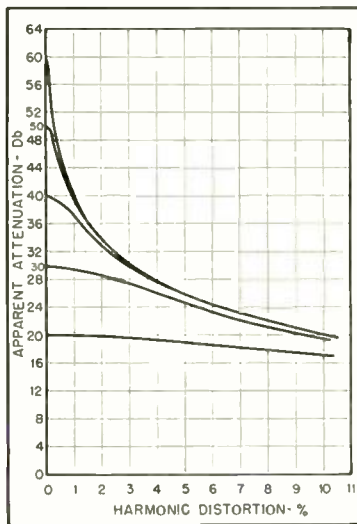

Fig. 3. Apparent attenuation vs harmonic distortion of the test signal for constant fundamental frequency attenuation levels of 60, 50, 40, 30, and 20 db.

such as 60 db. (Less than 0.20 per cent distortion reduces the apparent attenuation by 6 db or 10 per cent.) For low levels of attenuation such as 20 db, the effect of distortion is not so great. (8.0 per cent of distortion is required to reduce the attenuation by 2 db or 10 per cent.)

The solid curve of Fig. 4 shows how distortion may affect the attenuation characteristics of a high-pass filter having a cut-off frequency of 110 kc, as measured with a voltmeter at  $R_2$ . The dotted curve indicates the approximate attenuation of the fundamental frequency by this filter. In this extreme example it will be noted that the attenuation jumped almost 10 db at a frequency of  $\frac{1}{2} f_c$  and another 6 db at a frequency of  $\frac{1}{3} f_c$ .

Since only the attenuation of the fundamental is of interest in high-pass

Fig. 4. Apparent attenuation characteristics of a high-pass filter as measured by a non-frequency-sensitive voltmeter. Dashed curve represents the approximate attenuation of the fundamental frequency by the filter.

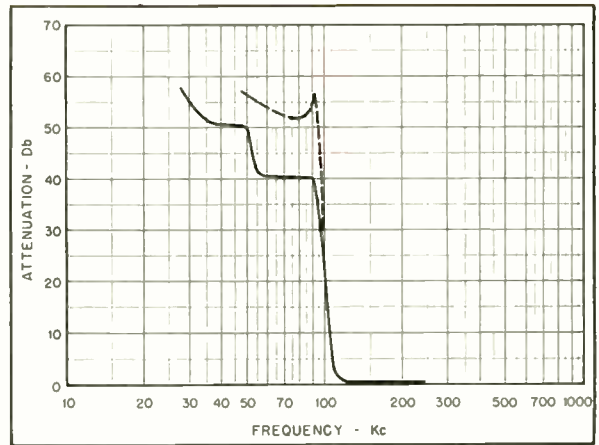

filter characteristics measurements, a method must be used to either, (1) measure the fundamental component of  $E$  and  $V$  only, or (2) determine the total amount of distortion present in  $V$ , and by use of Fig. 3 subtract the effect of the harmonic voltages from the instrument indication.

#### Test Procedure

The first of the above may be accomplished by using a wave analyzer in the test circuit. The wave analyzer is an instrument normally used to determine quantitatively the magnitude of each of the harmonics of a wave shape. It consists of a vacuum tube voltmeter, plus a circuit that may be tuned to respond to one frequency only. The meter may be calibrated to read voltage, per cent, or level in db. When the instrument is used to measure high-pass filter characteristics, it may be thought of as an extremely narrow band, variable band-pass filter plus a voltmeter. In the test circuit of Fig. 1, the wave analyzer, tuned to the fundamental frequency of  $E$ , is connected across the output of the oscillator, and the gain of the oscillator is adjusted so that the fundamental voltage, i.e. that indicated on the analyzer's voltmeter, is at the proper magnitude. The wave analyzer, still tuned to the fundamental, is then connected across  $R_2$  and the fundamental component of  $V$  is read on the instrument. This procedure is then repeated for all frequencies to be checked and the resultant test data—the fundamental voltage readings across  $R_2$ —give a true indication of the attenuation characteristics of the filter.

The second method of determining true attenuation characteristics of high-pass filters does not require a wave analyzer, which is a specialized and expensive instrument, but requires a distortion meter or one or more narrow band-width, band-pass or band-elimination filters. The distortion meter indicates total harmonic content of any

signal measured by it in db or in per cent of the fundamental. When used to obtain filter attenuation data, the procedure is as follows: the input voltage  $E$  and the output voltage  $V$  are analyzed as to total harmonic content. As long as the harmonic content of  $E$  remains constant no adjustment is necessary except to keep  $E$ , as read on a voltmeter, constant. The voltage across  $R_2$  is also read by means of a voltmeter and analyzed with the distortion meter. Since the voltmeter will indicate the composite voltage or apparent attenuation, and since the per cent harmonic content is known, the attenuation of the fundamental frequency may be obtained directly from Fig. 3.

If a distortion meter is not available, a band-pass or a band-elimination filter can be utilized to determine how much of the voltmeter indication is due to fundamental and how much is due to harmonic voltages. The curves of Fig. 3 may then be used with voltmeter readings of the composite voltage at  $R_2$  to determine the attenuation of the fundamental by the high-pass filter.

## "ON AIR"

The Engineering Products Department of RCA has just issued a new four-page publication under the name "On Air" to supplement the bi-monthly *Broadcast News* which has kept broadcasters informed of the new equipment in both radio and TV.

*On Air* includes short articles on new equipment, modifications, and operation, with announcements of interest to station engineers and owners regarding special offers on apparatus. One outstanding announcement in the first issue concerns a Battery Cover to convert Type BN-2A Remote Amplifiers to give complete battery operation in case of failure of the a.c. supply. Address inquiries for *On Air* to A. Fischer, 15-6, Broadcast Equipment Section, RCA, Camden, N. J.

# Magnetic Recording of Meter Data

R. E. ZENNER\*

Recording equipment normally employed for sound may often be used to advantage as an aid to various types of instrumentation.

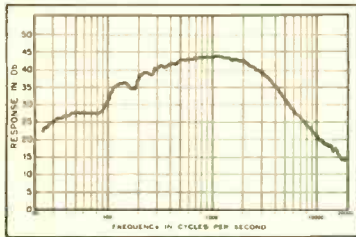

Fig. 1. Typical frequency-response curve for unequalized magnetic sound recorder.

**M**ETER DATA are considered, for purposes of this discussion, to be electrical signals representative of physical quantities, such as temperature or pressure, in which the intelligence band usually ranges from d-c to something less than 100 cps, although there is interest in considerably higher response in a few cases.

The physical experiment may involve great financial expenditure, and recording is then desired as a hedge against possible failure of simultaneously used telemetering systems. It is possible to construct magnetic recorders to operate under adverse conditions involving high accelerations, temperatures, and so on.

Recording is often desired because of its ability to change time scales by recording at one speed and playing back at another. This can be used to speed up slowly varying data for convenience of observation or to slow down data to bring it within the recording capabilities of oscillographs. When this is the property of major interest, the recorder might be located in a missile or at a telemetering receiving point.

In some cases a second or two of significant data may occur at any time within a much longer interval, such as ten to fifteen minutes, during which personnel may not be near the metering device and recorder. Magnetic recording lends itself well to such applications because of its long playing capabilities.

An endless loop of magnetic recording material may be operated continuously, erasing old data and recording

new. When an event of peculiar interest occurs, the erasing and recording may be terminated through a suitable time delay device so that the magnetic loop will retain data representing conditions prior to, during, and following the critical event.

Multiple track magnetic recording is often desired when numerous data are to be taken in a time too short to permit simultaneous analysis. Unlimited time for analysis is made available by recording the data.

The properties of magnetic recording which make it desirable for recording meter data are ruggedness, time-scale changing, long playing, erase and re-use

recording medium. However, variations in the mechanical contact between medium and recording head are usually a larger source of error than the variations in magnetic properties. Very limp coated tapes show less amplitude error than identical coatings on stiffer bases.

The following table lists approximate amplitude fluctuations on various recording media, as experienced in the Armour Research Foundation's laboratories

.0022" x .250" coated plastic tape	± 5%
.0022" x .250" coated paper tape	± 10%
.004" or .0036" diam. stainless steel wire, long wavelengths	± 10%
	short wavelengths ± 50%

Fig. 2. Design of one type of magnetic recording head (left) and playback oscillogram of square wave recorded by it (right).

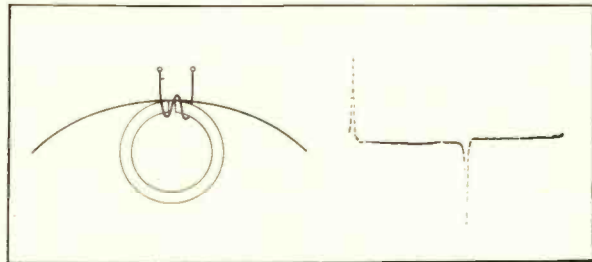

of the medium, multiple track capabilities, instantaneous playback without processing, and versatility of form of the recording medium.

#### Requirements

Most of the research and development effort in magnetic recording has been devoted to sound recording, and magnetic sound recorders have reached a high degree of perfection. However, there are certain properties in which the accuracy requirements for meter-data recording far exceed those of sound recording. In sound recording, instantaneous amplitude errors of 5 or 10 per cent are quite acceptable, and frequency shifts produced by variations in recording medium velocity up to 0.1 per cent in short time intervals with slow drifts up to 1 or 2 per cent are also quite acceptable. Greater accuracy in representation of amplitude and time are nearly always required in meter-data recording.

The inaccuracy of amplitude representation is partially due to variations in magnetic properties along a length of

.0015" x .250" stainless steel tape	± 25%
.0005" x .125" nickel-cobalt plating on edge of brass disk	± 10%

These figures are subject to considerable variation, depending upon mechanical considerations involving recording head design and head-medium pressure schemes.

In good quality apparatus for operation from the a.c. lines, wire or tape velocity fluctuations below 0.1 per cent with little or no slow drift can be achieved for short time intervals. In airborne apparatus much higher fluctuations are usually experienced, since small lightweight mechanical designs are demanded and the available power supply complicates speed control.

Since the intelligence bandwidth for meter data is quite narrow, and since direct recording and playback do not operate down to zero frequency, it is expedient to trade an increase in recorder bandwidth for increased accuracy of amplitude and time representation and to avoid the zero frequency problem.

When the transducers can readily be

\* Armour Research Foundation, Technology Center, Chicago 16, Ill.

made to furnish a frequency proportional to the intelligence amplitude, it becomes most convenient to record these frequencies. When this is done, the inherent amplitude accuracy of the system depends upon the accuracy of the mechanical drive system, rather than upon the signal level from the tape.

A refinement of this system utilizes a simultaneously recorded unmodulated carrier. During playback this unmodulated recorded signal will actually have frequency variations produced by errors in the recording and playback mechanical systems. These might be used to correct the drive itself, but have also been used to shift the center frequency of the playback discriminator in order to correct for drive system errors. A higher rate of correction is possible in the latter case without overshoot or hunting troubles.

This unmodulated carrier may also be used as a time reference by counting or other techniques.

#### Types of Recording

An advantage of this system is that it uses a signal which is handled well by magnetic playback heads of the kind generally used for sound recording. A typical frequency-response curve for an unequalized magnetic sound recorder is shown in Fig. 1. The FM system utilizes the region of high output and smooth response. It will be noted, however, that the low-frequency portion of the curve contains undulations. These are a result of spurious responses which have undesirable effects on some other forms of meter-data recording. These spurious responses can be minimized or practically eliminated by proper choice of playback heads.

A variety of pulse-time, Doppler note, harmonic distortion, binary digit, and other codes have been considered from time to time for meter-data recording. Some of these appear attractive because square wave recordings result in pips of playback voltage which can be used to operate flip-flop circuits for counting and regeneration of the square wave signal. Others are particularly suitable for existing transducers which convert temperature, pressure, velocity, and the like to various forms of electrical signals. The over-all accuracy of many such systems is adversely affected by the spuri-

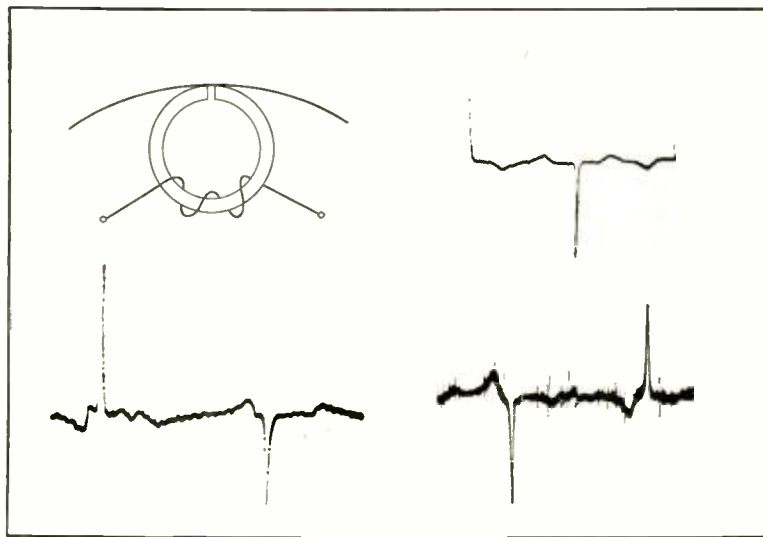

Fig. 3. Oscillogram from signal of Fig. 2 reproduced by different playback heads of the type shown at upper left.

ous responses to be described. While it is possible for recording heads to record spuriously, this is rarely encountered, and the phenomenon is nearly always due to playback heads.

Figure 2 illustrates the playback of a square wave recording of very long wavelength, using the type of playback head which gives the most perfect representation of the rate of change of recorded flux. A schematic diagram of the head is also shown. It will be noted that the signal coil surrounds a lower portion of the iron circuit and the recording medium. Such a head operates in response to the internal flux of the portion of recording medium bridging the gap. The signal coil is quite unaffected by more distant magnetic poles on the medium, provided the reluctance of the lower portion of the iron circuit is kept low. The structure is also relatively free of stray-field hum troubles, since stray flux tends to traverse the lower portion instead of threading the signal coil. In the figure it will be noted that the zero voltage line on one side of a pip is at a slightly different height than the zero voltage line on the other side. Both are actually zero, and the discrepancy is due to inadequacies of coupling circuits in the particular oscilloscope used. When a frequency-response sweep recording is

played back through this type of head, there are no undulations in the low frequency end of the response curve, provided the lower portion of the iron circuit has no gaps or joints to increase reluctance.

#### Spurious Response

Figure 3 illustrates playback voltage from the identical recording used for Fig. 2 but with a number of playback heads of the "open" type, wherein the signal coil surrounds a lower portion of the iron circuit and does not surround the recording medium. Only external flux of the recording medium can produce signals. Spurious pips are seen. By measurement of the spacings between true and spurious pips and measurement of the distances from gap to initial and final contact between recording medium and head, it has been determined that these spurious pips are due to playback at the initial and final contacts of head and medium. In open-type heads, these spurious responses can be reduced in amplitude and spread out in time if the initial and final lines of head-to-medium contact are not parallel to the gap, or if the medium encounters the head at grazing incidence, or both. Reduction by skewing initial and final contact lines is easier with wide magnetic tracks than with narrow ones. Coil placement low on the iron structure is also helpful. With a particular head design, the spurious response pattern will change if the angle of wrap on the head changes due to changing diameter of reels or the like. The pictures shown are from wire recordings. Greater and less spurious responses have been observed from tape and various tape heads.

If we now decrease the wavelength of

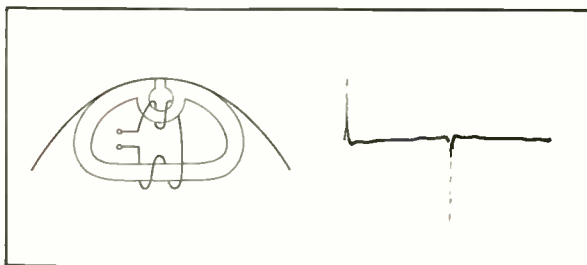

Fig. 4. Recommended playback head construction (left) and oscillogram from square wave recording of Fig. 2.

[Continued on page 33]



# AUDIO engineering society

Containing the Activities and Papers of the Society, and published monthly as a part of AUDIO ENGINEERING Magazine

## OFFICERS

Theodore Lindenberg, President

Audio Engineering Society,  
Box F, Oceanside, N. Y.

J. D. Colvin... Executive Vice-Pres. John G. Frayne... Western Vice-Pres.  
Norman C. Pickering... Secretary Ralph A. Schiegel... Treasurer

# Longitudinal Noise in Audio Circuits—Part 2

H. W. AUGUSTADT\* and W. F. KANNENBERG\*

A discussion of the general effect of the presence of longitudinal noise on a transmission circuit, with a description of the differences between metallic circuit noise and longitudinal noise. Test circuits and representative conditions are illustrated and discussed.

Experience shows that, in general, neither a longitudinal noise voltage nor a current can be impressed on the input circuit of an amplifier without degrading the signal-to-noise ratio of the system. It is, therefore, of interest to investigate by what means the longitudinal induced noise is converted into a metallic-circuit voltage in order that it may be amplified and appear in the output circuit of the amplifier.

### Shielding

The omission of an electrostatic shield from the input transformer of

\*Bell Telephone Laboratories  
Murray Hill, N. J.

the receiving equipment is, in general, the greatest single cause of trouble from longitudinal induced noise, especially when the center point of the input circuit is not grounded. Difficulties, in this case, generally will be experienced from longitudinal noise currents. The manner in which the translation from longitudinal to metallic-circuit noise takes place is represented schematically in Fig. 8. It is assumed, for the purposes of illustration, that the impedance to ground of the input equipment and interconnecting circuit is large compared to the impedance to ground of the receiving equipment. The impedance to ground of the amplifier results from the interwinding capacitances of the input

transformer, represented in the diagram as lumped parasitic capacitors  $C_1$  and  $C_2$ . A longitudinal noise current  $i_{l/2}$ , whose magnitude is determined by the coupling impedance  $Z_c$ , flows along the conductors of the circuit to ground through the capacitors  $C_1$  and  $C_2$ . The flow of this current through  $C_2$  causes little difficulty. However, the flow of the longitudinal current through  $C_1$  and the grid-to-ground impedance of the amplifier sets up a metallic-circuit voltage on the grid side of the coil which is amplified and degrades the signal-to-noise ratio of the system.

Figure 8 and its discussion show in fairly simple manner how a longitudinal noise current is converted into a me-

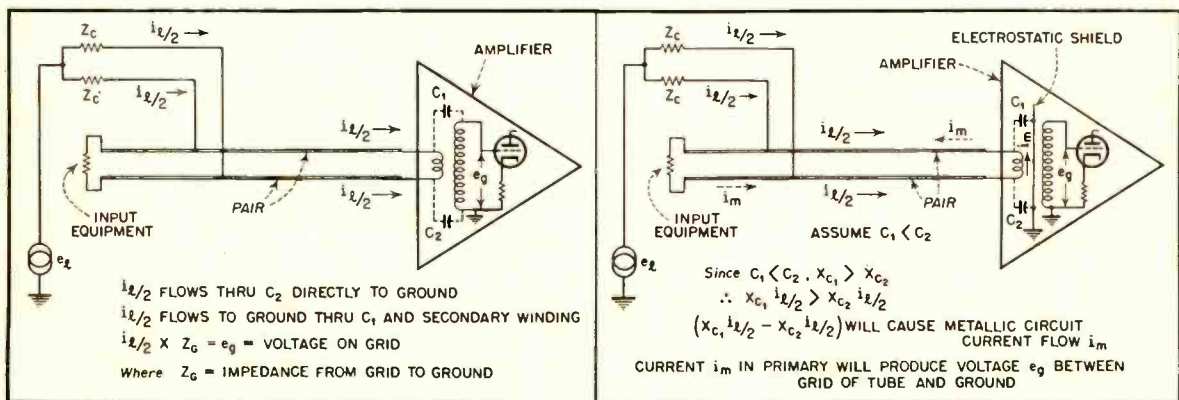

Fig. 8 (left). Conversion of longitudinal current to a metallic circuit voltage by interwinding capacitances in input transformer. Fig. 9 (right). Conversion of longitudinal current to metallic circuit voltage by capacitance unbalance.

talic-circuit noise voltage and thus becomes a source of noise in an audio system. Whether this noise source is troublesome or not in a particular system depends solely on the magnitude of the longitudinal noise current. The magnitude of the longitudinal noise current is, in turn, determined in part by the size of the coupling impedance  $Z_c$ . This example shows the desirability of obtaining a large physical separation between power circuits and the input circuits of audio equipment in order to minimize noise troubles from longitudinal induction.

One method of mitigating difficulties of the type described above is to employ an electrostatic shield in the input transformer of the receiving equipment. Then the disturbing currents will flow down the two conductors to ground through the capacitance between primary winding and shield and will not be able to reach the secondary winding. Note, however, that in order to be effective, the shield must reduce the interwinding capacitances to values so small that only a negligible amount of the longitudinal current flows from the primary to the secondary winding of the transformer.

The introduction of an electrostatic shield in the input transformer of the receiving equipment may greatly reduce the troubles resulting from longitudinal noise, but it does not entirely eliminate them. Another manner in which the longitudinal noise is con-

verted into a metallic circuit voltage is depicted in Fig. 9. The conditions assumed here are the same as those discussed in connection with Fig. 8. An electrostatic shield has, however, been introduced into the input transformer in order to eliminate the capacitance between the primary and secondary windings. Assume that, due to the physical construction of the coil, the capacitances between the ends of the primary winding and the shield are not identical. This condition will always occur, of course, when the primary windings are layer wound over the electrostatic shield so that one end of the winding is at greater physical distance from the shield than the other. For purposes of illustration and analysis, these distributed capacitances have been assumed to be lumped at the terminals of the coil and  $C_2$  is assumed to be larger than  $C_1$ .

Under the assumption that the circuit is subject to a longitudinal noise current, equal longitudinal currents  $i_l/2$  flow down the conductors of the circuit to ground through the capacitors  $C_1$  and  $C_2$ . Since  $C_1$  does not equal  $C_2$ , and by supposition equal currents flow through them to ground, the potential drops across the capacitors will not be equal. Since the two terminals of the input transformer have different potentials to ground, a potential difference must exist across the primary of the coil. This voltage appears on the secondary side of the transformer as the

grid to ground voltage  $e_s$ , and it also produces the small primary metallic circuit current  $i_m$ . This metallic circuit current is indicated by a dashed arrow in Fig. 9.

#### Effect of Circuit Balancing

At this point, the question may be raised, "Why not drain the longitudinal current to ground by shorting the center tap of the input coil to ground and thereby eliminate the necessity for an electrostatic shield and also avoid the difficulties due to capacitance unbalances in the input transformer?" (Grounding the center point of the input circuit, either at the source or the receiving equipment does, it is true, eliminate most of the troubles resulting from longitudinal noise currents but, under certain conditions, it greatly increases the possibility of noise troubles from longitudinal noise voltages.

The reason for this may be learned from a consideration of Fig. 10, in which it will be assumed that the input circuit of the amplifier is subject to a longitudinal noise voltage. The effect of such a voltage on the circuit is simulated by means of the zero-impedance generator  $e_l$ . It is further assumed that the source of excitation is connected to the input circuit by means of an ideal repeating coil, between whose center point and ground the longitudinal voltage is introduced, and that the center tap of the input coil on the receiving equipment is strapped to ground.

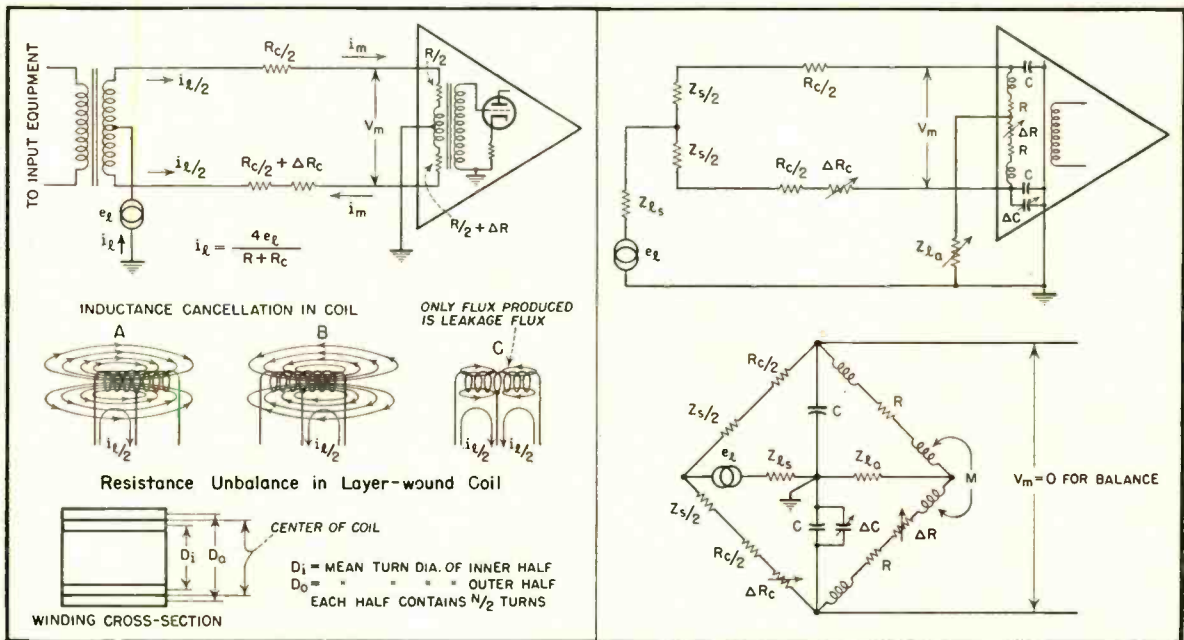

Fig. 10 (left). Conversion of a longitudinal voltage to a metallic circuit current by metallic circuit unbalances. Fig. 11 (right). Circuit elements (above) which may require adjustment to achieve satisfactory equipment performance in the presence of longitudinal noise. Equivalent bridge circuit (below) for analytical purposes.

The longitudinal current produced by the applied voltage is  $i_l = \epsilon e_l / (R + R_s)$  in which  $R_s$  is the resistance of the conductors of the input circuit and  $R$  is the resistance of the primary winding of the input transformer. Note that neither the primary inductance of the input transformer or of the repeating coil, nor the internal input impedance of the amplifier, nor the output impedance of the input equipment appears in this expression. These latter factors cancel out because the longitudinal circuit currents flow in opposing directions to ground through the primary windings of the coils, and hence the associated magnetic fluxes set up by them cancel out, as indicated in *a*, *b*, and *c* of Fig. 10. The impedance, due to the residual leakage flux will, in general, be negligible with respect to the winding resistance in the frequency band of interest, i.e. power frequencies and their important harmonics. The repeating coil has, of course, no leakage by the assumption that it is an ideal transformer.

Consider first the consequences of resistance unbalances only on this cir-

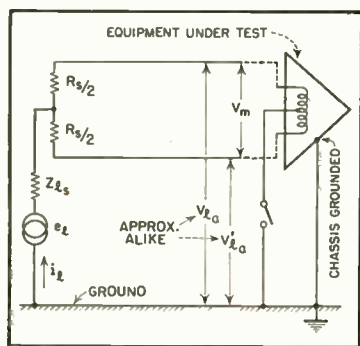

Fig. 12. Test circuit for laboratory evaluation of performance of equipment in the presence of longitudinal voltage or current.

cuit. It is assumed in the illustration that the input transformer is a layer-wound coil, and hence the resistance of its inner winding is less than that of its outer winding. This resistance unbalance in the coil is designated  $\Delta R$ . It is also assumed that the input conductors are slightly unbalanced, and this conductor resistance unbalance is designated  $\Delta R_s$ . On the assumption that the unbalances are a small part of their respective resistances, their effect on the circuit may be determined by assuming that equal longitudinal currents  $i_l/2$  flow down the two conductors to ground. The flow of these equal currents through resistances which differ slightly in magnitude will produce slightly different potential drops along the two paths to ground. This difference

in the two potential drops will cause a metallic-circuit current  $i_m$  to flow in the input circuit of the equipment of the correct magnitude to make the potential drops along the two paths to ground equal. However, the flow of the metallic circuit current  $i_m$ , indicated by the dashed arrow in the figure, through the primary winding of the input transformer sets up a voltage  $V_m$  across the terminals of the receiving amplifier. This then is another means by which longitudinal noise is converted into metallic-circuit noise.

#### Impedance Unbalance

The actual means for converting the longitudinal noise voltage into metallic-

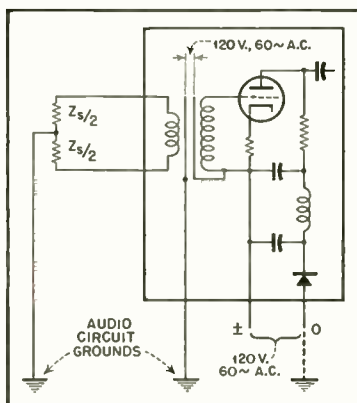

Fig. 13. Analysis of source of noise in an a.c.-d.c. amplifier.

circuit noise, in the general case, is impedance unbalance in the two halves of the input circuit. This impedance unbalance may exist in the input circuit of the receiving equipment, in the connecting pair, or it may originate in the input equipment. Unbalance anywhere in the two halves of the circuit will, under the conditions assumed in Fig. 10, convert part of the longitudinal current into a metallic-circuit current. The remedy which this analysis suggests is to reduce the circuit unbalances and so protect the circuit against longitudinal noise voltages.

The magnitude of the metallic-circuit voltage introduced in the input circuit, under the conditions assumed in Fig. 10, is a function of the magnitude of the longitudinal current. This, therefore, suggests that an alternate remedy in this case is to remove a center tap ground from the circuit in order to reduce the longitudinal current to a negligible quantity and thereby reduce the metallic-current resulting from circuit unbalances. It is thus apparent that the expedient of operating the input circuit of the equipment with a center-point ground is not a general protective measure against longitudinal

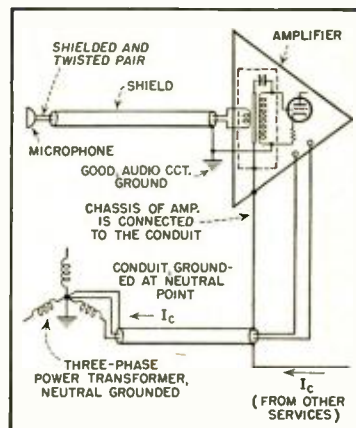

Fig. 14. Multiple grounding method.

noise. The very act of putting center tap grounds on a circuit, while rendering the circuit relatively insensitive to longitudinal noise currents, greatly increases its susceptibility to longitudinal noise voltages. Likewise, operating a circuit without center point grounds makes it relatively insensitive to longitudinal noise voltages and markedly increases its sensitivity to longitudinal noise currents.

In actual conditions of operation, the input circuits of audio systems may be subject simultaneously to both types of longitudinal noise, and the problem is therefore to uncover a general solution that will protect the circuit under both kinds of exposure. The solution, as may have been anticipated, involves the simultaneous adjustment of all the factors discussed so far. The problem which must be solved in a given design may be grasped by a consideration of Fig. 11. The metallic circuit voltage  $V_m$  must be reduced to a negligible quantity for two conditions of operation: with  $Z_l$  equal to zero, representing the case of a longitudinal noise voltage; and with  $Z_l$  large compared with the circuit impedance to ground, representing the case of a longitudinal noise current.

The elements of the circuit which must be adjusted to achieve the desired objective are shown as circuit variables (it is assumed that an electrostatic shield is incorporated in the input transformer in order to eliminate the transformer interwinding capacitances). The circuit of Fig. 11 is also presented schematically in the alternate Wheatstone bridge form. The problem is then to adjust the circuit variables so as to reduce the bridge output to zero in the presence of the longitudinal voltage  $\epsilon_l$ . The variables which require adjustment are the series circuit impedance unbalances represented in the figure as conductor and coil resistance unbal-

ances, the impedance unbalances to ground of the circuit represented in the figure as capacitances, and the impedance to ground in the center tap circuit of the input transformer.

The entire input circuit of an audio system must be so designed that it will perform in an acceptable manner in the presence of longitudinal noise. In general, this means that appropriate protective measures against longitudinal induction must be incorporated in all the elements of the input circuit, including input equipment and the connecting pair, as well as the receiving equipment. This is true because both the input equipment and the connecting pair can equally well convert the longitudinal noise into metallic-circuit noise. The problem is not restricted to amplifiers alone as longitudinal conversion sources, but is likewise true for microphones, phonograph pickups and all other types of input equipment.

#### Equipment Limitations

The limitations of a piece of equipment must be understood in order to use it effectively, and these limitations are generally established by suitable test procedures. From the preceding discussion, it is apparent that data is desired, in appropriate form, on the equipment in the presence of both types of longitudinal induction. This means that the test circuit should provide a measure of the effect of the series impedance unbalances of the two halves of the metallic circuit and of their impedance unbalances to ground, and should also reflect the effect of the other factors such as interwinding capacitances that contribute to poor performance in the presence of longitudinal noise. An appropriate test circuit for this purpose is shown in Fig. 12.

The test circuit of Fig. 12 is arranged to impress the longitudinal voltage on the equipment under test via the midpoint of the source impedance for which the equipment was designed. The longitudinal voltage may be impressed through an impedance  $Z_1$ , whose value is dictated either by the conditions of the test or the sensitivity of the instruments used in making the test. Appropriate precautions should be taken to insure that the test circuit is itself not a source of error.

The test circuit is employed to evaluate the performance of the equipment in the presence of a longitudinal voltage and in the presence of a longitudinal current. The performance of the equipment in the presence of a longitudinal voltage is determined by measuring the metallic-circuit voltage  $V_m$  and the longitudinal voltage  $V_{1a}$  under the condition of minimum—preferably

zero—longitudinal current  $i$ . The measurement is therefore made with the center point of the input circuit of the equipment open circuit to ground. The longitudinal voltage suppression of the equipment, under these conditions of operation, is the ratio of  $V_{1a}$  to  $V_m$ . In decibels, it is  $20 \log_{10} V_{1a}/V_m$  and it should be determined over the appropriate frequency band.

The performance of the equipment in the presence of a longitudinal current is determined by measuring the ratio of the metallic circuit voltage  $V_m$  to the longitudinal current  $i$  under the condition of minimum—preferably zero—longitudinal voltage  $V_{1a}$ . This measurement is therefore made with the center point of the input circuit of the equipment shorted to ground. The longitudinal current suppression of the equipment, under these conditions of operations, is the ratio of  $V_m$  to  $i$ . It is generally expressed as so many microvolts per ampere and should be determined over the appropriate frequency band.

#### Field vs Test Performance

The correlation between the performance of a piece of equipment when in a test circuit and when installed in the field is often difficult to establish because of the wide range of field operating conditions. This situation is particularly true when it comes to predicting with accuracy, on the basis of laboratory test data, the longitudinal suppression performance of equipment. Hence, in the remainder of this article, some of the limitations and special conditions encountered will be indicated briefly as a guide to the wide range of problems encountered in the practical application of this information. A source of possible discrepancy between predicted and actual performance resides in the fact that lumped noise sources are employed in both the analysis and test circuits, whereas the noise experienced in the field is usually that due to a distributed source. In the case of the interconnecting pair between the sending and receiving equipment, the metallic-circuit impedances and the impedances to ground are, in addition, distributed rather than lumped elements. It generally will be found, however, that a satisfactory correlation between the longitudinal suppression performance of a piece of equipment in a test circuit and in the field can be established when the effect of these factors are correctly evaluated.

Another factor of importance is that in this discussion it has been assumed that the longitudinal noise is introduced into the input circuit between the sending and receiving equipment. However,

[Continued on page 34]

## Employment Register

POSITIONS OPEN and AVAILABLE PERSONNEL may be listed here at no charge to industry or to members of the Society. For insertion in this column, brief announcements should be in the hands of the Secretary, Audio Engineering Society, Box F, Oceanside, N. Y., before the fifth of the month preceding the date of issue.

- **Wanted:** E. E., electronics major, with extensive bkgrnd in magnetic and audio cct design and acoustical theory and practice. Must have at least 5 yrs exp. in product design on products now being sold nationally. Must be capable of following product from experimental through production, and be responsible for specifications, quality control, field tests, operation and service manuals on product developed. Must be creative and have an exceptionally high degree of mechanical aptitude. State age, education, and qualifications when answering. Location: Minnesota. Box 102.
- **Communications Engineer (MIT), 22,** single, with good theoretical background and some experience; interested in research, development, or teaching in audio, acoustics, electric circuits, and vacuum-tube circuits. Box 111.
- **Graduate Student of radio and television** desires Junior Engineering position in audio or recording industry. Age 23, married, child. Willing to travel occasionally. Prefer midwest or south. Box 113.
- **Recording Engineer.** Experienced mixer; knowledge of classical music. Knows motion picture and radio mixing techniques. 30, married, presently employed. Graduate of Hollywood Sound Institute. Box 121.
- **Audio Engineer.** Graduate Hollywood Sound Institute, 25, married. Now attending television production school. Desires position with broadcast or recording studio, evenings, N.Y.C. Free to travel for full-time position. Box 122.
- **Graduate:** Advanced Technology course at RCA Institutes, 26, married, with knowledge of music, desires position in audio field; salary secondary. Box 101.
- **Audio Engineer:** M.S. Physics, Electrical Engr; ten years research, development, design experience with sound recording, acoustic measurements, and transducers. Thorough bkgrnd in magnetic and mechanical recording including magnetic recording systems for computer applications. Presently employed, prefer firm in which could invest capital, small city or suburban location. Box 201.
- **Graduate VT:** employed at present. Desires position in audio field. Some experience. Age 20, single, and in good health. Willing to learn, and will go anywhere. Box 202.
- **Audio Engineer:** experienced man with family desires position in recording, broadcasting, film, or TV sound. Excellent operator, troubleshooter, and maintenance man. Superior knowledge of classical music. Studio and equipment design and construction experience. Fluent English, French, and German. Willing to relocate. Box 203.



## Notes on Commercial Audio

EDWARD TATNALL CANBY\*

**R**ECENTLY there have been complaints among engineers as to the audio sections of current commercial home machines, both the home radio-phonograph type and the TV set. There was that recent article in one of our trade magazines describing the moderately priced console that gave forth (as I remember it) with a mere 50 per cent harmonic distortion at something below its "rated" output. There are those huge and stately television sets with the enormous viewing tubes and the cute semi-invisible little speakers hidden away somewhere around the periphery. . . . I'd like to broach a few generalizations at this time (how the radio MC's love that phrase), most of which ultimately have to do with records, as everything in this column theoretically does, however far afield I may roam.

### Audio in Commercial Radio-Phonos

Let's grant that a major reason for dreadful audio in any commercial home machine, TV, AM or what have you, is the stringent necessity for making a profit in a highly competitive market, with the usual mark-ups between manufacturer and consumer—not to the cost of chrome and plastic dressing that assuredly does not add to audio efficiency. An improvement costing a few cents per unit at the manufacturing stage adds dollars to the final price tag, where every cent counts. All that can be done is a kind of pulling up by the bootstraps, an increase in the efficiency of the whole production process from designing through to sales, so that for the same price a better value can be given.

I am sure, ideally speaking, that we could have a lot better audio in our commercial home machines if somebody really got interested, and for the same price, same profit. But is anyone interested? Often, intense competition leads not to improved quality, but to a sort of industry-wide unofficial *laissez-faire* agreement that existing manufacturing standards shall stay put. Business has enough headaches producing present models—anyone who willfully spills apple carts by changing well-oiled procedures is just a plain heel. Until some really enterprising outfit comes along and (a)

sweats blood to make a better product at the old price, and (b) sells that improvement to a very large public, things tend to go along about as they have been going, competition or no competition. Competitive force is spent mainly in the advertising departments, who fight it out with super-duper words and pictures.

And so, in the commercial home phonograph field, we continue to get the usual blurbs, plus such concessions to current interest in high fidelity as that juicy and quite safe expression, "fine fidelity"—in my dictionary a term that always indicates limited tonal range! At this point, nobody that I know of has come forth with a standard commercial phonograph of really superior audio performance pricewise and plugged it successfully enough to catch the public's attention so that inferior products have actually suffered. In spite of the claims, as usual, to "gorgeous, realistic, concert hall tone," and so on, audio quality in home sets continues about what it has been for a long, long time. Maybe a bit wider range, but increased distortion coming through makes things no better than before. (I have a 1934 Montgomery Ward radio that I'll stack up against any new machine for "tone.")

But note well—however shocked the engineer may be at what he hears from the commercial phonograph—that there can be no change until the public actually *gets to hear the difference*, and hears it in droves, via the ear, not the eye. As long as phonographs are sold by eye—both in the advertising and in the "new look" of the machines themselves—the audio components will continue on an as-is basis, and everyone will be quite happy.

Which leads to a major and pertinent point. The home phonograph industry has scarcely made a dent *on itself* as yet in the way of improved audio. But something else has—the new and upsurging "high fidelity" separate unit field. The dent doesn't show yet, but it will. It's bound to, because people are beginning to hear the difference and to hear about it. Since this magazine was founded, the market for separate units has developed from practically zero to a sizable industry. As late as 1946, when I wanted a small phonograph amplifier, I was forced

[Continued on page 40]

# Pops

RUDO S. GLOBUS\*

A new column, designed to fulfill the demand of those who wonder which popular records are good, both musically and technically. Your comments and criticisms will be welcomed.

**O**UR\* PET HATE in 1949 was the thing called Bop, Be-Bop, Re-Bop, and other fancy names describing a mellifluous nonsense, a dainty horror, a sweet clang-bang, mish-mash which served to exhibit the pretty boys of jazz with their hair down over their dainty little chins. 1950 finds us with little to hate and much to long for. Therefore, hence to a continued exploration of our modern musical crusade . . . the renaissance of jazz.

What we have to say today is of importance to all concerned with recorded music, from the tiny tots who get their kicks from Rudolph, he of the crimson proboscis, to the sine-curve madmen. To their great discomfort, we propose to classify jazz as "Chamber Music." To clarify the importance of the strange classification, we want to examine some of the "listening" problems of modern man.

The enterprising family that purchased, built, or commandeered a souped-up record player and brought up its tiny ones in the shadow of symphonic music fresh off shellac is in for a slight shock. The first time little Rollo is shoved into a local auditorium to listen to a real, live symphony concert he will probably nose his thumb at the hundred more or less music men. His complaints? They don't play loud enough . . . can't hear the brass . . . triangle sounds like a Christmas tree ornament . . . strings sounds dull . . . and so on, ad infinitum. And he will be right. There is a vast difference between concert hall reception and the recorded copy. And if we go a little deeper into the problem, we will stick our necks out along with the little tyke and agree with him . . . the records win out in the end. Assuming that the unit is good enough and the records of first-rate quality, home reception is infinitely more satisfactory from the sound point of view than the real thing. Despite all our complaints and our insatiable search for perfection, whatever that is,

[Continued on page 37]

\* 960 Park Ave., New York 28, N. Y.

\*\* Mr. Globus', not necessarily AE's.



# AUDIO DESIGN NOTES

## Chart Showing Reduction in Output Impedance Obtained with Negative Feedback

WILLARD F. MEEKER\*

**A**N IMPORTANT PROPERTY of voltage-controlled negative feedback in audio amplifiers is the reduction of the output impedance which it produces. The amount of this reduction is ordinarily obtained in terms of the fraction of the output voltage which is fed back and the amplification factor of the amplifier (gain with output open-circuited). However, the amount of feedback in an audio amplifier is often expressed as the number of decibels reduction in gain produced by the feedback (db of feedback). Consequently, it would be convenient to have the reduction in output impedance expressed in terms of the reduction in gain. This can be done if the output impedance without feedback and the load impedance are known. The chart shows these relations for negative, voltage-controlled feedback and non-reactive output and load impedances. The chart is based upon the following relation, which is derived from conventional feedback formulas:

$$R'_g = \frac{1}{1 - (1 - Q) \frac{R_g + R_l}{R_l}} R_g$$

where  $R'_g$  = output impedance with feedback

$R_g$  = output impedance without feedback

$R_l$  = load impedance

$Q$  = factor by which gain is multiplied if feedback is removed.

### Examples:

(1) Assume an amplifier having an output impedance without feedback of 500 ohms and a load impedance of 500 ohms.

$$\begin{aligned} R_g &= 500 \text{ ohms} \\ R_l &= 500 \text{ ohms} \\ \frac{R_l}{R_g} &= 1 \end{aligned}$$

\* Research Division, Stromberg-Carlson Co., Rochester 3, N. Y.

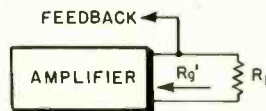
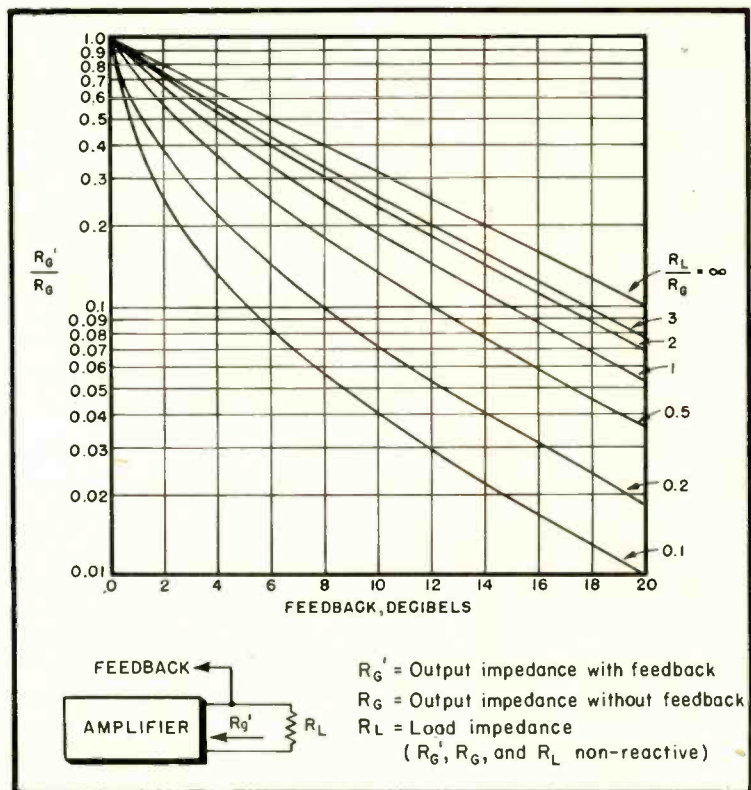

$R'_g$  = Output impedance with feedback  
 $R_g$  = Output impedance without feedback  
 $R_l$  = Load impedance  
 ( $R'_g$ ,  $R_g$ , and  $R_l$  non-reactive)

If 10 db of feedback are used, then following the curve for  $R_l/R_g=1$  to its intersection with the line representing 10 db of feedback, we find  $R'_g/R_g=0.19$ . Thus, the output impedance with 10 db of feedback is

$$\begin{aligned} R'_g &= 0.19 \times R_g \\ &= 0.19 \times 500 \\ &= 95 \text{ ohms} \end{aligned}$$

(2) Assume an amplifier with a beam tube output stage in which the output impedance, without feedback, is ten times the load impedance. How many

decibels of feedback are required to reduce the output impedance to a value equal to the load impedance?

$$\begin{aligned} R_g &= 10 R_l \\ \frac{R_l}{R_g} &= 0.1 \\ R'_g &= R_l \\ R'_g &= 0.1 R_g \\ \frac{R'_g}{R_g} &= 0.1 \end{aligned}$$

Following the curve for  $R_l/R_g=0.1$  to its intersection with  $R'_g/R_g=0.1$  we find 5.2 db of feedback required.

## Phonograph Reproduction—I

Beginning a discussion of the design for a control unit to be used with the Musician's Amplifier

PHONOGRAPH REPRODUCTION can be enjoyable to a large extent only if it is a fairly exact facsimile of the original performance. In spite of this, it is unusual to find that exactness in many systems because of a number of factors. One of these factors is the failure of the equipment designer to provide suitable electrical facilities to permit the control of de-emphasis to match the original recording. Another is the presence of annoying needle scratch, which can be extremely disagreeable in the case of worn records, many of which are sure to be highly prized by the owner. Still another factor is the tendency of the individual to overemphasize the high-frequency spectrum, as occasionally mentioned by Mr. Canby in his columns. The existence of "tweeters" in a speaker system creates a desire to "hear those highs" beyond the intent of composer or performer, with the result that the reproduced signal bears only a faint resemblance to the original.

Many of the preamplifier articles which have appeared in this magazine

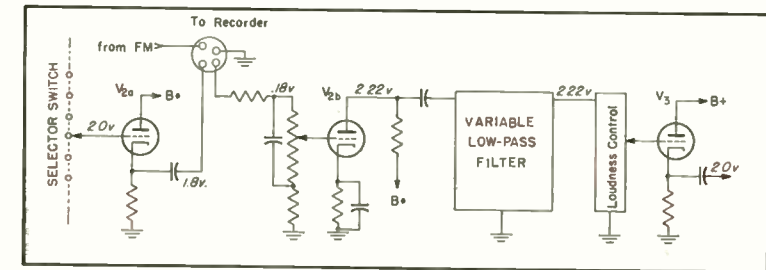

Fig. 1. Block diagram to show basic circuit before refinements of design provide complete schematic.

have said the same thing different ways, and many have provided means for achieving the required de-emphasis or "roll-off." None so far has provided for a sharper cutoff in the high-frequency response to reduce needle scratch to a reasonable level. It is the purpose of this article to describe the design steps taken to provide a suitable low-pass filter arrangement which can do the same work as a noise-suppressor circuit, but do it under the control of the operator rather than of the music itself.

### Requirements

In this and the succeeding article, we shall attempt to outline the design procedure for a control amplifier designed to work with a power amplifier which is assumed to have no control except a simple gain control, preferably with discrete steps of the order of 5 db. Such an amplifier was described in a recent issue,<sup>1</sup> and it is for this particular amplifier that the control unit to be described was built.

Before commencing any design problem, it is first necessary to set down the requirements so that they may be met successfully. Since this unit is to be used for a home entertainment system, it must provide for radio and phonograph, and for this particular application we shall add a wire recorder, just to make it more interesting. The writer finds it desirable to be able to record one radio program while listening to another. For this purpose a Webster Model 178 wire recorder is used because of its one-hour capacity and because it is simple to operate.

Therefore, with phonograph provision, assuming the use of one of the high-quality, low-level magnetic pickups, an equalized preamplifier is necessary. Certain modifications must be made in the design to accommodate the different makes of pickups because of the wide difference in output voltages. To play all types of records demands a

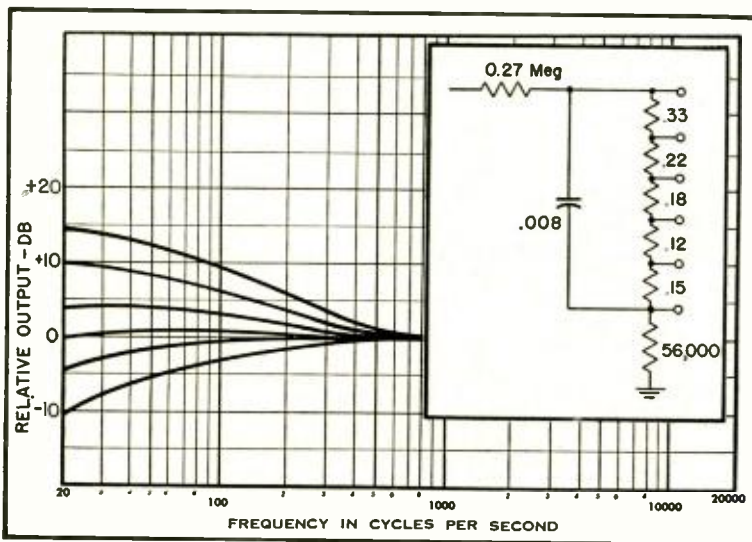

Fig. 2. Circuit of bass-boost control (insert) and curves obtained when working into unloaded grid.

<sup>1</sup> David Sarser and Melvin C. Sprinkle, "Musician's Amplifier," *AUDIO ENGINEERING*, Nov. 1949.

**Response  $\pm 2.5$  db, 40 cps to 15 kc.,  
Output -46 db.**

*Broadcast Engineers Helped Design it!  
Network Shows Use it!*

*Now Compare it with Any in Your Studios!*

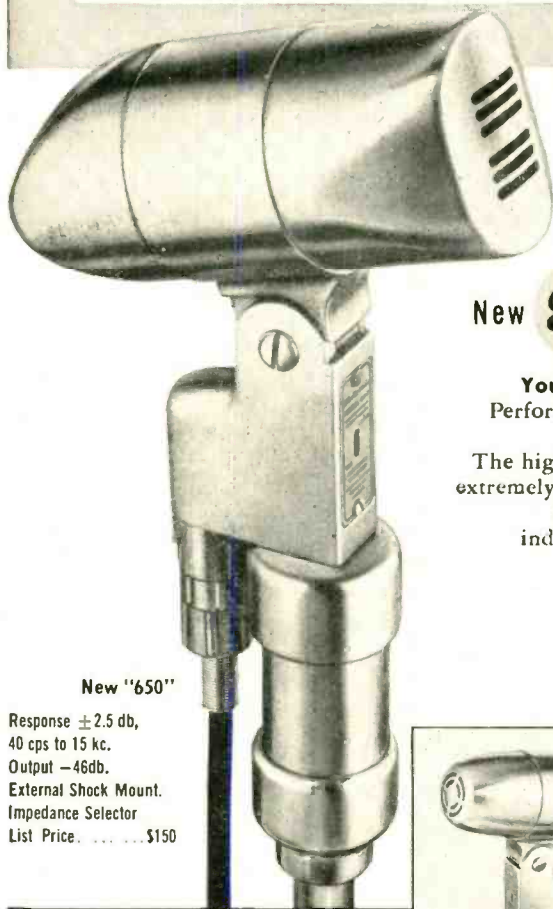

**New "650"**

Response  $\pm 2.5$  db,  
40 cps to 15 kc.  
Output -46db.  
External Shock Mount.  
Impedance Selector  
List Price. . . . . \$150

New  High Fidelity Broadcast Dynamic

**You've wanted** microphones like these!  
Performance meets the highest FM and AM broadcast standards. The bass end is smooth and flat. The highs are particularly clean and peak-free. Construction is extremely rugged and shock-resistant. Has E-V Acoustalloy diaphragm. Omni-directional. Each microphone individually laboratory calibrated and certified. Try one. Compare it with any mike in your own studios.

*Write for full facts today!*

**Electro-Voice**

ELECTRO-VOICE, INC., BUCHANAN, MICHIGAN  
Export: 13 E. 40th St., New York 16, U. S. A. Cables: Arlab

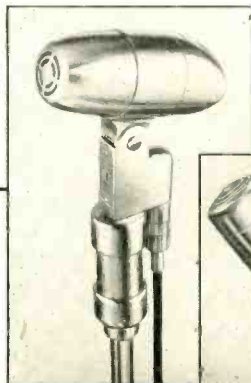

**New "645"**

Response  $\pm 2.5$  db,  
40 cps to 15 kc.  
Output -50 db.  
External Shock Mount.  
Impedance Selector.  
List Price. . . . . \$100



**The "635"**

Response  $\pm 2.5$  db,  
60 cps to 13 kc.  
Output -53 db.  
Impedance Selector.  
For Hand or Stand.  
List Price. . . . . \$60

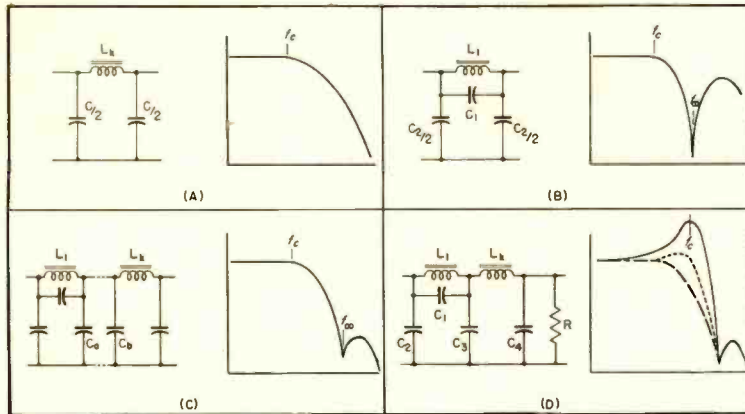

Fig. 3. (A) Constant- $k$  low-pass filter section, with typical response curve; (B)  $m$ -derived section; (C) combined sections with resulting curve; (D) complete filter with terminating resistor. Solid curve shows response when  $R = 0.5$  meg; dashed line is curve for tabular values of  $R$ ; dotted curve for  $R$  above optimum.

number of different roll-off characteristics, since the de-emphasis required to play frr records correctly is hopelessly inadequate for LP's. An intermediate condition must be supplied to fit the Victor curve correctly.

It is also desired to have some control over the low-frequency response, and for this reason we shall incorporate a bass control which will give a number of curves which range from a slight droop up to a boost of about 10 db at 50 cps. We also wish to incorporate a loudness control, of course, and a series of low-pass filters. Last, in order to feed the main amplifier a few feet through a shielded cable, the output impedance of the control unit must be reduced to something of the order of 600 ohms, preferably without using a transformer. The remaining control to be furnished is a selector switch to permit choice between phonograph with any of three different turnover frequencies, AM or FM radio, and one additional position to work with a low-level output from a high-quality tape recorder, to be added at some time in the future. The wire recorder is to be connected only to the FM radio receiver, and any manipulation of the selector switch should not disturb this connection. For playback from the recorder, its own push-button switch shall open the circuits and feed the playback signal into the output circuit.

None of these requirements is difficult of attainment, and the design proceeds in a simple straightforward manner—backward because the output signal must be approximately of a certain magnitude determined by the gain of the main amplifier. However, it is also necessary to accommodate the incoming signal magnitudes at the same time.

#### Design Steps

The output from the radio tuners is

essentially fixed at about 2 volts maximum, which is also about the same as the input to the main amplifier for normal output. Because of the desire for a

TABLE OF VALUES							
$f_c$	$L_1$	$L_2$	$C_1$	$C_2$	$C_3$	$C_4$	$R$
11000	.75	1.25	90	100	450	350	56,000
9000	*	*	133	150	650	500	47,000
8000	*	*	170	200	820	620	39,000
6500	*	*	250	300	1300	1000	33,000
5000	*	*	400	500	2000	1600	27,000

Fig. 4. Component values for (D) of Fig. 3 for five different cutoff frequencies.

low-frequency boost control, it is necessary to provide about 20 db of amplification, since most of the boost circuits introduce that much loss at the mid-frequencies. This calls for a single medium- $\mu$  triode stage between the radio inputs and the output of the con-

trol unit, and that is only to make up for the bass control. Besides, both the bass control and the loudness control should work into an unloaded grid in order to operate correctly. To obtain the desired low-impedance output to feed the shielded cable to the main amplifier, a cathode follower can be used. This circuit has a slight loss, of the order of 10 per cent. Figure 1 is a block diagram of the system from selector switch to output, with approximate signal voltage indicated at various points in the circuit.

Following the circuit from the selector switch, we first encounter another cathode follower. This is used to provide a low-impedance line to feed the wire recorder, since it is to be connected to the control unit by a short shielded cable. The Webster 178 recorder has four push-button switches—microphone recording, radio recording, playback, and out-of-circuit. It is planned to channel the entire signal through the recorder, with the "out-of-circuit" switch (marked LISTEN 4) shorting the two leads so the signal goes straight through the recorder. In the playback position (LISTEN 3), the circuit is opened and the output from the recorder is fed to the control unit. The FM radio signal goes to the recorder through another lead, regardless of the setting of the selector switch on the control unit, and is recorded by depressing the RECORD 2 button. RECORD 1 is for microphone recording, which also may be done without disturbing the remainder of the system.

If the output from the selector switch were to be connected to the recorder directly, the capacitance of the connecting cables would introduce a droop in the high-frequency response which would

Fig. 5. Response curves obtained with filter switch in five cutoff positions.

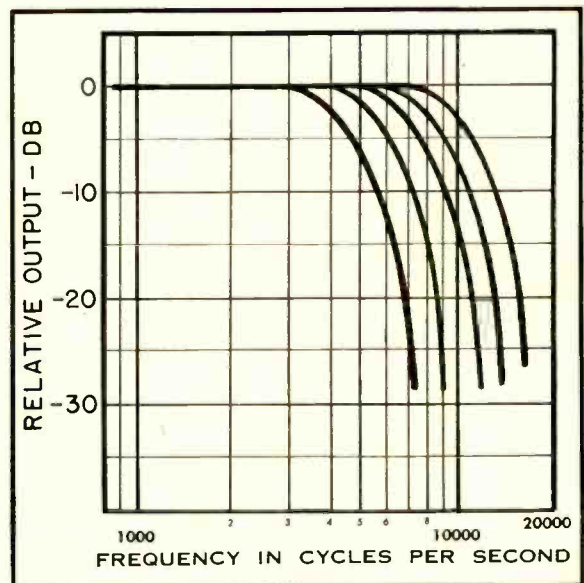

# SIGNS of Recording Progress



The Premium  
**'BROADCASTER'**  
For super-critical recording.



**'PLAYBACK'**  
The standard of  
the networks."



The economical  
**'AUDITION'**

**SOUNDCRAFT**

**SOUNDCRAFT DISCS**  
are stocked for you  
by 411 foremost radio  
parts distributors in  
all principal cities.  
Send for catalog and  
list.

**REEVES Soundcraft CORP.**

35-54 36th STREET, LONG ISLAND CITY 6, N. Y.

DELIVERED FROM LOCAL STOCKS BY YOUR DISTRIBUTOR

The little **SHURE** cartridges

that fill the Big need

for High Fidelity

Phonograph Reproduction . .



THE  
NEW SHURE "VERTICAL  
DRIVE"

CRYSTAL PICKUP CARTRIDGES

Big things often come in little packages . . . So it is with the superlative new Shure "Vertical Drive" Crystal Cartridges. They reproduce *all* the recorded music on the new fine-groove recordings—a reproduction that meets the strict requirements of high compliance and full fidelity. The "Vertical Drive" cartridges are requisite for the critical listener—the lover of fine music. They are especially recommended for those applications where *true fidelity* is essential.

W 23 A for  
standard  
width-groove  
records.  
SINGLE  
MODEL:  
W 21 A for fine-  
groove rec-  
ords.

W 22 A for both  
standard and  
fine-groove  
recordings.  
TURNOVER  
MODEL:

Unusually highly compliant, these "Vertical Drive" Cartridges will faithfully track standard records with a force of only 7 grams—micro-groove records with a force of only 5 grams (an added protection for treasured recordings). Will fit standard or special mountings. Have more than adequate output for the average audio stage.

**SHURE**

**SHURE BROTHERS, INC.**

Microphones and Acoustic Devices

225 WEST HURON STREET, CHICAGO 10, ILL. • CABLE ADDRESS: SHUREMICRO

be objectionable. (This was observed from experience.)

The bass control is one which is thoroughly described by Merchant,<sup>2</sup> and which is particularly useful for this application. Figure 2 shows the curves to be expected for the circuit diagrammed in the insert. Note the use of discrete steps in the tone control switch.

Low-Pass Filters

While the design of filters can be highly involved, for our purposes it is not necessarily so. To provide a reasonably sharp cutoff, it is customary to employ two sections—one of the constant- $k$  type and one of the  $m$ -derived type. These terms are used to designate the type of filter section. Figure 3 shows these two types in pi configurations. (A) is a constant- $k$  low-pass filter, with a response which cuts off gradually commencing at the cutoff frequency  $f_c$  as shown. (B) is an  $m$ -derived section with a sharper cutoff, but with a rise in the response above  $f_c$ , the frequency of maximum attenuation. This frequency occurs at the point of resonance in the parallel circuit  $L_1$  and  $C_1$ . By combining these two types of sections as at (C), a more suitable curve is obtained. It is desired to have a number of cutoff frequencies ranging from around 11 kc down to about 5 kc, with a suitable distribution being 11, 9, 8, 6.5, and 5 kc. This should cover practically all requirements, provided another switch position is so arranged as to cut out the filters altogether.

It is customary to design filters for a specific value of impedance. However, with five different cutoff frequencies, it would be necessary to employ to total of ten coils or to use tapped inductances which would have to be made specially to order, and at a high cost. To simplify the filter, let us consider the possibility of using only two coils and changing the impedance of the circuit. Eliminating some of the original calculations, let us choose two specific coil values from manufacturers' catalogs and proceed from that point.

These original calculations indicated that  $L_k$  should be approximately 1.25 h. for impedances of a suitable range. With the usual value of  $m$  at 0.6,  $L_1$  would be 0.75 h., and both of these values are commercially available. The formulas for a constant- $k$  section are

$$L_k = \frac{R}{\pi f_c} \quad (1)$$

$$C_k = \frac{1}{\pi f_c R} \quad (2)$$

Therefore, assuming a fixed value of 1.25 h. for  $L_k$ ,  $R$  will vary with the cutoff frequency,  $f_c$ , since  $R = \pi f_c L_k$ . Cal-

<sup>2</sup> Charles J. Merchant, "Simple RC Equalizer Networks," *Electronics*, Feb. 1944.

# TV FEATURES

OF THE

## MAURER

### 16 MM. CAMERA

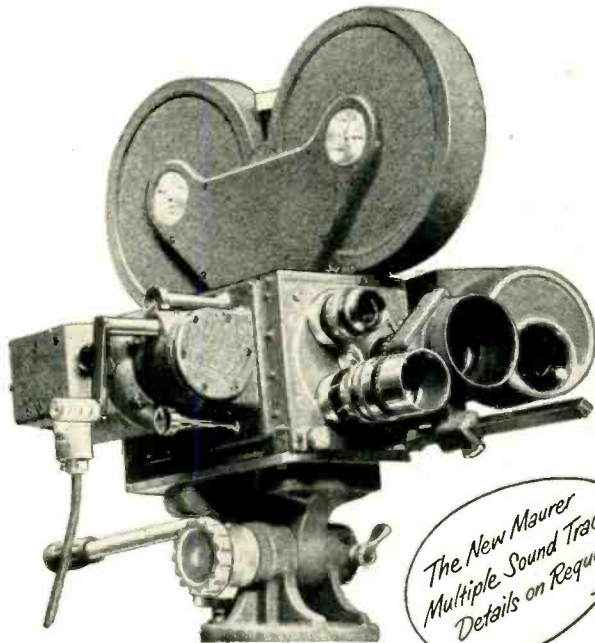

*The New Maurer  
Multiple-Sound Track  
Details on Request*

The Maurer 16 mm. camera is the answer to your exacting TV production requirements. Designed specifically for professional use, it produces steadier, sharper and more accurately composed pictures under all conditions. Ease of operation, combined with many other unique features make the Maurer Professional tops in performance and dependability.

**The 16 mm. Camera Designed  
Specifically for Professional Use!**

*For details on these and other exclusive  
Maurer features, Write:*

**J. A. Maurer, Inc.**

37-01 31st Street, Long Island City 1, N. Y.

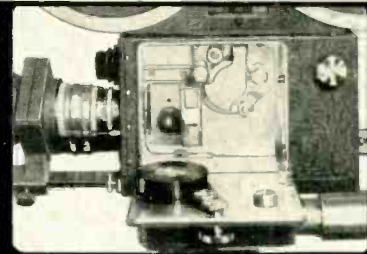

In the exclusive Maurer intermittent movement the functions of the pull-down claw and registration pin are combined, giving accurate registration in old or new film. Because it depends to a minimum extent upon the accuracy of 16 mm. perforations, this movement provides the most accurate registration obtainable.



The unique Maurer focusing system provides full field composition through the taking lens. The image seen through the clear glass viewfinder permits the greatest magnification ever obtained in a motion picture camera for critical focusing, therefore obtaining the greatest accuracy.



The Maurer variable shutter has a 235° open segment . . . allowing use of a smaller aperture with the same lighting . . . giving greater depth of field. Calibrated in 1/2 lens stops, it permits quick and accurate change of exposure while shooting. The additional light transmission permits you to shoot your originals in color easily a factor which is valuable now and may become much more important.

# Floating Action!

## for all TV Cameras "BALANCED" TV TRIPOD

Pat. Pending

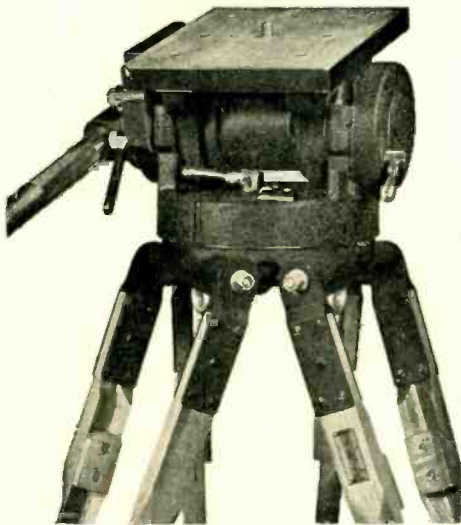

This tripod was engineered and designed expressly to meet all video camera requirements.

Previous concepts of gyro and friction type design have been discarded to achieve absolute balance, effortless operation, super-smooth tilt and pan action, dependability, ruggedness & efficiency.

Below:

3 wheel portable dolly with balanced TV Tripod mounted.

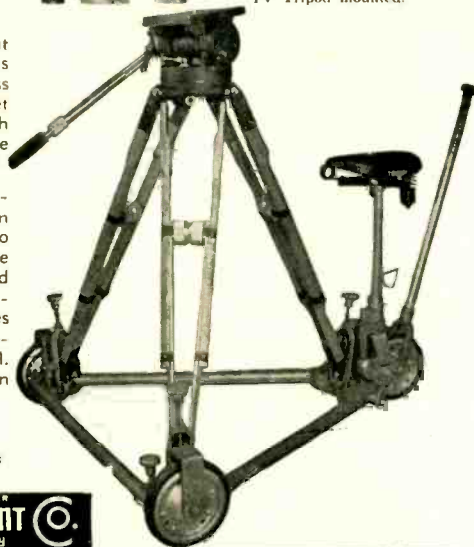

Complete 360° pan without ragged or jerky movement is accomplished with effortless control. It is impossible to get anything but perfectly smooth pan and tilt action with the "BALANCED" TV Tripod.

Quick-release pan handle adjustment locks into position desired by operator with no "play" between pan handle and tripod head. Tripod head mechanism is rustproof, completely enclosed, never requires adjustments cleaning or lubrication. Built-in spirit level. Telescoping extension pan handle.

Write for further particulars



## NEED BACK ISSUES?

Only a few are available and the supply is limited

- August 1948
- September 1948
- November 1948
- December 1948
- March 1949
- May 1949

- June 1949
- August 1949
- September 1949
- October 1949
- November 1949

1948 issues

50¢

1949 issues

35¢

Payment should accompany order.

Circulation Dept., Audio Engineering, 342 Madison Ave., New York 17, N.Y.

culating further, then, values of  $R$  for the five cutoff frequencies are shown to be 43,300, 35,400, 31,400, 25,600, and 19,700 ohms respectively, and the values for  $C_k$  may then be determined.

The formulas for the  $m$ -derived sections are

$$L_i = m L_k \quad (3)$$

$$C_i = \frac{1-m^2}{4m} C_k \quad (4)$$

$$C_i = m C_k \quad (5)$$

With  $m=0.6$ , the values for  $L_i$ ,  $C_i$ , and  $C_i$  may be calculated. We will consider later what to do with the varying impedance,  $R$ .

When the two sections are connected in series as at (C) of Fig. 3, the capacitors  $C_a$  and  $C_b$  may be combined since they are directly in parallel. Therefore, a table may be made up as shown in Fig. 4, with the values for the various capacitors rounded off. The values shown for  $R$  are approximately 1.25 times the nominal impedance of the filters, and are also rounded off to fit RMA preferred values. As mentioned before, the impedance of the filter changes with each switch position, yet the filters are being fed from a source of about 7500 ohms, which represents the impedance of the preceding triode tube. The performance of the filters under this condition may not fit the calculated curves exactly, but they will approximate the desired curves. If measuring facilities are available, the terminating resistor may be chosen on the basis of eliminating the peak which occurs just before the cutoff when the terminating impedance is too high. The tabular values for  $R$  will give approximately the same result, however, if no test instruments are at hand. These values were determined by measurement, and the filter as constructed gives the curves shown in Fig. 5.

### Filter Construction

Toroid coils are used for this filter because they are not very susceptible to

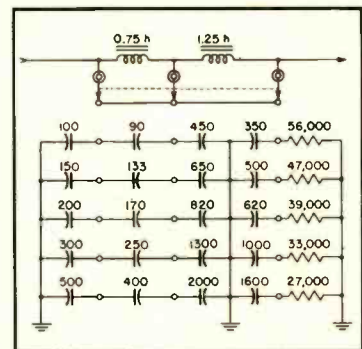

Fig. 6. Method of wiring 6-position, 3-circuit switch to make compact low-pass filter.



hum pickup and because they have high values of  $Q$ . With low- $Q$  coils, the filters would have a gradually decreasing transmission up to the cutoff frequency, instead of being flat up to that point.  $L_k$  is a 1.25 h. coil, such as Freed F-812T or UTC HQA-12;  $L_s$  has an inductance of 0.75 h., such as Freed F-810T or UTC HQA-11. Toroids are somewhat expensive, but their freedom from hum pickup makes them particularly desirable for low-level circuits.

Figure 6 shows the configuration for the entire filter unit, with component values. The capacitors can be selected from most dealers' stocks of ceramic types, and while exact values are desirable, it must be remembered that the cutoff frequencies were chosen to give a variety rather than any exact curves. Except for the coils, the entire filter can be made up on a Mallory 3136J switch, which has three circuits of six positions each, allowing for one off position and five cutoff frequencies.

When combined with the balance of the control unit circuit, this filter arrangement makes it possible to eliminate undesirable needle scratch to a remarkable degree, although of course it also removes the high frequencies in the reproduced music. With the correct roll-off circuits as a part of the phonograph input equipment, however, trouble from needle scratch is minimized anyhow, and the filter will seldom be used in lower than the 8-kc position, except for particularly noisy records.

As constructed, this filter is proving extremely satisfactory. It is in the circuit following the selector switch, and thus may be used on radio programs if necessary. The phonograph equalizer and roll-off circuits will be described in the next installment.

## CATHODE FOLLOWERS

[from page 13]

The final equation is (3a) of the original conditions. Consequently, solving it and (5a) for the optimum load will give the same result for the cathode follower that it did for the original tube, namely

$$R_L = 2r_p$$

In actual practice this value of load resistance is not strictly adhered to, and other, more complicated formulas may be used<sup>3,4</sup>, or the optimum load may be determined by experiment.

### Damping Properties

The superior damping ability of the cathode follower is generally one of the main reasons cited for its use as an out-

<sup>3</sup> K. R. Sturley, "Radio Receiver Design, Part II," New York: John Wiley and Sons, 1948, pp 56-64.

<sup>4</sup> W. B. Nottingham, "Optimum Conditions for Maximum Power in Class A Amplifiers," *Proc. I. R. E.*, Dec. 1941, p 620.

# He's Varying the Pitch While Recording!

With the Fairchild Studio Recorder, Unit 523, George Piros of Reeves Sound Studios is cutting a microgroove, long playing disk. George varies the pitch while recording. There's no overcutting on loud passages — no need to closely ride gain on the audio. He just changes pitch to follow pianissimo and fortissimo. Result . . . unusual dynamic range on a long-playing disk!



The Fairchild Studio Recorder Unit 523 offers continuously variable control of cutting pitch operable while recording. You don't have to change feed screws, belts, pulleys or other mechanisms. Simply rotate a conveniently located knob for smooth and vernier control of cutting pitch. This gives you continuous and instantaneous variation of pitch from 80 to over 500 lines per inch during the actual recording.

## FILM-SYNCHRONOUS

### Fairchild Disk Recorders



Fairchild Unit 523 is used in fixed studio installations for dubbing sound tracks for motion picture production. Absolute lip synchronism is guaranteed for use with your cameras and projectors. You get this same performance with the portable Fairchild Unit 539-G Disk Recorder shown at left. Many motion picture sound tracks are first recorded on FAIRCHILD SYNCHRONOUS DISK RECORDERS.

New, illustrated article contains a complete discussion of recording techniques. Write for your copy today. Ask for reprint SR.



# Fairchild

RECORDING EQUIPMENT CORPORATION

154th STREET AND 7th AVENUE

WHITESTONE, L. I., N. Y.

# BRIDGER

MODEL  
100

A unique new instrument which makes it possible to measure electronic circuits under operating conditions without loading by the measuring instruments. Provides a constant output/input voltage ratio for all frequencies from low audio to over 200 kc to drive voltmeter, oscilloscope, wave analyzer, and other instruments.



## SPECIFICATIONS Model 100 Bridger

**Input Impedance:** Approximately 100 megohms in parallel with 6 mmf at end of three-foot cable.

**Output Impedance:** 200 ohms, one side grounded.

**Voltage Ratio:** Output voltage/input voltage = 0.96, or -0.1 db provided undistorted output limit is not exceeded.

**Undistorted Output:** 40 volts up to 55 kc when feeding a high-impedance load with a capacitance of 75 mmf. Output decreases gradually above 55 kc, reaching 24 volts at 100 kc and 6 volts at 200 kc.

**Noise:** Output noise equivalent to 60 microvolts input, when fed by a high-impedance circuit. This low value has been achieved by using d.c. on the heater circuit of the cathode-follower tube.

**Dimensions:** 5 1/4 x 6 x 11 inches. **Weight:** 9 lbs.

**AUDIO INSTRUMENT CO.**  
1947 Broadway, New York 23, N. Y.

## THE AUDIO INSTRUMENT LINE

Miniature Preamplifiers for  
640AA Condenser Microphones

LOGGER—VTVM and logarithmic recording-meter amplifier with 50-db range

DISC-NOISE METER for both laboratory and routine studio maintenance use.

**A Dream-Come-True for the Sound Effects Man!**



# Gray

*Sound Effects*

## CONSOLE

for AM, FM, TV,  
Record and Film Studios

**3 TURNABLES** Continuously Variable 10 to 130 RPM  
**4 TONE ARMS** Operate Singly, Simultaneously or in Any Combination

Developed to be the last word for the production of sound effects, The Gray Console has found enthusiastic approval wherever used, by networks or independent stations. An almost infinite versatility is possible through three turntables, variable RPM's and four tone arms! Precision high fidelity amplifiers and equalizers are controlled on the efficient panel to enable exact fading, lapping, VU regulation and gain. Pilot lights monitor the circuitry. Each head has its own amplifier and

mixer control as well as tone control for high and low frequency compensation. Two auxiliary inputs with individual preamps bring in added effects from mikes, remote pickups, etc. These can also be used separately or mixed with the heads. A low and high-pass Sound Effects Filter, located on the output side, can be used alone or in cascade to form a band-pass filter.

Descriptive Bulletin 1001 tells all Write

**GRAY RESEARCH and Development Co., Inc.**  
16 Arbor St., Hartford 1, Conn.



put tube, and this damping quality attributed to its low effective generator impedance. It is not only the low effective plate resistance that provides the superior damping, however, but primarily the fact that the impedance matching is done on the basis of the original characteristics.

For example, the 6A5 triode has a  $\mu$  of 4.2 and an  $r_p$  of 800 ohms. The optimum load on a  $2r_p$  basis is therefore 1600 ohms. To match a 10-ohm speaker to this tube requires a transformer with an impedance ratio of 10:1600 or 1:160. The transformer also changes the impedance that the speaker sees by the inverse of this ratio, i.e., 1/160. The effective generator reflected impedance is therefore  $800/160$  or 5 ohms. The same tube hooked up as a cathode follower has an effective plate resistance of  $r_p/(\mu + 1) = 800/5.2 = 154$  ohms. To match a 10-ohm speaker to twice this value (308 ohms) would require a transformer ratio of 10:308 or 1:30.8. The reflected generator impedance seen by the speaker is  $154/30.8 = 5$  ohms, the same impedance that it saw in the original circuit, and therefore the damping factor has not been changed.

However, if the speaker is matched to twice the plate resistance of the original tube (the proper method), the same transformer is used as in the first case, and the speaker load looks like  $10(160) = 1600$  ohms to the tube. The tube looks like  $154/160 = 0.96$  ohms to the speaker, and the damping factor has been increased by  $5/0.96 = 5.2 = \mu + 1$  of the original tube. Since in general the optimum load given by manufacturers are greater than  $2r_p$ , the damping factor is further increased. The manufacturers' rating of 2500 ohms for the 6A5 would give an effective generator impedance of  $154/250 = 0.61$  ohms and a damping factor increase of  $5/0.61 = 8.2$  for cathode follower operation.

The principal relations in cathode follower operations may be summarized briefly as follows:

1. Bias point unchanged
2. Grid current point unchanged
3. Effective amplification factor reduced
4. Effective plate resistance reduced
5. Optimum load unchanged
6. Damping factor increased (if 5. is followed).

The advantage of cathode follower operation are numerous and include good frequency response, low distortion, and good damping properties. The disadvantages are few, but in some cases serious enough to preclude use of the stage. Principal among these are lack of voltage amplification (which imposes extremely severe requirements on the preceding stage if distortion is to be avoided), very low efficiency (for most designs), and low power sensitivity.

## METER DATA RECORDING

[from page 17]

the recorder square wave, the distance between true pips will decrease, but the spurious pips will stay in the same positions relative to the true pips. As this process is continued, there will occur superpositions of true and spurious pips, aiding at some wavelengths and opposing at others. This accounts for the undulations in the sine-wave response curves. It is further observed that when response curves are run at a variety of recording-medium speeds, the undulations are identical if the response is plotted against wavelength, but vary in position when the same data is plotted against frequency.

In addition to the amplitude undulations in the sine-wave response curve, these spurious responses also distort phase of the played back signal.

A considerable amount of effort has been expended in an attempt to approach closed-type head performance in an open-type head in order to retain the easy threading and multi-track capability of the open-type head. A satisfactory solution is the head construction illustrated in Fig. 4, together with the playback pattern for the same square-wave recording used in the previous figures. It will be noted that the spurious responses have been reduced to a low amplitude and smeared out over a long time. Two iron circuits are provided with a common gap, with a coil on each iron circuit and one iron circuit much longer and of higher reluctance than the other. Flux entering the iron at or near the initial and final contact points of medium and head will divide between the upper and lower iron paths. In linking the coils, voltages of opposite sense are developed, and, by correct choice of windings, these voltages may be balanced. As a magnetic reversal moves along the iron toward (or away from) the gap, the proportion of flux sent through the two coils changes gradually, resulting in a steady-state voltage of low amplitude. When the reversal crosses the gap, however, a violent flux reversal is experienced by the short iron circuit and a much lesser reversal by the long iron circuit. The same bucking behavior which minimizes spurious responses also reduces stray field hum.

In general, for meter-data recording systems where these spurious responses and their phase shift effects are troublesome, closed-type heads give best results but may be ruled out due to mechanical inconvenience, and two-coil, two-iron-circuit heads of the type described come closest to closed head performance without mechanical inconvenience.

# 2 Reasons Why

## MORE RADIO STATIONS USE

# Magnecorders

### THAN ANY OTHER PROFESSIONAL TAPE RECORDER

- 1 **BROAD BAND REPRODUCTION** — Users are really enthusiastic about the amazing tone quality and low distortion of Magnecordings. Magnecord frequency response extends from below 40 cps to 15 kc  $\pm$  2 db with less than 2% rms harmonic distortion at all frequencies. Magnecorded programs from remote pickups or studio lines meet the most critical broadcast standards.
- 2 **UNIT CONSTRUCTION** — Only Magnecord offers you the greater flexibility in use and greater economy of Unit Construction. Magnecord recorders, amplifiers, and other equipment are available as individual units. Buy only those you need. Combine or carry only those you need where you need them.

**PT6-AM RECORDER** is the heart of all Magnecord combinations. Weighs only 29 lbs. in carrying case, easily removable for rack mount. Quick-change capsules for recording at 7 $\frac{1}{2}$  or 15 in./sec. High speed rewind and high forward cueing speed, \$294.00



**PT6-JA RECORDER AND AMPLIFIER** is the only combination on the market today that offers such high professional quality at such a low price. Includes PT6-A Recorder plus amplifier with low impedance microphone and bridging inputs, 10-watt audio amplifier with monitor, speaker and jack for external speaker, zero level output terminal, only \$499.50

**PT6-P PORTABLE AMPLIFIER** is a highly versatile, light weight, self-contained unit including a record-playback-remote amplifier and power supply for use with PT6-A Recorder. Amplifier has 3 low level, independently mixed mike inputs plus bridging input for use with line level input. Power supply section has monitor amplifier and speaker.



**PT6-R RACK-MOUNT AMPLIFIER** is a high fidelity, single channel amplifier that quickly combines with the PT6-A Recorder in only 14 inches of rack space. Excellent with existing audio amplifiers.

See, Hear, Operate a Magnecorder Today. Write for complete specifications and name of nearest dealer.

# Magnecord, INC., CHICAGO 1, ILL.

360 NORTH MICHIGAN AVENUE

World's Largest and Oldest Manufacturers of Professional Magnetic Recorders.

## There is a UNI-MODE Cabinet Ensemble for Every Custom requirement!



With Uni-Modes, you can create an entertainment center that will combine utility, beauty and allow for future expansion. It's easy and surprisingly moderate in cost.

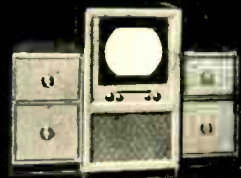

Tuners • Receivers • Phono Amplifier Systems • Loudspeakers  
Record Changers • Television Chassis • Recorders • Record Storage

**UNI-MODES are the complete answer for housing the finest high fidelity system equipment**

LUXURIOUS sectionals present an achievement toward which designers have been working for years—a unit group that lends itself to thousands of combinations and applications. The UNI-MODE idea combines sound basic furniture construction, colorful finishes, sparkling hardware, simple but rich modern design—to bring forth a product that will enhance the beauty of the finest home.

UNI-MODE is available in beautiful hand rubbed lacquer finishes in Blonde and Cardovan Mahogany; also unfinished, if desired. Interiors are attractive Tarragon Green or Afghan Red.

Speaker UNI-MODES are engineered "tuned port" types, designed to enhance the qualities of the finest high fidelity speaker systems. Heavy vibrationless construction, polished brass grilles, non-sagging Lumite plastic grille cloth, acoustically correct for true reproduction of high and low frequencies.

Send for free copy of Terminal's new 1950 Sound Equipment Catalog, "For True Sound Reproduction."



# TERMINAL

RADIO CORPORATION

Distributors of Radio & Electronic Equipment  
85 CORTLANDT STREET, NEW YORK 7, N. Y.  
WOrh 4-3311 • Cable: TERMRADIO

## CLARKSTAN SWEEP FREQUENCY GENERATOR PROVIDES AN AUDIO SWEEP SIGNAL FOR INSTANTANEOUS FREQUENCY CALIBRATIONS



40 CPS to  
10,000 CPS

A Clarkstan development for testing the behavior of audio and other alternating electrical apparatus with respect to frequency and associated phenomena. The generator operates in the audio range from 40 cps to 10,000 cps. The complete frequency range is regularly recurrent so that the signal may be used in conjunction with an oscilloscope. The sweep frequency is governed by 20 synchronizing pulses per second. Provides an instantaneous evaluation of the performance of amplifiers at various settings of tone control and pickup correction networks, wire recorders, film recorders, broadcast and aircraft receivers, motion picture sound equipment, loud speakers, microphones, transformers, filter pickups, preamplifiers and cutting heads. See your jobber or write for Technical Bulletin No. 157F.

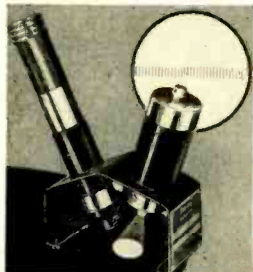

### RECORDING MICROSCOPE

Groove analyzer microscope for inspecting surface qualities of all types of disc recordings and pressings. Built-in light source is optimum for observing groove walls, width, depth of cut, etc. Either 20X or 40X plus excellent resolving power and light efficiency. Reticle (.002" per division) assists in making direct comparison measurements. Moderately priced at \$22.50 net. See your jobber or write for Bulletin 231F.

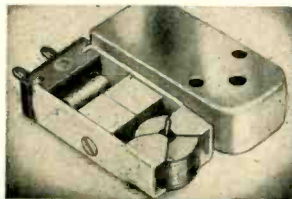

### RV WIDE RANGE CARTRIDGE

With Easily Removable Stylus

This wide range variable reluctance pickup meets requirements of discerning users. Now available with removable and interchangeable diamond stylus in various tip radii, .0010", .0020", .0025", .0030" for all type records. Now at new low price. See your jobber or write for Bulletin 141F. Prices: \$201 Cartridge with one diamond stylus — \$30.60 net. \$201 with sapphire stylus — \$18.00 net.

# CLARKSTAN

CORP

11927 W. Pico Blvd.  
Los Angeles 34, Cal.

## LONGITUDINAL NOISE

[from page 21]

it often happens that the noise is introduced, by means so far not considered, at other points of the circuit. A well known illustration and one which presents many design difficulties is that of an a.c.-d.c. amplifier operated on a.c. In this case, the amplifier itself is the source of the noise. This is true because the secondary side of the input transformer is directly connected to the a.c. power circuit. Poling of the power plug on the amplifier cannot be relied upon to reduce its noise, because in many areas the so-called low side of the power circuit has a substantial voltage to ground. In addition, this voltage often includes substantial amounts of the higher harmonic and therefore the more disturbing components of the power supply frequency.

The problem in designing a universal a.c.-d.c. amplifier is thus to make a unit with acceptable performance for either polarity of the a.c. power supply. This means that the signal-to-noise ratio of the amplifier must be acceptable when the full power circuit voltage is impressed between the windings of the transformer in the manner shown in Fig. 13. One method of solving this problem is by the use of two separate electrostatic shields. One shield encloses the secondary winding and is connected to the low side of this winding. The other shield encloses the primary winding and is connected to the audio circuit ground associated with the input circuit. This arrangement virtually eliminates the parasitic coupling capacitances between the primary and secondary windings of the transformer and thus substantially eliminates the flow of the longitudinal current through the transformer windings from this cause. It also eliminates the flow of the longitudinal current from winding to its associated shield since each winding is at its shield potential, from a longitudinal circuit point of view, by virtue of the connection between them. The longitudinal current flow is thus from one shield to the other, but this current flow will not degrade the signal-to-noise ratio of the amplifier.

### Multiple Grounds

Another manner in which longitudinal noise may be introduced in a system at a point other than the interconnecting pair is depicted in Fig. 14. In this case, it is assumed that the panel and circuit grounds on the amplifier have been separated for utmost flexibility in application. It is further assumed that on installation the circuit ground has

been connected to a quiet audio ground, but that the panel has been connected to the conduit of the power circuit. It is assumed, in addition, that the secondary winding of the input transformer has appreciable capacitance to its case and core which are electrically connected to the amplifier panel. Substantial currents originating from external sources are presumed to be returning to ground via the conduit. This condition sets up a potential difference between the amplifier panel and the audio circuit ground and causes noise currents to flow from the conduit to the audio ground via the secondary winding of the transformer and its associated capacitance to core and case. This noise current introduces a voltage into the equipment on the grid side of the input transformer. Installations in which transients on the power circuit appear in the output of the system may be subject to noise trouble of this type. This difficulty may be eliminated by employing the audio circuit ground for both panel and circuit ground purposes.

Summarizing, then, there are two general means by which longitudinal noise is introduced in a circuit, one of high internal impedance so that the noise has the characteristics of a constant current introduced into the circuit, the other of substantially zero internal impedance so that the noise has the characteristics of a constant voltage introduced into the circuit. It has also been shown that these two types of induced noise affect a circuit in different manners and therefore require widely different treatment to avoid their unwanted effect on a circuit. Superficial remedies to render a circuit insensitive to longitudinal noise are as apt to increase the difficulty as to mitigate it because of the diverse character of its two types. However, as outlined in this article, once the nature of longitudinal noise induction is understood, it is as amenable to reduction of its disturbing effects as many of the other sources of noise with which the audio engineer must contend.

### SMPE Changes Name

The name of the Society of Motion Picture Engineers was officially changed on January 1, 1950 to the Society of Motion Picture and Television Engineers, according to a recent announcement by Mr. Earl I. Sponable, President of the Society.

The increasing mutual interests of technical people in both motion pictures and television, as well as the Society's active participation in the development of new television techniques, are given as the outstanding reasons for the change. The Society's new test film for television station use, which was completed just a short time ago, has been enthusiastically received.

# TAPE HEADQUARTERS IS BECK'S

*San Francisco's Audio Specialists*



**LEFT: AMPEX Model 300.** Available for rack mounting, in console, or portable in two 75-lb. carrying cases. Response at 15-in. tape speed,  $\pm 2$  db 50 to 15,000 cps; at  $7\frac{1}{2}$ -in. speed,  $\pm 2$  db 50 to 7500 cps. Signal-noise, more than 60 db; flutter and wow, under 0.1 per cent rms at 15 in., under 0.2 per cent at  $7\frac{1}{2}$  in., harmonic distortion under 1 per cent. Plug-in head housing with drop-in threading; instantaneous start and stop. Console. \$1575.00 net • Rack \$1490.00 net • Portable. \$1595.00 net

**RIGHT: MAGNECORDER.** Building-block design for flexibility of combination. Ten-watt amplifier and power unit, PT6-J, left. Portable, contains three microphone inputs; signal-noise better than 45 db; harmonic distortion less than 2 per cent . . . . . \$221.50 net



Recorder mechanism, PT6-A. Half-hour at  $7\frac{1}{2}$ -in. speed. Response, 40 to 15,000 at 15-in. tape speed; 40 to 7000 at  $7\frac{1}{2}$ -in. . . . . \$278.00 net  
Units can be rack- or cabinet-mounted or adapted for continuous or long-playing operation.



**LEFT: PRESTO PORTABLE, PT-900.** In two 40-lb. cases. Response,  $\pm 1$  db 30 to 15,000 cps at 15-in. speed;  $\pm 2$  db 50 to 8000 cps at  $7\frac{1}{2}$ -in. speed. Signal-noise more than 55 db; harmonic distortion 2 per cent. Three microphone channels . . . . . \$695.00 net

**RIGHT: WEBSTER EKOTAPE, Model 101.** 80 to 6000 cps. High- and low-level inputs. External-speaker output . . . . . \$395.00 net  
Other models with various input and output combinations and for dual-speed operation.



**LEFT: CRESTWOOD, Model CP 200.** Single-unit 23-lb. portable with speaker. Seven watts output; 50 to 8000 cps; microphone and radio-phonograph inputs; phone and external-speaker jacks. Dual-track recording for full hour on 1200-ft. tape at  $7\frac{1}{2}$ -in. speed. Microphone and extra reel included . . . . . \$169.50 net

Full stocks of tape and recording accessories are maintained at Beck's  
25% cash with COD orders—2% discount for cash with order

**YOUR AUDIO NEEDS** are filled at Beck's with complete lines of sound equipment either by nationwide mail-order; from the Beck Soundmobile traveling the Pacific Coast; or direct from San Francisco Headquarters for sound. Beck's, at 90 Ninth St., has a well-equipped listening and demonstration studio.

## R. M. BECK Co.

*Everything in Sound*

90 Ninth Street • San Francisco 3, California  
MARKet 1-3330 UNDERhill 1-2025

# NEW PRODUCTS

● **General Electric's new "Triple-Play" variable reluctance phonograph cartridge RPX-050** makes it possible to convert any two- or three-speed record changer to provide high-quality reproduction without the necessity of shifting heads or arranging some means for adjusting stylus force for the two different pickups normally used. A simple twist of the easily-accessible, clearly-marked positioning knob places either the 1-mil or 3-mil stylus in playing position, and either stylus will track with but 8 grams of pressure, resulting in a minimum of wear on the records. Replacement of the styli is done in a matter of seconds, and while sapphire is used normally, diamond styli may be had on order. General Electric Co., Part Section, Receiver Division, Syracuse 1, N. Y.

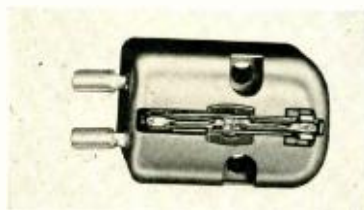

General Electric Co.

● **Phono arms** have a great effect on the output characteristics of pickups, and one new arm has recently been introduced which has a combination of features which are planned to improve overall performance. Resonances are virtually

eliminated, permitting perfect tracking of records at low stylus pressures; damping is adjustable by means of a knurled screw; the plug-in feature permits instantaneous changing of cartridges; off-set head provides minimum tracking error; and the arm length permits use with transcriptions up to 16 in. in diameter. The new viscous-damping principle used in this arm has been proved by daily use for over a year in the recording studios of a large record manufacturer. Further information may be obtained from Gray Research & Development Co., Inc., 16 Arbor St., Hartford 1, Conn.



Gray Research and Development Co., Inc.

● **Phase meter.** A completely electronic instrument for the direct measurement of the phase difference between two voltages makes it possible to study performance of amplifiers, networks, and other audio facilities. The instrument gives direct indications of phase angle without ambiguity on a large meter which has four full-scale ranges of 360, 180, 90, and 36 deg. In addition, 180 deg. phase reversing switches are provided for each channel. The frequency range extends

from 20 cps to 100 kc, and the input signal range is from 1 to 170 peak volts.

A complete description of this instrument is available from the manufacturers, Technology Instrument Corp., 1058 Main St., Waltham 54, Mass.



Technology Instrument Corp.

● **TV Microphone.** The new TV 655 dynamic microphone just introduced by Electro-Voice is slim and trim, and offers ultra-wide-range performance without any additional auxiliary equipment. This model may be plugged directly into standard preamplifiers, and it offers smooth,



Electro-Voice, Inc.

peak-free response from 40 to 15,000 cps within  $\pm 2.5$  db. Each microphone is individually calibrated and certified. Output

[Continued on page 47]

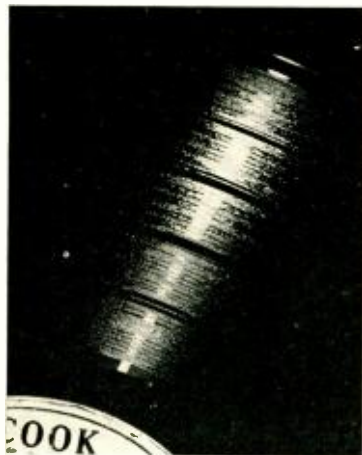

## SPECIFICATIONS

**White-white noise, 15-20,000 cps,** uniformly distributed within 1 db on a velocity basis.  
**White noise, 40-20,000 cps,** cut off at 40 cps to avoid arm resonances.  
**Switch bands—**Rapid switching between white and gray noise, for ear-testing of systems.  
**5 gray noise switch bands:** 12,000 cps gray (to-pass cutoff), 9,000, 7,000; 150 cycle (hi-pass cutoff), 80 cycle cutoff.  
**Calibration** frequency sweeps 20-20,000 cps.  
**Get aboard** with this remarkably rapid, easy and accurate way of analyzing performance of pickups, speakers, microphones and amplifiers. Methods are described in the engineering bulletin which comes with each Series 20 Record.

**FEEDBACK CUTTERS • Q-C SYSTEMS • AUDIOID SYNTHETIC DAMPING**

## Now—from COOK LABS THERMAL NOISE TEST RECORD

**series 20**  
**WIDE BAND RANDOM WHITE NOISE AT CONSTANT VELOCITY WITHIN 1 db, 15-20,000 CYCLES**

ANOTHER FIRST IN OUR SERIES OF FINE LABORATORY TEST RECORDS.

- Rapid system check
- Broadcast level set
- Shock excitation source
- Reflex cabinet adjustment
- Production test & control
- Measuring effective frequency range
- Filter calibration
- Measurement of transient response
- Amplifier overload point
- Intermodulation carrier

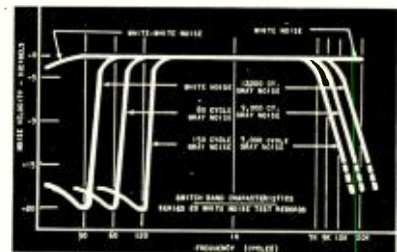

Side A of the series 20 record switches back and forth between white and gray noise, one switch-band recorded for each type of gray (see chart). If, by playing a switch-band, a plainly audible contrast is obtained between white and gray, the transient response of the equipment extends beyond the gray noise cutoff for that band.  
**Also Get** the new 20Kc Cook Series 10 Frequency and Intermodulation Test Record, for all steady state measurements . . . Only \$2.95 net.  
 Watch for new releases in the 20 Kc Series of Cook Test Records. We shall be happy to have your name on our mailing list.

**The Series 20 Record—\$4.80**

net  
 at your dealer, or order direct

**COOK LABORATORIES • • • 139 Gordon Blvd. • • • Floral Park, N. Y.**

## POPS

[from page 22]

we've reached the stage of more than satisfactory comparison and contrast.

Mind you, I've spoken about symphonic music. Chamber music presents an entirely different problem. No matter how good the recording, chamber music still demands direct presence at performance. Given a small hall and a congenial audience, the experience of live chamber music involves the factor of intimacy. The situation is easy to explain psychologically. The chamber music ensemble is small, its sound is comparatively thin and delicate (excuse us, Mr. Ives) and a rather close relationship is achieved between listener and performers, audience and musicians. Years of listening to live chamber music recitals and recorded performances, correlated with the opinions of others, have proven over again the necessity of a feeling of presence.

### Comparison with Jazz

What does this have to do with jazz? Jazz grew up historically under chamber music conditions. Small groups, small intimate "auditoriums," small, congenial groups. Serious chamber music was nurtured by the aristocracy, jazz by the *hoi polloi*. Chamber music was played by bewigged, be-powdered performers... need we mention the bop costumes? But despite the obvious historical and musical differences, the prime prerequisites for both types of "chamber music" remain the same. Everyone who has heard good jazz played under the proper conditions will understand what we mean. Listening to a ten-inch disc purporting to present a picture of jazz is grossly unfair. Where does the recording miss out? The audience relationship between the jazz performer and jazz group reaches a greater intimacy than in the case of "serious" chamber music for certain important reasons, among which is alcohol... an important aesthetic ally. But we can dispense with the juniper juice because the flowing tap is portable and can be found in any well-equipped home. The small, congenial group is also, with obvious exceptions, a home appliance, as is the small, smoke-filled room.

The difference lies in the musicians. A good jazz performance is 90 per cent created on the spot. Certainly there is a basic arrangement or pattern, and many of the ideas are old. But the heart of jazz is improvisation. The great moments of a jazz instrumentalist are never deliberate. Call it inspiration if you will, but a certain conflux of circumstances produces a drive, a beat, a group of solos, the eliciting of musical ideas which were not planned on paper. The jazz instrumentalist, like all musicians, requires time to warm up, to "feel" his idiom, to get the hang of things. Unlike the serious instrumentalist, he is not merely interpreting or re-performing something already well detailed on paper. The jazz instrumentalist is a composer playing a permanent audition. Part of the thrill of jazz is involved in the slow, struggling movement towards a clear articulation of the composer's ideas. Time and space do not permit detailing the advantages of being in the same small room where this is going on. One important point should be brought out, however. The jazz "Carnegie Hall" is a small room. We may eliminate a discussion of acoustics because the audience sits within inches of the instruments themselves. The hungry mumble of conversation

# HARVEY presents

## NAB ADOPTS NEW STANDARD MIKE PLUGS

New type Cannon plug with many exclusive features adopted by NAB as standard for all broadcast stations. Features include chrome-plated shell, moisture retardant shield on pin bases and plug, rubber bumper sleeve to protect studio furniture. Plugs are similar to former Cannon P3 series, (shown in parentheses.)

UA-3-11 (P3CG11).....\$2.91 net    UA-3-13 (P3-13).....\$2.25 net  
UA-3-12 (P3CG12)..... 2.40 net    UA-3-14 (P3-14)..... 1.35 net

**HARVEY has them in stock for immediate delivery.**

## E-V SLIM, TRIM, DYNAMIC MIKE FOR TV

New Electro-Voice ultra-wide range, high fidelity dynamic mike with Acoustalloy diaphragm. Slim...only 1 1/2" diameter, 11 3/8" long with swivel, 8 3/4" without swivel. Trim...aluminum case finished in Aluminite. Dark baked enamel with chrome trim, optional. Polished fluted aluminum head. Dynamic...with Alnico V and Armo magnetic iron magnetic circuit. Omnidirectional, becoming directional at higher frequencies. Frequency Response: 40-15,000 cycles  $\pm$  2.5 db. Output level 53 db below 6mw. For use on stand, hand or boom, blends readily with surroundings and can be concealed in props. Swivel is removable.



E-V model 655. List Price \$200.....Net \$120.00  
E-V model 655A. Similar but with pop-proof grille head.  
Stops wind and breath blasts.....Net \$120.00

## REL FM RECEIVER



Model 646-B is designed for the finest FM reception. It is available in table or rack mounting. Audio input can be fed in through front-panel switch; external field strength meter or recorder terminals provided.

**FREQUENCY RANGE:** 88 to 108 megacycles.  
**SENSITIVITY:** Receiver limits on input circuit noise at any frequency in the 88 to 108 megacycle band. For all input signals of four microvolts or more applied to the input terminals, the receiver output signal-to-noise ratio in a band from 50 to 15,000 cycles is within three db of the optimum obtainable at the

present state of the art where the limiting noise is random.

**FREQUENCY RESPONSE:** Plus or minus 1 db 30 to 15,000 cycles, including de-emphasis of 75 micro-second time constant.

**NOISE SUPPRESSION:** Receiver noise is 70 db or more below output of ten watts for any quieting carrier.

**WAVEFORM DISTORTION:** Receiver distortion up through the detector is less than 1% for 100% modulation. The ten watt audio amplifier associated with Model 646-B Receiver has less than 1.5% distortion at full output.

**IMAGE REJECTION:** Better than 45 db.

**I. F. REJECTION:** Better than 65 db.

**OUTPUT:** 10 watts, 500 and 8 ohms.

**CONTROLS:** Tuning, Audio input switch, Audio frequency gain, Radio frequency gain, Power switch.

**POWER SUPPLY:** 115 volts, 60 cycles, 125 watts.

**Price, complete...\$345.00**

## WESTERN ELECTRIC SPEAKERS

Here's another good buy from Harvey's. Genuine Western Electric speakers at a new low price, every one brand new in factory sealed cartons. These are the genuine article from our regular stock.

12" - 728-B.....\$41.90    8" - 755-A.....\$20.60

Telephone:  LUXEMBURG 2-1500

All in stock for immediate delivery.

**HARVEY**  
RADIO COMPANY INC.

103 West 43rd St., New York 18, N. Y.

NOTE: All prices are Net, F. O. B. N. Y. C. and are subject to change without notice.

## New Type 2A TAP SWITCHES

HAVE A CONSTANT CONTACT RESISTANCE OF  
**ONLY 1 or 2 MILLIOHMS!**

These high quality switches with up to 24 contacts were specifically developed to meet the need for rugged precision instrument switches that have longer operating life and are economical components in competitively priced electronic instruments and military equipment.

Write for Technical  
Bulletin No. 28.

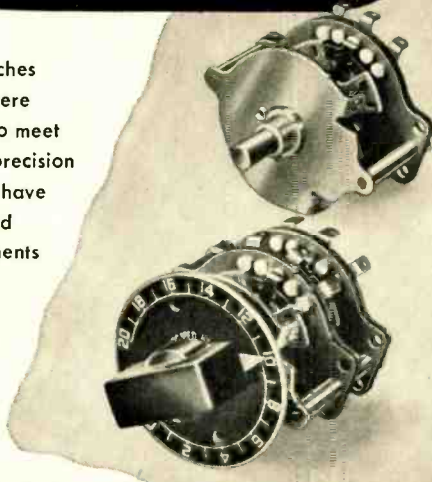

**TECH LABORATORIES** PALISADES PARK  
NEW JERSEY



*A Tiny, Sensational*  
**NEW LIGHTWEIGHT**  
with a long list of wins over heavies  
*The New Astatic*  
**"AC" CRYSTAL CARTRIDGE**



Model AC



Model ACD  
Turnover Type

**If** you want to see knockout performance from a miniature pickup cartridge, you are looking for the new Astatic "AC" Series Crystal Cartridge. This tiny unit weighs in at a total of five grams; is approximately 5/16" thick, 1/2" high and 1-1/2" long, not including pins. Yet, when it comes to performance the "AC" will take on all-comers. Frequency response, particularly in the high frequencies, is truly championship calibre. A new low measure of inertia of the mechanical drive system is chiefly responsible for the full wide range response, excellent tracking characteristics, and assures low needle talk and long life for needle and records.

Employs Astatic's exclusive Taper-Lock Needle, easily changeable without tools. Molded Bakelite housing, with metal mounting brackets (fit standard 1/2" mounting) and needle guards. Available in four models: AC-78 with 3-mil stylus tip, precious metal or sapphire; AC, with 1-mil stylus tip, precious metal or sapphire; AC-AG with new Astatic "ALL-GROOVE" stylus; ACD, turnover type with both 1 and 3-mil point needles. Write for complete details.

Astatic Crystal Devices manufactured  
under Brush Development Co. patents



may be an advantage or a disadvantage, depending on your point of view. But unlike symphonic music, chamber music, both serious and jazz, allows for a directness of hearing that is difficult, if not impossible, to improve on.

In the case of recorded "serious" chamber music, the only thing not available on records is visual presence. Otherwise, sound presence is practically perfect. The London recording of the Dvorak "American" Quartet by the Griller Quartet is a good example of perfect "sound" presence. In the case of recorded "jazz" chamber music, the difficulties are enormously more complicated. By limiting a jazz performance to the time requirements of a ten-, or even a twelve-inch record, the prime prerequisite of enough time and space to move around in is absent. Solos have to be cut, development is hindered . . . The jazz becomes synthetic. Whenever we speak of a good jazz recording, we of necessity speak in relative terms. There has never been a jazz recording (and hang me for being dogmatic) that can approximate the great live performances. The appearance of Little Red Riding LP on the recording scene offers a magnificent opportunity to ignore space and time. All that has happened so far has been to dub six or seven old ten-inch items on the more economical ten- or twelve-inch slow one.

Another difficulty was discussed last month. "Sound" presence has not been adequately achieved in jazz recordings. We don't feel a need for a reproduction of Pee Wee Russell's wheeze . . . the "real" sounds of the instruments will be enough. The old notion that the two-hit record masher, sometimes called "Little Egypt's portable six-inch wonder," is a good instrument for jazz reproduction purposes is pure buncom. The better the reproduction system, the better the approximation of a good jazz performance . . . and we trust that we are all looking for good jazz performances, eh? We can't do anything about "visual presence." If you can find any good jazz in your home town, you'll have to use your own dough. There's a limit to the generosity of the recording industry.

#### NEW RELEASES:

Last month we deliberately tantalized present and future jazz collectors by listing a few of the great discs in jazz history which are almost completely unavailable. With this little piece of sadism out of the way, we can now produce a list of recordings which up to a short time ago were unobtainable for love. Money helped . . . but only great quantities of it. Originally released in a limited edition by the British Rhythm Society, these priceless gems have now been pressed on unbreakable Vinylite and are available in most communities at standard pop prices.

Outside of their historical and musical value, the recordings are interesting from a technical point of view. B.R.S. dubbed these babies from particularly well preserved originals, eschewing the use of a noise suppressor for obvious reasons. The dub, when matched side by side with good copies of the original pressings, are indistinguishable from the originals. Surfaces are quite good, barring occasional brittleness on some sides.

Now that we are in a charitable mood, we can say a few good things about what was done under the conditions of acoustical recording. Since most of the following are acoustics, it is nothing short of a miracle that there is as much range as is available on these sides.



**Mandy Make Up Your Mind**  
Circa 1924

B.R.S. 1003

Clarence Williams Blue Five: Louis Armstrong, cornet; Charlie Irvis, trombone; Sidiney Bechet, soprano sax and sarrusophone; Clarence Williams, piano; Buddy Christian, banjo; Eva Taylor, vocal.

**I'm A Little Blackbird**  
Circa 1924

B.R.S. 1003

Clarence Williams' Blue Five: Louis Armstrong, cornet and the same group as above. Both Armstrong's and Bechet's patter work behind the vocal on both sides make for happy moments.

**Keyhole Blues** Circa 1927 B.R.S. 6

Louis Armstrong and his Hot Seven: Louis Armstrong, cornet and vocal; Kid Ory, trombone; Johnny Dodds, clarinet; Lil' Armstrong, piano; Johnny St. Cyr, banjo; Pete Briggs, tuba; Baby Dodds, drums. This, a superb record, literally takes one's breath away. Magnificent drive, Gravel Gertie at his best . . . and tuba, the vanishing jazz instrument. Despite the technical and time deficiencies of the recording, real excitement is generated.

**Pratt City Blues** Circa 1926 B.R.S. 10

Bertha "Chippie" Hill, vocal; Louis Armstrong, cornet; Richard M. Jones, piano. For other than the obvious reasons, this is an interesting recording. It isn't at all bad technically. Trumpet comes through beautifully. Piano is distorted, but pleasantly so. Actually a little out of tune, it has an old upright feel about it. Gorgeous solo by Satchmo and, as always, Chippie is one of our favorite people. A real blues flavor with beautiful work done by all. On a good reproduction system it comes over clear as a bell with just enough echo.

**Double Check Stomp**  
Circa 1929

B.R.S. 1005

Duke Ellington and His Orchestra: Arthur Whetsel, Cootie Williams, Freddy Jenkins, trumpet; "Tricky Sam" Nanton, trombone; Barney Bigard, clarinet; Johnny Hodges, alto sax; Harry Carney, bass sax; Duke Ellington, piano; Fred Guy, banjo; Wellman Braud, bass; Sonny Greer, drums. A good many of the great men on this side are no longer with us. Others are easily recognizable in connection with the later Ellington bands as well as their own combos. The early Ellington sides are less lush, less trickily orchestrated. There is more of a basic jazz flavor to them as well as an obvious spontaneity. Nanton's tram work on this side is tricky, off-beat, fascinating to listen to against the already recognizable Ellington rhythm style. The sound is good, although lacking in range and fullness. A "must" for Ellingtonians as well as jazz hounds, beginners and professionals.

**Monrovia** Circa ?

B.R.S. 1001

Jelly Roll Morton's Red Hot Peppers. Red Rositer, Briscoe, "Horsecollar" Draper, trumpets; Charlie Irvis, trombone; George Baquet, clarinet; Joe Thomas, Walter Thomas, Paul Barnes, saxes; Jelly Roll Morton, piano; Barney, banjo; Harry Prather, tuba; Williams Laws, drums. Not only a real dirty beat, but some lush dirty solo work. New Orleans Jazz, stylistically early, as shown by the consistent minor. Later work introduced midway modulations into a major key. Not this. A very, very, very good side.

**Someday Sweetheart**  
Circa ?

B.R.S. 1001

Jelly Roll Morton's Red Hot Peppers: George Mitchell, cornet; Kid Ory, trombone; Omer Simeon, clarinet and bass clarinet; Unknown, violins; Jelly Roll Morton, piano; Johnny St. Cyr, guitar; John Lindsay, bass; Andrew Hilaire, drums. First comment . . . unknown can drop dead. A corny violin in a setting which will attract the sentimental souls who liked the dance music orchestrations of the 20's. A great cornet man. George Mitchell has good moments . . . but this is for the sigh-a-while collector.

**Pops:**

Just a few lingering comments this month. Never to be outdone after a fad has reached saturation, we nominate Burl Ives' recording of Mule Train on Columbia

as the best of the lot. On this disc, you can at least smell the little critters. We don't care for Charlie Spivak . . . but if you do, the sweetest trumpet this side of Canaris is now going on London. As to the latest bouncer, the erstwhile "Wedding Samba," most effectively recorded by London, we remember a thing called "And the Angels Sing." The Andrews Sisters and C. Miranda (of the compote head) have done it for Decca. . . . Mr. Ross of London out-screches them. Good for a wiggle or two, at any rate. Which reminds me of "The Great Master Painter" . . . pick your own recording of it, we're neutral. Last but not least, four January strawberries to a New York station that has recorded a series in connection with H.O. which ain't no mo. A pleasant ditty entitled . . . "I'm just a Lousy Little Drip." One of those nice, slick commercial recording jobs, it's one of the whistleable things categorized last month.

## Here's Hi-fidelity FM and AM to Please the Experts

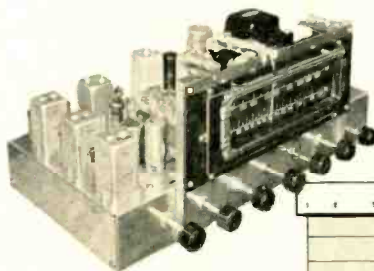

- The man who knows radio
  - The discriminating listener
- will recognize the superior performance of Browning FM and FM-AM without any shadow of doubt.

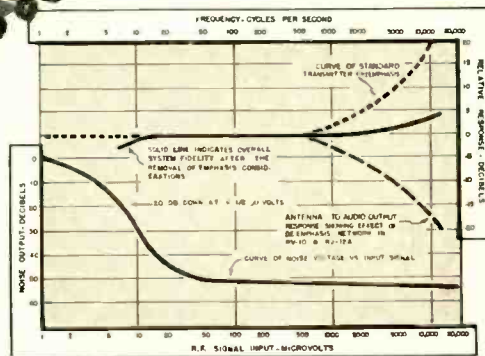

These are the performance curves which, to the man who knows radio, mean high-fidelity reception, flawless and noise-free.

And the non-technical listener who demands the best — brilliant music, clear speech, with lifelike "presence" — will know he has it just the instant he hears Browning FM and AM.

**MODEL RJ-20 AM-FM TUNER**

- Armstrong FM circuit; 20 db quieting with 6 1/2 microvolts.
- FM response 15-15,000 c.p.s. ± 1 1/2 db.
- Separate RF and IF for FM and AM.
- 20 db treble and bass boost.
- Variable AM bandwidth, 9 kc. and 4 kc.
- Tuning drift-free, precise.
- Self-contained power supply.

**MODEL RJ-12A FM-AM TUNER**

High-sensitivity tuner for distortion-free FM and quality AM. Armstrong FM circuit. Drift compensated. FM audio flat 15-15,000 c.p.s. ± 1 1/2 db. AM audio flat 20-6,600 c.p.s. ± 3 db. Triple-tuned i.f. Easy to install.

**MODEL RV-10 FM TUNER**

Small, compact, easily mounted. Armstrong circuit. Drift compensated. High-impedance output to feed any high-fidelity amplifier. Self-contained power supply. Audio flat 15-15,000 c.p.s. ± 1 1/2 db.

Write for a complete set of characteristic curves and performance data for any or all of these Browning Tuners.



**BROWNING**  
Laboratories, Inc.  
Winchester, Mass.  
ENGINEERED FOR ENGINEERS

*Announcing*  
THE NEW  
**AUDIO-SOUND DEPT.**  
AT  
**ARROW**

*featuring a complete line of*

ALTEC LANSING	BOGEN	GARRARD	NEWCOMB	REK-O-KUT
AMERICAN	BROWNING	GENERAL	PICKERING	SCOTT
ASTATIC	BRUSH	ELECTRIC	PRESTO	SONAR
ATLAS	CLARKSTAN	GRAY	RACON	STEPHENS
AUDAK	COLLINS	JENSEN	RADIO	THORDARSON
AUDIO DEVICES	ELECTRO-VOICE	MASCO	CRAFTSMEN	TURNER
BELL	ESPEY	MEISSNER	RASON	UNIVERSITY
				WEBSTER

**WALTER STEIGES mgr**

**Dlgbly 9-4714**

**ARROW ELECTRONICS**

I N C O R P O R A T E D  
82 CORTLANDT STREET, NEW YORK 7, N.Y.

## World-Wide Popularity

Since the inception of AUDIO ENGINEERING in May 1947, engineers and audio hobbyists have subscribed in ever-increasing numbers, not only in the 48 states and in all of the major foreign countries but in such places as Tasmania, Transvaal and Trinidad.

Each month AUDIO ENGINEERING covers the latest developments and practices in recording, reproduction and instrumentation for the entire audio field.

**Subscribe Now—Don't Miss an Issue! Back numbers are hard to get!**

AUDIO ENGINEERING  
342 Madison Avenue, New York 17, N. Y.

Sirs: Here is my  check (or  money order) for \$..... Enter my subscription order to AUDIO ENGINEERING for the next ..... issues. Subscription Price: In U.S.A., Canada and Pan American Union—12 issues \$3—24 issues \$5. All others \$4.00 per year. Please check one:  New Subscription  Renewal.

Name (please print) .....

Address ..... City ..... Zone ..... State.....

Occupation (give title and department) .....

Firm Name .....

## RECORD REVUE

[from page 22]

to buy an 8 watt P. A. job, there being nothing else that I could find on the market. Even that, designed not for hi-fi but for ordinary P.A. use, (with a 12-inch cheap speaker) gave quality that astonished most listeners. Since that time the "hi-fi" business has increased enormously. Tenfold, I am told, in an unspecified recent period of time.

Rumor is spreading everywhere that, for a certain amount of inconvenience, one can get enormously better sound quality for a given lump of cash if one acquires separate units. And the gap between this sort of equipment and the usual commercial home machine has been narrowing fast thanks to the foresight of those dealers who offer complete, ready-made, pre-wired plug-together outfits, mounted in cabinets if you wish. The major objection to separate units has always been that most people are scared stiff of the assembling job, as this column pointed out a long while back.

I do not propose, at this point, a merging between the home machine mass industry and the new hi-fi component industry. The two are still a long distance apart. However, there's no doubt at all that two developments will continue. (1) The hi-fi business will do more and more to make its offerings outwardly simple and easy to use by the terrified amateur; there will be an increasing demand from dealer outlets for the plug-together completely assembled systems, both as standardized no-choice outfits offered as a unit, and in the form of wired-to-your-order systems. This, to my mind, is the line of development that will do most to expand the present hi-fi business into areas where it has never before invaded. (2) The continued hi-fi expansion will ultimately affect the commercial home phonograph to the point where we find definitely improved audio in the standard offerings. It'll probably be done quietly and without special fanfare—it's hard to add any *more* adjectives to those already being used to describe present home machines! But the improvement will show in the hearing.

### TV Audio—Another Story

How about the complaints of poor audio in TV. Results in the hearing aren't different from poor audio in the phonograph, speaking objectively. But there are profound differences both in manufacturing and in the psychology of listening.

In addition to the usual production headaches, TV suffers from its own inherent complexity. TV costs too much. Especially since the public expects it cheap—on a par with good radio and phonograph equipment, which is enormously simpler to make. There just isn't anywhere to skimp safely in TV except in the defenseless and harmless audio section. (You can't skimp on high voltage stuff and pass safety tests.) It would seem to me as things are now that TV audio, except in the fanciest price-no-object custom models, is bound to be inferior—even dreadfully inferior. And so it

is. In spite of the blessings of "distortion-free" FM (which I note TV carefully avoids in its advertising), we find dinky little 50c speakers and amplifiers worthy of the best pre-war \$5 radio, and these in sets that outwardly are in the fancy console class, and cost it. Not much else is possible, I'd say, at this stage. Perhaps, given two midget speakers and a tiny amplifier, a clever designer might get somewhat more performance than the present average without increasing costs. But I don't see it—until TV itself is simplified and/or the general price level comes down. We can hardly expect TV to give us push-pull, feed-back and wide-range speakers, not to mention good FM reception, under present conditions. After all, the cheaper separate FM tuners sell for something like \$25 net, minus amplifier.

In other words, let's consider TV audio and the home phono-radio audio as problems in definitely separate areas. I think TV's excuse is a lot better than radio's—at the moment. (That the same companies are involved in both is neither here nor there.)

#### Fidelity Ratio

One major suggestion, before we drop TV audio. It has occurred to me rather strongly in recent TV shows I've watched, that maybe it's not such a good idea to build high-quality audio into present TV sets. That may sound a bit startling, but there's reason behind it.

There are two sorts of "intermodulation" distortion, so to speak, that occur now between the audio and video components as received by our senses. Both tend to throw realism out of line. One, suggested to me by Editor McProud, is "Scale Distortion"—the disparity between the size of the seen figure, speaking on the screen, and that of the audio voice, heard through the speaker. I'd add to this, myself, that there is also a perspective disparity that often becomes absurd. (It is common enough, for that matter, in the movies). This conflict is between a voice that sounds close-to—not via loudness but via liveness, or lack of it—and a seen figure that looks far away. It is a conflict between background and foreground, quite aside from volume. As we all should know, background and foreground in heard sound depends not on relative volume but on relative *liveness*.

The other distortion is more pertinent to this discussion—an "intermodulation," an inter-reaction between the fidelity of the picture and of the sound. Most of us immediately assume that, ideally, TV audio should be of the highest quality. I say no. Not with present TV video standards, which are just plain low fidelity. Let's put aside distortions such as moving patterns, ghosts, and what-nots. Even with a "perfect" picture, TV is low fidelity, and that in the specific sense of sharpness and clarity. The limit to visual sharpness imposed by the 500-minus\* lines of the picture is equivalent, I feel, to an audio limitation of tonal range, with its similar loss of sharpness and defini-

tion. The similarities in these two limitations are extraordinary. Wide-range FM reception is equivalent to a sharp-focus photograph. The TV audio reception equals a coarse newspaper reproduction—if it is that good. I find that to listen to wide-range, sharp sound and at the same time watch a picture which lacks an equivalent sharpness is intolerable. I find that the better quality sound merely adds to eye strain—for one tries hard to see what one hears, and can't. Since TV picture sharpness is limited, my own feeling is that TV audio should concentrate on low distortion in the middle-tonal range, perhaps even inserting filters in the high end, to eliminate entirely the highest range and with it a good deal of distortion. That would come nearer to a working balance between eye and ear fidelity.

#### The Phono-Radio-TV Combination

A development that, under present circumstances, this column feels constrained to deplore loudly is the super-combination that "adds TV" to a phono-radio console. I put quotes, "adds TV," because that, alas, is not what happens. The actual case is more likely that a record player is merely added to the TV set itself—playing through that fine TV audio system already mentioned. TV audio, with its picture, is one thing. TV audio, minus TV, is another altogether. The present attempt to sell customers this kind of super-combine on the grounds that anything else will soon be obsolete is to my mind a bad business. It is dishonest, intentionally or unintentionally. As things stand now, except in the price-no-object category, TV should be kept

## NOW! A NEW HOLL 500 CYCLE CROSSOVER LO-DISTORTION, 2-WAY SPEAKER SYSTEM



#### Theatre Quality at a Size and Price of Single-Way Systems

This outstanding Lo-Distortion Loudspeaker System maintains its feeling of presence at LOW LISTENING LEVELS. Bass response is clean. The single bass note "boom" of bass reflex systems is eliminated. Highs are clean and crisp. Listening fatigue is reduced to a minimum.

The Holl Special Plastic Process of mechanically damping cone compliance improves edge damping and reduces distortion caused by cone break-up.

#### SPECIFICATIONS

8-ohm-15-watts: FREQUENCY RESPONSE: 40 cycle fundamentals to 13,000 cps, plus. COMPONENT DATA: Bass section uses a low resonant 12-in. PM Woofer, with a completely enclosed and padded "spring-like" air chamber in back of cone. High section uses an 8-in. PM speaker having unusually good response to 13,000 cps plus. Its totally enclosed rear chamber is separate from the Woofer section.

#### CABINETS

Size: 33-in. high, 24-in. wide, 12-in. deep  
Finish: Model 510F, Natural or medium dark mahogany.  
Model 500U, Satin Black  
1/2-inch wood used throughout.



See and hear the Holl Speakers at your distributor or write for further details.

See you at the Parts Distributors Show, Stevens Hotel, Chicago, May 22-25, 1950

Hollywood Station Box 1230



Hollywood 28, California

(\*Although present standards are for 525 lines, about 40 are consumed by the blanking pedestal, leaving only approximately 485 for the picture. Ed.)

# RACON TWEETER

Here's how you can bring the concert hall right into your own living room! Simply add this Racon tweeter to your present 12 or 15" cone speaker and enjoy to the full the luxurious, life-like brilliance of FM and wide range recordings.

Response is clean and uniform to 12,000 cycles, with excellent usable output to 15,000 cycles. High frequency horn logarithmically expanded as two horns for wide, uniform distribution pattern. When used with crossover network, will handle amplifiers rated to 25-30 watts. Input impedance 4-15 ohms. Dimensions 10 3/4" wide, 7" high, 8 3/4" deep.

Cast aluminum throughout. Cutout template provided for easy flush mounting. Free wiring diagram and instructions to build an economical professional type 1,000-cycle crossover network.

Listen to the Racon tweeter at your nearest distributor or write for free Catalog A

Highest Music Quality  
At Low Cost!



MODEL  
CHU-2  
\$37.50  
List Price

Clean  
Output to  
15,000 Cycles!  
Wide Distribution Pattern!

ACOUSTICAL EXCELLENCE



Racon Electric Co., inc.  
52 East 19th Street, New York 3, N. Y.

ALL RACON PRODUCTS ARE GUARANTEED FOR 18 MONTHS

# RUMBLE WOW "SOUNDEX FLOATING DISC-DRIVE" PLAYBACK UNIT

A NEW  
DRIVE SYSTEM  
SELF-ISOLATING  
SELF-ALIGNING



Floating Disc Drive permits an absolutely uniform load and constant torque on the motor and kills transmission of vibration.

#### PICKUP ARM

1. Single stylus model with interchangeable cartridge carrier.
2. Double stylus model.

PROCTOR  
SOUNDEX  
CORP.

133 NORTH SIXTH AVENUE MOUNT VERNON, N. Y.

See Your Local Distributor • Write for Bulletin

## 1949 BOUND VOLUMES of AUDIO ENGINEERING

# \$8.95

Order Now — Limited Supply

U.S.A. & Canada only

AUDIO ENGINEERING

342 Madison Ave.

New York 17, N. Y.

strictly away from phono, in any man's home, if recorded music is to sound like music.

For the good of the quality audio industry, I suggest that those who are in the right position should do something dramatic about this unfortunate line of sales talk, and do it fast. It is perfectly obvious that if every home phonograph is to have TV in it, as things now are, audio will go downhill like a very dead skyrocket. Either that, or prices will go up as fast—and that is unlikely. If TV is expensive, then TV should take that responsibility upon itself and cease cutting into audio. Keep 'em strictly separate is my idea.

Bartok, Music for Strings, Percussion and Celesta (1935)

Los Angeles Chamber Symphony,  
Harold Byrns.

Capitol LP  
L-8048 (10")

Bartok, Concerto #2 for Piano and Orchestra (1926).

Andor Foldes, Lamoureux Orchestra,  
Bigot.

Polydor-Vox LP  
PLP 6620

Bartok, Improvisations, opus 20;  
Out of Doors Suite

Leonid Hambro, pianist.

Bartok Recordings  
LP: BRS 002

These three are by no means all of the items in what is now becoming a belated freshet, if not a flood, of new Bartok material in recorded form. All the music history books tell the old story of the neglected composers who, after they were dead and gone, usually in a pauper's grave or equivalent, were "discovered" by their unwise human neighbors and given posthumous fame; here it is, happening all over again. Bartok died a mere four years and a few months ago, and died in part at least because he was one of those independent souls who knew what he could do and had no intention of doing anything else, merely to make money. He died one of those little known yet notorious "moderns." Now, already, he is a well known and respected "classic master"—and so soon! Why could we have not done all this ten years ago?

As to the Bartok music—any engineer with an ear for unusual and pungent sounds, for strong rhythm, for marvelous "hi-fi" stuff, will be able and willing to take this splendidly civilized, savage music, even though it's a far cry from Kostelanetz, Tchaikovsky or Mozart! The three records above are all first class examples of the recording art, purely technically, and Bartok has, so to speak, outdone himself to provide extraordinary sounds to record.

The first prize goes to Capitol's remarkable recording of the Music for Strings, Percussion and Celesta, and I pick this as the finest example of good transient recording since the war—that is, among records I've heard. It's wide range and all that, but what is really remarkable is the sharpness and tightness of the drums and the piano, the surpassingly clean quality achieved in the transient percussive sounds that characterize their "tone" color. Most of us assume that transient trouble is largely in the reproducing equipment, especially in average home phonographs. A good trial of this recording will convince you that much trouble we hear in respect to transients, especially with piano and drums, is also in the recordings we play. But not here.

# MERIT

NEWS

## MERIT TRANSFORMERS Lead Again for Sound Equipment! with NEW OUTDOOR TYPE

Universal Line Transformers. To couple various line impedances to voice coil. Universal mounting bracket. Designed specifically for maximum service in the outdoor sound field. Features: Universal mounting (may be bolted or clamped to speaker bracket); Weather-sealed at moderate cost to withstand outdoor conditions; Encased in one piece drawn metal can; Potted to resist moisture absorption; Terminal board mounted inside can.

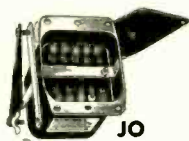

Mounting JO  
MIS. Center Case  
2 3/4 x 3 3/8  
Dimensions  
H W D  
4 1/4 4-7/16 3-9/16

TYPE NO.	LIST PRICE	OHMS IMPEDANCE PRIMARY	SEC. WATTS
A-4040	\$ 8.75	250-500-1000-1500-2000	4-8-16 8
A-4041	9.75	250-500-1000-1500-2000	4-8-16 12
A-4042	13.75	250-500-1000-1500-2000	4-8-16 25
A-4043	9.75	45-50	4-8 12

HEAVY DUTY OUTPUT TRANSFORMERS  
High Level Type to Couple Line to Speaker  
Sec. Impedance: 4-8-15-250-500 Ohms  
OPEN MOUNTING D

TYPE NO.	LIST PRICE	TUBE	PRI. IMPEDANCE	PRI. MA.	MAX. PER SIDE WATTS
A-3133	\$11.50	P.P. 6E, 5L6, P.P. 807	3300 c.t.	240	55
A-3131	7.00	6X4, 6V6, 6P2A3, 6A3, 6B4, 4S, 6P6N7, 46	5000 c.t.	80	30
A-3128	8.00	6P6V6, 6F6	8000 c.t.	50	14

SEALED-IN MOUNTING H

A-4033	16.50	P.P. 6E, 5L6, P.P. 807	3300 c.t.	240	55
A-4030	13.00	P.P. 6E, 5L6	6600 c.t.	80	34
A-4028	12.00	6P6V6, 6F6	8000 c.t.	50	14

Weatherproofed, potted for outdoor use at 100% over list price.

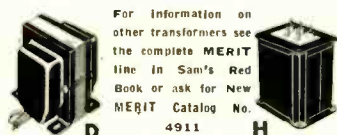

EQUIP WITH MERIT OUTDOOR TYPE TRANSFORMERS TODAY



The Second Piano Concerto—a wild, gay, superbly organized work of diabolical fury and good humor—is one of a series of remarkable new recordings from Vox, apparently made on tape and revolutionary in quality as far as this company is concerned. Piano is a bit hard-toned here—but that suits Bartok. Acoustics also a bit dead—also good for the music involved. Beautifully sharp highs. The first movement is for brass and percussion only (plus piano), the second for strings, the third for the Works. Some piece!

Peter Bartok's most recent LP of his father's music is all-piano. The piano itself is not of super-concert-hall quality; the recording is faithful, with as good transient quality as you're likely to get in current piano recording, the pitch very steady. (There has been much inexcusably wobbly LP piano of late.) The music is for the average ear rather fragmentary, dissonant, percussive, but with nice folk music tunes to help. A fine fire-engine, far background, adds spice at one point! 57th St. New York.

Beethoven, Piano Sonatas opus 101, 110.  
Leonard Shure, pianist.

Vox LP  
VLP 6120

Beethoven, Piano Sonata opus 28  
("Pastorale"),  
Gyorgy Sandor, pianist.

Columbia LP  
ML 4193 (1/2)

Beethoven, Piano Sonata opus 53  
("Waldstein")  
Claudio Arrau, pianist.

Columbia LP  
ML 2078 (10")

Here are three interesting piano recordings—directly comparable because of the similarity in the music. Musically the comparison rates them quite differently than the order of their technical merits. Leonard Shure, who has done a good deal of Beethoven recently, comes out on top, but with the worst recording; Gyorgy Sandor is in the middle in both respects, and Arrau, best in his recording, is to my ear decidedly the least of the three musically.

Speaking of transients—and what else is there to recording piano—these three offer examples of the extremes. The Shure record from Vox went sour somewhere in the processing apparently; previous Shure piano recordings, on 78, were excellent. This one is not only wobbly in pitch at many points, but the transients at the beginning of the piano notes are so added that at times one seems to hear bells or some strange wind instrument, not piano. The trouble is aggravated by poor dynamic range—parts that could be soft are over-loud compared with those parts that are supposed to be full power. A good record to study by ear and to analyze—if you are curious as to what can go wrong in piano recording. My suspicions are that trouble was in the LP processing. Arrau's piano is fullest, steadiest.

A most significant point comes out in the comparison between the two Columbia Beethoven sonatas. Same company, same type record. Same curve. (Or is it?) Yet the simple fact is that the Arrau record has decidedly stronger piano bass than the Sandor. Mike placement? Room acoustics? Weather? Obviously, the curve is quite beside the point—for the ear will insist on equalization here to balance the bass in the two, whatever the official recording curve may have been! And so it goes in a thousand other cases. Correct paper equalization for a given curve is only the beginning of good reproduction. No one in his right senses would deny its importance. But there

## Get Your Free Subscription



## If You Buy Electronic Parts and Equipment For Research or Industry

Be sure you or your firm is on our list to get the "Sun Radio MONTHLY MAILER". This publication brings to the industrial electronics field news of new, unusual or otherwise interesting items from our large, varied and up-to-date stock. Also a few real bargains each month for the quantity buyer. Items are presented with complete descriptions and complete lists of sizes, types and prices. We tell you everything we know about the products and let you decide for yourself -- we do not merely list things and shout at you to buy. You'll find it interesting reading even though it is primarily an advertising piece. To get your free subscription simply write us on your business letter-head. If there are others in your engineering or purchasing departments who could also make use of the "MONTHLY MAILER" send their names along too.

## ... and You'll Also Want Our Famous, 68-page Audio Catalog

Sun Radio's new 68-page manual-catalog, "1950 Audio Equipment" is a veritable gold mine of practical information on high-fidelity home music installations. You'll also like its listing of the choicest items in our great line of high-fidelity equipment, in logical, easy-to-find sequence geared to your purse and purpose. It's ABSOLUTELY FREE. Write for your copy today. You'll find it indispensable.



# Get Both FREE!

## 1. VALUABLE NEW BOOK ON CUSTOM HIGH-FIDELITY

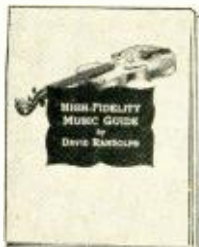

### "HIGH-FIDELITY MUSIC GUIDE"

by David Randolph (noted Musicologist and Music Consultant for Lafayette Radio) and the Technical Staff of Lafayette Radio.

**CONTENTS:** Requirements for high-fidelity reproduction of recorded and broadcast music; glossary of hi-fi terms; what is high-fidelity; how to plan custom high-fidelity installation; how to save money by using existing furniture; component "packages" recommended by David Randolph and by a famous research organization.

## 2. The Great New 1950 LAFAYETTE CATALOG

164 pages filled with "everything in radio", including the most complete section on high-fidelity components in the field!



By ordering your components from this catalog, you pay the lowest "net" prices on all famous makes of high-fidelity equipment: Altec-Lansing, Bell, Bogen, Brook, Browning, Cinaudagraph, Collins, Espey, Fisher, Garrard, General Electric, Goodell, Hallcrafters, Howard, Jensen, Lafayette, Meissner, National, Pickering, Radio Craftsmen, Scott, Stephens, Stromberg Carlson, Thordarson, University, Webster-Chicago, and many others.

Hear the famous Lafayette COMPONENT SELECTOR in action at Lafayette High-Fidelity Centers. Visit the store near you:



New York: 100 Sixth Avenue  
Bronx: 542 East Fordham Road  
Newark: 24 Central Avenue  
Chicago: 901 West Jackson Blvd.  
Atlanta: 265 Peachtree Street  
Boston: 110 Federal Street

Receive *both* hi-fi books FREE  
MAIL THIS COUPON TODAY!

LAFAYETTE RADIO (High Fidelity Div.) Dept. AB-50  
100 Sixth Avenue, New York 13, N. Y.  
or 901 West Jackson Blvd., Chicago 7, Ill.

Rush me free copy of  
 New "High Fidelity Music Guide"  
 1950 Lafayette Catalog. (Please do not request if you have already gotten a copy.)

Name .....  
 Address .....  
 City ..... Zone ..... State .....

PASTE ON PENNY POSTCARD

are so many additional factors that go into the right tonal balance for a given recording on a given machine in a given room, with (especially) a given car! This, I'd say, is the prime argument for the use of flexible, continuously variable tone controls in addition to various fixed cut-off and equalization positions.

**Holst, St. Paul's Suite for Strings.**  
Boyd Neel String Orchestra.

London 78:  
LA 99 (2)

**Britten, Variations on a Theme of Frank Bridge.**  
Boyd Neel String Orchestra.

London 78:  
LA 100 (3)

Two examples of the steely-string recording that is the hall-mark of English Decca, now known as London in this country. The peculiar tone quality that London achieves in these and others of the sort is a matter of some dispute—for one camp insists that this is "real hi-fi" and another finds it simply one kind of sound that can be had from strings, recorded wide-range. I find myself lined up with the second camp. No doubt about it, the London string tone is wide-range. But then, so is "TT" recording from H.M.V. and, for that matter, plenty of other brands. Yet none of them has the peculiar frrr sound. Whether it is a trick with the mikes and/or a matter of acoustics; I do not know, but I am increasingly aware that frrr string tone, however desirable it may be, is not the only possible wide-range string sound. In these two albums (I have 78's), the all-string orchestra I find too metallic and brilliant for naturalness. Hi-fi or not, I think I would prefer a softer sound, more mellow. But, and this must be emphasized, it's all a matter of taste.

My only *bona fide* complaint is in the Britten work, a matter of recording level. Much of that recording is at such a low level that virtually no sound at all can be heard. I'm all for avoiding too much gain riding—but not to such an extreme as this! Musically speaking, the Holst is a good humored suite of folk-dance-like material, beautifully worked up for strings. The Britten is an early work, rather stark and self-conscious, variations on a sickly-sweet theme, à la Delius.

**Tchaikowsky, Variations on a Roccoco Theme; Capriccio Italien.**

Vox LP  
PLP 6640 (10")

**Mozart, Piano Concerto #25 in C; K. 503.**  
Gaby Casadesus, the Lamoureux Orch. Bigot.

Vox LP  
PLP 6520 (12")

Here are two more of the quite astonishing Vox-Polydor LP's in a new series that Vox has evidently, for the first time, made from tape originals. Both of these are top quality, about as good as anything of the sort from the prototype Columbia LP catalogue—with one decided  *caveat*—one side of the Mozart concerto is badly off-center in my copy, as well as warped. (The pressing is by Columbia!) Wide range, low distortion, excellent acoustics, fine tonal balance—in short, just plain good, up-to-date recording. Nice piano, too.

Gaby Casadesus' earlier Mozart Concerto for Vox, same orchestra, at the time, I found her playing so-so too. Now, strange coincidence, I find I like her in this concerto, which is much better recorded. Is it she, or

A NEW AMPLIFIER  
**GUARANTEED FOR LIFE AGAINST OBSOLESCENCE**

Model ACA-100-VV (Double "V")

Yes, for the first time, you can have positive assurance that your amplifier will NEVER — BUT NEVER become obsolete. This revolutionary development in amplifier design by A. C. Shoney guarantees ideal operation—regardless of what kind of input device becomes available, whether it be a new type phono pickup; tape, film or wire recorder, photocell input; or what have you! plus —

- the highest fidelity circuit ever built into any super-fidelity amplifier,
- exclusive non-frequency discriminating scratch and noise suppressor,
- exclusive push-pull triode volume expander.

Write today, and get your name on our mailing list to receive literature on the revolutionary new ACA-100-VV (Double "V" for Very Versatile).

**AMPLIFIER CORP. OF AMERICA**

398-4 Broadway • New York 13, N. Y.

**Aerosound** ★

### OUTPUT TRANSFORMERS

FINEST QUALITY . . . PRACTICALLY PRICED

A new and unique design makes possible the following superlative performance specifications:

- Response  $\pm 1$  db 10 cps to 40 kc
- Full power from 20 cps to 20 kc
- Low phase shift permitting over 30 db of stable feedback
- Superior transient response measured by 20 kc square wave
- Tightly coupled and reactively balanced windings
- Economy with no sacrifice of quality

AVAILABLE IN THE FOLLOWING MODELS

12.5 WATTS	
TO-240	4,000 ohms @\$8.75 net
TO-250	5,000 ohms @\$8.75 net
TO-260	6,000 ohms @\$8.75 net
TO-270	10,000 ohms @\$8.75 net
20 WATTS	
TO-280	9,000 ohms @\$13.75 net
* TO-290	12,000 ohms @\$13.25 net

\*(Specially designed for optimum match with triode connected 807's as in the famous Williamson circuit)

All units have pushpull primaries and 4, 8 and 16 ohm secondaries

Descriptive literature and suggested circuitry available on request

Prices F.O.B. 25% deposit required Philadelphia with C.O.D.'s

**ACRO PRODUCTS COMPANY**  
 532B-30 Baltimore Ave. Philadelphia 43, Pa.

## PROFESSIONAL DIRECTORY

### C. J. LeBEL

AUDIO CONSULTANT

Sound Recording • Instrumentation

370 RIVERSIDE DRIVE  
NEW YORK 25, N. Y.

Custom-Built Equipment

### U. S. Recording Co.

1121 Vermont Ave., Washington 5, D. C.

STerling 3626

Consultation • Design • Fabrication

### Audio Facilities Corporation

608 Fifth Avenue

New York 20, N. Y.

### HERMAN LEWIS GORDON

Registered Patent Attorney

Patent Investigations and Opinions

Warner Building 100 Normandy Drive  
Washington 4, D. C. Silver Spring, Md.  
NAtional 2497 SIllepherd 2433

### Albert E. Hayes, Jr.

CONSULTING RADIO PHYSICIST

8 East Sampson St. Bay Park, L.I., N.Y.

### PREAMP FACTORY CLEARANCE

Ever-so-slightly scratched, priced for fast sale. Famous Roger equalizing preamplifier for variable reluctance pickups, all speeds. Circuit in Feb. 1948 Audio Engr., p. 18, adapted for 110 V. operation. Beautiful black-crackle steel can with gray aluminum cover. Amply rated power transformer, selected 6SC7, hum and noise was way down! Thousands sold at \$13.95. 10-day money-back trial. We pay postage when money accompanies order.  
RA-20HF with built-in power supply \$6.95 net.

ROGER TELEVISION INC.  
86 Walker St., New York 13, N. Y.

the recording? Part of a critics job is to keep close tabs on his own reactions and discount or explain them; frankly, at this point I have not heard Gaby's new Mozart concerto enough times to be sure yet that it is actually played better, as well as recorded better—but I'm inclined to think it is.

The little 10-inch Tchaikowsky record is quite a gem, with one virtually unknown work, the "Rococo" number, and another that is heard only occasionally, on which occasions it never fails to astound with its realistic imitation of an old fashioned Italian-American hurdy-gurdy.

#### Beethoven, Piano Concerto # 5

("Emperor"),  
Clifford Curzon, London Philharmonic,  
Szell.

London LP  
LLP 114

#### Brahms, Sonata # 3 in F minor, opus 5.

Julius Katchen, pianist.

London LP  
LLP 112

These two LP records, together with last month's Mozart symphony (AUDIO ENGINEERING, Jan. 1950) pretty much redeem London's reputation from the unfortunate low incident to the sad debut of the English LP's late last summer. The poor quality of the first LP's was hard to believe—but it was perfectly obvious that something would get done about it, and something has been done. There must have been some very feverish activity in frr during the last few months.

The Brahms Sonata is a beautiful piano recording, more steady as to pitch than many a respectable U.S. LP, and with fine tone quality, natural transients, excellent dynamic range. It is a youthful exuberant work—Brahms was a mere 20—and it is here played by a lad of 23 who really sails into it in all its original impetuosity. Nice work.

The "Emperor" is also a beautiful recording, but a trace of trouble still remains. The patching on the LP sides reveals some unfortunate differences of pitch. Whether this was a matter of inaccurate tables or tape capstans, or whether it stems from actual differences due to recording dates on different days, I don't know. No excuse, one way or the other—but the excellence of the rest, technically, makes amends.

This Curzon-Szell "Emperor" is good, but not best. The old Columbia Rudolph Serkin version with Bruno Walter and the New York Philharmonic, for instance, is a better musical job in every way (a top quality job, indeed). Still, Curzon is no pianist to be overlooked, on this account.

#### Strauss, Till Eulenspiegel.

Cleveland Orchestra, Szell.

Columbia LP  
ML 2079 (10")

Here is a thoroughly satisfactory and unpretentious "Till," nicely recorded, nicely played, fresh, light, airy. If you haven't acquired "Till," by all means try this version. Dividend, *verso*, is in the form of Strauss' Don Juan, which you may not find quite as interesting.

#### In Memoriam: Rosita Renard.

(Carnegie Hall Recital).

Soc. of Friends  
of Music, Bogota,  
Colombia (1 LP)

One more piano LP—and a most unusual one. This opens up, as a "first," to my knowledge, a new field for LP recording—

**SOLVE** your hi-fidelity  
problems with

## University TWEETERS

WIDEST SELECTION • BEST  
VALUE • HIGHEST QUALITY

### SINGLE UNIT TWEETERS

**MODELS 4408, 4409—600  
CYCLE TWEETERS:** Recommended for highest quality reproduction systems requiring a low crossover frequency. Cabro shaped horn results in perfect wide angle distribution. Frequency response 600 to 15,000 cycles. Model 4408 handles 6 watts and 4409 25 watts.



**MODEL 4407 ADAPTER  
MOUNTS 4401 TWEETER  
IN ANY 12" CONE UNIT:** Converts any 12" cone speaker into a wide-range coaxial reproducer in a few minutes. Installation is extremely simple and results in a dual speaker occupying little more space than the original cone speaker. Complete with 4401 tweeter.



**MODEL 4401—2000 CYCLE  
TWEETER:** An economical 6 watt unit for converting any good 10-15" cone speaker for extended response to 15,000 cycles. Wide Angle horn, compact design and low price bring excellent high fidelity well within the popular price range.



### DUAL TWEETERS



**MODEL 4402, MODEL  
4404:** Model 4402 reproduces to 15,000 cycles. Crossover at 2000 cps. Horizontal dispersion 100°, Vertical 50°. Handles 12 watts. Compact design mounts in any radio, phone, or speaker cabinet. Model 4404 incorporates 4402 tweeter in handsome walnut cabinet complete with high-pass filter and high frequency volume control. Any-one can install.

### CROSSOVER NETWORKS



**MODEL 4405 HIGH PASS  
FILTER:** An effective and economical unit for preventing lows reaching the tweeter unit. Contains high frequency control to balance highs and lows. Cutoff frequency 2000 cycles.

**MODEL 4410, 4420 LC  
CROSSOVER NETWORK:** Genuine LC frequency dividers for segregating highs and lows. Not to be confused with ordinary high-pass filters. Crossover frequencies: Model 4410 600 cycles, Model 4420 2000 cycles. Attenuator controls included and wired.

Write for Illustrated Catalog Today  
—Address Inquiries to Department B

**University  
LOUDSPEAKERS • INC**

80 SO. KENSICO AV., WHITE PLAINS, N.Y.

**NOW  
AT ALLIED  
on easy terms!**

**MAGNECORDER**

**MODEL PT6-JA**

**The Professional  
Magnetic Tape Recorder**

ONLY  
**\$49.95**  
DOWN

Own the Best the  
Easy-Pay ALLIED way



Here is the professional tape recorder selected by over 2400 critical users—radio stations, schools, recording studios and professionals. Portable dual unit recorder and amplifier. Conforms to NAB specifications. Frequency response  $\pm 2$  db 50 to 15,000 cps with less than 2% harmonic distortion. Amplifier has low impedance mike input with gain control, also high impedance input for radio tuner, etc. Monitor Speaker with volume control. 3" illuminated VU Meter, 10 watts power output with provision for external speaker; also 600 ohm line output terminal. Three position switch selects Record, Listen, or Amplifier. Amplifier position can be used as public address or single channel remote. Recorder mechanism has two tape speeds, 15 or 7½ inches per second, with easily interchangeable capstans driven by synchronous motor. Hi-speed rewind has separate motor. Complete with tubes and instructions. Less tape, reels and mike.

**96-205** PT6-JA Magne recorder. **\$499.50**  
CASH PRICE  
\$49.95 down, \$39.71 monthly for 12 months  
**96-266** PT6-JA1H Magne recorder with high speed forward. CASH PRICE **\$515.50**  
\$51.55 down, \$40.98 monthly for 12 months  
All other Magne record units available from ALLIED on easy payments.

**ALLIED RADIO**

833 W. Jackson Blvd., Dept. 17-B-0  
Chicago 7, Illinois.

Enter my order for Magne recorder Model.....  
 Down Payment enclosed. \$.....  
 Send complete Magne recorder literature.

Name.....

Address.....

City..... Zone..... State.....

the musical "documentary." On the one LP record is the entire concert this lady gave including encores, her last before she died. (Jan. 19, 1949). She was, as you can quickly hear, a very great pianist, and this is a memorable memorial.

The music (disc recording) is rearranged from concert order, but the applause—which invariably begins *before* the last note of a piece—is used to carry across the gaps between cuts, fading ingeniously as the next piece is dubbed in. Good idea. Recording, aside from some irregularities, blasting, is excellent and for a simple reason—the mike, probably through sheer force of circumstance, was a good distance away from the piano. A lesson to be learned here!

**PHASEMETER**

[from page 11]

$$\theta_{min} = (7\frac{1}{2}/10^4)(360) \quad (7)$$

where  $f$  is the frequency of operation. This expression sets an upper frequency limit for measurement of all phase angles between 0 and 360 deg. Indeed, to measure all angles, employing the pulse inverter when necessary,  $\theta_{min}$  must be equal to or less than 90 deg. Substitution of this value in Eq. (7) leads to a maximum frequency of operation of 35,700 cps. In practice, the minimum phase angle so specified must be somewhat less than 90 deg. because of the additional phase angle introduced by the pulse inverter. In order to measure all phase angles, the minimum angle must be equal to or less than 90 deg. less half the additional phase angle introduced by the pulse inverter. Measurement of the present phasemeter shows that the angle so introduced may be expressed approximately by

$$x = 0.001 f + 4^\circ \quad (8)$$

so that the expression for the maximum frequency now becomes

$$90 - \frac{1}{2}(0.001 f_{max} + 4) = (7\frac{1}{2}/10^4)(360) \quad (9)$$

whose solution gives  $f_{max} = 29,200$  cps. This value corresponds well with the upper frequency limit found experimentally of 29,000 cps.

Figure 5 shows the measured and computed phase shift values for a single stage of amplification, using a conventional resistance-capacitance coupling with a 6SJ7. The measured half-power points were at 30 and 30,000 cps. It will be noted that the maximum difference between theory and experiment occurs at 15,000 cps, with the amount of the difference being 1.5 deg. This is within the accuracy stated for the meter.

It is concluded that this audio frequency phasemeter can be used to measure the relative phase angle between two sinusoidal signals within an accuracy of two per cent in the frequency range from 40 to 29,000 cps and without any ambiguity or instability.

**BRITAIN'S  
FINEST  
LOUDSPEAKER  
COMES TO YOU**

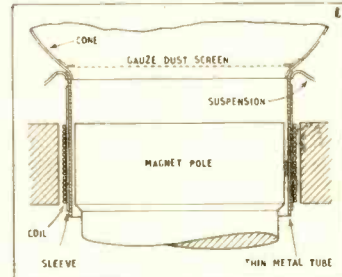

BARKER loudspeakers have something possessed by no other—the famous patented drive of fine aluminium wire over long life latex skin on wafer thin aluminium tube in high flux magnet field. All drive together for middles and lows, but at high compliance of latex allows tube to drive alone by induction its light weight extending frequency range smoothly to over 15,000 cps. Extremely high critical damping due to closed tube circuit gives dead-beat transient control and irons out resonances to give well known clean cut BARKER NATURAL REPRODUCTION.

Two models, 14,000 or 17,500 lines/sq. cm., 12 in. frames; 15 or 8 ohms coil. Prices \$45 and \$60 insured to your home.

Write today to

Barker Natural Sound Reproducers  
BCM/AADU, London, W.C.1, England.

**IRE National Convention**  
GRAND CENTRAL PALACE  
and  
HOTEL COMMODORE  
New York

**RADIO ENGINEERING SHOW**  
March 6-9 1950

230 Exhibitors

**Come Again-  
Audio Men!**

15,710 qualified engineers and technically minded people visited the 1949 Radio Engineering Show. 46% were interested in audio equipment—and found it well represented in the exhibits and technical papers. "Spotlight the New" again, March 6-9, at the Radio Engineering Show. Non-member registration is \$3.00.

**The Institute of Radio Engineers**

1 East 79th St. New York 21, N. Y.



## NEW LITERATURE

● **Output transformers.** A new line of high-fidelity output transformers is described in literature available from Acro Products Co., 5328-30 Baltimore Ave., Philadelphia, 43, Pa. These units have unusual frequency, power handling, and fidelity characteristics, with response within  $\pm 1$  db from 10 to 40,000 cps; they will deliver full rated power at 20 cps, and will handle twice the nominal power rating over the useful audio range. Available in six models for most popular tubes, including one for 807's in the famous Williamson circuit.

● **Rectifiers.** The Seletron Rectifier Division of Radio Receptor Co. has prepared a new 4-page folder showing applications of their "Seletron" rectifiers up to 75 kw, as developed by their customers. Illustrated and described are typical installations used in theatres, motor supplies, and electroplating processes. Address Seletron Division, 251 W. 19th St., New York 11, N. Y.

● **Power supplies and circuit panel.** Descriptive literature is available on two separate power supplies for experimental or laboratory use. Model 103 provides two separate "B" voltages variable from 0 to 300 volts at a maximum of 75 ma each, or 150 ma when paralleled; one "C" supply adjustable from +50 to -50 volts; and a heater supply of 6.3 volts at 5 amps. Model 245 is regulated, and provides d.c. from 200 to 500 volts, with either side grounded, and at a current of 200 ma. The circuit panel is a simple method of connecting vacuum-tubes for study or research, and is useful to experimenter or laboratory worker. These brochures may be obtained by writing Kepco Laboratories, Inc., 149-14 41st Ave., Flushing, N. Y.

● **Polystyrene.** The fabrication of polystyrene is summarized in a pocket-size reference booklet, with successful methods for sawing, turning, milling, drilling, threading, tapping, grinding, polishing, cementing, and many other machining operations being described. Write for copies to Plax Corporation Division, Hartford-Empire Co., P.O. Box 1019, Hartford 1, Conn.

● **Transformers.** A new catalog describing the complete line of transformers for broadcasting and other professional applications, as well as for amplifier constructors, the replacement field, and amateurs, has just been published by Peerless Electrical Products Division of Altec Lansing Corp. The line covers output, input, interstage, plate and filament, power smoothing and swinging chokes, modulation and replacement types. The catalog also lists the augmented line of 20-20 transformers, which have achieved widespread recognition. Write Altec Lansing Corp., 161 Sixth Ave., New York 13, N. Y., or 1161 N. Vine St., Hollywood 38, California.

● **Special Shapes.** Cold-finished flat wire and precision rolled strip in stainless steel and nickel alloys are described in a bulletin recently made available from Alloy Metal Wire Co. Inc., Prospect Park, Pa.

## NEW PRODUCTS

[from page 36]

level for a 10 dyne/cm<sup>2</sup> sound pressure is -45 vu, and impedance is either 250 or 30 ohms, at the choice of the user. The microphone has a diameter of 1-1/16" and is 11 3/4" in length, including the swivel mounting. For further information, write for TV Bulletin 156; Electro-Voice, Inc., Buchanan, Mich.

# AMPERITE

## Studio Microphones at P.A. Prices

Ideal for BROADCASTING

- RECORDING
- PUBLIC ADDRESS

"The ultimate in microphone quality," says Evan Rushing, sound engineer of the Hotel New Yorker.

- Shout right into the new Amperite Microphone—or stand 2 feet away—reproduction is always perfect.
- The only type microphone that is not affected by any climatic conditions.
- Guaranteed to withstand more "knocking around" than any other type mike.

**Special Offer:** Write for Special Introductory Offer, and 4-page illustrated folder.

**AMPERITE Company, Inc.**

561 BROADWAY • NEW YORK 12, N. Y.

In Canada: Atlas Radio Corp., Ltd., 560 King St. W., Toronto



Models  
RELG—200 ohms  
RBHG—Hi-imp.  
List \$42.00



"Kontak" Mikes  
Model SKH, list \$12.00  
Model KKH, list \$18.00

meet the **Mrs.** model three  
(amplifier)

and **Mr.** multiple unit  
(speaker)

they're a **wonderful** couple

"they perform so well together" - - - -

**audio pacific co.**

our new office  
6110 Santa Monica  
Hollywood 38, Calif.

**THE McINTOSH  
Pre-Amplifier Equalizer Model AE-2**

will be at home in the record library. It was designed inside and out for The Music Lover. A fixed two position filter provides 6db per octave rise below 300 or 500 cycles. A variable equalizer with two non-interacting controls gives:

- up to 15db bass boost
- or up to 20db bass attenuation
- up to 15db treble boost
- or up to 20db treble attenuation

Five input circuits can be selected from:

1. Low level Microphone
2. G.E. Pickup (automatically equalized)
3. Pickering Pickup (automatically equalized)
4. Crystal Pickup
5. Tuner



**Model AE-2 Pre-Amplifier Equalizer**

1. Adjustable input levels.
2. Non-interacting equalizing controls. Independent bass boost and attenuation control. Independent treble boost and attenuation control.
3. Flat response settings.
4. Self-contained power supply.
5. Remote control of power amplifier.
6. All tubes shock mounted.
7. 300 and 500 cycle turnover.
8. Low impedance output.
9. Harmonic distortion less than 1% 20 to 20,000 cycles at 4 Volts out.
10. Gain from microphone input 56db.
11. Maximum gain from tuner input 27db.
12. Output level
  - Normal, 2 Volts
  - Maximum 6 Volts

For complete details ask your dealer or write to:  
**McIntosh Engineering Lab., Inc.**  
910 King Street Silver Spring, Maryland  
Telephone: Juniper 7-9200

**THE HARTLEY-TURNER 2nd. YEAR.**

Our first year of serving you has resulted in many interesting contacts and customers. It has given us much useful information on the sort of service American high-fidelity enthusiasts require. Now we have to consolidate, and that we aim to do by the tried method of personal recommendation.

Advertising over-statement is soon found out. What we offer you is intelligent letters, sound technical service, and products of outstanding performance. Add to this good deliveries and impeccable after-sales service, and a realization that the distance between you and us is bridged if we "play the game" at all times.

Those of you who have not yet written to us should send a dollar bill for "New Notes in Radio" and a continuing supply of data sheets and other technical helps, but descriptive leaflets are free for the asking. Leaflets of what? Of the Hartley-Turner 215 speaker and all the other things necessary for the truly musical reproduction of radio and records.

Many like the way we solve the problems, especially the low cost. You will too. And we want the co-operation of really intelligent dealers as exclusive territorial agents.

**HARTLEY-TURNER 215 SPEAKER \$40.00**  
(postage and insurance paid).

**H. A. HARTLEY Co. Ltd.**  
152 HAMMERSMITH ROAD  
LONDON W.6, ENGLAND.

**ADVERTISING  
INDEX**

Acro Products Company	44
Allied Radio Corp.	46
Amperite Co., Inc.	47
Amplifier Corp of America	44
Arnold Engineering Company	1
Arrow Electronics Company	40
Astatic Corporation, The	38
Audak Company	3
Audio Devices, Inc.	Cover 2
Audio Facilities Corp.	45
Audio Instrument Company	32
Audio Pacific Company	47
Barker Natural Sound Reproducers	46
Beck, R. M. Company	35
Bell Telephone Laboratories	2
Browning Laboratories, Inc.	39
Camera Equipment Company	30
Clarkstan Corp.	34
Cook Laboratories	36
Daven Co., The	Cover 3
Electro-Voice, Inc.	25
Fairchild Recording Equip. Corp.	31
General Radio Company	8
Gordon, Herman Lewis	45
Gray Research & Dev. Co.	32
Hartley, H. A. Co., Ltd.	48
Harvey Radio Company, Inc.	37
Hayes, Albert E. Jr.	45
Holl Audio Industries	41
Hollywood Sound Institute	48
Hycor Company, The	48
Industrial Electrical Works	6
Institute of Radio Engineers	46
Lafayette Radio	44
LeBel, C. J.	45
Magnecord, Inc.	33
Maurer, J. A. Inc.	29
McIntosh Engineering Lab, Inc.	48
Merit Transformer Corp.	43
Partridge Transformers, Ltd.	48
Pickering & Co., Inc.	5
Proctor Soundex Corp.	42
Professional Directory	45
Racon Electric Co., Inc.	42
Radio Corp. of America (Broadcast Equip. Div.)	7
Reeves Soundcraft Corp.	27
Shure Brothers, Inc.	28
Sun Radio & Electronics Co., Inc.	43
Tech Laboratories, Inc.	38
Terminal Radio Corp.	34
United Transformer Corp.	Cover 4
U. S. Recording Co.	45
University Loudspeakers, Inc.	45

**AUDIO ENGINEERING SCHOOL**

Practical engineering training in Audio fundamentals, Disc, Film, Magnetic Recording, and Audio frequency measurements.  
Studio training simulates Broadcast, Motion Pictures, Television, and Commercial Recording work.  
Approved for Veterans  
**Hollywood Sound Institute, Inc.**  
1040-A North Kenmore, Hollywood 27, Calif.  
Correspondence Courses Available  
Specify if Veteran or Non-Veteran



*"To Specification"*

**AUDIO TRANSFORMERS**

"To Specification" or Standard. If the problem is Transformers or Chokes, none are more experienced to find the solution than the acclaimed specialists of twenty years standing . . . Partridge.

**PUSH-PULL OUTPUT TRANSFORMERS**

Full A.F. range with minimum distortion. Rating 12 W. for 0.5% harmonic distortion at 50 cps. Six models, accurate anode/anode load matching between 4,000 and 12,000 ohms. Specify tubes and speaker.

Price, including postage, packing and insurance. Unpotted (DN/404B) . . . . . **\$10.50**

Potted (DN/404B) . . . . . **\$11.50**

**WILLIAMSON OUTPUT TRANSFORMER**

A "quality" 20 W. transformer built to the Williamson design (see "Wireless World" August 1949). The finest possible transformer of its type. Weight 12 lbs. Model available for 807 tubes (See "Audio Engineering" Nov. 1949.)

Price, including postage, packing and insurance. Unpotted (VDN/436B) . . . . . **\$18.50**

Potted (VDN/436B) . . . . . **\$19.50**

**IMMEDIATE DELIVERY**

is given on the above. Technical literature free on application to—



**PARTRIDGE  
TRANSFORMERS LTD**

Roebuck Road, Tolworth, Surrey, England

**HIGH "Q" DECADE-INDUCTORS**



**HYCOR DECADE**—Inductor units are indispensable for design and experimentation work on audio filters.

The units are available in four ranges up to 10 henries. Units may be used individually or all four may be connected in series to obtain 11.11 henries in 1 milli-henry steps.

Toroid coils are used to obtain high "Q", stability and low pickup from external fields. Inductance accuracy is 2%.

The units are economically priced to bring them within the reach of all audio experimenters. Send for Bulletin D.

**THE HYCOR COMPANY**  
11423 VANOWEN ST.  
NORTH HOLLYWOOD, CALIF.

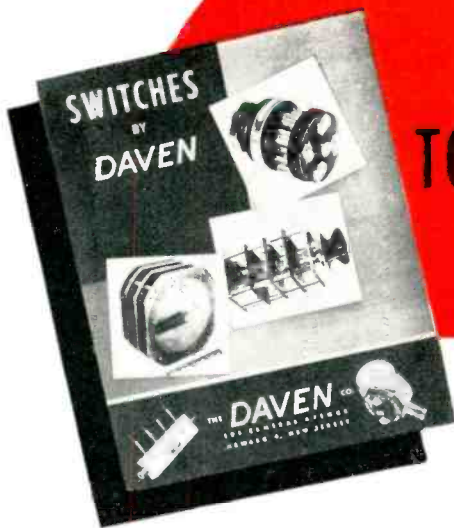

# ... FOR THOSE TOUGH "Switching" PROBLEMS TRY DAVEN!

Whether you use switches for industrial applications, communications or laboratory work a Daven constructed unit will give maximum performance. Many years of engineering experience and skilled workmanship have been combined to make a truly superior switch.

WRITE FOR YOUR COPY  
OF OUR NEW SWITCH BULLETIN

Daven switches are the rotary selector type—outstanding in design and capable of withstanding the most critical tests. They are preferred by engineers who want the best.

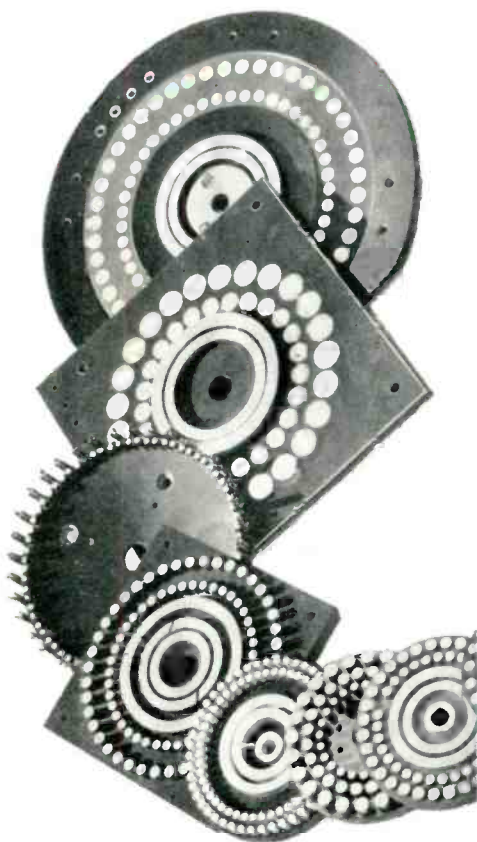

### Some outstanding features are—

- Low and uniform contact resistance.
- Minimum thermal noise.
- High resistance to leakage.
- Trouble-free operation and long life.
- Roller-type positive detent action.
- Depth of unit not increased by addition of detent.

### A full line of standard switches are available Listed below are a few of the popular types

Type	Operation	Maximum No. of Positions (per pole)	Maximum Poles Per Deck	Deck Diameter
C1A	make before break	31	1	1 3/4"
C2B	break before make	15	1	1 3/4"
C7A	make before break	11	2	1 3/4"
C8B	break before make	5	2	1 3/4"
D1A	make before break	47	1	2 1/4"
D7A	make before break	14	4	2 1/4"
D9A	make before break	9	5	2 1/4"
D10B	break before make	5	5	2 1/4"
E3A	make before break	47	2	2 3/4"
E4B	break before make	23	2	2 3/4"
E7A	make before break	23	4	2 3/4"
E8B	break before make	12	4	2 3/4"
F2B	break before make	30	1	3"

Single deck switches are round. Multi-deck switches are square.

DAVEN can adapt a standard switch for your special requirements. Our engineers will be glad to offer suggestions on your problems.

Send your detailed information to Department A-6.  
VISIT DAVEN AT THE IRE SHOW—Booth 94B





# FILTER SPECIALISTS

PRODUCERS OF PERMALLOY LUST TOROID COILS AND FILTERS FOR OVER A DECADE

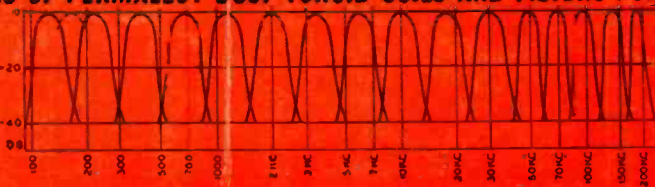

## FOR FILTERS

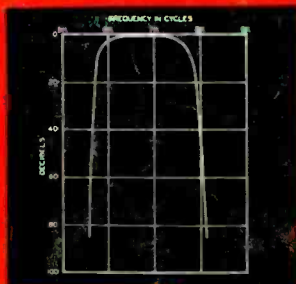

**BROAD BAND  
SHARP CUTOFF  
FILTER**

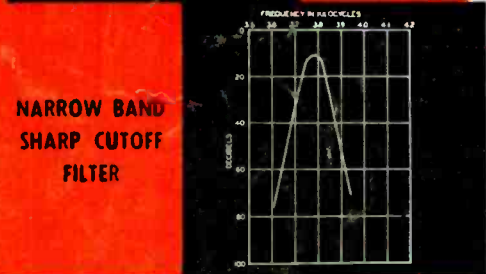

**NARROW BAND  
SHARP CUTOFF  
FILTER**



**LOW FREQUENCY  
— LOW PASS  
FILTER**

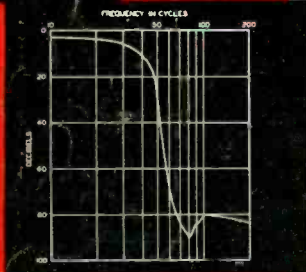

**SUB-OUNCER  
TOROID FILTERS**

Filters employing SUB-OUNCER toroids and special condensers represent the optimum in miniaturized filter performance. The band pass filter shown weighs 6 ounces.

## FOR HIGH Q COILS



**HQA, C, D TOROID COILS**  
1 1/8" Dia. x 1 1/2" H. gh.

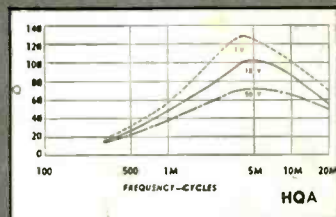

**HQB TOROID COIL**  
2 3/8" L x 1 3/8" W x 2 1/2" H.

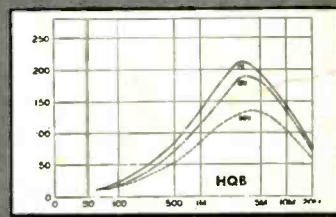

**UNCASED TOROIDS**

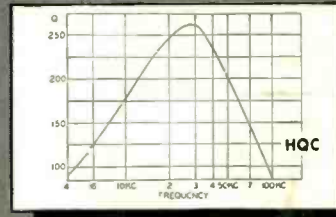

**VIC  
VARIABLE  
INDUCTOR**

1 3/8" L x 1 1/4" W x 1 1/2" H.

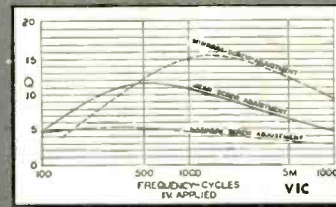
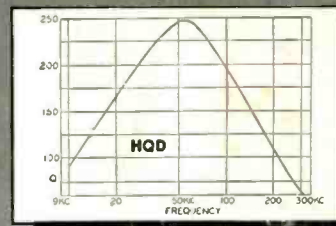

*United Transformer Co.*

150 VARICK STREET NEW YORK 13, N. Y.  
EXPORT DIVISION: 13 EAST 40th STREET NEW YORK 16, N. Y., CABLES: "ARLAB"

write for catalog PS-409