

# AUDIO ENGINEERING

DECEMBER  
1950  
35c



INCLUDING  
**VIDEO  
ENGINEERING**  
SECTION

Published by RADIO MAGAZINES, INC.

[www.americanradiohistory.com](http://www.americanradiohistory.com)



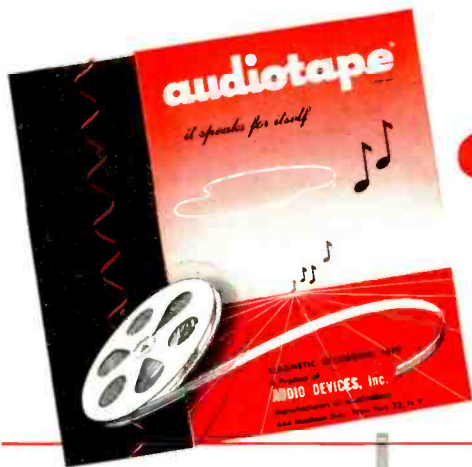

# Here's What These audio "Firsts"

## Have Done for You

... to lower the cost and improve  
the quality of magnetic recording tape

**First with liberal discounts to professional users**

TAPE PRICES	
Professional	Standard
33 1/2% off	33 1/2% off

—enabling radio stations, recording studios and educational institutions to save as much as 33 1/2% on the cost of magnetic tape.

**First with attractive resale discounts**



—and a nation-wide network of helpful, cooperative sound-equipment distributors in principal cities from coast to coast.

**First with red oxide tape on paper base**



—offering recordists a high-quality tape designed to match the characteristics of the vast majority of recorders, at *lowest possible cost*.

**First with supercalendered kraft paper base**



—providing maximum smoothness of texture and minimum noise, without the use of fillers which tend to come out or stiffen the paper.

**First with all-aluminum 7-inch reels**



—mechanically strong, light in weight, and permanently free from warping or twisting even under adverse conditions.

**First to give extra footage on standard size reels**

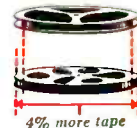

Audio's "full measure" of 1250 ft., 2500 ft., and 5000 ft. give *4% more tape* on every reel.

**First with black oxide tape on plastic base**



—offering highest fidelity of recording and reproduction for machines designed to use a high coercive-force oxide.

**First to offer paper base tape in 2500 and 5000 foot rolls**



—permitting maximum economy for professional applications where premium quality recordings are not required.

**First to produce a constant output tape**

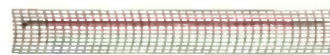

—made possible by Audio's specially designed coating machinery which controls coating thickness to within 5 *millionths* of an inch.

**First to guarantee output uniformity of**

± 1/4 db for 2500 ft. reel



± 1/2 db from reel to reel in 2500 ft. size



**First to produce a splice-free 2500 ft. roll**

—to *guarantee* that the tape is all one piece, with absolutely no splices in the entire length.



**First to develop the safe-handling package for professional-size rolls**



—permitting tape on hub to be transferred to or from turntable without danger of spilling—and simplifying the attachment of side flanges.

These "Firsts" are proof of the continuous research and development that keeps Audiotape foremost in the field. They are the result of more than a decade of experience — by the only company specializing solely in the manufacture of fine recording materials — both tape and discs.

That's why you can always look to Audio for the latest developments in the recording art. A trial order of Audiotape will speak for itself. Or send today for a free 300-foot sample.

\*Trade Mark

### AUDIO DEVICES, INC.

444 Madison Ave., New York 22, N. Y.

Please send me a free 300-foot sample reel of  plastic base or  paper base Audiotape.

NAME .....

COMPANY .....

ADDRESS .....

CITY ..... STATE .....

# AUDIO ENGINEERING

Successor to **RADIO**

Established 1917



**C. G. McProud, Editor**  
Luci Turner, Production Manager  
Lucille Carty, Circulation Manager

**Ladd Haystead, Publisher**  
S. L. Cahn, Advertising Director  
H. N. Reizes, Advertising Manager

**Editorial Advisory Board**

Howard A. Chinn  
John D. Colvin  
C. J. LeBel  
J. P. Maxfield  
George M. Nixon

**Representatives**

Sanford R. Cowan, Mid-West Sales  
342 Madison Ave., New York 17, N. Y.  
James C. Galloway, Pacific Coast Sales  
816 W. 5th St., Los Angeles 17, Calif.  
Technical Book & Magazine Co.  
297 Swanston St., Melbourne, C. I.  
Victoria, Australia

**CONTENTS      DECEMBER, 1950      Vol. 34, No. 12**

Audio Patents— <i>Richard H. Dorf</i> .....	2
Letters .....	4
Technicana .....	8
Editor's Report .....	10
Design, Construction and Adjustment of Reflexed Loudspeaker Enclosures — <i>David W. Worden</i> .....	15
A Continuously Variable Loudness Control— <i>E. E. Johnson</i> .....	18
Rapid Attenuator Calculation Using the Vector Slide Rule — <i>A. E. Richmond</i> .....	19
Determining Unknown Impedances in Transformers— <i>Louis H. Hippe</i> .....	21
Audio Design Notes Resonant Loudspeaker Enclosures— <i>Bob H. Smith</i> .....	22
<b>AUDIO engineering society SECTION</b>	
Convention Report .....	23
The Audio Fair Review .....	24
Audiana—High Fidelity— <i>Lewis S. Goodfriend</i> .....	34
Record Revue— <i>Edward Tatnall Canby</i> .....	36
Pops— <i>Rudo S. Globus</i> .....	36
New Products .....	50
Employment Register .....	59
New Literature .....	61
Annual Index .....	62
Advertising Index .....	64

**COVER**

Mr. Price Fish of CBS General Engineering Dept. is seen with two of the Fairchild Pic-Sync Magnetic Tape Recorders installed at the WCBS-TV Studios (New York). This 1/4-in. tape equipment is the heart of the CBS-TV "Mag-Neg-Tic" TV recording technique of reproducing sound from the tape in synchronism with motion picture film. A Fairchild Pic-Sync installation at the Hollywood CBS Studios includes recording and production editing facilities for the preparation of magnetic tape sound and TV picture film recordings for release from New York on the video network.

AUDIO ENGINEERING (title registered U. S. Pat. Off.) is published monthly at 10 McGovern Ave., Lancaster, Pa., by Radio Magazines, Inc., D. S. Potts, President; Henry A. Schober, Vice-President. Executive and Editorial Offices: 342 Madison Avenue, New York 17, N. Y. Subscription rates—United States, U. S. Possessions and Canada, \$3.00 for 1 year, \$5.00 for 2 years; elsewhere \$4.00 per year. Single copies 35c. Printed in U. S. A. All rights reserved. Entire contents copyright 1950 by Radio Magazines, Inc. Entered as Second Class Matter February 9, 1950 at the Post Office, Lancaster, Pa. under the Act of March 3, 1879.

## Wide Range Reproduction For the Home



### \* Triad Hi-Fidelity Amplifier Kit...

The Triad HF-10 Amplifier, from a circuit designed in cooperation with J. N. A. Hawkins, prominent sound engineer, has been produced especially for those who like to build their own sound reproducing systems. When used with the high quality speakers, tuners, turntables, and pick-ups now available, a system can be built that will meet the requirements of even the most critical music lover. The Triad HF-10 kit supplies the basic engineering and solves the most difficult mechanical layout problems. With 18 db. of feedback, affording a reflected impedance of less than 2 ohms to the 16 ohm speaker tap, within 1 db. linear frequency response from 20 to 20,000 cycles, and with a minimum of distortion over this same range, the HF-10 is worthy of use in the very finest home music installations.

### \* Features...

- Wide Frequency Response:** Within one db. from 20-20,000 cycles.
- Low Distortion:** Less than 2% from 50-18,000 cycles at full 10 watts output. Less than 1% from 20-20,000 cycles at 5 watts.
- Heavy Speaker Damping:** Reflects less than 2 ohms to speaker from 16 ohm tap.
- Equalization:** Continuously variable to +12 db. or -30 db. at 50 or 8000 cycles.
- High Gain:** 74 db. from crystal microphone or radio receiver; 96 db. (equalized for magnetic pickup) through preamplifier.
- Low Noise:** Hum and other noise 60 db. below maximum output. A-74J equalizing coil has 70 db. shielding.
- Beautiful Appearance:** Gray hammetone chassis with ivory silk-screened lettering, matching gray Triad transformers.

### \* Prices

- HF-10 Kit**—Includes S-31A, R-14A, A-74J, and C-10X Triad transformers, chassis, prints and assembly instructions. **List Price \$39.85**
- HF-10A Kit**—Same as above except for substitution of HS-81 output transformer for S-31A. **List Price \$57.75**

See your dealer or write for Bulletin HF-10, and Catalog TR-49A which describes the complete Triad line.

**2254 Sepulveda Blvd.  
Los Angeles 64, Calif.**



**FOR  
ABSOLUTE TOP QUALITY  
...at Popular Prices!  
REK-O-KUT  
TURNTABLES**



**CONTINUOUSLY VARIABLE SPEED  
RECORD PLAYER**

Plays without "wow" at any setting within its speed range of 25-100 R.P.M. The indispensable turntable for TV, AM, FM broadcast stations, dance studios, musicians, singers, record collectors and wherever audio-visual methods are employed. Plays through any amplifier, radio, TV set, or phonograph. Operates on 50 or 60 cycles. The only turntable to use in areas of varying voltages and frequencies or with portable power plants.

CVS-12 (Illustrated) .....\$84.95 NET  
CVS-12P in portable case with  
16" Dual-Stylus Pickup.....\$124.95 NET



**Famous  
Models  
T-12H and  
T-43H**

\*Recommended for use with Hi-Fi amplifiers and speaker systems because of low noise and rumble level, which is maximum-50 db. The only 11" dual speed turntables equipped with Hysteresis synchronous motors, thereby meeting standards for speed regulation and "wow" content specified by the N.A.B. Instantaneous speed shift engages either 78 or 33 1/2 R.P.M. idler without stopping turntable or removing disc.

T-12H ..... 78 - 33 1/2 ..... \$119.95 NET  
T-43H ..... 45 - 33 1/2 ..... \$119.95 NET  
Interchangeable idlers for third speed optional



**Model LP-743  
Three-Speed  
12" Transcription  
Turntable**

Designed to meet the growing demand for a good turntable which is priced between the deluxe models and ordinary phono motors... and dimensioned for easy replacement of obsolete motors in average consoles. Instantaneous speed changes - 78, 45, 33 1/2 R.P.M. without stopping turntable or removing disc .....\$54.95 net

*\*As attested to by America's top authorities on sound equipment.  
Reprints on request.*

Ask to see REK-O-KUT Products at Music Stores, Radio Parts Distributors and Audio-Visual Dealers, or Write for Literature.

**REK-O-KUT CO., Inc.**  
38-01 QUEENS BOULEVARD  
LONG ISLAND CITY 1, N. Y.

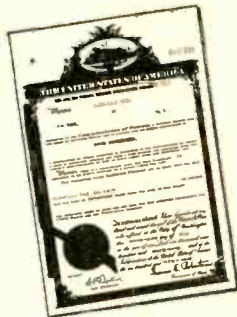

# AUDIO PATENTS

RICHARD H. DORF\*

**C**ONDENSER MICROPHONES (or should we say "capacitor microphones" these days?) are among the best available when they are designed correctly. They were used for a long time in broadcasting and are now reappearing in improved versions. One of the headaches connected with their use, however, is that a "head" amplifier must almost always be placed within a few inches of the microphone because the small microphone capacitance would be swamped by the capacitance of leads of any length.

One solution, of course, is the use of a cathode-follower at the end of a cable, since ordinary cathode followers can decrease the effective input capacitance by as much as 100 times. Even this is not sufficient, however, for with the conventional pentode cathode follower using a 0.5-meg. grid resistor—without any cable to speak of between microphone and grid—and a 25- $\mu$ f microphone the lower cutoff frequency (3 db down) is about 150 cps. Higher grid resistor values make for unstable operation. The "supercharged" cathode follower illustrated in Fig. 1, however, lowers the cut-

$V_1$  is connected across the output of the cathode follower  $V_1$ . Since it is in phase with the  $V_1$  cathode output voltage the total feedback of the circuit is greatly increased. For the circuit shown the effective input impedance (at the grid of  $V_1$ ) is

$$R_i = \frac{1}{1-G}$$

where  $G$  is the incremental gain from input to output. If  $R_i$  is to be large, as is desired,  $G$  must be very high, close to unity. And if the gain of  $V_1$  is infinite then

$$G = \frac{\mu}{\mu - 1}$$

The insertion of  $V_2$  makes for very large incremental gain, which makes the net feedback also very great. The effective input impedance thus is very much higher than for a conventional cathode follower and the effective input capacitance is correspondingly reduced.

The inventor's experiments and calculations show that with the 25- $\mu$ f microphone working into a conventional pentode amplifier with a grid resistor of 0.5 meg., the lower-frequency cutoff is 13,000 cps. With an ordinary pentode cathode follower and the same grid resistor, cutoff is at 150 cps. With the supercharged circuit the response is flat to 20 cps. Addition of a slant capacitor of 1,000  $\mu$ f, such as might be present due to a length of connecting cable between microphone and grid, resulted only in a loss of 1 db below 10,000 cps.

The supercharged circuit, therefore, is increased by a factor of about 300. Points A and B must be at the same d.c. potential. That at A is adjusted by breaking the connection between the points and setting  $R_5$ .

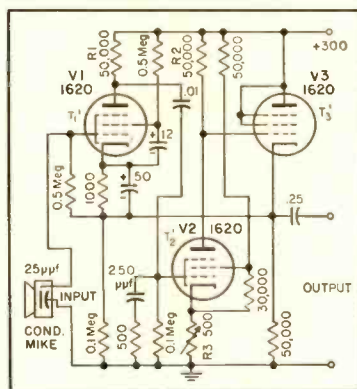

Fig. 1

off to 20 cps and even allows a 1,000- $\mu$ f length of connecting cable to appear between microphone and grid with negligible effects. It is the invention of Paul S. Veneklasen and is assigned to the United States as represented by the OSRD. The patent number is 2,508,586.

The first 1620 in Fig. 1,  $V_1$ , is a conventional cathode follower except that there is also a plate load resistor  $R_1$ . The plate output of  $V_1$  is fed in the conventional way to the grid of  $V_2$ , whose plate load resistor is  $R_6$ . The grid of  $V_3$  is directly coupled to the plate of  $V_2$ ;  $V_3$  is a second cathode follower. The output—that is, the cathode—of

### Heterodyne Oscillator

One of the common troubles in beat-frequency test oscillators is "pulling" between the oscillators when they approach the same frequency. The result is that the beat value is usable only down to a certain minimum frequency, below which the oscillators suddenly lock. The usual solution is separation of the oscillators, thorough shielding, and sometimes by adding buffer isolation between each oscillator and the mixer.

Ivor R. Worsley of London, England, has designed a beat-frequency oscillator for which the necessary space and cost have been reduced and which has a special arrangement to reduce the effects of pulling between oscillators. The patent, No. 2,510,165, is assigned to International Standard Electric Corp. The circuit is shown in Fig. 2.

The factor making for the reduction of space and cost is the use of a triode-pentode tube, such as the 6F7 (the inventor did not mention this tube). The triode section of the tube is used for the fixed oscillator and

[Continued on page 47]

\*Audio Consultant, 255 West 84th Street, New York.



# All Sound by **ALTEC**

## MICROPHONES



21B (stand)



639\*



633\*



21B (chest)



21B (lapel)



632\*

\*Formerly manufactured by *Western Electric Co., Inc.*

## AMPLIFIERS

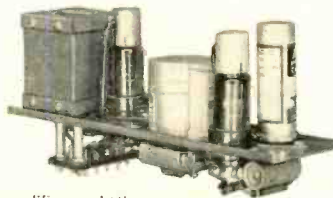

Pre-amplifiers and Mixers



Portable P.A. Amplifiers



Power Amplifiers

AMPLIFIERS AND SPEAKERS ILLUSTRATED ARE A FEW OF THE WIDE SELECTION AVAILABLE

## LOUDSPEAKERS



400B

755A\*

600B

728B\*

603B



754B\*

604B

800

757A\*

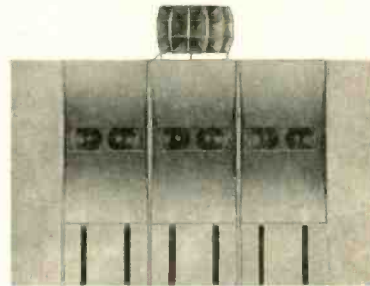

"The Voice of the Theatre"

\*Formerly manufactured by *Western Electric Co., Inc.*

## REPRODUCERS

9A\* and 9B\*



109 Reproducer Group\*

\*Formerly manufactured by *Western Electric Co., Inc.*

1161 N. VINE ST., HOLLYWOOD 38, CALIFORNIA  
161 SIXTH AVENUE, NEW YORK 13, NEW YORK

Also **PEERLESS TRANSFORMERS**





**We CHALLENGE the performance of any 12" speaker with a**

# Permoflux ROYAL EIGHT"

SAYS PERMOFLUX'S MR. HY-FY

This averaged laboratory response curve of the Permoflux 8T-8-1 proves that it compares with the finest speakers regard- less of size or price.



Hi-Fi Fans the country over have accepted this challenge—have asked their "soundman" for a demonstration—then, have installed a Permoflux Royal Eight" in their own audio equipment. Now they possess a magnificent speaker at a reasonable price which reproduces sound with superior sensitivity and fidelity as well as tonal qualities which YOU too will want to add to perfect the excellence of your own equipment.

Send for beautifully illustrated catalog No. J201 to address listed below for further information including a full page devoted to correct baffling of Royal Eight" and other size speakers.



*Servicemen!*



PERMOFLUX ROYAL EIGHT" WITH THE FAMOUS BLUE CONE  
DEALER'S PRICE \$10.50

### Check These Exclusive Features

Permoflux's exclusive slotted, treated cone gives the following results which makes their speaker comparable to any 12" speaker:

- Soft-suspended cone and extra-large spider provide extended low frequency response.
- Deeper, curvilinear cone greatly extends high-frequency response.
- High permeance yoke increases output.
- 8 ohm—10 watt voice coil.
- Big speaker performance in a small frame allows smaller more economical baffle.

Here's BIG SPEAKER performance—clean, brilliant, musical reproduction but at a sensible price level. Your customers will approve and buy. Order one for test today—your money refunded if you do not agree that it is truly outstanding in performance.

*Inquire about Permoflux's Complete Royal Blue Line 6" to 15" Speakers*

### 10-DAY TRIAL—MONEY BACK GUARANTEE



**PERMOFLUX**  
"SOUND IN DESIGN"

PERMOFLUX CORPORATION  
4902 W. Grand Ave., Chicago 39, Ill.

Please send \_\_\_\_\_ Permoflux Royal Eight" (8T-8-1)

Check  Money order enclosed



**ORDER NOW**

Name of Favorite Distributor \_\_\_\_\_

Your Name \_\_\_\_\_

Address \_\_\_\_\_

City \_\_\_\_\_ Zone \_\_\_\_\_ State \_\_\_\_\_

## LETTERS

### Ground Loudspeakers

Sir: It was with great interest that we found in *AUDIO ENGINEERING*, October 1949, an article on Ground Loudspeakers.

We avail ourselves of this occasion to draw your attention to the fact that ground loudspeakers have been developed and installed in the Olympia Stadium in Berlin by Telefunken as early as 1936. A description of the ground loudspeakers, the performance of which was fully satisfactory, is to be found, for instance in the periodical *Telefunken-Hausmitteilungen* No. 79 (1938) pages 66 and 67.

TELEFUNKEN  
Gesellschaft für drahtlose  
Telegraphie m.b.H.  
Berlin SW 61,  
Mehringdamm 32-34

### Choral Recording

Sir: For a long time there has been a controversy between engineering balance and the proper acoustical balance of orchestral and choral groups. Unfortunately this controversy stems from the failure of engineers and conductors getting together on interpretation of individual selections.

We are currently specializing in large a capella and choral groups including the famous St. Olaf Choir of Northfield, Minn., the Concordia Choir of Moorhead, Minn., The Notre Dame Cathedral Choir of Paris (France) recorded in the cathedral itself, The Cathedral Choir of the First Presbyterian Church of Hollywood, and many others. These choirs consist of about sixty voices, and we have found in many instances that it is necessary to rearrange the music for proper recording balance. There is a vast difference between a concert arrangement and a recording arrangement, which few engineers or musical directors recognize. As a result there is always the tendency to run into shattering or complete loss of balance on high-volume passages.

It is practically impossible to record consecutive thirds in women's voices and maintain proper diction or definition. However, if a simple expedient of inversion is applied to the music itself the results are very gratifying. The foregoing, of course, is just one of the many problems to be met on individual selections, and impossible to get across to some musical directors for it is treading on sacred ground, so to speak. Any good director can usually be interested in the laws of acoustics in recording it properly approached. Here the engineer should be thoroughly versed in musical terminology in order to get his point across. A good approach is to point out that film, radio, and phonograph recording has a distinct technique of its own to be met and if the director is given an opportunity to see what happens when these problems are not met, he will correct the situation.

On the surface, this report may sound ambiguous, but the writer has spent years in research and study from the viewpoints of musicianship, scoring, and engineering, and has given many courses in colleges throughout the country in acoustic balance. It is a highly specialized field of research, and is extremely fascinating. To both the engineer and the musical director it opens horizons in music that have not been touched.

Eddison von Ottenfeld, Mus.D.  
Vonna Records,  
12129 Hartsook,  
North Hollywood, Calif.



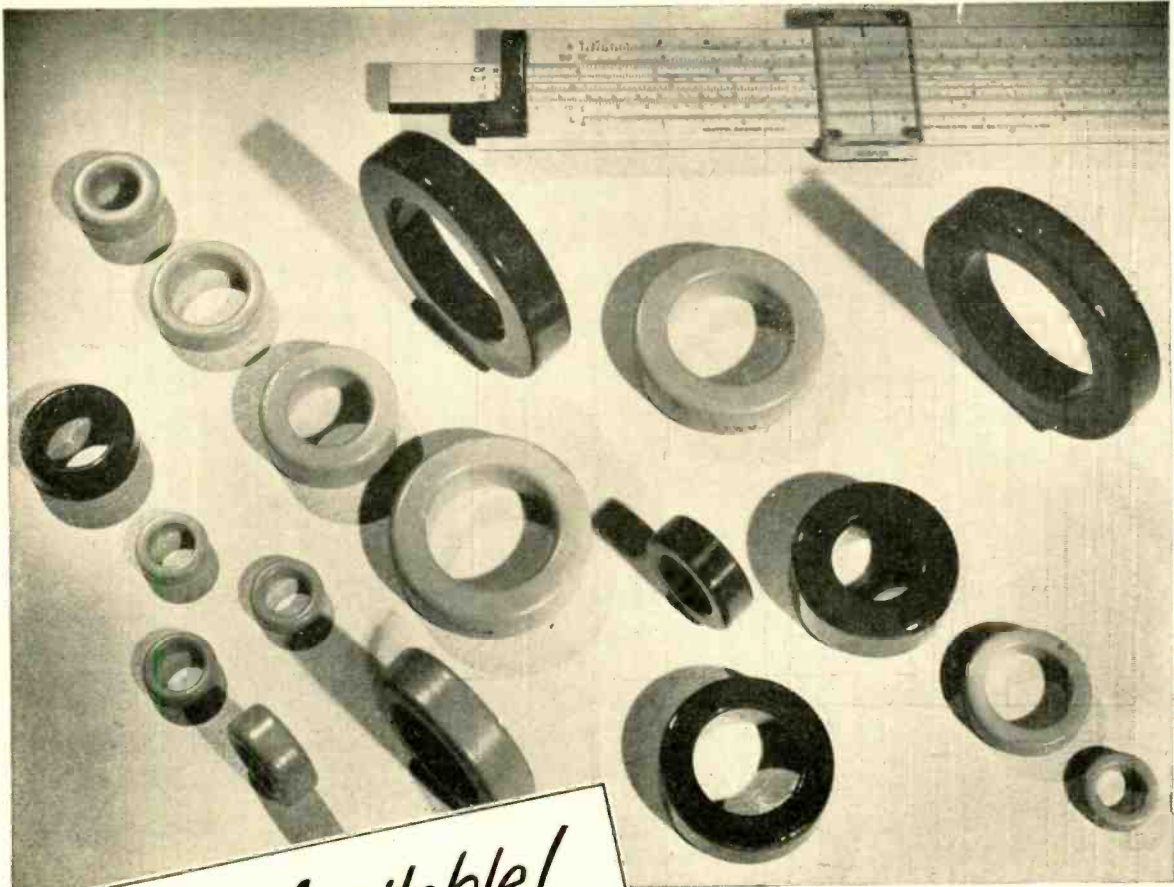

*Now Available!*  
**MOLYBDENUM PERMALLOY  
 POWDER CORES\***

**HIGH Q TOROIDS for use in  
 Loading Coils, Filters, Broadband  
 Carrier Systems and Networks—  
 for frequencies up to 200 KC**

**COMPLETE LINE OF CORES  
 TO MEET YOUR NEEDS**

- ★ Furnished in four standard permeabilities—125, 60, 26 and 14.
- ★ Available in a wide range of sizes to obtain nominal inductances as high as 281 mh/1000 turns.
- ★ These toroidal cores are given various types of enamel and varnish finishes, some of which permit winding with heavy Formex insulated wire without supplementary insulation over the core.

For high Q in a small volume, characterized by low eddy current and hysteresis losses, ARNOLD Moly Permalloy Powder Toroidal Cores are commercially available to meet high standards of physical and electrical requirements. They provide constant permeability over a wide range of flux density. The 125 Mu cores are recommended for use up to 15 kc, 60 Mu at 10 to 50 kc, 26 Mu at 30 to 75 kc, and 14 Mu at 50 to 200 kc. Many of these cores may be furnished stabilized to provide constant permeability ( $\pm 0.1\%$ ) over a specific temperature range.

\* Manufactured under licensing arrangements with Western Electric Company.

W&O-930

**THE ARNOLD ENGINEERING COMPANY**  
 SUBSIDIARY OF ALLEGHENY LUDLUM STEEL CORPORATION  
 147 EAST ONTARIO STREET, CHICAGO 11, ILLINOIS

**RCA TAPE RECORDER Type RT-11A**

50 to 15,000 c.p.s. ( $\pm 2$  db) at 15 in/sec  
50 to 7,500 c.p.s. ( $\pm 2$  db) at 7 1/2 in/sec

**COMPLETE**—with motor board, plug-in type recording amplifier, plug-in playback amplifier, two standard NAB reels, power supply and panel and shelf.

• Split-second start and stop

• Push-button operation

• Extremely accurate timing—  
with synchronous capstan

• Smooth tape runs—via  
sapphire guides

• Automatic tape lift for fast  
"forwards" and rewinds

• Microswitch "tape-break"  
control—no tape spills, snarls

• Remote control of all  
operations

• Rack or console mounting

• Plug-in amplifiers

• Interlock system for vital  
controls

• 3 heads—Erase—Record—  
Playback

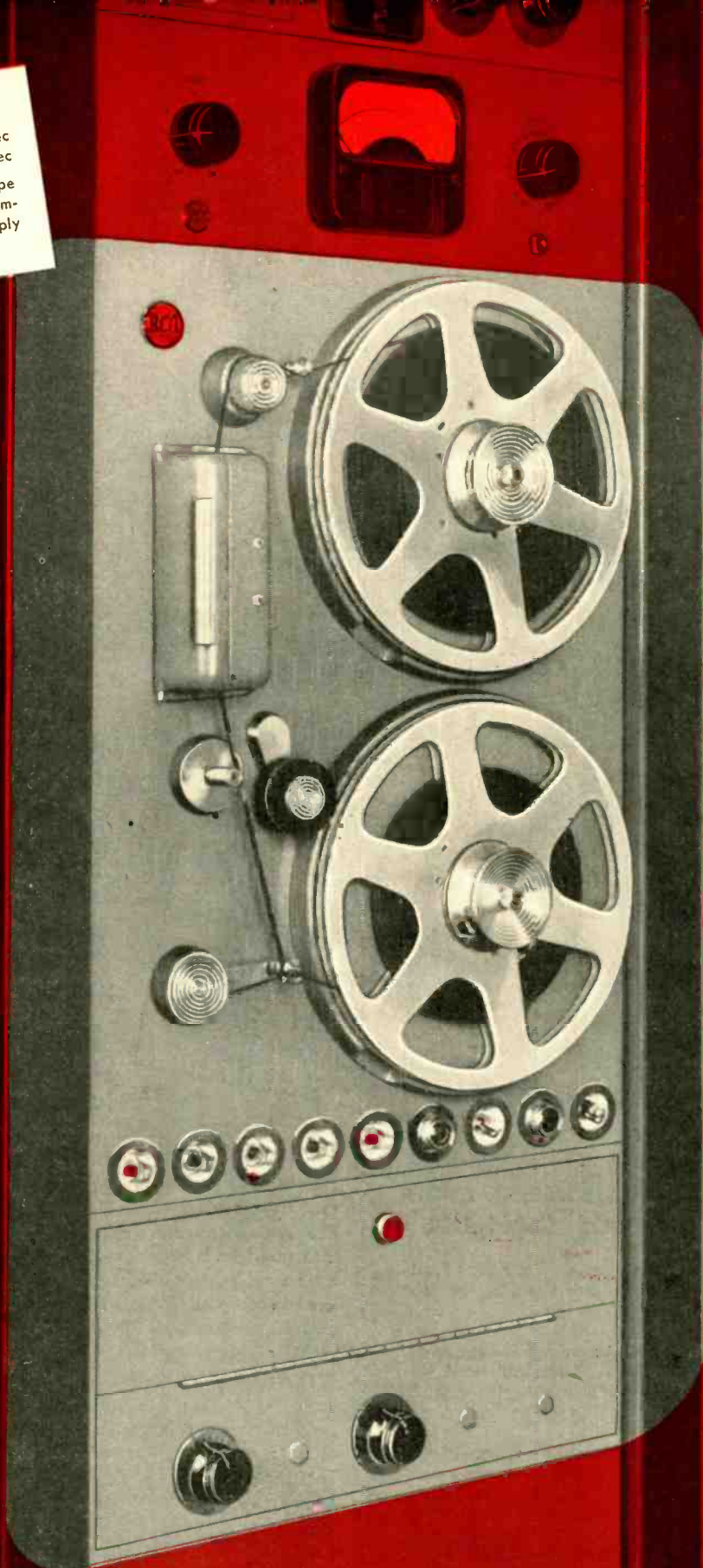



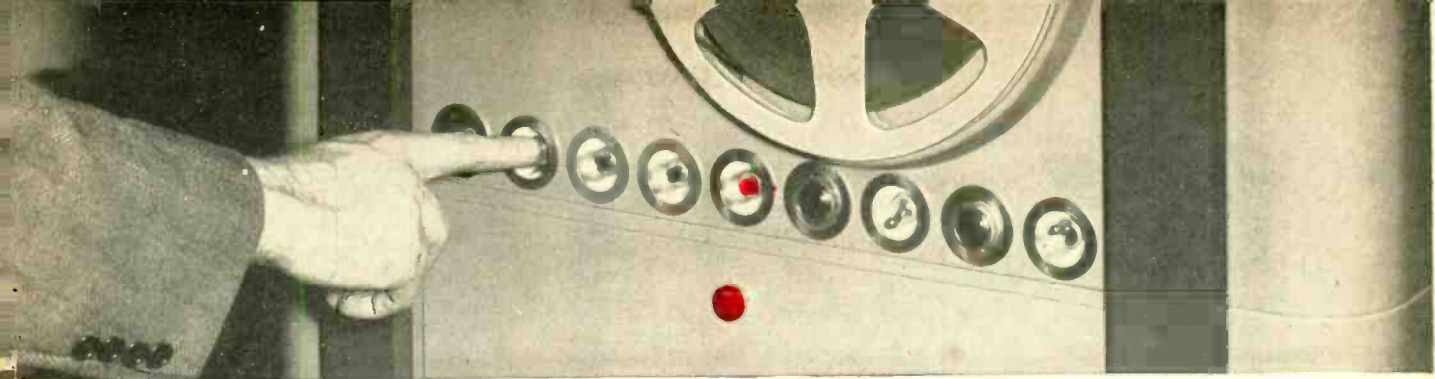

PUSH-BUTTON CONTROL puts tape recording facilities at your fingertips.

# NEW - High-Fidelity Tape Recorder -the finest money can buy!



Remote Control Unit, MI-11948. Available extra.

This is the world's foremost professional tape recorder, the one recorder that has *everything*—accurate timing, low wow and flutter, plus quick starting. All operations are push-button controlled. All functions—including cueing—can be extended to remote positions.

Designed for applications where operating TIME and RELIABILITY are prime factors, the new Type RT-11A Recorder offers a number of exclusive features. For example, you can start or stop the tape in 0.1 second. You can jockey the tape back and forth for cueing without stopping. You can rewind a standard 10½-inch reel in one minute!

A synchronous capstan makes it practical to hold recording time to  $\pm 2\frac{1}{2}$  seconds in a 30-minute run.

And with synchronizing equipment . . . for which provision is made . . . *timing can be held to 0.3 second on any length program!*

### Many more important features, too.

Self-centering "snap-on" hub adaptors assure perfect reel alignment with either RMA or NAB reels. A complete system of control interlocking virtually eliminates the possibility of accidentally erasing a program—makes it impossible to snarl or "spill" the tape. "Microswitch" control stops the machine if the tape is severed—applies reel brakes instantaneously. The tape automatically lifts *free and clear* of heads during fast forward runs or re-winds. Tape alignment over the heads is held precisely by a floating casting. Starting wow is reduced to the vanishing point.

BY ALL MEANS, call your RCA Broadcast Sales Engineer for complete details. Or mail the coupon.



AUDIO BROADCAST EQUIPMENT  
**RADIO CORPORATION of AMERICA**  
ENGINEERING PRODUCTS DEPARTMENT, CAMDEN, N.J.

In Canada: RCA VICTOR Company Limited, Montreal

RCA Engineering Products,  
Department 7L,  
Camden, New Jersey

Send me more information (including price and delivery) on your new De Luxe Tape Recorder, Type RT-11A.

NAME \_\_\_\_\_

ADDRESS \_\_\_\_\_

STATION OR FIRM \_\_\_\_\_

CITY \_\_\_\_\_ STATE \_\_\_\_\_

You saw it at  
the Audio Fair...

"exciting current  
test" Another in a series which  
demonstrates  
**PEERLESS**  
transformer  
superiority!

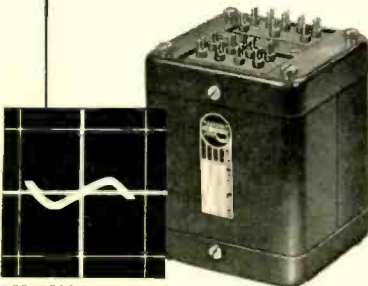

PEERLESS S-240-Q



Competitor No. 1



Competitor No. 2



Competitor No. 3



Competitor No. 4

Since the 1949 Audio Fair, comparative square wave tests on transformers shown all over the country have demonstrated Peerless superiority... Now Peerless emphasizes another very important property of transformers as shown by the "exciting current test."

An output transformer's ability to deliver plenty of clean, low-frequency power (the goal of every music lover) is inversely proportional to the amplitude and distortion of its exciting current.

PEERLESS superior low-frequency power handling capacity is illustrated in these comparative oscillograms.

Write for complete data.

**PEERLESS**  
Electrical Products



161 Sixth Avenue  
New York 13, N.Y.

9356 Santa Monica Blvd.  
Beverly Hills, Calif.

# TECHNICANA

## Tape-Movie Synch

The accurate synchronization of 1/4-inch magnetic tape recordings with motion picture films is covered by Walter T. Selsted in *J. Soc. Mot. Pict. Tel. Eng.* for September 1950. The equipment was designed to work with the Ampex model 300 and consists of a synchronizing signal generator and differential speed detector and power amplifier. The synchronizing signal is an 18-kc tone modulated by the sixty cycle voltage supply for the motion picture camera. The audio input and the modulated 18 kc are then recorded on the tape.

In the playback the 18 kc is filtered from the audio output and fed to an 18-kc limiter amplifier, 60-cps detector, and 60-cps 10-watt power amplifier. This approximately 60-cps signal drives a rigidly mounted synchronous motor, the rotor of which drives the rotor of a second synchronous motor with a free stator. The second stator is fed from the 60-cps supply driving the projector. If there is a difference between the output from the tape and the projector supply, the second stator will rotate. The second stator operates a d.c. potentiometer controlling a variable-frequency oscillator. The oscillator output is near 60 cps and is corrected by the two-motor differential system to synchronize the tape. The tape drive capstan is driven from the oscillator through a 50-watt amplifier.

## Phono-Tape Adapter

The Italian journal *Radio* for September 1950 carries the description of an assembly to adapt a phonograph-radio into a tape recorder.

Using no motors, the unit derives its power from the phonograph drive spindle through a variable speed system. The tape speed is about 15 in./sec., and the tape is driven in both directions to provide a total recording time of 15 minutes. The radio-phonograph amplifier is used for both record and playback, while the assembly contains the bias oscillator. The general claim for the adapter is its low cost, which is made possible by the elimination of any motors. The quality is said to be adequate for music.

## Motion Picture Tape

Loren L. Ryder reporting in the *International Projectionist*, September 1950, states that large savings in the production costs of motion pictures are being effected through the use of magnetic recording film systems. Production, scoring, and dubbing recordings are largely magnetic-to-magnetic

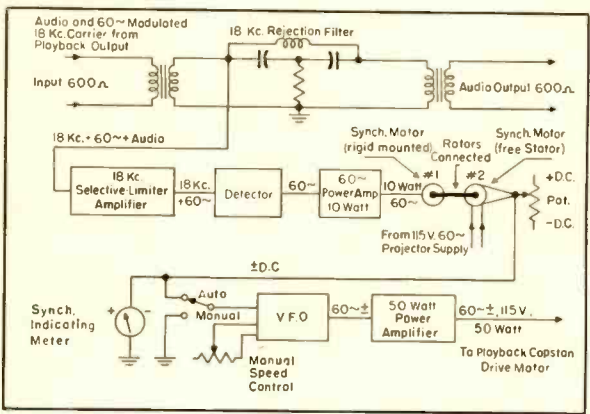

with only the negative for release printing having a photographic sound track.

In practice, two recorders, each loaded with 2500 feet of film, are assigned to each production, eliminating loading delays and minimizing run-outs. The recorders are fully automatic, being turned over and "killed" by the cameraman as he operates the camera. Synchronization is also automatic. When trouble appears the equipment is exchanged.

Such use of magnetic film has eliminated much of the film costs formerly required in dubbing and editing, since the magnetic film is never cut and may be used indefinitely.

## Australia Audio

The importance of high quality audio equipment in radio broadcasting is the subject of an article by J. E. Telfer in the *Amalgamated Wireless Technical Review* (Australia) Vol. 8 No. 4, June 1950. In this 30-page paper Mr. Telfer discusses the fundamental requirements of studio design and broadcast audio facilities. Various pieces of equipment are described and illustrated. Many of these are of Australian design and others are American.

One important phase of the discussion is the comparison of the land line facilities in the United States and in Australia. In the U. S. the four major networks employ 130,000 miles of telephone circuit, while in Australia only 8,000 miles of land line are used. However, the Australian lines cover

[Continued on page 48]



## A SIMPLE ACOUSTIC CALIBRATOR for Your Sound-Level Meter



THE G-R Type 759-A and -B Sound-Level Meters have built-in calibrators for their electrical circuits; no means are readily available, however, to check the condition and calibration of their associated microphones.

The new Type 1552-A Sound-Level Calibrator is introduced as a simple, convenient and accurate method for calibrating both the microphone and the over-all system. Essentially it consists of a small, stabilized and rugged loud-speaker mounted in an enclosure which fits over the microphone in the sound-level meter. The acoustic coupling between the calibrator and the microphone is fixed and can be repeated accurately. Any audio oscillator with a harmonic content of less than 5%, supplying 2 volts at 400 cycles, can be used to operate the calibrator. A 500-

ohm potentiometer is required as an output control if the oscillator is not equipped with such a control. An accurate vacuum-tube voltmeter is needed to measure the voltage across the calibrator.

The level at which the calibrator is used is such that its operation is not affected by ordinary background noises. This simple device is an ideal means not only for assuring consistency of calibration and locating defective microphones, but also for inter-standardization of several sound level meters.

*The audio oscillator, v-t voltmeter and potentiometer shown in the set-up photograph are standard G-R items. If you need these or if you do not know about the complete line of G-R noise and vibration measuring and analyzing equipment. WRITE FOR THE "NOISE PRIMER".*



The Sound-Level Calibrator was designed for use primarily with the Shure Brothers Type 9898 microphone as used on the G-R Type 759-B Sound-Level Meter. It can be used on other microphones such as the Brush BR2S Sound Cell Microphone and the Western Electric Type 633-A Dynamic Microphone.

TYPE 1552-A Sound-Level Calibrator . . . . . \$45.00



# GENERAL RADIO COMPANY

Cambridge 39,  
Massachusetts

90 West St., New York 6 920 S. Michigan Ave., Chicago 5 1000 N. Seward St., Los Angeles 38

# EDITOR'S REPORT

---

## MONITORING SYSTEMS

**T**HE IMPORTANCE of monitoring systems is often overlooked by the design engineer or by the purchasing department when a recording studio installation is being laid out. It is not enough that just any loudspeaker system be located somewhere in the monitoring booth, with the hope that it is capable of reproducing the material so that it is possible to determine accurately the balance of an orchestra or between the orchestra and a singer, for example. Monitoring systems—from the point where the amplifier is tied to the recording system clear to the acoustic output of the speaker into the air—are of tremendous importance, and influence the quality of the entire product.

As an example, assume that a monitoring system is deficient in bass. In order to obtain well balanced reproduction, the musical director may insist upon additional equalization of the low frequencies or a change in microphone placement, with the result that the product has too much bass if reproduced on a standard system. This will not show up on playback because the same system is used both times, and the increased bass level on the recording will appear to be correct when reproduced on a bass-deficient system.

Obviously, the same condition can obtain with high frequencies, but an even worse loss may be caused by the presence of an untoward number of people in the monitor room during the recording. If a microphone setup is made with only the musical director and the engineer in the monitoring room and the balance is apparently correct, it should be apparent to anyone that the influx of a number of people who presume to have an interest in the recording will most certainly affect the acoustics of the room. Changes in balance to compensate for changes in monitoring conditions will be reflected in the recorded result.

For a variety of reasons, radio stations provide a cli-

ents' booth in many cases, and it is usual for the number of persons in the monitoring room to be restricted. Where such restrictions cannot be imposed, it seems desirable that a location be chosen for the loudspeaker where changes in room acoustics will have a minimum effect. This suggests that the speaker be mounted forward and above the mixing console, where it would be impossible for anyone to come between it and the engineer or the producer.

If a recording system is set up with variable equalization available to the engineer, it seems logical that the tap-off for the monitoring system should follow that equalization. Between the tap-off point and the recording cutter, the only equalization that should be permitted—in addition to the decompensation required for the pre-emphasis—is that which is fixed or semi-fixed for compensation of the cutter, or for processing losses. Similarly, no variable equalization should be permitted in the monitoring system, except that which is adjusted with the aid of a soldering iron. If level adjustments are available at the console, some loudness compensation should be added automatically. Since the final product is dependent on what is heard in the monitoring room at the time of recording, the monitor system is of prime importance, and should receive at least as much attention as any other part of the installation.

Both amplifiers and speakers should be set up on the basis of a standard playback curve, and should be most carefully maintained in accordance with those curves if there is to be any standardization of the product. The Standard Playback Curve recently adopted by the Audio Engineering Society is ideal for the electrical circuits. The choice of speaker, housing, and location should be made after thorough tests, and after the acoustic output of the speaker in its selected location is carefully assessed. Only by attention to every detail can a consistent product be expected from any recording studio.

Beyond that . . .

**The Editors and Staff of Audio Engineering  
wish you a very Merry Christmas  
and a Happy New Year.**



# PICKERING

## diamond stylus pickups

ACKNOWLEDGED BY ENGINEERS  
AS THE FINEST AVAILABLE!

- The superiority of diamond styli to styli of other materials has been thoroughly established.
- Exhaustive tests prove resistance to abrasion of diamond styli is many times greater than that of the next hardest material.
- Great resistance to abrasion means a minimum of record wear, longer record life and concert hall quality music all the time.

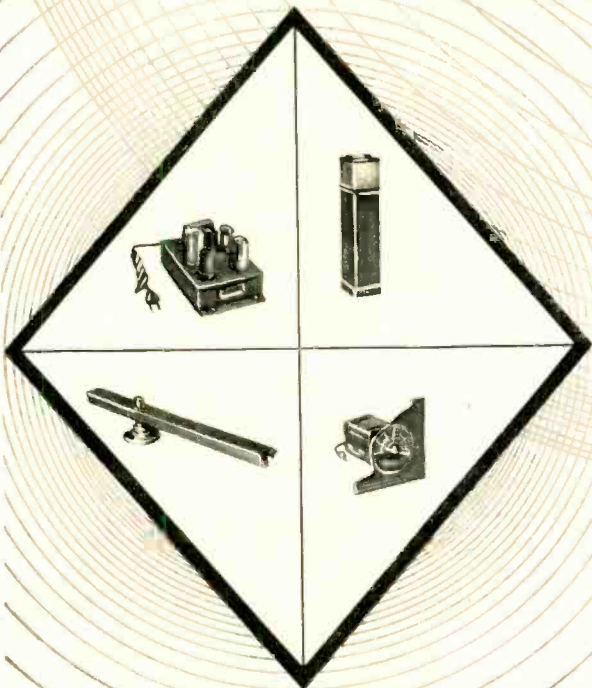
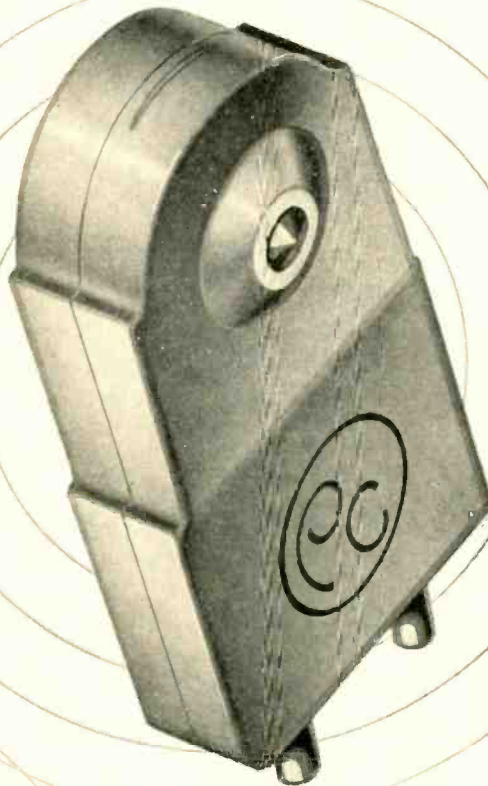
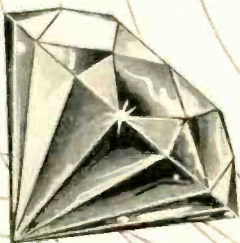

Pickering pickup cartridges, equipped with diamond styli, may cost more than cartridges with other stylus materials but the useful life of a diamond stylus cartridge is so much greater than is represented in the cost differential that from all practical viewpoints—length of service, listening pleasure, and record life—Pickering diamond stylus cartridges cost less.

The diamonds used in Pickering cartridges are whole diamonds, not splints. They are well cut, gem-polished to high accuracy and precisely mounted to ride free and smooth in the groove walls, recreating all the fine tones and modulations pressed into modern recordings.

The supremacy of Pickering Diamond Cartridges is unchallenged. They meet every exacting requirement of the most critical record playing enthusiast who insists upon the finest musical reproduction; who wants the realism and brilliance of a live performance and who is anxious to maintain the useful life of his record collection.

**PICKERING & COMPANY, Inc.**  
Oceanside, L. I., N. Y.



*World Wide Distributors*

*Of*

**AMPEX**

**MAGNETIC TAPE RECORDERS**

Write for  
Comprehensive  
Illustrated  
TECHNICAL  
BROCHURE  
No obligation

**AUDIO & VIDEO PRODUCTS CORP.**

1650 BROADWAY, NEW YORK 19, N. Y. • PLAZA 7-0780



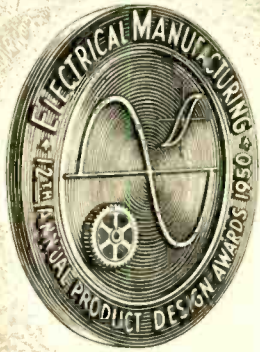

HIGHEST

# Award FOR

## Precision Magnetic Tape Recorder for HIGH-FIDELITY Professional Use

The Jury of Award for the 12th Annual Electrical Manufacturing Products Design Competition selected Ampex Model 300 as an outstanding achievement in product development, design and engineering.

We at Ampex were more than delighted to find our name in the winning group which included four other manufacturers receiving similar top-flight awards.

During the past several months Model 300 has, performance-wise, just about revolutionized magnetic tape recording standards throughout the world of entertainment as well as in scientific research. Write for Model 300 specifications and the address of your nearest Ampex distributor.

★ FOR FULL DETAILS OF AWARD read October (1950) Product Design Issue of Electrical Manufacturing Magazine.

HIGHEST ACHIEVEMENT  
in  
INTEGRATED DESIGN!



AX-29

# AMPEX

STANDARD OF

MODEL 300

THE GREAT RADIO SHOWS

## MAGNETIC TAPE RECORDERS

AMPEX ELECTRIC CORPORATION • San Carlos, California

Testing for sound lost between telephone receiver and ear. Many subjects were used in these tests.

## How to compensate for a curl . . . and add to your telephone value



Bell scientists know that the telephone is not used under ideal laboratory conditions. There is never a perfect seal between receiver and user's ear. A curl may get in the way, or the hand relax a trifle. And ears come in many shapes and sizes. So some sound escapes.

Now, sound costs money. To deliver more of it to your ear means bigger wires, more amplifiers. So Bell Laboratories engineers, intent on a thrifty telephone plant, must know how much sound reaches the ear, how much leaks away. They mounted a narrow "sampling tube" on an ordinary

handset. The tube extended through the receiver cap into the ear canal. As sounds of many frequencies were sent through the receiver, the tube picked up a portion, and sent it through a condenser microphone to an amplifier. That sampling showed what the ear received.

As a result, Bell scientists can compensate in advance for sound losses—build receivers that give *enough* sound, yet with no waste. That makes telephone listening always easy and pleasant.

It's another example of the way Bell Telephone Laboratories work to keep your telephone service one of today's biggest bargains.



Automatic recorder plots sound pressures developed in the ear canal at different frequencies.

# BELL TELEPHONE LABORATORIES



Working continually to keep your telephone service big in value and low in cost.



# Design, Construction and Adjustment of Reflexed Loudspeaker Enclosures

DAVID W. WORDEN\*

Practical procedure in the planning for a reflexed speaker cabinet, with constructional hints which will simplify the work of building.

UNLIKE THE EXPONENTIAL HORN, multiple speaker, and large or "infinite" baffle arrangements, the reflexed enclosure is a resonant device. If the resonant frequency of the enclosure is made equal to the frequency of the loudspeaker cone resonance, a cancellation of resonant effects occurs and the result is smooth response down to a frequency somewhat lower than the loudspeaker would otherwise reproduce. Furthermore, the speaker diaphragm works into a favorable acoustical impedance, which means increased efficiency, reduced distortion and improved transient response. The damping characteristics of this enclosure are inherently rather poor, but a liberal use of sound absorbents—necessary for good cancellation of resonant peaks—results in excellent damping. A further advantage is its compactness and flexibility of physical shape and size.

The speaker resonant frequency determines the low-frequency cutoff of the system, since there is naturally a limit as to how far the response of the system will extend below this frequency. Hence the speaker should be chosen which has a low resonance; if response down to 30 cps is desired, the speaker should resonate at around 60 cps or less. Hence for best results 12- or 15-in. drivers are preferred, although the performance of any speaker will be greatly improved with a properly designed enclosure.

The reflexed enclosure is nothing more nor less than a cavity resonator of the type developed by H. Helmholtz. Referring to Fig. 1, it consists of an enclosed volume of air  $V$  coupled to the outside by means of a mass of air  $M$  in an open tube, or port. The magnitudes of  $V$  and  $M$  determine the resonant frequency. The operation is analogous to that of a parallel tuned circuit.

The volume,  $V$ , and the mass,  $M$ , of air in the exhibit acoustical reactance (capacitive and inductive, respectively) just as do their electrical counterparts. Also, similarly, the  $Q$  of the circuit is determined by the amount of resistance

present, the acoustical resistance being supplied by sound absorbent lining inside the box and by curtains of burlap or similar material stretched across the port. The impedance of such a parallel tuned circuit is maximum at resonance.

The speaker is also a resonant device. The moving parts (cone and voice coil) and their suspension are mechanically equivalent to a weight acted upon by a spring. Such a system behaves like a series resonant circuit, which shows minimum impedance at resonance. Hence if the two systems be connected together and adjusted to resonate at the same frequency, the impedance "peak" of one fills the "valley" of the other and the combination tends toward constant impedance over a broad range of frequencies. If the resistive element,  $Q$ , of one of these circuits is adjustable, the cancellation of resonant effects can be brought about more closely.

The simplified equivalent circuit of the combination of speaker and enclosure is essentially as shown in Fig. 2.

## Phase Effects

The question is often raised as to the phase of the signal issuing from the port relative to that from the speaker. The popular belief that phase shift in the reflexed box is due to internal reflections, and hence to greater path length, must be discounted in view of the fact that—with the usual box dimensions—path length could not possibly account

for more than 20 deg. or so around 60 cps. The phase shift is due rather to the nature of the resonator, which may be considered as a closed organ pipe with lumped constants; the enclosed air,  $V$ , must always be a node and the air,  $M$ , a loop. (Note that no overtones are possible, in contrast with the organ pipe.) One quarter wavelength then must exist between node and loop, which means 90 deg. phase shift. This is sufficient to give an additive component, even if the signals from port and cone are equal; however, near resonance, the stiffness of the enclosure limits the cone amplitude to a very small value, and the radiation is almost entirely from the

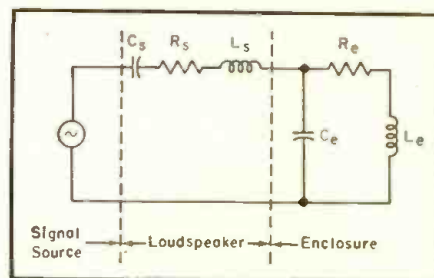

Fig. 2. Simplified electrical equivalent of loudspeaker mounted in reflexed cabinet.

port. Furthermore, the output of a loudspeaker contains, near resonance, a strong component at 90 deg. with respect to diaphragm velocity, which would be in phase with the enclosure output. Thus the phase relations are favorable regardless of the shape or proportions of the box.

The large reduction in loudspeaker-generated distortion is due to the restriction of cone amplitude mentioned above. Henney<sup>1</sup> shows the maximum distortion in an open-back cabinet of 43 per cent to be reduced to a maximum of 12 per cent in a reflexed enclosure. This represents a reduction in distortion of over 72 per cent.

## Design Procedure

Lord Rayleigh presents the following formula for the frequency of resonance

<sup>1</sup>"Radio Engineers' Handbook," 3rd. Ed. McGraw-Hill Book Co., New York.

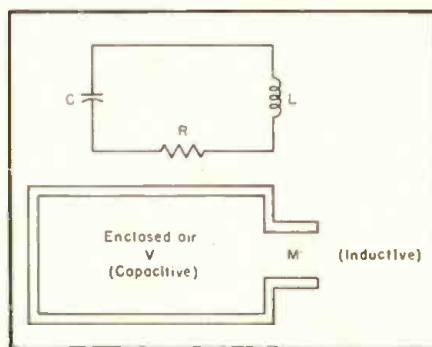

Fig. 1. Reflexed enclosure reduced to Helmholtz resonator equivalent, with electrical circuits corresponding to the acoustic network.

\* Engineering Department, Consolidated Vultee Aircraft Corp.

(Theory of Sound, Vol. II), for an enclosure of the type shown in Fig. 3.

$$f = \frac{c}{2\pi} \sqrt{\frac{A}{V(L + \frac{1}{2}\sqrt{\pi A})}} \quad (1)$$

where

- $f$  = resonant frequency, cps.
- $c$  = velocity of sound, in./sec.
- $\pi$  = 3.1416
- $A$  = area of cross section of port, sq. in.
- $V$  = net internal volume of enclosure, excluding volume of port, speaker, sound absorbents, etc., cu. in.
- $L$  = port length, in.

The velocity of sound is approximately 13,560 in./sec. at 70° F. Using this value, combining constants and solving for  $V$ , the formula becomes:

$$V = \frac{4.657 \times 10^6 A}{f^2 (L + .886 \sqrt{A})} \quad (2)$$

The first step is to determine the design frequency,  $f$ , which may be done in the following manner: with the loudspeaker in open air and connected to the output of an audio oscillator, vary the frequency slowly from about 30 to 150 cps. Note the frequency at which the cone amplitude is greatest. The peak may be rather broad; so run across it several times, noting the frequencies above and below the peak at which the diaphragm motion noticeably decreases, and average these two readings. Bits of paper torn up and placed on the cone may assist in observing the amplitude of the cone movement.

A better method, particularly with small speakers, is to isolate the signal generator and voice coil by means of a series resistance several times the nominal voice coil impedance, and read the voltage developed across the voice coil with a good a.c. rectifier-type voltmeter. These readings may be plotted against frequency and the resonant peak may be read accurately from the graph. This method is also the best for testing the completed enclosure.

Now that  $f$  is known, there remain an infinite number of combinations of  $V$ ,  $A$  and  $L$  which would yield the desired result. A value for  $A$  may be arbitrarily chosen; it should be from one half to

one times that of the speaker opening. Past practice seems to indicate this choice; at least, a number of successful enclosures have port areas within this range. The larger area is preferable since it radiates more sound energy, but, if it is too large the internal dimensions of the box may approach quarter wavelength, since the volume increases with port area. The area of the speaker cone may be computed from:

$$A' = \pi S \left( \frac{D+d}{2} \right) \quad (3)$$

where

- $A'$  = speaker cone area, square inches
- $S$  = slant height of cone, inches
- $D$  = diameter at outer edge of cone, inches (do not include corrugations)
- $d$  = voice coil diameter, inches

From here on, the following procedure is suggested. Choose a value for  $A$ , say  $A = A'$  to begin with. Set  $L$  equal to the thickness of the material of the box plus the thickness of the absorbent lining, as this will be easiest to construct, then solve for  $V$ . Compare this computed volume with the space available, or cabinet size desired; and if it seems too large, either increase  $L$  or decrease  $A$  or both until a satisfactory compromise is obtained.

#### Box Shape

Now a word as to the shape of the box: the only restriction is that the inside lengths should be kept small in order to discourage air column resonances which may occur at frequencies where such dimensions are equal to a quarter wavelength. With the usual proportions, these resonant frequencies are high enough to be readily absorbed by the lining of the box, but if the enclosure were unusually long, trouble might be encountered. Also, the box will be in-

herently stronger and will require less material, the closer its shape is to a cube.

To the calculated net volume,  $V$ , must be added the volumes of the speaker itself, of that portion of the port which projects within the cavity, and of any other objects to be located within the box. The dimensions corresponding to the resulting gross volume will be inside measurements, and the thicknesses of the enclosure walls and lining must be added in order to obtain the overall dimensions. The volume displaced by the speaker may be estimated by computing the volumes of the cone plus a cylinder enclosing the magnetic structure. A table of approximate values is given below for convenience; however, individual speakers vary greatly, and actual measurements should be used whenever possible.

Nominal Speaker Size (In.)	Approximate Displacement (Cu. In.)	Approximate Cone Area (Sq. In.)	Approximate Resonant Frequency (cps)
6	10-20	20	150-200
8	30-60	38	100-150
10	70-140	60	70-100
12	100-200	85	60-85
15	200-400	115	40-65

The actual shape of the enclosure, if not dictated otherwise, usually develops in this fashion: the front face area is made large enough to accommodate the speaker and port comfortably, and its area computed. The gross inside volume divided by the (inside) area of the front face gives the required depth. The frontal area, port depth, or port area may be changed, if necessary, to adjust the depth to a satisfactory value.

An example may help to clarify the foregoing. Suppose a reflexed enclosure is to be designed around a 12-in. speaker which shows cone resonance at 70 cps. The cone area [ $A'$  in. Eq. (3)] is computed to be 85 sq. in., and this value will be used for  $A$  in Eq. (2). Now, assuming  $\frac{3}{4}$ -in. plywood for the box and  $\frac{3}{4}$ -in. lining,  $L = 1\frac{1}{2}$  in. for the first trial. The net volume as computed from Eq. (2) is 8355 cu. in. Adding 200 cu. in. for the speaker gives a gross volume of 8555 cu. in.

The area of the front is estimated as

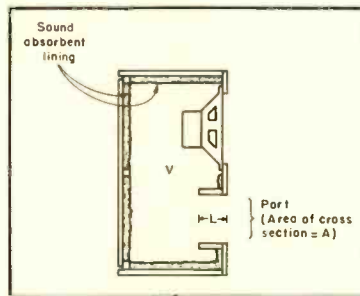

Fig. 3. Basic arrangement of ported cabinet using a port of finite length.



follows: the long side of the port may be made approximately equal to the diameter of the speaker cutout; this is economical in space and balances the appearance. The diameter of the speaker opening (and one side of the port rectangle) is  $10\frac{1}{2}$  in. The other side of the port opening is then  $85/10\frac{1}{2} = 8.1$  in., or approximately  $8\frac{1}{8}$  in. (Great accuracy is not necessary, since the resonant frequency varies as the square root of the volumes, areas, etc., [See Eq. (1)]. Allowing 3 in. edge clearance and 2 in. between the speaker and port, the inside dimensions of the front will be  $(3 + 8\frac{1}{8} + 2 + 12 + 3) = 28\frac{1}{8}$  in. long by  $(3 + 12 + 3) = 18$  in. wide (speaker diameter is 12 in.). The frontal area is (18)  $(28\frac{1}{8}) = 506$  sq. in. and the depth, then, must be  $8555/506 = 16.9$  in. inside. Allowing  $1\frac{1}{2}$  in. for the wall thickness including lining, the outside dimensions become  $31\frac{1}{8} \times 21 \times 19.9$  inches. Suppose, now, that the front dimensions are satisfactory but the depth is too great. The port length  $L$  may be arbitrarily increased, say to 4 in. The volume, Eq. (2), now becomes 6639 cu. in. net; adding 200 cu. in. for the speaker and 289 cu. in. for that portion of the port tube projecting into the enclosure, measured as shown in Fig. 4, the gross internal volume equals 7128 cu. in. The inside depth, then, is  $7128/506 = 14.1$  in. or 17.1 in. outside.

#### Construction Notes

The box should be very rigid in order to resist vibration. All joints, corners, etc. should be strong and tight, preferably reinforced with strips, and large panels should be braced. The back should be attached with a liberal number of screws so that it may be removed to give access to the interior. If a pliable material such as hair felt is used for lining the enclosure, it may be attached to furring strips, thus spacing the lining away from the wood and increasing the low-frequency absorption. Take precautions against air leakage; the speaker gasket should seat against the wood, wiring should be brought out through a bulkhead type of plug or receptacle which may be mounted securely with screws, and the removable back panel should fit snugly. A good method for attaching the back is shown in Fig. 5.

Items of equipment may be located

within the box provided they are not affected by the high pressures developed inside the resonator. Output transformers and dividing networks may be mounted in the box, but amplifying stages, for instance, might be subject to acoustical feedback if placed inside. Tweeter mechanisms should be well protected from this pressure.

#### Adjustment Procedure

Install the speaker in the completed enclosure and screw the back into place. Connect an audio oscillator to the loudspeaker input, and adjust the signal to a comfortable level. Now vary the frequency through the range below 200 cps, noting the frequencies of any peaks which may appear in the output. One of

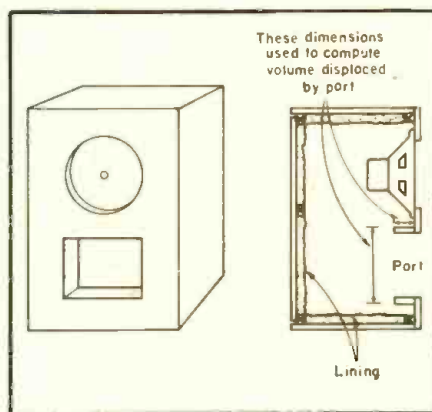

Fig. 4. Reflexed cabinet appearance, showing measurements to compute port displacement.

three conditions is likely to be encountered, as follows:

1. Enclosure frequency too high or too low. Two large peaks appear; one at loudspeaker resonance and the other at enclosure resonance.
2. Enclosure frequency slightly too high or too low. Two peaks appear, equally spaced above and below loudspeaker resonant frequency, but one noticeably stronger than the other. The enclosure frequency should be adjusted toward the smaller peak.
3. Correct tuning. Two peaks of equal amplitude, equally spaced above and below loudspeaker resonance.

The enclosure resonant frequency can be increased by decreasing the enclosed volume,  $V$ . A simple method for doing this is to place wooden blocks, such as might be cut from  $4 \times 4$  material, inside the enclosure. These may simply be tossed in through the port while adjust-

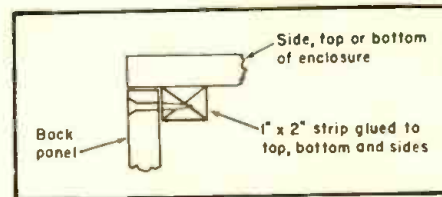

Fig. 5. Construction detail for corners of speaker cabinet.

ments are being made, and fastened down later. The easiest way to lower the frequency is to decrease the port area,  $A$ , which may be done with strips of wood cut to fit along one side of the port, the width being equal to the port depth,  $L$ . These strips may be fastened in place with screws.

When the frequency has been correctly adjusted, the damping may be increased by stretching porous cloth material (burlap, etc.) over the port opening. Experiment with various weights and layers of cloth until the two peaks just disappear. Too much damping will cause the single peak at speaker resonant frequency to appear.

As an alternative to merely detecting the resonant peaks by ear, a voltmeter may be used as described previously, and the response curve plotted.

It may be advisable to recheck the frequency adjustment after the system has been in use for some time. Loudspeakers, particularly when new or recently re-coned, tend to show a lower value of resonant frequency after a period of time due to the cone suspension becoming more pliable with use. The loudspeaker resonance may always be found by blocking off the port and exploring with the audio oscillator. The only peak which shows up with the port blocked is that due to the loudspeaker cone resonance.

One more requirement is that the amplifying equipment used to drive this speaker system be capable of good frequency response, low distortion, and low output impedance. Then, a correctly adjusted and well damped reflexed enclosure will add greatly to the "presence" effect by providing extended bass response that sounds full and true without the usual resonant "boom" or "rain barrel" effect. Percussion instruments, plucked strings and other signals with high transient components come through clean and sharp because of the excellent response to such signals. In short, the improvement in overall performance due to the enclosure is great enough to more than justify the labor and expense involved.

# A Continuously Variable Loudness Control

E. E. JOHNSON\*

A new approach to the problem of adjusting frequency response simultaneously with changes in level in order to compensate for varying sensitivity of the ear.

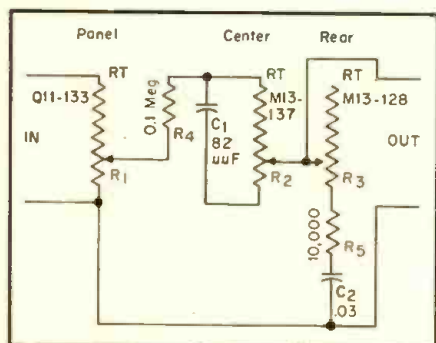

Fig. 1. Schematic of new loudness control which may be assembled from standard parts.

IT IS WELL KNOWN in audio circles that the human ear is very sensitive to both low and high frequencies at reduced volume levels. The accepted standard used in compensating for this hearing deficiency in audio systems is a set of curves at different levels known as the Fletcher-Munson curves. These curves show the amount of low-frequency and high-frequency boost that is required above some mid-range level to make the sound output of an amplifier appear balanced at all volume control settings.

Many attempts have been made to obtain the required compensation by use of single or multiple tapped volume controls, stepped loudness controls, and various types of bass and treble boost cir-

\* Engineer, International Resistance Company.

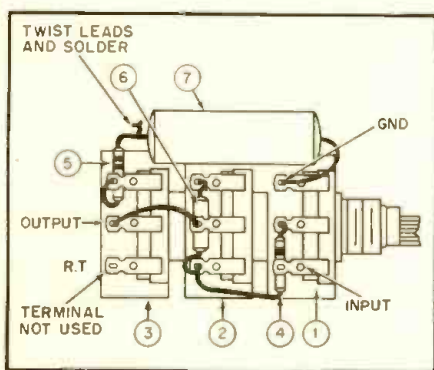
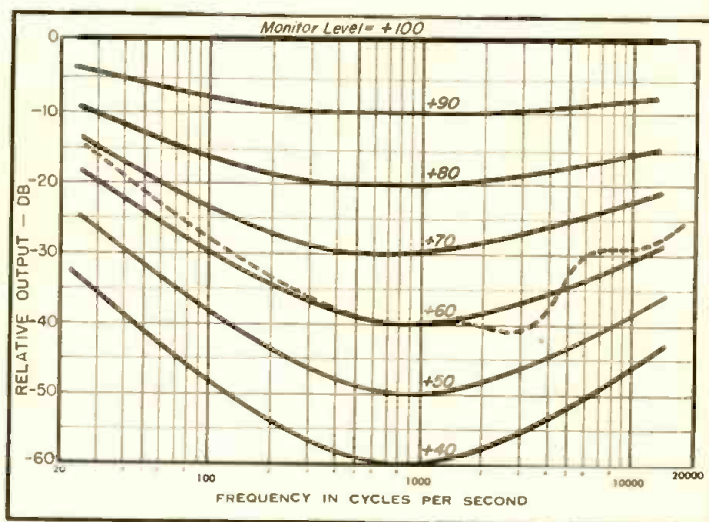

Fig. 3. Pictorial schematic showing exact wiring of components.

uits. None of these has given the performance of a truly continuously variable loudness control. The tapped volume control affords compensation only when its contactor is at the tap but does not provide proper compensation when located away from the tap. To obtain wider spread of compensation, two or three taps are used, but such controls are more difficult to manufacture and, therefore, are more expensive. The

networks. The center section  $R_2$  forms one variable leg of a potentiometer circuit and the rear section  $R_3$  forms the other leg. Fixed resistor  $R_4$  acts as a limiting resistor to keep the input impedance as constant as possible when the control is set near maximum output. The center control in combination with capacitor  $C_1$  forms the arm of the variable voltage divider network which decreases in impedance as the frequency

Fig. 2. Response curves for control at various level settings.



stepped type loudness control does not provide full flexibility of adjustment and is relatively expensive. The bass and treble boost circuits require multiple adjustments with change of volume for ideal compensation.

The control described in this article is a continuously variable loudness control that may be assembled easily from standard parts available widely from radio parts distributors. It may be wired into most audio systems as easily as an ordinary volume control.

#### Description

This new loudness control consists of three variable resistance units— $R_1$ ,  $R_2$ , and  $R_3$ —operated from one common shaft and in combination with the proper resistors and capacitors, as shown in Fig. 1.

The panel section  $R_1$  functions as a standard volume control supplying a variable voltage to the other sections which form the frequency-compensating

networks. The center section  $R_2$  forms one variable leg of a potentiometer circuit and the rear section  $R_3$  forms the other leg. Fixed resistor  $R_4$  acts as a limiting resistor to keep the input impedance as constant as possible when the control is set near maximum output. The center control in combination with capacitor  $C_1$  forms the arm of the variable voltage divider network that increases in impedance as the frequency is decreased, causing the output voltage to rise at frequencies below 1000 cps, as shown in Fig. 2.

The rear section  $R_3$ , fixed resistor  $R_5$ , and capacitor  $C_2$  form the arm of the variable voltage divider network that increases in impedance as the frequency is decreased, causing the output voltage to rise at frequencies above 1000 cps. The response curves for this control at various settings are shown in Fig. 2. The monitor level figures represent the actual listening level at which the compensation most closely follows the Fletcher-Munson curves, one of which is shown dotted for a level of +60 db. (Normal listening level in the average living room will range from +65 to +75 db.)

This arrangement offers a truly continuously variable loudness control that can be used to improve the sound quality of many radio, FM and TV receivers, as well as many sound systems. It must

[Continued on page 40]



**VIDEO  
ENGINEERING**



Put the "655" through the *Studio-Test*

See Why Audio Engineers Switch to This

# SLIM-TRIM TV DYNAMIC



- Test it for lows!
- Test it for highs!
- Test it for fidelity!
- Test it for voice!
- Test it for music!
- Test it for versatility!
- Test it for ruggedness!
- Test it for "non-pop"!
- Test it for convenience!
- Test it indoors, outdoors!

### It's the only Microphone with all these Features!

Slim-Trim Design • Dynamic Performance • Response 40-15,000 c.p.s.  $\pm$  2.5db • Individually Laboratory Calibrated • Power Rating -53 • Pop-Proof Head; built-in Blast Filter stops wind and breath blasts • Exclusive Acoustalloy Diaphragm withstands severest service • Omnidirectional; requires no closely associated auxiliary equipment • Changeable Low Impedance • Removable Swivel •  $\frac{1}{2}$ " or  $\frac{3}{8}$ "-27 thread mounting • Cannon XL-3 Connector • All parts precision ground • 20 ft. broadcast type cable. *Write today for further facts! Model 655. Price... \$200*



SEND FOR  
CATALOG  
NO. 110

## Electro-Voice INC.

400 CARROLL STREET • BUCHANAN, MICHIGAN  
Export: 13 East 40th St. • New York 16, N. Y., U. S. A. • Cables: Arlob  
MICROPHONES • PHONO PICKUPS • SPEAKERS • TV BOOSTERS

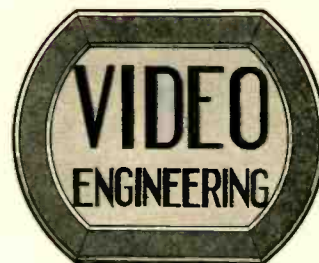

SECTION OF

**AUDIO  
ENGINEERING**

CONTENTS      DECEMBER, 1950

CBS Television Studio Intercommunication Facilities—	
<i>Robert B. Monroe</i> .....	V3
Audio Systems for TV Service—	
<i>W. L. Lyndon</i> .....	V8
Remote Television Broadcasting—	
<i>W. I. McCord</i> .....	V11
New Products .....	V13
New Literature .....	V13
Subject Index for 1950 .....	V15

**C. G. McProud, Editor**  
**Ladd, Haystead, Publisher**  
Luci Turner, Production Manager  
Lucille Carty, Circulation Manager  
S. L. Cahn, Advertising Director  
H. N. Reizes, Advertising Manager

#### Editorial Advisory Board

Howard A. Chinn	Robert M. Morris
Rodney D. Chipp	Chester A. Rackey

#### Representatives

Sanford R. Cowan, Mid-West Sales  
342 Madison Ave., New York 17, N. Y.  
James C. Galloway, Pacific Coast Sales  
816 W. 5th St., Los Angeles 17, Calif.  
Technical Book & Magazine Co.  
297 Swanston St., Melbourne, C. I.  
Victoria, Australia

#### COVER

Construction of the new antenna tower for the top of the Empire State Building is proceeding rapidly, and the antenna is expected to be in use early in 1951. This photograph was taken from the top of 10 East 40th Street by Omar Marcus.



# CBS Television Studio Intercommunication Facilities

ROBERT B. MONROE

**O**NE OF THE OUTSTANDING differences between an aural and a television broadcast is the number of technical and production personnel required in the broadcast studio. In the case of an aural broadcast, as a rule, three or four persons are involved. In a television broadcast, on the other hand, a considerably larger staff is required. Included are the director, assistant director, studio floor manager, announcer, video switcher, audio mixer, cameramen, camera-control operators, sound-effects operator, microphone boom operators, studio lighting operator, teletext projectionist, teletext camera-control operator, and others.

With such a large staff, it might be expected that considerable confusion would exist in the television studio. However, anyone who has observed the production of a program in a well designed and well equipped television studio has noted that the operation is unusually well coordinated with little, if any, confusion or misunderstanding on the part of any of the staff. The reason for this smooth functioning and good coordination lies in the use of an intricate system of studio intercommunication whereby each member of the staff is cued and directed in his activities.

In the past, the design of TV studio intercom facilities has often been looked upon as a minor task that could quickly be dispensed with after all important design details of the audio and video facilities had been completely worked out. It is now generally recognized that the TV intercom facilities represent one of the major elements of the TV studio plant. Furthermore it is realized that the equipment arrangement and circuitry of these facilities can become quite complex. The TV intercom facilities should, therefore, receive the same careful planning and attention to design detail as is accorded to the audio and video facilities of the plant.

It is the purpose of this paper to discuss the philosophy underlying the design of television intercom systems and to describe briefly some of the facilities which have proven satisfactory in CBS TV studio operations. It must be recognized, however, that television is a dynamic, fast growing industry, and the requirements demanded of the intercom facilities are likely to change as the art progresses.

## DESIGN CONSIDERATIONS

The term "TV intercom," as used in this paper, includes any facility that con-

**A complete description of the facilities required to make possible the direction and control of personnel in the production of a TV program.**

veys intelligence serving to aid, direct, or cue a member of the TV staff or cast in the performance of their duties. Obviously, this includes the spoken words of the program director as well as other key personnel in the control room. Not as obvious, but quite as important to many members of the staff, is the audio portion of the program material from which many cues are obtained. For example, the orchestra leader usually takes cues for his music from the dialogue of the program. The video picture monitor, although not commonly thought of as a conveyor of cues, also falls into the classification of an intercom device. In studio operations most of the staff depend on a picture monitor for information of one kind or another; the lighting operator to check the effectiveness of lighting effects, the audio operator to avoid boom-suspended microphones or microphone shadows in the picture, and the sound effects operator for synchronizing

sound effects with studio action. Thus it can be seen that the intelligence transmitted via the studio intercom system will take the form of spoken words, audio program material, and picture program material. All three are needed to convey the intelligence necessary to coordinate the activities of the large group of technical, production, and performing personnel.

The staff in the studio control room, which includes the director, assistant director, camera control operators, video switcher, and audio mixer, usually carry on direct conversation without the use of any special intercom facilities. When the director speaks, all in the control room hear him, and if necessary, answer him directly. The monitoring loudspeaker permits all to hear the audio portion of the program. If the basic design principles of control room layout have been followed, all are seated in a manner providing good visibility not only of the outgoing line picture monitor but also the monitor associated with each individual studio camera. Therefore, it can be seen that the intercom facilities serve mainly to convey information to the staff outside the control room, and in some cases, permit them to talk to the control room. The staff outside the control room include those in the studio, those in an associated teletext room, as well as those at other points remote from the studio.

## The Program Director

It is at the program director's desk in the studio control room, *Fig. 1*, that most of the coordination of a television program takes place. Because of the many responsibilities of the program director, it is very desirable that he be provided with the absolute minimum of equipment that he must operate. Ideally, all that should confront the director is a microphone; when he speaks, all concerned should hear him.

A TV intercom system should be designed to conform with this ideal situation as closely as possible, however, it has proven desirable to make some compromises and provide a few controls at the director's position for several special, although infrequent, operations described below. In addition, it has also proven desirable to provide a telephone jack into which a telephone headset or handset



Robert B. Monroe, Project Engineer  
CBS General Engineering Department

Born in Brooklyn, New York on October 17, 1908, Mr. Monroe attended Pratt Institute from 1937 to 1942 while being employed by Columbia Broadcasting System, Inc., where he went in 1934 and where he has since been continuously employed except for the war years.

From 1942 to 1945 he was associated with the Radio Research Laboratory, Harvard University (sponsored by the Office of Scientific Research and Development). He served successively as head of the Planning Department, head of the Standards Laboratory, and assistant to the Executive Engineer.

Mr. Monroe is a senior member of the Institute of Radio Engineers.



Fig. 1 (left). The director's position in a CBS-New York television studio. Four of the key switches on the small control panel connect the director's interphone instrument to various interphone stations in the studio. Two other key switches connect his desk microphone to the studio talkback loudspeaker and to the telecine room intercom loudspeaker. The assistant director is equipped with identical facilities. Fig. 3 (right). The type of telephone headset shown is generally used by CBS cameramen and camera control operators. The microphone boom operator in the background is wearing a pair of split headphones by means of which he receives instructions and cues.

can be plugged to permit the director to participate in two-way conversations with the studio cameramen or with other points equipped with two-way telephone facilities. It is good practice to provide the assistant director, who is usually seated immediately alongside the director, with independent facilities identical with those provided for the director.

#### The Interphone System

The only facility usually associated with the term "TV intercom" is the private telephone system mentioned above which provides two-way communication between control room, cameramen, and at times, other points. To differentiate these private telephone facilities from other studio intercom facilities, the telephone system may be referred to as the *interphone* system. The terminal equipment for these interphone facilities is usually supplied as an integral part of TV cameras and certain other video components, such as video switching units. When interphone stations are required at other points, the components may be procured and installed as desired.

In the case of TV field pick-ups, this relatively simple interphone system often constitutes the entire and only intercom facilities. While adequate for intercom purposes on the simpler type of remote pick-ups, these basic intercom facilities must be substantially augmented to meet the additional requirements encountered in TV studio operations.

Figure 2 shows, in simplified form, a typical studio interphone system of the type employed by CBS. It will be noted that the switching facilities permit either private camera-to-camera-control conversation, or a conference connection between all desired stations. The private camera-to-camera-control connection is useful in the routine alignment and maintenance of cameras. Should a camera fail during a rehearsal or air program, it is possible for the maintenance staff to work on it without interfering

with, or being distracted by, other conversations on the interphone system. In the conference position, where all desired interphone stations are paralleled, a portion of the audio from the director's microphone circuit is introduced into the interphone system permitting all stations to hear the director even though he is using a desk microphone rather than an interphone instrument. It is desirable to adjust the level from the director's microphone so it reproduces several decibels higher in level than other interphone conversations. By doing this the director's comments override and take priority over other conversations.

Should the director desire to engage in a two-way conversation with one of the interphone stations in the studio, he may employ an interphone instrument although this is usually only necessary when the studio is on the air. During rehearsals persons in the studio can be heard in the control room by means of the studio microphones and control room monitoring loudspeaker.

It is customary for the cameramen and camera control operators to employ telephone headsets of the type shown in Fig. 3, as this type of headset leaves both hands free for the many other operations they must perform. Some interphone systems employ headsets with two receiver units, one used with the interphone system, the other to reproduce audio program material. Most cameramen at CBS, however, prefer the single receiver type of headset as this leaves one ear free to hear directly what is happening in the studio. In this way they hear the aural portion of the program directly from the performers on the set. The camera control operators in the control room are served well by the single receiver type of instrument as they hear the audio portion of the program from the control room monitoring loudspeaker. For these reasons, the single headphone type of interphone instrument has been standardized at CBS.

Either the headset or hang-up handset type of instrument may be used by the director, assistant director, switcher, and audio operator depending upon the extent to which the interphone is used. A jack is provided at each of these positions to permit the use of either type. Currently the preference seems to be for the headset type of instrument.

#### Other Interphone Stations

In addition to the main interphone system connecting the cameramen, camera control operators, video switcher, and director, it is often advantageous to provide several interphone branch circuits permitting personnel in the control room to engage in conversation with certain members of the studio staff such as the studio floor manager, sound effects operator, and lighting operator. Thereby the director can work out special problems with the floor manager or can discuss lighting effects directly with the lighting operator. Similarly, the audio operator can discuss sound-effects levels or other problems directly with the sound-effects operator.

As described in the following sections, the floor manager, sound effects operator, and lighting operator receive their regular communication from other circuits and this telephone is an auxiliary facility for use in working out special problems, usually during studio rehearsals. For this reason, the hang-up handset type of instrument is preferred at the lighting and sound effects stations. A flashing light is used for calling, rather than a bell, to permit the calling circuit to be used when the studio is on the air. The floor manager uses the "production" headset jack, which is available in many studio cameras, when it is necessary for him to talk to the control room.

As can be seen in Fig. 2, these branch circuits are not a part of the main interphone system. When used, the station in the control room usually is dis-



connected from the main interphone system and engages in a private conversation with the branch station.

### Headphone Cueing Circuits

The two-way interphone system, as noted above, serves mainly to provide continuous communication with studio cameramen and occasional two-way communication with other persons in the studio. It is necessary to provide continuous cueing circuits to other personnel in the studio, such as the microphone boom operators, orchestra leader, announcer, as well as the sound-effects and lighting operators. This is accomplished through the use of headphones which may be connected into receptacles which are provided at strategic locations

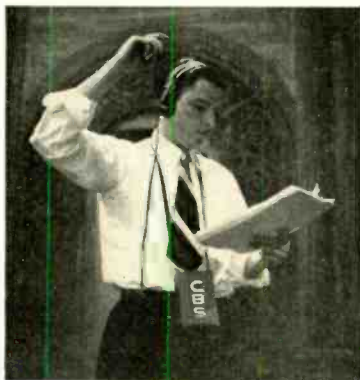

Fig. 4. Communication to the studio floor manager (as well as other studio personnel who must be free of the encumbrance of a wire connection) is accomplished by means of a low-frequency, induction-field radio circuit. One of the ultra-compact receiver units is shown in the above photograph.

throughout the studio. Unlike the interphone system which employs headsets with a single receiver unit, these headphones are equipped with two receiver units which have been wired to permit the reproduction of different information in each. These split-headphone cueing facilities are known as *headphone cue*.

It is necessary to provide two types of headphone cue. The first type is for the general use of technical and production personnel and, at CBS, is known as *regular* headphone cue. Regular cue reproduces the voice of the director in one of the two earphones and audio program material in the other earphone. The second type of headphone cue is specifically for the use of the microphone boom operators and, for that reason, is known as *boom* headphone cue. Like regular cue, boom cue reproduces the voice of the director in one earphone and audio program material in the other; however, the control room audio operator can break into the audio program side of the circuit and talk directly to the microphone boom operators at any time.

### Radio Link

The interphone system and headphone cue circuits provide communication and cueing facilities for most of the studio

technical and production staff. Both systems, however, require a direct wire connection and therefore restrict the movement of the persons at each end of the circuit. This is not a disadvantage in most cases since most of the studio staff are closely associated with equipment requiring other wire connections such as a camera, microphone boom, lighting panel, or sound-effects console. Other persons, however, notably the studio floor manager, must often be free to move to any part of the studio without the encumbrance of a cable yet must remain at all times within the range of the voice of the director in the control room. A radio circuit is provided for these persons. The receiver is an ultra-compact battery operated unit which is carried over the shoulder as shown in Fig. 4.

The radio link employed in CBS television studios is an amplitude-modulated induction-field system which operates with a power of a few watts in the low-frequency range between 100 and 200 kc. It is necessary to assign different frequency channels to systems operating in adjacent studios to prevent interference.

Some television studios have successfully employed radio cueing transmitters and receivers operating in the VHF portion of the spectrum. Such transmitters must, of course, be licensed.

In TV studio productions, portions of the program material often originate on

motion picture film and still slides or opaques. This film and slide material is integrated into the live portion of the program in the studio control room. For practical reasons, all projectors and associated film camera chains are usually centralized in a special area known as the telecine room. The telecine room serves all studio units in the plant.

Because of the physical separation of the telecine room and the control room, it is necessary to provide adequate intercom facilities between the two points. As the motion picture projectionist must be free to move about in loading, unloading, and rewinding film, it is desirable to provide a loudspeaker reproducer rather than the telephone headset type employed in the studio. In CBS studios, it is standard practice to provide two-way loudspeaker service between control room and telecine room. The telecine loudspeaker must be capable of operation at fairly high level, considerably higher than the conventional office type intercom systems, because of the high noise level that exists when several projectors are in operation.

Inasmuch as the telecine room serves all studios, switching facilities must be provided at each camera to permit the projectionist to connect his intercom facilities to the particular studio with which he is working. He must also be equipped to select audio program material, video program material, and headphone cue (which may be used in the

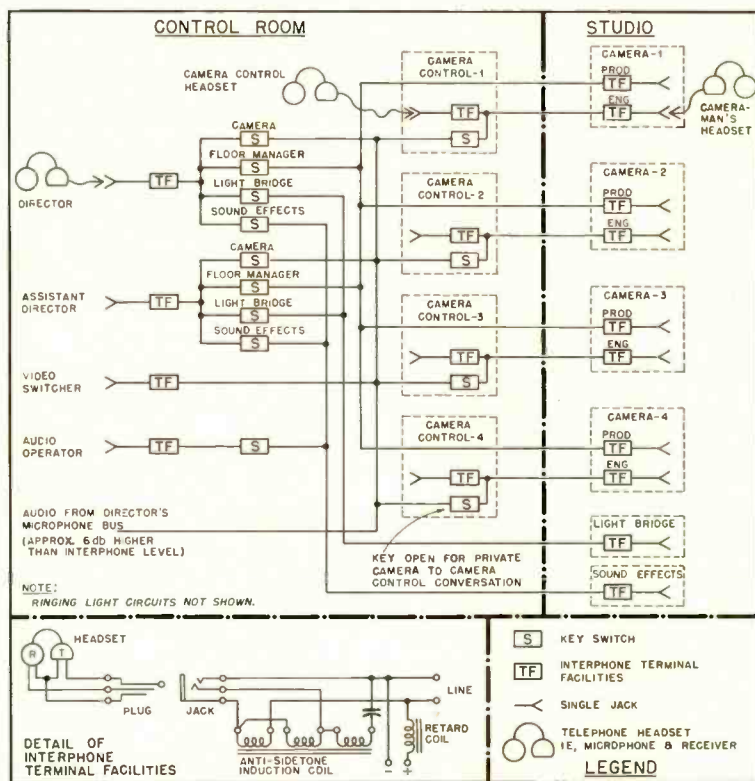

Fig. 2. The interphone system, one component of TV studio intercom facilities, provides telephone communication between control room and studio cameras as well as other points in the studio.

event of an intercom failure) from the desired studio. Furthermore, he must be equipped to extend control of starting and stopping motion picture projectors to the desired studio. His switching can be simplified by ganging as many of these functions as practicable on a single selector. In practice, it has proven desirable to gang the intercom circuits, audio program circuit, and headphone cue circuit on a single selector, and provide separate selectors for the video monitor and for projector extension control circuits. This permits him to control the projector and monitor the camera locally during setup yet maintain his intercom connection with the studio. A separate loudspeaker cueing circuit, similar to those employed on transcription turntables for cueing records, is provided when it is necessary to cue motion picture film aurally.

Duplicate intercom facilities must be provided at each of the telecine camera-control units unless these control units are located immediately adjacent to their associated film camera and projectors and can therefore make use of the same microphone, loudspeaker, and switch. These camera-control intercom stations may be equipped with independent studio selecting facilities or, if desired, the intercom facilities at both camera and camera-control may be switched by a common selector which may be located at either of the two points. The latter system is simpler but less flexible than the former method.

Although loudspeaker intercom reproduction has been found preferable at film cameras originating motion picture sequences, it has been found that headphone cue is more desirable for the operators of television optical projectors

(telops), Fig. 5, which are used for originating opaque as well as transparent slides. This is explained by the much closer cooperation required between the operators of these telop machines and the control room. In the case of the motion picture projectors, the actual starting and stopping of projectors is done usually by the video switcher in the control room. On the other hand, the telop operator must set up, change, fade, and superimpose slides directly from the telop and must therefore carefully follow the director's instructions, as well as the program continuity, at all times. For this reason, the continuous flow of cueing information on the regular headphone cue circuit is more desirable, in this case, than the intermittent instructions intended specifically for operators of film projectors on the intercom loudspeaker. At the same time, the head-

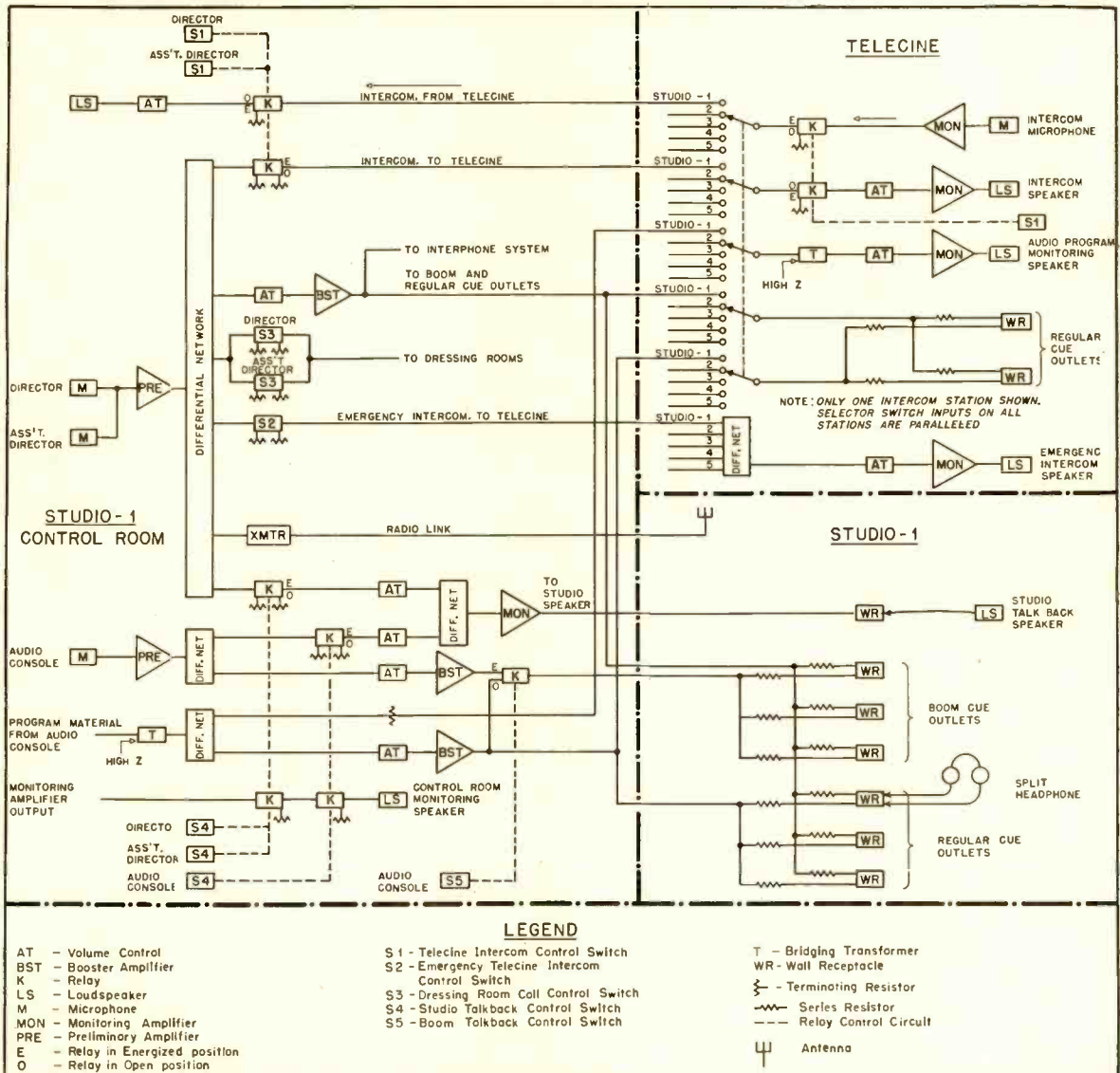

Fig. 6. A simplified block diagram showing the intercommunication facilities required in a modern television studio. These facilities augment the interphone system shown in Fig. 2.



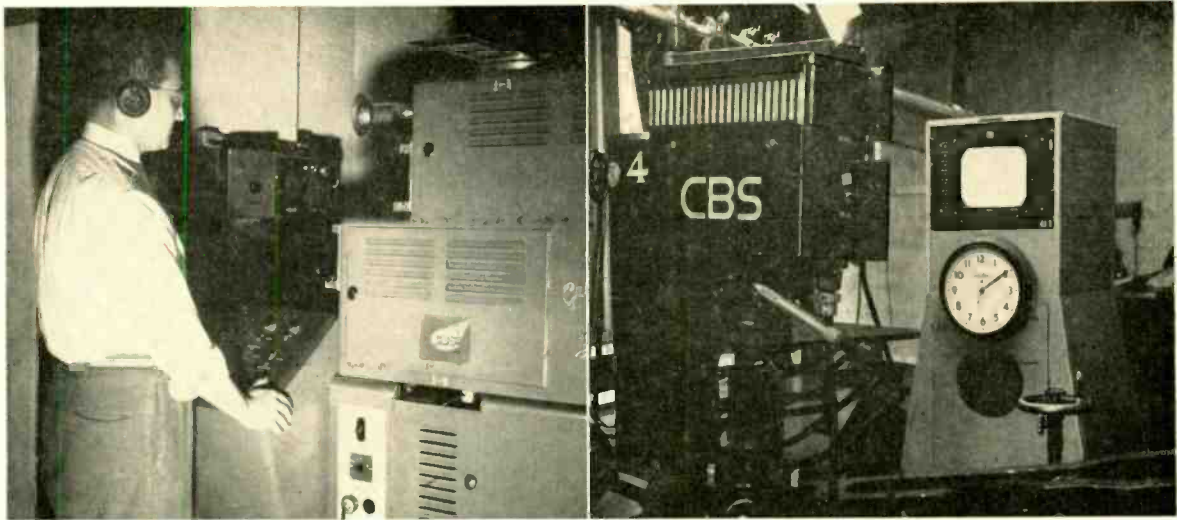

Fig. 5 (left). Operators of telop equipment in the telecine room receive instructions on cues on split headphones. They can talk to the studio control room by means of the microphone mounted near the top of the projector. The intercom control panel, lower right, contains a talkback key switch, a studio selector switch, and two headphone receptacles. Fig. 7 (right). The CBS studio floor monitor shown above is a mobile unit containing a picture monitor, a loudspeaker, and a clock.

phones tend to close out distracting sounds and permit the telop operator to concentrate on his work. The same facilities are used to talk to the studio from the telop projectors as are used in the case of the motion picture film projectors.

#### Emergency Telecine Intercom Facilities

As already described, each film camera in the telecine room is provided with an intercom system which can be switched to operate with the intercom facilities in any desired studio control room. It is the usual practice for the projectionist to set this switch to provide communication with the studio with which he is to work. A problem often arises when another studio desires to communicate with telecine (for example during routine maintenance or for a special test) and the intercom selector switch in telecine is not set to communicate with that studio. Similarly, the same difficulty would be encountered had the telecine operator forgotten to set up this switch or had inadvertently set it to the wrong position.

One way of establishing communication under these circumstances would be for the studio to call telecine on the regular telephone; however, this is not desirable as the need for communication with telecine may well be urgent and the telecine extension is often busy with other calls. For this reason, it has proven desirable to provide an "emergency" telecine intercom system.

The emergency telecine intercom facilities consist simply of one or more loudspeakers installed where they are clearly audible throughout the telecine area. These loudspeakers are driven by an amplifier of adequate size to produce the necessary sound level. Facilities in each of the studio control rooms, shown in Fig. 6, connect the director's microphone to the input of this amplifier whenever a control room key switch

marked TELECINE EMERGENCY is operated. After the attention of the telecine operator has thus been attracted by his emergency circuit, he can set up the regular intercom circuit which will provide the desired two-way communication.

#### Loudspeaker Talkback to Studio

The facilities described thus far provide aural communication and cueing

circuits for all technical and production staff concerned with a television studio production. Communication to performers in the studio is accomplished during radio rehearsals through a talkback loudspeaker. This talkback circuit, which is similar to those employed in aural broadcasting studios, permits the program director or his assistant to direct the activity of the performers at any

[Continued on page V13]

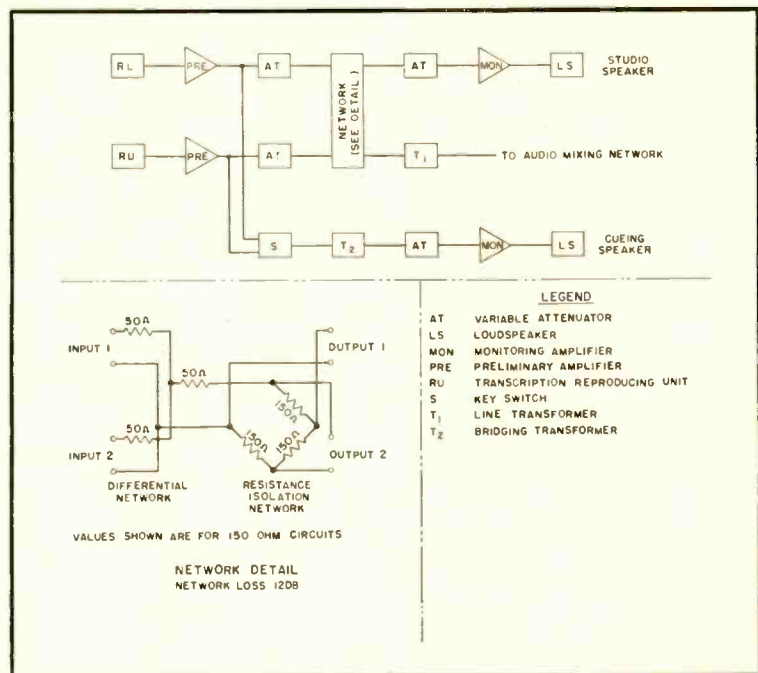

Fig. 8. The circuit arrangement employed to transmit transcribed program material simultaneously to both a studio loudspeaker and the audio program line. The resistance isolation network serves to prevent studio microphone program material in the audio mixing network from reaching the input to the studio loudspeaker amplifier. Without the isolation network, acoustic coupling between studio microphones and studio loudspeaker would result in singing.

# Audio Systems For TV Service

W. L. LYNDON\*

A discussion of the equipment necessary for use with a single-studio TV installation capable of presenting live programs in addition to transcribed and network shows.

**T**HE PREVIOUS ARTICLE in this series was devoted to the description of a simple audio-video switching unit, RCA Type TTC-3A1, which would permit a television system capable of handling only film, slides, and network programs to be placed on the air with a minimum outlay of equipment. Consideration shall now be given to the audio equipment requirements for a television system having a single studio, an announce booth, and facilities for handling film and remote or network program service. The lineup of audio equipment required for such an installation does not vary greatly from that of a comparably sized AM or FM installation; the main differences are the additional facilities necessary for handling the audio output of the film projectors and a communication system to be used by the program director for coordinating the program sequences.

This audio system is based on the use of standard stock speech input units and consists of three main items:

1. One 76B5 Consolette
2. One BCS-3A Control Unit
3. One rack of Speech Input Equipment

This arrangement is capable of switching, mixing, and monitoring the following program sources:

1. Studio
2. Announce Booth
3. Film

\* *Television Terminal Engrg., Engineering Products Dept., Radio Corporation of America, Camden, N. J.*

4. Transcription
5. Network and Remotes

Loudspeaker monitoring facilities are provided in the main control room, studio, announce booth, and projection room. The speaker in the studio serves as both a cue and talkback speaker. The studio speaker is also tied in on an override circuit which will permit transcriptions or sound effect records to be heard in the studio during "on-the-air" operation.

In order to simplify the description of this system, reference should be made to Fig. 1, a single-line block diagram of the 76B5 consolette which is employed as the system's basic unit.

## The Consolette

It will be noted that the consolette has four pre-amplifiers feeding into a six-position mixer system. Two of the mixers are connected through isolation line coils to six-position mechanically interlocked line switches. The program level from the remote lines, after equalization, and from the two turntable positions, is controlled by these two mixers. Each of the six mixers feed into a lever key which will permit placing the circuit to either a program or an audition bus. This feature permits circuits to be monitored before being switched to the program bus. These lever switches associated with the mixers are tied in with the studio cue and talkback circuit. When they are in the PROGRAM position, the talkback or cue circuit cannot be operated. In the normal OFF position, pro-

gram is automatically fed into the studio. In the audition position the talkback circuit between the control room and the studio can be operated. The program bus contains a program amplifier equipped with an interstage master gain control and has a normal output rating of +18 dbm with 0.5 per cent distortion from 50 to 7500 cps. and a maximum output level of +26 dbm with 1 per cent rms distortion over the same frequency range. Across the output of this amplifier is located a standard VU meter with an adjustable input control. This meter is also capable of indicating the plate current of each amplifier tube located in the program channel.

The monitoring amplifier located in the audition channel is provided with considerably higher gain and higher power output in order that it may be used in conjunction with a talkback circuit and also to provide sufficient volume for the speaker system. There are three speaker control relays located within the consolette and in this TV system they are used in conjunction with the control room speaker, studio speaker, and headphone monitoring for the microphone boom operator. The additional relays required for the projection room and announce booth are mounted on the rack equipment along with the AUDITION and ON AIR studio signal light control relays.

The input to the monitoring amplifier is terminated in a row of mechanically interlocked push-type switches which select the circuit to be fed to the input of the amplifier. This includes the audition position, talkback circuit, and five "cue" line inputs. Two of these "cue" positions are used in this television audio system to monitor the output of the two equalized remote line circuits.

The power supply for this consolette is a self contained unit housed in an electrically interlocked cabinet with the rectifier chassis so constructed that it may be readily hinged out for servicing. This unit is normally mounted at a point remote from the consolette and interconnections made by suitable shielded leads.

Figure 2 is a single line block diagram indicating how the consolette and the external units are combined to make up this TV audio system. The studio is shown as having a total of eight microphone circuits, four of which are normalised through jacks on the speech input rack to the consolette preamplifier inputs. The remaining four positions are terminated on jacks to be patched into the circuits as required.

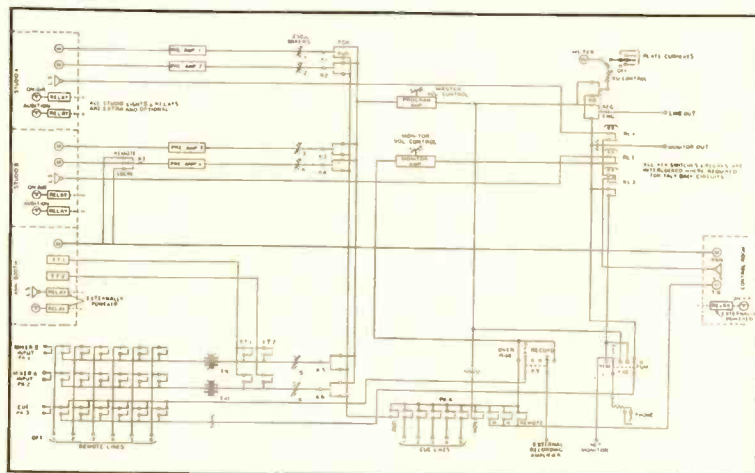

Fig. 1. Block Diagram of 76B5 consolette used for small station operation.



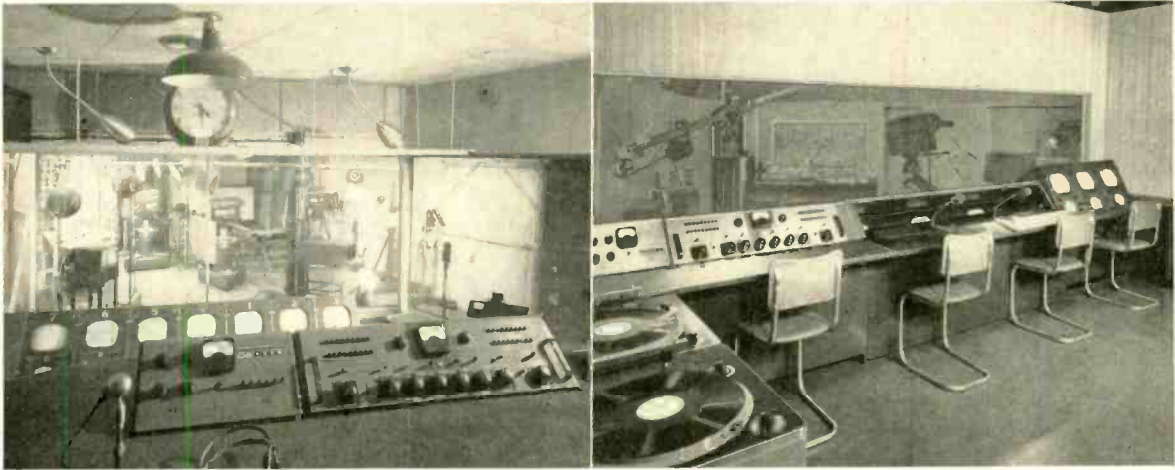

Fig. 3 (left). Typical station installation employing the audio system diagrammed in Fig. 2. The audio units are located on a higher level in order that the audio operator has visible access to the video monitors and to the studio. (Courtesy WENR-TV) Fig. 4 (right). This station also employs the audio system of Fig. 2, but is arranged differently. Note turntables at left, audio TV control at center, program director's console, and camera units at right, forming a single operating unit.

### Microphones

The quantity and types of microphones to be used is generally determined by the type of programming that is contemplated. Simple productions usually involve simpler microphone technique and many presentations can be handled very effectively with one microphone placed on a movable boom stand with possibly one additional floor-stand or desk microphone for commentary or announcement purposes. Productions of a more complex nature—such as dramatic presentations where more than one set is involved—present a greater problem and to do the job effectively and have the microphone in the right place at the correct time requires the use of a quiet, highly flexible boom stand having a large range of extension with a wide vertical and lateral swing. There are two types of microphone boom stands in general use today for television service. One of these is a semi-adjustable type which can have its extension and elevation adjusted beforehand and then wheeled into position. This type of stand can be used quite effectively on such production that will permit the microphone to be placed above the scene being televised and not requiring any extensive movement of the microphone during the show.

Shows of a variety or dramatic type where there is considerable movement of the artists require a boom stand that will literally permit the microphone to follow them around the set. This type of stand is in general use in the motion picture industry and one model recommended for TV programming is the MI-26574. This particular stand provides an operating station for the boom operator and the whole structure is mounted on rubber tired wheels which permit it to be readily moved across the floor. The length of the boom can be extended from 7 to 17 feet, and the microphone can be "gunned" through an angle of 280 deg. This boom stand, in the hands of a trained operator, can do

much to offset the disadvantages of picking up sound at a greater distance from the source than is encountered in the regular AM or FM system of broadcasting. In selecting this latter type of stand, consideration should be given to the size of studio in which it is to be operated. In small stations where staging space is at a minimum, it would be more practical and more economical to use the semi-adjustable stand.

Microphones that are used for broadcast service can also be employed for television programming. The microphone generally recommended for boom service is the type 77D. This is basically a ribbon microphone operating on a velocity-pressure principle. It has three directional characteristics, namely: uni-

directional, bi-directional, and non-directional. For boom service it is generally set in the uni-directional position, which will permit artists to operate at a greater distance from the microphone and its directive characteristic will favor reduction of reverberation and background noise level.

### Monitor and Signal Circuits

The studio monitor speaker serves three functions, namely:

1. Talkback
2. Cue or Monitor
3. Effects Speaker

The latter circuit permits sound effects records or transcriptions to be fed into the studio for special effects purposes while it is "on-the-air".

Relays are included in the rack equip-

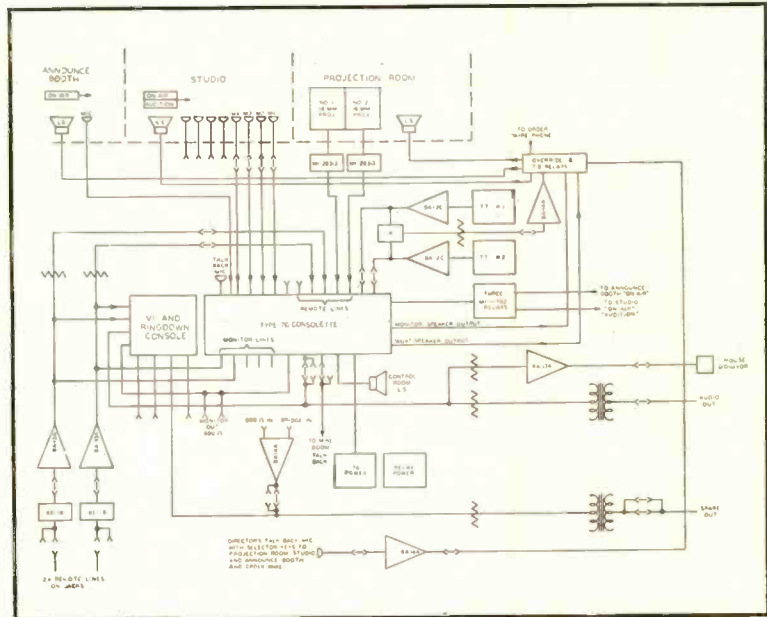

Fig. 2. Block diagram of complete audio installation suitable for a small TV station.



Fig. 5. A flexible and easily operated boom stand is an invaluable piece of TV studio microphone pickup equipment.

(Courtesy WOR-TV)

ment that will permit the operation of an ON AIR studio signal and AUDITION lights.

The equipment required for the announce booth consists of an announce microphone, a monitor loud speaker, and ON AIR signal light. Any of the previously mentioned microphones may be used for this service. When the studio is "off-the-air", program is automatically fed into the announce booth. The operation of the ANNOUNCE key on the console places the microphone in the circuit, opens the monitor speaker circuit, and turns on the ON-AIR signal light.

The output of this announce microphone circuit may be fed directly through the console to the line as, for example, in supplying commentary for slides or silent motion pictures, or it may be mixed with the output of the sound from the studio, motion picture projectors, the remote line circuits, or, if necessary, may be mixed with the output transcriptions.

The audio equipment for the projection room is of minor nature. Stations of this size would normally use two type TP-16B 16-mm projectors whose output level is +4 dbm. This should be attenuated to approximately -20 dbm before being fed into two of the remote line positions on the console. Due to the fact that considerable variation in frequency characteristic is likely to be encountered from the various types of films that may become available for television use, it is recommended that an M1-26313 equalizer be employed in the audio output of each projector. The equalizer has three bass and three treble boost positions as well as three bass and three treble attenuator positions, in addition to a flat response position. This equalizer is a "T" network and should be isolated from the input of the console by means of a line coil in order to obtain correct performance from the equalizer.

The loudspeaker serves as a monitor speaker and is tied in with the program director's talkback system.

In order to provide facilities for handling network and remote program circuits, two type BE-1B line equalizers and two type BA-13A studio amplifiers are included as part of the rack equipment. The line equalizers are capable of

equalizing normal program line circuits up to and including 15,000 cps. The studio amplifiers have sufficient gain to bring the equalized line levels up to such an output that they may be read on a standard VU meter. This permits the lines to be equalized and level adjusted before being placed on the air. The outputs of the BA-13A amplifiers are fed through a fixed attenuator pad to two of the remote line positions on the console, as well as to two of the monitor inputs, thus permitting complete remote-line checking before going on the air. There are a sufficient number of jacks located on the rack to permit the termination of a maximum of 24 remote line circuits.

Transcription service does not play as important a part in television broadcasting as required for AM or FM broadcasting, yet such facilities must be provided for producing background music, fill-in for slides and silent motion pictures as well as sound effects. This system employs two type 70D turntables. The output of each machine feeds into a type BA-2C preamplifier and then to the transcription inputs of the console. Across the outputs of the preamplifiers is located a two-way lever key switch which will permit the signal to be fed to the input of a BA-14A monitoring amplifier. This key switch also operates a relay which will permit this signal to be fed to the studio loudspeaker. This feature makes it possible for records to be used for dance purposes, accompaniments, and sound effects. The transcription service can also, at the same time, be fed through the console channel to the line.

The regular line output position of the console is normalled through jacks and an isolation transformer to the outgoing line. This line is also bridged by another BA-13A amplifier which normally acts as an isolation amplifier to feed a house monitoring bus. It may also be used as a spare amplifier when required. A spare BA-14A amplifier is provided with its 600-ohm and bridging input circuits terminated on jacks. Its output is also normalled through jacks and a line coil to provide a spare line output circuit.

A standard console alone very sel-

dom satisfies the complete requirements of a broadcasting installation, and a television system is no exception to the rule. In order to increase the flexibility of the system and provide additional features, a companion unit, BCS-3A, has been developed to mount adjacent to the console. It contains a standard VU meter with a calibrated input control and a ten-position selector switch. A number of circuits are normally connected to the input of this switch, such as the output of the two line amplifiers, the output of the spare BA-14A amplifier, and the regular output of the console. Across this switch is located a jack which will permit the use of a pair of headphones. On this panel is mounted the key switch for controlling the output of the two transcription turntables for the studio speaker over-ride circuit and a suitable volume control for the input of its associated amplifier.

A spare 250-ohm volume control is mounted on the console and its input and output circuits are terminated in line transformers whose 150/600-ohm inputs and outputs are terminated in jacks so that they may be patched into a circuit when so required. Located on the right side of the BCS-3A unit is a six position ring-down circuit, consisting of six relays, six indicator lights, and six ring-talk lever key switches. A jack is provided for inserting a standard telephone unit. These six input circuits are also terminated on jacks on the rack which permits them to be patched into the incoming lines as required. The power for operating the calling signal lamps is obtained from the 12-volt d.c. relay power supply. The ringing current is not supplied as part of this equipment. This intercom circuit, placed adjacent to the console, permits the operator to communicate directly with remote points without having to leave the equipment during a program.

In order that a program director may successfully produce a show, a means of dispatching information to a number of strategic points must be provided. To accomplish this, a separate talkback circuit consisting of a microphone, BA-14A amplifier, four relays and four control keys, is included as part of this system. The four lever key switches are to be located near the program director's point of operation. These circuits permit talkback to the following points by interrupting the program monitor circuit:

1. Projection Room
2. Studio
3. Announce Booth
4. Order Wire Circuit.

The order wire circuit is normally connected into a video switching unit such as a TS10A switching panel, which also provides a two-way phone circuit between the camera operator and the video operator.

The various amplifiers, equalizers, relays, isolation transformers, and six jack strips are assembled and wired in a standard cabinet rack which may be mounted as a single unit or in line with other equipment racks that are required

[Continued on page V14]



# Remote Television Broadcasting

W. I. McCORD

Continuing the description of the DuMont Telecruiser to cover the video phase of remote pickup operation with this versatile "portable studio."

**A**T THE PRESENT TIME, in television broadcasting, there are many schools of thought regarding the manner in which various types of programs should be handled. After having carefully studied all of these various ideas, we have designed the Du Mont Telecruiser which is engineered for efficiency and versatility. It is a complete television studio on wheels, transporting men and equipment to the scene of action. Its arrangement is quite flexible and allows the use of the Telecruiser either as a mobile vehicle or as an adjunct to studio operations. Many of the smaller stations who use the same equipment for remote operations and studio pickup have made provision for the Telecruiser to be driven into the studio area or adjacent to it and operate the Telecruiser as a studio control room. This manner of operation requires only the removal of the cameras from the Telecruiser and the playing out of the necessary amount of camera cable to connect with them. Handling of the equipment is thus minimized, and the Telecruiser is ready to roll in a few minutes time making possible close scheduling between studio programs and remote pickups. Also, this system makes it possible to use other large auditoriums or buildings, such as municipal stadiums, armories, halls, and so on, for studio operations that cannot be accommodated in the small area of the station's own studio. Television broadcasters who plan to use the Telecruiser for more than one of their stations dispatch it from station to station as needed. Also, it is possible to rent out the facilities to stations in the near vicinity thereby deriving some revenue from time when the Telecruiser would normally be inactive.

Being completely self-sufficient, the Telecruiser can readily be used advantageously for picking up special events or to cover emergencies at a moment's notice, providing a source of "on the spot news coverage," such as the televising of a fire, train wreck, floods, flood conditions, or other catastrophies. These scenes can be transmitted over the microwave relay back to the station, where they may either be rebroadcast to home receivers immediately, or through the use of the tele-transcription (recording on film) at a later time so as not to interfere with a scheduled show.



Complete equipment is transported on the Telecruiser to cope with any conditions which might be encountered in this line of work either for daytime or night operations.

Every effort has been made in designing the unit to minimize the time and labor required to set up for a television program and to replace equipment in the vehicle at the close of operations. The savings effected by labor-saving devices result in less overtime hours and require fewer operators than would otherwise be necessary. The morale of operators working in a unit which is so planned and arranged is a big factor and results in better employer/employee relationship and improved picture quality. Employees take more pride in the appearance of their equipment and will be more careful not to damage or abuse it. As a result, there are fewer instances of equipment failure and the station owner has the satisfaction of seeing his investment and capital equipment being protected.

#### Description

The basic vehicle which is used as our Telecruiser is a bus-type vehicle having been selected for its maneuverability, riding quality, and streamlined appearance. It is a Flexible Coach, 30 ft. long and 8 ft. wide, and with 9 ft. 3 in. overhead clearance. The wheelbase is 182 in. with a turning radius of 38 ft. 5 in. It is powered with a Buick 150 h.p. Fireball engine mounted in the rear and is

equipped with Bendix Westinghouse air brakes and all other standing road equipment to meet State and ICC regulations. All replacement parts are of standard manufacture available any place in the country. The vehicle is capable of over-the-road speeds up to 70 miles per hour and can negotiate rough road conditions. In many cases these units have been driven over open fields where one would hesitate to take an automobile. The short wheelbase makes possible getting the vehicle into small confined areas and the exceptionally low overhead clearance has many times allowed us to use the Telecruiser in places where it would have been impossible to take a higher unit.

The interior of the Telecruiser has been arranged to accommodate a triple image-orthicon chain transported in operable condition with all cameras, tripods, and cables quickly accessible. Three main sections divide the interior as follows: (1) Driver's compartment with provision for transporting personnel in comfortable seats. (2) A control room compartment containing the audio console director's desk and video operating console. (3) Storage compartment containing cable reels, camera tripods, microwave relay transmitter and parabolic reflector, lighting equipment and a 5-kw gasoline-driven generator to provide 120-volt 60-cps a.c. power.

The control room is the largest area and arranged so that the video console runs crosswise of the vehicle. Seated in comfortable operating chairs in front of this console are three video control operators. One of these operators is the switcher or technical director, who is responsible for the selection of the proper picture to feed to the phone line or microwave relay. On the top of the console, four units are mounted. Three of these units are identical individual camera control monitors, each one coupled directly with its associated camera and displaying the picture coming from that camera. The fourth unit is the mixer monitor and amplifier which contains the switching buttons and can accommodate up to four cameras. The special effects are controlled by this unit and the switcher can lap fade or superimpose the pictures. The lap and fading from one camera to another can



Fig. 1. The KBTW Telecruiser in use on location with the microwave relay "dish" in operation on its collapsible tower.

be done either manually or automatically with varying time rate, i.e. instantaneous, slow, medium, or fast, set by merely turning a knob control to either position. Underneath the console are located five units: one low-voltage supply and distribution amplifier, three power supplies, and the synchronizing generator. Each of these power supplies is connected by multi-conductor cable directly to the monitor unit above it, and to the low-voltage supply and distribution amplifier which distributes composite synch to each camera unit. The synch generator is coupled directly to the low-voltage supply and distribution amplifier unit.

#### Video Circuits

The output of the camera control monitor is fed directly to a built-in studio type video patch panel. All the video signals are controlled through the video patch panel which in turn feeds the signal to a picture distribution amplifier capable of providing up to eight video channels for line feeds. The output of the picture distribution amplifier is returned to eight points on the video patch panel and from there is distributed to microwave relay, line monitors, telephone line, etc. This signal is a standard 2-volt peak-to-peak. Over the video console is a 12 in. air/line monitor receiver, used to monitor either outgoing signal or to check on the signal from the station. A 'scope is also mounted on this panel and is used to monitor the video either from the various lines or the output of the picture relay transmitter. The director is located in this control room area and from his position can view all of the picture monitors. He is coupled to the camera control operators and the camera men by an intercom system and can direct camera angles or instruct the switcher over intercom hookup. Each position is also provided with a field telephone unit which in turn is connected to provide phone line to remote

relay transmitter position or to the main studio or transmitter. The audio man is also connected into this circuit from his position as described in the previous article.

All of the equipment mounted on these consoles is equipped with shock mounts and quick-action releases so that they can easily be pulled out for servicing or for removal from the vehicle if it is necessary to operate outside of the Telecruiser. Spacing of the units on the consoles has been done with adequate provision for ventilation and accessibility for changing tubes without removing the units. This also provides more working space for the operators. Two large exhaust fans have been provided behind the console to exhaust the heat produced by the power supplies and other equipment. The shelf over the console acts as a collector hood to conduct this heat into the exhaust fans. Having operated in this unit in very hot weather in Texas and elsewhere, we find that these fans are essential and that we can maintain comfortable operating conditions even under extreme sun loading.

In the Telecruiser, the operators follow the modern trend of working blind, observing all action on the camera control monitors. No provision being made for viewing live action through large windows which have proved to be a hangover from audio operating days. It is essential for the video operator to concentrate on picture quality and the distraction of live action will take his attention off the television picture. All of the a.c. power distribution is controlled from the control room area by a circuit breaker panel and a Variac compensates for fluctuation in line voltage. A main a.c. power switch is located in the rear compartment with provision for selecting either the self-contained 5-kw gasoline driven generator or outside commercial service. This system can accommodate either single-phase 120-V, single-phase 120/240, or three-phase a.c.

power. A 250-foot reel of four conductor #8 wire has been provided for connection to commercial power source that may be distant from the Telecruiser location. In the rear compartment, cable reels accommodate several assorted lengths of camera cable, microwave control cable, and a.c. power cable. All of these large cable reels are motor driven for ease of rewinding the cable. Other small cable reels are provided to accommodate microphone cable and video coaxial cable (RG59U).

The camera tripods are also located in this rear compartment along with four 250-watt flood lights for night operation. Other accessory equipment, adapter connectors, and various spare parts and tools are also included in this compartment. A removable door in the back of the video control console gives access from the storage compartment to the rear of the camera control units and provides an easy means of connecting and checking cables on this equipment.

#### Roof Platform

On the roof of the vehicle is a deck 20 ft. long and 6 ft. wide, covered with nonskid rubber material to provide safety for the operators. In addition a removable guard rail is also provided to keep the operators from accidentally backing off of the roof. Mountings to accommodate three cameras are attached to the deck and a clamping arrangement secures the camera tripod in place. With the cameras thus secured, it is possible to drive along while picking up a television picture. The microwave relay can also be secured to the roof and the picture relayed back from this vantage point. In order to relay the picture back to the tower however, it is essential to have an unobstructed line of sight air path between the microwave relay transmitter and the microwave relay receiver position. Sometimes it is necessary to place the microwave transmitter as far as 1000 ft. from the Telecruiser. In order to do this, the control unit is removed from the vehicle to a point closely associated with the transmitter unit and the video signal is fed to the control unit from the telecruiser by RG59U 72 ohm coaxial cable. This cable can be run as far as 2000 ft. when necessary.

In the WDTV Telecruiser (Pittsburgh) access to the roof is gained through a large hatch opening into the control room area. A ladder is provided on the control room wall so that the men can climb up onto the roof deck or pass equipment through the hatch. In the KBTW unit, the access to the roof is by a means of an exterior removable ladder.

#### STL Relay Facilities

On the KBTW Telecruiser, using the

[Continued on page V14]



# NEW PRODUCTS

● **Improved Inputuner.** Providing greater gain than any previous Du Mont Inputuner, the new series T3A is designed both mechanically and electrically for replacement of switch-type tuners in existing TV receivers. Standard mounting holes and identical space requirements make interchange of tuners a matter of minutes. Electrically the new Inputuner is designed to work into the i.f.

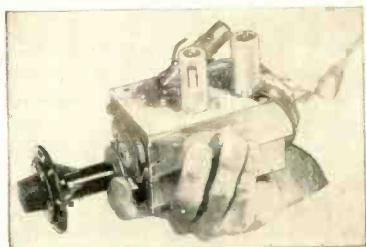

system of TV receivers using a separate sound i.f. Input impedance is 300 ohms. As in earlier models, the new T3A provides continuous tuning covering all TV channels as well as the FM band. It has low oscillator radiation and low noise figure. Cost is substantially lower than any previous Inputuner. Available at once to both jobbers and manufacturers from Electronic Parts Division, Allen B. Du Mont Laboratories, Inc., East Paterson, N. J.

● **TV Monitor.** Developed especially for TV station use, the new MTV-12 off-the-line monitor recently announced by Raytheon Manufacturing Company, Waltham, Mass. is ideal for viewing programs

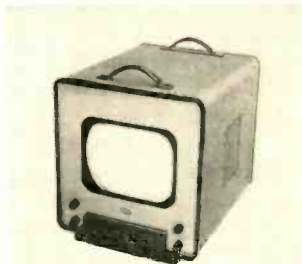

in control rooms, film rooms, announcers' booths and executive offices. Picture tube size is 12½ in. An audio channel and speaker are included in the unit and may be used for either cueing or monitoring. Sturdy construction and light weight make the MTV-12 well suited for remote pickup use. Overall dimensions are 16 x 18 x 21 in.

● **TV Demonstration System.** As many as 100 TV receivers may be fed from a single antenna through use of the TACO master antenna distribution system, recently placed in production by Technical Appliance Corporation, Sherburne, N. Y. In operation the signal is fed through a power amplifier into a mixer and then into isolation boxes feeding one or two receivers each. Where no more than eight receivers are to be used the amplifier may be used alone without isolation circuits. In high-signal areas the amplifier is not



necessary, the signal being fed directly from the antenna into individual isolation boxes.

● **TV Deflector Yoke Core.** Designed for deflection of wide-angle picture tubes, the new Westinghouse deflector yoke core is made of Hipersil, a cold-rolled grain-



oriented electrical steel. The core is wound and bonded in circular form from a continuous strip of 5-mil material. The resultant thin laminations plus excellent magnetic characteristics tend to produce superior linearity and sharper pictures. The core is entirely free from magnetic instability due to temperature change. Complete data will be supplied by Westinghouse Electric Corporation, P.O. Box 2099, Pittsburgh 30, Penn.

## NEW LITERATURE

● **Superior Electric Company, Bristol, Conn.** is now releasing a 16-page booklet fully describing the complete line of Powerstat variable voltage transformers. In addition to excellent illustrations, performance curves and wiring diagrams, the booklet contains a handy rating chart which provides engineers and purchasing agents with a quick selector index. When writing request Bulletin P550.

● **Allen B. Du Mont Laboratories, Television Transmitter Division, 1000 Main Ave., Clifton, N. J.** is now distributing an 18-page illustrated booklet on the Du Mont industrial color television system. Available to executives writing on business or professional stationery.

● **RCA Engineering Products, Camden 2, N. J.** has available for broadcasters an

illustrated folder describing and illustrating RCA's latest field TV equipment, including an improved friction head, a new tripod, new field desk, and a rotatable mount and remote control for microwave parabola. Requests should be addressed to Department No. 522 at the address above, and should ask for booklet titled New TV Field Equipment.

● **Andrew Corporation, 363 E. 75th St., Chicago 19, Ill.** will mail Bulletin 39, fully describing the Andrew Type 738 ultra-low-loss coaxial transmission cable, free on request of prospective users. Type 738 is a semi-flexible ¾-in. line suitable for connecting antennas to transmitters or receivers at frequencies from 25 mc to 2500 mc.

## CBS TELEVISION INTERCOM FACILITIES

[from page V7]

time during rehearsal. Talkback microphones are also available to the video switcher and audio mixer permitting them to use this loudspeaker circuit to communicate with members of the technical staff who may be away from their stations and therefore not wearing their regular headsets or headphones. Interlocking relays, which disable this circuit when the audio console line key switch is thrown to the "air" position, are incorporated, thereby preventing accidental use of the talkback loudspeaker when the studio is on the air.

When compared to aural broadcasting studios, television studios are usually quite large; as a matter of fact, studios which a short time ago were considered large are now regarded as medium in size. The talkback speaker must be capable of producing quite high levels at the stage in use, as for example, when being used over the playing of a large orchestra. Rather than attempt to cover a large studio with a single high power talkback loudspeaker and driving amplifier, it has proven more practical to employ a small mobile loudspeaker unit which is moved to the area of the studio in use. This talkback loudspeaker is one component of the studio floor monitor described below.

### The Studio Floor Monitor

The studio floor monitor, Fig. 7, is an indispensable unit of studio equipment. It is customary to provide at least two of these units in each studio. As can be seen, this unit combines, in a single cabinet, a picture monitor, a loudspeaker, and a clock. As described above, the loudspeaker is normally connected to the studio talkback circuit.

It is customary to place one or more of these floor monitor units at the stage in use in positions where they are visible to the greatest number of persons concerned with the production. Thus the performers, floor manager, and other studio personnel can see the production exactly as it is leaving the studio. Equally important, it is possible for them to follow the program continuity at

times when the action is originating on another set, on motion picture film, or from a remote point.

Smaller monitoring units containing only the picture monitor are provided for technical and production personnel who must closely follow the program continuity. Such units are installed at the sound-effects station, lighting panel, and in the announcer's booth.

#### Transcribed Audio Program Material

Portions of the audio material used in TV programs often originate on electrical transcriptions or magnetic tape. Quite often it is necessary for the performers in the studio to hear this recorded program material. One example where this would be necessary is in the case of a program wherein the inner thoughts of a performer are being made audible to the audience. This material is previously recorded and is played back at the appropriate time. It is essential, of course, that the performer in the studio hear this recorded material in order to properly coordinate his actions. Another example where recorded program material must be heard by the performers is in the case of music to which people in the studio are dancing. If this music is recorded, it is necessary that the dancers in the studio hear the music. Appropriate circuits must therefore be provided which will transmit recorded program material to a studio loudspeaker when desired, as well as to the regular outgoing audio program line. A block diagram of a suitable circuit arrangement intended for use with transcription turntables is given in *Fig. 8*. A similar arrangement will serve for magnetic tape reproducers.

The loudspeaker unit in one of the studio floor monitors may be employed to reproduce this recorded material in the studio.

#### Dressing Room Call System

Another branch of the TV studio intercom system which has proven extremely valuable in coordinating program production is a call system between the studio control room and the dressing rooms. This call circuit permits the director or his assistant to call each performer to the studio well in advance of his scheduled appearance.

The loudspeaker arrangement employed in the dressing room area will depend on the location and arrangement of the dressing rooms. Usually one or two loudspeakers placed in the dressing room corridor will be adequate. At other times, it may be necessary to install a small loudspeaker in each of the dressing rooms. In either event, the loudspeakers should be clearly audible at all points in the dressing room area. The associated circuits in the studio control room are shown in *Fig. 6*.

#### CONCLUSION

It can well be realized that a failure of the television studio intercom system during the production of a program would be just as devastating as a breakdown of the sound or picture facilities.

For this reason, the design details of the intercom facilities should be worked out with the greatest forethought and care. For dependability, only the most reliable components should be employed. In addition, the circuits should be arranged to provide all possible emergency operating facilities including such features as a jackfield providing access to all important circuits and components and, as well, emergency sources of a-c, relay, plate, and filament power. If plug-in amplifiers are used in the audio system, the same amplifier types should be employed in the intercom system to permit complete interchangeability of amplifiers. As a matter of fact, the intercom facilities should be treated as an extension of the audio system and employ the same components and construction practices. The essential requirement is the ability to restore the intercom facilities to a normal operating condition in a minimum of time in the event of a failure of any portion of the system. If this is not possible, a failure of the intercom system may easily result in the complete disruption of an important program production.

Intercom facilities of the type described above have been in operation in the CBS-New York television studios for several years and have proven adequate to handle the requirements of the most elaborate programs originating from these studios. The basic design of these intercom facilities is not new but has evolved as a result of CBS' many years of experience in television studio operations. Ideas and suggestions which resulted in the design described have been contributed by many members of the CBS television staff. Many contributions were also made by Howard A. Chinn, CBS Chief Audio-Video Engineer, under whose direction the design and installation of the facilities were undertaken.

---

## REMOTE TELEVISION BROADCASTING

[from page V12]

Du Mont 2000-mc relay, a permanently attached mast is provided to support the relay transmitter reflector, as shown in *Fig. 1*. This reflector is light weight with perforated metal reflecting surface, and the ribs are made of a fiber glass material. When not in use, the reflector dish is removed from the mast and stowed in the rear compartment. The mast itself can be folded back onto the roof. *Figure 1* also shows the exterior features of the KBTv Telecruiser. At the roof level are waterproof outlets which provide a.c. to the flood lights or to service cords. Also provided is an outlet for the announcer's microphone. Looking through the open door, an operator can be seen seated at the video console and the audio man can be seen

at the window just right of the open door. The exterior of the vehicle is attractively styled to serve as an advertising medium for the station.

Because of special operating conditions in various parts of the country and specific desires and needs of individual broadcasters there are no two Telecruisers built alike. Each one is custom built to incorporate the features deemed necessary. These features are established by close cooperation between the engineering staff of the station and the Du Mont Television Specialties Department, so that when the Telecruiser is delivered it is completely equipped and wired for audio, video, and a.c. having been thoroughly tested and checked out in all respects so that it will be operable immediately upon arrival at the station.

With a well trained crew of five men, it has been possible in many instances to leave the studio and proceed to a remote location having a picture for air broadcast in less than one hour's time after arrival at the pickup point. After the program has been completed, the Telecruiser can be ready to return to its base in a matter of approximately 30 minutes.

The two units described and shown in this article are now in active service in Pittsburgh and Dallas and have been used to pick up many hours of programming for their respective stations. They have proved through actual operation to be an indispensable piece of programming equipment, especially in those areas not presently connected with the various networks. Heretofore, stations in these areas have been dependent on film or recorded shows for the greater portion of their program material.

---

## AUDIO SYSTEMS FOR TV SERVICE

[from page V10]

as part of the overall television installation.

Several of these systems have been installed and are daily feeding programs to the local stations and in some instances, to a network. Each has all the essential facilities required for a small studio installation, and its circuit flexibility has proven its worth on more than one occasion.



## Video Engineering 1950

### SUBJECT INDEX

#### Audio

Audio Systems for TV Service; W. L. Lyndon, I May, V9; II Dec., V8.

CBS-TV Sound Effects Console; R. B. Monroe and P. E. Fish, I March, V12; II May, V12.

Steps to Improve TV Audio; Arthur Davis, March, V14.

#### Intercommunication Systems

TV Intercommunication Systems; R. B. Monroe, Dec., V3.

#### Lighting

Practical Television Lighting; C. A. Rackey, I July, V3; II Sept., V8.

#### Networks

CBS "Loss-Less" Video Isolation Network; D. E. Maxwell, Sept., V4.

#### Receivers

Economical 10"-to-16" Conversion Practices; Vinton K. Ulrich, March, V8.

#### Recording

Mechanics of TV Recording, The; Skipwith W. Athey, May, V5.

#### Remotes

Audio Co-ordination in Remote TV Broadcasting; W. I. McCord, July, V7.

Remote TV Broadcasting; W. I. McCord, Dec., V11.

#### Sound Effects

CBS-TV Sound Effects Console; R. B. Monroe and P. E. Fish, I March, V12; II May, V12.

#### Studios

Television City; E. Chisholm Thomson, Sept., V3.

#### Systems

Audio Systems for TV Service; W. L. Lyndon, I May, V9; II Dec., V8.

Basic Video System Planning; C. A. Rackey, March, V4.

TV Intercommunications Systems; R. B. Monroe, Dec., V3.

Laboratory TV System, A; Ralph L. Hucaby, Sept., V9.

### AUTHOR INDEX

Athey, Skipwith W.

Mechanics of TV Recording, The; May, V5.

Davis, Arthur

Steps to Improve TV Audio; March, V14.

Fish, P. E. and Monroe, R. B.

CBS-TV Sound Effects Console; I March, V12; II May V12.

Hucaby, Ralph L.

Laboratory Television System, A; Sept., V9.

Lyndon, W. L.

Audio Systems for TV Service; I May, V9; II Dec., V8.

McCord, W. I.

Audio Co-ordination in Remote TV Broadcasting; July, V7.

Remote TV Broadcasting; Dec., V11.

Maxwell, D. E.

CBS "Loss-Less" Video Isolation Network; Sept., V4.

Monroe, R. B.

TV Intercommunication Systems; Dec., V3.

— and Fish, P. E.

CBS-TV Sound Effects Console; I March, V12; II May, V12.

Rackey, C. A.

Basic Video System Planning; March, V4.

Practical Television Lighting; I July, V3; II Sept., V8.

Thomson, E. Chisholm

Television City; Sept., V3.

Ulrich, Vinton K.

Economical 10"-to-16" Conversion Practices; March, V8.

Here's why those in the know

-demand

**CANNON  
PLUGS**

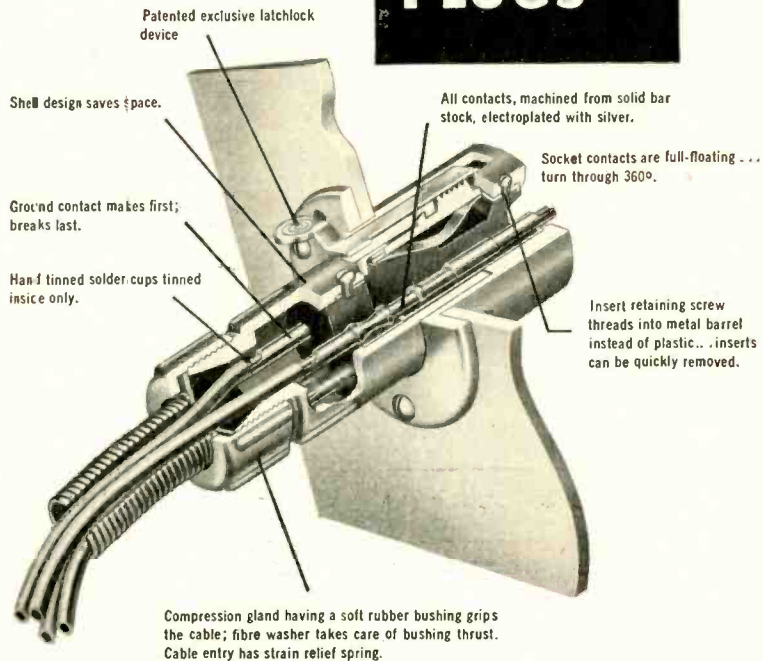

No corners are cut... nothing is overlooked to assure you outstanding performance with Cannon Plugs. So long an engineer's choice, the words "Cannon Plugs" have become part of our electrical language. Continued excellence of design... ability to meet your changing requirements... are good reasons why the Cannon line of connectors continues to excel where specifications must be met. XL Connector Series is just one of the many Cannon types—world's most complete line. Request bulletins by required type or describe your needs.

**CANNON  
ELECTRIC**

Since 1915

LOS ANGELES 31, CALIFORNIA

REPRESENTATIVES IN  
PRINCIPAL CITIES

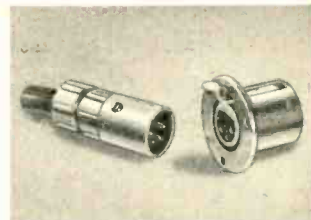

In Canada & British Empire: Cannon Electric Co., Ltd., Toronto 13, Ontario. World Export (Excepting British Empire): Frazar & Hansen, 301 Clay St., San Francisco.

There are 12 items in the XL line. Insert arrangements available: 3-15 amp. contacts, 4-10 amp. contacts—working voltage 250 volts. Zinc and steel plugs with bright nickel finish are standard. Satin chrome finish also available on steel plugs.

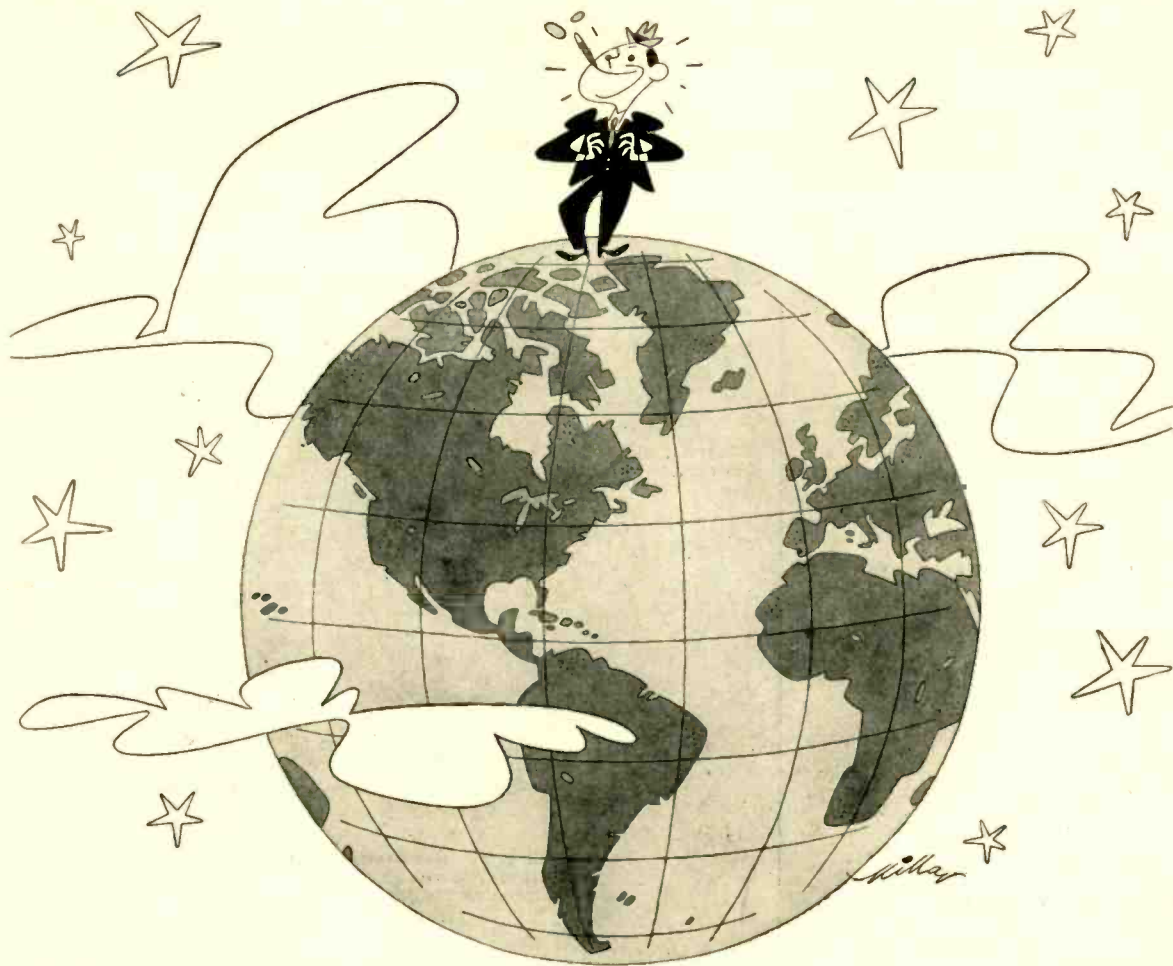

## Wonderful way to feel !

**You certainly can be on top of the world!**

Why not? Your car is paid for and your house is halfway there. You're making pretty good money . . . the kids are healthy and happy . . . and your wife just bought a new outfit—shoes to chapeau!

You don't owe anybody a red cent. Not only that—you've got a little money salted away for the kids' education and your own retirement.

Wonderful way to feel, isn't it?

If this description doesn't fit you—*make it!* You can. Here's how:

Start saving right now! Just as much as you possibly can—and regularly.

**One of the best ways . . .** one of the safest, surest ways . . . is to buy U. S. Savings Bonds through the Automatic Payroll Savings Plan where you work. Or, arrange to purchase Bonds regularly at your post office or bank.

U. S. Savings Bonds will bring you, in ten years, \$4 for every \$3. And you can count on that!

*Start your plan today.* It's the very wisest way to save!

## Automatic Saving is Sure Saving — U.S. Savings Bonds



Contributed by this magazine in co-operation with the Magazine Publishers of America as a public service.



# Rapid Attenuator Calculation Using the Vector Slide Rule

A. E. RICHMOND\*

A time saving method of arriving at results which often require considerable figure-work.

**R**ESISTIVE ATTENUATORS are used in a wide variety of audio circuits. They find application in audio level adjustment and in impedance matching, and are very widely used in such systems as recording, public address, and broadcasting.

Some attenuator design procedures have been used which are quite time-consuming and tedious. The procedure given in this article, using the "Vector" slide rule,<sup>1</sup> is comparatively rapid. With this method, attenuating pads having losses as great as about 26 db can be calculated quickly.

The very common "T" pad circuit of Fig. 1 will be used as the basis of this article. Based upon the method shown, the reader will doubtless be able to adapt the equations for other attenuator circuits to slide-rule computation.

## Equations

The equations forming the basis of the procedure make use of hyperbolic functions, the hyperbolic sine  $\sinh$  and the hyperbolic tangent  $\tanh$ . At first glance, these formulas may seem to complicate the work beyond that required for some

\*Consulting Engineer, Portland, Oregon.

<sup>1</sup> The article is based on the Log Log Duplex Vector slide rule No. N4083 of Keuffel & Esser Co. Illustrations used by permission.

other procedures. However, as will be shown, only ten easy steps complete the slide-rule solution of the entire attenuator, and knowledge of the theory of the hyperbolic functions is not even necessary.

The hyperbolic functions are obtained by the use of scales  $Sh1$ ,  $Sh2$ , and  $Th$ , which are illustrated in Fig. 2. This figure shows one side of the slide rule. These scales indicate the angles in radians whose hyperbolic sines and tangents, respectively, are given on scale  $D$ .

The equations used<sup>2</sup> as the foundation of the procedure are:

$$R_3 = \frac{\sqrt{Z_1 Z_2}}{\sinh \theta} \quad (1)$$

<sup>2</sup> Equations (1), (2) and (3) are from "Reference Data for Radio Engineers," Federal Telephone & Radio Corp., New York, 3d Ed., pp. 158-9, by permission.

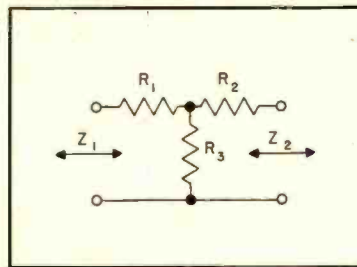

Fig. 1. Conventional "T" attenuator circuit, used as example in text.

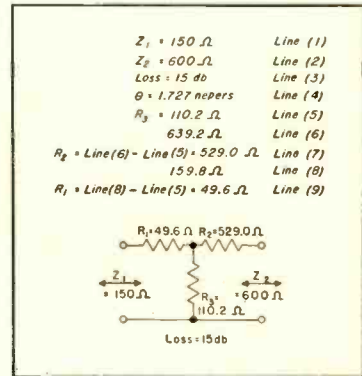

Fig. 3. Example of "paper" calculations. This figure shows the entire amount of paper work involved in designing attenuator to meet specifications of example in text. The remainder of the work is done directly on the slide rule. Bottom: the completed attenuator design required in the example.

$$R_2 = \frac{Z_2}{\tanh \theta} - R_3 \quad (2)$$

$$R_1 = \frac{Z_1}{\tanh \theta} - R_3 \quad (3)$$

where  $Z_1$  and  $Z_2$  are the input and output impedances between which the attenuator is matched, and either  $Z_1$  or

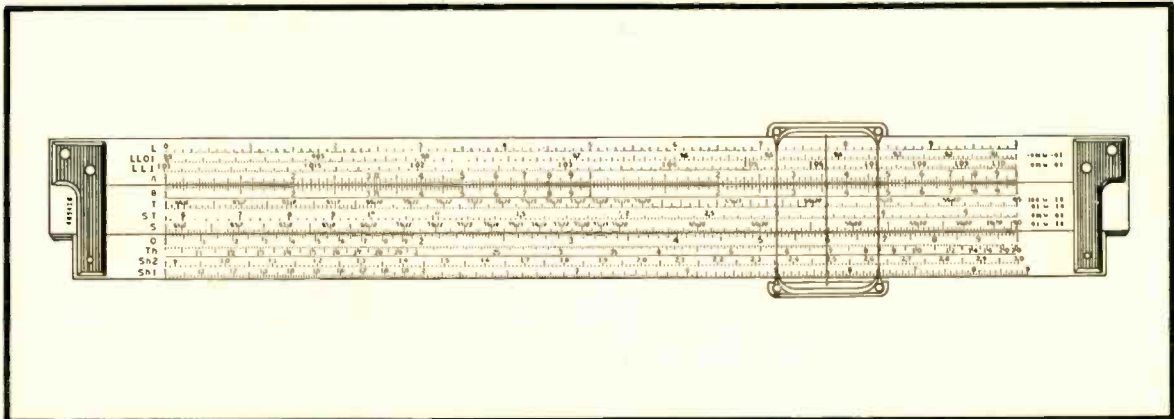

Fig. 2. The N4083 Slide Rule, showing the hyperbolic scales. Illustration shows one side of rule. Hyperbolic tangents are obtained by use of  $Th$  scale, while hyperbolic sines are given by use of scales  $Sh1$  and  $Sh2$ . (Copyright by Keuffel & Esser Co.)

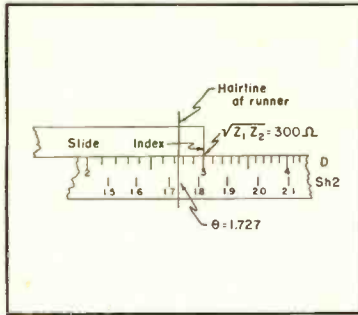

Fig. 4. Setting of  $\theta$  on scale *Sh2* (corresponds to step 4 in text). (Copyright by Keuffel & Esser Co.)

$Z_2$  may be the source and the other the load; and  
 $\theta$  = the loss introduced by the attenuator in nepers  
 = the loss in decibels divided by 8.686

The simple procedure for the design of the "T" pad will now be given, including a detailed example. In this discussion, it is assumed that the slide-rule operator is skilled in the common manipulations of the rule, locating decimal points, etc. Illustrations are included for those slide-rule operations involving the hyperbolic scales.

**Procedure**

Assume that a pad is required to have a specified loss and is to operate between known input and output impedances. The problem is to find the values of  $R_3$ ,  $R_2$  and  $R_1$  for the required "T" pad of Fig. 1.

(As an example, let  $Z_1$  be the input impedance of 150 ohms,  $Z_2$  the output impedance of 600 ohms, and the required loss 15 db. This information is entered as lines 1, 2, and 3 on a slip of paper, as shown in Fig. 3. This figure, incidentally, shows the entire amount of "paper" work required in the attenuator design, the remainder of the figuring being done on the slide rule.)

The first calculation is the determination of the value of  $R_3$ , which is a somewhat longer procedure than that for  $R_2$  or  $R_1$ . Proceed as follows:

1. Convert the loss in decibels to loss

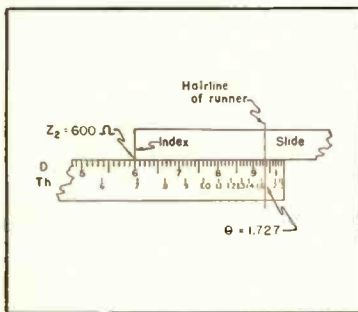

Fig. 5. Setting of  $\theta$  on scale *Th* (corresponds to step 6 in text). (Copyright by Keuffel & Esser Co.)

in nepers, by dividing the number of decibels by 8.686. Use scales *C* and *D* in the usual manner. The loss in nepers is represented by the symbol  $\theta$ .

(In our example,  $\theta = 15/8.686 = 1.727$ . This is entered as line 4 on the calculating sheet of Fig. 3. Some of the results, incidentally, will be given herein to a slightly greater accuracy than that obtainable with the 10-inch rule.)

2. (a) If the pad is to match un-

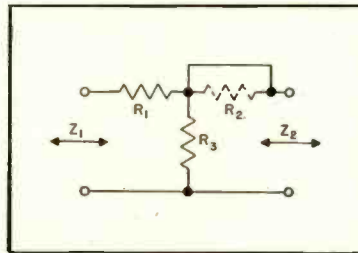

Fig. 6. The basic "T" attenuator circuit. Conversion to minimum-loss L-pad is made by eliminating  $R_2$ ; values of  $R_1$  and  $R_3$  are determined in accordance with text.

equal impedances, i.e., is unsymmetrical, multiply these impedances  $Z_1$  and  $Z_2$  together on scales *A* and *B*, and set the runner of the slide-rule to the square root of this product on scale *D*.

(In the example,  $150 \times 600 = 90,000$ , the square root of which is 300 on scale *D*. It is not necessary to record either the product or its square root, or even to observe the values.)

(b) If, on the other hand, the pad is symmetrical (matches equal impedances), simply set the runner to this impedance  $Z$  on scale *D*.

3. Set the index (the end of the scale) of the slide to the runner.

4. Set the runner to  $\theta$  on scale *Sh1* or *Sh2*, and read the value of  $R_3$  on the *CI* scale.

(In the given example, set  $\theta = 1.727$  on scale *Sh2* as shown in Fig. 4. If the rule is now turned over,  $R_3$  will be found as 110.2 ohms on scale *CI*. Enter the value of  $R_3$  as line 5 on the calculation sheet.)

Next, we find the value of  $R_2$ .

5. Set the index of the slide to  $Z_2$  on scale *D*.

(In the example being worked,  $Z_2$  is 600 ohms.)

6. Set the runner to  $\theta$  on scale *Th*, and record the reading at the runner on scale *CI* as line 6 on the calculation sheet.

(In the example, set  $\theta = 1.727$  on scale *Th* as shown in Fig. 5. The rule is now turned over, and the corresponding reading on scale *CI*, 639.2 ohms, is recorded as line 6.)

7. From the reading found in step 6, subtract  $R_3$  as determined in step 4. The result is the value of  $R_2$  for the desired pad.

(The value of  $R_1$  for the attenuator in

the example is 529.0 ohms, and is entered as line 7 on the calculating sheet.)

The procedure for obtaining  $R_1$  is similar to that for  $R_2$ , and does not require additional diagrams, for its explanation.

8. Set the index to  $Z_1$  on scale *D*.

(For our example,  $Z_1$  is 150 ohms.)

9. Set the runner to  $\theta$  on scale *Th*, just as in step 6. Record the reading of scale *CI* at the runner.

(In the example, this is 159.8 ohms, and is entered as line 8 in Fig. 3.)

10. From the reading found in step 9, subtract  $R_3$  as determined in step 4. The remainder is the value of  $R_1$  for the required pad.

(In the example,  $R_1$  is 49.6 ohms. The completed attenuator design is shown at the bottom of Fig. 3.)

For the convenience of those who

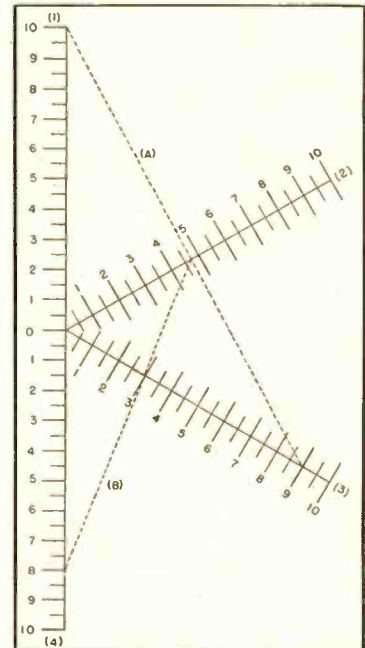

Fig. 7. Graphical solution for resistors in parallel; a handy device for attenuator design and general audio work.

(From "Motion Picture Sound Engineering," D. Van Nostrand Co., Inc., New York, N. Y., by permission)

do not have ready access to tables of hyperbolic functions, the decimal points of the *sinh* and *tanh* values can be located as follows:

The value of *sinh*  $\theta$  is roughly equal to  $\theta$  for values of  $\theta$  from 0 to 0.5. *Sinh*  $\theta = 1$  when  $\theta$  is roughly 0.89, and *sinh*  $\theta$  becomes 10.02 when  $\theta = 3.0$ .

The value of *tanh*  $\theta$  is roughly equal to  $\theta$  for values of  $\theta$  from 0 to 0.4. *Tanh*

[Continued on page 46]



# Determining Unknown Impedances in Transformers

LOUIS H. HIPPE\*

A simple method for obtaining information about the characteristics of unknown transformers.

IN MANY AUDIO INSTALLATIONS the technician is sometimes faced with the problem of determining quickly and with reasonable accuracy the unknown impedances of transformer windings. At other times the technician may find himself with a transformer that could be put to good use, but unfortunately he is unable to obtain sufficient data on the impedance capabilities of the transformer to make it usable in a practical application. At other times he may find that he has available several of the 400-cps power transformers of the type used in surplus military equipment. These transformers can often be used in audio installations where the power requirements are not too great—depending, of course, upon the internal insulation of the power transformer but “spec” sheets on winding impedances for audio service are not available for this type of transformer.

Once the impedances of primary and secondary windings of any transformer are known the transformer then becomes valuable and usable as a component in construction of new equipment or replacement in equipment already in use. However, unless the technician experiments by cut-and-try, he is not apt to know, even in a general sense, just what tubes or other components the transformer will allow him to match. Since cut-and-try requires a lot of time, and since there is no logical place to start, the transformer is likely to be relegated to the junk box where it will kick around until it eventually finds its way to the ash can. Good equipment can be saved from such a fate with a little effort and a minimum of equipment.

## Calculation Methods

There are several possible transformer impedance calculation methods and techniques available which will give results of reasonable accuracy. Although not of the caliber of laboratory measurements, the tolerances are accurate enough for average service.

Most audio technicians own or can borrow a volt-ohm-milliammeter (pre-

ferably of the vacuum tube type); a 1,000-cps audio oscillator can be built easily. With these two pieces of equipment, plus a few odds and ends, the unknown impedances of any transformer winding or choke can be quickly computed.

Figure 1 is the schematic of a 1,000-cps audio oscillator which will prove a valuable asset to the workshop and laboratory in addition to the specific use about to be described. It is inexpensive to build since parts are held to a minimum and may be selected from spare part components.

In making impedance calculations, it is well to remember that one of its constituents is reactance. Reactance of a given coil or transformer winding changes with the frequency applied. Because reactance changes with frequency, it follows that impedance also changes.

We are therefore interested in an oscillator as a source of voltage at 400 to 1,000 cps because it allows us to obtain a greater degree of accuracy in making

impedance checks on a transformer that will eventually be used in the voice-frequency range. A 60-cps test voltage source is somewhat less accurate especially if the transformer has poor response at 60 cps.

With the meter and test oscillator we can conduct our impedance determining experiment on the assumption that *voltage ratio is proportional to the turns ratio and that the impedance of a winding varies as the square of the turns.* This is expressed by the formula:

$$\frac{Z_2}{Z_1} = \left(\frac{V_2}{V_1}\right)^2 \quad (1)$$

Where  $Z_2$  is the known primary impedance.

$Z_1$  is the unknown impedance.

$V_2$  is the known applied voltage.

and

$V_1$  is the voltage measured across the unknown winding.

Note the statement, “where  $Z_2$  is the known primary impedance.” This value

[Continued on page 43]

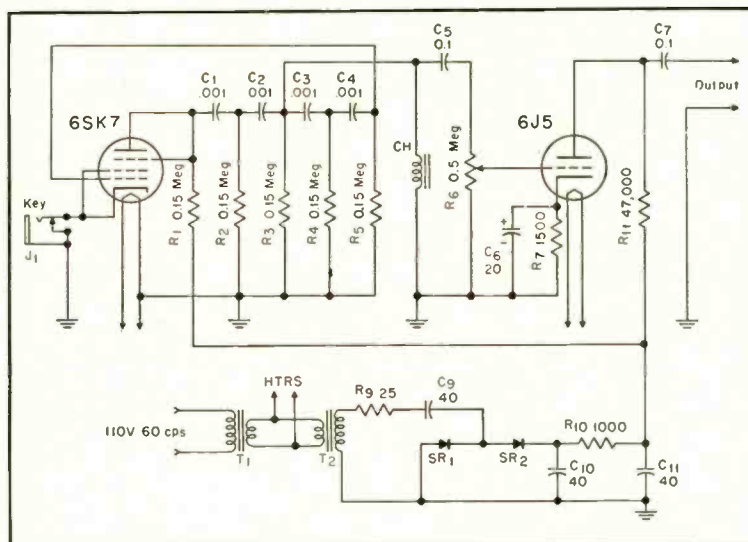

Fig. 1. Simple 1000-cps oscillator which can be constructed readily and which is useful in making measurements of the type described in this article. CH is small a.c.-d.c. filter choke; SR<sub>1</sub> and SR<sub>2</sub> are 60-ma selenium rectifiers; T<sub>1</sub> and T<sub>2</sub> are 6.3-volt, 1.5 amp filament transformers “back to back.”

\* 10636 Victory Blvd., North Hollywood, Calif.

# AUDIO DESIGN NOTES

## Resonant Loudspeaker Enclosures

BOB H. SMITH\*

THIS CHART is based upon the assumptions that the dimensions of the enclosure are small compared to wavelength, that the thickness of the port is negligible, and that the amount of air moving in the port is equal to the three halves power of the area of the port. Thus, the inductance of the port is:

$$M = \frac{\rho}{\sqrt{A}}$$

where  $A$  is the area of the port and  $\rho$  is the density of air. The compliance of the enclosure is:

\*Division of Engineering, University of California.

$$C_a = \frac{V}{\rho c^2}$$

where  $V$  is the volume and  $c$  is the velocity of sound. The resonant frequency of a Helmholtz resonator is:

$$f_r = \frac{1}{2\pi \sqrt{MC_a}} = \frac{c}{2\pi} \frac{A^{1/2}}{V^{1/2}}$$

This expression seems to agree well with experiment. In a typical case the error is 5 per cent.

It is customary to choose the resonant frequency of the enclosure equal to the anti-resonant frequency of the moving system of the speaker. Since the impedance of the resonator is purely resistive at resonance

and represents a very heavy load, no oscillatory transient occurs at this frequency. However, a new transient of higher frequency appears. It is caused by the mass of the moving system going into anti-resonance with the compliance of the box. Thus, the resonant enclosure does not completely eliminate the production of oscillatory transients but usually the new transient will be of shorter duration than the one which would have occurred without a resonant enclosure.

The radiation resistance is proportional to the area of the port and is usually too low for efficient energy transfer. Thus, the

[Continued on page 49]

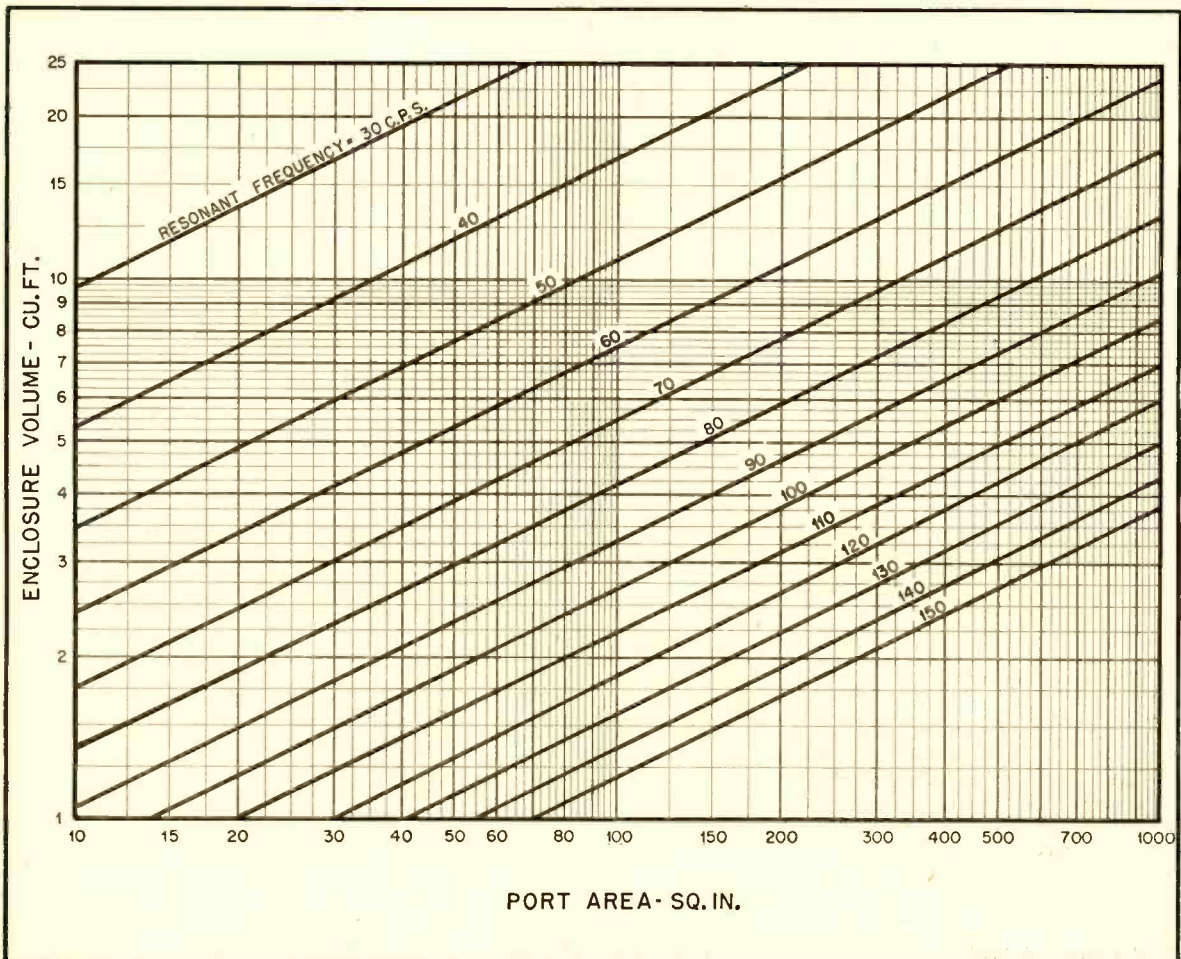





Audio Engineering Society,  
Box F, Oceanside, N. Y.

# AUDIO engineering society

Containing the Activities and Papers of the Society, and published monthly as a part of AUDIO ENGINEERING Magazine

## OFFICERS

John D. Colvin . . . . .	President	Bob Hugh Smith Western Vice.-Pres.
C. G. McProud . . . . .	Executive Vice-Pres.	Lawrence Shipley Central Vice.-Pres.
Norman C. Pickering . . . . .	Secretary	Ralph A. Schlegel . . . . .
		Treasurer

## Convention Report

**T**HE SECOND ANNUAL CONVENTION of the Audio Engineering Society fulfilled the hopes of the Society members and officers and, along with the Audio Fair, attracted a large number of visitors from the New York area as well as many hundreds from out of town. The five technical sessions were well attended, and some of the papers will appear in these pages in future issues.

At the Business Meeting, held on Thursday morning as the first session of the convention, witnessed the installation of the officers for the coming year. Theodore Lindenberg, retiring president, announced the results of the election, and after a brief farewell message relinquished the chairmanship of the meeting to John D. Colvin, newly elected president. The others taking office at this time were: C. G. McProud, executive vice president; Bob Hugh Smith, Western vice president; Lawrence Shipley, central vice president; Norman C. Pickering, secretary; and Ralph A. Schlegel, treasurer. The latter two were continued in the offices they held for the past year. Howard A. Chinn, H. E. Roys, and Theodore Lindenberg were elected to two-year terms as governors.

The annual honors were presented at the Banquet, held on Thursday evening, October 26. The Society's own award was presented to C. A. Rackey in recog-

nition of his continued work in furthering the progress of the Society since it was founded. Howard A. Chinn received the John H. Potts Memorial Award "for outstanding achievement in the field of audio engineering," a plastic-embedded silver metal awarded annually to a person chosen by the Society. Presentations were made by C. J. LeBel, acting on behalf of W. L. Black, chairman of the Awards Committee, who was unable to be present.

Following the banquet and the presentation of the honors, the diners were entertained by a musical group composed of Johnny Johnson and Harry Lennon with accordion and bass, and by Lee Irwin and The Mariners, from the Arthur Godfrey programs.

### SAN FRANCISCO SECTION ELECTS

The San Francisco chapter of the Audio Engineering Society announces the results of an election held recently for officers of the section for the 1950-51 term. The results were as follows: chairman, Dr. Vincent Salmon, Stanford Research Institute; vice-chairman, Harold Lindsay, Ampex Electric Corporation; secretary, Frank Haylock; treasurer, Myron J. Stolaroff, Ampex Electric Corporation; executive board members, Walter T. Selsted, Jack Hawkins, and Ross Snyder.



T. M. McCarty

### SOUTHERN MICHIGAN SECTION ELECTS NEW OFFICERS

The Southern Michigan Section of the AES announces the following results of the annual election: Chairman, T. M. McCarty, president, Gibson, Inc., Kalamazoo, Mich.; Vice-chairman, Earl S. Stone, chief engineer WELL, Battle Creek, Mich.; Secretary-Treasurer, Walter Fuller, chief electronics engineer, Gibson, Inc.; director (two-year term), Wade Allen, Allen Electric Co., Kalamazoo, Mich.; director (one-

[Continued on page 59]



Left, C. A. Rackey (left) receiving Society's Award from C. J. LeBel. Center, John D. Colvin, new president, welcomes visitors to the Convention and the Audio Fair. Right, Howard A. Chinn receives the John H. Potts Memorial Award from Mr. LeBel.

# The Audio Fair Review

**T**HE SECOND AUDIO FAIR has come and gone—with appreciably more success than its forerunner, the First Audio Fair. Again, for three days, the halls of the fifth and sixth floors of the Hotel New Yorker were more than filled with a milling throng interested in audio to the extent that they were willing to spend long hours on their aching feet to hear the newest in speakers, amplifiers, pickups, and recorders. And the new items were there *en masse*, along with the time-tested-and-tried devices that are always interesting to the enthusiast when demonstrated under what are the best conditions possible, in the opinion of the manufacturers, for their particular equipment. Actually, from the listeners viewpoint, it is doubtful if this is an ideal condition, because of the background of noise from the many exhibition rooms. However, there is no doubt about the over-all value of this type of exhibit, because—even though the conditions are not perfect—the visitors do get an impression of the quality of performance of the many items, and the interest awakened by it is sufficient to warrant further investigation under more intimate conditions.

For the professional engineer, the exhibits of tape recorders were of great interest, with many types being displayed for the first time. Microphones suitable for all purposes were seen, speakers of the highest quality for monitoring purposes, and all types of recording machines, tape, and discs. One complete display of a broadcast console attracted the broadcast engineers almost as much as the tape recorders—of which there were many more than one.

On the whole the Second Audio Fair was a much greater success than the first, with a fifty per cent increase in exhibitors and in registration—the preliminary figures for the attendance indicate that approximately 4700 visitors were present over the three-day exhibit, with many of them being on hand two or even three days.

The photographs of the various exhibit rooms will give to those unable to attend an idea of the highlights of the Fair—every exhibitor has something interesting to show, and each one of them spent a long and arduous three days of explaining and demonstrating, so that all felt a sense of relief each day when the

a.c. power was cut off signifying the end of the exhibit hours. Without this drastic means of signalling the closing hour, it is doubtful if the visitors would have left at all—especially on Friday evening, the only time many were able to attend. The following paragraphs will cover the exhibits in detail, with each exhibitor's display being described briefly.

**Altec Lansing Corporation** exhibited a new corner cabinet housing two 15-inch driver units and a multicellular horn, along with the other more familiar members of its line—the 800, the 604B, the 603, the 600, and the 8-inch model 800. The new unit, with the advantage of two low-frequency drivers, showed excellent response characteristics, and an extremely large power handling ability. The interest in this entire exhibit was so great that it was usually difficult to get into the room, but nearly everybody did at one time or another, and the demonstration of the strength of the field magnet used in one of the larger speakers was convincing—even to anyone who did not understand what it all meant to the performance of the speaker. The always-present-but-little-seen condenser microphone was also on hand for display, while others were in continual service for sound reinforcement during the technical sessions and the banquet.

**Ampex Electric Corporation's** new Model 400 Tape Recorder—of which much has been heard during the past few months—proved that it lived up to its specifications as to quality. The demonstration consisted of playing a tape on the big Ampex, re-recording it on the 400, and reproducing the output of the playback head of the smaller machine on an A-B test with the signal being recorded. This was a truly convincing method of demonstrating the quality of a new product in comparison to that of the already well established performance of the leader of the line. After hearing this demonstration, the listener had no doubts of the ability of the small machine to perform completely in accordance with its specifications, which are sufficiently stringent for practically any professional application.

**Amplifier Corporation of America** presented a 24-hour, 3 3/4-in. per second recorder with quality considerably better than most 7 1/2-inch machines of a year ago. The improvements in slow-speed tape

From the top, reading counterclockwise: Audio Engineering, Altec Lansing Corp., Arrow Electronics, Inc., Amplifier Corporation of America, Ampex Electric Corp., Cinema Engineering Co.

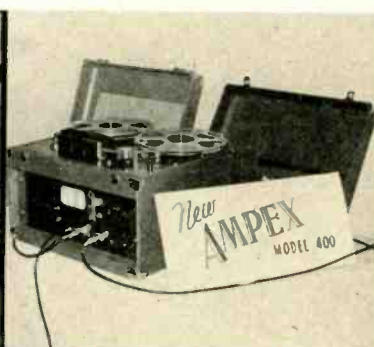
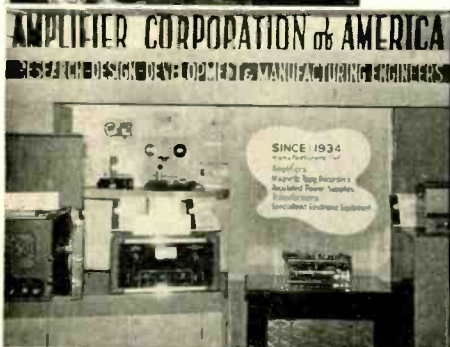
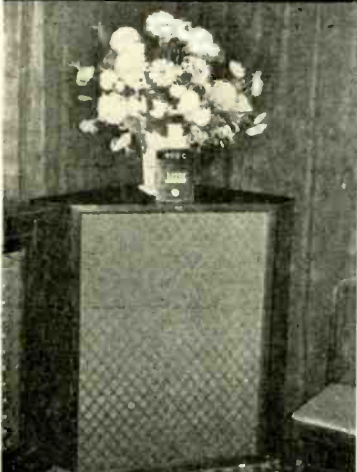
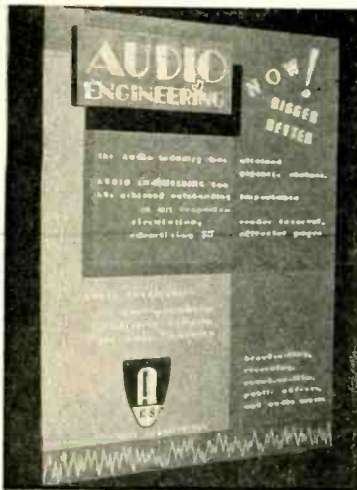



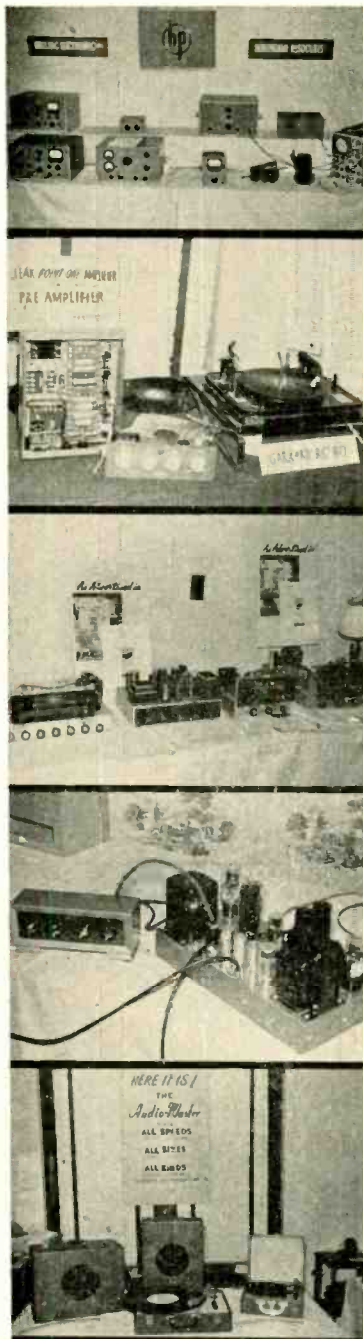

recorders has been truly remarkable in the last twelve months, and for applications requiring a high quality source of sound for long periods, a machine of the type exhibited here would certainly serve the purpose admirably. With such an installation, hotels and restaurants could be freed from the need for wired services, and would be able to schedule the kind of music or entertainment that was most suitable for the hour or location. In addition to the long-playing machine, a large number of other types of recorders were on display, of sufficiently wide variation of cabinet, styling, and facilities to fill the needs of most semi-professional users.

**Arrow Electronics, Inc.**, a New York City jobber, kept its display room full of visitors during most of the show hours, and well it might, because of the wide variety of components for high-quality music systems that were on display. The jobbers had somewhat of an advantage over some manufacturers because they have available all types of equipment, and are therefore able to make comparisons right on the spot. Tuners, turntables, amplifiers, even television parts, all were on display here.

**Audak Company**, preferring to demonstrate for quality of sound rather than quantity, conducted its displays of performance behind closed doors. To many visitors, this was a welcome change from the somewhat overpowering sound which filled the corridors of the fifth and sixth floors of the hotel. Using a choice of two recognized amplifiers and a high-quality two-way speaker system, the performance of the Audax Polyphase pickup was shown at normal living room levels, and with the finest of taste in selection of program material. Available now with special adapters to fit the Webster and Garrard changers, the Audax Polyphase—with two styli and therefore capable of reproducing all types of home records without changing arms or heads—is rapidly gaining favor, both for its quality and for its convenience in use.

**Audio Devices, Inc.** had only two items to exhibit—but each of these was available in so many varieties that their display was still quite elaborate. First, the famous Audioclips were there in full force, in many diameters and in all grades from the perfection required for masters to the smaller and lighter-base types used by the amateur. Second, the variety of magnetic tapes on display was so great as to surprise those who have previously known only of the standard ¼-in. plastic

or paper tape used on conventional tape recorders. Types shown included plastic-base tape from ¼ to 2 inches wide, several widths of paper-base tape, 16-mm film with single and double perforations, 17.5-mm film with single perforations, and 35-mm film with double perforations. All it takes to bring out a special tape is to show a need for it, and anything imaginable can be made.

**Audio Instrument Company** showed a new device intended to generate a signal, composed of both low and high frequencies, which could be used with any oscilloscope to give a qualitative measurement of intermodulation distortion, as well as with the Bridger—an instrument designed to permit the measurement of small audio voltages without appreciable loading of the source. This instrument has fulfilled the need for an a.f. coupling unit of extremely high impedance, a necessity in development and laboratory work, and a useful accessory in the service and experimenter's shop. The Intermodulation Set offers in compact form a source of signal for IM measurements which is entirely suitable for most developmental work.

**The Audio Master Company** displayed a number of portable record and transcription players which fill the need for a small unit suitable for the salesman who has a product which is best demonstrated by the use of records, or by a salesman for the records or transcriptions themselves. These units are also well adapted for p.a. system use, as well as for schools and other educational applications.

**Bell Sound Systems Inc.** displayed for the first time a new amplifier of exceptional merit, Model 2145. This all-triode unit with an output in excess of 15 watts combines a number of useful features, principal of which is the use of a remote control unit which is connected to the main chassis by a single cable. All inputs are plugged directly into the amplifier chassis, and by the use of cathode followers the signal can be fed to the control unit by a cable as long as 25 feet without frequency discrimination. The high-gain input employs a two-stage preamplifier on the main chassis, thus isolating the low-level signals from the cable. The selector switch on the remote control assembly makes a choice between phono and radio signals, compensates for record characteristics, and adjusts high-frequency roll-off. Bass and treble tone controls and a compensated volume con-

From the top, reading counterclockwise: Burlingame Associates, British Industries Corp., Browning Laboratories, Inc., Bell Sound Systems, Inc., The Audio Master Co., Audak Company, Inc., Audio Instrument Co., Audio Devices, Inc.

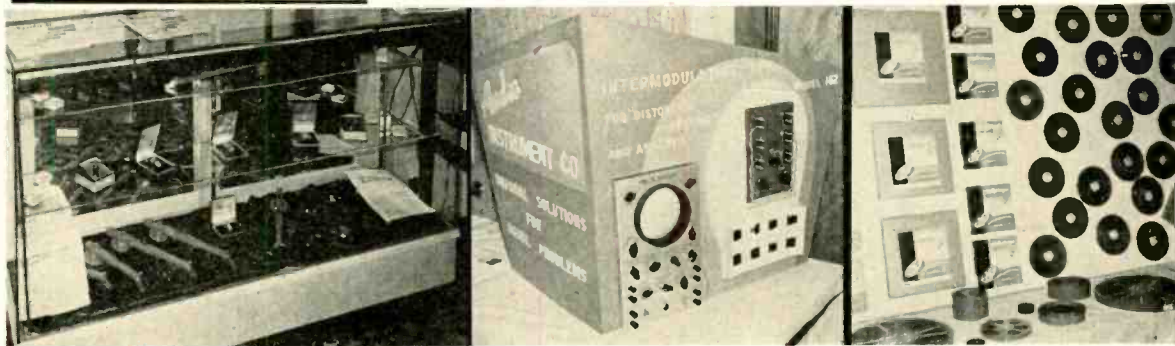



trol complete the remote unit complement, with the signal being fed back through the cable from the output of another cathode follower in the remote box. In all, this unit appears to have had much thought in its design, and was apparently planned with the needs of the user well in mind.

British Industries Corporation had a number of imported items on display, including the Garrard RC80 record changer, the Leak "Point One" amplifier, and the complete line of Wharfedale speakers. Both the changer and the amplifier are well known in this country by this time, but the Wharfedale line is relatively new. This group of speakers, ranging from an 8-inch model up to a 15-inch heavy-duty job, provide a full range of types for all applications where quality is a requisite. Most of the models are built with cloth surrounds, resulting in lowered resonant frequencies, and giving an extremely flexible cone mounting. The Point One amplifier, of a type similar to the "Williamson" now so famous in this country, derives its name from the distortion at rated output, 0.1 per cent.

Browning Laboratories had on display its entire line of tuners, just recently improved with the addition of automatic frequency control. Two models of the AM-FM receivers were shown, one with a power supply on the same chassis and with complete tone control facilities, and another consisting solely of a tuner for both bands and designed for systems where the control of tone and volume is incorporated in a separate amplifier unit. The smaller FM-only chassis is primarily intended for use where a suitable AM chassis is already available, or for those critical listeners who do not want anything but FM. This unit has its own power supply, but does not have the tone controls. All models have exceptional sensitivity on the FM band, and the quality is above normal on either type of receiver.

Burlingame Associates and Brujac Electronic Corporation exhibited a number of unusual items, among them being a Danish importation in the form of an elaborate oscilloscope. The entire standard line of Hewlett-Packard products was shown, with prominence being given to the newer types of combined gain sets and oscillators. Laboratory power supplies, high-gain a.f. voltmeters, and the versatile Tektronix oscilloscope filled out the line of equipment shown.

Cinema Engineering Company had a number of useful and practical items of

particular interest to the professional, although the advanced experimenter is also likely to find many uses for the convenient chassis available from this company. In addition to these shock-mounted, quick change chassis, a wide line of attenuators, filters and equalizers was shown, all designed with the needs of the particular application uppermost in the requirements for the product.

The Daven Company, long established as one of the "standard" manufacturers, exhibited its newer line of instruments, topped off by the distortion and noise measuring set described in these pages last month. The Daven line of laboratory instruments is expanding gradually, and each new addition lives up to the reputation of the builder and further enhances it. The 11-A Gain Set, announced last year, is now a familiar item, and many of them are in continuous service. It is expected that the new distortion measuring instrument will soon achieve wide use among those who require high precision in measurements.

Electronic Workshop exhibited a variety of equipment ranging from a cleverly designed miniature audio oscillator to complete custom equipment for the home. Their own design of amplifier was presented in a highly polished chrome plated model for the Fair or for those who enjoy having equipment which may be shown off as a prized possession. With a preamplifier having the same knob spacing as the Browning tuners usually employed by EW in their custom work, the resulting appearance of the installation is well above average.

Electronics of Staten Island, a newcomer to the audio field this year, had two new corner speaker cabinets on display, one containing the speaker alone and another with a built-in tuner, amplifier, and record changer. The performance from these cabinets was above average, indicating the advantage of using the room corner as an element of the speaker housing by reducing the solid angle into which the speaker must radiate. Cabinetry and finish on both models displayed were of excellent appearance, and because of their relatively small size these units would make welcome additions to most living rooms.

Electro-Voice, Inc. displayed its entire line of microphones, pickup cartridges, and speakers, the latter including mechanisms only as well as a number of furniture cabinets. Outstanding among the line is the Patricia, a massive corner cabinet constructed under license from Klipsch, and incorporating a low-fre-

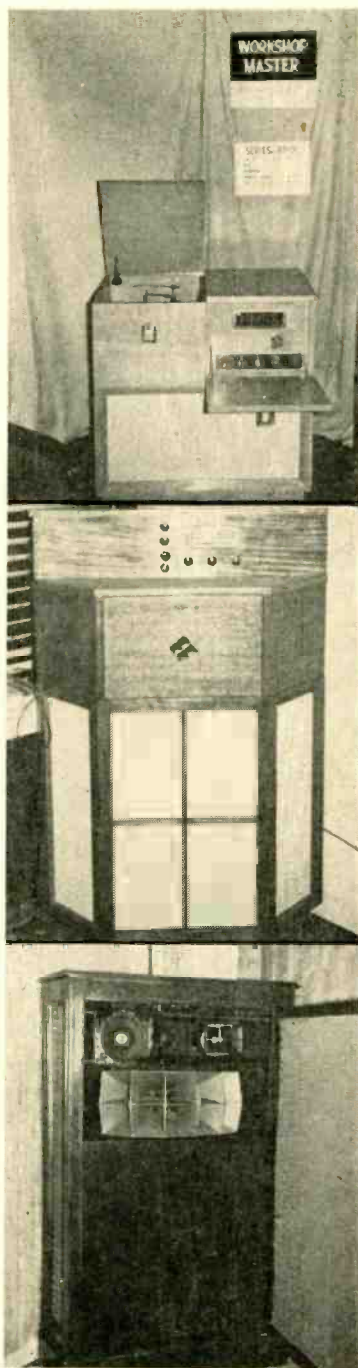

From the top, reading clockwise: Electronic Workshop, Electronics of Staten Island, Electro-Voice, Inc., The Daven Company, Fairchild Recording Equipment Corp., Fisher Radio Sales Co., Inc.





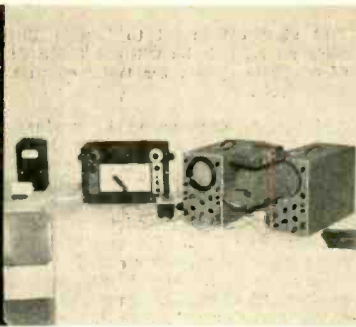
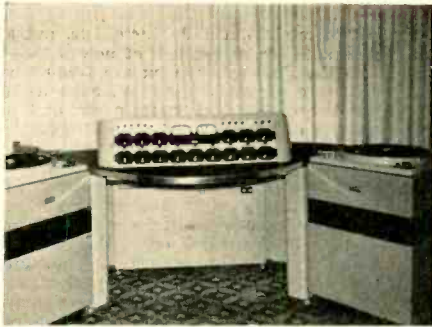

From the top, reading clockwise: Gates Radio Company, Gaylor-Knoop Co., Hudson Radio & Television Corp., General Electric Co., Harvey Radio Co., Inc., Harrison Radio Corp.

quency horn folded into the corner, two direct-radiating cones, and two multicellular horns, the smaller covering the range from around 3500 cps as far as the signal source required.

**Fairchild Recording Equipment Corporation** exhibited a complete line of high-quality disc recording apparatus, together with a rack of equipment designed for the better quality transcription studio where off-the-air recordings are made as a regular business. Outstanding interest was shown in an equalizer which featured continuously variable peak frequencies at both low and high ends of the spectrum, and with continuously variable amounts of equalization at the frequencies selected.

**Fisher Radio Corporation** showed their line of high-quality radio receivers and amplifiers along with the new Concertone tape recorder, which is the most compact model yet shown which will handle the standard 10-inch reels on NAB hubs. Incorporating a three-motor chassis of cast aluminum, with the amplifiers mounted directly on the unit, the entire recorder can readily be carried in a single case. This model is made with two speeds—7½ and 15 inches per second—and with either single or double track heads, either type of which is readily changed for the other in a matter of minutes.

**Gates Radio Company** had on display a complete console for broadcast station use, along with several types of amplifiers and remote input equipments. One model of remote amplifier, designed for use with either a.c. or batteries, is equipped with an automatic changeover feature which connects the battery supply immediately in case of failure of the power source. The station console, with two turntables, is so arranged as to provide for comfortable operation and has facilities for two separate programs, or for one program and one audition channel. Neatness of design and construction features the entire Gates line, and accessibility for maintenance is one of the strong features of the equipment.

**Gaylor-Knoop Company**, manufacturers' representatives, showed the lines of Allen B. DuMont Laboratories, Ballentine Laboratories, and Clough Brengle Co., with cathode ray oscilloscopes with attached Polaroid Land camera for permanently recording the traces under observation, a product of the DuMont organization. From Ballentine, the new models of electronic voltmeters—always so popular in the field—were shown, together with a number of accessories which extend their usefulness. The Clough Brengle Audiomatic sweep gen-

erator, which provides a frequency swept signal over the entire audio range or over any selected part of it, was also a hit with the visitors who are engaged in any sort of development work.

**General Electric Company** exhibited two of its major products in the audio line—pickups and loudspeakers. A mammoth phonograph cartridge employing the quick-change stylus assembly was an attractive feature, since it showed the method by which the styli were changed for standard or LP records, and in a form large enough for everyone to see the actual working of the device. The display of a S-1201 speaker actuated by a 60-cps a.c. source and illuminated by means of a Stroboscop gave convincing demonstration of the operation of the speaker cone under high-level excitation. A moving cutaway of one of the same speakers served to show the features of the internal construction, with the magnet, polepieces, voice coil and support being plainly visible when the unit split apart.

**Harrison Radio Corporation** featured the Electronic Workshop A-18 amplifier, shown for the first time at the Fair. In addition, the current most popular lines of equipment—including turntables, phonograph pickups, speakers, and radio tuners, were all there in abundance. Harrison also had a novelty item as a giveaway which was the source of fun for the visitors all through the Fair days.

**Harvey Radio Company, Inc.**, featured the Magnecorder in its various forms, together with the Lansing corner speaker, Rek-O-Kut turntables, and the Audak Polyphase pick-up, and with this assembly of components which are now familiar to the music lover and audio hobbyist alike produced a quality of sound which was only to be expected from such distinguished equipment.

**Hudson Radio & Television Corporation**, another New York City jobber, exhibited a wide variety of components for sound systems, ranging from the Audio Pacific, Bell, Electronic Workshop, and H. H. Scott amplifiers through Radio Craftsmen AM/FM tuners, a selection of speakers, and the Masco tape recorder. The Audio-Pacific amplifier, exclusive at Hudson, was shown to have exceptionally flat frequency response and low distortion throughout the entire range.

**Langevin Manufacturing Corporation**, showed a full line of quality transformers along with a number of professional type plug-in amplifiers and two power amplifiers designed for home or professional use. One of these latter units, encased in a convenient wall mounting cabinet, and of excellent quality, is

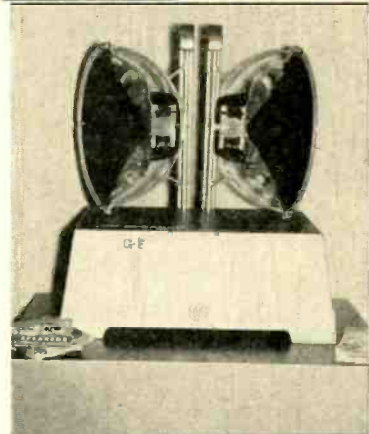



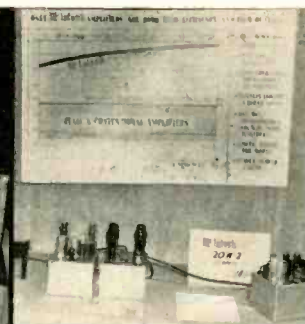

Upper left, Leonard Radio, Inc. Center, left to right, Magnecord, Inc., Langevin Mfg. Corp., McIntosh Engineering Laboratory, Measurements Corp.

especially suitable for use in wired music systems or for p.a. use in such places as restaurants, dance halls, skating rinks, and other such locations where the highest quality and reliability are requisite.

**James B. Lansing Sound, Inc.** had on display one of their largest speaker systems for home use, although from its quality and output power it would definitely be suitable for monitoring in professional applications. This model, the D-1005, incorporates two woofers and an eight-cell horn with a crossover in the vicinity of 1000 cps. It was finished in a light blond hardwood, and presented a very attractive appearance. The entire line of speaker mechanisms was also shown, ranging from the 8-inch model up to the heavy-duty 15-inch woofers.

**Leonard Radio, Inc.**, with a complete line of radio tuners, amplifiers, speakers, turntables, and even a TV console suitable as an entertainment center for the home, featured the Markham-Williamson amplifier, a new 15-watt unit with a remote control unit permitting adjustment of tones and volume to the user's satisfaction without the need for him to leave his favorite easy chair. This amplifier is built along the lines of the entire Williamson circuit—from low-level input to output stages—and is sure to be another contender for amplifier honors.

**Magnecord, Inc.** had several models of its recorders available and all on demonstration, ranging from the portable PT63J through its various forms up to the new console PT7-AX in a cabinet which contains all the amplifiers necessary with the machine. This model has attracted considerable attention, largely because of its mechanical features and the convenience of operation. It is the

first standard model to handle 10-inch reels on NAB hubs without the addition of a special panel for the feed and rewind reels.

**McIntosh Engineering Laboratory** exhibited its two amplifier models, the 50-W-2 and the 20-W-2, along with the new preamplifier AE-2 which incorporated the input stages and controls necessary for a complete reproducing system. The McIntosh amplifier circuit has been proven more efficient than most others, and it is of unquestionable quality. The smaller model, using two 6V6's in the output stage, has an output of 20 watts, which is remarkable for 6V6's. The unit is compact, being housed in a single chassis unit of unconventional design. The 50-W-2 model, using 6L6's, consists of two similar chassis, the power supply being separate from the amplifier. These models are extremely flexible,

**Panoramie Radio Products, Inc.** put a new note—or rather lots of new notes—into the Fair by showing the frequency structure of various signals, such as a number of musical instruments and a number of human voices. The Panoramic sound analyzer continually sweeps over the audio spectrum and indicates the amplitude of all frequencies present on the screen of a c-r tube, thus permitting the user to observe the characteristics of the signal present or in the case of amplifier testing, to observe the amount and character of distortion present in the output signal. A number of similar instruments for a wide variety of different purposes were also on display, but the analyzer attracted the most attention.

**Peerless Electrical Products Division** of Altec Lansing Corporation had a large number of interesting items on display. The now-famous Musicians amplifier, described in *Æ* in November 1949, leads

and are readily adaptable to a wide variety of requirements.

**Measurements Corporation** displayed its line of precise laboratory instruments, with the intermodulation meters—two of them and both new—taking the spotlight. These instruments, which were described in last month's issue, incorporate several new and useful features, and serve to round out the line of measuring instruments designed for the laboratory or for the advanced experimenter—if his needs warrant the most accurate instrumentation.

**Midway Radio and Television Corporation**, another New York jobber recently to enter the field, displayed the Radio Craftsmen tuner, and offered to visitors a stroboscope disc useful in checking accuracy and constancy of turntable speed. Midway also featured the Rauland 1825 amplifier with its unique preamplifier which can be mounted in a number of methods so that the user can select the mounting which best fits his requirements. When a relatively small space is available for the controls of the amplifier, the Rauland is especially attractive.

**Milo Radio & Electronics Corporation** offered as its most interesting exhibit a display of the new Modular amplifiers and components which incorporate a new style of construction which permits the joining of several units or component assemblies together to make a single, solid chassis. Thus a power supply can be placed on a chassis along side the power amplifier, and other parts or sections of amplifier can be added as required or as the need for them develops. The Garrard changer was also featured by Milo, along with the new Audax head mounting for this changer.

the line for popularity, and it is now followed by the Musicians Amplifier, Senior, which is a theatre-type 50-watt unit employing 845's. This unit is intended to be driven by the original Musicians unit. Also shown was a new amplifier using the space-charge-grid tubes which have finally reached the market. This model will be described shortly in these pages, and will undoubtedly follow the Musicians amplifier into the Hall of Fame for good audio equipment.

**The Permolux Corporation** proved how good their Royal Eight speaker could be, with performance essentially comparable to that from earlier 12-inch speakers. In a small cabinet with a single speaker, the performance was better than would be expected from standard console radio receivers, and when four units were mounted in a single housing, the output at the lower frequencies was remarkable considering the size of the basic cone speaker. Also on display were the high-fidelity headphones, which consist essentially of a pair of minute cone speakers mounted in receiver cases and equipped with sound-proof pads to ensure good coupling between the units and the eardrums.

**Pickering & Company, Inc.** presented a modern display showing drawings of their units in normal position, and augmented with the actual components alongside. A number of the model 180L column loudspeakers adorned the room, and the choice of music showed off the performance of the speakers to advantage. Most striking of the demonstrations was the performance of the model 190 arm playing on a turntable an angle of 45 deg. from the horizontal, showing the remarkable balance of the arm, with its



cartridge, during the playing of records on normal turntables.

**Presto Recording Corporation** displayed a full line of recording equipment for both tape and disc. A new professional model of tape recorder, designed to mount either on a rack or on a conventional recorder console, was shown for the first time, and its many features pointed out in detail. The smaller Model PT900 was also on display, as were a number of different models of disc recording machines of varying capabilities. The large tape machine is designed to operate either directly or remotely, and it provides for the 10-inch reels on NAB hubs. Both of the basic Presto chassis are three-head models, and permit simultaneous monitoring of the recorded signal during recording.

**Radio Corporation of America** exhibited two physical arrangements of its tape recorder, one being rack mounted so that

performance better than would normally be expected from a study of the cabinet dimensions.

**Rangertone, Inc.** exhibited their lip-sync system which permits the use of ¼-in. magnetic tape with sprocket hole driven motion picture film at a considerable saving in cost over the use of optical film for the sound recording. By recording a 60-cps signal from the camera motor supply at the same time as the sound is recorded, it is possible on playback to compare the 60-cps recorded signal with the frequency of the power supply driving the projector and to vary the speed of the tape recorder so as to keep the sound track in exact synchronism with the picture. This is an important improvement in tape recorders, and is resulting in their widespread use in motion picture production.

**Reeves Soundcraft Corporation** presented a modern display of magnetic tape

LP's and other plastic records. The basic 210-B amplifier is a complete unit, with provision for phonograph equalization and has, in addition, tone controls giving a wide range of variation of both bass and treble response.

**Scully Machine Company** displayed one of their famous recording machines, complete on its own console table, and with microscope, elapsed-time meter, and control switches. This machine, well known for its reliability and ease of operation, still remains one of the finest instruments of its type. It will cut either inside-out or outside-in, with both standard and microgrooves, and has an automatic spiralling feature which contributes to its adaptability in recording studios of the highest quality.

**Mark Simpson Mfg. Co. Inc.** featured their new Masco Sound-Reel magnetic recorder, with a number of interesting features for a small and inexpensive ma-



Reading clockwise; Midway Radio & Television Corp., Milo Radio & Electronics Corp., Peerless Electrical Products Div. of Altec Lansing Corp., Panoramic Radio Products, Inc., The Permflux Corp., James B. Lansing Sound, Inc.

the functioning of the mechanism could be studied readily without the necessity of crawling into a console. Mounted in a console cabinet, the same chassis becomes a more-familiar design of recorder, and can be controlled remotely if desired by a similar set of operating controls. Also shown in the room occupied by the Engineering Products Department was the new Starmaker microphone, a miniature ribbon microphone designed for use on audience participation shows or on television where the performer should not be hidden by the microphone. Two cabinet mountings for the LC1A speaker were also shown and, with a signal of undoubted quality from the tape recorders, showed excellent characteristics.

In another of RCA's rooms the new model of the duo-cone speaker—the 515S2—was on display, both visual and aural. This unit is lower priced than the LC1A, but gives the listener who wants good quality a high degree of performance with a two-way unit combined in a single housing.

**Radio Music Corporation** displayed a number of professional-type transcription pickups, using a single arm and three interchangeable heads. One head is designed solely for lateral transcriptions, another solely for vertical, and a third serves to play both about equally well. Also on display were a number of amplifiers for wired music systems, restaurants, and other such applications where continuous reliable operation is required. A new line of speakers and speaker housings were shown, with per-

formance better than would normally be expected from a study of the cabinet dimensions. In several dimensions and spoolings along with a variety of recording discs ranging from 6 inches up to 17½ inches in diameter. Newest products of this company include a line of TV picture tubes, principally of the dark face rectangular types which are being used almost exclusively in current production sets. With this diversification, the Reeves line is now usable in practically all branches of the electronic entertainment field.

**Rek-O-Kut Company, Inc.** displayed a variety of turntables and disc recording mechanisms, together with amplifiers for use in recording and playback. Outstanding among the turntables is the heavy-duty type with hysteresis motor drive, having the smoothest of drives and a minimum of external hum fields. The use of a 6-inch speaker in an especially designed cabinet was noted as an eye-opener as to the quality of tone obtainable. For applications where an inexpensive monitor speaker is desired—as in schools or other places where the budget does not permit the use of more elaborate systems—this model would be ideally suited. The Rek-O-Kut line also includes a variable speed turntable, adjustable over a wide range, and several transcription players designed for portable use.

**Hermon Hosmer Scott, Inc.** exhibited the model 210-B Dynaural Amplifier, along with several smaller items of equipment intended for use with phonograph reproduction systems to reduce the needle scratch usually heard from shellac records. The new units also operate to reduce pops and crackles from

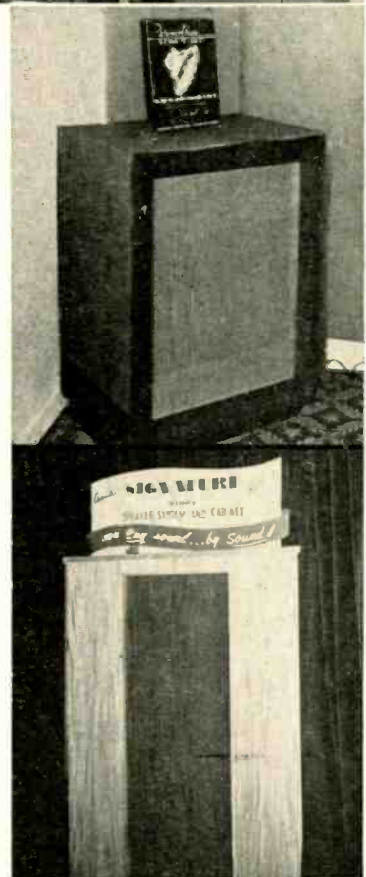



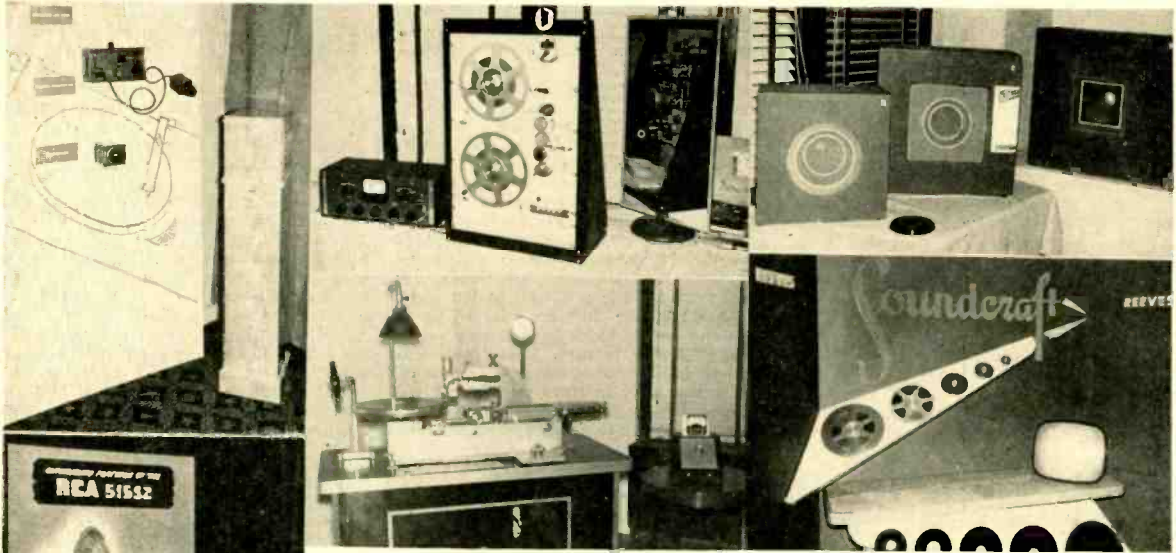

Left, from top to bottom: Pickering & Co., Inc., RCA (Harrison, N. J.), Rangertone, Inc., RCA (Camden). Above: upper left, Presto Recording Corp.; upper right, Radio-Music Corp.; lower left, Scully Machine Co.; lower right, Reeves Soundcraft Corp.



chine. Extremely compact, the Sound Reel will record at  $3\frac{3}{4}$  or  $7\frac{1}{2}$  inches per second, and is reversible so as to record on two tracks. Also shown was the small tweeter designed to mount in front of a 12- or 15-inch cone and to be connected across the voice coil of the large cone without any crossover network.

some suitable spot, permitting the placement of the amplifier at some more convenient location than is usually available at the desired control panel.

Somerset Laboratories, Inc. displayed their new noise suppressing amplifier with a remote control unit designed to permit the user to adjust volume, tone, and suppression from his easy chair. Also shown were several models of the noise suppressor unit separate from the main amplifier and for use with existing equipment. In one form of the complete equipment a separate control panel is supplied which can be mounted in a cabinet at

Sonar Radio Corporation demonstrated a new tape recorder equipped to handle 10-inch reels and of quality superior to the usual home-type machine. This model is equipped with three heads, permitting simultaneous monitoring of the recorded tape during the actual recording process. Complete in four panels for rack mounting, the unit is approximately 24 inches high, providing for the recorder chassis, record and playback amplifiers, and the loudspeaker and power supply panels. In another model, the recorder chassis is separate, and the amplifiers and speaker are rack mounted units which may be

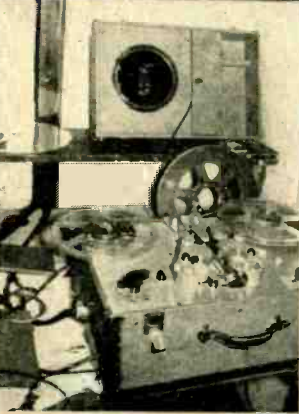

Below: upper left, Rek-O-Kut Co., Inc.; upper right, Hermon Hosmer Scott, Inc.; lower left, Mark Simpson Mfg. Co., Inc.; lower right, Somerset Laboratories, Inc.





*Incomparable...*

**DISTINGUISHED FROM ALL OTHERS BY  
LONGER LIFE AND SUPERIOR PERFORMANCE!**

# GARRARD

**THE WORLD'S FINEST RECORD CHANGER**

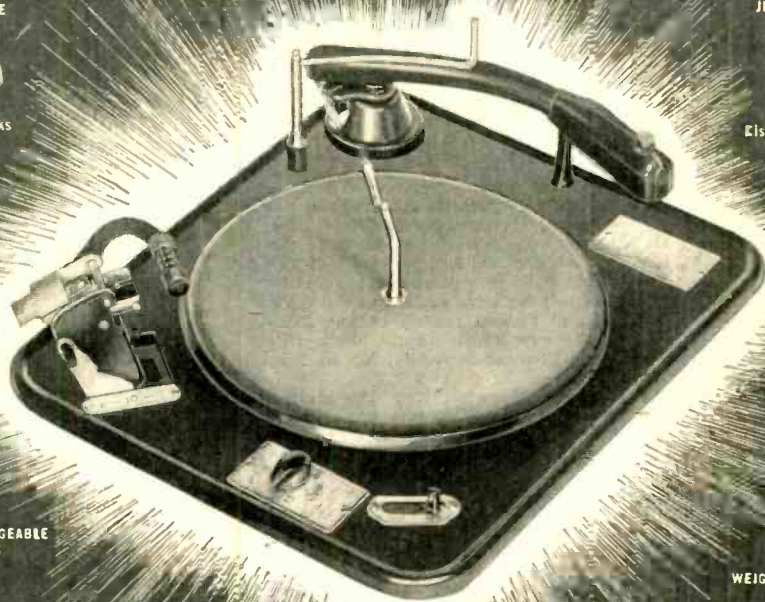

**PUSHER TYPE PLATFORM**



It always works

**AUTOMATIC STOP**



At end of 7 1/2" type records

**MUTING SWITCH**



Silence between records

**TWO INTERCHANGEABLE SPINDLES**



Plays records as intended

**JEWEL MOUNTED TONE ARM**



Disturbing resonance eliminated

**HEAVY DUTY SILENT MOTOR**



Absolute no rumble

**HEAVY DUTY DRIVE SHAFT**



No wobble. No wavers

**WEIGHTED TURNTABLE**



Gives flywheel action

## *Triumph* MODEL RC-80

Plays all speeds — fully automatic Easily and inexpensively installed in your present set

At your dealer or write to

GARRARD SALES CORP., 164 Duane Street, New York 13, N. Y.

### LEAK

**"POINT ONE"**

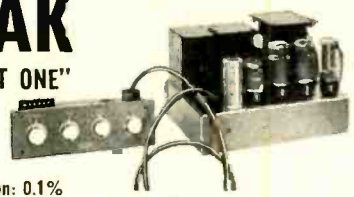

Distortion: 0.1%

A new model of Britain's best audio amplifier with compensated settings for all type recordings.

Triple loop power amplifier and pre-amplifier assure clear, undistorted musical reproduction. Certified tests by British Nat'l Physical Lab. (equiv. U. S. Bureau of Standards) prove it surpasses manufacturer's performance claims. Leak "Point One" provides the ultimate in clarity and frequency response.

### WHARFEDALE SPEAKERS



Magnificent speakers, yet inexpensive, with remarkable response. Built by Wharfedale Wireless Works under the direction of world-famous engineer, G. A. Briggs. Brilliant performance approaching living sound. Endorsed by S. E. C.

#### BOOKS by G. A. BRIGGS

"LOUDSPEAKERS" (\$1.25) and "SOUND REPRODUCTION" (\$2.25) written by renowned authority on sound, G. A. Briggs. The only such books written expressly for the layman. A "must" for those interested in finest musical reproduction.



At your dealer or write to

BRITISH INDUSTRIES CORP., 164 Duane Street, New York 13, N. Y.



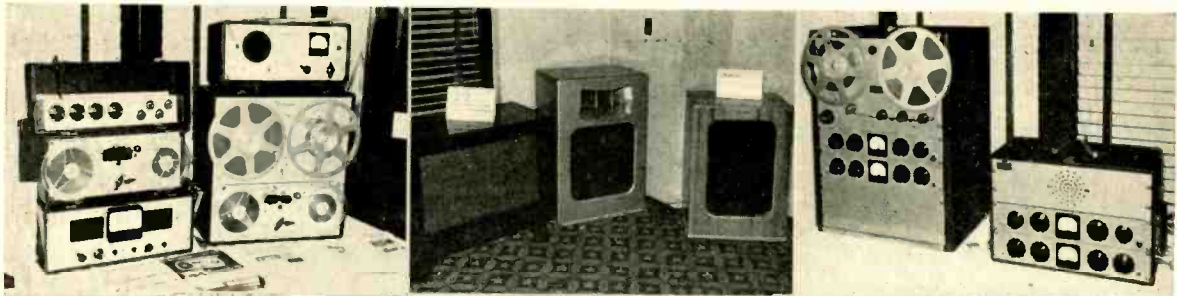

Top row, left to right: Sonocraft Corp.; Stephens Mfg. Co. Inc.; Sonar Radio Corp.; at right, Tech Laboratories, Inc. At left, upper, Sun Radio & Electronics Co. Inc.; lower, University Loudspeakers, Inc. Below, upper row, left to right: Terminal Radio Corp.; The Tetrad Corp.; Transit Sound Systems, Inc.; lower row, Triad Transformer Mfg. Co.; United Transformer Co.; U. S. Recording Co.



located remote from the recorder unit. Sonocraft Corporation featured the entire line of Magnecorder equipment, for which they are one of the jobbers in the New York area. On display were both the PT6 and PT63 recorder units, the auxiliary chassis for large reels with the NAB hubs, and several models of amplifier-speaker-power supply units, along with the multichannel mixer for up to four microphones.

Stephens Manufacturing Corporation exhibited its complete line of speakers and cabinet models, with the two-way systems taking the lead in favor among the visitors. The Hy-Son super tweeter, first shown at the 1949 Fair, is now in complete production, and the addition of this unit to a regular two-way system improves the performance in the upper-highs to a remarkable degree. Stephens models include crossovers at both 600 and 800 cps, and multicellular horns are available in a wide variety of sizes and shapes to fit every requirement.

Sun Radio & Electronics Co. Inc., one of the most aggressive jobbers in the New



York area, exhibited a new unit known as the Realist—a corner cabinet incorporating a high-frequency speaker directed upwards at an angle from the rear of the unit. In usual hard-walled living rooms, this model gives a remarkable distribution of sound, and by the very realism of the sound source makes the unit live up to its name. Another feature of this display was the presence of a shadowgraph unit on which visitors could compare their own styli with the standard shape for a given type in order to determine if wear had progressed to a degree which would make replacement advisable.

Tech Laboratories, Inc. displayed the artificial reverberation generator developed by Audio Facilities Corporation and marketed solely by Tech. This unit is capable of introducing a controllable amount of reverberation to any signal, and eliminates the need for costly echo-chamber equipment setups for radio sta-

[Continued on page 53]

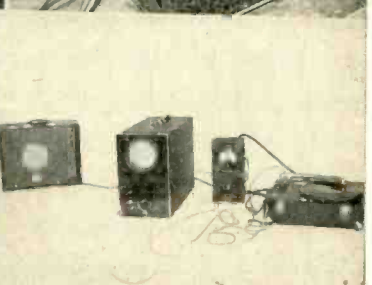
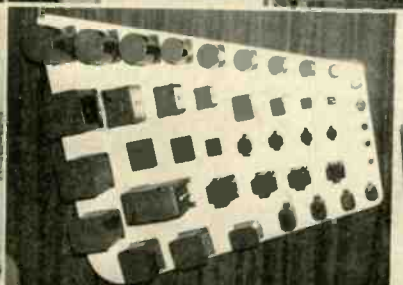
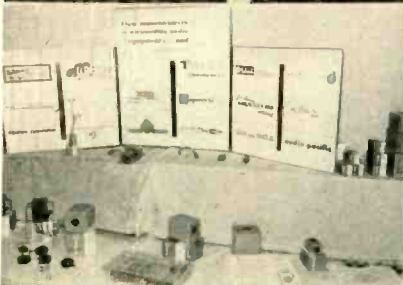



# if it's TAPE...it's PRESTO if it's PRESTO...it's the BEST

## PRESTO PORTABLE RECORDER PT-900

Combining the features of machines costing hundreds of dollars more, the PT-900 answers the need for a recorder of ultra-high fidelity in a completely portable, compactly designed unit. Equipped with separate amplifiers for recording and monitoring; individual heads for erase, record, playback; three microphone input; dual speed (15" and 7½/sec.). Frequency response from 50 to 15,000 cps.



## PRESTO PORTABLE RECORDER RC-10/14

This machine is identical to the RC-10/24, except for panel size and selector control. With a panel 19" x 14", the RC-10/14 is shown mounted in a durable, leatherette carrying case. Weighing just 68 pounds, this tape transport mechanism has all the audio quality, speed regulation and reliability of a fine console type unit, at a cost far below a studio recorder. PRESTO amplifier (model 900-A2), as shown with model PT-900, is recommended.

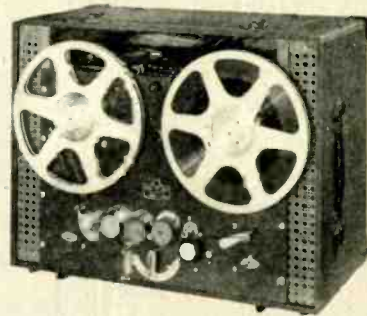

## PRESTO RACK MOUNTED RECORDER RC-10/24

The number one choice of engineers seeking the finest tape machine for relay rack mounting. Rugged construction and precision engineering combine to bring almost faultless operation. Push-button control, three magnetic heads, speeds of 15" and 7½"/sec.; fast-forward and rewind speed of 250"/sec.; frequency response to 15,000 cps. Accommodates reels up to 10½" in diameter. Panel size: 19" x 24½". Constant tape tension assured by torque motors. Illustrated with the PRESTO 900-A2 amplifier, recommended for use with this recorder.

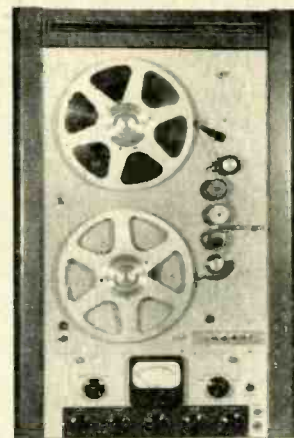

**AMERICA'S MOST COMPLETE SELECTION OF FINE TAPE RECORDERS**

 **PRESTO**

**RECORDING CORPORATION**

Paramus, New Jersey

In Canada: Woller P. Downs, Ltd., Dominion Square Bldg., Montreal, Canada  
Overseas: M. Simons & Son Company, Inc., 25 Warren Street, New York, N. Y.

# AUDIANA

LEWIS S. GOODFRIEND

## High Fidelity

**I**N THE PREVIOUS ARTICLE, the conclusion was reached that high fidelity defined as the acoustic facsimile—can never be attained using single-channel systems. However, it must be admitted that there are many excellent sound reproducing systems installed in rooms and studios. To reconcile these two facts an examination of the good single-channel systems shows that all of the system components are of the highest quality, and that no compromises have been made in order to save either space or money. In other words, a single-channel system can be made to approach the acoustic facsimile and thus provide pleasing reproduction. After the multitude of listener tests that have been conducted to date, there is little doubt left that the nearer the approach to the facsimile goal the more pleasing is the result.

No manufacturer or designer can say that any sacrifice of quality is justified by the existing inherent spatial distortion introduced by a single-channel system. Such compromises with cost and quality all tend to decrease the acceptability of the unit. Nonetheless, many manufacturers and designers continue to produce units with inadequate frequency compensation for phonographs, insufficient power before acceptable distortion is exceeded, and insufficient power-supply filtering. In listing these three, it is assumed that there is sufficient copper and iron in the transformers to prevent overheating of the power transformer and to prevent saturation in the output transformer.

According to several tests, the perceptible harmonic distortion for both speech and music is one per cent. This is the point at which the distortion is perceived *during* a listener test. A distortion as low as 0.2 per cent may be sufficient to cause auditory fatigue over long periods of listening. Improperly equalized phonograph (and radio) channels and FM de-emphasis circuits cause a response that sounds *different*. This means that the listener cannot associate what he hears with fact. Thus the lack of proper equalization leads to outright annoyance. Finally, if we force our push-pull output tubes to filter the 120-cps

ripple out of the high-voltage supply, we have already used some of their power capabilities. The unbalance between tubes in a push-pull stage, unless carefully compensated, will permit an excessive hum level. The distortion caused by unbalance may be less than the fatigue level.

A survey of a number of amplifiers in the medium price range shows that 31 out of 55 have no filter choke ahead of the output-stage high-voltage supply. These figures include an FM receiver specifically designed for quality listening. Without a detailed study of tone controls and variable equalizers, it is still safe to say that equalization is generally achieved without regard to the phase delays introduced by most trick equalizers. And as hard as many have tried to prove otherwise phase distortion changes *timbre*, the quality or body of sound. These seemingly innocent moneysavers are obviously large factors in the lowering of the quality level from a near-facsimile to a merely pleasing system. If there is any question of the reduction of power capabilities by the filtering action in the push-pull output stages, a quick check of the equations in any vacuum tube or electronics text will give the answer.

### Power vs. Distortion Curves

The matter of power level and distortion have been detailed before, but the fact remains that many units have a single-frequency distortion rating that is exceeded at many other frequencies. One way to avoid this is to check the maximum output level for the rated distortion level. If the power available at all frequencies is not greater than half the rated power the unit does not meet the power rating and obviously cannot fulfill the requirements of an amplifier of that rated power. This is the major stumbling block for most amplifiers in the high-quality performance group. They are good at low levels, but at high level they just do not seem to fill the room. When a power rating and distortion level are given they should indicate that at the rated power level the rated distortion will not be exceeded at any frequency. In any case, if the dis-

tortion at normal output levels is greater than 1 per cent the builder or purchaser should reject it as not suited to his need.

The comments made here are not really a criticism of the manufacturers. They are intended only to point out the need for job-rating amplifiers and designing them with the acoustic facsimile as a goal.

Other components of the single-channel system from microphone or recording through to the loudspeaker are equally important to the quality. However, an excellent group of transducers is available having far lower harmonic distortion from non-linear elements than the acceptable minimum. Few individuals are in a position to design and build their own transducers but here, at least, manufacturers agree on most basic design requirements. A real problem in the use of transducers is to make them cosmetically attractive. But this is no topic for discussion here.

One problem in high-fidelity, always present, is noise, and most frequently, record surface noise. Unfortunately, it is present in most shellac records, even though they are of the highest quality. A good audio system reproduces the noise. It is up to the listener to decide whether to sacrifice musical fidelity to achieve noise-free reproduction, and most good audio systems include cut-off filters or noise suppressors. But this noise is part of the signal and the *equipment is not to blame* if it reproduces the surface noise along with the desired music. Many of the modern record pressing techniques have helped reduce surface noise and bring our recorded channel nearer to our goal.

Finally, no delicate set of electronic instruments can remain trouble-free indefinitely. To maintain the quality of transducers and amplifiers they should be properly enclosed, ventilated as required, and subjected to preventive maintenance.

If the acoustic facsimile is considered the goal in audio reproducing equipment design, it becomes easy to provide pleasing quality and results in a satisfied listener. Compromise with quality compromises our objective—high fidelity.



New 1951 • • MODEL V-4A

# Heathkit VTVM KIT

HAS EVERY EXPENSIVE Feature

- ★ Higher AC input impedance, (greater than 1 megohm at 1000 cycles).
- ★ New AC voltmeter flat within 1 db 20 cycles to 2 megacycles (600 ohm source).
- ★ New accessory probe (extra) extends DC range to 30,000 Volts.
- ★ New high quality Simpson 200 microampere meter.
- ★ New 1/2% voltage divider resistors (finest available).
- ★ 24 Complete ranges.
- ★ Low voltage range 3 Volts full scale (1/3 of scale per volt).
- ★ Crystal probe (extra) extends RF range to 250 megacycles.
- ★ Modern push-pull electronic voltmeter on both AC and DC.
- ★ Completely transformer operated isolated from line for safety.
- ★ Largest scale available on streamline 4 1/2 inch meter.
- ★ Burn-out proof meter circuit.
- ★ Isolated probe for dynamic testing no circuit loading.
- ★ New simplified switches for easy assembly.



New  
LOW PRICE **\$23.50**

The new Heathkit Model V-4A VTVM Kit measures to 30,000 Volts DC and 250 megacycles with accessory probes — think of it, all in one electronic instrument more useful than ever before. The AC voltmeter is so flat and extended in its response it eliminates the need for separate expensive AC VTVM's. + or - db from 20 cycles to 2 megacycles. Meter has decibel ranges for direct reading. New zero center on meter scale for quick FM alignment.

There are six complete ranges for each function. Four functions give total of 24 ranges. The 3 Volt range allows 33 1/3% of the scale for reading one volt as against only 20% of the scale on 5 Volt types.

The ranges decade for quick reading.

New 1/2% ceramic precision are the most accurate commercial resistors available — you find the same make and quality in the finest laboratory equipment selling for thousands of dollars. The entire voltage divider decade uses these 1/2% resistors.

New 200 microampere 4 1/2" streamline meter with Simpson quality movement. Five times as sensitive as commonly used 1 MA meters.

Shatterproof plastic meter face for maximum protection. Both AC and DC voltmeter use push-pull electronic voltmeter circuit with burn-out proof meter circuit.

Electronic ohmmeter circuit measures resistance over the amazing range of 1/10 ohm to one billion ohms all with internal 3 Volt battery. Ohmmeter batteries mount on the chassis in snap-in mounting for easy replacement.

Voltage ranges are full scale 3 Volts, 10 Volts, 30 Volts, 100 Volts, 300 Volts, 1000 Volts. Complete decade coverage without gaps.

The DC probe is isolated for dynamic measurements. Negligible circuit loading. Gets the accurate reading without disturbing the operation of the instrument under test. Kit comes complete, cabinet, transformer, Simpson meter, test leads, complete assembly and instruction manual. Compare it with all others and you will buy a Heathkit. Model V-4A. Shipping Wt., 8 lbs. Note new low price, \$23.50.



**New 30,000 VOLT DC  
PROBE KIT**

Beautiful new red and black plastic high voltage probe. Increases input resistance to 1100 megohms, reads 30,000 Volts on 300 Volt range. High input impedance for minimum loading of weak television voltages. Has large plastic insulator rings between handle and point for maximum safety. Comes complete with PL55 type plug.

No. 3366 High Voltage Probe Kit.  
Shipping Wt., 2 pounds.

**\$550**

---

*Heathkit*  
**RF PROBE KIT**

Crystal diode probe kit extends range to 250 megacycles = 10% comes complete with all parts, crystal, cable and PL55 type plug.

No. 309 RF Probe Kit.  
Shipping Wt., 1 lb.

**\$550**



EXPORT AGENT  
**ROCKE INTERNATIONAL CORP.**  
10 E. 40th ST.  
NEW YORK CITY (16)  
CABLE: ARLAB-N.Y.

**The HEATH COMPANY**

... BENTON HARBOR 25, MICHIGAN

# RECORD REVUE

EDWARD TATNALL CANBY\*

## Towards Audio Fair III

**T**HE MANFOLD BENEFITS accruing from Audio Fair II, held this October, will without the slightest doubt continue to make themselves felt right up until Audio Fair III bursts upon us next fall, a bigger and better show as the result of our experience this year. So, though this'll appear a bit *en retard*, constructive remarks seem definitely in order.

Let me at once praise the management of the Fair as fulsomely as I can, including several officers of this sheet who had, so to speak, an enormous hand in the vast quantity of dirty work that had to be done in preparation. The whole thing was a model of smoothness and efficiency and I can't remember a single flaw of any sort in that smoothness—all was trouble-free and easy, even to the pre-fabricated badges for the entire exhibiting personnel!

However, I have a few small bones to pick with that personnel, and indeed I sort of feel, to use the old phrase, that it's my duty to do so, on behalf of my clients, the musicians and the music-lovers, since I represent a passle of 'em in this magazine.

Let's waste no more words. The Fair was beautifully managed but there wasn't a thing the management could do (other than providing virtually sound proof rooms) to reduce what became by the final day a most frightening bedlam.

Look, gentlemen of the Audio profession—this is from the horse's mouth. I know you had a lot of powerful equipment to demonstrate and the neighbors made so much noise that you had to whomp up your 50-watters to drown 'em out. I also know that there were thousands of engineers, radio servicemen, and others whose interest was not so much musical as technical. Those numerous individuals had to be catered to. The dealers who sell audio parts were there, as well as the makers who needed to find out what was what outside of their own bailiwicks. All of which is conducive to noise.

But as this column has said again and again (and no further back than the October issue), the business of Audio is music. The purpose of almost all Audio in the quality field is music. What, then, of the people who acquire Audio in order to hear music? What some of you may not realize

is that these people were also present at the Audio Fair, by the thousands. Some were engineers too, professional or amateur; many had dabbled in technicalia enough to feel some confidence at the sight of a battering ram woofer, about to give with the bass. Most, on the other hand, were suddenly launched into an unfamiliar and decidedly strange environment, to put it mildly.

Think this way: our industry has expanded enormously in the last couple of years—that, after all, is the very reason for the Audio Fair itself. But that expansion has been largely via conversion of many music lovers to "hi-fi," about which you can be dead sure, almost all of the converts knew nothing whatsoever, previously. That means that most of them (the ones who are out buying up expensive audio equipment) still know very little about the technical aspects and—here's the point—are decidedly awed by the professionals and the heady shop talk, as any green-horn is, who suddenly finds himself in the Holy of Holies, the very temple of Audio! Most of our converts, then, are given to extreme timidity. Which doesn't indicate any lack of interest: merely a lack of aggressiveness in the presence of audio people.

Now, as I saw it, things went something like this. Most exhibit rooms were crowded with on-listeners. (Like onlookers—get it?). Up front and aggressive were the engineers, the sales people, the manufacturers, the professionals, the habitués, the advanced and long-time amateurs. These people, very much at home and thoroughly aggressive did all the talking, asked the questions, put out with opinions, looked big and important.

However, perhaps half of the people in each exhibit were acting mousy. They snooped around quietly, saying nary a word (for fear of making a boner), listening respectfully over peoples' shoulders, hastily backing out of any argument. These were the neophytes, the unsure, audio-wise. They were, in large measure, the converted music lovers. And though they didn't say much, though they acted mouse-like, they were having thoughts, you may be sure. And they were looking for music. Looking for audio equipment that could give them the music they wanted.

[Continued on page 55]

## Pops

RUDO S. GLOBUS\*

**S**EVERAL WEEKS AGO, I received a letter boldly typewritten on bold paper by a bold soul who has made his name in this world by writing record reviews for whatever bold publications would pay him. Now retired and content without the mantle of glory weighing on his shoulders, he indicated that he has been out of the business for a long time, liked some of the conclusions that I have drawn, and requested that I get together with some of the big people in the business and find out how they feel about things.

Ever willing to comply with all legitimate requests, I arranged for an interview with one of the really great men in the business and we talked for well over an hour about all things pertaining. The interview was arranged with the background of a long evening spent at Eddie Condon's and the genius of Edmund Hall echoing in my ears. In the history of Condon's, I can't remember any group which can top the one that is now holding forth. Made up of Cutty Cutshall on trombone, "Wild Bill" Davidson on trumpet, Gene Schroeder on piano, and Edmund Hall on clarinet, the group is valiantly putting Humpty Dumpty back together again. One of the big reasons is the still enlightened and smoldering blowing of Mr. Hall, who boasts that he never took a legitimate lesson in his life and won't be bothered with all the technical exercises and practicing that characterizes lesser men.

So . . . to get to the point . . . we asked Edmund Hall the leading question:

"How do you feel about recording jazz under studio conditions?"

The answer is scribbled down on over twenty pages of yellow stock, but it adds up to just one thing . . . he doesn't like it. The reasons are good and are pretty much in line with the stuff I've been writing for months. Ed says that he and practically every other jazz man freezes in a studio. You can't loosen, you can't relax. What

[Continued on page 38]

\* 279 W. 4th St., New York 14, N. Y.

\* 960 Park Ave., New York 28, N. Y.



# BEATEN PATH

**90%** of those who exhibited at the New York Audio Fair — many of them presenting new models for the first time and with understandable pride in demonstrating only through the BEST equipment — were observed to be using

## **Audax POLYPHASE reproducers**

What a striking tribute to this super-realistic performer which, when introduced but a few short months ago, was backed only by our own findings as to its overwhelming superiority! What a remarkable dramatization of the old adage about customers beating a path to one's doorstep!

Thousands of visitors, too, came and listened and were astonished by POLYPHASE's amazing facsimile realism. "Never before such amazing EAR-QUALITY!" . . . was the unanimous verdict.

Yes . . . and this must mean something to YOU.

The unique technical story of WHY this sensational reproducer fairly revolutionizes listening, is set down in literature which is yours for the asking; but after you have read it all — only YOU can decide what sounds best and most pleasing to your ears. Therefore, see and hear POLYPHASE yourself — compare it with any other reproducer at any price — then YOU be the judge!

### **AUDAK COMPANY**

500 Fifth Avenue      New York 18

*"Creators of Fine Electro-Acoustical Apparatus for Over 30 Years."*

"The Standard by which Others  
Are Judged and Valued"

Available with the new  
compass-pivoted Audax Arms  
as well as for Record Changers

One single magnetic unit  
plays all home records.



# CHICAGO

## Preferred Transformers

### geared to **TODAY'S** **ELECTRONIC** **CIRCUITS**

#### Designed to Meet The Requirements of Today's Most-Used Tube Types

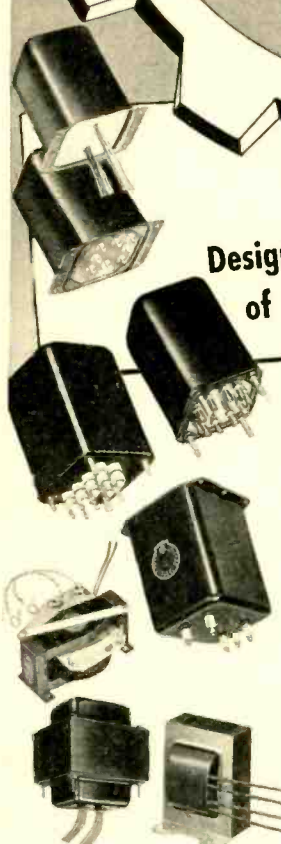

**1. Power Transformers.** Famous, advanced-design, Sealed-in-Steel construction. Exactly suited to specific requirements—one range of ratings expressly designed for capacitor input, another for reactor input.

**2. Full Frequency Audio Transformers.** For optimum performance—high-fidelity  $\pm 1/2$  db from 30 to 15,000 cps. Other ranges available: Public Address— $\pm 1/2$  db, 50-10,000 cps; Communications— $\pm 1/2$  db, 200-3,500 cps.

**3. JAN-T-27 Transformers.** Now available for quick shipment from stock. Hermetically-sealed units which meet all requirements of Grade I, JAN-T-27 specifications for Class A operation. Full range of Power, Audio and Reactor units available.

**4. Driver and Modulation Units.** For Amateur and commercial speech transmitters. Matched sets of drivers, modulation transformers and reactors provide frequency response  $\pm 1$  db over entire range from 30-15,000 cycles.

**5. Television Transformers.** A complete catalog line in a range of designs that are the exact duplicates of units used in leading TV sets. Built by CHICAGO—the largest single manufacturer of original equipment TV transformers.

#### WRITE FOR FREE CATALOGS

You'll want these two important Catalogs—the New Equipment Line listing Sealed-in-Steel and JAN-T-27 units, and the Replacement Line showing a complete range of Radio, TV and Vibrator transformer replacements. Send for these valuable FREE catalogs today—or get them from your distributor.



## CHICAGO TRANSFORMER

DIVISION OF ESSEX WIRE CORPORATION

3501 ADDISON STREET • CHICAGO 18, ILLINOIS



## POPS

[from page 36]

with green, red, yellow, orange, purple and blue signal lights flashing at you, with a time limit to meet, with a pre-arranged idea of what you're going to do, it just doesn't work out . . . and why?

Hall is very sensitive about recording technique. When I asked him the usual question about the best recordings, his initial answer referred to recordings that were "cleanest." His first list included those that had the least surface noise and the best balance, and sounded remotely like the original. When we complained bitterly about such criteria, we got an answer which was more to the point. The best ones were impromptu sessions . . . walking into the studio cold with no idea of what was going to happen and then letting loose. And here Hall gave us the big idea of the moment. You have to have an audience in order to play jazz. It just doesn't feel right to sit in an empty studio and play into a mike. There isn't a mike made than can respond in the way a live audience does. No matter how good some recordings are, they're nothing compared to the kind of stuff that could and would have resulted from genuine jazz conditions.

Ed's been in the business for a long time. He made his first recording in 1926 for Victor with the "Ross DeLuxe Syncopators" from Jacksonville, Fla. The recording was made in a tobacco warehouse with one mike and some impromptu drapes hung indiscriminately around the barn. He has no illusions about the "Great Old Days." He prefers modern studio conditions, but puts the finger right down the line and points squarely at the people who haven't learned the big lesson about jazz recording yet. It goes something like this:

"It's O.K. to call up any bunch of guys to do a legit date. Any guy who plays good and can read music will do fine for a regular recording session. But for this kind of stuff (dixieland and the rest) you gotta have the right men. If you don't have the right men, it's no good."

These are the words of a jazz man who's known all the greats in the business, played with all of them, and is not prone to telling stories out of school. The right men don't grow on every tree. There are only a few clarinet players, trumpet and trombone men, pianists, drummers, etc., who can play jazz. As Ed puts it . . .

"Any good man can sit in on a session cold, and as long as the piano man knows the chords and the trumpet can blow the melody, we can handle it."

But in this day of the all-wise musical director, it would not be too far-fetched to expect to find Jascha Heifetz playing lead fiddle in a recording session doing a combo of Muskrat Ramble and Jazz Me Blues. This is not professional snobbery, nor is it resentment, because all the big men are making a lot of money. It is simply a statement of fact which is emphasized by the naming of those (which we can't do here) who have become the leading lights in modern jazz recording. Hall comes out openly and says they don't know what it's all about. They may sell a few records, but in the long run it doesn't pay off because the stuff is second rate. Hall agrees completely with the thesis that the way to record the stuff is to find the perfect combo and catch them at the job. Tape record all night and edit the next day. The men are really loose during the session and even if three quarters of the stuff is worthless,



there'll be enough to fill both sides of an LP. But, with reference to the way things are now, Ed puts it on the line.

"It's not what you can do . . . it's who you know."

That is the trite but true comment on the record business set up now. In the old days, with after-hour sessions when musicians got together, the big men stood out. There was never any question about it. These were the sessions that used to produce the big moments and were the heart of good jazz. These were the conditions for perfect jazz recording. Today, with the domination of music directors, the powers that be don't know how to pick the right men, depend upon pull and reputation, and what remains is a pretty tired specimen of a good thing. There is further the problem of good days and bad days, and the final decision as to what should be pressed and what shouldn't.

Hall used to be the standout at Cafe Society Downtown during the rough and ready days, and there is no wonder that his list of "best" recordings dates back to those days. Heading the list are two discs that Hall picked out primarily because everybody was relaxed on the date. The first was a complete impromptu. Hall and the men showed up at the session with no idea of what they were going to do. It was the first date for Commodore and they decided to do two blues sides. What resulted was the memorable Uptown and Downtown Cafe Society Boogie. One side is fast blues, the other slow. The other select record was the great Commodore 10-inch of The Man I Love, featuring Emmet Berry on trumpet, Eddie Haywood on Piano, Sid (Big Sid) Catlett on drums, and of course the great E. Hall on clarinet.

In the classical group there are the great 12-inch discs that Hall did for Blue Note of High Society and Royal Garden Blues, all done with the original Cafe Society crew. If you listen to these, what strikes you immediately is the obvious superiority of the 12-inch over the 10-inch size. The list is incomplete without the five great sides on Commodore that Ed did with Teddy Wilson. Jazz Quartet, on 10-inch, produced the superlative recordings of "Night and Day," "Out of Nowhere," "Caravan," "Showpiece," and "Sleepy Time Gal." All the recordings are rare and marvelous manifestations of really great jazz clarinet playing and pretty much highlight the inimitable Hall style. Ed, of course, disclaims style and points to the fact that there were things he did fifteen years ago that he wouldn't do the same way today. But there is still something consistent throughout.

Coming out shortly on the Victor label are a series of things that Hall points to with pride. Recently recorded, there is a job on "Walking the Blues" that Ed did with Gene Krupa, Joe Bushkin, Cutty Cutshall, Wild Bill Davidson and Ernie Cassires (whom Hall considers the great baritone sax in the business). The same date features a job on "I'm Forever Blowing Bubbles" and "The Kiss my Sweetie Gave to Me." The group sounds magnificent and it should be a good chance to see what progress the big companies are making on the jazz front. Hall says to watch out for them . . . we will.

### Specialized Pot Luck:

For months, gossip columns, magazine articles, radio programs, et al have been plugging away at something called the "greatest voice in the world." Going by the name of Yma Sumac, the singer has a range of over four octaves, is a *femme fatale*

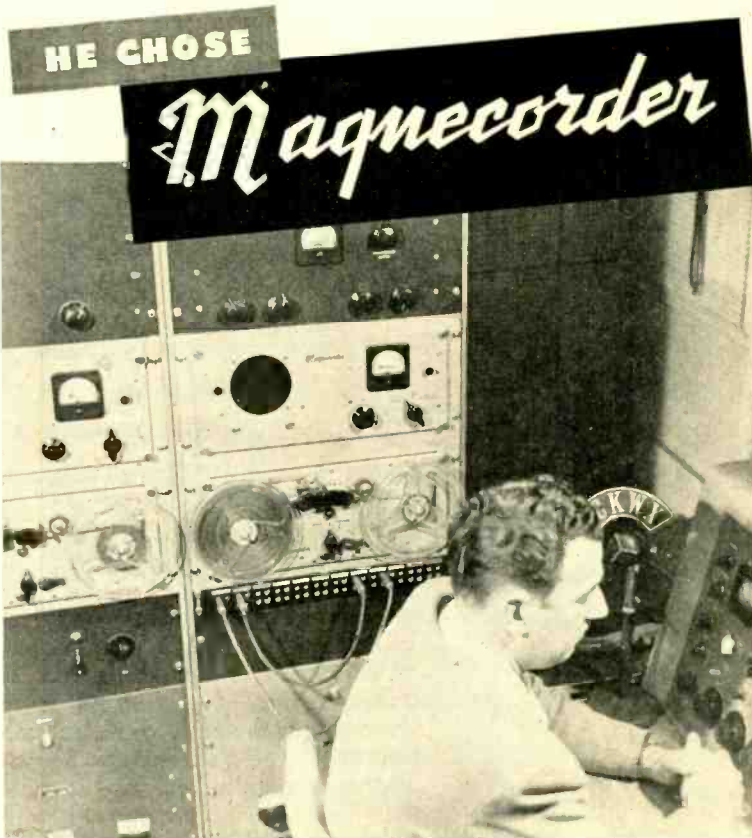

## THE FIRST CHOICE OF RADIO ENGINEERS

More radio engineers use Magne recorders than all other professional tape recorders combined. Here's why:

### HIGH FIDELITY, LOW COST

Stations are enthusiastic about the life-like tone quality and low distortion of Magne recordings. Magne recorder frequency response: 50 — 15kc ± 2 db. Signal-noise ratio: 50 db. Harmonic distortion less than 2%. Meets N.A.B. standards. No other recorder offers such fidelity at such a moderate price.

### GREATEST FLEXIBILITY

Mount a Magne recorder in a rack or console cabinet for delayed studio and network shows. Slip it into its really portable cases for remotes. Add to your Magne recorder equipment as you need it—combine Magne recorders to suit every purpose.

### MORE FEATURES

Your Magne recorder, new or old, can now have 3 heads (separate erase, record, and playback) to permit monitoring from tape. Three speeds (15" — 7½" — 3¾" — up to an hour on a 7" reel) available on both PT6 and PT63 equipment. Dual track heads also available if desired.

### Write for NEW CATALOG

MAGNECOR, INC., Dept. A-B-12  
360 North Michigan Avenue, Chicago 1, Ill.  
Send me latest catalog of Magne recorder Equipment.

Name.....  
Company.....  
Address.....  
City..... Zone..... State.....

HE CHOSE

Magne recorder

### MAGNECOR

For every purpose . . .  
every purse!



PT6 SERIES

Most widely used professional tape recorder in the world.



PT63 SERIES

Three heads to erase, record, and monitor from the tape.



PT7 SERIES

A complete console for only \$950.00. Outstanding features and flexibility. Models for portable or rack mount also available.

## The Finer Recordings Are Made With SOUNDCRAFT Tape And Discs

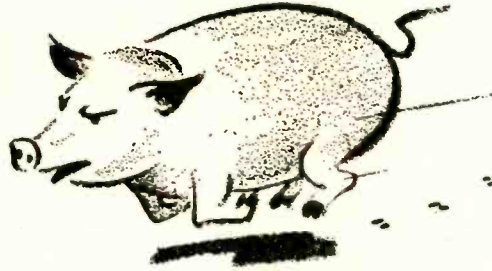

You are not buying a pig-in-a-poke when you specify Reeves Soundcraft for your recording needs.



**SOUNDCRAFT MAGNETIC TAPE.** In all the qualities which determine tape performance, Soundcraft offers distinct improvement over standards of the past. Superior both electrically and mechanically, Soundcraft tape is limited only by the characteristics of the equipment with which it is used.

**SOUNDCRAFT RECORDING DISCS.** Long a network standard, Soundcraft discs today approach perfection in the field of recorded sound. Whether you record at  $33\frac{1}{3}$  standard groove, 78, or  $33\frac{1}{3}$  LP—you may be certain that Soundcraft discs will enhance your recording quality, at the same time effecting considerable economy.

Only by actually using Soundcraft tape and discs can you learn, to your own satisfaction, how greatly they can improve your recordings. Write TODAY for the Soundcraft story. Mail coupon below for FREE booklet. Do it NOW!

### SOUNDCRAFT'S PROOF OF QUALITY LIES IN ITS PROOF OF PERFORMANCE

Dear Soundcraft:

Please send your recording media catalog.

Our favorite disc distributor is \_\_\_\_\_

Name \_\_\_\_\_

Address \_\_\_\_\_

REEVES — "20 YEARS WITH SOUND RECORDING MEDIA."

**REEVES Soundcraft CORP.**  
10 EAST 52nd STREET, NEW YORK 22, N. Y.

EXPORT—REEVES EQUIPMENT CORP. • 10 E. 52ND, N. Y. 22, N. Y.

of the old school and according to the blurbs released by her press agent is the "greatest singing discovery ever to be found inside the frame of the most alluring woman in the world."

It was therefore with trepidation that I tore off the cellophane covering of a 45-r.p.m. album called the "Voice of Xtabay." With trembling fingers I examined the "alluring" portrait of the Inca singer and read the blurb which featured such hot bits of prose as "child of the Andes peaks," "thrilling authenticity," "yet it is all one voice . . . one alluring young woman," etc. The fabulous one is singing Inca music and lyrics by Moises Vivanco, who is said to be a specialist in this sort of thing and is assisted by one Leslie Baxter who is responsible for conducting and arranging the background. If my memory serves me right, Baxter is responsible for some other rare gems, such as "Music out of the Moon," featuring The Theremin and various other oddities.

I have listened to all eight sides of this album and wish to make the following pronouncement. I am full of admiration for Capitol Records and their audacious enterprise in revealing to the world of ears these wondrous things. But again, they have taken something which is essentially good and crummed it up with some of the most vulgar arranging and trite special effect recording to be heard in a long time. Sumac is indeed marvelous. She does have an extraordinary range and can project dramatic quality beautifully. She has not been helped by ridiculous overorchestration of primitive music and simply bad orchestral effects. The striking quality of the music is lost under the heavy sway of the lushest of impressionistic orchestration techniques. Those who know authentic South American Indian music realize that it isn't helped by sophistication. The same recording date with a small native group behind the marvelous Yma would have been notable. Therefore . . . cheers to Capitol records for the enterprise, bravos to Miss Sumac for the voice and "allure," curses to Mr. Baxter for poor taste. In any case, you really have to buy the thing. In its present state, it is a novelty which had marvelous potentialities (Miss Sumac is a significant combination of Erna Sach and Sophie Tucker), which can be listened to with open mouth and dilated nostrils.

### LOUDNESS CONTROL

[from page 18]

be pointed out, however, that there is an insertion loss of 6 db which must be compensated for in low-gain systems if full output is required. Also, the unit is not satisfactory for operation in the plate circuits of high-impedance tubes since its input impedance is not constant at or near full volume settings. Impedance is fairly constant if the control is used up to approximately 75 per cent of its rotation.

The three-section control required is readily assembled with a standard IRC type Q Volume Control and two IRC Multisections. The Multisections are rear control sections so designed that they may be added to Type Q Controls or to other Multisections in the same manner as switches are attached. Simple



assembly instructions are included with each Multisection. A pictorial schematic of the assembled unit is shown in Fig. 3, while its over-all appearance is shown in Fig. 4.

#### Demonstration Unit

Those who wish to demonstrate the remarkable difference this new control can make in producing a pleasing, well-balanced sound output at low volume levels over the results of an ordinary,

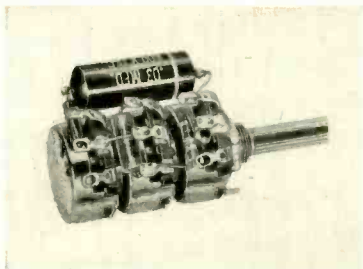

Fig. 4. External appearance of completed control.

uncompensated volume control may assemble a very effective demonstrator unit with the use of the new IRC Concentri-kit, an arrangement which permits the quick assembly of a wide variety of concentric controls. When used in conjunction with Multisections will provide a triple-single concentric control, shown in schematic form in Fig. 5.

The outer shaft of this demonstrator unit varies the panel section  $R_1$  which is

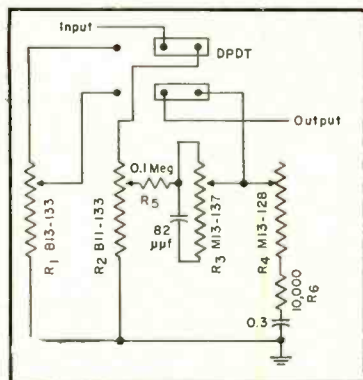

Fig. 5. Schematic of demonstrator unit used to show advantages of the new loudness control.

an ordinary uncompensated volume control. The inner shaft varies the three rear sections,  $R_2$ ,  $R_3$ , and  $R_4$ , which comprise the continuously variable loudness control. By means of a d.p.d.t. slide switch the output is adjusted for the same volume level through each control at 1000 cps and direct comparison may be quickly made at low level. Appearance

## SUPERIOR REPRODUCTION WITH

# Gray

RESEARCH

## TRANSCRIPTION ARMS

### NEW VISCOUS-DAMPED 108-B ARM



For all records—33 1/3, 45 and 78 r.p.m. Radically new

suspension development on the viscous damping principle for perfect tracking of records and elimination of tone arm resonances. Instant cartridge change with automatic correct stylus pressure. Solves all transcription problems. Ideal for LP records. For Pickering, new GE (short), old GE (long) cartridges. Write for bulletin. Price, less cartridges, \$56.00 (effective Sept. 1st). Cartridge slides for both GE and Pickering are furnished.

### MODEL 106-SP ARM



Designed to meet strictest

requirements of modern highly compliant pick-up cartridges. 3 cartridge slides furnished enable GE 1-mil, 2 1/2-mil or 3-mil cartridges or Pickering cartridge to be slipped into position in a jiffy. No tools or solder! Superb reproduction of 33 1/3, 45 or 78 r.p.m. records. Low vertical inertia, precisely adjustable stylus pressure. Write for bulletin. Price, less cartridges, \$45.15

## EQUALIZERS

### MODEL 603 EQUALIZER



Latest of the universally adopted Gray Equalizers used, with Gray Tone Arms, as standard professional equipment by broadcast stations. High-frequency characteristics obtainable comprise 5 steps — flat, high roll-off, NAB, good records, poor records. For both GE and Pickering cartridges. Price, \$60.70

### MODEL 602 EQUALIZER

Has 4 control positions, highly accurate response curves. Price, \$49.50

Write for bulletins on Gray Equalizers.

**GRAY RESEARCH** and Development Co., Inc.  
18 Arbor St., Hartford 1, Conn.

Division of The GRAY MANUFACTURING COMPANY  
Originators of the Gray Telephone Pay Station and the Gray Audograph

# SUCCESSFUL

## because they have the Right Disc Recorders

**THE LARGEST INDEPENDENT RECORDING STUDIO IN THE EAST SAYS:** "We've been using Fairchild Disc Recorders exclusively for many successful years. They stand the test of continuous operation with high quality output. That's the international reputation of the work we turn out—high quality!"

Mr. C. L. Stewart, Business Manager,  
Reeves Sound Studios

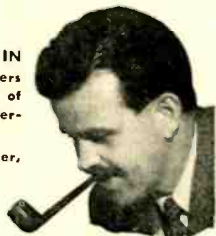

**MERCURY RECORDS SAYS:** "Reeves-Fairchild Thermo-Dynamic Margin Control represents an unbeatable combination... puts Mercury Records at the top in progressive recording techniques".

Mr. David Hall, Musical Director of Mercury Classics

With Fairchild's exclusive features, you too can be successful in the new markets for low noise LP, TV and Theatre film sound track recording. The FAIRCHILD STUDIO RECORDER with pitch-variable-while-recording is shown on the right. No lead screws or gears to change. Continuous pitch change from 80 to over 500 lines per inch simply by rotating the convenient knob. This is the famous MARGIN CONTROL which puts up to 25% more recording time in the same space—without reducing top recording levels. 70 db dynamic range on disc is now made possible with the Fairchild THERMO-STYLUS and MARGIN CONTROL—"an unbeatable combination".

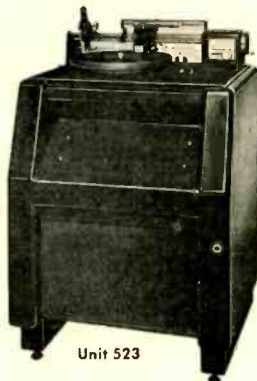

Unit 523

## Fairchild Synchronous Disc Recorders



**Accurate Program Timing**—Synchronous direct to the center gear drive for "shows on the nose".

**Freedom From Wow**—No slippage. No musical pitch change to make listeners aware the show is transcribed—extremely important at 33 $\frac{1}{3}$  rpm.

**Sound on Film Dubbing**—Many of the motion picture sound tracks you hear and enjoy are first recorded on Fairchild Synchronous Disc Recorders.

Microgroove and Standard Pitch recording can be done with any of the 3 Fairchild Disc Recorders: Unit 523 for the finest fixed installation, Unit 539-K for the small budget studio, Unit 539-G (shown above) for console performance in a portable case. Fairchild "sync-disc" recorders for standard and microgroove recording are made in 3 models, from \$715 (less cutter head and pickup).



154th ST. AND 7th AVE.

WHITESTONE, L. I., N. Y.

FR-119  
Write for  
Series DRS  
Literature  
Today  
It's Free

of the completed demonstrator unit is shown in Fig. 6.

Following are simple assembly instructions for both the continuously variable loudness control and the unique demonstrator unit.

Assemble to the "Q" control the two specified Multisections, in the order shown in Fig. 3, using instructions included with each. Assemble the additional parts and make all required connections as shown, solder, and cut shaft to required length. Install and wire into any high-gain audio amplifier.

To construct the demonstrator unit, assemble Concentrikit by following instructions included using B13-133 ( $R_1$ ) as panel unit and B11-133 ( $R_2$ ) as rear

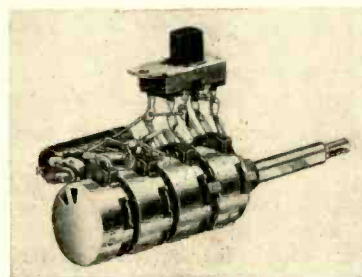

Fig. 6. External appearance of demonstrator unit.

unit. Omit cover on rear. Assemble M13-137 ( $R_3$ ) and M13-128 ( $R_4$ ) per instructions included with each Multisection. Attach this assembly in place of rear cover on the above Concentrikit being sure inner shaft rotates both sections  $R_3$  and  $R_4$ . Assemble the additional parts and make all required connections to the last three controls  $R_2$ ,  $R_3$ , and  $R_4$  in exactly the same manner as described previously for the loudness control. An additional connection is required between the most counter-clockwise terminal of the panel section and that of the second section to form a common ground.

Assemble d.p.d.t. switch as shown by photograph of completed control, Fig. 6, and make necessary connections as shown by schematic, Fig. 5. It is advisable to ground the metal case of switch, if that type is used, to reduce possibility of hum pickup during operation of switch.

(All wiring to and from control should be as short as possible and should be shielded to reduce hum pickup. Use low-capacitance wire to avoid loss of highs due to shielding. The complete assembly can be mounted in a small steel box to form a well shielded unit.)



## UNKNOWN IMPEDANCES IN TRANSFORMER

[from page 21]

must, of course, be found first in order to make the formula operative.

Impedance, being made up of resistance, can be determined by Ohm's Law applied to those circuits having impedance. The formula for Ohm's Law in a.c. circuits is:

$$Z = \frac{E}{I} \quad (2)$$

Where  $E$  = e.m.f., in volts

$I$  = current, in amperes

$Z$  = impedance, in ohms.

### Procedure

Adjust the output of the audio oscillator to about 25 volts on the meter. Apply this voltage to one winding of the transformer under test and at the same time measure the current drawn. (See Fig. 2.) Since reflected impedance from

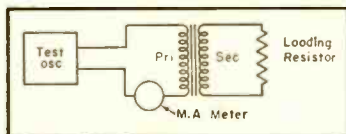

Fig. 2. Schematic of arrangement used for measuring voltage ratio between transformer windings preliminary to calculating impedance ratios.

secondary to primary under load will have an important bearing on the final result, the secondary of the transformer under test should carry a load. This can be a resistor, a speaker or a pair of headphones as an example. If a resistor is used it should be of the non-inductive carbon type to avoid reflected reactance. Once two known values are found, the impedance may be calculated from the above formula.

A more accurate method of making the measurements is to treat the primary of the transformer as a choke, leaving the secondary unloaded for the moment, and determine the inductance of the winding and find its reactance. This can be done by substitution as shown in Fig. 4.

Adjust  $R$  so that the voltage drop across  $R$  balances and equals the voltage drop across the primary. The voltage drop across the transformer primary is, of course, not due to inductance alone, but is caused by its impedance. Measure the d.c. resistance of that section of  $R$  in which the voltage drop occurs, then solve for the inductance of the primary with the formula:  $L = \frac{R}{2\pi f}$ . Once the in-

# Air-Tone HEADQUARTERS FOR MAGNecord.



**MAGNecord PT6-JA  
RECORDER &  
AMPLIFIER**

Portable rig for superb professional sound reproduction. Easy operating, exceptional high fidelity, the finest in Magnetic recording. 10 watts output.

Complete Systems from \$548

### MCINTOSH AMPLIFIERS

Highest quality, efficiency. Full dynamic range. Frequency range—20 to 20,000 plus or minus 0.2 db; 10 to 200,000 plus or minus 2 db. Lowest phase shift distortion; lowest noise level.

50W-2 for less than 1% distortion  
 • Continuous single freq. rating  
 • 50 watts RMS—Peak 100  
**\$249.50 net**

20W-2 for less than 1% distortion  
 • Continuous single freq. rating  
 • 20 watts RMS—Peak 40  
**\$149.50 net**



### ELECTRO-VOICE SPEAKER #SP 15

Frequency response 70-13000 c.p.s. ± 5db. Maximum instantaneous power input: 30 watts. Field excitation: 5¼ lb. Alnico V Orange Sreak Magnet. Radax crossover frequency: 3000 c.p.s. Base cone resonance: 38 c.p.s. High Frequency cone resonance: 250 c.p.s.

**\$57.00 net**

### ELECTRO-VOICE MICROPHONE #650

Response ± 2.5 db, 40-15,000 cps. Extremely high output level - 46 db. Impedance selector. External shock mount. Non-metallic Acoustalloy diaphragm. Individually laboratory calibrated.

**\$90 net**

*Electro-Voice Microphones used exclusively at Robin Hood Dell concerts.*

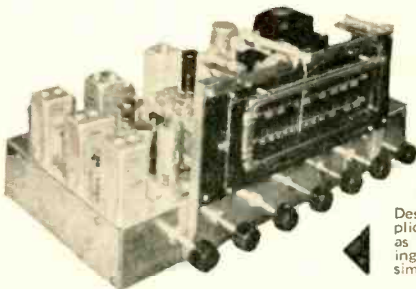

### BROWNING FM-AM TUNERS

Designed for high fidelity receiving applications in the broadcast band as well as the 88-108 MC. FM band. Incorporating Automatic Frequency control for simplified FM tuning.

**From \$87.75**

### PERMANENT DISPLAY

Equipment Shown at Audio Fair

Literature Available

# Air-Tone

## SOUND & RECORDING COMPANY

1527 CHESTNUT ST., PHILA. 2, PA. — RI. 6-8388





primary, but with  $R$  removed, voltage ratio measurements can be made on the secondary winding, as at A in Fig. 3, and its impedance determined by the formula (1). Succeeding measurements and calculations can be made on any number of multiple secondary windings.

#### Tapped Winding Calculations

Now suppose we have a transformer with a tapped winding in which the impedance of two sections is known, but the third unknown, as at B in Fig. 3. The impedance of the unknown section can be calculated from the formula:

$$Z_x = Z_a \left( \sqrt{\frac{Z_t}{Z_a}} - 1 \right) \quad (4)$$

Where  $Z_x$  = unknown impedance;  
 $Z_a$  = impedance of known section  
 and  
 $Z_t$  = total impedance of sections  
 $Z_x$  and  $Z_a$ .

In order to make our impedance calculations complete for a given transformer, it is not only necessary to know the impedance of individual windings and tapped sections, but also those tapped windings on the same core in combination. The commercially made variable impedance transformers have this information in chart form for easy reference. Such ready information makes the transformer more versatile for any given application and saves the builder much time and many a headache. We can index the impedance for our transformer in the same manner. The third and last formula makes this completeness possible.

Suppose we have a transformer in which we have a two-section tapped winding having impedances of 500 ohms and 10 ohms respectively, as shown at C in Fig. 3.

Substituting in the formula:

$$Z_x = 10 \left( \sqrt{\frac{500}{10}} - 1 \right) = 368 \text{ ohms.}$$

The impedance of any other tapped winding combinations can be calculated in the same manner.

Note also that in this formula it is not necessary to know the primary impedance. The calculations deal with only the knowns and unknowns of the secondary windings. The resultant values apply to tapped windings on the same core; this fact should be kept in mind when making calculations employing the last formula.

# HARVEY Presents the Newest Development In Tape Recording!

## NEW *Magnecorder* PT63-AH

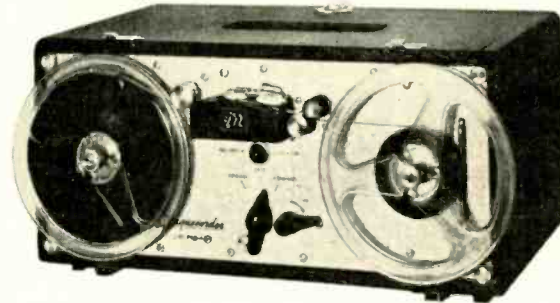

### 3 HEADS: Erase . . . Record . . . Playback

Designed To Monitor Directly From The Tape  
While You Are Recording!

Developed from the famous PT6, the new MAGNECORDER PT63 offers 3 separate heads — Erase, Record, Playback — for MONITORING FROM THE TAPE while recording. The addition of this feature assures finer results by eliminating most recording errors. All heads, contained in a single housing, are individually alignable and replaceable, and each one is triple shielded to eliminate cross-talk and hum. 7 1/2-inch and 15-inch tape speeds, easily interchangeable. (3 speeds . . . 3 3/4", 7 1/2" and 15" . . . are also available at slight additional cost). Attractive black grain leatherette over wood construction. **\$350.00** Net, with Case.

### PT63-J AMPLIFIER



A new single channel portable amplifier which contains a separate record and playback amplifier so that you can monitor from the tape while recording. In addition, 10 watts of audio is provided to drive both the 5-inch monitor speaker or an external loudspeaker. Response flat from 50-15kc at 15"/sec. The 19" x 7" control panel provides a switch to change equalization for either 7 1/2" or 15" tape speeds. Switching is also provided for record, playback or bias readings on the 3" VU meter. May be directly rack mounted when removed from case. **\$387.00** Net, with Case

VISIT THE  
AUDIO-  
TORIUM

Come in and visit our new sound department . . . all these items and many more on working display at all times.

Telephone:

LUxemburg 2-1500

**HARVEY**  
RADIO COMPANY INC.

103 West 43rd St., New York 18, N. Y.

NOTE: In view of the rapidly changing market conditions, all prices shown are subject to change without notice and are Net, F.O.B., N.Y.C.

# "Controlled Reluctance"

MICROPHONES PROVED\* TO BE THE  
FINE-QUALITY-**ECONOMICAL** ANSWER TO  
MANY MICROPHONE PROBLEMS



MODEL 510

The "HERCULES"—Here is a revolutionary new microphone unit that provides the ruggedness, the clear reproduction, and the high output long needed for Public Address, Communications, Recording at an amazingly low price!

List Price \$14.50



MODEL 520

The "GREEN BULLET"—Specially designed to provide quality music and speech reproduction at moderate cost. A streamlined unit that lends itself to fine-quality, low-cost installations where durability is an important factor. Features high output, good response, high impedance without the need of a transformer.

List Price \$17.50



MODEL 505C

The "RANGER"—Recommended for those applications where long lines are used and a rugged hand-held microphone is needed. Ideal for outdoor public address, mobile communications, hams, audience participation shows, etc. Designed for clear, crisp natural-voice response of high intelligibility. Has heavy-duty switch for push-to-talk operation.

List Price \$27.50



MODEL 520SL

List Price \$35.00

The "DISPATCHER"—Complete unit, includes Model 520 Microphone, A88A Grip-To-Talk Slide-To-Lock Switch, and S36A Desk Stand. Designed to handle the most severe field requirements of paging and dispatching systems. Ideal for police, railroad, taxicab, airport, bus, truck and all emergency communications work.

List Price \$9.00

**CONTROLLED RELUCTANCE CARTRIDGE**—Available for service installation. Ideal for replacement of crystal cartridges in Shure cases of Models 707A and 708 Series. Can also be used in most semi-directional microphones where space permits. Supplied with rubber mounting ring.

\*Specific information provided on request.

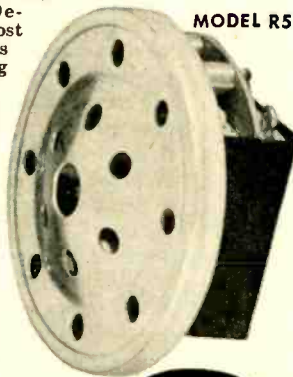

MODEL R5

**SHURE**

Patented by Shure Brothers, Inc.

**SHURE BROTHERS, Inc.**

Microphones and Acoustic Devices

225 West Huron Street, Chicago 10, Ill. • Cable Address: SHUREMICRO

## VECTOR SLIDE RULE

[from page 20]

$\theta = 0.9$  when  $\theta = 1.47$  approximately, and  $\tanh \theta$  becomes about 0.9951 when  $\theta = 3.0$ .

### Minimum-Loss Networks

An impedance-matching device is occasionally required which may nevertheless introduce a certain amount of loss into a system. In order to keep this loss at an absolute minimum, a transformer is often indicated to accomplish the impedance match.

Where some additional loss is permissible, a "minimum-loss" resistive attenuator can often be used. When its loss can be tolerated, the attenuator is often much less expensive than the transformer, and is smaller and lighter.

The minimum amount of loss which a "T" attenuator must be designed to introduce is determined by the ratio of the impedances which it is intended to match. The resulting actual design is an "L" pad, based upon the "T" pad circuit previously discussed. However, when the pad is designed for the minimum possible amount of loss for a given impedance ratio,  $R_2$  vanishes and only  $R_1$  and  $R_3$  remain to be calculated (see Fig. 6).

A procedure for the design of minimum-loss pads is based on the equation<sup>3</sup>:

$$\theta = \cosh^{-1} \sqrt{Z_1 Z_2}$$

In this formula,  $\theta$  is the loss of the attenuator in nepers (= loss in db divided by 8.686).  $Z_1/Z_2$  is the ratio of the impedances to be matched, so chosen that the ratio obtained is greater than unity.

The procedure is as follows:

1. Obtain the ratio  $Z_1/Z_2$  on scales A and B of the "vector" slide rule.

2. Record the reading on scale A of this impedance ratio, and subtract the number 1 from this result. Set the runner to this new value on scale A.

3. The runner now indicates on scale  $Sh1$  or  $Sh2$  the minimum loss  $\theta$  in nepers of the desired attenuator. If the ratio of the impedances is less than 2, then  $\theta$  will be less than about 0.882 and scale  $Sh1$  is used; for greater impedance ratios, refer to scale  $Sh2$ .

4. To determine this minimum loss in decibels, divide  $\theta$  by 8.686. Use scales C and D.

5. Calculate  $R_3$  and  $R_1$ . These resistances are found with the "vector" slide rule, as explained before. Steps 5, 6 and 7 are omitted, since  $R_2$  is not used in the special case of the minimum-loss pad.

Note that  $R_1$  is always located on the high-impedance side of the attenuator.

<sup>3</sup>From "Reference Data for Radio Engineers," Federal Telephone & Radio Corp., New York, 3d Edition, pp. 158-9, by permission.



The pad may match a high impedance to a lower impedance, or vice versa.

The range of the "vector" slide rule allows minimum-loss pads to be designed to match impedances having ratios as great as 100 to 1 (this ratio causing the minimum loss to be 26 db).

It is often difficult to find the correct values of resistances from stock for any certain attenuator. Resistance values can then be selected which can be connected in series or in parallel to give the required resistance values. It is found that the graphical solution illustrated in Fig. 7 speeds up the work considerably when parallel resistance combinations are needed.

The following rule applies to the use of Fig. 7:

*If a straight-edge be laid connecting points corresponding to two resistance values upon alternate scales, the intersection of the straight-edge with the intermediate scale indicates the equivalent resistance of a parallel combination of the first two resistances.*

Example: If resistors of 100 ohms and 90 ohms be connected in parallel, what is the resistance of the parallel combination?

Solution: The dotted line (A) in Fig. 7 connects 100 ohms and 90 ohms on alternate scales (1) and (3). The equivalent parallel resistance is read as 47.4 ohms on the intermediate scale (2). This process can be continued for more than two resistors in parallel. Suppose that a third resistor of 80 ohms be connected in parallel with those of the example. Dotted line (B) connects the resistance already in the circuit (47.4 ohms) with the added value of 80 ohms on scale (4), and the new equivalent resistance is found on scale (3) to be 30 ohms.

This chart, while simple, is found to be a great time-saver for general use in connection with audio systems.

## AUDIO PATENTS

[from page 2]

the pentode section is the mixer. The variable oscillator uses a separate triode.

Each of the oscillators is coupled to a grid of the mixer pentode by adding a pickup coil to the tuning inductor and connecting this to the pentode. Assuming that both oscillators are well shielded and the leads dressed, the main danger of pulling comes from capacitance between the triode and pentode plates within the combination tube; this is indicated by a dotted capacitor in the drawing, and is by no means negligible. The output of the pentode plate contains components of both oscillator frequencies, so that the variable oscillator frequency may be coupled to the fixed oscillator through the dotted capacitor, the lower part of *L*, and the bypass capacitor *C*, to ground. This creates a potential difference between the triode anode and grid.

To prevent pulling, *C*, is connected between the pentode plate and the upper end of *L*, which is connected to the grid through *C*. This forms a bridge, the arms of which are the two sections of the coil, the ca-

## Newest AMPEX

### HIGH FIDELITY MAGNETIC TAPE RECORDER Model 400

**T**ERMINAL brings you this new incomparable 15,000 cycle performance at 7½ inches per second that equals the performance of 15 IPS full-track recorders and gives 4 to 1 savings in tape cost.



**\$795<sup>00</sup>**  
NET

**2 FULL HOURS OF PROGRAM  
MATERIAL CAN BE COMBINED ON ONE 10" REEL**

**METER & OUTPUT SWITCH** — Position "B" (Level), connects meter "Line Output" plug, and "Phones" monitor plug to the output of the playback for monitoring of playback, while recording or playing back tapes. Position "A" connects "Line Output" plug, and "Phones" monitor plug to the record amplifier for direct monitor of the incoming program. Under position "A" there are three switch positions designated: LEVEL — which connects the meter to measure record volume level.

**BIAS**—which connects the meter to indicate proper record bias.

**ERASE**—which connects the meter to indicate proper erase current.

**SPEED CHANGE** — Toggle switch permits quick choice of 7½ or 15 i.p.s. tape drive speeds.

**RECORD BIAS ADJUSTMENT** — Biased for maximum output of 1000 cycle tone (factory adjusted).

**7½"-15" EQUALIZATION** — Adjusts electronics for proper operation at 7½ or 15 i.p.s.

**INPUT TRANSFER SWITCH** — Properly connects input plug for: I) 200 ohm microphones such as R.C.A. 44BX, KB-2C, etc. II) Balanced bridge for bridging telephone lines or balanced studio lines. III) Unbalanced bridge 100,000 ohm input for radio tuner, phono pre-amp, bridging public address equipment or unbalanced studio lines.

**FOUR-INCH "VU" METER** — Volume level meter used to indicate proper record volume level. This instrument can be switched for several functions as listed under "Meter & Output Switch."

**OUTPUT LINE TERMINATION SWITCH** — Places 600 ohm terminator across amplifier when same is not externally loaded (This is necessary for proper meter calibration).

**OPERATION SELECTOR** — Switch provides for normal forward or fast forward or fast rewind.

## CUSTOM SET-BUILDERS — AUDIO ENGINEERS

Terminal Radio can furnish promptly all components required for FAS amplifiers and speaker systems, in addition to turntables, pickups, and FM-AM chassis necessary to assure the superlative performance of which FAS installations are capable. If you haven't a copy of the Terminal Radio catalog on hand, write for one today!

## FREE... WRITE FOR YOUR PORTFOLIO OF 15 IDEAS FOR CUSTOM RADIO-PHONOGRAPH INSTALLATIONS.

This profusely illustrated booklet gives you actual photos of installations in typical room settings.

**New 1951 Terminal Sound Catalog now available  
Write for your free copy!**

# TERMINAL

RADIO CORPORATION

Distributors of Radio & Electronic Equipment

85 CORTLANDT ST., NEW YORK 7, N. Y. • WOrth 4-3311 • Cable: TERMRADIO

## PRECISION EL the GROMME



- Out-performs larger
- Response  $\pm 1$  DB 20 to
- Total distortion 1.5%
- Peak power 20 watts
- 10 DB feedback.

50 PG List \$73.50

Both models feature the circuits known to electronics bass and treble controls, h

## PRECISION

641-43 MILWAUKEE A

Rush  
Avoid Christmas  
and  
Mail Early

Postage  
Will be Paid  
by  
Addressee

No  
Postage Stamp  
Necessary  
If Mailed in the  
United States

### BUSINESS REPLY ENVELOPE

First Class Permit No. 41987, Sec. 34.9, P. L. & R., New York, N. Y.

## AUDIO ENGINEERING

342 MADISON AVENUE

NEW YORK 17, N. Y.



## look to ALLIED for your high-fidelity custom sound components

WORLD'S LARGEST STOCKS  
OF ALL FAMOUS MAKES

### ON HAND FOR IMMEDIATE DELIVERY

Altec-Lansing • Audio  
Development • Bell • Bogen  
Brook • Browning • Collins  
Clarkston • Electro-Voice  
General Electric • Jensen  
Jim Lansing • Knight  
Livingston • Magnecord  
Markel • Masco • Meissner  
McIntosh • National  
Pickering • Presto  
RCA • Rek-D-Kut  
Radio Craftsmen • Scott  
Stephens • Thordarson  
University • V-M Corp.  
Webster-Chicago  
Western Electric

IF IT'S HI-FI...  
**ALLIED HAS IT!**

Just name your need in high-fidelity audio components—ALLIED will deliver *immediately* from the country's largest in-stock supplies. Make your selections of tuners, amplifiers, speakers, baffles, cabinets, record changers, transcription and phono equipment, wire and tape recorders, pre-amps—all the equipment you want, with the exact specifications required—at the price you want to pay. For *everything* in hi-fidelity sound, depend on ALLIED.



### FREE 1951 CATALOG

Write today for our complete Buying Guide. (Custom Installers... ask to be put on our special mailing list.) WE STOCK EVERYTHING—FOR IMMEDIATE SHIPMENT—ANYTIME—ANYWHERE.

## ALLIED RADIO

833 W. Jackson Blvd., Dept. 17-M-0  
CHICAGO 7, ILLINOIS



### British Hearing Aid

The design of hearing aids in Great Britain is as controversial as elsewhere, and in *Wireless World* for August 1950 A. Poliakov describes some of the factors affecting one particular British model.

Listed as the attributes of a good aid in order of importance are optimum volume, avoidance of pronounced peaks, low case noise, and a "nice looking response curve." The optimum volume is a point which the author has studied over a period of years and concludes is within the range 75 to 98 db above reference. In addition, compression is added so that no bad transients will affect patients with recruitment, and also that the optimum level may not be exceeded. For low level signals, a.v.c. action is used. The use of baked lacquer on the smooth metal case minimizes case noise. Hinges are eliminated by a sliding case lock on the inside. The frequency response is varied by use of different earpieces, and not by changing amplifier response. Finally, the cost of aids is discussed in relation to radio receiver prices.

### Transistor Noise

The application of transistors to the solution of various audio problems has been limited, to date, by their high noise level. H. C. Montgomery discusses this problem in the September 1950 *Bell Laboratories Record*. Transistor noise level is a function



of the biases on the emitter and the collector electrodes, but its spectrum shape is constant. The octave noise level is constant throughout the spectrum which means that the noise power in the 50-100 cps octave is the same as that in the 20 to 40 kc octave. The noise therefore has a predominantly large low-frequency character. For an average Type A (Bell Telephone Laboratories) Transistor in a single-stage amplifier, the noise is 80 db below undistorted output in the 100-3,000 cps band and 75 db down for the 10-cps to 1-mc band.

#### Conference Telephone

An advanced design conference telephone system is described in the *Ericsson Review*, No. 1, 1950 by G. Thames. The new system known as the Ericsson DYA permits conference calls to be carried by microphones and loud speakers in addition to the telephone handset. The entire system is compatible with PBX or public telephone exchange systems and may be used without disrupting regular telephone service. In the DYA system any extension telephone may be designated as *master station* for the conference system. At a master station, it is always possible to maintain secrecy, since the main station has control over who is connected to the conference. The lines connected to the conference are always indicated by lighted bulbs with numbered lenses. Also PBX (local internal) calls may be interrupted and the conference line used with the PBX line held until the end of the conference call, at which time the PBX call may be picked up from the held position.

The remainder of the article discusses the detailed operation and installation of such a system and describes the components.

### AUDIO DESIGN NOTES

[from page 22]

amount of power radiated by the port is approximately proportional to the area. In practice, this means that for a given resonant frequency the larger the enclosure the larger will be the port and the more effective the resonator. Usually, one does not use a port area less than half, nor more than twice the cone area.

The importance of sturdy construction of the cabinet can not be overemphasized. Motion of the walls absorb energy which would otherwise have been radiated from the port. It is good practice to stiffen the back and front of the cabinet with 2 x 4's. The force produced by the voice coil might be as high as 5 lbs. at the resonant frequency and the enclosure must be able to stand this force without rattling.

In order to eliminate radiation from the port at higher frequencies the interior of the enclosure is usually lined with some absorbing material such as Celotex. The material used should have high absorption at the higher frequencies (500 cps up for example) but negligible absorption at the resonant frequency. The objection to simultaneous radiation from the port and cone is that destructive interference occurs at certain frequencies causing large dips in the response curve. This difficulty does not occur at the resonant frequency because here the radiation from the cone is negligible compared to the radiation from the port.



## THE FIRST CHOICE OF RADIO ENGINEERS

More radio engineers use Magnecorders than all other professional tape recorders combined. Here's why:

#### HIGH FIDELITY, LOW COST

Stations are enthusiastic about the life-like tone quality and low distortion of Magnecordings. Magnecorder frequency response: 50 - 15kc ± 2 db. Signal-noise ratio: 50 db. Harmonic distortion less than 2%. Meets N.A.B. standards. No other recorder offers such fidelity at such a moderate price.

#### GREATEST FLEXIBILITY

Mount a Magnecorder in a rack or console cabinet for delayed studio and network shows. Slip it into its really portable cases for remotes. Add to your Magnecord equipment as you need it—combine Magnecorders to suit every purpose.

#### MORE FEATURES

Your Magnecorder, new or old, can now have 3 heads (separate erase, record, and playback) to permit monitoring from tape. Three speeds (15" - 7 1/2" - 3 3/4" —up to an hour on a 7" reel) available on both PT6 and PT63 equipment. Dual track heads also available if desired.

#### Write for NEW CATALOG

MAGNECORDER, INC., Dept. A-12  
360 North Michigan Avenue, Chicago 1, Ill.  
Send me latest catalog of Magnecord Equipment.

Name.....  
Company.....  
Address.....  
City.....Zone..... State.....

### MAGNECORDER

For every purpose . . .  
every purse!



**PT6 SERIES**  
Most widely used professional tape recorder in the world.



**PT63 SERIES**  
Three heads to erase, record, and monitor from the tape.



**PT7 SERIES**  
A complete console for only \$950.00. Outstanding features and flexibility. Models for portable or rack mount also available.

# NEW PRODUCTS

● **Audio Generator.** Designed essentially for supplying the two-tone test signals necessary for intermodulation measurement, General Radio's new Type 1303-A audio generator is equally well suited for use as a general purpose beat-frequency oscillator. It may be used to generate a single low-distortion signal adjustable in frequency from 20 cps to 40 kc; two signals, each separately adjustable, one to 20 kc and the other to 10



kc; or two signals with a fixed difference in frequency maintained between the two as the frequency of one signal is varied. The fixed difference frequency is adjustable up to 10 kc, and the lower of the two frequencies is adjustable up to 20 kc. Output of the generator is continuously adjustable up to 10 milliwatts into 600 ohms with less than 0.25 per cent distortion. Calibration is in both volts and db. Descriptive material may be obtained by writing General Radio Company, 275 Massachusetts Ave., Cambridge 39, Mass.

● **High-Quality Speaker.** Both high-quality reproduction and moderate purchase price are features of the Model 515S2 speaker recently introduced by RCA. Useful response range is 40 to 12,000 cps and power handling capacity is 25 watts. The vibrating system of the 515S2 consists of two voice coils and cones excited by a single 2-lb. Alnico

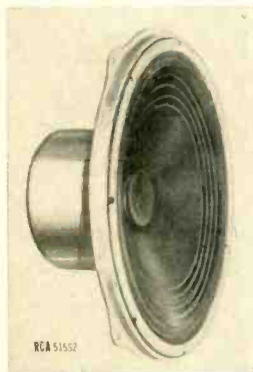

V magnet. The woofer and tweeter are so mounted that the larger cone is effectively a continuation of the smaller, and as a result the two cones vibrate as a

single unit in the crossover-frequency range. Thus is avoided the distortion which frequently is present when woofer and tweeter are operated in different planes. Technical description may be obtained from Tube Department, Radio Corporation of America, Harrison, N. J.

● **Cable Tacker.** Of particular interest to installers of sound equipment and juke boxes is the Phillips cable tacker, a one-hand-operated tool which handles all sizes of cable up to 1/2 in. OD. Concave center guides instantly center both large



and small cables which are anchored without damage to insulation. Full description may be obtained from Phillips Manufacturing Company, Minneapolis, Minn.

● **Miniature Attenuator.** Following today's trend toward miniaturization of electronic components, the new Daven Series 730 T-network attenuator offers 30 steps of attenuation in a unit only 2 1/4 in. in diameter. Available in steps of



0.5, 1.0, 1.5 or 2.0 db, the unit has a flat frequency characteristic to 30 kc. Resistance accuracy is  $\pm 5$  per cent. Zero insertion loss and constant input and output impedance are also characteristic of the new attenuator. Further information may be obtained by writing The Daven Company, 191 Central Ave., Newark 4, N. J.

● **Audio Oscillator.** Exceptionally compact in size, the new Model 510-A oscillator has a frequency range of 18 cps to 210 kc in four decades, and has output constant within 0.5 db over the entire frequency range. Power output is 10



volts into 10,000 ohms with distortion less than 0.3 per cent from 100 cps to 15,000 cps, and rising no more than 0.5 per cent at 30 cps. Total frequency error due to drift and calibration is less than two per cent. Output control is logarithmic and is calibrated in output voltage. Dimensions are  $4 \times 5 \frac{1}{2} \times 4$  in. Full technical description may be obtained from the manufacturer, The Electronic Workshop, 351 Bleeker St., New York 14, N. Y.

● **Dynamic Microphone.** Full vision for both performer and audience is afforded by the new American type D-33 micro-



phone. Weighing only seven ounces, the D-33 does not require a pre-amplifier, and is distinctively finished in gold and black. Pickup pattern is omnidirectional. Available in all popular impedances. Descriptive material is available from American Microphone Company, 370 S. Fair Oaks Ave., Pasadena 1, Calif.

● **VTVM Kit.** The new Knight VTVM kit brings precision measurements within the reach of even the most modest purse. An excellent all-around test instrument for servicemen, amateurs, experimenters and laboratories, the instrument offers four milliamperage ranges and six capacitance ranges in addition to the standard twenty VTVM ranges. Matched-pair resistors are used for accuracy of measure-



# PRECISION ELECTRONICS PRESENTS the GROMME CUSTOM AMPLIFIERS

Designed by Sound Engineers  
for CRITICAL MUSIC LOVERS



- For those who want the best
  - Response 10 to 100,000 CPS ( $\pm 0.1$  DB 10 to 50,000 CPS).
  - Passes square waves 20 to 10,000 CPS
  - Total distortion 0.2% or less at 20 watts.
  - Peak power 50 watts.
  - 25 DB feedback; Damping factor-11.
- 200 PG List \$225.00

- Out-performs larger amplifiers.
  - Response  $\pm 1$  DB 20 to 20,000 CPS.
  - Total distortion 1.5% or less at 10 watts.
  - Peak power 20 watts.
  - 10 DB feedback.
- 50 PG List \$73.50

Now! Available  
with Pfanstiehl  
pre amps.....



Both models feature the most advanced circuits known to electronics; 4 inputs, feedback pickup pre-amp, calibrated bass and treble controls, hum inaudible. Free technical bulletin.

## PRECISION ELECTRONICS, INC.

641-43 MILWAUKEE AVENUE

CHICAGO 22, ILLINOIS

capacitor  $C_2$ , and the dotted capacitance. When the bridge is balanced by correct adjustment of  $C_2$ , feedback from pentode plate to triode plate in balanced out, and the obtainable audio frequency is much lower than before. As an illustration, if  $L$  happens to be centertapped,  $C_2$  and the dotted capacitance should be equal.

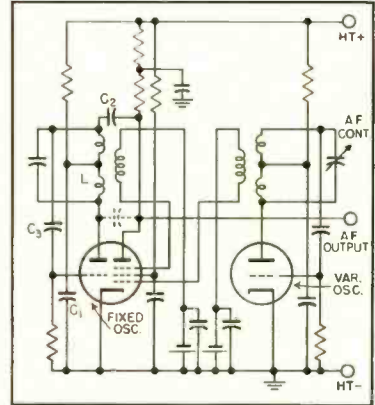

Fig. 2

## TECHNICANA

[from page 8]

all the requirements of that country's broadcasting service.

Some of the ideas presented here offer a fresh approach to the problem for U. S. and European readers, and although frequent reference to American sources is made, their use is not without understanding.

### British Hearing Aid

The design of hearing aids in Great Britain is as controversial as elsewhere, and in *Wireless World* for August 1950 A. Poliakov describes some of the factors affecting one particular British model.

Listed as the attributes of a good aid in order of importance are optimum volume, avoidance of pronounced peaks, low case noise, and a "nice looking response curve." The optimum volume is a point which the author has studied over a period of years and concludes is within the range 75 to 98 db above reference. In addition, compression is added so that no bad transients will affect patients with recruitment, and also that the optimum level may not be exceeded. For low level signals, a.v.c. action is used. The use of baked lacquer on the smooth metal case minimizes case noise. Hinges are eliminated by a sliding case lock on the inside. The frequency response is varied by use of different earpieces, and not by changing amplifier response. Finally, the cost of aids is discussed in relation to radio receiver prices.

### Transistor Noise

The application of transistors to the solution of various audio problems has been limited, to date, by their high noise level. H. C. Montgomery discusses this problem in the September 1950 *Bell Laboratories Record*. Transistor noise level is a function

## look to ALLIED for your high-fidelity custom sound components

WORLD'S LARGEST STOCKS  
OF ALL FAMOUS MAKES

ON HAND  
FOR IMMEDIATE  
DELIVERY

Altec-Lansing • Audio Development • Bell • Bogen  
Brook • Browning • Collins  
Clarkstan • Electro-Voice  
General Electric • Jensen  
Jim Lansing • Knight  
Livingston • Magnecord  
Markel • Masco • Meissner  
McIntosh • National  
Pickering • Presto  
RCA • Rex-O-Kut  
Radio Craftsmen • Scott  
Stephens • Thordarson  
University • V-M Corp.  
Webster-Chicago  
Western Electric

IF IT'S HI-FI...  
ALLIED HAS IT!

Just name your need in high-fidelity audio components—ALLIED will deliver immediately from the country's largest in-stock supplies. Make your selections of tuners, amplifiers, speakers, baffles, cabinets, record changers, transcription and phono equipment, wire and tape recorders, pre-amps—all the equipment you want, with the exact specifications required—at the price you want to pay. For everything in hi-fidelity sound, depend on ALLIED.



### FREE 1951 CATALOG

Write today for our complete Buying Guide. (Custom Installers... ask to be put on our special mailing list.) WE STOCK EVERYTHING—FOR IMMEDIATE SHIPMENT—ANYTIME—ANYWHERE.

### ALLIED RADIO

833 W. Jackson Blvd., Dept. 17-M-0  
CHICAGO 7, ILLINOIS



The pad may match a high impedance to a lower impedance, or vice versa.

The range of the "vector" slide rule allows minimum-loss pads to be designed to match impedances having ratios as great as 100 to 1 (this ratio causing the minimum loss to be 26 db).

It is often difficult to find the correct values of resistances from stock for any certain attenuator. Resistance values can then be selected which can be connected in series or in parallel to give the required resistance values. It is found that the graphical solution illustrated in Fig. 7 speeds up the work considerably when parallel resistance combinations are needed.

The following rule applies to the use of Fig. 7:

*If a straight-edge be laid connecting points corresponding to two resistance values upon alternate scales, the intersection of the straight-edge with the intermediate scale indicates the equivalent resistance of a parallel combination of the first two resistances.*

Example: If resistors of 100 ohms and 90 ohms be connected in parallel, what is the resistance of the parallel combination?

Solution: The dotted line (A) in Fig. 7 connects 100 ohms and 90 ohms on alternate scales (1) and (3). The equivalent parallel resistance is read as 47.4 ohms on the intermediate scale (2). This process can be continued for more than two resistors in parallel. Suppose that a third resistor of 80 ohms be connected in parallel with those of the example. Dotted line (B) connects the resistance already in the circuit (47.4 ohms) with the added value of 80 ohms on scale (4), and the new equivalent resistance is found on scale (3) to be 30 ohms.

This chart, while simple, is found to be a great time-saver for general use in connection with audio systems.

## AUDIO PATENTS

[from page 2]

the pentode section is the mixer. The variable oscillator uses a separate triode.

Each of the oscillators is coupled to a grid of the mixer pentode by adding a pickup coil to the tuning inductor and connecting this to the pentode. Assuming that both oscillators are well shielded and the leads dressed, the main danger of pulling comes from capacitance between the triode and pentode plates within the combination tube; this is indicated by a dotted capacitor in the drawing, and is by no means negligible. The output of the pentode plate contains components of both oscillator frequencies, so that the variable oscillator frequency may be coupled to the fixed oscillator through the dotted capacitor, the lower part of L, and the bypass capacitor C<sub>1</sub> to ground. This creates a potential difference between the triode anode and grid.

To prevent pulling, C<sub>1</sub> is connected between the pentode plate and the upper end of L, which is connected to the grid through C<sub>2</sub>. This forms a bridge, the arms of which are the two sections of the coil, the ca-

# Newest AMPEX

## HIGH FIDELITY MAGNETIC TAPE RECORDER Model 400

**T**ERMINAL brings you this new incomparable 15,000 cycle performance at 7½ inches per second that equals the performance of 15 IPS full-track recorders and gives 4 to 1 savings in tape cost.



**\$795<sup>00</sup>**  
NET

**2 FULL HOURS OF PROGRAM  
MATERIAL CAN BE COMBINED ON ONE 10" REEL**

**METER & OUTPUT SWITCH** — Position "B" (Level), connects meter "Line Output" plug, and "Phones" monitor plug to the output of the playback for monitoring of playback, while recording or playing back tapes. Position "A" connects "Line Output" plug, and "Phones" monitor plug to the record amplifier for direct monitor of the incoming program. Under position "A" there are three switch positions designated: LEVEL — which connects the meter to measure record volume level.  
**BIAS**—which connects the meter to indicate proper record bias.  
**ERASE**—which connects the meter to indicate proper erase current.  
**SPEED CHANGE** — Toggle switch permits quick choice of 7½ or 15 i.p.s. tape drive speeds.  
**RECORD BIAS ADJUSTMENT** — Biased for maximum output of 1000 cycle tone (factory adjusted).

**7½"-15" EQUALIZATION** — Adjusts electronics for proper operation at 7½ or 15 i.p.s. **INPUT TRANSFER SWITCH** — Properly connects input plug for: I) 200 ohm microphones such as R.C.A. 44BX, KB-2C, etc. II) Balanced bridge for bridging telephone lines or balanced studio lines. III) Unbalanced bridge 100,000 ohm input for radio tuner, phono pre-amp, bridging public address equipment or unbalanced studio lines.

**FOUR-INCH "VU" METER** — Volume level meter used to indicate proper record volume level. This instrument can be switched for several functions as listed under "Meter & Output Switch."

**OUTPUT LINE TERMINATION SWITCH** — Places 600 ohm terminator across amplifier when same is not externally loaded (This is necessary for proper meter calibration).

**OPERATION SELECTOR** — Switch provides for normal forward or fast forward or fast rewind.

## CUSTOM SET-BUILDERS — AUDIO ENGINEERS

Terminal Radio can furnish promptly all components required for FAS amplifiers and speaker systems, in addition to turntables, pickups, and FM-AM chassis necessary to assure the superlative performance of which FAS installations are capable. If you haven't a copy of the Terminal Radio catalog on hand, write for one today!

**FREE... WRITE FOR YOUR PORTFOLIO OF 15 IDEAS  
FOR CUSTOM RADIO-PHONOGRAPH INSTALLATIONS.**

This profusely illustrated booklet gives you actual photos of installations in typical room settings.

**New 1951 Terminal Sound Catalog now available  
Write for your free copy!**

# TERMINAL

RADIO CORPORATION

Distributors of Radio & Electronic Equipment  
85 CORTLANDT ST., NEW YORK 7, N. Y. • WOrth 4-3311 • Cable: TERMRADIO



ment. Zero-center d.c. dial is included for FM discriminator alignment. Uses 1/4-in. meter. Complete information may be obtained from Allied Radio Corporation, 833 W. Jackson Blvd., Chicago 7, Ill.

● **Record Player-P.A. System.** Portable and self-contained within a single carrying case, the Rauland-Borg Model 1254 record player-p.a. system features a 15-watt amplifier with mixing controls to permit use of phono background with live program material. Three-speed changer is equipped with a dual-type crystal cartridge and is designed to play all types of commercial recordings up to 12 in. Heavy-duty 12-in. speaker is supplied with 35-ft. cable and plug. Weighing only 40 pounds, the entire system is

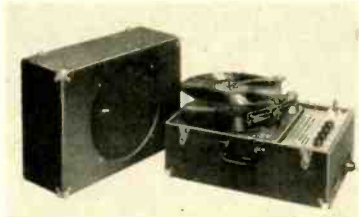

housed in a dark green leatherette carrying case. Full description may be obtained by writing Rauland-Borg Corporation, 3523 Addison St., Chicago 18, Ill.

● **Tiny Precision Potentiometer.** No larger in diameter than a copper cent is the new Model AJ Helipot potentiometer, well suited for both commercial and military applications where space and weight must be considered. Model AJ is a ten-turn unit with an 18-in. resistance ele-

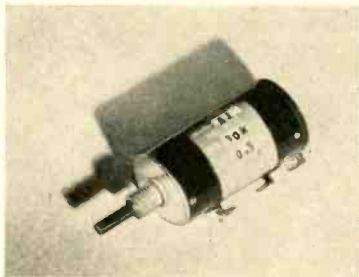

ment, and is available from stock in eight resistance values ranging from 100 to 50,000 ohms. Power rating is two watts and weight is less than one ounce. Further details may be obtained by writing for Bulletin 108 to Helipot Corporation, South Pasadena, Calif.

● **35-MM Magnetic Recorder-Reproducer.** Performance standards of the Motion Picture Research Council are surpassed in the new RCA magnetic recording system designed for high-quality professional magnetic recording in film production. The new system is aimed at reducing film and processing costs, and providing greater flexibility in meeting acoustical conditions. In addition to the magnetic record-reproduce unit, the system includes a mixer amplifier, recording amplifier, a bias oscillator for recording, and an oscillator-preamplifier and equalizer for playback. Also included is a self-contained high-and-low voltage power supply. Both 16-mm and 35-mm systems are available, either in portable carrying

cases for location work, or as rack-mounted equipment for studio installation. Frequency range of the system is 30-10,000 cps  $\pm$  one db, flutter is only .04 per cent rms total, and signal-to-noise ratio is 57 db.

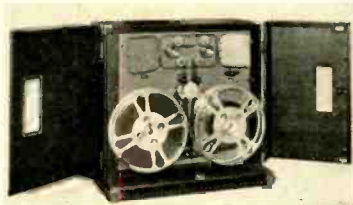

● **Intermodulation Meter.** Compact and completely self-contained, the new Model 31 intermodulation meter recently introduced by Measurements Corporation, Boonton, N. J., may be used as a labora-



tory standard in evaluating the performance of audio systems. The meter is direct-reading in percentage of intermodulation and input volts. Among the uses for which it is well suited are the correct adjustment and maintenance of broadcast transmitters, checking linearity of film and disc recordings, adjustment of bias in tape recording, and for quality control of audio components and equipment. Model 31 is 8 in. high  $\times$  19 in. wide  $\times$  9 in. deep.



### Brings You Record Fidelity You Never Believed Possible!

"An exciting discovery," writes Edward Tatnall Canby, noted authority on sound reproduction, in *The Saturday Review of Literature*...

Like a baton in the hands of a symphony conductor, this remarkable new General Electric stylus brings you the full tonal quality of recorded music as you've never heard it before! Its feather-light tip tracks the record groove with a compliance delicate enough to pick up frequencies through 10,000 cycles per second!

Ask your dealer for a demonstration today!

*Some Highs and Lows*  
Perhaps the most exciting discovery this column has made concerns the familiar G-E reluctance magnetic cartridge G.E., it seems, has issued as many as three types of styli already in its continuing efforts to meet the vital tracking problems. The latest type... is astonishingly better...  
If you have the earlier type of G-E needle in your cartridge by all means acquire the newest one... Congratulations to G.E. for progress in a difficult area.  
—EDWARD TATNALL CANBY

#### HOW COMPLIANT CAN A NEEDLE BE?



SINGLE-TWIST STYLUS

The single-twist arm and single damping block of this stylus were designed for a tracking pressure of 21 grams. It was recognized, however, that lighter pressure would lengthen both record life and stylus life.

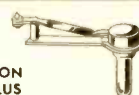

BATON STYLUS

Reproduces each tone value with amazing clarity. Tracks at 6 grams—thus providing the maximum degree of compliance that may be used successfully with commercially available tone arms.

SEND FOR  
BATON STYLUS  
FOLDER—IT'S FREE!  
Write: General  
Electric Company,  
Section 44120,  
Electronics Park,  
Syracuse, New York



You can put your confidence in—  
**GENERAL ELECTRIC**

● **Reluctance Cartridge Adapter.** For many users of Western Electric 9A Reproducing Equipment, an adapter head which accommodates a standard variable reluctance cartridge will be of interest because it permits the playing of micro-groove records through the regular switch and filter with a minimum of expense for conversion. When the adapter is in use, the impedance of the filter is matched to the reluctance cartridge, and the usual high-fidelity response is assured, together with high output signal. For vertical and lateral transcriptions the regular 9A arm is plugged back into the arm, giving complete flexibility of playing equipment. Further information is available from the manufacturer, Broadcast Service Co., Arcade Bldg., St. Louis 1, Mo.

● **Tape Recorder.** Although moderately priced, the new Sonar Model T-10 tape recorder is claimed by the manufacturer



to meet performance standards fitting it for many types of professional application. Amplifier response is 20 to 20,000 cps  $\pm$  1 db, and tape response is 35 to 12,000 cps at 7.5 in. per second, according to the manufacturer. Double-track automatic-reverse recording mechanism permits one hour of uninterrupted recording or playback. Literature may be obtained free of charge from Sonar Radio Corporation, 59 Myrtle Avenue, Brooklyn 1, N. Y.

● **Motors for Radio Use.** For many applications in radio, small motors with a wide range of speeds are occasionally required. The new Barcol YAZ motor is reversible, and is equipped with a geared head; it has high starting torque, and electrodynamic braking for rapid stopping. The motor itself is the shaded-pole type, producing no interference in radio

## MODEL RJ-20A



### MODEL RJ-20A FM-AM TUNER

- Armstrong FM circuit: 20 db quieting with 6½ microvolts
- Separate r.f. and i.f. on both bands
- AFC on FM with ON/OFF switch
- AM bandwidth selection, 9 kc. and 4 kc.
- Drift-compensated
- FM audio 15-15,000 cycles  $\pm$  1½ db.
- 20 db treble and bass boost
- self-contained power supply.

### MODEL RJ-12B FM-AM TUNER

- Armstrong FM circuit: 20 db quieting with less than 10 microvolts
- Separate r.f. and i.f. on both bands
- AFC on FM with ON/OFF switch
- Drift-compensated
- FM audio 15-15,000 cycles  $\pm$  1½ db
- AM audio 20-6600 cycles  $\pm$  3 db
- Triple-tuned i.f.

## MODEL RV-10A

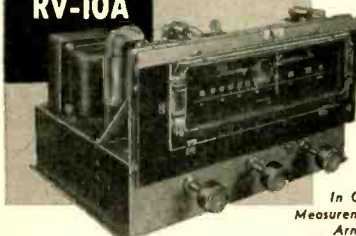

### MODEL RV-10A FM TUNER

- Armstrong FM circuit: less than 10 microvolts for complete limiting
- AFC with ON/OFF switch
- 2-stage cascade limiter
- Tuned r.f. stage
- Drift-compensated
- High impedance output.

Learn the full specifications for Browning high-fidelity — write for complete performance curves and data on these models.

In Canada, address:  
Measurements Engineering Ltd.  
Auriprior, Ontario.



ENGINEERED  
FOR  
ENGINEERS

**BROWNING**  
Laboratories, Inc.  
Winchester, Mass.

## leading audio engineers choose BROWNING FM-AM TUNERS for discriminating listeners

For custom installations, audio engineers know they must please the most severe judge of high-fidelity — the serious music listener. These engineers know, too, that only the best engineering resources can produce such gratifying performance.

... And that is why leading audio engineers choose from these BROWNING models for their exacting custom installations.

## MODEL RJ-12B

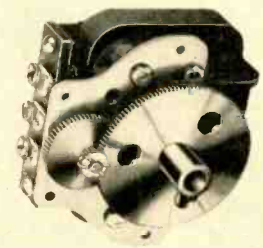
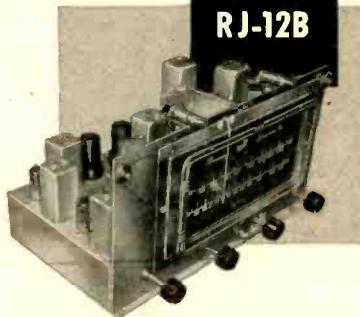

receivers, and a balanced rotor minimizes vibration. In the open type, as shown, these units are available with speed reductions from 20:1 to 360:1. Closed types can be supplied with speed reductions ranging from 7.2:1 to 1,333,800:1. For full information on this line of motors, write Barber-Colman Co., Rockford, Ill.

● **Grommes Custom Amplifiers.** A new line of amplifiers designed for incorporation into home music systems as well as for high-quality public address installations has just been announced by Precision Electronics, Inc., 641 Milwaukee Ave., Chicago 22, Ill. Available in two chassis types for three models, these amplifiers are equipped with four input channels and



means for convenient switching from magnetic pickup, crystal pickup, microphone, or radio tuner. Model 200 PG has a separate remote control unit which may be operated from the main amplifier chassis, which has a power output of 20 watts with less than 0.5 per cent distortion or 10 watts at 0.1 per cent distortion. Models



50 and 51 are single-unit models rated at 10 watts with less than 2 per cent distortion. Complete specifications may be obtained by writing the manufacturer.

● **Magnetic Reproducer.** Availability of the Type L-6 Polyphase pickup with special connector for plugging into the Webster changer tone arm is a recent announcement of The Audak Company,



500 Fifth Ave., New York 18, N. Y. Once plugged in the reproducer becomes a permanent part of the arm assembly and requires no further adjustment except for stylus replacement.

## THE AUDIO FAIR REVIEW

[from page 32]

tions and recording studios. The machine employs a continuous loop of magnetic tape with suitable amplifiers and control circuits so as to add any desired amount of reverberation with a controllable decay time. Also shown was a complete line of attenuators, both of the conventional type and the newer lever type, believed by many engineers to be more convenient in use.

Terminal Radio Corporation exhibited only a small number of the many lines they represent in New York, but featured in their display was the Ampex line of magnetic recorders. Both the 300 in portable cases and the newer model 400 were shown, with performance of the high quality to be expected from the Ampex machines.

The Tetrad Corporation brought a valuable collection of diamonds to the Fair and displayed them in a glass case under the protection of a uniformed patrolman from the city police force. These diamonds were industrials which will be processed into styli for use in pickups, and the total value of the collection was claimed to be \$102,000. Also on display were a number of charts showing the faulty tracking resulting from worn styli, together with a number of photos showing the stylus wear resulting from the use on a relatively small number of plays, using both diamonds and sapphires.

Transit Sound Systems Co. Inc. exhibited a new machine which uses a 1 3/4-in. tape which plays back and forth on twelve parallel tracks, permitting the playing of a continuous program from 10 to 20 hours long. The machine uses multiple heads, making it possible to play any of six different tracks as selected, on a single channel, or to have six different programs playing on a number of channels, thus giving the listeners a choice of programs. Operation is as simple as a home radio, with a single switch to turn the machine on or off; after running the tape through in one direction, it re-

# 9205 DEGAUSSER

Demagnetizes magnetic tape and film to erase recording and residuals. Accommodates 5400 foot reels of 1/4" tape; 1000 foot. 35mm. Write for details.



Net Price ..... \$59.50



**CINEMA ENGINEERING COMPANY**  
1510 WEST VERDUGO AVENUE, BURBANK, CALIFORNIA

Export Agents: Frazer & Manson, Ltd. • 301 Clay Street • San Francisco, Calif., U. S. A.



*Tops in Quality, Value and Dependability!*

**HUDSON**  
RADIO & TELEVISION CORP.

Our Giant Store and Warehouse features Every Modern Shopping Convenience, including a Complete Line of RCA Tubes, Test Equipment, Batteries, Radio and TV Replacement Parts, etc. Visit our Elaborate Sound Studio and New York's First "Radio Super-Market"—Serve Yourself and Save on Thousands of Standard and Surplus Items! Mail Orders Shipped to All Parts of the World—Quickly, Completely!

### NEW RCA WO-56A 7" OSCILLOSCOPE

Unequaled in Performance, Unmatched in Versatility! This new extremely sensitive RCA 7" Scope features DUAL CONTROLS for Coarse and Fine adjustments, Identical Vert. and Horiz. Amplifiers... for response flat down to DC... for measuring DC component in AC signal circuits. Push-Pull throughout, High Amplifier Output and Gain, Phase Equality. Advanced sweep facilities include preset fixed positions for TV vert. and horiz. waveforms, plus or minus sync for easy lock-in of upright or inverted pulse waveform, line-frequency sweep and sync, with phasing. Frequency Response of both amplifiers flat within —2 db from DC to 500 Kc; within —6 db at 1 Mc; useful beyond 2 Mc. Square wave response — no tilt and over-shoot. Both amplifiers have frequency-compensated and voltage-calibrated attenuators. Peak-to-peak calibrating voltage source.

No. A19, Ship. Wt. 31 lbs. .... Net **\$197.50**



### TERRIFIC! RCA 515S2 15" Duo-Cone SPEAKER

Engineers and professional sound technicians have nothing but praise for this sensational new RCA unit. A development of Dr. H. F. Olson, famous RCA speaker authority, it provides remarkable listening quality at a moderate price. Employs two voice coils, each driving one of the duo-cones, which vibrate as a single cone, at crossover frequencies (around 2,000 cps), avoiding "crossover" interference. Has high sensitivity at high power levels — will handle up to 25 watts. Delivers superb, high fidelity performance from 40 to 12,000 cps, over 60° angle. Requires no crossover network. Magnetic structure contains a bridge network to supply equal flux density to the air gap for each voice coil, from a 2 pound Alnico V magnet. 16 ohms impedance.

No. A53, RCA 515S2 Speaker, Ship. Wt. 18 lbs. .... Net **\$48.50**  
Price Includes 2% Discount



### RCA TV COMPONENTS

All RCA Television Components are "Originals," designed with characteristics which are correct both electrically and mechanically for the tubes and circuits. They are competitively priced!



### RCA TUBES

RCA's unparalleled research facilities and manufacturing experience contribute to the quality, dependability, and operating economy of EVERY RCA tube. The Quality of RCA tubes is Unquestioned!



**FREE!**  
SEND FOR OUR  
NEW 1951  
CATALOG

**HUDSON**  
RADIO & TELEVISION CORP.

212 FULTON ST.  
NEW YORK 7, N.Y.  
Digi 9-1192

Hudson Radio & Television Corp. Dept. 12A  
212 Fulton St., New York 7, N. Y.

Please send:  515S2 Speaker,  RCA WO-56A  
Enclosed:  Full Payment,  20% Dep.

SEND FREE HUDSON CATALOG—Just Out!

Name.....

Address.....

City.....Zone.....State.....

Most Complete Stock of Radio, Television,  
Electronic and Sound Equipment in the East!

MAGNETIC  
RECORDING  
TAPES TO  
THE HIGHEST  
PROFESSIONAL  
STANDARDS

Now the well-known Duotone super-quality is available in magnetic recording tapes for commercial and home recorders. The six Duotone quality features assure finest sound reproduction for professional programming and the ultimate in home entertainment. For finest performance on any tape recorder, use Duotone professional quality magnetic tapes!

- Interchanges with Other Tapes
- Constant Tracking and Winding
- No Snarls or Backlash

- Low Inertia Plastic Wheel
- Low Friction—Long Life
- High Output—Minimum Background

DUOTONE SUPER QUALITY IS AVAILABLE  
IN TAPES FOR EVERY RECORDING NEED

Made with plastic or kraft paper base in extra long 625 or 1250 foot lengths. Plastic base is tough with high tear strength and special smooth finish for uniform coating. All kraft bases are super-calendered for perfect surfacing without fillers. For complete data on Duotone standard and special tapes, call or write for illustrated catalog.



Canadian Representative: CHARLES W. POINTON, TORONTO, CANADA  
Export Division: AD. AURIEMA, INC., NEW YORK CITY, N. Y.



*Now-famous*  
**DUOTONE**  
*quality...*

— IN A  
**RECORDING  
TAPE  
FOR EVERY  
PURPOSE**

*6 WAYS  
to better  
Recordings*

verses automatically, and continues. Production of this machine is to be started immediately, with completed models expected in from 90 to 120 days.

Triad Transformer Mfg. Co. exhibited a full line of transformers for high-quality audio use as well as for a number of geophysical applications. The popularity of the line of audio and power transformer is attested by the list of users, which includes such names as Gates, Concertone, McIntosh, Magnecord, Presto, Newcomb, Lear, Audio Pacific, Westrex, and others of equal importance in the field. The Triad line, although relatively new to audio, is well established on the Pacific coast, largely because of the ability and reputation of the designer and chief engineer, Lou Howard, who has been responsible for the design and production of quality transformers for many years.

U. S. Recording Company introduced a new portable transcription and record player employing an all-play stylus and reproducing through a small speaker mounted in the cover of the case. The quality of reproduction would serve admirably in applications where a portable equipment would be used, and was considerably above the average for similar equipment. An item of great interest to most visitors was the spring-driven magnetic recorder designed for portable use, and shown as a sample of the work being done in Germany at the present time. It is said that negotiations are being carried on for the manufacture of this device in the United States, and it is thought that such a device would be well received.

United Transformer Company exhibited a complete line of audio and power components ranging from the smallest models used in hearing aids up to the largest used in amplifier service. Also shown were a number of completed amplifiers, following the circuits published in UTC literature. From the performance obtained, it is obvious that the equipment will satisfy the needs of most users, and the wide variety of transformers in the line ensures full coverage of all requirements.

University Loudspeakers, Inc. displayed a number of speakers for p.a. systems of various power requirements, as well as the line of cone speakers, coaxial units, tweeters and horns. One feature of the exhibit was the display of a cabinet containing a three-way speaker system with separate controls on the three ranges. The "highs" channel covered the range from 3000 to 15,000 cps, the "middles" channel covered the range from 300 to 3000 cps, while the "lows" channel covered from 45 to 300 cps. Separate control of these channels made it possible for the listener to determine for himself the effect of varying the response of the sections, and pointed out the need for good balance throughout the entire audio spectrum.

With the closing of the exhibits on Saturday afternoon, both exhibitors and visitors alike began to plan for the third Audio Fair, which will be held in the same place on Nov. 1, 2, and 3, 1951. Many exhibitors have already expressed their desires for the same or for more space, and will of course have first choice of the rooms they occupied this year. Several other organizations not yet represented at the Fairs have already indicated their intention of being in next year, so it is certain to be bigger and better as time goes on.

**SUBSCRIBE — for yourself or friends — NOW**

AUDIO ENGINEERING is the ideal Christmas Gift

AUDIO ENGINEERING

342 Madison Avenue, New York 17, N. Y.

Sirs: Here is my  check (or  money order) for \$..... Enter my subscription order to AUDIO ENGINEERING for the next ..... issues. Subscription Price: In U.S.A., Canada and Pan American Union—12 issues \$3—24 issues \$5. All others \$4.00 per year. Please check one:  New Subscription  Renewal.

Name (please print) .....

Address .....

City ..... Zone ..... State .....

Indicate occupation and firm name in margin below



## RECORD REVUE

[from page 36]

If audio people sold only to audio people, our business would be simple enough. But—say it again—the main business of audio is not audio but *music*.

In an exhibit with which I was connected we insisted on keeping the door closed, with a sign, "OPEN—COME IN" on it, because the instant the door opened the *music* we were trying to sell was utterly destroyed.

No music lover worth his salt will listen to more than *one* source of music at a time.

I think we garnered a fine harvest of good will among the motley music lovers in that exhibit and I see no reason why others should not, in Audio Fair III, share the happy results with us.

Therefore I respectfully—and I hope, constructively—suggest that in future exhibits of audio equipment the exhibitors ponder these principles.

1. Keep your door closed, so that *one* source of music, no more, is audible at a time. Elementary musical principle.

2. Study your room acoustics and deaden one or two walls with cloth, for good sound quality. Adds to the visual effectiveness of your exhibit, as well.

3. Place speakers carefully—in a corner when possible, and at a distance from the spot where visitors congregate. There was enormous variation between good and bad in this respect at this year's show.

4. Remember the timid music lover and respect his intentions: keep the *average* loudness level down low; save your full volume for *short* tests. A good 30-second burst at full volume will do far more to impress your audience than a steady pounding can ever do. With *average* volume low, you will not drive away customers, as too many exhibitors did this year.

5. Use good records, new ones, and make a point of handling them carefully in front of your visitors. Record collectors are highly sensitive about this. A pile of dusty, scratched-up unprotected records is the worst possible kind of publicity for an audio exhibit! Make a point, too, of the music itself, as far as you are able; be aware of what is playing, keep the record album in plain sight. A wise exhibitor will have at least one knowledgeable person on his staff who can show an intelligent interest in music—enough to gain the visitor's confidence. (He doesn't know too much himself, after all.)

6. EQUALIZE! Yes, there are plenty of audio equipment purchasers who want highs, highs, highs. But there are plenty more who want faithful reproduction and are out to buy it. That means correct equalization for the high pre-emphasis in most commercial discs. Your machine will never sound the worse for proper equalization. Again, if you want to demonstrate highs—do it in short bursts. But return to the proper setting in between.

7. An after-thought: Many audio exhibitors arrived at the Fair with much audio equipment and not a thing to play on it. Both tape and disc machines were shipped mute, so to speak, until some frantic staff member could dash over to Macy's and buy the first record that he could get hold of, or until some other exhibitor would kindly lend a tape. The business of audio is music. Bring along a good selection of records, chosen carefully, and have them in plain sight, where music lovers can see them and approve. It will do you no harm (and may bring you new followers) to display

## SUPERIOR RECORD REPRODUCTION ASSURED with SMOOTH RUNNING, NOISELESS —

### "SOUNDEX FLOATING DISC-DRIVE" PLAYBACK UNIT

For every type of recording, a continuously variable speed, from 30 to 110 RPM can be accurately set and regulated manually. Precision settings for 33 1/3, 45 and 78 RPM are easily attained. Using 33 1/3 RPM on a 15 minute run, with a line voltage change of 10 volts, the change in speed remained so constant, that the variation was only 2 RPM in 500. On constant voltage, the speed variation was only 1/4 RPM or 0.05 per cent. "Floating Disc-Drive" completely isolates the motor from the turntable: minimizing mechanical vibration, rumble and other harmful effects of direct drive systems—such as rim, gear train etc.



16" turntable—Model No's. TT12 and TT16—\$159.50 less pickup arm

#### PICKUP ARM

... with "finger-tip" pressure control  
Non-resonant arm assures perfect tracking and less record wear. Scale pressure ranges, 0 to 25 grams. Models are available for every type of cartridge:

No. SS16—single stylus } \$39.60 net  
No. DS16 double stylus }

Send inquiries to BRUJAC ELECTRONIC CORP.  
103 LAFAYETTE ST. • NEW YORK 13, N. Y.



### NEED BACK ISSUES?

- August 1948
- September 1948
- June 1949
- September 1949
- November 1949
- December 1949
- January 1950

- February 1950
- March 1950
- June 1950
- July 1950
- August 1950
- September 1950
- October 1950

1948, 1949—50¢ each

1950—35¢ each

Payment must accompany order.

Circulation Dept., Audio Engineering, 342 Madison Ave., N. Y. 17, N. Y.

## RADIO SHACK NEW ENGLAND'S AUDIO LEADER

PRESENTS

THE AMPEX  
MAGNETIC TAPE RECORDER  
NEW MODEL "400"

15 kc at 7 1/2 ips!  
15 and 7 1/2 speeds  
66 minutes at 7 1/2!  
Half or full tracks  
Fully portable!



The brilliant new Ampex "400" features a 30-15,000 cycle response at 7 1/2", established a new high in fidelity at that speed and in its price range. Complete in ONE portable case. Complete plug-in head housing and other Ampex exclusives! Only \$750.00. Write for details!

## FREE! RADIO SHACK'S GIANT 1951 CATALOG!

Write today for your FREE copy of audio's most complete and authoritative buying guide. 172 pages of parts, kits, books, tools, equipment. 34 pages devoted exclusively to audio products by: Klipsch, Williamson, Brook, Altec-Lansing, Scott, Pickering, Browning, Stephens, Rek-O-Kut, Presto, Garrard, Thordarson, Meissner, Bogen, Radio Craftsmen, etc.

PLEASE SEND ME THE FREE CATALOG

NAME \_\_\_\_\_

STREET \_\_\_\_\_

CITY \_\_\_\_\_ STATE \_\_\_\_\_

RADIO SHACK CORPORATION

167 Washington St., Boston 8, Mass.

# Acmetape

Lowest priced recording tape on the market  
Save 30 to 40 per cent on your tape costs

BROWN OXIDE STRONG ACETATE BASE

600-ft. reels ..... \$1.45 each  
(1 to 3 reel lots)

1200-ft. reels ..... \$1.95 each  
(3 reel lots)

"Reel Your Own"—3900-ft. roll . . \$3.95

*Best Christmas gift possible for your recording enthusiast friends*

**SOLD ONLY BY MAIL**

Orders accompanied by check or money order mailed prepaid  
You pay postage if we ship C.O.D.

Agents' inquiries invited  
98 Jay Street,

Brooklyn 1, N. Y.

*Acme*

## Now Available! audio anthology

Paper cover . . . \$2.00

Board cover . . . \$3.00

*Distributors write for quantity discount*

The long awaited compilation of reprints from early issues of AUDIO ENGINEERING, most of which are unobtainable.

Contains 37 articles on the following subjects:

- Amplifiers
- Speakers
- Noise Suppressors
- Phonograph Equipment
- Tone and Loudness Controls
- Dividing Networks

These articles have been of great interest to readers of AUDIO ENGINEERING over the past three years. Assembled in one volume, they comprise the most authoritative reference work for the audio hobbyist.

---CUT OUT---MAIL TODAY---

Book Division, Dept. A9  
Radio Magazines, Inc.  
342 Madison Ave., New York 17, N. Y.

Sirs: Enclosed is my  check  money order for \_\_\_\_\_ copies of the Audio Anthology.

(Please check one)  Paper cover  Board cover

Name (print carefully) .....

Address .....

City ..... Zone ..... State .....

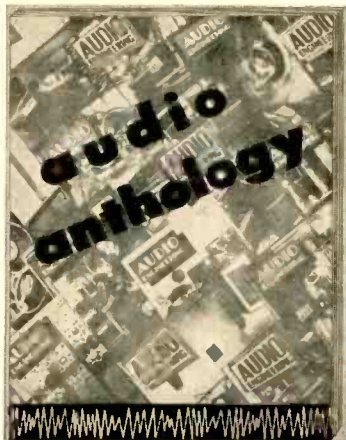

a bit of Mozart and Bach and Beethoven. Even if it never gets played. So here's to a musical Audio Fair III.

### RECORDS

Varèse, *Intégrales*; Density 21.5; *Ionization*; *Octandre*.

Rene Le Roy, flute; N. Y. Wind Ensemble, Juilliard Percussion Orch., Waldman. EMS LP EMS 401

Gabrieli, *Seven Canzonas for Brass Instruments*. N. Y. Brass Ensemble, S. Baron.

Esoteric LP ES 503

Schutz, *Weihnachts-Historie (The Christmas Story)*.

The Cantata Singers; Charlotte Bloecher, Wm. Hess, Paul Matthen, conducted by Arthur Mendel. REB LP REB 3

Ives, *Symphony #3 (1901-04)*; *Music of the Am. Revolution*. National Gallery Orchestra, Bales.

WCFM LP LP-1

It was surely a milestone of some sort or other in American musical history when, 'tother week, no less than three copies (it sounded like more) of the Varèse recording listed above were used at the Audio Fair to demonstrate hi-fi audio equipment! Varèse, no less than Ives (of an earlier generation) has been one of the lost pioneers of ultra-modern music, than which nothing could be further removed from electronic engineering—or at least until now. Varèse is a Frenchman to the core, in spite of his long residence in the U. S. and an artist of the longest-haired sort you can imagine; but he was one of the first to discover that things like sirens and bottles and assorted bits of heavy machinery could be used to make music of a new sort. His music, in the 1920's, was violently, incredibly radical. Few ever heard it. Now, in the 50's, it sounds just as radical as ever—but it makes the most superb hi-fi material for wide range recording. And so Edgar Varèse comes into his own! The Varèse record consists of one work for massed percussion (including sirens), another that surely holds all "records" for sheer potency of brassed dissonance, and several more works that fall between these. You will either howl with pain or giggle with amusement—but remember that Varèse is held in very great respect by musicians, that his noisy experiments led to much that is already a solid part of today's music and quite taken for granted by you yourself.

Points of interest above: Note the listing of four tiny companies (two record shops, a lone engineer and a cooperative radio station) which can between them stand up to the very best on LP from any of the large companies. Such is LP recording these amazing days. The smaller companies, dozens of them, are beating the biggies at their own game.

Ives as a lone wolf experimenter in the 1900 period, also contributed much that is now taken for granted in music. His 3rd symphony is a mild work, based on old fashioned hymn tunes, mostly scored for strings, and you will find it quite agreeable though in 1904 it was highly eccentric. Very nice, quiet string recording, with what seems to be flat high end. Good.

Schutz and Gabrieli, from the 17th century, were two earlier experimenters. The Gabrieli brass music makes a superb record, as done in the live studio at Reeves in New York. (Note that clean, simple brass har-



monics allow for very high levels with relatively little tracking trouble.) Gabrieli practically invented instrumental "orchestral" music right here, applying the earlier choral techniques to massed groups of brasses. Schütz, writing in the dreary days of the 30 Years' War in Germany, developed much of the mixed voice-and-instrument style that Bach and Handel later used. Engineer Robert Blake (REB) obviously has a fine ear for miking this difficult variety of music and his record is worth an engineering study quite aside from the music itself. Trumpets, recorders, organ, solo voices, orchestra, chorus et al. Blake also recorded the Varèse LP.

**Bizet, Carmen Suite; Smetana, Die Moldau**  
Orch. of the Viennese Symph. Soc.,  
Singer. **Remington LP**  
RLP 149-10  
(10")

**Schubert, Symphony #1; Mozart, Fantasia in F minor, K. 608.**  
Orch. of Viennese Symph. Soc.; Vienna  
Symphony, Fekete. **Remington LP**  
RLP 199-2  
(12")

Here are two of the best from the first batch of the new bottom priced Remington LP's, sold through department stores. The new material and/or processing method gives a surface that hisses quietly, like fine British shellac—hardly objectionable. As to durability, I couldn't say. Also, there is little in the way of quality that will interest a hi-fi man, some of the recording being thin and (on a good outfit) considerably distorted. But the Carmen-Moldau recording above, is really excellent—no complaint at all; and the Mozart is good, too, though the Schubert on the other side is of the distorted type.

Important point for music-lovers is that there are a number of quite unusual musical items already in the list, a development that was hardly to be expected; the Mozart Fantasia, originally for mechanical organ, is one—though the arrangement and playing are both poorish—and another is the superb voice of Elizabeth Wysox in a pot-pourri of operatic arias. Keep an eye on these.

**Brahms, Symphony #4 in E minor.**  
Boston Symphony, Munch  
**RCA Victor LP**  
LM 1086

**Rachmaninoff, Piano Concerto # 2.**  
Wm. Kapell; Robin Hood Dell Orch.,  
Steinberg.  
**RCA Victor LP**  
LM 1097

Here are two standard works re-done under new RCA auspices and on LP, and the slight perplexity noted last month re RCA's LPs continues—even though both of these and plenty more like 'em are excellent recordings.

The new Boston under Munch is a lighter, more streamlined orchestra in the sound than recently under Koussevitsky. The Brahms is given a nicely tailored, rather French performance that suddenly turns positively furious in the coda to the third movement and in the last movement. Interesting. The Rachmaninoff meanders its involvively Romantic way, about as it always does (to my somewhat jaundiced ear) and my best comment is technical, that the piano is nicely balanced, a bit dead sounding, the orchestra well adjusted in volume but too much in the background as to liveness perspective.

As to recording characteristics—doubt. The Boston recording is on the beam, i.e.

# Square Wave Generator



## MODEL 71

### SPECIFICATIONS

**FREQUENCY RANGE:** 5 to 100,000 cycles.  
**WAVE SHAPE:** Rise time less than 0.2 microseconds with negligible overshoot.  
**OUTPUT VOLTAGE:** Step attenuator giving 75, 50, 25, 15, 10, 5 peak volts fixed and 0 to 2.5 volts continuously variable.  
**SYNCHRONIZING OUTPUT:** 25 volts peak.  
**R. F. MODULATOR:** 5 volts maximum carrier input. Translation gain is approximately unity—Output impedance is 600 ohms.  
**POWER SUPPLY:** 117 volts, 50-60 cycles.  
**DIMENSIONS:** 7" high x 15" wide x 7 1/2" deep, overall.

MANUFACTURERS OF  
Standard Signal Generators  
Pulse Generators  
FM Signal Generators  
Square Wave Generators  
Vacuum Tube Voltmeters  
VHF Radio Noise & Field  
Strength Meters  
Capacity Bridges  
Megohm Meters  
Phase Sequence Indicators  
Television and FM Test  
Equipment

**MEASUREMENTS CORPORATION**

BOONTON NEW JERSEY

## The HIT of the AUDIO FAIR

Plays 10 1/2" Reels!



Complete, for  
console installation with  
single or dual track heads: **\$345<sup>00</sup>**

# CONCERTONE

□ The professional quality tape recorder you have been waiting for! NAB standards; trades throughout; 40-15000 cycles at 15", 40-8000 cycles at 7 1/2". Three motors; flutter less than 0.1%; signal-to-noise better than 50 db. Three heads for simultaneous erase, record, playback. Quick change from single to dual track. Write for booklet.

**FISHER RADIO CORPORATION • Distributors • 45 E. 47th St., N. Y.**  
In Los Angeles: Magnetic Recorders Co., 7120 Melrose Ave., Los Angeles 46, Calif.

# AMPERITE

## Studio Microphones at P.A. Prices

Ideal for  
**BROADCASTING  
RECORDING  
PUBLIC ADDRESS**

"The ultimate in microphone quality," says Evan Rushing, sound engineer of the Hotel New Yorker.

• Shout right into the new Amperite Microphone—stand 2 feet away—reproduction is always perfect.

• Not affected by any climatic conditions.  
• Guaranteed to withstand severe "knocking around."



Models  
RBLG—200 ohms  
RBHG—Hi-imp.  
List \$42.00



"Kontak" Mikes  
Model SKH, list \$12.00  
Model KKH, list \$18.00

**Special Offer:** Write for Special Introductory Offer, and 4-page illustrated folder.

**AMPERITE Company, Inc.**

561 BROADWAY • NEW YORK 12, N. Y.  
Canada: Atlas Radio Corp., Ltd., 560 King St. W., Toronto

## More Pleasure...for Less



**MUSIC LOVERS  
AMPLIFIER  
\$29.50**

Especially designed by CONCORD engineers to give the HI-FI Fan an inexpensive yet good quality unit. Normal rated output 8 watts (harmonic distortion only 2%). Three inputs for magnetic, and crystal cartridges, and radio tuner; built-in pre-amp for reluctance pickups; separate bass and treble controls with flat position—bass gives 10db boost, treble gives 12db boost and 14db attenuation. Freq. resp. at rated output 40-15,000 cps ±1db. Tubes: (2)6V6, 6SL7, 6SC7, and 6X5 rect. For 117V, 60 cycle AC. Brown hammer-rod finish. Size: 10-1/2 x 6 x 5-1/4". With tubes. **29.50**  
2-295A -- Shpg. wt. 10 lbs. ....

**ATTENTION HI-FI CUSTOM INSTALLERS**

Write on business letterhead for information on Concord's Dealer Plan and Technical Advisory Service designed especially for custom installation men. Write now for FREE information.

### CONCORD RADIO CORP.

Mail Order Center and Showroom  
901 West Jackson Blvd. Chicago 7, Ill.

CONCORD RADIO CORP. Dept AM-50  
901 W. Jackson Blvd., Chicago 7, Ill.

Enclosed \$..... (Include shipping charge. Any excess will be refunded.)

Rush Music Lovers Amplifiers @ \$29.50

Send FREE latest Bargain Bulletin

Name.....

Address.....

City..... Zone..... State.....

of the sort one now expects from that section of RCA: a clearly distant-mike technique that seemingly dulls the highs on first hearing (no sharp edge to the strings, etc.). Yet a perfectly legitimate musical sound from the concert hall viewpoint—probably more "natural" than the forced brilliance of the famous ffr technique with its steely sharp tone qualities. The Robin Hood Dell is a Philadelphia offshoot, recorded in the Academy of Music, reportedly a very fine hall for music. This recording is dead, decidedly, than the Boston recording, the orchestra similarly distant-miked, by the sound. Strange—but this one will play very nicely with only slight roll-off. If it was not recorded "flatter" than others of the RCA line, then we have here one of those combinations of mike technique (softening of the highs via distance), actual acoustics and, most important, the composer's sonorities—Rachmaninoff's tend towards the dark and fusty. Try this one yourself and be convinced. Not a good recording, however you play it (compare, if you wish, with the first mvt. of the same music on the "Twilight Concert" disc reviewed below); the piano is tinny, hard, there is no real bass nor much in the highs of interest. (In any case, the more I listen the more am I convinced that mike technique greatly affects the apparent "curve" of a finished recording and so, in practice, the equalization that must be used for a balanced sound in the reproduction.)

### "Twilight Concert."

The Columbia Symphony Orchestra,  
Bodzinski. **Columbia LP  
MI 4311**

Sir Thomas Beecham conducting the  
Royal Philharmonic and the Columbia  
Symphony Orchestras. **Columbia LP  
MI 2134**

Here are two useful and pleasant pot-pourris of assorted stuff (too much to list, but the titles are mostly very familiar) that most engineers will want to have around for general test and background purposes. The Twilight Concert, with eight numbers including the first movement of the Rachmaninoff Concerto above, is a model of excellent recording with fine acoustics, low distortion, smooth, deep perspective, excellent low bass as well as fine highs, sharp but not too sharp. Sir Thomas (who offers the least interesting music) gets similar sounds from the same Columbia Orchestra on his ten-inch disc, one side of which he made here; but the Royal Philharmonic sound is noticeably duller, less live, not as satisfactory, by any means. Who said we couldn't match the British? Incidentally—here's the same old story: your tendency will be to boost the highs a bit for the Royal, to compensate for duller acoustics; and yet (with tape) the chances are good that the actual recording curve is the same for both sides of this record.

\* \* \* \* \*

Obvious conclusion to this month's technical look-see at new recordings: Can't somebody get after the haughty big companies and badger them into at least nominal conformity to one LP curve or perhaps better, an area of tolerance in respect to recording curve? By which I mean an accepted set of outside limits, as to turnover, pre-emphasis, within which all companies agree to operate. The tolerance should be, of course, small ideally but it will have to be quite large practically. Still—even such wide tolerance as, say, between 400 and 600 cps turnover and between 8 and 12 db pre-emphasis at 10,000 would be immeasurably better than the constant doubts to which we are now subjected.

**GET THIS  
IN - BUILT  
TWIN DRIVE  
with  
CROSS OVER  
and  
FEED - BACK  
FOR XMAS**



The idea of crossovers and twin units seems to have got such a grip that some U. S. friends ask us why we don't make such things. Well, of course we do, only we do it better and build the whole lot into one, plus a dose of self adjusting feed back which no other speaker, single, twin or triplet, possesses. Our drive is patented in U. S. A. as elsewhere and only genuine Barker speakers have its resultant quality of full audio frequency range plus freedom from significant resonances plus dead beat motion which pin-points transients and detail, plus an overall smoothness making highs, middles and lows equally clear-cut and true. You may ask: Ah! but what about that large cone? If our cone was normal that might hit home, but again it is a patented special with perfectly graded compliance from apex to rim, making it comparable with a whole series of matched cones covering the needs of efficient radiation from below 40 to over 15,000 cps. Back to the drive: it is a very thin, light metal tube fixed to the cone apex. On it is a coil of fine wire over a skin of long life stabilised latex. Up to the middles the latex won't flex so the coil drives, but as the frequency rises the latex gives and the metal tube takes over by induced currents, giving efficient drive to beyond audio limits. A simple but true dual action with in-built, truly matched cross-over. And how the feed-back? Send for details of the Barker Model 150, 12 ins. unit with 17,500 gauss magnet, SGO post and insurance paid to your home. ACT NOW!

**BARKER NATURAL SOUND REPRODUCERS  
BCM/AADU, LONDON, W.C.1, ENGLAND.**

**"HAVE YOU HEARD  
THE SOUND OF QUALITY?"**



**NEWCOMB SOUND IS BETTER**

Manufacturers of public address, mobile, phonograph, musical instrument and wired music amplifiers • Portable systems • Portable phonographs and radios • Transcription players • Rack and panel equipment.

Write today! Circle items of interest and indicate whether you are a Dealer, Parts Jobber or Sound Specialist.

**NEWCOMB AUDIO PRODUCTS CO.**  
DEPT. T, 6824 LEXINGTON AVE.  
HOLLYWOOD 38, CALIFORNIA



**A**  
**TIME-TESTED**  
**DEPENDABLE**  
**SOURCE**  
**FOR**

**HIGH-PRECISION FRACTIONAL H.P. INSTRUMENT-TYPE MOTORS & GENERATORS PRODUCED TO ORDER**

GOVERNOR CONTROLLED SELF-SYNCHRONOUS DRAG CUP VELOCITY & ACCELERATION DC & AC TACHOMETER SHUNT SERIES COMPOUND PERMANENT-MAGNET SPLIT-FIELD SEPARATELY EXCITED UNIVERSAL INDUCTION RELUCTANCE HYSTERESIS ONE, TWO & THREE PHASE DC & AC SERVO TOTALLY ENCLOSED AC DYNAMICALLY BRANDED REELMOTORS ONE, TWO, THREE & FIVE SPEED SYNCHRONOUS MOTORS

Experienced for years in meeting customers' exacting requirements for high-precision instruments designed by engineers of ability and sagacity, and manufactured with extreme care and skill. Over 500 different basic types may be varied to meet your own unique requirements of use, either electrically or physically.

**ELECTRIC INDICATOR CO.**

PARKER AVENUE  
STAMFORD, CONNECTICUT

**AS ONE MAN SAID TO ANOTHER**

Dear Sirs:

A short time ago a friend of mine in Massachusetts purchased one of your transformers. His enthusiasm knew no bounds so I am sending you an International Money Order on this date for one of these transformers. I might add that I am looking forward to doing business with you after the recommendation that I have received.

Sincerely yours,

New Model Type 2R36B Pri. 10,000 ohm e.t. Incremental Ind. over 100 H. Sec. 2 1.25 ohm, 2.8 ohm, 5 ohm, 7.8 ohm, 11.3 ohm, 15.3 ohm and 20 ohm. Leakage reactance under 15 mil. Size: 5 1/2" x 4" x 6". P.C. 4 3/4" x 3 1/2". Weight: 12 lbs. Today's Price: \$13.00 post free, duty extra.

**SAVAGE TRANSFORMERS LTD.**  
Devizes, Wilts, England

**SAVAGE DEVIZES**



## AES NEWS

[from page 23]

year term), Arris Geranis, chief engineer, WBCK, Battle Creek, Mich.

Larry Wells, chief engineer for the Allen Electric Company, has been appointed Program Chairman for the coming year. Section meetings are held the third Tuesday of each month with the exception of June, July, August, and December. Members of other sections who may be traveling through the area are invited to attend meetings of the Southern Michigan Section, and may obtain information about the time and meeting place from any of the officers.



## Employment Register

EMPLOYMENT OPPORTUNITIES may be listed here at no charge to industry or to members of the Society. For insertion in this column, brief announcements should be in the hands of the Secretary, Audio Engineering Society, Box F, Oceanside, N. Y. before the first of the month preceding the date of issue. Replies to box numbers should be addressed to AUDIO ENGINEERING, 342 Madison Ave., New York 17, N. Y.

★ Positions Open

● Positions Wanted

★ **Very Confidential.** Three of the nationally known television manufacturing companies have come to us for:

1. Quality Control Engineer
2. Receiving Tube Engineer
3. Purchasing Director who has experienced buying all component parts for television manufacturing.

These positions will pay \$10,000 up and require the highest grade ability. Send full details of your experience, age, salary requirements privately to

Thorndike Deland  
1440 Broadway,  
New York 19, N. Y.

We are retained by our clients and do not charge the individual. All negotiations handled confidentially.

★ **Motion Picture Technicians.** The Signal Corps Photographic Center is interested in receiving applications from experienced motion picture technicians for openings as: film editors, recordists, mixers, cameramen, laboratory technicians, scenic artists, scenario writers, directors, animators, animation photographers, studio carpenters, grips, property men, studio electricians, and film librarians. Salaries range from \$3450 to \$6400. Those interested should write to the Signal Corps Photographic Center, 35-11 35th Ave., Long Island City 1, N. Y.

## Audio

**NEW Intermodulation Meters**

**Highest Professional Flexibility at Low Cost!**

### MODELS 165 and 169

These are self-contained, precision instruments for the accurate direct-reading of per cent intermodulation. Compact, both have integral, high quality signal generators to provide the mixed two-frequency tone for test input. The output from apparatus under test passes through the analyzer section for conversion and measurement on the built-in meter.

### MODEL 165 IM METER

Specially designed for factory production testing and laboratory work, this versatile meter makes both low and high frequency tests—since it includes adjustable voltage ratio and frequency. Low test frequency: 60 cps from internal oscillator, or 40-150 cps from your own oscillator. High test frequency: 2, 7, 12 kc from internal oscillator, or 2-20 kc from your own oscillator. Signal generator output: +8 dbm. 600 ohms. Analyzer input: 1 volt min., 500 k ohms. LF/HF voltage ratios: 4:1, 1:1. Voltage ranges: 3, 10, 30 v. Intermodulation: full-scale ranges of 3, 10, 30%. Panel size: 7" x 19". Power supply: 117 v., 60 cps.

### MODEL 169 IM METER

Of maximum versatility, this precision laboratory instrument covers an exceptionally wide LF range. Ideal for disc reproducer testing at 400 and 4000 cps as recommended by H. E. Roys—and for system testing with all usual frequencies. Also measures noise levels.

### MODEL 170 GALVO-PROTECTOR

Connected between the Wheatstone Bridge and your galvanometer, it prevents meter damage and speeds Bridge balancing. Its non-linear element is an automatically changing shunt for the meter, keeps the pointer on-scale—from far-off-balance through perfect-balance adjustments.

WRITE NOW FOR CATALOG

**Audio**  
**INSTRUMENT COMPANY**  
Dept. T, 133 W. 14th St., NEW YORK 11, N. Y.

**TWIN-TRAX TAPE RECORDER**

Available to you direct from the factory at savings that make TWIN-TRAX the only professional-type recorder in the popular-price field. More than a dozen model variations for portability, long-play, continuous operation, etc. For a better tape recorder that combines professional quality with operating ease and trouble-free construction, it's TWIN-TRAX. Write today for complete literature. Trade Mark Registered

**AMPLIFIER CORP. OF AMERICA**  
398-4 Broadway • New York 13, N. Y.

## CLASSIFIED

Rates: 10c per word per insertion for noncommercial advertisements; 25c per word for commercial advertisements. Rates are net, and no discounts will be allowed. Copy must be accompanied by remittance in full, and must reach the New York office by the first of the month preceding the date of issue.

### Equipment

WE PURCHASED a Brush Wire Recorder (\$800 with extras) to fulfill two-year contract with national detective bureau for secret recordings. Contract has expired. For three hours of amazing wire recording quality (50-8000) without wows or extraneous noises, this recorder is peerless. In pinches, we have recorded music from which masters were dubbed. Price \$175.00. Reco-Art Co., 1305 Market Street, Philadelphia 7, Penna.

FOR SALE: Two UTC LS-50 transformers, one each LS-12X, HA-101X, LVM-1 (500-ohm line to v.c.). Entire lot \$25.00. Box CD-1, AUDIO ENGINEERING.

FOR SALE: Custom radio-phono assembly in one-piece solid walnut cabinet, with Hallcraft AM-FM chassis, JAP-60 spkr, Webster 100-27 with GE dual pickup, 7 cu. ft. infinite baffle chamber, Kimsul lined. \$410. New York area only. Box CD-2, AUDIO ENGINEERING.

PRESTO 90-A amplifier for portable or studio recording, 30-15,000 cps, three microphone inputs, Weston VU meter, equalization selector, line recording, public address. Excellent condition. \$225.00. Reco-Art Company, 1305 Market Street, Philadelphia 7, Penna.

## ELECTRONICS TECHNICIANS WANTED

The RCA Service Company, Inc., a Radio Corporation of America subsidiary, needs qualified electronics technicians for U. S. and overseas assignments. Candidates must be of good character and qualified in the installation or maintenance of RADAR or COMMUNICATIONS equipment or TELEVISION receivers. No age limits, but must have at least three years of practical experience.

RCA Service Company offers comprehensive Company-paid hospitalization, accident and life insurance programs; paid vacations and holidays; periodic review for salary increases; and opportunity to obtain permanent position in our national and international service organization, engaged in the installation and maintenance of AM, FM and TV transmitters, electronic inspection devices, electron microscopes, theatre and home television, r-f heating equipment, mobile and microwave communications systems, and similar electronic equipment.

Base pay, overseas bonus, payments for actual living and other expenses, and benefits mentioned above add up to \$7,000 per year to start for overseas assignments, with periodic review of base salary thereafter. Openings also available at proportionately higher salaries for specially qualified technicians with supervisory ability.

Qualified technicians seeking an advantageous connection with a well-established company, having a broad-based, permanent peacetime and wartime service program, write to

Mr. C. H. Metz,  
Personnel Manager,  
RCA Service Company, Inc.,  
Camden 2, New Jersey

★ **Electronic Sales Engineer.** To sell top quality line of broadcasting, recording and motion picture studio sound equipment and components in New York Metropolitan area. Must have five years experience in sales of this type of equipment. Salary, commission, and expenses. Box 1201.

★ **WANTED:** Signal Corps Center, Fort Monmouth, N. J. has openings in the following Civil Service positions:

**Military Instructors**—Microwave relay, radar, radio electronics, fixed station radio, central office techniques, teletype installation and maintenance, repeater and carrier, dial central office maintenance, theory of electricity. \$3100-4600.

**Electronic Engineers**—Participate in design, development, modification, construction, and testing of electronic equipment—radio, radar, wire communications, instrumentation, sonar, etc. Responsibility depending upon experience and ability. \$3100-6400.

**Technical Writers**—Write, edit, prepare technical publications, handbooks, circulars, instruction books, etc. Edit and revise scientific manuscripts on radio, radar, electronics, communications, and photography. Write instruction manuals on theory, operation, and maintenance of Signal Corps equipment; determine media and method of presentation of material; prepare charts, graphs, schematic diagrams etc. \$3100-5400.

Applicants for any of these positions should write Chief, Civilian Personnel Branch, Signal Corps Center, Fort Monmouth, N. J., submitting a completed Standard Form 57, "Application for Federal Employment" (obtainable at any first or second class post office) for review before going to Fort Monmouth for a personal interview.

## PROFESSIONAL DIRECTORY

### C. J. LeBEL

AUDIO CONSULTANT

Sound Recording • Instrumentation

370 RIVERSIDE DRIVE  
NEW YORK 25, N. Y.

Custom-Built Equipment

### U. S. Recording Co.

1121 Vermont Ave., Washington 5, D. C.

STerling 3626

Consultation • Design • Fabrication

Audio Facilities Corporation

133 West 14th Street,  
New York 11, N. Y.

### HERMAN LEWIS GORDON

Registered Patent Attorney

Patent Investigations and Opinions

Warner Building 100 Normandy Drive  
Washington 4, D. C. Silver Spring, Md.  
National 2497 Shepherd 2433

### RICHARD H. DORF AUDIO CONSULTANT

Sound Systems Recording Installations  
Product Design Technical Literature

255 W. 84th Street Phone  
New York 24, N. Y. Schuyler 4-1928

### AUDIO ENGINEERING SCHOOL

Practical engineering training in Audio fundamentals, Disc, Film, Magnetic Recording, and Audio frequency measurements.

Studio training simulates Broadcast, Motion Pictures, Television, and Commercial Recording work.

Approved for Veterans

Hollywood Sound Institute, Inc.  
1040-A North Kanawha, Hollywood 27, Calif.

Specify if Veteran or Non-Veteran

## MARCH OF DIMES

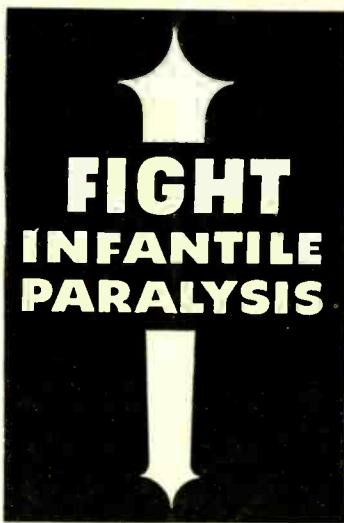

JANUARY 15-31



## DIAMOND Phonograph Needles



It is becoming more and more widely known that a perfect diamond playback stylus possesses many advantages over any other type of needle. Some of these advantages are (1) preservation of records—especially LPs—from wear, and (2) savings on needle replacements. One TeleveX diamond stylus will outlast 50 to 100 sapphires, yet costs only about as much as 10 sapphires.

The TeleveX diamond styli are the finest that can be made, are unconditionally guaranteed, and have been recommended by leading record critics. They should not be confused with cheaper diamond needles. To obtain the full benefit of a diamond stylus, it is necessary to get the best diamond stylus. It may cost a few dollars more, but in the long run it is by far the cheapest.

To order, send a sample of the needle(s) used in your playback equipment, or if more convenient send the entire cartridge (except Pickering). Price for replacement of sapphire tips is \$15.00, metal tips \$16.00. If both LP and standard replacements are ordered at same time, deduct 10%. (Record changers, etc. with diamond styli available. Specify make, model and cartridge(s) desired. Prices quoted without obligation.)

**TELEVEX 467 West 238th St.  
NEW YORK 63, N. Y.**

## DIAMOND \$9.75 STYLI EACH POSTPAID

Made from **WHOLE**  
natural **DIAMONDS**  
unconditionally  
**GUARANTEED!**

At the price of \$9.75 each, postpaid, our diamond styli cost you less because we are the only manufacturer offering diamond styli direct to the consumer. Without a diamond stylus, your valuable records run the risk of damage unless you change needles at least every 20 hours of playing time. A DIAMOND tipped needle will last a minimum of 1000 playing hours without causing any damage to your records, while giving you highest fidelity reproduction and NO distortion. Using ordinary needles for the same 1000 hours could cost you as much as \$90.00 in needle replacements.

### Here Are Some Proven Facts About our DIAMOND STYLI

- 70% of the diamond stylus used by broadcasting stations are made at our plant.
- Our styli are made from whole, natural diamonds—Not chips or splints.
- Tip radius accurate to plus or minus .0001".
- Inspected by microscope and shadow-graph to insure high polish and accurate radius.
- Lowest mass mounting of diamond tip obtainable, a MUST for high fidelity reproduction.
- Either metal or sapphire tipped needles can be re-tipped with DIAMOND.
- Guaranteed complete satisfaction.
- Return shipment made the same day received via air mail delivery on all shipments outside a 200 mile radius of Boston.
- If you live in Boston or vicinity, you may bring your needle assembly to our plant and it will be re-tipped with DIAMOND while you wait.

Send us your replaceable needle assembly to be re-tipped with DIAMOND. Available for either LP or Standard records. Send check or money order to:

**THE TRANSCRIBER CO.**  
Diamond Stylus Engineers  
Designers • Manufacturers  
172 Green Street, Boston 30, Mass.

## NEW LITERATURE

● Cinema Engineering Co., 1510 W. Verdugo Ave., Burbank, Calif. is now issuing Catalog 14-R titled "Non-Inductive Wire-Wound Precision Resistors". The catalog describes a line of resistors ranging in accuracy from one per cent to 1/20 of one per cent, and in wattage capacities from one-quarter to 10 watts. Charts and illustrations are included.

● Electronic Instrument Co., Inc., 276 Newport St., Brooklyn 12, N. Y. is now releasing its 1951 catalog of kits and complete instruments in the Elco line. Included are VTVM's, oscilloscopes, sweep generators, signal generators, tube testers, signal tracers, volt-ohm-milliammeters, battery eliminators, high-voltage probes, r.f. probes, and crystal probes. Catalog will be mailed free on request.

● Newcomb Audio Products Co., 6824 Lexington Ave., Hollywood 38, Calif. has just published a complete new catalog featuring Newcomb portable sound equipment for schools, churches, clubs, etc. All items are illustrated and thoroughly described with detailed specifications. Catalog will be mailed free on request.

● Tube Department, Radio Corporation of America, Harrison, N. J. is now supplying to those with technical interest in receiving tubes a revised edition of the popular booklet "RCA Receiving Tubes for AM, FM and Television Broadcast". As an added convenience to users of the booklet, a section is included where types of tubes having similar characteristics and the same heater or filament voltage are bracketed. Copy may be obtained from RCA tube distributors, or by sending 10¢ to Commercial Engineering, RCA Tube Department, Harrison, N. J.

● Radio Tube Division, Sylvania Electric Products, Inc., 500 Fifth Ave., New York 18, N. Y. is now supplying through authorized Sylvania distributors a 128-page loose-leaf book titled "Servicing TV Receivers." Devoted to the servicing and maintenance of home TV equipment, the new book is wire-bound permitting it to lie flat when in use. Extensive illustration includes 53 screen patterns, 17 wave-form patterns, and seven schematic diagrams.

## ERRATUM

SAVAGE TRANSFORMERS LTD., Devides, Wilts., England, carried an advertisement in the October issue in which the transformer impedances were indicated in "μ" instead of in "Ω." This regrettable error occurred somewhere between advertising production and final pages, and should not be assumed to indicate that some new transformer characteristic was intended.

### SENSATIONAL NEW BOOK

**ELEMENTS OF SINGLE AND DUAL TRACK MAGNETIC TAPE RECORDING and 1001 APPLICATIONS**

by A. C. Shaney

INFORMATIVE! INSTRUCTIVE! INTERESTING!

ONLY  
**\$1.00**  
POSTPAID

The book that brings you up-to-date on tape recording. Complete history, theory, design and uses. 144 pages of FACTS!

Order today. Remit with order, please. Booklet mailed same day.

**AMPLIFIER CORP. of AMERICA**  
398-4 Broadway, New York 13, N. Y.

## WANTED

Amplifiers, tuners, speakers, 2 or 3 speed changers, recorders. Used high quality equipment in perfect condition will be bought or swapped.

J. Colbert 85-08 168 Place Jamaica 3, N. Y.

## FREE NEW 1951 PUBLIC ADDRESS & SOUND EQUIPMENT CATALOG

Send your name & address to—  
**INTERSTATE SUPPLY CO.**  
24 SO. TENTH • ST. LOUIS 2, MO.

## MILO SOUND has all the best lines!

Take your choice of the world leaders in audio equipment. Here's just a partial list—from MILO SOUND'S great warehouse of complete stocks:

ALTEC	LIVINGSTON
APPROVED	MASCO
ASTATIC	MEISSNER
ATLAS	MINNESOTA
AUDAK	MINING
AUDIO DEVICES	NEWCOMB
BELL	PENTRON
BOGEN	PERMOFLUX
BROOK	PICKERING
BROWNING	PRESTO
BRUSH	RACON
CLARKSTAN	RADIO
COLLINS AUDIO	CRAFTSMEN
ELECTRONIC	RAULAND
WORKSHOP	REK-O-KUT
ELECTRO-VOICE	SCOTT
ESEY	SHURE
GARRARD	SOMERSET
GE	STEPHENS
GRAY	TURNER
HOLL	UNIVERSITY
JENSEN	UTC
LEAK	VM
	WEBSTER

Visit our Showroom.

Write for Literature

**MILO sound**  
200 GREENWICH ST., NEW YORK 7, N. Y.  
The ONE source for ALL your audio needs

# Audio Engineering—1950

## SUBJECT INDEX

### Acoustics

— of London's New Concert Hall; Nov., 26.

Impact of — on Music, The; Robert H. Tanner; Nov., 21.

Reverberation-Time Calculation, Simplified; (Chart) Lewis S. Goodfriend; May, 20.

### Audio Engineering Society Papers

Automatic Audio Gain Controls; J. L. Hathaway; I Sept., 16; II Oct., 27. Convention Program; Oct., 30.

Diamond as a Phonograph Stylus Material, The; E. J. and M. V. Marcus; July, 25.

Longitudinal Noise in Audio Circuits; H. W. Augustadt and W. F. Kannenberg; I Jan., 22; II Feb., 18.

Sound Reinforcing Systems; Arthur W. Schneider; Nov., 27.

### Amplifiers

Automatic Audio Gain Controls; (AES) J. L. Hathaway; I Sept., 16; II Oct., 27. Cathode Follower Output Stage, The; Robert M. Mitchell; Feb., 12.

Equipment Report: Rauland 1825 High-Fidelity Phono Amplifier; April, 25.

Feedback —, Considerations in the Design of; Herbert I. Keroes; I May, 14; II June, 17.

For Golden Ears Only; Joseph Marshall; Mar., 13.

Limiting —, Performance and Operation of a New; G. A. Singer; Nov., 18.

Loudspeaker Damping as Function of Plate Resistance of Output Tube; Donovan V. Geppert; Nov., 30.

Reduction in Output Impedance Obtained with Negative Feedback, (Chart); Willard F. Meeker; Feb., 23.

"Williamson" Type — Using 6A5's; J. H. Beaumont; Oct., 24.

### Amplifiers, Pre-

Audio Input System for the Discriminating Listener, An; Wayne B. Denny; Jan., 9.

Equalized — using Single-Stage Feedback; Lawrence Fleming; March, 24.

Phonograph Reproductions; (Audiana) C. G. McProud; I Feb., 24; II March, 20.

Analogs, Dynamical; (Audiana) Lewis S. Goodfriend; I Sept., 20; II Oct., 36.

Attenuator Calculator using Vector Slide Rule. Rapid; A. E. Richmond; Dec., 19.

### Audiana

Construction Practice; C. G. McProud; friend; I Sept., 20; II Oct., 36.

Dynamical Analogs; Lewis S. Goodfriend; I Sept., 20; II Oct., 26.

Equivalent Circuits; Lewis S. Goodfriend; Aug., 20.

High Fidelity; Lewis S. Goodfriend; I Nov., 32; II Dec., 31.

Miller Effects, The; Lewis S. Goodfriend; July, 28.

Phonograph Reproduction; C. G. McProud; I Feb., 24; II March, 20.

Recording Characteristics; C. G. McProud; II, Jan., 20.

Audio in England; H. A. Hartley; I Jan., 42; II Nov., 36.

### Audio Fair, The

Directory of Exhibitors; Oct., 32. Review; Dec., 24.

### Broadcasting

Frequency-Controlled Rotary Converters; Robert W. Carter; June, 18.

Remote Installations; Elliott D. Full; Oct., 18.

Cabinets for Home Use, Readers' Sug-

gestions; March, 19.

Cathode Follower Output Stage, The; Robert M. Mitchell; Feb., 12.

### Charts

Hygrometric Chart, A New; "Stylus"; April, 24.

Reduction in Output Impedance Obtained with Negative Feedback; Willard F. Meeker; Feb., 23.

Resonant Loudspeaker Enclosures; Bob Hugh Smith; Dec., 22.

Reverberation-Time Calculation, Simplified; Lewis S. Goodfriend; May, 20.

Wavelength for Air; Lewis S. Goodfriend; Oct., 34.

### Components

Frequency Controlled Rotary Converters; Robert W. Carter; June, 18.

Optimum Use of Nickel Alloy Steels in Low-level Transformers; L. W. Howard; Oct., 20.

Construction Practice; C. G. McProud; I April, 26; II May, 19; III June, 26.

### Controls

Overcoming Fletcher-Munson Effects; Nathan Grossman and Meyer Leifer; April, 22.

Continuously Variable Loudness —; E. E. Johnson; Dec., 18.

Equipment Report: Rauland 1825 High-Fidelity Phono Amplifier; April, 25.

Filter Characteristics, Measurement of High-Pass; Werner E. Neuman; Feb., 14.

Flewelling Audio System, The; E. T. Flewelling; Nov., 15.

Hearing Aid Trends; F. Hardwick; June, 23.

High Fidelity (Audiana); Lewis S. Goodfriend; I Nov., 32; II Dec., 34.

Imagery for Describing Reproduced Sound; Vincent Sahnou; I Aug., 14; II Sept., 14.

Intermodulation Measurements, Simplified; John M. van Beuren; Nov., 21.

### Loudness Controls

Continuously Variable —; E. E. Johnson; Dec., 18.

Overcoming Fletcher-Munson Effects; Nathan Grossman and Meyer Leifer; April, 22.

### Loudspeakers

Adventure in Loudspeaker Design, An; Howard T. Souther; June, 14.

Crossover Network for Unequal Voice-Coil Impedances; Watson F. Walker; July, 14.

Design, Construction, and Adjustment of Reflexed Cabinets; David W. Worden; Dec., 15.

— for the Range from 5 to 20 kc, A; B. H. Smith and W. T. Selsted; Jan., 16.

New — of Advanced Design, A; Daniel J. Plach and Philip B. Williams; Oct., 22.

Resonant — Enclosures, (Chart); Bob Hugh Smith; Dec., 22.

Sensitivity, Directivity, and Linearity of Direct Radiator —; Harry F. Olson; Oct., 15.

Symmetrical Corner —, A; W. E. Gilson and J. J. Andrea; Mar., 16.

Transient Testing of —; Murlan S. Corrington; Aug., 9.

### Measurements

Audio Frequency Phasemeter, An Improved; O. E. Kruse and R. B. Watson; Feb., 9.

Determining the Tracking Capabilities of A Pickup; H. E. Roys; May, 11.

Determining Unknown Impedances in Transformers; L. H. Hippe; Dec., 21.

Distortion and Noise Meter, Fixed-Filter Type; J. P. Smith; Nov., 22.

Filter Characteristics, — of High-Pass; Werner E. Neuman; Feb., 14.

Impedance "Jig", An; Allen W. Smith; March, 18.

Intermodulation —, Simplified; John M. van Beuren; Nov., 24.

Intermodulation Analyzer for Audio Systems, An; Roy S. Fine; July, 11.

Phase-Shift Method of Measuring Flutter; Charles A. Hisserich and Arthur Davis; July, 15.

Simple Stroboscopes; L. B. Hedge; Aug., 22.

Transient Testing of Loudspeakers; Murlan S. Corrington; Aug., 9.

White Noise Generator for Audio Frequencies; J. M. Gottschalk; May, 16.

White-Noise Testing Methods; Emory Cook; March, 13.

### Microphones

Bantam Velocity —, The; L. J. Anderson and L. M. Wigington; Jan., 12.

KB-3A High-Fidelity Noise-Cancelling —, The; L. J. Anderson and L. M. Wigington; April, 16.

Unobtrusive Pressure —; Harry F. Olson and John Preston; July, 18.

Miller Effect, The (Audiana); Lewis S. Goodfriend; July, 28.

Motion Pictures, Magnetic Recording in; M. Rettinger; I March, 9; II April, 18.

### Negative Feedback

Considerations in the Design of — Amplifiers; Herbert I. Keroes; I May, 14; II June, 17.

Reduction in Output Impedance Obtained with, (Chart); Willard F. Meeker; Feb., 23.

Networks, Crossover, for Unequal Voice-Coil Impedances; Watson F. Walker; July, 14.

### Noise

Longitudinal — in Audio Circuits (AES Paper); H. W. Augustadt and W. F. Kannenberg; I Jan., 22; II Feb., 18.

White-Noise Generator for Audio Frequencies; J. M. Gottschalk; May, 16.

White-Noise Testing Methods; Emory Cook; March, 13.

P. A. Systems, Aircraft; George H. Warfel; Jan., 19.

Patent Infringement and the Home Experimenter; Albert E. Hayes, Jr.; June, 28.

Phasemeter, An Improved Audio-Frequency; O. E. Kruse and R. B. Watson; Feb., 9.

Phonograph Records, The Best British of 1949; H. A. Hartley; Nov., 38.

### Phonograph Reproduction

Determining the Tracking Capabilities of a Pickup; H. E. Roys; May, 11.

— (Audiana); C. G. McProud; I Feb., 24; II March, 20.

Diamond As a Phonograph Stylus Material; (AES Paper) E. J. and M. V. Marcus; July, 25.

### Psycho Acoustics

Controversial Idea from England; P. G. A. H. Voigt; Oct., 40.

### Recording, Disc

Columbia Hot-Stylus Recording Technique, The; William S. Bachman; June, 11.

Heated Stylus Recording Technique (AES); Leon A. Wortman; July, 24.

New Technique for Reducing Distortion in Sound Recording; Caldwell P. Smith; April, 28.



Recording Characteristics (Audiana); C. G. McProud; I Jan., 20.  
 Recording and Fine-Groove Technique; H. E. Roys: Sept., 11.  
**Recording, Magnetic**  
 Art of Tape Recording, The; Joel Tall; I May, 13; II June, 20; III July, 22; IV Aug., 16; V Sept., 15.  
 ——— of Meter Data; R. E. Zenner; Feb., 16.

Anderson, L. J. and Wigington, L. M.  
 Bantam Velocity Microphone, The; Jan., 12.  
 KB-3A High-Fidelity Noise-Cancelling Microphone, The; April, 16.  
 Andrea, J. J. and Gilson, W. E.  
 Symmetrical Corner Speaker, A; March, 16.  
 Augustadt, H. W. and Kannenberg, W. F.  
 Longitudinal Noise in Audio Circuits (AES); I Jan., 22; II Feb., 18.  
 Bachman, William S.  
 Columbia Hot-Stylus Recording Technique, The; June, 11.  
 Beaumont, J. H.  
 "Williamson" Type Amplifier Using 6A5's; Oct., 24.  
 Beranek, Leo L.  
 Speech Communication Conference at M. I. T. (Report); July, 21.  
 Blakesley, Jay  
 Performance Plus Economy Tape Recorder; Nov., 20.  
 Carter, Robert W.  
 Frequency-Controlled Rotary Converters; June, 18.  
 Cook, Emory  
 White-Noise Testing Methods; March, 13.  
 Corrington, Murlan S.  
 Transient Testing of Loudspeakers; Aug., 9.  
 Davls, Arthur and Hisserich, Charles A.  
 Phase-Shift Method of Measuring Flutter; July, 15.  
 Denny, Wayne B.  
 An Audio Input System for the Discriminating Listener; Jan., 9.  
 Fine, Roy S.  
 Intermodulation Analyzer for Audio Systems, An; July, 11.  
 Fleming, Lawrence  
 Equalized Pre-Amplifier Using Single-Stage Feedback; March, 24.  
 Flewelling, Edmund T.  
 Flewelling Audio System, The; Nov., 16.  
 Full, Elliott D.  
 Remote Installations; Oct., 18.  
 Geppert, Donovan V.  
 Loudspeaker Damping as a Function of the Plate Resistance of the Power Output Tube; Nov., 30.  
 Gilson, W. E. and Andrea, J. J.  
 Symmetrical Corner Speaker, A; March, 16.  
 Goodfriend, Lewis S.  
 Dynamical Analogies (Audiana); I Sept., 20; II Oct., 36.  
 Equivalent Circuits (Audiana); Aug., 20.  
 High Fidelity (Audiana); I Nov., 32; II Dec., 34.  
 Miller Effect, The (Audiana); July, 28.  
 Reverberation-Time Calculation, Simplified (Chart); May, 20.  
 Wavelength for Air (Chart); Oct., 24.  
 Gottschalk, J. M.  
 White-Noise Generator for Audio Frequencies; May, 16.  
 Grossman, Nathan and Leifer, Meyer  
 Overcoming Fletcher-Munson Effects; April, 22.  
 Hardwick, F.  
 Hearing Aid Trends; June, 23.  
 Hartley, H. A.

——— in Motion Pictures; M. Rettinger; I March, 9; II April, 18.  
 New Technique for Reducing Distortion in Sound Recording; Caldwell P. Smith; April, 28.  
 Performance plus Economy Tape Recorder; Jay Blakesley; Nov., 20.  
 Reverberation-Time Calculation, Simplified (Chart); Lewis S. Goodfriend; May, 20.

## AUTHOR INDEX

Audio In England; I Jan., 42; II Nov., 36.  
 Best British Records of 1949; Nov., 38.  
 Hathaway, J. L.  
 Automatic Audio Gain Controls (AES); I Sept., 16; II Oct., 27.  
 Hayes, Albert E., Jr.  
 Patent Infringement and the Home Experimenter; June, 28.  
 Hedge, L. B.  
 Simple Stroboscopes; Aug., 22.  
 Hippe, L. H.  
 Determining Unknown Impedances in Transformers; Dec., 21.  
 Hisserich, Charles A. and Davis, Arthur  
 Phase-Shift Method of Measuring Flutter; July, 15.  
 Howard, L. W.  
 Optimum Use of Nickel Alloy Steels in Low-Level Transformers; Oct., 20.  
 Johnson, E. E.  
 Continuously Variable Loudness Control; Dec., 18.  
 Kannenberg, W. F. and Augustadt, H. W.  
 Longitudinal Noise and Audio Circuits (AES); I Jan., 22; II Feb., 18.  
 Keroes, Herbert I.  
 Considerations in the Design of Feedback Amplifiers; I May, 14; II June, 17.  
 Kruse, O. E. and Watson, R. B.  
 Audio Frequency Phasemeter, An Improved; Feb., 9.  
 Leifer, Meyer and Grossman, Nathan  
 Overcoming Fletcher-Munson Effects; April, 22.  
 Lode, Tenny  
 Stereophonic Reproduction; Jan., 15.  
 McProud, C. G.  
 Construction Practice (Audiana); I April, 26; II May, 19; III June, 26.  
 Phonograph Reproduction (Audiana); I Feb., 24; II March, 20.  
 Recording Characteristics (Audiana); I Jan., 20.  
 Marcus, E. J. and M. V.  
 Diamond as a Phonograph Stylus Material, The; July, 25.  
 Marshall, Joseph  
 For Golden Ears Only; March, 13.  
 Mecker, Willard F.  
 Reduction in Output Impedance Obtained with Negative Feedback (Chart); Feb., 23.  
 Mitchell, Robert M.  
 Cathode Follower Output Stage, The; Feb., 12.  
 Neuman, Werner E.  
 Measurement of High-Pass Filter Characteristics, The; Feb., 14.  
 Olson, Harry F.  
 Sensitivity, Directivity, and Linearity of Direct Radiator Loudspeakers; Oct., 15.  
 Olson, Harry F. and Preston, John  
 Unobtrusive Pressure Microphone; July, 18.  
 Plach, Daniel J. and Williams, Philip B.  
 New Loudspeaker of Advanced Design, A; Oct., 22.  
 Preston, John and Olson, Harry F.  
 Unobtrusive Pressure Microphone; July, 18.  
 Rettinger, M.  
 Magnetic Recording in Motion Pictures; I March, 9; II April, 18.  
 Richmond, A. E.  
 Rapid Attenuator Calculator using Vec-

tor Slide Rule; I Dec., 20.  
 Roys, H. E.  
 Determining the Tracking Capabilities of a Pickup; May, 11.  
 Recording and Fine-Groove Technique; Sept., 11.  
 Salmon, Vincent  
 Imagery for Describing Reproduced Sound; I Aug., 14; II Sept., 14.  
 Schneider, Arthur W.  
 Sound Reinforcing Systems (AES); Nov., 27.  
 Selsted, W. T. and Smith, B. H.  
 Loudspeaker for the Range from 5 to 20 kc. A; Jan., 16.  
 Sliger, G. A.  
 New Limiting Amplifier, Performance and Operation of a; Nov., 18.  
 Smith, Allen W.  
 An Impedance "Jig"; March, 18.  
 Smith, Bob Hugh  
 Resonant Loudspeaker Enclosures (Chart); Dec., 22.  
 Smith, Bob Hugh and Selsted, W. T.  
 Loudspeaker for the Range from 5 to 20 kc. A; Jan., 16.  
 Smith, Caldwell P.  
 New Technique for Reducing Distortion in Sound Recording; April, 28.  
 Smith, J. P.  
 Fixed-Filter Type Distortion and Noise Meter; Nov., 22.  
 Sonthier, Howard T.  
 Adventure in Loudspeaker Design, An; June, 14.  
 "Stylus"  
 Hygrometric Chart, New; April, 24.  
 Tall, Joel  
 Art of Tape Recording, The; I May, 13; II June, 20; III July, 22; IV Aug., 16; V Sept., 15.  
 Tanner, Robert H.  
 Impact of Acoustics on Music, The; Nov., 21.  
 van Beuren, John M.  
 Simplified Intermodulation Measurements; Nov., 24.  
 Volgt, P. G. A. H.  
 Controversial Idea from England, A; Oct., 40.  
 Walker, Watson F.  
 Crossover Network for Unequal Voice-Coil Impedance; July, 14;  
 Warfel, George H.  
 Aircraft P. A. System; Jan., 19.  
 Watson, R. B. and Kruse, O. E.  
 Audio Frequency Phasemeter, An Improved; Feb., 9.  
 Wigington, L. M. and Anderson, L. J.  
 Bantam Velocity Microphone, The; Jan., 12.  
 KB-3A High-Fidelity Noise-Cancelling Microphone, The; April, 16.  
 Williams, Philip B. and Plach, Daniel J.  
 New Loudspeaker of Advanced Design, A; Oct., 22.  
 Worden, David W.  
 Design, Construction, and Adjustment of Reflexed Cabinets; Dec., 15.  
 Wortman, Leon A.  
 Heated Stylus Recording Technique (AES); July, 21.  
 Zenner, R. E.  
 Magnetic Recording of Meter Data; Feb., 16.

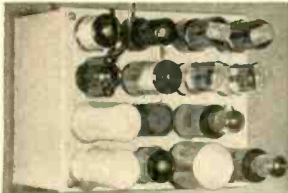

20 W-2 Amplifier \$149.50



AE-2 Equalizer PreAmp \$74.50

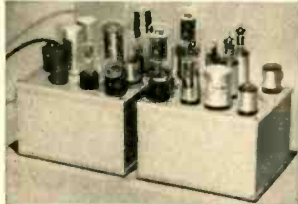

50 W-2 Amplifier \$249.50

# McIntosh

Engineering Laboratory, Inc.  
910 King St. Silver Spring, Md.  
Prices Subject to Change Without Notice.

## THE POWER OF THE PRESS AND THE SPEAKER

This ad marks the end of the second year of our regular advertising in A.E. Next month will mark the beginning of the third. Those two years have resulted in the 215 speaker becoming an accepted feature of the American way of living. Two reasons contribute to this success.

First, the ability of this magazine to get into the hands of men who do understand audio engineering. We have utilized the power of the press to bring an honest message to thinking readers. Secondly, the ability of this company to make better speakers, for the best sales story in the world is futile unless the goods are there to back up the promised performance.

The 215 has that performance. In the words of a new customer: "I had a chance to hear the Hartley-Turner speaker with very good amplifiers and pickups. I found it far better than three U.S. speakers priced up to \$90.00. I am a musician and think I know good tone quality. I do not like speakers that scream high fidelity with every note, or that remind you of curves and graphs instead of tone. Without intent to flatter, I must say I was amazed and delighted with the Hartley-Turner. It was very poorly mounted and still sounded well."

We have nothing more to say just now except that we should like to send a Christmas card to the thousands of new friends we have made since we first told you about ourselves. Alas, we haven't the clerical staff to get them over to you in time, so now, if that will serve instead, we wish you all a very merry Christmas and the best of luck in the new year.

**H. A. HARTLEY CO. LTD.,**  
152, Hammersmith Road,  
London W6, England

## ADVERTISING INDEX

Acme	56
Air-Tone Sound & Recording Co.	43
Allied Radio Corp.	48
Altec Lansing Corp.	3, 8
Ampex Electric Corp.	13
Amperite Co., Inc.	58
Amplifier Corp. of America	59, 61
Arnold Engineering Co., The	5
Audak Co.	37
Audio Devices, Inc.	Cover 2
Audio Facilities Corp.	64
Audio Instrument Co.	59
Audio and Video Products Corp.	12
Barker Sound Reproducers	58
Bell Telephone Laboratories	11
British Industries Corp.	34
Browning Laboratories, Inc.	52
Cannon Electric Dev. Co.	V15
Chicago Transformer Div.	38
Cinema Engineering Co.	53
Classified Ads	60
J. Colbert	61
Concord Radio	58
Daven Co., The	Cover 3
Dorf, Richard H.	64
Duotone Co.	54
Electric Indicator Co.	59
Electro-Voice, Inc.	V2
Fairchild Recording Equipment Corp.	42
Fisher Radio Corp.	57
General Electric Co.	51
General Radio Co.	9
Gordon, Herman Lewis	64
Gray Research and Dev. Co., Inc.	41
Hartley, H. A., Co., Ltd.	64
Harvey Radio Co., Inc.	45
Heath Co.	35
Hollywood Sound Institute, Inc.	60
Hudson Radio & Television Corp.	53
Interstate Supply Co.	61
LeBel, C. J.	64
Magnecord, Inc.	39, 49
McIntosh Engineering Laboratory, Inc.	64
Measurements Corp.	57
Milo Radio & Electronics Corp.	61
Newcomb Audio Products Co.	58
Partridge Transformers, Ltd.	64
Permoflux Corp.	4
Pickering & Co., Inc.	11
Precision Electronics, Inc.	48
Presto Recording Corp.	33
Proctor Soundex Corp.	55
Professional Directory	60
RCA Service Co., Inc.	60
Radio Corp. of America	6, 7
Radio Shack Corp.	55
Reeves Soundcraft Corp.	40
Rek-O-Kut Co., Inc.	2
Savage Transformers Ltd.	59
Shure Brothers, Inc.	46
Tech Laboratories, Inc.	44
Televex	61
Terminal Radio Corp.	47
Transcriber Co.	61
Triad Transformer Mfg. Co.	1
U. S. Recording Co.	64
United Transformer Co.	Cover 4

## Partridge News

*Individually tested*  
**AUDIO TRANSFORMERS**  
to the 'WILLIAMSON'  
Specification

This range of 20 watt push-pull output transformers is intended for use in equipment reproducing the full audio frequency range with the lowest distortion. The design and measured performance is exactly as specified by Williamson in the "Wireless World" August 1949 (see also Audio Engineering November 1949). The transformer is available in a varied range (separate models suitable for KT66, 807 tubes, etc.) Performance assured by comprehensive testing procedure applied to each unit. Close limits set on shunt reactance at 50 cps., series reactance at 5 Kc/sec., d.c. resistances and interwinding insulation resistances at 2 K.V. This is the best possible transformer of its type (weight 14 lbs.) Our new technical data sheet is available and will be rushed to you by airmail upon application. The price of the quoted model is \$19.50. Postage, packing and insurance \$1.50 extra. We can guarantee immediate despatch.

## PARTRIDGE TRANSFORMERS LTD

Roebuck Road, Tolworth, Surrey, England

## BOUND VOLUMES 1950

Enter your order now for your copy of the 1950 bound volume of AUDIO ENGINEERING. For permanent reference, the bound volume is easier to store, easier to find things in, and it keeps your copies in mint condition throughout the years. The ideal way to keep these valuable issues.

**1950 Bound Volumes . . \$8.95**

## FOR 1951

A new offer, made now for the first time entitles you to subscribe or to renew your present subscription for one year at the cost of \$10.00, which includes a bound volume delivered to you around January 1, 1952. Each month you will receive AUDIO ENGINEERING—read it, cut out coupons to your heart's content, mark on the pages as much as you want. At the end of the year, you receive a fresh, new bound volume of 1951 issues which you can keep as a permanent record. Stop trying to keep each issue neat and clean—use it. Then, at the end of the year, you'll receive a completely new set—no creases, no dog-eared pages.

Dept. SV

**AUDIO ENGINEERING**

342 Madison Ave., New York 17, N.Y.



**POWER AND  
IMPEDANCE  
MEASUREMENTS**

# DAVEN

**OUTPUT POWER METERS**  
*of unexcelled accuracy and reliability*  
**have many applications**

TYPE OP-182



Impedance Range: 2.5 ohms to 20,000 ohms. Remains essentially resistive over frequency range of 30 to 10,000 cps. Accuracy  $\pm 5\%$ .

Power Range: 0.1 mw. to 50 watts in steps of 0.1 mw.

Indicating Meter: Calibrated from 0 to 50 milliwatts and from 0 to 17 db. —Zero level: 1mw.

Meter Multiplier: Will change reading of indicating meter by ratios of 0.1:1, 1:1, 10:1, 100:1, or decibel reading by -10, 0, +10, +20.

The DAVEN Output Power Meters are designed to measure the actual power delivered by an audio signal system to a given load. However, because of the characteristics of the circuit, they are admirably suited to other applications, namely:

1. Determination of Characteristic Impedance of an A.C. Source.
2. Effects of Load Variation on a Signal System.
3. Transmission Line Equalization Measurements.
4. Measurement of Insertion Loss in Multi-channel Mixer and other complex circuits.
5. Filter and Transformer Measurements.
6. Radio Receiver Measurements.

The equipment shown on this page is built to DAVEN'S well-known standards of precision. Please write for more detailed data. Let our engineering department help you on specific problems.

TYPE OP-962



Characteristics similar to OP-961, except that it can measure up to 100 watts.

Impedance Range: 40 selected impedances between 2.5 and 20,000 ohms. Accuracy  $\pm 2\%$  over frequency range 30 to 10,000 cycles.

Power Range: 0.1 mw to 100 watts in 0.1 mw steps. Range may be extended below 0.1 mw by use of external amplifier.

Indicating Meter: Calibrated from .01 watt to 1 watt and from -10 to +10 db. Zero level: 1mw.

Meter Multiplier: Extends range of meter from 0.01 to 100 times scale reading.

TYPE OP-961

Impedance Range: 2.5 ohms to 20,000 ohms. Remains essentially resistive over frequency range of 30 to 10,000 cps. Accuracy  $\pm 2\%$ .

Power Range: 0.1 milliwatts to 50 watts in steps of 0.1 milliwatts.

Indicating Meter: Calibrated from 1 to 50 milliwatts and 0 to 17 decibels. Zero level: 1mw.

Meter Multiplier: Extends the power reading of the indicating meter from 0.1x to 1,000x scale value, or the db. reading from -10 to +30 db. in steps of 2 db.



THE **DAVEN** CO.

185 CENTRAL AVENUE • NEWARK 4, NEW JERSEY



## PERMALLOY DUST TOROIDS FOR MAXIMUM STABILITY...

The UTC type HQ permalloy dust toroids are ideal for all audio, carrier and supersonic applications. HQA coils, Q over 100 at 5,000 cycles... HQB coils, Q over 200 at 4,000 cycles... HQC coils, Q over 200 at 30 KC... HQD coils, Q over 200 at 60 KC... HQE (miniature) coils, Q over 120 at 10 KC. The toroid dust core provides very low hum pickup... excellent stability with voltage change... negligible inductance change with temperature, etc. Precision adjusted to 1% tolerance. Hermetically sealed.



**HQA, HQC, HQD CASE**  
1 13/16" Dia. x 1 3/16" High



**HQB CASE**  
1 5/8" x 2 5/8" x 2 1/2" High



**HQE CASE**  
1 1/2" x 1 5/16" x 1 3/16" High

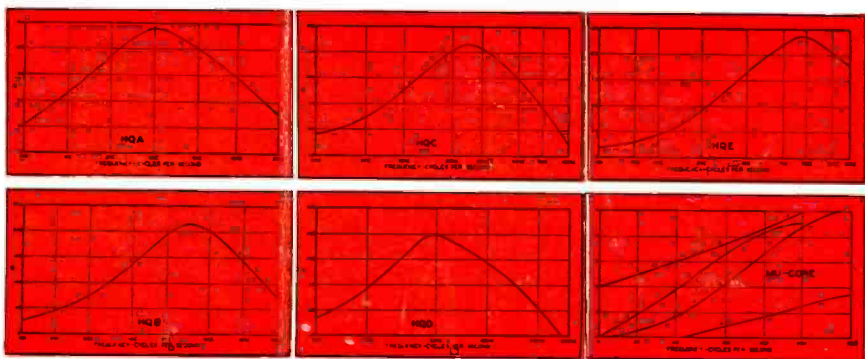

Type No.	Inductance Value	Net Price	Type No.	Inductance Value	Net Price	Type No.	Inductance Value	Net Price
HQA-1	5 mhy.	\$7.00	HQA-16	7.5 hy.	\$15.00	HQC-1	1 mhy.	\$13.00
HQA-2	12.5 mhy.	7.00	HQA-17	10. hy.	16.00	HQC-2	2.5 mhy.	13.00
HQA-3	20 mhy.	7.50	HQA-18	15. hy.	17.00	HQC-3	5 mhy.	13.00
HQA-4	30 mhy.	7.50	HQB-1	10 mhy.	16.00	HQC-4	10 mhy.	13.00
HQA-5	50 mhy.	8.00	HQB-2	30 mhy.	16.00	HQC-5	20 mhy.	13.00
HQA-6	80 mhy.	8.00	HQB-3	70 mhy.	16.00	HQD-1	.4 mhy.	15.00
HQA-7	125 mhy.	9.00	HQB-4	120 mhy.	17.00	HQD-2	1 mhy.	15.00
HQA-8	200 mhy.	9.00	HQB-5	.5 hy.	17.00	HQD-3	2.5 mhy.	15.00
HQA-9	300 mhy.	10.00	HQB-6	1. hy.	18.00	HQD-4	5 mhy.	15.00
HQA-10	.5 hy.	10.00	HQB-7	2. hy.	19.00	HQD-5	15 mhy.	15.00
HQA-11	.75 hy.	10.00	HQB-8	3.5 hy.	20.00	HQE-1	5 mhy.	6.00
HQA-12	1.25 hy.	11.00	HQB-9	7.5 hy.	21.00	HQE-2	10 mhy.	6.00
HQA-13	2. hy.	11.00	HQB-10	12. hy.	22.00	HQE-3	50 mhy.	7.00
HQA-14	3. hy.	13.00	HQB-11	18. hy.	23.00	HQE-4	100 mhy.	7.50
HQA-15	5. hy.	14.00	HQB-12	25. hy.	24.00	HQE-5	200 mhy.	8.00

## UTC INTERSTAGE AND LINE FILTERS



**FILTER CASE M**  
1 3/16" x 1 11/16"  
1 5/8" - 2 1/2" High

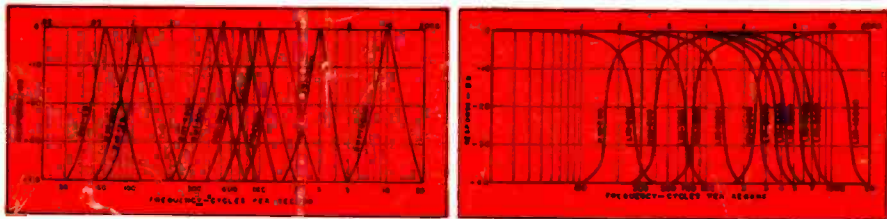

These U.T.C. stock units take care of most common filter applications. The interstage filters, BMI (band pass), HMI (high pass), and LMI (low pass), have a nominal impedance at 10,000 ohms. The line filters, BML (band pass), HML (high pass), and LML (low pass), are intended for use in 500/500 ohm circuits. All units are shielded for low pickup (150 mv/gauss) and are hermetically sealed.

**STOCK FREQUENCIES**  
(Number after letters is frequency)  
Net Price \$25.00

BMI-60	BMI-1500	LMI-200	BML-400
BMI-100	BMI-3000	LMI-500	BML-1000
BMI-120	BMI-10000	LMI-1000	HML-200
BMI-400	HMI-200	LMI-2000	HML-500
BMI-500	HMI-500	LMI-3000	LML-1000
BMI-750	HMI-1000	LMI-5000	LML-2500
BMI-1000	HMI-3000	LMI-10000	LML-4000
			LML-12000

*United Transformer Co.*

150 VARICK STREET NEW YORK 13, N. Y.  
EXPORT DIVISION: 13 EAST 40th STREET, NEW YORK 16, N. Y. CABLES: "ARLAB"