

AUDIO ENGINEERING

AUGUST
1950
35c

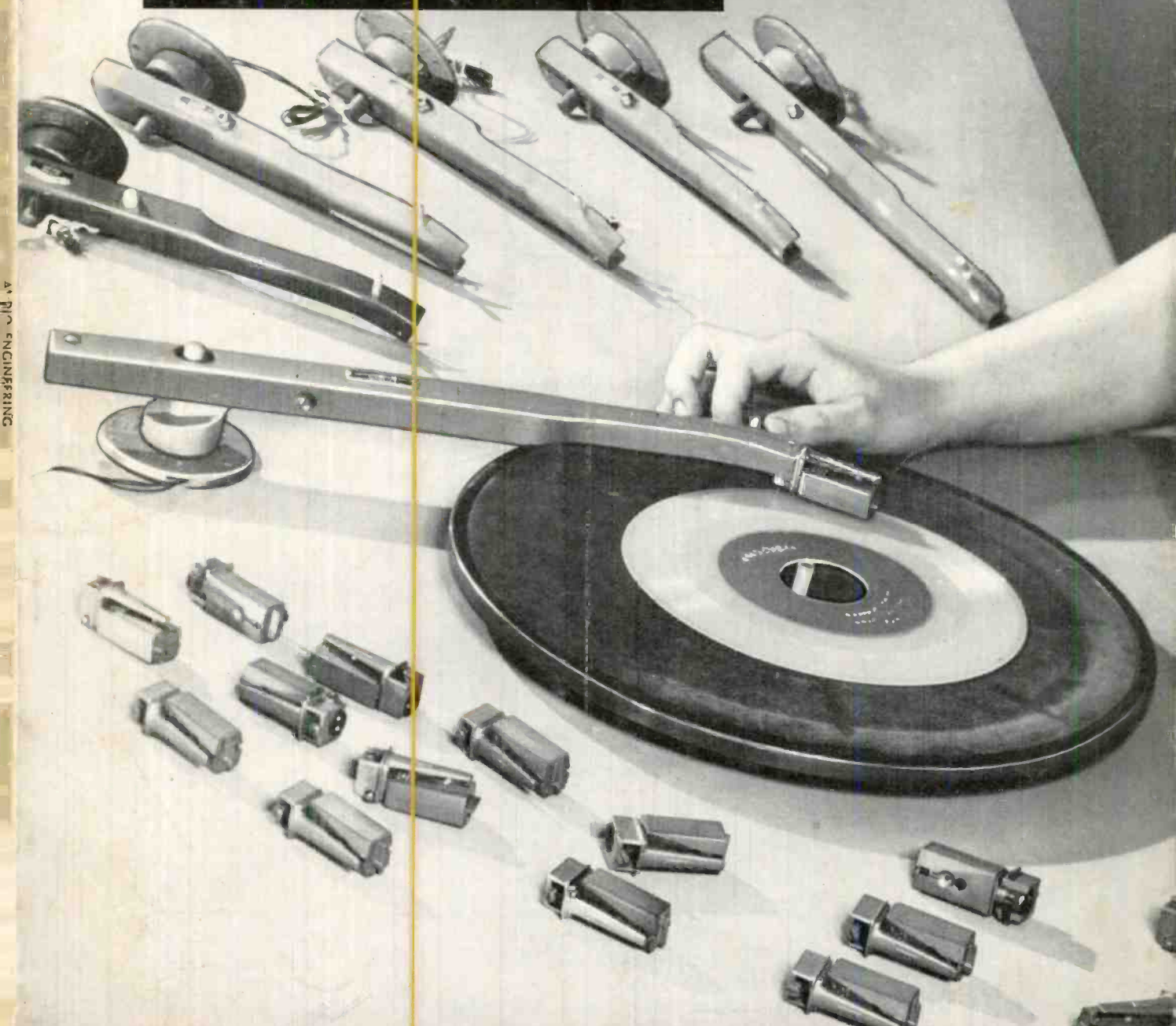

Published by RADIO MAGAZINES, INC.

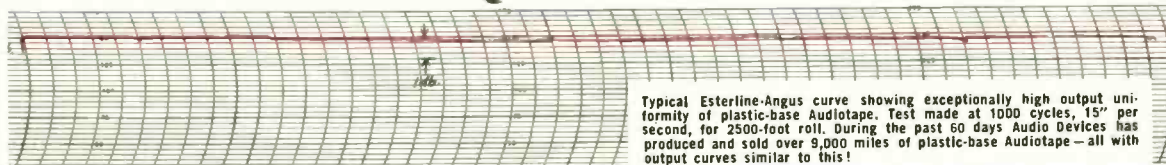

Typical Esterline-Angus curve showing exceptionally high output uniformity of plastic-base Audiotape. Test made at 1000 cycles, 15" per second, for 2500-foot roll. During the past 60 days Audio Devices has produced and sold over 9,000 miles of plastic-base Audiotape—all with output curves similar to this!

UNIFORMITY PLUS

that's what you get in every reel of

audiotape*

Unequalled uniformity of output volume is one of the outstanding advantages of Audiotape. This is especially important in professional work where shows are edited and assembled on tape. For even slight variations in output can become very objectionable when splicing brings high and low volume sections together.

Every 2500-foot reel of plastic-base Audiotape is *guaranteed* to have a volume deviation, at 1000 cps, of not more than $\pm 1/4$ db within the entire length—and not more than $\pm 1/2$ db from reel to reel. And these are *outside limits*, not averages. What's more, every 2500-foot reel is guaranteed to be en-

tirely free from splices!

This extremely high uniformity is made possible by Audio's specially designed coating machines, which permit control of coating thickness to within *five millionths* of an inch. During the past 60 days, these machines have turned out more than *9,000 miles* of plastic-base tape—with a volume deviation of not more than $\pm 1/2$ db!

Remember—when you use Audiotape, you can be *sure* of the results every time. For every foot of Audiotape is monitored for output, distortion and uniformity—your assurance of the finest, professional quality recording tape obtainable.

*Trade Mark

- **STRAIGHT-LINE SLITTING** that makes tape track and wind absolutely flat.
- **FREEDOM FROM CURL** that permits tape to maintain perfect contact with heads.
- **SMOOTH UNWINDING**, with no tendency to stick layer-to-layer.
- **NO FRICTION SQUEAL**. Smooth surface rides quietly over pressure blocks and tensioning devices.
- **LOW COST**. 2500-foot roll on NAB hub has list price of \$10—subject to Audio's usual discounts to professional users.
- **IMPROVED PACKAGING**. 2500 and 5000 foot rolls of Audiotape, on hub or complete reel, are boxed in special containers for easier and safer handling and storage. Folding inner section permits loading onto turntable without danger of spilling tape—also permits easy attachment of reel flanges on hub.

TEST IT—COMPARE IT

We will be glad to send you a free 200-foot sample reel of either plastic-base or paper-base Audiotape. It will speak for itself.

AUDIO DEVICES, INC.

444 MADISON AVE., NEW YORK 22, N. Y.

Export Dept.: ROCKE INTERNATIONAL, 13 East 40th St., New York 16, N. Y.

DELTAMAX *-now available!*

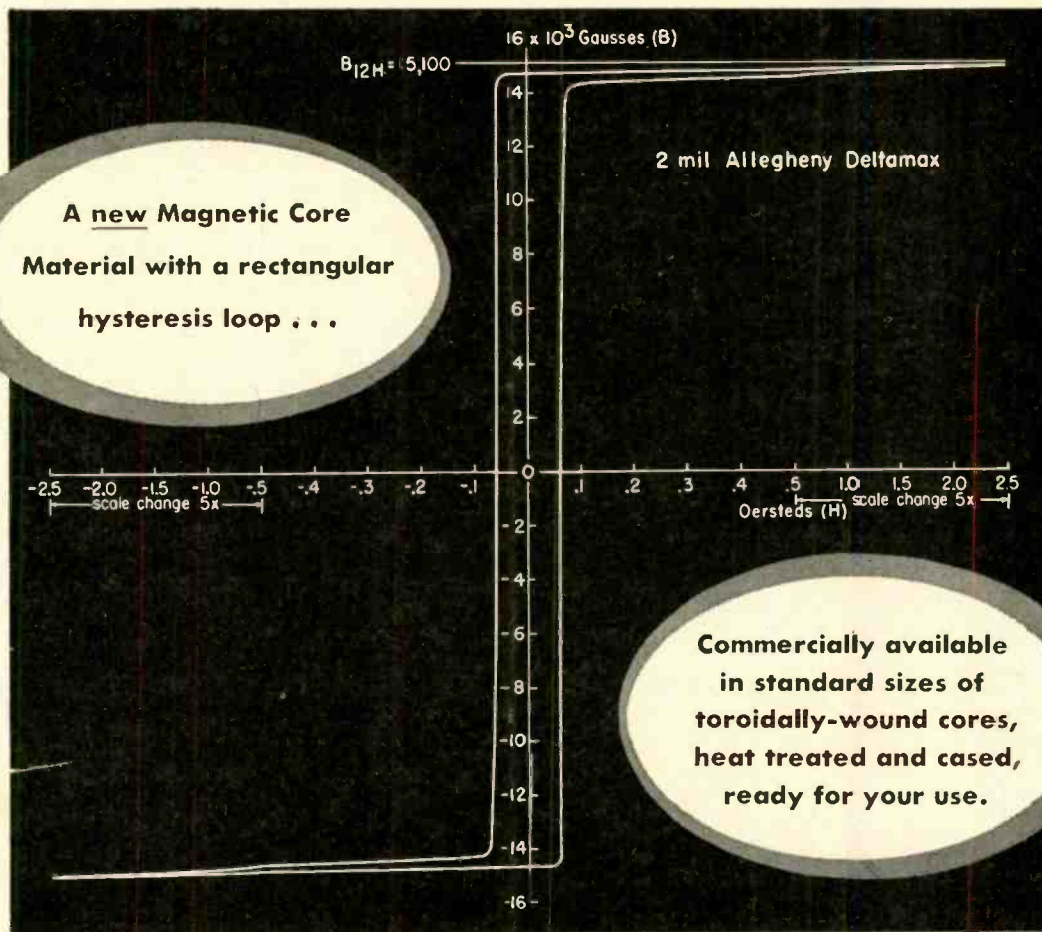

Where can YOU use a Magnetic Material with these specialized, dependable characteristics?

The properties of Deltamax are invaluable for many electronic applications, such as new and improved types of mechanical rectifiers, magnetic amplifiers, saturable reactors, peaking transformers, etc. This new magnetic material is available now as "packaged" units (cased cores ready for winding and final assembly) distributed by the Arnold organization. Every step in manufacture has been fully developed; designers can rely on

complete consistency in each standard size of core.

Deltamax is the most recent extension of the family of special, high-quality electrical materials produced by Allegheny Ludlum, steel-makers to the electrical industry. It is an orientated 50% nickel-iron alloy, characterized by a rectangular hysteresis loop with sharply defined knees, combining high saturation with low coercivity.

● *Call on us for technical data.*



THE ARNOLD ENGINEERING COMPANY

SUBSIDIARY OF ALLEGHENY LUDLUM STEEL CORPORATION
147 EAST ONTARIO STREET, CHICAGO 11, ILLINOIS

W&D 2379

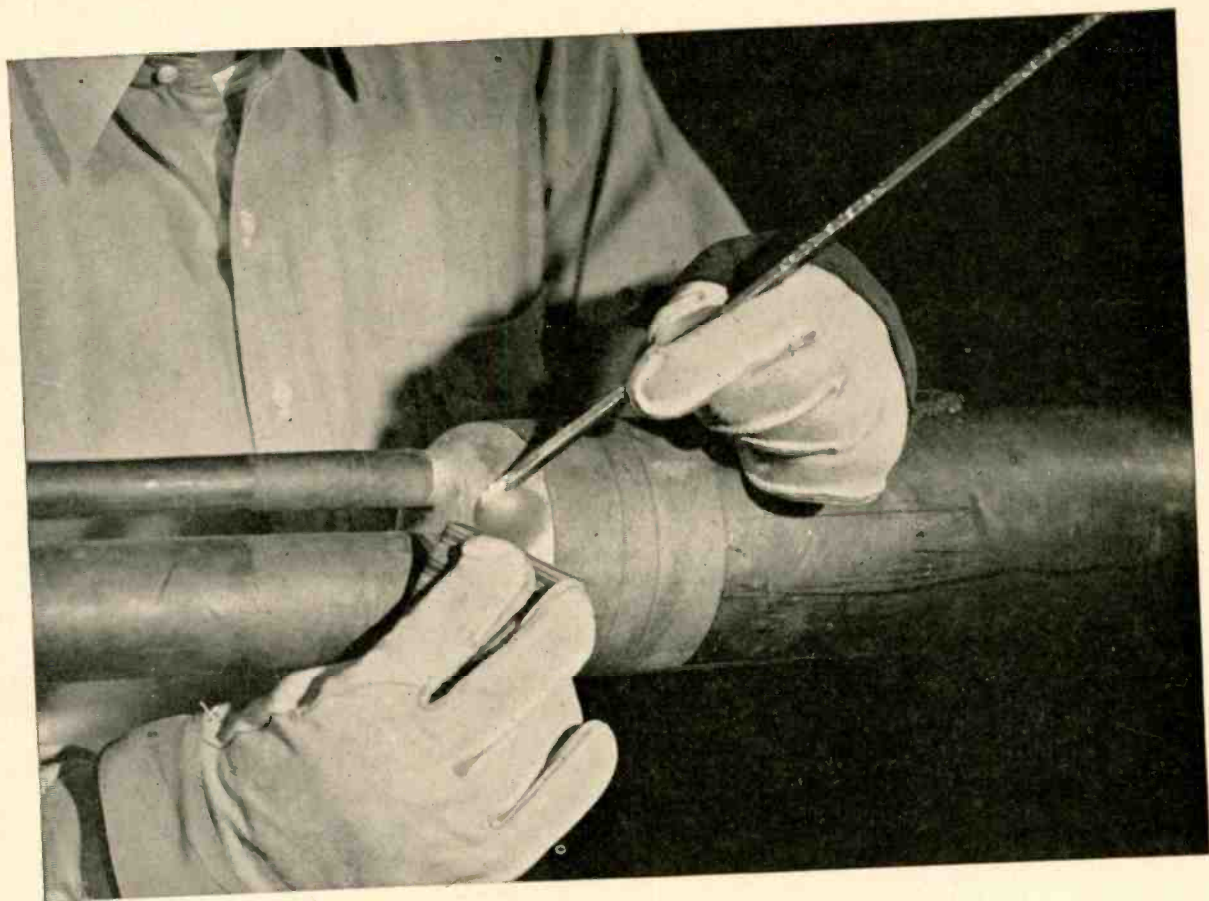

*He seals out
trouble...*

**TO KEEP THE COST
OF YOUR TELEPHONE
SERVICE DOWN**

To make cable joints tight and strong, splicers formerly used lots of solder. Then, Bell Telephone Laboratories developed a new technique for making better joints with much less solder. This saves one million pounds of solder a year — helps keep the price of your telephone service low.

Two kinds of solder are now used. One makes the splice strong; the other seals it. First, the splicer builds up a joint with a solder of lead and tin, which flows easily under his wiping cloth. To seal the joint, he applies a light coating of low-melting-point solder, composed of lead, tin and bismuth. On contact with the still hot joint, it flows into and seals every pore.

Cable-sealing solder is only one of 30 low-melting-point alloys which Bell metallurgists have developed for special uses — in fuse wires, for example, and in the solder connecting hair-like wires to piezoelectric crystals for electric wave filters.

Continuing research with a substance seemingly as commonplace as solder demonstrates again how Bell scientists help keep your telephone service the world's best.

BELL TELEPHONE LABORATORIES



• WORKING CONTINUALLY TO KEEP YOUR TELEPHONE
SERVICE BIG IN VALUE AND LOW IN COST

AUDIO ENGINEERING • AUGUST, 1950

Transient Testing of Loudspeakers

MURLAN S. CORRINGTON*

A discussion of the relation between the sound-pressure curve of a loudspeaker and the transient response to a suddenly-applied unit sine wave, supported by photographs and oscillograms.

IT IS KNOWN from the theory of linear dynamic systems of minimum-net-phase-shift type that the amplitude response, the phase characteristic, and the transient response to various applied wave forms are merely equivalent ways of observing the same inherent performance of the circuit.^{1,2} Any one of the three can be used to compute either of the other two. The labor of this computation is often great and is seldom attempted. If one had enough experience and were a keen observer, any one test would be adequate.

Many people use sound pressure curves to measure loudspeaker performance, and some laboratories now use transient tests also.³⁻¹⁶ In the reproduction of speech and music, it is important that the sound start and build up as fast as the original, and when the signal ends the speaker should also stop. Thus when the hammer hits the string of a piano, the sound starts suddenly as the energy of the impact causes the string to vibrate. The loudspeaker must be able to start suddenly also, and when the damper comes down on the string at the

end of the note, the loudspeaker must stop suddenly.

One test which is used to observe this performance is to apply a sine wave suddenly to the voice coil of the speaker and to observe the sound pressure with a microphone in front of the speaker on the axis. After a short time the applied sine wave is suddenly reduced to zero. The build-up and decay of the sound pressure is then observed on an oscilloscope. In many cases these results are confusing, because of lack of experience in interpreting the curves. Very little theory has been given in the literature to explain the effect of peaks and valleys in the sound pressure curve on the transient. This paper has three purposes. First there will be presented the theory of ringing of such a circuit when a signal is suddenly applied, and next it will be shown exactly how each peak contributes to the transient. Finally, a conventional 12-inch speaker will be used to show how the cone breaks up into symmetrical and asymmetrical resonant modes, and also the transient performance at each of the selected frequencies.

Theory

We shall begin the theory by taking a sound pressure curve having two peaks near the high-frequency cutoff of the

speaker, as shown by Fig. 1. The frequency has been normalized to unity at cutoff by dividing by the cutoff frequency ω_0 . Thus, if $\omega_0 = 10,000$ cps, for example, the first peak occurs near 5000 cps and the second at 10,000 cps. To simplify the interpretation, the low-frequency end is assumed flat. After this simplified case is thoroughly understood, it is easy to generalize to the more complicated curve of an actual speaker. It

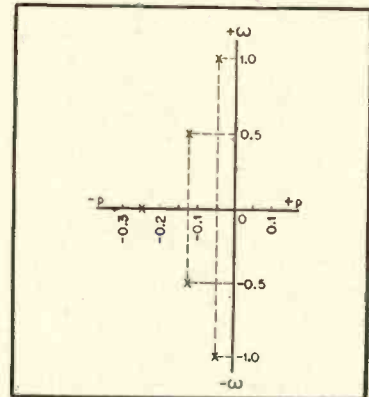

Fig. 2. Pole locations in complex frequency plane for a typical loudspeaker.

will be assumed that the loudspeaker is a minimum-net-phase-shift network. This may not be strictly true at high frequencies when cone breakup may cause cancellation at a point, but appears to be true for piston action.

The locations of the poles in the complex frequency plane can be determined by noting that the maxima are near frequencies zero, 0.5, and 1.0. The Q 's are different, and the pole at zero frequency is low Q , the one at 0.5 is higher, and the one at 1.0 is highest. This is easily decided by noting the width of the resonant peaks. The exact pole location can be found by using a probe in an electrolytic tank, by stretching a rubber sheet over some vertical posts, or by trial and error.¹⁷⁻¹⁹ For the curve of Fig. 1, they are located at the points shown by Fig. 2. Although the curve is

* Home Instrument Department, RCA Victor Division, Camden, N. J.
Paper delivered at the first National Convention of the Audio Engineering Society, New York City, October 29, 1949.

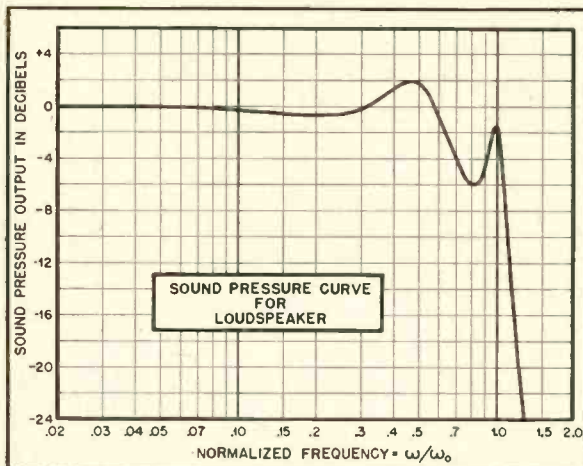

Fig. 1. Sound pressure curve for a loudspeaker.

for a loudspeaker, these results apply to any other linear system, such as pickups, electrical networks, microphones, etc.

All of the poles are in the left half of the p -plane. There is one on the axis at $p = -.25$, corresponding to the maximum in the sound-pressure curve at zero frequency. A conjugate pair occurs at $-.125 \pm 0.5i$ corresponding to the peak at frequency 0.5, and a second conjugate pair occurs at $-.05 \pm i$, corresponding to the high-frequency peak at unity.

Since there are five poles and no zeros, the impedance function is easily found, as shown by equation (1).

$$Z = \frac{1}{[p + .25] [(p + .125)^2 + .25] [(p + .05)^2 + 1]} \quad (1)$$

The first bracket corresponds to the pole at $p = -.25$. The second bracket is obtained from the conjugate pair of poles at $p = -.125 \pm 0.5i$ as is readily seen, and the third bracket is obtained from the second conjugate pair of poles at $p = -.05 \pm i$.

The transient response to a unit impulse, which is a spike of current of infinite height and zero duration, having unit area under the curve, corresponds to the transient generated by a noise pulse. This result can be obtained from the Heaviside expansion theorem,²⁰ by expanding in partial fractions and applying the inverse Laplace transform term by term,²¹ or by evaluating the required contour integrals.²² It is shown by equation (2).

Transient response to unit impulse

$$= (-.4984 \sin t + 1.1913 \cos t) e^{-.05t} + (1.7231 \sin \frac{1}{2}t - 4.8112 \cos \frac{1}{2}t) \times e^{-.185t} + 3.6199 e^{-.25t} \quad (2)$$

The equation shows, in the first line, that the pole at $p = -.05 \pm i$ causes ringing at the pole frequency, at $\omega/\omega_0 = 1$, and has a damping factor corresponding to the distance of the pole from the real frequency axis, $p = -.05$. The higher the Q , the nearer the pole is to the axis. For

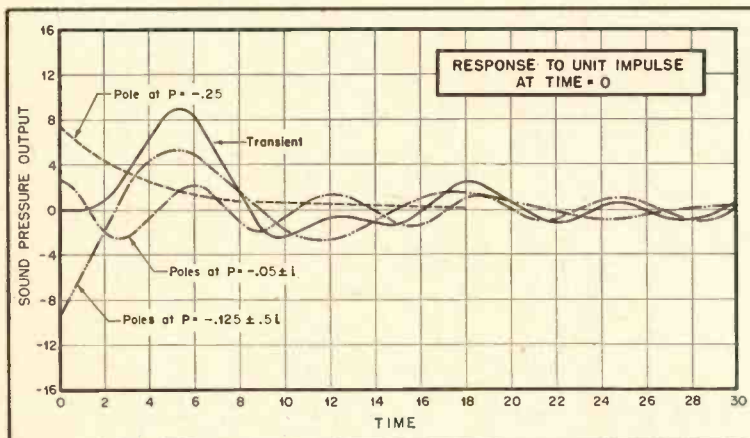

Fig. 3. Transient response to a unit impulse of a sine-wave signal.

example, in an ordinary series-loaded parallel-resonant circuit this distance is $-\frac{\omega_0}{2Q}$, where ω_0 is the resonant frequency.

The second line shows the ringing caused by the pole at $p = -.125 \pm 0.5i$, and the third line is the ringing at zero frequency, which is an ordinary decay curve.

The coefficients are determined by the pole locations and moving any one pole affects all the coefficients.

The curve of the impulse response is shown by Fig. 3. It starts slowly from zero, builds up to the first maximum, and then decreases toward zero, oscillating about the zero axis. The two transients of frequency 0.5 and 1.0 are beating to-

Another way is to multiply the operational form of the impedance by the operational form of the desired applied wave form, and to find the inverse Laplace transform of the product.²¹

This latter method can be explained more easily in terms of spectra. By means of the Fourier transform or the Laplace transform it is known that the transform of a suddenly-applied unit

sine wave $\sin \omega_0 t$ is $\frac{\omega_0}{\omega_0^2 - \omega^2}$. This result

is equivalent to the amplitude and phase of the spectral density. For a wave of frequency one half the spectral distribution is as shown by Fig. 4. The curve rises smoothly from 2 at zero frequency, approaching infinity at frequency one

Fig. 4. Variation of spectral density with applied frequency.

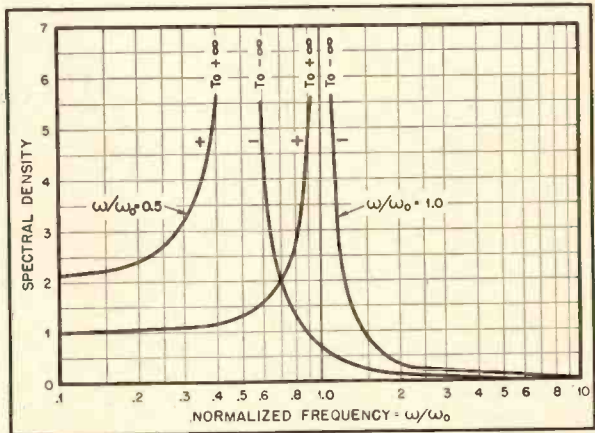

gether. The components of the transient are shown. The one due to the pole at $-.125 \pm 0.5i$ is the dominant one, but the one at $-.05 \pm i$ dies out more slowly. The usual broadening of a pulse by the tuned circuits is evident.

Starting from the impulse response, the response to any other applied wave form can be obtained by applying the convolution or superposition theorem.^{20, 21}

half. At this point the phase shifts 180 deg., and the amplitude then rises smoothly from minus infinity toward zero. If the applied frequency is raised to unity, the shape is similar, as shown. To find the transient response at a given instant, this spectral density is modified in amplitude and phase in accord with the selectivity curve of Fig. 1.

It is easy to see that if the points of high spectral density are near to a peak in the response curve of Fig. 1, a great deal of energy will be impressed on the network at this frequency. The circuit will ring strongly at the frequency corresponding to the peak.

As an example of this theory, apply the unit sine wave to the two peaks of Fig. 1. When this is done, the response is as shown by the following two equations.

Transient response to suddenly applied unit sine wave at $\omega/\omega_0 = 0.5$

$$= -16.325 \sin \frac{1}{2}t - 9.383 \cos \frac{1}{2}t + (0.223 \sin t - 0.827 \cos t) e^{-.05t} + (19.797 \sin \frac{1}{2}t + 4.418 \cos \frac{1}{2}t) \times e^{-.185t} + 5.792 e^{-.25t} \quad (3)$$

Response at $\omega/\omega_0 = 1.0$

$$= 10.332 \sin t + 7.039 \cos t - (12.030 \sin \frac{1}{2}t + 4.683 \cos \frac{1}{2}t) e^{-.05t} + (3.191 \sin \frac{1}{2}t - 5.763 \cos \frac{1}{2}t) \times e^{-.125t} + 3.407 e^{-.25t} \quad (4)$$

Equation (3) corresponds to the first peak in the sound pressure curve, and equation (4) corresponds to the peak at frequency 1.0. The first line of each equation gives the steady-state term.

It should be noted that the peak nearer in frequency to that of the applied wave causes the stronger ringing, but both are present. As the frequency of the suddenly applied wave moves from the lower peak toward the other, the transient caused by the first pair of poles becomes weaker, and the other transient becomes stronger. The decay curve due to the pole at the origin becomes weaker as the frequency of the applied wave moves away from this pole. The amplitudes of these transient components, for varying applied frequency, are shown by Fig. 5. The closer the applied frequency is to a peak in the response curve, the stronger this peak will ring.

The response due to a suddenly applied unit sine wave at frequency 0.5, corresponding to equation (3), is shown by Fig. 6. The transient starts out slowly, due to the time required for the signal to pass through the network, reaches the first maximum, and then oscillates about the zero axis, rapidly approaching the amplitude and phase of the steady-state curve. The transient due to the pole at the same frequency as the applied sine wave is very strong, being nearly as high as the steady-state curve at the first maximum, but it dies out rapidly due to the heavy damping. The transient due to the higher frequency pole is weak, but dies out slowly.

When the frequency of the suddenly applied sine wave is moved up to the second peak of the response curve, the results corresponding to equation (4)

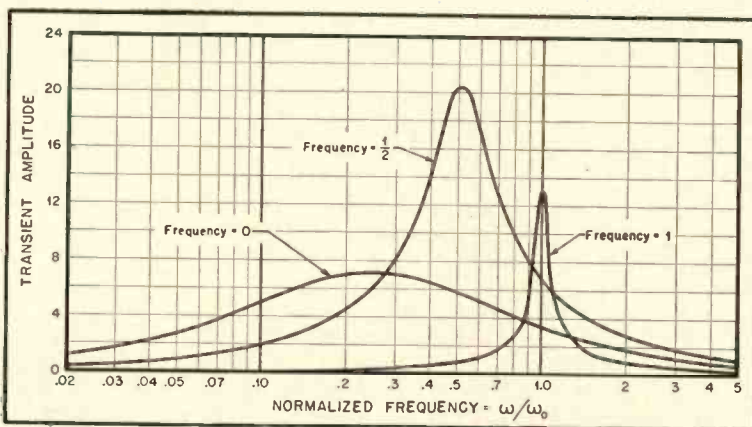

Fig. 5. Variation of transient components with frequency of applied unit-step sine wave.

are as shown by Fig. 7. The transient starts out slowly in the positive direction and soon reaches a maximum. Beyond this point the oscillation is about the zero-frequency axis, but of varying amplitude as the two oscillatory components come in and out of phase.

Because of the high Q of this pole, the resulting transient does not approach the final steady state nearly so rapidly as it does at the other pole (see Fig. 6).

Experimental Results

The sound pressure curve of a standard 12-inch speaker is shown by Fig. 8. The low-frequency resonance occurs at 75 cps, the usual rim resonance occurs in the region between 1200 and 1500 cps, and there is peaking of about 8 db in the upper register. The upper frequencies cut off rather rapidly beyond 6000 cps. The voice coil impedance shows the main resonance at 75 cps. The higher

frequency symmetrical modes cause small variations in the impedance curve, but are largely swamped by the rising electrical impedance of the voice coil.

Several points have been marked with the letters A, B, C, D, etc. We will now examine the cone breakup and transient response to a suddenly applied sine wave at each of these frequencies. The inextensional radial modes occur at the low frequencies A, B, C, D, while the extensional circular modes occur at the high frequencies F, G, H.

Figure 9(A) corresponds to point A of Fig. 8 and was made by sprinkling lycopodium powder on the cone. The frequency was then set near the low-frequency resonance of the cone, which caused the powder to climb up the cone and distribute itself uniformly. The frequency was then raised to 400 cps and left there. The light yellow powder was shaken off of the moving parts of the

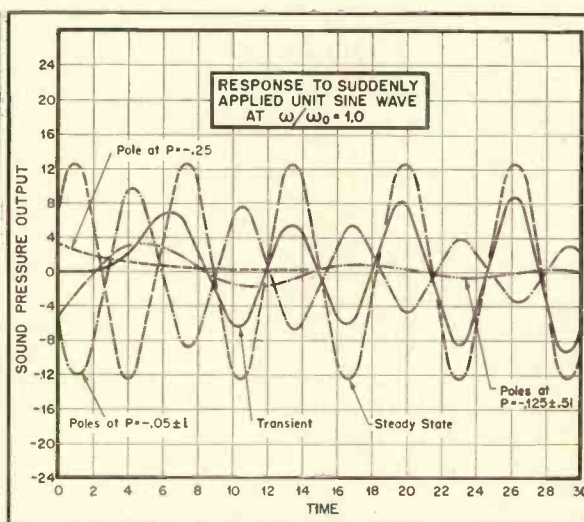
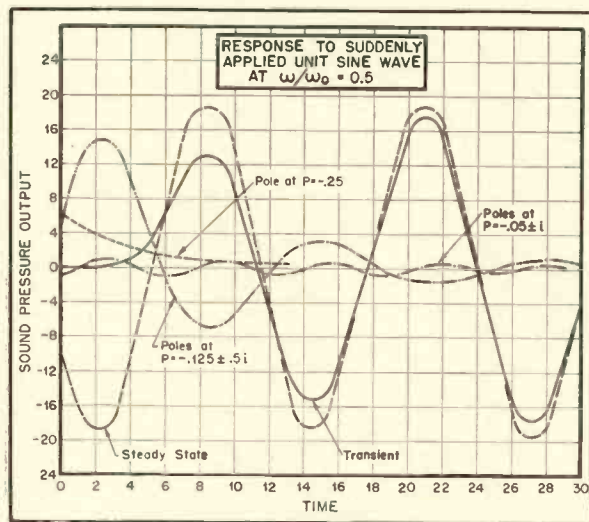

Fig. 6 (left). Response to suddenly applied unit sine wave at $\omega/\omega_0 = 0.5$. Fig. 7 (right). Response to suddenly applied unit sine wave at $\omega/\omega_0 = 1.0$.

cone, and allowed to remain at the nodes. There are thus four radial nodes, uniformly spaced, with the anti-nodes on opposite sides of a given node moving 180 deg. out of phase. This tends to pump air back and forth across a node, and does not result in a peak in the sound pressure output because of this "short circuit" of the air path.

Figure 9(B) shows the response to the suddenly applied sine wave. Since there are no pronounced peaks near 400 cps, the buildup is smooth and fast. The decay is rather uneven as the different resonant frequencies are excited at cutoff and die away at different rates. The frequency corresponding to the main resonance at 400 cps hangs on longer than any other because of the large amount of energy stored in the cone. There is a slow oscillation at 75 cps superimposed corresponding to the resonance peak due to the cone and suspension resonance.

When the frequency is raised to 450 cps, there are eight radial nodes, symmetrically spaced as shown by Fig. 10(A). This corresponds to point B of Fig. 8. There is little effect on the sound pressure curve because the antinodes merely pump air across the nodes.

Since there is no peak near this point, the transient buildup shown by Fig. 10(B) is smooth and rapid. When the signal is cut off, the ripple is at the small peak in the response at 480 cps. A slow oscillation at the 75-cps resonance is superimposed. Some high-frequency beating is evident right at cutoff as the higher frequency transients die out rapidly.

The peculiar standing wave pattern of

Fig. 11(A), corresponding to point C of Fig. 8, is somewhat unsymmetrical and apparently is a mixture of two normal modes. The one wide node apparently is moving slightly in the center. The corresponding transient response is shown by Fig. 11(B). The 75-cps oscillation is superimposed as before, and there is considerable beating between transients just after cutoff.

When the frequency is 940 cps, cor-

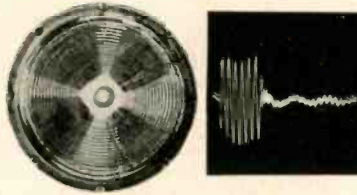

Fig. 9A (left). Cone breakup at 400 cps, with four radial nodes; point A. Fig. 9B (right). Transient response to same signal.

responding to point D, the cone vibrates as shown by Fig. 12(A). There are two main nodes, but opposite sides are in phase and the rim is not moving strongly. The transient of Fig. 12(B) shows that the 75-cps oscillation is much weaker than in the previous cases, since the applied sine wave is much farther from this peak in frequency. The 940-cps note persists for a long time because of the high stored energy and low damping, since the voice coil need not move.

Figure 13(A) is one of the first symmetrical extensional modes and occurs at 1450 cps, at point E of Fig. 8. The

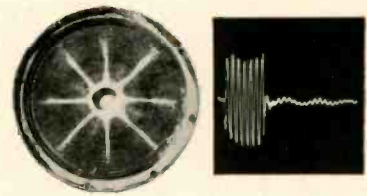

Fig. 10A (left). Cone breakup at 450 cps, with eight radial nodes; point B. Fig. 10B (right). Transient response to same signal.

frequency is high because the paper must stretch and this results in high stiffness. The rim is 180 deg. out of phase with the center of the cone. The powder cannot shake off the cap so it appears as a dense white cloud. This resonance is characteristic of all cone speakers where the rim is not properly terminated to eliminate standing waves, and normally shows up as a hole between 1000 and 2000 cps, although it may be somewhat lower in large cones.

As shown by Fig. 13(B), there is considerable ringing at buildup and decay, because of the dip in the sound pressure curve and because of the high energy storage. The high-frequency oscillation beyond cutoff corresponds to the adjacent peak near 1800 cps.

Figure 14(A) shows the next higher circular mode, corresponding to point F, with two nodes. The center cap is moving strongly, a node surrounds it, and there are two more antinodes. There is some evidence of superimposed radial nodes. The buildup and decay of Fig. 14(B) are fairly smooth, but there is considerable irregularity as the different transients come in and out of phase.

The next higher symmetrical mode, occurs at 2700 cps and is shown by Fig. 15(A). It corresponds to the peak at point G in the sound pressure curve. There are 3 circular nodes. The corresponding buildup and decay of Fig. 15B shows considerable evidence of the transients, corresponding to the various peaks, coming in and out of phase as they beat together.

The final photograph of Fig. 16(A) shows four circular nodes. These are not quite so clearly defined as the preceding ones because the corrugations affect the cone flexibility. The center of the cone is moving strongly. The buildup and decay of Fig. 16(B) show the expected interaction between transients at the beginning and end of the wave. Since this frequency is several octaves away from the 75-cps cone resonance, there is very little evidence of 75-cps components in the curve.

Conclusions

There are several ways to measure the transient performance of a loud-

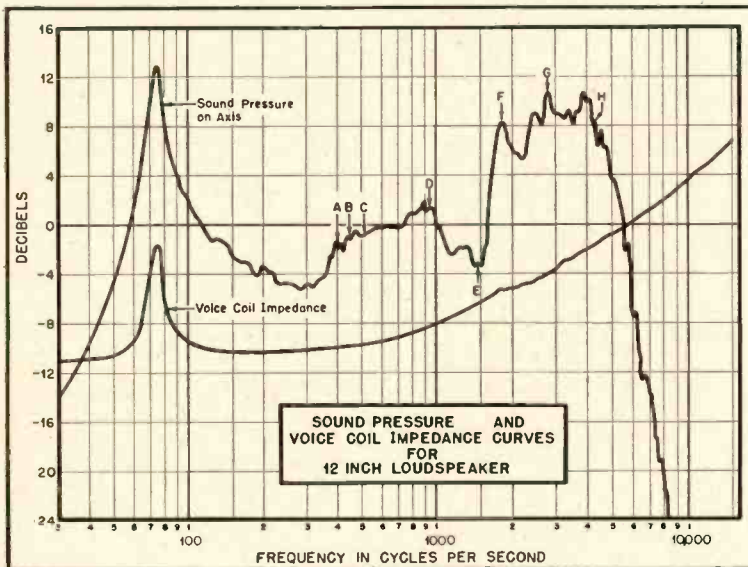

Fig. 8. Sound-pressure and voice-coil impedance curves for a 12-inch loudspeaker.

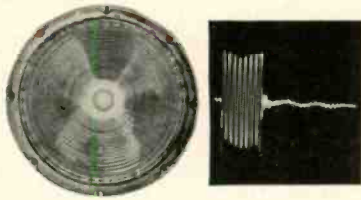

Fig. 11A (left). Cone breakup at 510 cps, with four radial nodes; point C. Fig. 11B (right). Transient response to same signal.

speaker. The unit impulse gives all of the information at one test, but is hard to interpret, because it causes all the peaks to ring strongly simultaneously, in proportion to the area under the curve. The suddenly applied unit sine wave is more selective, since it emphasizes the ringing of the peaks of nearly the same frequency as the applied sine wave.

The resonances in the cone fall into four general classes:

1. Low-frequency resonance—cone moving as piston.
2. Radial modes.
3. Symmetrical modes.
4. Combination modes.

They can be measured by means of

1. Dust patterns.
2. Acoustic probe.
3. Electrostatic or mechanical probe.
4. Stroboscope.

The dust-pattern method is very simple and direct, although the others may give more numerical data.

Whenever a transient wave form is applied to such a system, there will be ringing corresponding to each pole, or



Fig. 12A (left). Cone breakup at 940 cps, with two radial nodes; point D. Fig. 12B (right). Transient response to same signal.

conjugate pair of poles, in the complex frequency plane. The amplitude of each component is determined by the spectrum of the applied wave, and also by the influence of neighboring poles on each other.

Since some of the frequencies generated are not harmonically related to the applied signal, they cause an annoying type of distortion somewhat similar to intermodulation. The ear is very sensitive to this type of inharmonic distortion, and it is thus evident that a high-

quality speaker should be as smooth as possible in the sound pressure curve.

Acknowledgment

The equipment used for these tests was built by Roy Fine and Marshall Kidd of this laboratory, and they helped



Fig. 13A (left). Cone breakup at 1450 cps, with one circular node; point E. Fig. 13B (right). Transient response to same signal.

obtain the photographs shown. The author wishes to thank them for this invaluable assistance.

REFERENCES

¹T. Murakami and Murlan S. Corrington, "Relation between amplitude and phase in electrical networks," *RCA Review*, vol.

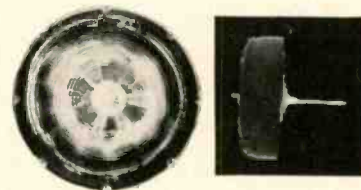

Fig. 14A (left). Cone breakup at 1800 cps, with two circular nodes; point F. Fig. 14B (right). Transient response to same signal.

9, pp. 602-631; Dec. 1948. (Contains an extensive bibliography.)

²W. L. Sullivan, "Analysis of systems with known transmission-frequency characteristics by Fourier integrals," *Elec. Eng.*, vol. 61, no. 5, pp. 248-256; May, 1942.

³H. Backhaus, "Über Strahlungs- und Richtwirkungseigenschaften von Schallstrahlern," *Zeitschrift für technische Physik*, vol. 9, p. 491; 1928.

⁴H. Neumann, "Ein- und Ausschwingvorgänge an elektro-dynamischen Lautsprechern mit starken Magnetfeldern," *Zeitschrift für technische Physik*, vol. 12, p. 627; 1931.

⁵H. Backhaus, "Über die Bedeutung der Ausgleichvorgänge in der Akustik," *Zeitschrift für technische Physik*, vol. 13, pp. 31-46; 1932.

⁶N. W. McLachlan, "On the symmetrical modes of vibration of truncated conical shells; with applications to loud-speaker diaphragms," *Proc. Phys. Soc.*, vol. 44, pp. 408-420; 1932. Discussion pp 420-425.

⁷N. W. McLachlan, "The axial sound-pressure due to diaphragms with nodal lines," *Proc. Phys. Soc.*, vol. 44, pp. 540-545; 1932.

⁸H. Benecke, "Über die Schwingungsformen von Konusmembranen," *Zeitschrift für technische Physik*, vol. 13, pp. 481; 1932.

⁹Goswin Schaffstein, "Untersuchungen an

Konuslautsprechern," *Hochfrequenztechnik und Elektroakustik*, vol. 45, no. 6, pp. 204-213; June 1935.

¹⁰J. H. G. Helmbold, "Oszillographische Untersuchungen von Einschwingvorgängen bei Lautsprechern," *Akustische Zeitschrift*, 1937.

¹¹W. O. Rogers, "Stroboscope aids dynamic speaker design," *Electronics*, vol. 10, p. 30; Aug. 1937.

¹²P. David, "Dans quelle mesure l'étude d'un haut-parleur en régime permanent, permet-elle de prévoir son comportement en régime transitoire," *l'Onde Electrique*, vol. 17, pp. 309-319; June 1938.

¹³D. E. L. Shorter, "Loudspeaker transient response," *B. B. C. Quarterly*, vol. 1, pp. 121-129; Oct. 1946.

¹⁴Piero Giorgio Bordon, "Asymmetrical vibrations of cones," *J. Acous. Soc. Am.*, vol. 19, no. 1, pp. 146-155; January 1947.

¹⁵G. Guyot, "Étude sur les haut-parleurs en régime transitoire," *Revue Générale de*

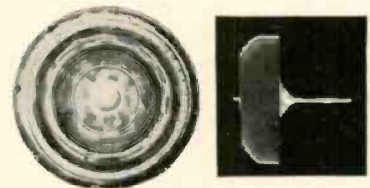

Fig. 15A (left). Cone breakup at 2700 cps, with three circular nodes; point G. Fig. 15B (right). Transient response to same signal.

l'Electricité, vol. 57, pp. 245-253; June 1948.

¹⁶Robert Campbell, "Sur la vibration d'un haut-parleur elliptique," *Comptes Rendus des séances de l'Académie de Paris*, vol. 228, pp. 970-972; March 21, 1949.

¹⁷W. W. Hansen and O. C. Lundstrom, "Electrolytic tank impedance-function determination," *Proc. I. R. E.*, vol. 33, pp. 528-534; Aug. 1945.

¹⁸Richard W. Kenyon, "Network design using electrolytic tanks," *Electronic Industries*, vol. 5, pp. 58-60; March 1946.

¹⁹A. R. Boothroyd, E. C. Cherry and R. Makar, "An electrolytic tank for the measurement of steady-state response, transient response, and allied properties of networks," *Proc. I. E. E.*, vol. 96, pp. 163-177; May 1949.

²⁰Vannevar Bush, "Operational Circuit Analysis": John Wiley & Sons, Inc., New York, N. Y., 1929, 1937.

²¹Murray F. Gardner and John L. Barnes, "Transients in Linear Systems," vol. 1; John Wiley & Sons, Inc., New York, N. Y., 1942.

²²N. W. McLachlan, "Complex Variable and Operational Calculus with Technical Applications," Cambridge University Press, 1939.

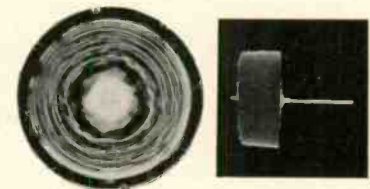

Fig. 16A (left). Cone breakup at 4200 cps, with four circular nodes; point H. Fig. 16B (right). Transient response to same signal.

Imagery for Describing Reproduced Sound*

VINCENT SALMON**

A description of the body of terms suggestive of the sensations experienced—classified, defined, and illustrated as much as possible to facilitate oral or written description.

MOST OF US LISTEN to sound for the pleasure and information we derive therefrom. There are, however, many individuals, who are not satisfied with hearing merely the corpus of the sound: they must dissect it, name the parts, and describe the function of each, in order to discover the reasons for pleasant or unpleasant auditory effects. These audio anatomists have made their ears a substitute for a whole laboratory of such acoustical instruments as frequency meters, sound level meters, response curve recorders, wave analyzers, and integrators. The calibrations of the ear, however, are not expressed by the unique, constant, and universally understood readings as are associated with the physical instruments named. Rather, the judgment of the ear is expressed by a vague, inconstant and unorganized body of terms that both name the "instrument" and supply the "calibration." This study of vocalized terms constitutes the imagery by means of which the auditory sensations evoked in the auditor (person listening) are described.

When used by qualified auditors, this imagery permits defects located by the ear to be described to other persons and thus provides for communication between the auditor and the engineer who must correct the defects described. The imagery also allows a critic of recorded music to convey his evaluations to his readers; it may even be useful to the ordinary listener in deciding where to set his tuning, tone, or volume controls, or even the on-off switch. A standardized usage would be most helpful for all of these purposes.

In this paper an attempt will be made to organize the imagery; to elaborate on the meaning of some of the terms; to indicate the probable physical variables involved; and finally to arrange homologous terms in a scale of values for more or less quantitative use. The terms and definitions offered must be regarded as representing but one preliminary usage, and the definitions are stated in positive terms for convenience of language only. It is hoped that after a period of field use and experience more sharply drawn definitions may be warranted. The opinions expressed are of course purely personal and do not necessarily represent those of the author's employers.

* Presented in part at the Thirty-third Meeting of the Acoustical Society of America, May 8-10, 1947. Many of the data herein reported were obtained while the author was employed by the Jensen Manufacturing Company, Chicago, Illinois, and are published with their permission.

** Stanford Research Institute, Stanford, California.

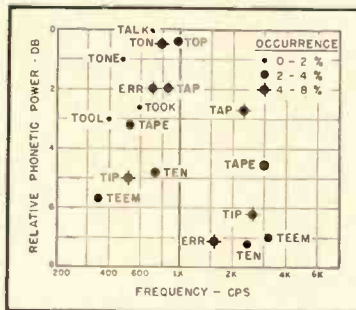

Fig. 1. Distribution of vowel phonetic power by formant frequency and rate of occurrence. The type of symbol indicates the fraction of the time the energy level shown is exceeded.

The terms may be divided conveniently into four groups:

1. Colorful synonyms for sensations due to objective characteristics of a sound system, such as noise and distortion.
2. Terms used for indicating sensations characteristic of a given frequency region.
3. Terms comparing the sensations produced by two important frequency regions.
4. Terms referring to rather tenuous sensations due to the over-all effect of the sound as a whole.

The treatment of the terms will be preceded by a discussion of the pertinent physical characteristics of sound sources, particularly for speech and music, and a subjective frequency-range notation will be offered. For convenience the terms will be set off in italics.

Sound Sources

Generally speaking, the most striking audible characteristics of a sound system arise from the response-frequency characteristic and the interferences, the latter including both noise and distortion. As ordinarily semi-subjectively used, response refers to the transmission characteristics (of a linear system) which determines the spectral composition of the output when the input is a signal of complex frequency composition. In musical terms, a non-flat response is recognized by a change in timbre, the amount of change depending on the source spectrum and the response of the sound system. Hence a knowledge of the spectral characteristics of sound sources will indicate the regions in the frequency

scale to which particular attention must be paid in assessing the effect of response changes in the sound system.

We will first examine the characteristics of male speech.¹ Since vowels account for the major portion of the loudness of speech sounds only these speech sounds will be considered. Figure 1 shows the relative phonetic (short-time) power of typical vowels as a function of the frequency at which maxima occur in the spectra. Since not only the loudness but also the relative rate of occurrence is important, this rate is shown by the type of symbol on the diagram. A brief examination reveals that there are two fairly well-defined frequency regions in which male vowel sounds have high energy, roughly 500 to 900 cps and 1500 to 3000 cps. In terms of loudness, the upper region is the more important because of the increased sensitivity of the ear in this octave. In fact, one may suspect that evolution is responsible for this coincidence.

In Fig. 2 are shown similar data for musical instruments,² revealing a somewhat less marked division of important regions. From this diagram and from the original data the important regions turn out to be roughly 300 to 700 cps and 2000 to 3500 cps.

While the preceding data are rough and subject to considerable explanation of what is plotted, they agree in pointing out that the regions of 300 to 800 cps and 1500 to 3500 cps are the most important for both speech and music. We may go further and venture the statement that these frequency regions are critical as regards the response of a sound system, and that particular attention should be given them in designing, installing, and operating electroacoustical equipment.

Frequency Range Notation

Just as colors have common names in addition to standard tristimulus values, the audible spectrum has a more or less accepted pitch subdivision into low, middle, and high ranges supplementing a statement of the frequencies of signal components lying in each range. This subdivision was first proposed by Knowles³ as a result of

¹H. Fletcher, "Speech and Hearing," New York: D. Van Nostrand Co. Inc., 1929; pp. 64-84.

²L. J. Sivian, H. K. Dunn and S. D. White, *J. Acous. Soc. Am.*, 2, pp. 330-371 (1931).

³H. S. Knowles, in Pender and McIlwain, "Electric Communication and Electronics Handbook." New York: John Wiley & Sons, Inc., 1936; pp. 6-16.

synthesizing listener reactions, and is shown modified in Fig. 3 to emphasize both recent usage and the two important frequency regions of speech and music. Although the boundaries of these regions are not as sharply defined as implied by the diagram, it is seen that the *lower middle* and *lower high* frequency regions cover the important ranges discussed earlier. When a sound system is audited, these ranges may be located by listening for vocal and instrumental sounds having large components in the region of interest. In male speech and singing the long vowels *a* and *e* are very useful sign-posts, especially in the *lower highs*. In orchestral instruments, the bass viol, trumpet, trombone, and cymbal furnish guide-points over the whole spectrum, whenever they are sufficiently audible above other instruments.

If both music and speech are averaged, the mean spectrum depicted in Fig. 4 results, in which the relative pressure level per unit frequency interval is shown as a function of frequency. The total power integrated over the whole spectrum may be expected to be about 28 db above the value at the spectrum maximum. It is seen that the two important frequency regions fall along the upper slope of the spectrum, the slope being about -6 db per octave. The *lower middles* start with the spectrum maximum, and the *lower highs* include a hump at 2500 cps. It should be emphasized that this spectrum is obtained from the average of a good many consecutive measurements, and hence does not necessarily correspond to what is heard at any one instant. We actually hear a succession of transients, rather than the steady state implied by these curves.

For convenience, the frequency range notation depicted in Fig. 3 is shown in Table I.

Synonyms for Objective Characteristics

The disrepute in which the critical listener holds those reproduced frequency components that are not present in the original signal is evinced by the number and vehemence of the terms used to describe noise and distortion. Distortion, usually due to non-linearity of the steady-state transfer characteristic, is noticed by its absence in

a *clean* system. If noticeably present, the sound is *dirty*: in a badly overloaded amplifier, e.g., we can hear the *hash-up* or *mush-up*. If this is accompanied by sudden rectification (as in single-ended output stages or in moving-coil loudspeakers with an asymmetrical magnetic field and suspension system), one can hear the *thump* when the signal *hits-bottom*. In a badly overloaded system, energy is transferred to the harmonics, and often the sound becomes *strident* if the harmonic energy peaks in the *lower highs*.

In ordinary recorded music, the inability of the stylus to track at high groove curvatures leads to objectionable high-frequency distortion variously described as *fuzz*, or *lace*. If it occurs principally on high-amplitude peaks, the resulting *crackle* is a form of overload distortion. A rather small amount of distortion together with excess loudness in this high-frequency region will cause violins to sound *wiry*, male voices to have *kasoo*, and brass instruments to show *jamming* in the upper octaves.

Many loudspeakers are two-way: that is,

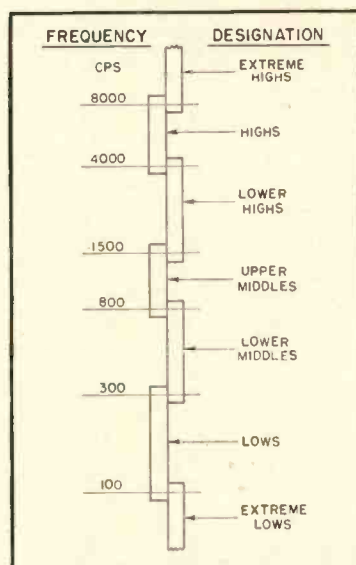

Fig. 3. Frequency-range notation.

TABLE I
Frequency Range Notation

Designation	Frequency Limits
Extreme Lows	Below 100 cps
Lows	100- 300
Lower Middles	300- 800
Upper Middles	800-1500
Lower Highs	1500-4000
Highs	4000-8000
Extreme Highs	Above 8000

the frequency range is divided, and each portion is handled by separate radiating systems. This sometimes leads to *cross-over distortion* in the region in which the energy shifts from one speaker to the other. While the causes are obscure, it is quite likely that rapid phase shifts at *cross-over* may lead to interference peaks in the signal wave form, causing the *marbles* or *garble* sometimes observed. If the dividing network permits both speakers to radiate in an appreciable common frequency interval, the inter-

ference may lead to a very *rough* over-all sound, corresponding to the erratic behavior with frequency of the received sound pressure in the *cross-over* region. It is hence best not to place the *cross-over* frequency in the center of the critical bands of either the *lower middles* or *lower highs*.

Some loudspeakers (principally cone-type direct-radiators) produce subharmonics when a steady sinusoidal signal of the proper frequency is applied above a minimum power level and for a long enough time. Although these three conditions are rarely met in reproducing the succession of transients that constitute music and speech, the distortion, known as *breakup*, is evinced by *birdies* and *tweets*, and is startling and unwelcome.

Another type of distortion, due to intermodulation, shows up as a *harsh* and sometimes disagreeably *rough* tone. As source material for seeking this distortion, a *clean* program employing two sopranos or soprano and flute, following melodic lines of parallel thirds or sixths, is very suitable.

Transient distortion, while not as yet completely understood in terms of its effects on the ear, does cause trouble at the resonant frequencies of smaller direct-radiator loudspeakers, diaphragm-type crystal microphones, and crystal pickups. The devices are shock excited by the signal, and are usually insufficiently damped, so that the excited resonant oscillation *decays* slowly, and *hangs-on*. This also results in altering the *attack* of a suddenly applied signal, which may become *slurred*.

Another type of interference is noise, here understood to be an irregular perturbation ordinarily present even in the absence of the signal (note, however, modulation noise in magnetic and other recording processes). When the cause of the noise is mechanical, as in defective or ill-designed speakers, pickups and microphones, we may hear *rattles*, *needle-talk*, *buzz*, *rub*, or *whewee*. The last refers to the passage of

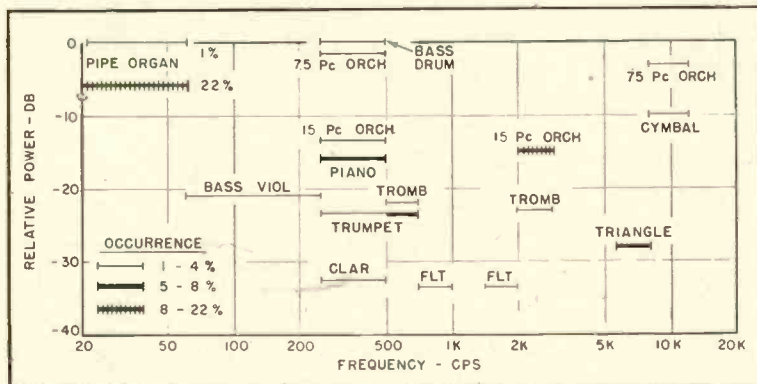

Fig. 2. Distribution of energy in orchestral instruments by dominant frequency ranges and rates of occurrence. The type of symbol indicates the fraction of the time the energy level shown is exceeded.

[Continued on page 28]

The Art of Tape Recording—IV

JOEL TALL*

The mechanics of tape editing—covering the actual methods of cutting and splicing magnetic tape recordings into a finished program.

DISREGARDING every other quality which makes tape recording valuable to professional workers in audio, tape would still continue to be valued because of its facility of editing. How well the tape can be edited depends upon the judgment of the production personnel, the expertness of the tape editor, the recording itself, and last and possibly least, the facilities that are available. In any case, the edited version of the recording can be no better than the original as far as tonal quality is concerned, although some improvement in tonal balance can be achieved through the various processes of re-recording.

There are certain logical steps which must be taken in the production of a completely edited tape before the tape is ready for playback. Consider one simple form of tape editing, the process by which a talk or speech is condensed without disturbing its meaning or impact. Assume that a half-hour recording of a political speech must be cut to nine minutes and thirty seconds air time. The permission of the speaker must be obtained to condense the speech, and its sense must not be disturbed. Obtain a typed draft of the speech, if it is available, or have a competent stenographer

*Columbia Broadcasting System, New York.

make a typewritten transcript from the tape itself. After this transcript of the speech has been studied, a capable director can condense the speech into the required time *on paper*. (A word of warning may be in order at this point. Occasionally a speaker will wander from his script and "extemporize." In such cases the tape editor will be at a loss unless he makes a practice of not discarding any part of the recording until the editing job is finished.) After the speech has been edited on paper, the production personnel and the tape editor should monitor the tape two or three times: first, to make certain that the excerpts preserve the ideas the original tape contained; and second, that the parts that are to be joined together are "joinable."

That strange word "joinable" means this: A speaker will try to convince his audience by the use of oratorical devices. He will change mood, level, pace, and inflection. He may be sad, joyful, sarcastic, cynical or earnest. It is impossible to edit tape without taking into consideration all of these factors. To attempt to separate mood from pace or level from inflection is useless. They must be considered together, in the many combinations of sounds that make the human voice a most expressive musical instrument. The art in tape editing lies

in the editor's ability to interpret correctly the many factors contained in speech and to utilize them in producing a coherent and authoritative product. Because of this, there can be no hard and fast "rules of editing." There are some fairly adequate generalizations that will result in better productions. For example, it would create a weird effect if a phrase spoken in a high-pitched, excited voice were joined to another phrase in a calm, low-modulated voice. Or suppose that the speaker were popular and frequently had to over-ride applause during his speech. A phrase from the "applause in background" portion could not be joined to a phrase from the "no applause" portion without dubbing-in applause where it is needed.

Where to Cut and Why

As the advertisements tell us, tape is edited by cutting with scissors and splicing the two ends together with an adhesive. The actual methods now in use will be described later. Right now the question is "Where shall I cut the tape?" There are many places where you *can* cut it but there is only *one* spot that is exactly right. In order for you to understand why there is only one right place to cut the tape, we shall diverge from editing to a short discussion on the subject of "hearing."

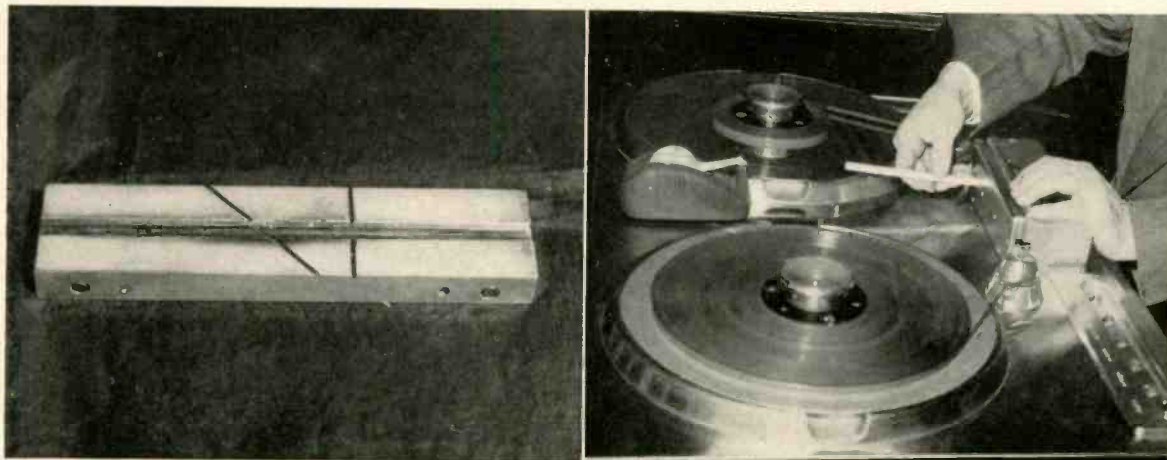
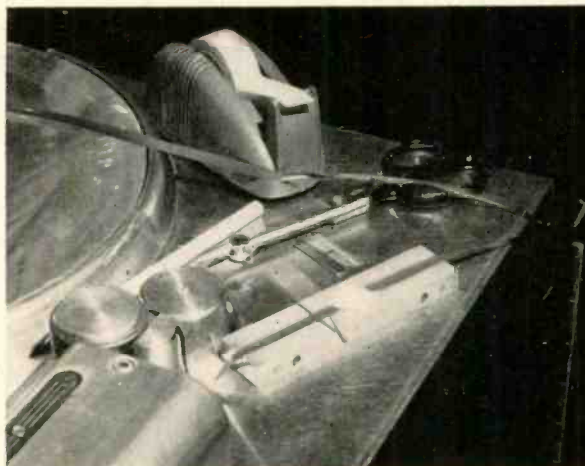

Fig. 1, left. Adjustable splicing block. The original was designed by the author in 1947 and made by Victor Piliero, CBS engineer. Fig. 2, right. Method of marking a cut with a grease pencil inserted through the marking aperture which is at the center of the playback head.

The human ear, when it is behaving normally, can understand, or perceive, an unrelated sound following another sound after a period of time approximately 0.14 seconds long. At the standard tape speed of 15 inches per second, that length of time represents about 2.27 inches of tape. (The ordinary key-click at the above speed would occupy from $\frac{1}{4}$ to $\frac{1}{2}$ inch of space on the tape.) This 2.27-inch space, in normal speech, represents about twice the distance between words. Therefore, to edit accurately, you must find the right place to cut within a space of one to two inches. Within that space you must try to match, as closely as possible, the background sound recorded at the beginning of the next phrase to be joined. After you have noted that the backgrounds match, you must still observe the speaker's natural "pace." The speaker's "pace" or "gait" will vary according to what he is saying and his natural pace must be observed and followed in the edited version so that it is the same as in the original recording. In this connection do not forget that the man who speaks must breathe. Allow time for this function even though it is not audible. The expert tape editor will observe natural breathing habits and edit accordingly. Occasionally this will force him to clip out "breaths" of various lengths and intensities, and sighs and hesitant speech sounds, and insert them in their proper places in the edited tape.

Mood, pace, level, and inflection should be considered together. When a speaker becomes angry or excited, he generally speaks more rapidly, at an increased level and in a higher pitched voice. The tape editor should be able to judge, before cutting the tape, whether two wanted sequences of a tape recording can be joined with reasonable naturalness and credibility. If it is evident

Fig. 5. Tape ends are joined together in the splicing block. The #41 Scotch tape is applied at an angle to the magnetic tape so there will be the least possible disturbance to smooth motion of the tape through the head assembly.



that they cannot be matched together as originally recorded, they may be matched by re-recording, utilizing some of the methods previously noted. If re-recording is inconvenient, and the sequence is absolutely necessary to the show, a pause of matching background sound may be put between the two segments to give the sequence some flavor of actuality.

It is not desirable to end a sentence with an "up" inflection unless the speaker is meant thus to interrupt himself or to be interrupted by another voice or sound immediately. There must be no pause whatsoever on an interruption of this nature. It should be completely evident to the listener that it was an interruption and no background sound should intervene.

At other times the editor will find places in his show where a pause is required for an effect, dramatic or otherwise. In such cases it is important that the background sounds in the pause match the background of the end of the preceding tape segment and that of the

beginning of the following one. If there is an unavoidable change in the character of background sound from one tape sequence to another, there is only one short-cut to making the whole thing believable. That is to leave in the background of one or the other sequence and clip the other sequence close to the first word. Another way to achieve homogeneity is to dub both sequences accompanied by another masking sound at fairly low frequencies, but intelligibility will then be diminished.

Where a transition effect on tape is needed it may be obtained either by re-recording and cross-fading or by using a recorded fade-out of one background and a fade-in of the other background. Effects of this nature on tape are limited only by the ingenuity of the engineer and his experience in the medium.

Editing Quiz Shows

Radio showmen who are alive to the possibilities of tape consider it is best used for editing audience-participation shows. It is only by using tape that some

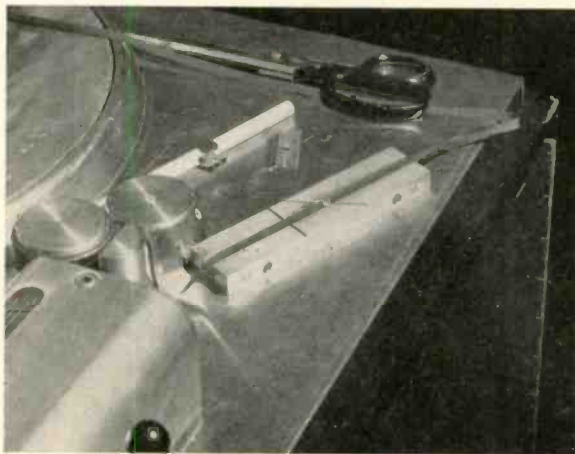

Fig. 3, left. Marked tape ready to be cut at the first mark. Use a slicing action when cutting to avoid fracturing the tape ends. Fig. 4, right. Running off tape to be discarded. This section of the tape is between points previously marked.

artists turn in consistently excellent performances. The artist (or master of ceremonies, if you prefer) is then relieved of the fear of a "dead" or "wise" participant, for he can be clipped out easily.

There is no great obstacle for the engineer who edits a first-class quiz-show. If he understands his medium and knows the routine of the show, he can turn in a very creditable job. The same conditions prevail as in the editing of a speech, except that the pace is generally faster, there are more interruptions and the backgrounds change rapidly. Perhaps it will be of use to outline the procedure in editing a typical quiz show.

The show was recorded in duplicate and lasted approximately forty-five minutes. The personnel of the show knew it was being recorded for editing. If an error in a music cue or commercial was made, the show was stopped and the error corrected. (In most cases, however, because of background change, it proved to be better to use the original than the amended version.)

When the original show was performed it was also recorded on disks for the use of the producer. He and his staff would then time the sequences needed, figure out the necessary editing and approximate the position of each part in the finished show. Thus when the time came for editing the tape, the editor knew approximately whether or not the parts would fit together. Rarely, however, would the show be put together in anything like the sequence in which it was recorded. To get listeners' interest, the first contestant in the original show might become the fifth in the edited version and vice versa. In order to fit these parts of a tape-puzzle together it was necessary to match wherever possible. Some pieces joined on applause,

Fig. 8. Tape editor A. J. Sisco splicing tape at NBC cutting room. (NBC photo)



others on a laugh. Once, when it was necessary to cut the show by one chorus of a song the same note in two different choruses was cut in half and the two half notes joined together. Luckily the musicians stayed in pitch. However, it is possible to edit musical numbers in this way only when the music is played rapidly and there is little reverberation. It is not workmanlike to edit music unless it is possible to hit the same note exactly, played by the same instruments in the identical manner. All factors must match, otherwise a re-recording session and cross-fading is called for. After the show was edited to the proper time (29 minutes and 45 seconds), the edited tape was played back and a copy made on fresh tape. While recording the copy, which was for air use, the levels were corrected so that the overall effect was as smooth as possible.

It can be readily understood that the tape editor must be more than a mechanical splicer of loose ends of tape. Whether

the show be musical, dramatic or quiz, the "feeling" of the show determines how it should be edited.

Many special instances could be cited, but the following is an example of what can be accomplished through the exercise of judgment and common sense.

Several years ago a recording of a native woman made on one of the South Pacific Islands required editing. She had recorded, in English, her distrust and distaste for the invaders of her island. As she said the word "Soldiers!" explosively, she followed it with a nervous laugh. In the sequence in which her words had to be used, the little nervous laugh after "those soldiers" would have been completely misunderstood. Thus, in order to retain what dramatic value there was, the laugh was changed into a sob by inverting its inflections, which left the sequence entirely in character.

No doubt it is understood that recognition of sound depends upon the speed at

[Continued on page 29]

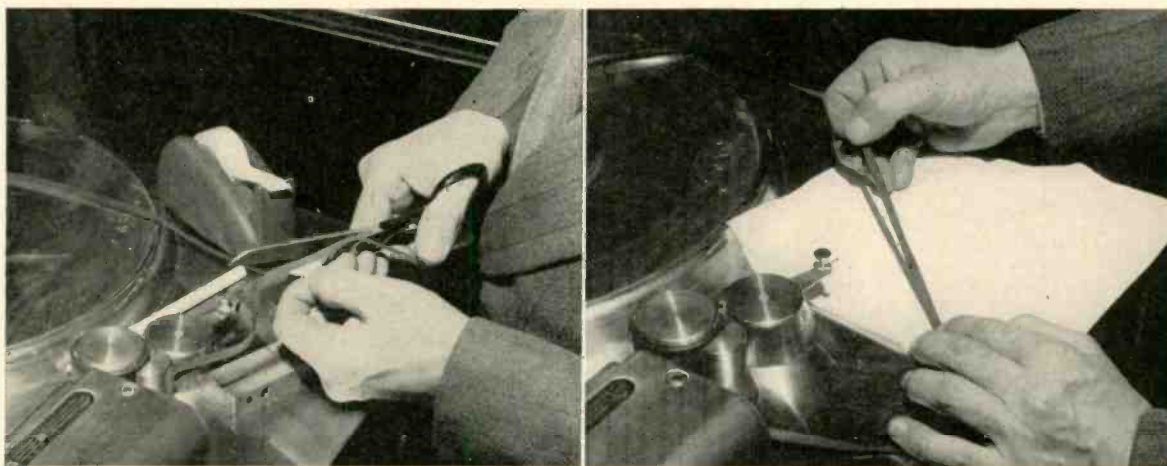

Fig. 6, left. Undercutting at the splice. The cut should taper out at both ends. Fig. 7, right. A completed splice. Note that the cut can be seen. A perfect splice cannot be noticed easily when running through the playback machine.



AUDIO engineering society

Containing the Activities and Papers of the Society, and published monthly as a part of AUDIO ENGINEERING Magazine

OFFICERS

Theodore Lindenberg, President

J. D. Colvin . . . Executive Vice-Pres. John G. Frayne . . . Western Vice-Pres.
Norman C. Pickering Secretary Ralph A. Schlegel Treasurer

Audio Engineering Society,
Box F, Oceanside, N. Y.

AES Convention and The Audio Fair

THE SECOND ANNUAL CONVENTION of the Audio Engineering Society, to be held at Hotel New Yorker on October 26, 27, and 28, promises to be even more interesting and instructive than the first, held last October.

John D. Colvin, chairman of the Convention Papers Committee, has secured over twenty papers from engineers throughout the country, and they will be presented at four technical sessions—Thursday afternoon, Friday morning and afternoon, and Saturday morning. The Thursday session will be preceded by the annual business meeting of the Society, at which time the new officers will be installed.

The Annual Banquet will occupy the evening of Thursday, Oct. 26, and will be held in the Main Ballroom of the hotel, with accommodations for over four hundred people.

The Audio Fair

Running concurrently with the convention of the Society, The Audio Fair 1950 will open at 9:00 a.m. on Oct. 26 and continue to 6:00 p.m. on Oct. 28. The exhibits will be open until 9:00 p.m. on Friday, Oct. 27, thus permitting those who cannot attend during the daytime hours to see and hear the wide variety of equipment on display.

Because of the great increase in the interest shown in all phases of audio over the past few years, and the consequent desire of manufacturers to display their products as completely as possible, The Audio Fair 1950 will occupy two floors of the hotel—the fifth and the sixth. This additional space will give more room for the visitors, as well as more display space for the exhibitors.

The 1949 Audio Fair attracted 3022 visitors, with practically every state represented, as well as 28 foreign countries. The 1949 Audio Fair, it must be remembered, was the first exhibition ever held that was devoted entirely to audio, and the success of the convention and exhibits presents a convincing argument of the wide interest in audio.

The Audio Fair idea—that of being able to hear as well as see the equipment being exhibited—was a distinct innova-

tion in the exhibit world, but its value was demonstrated beyond question at the first Fair. Visitors were most enthusiastic over the method of presenting the exhibits, and the advantage of seeing and hearing was shown to be a requirement in displays of audio equipment.

As before, all exhibits are free of charge. All visitors will be required to register and will be given identifying badges so that it will not be necessary to register each time they come to the hotel. Technical sessions of the Society are free to members, with a nominal charge being made to non-members for attendance.

Formal announcements of the Convention and The Audio Fair will be sent to Society members during August, together with advance registration cards and requests for hotel reservations at the Hotel New Yorker.

LECTURE COURSE NOTES AVAILABLE

For those who did not attend the Society's Fall Lecture Series which commenced last November and continued weekly until the end of February, the announcement of the availability of the Lecture Course Notes will be of considerable interest.

The course covered the Elements and Practice of Sound Recording, with thirty-two lectures ranging from the subjective aspects of recording to day-to-day maintenance problems. The subjects covered include: a general survey of recording methods; discussions of disc, tape, and film recording principles and equipment; microphone placement and studio acoustics; speech input systems; monitoring philosophies and methods; over-all system layout for recording and re-recording plants; and equipment scheduling and maintenance.

The notes are those furnished to registrants for the course, and in addition to containing much information in themselves, they cite collateral reading in the form of an extended bibliography. To cover the thirty-two lectures, the notes consist of 117 pages and over 250 illustrations. Page size is 8½ × 11 in. and the sheets are carried in a binder.

Society members may obtain copies of these notes at a cost of \$2.00—actually less than the cost of preparation of the notes themselves. The rate for non-members is \$3.00. Checks or money orders should be made payable to the Audio Engineering Society, and mailed to F. Sumner Hall, 153 W. 33rd St., New York 1, N. Y.



Employment Register

POSITIONS OPEN and AVAILABLE PERSONNEL may be listed here at no charge to industry or to members of the Society. For insertion in this column, brief announcements should be in the hands of the Secretary, Audio Engineering Society, Box F, Oceanside, N. Y., before the fifth of the month preceding the date of issue.

● **Audio Technician:** Employed in audio field at present; experienced in development and construction. Enthusiastic, good troubleshooter and maintenance man; wide knowledge of serious music. Desire position in studio, lab, or custom installation firm. Box 801.

● **Radio Engineer Wanted:** by prominent Chicago electronic mfg. to design and supervise mfg. of full line of com'l amps. Must have engineering degree or equivalent, and minimum of 2 yrs. design exp. in commercial P.A. systems. Give details including age, education, experience, reference, availability and salary expected. Box 601.

● **Electrical Design Engineer Wanted:** By large, modern, Eastern manufacturing firm for experimental development work in industrial electronics. Applicant must have degree in electrical engineering with communications or electronic option or equivalent in 10-15 years practical experience. Give details, including age, education, experience, references, availability, and salary expected. Box 401.

● **Audio, TV Field Engineer.** 10 yrs practical experience in maintenance of professional audio, TV, and radar equipment; design and maintenance custom home music systems. Member AES; Assoc AIEE. Good tech. educ. bkgnd; exc. references; exp. customer relations; extremely conscientious. Presently mgr. TV service lab and field service technician, electronic organs: Desire field work hi-fi audio or TV. Prefer Washington, D. C. area; consider other. Box 701.

● **Audio Engineer.** BS in radio from NYU, 26, married. Well versed all phases comm'l disc and tape rec'd'g. Presently employed large NYC studio, but not happy. A "future position" more desirable than a "present job." 9 yrs audio exp; available immediately, NYC metropolitan area. Box 601.

● **Audio and Electrical Engineer:** MS in physics; MS in EE. 10 yrs research, development, and design experience with magnetic and disc sound recording, acoustic measurements, and transducers. Also experienced in magnetic recording systems for computer applications. In present position for 10 years, but desire change to smaller company. Box 402.

Equivalent Circuits

IN MANY AUDIO CIRCUITS, both electronic and acoustic, it is often desired to study the circuit behavior over a wide range of frequency and parameter values. To do so without actually constructing the unit involved requires that a circuit be drawn which is not the schematic of the parts as planned, but is the actual circuit at all frequencies. Then this exact circuit may yield several circuits that are its equivalent at some specific frequency or over a particular range of frequencies. From this equivalent circuit it is possible to derive relatively simple mathematical expressions for the operating characteristics. Also from the equivalent circuit the designer may determine the effect on operation of varying values of circuit constants.

To obtain the equivalent circuit we must first have the exact circuit. This is not, in general, the same as the schematic diagram which shows the electronic symbol for the part that is to go at a certain point in a piece of equipment. Where a wire wound resistor may be

shown on the schematic, a resistor and inductance in series must be shown for audio work (it should be noted that even the exact audio circuit is only an equivalent circuit for low frequencies if the entire radio spectrum is considered, and distributed capacitance between turns of a wire-wound resistance shall be neglected along with a few other items of interest only to UHF engineers). Also a vacuum tube must be considered as a generator having an internal impedance, and series and shunt capacitances. An example of the use of the equivalent cir-

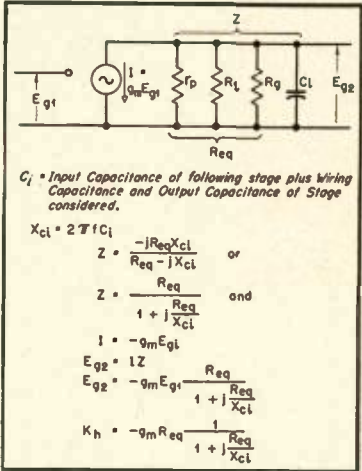

Figure 3

capacitor is chosen so that its reactance is small even at low frequencies, and that the load resistor R_L is small compared with the reactance of the capacitances in the output. Finally, the cathode bypass capacitor is selected so that its reactance will be very small at the lowest desired frequency. These original design requirements indicate possible simplifications of the circuit to enable the development of mathematical expressions for operation in the middle frequency region. This equivalent circuit for the mid-frequency band is shown in Fig. 2. The equations may be obtained by applying Kirchoff's law and Ohm's law to the loop. However, we have now reduced the circuit to the generator impedance in series with a pair of resistors in parallel. This permits an even simpler solution if we transpose the source to a current source. This is done at (C) in Fig. 2. The result is now obtained in one step.

$$K = \frac{E_{g2}}{E_{g1}} = -g_m R_{eq}$$

The substitution of a current source with equal parallel resistance for a voltage source with a series resistance will not be proved, but the reader may refer to

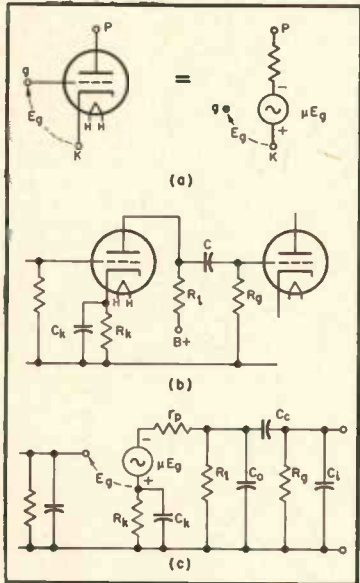

Figure 1

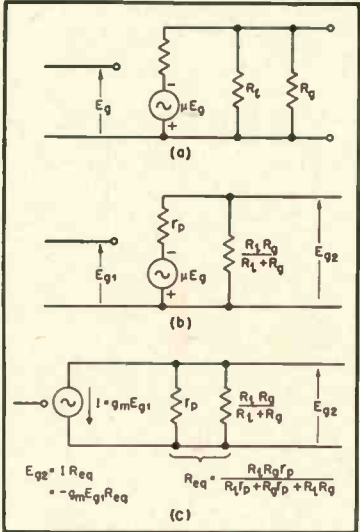

Figure 2

circuit and its derivation is afforded in determining the gain of a triode at all frequencies.

In Fig. 1 the original schematic has been redrawn as the exact circuit (for audio). It may be seen that the grid resistor of the tube under study and its input capacitance are considered with the preceding stage, while the input capacitance C_i of the following stage is included in the analysis along with its associated grid resistor. In designing triode amplifier stages, the coupling

Electric Circuits by the E. E. Staff, M. I. T., published by John Wiley and Sons, New York. This substitution is frequently useful, in this case having saved four steps.

High-Frequency Equivalent Circuit

Another circuit that is easily analyzed by this substitution is the high-frequency equivalent circuit which is shown in Fig. 3, along with the equations. It is obvious that this expression for the gain at high frequencies is the same as that at mid-frequencies multiplied by the factor

$$\frac{1}{1 + j \frac{R_{eq}}{2\pi f C_i}}$$

The low-frequency equivalent circuit may be solved without considering the reactance of the cathode bypass capacitor, which is the usual case. However, for a complete solution, Terman has shown that a third multiplier may be included. This gives the general expression for the gain of a triode amplifier at any frequency as

$$K = -g_m R_{eq} \frac{1}{1 - j \frac{2\pi f C}{R_o}} \times \frac{1}{1 + \frac{R_{eq}}{2\pi f C_i}} \times \frac{1}{1 + \frac{g_m R_k}{j 2\pi f C_k R_k}}$$

From this expression, many authors have derived a set of general frequency-response curves plotted against $\frac{f_s}{f}$ and $\frac{f_1}{f}$,

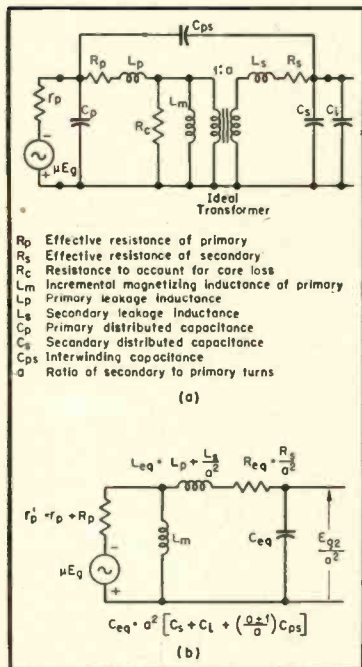

Figure 4

in which case the following relations hold

$$f_i = \frac{1}{2\pi R_o C}, f_s = \frac{1}{2\pi R_{eq} C_i}, \text{ and } f_1 = \frac{1}{2\pi C_k R_k}$$

and the gain becomes

$$K = -g_m R_{eq} \frac{1}{1 - j \frac{f_1}{f}} \times \frac{1}{1 + j \frac{f}{f_s}} - \frac{1}{1 + \frac{g_m R_k}{1 + f/f_1}}$$

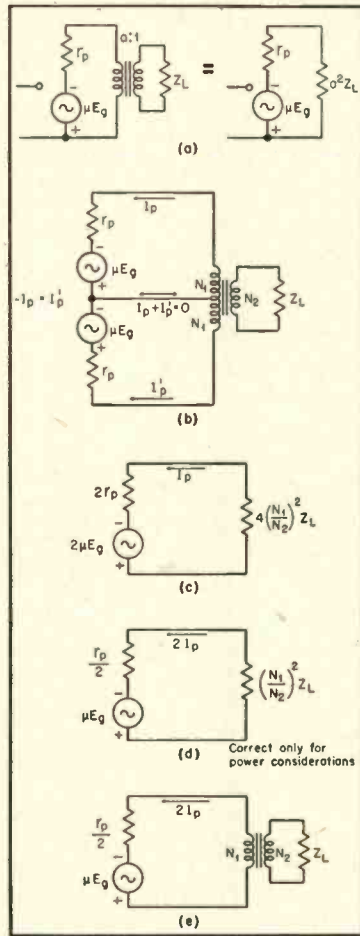

Figure 5

In all of the above equations it is possible to have a complex gain, and the phase angle may be determined readily from the expression after numerical substitutions have been made.

Transformers

The audio engineer draws the symbol for a transformer on a sheet of paper, writes some numbers down, and there the transformer engineer takes over. However, what happens inside the case does not always give the desired result. When it does, it is probably being done by an expensive transformer. The rea-

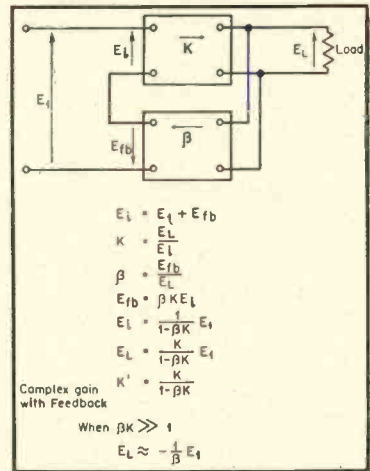

Figure 6

sons for this are manifold. Besides using plenty of core material the designer has to cope with some conflicting requirements. Among them are: the core size needed for linear operation coupled with the increased losses in the larger core; increased copper losses; and increased winding capacitance. These last two items are caused by the longer winding length per turn needed to wind coils for the larger core. The whole picture is shown in Fig. 4, where the various items are listed along with the exact and equivalent circuits. In this case even the exact circuit is not absolutely correct since it is impossible to indicate the distributed parameters, such as the capacitance between turns and the copper loss. They are therefore indicated as lumped constants, and do provide accurate results. In the equivalent circuit all values have been referred to the primary.

The simplifications provided by the use of the equivalent circuit is shown in the case of the push-pull output stage, Fig. 5. Any of the circuits shown are equivalent to the push-pull arrangement, but permit simpler methods of study.

[Continued on page 37]

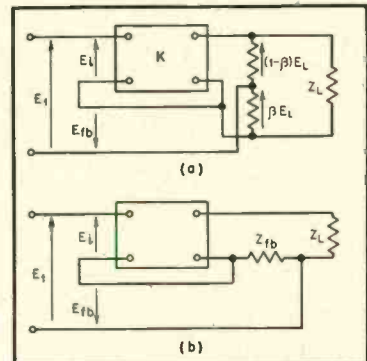

Figure 7

Simple Stroboscopes

Dr. L. B. HEDGE*

A discussion of a device so familiar that its users rarely consider the fundamental principles under which it operates.

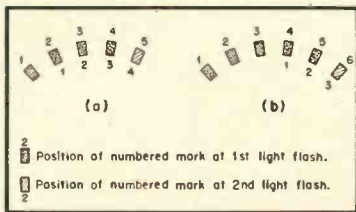

Fig. 1. Stroboscope pattern formation: (A) basic or first-order pattern; (B) higher-order pattern—in this example, the third.

THE STROBOSCOPE has been and is widely used in simple as well as complex applications for measuring, checking, and controlling speeds of rotation and other periodic motions. In more complicated arrangements it is used for the observation and study of repeated phases of intricate motion cycles. For the experimenter and technician it furnishes an accurate and easily contrived method for measuring motor, turntable, capstan, and drive speeds in recording and reproducing equipment, and for maintaining checks on them.

A simple stroboscope for speed check use on rotating equipment consists of an accurately timed, flashing light source and a circular array of equally spaced marks so arranged that successive marks occupy the same physical position during successive light flashes—the pattern of these marks thus appearing stationary, as at (A) in Fig. 1. The speed of rotation of the array which will make the pattern formed appear stationary is related to the angular spacing of the marks and their total number by the simple formulas:

$$S = \frac{\theta f}{6} = \frac{60f}{n} \dots (1)$$

$$\theta = \frac{6S}{f} = \frac{360}{n} \dots (2)$$

$$n = \frac{60f}{S} = \frac{360}{\theta} \dots (3)$$

where

S = rotational speed (revolutions per minute)

f = light flash repetition rate (flashes per second)

θ = angular spacing between successive marks (degrees)

* 7211 Massachusetts Ave., N.W., Washington 16, D. C.

n = total number of marks in the array. It should be noted that the flash repetition rate is twice the supply frequency for a glow lamp operating on alternating current. Also to be remarked is the fact that any integral multiple of n marks will give a stationary pattern also, and that a similar effect will be observed if the n -mark array is rotated at a speed which is an integral multiple of the speed S , as at (B) in Fig. 1. For example, an array of lines spaced 4 deg. apart will appear stationary under illumination

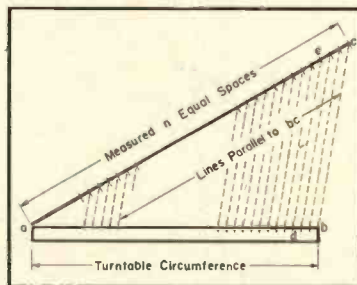

Fig. 2. Simple method commonly used for laying out a rim array for a phonograph turntable.

from a flash lamp supplied by a 60-cps source at a rotational speed of

$$S = \frac{4 \times 120}{6} = 80 \text{ rpm.}$$

(basic or 1st order stationary pattern)

and it will also appear stationary at speeds of 160 and 240 r.p.m. (2nd and 3rd order stationary patterns). Stationary patterns of higher orders than three are usually too blurred to be useful except with special short-pulse lamps.

If an array designed to give a stationary pattern with given lamp frequency and rotation speed is rotated under that light at a different speed, the pattern will move. This motion of the pattern, if it is not too fast, may be timed and used to give an accurate speed indication over a range of speeds above and below the design stationary pattern speed. Thus an array of lines spaced 4 deg. apart and illuminated by a 60-cps (120 flash per second) flash lamp will appear, when rotated at the standard phonograph turntable speed of 78.26 r.p.m.,¹ as a pattern turning backwards (in the direction opposite to the rotation of the array) at 1.74 r.p.m.—if the array is rotated at 90 r.p.m., the pattern will appear to rotate forward at 10 r.p.m. The time required for an element of the pattern to make one revolution can be easily checked to within one second with a watch or clock which has a sweep-second hand. In the example above this will give an accuracy of speed measurement of not less than 3 per cent between 70 and 90 r.p.m. Between 75 and

[Continued on page 31]

¹ More exactly 78 6/23; see the fourth line of Table 1.

TABLE I

Design Constants for Simple Stroboscopes

ARRAY NO.	LAMP FREQUENCY		50			100			120		
	No. of Marks	Angular Spacing	1	2	3	1	2	3	1	2	3
1	72	5°	41 2/3	83 1/3	125	83 1/3	166 2/3	250	100	200	300
2	80	4° 30'	37 1/2	75	112 1/2	75	150	225	90	180	270
3	90	4°	33 1/3	66 2/3	100	66 2/3	133 1/3	200	80	160	240
4	92	3° 54' 47"	32 2/23	65 2/23	97 10/23	65 2/23	130 10/23	195 10/23	78 6/23	156 12/23	234 18/23
5	120	3°	25	50	75	50	100	150	60	120	180
6	132	2° 43' 38"	22 8/11	45 2/11	68 2/11	45 2/11	90 10/11	136 4/11	54 6/11	109 4/11	163 7/11
7	144	2° 30'	20 2/3	41 2/3	62 1/2	41 2/3	83 1/3	125	50	100	150
8	160	2° 15'	18 3/4	37 1/2	56 1/4	37 1/2	75	112 1/2	45	90	135
9	180	2°	16 2/3	33 1/3	50	33 1/3	66 2/3	100	40	80	120
10	246	1° 40'	13 8/9	27 7/9	41 2/3	27 7/9	55 2/3	83 1/3	33 1/3	66 2/3	100

Rotation speeds for stationary patterns under common power-line frequency flashing lamp illumination.

Lamp frequency is equal to twice the power frequency for an a.c. flashing lamp.

**NOW YOU CAN
Monitor
DIRECT FROM THE TAPE!**

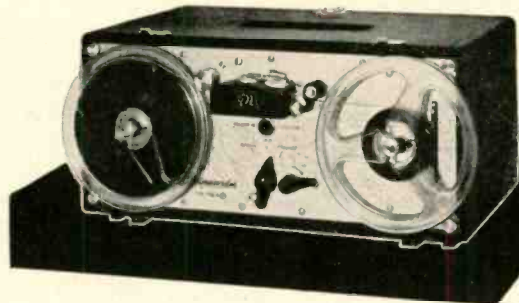

THE NEW

PT63-JA



Magnecorder

HAS EVERYTHING!

3 HEADS! Separate erase, record and playback heads let you monitor direct from the tape while recording. Prevents recording errors. Heads can be individually aligned or replaced. Response flat from 50-15kc, ± 2 db at 15". New PT63-J amplifier has separate record and playback amplifiers plus 10 watts of audio. Switch for bias, record or playback VU meter readings.

3 SPEEDS — Double recording time! PT63 or PT6 units also available with 2-speed hysteresis synchronous motor. Will provide 3 $\frac{3}{4}$ ", 7 $\frac{1}{2}$ " or 15" tape speeds. Slower 3 $\frac{3}{4}$ " tape speed gives response flat from 50-4000cps, ± 2 db. One hour on 7" reel! Excellent for interviews, conferences — all voice work!

PT6-JA



THE WORLD'S MOST POPULAR PROFESSIONAL TAPE RECORDER

FOR FIDELITY No other recorder and amplifier offers such high fidelity (flat from 50 to 15 kc) at such a low price! Meets N. A. B. standards.

FOR FLEXIBILITY PT6-JA recorder and amplifier can be rack mounted and quickly transferred to portable cases for remote operation.

FOR FEATURES PT6-A mechanical unit now available with 3 speeds. Can be converted to 3-Head Monitoring unit with Kit 101. Kit contains PT63 three-head unit and line-level amplifier for monitoring.

WORLD'S FINEST RECORDER VALUE



NEW PT-7 CONSOLE RECORDER \$950.00 net.

New positive drive — 3 heads — permits use of 10 $\frac{1}{2}$ " N.A.B. reels even in portable — Remote controls — Gleaming black cabinet.

PT7 series also available in portable and rack mount models.

See your Magnecord dealer or write for latest specifications

Magnecord, INC.

Dept. A8, 360 N. Michigan Ave., Chicago 1, Ill.

PLEASE SEND ME COMPLETE INFORMATION ON PT63 PT6 PT7

NAME

ORGANIZATION

ADDRESS

CITY STATE

RECORD REVUE

EDWARD TATNALL CANBY*

Hi-fi at Seven-and-a-Half

MORE OR LESS BURIED in the midst of this magazine's small type in the April issue (p. 47) was an announcement of a lot more significance than may have seemed off-hand. A new tape playback machine was described, the Ampex model 450, a non-recording machine using the double track system with automatic reverse, playing at $7\frac{1}{2}$ in. per second. Its intended use, as one could glean from the brief description, was mainly in the fields of "wired music" and other background long-play systems. The joker, which was probably missed by most of our sharp-eyed readers (so used are we to seeing sensational announcements in sensational-sized type!), was in the specs. Especially since those specs, I have reason to know, are decidedly on the conservative side and quite cautiously worded.

"The tape speed is $7\frac{1}{2}$ in./sec. and frequency response is within ± 2 db from 50 to 10,000 cps, ± 3 db 30 to 12,000 cps, with less than one per cent harmonic distortion at an output level of $+17$ dbm." Better read that twice.

Advance Demonstration

Back in the early spring I was first let in on the new set of tape developments on which this later announcement presaged the beginning of commercial operations. Two machines were brought to New York (and later to Chicago) by Ampex; both, it seemed, were more or less experimental models, partly made of present-stock mechanical parts. One played at $7\frac{1}{2}$ -in., twin-track, the other at $3\frac{3}{4}$ in., also twin-track. One of them incorporated a new thyatron reversing system, a clear improvement over the earlier type of reverse in the other. Various other mechanical details of improvements were also pointed out—which would normally be of great interest in any good quality new machine. But these things were not what had me excited.

Performance, electrically, was the astonishing, almost unbelievable feature. To put it in slightly slangy terms, here was a machine which, at $7\frac{1}{2}$ in. per second, double track, was able to play music *essentially*

flat to 15,000 cps! I heard it. (True, I "saw" no actual tests, but the quality was obviously different from anything I had before heard at $7\frac{1}{2}$ in. Printed confidential specifications, plus an explanation—to follow here in a moment—did the rest.)

Here was a second machine, running at the crawling speed of $3\frac{3}{4}$ in., which reproduced its music *essentially flat to 9000 cps*. The performance here was even more startling.

The music had presumably been recorded, in both cases, on equipment of similar design, though the recording unit was not demonstrated.

Why and Wherefore

If you will think a moment, you will note that performance of this sort, from tape, in effect does what had begun to seem extremely unlikely to most of us—it *doubles the efficiency* of the tape medium, as compared to presently existing machines, both amateur and professional, and even including the famous Ampex model 300, which claims no more than 50 to 7500 cps. at the $7\frac{1}{2}$ in. speed. As one advertiser of phono equipment puts it, this calls for a WOW of appreciation! — Followed immediately, double-take-style, by a somewhat startled "HOW"?

Claims vary from one tape machine manufacturer to another, partly as a matter of degree of caution. But it will be evident immediately that the average claim *in re* frequency range for existing machines runs between 7000 and 9000 cps as the top at $7\frac{1}{2}$ in., 12 to 15 kc. at 15 in. Sonar claims 9,500 as the top at $7\frac{1}{2}$ in. in its new machine. My own Magne recorder at the moment measures "flat" (again speaking slangily) to 9000 at that speed, to 18,000 at 15. But no one, so far, has made the slightest pretense of claiming what Ampex claims—in the wildest of optimistic publicity! Ampex is hardly in a position, on the other hand, to make unsubstantiated claims of any sort, especially in this respect.

The answer, if I understand it, is in a genuinely new advance in manufacturing technology. The gap width, thanks to what is fundamentally not an electrical but a mechanical problem, has been reduced from

[Continued on page 35]

Pops

RUDO S. GLOBUS*

YOU WILL EXCUSE me if, for once, I indulge in a rather generalized discourse (probably more with myself than with a reading audience) about many things related to the subject matter of this column. My piece of last month is certainly at the root of all this, as well as a great deal of recent soul-searching on the situation of the technician . . . sic Audio Engineer. There will be much that is unfunny . . . and much that is rather (to use a technical term) metaphysical. If you object to the ponderous pretentiousness involved in an attempt to explain the vast confusion entailed in the problem confronting our ilk, pass on to the appended reviews or skip me this time. If you don't object . . . consider seriously what is to be said. The tone is not intentionally dogmatic. Following your own soul searching, I believe either a rebuttal or an advanced statement of what is to come very much in order.

Let's not fool around. If we are to be radically open and aboveboard about the situation as it stands, we are faced with a most appalling conglomeration of trash, nonsense, muddle-headed thinking . . . and a purely mechanical submission to the power of techniques, disemboweled formulations, and a vulgar, low-level status. Beginning with the purely technical problem, I will cite another example relevant to a situation mentioned some months ago. Those of us who are at all interested in listening to recorded music of any and all types still require an "apparatus" to take the physical phenomenon of an impressed disc out of its moribund "materialism" and project it in some form vaguely approaching the musical. In order to do this, we must either be adequately trained engineers . . . therefore capable of building our own "transforming" machines, or of coming to some conclusion as to components available on the market. If we are not adequately trained, we must pass this responsibility over to someone who

[Continued on page 33]

* 960 Park Ave., New York 28, N. Y.

* 279 West 4th Street, New York 14, N. Y.



L-6W Polyphase reproducer
(for Webster changer)

The Standard by Which Others Are Judged and Valued

From a letter: "... Have been hearing some very fine reports on your new POLYPHASE reproducer. However, in your advertising, you do not give any figures on compliance and distortion. . . ."

Here is our answer

COMPLIANCE: "No one is interested in meaningless figures—although they would embellish the advertisement. However, we are sure that everyone is much interested in a compliance that is greater than that of any pickup ever created. . . . that is POLYPHASE."

DISTORTION: "No one is interested in any form of distortion, as such. However, we are sure that everyone is much interested in the practical absence of distortion. . . . that is POLYPHASE."

VIBRATORY MOMENTUM: The vibrating mass in POLYPHASE is tinier, by far, than in any pick-up hitherto created. VIBRATORY MOMENTUM at last approaches the vanishing point. The result is a facsimile of the original performance.

Never before such EAR-QUALITY, such FAITHFUL RE-
PRODUCTION . . . that is POLYPHASE.

but...

see it, HEAR it and compare it with any reproducer at any price—then, you be the judge.

AUDAK COMPANY

500 Fifth Avenue

New York 18, N. Y.

"Creators of Fine Electro-acoustical Apparatus for over 30 years"

so simple

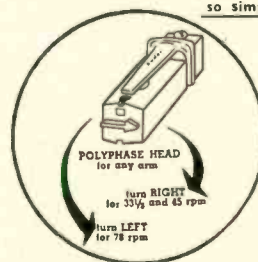

- One single high quality magnetic unit and same point pressure for all discs—6-8 grams and costs less than ordinary magnetics.
- Sapphire styli (or diamond) replaceable individually, as simply as you replaced steel needles.
- Output about 20 m.v.
- Response 20 to over 10,000 cps.
- Needle-talk at vanishing point.
- Tracking phenomenal.
- High or low impedance.
- Flexible plug-in connectors.
- EAR QUALITY, par excellence.
- Available for GARRARD, WEBSTER, etc. changers.

The new AUDAX arms are sensitized to the nth degree in order to meet the extremely high compliance of POLYPHASE.

There's an Audax for every purpose . . . Studios, etc. including high output types.

Send for editorial
reprint on
POLYPHASE principles.

NEW PRODUCTS

● **Three-Speed Record Player.** Expanding its line of audio equipment, Newcomb Audio Products Company, 1605 Cahuenga Blvd., Hollywood 28, Calif. announces the Model B-12 portable record player, de-



signed particularly for school music appreciation classes and for use as a counter record demonstrator. Among its features are a 6 x 9 in. Alnico speaker protected by a kickproof metal grill, a 5-watt Newcomb amplifier, and a washable maroon fabricoid case 13 3/4 x 14 1/2 x 7 1/4 inches. Handles records of all types up to 12-inch diameter.

● **Improved Connectors and Switches.** Wider face areas together with wider flanges to overlap greater area around installation holes are featured improve-

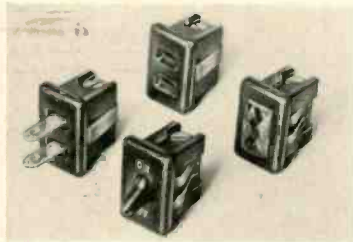

ments in the newly designed line of Diamond H Snap-In line of electrical connectors, pilot lights and switches. All items of the new line are available in black, brown, white, or special color to harmonize with the equipment in which they are employed. Manufactured by The Hart Manufacturing Company, 110 Bartholomew Ave., Hartford, Conn.

● **Record Cleaner.** Goodell "Record Life" is a liquid solution designed to remove dust particles and to thoroughly eliminate electrostatic charges from all types of record surfaces. It is non-toxic, contains no wax, alcohol, or other solvents, and



does not depend for its action on hygroscopic agents that might leave sticky or hard residue in the recording grooves. Manufacturer is Minnesota Electronics Corporation, 97 East Fifth St., St. Paul, Minn.

● **P. A. Driver Unit.** Operating flexibility is the keynote in the new Racon model PM-708TR all-purpose driver. In addition to being completely waterproof and tropicalized, designed with 75 to 100 per cent overload capacity, and built to withstand abnormal diaphragm excursion, it features a built-in 25-watt vacuum-impregnated line-matching transformer offering



available impedances of 15, 500, 1000, 1500, and 2000 ohms. The voice-coil suspension is made of bakelized linen cemented to the phenolic diaphragm with a thermosetting plastic. Induction heating is used to bake the diaphragm, voice-coil suspension and voice coil into an unbreakable bond. Full details of the PM-708TR will be supplied by Racon Electric Co., Inc., 52 East 19th St., New York 3, N. Y.

● **24-Hour Reference Recorder.** Unattended round-the-clock recording is a reality with the Magnemaster tape recorder now being manufactured by Amplifier Corp. of America, 398-4 Broadway, New York 13, N. Y. Designed for commercial applications where unattended, continuous recording is essential, the Magnemaster may easily be modified to suit specific requirements, including installation of a voice-activated circuit which provides start of tape feed within 0.1 second. The instrument consists of two complete rack-mounted recording-playback systems, each of which operates continuously for 12 hours at a tape speed of 3 inches per second. At the completion of 12 hours of twin-track recording

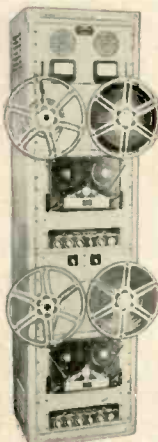

on one reel, a relay instantly sets the other reel into operation. Frequency range of the overall system is 50 to 4500 cps. Full technical information will be supplied free by the manufacturer.

● **440-Volt Rectifier Cartridge.** Answering the need for high-voltage rectifier cartridges in the radar, sonar, photoflash



and kindred fields, International Rectifier Corporation, 6809 S. Victoria Ave., Los Angeles 43, Calif. has developed a new line of selenium units available in phenolic, glass or hermetically sealed assemblies. Typical of the new line is the rectifier rated at 440 volts d.c. at 10 ma. with a peak current rating of 120 ma. and a peak inverse rating of 1500 volts. It is of the half-wave type and is 9/16 in. OD with an overall length of 1 1/2 in. Voltage drop at rated load is approximately 25 volts and its weight is 1/2 ounce. Further information will be supplied by the manufacturer.

● **TV Loudspeaker.** Reduction in required distance between the picture tube and the loudspeaker in TV receivers is made possible in a new line of Rola models by means of a magnetically-enclosed motor structure. Available in sizes



ranging from 5 to 12 inches, the new speakers use Alnico V in a high-efficiency magnetic structure which permits reduced weight and consequent lowered cost. Full information may be obtained from The Rola Company, Cleveland, Ohio.

● **Soldering Gun.** An advanced note of flexibility is introduced by the Model LW Versa-Tool, an instant-heating soldering gun recently presented to the trade by Phillips Manufacturing Company, Inc., 2816 Aldrich Avenue South, Minneapolis, Minn. The two-position trigger-actuated switch closes the circuit to a concentrated light beam in its first position, thus permitting the operator to use the tool as a flashlight. The second switch position maintains a completed light circuit and closes the circuit of the heating element. Carbon element is easily replaceable.

"I think Terminal's Sound Department is the best in the country" says leading audio authority*

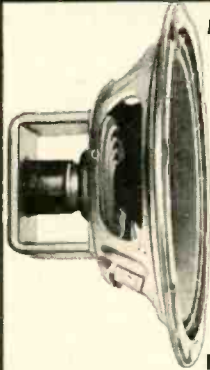

New Permaflux ROYAL EIGHT

A BARGAIN! The speaker that amazed 'em at the Audio Fair! Response 50 to 12,000 cps, 8 watts. Efficiency high, distortion low! 8" diameter, 8 ohm V.C.

Now only **8⁸²**

New UNIVERSITY 6200 Wide Range 12" Speaker

30 watt FOCUSED FIELD wide range PM speaker! Advanced magnetic structure concentrates all of the magnetic force where it belongs — in the voice coil. Response of 45 to well beyond 10,000 cycles with amazing efficiency. Standard 12" mtg., 6 to 12 ohm voice coil.



A real buy, at only **20⁵⁸**

New Webster-Chicago series 100 3-speed Automatic Changers



Terminal has the new Webster-Chicago record changers, available with Audak polyphase, General Electric reluctance, Pickering magnetic and standard crystal cartridges. Wide range cartridges with sapphire or diamond styli.

WRITE FOR OUR NEW SOUND CATALOG

EVERYTHING IN AUDIO FOR THE STUDIO & CUSTOM BUILDER!



radio craftsmen chassis as used in the finest custom installations

RC-100A TELEVISION CHASSIS with built-in booster.

This is the finest! Use 19" or 16" square or round kinescopes. Less picture tube, amplifier, speaker



230⁰⁰

radio craftsmen RC-10 FM-AM tuner with built-in pre-amplifier



compensated for G.E., Pickering and crystal phono cartridges. Continuously variable bass and treble controls with flat response from 20 to 20,000 cycles. Automatic frequency control entirely eliminates station drift.

119⁵⁰

RC-2 wide range amplifier

Companion unit for RC-10 tuner, or any high fidelity application. Over 10 watts output with less than 1% distortion. 20-20,000 cycles frequency response.

Net

39⁰⁰



*Richard H. Dorf, New York audio consultant and author of authoritative articles in leading radio publications

There is a UNI-MODE cabinet ensemble for every custom requirement!

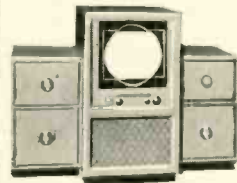

RECORD CHANGERS
TELEVISION CHASSIS
TUNERS
RECEIVERS
PHONO AMPLIFIER SYSTEMS
RECORD STORAGE

LOUDSPEAKERS RECORDERS

With Uni-Modes, you can create an entertainment center that will combine utility, beauty and allow for future expansion. It's easy and surprisingly moderate in cost! UNI-MODE is available in beautiful hand-rubbed Blonde and Cordovan Mahogany; also unfinished, if desired. Interiors are attractive Tarragon Green or Afghan Red.

See UNI-MODE in our sound catalog for pictures, sizes and prices.

Masterpiece in Cabinetry

An ELECTRONIC DECORATORS creation

Artfully constructed of finest woods, scientifically planned layout for proper housing of TV, radio, amplifier, record changer, speaker and record storage.

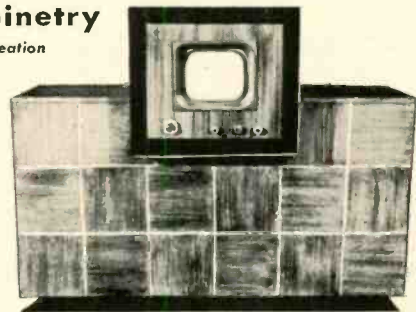
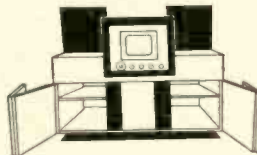

Dealers and installers — check with us for prices on your needs

TERMINAL
RADIO CORPORATION

Distributors of Radio & Electronic Equipment

85 CORTLANDT ST., NEW YORK 7, N. Y. • WOrth 4-3311 • Cable: TERMRADIO

NOW-famous
DUOTONE
 quality...



**MAGNETIC RECORDING
 TAPES TO THE HIGHEST
 PROFESSIONAL STANDARDS**

Now the well-known Duotone super-quality is available in magnetic recording tapes for commercial and home recorders. The six Duotone quality features assure finest sound reproduction for professional programming and the ultimate in home entertainment. For finest performance on any tape recorder, use Duotone professional quality magnetic tapes!

- Low Inertia Plastic Wheel
- Low Friction — Long Life
- High Output — Minimum Background
- Interchanges with Other Tapes
- Constant Tracking and Winding
- No Snarls or Backlash

**DUOTONE SUPER QUALITY IS AVAILABLE
 IN TAPES FOR EVERY RECORDING NEED**

Made with plastic or kraft paper base in extra long 625 or 1250 foot lengths. Plastic base is tough with high tear strength and special smooth finish for uniform coating. All kraft bases are super-calendered for perfect surfacing without fillers. For complete data on Duotone standard and special tapes, call or write for illustrated catalog.



Canadian Representative: CHARLES W. POINTON, TORONTO, CANADA
 Export Division: AD. AURIEMA, INC., NEW YORK CITY, N. Y.

— IN A
**RECORDING
 TAPE
 FOR EVERY
 PURPOSE**

*6 WAYS
 to better
 Recordings*

IMAGERY

[from page 15]

air through a small orifice. Another type of mechanical noise is the so-called *needle scratch* or *surface noise* present in disc recordings. It is due to irregularities in the groove walls, and if heard through a *flat system*, sounds *smooth* or *satiny*, corresponding to initially *white* (flat spectrum) noise with perhaps some *roll-off* of the *highs*. Ordinarily, however, the character of the *surface noise* is markedly influenced by undamped resonances in other parts of the system and becomes *scratch*. With pressings of a homogenous material, such as polyvinyl chloride acetate, *clicks* rather than *scratches* are noted. *Swish* is *scratch* periodic with the rotation of the record.

Thermal noise due to electron agitation often shows up as a *background of tube hiss*; a poor carbon (variable resistance) microphone also contributes the more irregular *frying* or *popping* noises which have prevented its use in high-quality systems.

When dynamic devices such as limiting amplifiers and variable band-width noise suppressors are improperly used, the finite time constants of attack and release may cause a subtle form of distortion. With the latter devices, *breathing* may occur when the time constants are set too large, and the program changes its dynamic range rapidly, thus making audible the changing cut-off. However, the trouble can be obviated by the intelligent use of the suppressor.

The above terms for the most part, refer to fairly definite objective quantities for which physical measures exist. The difficulty comes in setting up scales of values with a one-to-one correspondence between the term and its physical correlate; such a refinement is not completely possible at present. These terms are listed in Table II.

TABLE II

Description of Distortion and Noise	
General	Clean, dirty.
Overload	Hash-up, mush-up, hits bottom, thump.
Noise	Rattles, buzz, rub, wheeze. Background noise, tube hiss, frying, popping, sizzle, smooth, satiny.
Records	Needle talk, scratch, surface noise, clicks, swish, Fuzz, lace, kazoo, wiry, jamming.
Subharmonics	Breakup, birdies, tweets.
Intermodulation	Harsh, rough.
Cross-over	Marbles, garble.
Dynamic	Thump, breathing
Transient	Attack, hangs on, slurred.

To be concluded in September

TAPE RECORDING

[from page 18]

which the tape moves past the head. The faculty of recognizing sounds at various speeds must be well-developed if the tape editor expects to achieve any appreciable speed and finesse. Constant practice is required, so that the ear becomes familiar with all commonly encountered sounds.

The easiest sound to recognize—and therefore to edit—is the sound of *s* and similar sibilant sounds such as *ch*, *sh*, *ts*, *tz*, and so on. The hard sounds of *t*, *p*, *b* and similar sounding combinations of sounds are also quite easy to recognize. The sounds of *r*, both round and guttural, are more difficult to determine, especially when they occur in the middle of a word. Compound sounds, such as the beginning *y* of *you* and other *y* and *u* sounds, are difficult to apprehend and sometimes are recognizable only at normal tape speed. The tyro editor would do well to practice the recognition of sounds and to exercise himself in the art of editing tape by cutting out slurred *r*'s, *u*'s and other sounds as mentioned above.

Editing of musical recordings is done in the same manner as that of voice and sound, with the exception that the editor of music should be acutely conscious of rhythm, pitch, and "overhang." By "overhang" is meant those lingering tonal beats, especially of string instruments, that are somewhat similar to reverberation. Because of these lingering overtones, it will often be difficult to edit a musical piece without the use of re-recording techniques. However, in some cases, by cutting at the beginning of a bar exactly, an acceptable job can be done.

Tape Splicing

The actual mechanics of tape editing are fairly simple. Some tape editors work with scissors and Scotch tape. Some use a patented cutting and patching mechanism similar to a motion picture film splicer. Since 1947, the author has used a cutting block which he designed and which has proved satisfactory. The final result to strive for in the mechanical process of editing is a smooth splice, with the ends of the tape abutting each other with no discernible space between. A diagonal cut which eliminates the 90-deg.-cut "clicks" has been found most satisfactory. In addition to eliminating clicks, which are very disconcerting to the listener, the diagonal cut helps to make background blending easier. The splicing block is made of a piece of brass $7\frac{1}{2}$ in. long and $1\frac{1}{2}$ in. wide and $\frac{3}{4}$ in. thick. A slot $\frac{1}{8}$ in deep and .248 in. wide is machined in this block. The $\frac{1}{4}$ in. tape

Let's cut
the boloney!



Reeves ads could CLAIM that Soundcraft's wonderful new magnetic recording tapes are strong enough to make firemen's suspenders (red oxide, of course) and that the coercive force is helpful in a harem, but what you REALLY want is PROOF.

Reeves ads could CLAIM that Soundcraft recording lacquer resists moisture like duck feathers and that cutting surfaces are so smooth they make better slippers than banana peels, but what you REALLY want is PROOF.

Reeves ads could CLAIM that Soundcraft's transcription cutting and playing jewels wiggle and waggle their beautiful angles and gorgeous shanks to really cut a lacquer, but what you REALLY want is PROOF.

Tell You What We're Gonna Do:

So well have the above necessary evils to the professional recording trade been accepted in spite of good, honest, plodding competition, that Soundcraft's researches into better recording media and radically improved manufacturing processes have already been amply rewarded. But Soundcraft isn't selfish. SC wants EVERYBODY to have the benefit. Naturally recording experts are bored with inconsistent audio performance. SC doesn't want you to take a chance with a hard earned buck. Instead SC will risk it's two bucks. SC wants you to try a month's supply of any or all Soundcraft recording media. We'll bill it through your least credit-conscious local distributor. You CAN'T be dissatisfied. SC will refund 100% for any portion or ALL of your order upon your say so and return of the balance to your distributor. To try is to progress. PROVE Soundcraft yourself at SC expense. Coupon us today for a SC catalog so you can make your selections.

Dear Soundcraft:

Please send your recording media catalog. Our favorite disc distributor is _____

Name _____

Address _____

REEVES — "20 YEARS WITH SOUND RECORDING MEDIA."

REEVES Soundcraft CORP.

35-54 36th STREET, LONG ISLAND CITY 6, N.Y.

IMMEDIATE DELIVERY ON ALTEC 21B MIKES

Production Facilities
Stepped Up To Meet
Unprecedented Demand

All Types Now Available...

Since March of '49, Altec has been scrambling to catch up with the deluge of orders that followed the introduction of the 21B miniature microphone. Now, the company is happy to announce that expanded production facilities are in operation, and deliveries will be made upon receipt of order. This is true for all models of the 21B stand, chestplate and lapel.



"The mike that became a must" with entertainers and public speakers



1161 N. VINE STREET, HOLLYWOOD 38, CALIF.
161 SIXTH AVENUE, NEW YORK 13, NEW YORK

* A new brochure, giving full details on all models of the 21B, is available on request.

REK-O-KUT

for the **FINEST** in MICRO-GROOVE PLAYBACK Equipment

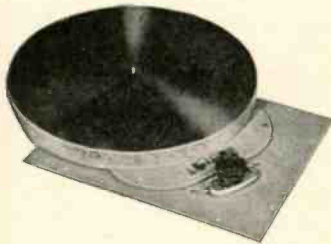

- Q. What turntable do you recommend for use with a Brooke, McIntosh, Leak or similar amplifier . . . Altec Lansing, Stevens or similar speaker . . . or with Audak, G.E., Pickering or equally good pickups?
- A. Our model T-12H or T-43H.
- Q. Why?
- A. In order to reproduce your records properly without noticeable rumble, you require a motor that is down to -50 db minimum. Any high fidelity system is no better than its weakest link.
- Q. Who are the most critical users of your turntables?
- A. The leading record manufacturers . . . for testing new recordings.

MODEL	SPEED	SPECIFICATIONS	NET PRICE
T-12H	78-33 1/3	Noise Level: 50 db Motor: Hysteresis Synchronous Chassis: Aluminum casting, cross ribbed, flush mount Turntable: Aluminum, lathe turned	\$109.50
T-103A		45 rpm idler with record adapter interchangeable with 33 1/3	6.00
T-43H	45-33 1/3	same as for model T-12H	109.50
T-104		78 rpm idler, interchangeable with 45 rpm	5.50

Write for our new catalog, listing the complete line of Recorders, Phonographs, Record Players, Recording and Transcription Turntables, Recording Mechanisms, Amplifiers, Cases and Accessories.

REK-O-KUT CO., Inc. 38-07 QUEENS BOULEVARD
LONG ISLAND CITY 1, N. Y.

will then fit snugly in the block so that it can be cut accurately. In the middle of the block, a 45-deg. angle cut is made, as shown in *Fig. 1*, extending to the bottom of the tape groove, wide enough to admit a single-edged razor blade (See figure #1).

When editing on any tape machine the place to mark the tape for cutting is at the magnetic gap in the play head as in *Fig. 2*. Any sound you have heard will have passed this point. It is best, if possible, to mark both sides of an excerpt *before* cutting. Then it is only necessary to cut at both marked spots and join together. (See *Figs. 3 and 4*.)

A number of methods for splicing tape have been tried. Tape can be cemented together if overlapped, but the cement may disturb the binder in the magnetic-coating, and an overlap splice is neither as accurate nor as quiet as a butt splice. Heat-vulcanizing has been tried on plastic tape with great success, but it is not recommended where a splice might have to be removed for a change in script. Scotch tape #41, which has a minimum of "tackiness" and does not "bleed", permits quick and permanent splicing and is the favorite adhesive in the industry to date.

The simplest way to make a good splice is to use a block such as has been described. There are several good tape editors who mark their "spots" and cut *both* diagonally with scissors at the same time. However, in that case, it requires practice to keep the tape ends lined up perfectly until they are patched together.

After about a one-inch length of #41 Scotch tape has been stuck to the recording tape ends, it should be firmly pressed to the tape so that the adhesive is thoroughly engaged, as shown in *Fig. 5*. When splicing tape in a jig, be careful not to press the tape with such force that the recording surface is depressed at the splice. When this surface is pressed in it will not be in good contact with the magnetic heads and the high frequencies will be attenuated at the splice. Then the superfluous Scotch tape should be trimmed with scissors, cutting smoothly *into* the recording tape for a depth of about .002 in., as in *Fig. 6*. This undercutting is advised so that no adhesive will appear on the surface of the tape and, subsequently, on the recording and play heads. Undercutting also makes the compliance of the splice more nearly the same as that of the tape itself, thus assuring better head contact and less "skip." Care in splicing, resulting in a finished splice similar to the one shown in *Fig. 7*, pays off by making the completed show sound perfectly natural, avoiding any sign whatsoever that it has been edited.

Where it is necessary, to save time, strips of adhesive tape (#41) may be

cut in advance, in widths of 3/16 in. or so, and used to make splices that are not of a permanent character. An experienced editor can make a good, permanent splice in approximately thirty-five seconds, while a temporary splice may take ten seconds less. Figure 8 shows a tape editor at work in an NBC tape cutting room.

If the tape is to be re-used time and time again (which is one of the reasons why tape is used) it is better to make perfect splices of the permanent kind. Then, after the tape has been erased and used again for recording, there will be no embarrassing "holes" in the recording. The adhesive tape, needless to say, does not record magnetically.

Auditory Fatigue in Editing

We have thus far covered editing in two of its aspects—how to cut tape and why and how to make a clean splice. The psychological aspect of tape editing becomes the next problem. You will find that the concentration required of your hearing system during an editing session is extremely fatiguing. Since, the monitor system must be set at a fairly high level in order to hear extraneous noises at low levels and soft sibilant endings of words, auditory fatigue sets in rather rapidly. Hearing-fatigue lowers the ability of the ear to detect sounds by almost 50 per cent and causes more than normal distortion in the system of hearing itself, so the reason for the above opinion is self-evident.

Editing tape is in itself a profession and like any other work, the more editing you do, the better you become at it. There is nothing that will take the place of practice and the exercise of your own acumen. You may devise methods of your own for editing that will prove to be better than those outlined. The main object is to become familiar with the workings of your equipment; the rest is practice and common sense.

STROBOSCOPES

[from page 22]

85 r.p.m. the same timing accuracy will give a speed determination closer than 0.7 per cent, and use of a stop watch for timing should better these accuracies by ten fold.

Table I is a compilation of the design elements for a group of easily constructed arrays (with second and third order effects) which will provide stationary basic patterns at rotational speeds from 33 1/3 to 125 r.p.m. with lamp-flash rates of 50, 100, and 120 (25, 50, and 60 cps a.c. supply). Arrays 4, 8, and 10 may be placed on one disc to provide a convenient "universal" strobo-

HARVEY presents

BELL RE-CORD-O-PHONE

Model RT-65 tape recorder with 3.5 watts power output. Has inputs for microphone, external radio or phono. Records at 7 1/2 inches per second, rewind ratio 6:1. Dual track tape provides full hour on 7" reel, half hour on 5" reel. Internal 6", 8-watt, speaker disconnects automatically when using remote speaker. Amplifier specially designed, 3.5 watts with excellent response from 70 to 8000 cps. Interlock switch prevents erasing in rewind position.



Neon lamp level indicator, headphone monitoring. Shpg Wt. 37 lbs. Complete with microphone, tubes, full reel tape, manual.....\$113.00

WESTERN ELECTRIC SPEAKERS

Here's another good buy from Harvey's. Genuine Western Electric speakers at a new low price, every one brand new in factory sealed cartons. These are the genuine article from our regular stock.

12" — 728-B.....\$31.20 8" — 755-A.....\$22.35

MAGNECORD SERIES 6 RECORDERS AND AMPLIFIERS

PT6-JA Recorder and Amplifier...the only combination on the market today that offers such high professional quality at such a low price. Includes PT6-A Recorder plus Amplifier with low impedance microphans and bridging inputs, 10-watt audio amplifier with monitor, speaker and jack for external speaker, 600 ohms balanced line output terminal.



PT6-JA—Magnecord combination\$499.50

With high speed forward for cueing..... 515.50

PT6-A—Recorder 278.00

PT6-AH—Recorder with high speed forward for cueing..... 294.00

PT6-J—Amplifier 221.50

WILLIAMSON AMPLIFIER MANUAL

Just received from England, the complete Williamson Amplifier Manual, containing articles reprinted from "Wireless World" plus additional design information and answers to builders queries. Limited supply, order yours at once.....75¢

WILLIAMSON HR-15 AMPLIFIER KIT

Kit is complete with tubes, punched chassis, prewired resistor board, sockets, genuine Partridge output transformer, and all necessary parts, \$75.00 net.

McIntosh Amplifiers

We have the McIntosh Amplifiers in stock for immediate delivery. Full information on request, or come in and hear a demonstration.

20 W-2 Amplifier\$149.50

50 W-2 Amplifier\$249.50

AE-2 Equalizer Pre-Amp\$74.50

REL FM Receiver — Tuner

Still available, this outstanding FM receiver by REL. Many excellent features, 10-watt output, less than 1.5% distortion, 70 db noise suppression. Complete....\$345.00

SPECIAL ANNOUNCEMENT

You are invited to a pre-view of our new sound room to be formally opened in September. Come in now. You will find recorders, phono tables, amplifiers, tuners and speakers on display and demonstration. Fingertip control panel permits interconnecting any combinations for comparison. We'll also invite you to the grand opening, but don't wait.

Telephone: 7-HRC LUXemburg 2-1500

All in stock for immediate delivery.

HARVEY
RADIO COMPANY INC.

103 West 43rd St., New York 18, N. Y.

NOTE: All prices are Net, F.O.B. N.Y.C. and are subject to change without notice.

From Great Britain...
the Wharfedale W10/CSB

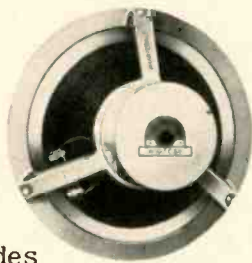

provides

BIG SPEAKER FIDELITY
for only \$28.50!

Distributed exclusively by Sun Radio & Electronics Co., Inc., in Eastern United States, the Wharfedale W10/CSB offers the optimum in performance from a single speaker. Designed by Mr. G. A. Briggs, renowned loudspeaker authority and author. This speaker is used by the BBC for monitoring purposes.

Especially suitable for average size living room use, this speaker offers true presence effect with brilliant treble response and richly defined bass response. The 10" size facilitates simpler installation than larger or smaller diameter speakers. Made of the finest materials with precision construction. Cloth suspension minimizes hangover. Voice coil impedance 2-3 ohms or 12-15 ohms. Only \$28.50



Special Cabinet Particularly Suited to the W10/CSB

Furniture in good taste (mahogany or blonde) designed by Sun Audio experts primarily for the Wharfedale speaker. \$44.50

This combination of speaker and cabinet at \$73.00 presents one of the best buys in audio equipment available on the market today. Speaker installed in cabinet and tested in our laboratory prior to shipment.

Send for free copy of our famous 68-page Audio Catalog. It lists among other things the full Wharfedale line for which we are exclusive Eastern Distributors.

Sun Radio
& ELECTRONICS CO. INC.
122-D DUANE ST. • NEW YORK 7, N.Y.
2 Blocks North of Chambers St.
BARCLAY 7-1840

scope for record-player use, with basic stationary patterns of 78 6/23, 45, and 33 1/3 r.p.m. with 60-cps (120 flash per second) illumination; similarly, arrays 2, 6, and 9 will indicate speeds of 75, 45 5/11, and 33 1/3 r.p.m. with 50-cps (100 flash per second) lighting. These latter arrays may also be used with 25-cps (50 flash per second) illumination, giving a second-order pattern.

Lamp Requirements

The flashing lamp necessary to simple stroboscopic measurements is easily provided—an ordinary incandescent lamp (preferably of low wattage and not frosted) will serve, although the variation of intensity of light from such a lamp is not sufficient to bring out the stroboscope pattern sharply. A single-tube fluorescent lamp (not a pair—dual fluorescent fixtures are usually so designed that each tube illuminates the periods of darkness of the other) will serve nicely. A neon or argon glow lamp is probably the most satisfactory light source easily obtainable, since such a lamp will give a sharp ignition flash on each pulse of the alternating current supply. These lamps are readily available—they are often used as low-drain pilot lamps and as safety and night lights.

A record player or recorder turntable may be easily equipped with a permanent speed-check stroboscope which will also serve to give warning of mechanical faults in equipment which show up as speed variations in the turntable. A strip of paper marked with properly spaced lines and attached to the periphery of the turntable where it may be illuminated by a neon lamp connected across the a.c. motor supply will furnish such a set-up.

If the turntable is to be used for several record speeds, a different band may be marked for each speed. A strip of paper, cut to the length of the turntable periphery, may be marked with the appropriate number of marks (determined from Table I or from formula 3) as shown in Fig. 2. The two ends of the strip count as the same mark. The values in Table I were selected to provide the most useful stationary pattern speeds consistent with ease of protractor and compass layout of the corresponding arrays. For a rim stroboscope the dividing scheme illustrated in Fig. 2 is equally easy of use for any whole number of marks and spaces. The whole number closest to the value given by formula 3 will give the slowest pattern drift for a given set of conditions, and may well be used to advantage. Thus, for a 45 r.p.m. rim stroboscope to be lighted by a 50-cps (100 flash) lamp:

$$n = \frac{60 \times 100}{45} = 133 \frac{1}{3}$$

133 is the nearest whole number, and the pattern formed by an array of 133 marks will drift backward about one revolution in 9 minutes.

A little experimenting with simple stroboscopes will soon convince the user of their great versatility and usefulness. There are probably no simpler or more fascinating precision instruments that can be handmade with as little cost and technical skill.

THE AUDIO FAIR
—1950—
October 26-27-28, 1950
HOTEL NEW YORKER
New York City

RACON TWEETER

Highest Music Quality
At Low Cost!



MODEL
CHU-2
\$37.50
List Price

Clean
Output to
15,000 Cycles!
Wide Distribution Pattern!

Here's how you can bring the concert hall right into your own living room! Simply add this Racon tweeter to your present 12 or 15" cone speaker and enjoy to the full the luxurious, life-like brilliance of FM and wide range recordings.

Response is clean and uniform, with excellent usable output to 15,000 cycles. High frequency horn logarithmically expanded as two horns for wide, uniform distribution pattern. When used with crossover network, will handle amplifiers rated to 25-30 watts. Input impedance 4-15 ohms. Dimensions 10 3/4" wide, 7" high, 8 3/4" deep.

Cast aluminum throughout. Cutout template provided for easy flush mounting. Free wiring diagram and instructions to build an economical professional type 1,000-cycle crossover network.

Listen to the Racon tweeter at your nearest distributor or write for free Catalog A

IN CANADA:

Dominion Sound Equipments Ltd.,
4040 St. Catherine St. W., Montreal 6, Quebec

ACOUSTICAL  EXCELLENCE

Racon Electric Co., Inc.
52 East 19th Street, New York 3, N. Y.

ALL RACON PRODUCTS ARE GUARANTEED FOR 18 MONTHS

POPS

[from page 24]

is, or depend on the sanctity of national advertising. Eliminating the naive, there is vast evidence of the creeping paralysis induced by the technical straitjacket. I, for one, have never found the concept of specialization satisfactory on any level. There is a folkway with reference to engineers which carries an extraordinary degree of truth as well as some over-generalization. It is certainly true that a whole coterie of "audio-engineers" specializing in the theoretical and applied problems of reproducing equipment are thoroughly detached from the essential problem, which, to my way of thinking, is a musical one. Hence, the mutilated recordings of our highly sophisticated time, the expensive custom-jobs suited perhaps to the approximation of a theoretical limit but overlooking the very real problems involved in musical reproduction.

Musically, the problem is perhaps more severe. With some exceptions, the recording industry . . . and to be brutally frank, the music business in general . . . is captive to the musically inept. It is my pitiful misfortune to be extremely closely connected with our third largest industry, the music business, in an intimate relationship which breeds only the highest contempt, on the one hand, and the most bathetic sympathy on the other. For those of you who are connected with the business either in the form of technical indulgence or listening status, it would be wise to let a little bit of reality seep through and recognize the fact that the mountain of the gods is now populated by second-rate satans.

Mass Buying

Who is to blame? YOU are! You refuse to trust yourself any longer. Willingness to accept the stereotypes of mass appeal have brought the walls crumbling down on us. The LP market is fantastic now. It is due to musical reasons? Is the LP superior (when played on the type of instrument that most of them are played on) to the good 78 r.p.m. shellac model? Decidedly not. Are records supposed to be bought and used for musical reasons? The third step of the syllogism is obvious.

What has happened in the United States during the past fifteen years constitutes more than anything else a shift in objectives. The shift could not have been accomplished if the buying public hadn't been all too willing to fall into line and accommodate the ambitions and objectives of the controlling factors in the record industry, music business, and engineering arts. The objective is clearly directed towards sales. There is no need to hash around the problem of economic motivation. What is most ironic is the fact that fifteen years ago it would have been possible to combine economic motivation with something called artistic integrity. The boom market in the record and music business indicated that quality was easily as saleable as junk.

NEW RELEASES:

From the above, it is obvious that I am hopping mad. For several months now, I have plied the charitable road. Prior to doing the column, I've gone through new release after new release, listening fairly and objectively, hoping to find just one record that I could shake hands with . . . pat it on the back and send it merrily on its way. No such luck! Some months ago, I received a card from one of this column's readers asking why I didn't review good recordings. The card raised a question . . . and since I

Anyone Can build a HEATHKIT



**Heathkit
SIGNAL
TRACER KIT**
\$19.50



**Heathkit
VACUUM TUBE
VOLTMETER KIT**
\$24.50



**Heathkit
TUBE CHECKER KIT**
\$29.50



**Heathkit
BATTERY
ELIMINATOR KIT**
\$22.50



**Heathkit
CONDENSER
CHECKER KIT** \$19.50



**Heathkit
IMPEDANCE
BRIDGE KIT** \$69.50



**Heathkit
R.F. SIGNAL
GEN. KIT** \$19.50



**Heathkit
HANDITESTER
KIT** \$13.50



**Heathkit 5"
OSCILLOSCOPE
KIT**
\$39.50



**Heathkit
TELEVISION
GEN. KIT** \$39.50



**Heathkit
AUDIO GEN.
KIT** \$34.50



**Heathkit
ELECTRONIC
SWITCH KIT**
\$34.50

Heathkits are beautiful factory engineered quality service instruments supplied unassembled. The builder not only saves the assembly labor cost but learns a great deal about the construction and features of the instrument. This knowledge aids materially in the use and maintenance of the equipment. Heathkits are ideal for and used by leading universities and schools throughout the United States. Each kit is complete with cabinet, 110V 60 cycle transformer (except Handitester), all tubes, coils assembled and calibrated, panel already printed, chassis all punched, formed and plated, every part supplied. Each kit is provided with detailed instruction manual for assembly and use. Heathkits provide the perfect solution to the problem of affording complete service equipment on a limited budget. The basic three instruments — an Oscilloscope, Vacuum Tube Voltmeter, and Signal Generator can be purchased in Heathkits for \$93.50, about the cost of a factory-built VTVM alone. Write for complete catalog.

HEATH COMPANY

BENTON HARBOR 25,
MICHIGAN

EXPORT DEPT., 13 E. 40th ST., NEW YORK 16, N.Y. . . . CABLE ARLAB-N.Y.

Air-Tone HEADQUARTERS FOR MAGNECORD



McIntosh Amplifiers

Highest quality, efficiency. Full dynamic range. Frequency range—20 to 20,000 plus or minus .2db; 10 to 200,000 plus or minus 2db. Lowest phase shift distortion, lowest noise level.

50 W-1 for less than 1% distortion

• Continuous single frequency rating
• 50 watts RMS—Peak 100 \$249.50 net

20 W-2 for less than 1% distortion

• Continuous single frequency rating
• 20 watts RMS—Peak 40 \$149.50 net

AIR-TONE HEADQUARTERS FOR MAGNECORD

Air-Tone offers Magnecord recording equipment for all those who desire the ultimate in Magnetic recording. Easy operating, Magnecord provides unusually high fidelity, great flexibility in use, outstanding realism in tone.

PT6-JA Recorder & Amplifier

Portable rig for professional, superb reproduction of all types of program material. 10-Watts output. Highest Quality, Greatest Value. \$499.50



Air-Tone

SOUND & RECORDING COMPANY
1527 CHESTNUT ST., PHILA. 2, PA. — RI. 6-8388

World-Wide Popularity

Since the inception of AUDIO ENGINEERING in May 1947, engineers and audio hobbyists have subscribed in ever-increasing numbers, not only in the 48 states and in all of the major foreign countries but in such places as Tasmania, Transvaal and Trinidad.

Each month AUDIO ENGINEERING covers the latest developments and practices in recording, reproduction and instrumentation for the entire audio field.

Subscribe Now—Don't Miss an Issue! Back numbers are hard to get!

AUDIO ENGINEERING
342 Madison Avenue, New York 17, N. Y.

Sirs: Here is my check (or money order) for \$..... Enter my subscription order to AUDIO ENGINEERING for the next issues. Subscription Price: In U.S.A., Canada and Pan American Union—12 issues \$3—24 issues \$5. All others \$4.00 per year. Please check one: New Subscription Renewal.

Name (please print)

Address

City Zone State

Occupation (give title and department)

Firm Name

am going to have to pan this month's batch, a word of explanation is in order.

A considerable number of mass circulation magazines have "record critics" who devote some space every week to the new "pops." With the exception of a few (and I consider George Avakian to be one of the best informed and most honest "jazz" critics around today), the monthly output gets varied bravos or insipid biographical commentaries. In my book, this represents an evasion of the job at hand. Reviews serve as buying guides in the final analysis. To review the pop items that come out daily, mention who is on the label (and I've said all this before) is a waste of time. This column is, and will continue to be, an objective guide to the situation as it stands. I am not going to sell you what I wouldn't buy myself. To make up for it, next month's column will begin an informal series of listings of things that I think are the best in pops (of any shape or variety). Sporadically, the list will be enlarged to include a basic guide for the collector. There will be a few contemporary items; most of the stuff is old. I can't vouch for availability, but with the right amount of money in hand, anything can be had.

Alec Wilder Octets Mercury MG 25008

I'm particularly fond of Wilder's stuff. I'm not certain whether it should be reviewed in a pop column or not despite the beat. At any rate, the facile composer-arranger has a knack when it comes to handling wind instruments . . . always featured in the octet arrangements. This is, again, a 10-inch LP, nicely done. Hard stuff to push . . . because you either like it or not. Titles, as always, are cute and therefore should be listed . . . The Children Met the Train; Remember Me to Youth; They Needed no Words; Jack, This Is My Husband; Little White Samba; The Amorous Poltergeist, etc. To those fearful ones, Frank Sinatra is not conducting.

James P. Johnson Decca DL 5190

Not much to be said here. I don't like the piano recording, and being an old J.P.J. fan from way back, I return to objections mentioned above. I don't want anybody to select my evening's pleasure for me via LP. Any well stocked jazz shop has the stuff on this baby . . . despite the fact that the originals weren't well recorded either.

POT LUCK:

One of the best pop tunes of the past ten years was the luscious "Bewitched, Bothered and Bewildered." The past couple of months have seen a revival in numerous lush arrangements. No need to review them, because they all do a good job of murdering a wonderful pop. For those of you who must have it, go back to the original Goodman version on Columbia. Helen Forest did a tasteful vocal and the orchestration is just right . . . one of Benny's best straightfs. For that matter, another word to the wise. Since Disc Recording Co. left this world, a lot of their jazz recordings have been awfully hard to lay a hand on. There are still a few floating around. If possible, track down the Charlie Ventura Trio recording of "Body and Soul" and "Stompin' At the Savoy," both on a 12-in. 78. Recorded at Town Hall, Krupa is on drums in a neat, neat recording. This is a gem in my books (despite an occasionally noisy audience). Recording is very good, despite the hall and audience. Ventura is brilliant . . . buy, buy, buy. If you can't get any copies, drop me a note and I'll try and track them down for you.

RECORD REVUE

[from page 24]

the usual 1/2 mil of many machines to the fabulously small size of 1/4 mil. This, as technical experts will understand, allows for the recording of a wider range of frequencies at the usual speeds.

Don't ask me details on how the thing is done—though it was explained to one of my ears, only to dribble out of the other one. Don't ask me how the serious difficulties encountered with such tiny gaps have been met—as clearly Ampex must have met them, unless the company is putting itself on a very long and shaky limb. You might try pumping Walter Selsted of Ampex, who did the development work—or if Mr. Selsted quite correctly clams up, then you may tackle the Veeps and the Prexies of Ampex Electric, who may or may not be ready to confide.

It's enough for this column that here we have, presumably in an advanced stage of preliminary development, a basically new thing in tape recording, with some very interesting implications. Let us, for now, take it as granted that the Ampex development will prove sound, bug-free, and as good or better than as claimed. A fairly reasonable assumption. What then, may be the consequences of the doubling of recording efficiency here achieved?

Equipment Available

By the time this is in print (it is being written earlyish so that our editor may take his much-deserved vacation in peace and editorial security) there will no doubt be a further announcement from Ampex, of a model 400 (a complete recorder-playback unit) to supplement the presently-announced model 450 playback machine. My unofficial impression is that this machine is a kind of feeler model to test out the possibilities inherent in the improved efficiency of the central mechanism. There are two major fields in which tape machines incorporating this sort of improved efficiency may be expected to operate.

Record Releases

Erna Sack sings Opera Highlights and Song Favorites
Mercury LP
MG 10044

Ellabelle Davis sings Negro Spirituals
(with orchestra, piano)
London LP
LPS 182 (10")

Here are two phenomenal voices that have one thing very much in common: both have that consummately accurate sense of exact pitch and of beautiful phrasing that one in a hundred "great" vocal artists are lucky enough to be born with. A subtlety, you may say—but listen hard, and judge for yourself. There's nothing like it and even a tin plated ear can catch on, after a few notes.

The Mercury Sack record, the third re-issue, is an example of a good and well justified pot-pourri of older recordings; for Sack is surely one of the most astonishing voices of all time, both in its extraordinary range and (more important) the musicianship, above-mentioned, behind it. These are technically of good pre-war quality, quite wide range but with some distortion in the high end and a fair amount of surface interference. Acoustically the recordings vary greatly—in some she is close, others at a distance; levels differ and orchestral sound differs. The operatic arias are useful in giving an idea of Sack's wider musical range.

Gray

RESEARCH

FEATURES IDEAL REPRODUCTION

TRANSCRIPTION ARMS

NEW VISCOUS-DAMPED 108-B ARM

For all records — 33 1/3, 45 and 78 r.p.m. Radically new suspension

development on the viscous damping principle for perfect tracking of records and elimination of tone arm resonances. Instant cartridge change with automatic correct stylus pressure. Solves all transcription problems. Ideal for LP records. For Pickering, new GE (short), old GE (long) cartridges. Write for bulletin. Price, less cartridges, \$50.70



MODEL 106-SP ARM

Designed to meet strictest requirements of modern highly compliant pick-up cartridges. 3 cartridge slides furnished enable GE 1-mil, 2 1/2-mil or 3-mil cartridges or Pickering cartridge to be slipped into position in a jiffy. No tools or solder! Superb reproduction of 33 1/3, 45 or 78 r.p.m. records. Low vertical inertia, precisely adjustable stylus pressure. Write for bulletin. Price, less cartridges, \$45.15



EQUALIZERS

MODEL 603 EQUALIZER

Latest of the universally adopted Gray Equalizers used, with Gray Tone Arms, as standard professional equipment by broadcast stations. High-frequency characteristics obtainable comprise 5 steps — flat, high roll-off, NAB, good records, poor records. For both GE and Pickering cartridges. Price, \$50.70

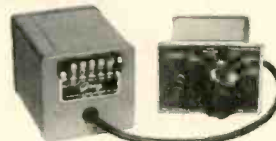

MODEL 602 EQUALIZER

Has 4 control positions, highly accurate response curves. Price, \$49.50

Write for bulletins on Gray Equalizers.

GRAY RESEARCH and Development Co., Inc.
18 Arbor St., Hartford 1, Conn.

Division of The GRAY MANUFACTURING COMPANY
Originators of the Gray Telephone Pay Station and the Gray Audograph



New Type 2A TAP SWITCHES

HAVE A CONSTANT CONTACT RESISTANCE OF
ONLY 1 or 2 MILLIOHMS!

These high quality switches with up to 24 contacts were specifically developed to meet the need for rugged precision instrument switches that have longer operating life and are economical components in competitively priced electronic instruments and military equipment.

Write for Technical Bulletin No. 28.

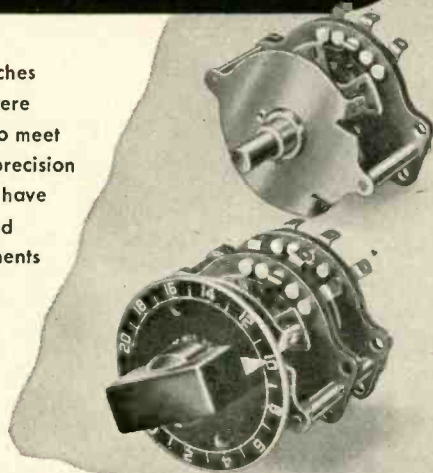

TECH LABORATORIES PALISADES PARK
NEW JERSEY

IN ORDER TO FIND IT— WHY NOT BIND IT?

Your reference library of AUDIO ENGINEERING can be up-to-the-minute by keeping your copies in an AUDIO Binder.



APPEARANCE . . . Your den, workshop . . . or wherever you do your experimentation can be kept in "apple-pie" order when all your copies of AUDIO ENGINEERING are within easy reach. The deep, blue cover will harmonize with any color scheme and . . . in addition, the backbone will be gold-stamped with AUDIO ENGINEERING and any year you specify.

CONVENIENCE . . . No more wondering what happened to last month's issue . . . or the month before . . . Just reach for your Binder and no time is lost finding the information you need . . . AT ONCE.

WORKMANSHIP . . . DuPont Fabricord . . . stainproof and washable . . . rigid backbone with bound-in metal support . . . center channel to keep magazines securely in position.

COST . . . For only \$2.50 you can have this handsome binder for your ready reference.*

* (Foreign orders add 50¢ per binder)

Audio Engineering
342 Madison Ave., New York 17, N. Y.

Enclosed find \$ for Binders

Name

Address

City Zone State

Year Wanted 1947 1948 1949 1950.

The Ellabelle Davis Spiritual arrangements—some for piano accompaniment, some for fancy orchestral background—a re straightforward conventional corn; but the Davis voice and sense of pitch make one immediately forget the background. This is perhaps the only time I have ever enjoyed listening to commercially "arranged" spirituals—and it is all Davis' work. Gorgeous wide-range recording, the voice very close, with beautiful sibilants.

Bartok, Sonata for Two Pianos and Percussion.

Wm. Masselos, Maro Ajemian, pianos.
Saul Goodman, Abraham Marcus, percussion.

Dial LP #1

Alban Berg, Lyric Suite

Pro Arte String Quartet

Dial LP #5

Dello Joio, Ricercari for Piano and Orchestra.

Concert Hall Symphony, Swoboda; Germaine Smadja, piano

Concert Hall LP DL 6 (Lim. Ed.)

Milhaud, Concertino de Printemps; Violin Concerto #2.

French Nat. Radio Orch., Milhaud. Louis Kaufman, violin.

Capitol LP P 8071

If you want to know what LP is doing for today's music—and for us listeners in making new music more easily understood try this brief cross-section of dozens of very interesting new releases. The tape-LP combination is unbeatable in the contemporary music field—where in ye old days, when we got anything at all on records it was more than usually a blurry mess of dreadful distortion.

The Bartok, though not as tight and authoritative a performance as Vox's reissue of Bartok's own playing (with his wife) on a pre-war broadcast, is one of the best percussion-piano records to date. I disagree with some who say that this is better than Capitol's recording of the similar Bartok work, the Music for Strings, Percussion and Celesta—but this is good, very good. Terrific percussion sounds—xylophone, all sorts of drum sounds, etc. The two pianos are fine, though perhaps not quite big enough in the balance compared to a stage performance I heard of the music. This makes an unusual test-demonstration record.

Berg's Lyric Suite is extremely dissonant and extremely romantic—a combination that perhaps you may not have imagined as possible! Try it and see—the fine recording again makes this not at all difficult to listen to on a good outfit. Try the wiry, snarling third movement. Dello Joio's Ricercari (that's plural) are three related movements in a good humored, rather brassy orchestral style with a quicksilver piano, expertly fluent. A couple of plays should make you enjoy it—but you have to subscribe; it's Limited Edition.

Milhaud, already an almost-elder statesman of French music, has some delightful music for you in the "Concertino de Printemps"—a burbling, gurglingly joyous little piece for a nice collection of close-up, beautifully recorded instruments. Sounds like spring! The Violin concerto is heavier stuff but not really difficult at all the fine recording makes it easy to listen to. Note that the Dial company, making only LP's (like almost everybody but the major outfits) is recording *only* contemporary music, and in excellent performances musically. One of the best things to have come out of LP.

AUDIANA

[from page 21]

Feedback Stages

Feedback amplifiers have been discussed at length elsewhere, and all that will be done here is to indicate the general equivalent circuits for voltage and current feedback, and for the general solution. This is done in Figs. 6, 7, and

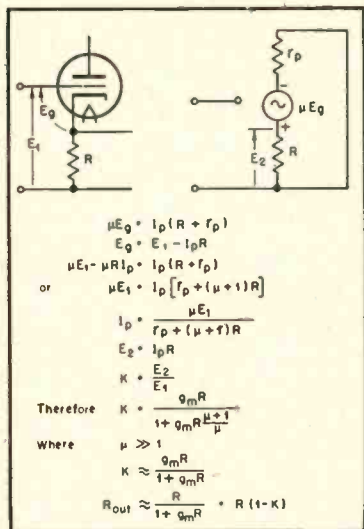

Figure 8

8. The last circuit is the special case for the cathode follower, and if the input capacitance due to Miller Effect is computed it will be found to be very low. The output impedance also has been reduced through the use of this circuit.

For the solution of acoustical problems using equivalent circuits, it is only necessary to draw the circuit using electrical symbols and converting the values to appropriate units through the use of dynamical analogies. The circuit may then be handled as any electrical circuit.

Use of equivalent circuits and the network theorems provide simple, easily handled solutions to many complex circuits. However, it is always necessary to keep in mind the major limitation of equivalent circuit theory, where linear operation of all circuit elements is assumed.

AUDIO PATENTS

[from page 6]

Changes in the average bias caused by changes in input amplitude are offset by the coupling of the grid return to the output point—the plate. Because R_2 is so large, it, with C_1 forms an integrator circuit to prevent any feedback of the square wave itself, but it allows unidirectional current to flow from the plate to counteract the charging

of C_1 due to grid current, and maintaining average bias just about in the middle of the tube's characteristic. As a result, square-wave symmetry is maintained over large variations of input voltage.

The inventors gave the values listed on the diagram and said that they had satisfactory operation from 2,000 to 5,000 cps at amplitudes of 20 to 200 volts. The parenthesized values in the figure were those I used in experiments, with a 6SJ7 instead of a 6SH7. From 25 volts upward the square waves remained unchanged after R_2 was initially adjusted for symmetry. (The final setting left approximately 2.5 megohms in the circuit.) Within the limits of the available amplifiers and oscilloscope, operation appeared satisfactory from 10 through 20,000 cps.

Musical Instrument

Believing there is considerable interest in

electronic music, we present another music circuit. Invented by T. J. George (Patent No. 2,483,823), it provides both flute- and string-type tones and has delayed keying to provide a soft attack and decay.

The tube is a triode with one or two diodes in the envelope. The triode elements are connected in any standard oscillator circuit, and a diode plate is used for keying and output. The diagram in Fig. 2 shows suitable values for use with middle C.

A 9-volt negative bias is permanently fed to the diode plate. This is higher than the peak signal appearing from cathode to ground so that the diode does not conduct and nothing appears in the output. When the key is pressed, 100 positive volts from a power-supply bleeder is fed to the diode plate through a time-constant network. Gradually the plate conducts, making for a musically desirable slow attack. If the out-

Advance Orders
now being accepted!

audio anthology

Paper cover . . . \$2.00

Board cover . . . \$3.00

Distributors write for quantity discount



The long awaited compilation of reprints from early issues of AUDIO ENGINEERING, most of which are out of print and unobtainable.

Contains 37 articles on the following subjects:

- Amplifiers
- Speakers
- Noise Suppressors
- Phonograph Equipment
- Tone and Loudness Controls
- Dividing Networks

These articles have been of great interest to readers of AUDIO ENGINEERING over the past three years. Assembled in one volume, they comprise the most authoritative reference work yet available to the audio hobbyist.

---CUT OUT---MAIL TODAY---

Book Division, Dept. A
Radio Magazines, Inc.
342 Madison Ave., New York 17, N. Y.

Sirs: Enclosed is my check money order for _____ copies of the
Audio Anthology.

(Please check one) Paper cover Board cover

Name (print carefully)

Address

City Zone State

A
TIME-TESTED
DEPENDABLE
SOURCE
FOR

HIGH-PRECISION FRACTIONAL H.P. INSTRUMENT-TYPE
MOTORS & GENERATORS
PRODUCED TO ORDER

GOVERNOR-CONTROLLED
SELF-SYNCHRONOUS
DRAG CUP
VELOCITY & ACCELERATION
DC & AC TACHOMETER
SHUNT
SHIES
COMPOUND
PERMANENT-MAGNET
SPLIT-FIELD
SEPARATELY EXCITED
UNIVERSAL
INDUCTION
RELUCTANCE
HYSTERESIS
ONE, TWO & THREE PHASE
DC & AC SERVO
TOTALLY ENCLOSED
AC DYNAMICALLY BRAKED
REELMOTORS
ONE, TWO, THREE & FIVE-SPEED
SYNCHRONOUS MOTORS

Experienced for years in meeting customers' exacting requirements for high-precision instruments designed by engineers of ability and ingenuity, and manufactured with extreme care and skill. Over 500 different basic types may be varied to meet your own unique requirements of use, either electrically or physically.

ELECTRIC INDICATOR CO.
PARKER AVENUE
STAMFORD, CONNECTICUT

Ready NOW
ULTRASONIC FUNDAMENTALS

By S. YOUNG WHITE

The rapid increase in the use of ultrasonics during the last few years makes it natural that the well-informed sound engineer should want to learn something of the applications and potentialities of this amazing new field. But interest in ultrasonics is not confined to the sound engineer—it is of still greater importance to the industrial engineer for he is the one who will visualize its uses in his own processes.

Elementary in character, **ULTRASONIC FUNDAMENTALS** was written originally as a series of magazine articles just for the purpose of acquainting the novice in this field with the enormous possibilities of a new tool for industry. It serves the double purpose of introducing ultrasonics to both sound and industrial engineers. The list of chapter headings will indicate how it can help you.

CHAPTER HEADLINES

Too Much Audio. Opportunities in Ultrasonics. Elements of Ultrasonics. Experimental Ultrasonics. Coupling Ultrasonic Energy to a Load. Ultrasonics in Liquids. Ultrasonics in Solids. Testing by Ultrasonics. High-Power Ultrasonics. Notes on Using High-Power Ultrasonics. Applications of Ultrasonics to Biology. Economics of Industrial Ultrasonics.

The applications of ultrasonics have already extended to many industries, and as its possibilities are explored they will increase a hundredfold. To keep abreast of its growth, engineers in all fields must know what they may expect from ultrasonics, how it is used, how the energy is generated, and the techniques of applying ultrasonic treatment to many processes.

ULTRASONIC FUNDAMENTALS is not a big book—it does not cover the entire field of ultrasonics with hundreds of pages of dull reading. But in the three hours it will take you to read it, you will get a down-to-earth glimpse into the far-reaching possibilities of a new art.

ULTRASONIC FUNDAMENTALS
By S. YOUNG WHITE
36 pages, 40 Ill., 8 1/2 x 11, paper cover
\$1.75

Book Division, Dept. A
RADIO MAGAZINES, INC.
342 Madison Avenue New York 17, N. Y.

put were a sine wave, the waveform during the attack buildup would vary, but the addition of C_3 makes output essentially sawtooth in shape, so there is not much variation.

The sawtooth waveform contains harmonics of the fundamental with gradually decreasing amplitudes. The inventor makes use of this complexity to obtain two basic tone qualities from the device. To create a flute-type tone, R_1 , R_2 , and C_1 , a low-pass filter, remove most of the harmonics. To get the string or reed effect, C_2 , C_3 , and R_3 act as a high-pass filter to get that "buzzy" quality.

One triode oscillator is required for each pitch in the instrument, but if it has two manuals, each can use one of the two diodes in the tube, with a circuit similar to that shown following each diode and each keyed by one of the manuals. The string outputs of all the generators are common, and so are the flute outputs. The common flute and string busses may then be mixed together in whatever proportions the designer needs to get various total tone qualities and the resultant may then be passed through tuned circuits to create formants, which imitate the mechanically resonant structure of an acoustic instrument and help give each instrument its characteristic tone quality.

When the key is released, C_1 , which is now charged positively, must discharge through R_2 before the diode ceases to conduct. That takes care of the gradual decay required for good musical effect.

Electronic music patents are fairly plentiful these days, but it is a good idea to describe them only if there is sufficient interest. We would like very much to hear from readers about that. Should we keep on writing about interesting music patents or stick to the more conventional circuits and devices? Any other comments?

A copy of any patent may be obtained for 25¢ from the Commissioner of Patents, Washington 25, D. C.

NEW LITERATURE

● **Cleveland Electronics, Inc.**, 6611 Euclid Ave., Cleveland 3, O., is now distributing Catalog 127-M, listing the complete Cletron line of replacement loudspeakers for TV, auto radio, and home radio. All models are clearly illustrated, described, and priced. The catalog will be supplied free to members of the trade.

● **The Polymer Corporation**, Reading, Pa., has issued a technical bulletin covering various processes and procedures for the machining of nylon bar stock. Sawing, turning, drilling, centerless grinding, threading and tapping are all given treatment both in text and through illustration. In writing, request Bulletin No. 8.

● **Magnetic Recording Division**, Armour Research Foundation, 35 W. 33rd St., Chicago 16, Ill., has compiled and is offering for free distribution a bibliography on magnetic recording. In addition to offering a comprehensive listing of reference material, the bibliography contains a reprint of what is believed to be the earliest statement on magnetic recording.

● **Technology Instrument Corporation**, 1050 Main St., Waltham 54, Mass., has available the first issue of its Laboratory Report No. 1. This report is the result of extensive research on the measurement of phase-angle difference between two electrical signals, and is titled "Low Frequency Characteristics of the Type 320-A Phase Meter." Copies of the paper may be obtained by request in writing.

PROFESSIONAL DIRECTORY

C. J. LeBEL

AUDIO CONSULTANT

Sound Recording • Instrumentation

370 RIVERSIDE DRIVE
NEW YORK 25, N. Y.

Custom-Built Equipment

U. S. Recording Co.

1121 Vermont Ave., Washington 5, D. C.

STerling 3626

Consultation • Design • Fabrication

Audio Facilities Corporation

133 West 14th Street,

New York 11, N. Y.

HERMAN LEWIS GORDON

Registered Patent Attorney

Patent Investigations and Opinions

Warner Building 100 Normandy Drive
Washington 4, D. C. Silver Spring, Md.
National 2497 Stilepherd 2433

Albert E. Hayes, Jr.

CONSULTING PHYSICIST

Audio • R.F. • Video

8 East Sampson St. Bay Park, L.I., N.Y.

RATES FOR
PROFESSIONAL CARDS
IN THIS DIRECTORY

●
\$10 Per Month.
Orders Are Accepted
for 12 Insertions Only

"HAVE YOU HEARD
THE SOUND OF QUALITY?"



NEWCOMB SOUND IS BETTER

- Manufacturers of public address, mobile, phonograph, musical instrument and wired music amplifiers • Portable systems • Portable phonographs and radios • Transcription players • Rock and panel equipment.
- Write today! Circle items of interest and indicate whether you are a Dealer, Parts Jobber or Sound Specialist.

NEWCOMB AUDIO PRODUCTS CO.
DEPT. T, 6824 LEXINGTON AVE.
HOLLYWOOD 38, CALIFORNIA

TWIN-TRAX* TAPE RECORDERS

designed... **ENGINEER** in mind
with the

A COMPLETE SERIES

... of high-fidelity, dependable tape recorders — from transport mechanisms to highly specialized instruments, including the one YOU want. Write today for catalog 510F. Includes ALL technical specifications and direct factory prices.

AMPLIFIER CORP of AMERICA
398-4 Broadway New York 13, N. Y.

*Trademark Reg.

AUDIO ENGINEERING SCHOOL

Practical engineering training in Audio fundamentals, Disc, Film, Magnetic Recording, and Audio frequency measurements.

Studio training simulates Broadcast, Motion Pictures, Television, and Commercial Recording work.

Approved for Veterans

Hollywood Sound Institute, Inc.
1040-A North Kanmore, Hollywood 27, Calif.

Specify if Veteran or Non-Veteran

WANTED

Acoustic Engineer, experienced

Acoustic or audio research engineer for development work on loudspeakers and microphones. Progressive concern located in New York suburban area. Salary to \$6,000. Send complete resume. Box 358, Audio Engineering, 342 Madison Ave., New York 17, N. Y.

• **British Industries Corporation**, 164 Duane St., New York City, N. Y., is now distributing *The International Radio Tube Encyclopedia*, edited by Bernard B. Babani. Price is \$6.50. It is unique in that it is the most inclusive volume of this kind yet to be published. Over 14,500 tubes are described, considerably more than have been covered in comparable texts. Included are tube types used by the Armed Services of the U. S., Europe and Great Britain, in addition to normal civilian patterns. Tube base connections are shown in continuation columns immediately following tube characteristic columns, thus eliminating the need for repeated reference to other sections.

• **General Cement Manufacturing Company**, 919 Taylor Ave., Rockford, Ill., is now releasing to jobbers a new 64-page catalog which includes listing of over 5000 radio and television products and service. In writing request Catalog G-C 154.

LETTERS

[from page 2]

facturers to stress the audio end of their receivers.

The future of telecine may hinge on such a standard, for if a material increase in audio fidelity is accomplished by a general improvement in TV receiver audio design, the live portions of telecasts would stand out much more than they do now.

Frank E. Sherry, Jr.,
Sound Engineer,
Gerdes Sound Pictures,
Victoria, Texas

Postcards

Sir: Congratulations on your May editorial on the need for identification when writing to manufacturers.

The engineer who writes us on a postcard, in pencil, will receive only a single sketchy description of our equipment, for we have no way of distinguishing his inquiry from the hobbyist's. Therefore, we say to engineers—as strongly as we can: If you want your letter treated with the deference due a professional inquiry, write like a professional! If your company makes it difficult for you to get catalogs and you want to write, at least write a letter and identify yourself.

Mr. Gera's letter in the June issue is somewhat in error—the hobbyist is a good market only for amplifiers, pickups, loudspeakers, components, and transformers. In the instrument field, his purchases are nil.

Instrument Sales Manager,
New York City

THE AUDIO FAIR

— 1950 —

October 26-27-28, 1950

Hotel New Yorker

New York City

**AN IMPORTANT NEW
PHOTOFACT BOOK!**

for **SOUND TECHNICIANS
AUDIO ENGINEERS
CUSTOM BUILDERS**

VOLUME TWO

**Howard W. Sams' Post-War
"AUDIO AMPLIFIERS"**



Full Analysis of
104 Important
Audio Amplifiers,
12 Popular Tuners
and Associated
Equipment

Based on Actual
Study of the
Equipment

COMPLETE, AUTHORITATIVE DATA

This new volume continues to fill the large sustained demand for data on Audio Amplifiers and associated equipment. Invaluable to public address and sound technicians, audio engineers, custom installers, BC engineers, and students. Provides a complete, clear, uniform analysis of 104 well-known audio amplifiers and 12 important tuners. Includes detailed circuit and design data based on original laboratory examination of the equipment. All new material, continuing audio equipment coverage begun in Volume 1 (see below). Profusely illustrated with hundreds of photos and diagrams. 368 pages; 8½ x 11"; sturdy bound.

ORDER AA-2. Only... **\$395**



VOLUME ONE

**Howard W. Sams' Post-War
"Audio Amplifiers"**

This is the initial volume covering audio equipment produced after the war, through 1948. Covers 102 audio amplifiers and FM tuners, plus data on important wire and

tape recorders. Includes the products of 29 well-known manufacturers. 352 pages; fully illustrated; in sturdy binding, 8½ x 11". ORDER AA-1. Only... **\$395**

**ORDER BOTH VOLUMES AND OWN
A COMPLETE, AUTHORITATIVE SOUND LIBRARY**

HOWARD W. SAMS & CO., INC.

Order from your Parts Jobber today, or write direct to HOWARD W. SAMS & CO., INC., 2201 East 46th Street, Indianapolis 5, Ind.

My (check) (money order) for \$..... enclosed. Send the following books:

- AA-2. "Audio Amplifiers." Vol. 2, \$3.95
- AA-1. "Audio Amplifiers." Vol. 1, \$3.95

Name.....

Address.....

City..... Zone..... State.....

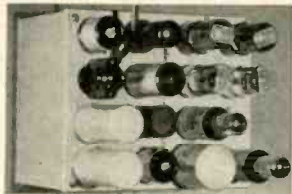

20 W-2 Amplifier \$149.50



AE-2 Equalizer PreAmp \$74.50



50 W-2 Amplifier \$249.50

McIntosh

Engineering Laboratory, Inc.
910 King St. Silver Spring, Md.
Prices Subject to Change Without Notice.

HARTLEY-TURNER PRICE LIST for new audio range

215 Speaker	\$ 40.00
New Tone-control Pre-amplifier	\$ 23.00
New 20 watt Amplifier	\$102.00
New Needle-armature pickup for all records, with 2 sapphires	\$ 10.00
New 33 1/3 r.p.m. Phonograph Motor \$	\$ 14.00

The above prices do not include tubes, which are standard R.C.A. types. A set of tubes will cost you \$17.90. Thus, for the modest outlay of \$206.90 (plus the import duty on the equipment) you can have a complete L.P. phonograph which is a real hi-fidelity job, designed only for the best possible performance regardless of cost.

More important, if you are a member of a Hartley-Turner Speakeasy it will cost you considerably less.

Mailing of full information on the above and other new products will begin early in September to all names on our list. (When New Notes subscribers will also receive the new data sheets and a copy of our new essay on "The reproduction of micro-groove records.")

If you have not already got your name on that list, write today; and if you include a dollar bill as a subscription, you will also receive all our technical data and "New Notes in Radio," the pocket guide to high-fidelity.

H. A. HARTLEY Co. Ltd.,
152 Hammersmith Road,
London W.6, England.

ADVERTISING INDEX

Air-Tone Sound & Recording Co.	34
Altec Lansing Corp.	30
Amperite Co., Inc.	2
Ampex Electric Corp.	40
Amplifier Corp. of America	39
Arnold Engineering Co.	1
Audak Company	25
Audio Devices, Inc.	Cover 2
Audio Facilities Corp.	38
Bell Telephone Laboratories	8
Daven Co., The	Cover 3
Duotone Company, Inc.	28
Electric Indicator Co.	38
Gordon, Herman Lewis	38
Gray Research & Dev. Co.	35
Hartley, H. A. Co., Ltd.	40
Harvey Radio Company, Inc.	31
Hayes, Albert E. Jr.	38
Heath Company	33
Hollywood Sound Institute	39
Industrial Electrical Works	6
LeBel, C. J.	38
Magnecord, Inc.	23
McIntosh Engineering Lab, Inc.	40
Newcomb Audio Products	39
Partridge Transformers, Ltd.	40
Pickering & Co., Inc.	5
Presto Recording Corp.	7
Professional Directory	38
Racon Electric Company, Inc.	32
Reeves Soundcraft Corp.	29
Rek-O-Kut Company, Inc.	30
Sams, Howard W. & Co., Inc.	39
Sun Radio & Electronics Co., Inc.	32
Tech Laboratories, Inc.	36
Terminal Radio Corp.	27
Triad Transformer Mfg. Co.	3
United Transformer Corp.	Cover 4
U. S. Recording Co.	38

Partridge News

**Individually tested
AUDIO TRANSFORMERS**
to the 'WILLIAMSON'
Specification

This range of 20 watt push-pull output transformers is intended for use in equipment reproducing the full audio frequency range with the lowest distortion. The design and measured performance is exactly as specified by Williamson in the "Wireless World" August 1949 (see also Audio Engineering November 1949). The transformer is available in a varied range (separate models suitable for KT66, 807 tubes, etc.) Performance assured by comprehensive testing procedure applied to each unit. Close limits set on shunt reactance at 50 cps., series reactance at 5 Kc/sec., d.c. resistances and interwinding insulation resistances at 2 K.V.

This is the best possible transformer of its type (weight 14 lbs.) Our new technical data sheet is available and will be rushed to you by airmail upon application. The price of the potted model is \$19.50 post free to your door. Immediate from our stocks.

PARTRIDGE TRANSFORMERS LTD

Roebuck Road, Tolworth, Surrey, England

FOR RECORDING TELEMETERING SIGNALS (up to 40 kc.)



Almost overnight Ampex Magnetic Tape Recorders revolutionized radio network broadcasting. Ampex succeeded in this most critical service because of simple and dependable operation, plus a tone quality that is unequalled. Ampex is now available in several models for a wide range of requirements. Inquiries for special instrumentation and industrial control application promptly answered.

- MODEL 300C \$1575
- YU METER PANEL (EXTRA \$105 (F.O.B. San Carlos))

IMPORTANT NEW TOOL FOR INDUSTRY AND SCIENCE

AMPEX

MAGNETIC TAPE RECORDER

"STANDARD OF THE GREAT RADIO SHOWS"

Get FREE BOOKLET today!

AMPEX ELECTRIC CORP., San Carlos, California

Without obligation please send 16-page illustrated booklet containing technical specifications of Ampex Magnetic Tape Recorders.



NAME _____

ADDRESS _____

CITY _____ STATE _____

Our need is for:

- | | |
|--|--|
| <input type="checkbox"/> Laboratory Research | <input type="checkbox"/> Telemetering |
| <input type="checkbox"/> Multi-Channel Recording | <input type="checkbox"/> Industrial Recording |
| <input type="checkbox"/> Recording/Broadcasting | <input type="checkbox"/> Aerophysical Research |

Distributed by ...

BING CROSBY ENTERPRISES (Hollywood)
AUDIO & VIDEO PRODUCTS CORP. (New York City)
GRAYBAR ELECTRIC COMPANY (Everywhere)
EXPORT: WESTREX (New York City)

TWENTY YEARS OF ATTENUATOR PROGRESS

BY

DAVEN



As one of the oldest and most progressive manufacturers of attenuators, we take pride in presenting our recent contribution to the users of fine volume controls . . . the "Knee-Action Switch.*" This revolutionary type of rotor is now being offered on Daven attenuators and switches at no additional cost.

For longer life and uninterrupted performance, we offer a switch with the following advantages:

- ★ Multiple wiping blades of the "Knee-Action Switch" are enclosed in a tamper-proof housing.
- ★ Each blade conductor is individually spring loaded, giving a perfect balance to the entire conducting surface.
- ★ Uniform pressure on the contacts and slip rings is assured, resulting in low, even contact resistance, over the life of a unit.
- ★ The considerably shorter rotor arms result in lower over-all switch resistance, due to the reduced conducting path.

* PATENTED

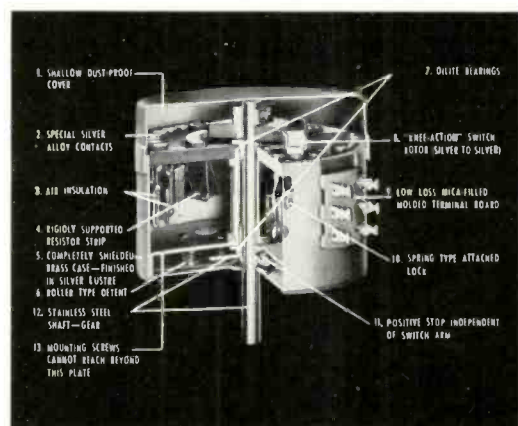

For Further Information Write to Dept. A-6



THE **DAVEN** CO.

191 CENTRAL AVENUE
NEWARK 4, NEW JERSEY

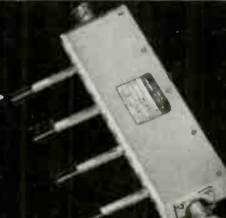



MINIATURE COMPONENTS FROM STOCK...

SUBOUNCER UNITS

FOR HEARING AIDS...VEST POCKET RADIOS...MIDGET DEVICES

UTC Sub-Ouncer units fulfill an essential requirement for miniaturized components having relatively high efficiency and wide frequency response. Through the use of special nickel iron core materials and winding methods, these miniature units have performance and dependability characteristics far superior to any other comparable items. They are ideal for hearing aids, miniature radios, and other types of miniature electronic equipment. The coils employ automatic layer windings of double Fornex wire...in a molded Nylon bobbin. All insulation is of cellulose acetate. Four inch color coded flexible leads are employed, securely anchored mechanically. No mounting facilities are provided, since this would preclude maximum flexibility in location. Units are vacuum impregnated and double (water proof) sealed. The curves below indicate the excellent frequency response available. Alternate curves are shown to indicate operating characteristics in various typical applications.

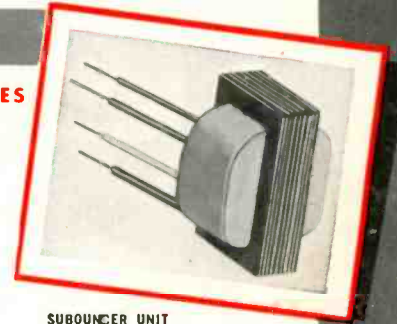

SUBOUNCER UNIT
Dimensions...9/16" x 5/8" x 7/8"
Weight......03 lb.

Type	Application	Level	Pri. Imp.	D.C. in Pri.	Sec. Imp.	Pri. Res.	Sec. Res.	List Price
*S0-1	Input	+ 4 V.U.	200 50	0	250,000 62,500	16	2650	\$5.60
S0-2	Interstage/3:1	+ 4 V.U.	10,000	0	90,000	225	1850	5.60
*S0-3	Plate to Line	+ 20 V.U.	10,000 25,000	3 mil 1.5 mil.	200 500	1300	30	5.60
S0-4	Output	+ 20 V.U.	30,000	1.0 mil.	50	1800	4.3	5.60
S0-5	Reactor 50 HY at 1 mil. D.C.							5.10
S0-6	Output	+ 20 V.U.	100,000	.5 mil.	60	3250	3.8	5.60

*Impedance ratio is fixed, 1250:1 for S0-1, 1:50 for S0-3. Any impedance between the values shown may be employed.

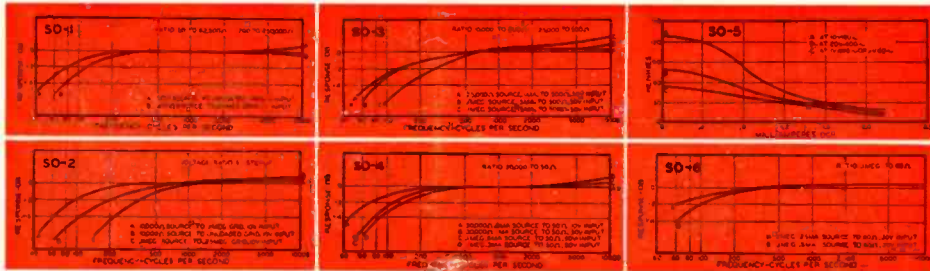

SUB-SUBOUNCER UNITS

FOR HEARING AIDS AND ULTRA-MINIATURE EQUIPMENT

UTC Sub-SubOuncer units have exceptionally high efficiency and frequency range in their ultra-miniature size. This has been effected through the use of specially selected Hiperm-Alloy core material and special winding methods. The constructional details are identical to those of the Sub-Ouncer units described above. The curves below show actual characteristics under typical conditions of application.

Type	Application	Level	Pri. Imp.	D.C. in Pri.	Sec. Imp.	Pri. Res.	Sec. Res.	List Price
*SS0-1	Input	- 4 V.U.	200 50	0	250,000 62,500	13.5	3700	\$5.60
SS0-2	Interstage/3:1	+ 4 V.U.	10,000	0	90,000	750	3250	5.60
*SS0-3	Plate to Line	- 20 V.U.	10,000 25,000	3 mil 1.5 mil.	200 500	2600	35	5.60
SS0-4	Output	+ 20 V.U.	30,000	1.0 mil.	50	2875	4.6	5.60
SS0-5	Reactor 50 HY at 1 mil. D.C.							5.10
SS0-6	Output	- 20 V.U.	100,000	.5 mil.	60	4700	3.3	5.60

*Impedance ratio is fixed, 1250:1 for SS0-1, 1:50 for SS0-3. Any impedance between the values shown may be employed.

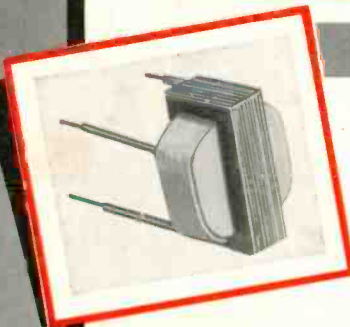
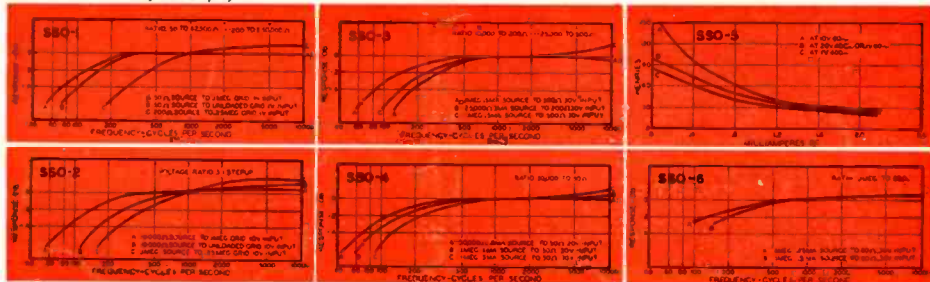

SUB-SUBOUNCER UNIT
Dimensions...7/16" x 3/4" x 5/8"
Weight......02 lb.

United Transformer Co.

150 VARICK STREET NEW YORK 13, N. Y.
EXPORT DIVISION: 13 EAST 20th STREET, NEW YORK 16, N. Y. CABLES: "ARLAB"