

EXPERT ADVICE ● TOP TIPS ● BEST BUYS ● MORE FACTS

BIGGEST EVER
AMIGA ANSWERS!

AMIGA SHOPPER

The top-selling serious Amiga magazine

EXTRA RAM

How your Amiga's memory works and how you can get more from it.....page 24

PIANO TUTOR

Is this neat solution the easiest way to learn how to play?page 29

ROCK HARD!

We put Roctec's new hard drive through its paces — how does it compare?.....page 32

AMIGADOS

How to create your own Filofax.....page 121

PD WORLD

All the latest low-cost and no-cost software rigorously reviewed and ratedpage 146

ISSUE 13 ● MAY 1992 ● £1.25 ● YOUR DEFINITIVE GUIDE

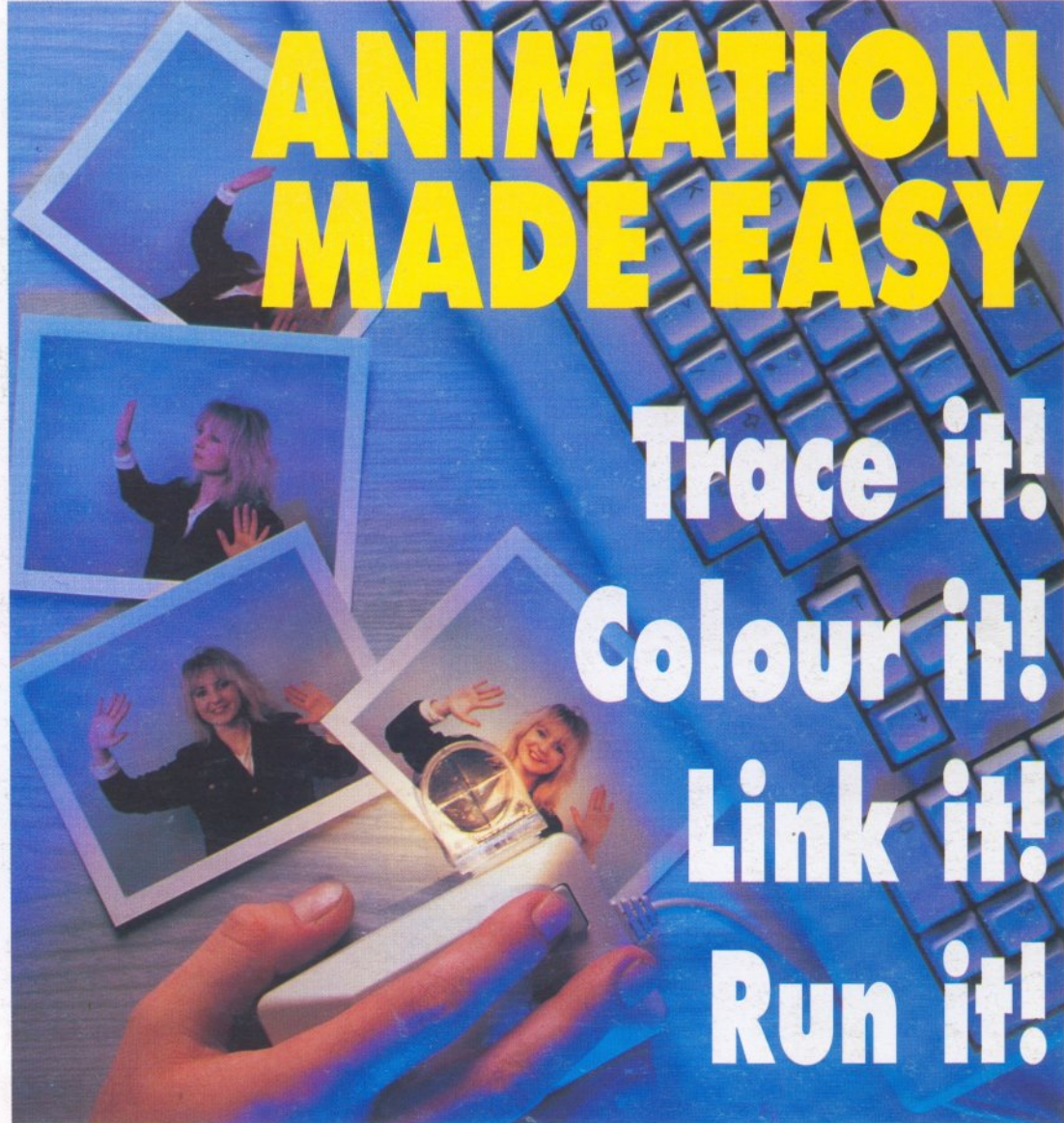

ANIMATION MADE EASY

Trace it!
Colour it!
Link it!
Run it!

We show you how to use Tracey to produce top-notch images



**BEGINNERS
START HERE**

We'll help you master your Amiga

AMIGA ANSWERS

Got a problem? Pages
- We'll solve it! 39-76

TRACEY
YOUR GREAT TRACING TOOL

WORTH £7.95

IF YOUR TRACEY IS MISSING THEN TELL YOUR NEWSAGENT

FREE!

YES - IT'S THE WORLD'S FIRST
FREE AMIGA PERIPHERAL!

Future
PUBLISHING



Your guarantee of value

POWER COMPUTING

Economy Packs

- 1 PC880E + 10 Maxell Disks £52
- 2 PC880E + 10 Maxell Disks and Zip Stick £61
- 3 PC880E + 10 Maxell Disks and 512K RAM with clock £79
- without clock £76
- 4 PC880E + 10 Maxell Disks, 1MB RAM (For A500+ only) £92
- 5 PC880E + 10 Maxell Disks and 1.5MB £101
- 6 PC880E + 40 Maxell Disks, DD40 diskette box, Power Mouse, Zip Stick & 512K RAM £114
- 7 PC880E + 40 Maxell Disks, DD40 diskette box, Power Mouse, Zip Stick & 1MB RAM (for A500+ only) £129
- 8 PC880E + 40 Maxell Disks, DD40 diskette box, Power Mouse, Zip Stick & 1.5MB RAM £169

Home Packs

- 1 PC880B + 10 Maxell Disks £75.95
- 2 PC880B + 10 Maxell Disks & Zip Stick £84.95
- 3 PC880B + 10 Maxell Disks, 512K RAM with clock £97.95
- without clock £91.95
- 4 PC880B + 10 Maxell Disks & 1MB (for A500+ only) £112.95
- 5 PC880B + 10 Maxell Disks & 1.5MB RAM £152.95
- 6 PC880B + 40 Maxell Disks, DD40 diskette box, Power Mouse, Zip Stick & 512K RAM £148.95
- 7 PC880B + 40 Maxell Disks, DD40 diskette box, Power Mouse, Zip Stick & 1MB RAM (for A500+ only) £163
- 8 PC880B + 40 Maxell Disks, DD40 diskette box, Power Mouse, Zip Stick & 1.5MB RAM £199

Executive Packs

- 1 Dual Drive inc. PSU + 10 Maxell Disks £125
- 2 Dual Drive + 10 Maxell Disks & Zip Stick £134
- 3 Dual Drive + 10 Maxell Disks & 512K with clock £159
- 4 Dual Drive + 10 Maxell Disks & 1MB RAM £174
- 5 Dual Drive + 10 Maxell Disks & 1.5MB RAM £214
- 6 Dual Drive + 40 Maxell Disks, DD40 diskette box, Power Mouse, Zip Stick & 512K RAM £203
- 7 Dual Drive + 40 Maxell Disks, DD40 diskette box, Power Mouse, Zip Stick & 1MB RAM £219
- 8 Dual Drive + 40 Maxell Disks, DD40 diskette box, Power Mouse, Zip Stick & 1.5MB RAM £258

GVP Series 2 Hard Disk (A500)

Up to 8MB FAST RAM on-board
 52QMB 0MB **£379** 105QMB 0MB **£579**
 52QMB 2MB **£439** 105QMB 2MB **£631**
 52QMB 4MB **£469** 105QMB 4MB **£691**
 52QMB 8MB **£649** 105QMB 8MB **£840**

GVP Series 2 Hard Card or Nexus Hard Card

High speed 'FAASTROM' controller
 Up to 8MB Simm RAM on board fully auto booting
 Supports external SCSI devices
 For A1500/A2000

Bare **£199**
 52QMB **£279** 105QMB **£479**
 52QMB 2MB **£339** 105QMB 2MB **£539**
 52QMB 4MB **£399** 105QMB 4MB **£599**
 52QMB 8MB **£469** 105QMB 8MB **£749**

GVP G-Force

68030 Accelerator board **£549**
 68882 maths co-processor **£1249**
 25MHz 1MB RAM **£1685**
 40MHz 4MB RAM **£65**
 50MHz 4MB RAM **£234**
 Simm 32 x 1MB-60 **£35**
 Simm 32 x 4MB-60
 Hard drive mount kit

GVP A2000 RAM Expansion

2MB **£159** 4MB **£219** 6MB **£279** 8MB **£339**

GVP Sound Sample **£73**

All GVP products come with a 2 year guarantee

Kickstart Switcher

The Power Kickstart Switcher fits into any A500 or A500+ and can be fitted with up to three Kickstart ROMS and can be enabled when you switch on your Amiga. This gives you all the benefits of the new versions of Kickstart while still being able to use your old games and software.
 Kickstart Switcher (bare) **£14.95**
 Switcher with Kickstart 1-3 **£44**
 Switcher with Kickstart 2-04 **£64**
 Switcher with Kickstart 1-3 and 2-04 **£94**

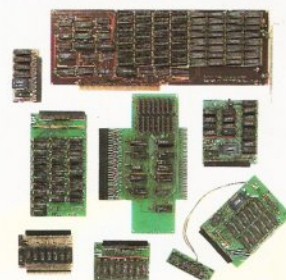

PC501 + RAM Card

Our RAM board is designed specially for the new A500+ computer and comes with 1MB of RAM on board to expand your memory to 2MB of chip RAM. Plug in and go operation - fits into trapdoor. Gives you a total of 2MB of chip RAM **£49**
 32 chip RAM card **£39.95**

8MB A500 RAM Board

Plugs into side slot
 Fully auto config
 Full thru'port
 Expand 2MB-8MB
 2MB **£129** 4MB **£189**
 8MB **£299** 1x4Zip **£24**

1.5MB RAM Board

Plugs easily into your Amiga **£79**
 Fully supports 1MB chip RAM
 Fully compatible with 'Fatter Agnus' (Kickstart 1.3 and above, not compatible with A500+)

A500 RAM Card

A 512K RAM expansion with battery backed clock and a free disk packed with useful software
 (4chip RAM) **£29**
 512K RAM Card without clock **£24**
 16 chip RAM Card with clock **£24**
 16 chip RAM Card without clock **£19** (A500+ compatible)

1MB RAM with Thru'port

Expand your A500's memory to a total of 2MB without disposing of your existing 512K upgrade. Works with 1MB of chip RAM, simple internal fitting. **£49.95**
 (512K RAM must be 4 chip type, or not exceeding 9cm in length)

ARIES A2000 RAM EXPANSION

2MB **£129** 4MB **£169** 6MB **£209** 8MB **£249**

Send your order to Power Computing Ltd, Unit 8 Railton Road, Woburn Road Industrial Estate, Kempston, Bedford MK42 7PN
 Ring your credit card order through on **0234 843388 (10 lines)** or fax your order on **0234 840234**. Technical Helpline **0234 841882**

All prices include VAT, delivery and are subject to change. Specifications are subject to change without notice. Next day delivery £4.50 (U.K. mainland only), all trademarks acknowledged.

WELCOME

AMIGA SHOPPER AT A GLANCE GUIDE

To help you find what you want quickly and easily, this is a cross-referenced list of all the products and subjects covered in this month's *Amiga Shopper*. The subjects covered in Amiga Answers are detailed on page 39; the many PD programs covered on page 146 are listed there. The page numbers given are for the first page of the article in which the product is mentioned.

| | |
|--------------------|--------|
| A570 | 34 |
| Amiga Answers | 39 |
| AmigaDOS | 121 |
| AMOS | 99 |
| Amiga Shopper Show | 75,138 |
| Animation | 18 |
| AVideo | 86 |
| Bulletin boards | 94 |
| Buying advice | 158 |
| CD-ROM | 34 |
| CDTV | 34 |
| Comms | 94 |
| Competition | 162 |
| Databases | 132 |
| Desktop publishing | 78 |
| DPaint III | 18 |
| DTP | 78 |
| Education | 108 |
| End Zone | 94 |
| For sale | 145 |
| Graphics | 18 |
| Letters | 13 |
| Listings | 127 |
| Memory | 24 |
| MIDI | 90 |
| Modems | 94 |
| Music | 29,90 |
| News | 7 |
| Piano Tutor | 29 |
| Pixel 3D | 86 |
| Product Locator | 160 |
| Public domain | 146 |
| RocHard | 32 |
| Reader ads | 145 |
| Shareware | 146 |
| Shell | 137 |
| Subscriptions | 128 |
| Superbase Personal | 132 |
| Talking Shop | 13 |
| Tekno Amiga | 108 |
| Tracey | 16,18 |
| TouchWindow | 108 |
| User groups | 142 |
| Video | 84 |

Are there any products or subjects you'd like us to take a look at? Well, just drop a line to:
**Amiga Shopper,
30, Monmouth Street,
Bath BA1 2BW.**

And congratulations to you all. You're all living proof! Living proof the Amiga's more than just a games machine – for you're just one of the many readers who've taken our monthly circulation figures from zilch to well over 45,000 in twelve short months.

So, by way of a little thank-you, we decided to present you with a small, but perfectly formed, freebie on this month's ish – the delightful and quite delectable Tracey. Now Tracey's dead handy when it comes to any 2D artwork you might want to import into your DTP, graphics and animation packages. As you'll soon find if you give her a whirl by following the instructions on page 16.

Otherwise, there's loads of meaty stuff to get your teeth into this month. The start of an everything-you-wanted-to-know-about-memory-but-forgot-to-ask two-parter for starters. And then there's a look at the new RocTec hard drive, Miracle's ingenious Piano Tutor and all the usual columns there's too little space here to mention.

But the page to turn to if you're *really* serious about your Amiga – well, serious enough to stay up half the night tapping its keyboard – is page 127.

Yep, Listings.

Now this could be the start of something big. We want all your self-penned lists of demos, utilities, applications, neural networks, missile guidance systems – the works. And besides fame and err... more fame, we'll give you four blue beer vouchers for any we print. So get coding!

And finally, but, as it happens, for the first time ever, we've run a Product Locator on pages 160/161 detailing every piece of Amiga hardware we can think of. Any bets on how many pages this'll be by this time next year?



Andy Stoner
Editor

PUBLIC DOMAIN WORLD

WORD PROCESSOR SPECIAL

There are thousands of Amiga programs which are available for little more than the price of a disk. And many more which allow you to try the software free before you buy. Each month in Public Domain World we examine the best of these programs and explain how to get hold of them.

This month our resident PD sampler, Ian Wrigley, scans through his latest batch to pick out the top PD and shareware word processors that'll give commercial packages a run for their money:

WORD UP!

BUT NOT LOST FOR WORDS...STARTS ON PAGE 146

AMIGA ANSWERS

21 PAGES DEVOTED EXCLUSIVELY
TO ANSWERING YOUR QUESTIONS

Every month in Amiga Answers our panel of experts answer more genuine reader questions than any other Amiga magazine. And for beginners our starter page will help you get to grips with your Amiga, and understand the other features in this month's issue.

We answer questions every month on
Workbench • The CLI • Comms • Programming •
DTP • Video • Business software and more.

THE ANSWERS START ON PAGE 41
THE SHOW STARTS ON PAGE 75

FOR A FULL LIST OF CONTENTS, TURN THE PAGE

Your guarantee of value

This magazine comes from Future Publishing, a company founded just seven years ago, but which now sells more computer magazines than any other publisher in Britain. We offer:

Better advice. Our titles are packed with tips, suggestions and explanatory features, written by the best in the business.

Stronger reviews. We have a cast-iron policy of editorial independence, and our reviews give clear buying recommendations.

Clearer design. You need solid information, and you need it fast. So our designers highlight key elements in the articles by using charts,

diagrams, summary boxes, annotated photographs and so on.

Greater relevance. At Future, editors operate under two golden rules:
• Understand your readers' needs.
• Satisfy them.

More reader interaction. We draw strongly on readers' contributions, resulting in the liveliest letters pages and the best reader tips. Buying one of our magazines is like joining a nationwide user group.

Better value for money. More pages, better quality: magazines you can trust.

Future
PUBLISHING

The home of Britain's finest computer magazines:
Amiga Shopper • Amiga Format • Amiga Power
• Public Domain • Commodore Format
• PCW Plus • PC Plus
ST Format • Your Sinclair • Sega Power
Amstrad Action • PC Answers • PC Format
Mountain Biking UK • Needlecraft • Classic CD
• Cycling Plus • Photo Plus • Total!

10 MARKET PLACE
ST. ALBANS
HERTS AL3 5DG
TEL (0727) 56005/41396

THE GALLERY
ARNDALE CENTRE
LUTON, BEDS LU1 2PG
TEL (0582) 457195/411281

Hobbyte

ST ALBANS
SNOW OPEN
SUNDAYS
10.00AM - 4.30PM

COMPUTING
ESTABLISHED 8 YEARS

PRICES SLASHED!!!
AMIGS FROM
ONLY £279

AMIGA STARTER PACK

Full Amiga 500 pack, WITHOUT Cartoon Classics, BUT WITH: Virus Killer, Home pack including Word Processor/Spell Check, Spreadsheet, Database,
PLUS: JOYSTICK

AMIGA 512K £279
With 10 individually packed games, Deluxe Paint II, GFA Basic, 16 Nights Holiday Accommodation £299
With Philips 8833 Mk II Monitor + Leads £499

WANT MORE GAMES? JUST ASK!

AMIGA GAMES PACKS

CARTOON CLASSICS
Full Amiga 500 pack, PLUS: Lemmings, The Simpsons - Bart v The Space Mutants, Captain Planet and the Planetheers, Deluxe Paint III.
PLUS: Home pack including Word Processor/Spell Check, Spreadsheet, Database, Virus Killer

1MB AMIGA £329
2MB AMIGA £369
CARTOON CLASSICS S/W Games only £19
1 MB with Philips 8833 Mk II Monitor + Leads £529

WANT MORE GAMES? JUST ASK!

AMIGA THE LOT!!

EVERYTHING YOU COULD EVER NEED!!
CARTOON CLASSICS GAMES PACK AS LEFT,
PLUS: 10 GREAT INDIVIDUALLY PACKAGED GAMES

previous RRP's £19.99-£39.99 each, phone to choose from current list of 15, or leave it to us! Children's games available.

35 Programme Hobbyte PD Greats pack, including Virus Killers, the BEST Star Trek, Arcade Classics, Board Classics, Shoot-em-Up Classics, Best of the Utilities, Home pack including Word Processor/Spell Check, Spreadsheet, Database
DUST COVER, 10 BLANK DISCS, DISC BOX, MOUSE MAT, MICROSWITCH TURBO JOYSTICK

1MB AMIGA £359
2MB AMIGA £399
1MB AMIGA With Philips 8833 Mk II Monitor + Leads £559

WANT MORE GAMES? JUST ASK!

ABSOLUTE BEGINNERS PACK

FULL AMIGA 500 PACK, PLUS:
ANY 1 FROM: FLIP IT + MAGNOSE, MATCHED PAIRS, EDD THE DUCK OR POSTMAN PAT

FUN SCHOOL 2 + **FUN SCHOOL 3** OR **FUN SCHOOL 4**
(specify under 6 years, 6 to 8 years, or 8+ years) (specify under 5 years, 5 to 7 years, or 7+ years) (specify under 5 years, 5 to 7 years, or 7+ years)

12 stunning UK educational games with beautiful pictures, exciting animation and music that help to develop number, word and other skills. Up to 6 skill levels. Conform to National Curriculum requirements.

HOBBYTE EDUCATIONAL PACK, featuring up to 12 'Learn while you play' games (varies according to age group)

HOBBYTE 30 EASY CHILDREN'S GAMES, 10 disc pack inc; Train Set Game, Flashbier.

PLUS: JOYSTICK + DELUXE PAINT II + 10 BLANK DISCS
1MB Amiga £359
Absolute Beginners s/w pack £55

With Philips 8833 Mk II Monitor + Leads £559

WANT MORE GAMES? JUST ASK!

A500 PROFESSIONAL FAMILY PACK

FULL AMIGA 500 PACK

PLUS: Cartoon Classics includes Lemmings, The Simpsons, Captain Planet, Deluxe Paint III

PLUS: The Works Platinum, WP, Spreadsheet, Database

PLUS: Their Finest Hour Flight Simulator AND Battlechess

OR ANY Fun School OR Digita Home Accounts

PLUS: 10 Blank Discs, Disc Box, Mouse Mat, Dust Cover, Joystick + 15 disc Hobbyte PD Greats Pack (see 'The Lot') inc. Virus Killer.

1MB Amiga Pack £419

1MB Amiga Pack PLUS Monitor £619

As above PLUS Star LC 200/Citizen 9 pin

Colour Printer + Leads £799

WANT MORE GAMES? JUST ASK!

ORDERING : TELESALES NO: (0727) 56005

Next day delivery for credit card orders placed before 4.30pm subject to availability. Alternatively send cheque, postal order, bankers draft or official order (PLCs, Education and Government bodies only) to: Dept. AS, Hobbyte Computer Centre, 10 Market Place, St. Albans, Herts AL3 5DG. Please allow 7 working days for cheque clearance. Subject to availability, despatch is normally within 24 hours of receipt of cleared payment. Prices are correct at time of going to press, however, we are sometimes forced to change them, either up or down. Please check before ordering.

DELIVERY CHARGES: UK Mainland (not Highlands)
Small consumables & software items Despatched by post, please check charges when ordering
Other items, except lasers Next day courier service, £10 per box
Laser printers Next day courier service, £17.50
Offshore and Highlands Normal rate plus £20 + VAT per box

In addition we offer the following express services:
Saturday deliveries Normal rate plus £10 + VAT per box
7am to 9am next day Normal rate plus £10 + VAT per box
Am next day Normal rate plus £5 + VAT per box

AMIGA FIRST STEPS CLASS OF THE 90'S PACK

FULL AMIGA 500 PACK, PLUS: A501 512K RAM expansion Lets Spell at Home, Music Mouse, Prowrite WP, InfoFile spreadsheet, Deluxe Paint II, Deluxe Print, Music Mouse, LOGO, Talking Turtle, BBC Emulator, 5 BBC programmes, 10 discs, DOs and DON'Ts poster, Resource File, In Pack Video, NAPE Booklet.
PLUS:HOBBYTE EDUCATIONAL PACK, featuring up to 12 'Learn while you play' games (varies according to age group)
HOBBYTE 30 EASY CHILDREN'S GAMES, 10 disc pack inc; Train Set Game, Flashbier. **PLUS JOYSTICK**

1MB AMIGA £449
2MB AMIGA £489
DP III instead of DP II ADD £29
With Philips 8833 Mk II Monitor + Leads £648
First Steps Software Upgrade Pack £149

* SOFTWARE *

• ALL LATEST GAMES AVAILABLE AT BEST PRICES: EG.

| | |
|------------|----------------------|
| RRP £15.99 | Hobbyte Price £10.29 |
| RRP £19.99 | Hobbyte Price £12.89 |
| RRP £24.99 | Hobbyte Price £16.19 |
| RRP £25.99 | Hobbyte Price £16.79 |
| RRP £29.99 | Hobbyte Price £19.39 |
| RRP £30.99 | Hobbyte Price £20.09 |

• ALL OTHER GAMES TITLES 35% OFF •

• **E4 SOFTWARE SPECIALS:** Phone for our latest list of E4 TITLES. Current list includes: Carrier Command Flight Sim, Back to the Future III, Fantovision Painting package, Colossus Chess, Sim City, Fast Break Basketball, Toobin' Water Sports Sim + LOTS MORE

THIS MONTH'S BARGAINS:

| | | |
|--------------------|--------|--------|
| Deluxe Paint III | £29.99 | £39.99 |
| Platinum Works | £29.99 | £49.99 |
| Amos | £49.99 | £29.99 |
| Fun School 4 | £24.99 | £14.99 |
| Sim City + Populus | £29.99 | £12.99 |

HOBBYTE EXCLUSIVE

Hobbyte 52 MB, A590 Hard Drive for Amiga 500

Reviewed 'BEST BUY' by Amiga Computing Dec '91 **£399** INC P+P
extra 2 MB RAM £70

WANT MORE GAMES OR OTHER EXTRAS?

JUST ASK & WE GUARANTEE TO BEAT THE COMPETITION
WITH THE BEST PACK AT THE BEST PRICE!

CBM CDTV

WITH FREE LEMMINGS, HUTCHISONS
ENCYCLOPEDIA, WELCOME DISK AND DISK CADDY £439
OR, WITH £90 RRP WORTH OF TITLES OF YOUR CHOICE £489

ALL CDTV TITLES AT 20% OFF

FULL RANGE OF ACCESSORIES AND TITLES AVAILABLE

NO DEPOSIT CREDIT FACILITIES (UK mainland)

Credit terms at 34.8% APR (variable) can be arranged for purchases over £150, subject to status. Competitive leasing schemes are also available for businesses, including sole traders and partnerships. Just telephone for written details and application form.

| | |
|----------------------------------------------------|---------|
| PHILIPS 8833 COLOUR MONITOR, LEADS (WITH ANY PACK) | £199.99 |
| GOLDSTAR TV/MONITOR WITH REMOTE CONTROL +LEADS | £189.99 |

AMIGA 1500/2000

Full UK spec. latest version with 1MB RAM, mouse, manuals and discs, including Workbench V2. Hard disc configurations include the high performance GVP II Controller + RAM card, expandable to 8MB. Fast reliable Quantum 52MB + 105MB drives only are used.

All systems include **35 Programme Hobbyte PD Greats Pack** including Virus Killers, the BEST Star Trek, Computer Conflict, Breakout and construction Kit Blizzard and other games, Arcade Classics, Board Classics, Shoot-em-Up Classics, Best of Utilities, Home Pack including Word Processor/Spell Check, Spreadsheet, Database.

AVAILABLE WITH OR WITHOUT THE A1500 SOFTWARE PACK including The Works, Platinum database, WP, Spreadsheet, Deluxe Paint III, **PLUS EITHER:** Sim City, Populus, Their Finest Hour, Battlechess, A-Z of Computer Jargon, 'Get the most out of your Amiga', **OR:** Puznik, Toki, Digita Home Accounts, Amiga Book

| | Without A1500 Software Pack | With A1500 Software Pack |
|-----------------------------|-----------------------------|--------------------------|
| DUAL DRIVE | 495 or 379* | 545 |
| DD + GVP + 20 MB HD | 699 | 749 |
| DD + GVP + 52 MB HD | 785 | 835 |
| DD + GVP + 52 MB + 2MB RAM | 845 or 665* | 895 |
| DD + GVP + 105 MB HD | 925 | 975 |
| DD + GVP + 105 MB + 4MB RAM | 1049 | 1095 |

EXTRA RAM (FITTED IF REQUIRED) £60 PER2MB

SPECIAL MONITOR DEALS WITH A1500/2000

Philips 8833/CBM Colour Monitor and leads ADD £195
High Res Colour Monitor CBM 1950 and flicker fixer ADD £545

* These prices when you trade in your own old A500. Additional trade in allowances for most A500 peripherals. Trade-ins available on other configurations.

PHONE FOR DETAILS

EXTRAS inc VAT

| | |
|----------------------------------------------------------------------------|--------|
| Star LC200 colour printer with leads | £179 |
| Star LC24-200 colour printer with leads | £269 |
| Citizen Swift 9 pin colour printer with leads | £189 |
| Citizen Swift 24 pin colour printer with leads | £279 |
| Citizen Swift 224 colour printer | £239 |
| Commodore stereo colour monitor, + leads | £219 |
| Second external 3.5" drive with daisychain through port and disable switch | £49 |
| A501 The Official CBM 512K RAM exp. | £39 |
| 512K RAM Expansion + Clock | £21 |
| 1MB RAM Expansion for Amiga 500 Plus | £45 |
| GVP A500 52 MB HD | £359 |
| At once AT Emulator for A500 | £179 |
| A590 20MB Hard drive | £269 |
| A590 20MB Hard drive + extra 2MB | £319 |
| A590 52MB Hard drive | £399 |
| 10 blank discs 100% guaranteed with PIN no in box | £6.99 |
| 50 blank discs 100% guaranteed with PIN no | £16.99 |
| Supra A500 RX 8MB RAM expansion, populated to 2MB | £199 |
| 62 Genlock for 2000/1500 | £670 |
| A2300 internal genlock for 2000/1500 | £99 |
| A2088 XT Bridge Board, 640K, MS DOS 3.3 + 5.25" drive, for 2000/1500 | £119 |
| 2286 AT Bridge Board | £349 |
| A2058 8MB RAM exp board, populated to 2MB, for 2000/1500 | £199 |
| 8UP 8MB RAM exp board, pop to 8MB for 2000/1500 | £399 |
| A2630 68030 card, populated to 2MB for 2000/1500 | £999 |
| Microway Flicker Fixer for 2000/1500 | £125 |
| GVP/20MB Quantum HD (for A2000/1500 takes up to 8MB RAM) | £189 |
| GVP/52MB Quantum HD (for A2000/1500 takes up to 8MB RAM) | £299 |
| GVP/100MB Quantum HD (for A2000/1500 takes up to 8MB RAM) | £449 |
| CBM 1950 Monitor + Microway Flicker Fixer | £569 |

COMMODORE PREMIER DEALER

Hobbyte proudly announce this highest CBM accolade, awarded to only the top few dozen CBM dealers offering the best in expertise and support. All Amigas full UK versions.

TELE-ORDER (0727) 56005

INSIDE THIS ISSUE

AMIGA SHOPPER Issue 13 May 1992

Editor: Andy Storer

Deputy Editor: Cliff Ramshaw

Layout Sub-Editor: Diana Taylor

Production Editor: Alison Harper

Consultant Editors: Jeff Walker,
Mark Smiddy

Contributors: Jason Holborn, Paul
Andreas Overaa, Jolyon Ralph, Gary
Whiteley, Phil Harris, Ian Wrigley,
Wilf Rees, Jon Bates

Guest Composer: Samuel Barber

Ad Manager: Margaret Clarke

Senior Ad Sales Executive:

Shaun Lancaster

Production: Tracy O'Donnell

Illustrations: Kev Sutherland,

Jolyon Webb, Sean McAlorum

Production Technicians:

Simon Windsor, Chris Stocker,

Jerome Clough

Assistant Publisher: Stuart Arderton

Circulation Director: Sue Hartley

Promotions Manager:

Michele Harris

Group Publishing Director:

Greg Ingham

ABC audited circulation:

July-December 1991:

45,209 copies/month

Printed by Thamesmouth Printing

News Trade Distribution -

UK: Future Publishing 0225 442244

Worldwide: MMC Ltd 0483 211678

This magazine is copyright © 1992

Future Publishing Ltd. No

part of this magazine may be

reproduced without written

permission. We welcome

contributions for publication but

regret that we cannot return any

submissions. Any correspondence

will be considered for publication

unless specifically stated

otherwise.

Editorial

30 Monmouth Street,

Bath BA1 2BW

Tel: 0225 442244

Fax: 0225 446019

E-mail: amshopper@cix.compulink

Advertising

Rayner House, 23 Higher Hillgate,

Stockport SK1 3ER

Tel: 061-474 7333

Fax: 061-476 3002

Subscriptions

The Old Barn, Somerton TA11 7PY

Tel: 0458 74011

News 7 MIDI 90

The accelerator card for your A500 that's three times faster than an A3000 PLUS an amazing 32-bit graphics system

Why a little Basic can help you master your MIDI

Talking Shop 13 The world of Comms 94

Amiga Shopper's Editor replies to your letters

What should you bear in mind when buying a modem?

HOW TO USE TRACEY 16 The AMOS column 99

All you need to know to take your free peripheral in hand

OK, we don't cover games, right? Right. But here's where to turn if you want to know how to write them

Piano Tutor 29 Education 108

How to use your Amiga to learn the piano the easy way

How to use your Amiga to produce silk screen prints!



RIGHT OUT OF NOWHERE! 10 - IT'S THE A600!

Just when you thought the A500 Plus was the state of the art, there's a new Amiga in town. And it'll be launched at our Show! Check out its details here first

AmigaDOS 121

Mark Smiddy shows you how to create your own menu-driven digital diary using less than a 100 lines of code

Listings 127

Or how you can win £20 by sending us your programs

Business Shopper 132

Why keeping track of your videos is easy using Superbase

Expert Tips 137

Ten top tips on how to get the most from your Shell

Showing Out 138

Our at-a-glance guide to the Amiga Shopper Show

ANIMATION MADE EASY 18

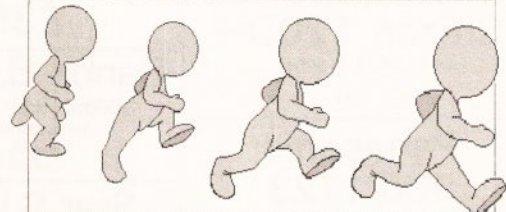

Or how to become a digital Disney in five easy pages. Catch the first part of an animation tutorial that'll have you creating your own moving masterpieces faster than you can say 'Mbeep Mbeep!'

Rock hard 32

Is RocTec's new 52Mb hard disk the best on the market?

Amiga CD 34

The first of a new series monitoring Amiga CD-ROM, kicks off with a look at running PC CD disks on the new A570

Amiga Answers 39

Yep, it's the BIGGEST ever! 21, yes 21 pages of the most definitive expert advice in the Amiga world

Show Answers 75

Ask a question and win a RAM upgrade! Go on, it's easy!

Desktop publishing 78

Have you ever fancied publishing your own newsletter or circular? We show you how to produce the best results

Video 84

We show you how to convert 2D images into 3D forms with Pixel 3D PLUS: AVideo 12 - the new DCTV/HAM-E?

MEMORY 24

Everything that's worth remembering about what you've always wanted to know about how your Amiga organises its memory. Never forget again with the first part of this definitive guide

User Groups 142

Amiganauts of the world unite! This is the place to be...

Readers Ads 145

Bag yourself a bargain before someone beats you to it

Public Domain World 146

Turn here for all the latest PD and shareware releases

Product Locator 160

All the Amiga hardware under heaven is listed here

Win a Genlock! 162

Just answer three simple questions - but make it fast!

WeServe of Hampshire Established 7 years

New 24pin Colour* Citizen 224

Enhanced 24pin printer, *optional colour
with easy to use control panel
2 year warranty. Price with cable & paper

Optional Colour kit £26.00 with printer
Amiga printer driver £5.00

£225

NEW Amiga Workstation /Expansion System

Monitor stand with shelf for drives etc.
Strong metal construction made from
14SWG steel epoxy coated Amiga
colour.

Special price **£27.50**

New HP Deskjet Colour

300dpi colour inkjet printer.
Colour laser quality at 1/10 of the cost.
3 year warranty. Price with cable & paper

£579

All Citizen printers have
2 year warranty

Swift 24E

Enhanced 24pin. Colour printer
with cable & paper

£275

Printer Drivers

Citizen Swift Colour 5.00
Canon BJ-10e 4.95
Deskjet 500 Colour 9.95

Printer Dust Covers
most types in stock
from **£4.70 inc VAT**

Citizen Swift 9
with cable & paper
£175

Citizen 120D +
with cable & paper
£119

Panasonic
KXP1123
Probably the best 24pin mono
printer available. With cable & paper
£179

Panasonic/Epson

| | |
|-------------------------|-----|
| KXP1170 9pin | 134 |
| KXP1124i 24pin | 227 |
| KXP4420 Laser | 728 |
| Epson LX400 9pin | 135 |
| Epson LQ450 24pin | 239 |
| Epson LQ570 24pin | 281 |
| Epson 4100 Laser | 839 |

Prices include VAT cable & paper

Deskjet 500
HP 300dpi Inkjet printer. Laser
quality at dot matrix price.
3 year warranty. With cable & paper
£359

Canon BJ-10ex
360dpi Inkjet printer
with cable & paper
£235

Star SJ-48
360dpi Inkjet printer
with cable & paper
£229

Star

| | |
|--------------------------|-----|
| LC10 Mono 9pin | 135 |
| LC200 Colour 9pin | 189 |
| LC2410 Mono 24pin | 182 |
| LC24200 Mono 24pin | 219 |
| LC24200 Colour 24pin .. | 275 |

Prices include VAT cable & paper

Naksha Mouse
for Atari ST & Amiga
with house & mat
£21.50

Squik Mouse
for Atari ST & Amiga
£13.90

Naksha Scanner
200 to 400dpi. 105mm width
with express-IT software
£109

True Mouse
for Atari ST & Amiga
£15.90

1M Simm
£29.90

Suitable for GVP Hard Disks etc.
£29.90 per 1M

Midi Interface
4 channel Midi Interface for Amiga
£29

Dr. T's Midi Music Software
(not suitable for A500+) **£9.95**

GVP Series 2 52M
for A500 **£369**

Supra 500XP 52M
for A500 **£329**

Protar Visto 14CM
14" Colour Monitor with cable
£209

Philips
CM8833 MK1
Refurbished Colour Monitor
1 full years warranty with cable
£169

Philips CM8833 MK2
Colour monitor with cable
£219

Commodore 1M drive
A1011 CBM 1M
External Floppy **£59**

Cumana CAX354
External 1M Drive
£54.95

Roctec 1M Drive
for A500 **£59.90**

Accessories

| | |
|--------------------------------|-------|
| Joystick/Mouse twin extension | 4.70 |
| 3M Joystick/Mouse lead | 3.75 |
| A500 Printer cable | 7.95 |
| Modulator/Disk Extension | 10.95 |
| 23way Plug or socket | 2.95 |
| A500 Dust Cover | 4.70 |
| A501 1/2M Memory + Clock | 29.00 |
| Mouse Mat (thick soft type) .. | 4.95 |
| Mouse House | 2.95 |
| 1M internal 3.5" drive | 57.50 |
| A500 replacement PSU | 39.00 |
| 1/2Meg Ram NO Clock | 23.90 |
| Delta 3AS Analogue Joystick | 15.90 |

Vidi-Amiga
VIDI-ST Real time mono frame grabber
Plus: Colour Software & filters + Art &
design package **£109**

The Complete
Colour Solution
As above but includes Electronic
colour splitter **£159**

1/2 Meg Ram + Clock
£24.95

A2286 Bridgeboard
CBM 286 Bridgeboard for A1500
£319

GVP Series 2 52M
for A1500 **£279**

Amiga 1500
with full software pack
£499

CBM 1084SD
Colour monitor with cable
£229

A500 PLUS
Cartoon Classics full software pack
£325

SONY
DISKETTES
SONY branded
(lifetime warranty)
(100% certified error free)

| | |
|-----------------------------|--------|
| 10x 3.5" DS/DD 135tpi | 7.50 |
| 50x 3.5" DS/DD 135tpi | 32.30 |
| 100x3.5" DS/DD 135tpi | 59.93 |
| 250x3.5" DS/DD 135tpi | 141.00 |
| 1kx 3.5" DS/DD 135tpi | 540.50 |

DISKETTES
SONY bulk
(lifetime warranty)
(100% certified error free)

| | |
|----------------------------------|--------|
| 10x 3.5" DS/DD 135tpi | 5.95 |
| 50x 3.5" DS/DD 135tpi | 21.86 |
| 100x3.5" DS/DD 135tpi | 39.60 |
| 250x3.5" DS/DD 135tpi | 94.88 |
| 1kx 3.5" DS/DD 135tpi | 353.68 |
| 40 x 3.5" Disk box with lock .. | 5.49 |
| 100 x 3.5" Disk box with lock .. | 7.50 |

Carriage on 50+ disks £3.53

Phone for our 60 page catalogue
EDUCATIONAL AND GOVERNMENT ORDERS WELCOME
All products have a 30 day money back & 12 month warranty.
Prices are subject to variation without prior notification.
Established 7 years. 3 minutes from M27 Junction 11.
Free parking. Open 9 to 5.30 Monday to Friday & 9 to 5 Saturday
Postage 94p or £3.53 Securicor £6.46 (£5.50 + VAT)

WeServe



Larger items delivered
by Securicor



Amiga/Shopper Dept.
40-42 West Street
Portchester Hants
PO16 9UW
Tel: 0705 325354

High quality products. Full technical support.

Visit our Showrooms. See before you buy.

High quality products. Full technical support.

Visit our Showrooms. See before you buy.

Video value from Germany

Genlock junkies will be interested in the range of products available from the German-based company Electronic Design.

Among the products the company sells are the Sirius Genlock (DM 1598, about £570), the Y/C Genlock (DM 1050), the PAL Genlock (DM 698), the Y/C Colorsplitter (DM 498), the Video Converter (DM 298) and the Flicker-Fixer (DM 498). Electronic Design is on ☎ 010 49 2262 6446.

INNOVATIONS ON TRUSTED PRODUCTS

New from Inovatronics is an updated version of *CanDo*, the application generator. Version 1.6 boasts a number of new features, many suggested by users of the original product:

- Gameport support, such that applications can now interface to joysticks, mice and trackballs.
 - Proportional sliders on windows. The contents of windows can now be scrolled both horizontally and vertically.
 - Support for hexadecimal file input/output. Non-textual files can now be manipulated.
- In addition, *CanDo* 1.6 comes with improved ARexx support, an improved on-line help facility, new tools and new scripting language commands. Upgrades to registered owners of version 1.5 cost £5, while upgrades for owners of earlier versions cost £45. *CanDo* 1.6 sells for £99.

Continuing the update trend, Inovatronics is shipping the latest release of *Directory Opus*, the disk management program.

Among version 3.41's new features are improved Workbench 2 support, enabling the use of multiple fonts, the use of a middle mouse button as a hotkey, and obviating the need for the *arp.library*. In addition, the program has improved recognition of file types, including *PowerPacker* crunched IFF files.

Directory Opus runs on any Amiga with a minimum of 1Mb of RAM. It costs £39. Upgrades for existing users are free. Inovatronics' products are distributed in the UK by Checkmate Digital ☎ 071 923 0658. Inovatronics is on ☎ 010 1 214 340 4991.

Amigas set for lift-off with new processor accelerators

ROCKET POWER FOR

AMIGAS

A flight of new processor accelerators comes screaming to these shores from American-based Computer Systems Associates.

The first is an upgrade for owners of Commodore's A2630 accelerator board. The Rocket Launcher consists of a 68030 processor (with memory management unit) and 68882 maths co-processor, both clocked at 50MHz. The two chips simply replace the old chips on the board, immediately doubling the speed and providing complete compatibility with existing hardware and software. The Rocket Launcher uses proprietary logic to remove the synchronisation delays typical with such accelerators, keeping CPU to DRAM access constant. It costs £595, which includes a trade-in on the A2630's old chips.

Also new is the 38 Special, a 68030 accelerator clocked at 38MHz for the A500 and A2000. Like its little brother, the Mega-Midget Racer, the 38 Special replaces the standard CPU inside the Amiga. It comes with its own separate maths co-processor

(clocked at 50MHz), and can have 2, 4 or 8Mb of 32-bit Dynamic RAM. There is also room for an optional 512K of Static RAM. In either case, it is possible to remap the Kickstart operating system into 32-bit RAM to greatly speed up operation. The 38 Special costs £850; or £1000 with 2Mb, £1250 with 4Mb, and £1550 with 8Mb of Dynamic RAM. The 512K Static RAM upgrade costs £99.

The biggest, fastest and best is the 40/4 Magnum, described by CSA as no mere accelerator but a 'Single Board Computer'. Its key component is a 68040 processor with built-in Floating Point Unit. This gives a speed which is claimed to be three times that of the fastest 68030-based Amiga. Performance is further increased by the inclusion of a Direct Memory Access SCSI card, one parallel port and two serial ports - all optimised to work with

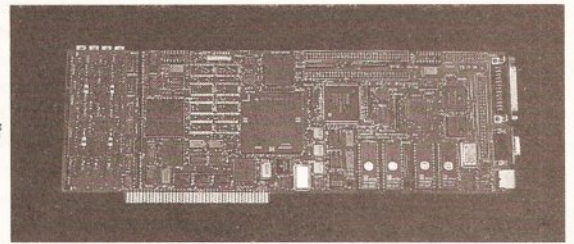

Go on boost your Amiga to more than triple the speed of an A3000 with CSA's 40/4 Magnum

the processor's blistering speed. The board comes with 1Mb of Static RAM, and can take up to 16Mb of Dynamic RAM in the form of plug-in SIMMs. A price for the 40/4 Magnum is yet to be announced.

All of CSA's products are distributed in the UK by Omega Projects ☎ 0925 763946. CSA is on ☎ 010 1 619 566 3911.

Andy Warhol's Elizabeth Taylor meets Amiga-power courtesy of thoroughly post-modern Julie Myers. Richard Burton was not available for comment...



BEAUTY IS SCREEN DEEP

Amiga computers will be used at the National Portrait Gallery to demonstrate the effects of computer graphics on the perception of portraits.

Artist Julie Myers will be working with the computers in the Gallery's Education Studio, demonstrating in particular how society's conception of beauty is contingent on cultural values. She will be working with two pairs of portraits. The first two, by Andy Warhol (who helped launch the

Amiga), will be Elizabeth Taylor 1967 and Mick Jagger 1975. The second pair will be John Wilmot, 2nd Earl of Rochester, after Jacob Huysmans c1665-70, and Nell Gwyn, studio of Sir Peter Lely, c1675.

Members of the public are welcome to turn up to watch Julie and discuss her work on Fridays and Saturdays until April 30 between 16.00 and 17.00. The National Portrait Gallery is on ☎ 071 306 0055.

TOWER POWER

Turn your Amiga 500 into an Amiga 2000 with Checkmate Digital's HiQ A500 Tower.

The system comes as a kit to turn a humble A500 into a fully expandable machine, fitting the innards into a 24" tall tower cabinet and giving a detachable keyboard. The tower contains seven expansion slots: three A2000 100-pin slots, one A2000 86-pin accelerator slot, and two PC-XT compatible slots and a video slot.

A key and lock is provided for security access (!). The tower also sports an LED speed display and a sliding panel door to protect the floppy disk drives. Its steel case has an external enamel coat and is nickel plated internally. The HiQ A500 Tower costs £449 from Checkmate Digital ☎ 071 923 0658.

CITIZEN CAN

Owners of Citizen printers will be pleased to hear of a custom-made printer driver giving much improved graphical results.

Based on the Irseesoft *Turbo Print Professional* package, the *Citizen Print Manager* is available to all Amiga owners free until the end of June. After that it will retail at £14.10.

The driver is said to offer the following benefits: removal of banding; image smoothing to give sharper images; ease of use, overriding application settings; image scaling; colour and gamma correction.

The driver can be used with any of the printers in the Citizen range. It can be obtained by ringing the Freephone number ☎ 0800 444276. Citizen Europe is on ☎ 0895 272621.

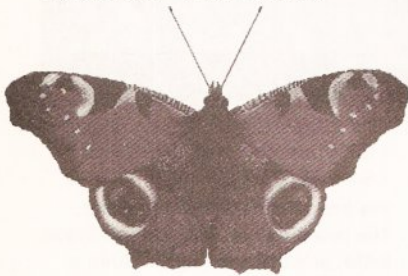

Delicacy of tone and vibrancy of colour become a reality with Citizen's very own printer driver for the Amiga, the *Citizen Print Manager*

GRAPHICS GALORE

A high-end graphics system has been launched by American company Progressive Peripherals and Software.

Called Rambrandt, the system provides two 32-bit screen buffers each with a maximum resolution of 1024x1024 pixels. The two buffers may be linked to provide a maximum scrollable work area of 1024x2048 pixels. Rambrandt has a palette of 16.7 million colours, plus a 16 colour overlay and an 8-bit alpha channel for genlocking.

It is based around the Texas Instruments TMS34020 graphics processor and 34082 graphics

processor, which provide hardware bit-blitting, zooming and panning, and three-dimensional rendering. Over 200 graphics functions are provided in 2D and 3D libraries. The video industry compression standard, JPEG, is supported.

In addition, the board has the capability to digitise a 16.7 million colour frame in 1/30th of a second.

Both RGB and composite are supported for input and output. 8Mb of Video RAM is supplied, plus a further 8Mb of Dynamic RAM for the storing of resident applications. Rambrandt costs £1500.

Also new from PPS is a 68040

accelerator card for the A1500/2000/3000 family of computers.

The card is clocked at 25MHz and provides processing power of 19.2 million instructions per second. It contains a Floating Point Unit as well as a 4K data and a 4K instruction cache. The card costs £1499 without RAM, or £1569 with 4Mb of 32-bit RAM. It is expandable up to 32Mb. Distribution of both products in the UK is by, amongst others, Power Computing ☎ 0234 843388. Progressive Peripherals And Software is on ☎ 010 1 303 825 4144.

MORE COMPUTERS THAN KIDS

A survey carried out by Texas-based Channel Marketing Corporation estimates that US households will have an average of 2.2 computers.

Since that's more computers per home than children, we can only assume computing is more fun than err... not computing.

A spot of star gazing reveals the future vision of printing — the new LC24-20, for home business and education

ANOTHER STAR IS BORN

Those on the lookout for a new printer will be interested in Star's new offering, the £300 LC24-20. The 24-pin printer replaces the LC24-10 and is aimed at education, home and business users. Its new features include a panoramic LCD control panel which aids user operation and set-up procedures, and Auto Emulation Change, which enables the printer to automatically change to one of the industry standard emulations depending on the control codes it receives from the computer.

At its fastest, the LC24-20 outputs text at a claimed 210 characters per second, with a choice of ten fonts. It comes with a 16K print buffer, expandable to 48K. The interface is a Centronics parallel one; a serial interface is available as an option. The LC24-20 costs £304.33 from Star ☎ 0494 471111.



The Star LC24-20 really is the business. With a maximum print speed of 210 cps, those letters will be flying out

FRESH MEMORIES FROM POWER

Power Computing is launching a whole series of new RAM expansions, starting from £19 in price.

The Miniature 512K uses just four chips and fits any Amiga 500. It is available with or without a battery backed clock. A disable switch and a disk of utility software is included. It costs £29, or £24 without the clock.

The sixteen chip 512K board also fits any A500, and comes with a disable switch. It costs £24, or £19 without a battery backed clock.

The Power 1.5Mb expansion fits standard 1.3 A500s to give a total of 512K of Chip RAM and 1.5Mb of Fast RAM. It comes with a battery backed clock and costs £79.

The PC501+ is an eight chip 1Mb board specifically for the A500 Plus, bringing its memory up to 2Mb of Chip

RAM. It costs £49. The 32-Chip expansion performs a similar feat, but using 32 chips. It costs £39.95.

The 1Mb board with throughport fits into a 1.3 A500's trapdoor expansion, enabling a further 512K board to be plugged in afterwards. It costs £49.95.

An 8Mb expansion is also available to fit in the A500 or A500 Plus's side expansion slot. It includes a throughport for the further addition of a hard drive. The board is available with 2, 4 or 8Mb of RAM, costing £129, £189 and £299 respectively.

Finally, the Aries board offers up to 8Mb of expansion RAM for the A1500 or A2000. It costs £129, £169, £209 and £249 with 2, 4, 6 and 8Mb respectively. Power Computing is on ☎ 0234 843388.

WORDWORTH WORRIES

Grey imports of Digita's *Wordworth* have been returning to these shores at greatly reduced prices.

These versions were originally intended for sale in the USA, and are not officially supported in this country. They do not contain valid UK support registration cards, meaning that owners are neither eligible for technical support or future upgrades. Furthermore, the imports are an outdated version of *Wordworth*.

Digita recommends that customers check with dealers that the copy they purchase is a genuine UK version. To avoid this in future, exported versions will be marked "Export only, not for re-sale in the UK". Digita is on ☎ 0395 270273.

Diary Dates

April 12: All Formats Computer Fair. Northumbria Centre, Washington. ☎ 0225 868100.

April 18: Computer Technology Fair. The Corn Exchange, Brighton. ☎ 0273 607633.

April 26: All Formats Computer Fair. National Motorcycle Museum, Solihull. ☎ 0225 868100.

May 15-17: Amiga Shopper Show. Wembley, London. ☎ 051 356 5085.

May 16: All Formats Computer Fair. Horticultural Hall, London. ☎ 0225 868100.

May 17: All Formats Computer Fair. Brunel Centre, Bristol. ☎ 0225 868100.

Wordworth

a writer's dream

v1.1

The graphical nature of Wordworth® makes producing documents faster and easier. The WYSIWYG display shows exactly how your printed document will look, different fonts, styles and sizes, headers and footers, graphics and so on.

Commands are grouped under a series of pull-down menus, accessible either by the mouse or keyboard. Frequently used commands have on-screen icons, including Help, should you need it.

Experience the look and feel of the new and exciting WB2 (even if you use WB1.3). Each document is a separate multi-tasking window, which means you could for example, print one document while editing another.

Digita's® innovative *Human Interface Protocol*™ is incorporated setting a new standard in speed, style and elegance. "It *HIP*™ system is intuitive and a pleasure to use." – thank you Amiga Shopper, it's nice to be appreciated.

Graphics have always been the Amiga's strong point. Now it's better than ever. Pictures from Deluxe Paint can be placed in a document, and then sized, scaled and dragged (text automatically reformats around the image).

Wordworth's enhanced fonts will give you the very best printed quality. You can also print special symbols, such as boxes, arrows and so on. Better still, you can mix graphics, Wordworth's enhanced fonts, Amiga fonts, Colorfonts and your printer's own internal fonts, all on the same page. There's even a driver for Postscript printers.

You needn't worry about your existing information – Wordworth will let you open documents from most word processors, including Kindwords, Protext and Wordperfect (you can also mailmerge with Superbase).

When Amiga Format said "a new word processor that will give the rest of the world a run for its money" they weren't joking.

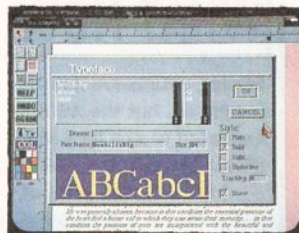
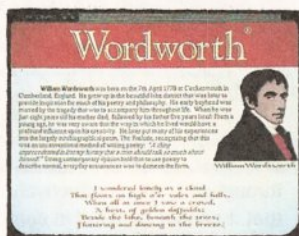

Wordworth is written in the UK by Digita. Which means you'll be using an English Collins spelling checker and thesaurus, and you'll know where to come for professional support.

The only way to really appreciate Wordworth is to use it. Phone 0395 270273 for more information or, write to Digita, FREEPOST, Exmouth EX8 2YZ.

Wordworth costs £129.99, which includes VAT, postage and packing; and when purchased from Digita, comes with a 7 day money-back guarantee.

If you already own a word processor, for a limited period only, you can trade-up for just £89.99 by returning your original disks to Digita with your order.

Summing up, Amiga Shopper said: "Pounds-per-feature no other Amiga word processor comes close. Wordworth is what every owner of Kindwords would wish they had." Dreams become reality with Wordworth.

Machine support
Written specifically for the Amiga
Fully supports WB V1.3 and V2.00
All medium or high resolution modes
(mono and colour)
Requires 1MB of memory

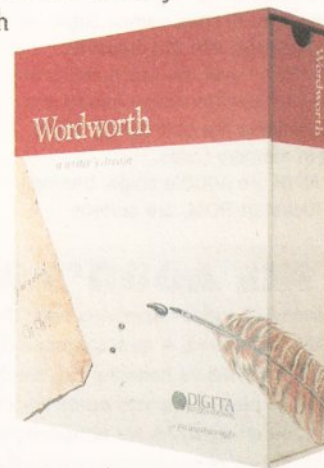
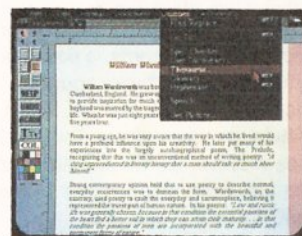

DIGITA®
INTERNATIONAL
software that's right™

Wordworth is available from John Menzies, Virgin, W H Smith and all good computer retailers or to the trade through Columbus, Gem, HB Marketing, IBD, Lazer, Leisuersoft, Precision and SDL.

Digita International Ltd Black Horse House Exmouth EX8 1JL ENGLAND Tel 0395 270273 Fax 0395 268893

— A member of the Digita group —
Digita, the Digita logo, Wordworth and the Wordworth logo are registered trademarks, and *HIP*, *Human Interface Protocol* and *software that's right* are trademarks of Digita Holdings Ltd.
All other trademarks and their owners are acknowledged. Sold subject to standard conditions of sale E & OE.

Secretly unveiled to select developers, there's a new New A600 all set for

Commodore is to launch both the A570 CD-ROM drive and a brand new Amiga at May's Amiga Shopper Show at the Wembley Exhibition Centre.

The A600 is the vanguard in a new generation of Amigas from Commodore. The machine is very much aimed at the home user. Unlike all previous Amigas, it has a built in RF modulator for direct connection to a TV. It is also smaller, missing a numeric keypad.

The main innovation is a slot for accepting memory cards, a possible new medium for software houses, particularly games producers, which may help to reduce piracy. The A600 comes with Workbench and Kickstart 2, the enhanced chip set and 1Mb of Chip RAM. An IDE hard disk controller is fitted as standard; a model will be available with a hard disk fitted internally.

The choice of an IDE rather than a SCSI interface seems peculiar on the face of it. It can probably be explained by both the simplicity of the interface and the huge amounts of 2.5 inch IDE drives being manufactured for the PC market.

NEW GAYLE CHIP

A new custom chip, named Gayle, is also included with the machine. Gayle takes over the functionality of the older Gary (memory control) and also handles the addressing of the plug-in memory cards.

All of the A600's chips, barring the Kickstart ROM, are surface

The first of Commodore's new generation of Amigas, the A600, is to have its public launch at the Amiga Shopper Show. This, plus the first unveiling of the A570 CD-ROM drive, means the show looks set to be the most exciting since the Amiga's launch

mounted. Commodore has been intending to do this for some time, the prime reason being economy.

Unfortunately, it means that it is no longer a simple matter of unplugging chips from the motherboard and replacing them. Thus, many internal add-ons for the A500, such as accelerators, graphics adaptors and internal memory expansions, will not work with the A600. This is exacerbated by alterations in the trapdoor expansion, so existing memory boards and PC emulators will be incompatible.

THE A570'S DEBUT

The other main launch of the show is the A570 CD-ROM drive. Previewed in last month's *Amiga Shopper*, the A570 will plug into the side expansion slot of an Amiga 500 to give CDTV compatibility. In addition, it can be used in a similar manner to a huge, read-only hard disk. The Fred Fish collection of PD programs is already available as a single CD for just this purpose.

There has been some criticism of the A570 because of its lack of a

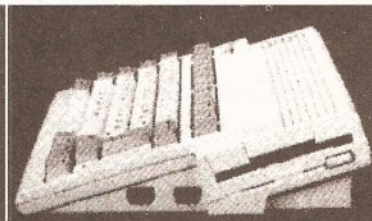
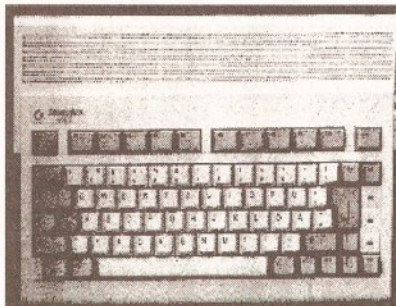

The first shots of the new A600 – grainy but nevertheless worth printing as they show off its unique design

throughport, which effectively means that it cannot be used in conjunction with the A590 hard drive. The A600, with its internal hard disk controller, will not suffer from this problem, which may explain Commodore's apparent lack of concern over existing A590 owners. At any rate, hard drives that have a throughport, such as Supra's 500XP, are compatible with the A570. No doubt

some enterprising hard drive dealers will soon be offering part exchange deals on A590s for compatible drives as the CD-ROM drive sells in the enormous quantities which it surely must.

OTHER SHOW STARS

The Amiga Shopper Show is the UK's only 100% Amiga event this year. It's on at Wembley from May 15-17, and

THE A600'S MEMORY CARDS

Instead of a side expansion port, the A600 sports a slot for a plug-in RAM/ROM card. A new custom chip, Gayle, takes care of the addressing of this as well as handling the functions of the older Gary chip.

The plug-in memory cards are credit card sized devices that can contain either RAM, for temporary storage of data, or ROM for the distribution of pre-written applications and games.

In the PC world, these cards range from 16K to 4Mb in capacity. There is an interface standard, known as PCMCIA, already in place. It is likely Commodore will use this standard rather than opting for its own.

The advantage the cards offer is that segments of code can be executed on the card without being loaded into the computer's conventional memory. This would mean that copying the program would be very difficult. It is likely that, for games, the cards could be used as a software lock or 'dongle'. Serious applications could be supplied on a single card, providing access times believed to be in excess of 300 times quicker than a hard drive.

WHAT NOW FOR THE A500 PLUS?

Pricing details are not yet confirmed, but the A600 is expected to sell for £399 – the official price of the A500 Plus.

In reality, the price of the A500 Plus dropped to the region of £350 shortly before Christmas as dealers attempted to increase sales. The price has failed to climb back up. The big question is: if the A600 sells for £399, what will happen to the A500 Plus?

There is already evidence to suggest that Commodore will be limiting further production of the A500 Plus, which was surreptitiously introduced last November. Those remaining will probably be sold at current prices, if not discounted even further.

A sensible move would be for Commodore to bundle the two machines' different selections of

software in a bid to attack two different markets: one as a games machine pure and simple, the other as an education/home productivity package. Quite which would be which is unclear. Although the A600 is a technically superior machine, particularly with its on-board hard disk controller, aspects such as its built-in RF modulator and its lack of a numeric keypad suggest that Commodore intends it to be a games machine.

It could well be that the A500 Plus will be dropped altogether, with two A600 models (one with an internal hard disk) being targeted at these two areas. When asked about this, Commodore's Andrew Ball refused to comment.

Amiga in town. And here are the EXCLUSIVE details!

Amiga Shopper Show

it's your chance to see just how vibrant the Amiga market really is.

As well as the exciting new A600 and the new A570 CD-ROM drive, Commodore will be demonstrating CDTV with its wealth of new software.

US GIANTS

Stateside hardware giant GVP will be there too, showing off its impressive range of hard drives, accelerators, sound boards and graphics cards.

Supra, the other major player in the peripheral field, is to attend with its fine array of high quality, low cost hard drives, memory expansions and modems.

Progressive Peripherals and Software will be there to show its amazing Rambrandt graphics system. Rambrandt, as revealed on page 8, combines high resolution 32-bit colour with dedicated processing power to produce graphics capabilities of undreamt of speed and power.

A number of other big names have also booked space already: Checkmate Digital, Cortex, Digita, HiSoft, Power, Precision, Rombo, Silica, WTS and Zone are just some of those who will be present.

As well as all of this, there'll be plenty of opportunity to run away with some amazing prizes and loads of bargains. Check out our form on page 75 to see how you can win a free memory expansion.

ANSWERS SHOW PANEL

The infamous *Amiga Answers* panel are swotting up at this very moment, preparing to solve your problems – we'll be holding question and answer sessions throughout the show, so if you've got a problem, any problem, bring it to us, and watch it disappear in a puff of logic.

There will also be seminars running by prominent developers for you too. Come along and learn how to get the most out of your hard and software. Turn to page 138 to find out exactly who is going to be there, and why you ought to be too.

Phone our ticket hotline ☎ 051 356 5085 to book your place in advance and receive a free show guide.

Interested exhibitors should call Mike Jennings on ☎ 0225 442244.

THOSE NEW AMIGA RUMOURS RATED

Speculation has been rife in the last few months over the exact specifications of Commodore's new machines. That a new range of machines is planned is certain, but exactly what they are is something Commodore is at pains to keep very, very quiet.

Nevertheless, a large body of rumours has escaped: leaks from developers who have early access to prototype machines and are bound by Non-Disclosure Agreements; educated guesses from industry pundits; and leaks from Commodore itself.

Here *Amiga Shopper* looks at the most popular predictions for the new Amiga range, and gives each of them a plausability rating out of ten.

● The A300

The machine first revealed in *Amiga Shopper* issue 11, said to be a cut-down version of the A500. The main differences are the lack of a numeric keypad and only 512K of RAM. It was rumoured that the machine would be priced under £300 as a games machine to compete with the increasingly popular console systems. Now, it seems that these rumours were caused by some confusion over the A600, which has many features in common.

Plausability 1/10

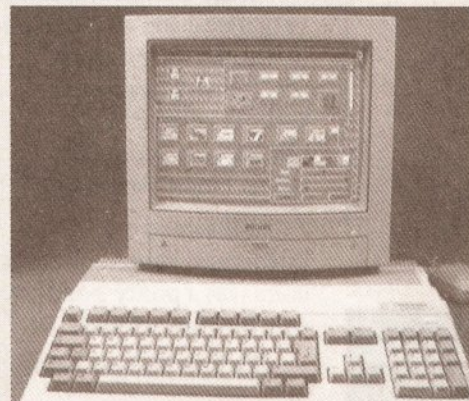

The A500 Plus – only just launched but already being threatened by rumours of an A600 Plus

● The A600 Plus

Unconfirmed reports from the USA suggest further enhancements to the new A600. These include the new Extended Chip Set and Workbench 2, as used in the A500 Plus, and 2Mb of RAM as standard, with 1Mb devoted to Chip memory and 1Mb to Fast. Although the machine will use the usual 68000 processor, this will be clocked at 14.3MHz, nearly doubling the speed of most applications.

Finally, it will come with Commodore's new high density floppy drive, providing 1.76Mb of storage space. Although not yet announced, the high density drive has been found lurking in some A3000 models.

Plausability 6/10

● The A800

First reported in *Amiga Shopper* issue 11, the A800 is a mid-range Amiga, supposedly coming with a Motorola 68020 processor and 16-bit CD quality sound. The machine would fill the current gap between the A500 Plus and the high-end A3000 machines.

Plausability 4/10

● The A2200

This is another version of the A800 rumour, billed as a scaled down version of the A3000 and a replacement for the ailing A2000, which many expect Commodore to cease producing.

With a 68020 processor clocked at 14.3MHz, space for a 68881 maths co-processor and a true 32-bit memory bus, the A2200 would make an excellent mid-range machine to compete with the likes of the Apple Mac and 386 PC.

The A2200 will come with 1Mb of Chip RAM (expandable to 2Mb) and 1Mb of Fast RAM (expandable to 8Mb on the motherboard). A flicker fixer is built-in.

There will be plenty of expansion possibilities, including an accelerator slot, a 32-bit SCSI controller and two 32-bit bus slots. It will come with either two high density floppy drives or one floppy and a hard drive.

Plausability 7/10

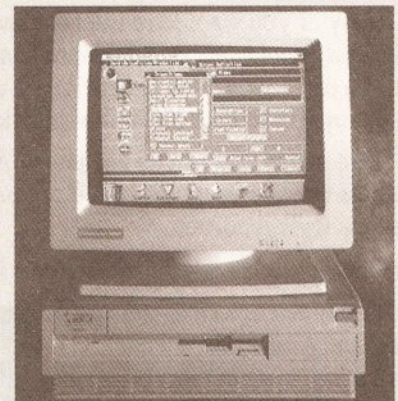

King of the Amigas – the A3000. Soon to be deposed by a 68040-based workstation?

● The A4000

Or the AmigaStation – This is the rumoured top of the range Amiga based around the powerful 68040 processor and first reported in *Amiga Shopper* issue 11.

The A4000 will come with the Enhanced Chip Set, 2Mb of Chip RAM and either 4 or 8Mb of Fast RAM, expandable to 32Mb on the mother board.

It will also have 16-bit CD quality sound, and a graphics card with a co-processor providing a 1280x1024 pixel display.

This will be in 256 colours from a palette of 16.7 million; the addition of extra video RAM will provide a full 16.7 million colours at once.

Plausability 5/10

Home Accounts 2

the best gets better...

When Home Accounts was launched four years ago we had just one goal—to create the best home finance program. Over 30,000 of you agreed with us and purchased Home Accounts, not only for use in the home, but also for business, clubs and charities.

It seemed like a good idea to let you tell us exactly what to put into Home Accounts2®

Which you did.

Some of you didn't like the restrictions on the number of income accounts, expenditure types, and transactions. So we removed them.

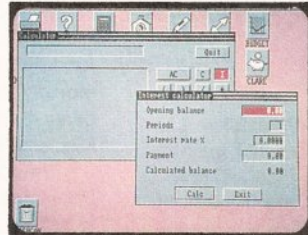

Some of you wanted more graphics, so we added pie charts, scatter and line graphs. We thought we'd better smarten up the bar graphs, so we added 3D effects, stacking and overlaying, and we made sure you can print them.

Many of you wanted to calculate mortgage rate changes, loan repayments, retirement planning and so on. So we added a pop-up calculator and interest calculator. There's also an option to take account of inflation.

Since nearly half of you use Home Accounts for small business bookkeeping, we added options for VAT and business style reports.

Then, our technical people added a little . . .

Investment accounts, net worth statement, password, cheque numbering, custom reports, flexible year period. And (to save you disturbing them on our support hotline) an on-line help system, should you need it.

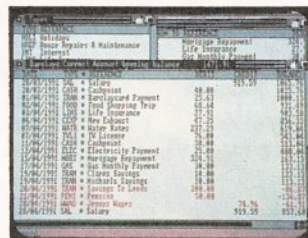

They also added our acclaimed *Human Interface Protocol*™, which first appeared in *Wordworth*®. As you can see, it sets a new standard in speed, style and elegance for Workbench. (It also contains a screen saver, *Playtime* games and a few other goodies.)

Amiga Format said, "Digita have made great efforts to listen to their customer comments and the result is a package which will suit any household. Everything the home user needs has been included—and more".

Home Accounts2 is written by Digita®. Which means you'll be using a program designed for the way British finances work, and you'll know where to come for professional support.

The only way you can really appreciate Home Accounts2 is to use it. Phone 0395 270273 for more information or, write to Digita, FREEPOST, Exmouth EX8 2YZ.

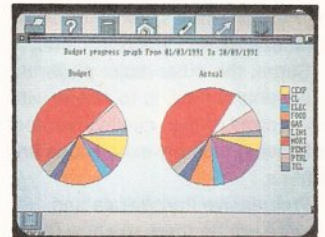

Home Accounts2 costs £54.99, which includes VAT, postage and packing; and when purchased from Digita, comes with a 7 days money-back guarantee.

If you already own a home finance program, for a limited period only, you can trade-up for just £29.99 by returning your original disks to Digita with your order.

Amiga Computing concluded, "A completely functional, very useful and amazingly easy program to use. If you're a wary newcomer to accounts packages then cast off your doubts and splash out on Home Accounts2."

As it turned out, listening to Home Accounts users was a pretty good way to write software.

The best just got better.

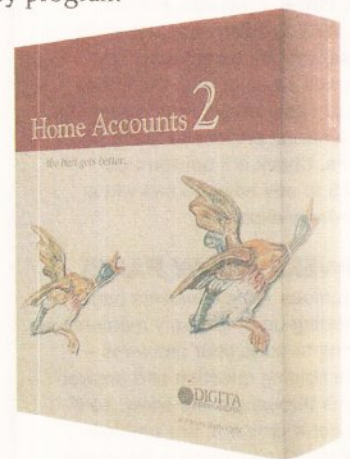

Machine support
Written specifically for the Amiga
Fully supports WB1.3 and 2.00
All medium and high resolution modes (mono and colour)

DIGITA
INTERNATIONAL

software thats right™

Home Accounts2 is available to the trade through Columbus, Gem, HB Marketing, IBD, Lazer, Leisuresoft, Precision and SDL.

Digita International Ltd Black Horse House Exmouth EX8 1JL · ENGLAND Tel 0395 270273 Fax 0395 268893

— A member of the Digita group —

Digita, the Digita logo, Home Accounts2, the Home Accounts logo, and Wordworth are registered trademarks, and *HIP*, *Human Interface Protocol* and *software thats right* are trademarks of Digita Holdings Ltd. All other trademarks and their owners are acknowledged. Sold subject to standard conditions of sale E & OE.

NEW AMIGAS

Time has moved on since the A2000 and 500 were produced, and the success of these models has greatly enhanced CBM's presence in the computer market.

But the release of a machine with a 68020 CPU will take away the 2000's and 1500's market, leaving them for dead in terms of raw power.

The question is, is CBM going to beef up the 2000's or just leave them at their present spec? The mid-range Amigas deserve to be enhanced if they are to be taken seriously in the business sector in the next few years. With PC power on the increase in both graphics and CPU stakes, and their price doing a skydive, a new rethink is needed.

Perhaps an Amiga 2000 Revision C is needed with: A 68020/68881 processor combination to place it just below the A3000's power.

A major update in GFX resolution and colour (the HCS chips are like a halfway effort), maybe 8 bit-plane (256 colours) and 16-bit colour (65536 colour palette) selection as opposed to 12.

16-bit Sound 8 channel stereo. And a built-in hard disk controller like the 3000's. Along with some minor but important things such as space for 8 meg on-board memory (32-bit with a 68020) making it easy to upgrade with just the cost of the chips and the memory on existing cards eg GVP HD+, going on the end in case you run out of 32-bit.

These enhancements would once again place the 2000 in the league of the new SVGA 386 PCs. I am not knocking the Amiga but as I said - *time moves on*.

Marc Kelly
Dyfed

Indeed it does... and it looks as though some of your suggestions are already being implemented if the news feature on pages 10 and 11 of the issue is anything to go by.

KICKSTART CARDS

Why doesn't Commodore bring out the Kickstart 2 upgrade for the Amiga 1500/200 on a card?

It could put the new ROM chip and the full ECS (including the Super Agnus) on it and have a switch sticking out at the back to turn it on or off, giving a true compatibility with Kickstart 1.3 - unlike the current ROM sharers that don't really live up to their claims.

If a PC emulator can be put on a tiny card that fits in an Amiga 500, then it must be much easier to put Commodore's own chips on a card for the 2000.

The present upgrade options available to owners of all 1.3 machines are nothing short of

disgraceful. To upgrade to the current A500 Plus costs £80 for the ROM and manuals, £50 for the new Denise chip and a staggering £200 for the Super Agnus - which isn't even an official option!

For owners of 1.3 Amiga 500s it is hardly worth paying the best part of £350 to upgrade when they could buy a brand new A500 Plus for much the same price.

I can't help but feel that we owners of older machines have subsidised new owners by paying higher prices for our computers while they were still in need of serious improvement. Still better machines can now be bought for substantially less, although we don't get any benefit from the developments we funded.

For instance, I bought a 1.3 Amiga 1500 in November after being told by Commodore that the 1500 Plus wouldn't be released until Spring. A few weeks later the 1500 Plus was released unannounced for £80 less than I had paid. Even if I'd bought one I would still have to pay £200 for the Super Agnus!

Although you may say that no software currently requires any of the ECS to run, it won't be long before owners of 1.3 machines are left out in the cold. How much software released today works on a 1.2 machine with an old Angus?

PE Browne
Bradford

A good point about the trap-door upgrade card and one which I can see no obvious problems with. Maybe such a card will be made available at some point but who can say? As for CBM's attitude about upgrades - I agree again - it does seem to be somewhat ambivalent towards existing owners.

STUDENT DISCOUNTS

The price of soft and hardware in this country is too much for us students. Why can't we be given discounts? I remember a few years

Talking Shop

Welcome to your letters page - the only place to be if you're serious about your Amiga.

If you've got a view then send it to:
Andy Storer, Talking Shop, Amiga Shopper,
30, Monmouth St, Bath, BA1 2BW

ago seeing the store price list for a computer shop. The shelf price was about three times as much!

Let me give you an example. I recently bought *Wordworth 1.1* for £79.99 from an independent retailer. This is £50 cheaper than Digita would provide it for - ironic isn't it?

Why can't companies give a discount if students buy direct from them? Proof of student status could be found in the Community Charge discount certificates that we are issued with.

If educational establishments can get discount - not necessarily for bulk purchases - why can't students if the item is going to be for an educational use?

Simon Griffiths
London

I'm afraid this is one of those issues, like the plea last month for companies to offer hire purchase schemes, that can only be resolved by publicity. Hopefully advertisers

reading this might be first on the block to offer student discounts. I'm sure they'd do good business.

Meanwhile, have you tried lobbying your Student's Union? - I know that they once managed to tie up discount insurance deals.

READERS' PANELS

A friend of mine recently bought *Wordworth* and was kind enough to let me borrow it. Having read nothing but good things about it, I was disappointed to find that, for the money, it was very average.

I could not understand this, as all the reviews raved on about it - then the penny dropped.

Going back through my back numbers of *Amiga Shopper*, I noticed that the reviews of most software seem to assume that we all have hard drives and very quick printers, not to mention vast amounts of money to spare.

As an example, one of the major problems with *Wordworth* (and probably most other word processors) is that the machine "locks up" when printing something. This may not be a problem if you have a state-of-the-art laser or 24-pin printer, but with a simple 9-pin it's most annoying.

The point I am trying to get across is that the articles now appearing in *Amiga Shopper* seem to be aimed at the wrong level - how about bearing in mind that most people who are attempting to use their Amiga seriously are doing so without accelerator boards, hard drives and 8Mb upgrades, having to cope instead with just two drives and a monitor?

If sinking to such depths of realism is beyond you, then how

HOW DO I GET TO WRITE FOR AMIGA SHOPPER?

I have been reading your magazine, *Amiga Shopper* for some time and enjoy it immensely. I find it very informative and congratulate you on being first with most products.

At the moment I am taking exams in English Literature and language as well as typing classes. I plan to take a course in Desktop Publishing later this year.

Can you possibly inform me of the necessary qualifications and experience needed to enter your line of work, perhaps staff writing or reviewing?

R A Jenkins
Bracknell

Some would say the secret to securing a career in journalism is to develop a capacity to consume large amounts of beer on a daily basis.

So it's probably just as well there are no formal qualifications necessary. What *Amiga Shopper* would require though is proof of your ability to write clearly and effectively. And the best way to give us this is to submit articles which demonstrate it.

But every magazine has its own style of writing and ours depends on Clarity, Depth and Balance. So just bear these words in mind when you send us some samples - if we like 'em, we'll print 'em - and pay you too!

continued on page 14

continued from page 13

about instigating a 'Readers Panel' of reviewers – you have the details of what hardware/software we have from those of us who have replied to the surveys; why not pick out two or three readers at random to add their comments – after all, if hi-fi and car magazines can do it, I see no reason why a serious computer magazine can't.

Peter Brook
Southport

Readers Panels eh?... mmm, I'll have to give that one some thought. In the meantime, I'll have a word with our contributors to bear your points in mind. I'm sure they're aware of the 'bias' you refer to but that doesn't mean they don't need reminding of it from time to time. I'll also pass your letter on to *Amiga Answers* to help sort out your 'lock-up' problems.

COME ON DOWN

Please find enclosed my £14.95 cheque for 12 months' subscription to *Amiga Shopper*.

I think your magazine is excellent in dealing with a variety of subjects. However I would like to suggest that more tutorials on *Amiga Basic* would be of great interest to a large number of readers. I have what could be described as a smattering of *Basic*, ie a bit above beginner stage but not enough to write fairly complicated programs. I have in mind sorting, cursor positioning,

buffer, artificial intelligence etc.

My complaint with the *Amiga* is that the whole industry seems geared to make owners buy ready-made programs. There's not enough encouragement for *Amiga* owners to learn programming for themselves.

I have bought several books which are fine for graphics but fairly useless for utility programming. You could redress this balance perhaps with an on-going tutorial starting with a database including creation, view, sort, search, print etc, following up with some application programs such as selection, probability and artificial intelligence.

There will be complaints from experts that such articles are beneath them, but they are already catered for. In the main I would say that the majority of your readers are not experts, do not have bottomless pockets and will welcome the chance to further their knowledge without more expense.

Your thoughts in this matter will be appreciated.

W Evans
Emsworth, Hants

I can only offer that we're always running series on programming and *AmigaDOS*; in fact we just finished a long series on *Basic* in December.

We also have new ones in the pipeline – next month for instance we're starting a series on artificial intelligence – including how to program a neural network in *AMOS*! But point taken and be prepared for more tutorials galore.

PLAIN BATTY

I tried making pancakes with the CD-ROM drive in my CDTV.

Unfortunately laser beams don't seem to agree with batter. I can laugh about it now.

Mark Smith
Liverpool

I had a similar problem using my disk drive as a toaster. Any readers who can help either of us should send their advice to 'All machines should multi-task', *Amiga Shopper*, 30, Monmouth St, Bath, BA1 2BW

A CYBORG WRITES...

I am a regular purchaser of *AS* and get a great deal of information about using the *Amiga* and products available.

A major problem I have is that I am usually so totally engrossed by the editorial pages that I skip over the advertising that is discretely interspersed within it. The nature of my problem is that I seem unable to transfer all the data from magazine to brain within a period of a month ie before the next issue comes out.

This situation is further compounded when I am seduced by the lure of a useful utility on the

coverdisk of *Amiga Format* and end up having to read that magazine as well. Obviously, this does not take as long because I have a cerebral game filter utility (CGFU) written in C which I developed twenty years ago on an Atari 2600.

Do you think that it would be possible to develop an opto-data exchange system based on interleaved memory? A further enhancement could be to increase the baud rate on the Eye to 25 hours/day. How about multiplexing the Eye and reading two pages at once?

A totally original approach to the problem would be to reduce the volume of data requiring transfer. How about a magazine of say, 140 pages with no colour editorial or advertising pages selling for 99p? I have returned many of your reader questionnaires but this never seems to be an option. Any suggestions would be appreciated from yourselves or your readers.

Deryck Lawrence
Kent

Err... yes Deryck. I think it's probably more realistic to build yourself an off-line OCR scanner with direct neural hook-ups which you can use while you're asleep than expect to see a 140 page magazine, with no advertising, selling for 99p. Thanks for the idea though – I like your style.

SCANNER RIVALS

In the March edition of *Amiga Shopper* you carried a review relating to hand scanners written by Jeff Walker.

The article claims that the M-105 is used by all the rival scanner manufacturers and implies that the M-105 Plus produces better results.

We wish to point out that this is totally incorrect since the same scan head, the so called M-105 Plus is used by Pandaal, Evesham Micros and Datel.

The M-105 Plus scanner head, which is manufactured by Marstek, has been in existence since July 1991 and has been available to all its customers, including ourselves, since that date.

The reason that it is called a 105 Plus is to differentiate the software bundled with the PC version; this, of course, has no relevance whatsoever to *Amiga* users. We can only conclude that the scan head that was being used as a comparison was improperly set up, or that it was a very early or faulty model.

Furthermore, the article claims that the Pandaal Daatascan professional software was not licensed because what was wanted was "something with more features". The real reason that the software was not licensed was political. Indeed our scanner software and hardware is licensed

IF ONLY I'D REALISED...

CONTINUING OUR SERIES OF HANDY TIPS BRINGING YOU THE BENEFITS OF HINDSIGHT...

£5
WINNER

I have a Star LC200 colour printer which I use with *Kindwords* 2. Yes I know everyone harps on about *Kindwords* being slow and archaic but I only need a word processor for the odd letter or report so its does me fine.

Anyway to the point, *Kindwords* does not allow embedded commands. So, to use the in-built fonts and styles of my printer using the DIP switches and combine colours, styles and fonts was a nightmare. It meant running the paper through the printer more than once after altering and deleting text.

Then one day with nothing better to do I read the printer manual and guess what? That's right! The Star printer does allow you to send commands to it through the word processor even if the software does not normally allow for them.

On page 96 of the manual it states how to embed printer commands using capital letters enclosed in double parentheses followed by a number. This will allow you to access the printer's built-in fonts, colour and sizes. Whether it works with other word processors I do not know, but when in doubt read the manual.

I hope this tip is of as much use to others as it has been to me. By the way, great mag, it's amazing the little tips you can pick up in it.

Ken Price
Port Talbot
Wales

Ahhh... manuals – I too am one of those people who only read them when I encounter a problem. A fiver's on its way to you Ken and any other reader with a handy tip, no matter how embarrassing.

Just send it to: "I can laugh about it now", *Amiga Shopper*, 30, Monmouth St, Bath BA1 2BW

for distribution in Europe by Marstek itself and also by Evesham Micros.

We have been designing scanning software since 1988 and believe in continued product development and support. This is why we are now supplying version 2.02 for the *Amiga* which supports 16 true grey scales. We will of course continue to improve the specifications.

Abb Pandaal
Managing Director
Pandaal

FEEDBACK

The KCS Power Board – this is an excellent device, and over the past couple of years I have upgraded to version 2.0 then 2.83 of the software, KCS has been advertising version 3.0 of the software in your magazine since the November issue (ie in October 1991). However requests for the new software have brought no reply from England, and the response from the local importer that this is "vapour ware" – I could understand it if the advertiser withdrew his advertising after a month when they could not supply the goods, but it has been there for the past five months.

Mike Simpson
Whalan
Australa

Pity about the cricket as well, eh Mike? Sorry... KCS's V3 software is readily available over here. Try Bitcon Devices at 88, Bewick Rd, Gateshead, Tyne & Wear NE8 1RS. If any other readers have doubts about hardware or software hype then let us know at: 'Watch it!', *Amiga Shopper*, 30, Monmouth St, Bath BA1 2BW.

Swift Microcomputers Ltd

84 High Street North, Dunstable, Bedfordshire, LU6 3HP

Tel: (0582) 476257 Fax: (0582) 476258

COMPUTERS

**COMMODORE
CDTV
£445**

**AMIGA A500+
CARTOON
CLASSICS
£349**

**AMIGA A500+
2mb RAM
CARTOON
CLASSICS
£399**

**A500 WITH 1mb
RAM
EXTERNAL
DRIVE
£369**

DISKS & BOXES

50 Disks + 100 box £25
100 Disks + 100 box £36
200 Disks + 2x100
Boxes £70
400 Disks + 4x100
Boxes £138

3.5 DS/DD DISKS

50£21.00
100£33.00
250£77.00

**500+ CALL FOR
BEST PRICE**

3.5 DS/HD DISKS

10£6.00
50£28.00
100£54.00

**PHILIPS
CM8833 Mk2
£215
(Inc. Lead)**

KAO BRANDED 3.5 DS/DD

**BOX OF 10 DS/DD
£6.50**

UPGRADING

Internal Drive....£46
External Drive ..£49
Cumana Drive ..£59
.5 Meg RAM£21
1Meg RAM (+) .£41
2.04 K/Start£49
Hi-res S/Denise£36
Fatter Angus£49
ROM Sharer£29

PRINTERS

CANON BJ10ex .£239
STAR LC20£150
STAR LC24-10...£219
STAR LC200£209
STAR LC24-200 .£269

HOW TO ORDER

Visit our showroom
with easy parking or
send cheque or postal
order to the above
address.
Access and Visa
accepted.

**ALL PRICES INCLUDE VAT AND DELIVERY. ADD £9
FOR NEXT DAY DELIVERY.**

Using your Tracey

Baffled by the bit of plastic stuck to the front cover of Amiga Shopper? Jason Holborn shows you how this seemingly simple gadget can turn you into a pixel Picasso

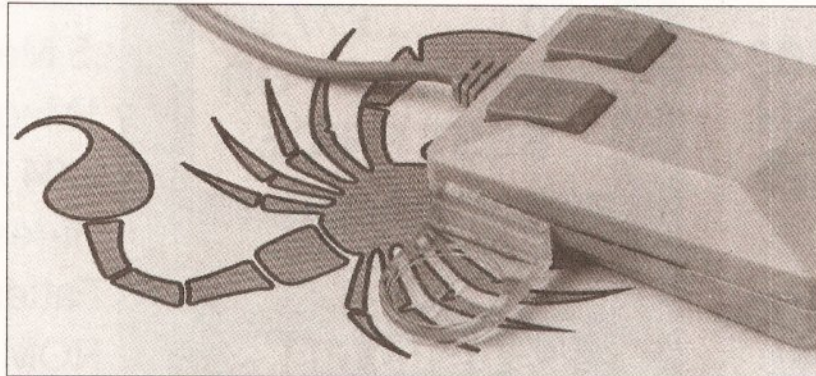
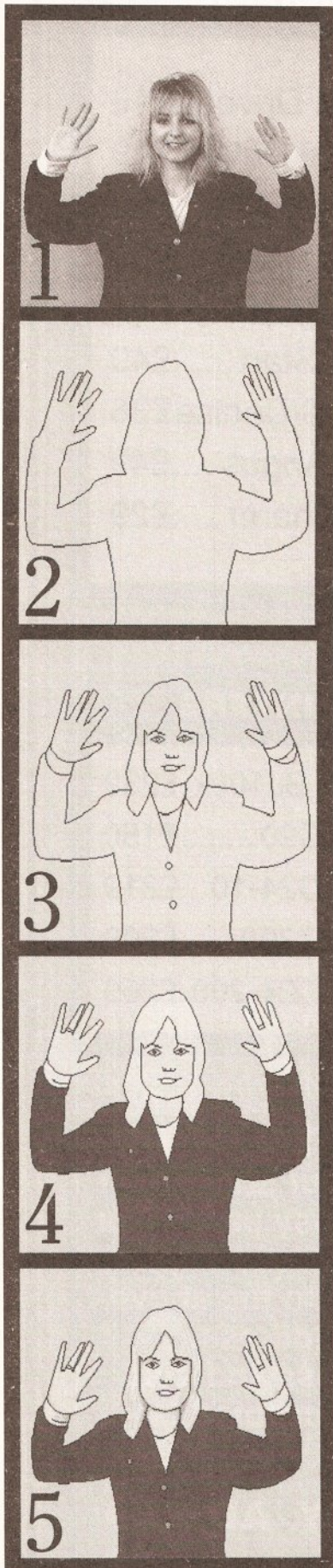

Who would have thought it? Such a simple idea, so easy to use and such effective results. The Tracey is ideal for budding Botticellis or modern day Monets

The Tracey supplied with this month's issue of *Amiga Shopper* is a superbly simple, yet effective, tracing tool (hence the name) which is ideally suited to graphics and especially animation. If you're the kind of person who has about as much artistic talent as a half-eaten bag of salt and vinegar crisps then you'll find Tracey a real godsend.

Fitting Tracey to your mouse is such a simple task that even your grandmother could do it with one arm tied behind her back. Supplied with your Tracey is a set of velcro pads which are used to stick Tracey to the side of your mouse whilst still allowing you to remove it between sessions with *DPaint*. If you're right-handed, then stick Tracey on the left-hand side of your mouse. If you're left-handed, then you'll probably want to attach Tracey to the opposite side of your mouse.

Before you can start tracing away, you must first alter the sensitivity of your mouse pointer using the Preferences program on your Workbench.

If you've got a 2.0-based Amiga, then boot up the Preferences program 'Input' and select a mouse speed setting of '4'. For 1.3-based Amigas, you'll find the necessary setting in the first screen of the main Preferences program. Either way, this should result in a much slower mouse pointer.

Once all this is done, your Tracey

will have been successfully installed (now that didn't hurt a bit, did it?). Now let's get down to some serious tracing...

1. Here's the image that we're going to trace in all its beauty. Before you start tracing though, it's important to ensure that the image will fit on to your computer screen. To do this, boot up your paint package (we'll assume you're using *Deluxe Paint* from now on) and move the mouse pointer so that it sits in the centre of the screen.

Now pick up your mouse and place it on to the image which you intend to trace so that Tracey's crosshairs are in the centre of the image. Now move the mouse across to the far right of the image and then to the far left. Does it fit? If so, then do a similar check for the vertical height of the image.

If the image doesn't fit, then you could try reducing the image using a photocopier. Most public libraries have photocopiers these days, so there's no excuse for giving up at this early stage.

2. Tracing in a complex image like the photograph of Diana Taylor, our layout-sub, (*all fan mail to the usual address, but she does have a rather large boyfriend - Ed*), is a real test of anyone's artistic talents; so it's always best to start by getting the general shape first. So, before you even start to think about adding detail, it's a good idea to trace

around the boundaries of the image to form an outline.

Once you've got your outline, adding details will become considerably easier.

Getting used to Tracey can take some time but you'll find things a lot easier if you follow a couple of very simple rules. Always keep the mouse in contact with the image when tracing and try to keep the mouse pointing directly forwards at all times. If you don't, your traced image will come out looking a bit strange to say the least! A steady hand would come in handy too!

3. Once we've got our basic outline, we can start to add in some detail. Once again though, don't try to be too adventurous - as long as the image is recognisable and you can see what goes where, then this is good enough. Once this is completed, you can add in more minute detail by eye.

4. The outline is there - all that now remains is to start adding colour. At this stage we're not too fussed about such things as shading, so just add in basic colour using *DPaint*'s 'Flood' tool.

Once all the individual sections have been coloured in, you'll have a sort of "posterised" version of the final image. If you've got a lot of frames to draw, you could quite easily stop here, but your animation will look rather flat, so it's time to start adding in the real detail...

5. Now for the time consuming bit that unfortunately requires just a little bit of artistic talent. As you can see, we've made our traced image look rather more human by adding in a bit of subtle shading to break up what was a rather flat image.

Completing a single frame for your animation will take time, so don't give up after the second or third. Just think, once all your frames are drawn, you'll have an animation to be proud of! For more tips, see our feature on page 18... **AS**

POWER COMPUTING

Power Scanner v2.0



Features

100-400 DPI scanning resolutions
64 Greyscales
Thru'port for printer

Software

Full screen image editor
Interlace mode on/off
Edit true greyscale & colour images
Fully multi-tasking

Editing

Cut rectangle, cut lasso, crop, flip,
rotate, scale, draw, lines, circles,
boxes ellipses, freehand, zoom mode

Scanning

Unique 'True feel' real time scan
mode - Know instantly if you are
scanning the image too quickly
Automatic selection of 100-400 DPI
Produce true greyscale images



Actual Amiga Screen Shots

£99 inc. VAT **£239** inc. VAT
GREYSCALE COLOUR

PC880B Power Drive



£69.95

Viruses, diskswapping, clicking drives,
disks which won't back up. Is there no
end to the whingeing of the Amiga
user?

At Power, we want to tell you just
where you can stick your disks and
worries. In fact we will show you. The
slot in this picture belongs to our
PC880B, the first intelligent disk
drive. Insert a disk.

Now you can back up at lightning
speeds using the inbuilt Blitz Amiga
hardware*, with free software, (even
if the disk is Atari or PC) and if your
computer has a virus the PC880B will
stop it being written to the bootblock
of any of your drives, though you can
still save files as normal.

When you do not want these features,
switch them off and the PC880B will
sit quietly, without clicking,
pretending to be simply an extra drive.

The PC880B, the only drive to
introduce Blitz Amiga, the Power
anti-click device and to combat
viruses, is only available direct from
Power, priced at just **£69.95**

We have noticed how pricey unintell-
igent drives are. Perhaps, it's your
turn to tell people where to stick it.

* Due to the precision nature of the Blitz copier high
density disks may be required with some internal
drives.

Dual Drive

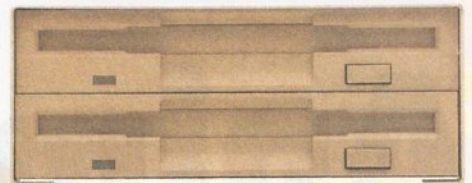

£125

Our latest dual drive uses the slimline,
ultra low power NEC drive
mechanism. This drive takes less than
half the power of a normal floppy
drive. The new dual drive includes all
the features you would expect from a
Power Computing Drive.

The NEC drive mechanism is able to
access high density 1.44MB disks.
While this may not be of use to you at
the moment (the Amiga can only
access 880K), watch this space for our
new 'high density' Interface, on the
market soon!

Whisper quiet operation

Blitz Copier built-in (switchable)

Virus blocker built-in (switchable)

Anti-click

PSU included

New Products

Released or available soon
8MB board with thru'port
1.44MB interface
1.44MB disk drive
Scanner software upgrade
PC880B with X-Copy
Power Scanner v2.0

Name

Address

Postcode

Telephone No.

System owned

Description

Credit card No.

Expiry date

I enclose a cheque/postal order for
£

Signature

Make cheques payable to Power Computing Ltd

Power Computing Ltd

Unit 8 Railton Road

Woburn Road Industrial Estate

Kempston Bedford MK42 7PN

Ring your credit card order through

on **0234 843388** or fax your order on

0234 840234

All prices include VAT, delivery and are subject to change. Specifications are subject to change without notice. Next day delivery £4.50 (U.K. mainland only), all trademarks acknowledged.

If you followed our beginner's guide to graphics in issue 10, the next step forward for you could well be animation. So if you long to produce the kind of animation which would put Walt Disney to shame, this feature is for you...

Animation made

When the hardware engineers at Los Gatos-based Amiga Inc started work on their Lorraine games console, the fore-runner of the machine we now know and love, they prepared the machine with the future in mind. Back in those days, such things as Desktop Video and computer-based animation were nothing more than silicon dreams, but Jay Miner and his team of engineers were forward-thinking enough to produce a machine that eventually developed into the all singing and dancing Amigas we have today.

One area to which the Amiga is particularly well suited is that of animation. Thanks to the Amiga's powerful graphics hardware and its ultra-fast blitter chip which allows large sections of screen to be moved around almost instantaneously, animators worldwide have taken the Amiga on board.

Computers such as the Amiga are being used increasingly more for professional animation in films and cartoons. Little more than a few years back, animators had to draw and then paint every frame by hand. However, since the advent of powerful computer systems boasting very fast and colourful high-resolution screen displays, animators have swapped their paint brushes for the mouse and touch tablet.

Even such great names as the Walt Disney Studios in the USA use Amigas extensively for training purposes. There have also been many examples of the Amiga being used in blockbuster feature films. Take *RoboCop 2*, for example. The Amiga was used almost exclusively to produce the computerised face of 'Nuke' lord Kane, a drug-crazed killer whose brain was implanted into a deadly robot.

The animation of Kane's computerised face in *RoboCop 2* was produced on an Amiga running

Sculpt 4D and there are many other sequences in the film which were only made possible thanks to the Amiga.

AMIGA MOVIES

The kind of complex animations which we see in cartoons and feature films take many, many hours to produce, but it is possible to achieve similar results on your Amiga in a fraction of the time. Better still, you don't even have to be a particularly talented artist to produce some quite acceptable results. With a little bit of know-how and a few tricks of the trade tucked up your sleeve, you too could well be

the next Eric Schwartz.

So what do you need to get started? Well, an Amiga equipped with some extra RAM would certainly be a good place to start. Whilst you can produce animations on a machine with just a megabyte of memory, you'll soon start to feel rather held back and you'll almost certainly run out of memory once you start to work on larger projects. If you can afford it, then treat yourself to at least 2Mb of extra RAM. This will give you a much more usable system.

A hard drive is also a worthwhile

investment. Because you'll be working with a large number of individual frames, storing all these files on to floppy disk will soon become very laborious. Not only that, but animation files can be rather large, so the faster speed of operation which a hard drive offers can save you a lot of time, time which would have previously been wasted waiting for your diskdrive to load a file.

DRAWING FRAMES

In the world of professional animation, each and every frame that makes up the animation must be drawn and then painstakingly painted by hand.

These days most animators use computers but the techniques involved have remained relatively unchanged. For every second of animation, the animator must draw 25 individual frames. Technically 50 frames (or 60 for NTSC television systems) are needed for every second of motion, but this is cut in half using a technique called 'Frame Doubling' whereby each frame is played twice before moving on to the next one.

As you can probably already start to appreciate, drawing all the frames required for even a short animation sequence can take a very long time. After all, if 25 frames are needed for every second of motion, you'd need 250 frames for just 10 seconds of animation. That amounts to a lot of drawing!

There are ways of cutting down on the number of frames you need though. One method is to use some frames over and over again by increasing the number of times that the frame is repeated before moving on to the next. If you think about it, if the character or object that you are animating stops moving for a couple of frames, why draw a series of

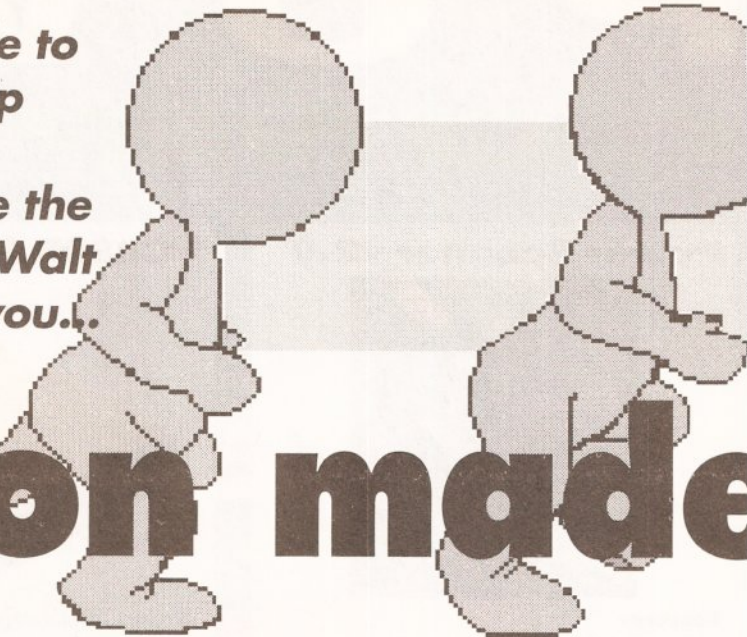

BEGINNERS

HOW DOES ANIMATION WORK?

Most of us have tried our hand at animation at one time or another. When you were at school, perhaps you remember drawing a series of tiny pictures on the corners of pages? By making each picture progressively different and flipping the pages, the illusion of movement was created. Most of us treated this as an ideal way to while away a boring lesson, but it's actually a great demonstration of the theory behind animation.

Just like our text book doodles, animations are nothing more than a series of static frames. They're pretty useless on their own, but flip through them rapidly and the human brain can be fooled into seeing motion. This is exactly the same technique used for traditional movies. You may well think that *Terminator 2* was just one continuous recording, but Arnie's antics were really nothing



BEGINNERS START HERE

BEGINNERS

more than hundreds of thousands of

static images. Obviously the cameraman didn't shoot every frame individually, but the technique used to reproduce the live action is exactly the same as an animation.

WHAT IS ROTOSCOPING?

Pioneered by Max Fleischer, the creator of Betty Boop and Popeye the Sailor, Rotoscoping is a technique whereby the movement of animated characters is based around real life actors who act out what the characters should do, therefore making the task of making a life-like animation a faster and easier proposition.

Rotoscoping has been used extensively in animated feature films such as Walt Disney's *Snow White and the Seven Dwarves*, JRR Tolkien's *Lord of the Rings* (a film which possibly demonstrates the technique best) and Fleischer's own *Gulliver's Travels*.

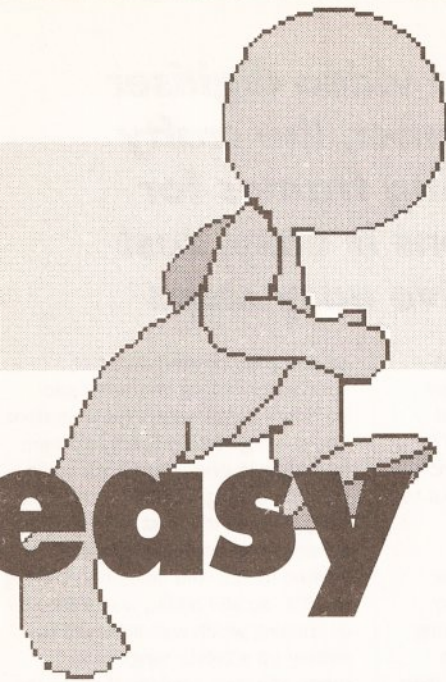

frames which are virtually identical? Instead, you can save yourself a lot of time by only drawing frames which portray motion – if the character in your animation starts to walk, falls over or gets blown up by Semtex, for example. If the object then stops moving for a few frames (or, in the case of the Semtex, has been blown into smithereens), you can just repeat the last frame in the sequence over and over again until the character starts to move again.

Sounds like common sense, but you'd be surprised just how many people waste time drawing each and every frame from scratch!

One of the most difficult aspects of animation is not the actual

process of pulling frames together, but that of drawing the frames in the first place. Even the most talented Amiga artist would probably be hard

look rather useless, but you'll soon come to realise that this rather unobtrusive little piece of plastic is one of the most useful animation tools that you're ever likely to own.

Tracey can be used in a number of ways. If you don't feel too comfortable with a mouse and would rather sketch out your frames in the time honoured fashion with pencil and paper, then Tracey can be used to accurately trace your sketches into your Amiga using just about any paint package. (If you're still at a loss as to how to use this little device, turn to page 16, where we've come up with a short tutorial to help you bring photos to life with a little help from Tracey).

Another very useful addition to any animation set up is a video digitiser or even a hand scanner. Video digitisers are particularly useful because they can be used to grab action from the real world which can then be used as the basis for your animation. Let's say, for

example, that you wanted your character to walk across the screen. Unless you feel confident enough to draw the frames yourself, you could cheat by simply pointing a video camera at your best friend and then grabbing a series of digitised stills which show how people walk in real life. These could then be turned into a true animation using a technique called Rotoscoping. (Want to know more, just turn the page for a full tutorial on this technique?).

Over the next few pages we'll be showing you just how to put these techniques to work to produce an animation. Don't worry if you think you're about as artistic as the average monkey – follow the tutorials on rotoscoping, animated brushes and merging the frames and I think you'll be amazed just how easy it is to get started in animation.

continued overleaf



Animations are part and parcel of games, but how many of you knew that the humble Amiga was responsible for animated sequences in the blockbusting film, Robocop 2

pushed to create a lifelike animation.

Included on the cover of this month's issue of *Amiga Shopper* is a very useful little gadget from SideWise Ltd called Tracey. It may

ERIC SCHWARTZ

One of the most famous Amiga animators has to be 20-year old Eric Schwartz, a student of art and illustration at the Columbus College of Art and Science in Ohio USA. Famous for his Aerotoons and Anti-Lemmings demos and several others featuring the antics of a certain female squirrel called Amy, Eric works exclusively on the Amiga producing animations in his spare time.

Eric spends between one and five weeks on each animation depending upon its complexity. Anyone who has monitored the works of Schwartz will probably already have noticed that Eric's animations are becoming progressively more complex and demanding, requiring more and more RAM just to run them. Most of his early work ran

on a 512k machine, but Eric's animations have become so complex that many of his more recent works require at least 2Mb just to run. His latest production, *Amy vs Walker 2*, requires at least 3Mb!

Eric has produced over 30 animations over the past couple of years using a variety of software packages running on a hard disk-based Amiga 2000 with just 3Mb of RAM. At the moment, Eric uses Electronic Arts' *Deluxe Paint 3* and *4* to draw all the frames of his animation by hand. Once all the frames have been drawn, these are then pulled together to form the final animation complete with sampled sound effects using Gold Disk's rather ageing *MovieSetter* package.

Eric has already produced several animations under commission for several US-based software houses and it seems certain that we'll be seeing a lot more from Schwartz in the future. In the

meantime, why not check out Eric's work for yourself? They're available from most public domain libraries including Seventeen Bit Software who can be contacted on 0924 366982.



Amy the Squirrel, star of many Schwartz animations. Follow our tutorials, and maybe you'll be the next animation whizz-kid

ROTOSCOPING

If you've got a video digitiser or a hand scanner, the crafty trick of grabbing frames for your animations is easy. Just follow these five easy steps

Drawing frames completely from scratch can take an absolute eternity (even with Tracey to help things along!), but there are far easier and considerably quicker ways of achieving the same ends. If you're lucky enough to own a video digitiser or even a hand scanner, you can use these very handy devices for animation work.

Say, for example, you wanted to produce an animation of a cartoon character walking across the screen. As you will probably already know, drawing such an animation by hand is by no means a simple task, but plug in a digitiser, rig up your video camera and it becomes an absolute breeze. Instead of drawing the frames yourself, you could digitise yourself walking and then use the sequence of digitised frames that you have as a guide for your cartoon character, therefore

"Rotoscoping is used within the film and TV industry to produce lifelike animations."

ensuring that he walks convincingly. This technique is called 'Rotoscoping' and is used extensively by non-animators within the film, TV and even Amiga games industry to produce life-like animations.

Using a realtime digitiser like VidiAmiga makes the process of producing frames for an animation so much easier simply because you can act out what you want your animated characters to do in front of a camera, safe in the knowledge that your characters will walk, talk and act in a lifelike manner. Read on and I'll show you how it is done.

1. First we start with a digitised frame. In this particular case, the very handsome chap that I digitised – ok, it's me! – (send all fan mail to "You lying barst!" – Ed) was grabbed

using VidiAmiga and the Vidi RGB colour splitter connected up to my trusty Philips Camcorder. Several frames we grabbed into memory to form the short animation sequence that I required and then saved out to disk for editing.

2. Once again, we load up *Deluxe Paint* which is used exclusively to prepare the frame. If you're working with 16 colour grey scale images such as those produced by Vidi, then boot up *DPaint* in 32 colours. Although the image itself doesn't use the extra 16 colours we now have at our disposal, they're going to come in very handy later on.

Now we need to draw an outline around the digitised image. Before we can do this though, we need a highly contrasting colour which won't blend in with any of the colours used within the digitised image. I used a nice shade of yellow (although unfortunately you can't see that here) simply because it stands out well against the grey scale backdrop image.

Pick one of the spare sixteen colours and then draw an outline around the digitised image so that all the main detailing within the image is shown.

3. Now we have our outline, we no longer need the digitised image so it can therefore be removed. This is achieved by setting up a Stencil within *DPaint* with the only colour marked being the colour that we used to draw the outline. Once the stencil has been defined, click on the 'CLR' gadget within the *DPaint* toolbar and the digitised image will be removed leaving our outline in place. The stencil can now be turned off.

4. After changing the colour of the outline to black, the next step is to add in some basic colour using the *DPaint* fill tool just like we do with the picture of Diana we trace in overleaf. Once again, it's not important to add in too much detail at this stage as long as it is quite obvious what the image is supposed to be.

5. The final stage in the preparation of our first frame is to add in a little detail. The animation sequence that I produced using the image you see

on this page needed a sort of Terminator-looking character and therefore detail wasn't too important. You could go totally overboard here by adding in every detail, but you'd end up painting frames for the next two years, so it's best to keep things as simple as possible. Obviously I wanted to stop the animation looking too flat, so all I added was a little bit of shading which was achieved by setting up a colour range of skin tones and then applying them to the image using the *DPaint* 'Smooth' operator.

We now have a cartoon-like image which looks very life-like indeed thanks to our original digitised image. You could just use the digitised images that you grabbed as they are, but you can let your imagination run wild using rotoscoping.

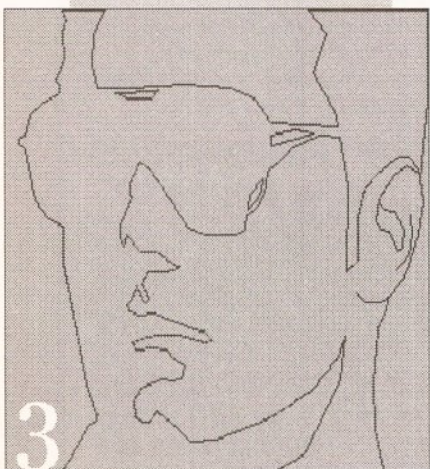
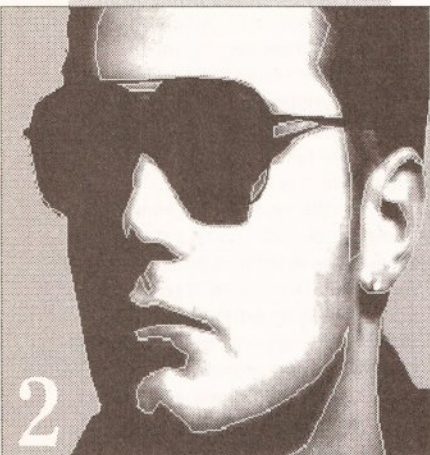
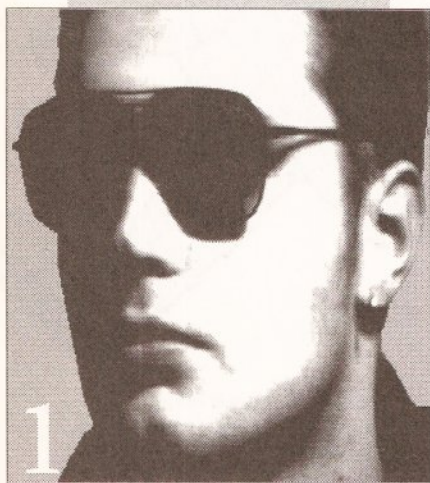

ANIMATED BRUSHES

If your frame drawing talents won't even stretch to Rotoscoping, DPaint has a few clever tricks up its sleeve...

Drawing each and every frame for even the simplest of animations can be a very time consuming task, but good old *DPaint 3* has a few tricks up its sleeve which will take this laborious task away from you almost completely. By taking advantage of its powerful brush animation facilities, very complex animations can be built up from just a single hand drawn frame.

For example, say you wanted to produce an animation of a car moving from one side of the screen to the other. Under normal circumstances, you'd have to draw all the necessary frames yourself, but *DPaint* allows you to cheat using its very powerful AnimBrush and BrushMove facilities. By simply

defining a single brush and telling *DPaint* where you wish the brush to move to on the screen, it'll automatically generate all the frames for you. Let's put our example to the test.

1. First of all we need a picture of a car. It's best to draw one by hand, but if your artistic talents couldn't even handle this, then a digitised image will do the job perfectly well as long as it is a side on view.

2. To make things a little harder, the car illustrated has 4-spoke alloy wheels. If we just picked up this car and moved it from one side of the screen to the other, it would look very naff indeed simply because the wheels wouldn't appear to turn.

To make them turn, we must first cut out one of the wheels as a brush and then clear the screen (make sure you've saved the car first!). Now go up the Anim->Frames menu and select Set #... and then type in the number

of frames that the wheel will rotate in. Now paste the brush down onto the screen, pick it up again as a brush (*DPaint* requires you to do this so it knows where to start drawing) and then Select the Move option from the Anim menu. Because the wheel is completely symetrical, we only need to rotate it -90 degrees, so enter this into the Z Angle box. *DPaint* will automatically draw the animation across 10 frames, so click on the DRAW gadget and *DPaint* will do its stuff.

3. Once the frames have been drawn, we need to pick the rotating wheel up as a brush. This is done by selecting Pick Up from the Anim->Anim Brush menu. You now have an anim brush of a rotating wheel.

4. Load your original car image back in and then proceed to paste each

frame of the rotating wheel on to the wheels of the car, advancing one frame each time by pressing the 2 key on the Amiga keyboard. Don't forget to do this for the front and back wheels.

5. Press 4 and you should see a perfect animation of the wheels turning on your car. Good, eh?

6. Now we need to make the car move from one side of the screen to the other. Once again, we need an anim brush, but this time we need to pick up the entire car. Pick up the car using the same procedure detailed in step 3. Once you've done this, clear all frames by clicking on the CLR gadget.

7. Because we want the car to be partly obscured when it first appears, we need to change the brush handle position. Select Place from the Brush->Brush Handle menu and then press the left mouse button and drag the onscreen crosshair until the mouse pointer is near the

front of the car. Let go of the left mouse button and the operation will be complete.

8. Now we have our anim brush car, we need to increase the number of frames that the animation will fill up. So, using the same

technique detailed in step 2, increase the number of frames to 25. Making sure that you're on frame 1 (the frame counter in the top left hand corner of the screen will tell you this, paste the car down in the right hand side of the screen so that only the bonnet is showing.

9. Go up to the Anim menu and select Move again. Clear the -90 value we entered into the Z Angle box and enter -400 into the X Dist box. You'll also have to change the Frame Count box so that it reads 25 instead of 10. Click on Draw and the frames will be rendered.

10. We now have our completed animation! Press key 4 to view it in all its animated glory!

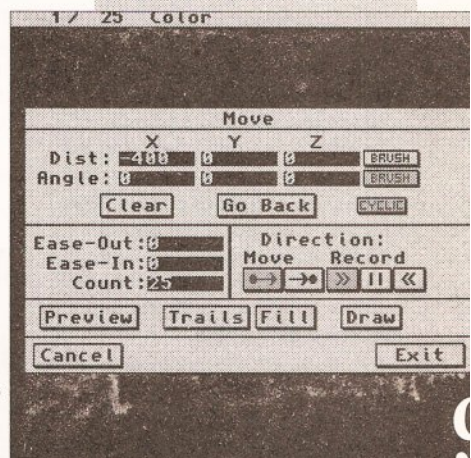
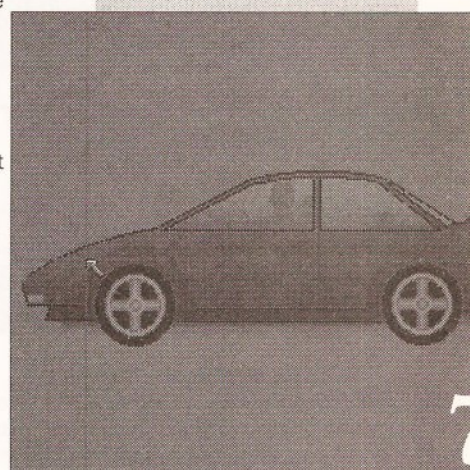
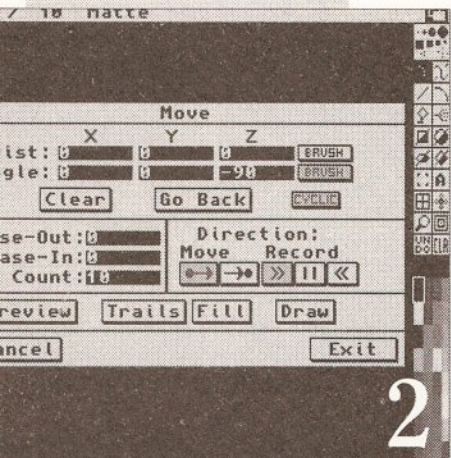
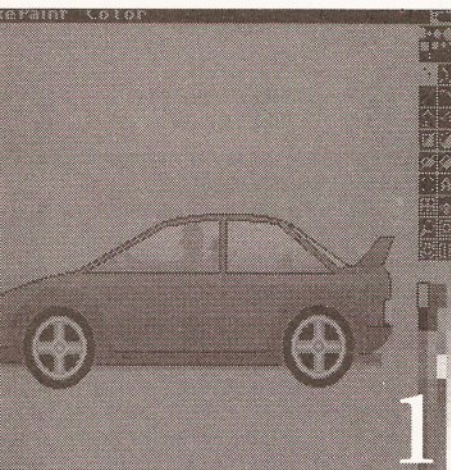
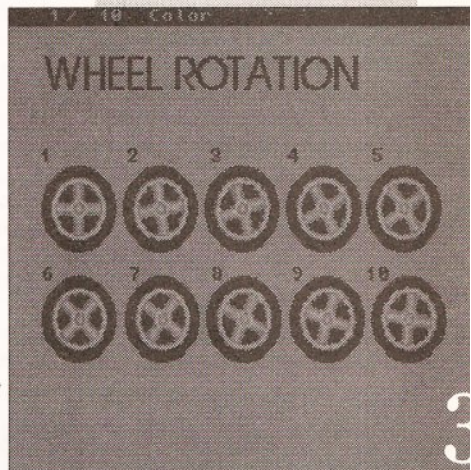

"...complex animations can be built up from a single hand drawn frame."

AND FINALLY...

Once you've got your frames, all that remains is to pull them all together to form an animation. Jason Holborn brings still shots to life

Once the very time consuming task of drawing all those frames is complete, all that remains is to merge them all together in the correct format to produce your animation.

Quite a few packages are available both commercially and in the public domain that will allow you to do this, but by far the simplest and undoubtedly the most commonly used package is *Deluxe Paint 3* (or 4). If you've recently bought yourself either an A500 Plus, an Amiga 1500 or even an Amiga 3000, then you'll already own this superb piece of animation and paint software.

2. Now that the correct number of frames have been allocated, we can now start to load in our frames.

It's well worth devising some form of filename convention when you're drawing your frames so that you know instantly in which order the frames should run. If you don't do this, you'll waste a lot of time loading up frames which you don't need before you find the correct frame. Worse still, you could end up with frames being placed in the wrong position within your animation.

A much better bet is to number each frame as it is drawn. You could, for example, call the first frame

'FRAME1.IFF' and then save the next as 'FRAME2.IFF' and so on. This way, you'll be in no doubt whatsoever which frames are which.

This brings us neatly on to another point which you must consider when drawing frames – always stick to the same colour palette for all frames.

Despite the fact that animations consist of many different frames, they must all share a common colour palette. If you start changing colours halfway through an animation, programs such as *DPaint* will think that the colour palette for the entire animation should be taken from the last frame that you loaded. As a rule, choose a colour palette and *stick to it!*

Before you start to load any frames, check to make sure that you're on frame 1. You can tell this

at a glance by reading the value of the frame counter which is on the left hand side of the menu bar. If everything is ok, you can load your first frame.

3. Once the first frame has been loaded, press key '2' on your Amiga keyboard. This will advance you forward by one frame.

If everything is going ok, the screen should clear. Don't worry – this is just *DPaint's* way of telling you that you've moved on to a clear frame. Load up the next frame and then repeat this process until all the frames for your animation have been loaded.

4. Now for the fun bit – it's time to test your animation. To replay your animation, press key '4' on your Amiga keyboard and your animation should spring to life.

If it's going too fast, you can slow down the speed at which *DPaint* replays animations by selecting the 'Set Rate' option from the Anim->Control pull down menu. By default, *DPaint* plays animations at 30 frames per second, so just change this figure to a lower value to slow things down a bit.

Well, there you go, pictures in motion at last. If you're not happy, keep practising for next month, when we're going to add music to the motion. **AS**

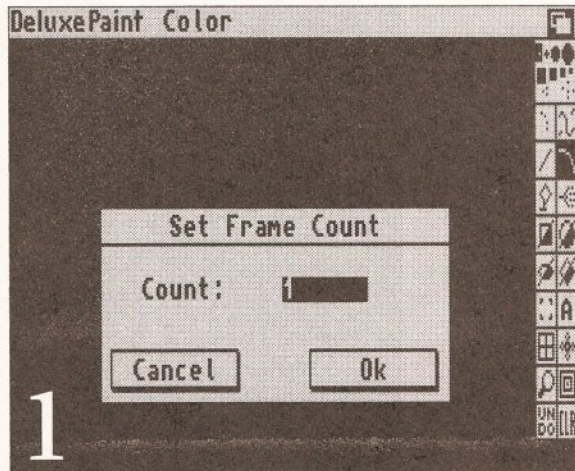

We'll assume that you are using *DPaint* for the sake of this tutorial. If you aren't, then just check in the manual for your program's equivalent commands. Anyway, let's get on with the serious task of breathing life into your animation...

1. Upon loading *DPaint*, the first thing you must do is to tell the program how many frames your animation uses. This is achieved by selecting the 'Set #...' option in the Anim->Frames pull down menu. Once selected, a requester will appear containing just a single text field. Just enter the number of frames that you'll need, press <RETURN> and *DPaint* will do the rest.

If you've got the menu bar activated, you'll notice that in the top left hand corner an extra display will be shown which tells you which frame is presently being displayed. This will come in particularly handy once we start to load in frames.

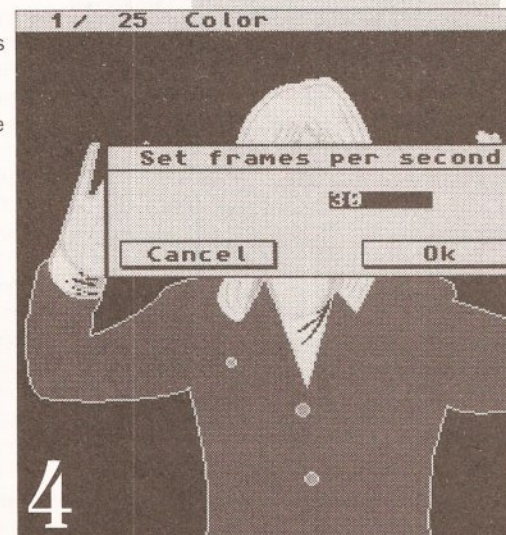
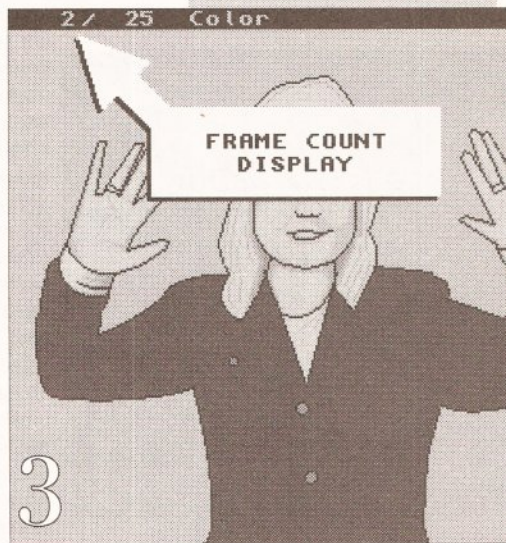
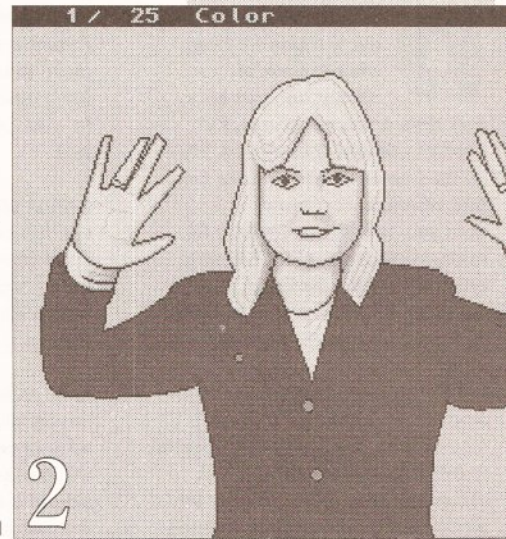

NEXT MONTH • NEXT MONTH

As well as a detailed look at the various animation packages available for the Amiga, we'll be taking our animation one step further with the addition of sound effects and music. In the meantime though, have fun with your new animation skills and don't forget to remember us when you get that top job at Disney!

FREE

BRITAIN'S No1 Sound Sampling System "EVERY AMIGA OWNER SHOULD HAVE IT" - Amiga Format



TECHNOSOUND

Worth £39.99 - FREE when you purchase any one of the following:



- ROMBO**
- Complete Colour Solution ..£149.99
 - Vidi Amiga£119.99
 - RGB Colour Splitter.....£79.95
 - Take 2 Animation£99.95

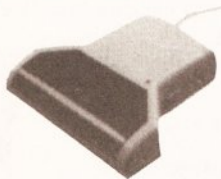

DAaTA SCAN Pro GS V2.02
Pandaal hand scanner with latest greyscale software £129.99

£7 OFF TECHNOSOUND TURBO WHEN PURCHASED SEPARATELY
RRP £39.99 £32.99 (INCLUDES AUDIO LEADS)

FIRECREST DISTRIBUTION
119 UNDERHILL CRESCENT,
ABERGAVENTNY, GWENT NP7 6DU.
TEL (0873) 850028

ADD £2.00 P&P



Switchable voice/fax line

0983 551496

Open 10am-7pm
 Monday to Saturday



| | | | |
|--------------------------------------------------------------------------------------------------------------------------------------------------------------------------------------------------------------------------------------------------------------------------------------------------------------------------------------------------------------------------------------------------------------------------------------------------------------------------------------------------------------------------------------------------------------------------------------------------------------------------------------------------------------------------------------------------------------------------------------------------------------------------------------------------------------------------------------------------------------------------------------------------------------------------------------------------------------------------------------------------------------------------------------------------------------------------------------------------------------------------------------------------------------------------------------------------------------------------------------------------------------------------------------------------------------------------------------------------------------------------------------------------------------------------------------------------------------------------------------------------------------------------------------------------------------------------------------------------------------------------------------------------------------------------------------------------------------------------------------------------------------------------------------------------------------------------------------------------------------------------------------------------------------------------------------------------------------------------------------------------------------------------------------------------------------------------------------------------------------------------------------------------------------------------------------------------------------------------------------------------------------------------------------------------|----------------------------------------------------------------------------------------------------------------------------------------------------------------------------------------------------------------------------------------------------------------------------------------------------------------------------------------------------------------------------------------------------------------------------------------------------------------------------------------------------------------------------------------------------------------------------------------------------------------------------------------------------------------------------------------------------------------------------------------------------------------------------------------------------------------------------------------------------------------------------------------------------------------------------------------------------------------------------------------------------------------------------------------------------------------------------------------------------------------------------------------------------------------------------------------------------------------------------------------------------------------------------------------------------------------------------------------------------------------------------------------------------------------------------------------------------------------------------------------------------------------------------------------------------------------------------------------------------------------------------------------------------------------------------------------------------------------------------------------------------------------------------------------------------------------------------------------------------------------------------------------------------------------------------------------------------------------------------------------------------------------------------|-------------------------------------------------------------------------------------------------------------------------------------------------------------------------------------------------------------------------------------------------------------------------------------------------------------------------------------------------------------------------------------------------------------------------------------------------------------------------------------------------------------------------------------------------------------------------------------------------------------------------------------------------------------------------------------------------------------------------------------------------------------------------------------------------------------------------------------------------------------------------------------------------------------------------------------------------------------------------------------------------------------------------------------------------------------------------------------------------------------------------------------------------------------------------------------------------------------------------------------------------------------------------------------------------------------------------------------------------------------------------------------------------------------------------------------------------------------------------------------------------------------------------------------------------------------------------|---------------------------------------------------------------------------------------------------------------------------------------------------------------------------------------------------------------------------------------------------------------------------------------------------------------------------------------------------------------------------------------------------------------------------------------------------------------------------------------------------------------------------------------------------------------------------------------------------------------------------------------------------------------------------------------------------------------------------------------------------------------------------------------------------------------------------------------------------------------------------------------------------------------------------------------------------------------------------------------------------------------------------------------------------------------------------------------------------------------------------------------------------------------------------------------------------------------------------------------------------------------------------------------------------------------------------------------------------------------------------------------------------------------------------------------------------------------------------------------------------------------------------------------------------------------------------------------|
| <p>ACCOUNTS</p> <p>Arena Integrated Ac.....99.64</p> <p>Cashbook Controller.....37.60</p> <p>Cashbook Combination...54.99</p> <p>EasyLedgers.....153.46</p> <p>Home Accounts Bundled.19.74</p> <p>Home Accounts 2.....39.95</p> <p>Personal Finance Mgr.....25.85</p> <p>System 3 Integrated.....39.95</p> <p>BOOKS 40 Lines Stocked</p> <p>68000 Asm Lan Prgrm.21.95</p> <p>Assembly Lang Prgrm.14.95</p> <p>Amiga Basic In/Out.....18.95</p> <p>Amiga C Beginners.....18.45</p> <p>Amiga For Beginners...15.95</p> <p>AmigaDOS 2 Companion 23.45</p> <p>AmigaDOS Inside/Out.18.45</p> <p>CBM ROM Kr Incs & Docs.99.95</p> <p>CBM Hardware RI Mnl.....21.95</p> <p>CBM ROM Kr Libraries..29.95</p> <p>CBM ROM Kr Devices.....29.95</p> <p>CBM Service M1 A500 14.95</p> <p>CBM Schem. A2000/6.14.95</p> <p>CBM AmigaDOS Manual.21.95</p> <p>Kids And The Amiga...14.95</p> <p>Using AReXX on Amiga.29.95</p> <p>CABLES 100 Lines Stocked</p> <p>D23S/2Ph-Scart Mon.....11.75</p> <p>D23S-D155 NEC MS 3D.14.10</p> <p>D25P-C36P 2M Printer.....6.58</p> <p>D25P-D25P 25W 2M.....13.16</p> <p>D25P-D25P 9W 2M Mod.11.28</p> <p>DINSP-DINSP MIDI.....5.17</p> <p>Gender Changers.....7.99</p> <p>Null Modem Cable 2M.....11.75</p> <p>Null Modem Cable 5M.....15.98</p> <p>Null Modem Cable 10M.....18.80</p> <p>Socket D23S & Hood.....5.17</p> <p>Switch Box D25S x 2.....19.74</p> <p>COMMUNICATIONS</p> <p>Comms PD (2 Disks).....4.70</p> <p>COMPUTER AIDED DESIGN</p> <p>Design Works.....59.69</p> <p>Professional Draw 2.....89.77</p> <p>DATABASE MANAGERS</p> <p>InfoFile.....46.06</p> <p>Mailshot Plus.....39.01</p> <p>Prodta 1.2x.....66.56</p> <p>Superbase Personal.....26.79</p> <p>Superbase Personal 2.....34.78</p> <p>Superbase Pro 4.....189.88</p> <p>DESKTOP PUBLISHING</p> <p>AmigaTeX Typesetting...111.39</p> <p>AmigaTeX Drivers (1).....52.64</p> <p>Clip Art PD 15 disks.....29.61</p> <p>GDType: Publisher HD.....32.90</p> <p>GDType: Designer HD.....32.90</p> <p>GDType: Video HD.....32.90</p> <p>GDType: Decor. HD.....32.90</p> <p>Outline Fonts.....99.64</p> <p>PageSetter 2.....45.59</p> <p>pageStream 2.2.....169.67</p> <p>Pro Clips Str. Art.....23.97</p> <p>Pro Page 2.7 2Mb.....169.67</p> | <p>Saxon Publisher 2Mb.....199.75</p> <p>DUST COVERS 15 lines stocked</p> <p>Monitors 14" 1084/8833.....9.87</p> <p>Amiga 500.....7.99</p> <p>EDUCATION</p> <p>Maths Adventure.....24.91</p> <p>Mega Maths A Level.....24.44</p> <p>Micro English (GCSE).....23.97</p> <p>Micro French (GCSE).....23.97</p> <p>Micro Maths (GCSE).....23.97</p> <p>Money Matters UK <6.....19.74</p> <p>My Paint 2.....24.91</p> <p>Picture Book <8.....19.74</p> <p>Primary Maths.....24.44</p> <p>EDITORS</p> <p>CygnusEd Pro 2.....59.69</p> <p>Turbo Text.....59.69</p> <p>GRAPHICS</p> <p>Animation Studio.....79.90</p> <p>Art Department Pro 2.....149.93</p> <p>DC TV Colour System.....479.87</p> <p>Deluxe Photolab.....56.40</p> <p>Deluxe Paint 3.....49.82</p> <p>Deluxe Paint 4.....64.86</p> <p>Deluxe Video 3.....69.56</p> <p>Digi Paint 3.....54.05</p> <p>Imagine 2.X.....209.62</p> <p>Pixmate.....39.95</p> <p>Real 3D Turbo 2Mb.....329.94</p> <p>Real 3D 1.3.....119.85</p> <p>Scene Maker.....Query</p> <p>Scene Generator.....35.72</p> <p>Scenary Animator.....69.56</p> <p>Sculpt Animate 4D 2Mb.337.23</p> <p>Sharp Colour Scanner.....549.90</p> <p>Vista Pro 3Mb.....79.90</p> <p>HARDWARE</p> <p>3.5" External Drive.....58.75</p> <p>3.5" Int A2000 Drive.....58.75</p> <p>512K A500 RAM/Clock.....29.61</p> <p>Amiga 1500 & Software.....579.98</p> <p>Amiga 1500 & 2 Drives.....519.82</p> <p>Amiga 1500 & 1 Drive.....489.74</p> <p>Amiga 3000 16/40.....Query</p> <p>Amiga Release 2 & ROM.84.77</p> <p>Chip CIA 6520.....14.57</p> <p>Chip ECS Denise.....39.95</p> <p>Chip A500 52Mb 0-8Mb.....369.89</p> <p>Chip A2000 52Mb 0-8Mb.....279.65</p> <p>GVP A2000 2-8Mb RAM.169.67</p> <p>GVP A500 120Mb 0-8Mb.559.77</p> <p>GVP 68030 22Mh 1-13Mb.539.56</p> <p>GVP A2000 120Mb 0-8Mb.449.79</p> <p>GVP 68030 50Mh 4-32Mb.1549.59</p> <p>Naksha Mouse & Game.....29.61</p> <p>Quantum 52Mb SCSI HD.199.75</p> <p>ROM Sharer.....23.97</p> | <p>SCSI HD Case & PSU.....119.85</p> <p>INTEGRATED PACKAGES</p> <p>Appelizer.....30.55</p> <p>Graphics Starter Kit.....56.40</p> <p>Office By Gold Disk.....69.56</p> <p>The Works Platinum.....69.56</p> <p>The Works Bundle.....39.95</p> <p>MULTIMEDIA</p> <p>Amiga/Vision (CBM).....95.88</p> <p>Hyperbook.....49.82</p> <p>PROGRAMMING</p> <p>AMOS Compiler.....24.91</p> <p>AMOS Creator.....34.78</p> <p>AReXX.....33.84</p> <p>CX Tools For AReXX.....74.87</p> <p>Devpac 2 Assembler.....43.71</p> <p>Devpac 3 Assembler.....54.99</p> <p>GFA Basic Compiler.....23.97</p> <p>GFA Basic Interp.....29.61</p> <p>HighSpeed Pascal.....79.90</p> <p>Lattice C 5.1.....159.80</p> <p>Power Windows.....59.69</p> <p>TurboPrint Pro.....9.87</p> <p>REBIBONS</p> <p>6 CBM MPS1230.....28.20</p> <p>6 CBM MPS1500.....33.84</p> <p>3 CBM MPS1500 Colour.36.66</p> <p>6 Citizen 120D.....19.74</p> <p>SOUND</p> <p>AudioMaster 4 s/w.....49.82</p> <p>Audition 4 s/w.....43.71</p> <p>Bars & Pipes Pro.....219.96</p> <p>Deluxe Music.....54.99</p> <p>GVP Sound Studio.....59.69</p> <p>MIDI Plug Interface.....25.38</p> <p>Music X Junior.....66.27</p> <p>Sequencer One.....74.73</p> <p>Sonix 2.....49.82</p> <p>Sound Enhancer.....39.95</p> <p>SoundMaster Sampler.....109.98</p> <p>Stereo Master Sampler.....34.78</p> <p>SuperJAMI Composer.....89.77</p> <p>SPREADSHEETS</p> <p>Advantage.....69.56</p> <p>DGCalc 312 x 52.....30.55</p> <p>Professional Calc.....149.93</p> <p>Superplan.....49.82</p> | <p>UTILITIES</p> <p>Ami-Back SCSI Backup.....49.82</p> <p>B.A.D. Optimiser.....34.78</p> <p>BBC Emulator.....35.72</p> <p>Byte 'N' Back.....19.74</p> <p>CrossDOS Transfer.....24.91</p> <p>Directory Manager.....29.61</p> <p>Directory Opus.....35.72</p> <p>Disk Master 2.....49.82</p> <p>Doctor Ami.....40.89</p> <p>GB Route Plus.....59.69</p> <p>Mavis Beacon Typing.....27.73</p> <p>Personal Fonts Maker.....49.82</p> <p>Quarterback Tools.....59.69</p> <p>TurboPrint Pro.....44.65</p> <p>X Copy Professional.....37.60</p> <p>Your Family Tree 2.....66.27</p> <p>VIDEO</p> <p>Broadcast Tiler.....184.01</p> <p>Digi View Grid 4.....109.98</p> <p>GD Fonts: Decor 1.....64.86</p> <p>Hitchai Camera/Lens.....204.45</p> <p>Home Tiler.....34.78</p> <p>Rendale 8802 Genlock.....189.88</p> <p>RockGen Genlock.....99.64</p> <p>Scala Presentations.....179.54</p> <p>Scala 500.....79.90</p> <p>ShowMaker.....179.54</p> <p>Video Director.....129.72</p> <p>Video Ease Tiler.....37.60</p> <p>Video Tiler.....84.60</p> <p>Vidi Complete Solution.....159.80</p> <p>WORDPROCESSORS</p> <p>Excellence 2.....69.56</p> <p>Final Copy WP/DTP.....79.90</p> <p>Kindwords 2.....36.66</p> <p>PenPal 1.3.....59.69</p> <p>Personal Write.....29.61</p> <p>Protect 4.3.....49.82</p> <p>Protect 5.5.....101.99</p> <p>ProWrite 3.7.....99.64</p> <p>QuickWrite.....39.95</p> <p>Scribble Platinum.....42.77</p> <p>TransWrite.....32.90</p> <p>WordPerfect.....189.88</p> <p>Wordworth.....87.89</p> <p><small>* Please check availability</small></p> |
|--------------------------------------------------------------------------------------------------------------------------------------------------------------------------------------------------------------------------------------------------------------------------------------------------------------------------------------------------------------------------------------------------------------------------------------------------------------------------------------------------------------------------------------------------------------------------------------------------------------------------------------------------------------------------------------------------------------------------------------------------------------------------------------------------------------------------------------------------------------------------------------------------------------------------------------------------------------------------------------------------------------------------------------------------------------------------------------------------------------------------------------------------------------------------------------------------------------------------------------------------------------------------------------------------------------------------------------------------------------------------------------------------------------------------------------------------------------------------------------------------------------------------------------------------------------------------------------------------------------------------------------------------------------------------------------------------------------------------------------------------------------------------------------------------------------------------------------------------------------------------------------------------------------------------------------------------------------------------------------------------------------------------------------------------------------------------------------------------------------------------------------------------------------------------------------------------------------------------------------------------------------------------------------------------|----------------------------------------------------------------------------------------------------------------------------------------------------------------------------------------------------------------------------------------------------------------------------------------------------------------------------------------------------------------------------------------------------------------------------------------------------------------------------------------------------------------------------------------------------------------------------------------------------------------------------------------------------------------------------------------------------------------------------------------------------------------------------------------------------------------------------------------------------------------------------------------------------------------------------------------------------------------------------------------------------------------------------------------------------------------------------------------------------------------------------------------------------------------------------------------------------------------------------------------------------------------------------------------------------------------------------------------------------------------------------------------------------------------------------------------------------------------------------------------------------------------------------------------------------------------------------------------------------------------------------------------------------------------------------------------------------------------------------------------------------------------------------------------------------------------------------------------------------------------------------------------------------------------------------------------------------------------------------------------------------------------------------|-------------------------------------------------------------------------------------------------------------------------------------------------------------------------------------------------------------------------------------------------------------------------------------------------------------------------------------------------------------------------------------------------------------------------------------------------------------------------------------------------------------------------------------------------------------------------------------------------------------------------------------------------------------------------------------------------------------------------------------------------------------------------------------------------------------------------------------------------------------------------------------------------------------------------------------------------------------------------------------------------------------------------------------------------------------------------------------------------------------------------------------------------------------------------------------------------------------------------------------------------------------------------------------------------------------------------------------------------------------------------------------------------------------------------------------------------------------------------------------------------------------------------------------------------------------------------|---------------------------------------------------------------------------------------------------------------------------------------------------------------------------------------------------------------------------------------------------------------------------------------------------------------------------------------------------------------------------------------------------------------------------------------------------------------------------------------------------------------------------------------------------------------------------------------------------------------------------------------------------------------------------------------------------------------------------------------------------------------------------------------------------------------------------------------------------------------------------------------------------------------------------------------------------------------------------------------------------------------------------------------------------------------------------------------------------------------------------------------------------------------------------------------------------------------------------------------------------------------------------------------------------------------------------------------------------------------------------------------------------------------------------------------------------------------------------------------------------------------------------------------------------------------------------------------|

Richard & Angela Howe: Applied Research Kernel Dept ASM, Corve Farmhouse, Corve Lane, Chale Green, Nr. Ventnor, PO38 2LA, U.K.

POST & PACKING (on items averaging less than 1kg):
 U.K. £0. Special Delivery £3.29, Securicor £9.87.
BPPO & CHANNEL ISLANDS £0. Special Delivery £3.29.
EUROPE £5 1st item + £3 for each additional item.
WORLD £15 1st item + £3 for each additional item.

CHEQUES London Sterling to A.R.K. Cheques may clear.
NORMAL DESPATCH Stock 24 hrs. Supplier 48 hrs.
EXPORT & BPPO Remove UK VAT (£1.175) (Not Books)
 V.A.T. Prices include V.A.T. Books are zero rated.
PRICES Are necessarily subject to change.
MEMORY Assume 1Mb RAM to load, unless stated.
 Visitors are always welcome by appointment

AUTHORISED DEALER FOR * AMIGA * STAR *

AMIGA (UK MODELS ONLY)

| | |
|-------------------------------------------------------------|------------------------|
| Amiga 2000 PLUS PVP Video Pack with 52Mb HDD, A2300 Genlock | £1049.00 |
| DPaint III and Scala Presentation Software | £539.00 |
| Amiga 1500 PLUS with KICKSTART 2/WB 2 & S/WARE | £579.00 |
| Amiga 1500 DOUBLE with 1.3 and 2.04 ROMs Mouse Switched | £149/£219/£289/£359.00 |
| Supra RAM 8Mb Board for A2000 Pop 2/4/6/8Mb | £149/£219/£289/£359.00 |
| Supra RAM 500RX 8Mb for A500/Plus Pop 2/4/8Mb | £149/£239/£419.00 |
| A500 PLUS Cartoon Classics Pack | £349.00 |
| A2086 XT/AT Bridgeboard | £119/£299 |

PRINTERS

| | |
|---------------------------------------|---------|
| Citizen 120D+ (C64 version available) | £125.00 |
| Star LC-20 | £135.00 |
| Star LC-200 Colour | £195.00 |
| Star LC24-10 | £179.00 |
| Star LC24-200 | £219.00 |
| Star LC24-200 Colour | £269.00 |
| Star XB24-200 24 pin Colour | £398.33 |
| Star StarJet SJ-48 Bubble Jet | £225.00 |

MONITORS

| | |
|-----------------------------------------------------|---------|
| Commodore 1084S Stereo Colour | £249.00 |
| Philips 8833-II Stereo Colour + On-site Maintenance | £239.00 |
| Goldstar TV/Monitor for Amiga with Remote Control | £179.00 |

MICROBOTICS 68030 ACCELERATORS

| | |
|-------------------------------------------|--------------|
| VXL-30 25MHz Without/With 25MHz 68881 FPU | £249/£319.00 |
| VXL-30 40MHz Without/With 25MHz 68881 FPU | £399/£469.00 |
| VXL-30 2Mb 32-bit RAM board for above | £199.00 |

DISK DRIVES

| | | |
|------------------------------------|--------|--------|
| Roolite Super Slim Amiga Ext. 3.5" | p&p £2 | £59.95 |
| A2000 Internal 3.5" | p&p £2 | £69.95 |
| A500 Replacement Internal 3.5" | p&p £2 | £59.95 |

MISCELLANEOUS

| | | |
|------------------------------------------|----------|---------|
| AlfaScan Plus Hand Scanner with Touch-up | p&p £2 | £159.00 |
| Commodore A2320 Display Enhancer | p&p £2 | £219.00 |
| KCS PC Board for A500 inc MSDOS 4.01 | p&p £2 | £199.00 |
| KCS PC Board for A500 without MSDOS | p&p £2 | £179.00 |
| KCS A2000 Adapter | p&p £1 | £69.95 |
| Alfa-Data Opto-Mechanical Mouse | free p&p | £19.95 |
| A500 512K RAM/Clock | free p&p | £25.99 |
| A500 Plus - 1Mb RAM Expansion | free p&p | £45.00 |
| Kickstart V1.3 ROM for A500/2000 | free p&p | £29.00 |
| CIA Chip 6520 | free p&p | £16.00 |

ALL PRICES INCLUDE 17.5% VAT. CARRIAGE £5 (EXPRESS £10)
 Prices subject to change without notice. E. & O. E.

Bargain Buys for Amigas

Supra WordSync 2000 Drives

| | |
|----------------------------------------|------|
| 52Mb Quantum LPS 11mS with 64Kb Cache | £239 |
| 105Mb Quantum LPS 11mS with 64Kb Cache | £379 |

Amiga 500 Hard Drives

| | |
|--------------------------------|------|
| GVP Series II HD8+ 52Mb (11mS) | £379 |
| SupraDrive 500XP 105Mb (11mS) | £399 |

(Both drives may be fitted with up to 8Mb RAM)

| | |
|--------------------------------|------|
| ICD Internal 52Mb Quantum LPS | £299 |
| ICD Internal 105Mb Quantum LPS | £459 |

(Replaces df0. External drive becomes df0)

Interquad Multiscan Monitor £329

0.28mm Dot Pitch Max Res 1024x768

Ideal for A500/A1500 PLUS Productivity Modes

Delta Pi ROM Sharer - MOUSE SWITCHED £19.99

OFFICIAL COMMODORE RELEASE 2.04 ROM UPGRADE £97

Includes Manual & Workbench, Extras, Fonts & A2091 Installation Disks

Delta Pi Software Ltd

8 Ruswarp Lane, WHITBY, N. Yorks YO21 1ND
TEL/FAX: 0947 600065 (9am - 7pm)

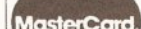

MEMORY MEMORY

Total recall

In the first of a two-part series, Mark Smiddy explains all you wanted to know about memory but forgot to ask

The concept of memory has to be one of the most complex issues to come to terms with. In this two-part series, the mysteries of memory will be unravelled, as we answer your queries on the intricacies of RAM and ROM.

Consider for a moment how we remember? Hypnotists have repeatedly proven we can rewind our lives and re-live past events. This means the human mind must be capable of storing colossal amounts of information. Assume one snapshot per second. At one year old, a child has stored a movie of over 21,000,000 frames long (not counting sleep). Not 21 million bits of information, but 21 million colour pictures; the associated stereo soundtrack; plus the tastes, smells and sensations of the world about them. Think about that...

● WHY DO COMPUTERS NEED MEMORY?

Computers use memory for all manner of things from the screen display to the programs. But in the end it all boils down to a single common denominator. Computers work on numbers which are stored in memory. When you double-click an icon on the Workbench, a program is loaded (transferred, copied, etc) into part of the Amiga's memory. Now two things will happen:

- The program will be executed by the CPU.
- The program will grab a certain amount of memory for itself.

This memory is used for all the 'housekeeping' jobs, jottings and so on. Think of the way we use a pen and paper to keep notes on and you'll get the idea.

● WHAT IS RAM?

RAM is an acronym for Random Access Memory. This is the sort of memory we think of when a program complains "Not enough memory" or "out of memory". RAM can be read from and written to so it is very versatile.

● WHAT IS ROM?

ROM (Read-Only Memory) on the other hand, can only be written once; it's used to hold the program

code which makes the machine what it is.

In the early days (before ROM was introduced), every time a computer was switched on, the bootstrap operating system loader had to be entered manually using switches. On the Amiga, the bootstrap and most of the operating system is always there when you switch on.

● DO I NEED MORE RAM?

How long is a piece of string? The answer, most probably, is yes.

For serious use, an Amiga needs a minimum of 2Mb, although it would be best to go for 3Mb.

Given 3Mb of RAM, the Amiga is capable of great things. Multi-tasking becomes a dream and you can use decent sized RAD disks to avoid having to boot from floppy disks. Better still, this will give you access to programs such as *VistaPro* or use *Wordworth* to its full capability.

● WHAT'S THE DIFFERENCE BETWEEN FAST AND CHIP RAM?

For the average user there is no difference whatsoever, all you really need to know is that there are xMb of memory fitted to your machine and that the more megabytes you have, the better.

Put more succinctly, Chip RAM is memory which can be accessed by the custom chips which are called Paula, Agnus and Denise. These clever little devices look after things such as the audio-visuals, the disk drives and the system DMA.

Some programs will run more slowly (fractionally) in Chip RAM because the custom chips can stop the processor's natural access to it by taking over the data bus. When a custom chip has hold of the data bus, the CPU has to wait until it has finished.

Programs running in Fast RAM do not have to suffer the indignation of being unable to access their savings (liquidise their assets, if you like) so they run marginally quicker. For this reason, RAM which is unavailable to the custom chips is called Fast RAM.

On the Amiga this Fast RAM lives on the expansion bus, in the case of the A500, or Zorro slots on the A1500 and above.

JARGON BUSTING • JARGON BUSTING

Address – A number which defines a unique memory location just like the house numbers on a street. The exact number of bits at that location depends on the width of the data bus usually 8 or 16.

Bi-directional – A bus (data path) is said to be bi-directional when the lines can act as inputs or outputs depending on what is required. The data bus is bi-directional, but the address bus is not.

Bit – A single binary digit - Binary digit.

Byte – Eight bits or an eight-bit wide memory location.

CAS – Column Address Strobe. Signal which informs the RAM to load the column address from its address lines. The bar indicates the signal is active low.

CS – Chip Select. When this line is LOW, the RAM is active and its output is available on the data bus. If this line is high, the data and address lines are high impedance and the chip does not appear on the bus.

D-type – An electronic circuit the input of which is copied to its output when a second input (clock) is activated.

DMA – Direct Memory Access. Memory reads and writes performed while the processor is engaged.

DRAM – Dynamic RAM. Normal memory found on Amiga computers. DRAM is based on an array of tiny capacitors which need to be refreshed every two-thousandths of a second.

DTL – Diode-Transistor Logic.

ECL – Emitted Coupled Logic. Also called CML or Current Mode Logic.

FET – Field Effect Transistor.

Gate – A logic circuit.

I2L – Integrated Injection Logic.

Latch – Another name for an S-R (Set-Reset) flip-flop. Some applications use D-types latches instead, since their behaviour can be controlled by a separate line.

Logic 0 – Represented in electronic terms as a line at ground OV.

Logic 1 – Represented in electronic terms as a line at Vcc; usually 5V for common TTL logic.

Longword – A 32-bit wide memory location or address.

MMU – Memory Management Unit. A device for controlling how memory is accessed by the CPU. An MMU will have complete control over the data and address buses and can provide virtual addressing in multi-tasking systems.

MOS – Metal Oxide Semiconductor. An alternative material to silicon or germanium

MOSFET – Metal Oxide Semiconductor Field Effect Transistor. See MOS.

NAND – Not AND. A logic function which reverses the effect of AND.

NOT – A logic function which reverses the value of a logic line. Therefore: 1 becomes 0, and 0 becomes 1.

DO I NEED MORE CHIP OR MORE FAST?

Many Amigas are restricted to 512K Chip RAM anyway, so every extra byte of memory added will automatically become Fast memory. This also applies to A1500/2000

memory request which asks for either type of memory is allocated Fast memory if enough is available. FastMemFirst is not found on Kickstart 2 machines because it's inherent in the allocation routines anyway.

NoFastMem does more or less

A typical (theoretical) memory map generalised for 68000 Amigas

| | |
|---------------|-----------------------------------------|
| 000000-03FFFF | 256K Chip RAM |
| 040000-07FFFF | 256 Chip RAM |
| 080000-0FFFFF | 512K extended Chip RAM (fatter Agnus) |
| 100000-1FFFFF | 1Mb extended Chip RAM (super fat Agnus) |
| 200000-9FFFFF | 8Mb primary auto-config space |
| A00000-BEFFFF | Reserved |
| BFD000-BFDF00 | Complex interface Adaptor B |
| BFE001-BFEF01 | Complex Interface Adaptor A |
| C00000-D7FFFF | Chip RAM |
| D80000-DBFFFF | Chip RAM |
| DC0000-DCFFFF | RTC |
| DF0000-DFFFFF | PAD registers |
| E00000-E7FFFF | Reserved |
| E80000-E8FFFF | Initial Autoconfig™ map |
| E90000-EFFFFF | Secondary Autoconfig™ space |
| F00000-FBFFFF | 256K ROM |
| FC0000-FFFFFF | 256K ROM |

machines. Later, 1Mb 1.3 machines came with a 1Mb Fatter Agnus chip and they too will only support extra Fast RAM. The A500 Plus will take either an extra 512K or 1Mb of Chip RAM and this is probably the cheapest way to upgrade the machine.

Generally speaking, the amount of Chip you have is limited by the Agnus you have fitted. Although upgrading to a 1Mb Agnus is feasible and straightforward for most machines, the 2Mb unit is very expensive; the current third-party upgrade boards retail at a ludicrous £200 – half the RRP of a complete machine! The majority of boards add Fast RAM and, when the chips are down, it's all the same to most applications.

● JUST WHAT ARE FASTMEMFIRST, MERGEMEM AND NOFASTMEM FOR?

The amount of memory the custom chips have access to is limited by the width of their address buses (see below). On the original machines, the first 512K of RAM was accessible; later machines had 1Mb; the newest models including the A500 Plus have access to 2Mb.

Because of these limitations, Chip memory is very precious. Every screen display you have and every sound sample you are playing requires valuable Chip RAM. It would therefore be lunacy to allow a program's first bite (byte) at the Chip RAM cherry when it really doesn't need it. For this reason, a small program patches part of EXEC (Kickstart's memory overlord) so a

the opposite; it switches Fast memory off. This is not however *strictly true*; because if the Fast memory suddenly disappeared, so would any programs which happened to be using it and the Amiga would crash. NoFastMem patches memory requests so programs *only* receive Chip memory. This is for compatibility with very old programs which expect to find Chip memory and attempt to access graphics and sound samples in Fast memory. When such applications send the address to the custom chips, part of it is chopped off and the effective address ends up somewhere in Chip RAM. At best, this causes Intuition's special DISPLAY_FIREWORKS mode; at worst, it will crash the machine.

MergeMem is used on older machines which have more than one RAM expansion card. As each card is mounted by AutoConfig™, it appears at an address determined by the Autoconfig™ software. However, EXEC sees the cards as separate chunks of xKb large even if they actually live at contiguous (sequential) addresses. MergeMem attempts to patch the address list so that 4Mb (for instance) looks like a chunk of memory 4Mb long, rather than eight chunks of 512K each.

● WHAT IS A BUS?

The bus is a collection of common electrical pathways, usually the tracks on a circuit board, but sometimes used more loosely as in: the data bus is bi-directional. There are two main buses in any computer system: the "address" bus handles all the memory addressing and the "data" bus looks after the

transfer of information.

The number of lines on a bus is called the "bus width". Most Amigas have a data bus 16 bits (lines) wide; this means the processor can gather a complete word of information in one fetch. High-end machines and processor accelerators feature a 32-bit data bus.

The width of the address bus determines how much memory can be accessed. The Amiga 500 has a 24-bit address bus or 16Mb (2²⁴) of ROM, RAM and memory mapped peripherals.

● SO WHY CAN I ONLY HAVE 9MB?

As I've already mentioned, the total addressing capability of a 68000 CPU is 16Mb and some of that is reserved for use by the system: 7Mb of it! 256 or 512K goes on the ROM, and the rest is used for memory mapped peripherals, the system hardware (CIA's, and the PAD), and some is reserved for future

expansion and the Autoconfig™ system.

● WHAT ABOUT AUTOCONFIG™ THEN?

Autoconfig™ is a rather clever idea developed by Commodore which automatically allocates peripherals to a free area of the address map.

On the A500 system, Autoconfig™ appears on the left-hand expansion connector, but on the A1500 models upwards the whole thing appears on a set of female edge-connectors: Zorro slots.

The basic idea is as follows. During the boot sequence the Amiga sends a signal (mapped initially at address &E80000) to the first slot on the bus. Configuration information is read from the board and the Amiga sends it an assigned address somewhere within the primary Autoconfig™ space starting at &200000 which is latched by hardware. This effectively makes the board disappear from the

JARGON BUSTING • JARGON BUSTING

- Nybble** – Four bits or half a byte. Sometimes written Nibble.
- Page** – A chunk of memory usually 256 bytes long.
- Propagation Delay** – The time it takes for an electronic signal to travel through an electronic circuit, usually logic gate.
- RAD disk** – A RAM disk which retains its contents after a reset.
- RAM** – Random Access Memory. Any memory which can be written to and read from.
- RAS** – Row Address Strobe. Signal which informs the RAM to load the row address from its address lines. The bar indicates the signal is active low.
- ROM** – Read Only Memory. A type of memory which retains its contents even when the power is turned off.
- RTL** – Resistor-Transistor Logic.
- SCRAM** – Static Column RAM. A very fast type of dynamic RAM which uses a special row-only addressing mode.
- SIMM** – Simultaneous In-line Memory Module. A set of SMT memory chips pre-mounted on a small PCB with an edge connector. By their nature, SIMMs are very simple to fit.
- SRAM** – Static RAM. Very fast memory, based on thousands of gates.
- Transistor** – An electronic switch.
- Tri-state** – A line which can have three states: On, Off, or high-impedance. The third state is used so that many lines can be connected together without interfering with each other. A chip is made active on the bus by pulling its not chip enable (-CE) line low.
- TTL** – Transistor-Transistor Logic.
- Vcc** – Volts Collector-Collector. The supply voltage: commonly 5 volts for TTL logic circuits.
- VLSI** – Very Large Scale Integration. Lots of components on a single chip.
- WE** – Write Enable. If this line is HIGH the RAM loads the contents of the current location on the data lines. If this line is LOW, the data is read from the data lines and stored.
- Word** – A 16-bit wide memory location or address.

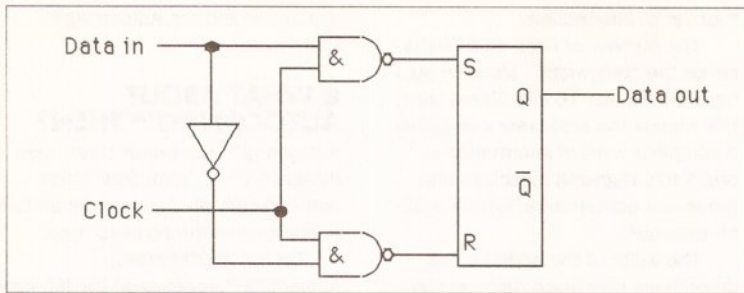

Figure 1: the D-Type or data flip-flop typically found in static RAM in expanded schematic form, showing the extra gates added to the basic S/R flip-flop

Autoconfig™ space, whereupon it passes a CONFIG-OUT signal to the next slot along thus enabling it to join the system.

In this way the Amiga handles the location of where boards appear in the memory map and, since the signals ripple through board-by-board,

separately because the amount of electronics involved is greatly reduced. If you just buy the memory expansion it should have a through-port which supports Autoconfig™ otherwise you will not be able to add a hard disk (or other auto-configuring peripheral) at a later date.

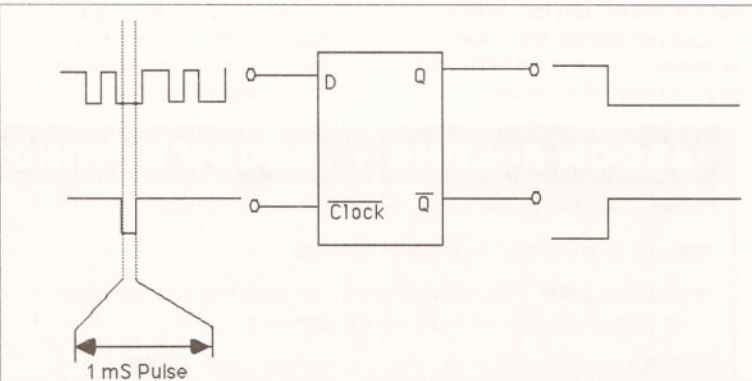

Figure 2: this simplified timing diagram shows the effect of a clock pulse. The output (Q) mirrors the logic level at D when the clock is active (low)

there is never any chance of two peripherals appearing at the same address.

Interestingly, since the Autoconfig™ space is 8Mb wide and this is used for Fast RAM only, the Amiga 500 Plus has a memory limit of 10Mb.

● I'VE HEARD OF STATIC RAM, WHAT IS IT?

Static RAM or SRAM was a fairly early development in LSI memory chips and is still in wide use today. Its primary advantage over DRAM (see below) is that data remains

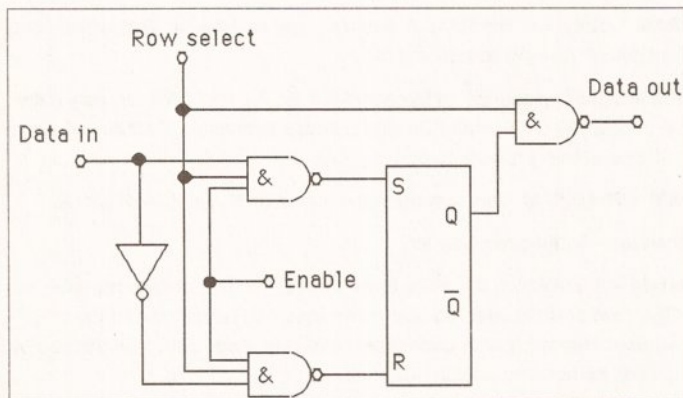

Figure 3: the complete SRAM memory cell. More complex and larger than its DRAM cousin

● SO WHAT IF I WANT A HARD DISK TOO?

No problem. Autoconfig™ (which should be supported by all peripherals) handles those too. It's worth pointing out that, if budget permits, a combined RAM and hard disk expansion system is far more cost-effective than buying the items

stored while power is applied; it does not require the constant topping up procedure of DRAM's leaky buckets. Therefore, SRAM does not require any external circuitry to boost the signal to correct logic levels. So on the face of it, SRAM sounds like the perfect solution for most applications; but in practice it isn't.

The design has two major flaws...

Every gate is constructed from several transistors and the whole thing requires at least five gates more in practical terms. In comparison to DRAMs, far more material is used to produce one gate, which means less memory cells per square millimetre of chip. The cost per byte is therefore higher, and more chips are required to satisfy system demands. More chips mean larger boards and cost becomes too prohibitive to use this construction in modern designs.

A basic SRAM cell (Figure 1) requires additional processing to provide the bi-directional data bus. By definition, this system requires separate routes for data in and data out. It also requires extra logic to handle the select line. One solution is shown in Figure 3.

● SO WHAT ABOUT DYNAMIC RAM?

The most common type of RAM used in micro-computers is DRAM or dynamic RAM and is notable because it is internally an analogue as opposed to a digital device. Compare that to static RAM which is entirely digital. Now take a look at Figure 4; don't worry if electronics gives you a headache, it's very simple.

By applying a voltage to the data line, current will charge the capacitor C1. This causes a logic one to be stored. By connecting data to 0V, the charge leaves the capacitor. This stores a logic 0. Reading from this circuit is accomplished in a similar fashion. The transistor is turned on, and the voltage level held on the capacitor is read from the data line.

● SO WHAT ABOUT REFRESH?

The DRAM memory cell is not without its problems. The difference between ON and OFF is in the order of millivolts (thousandths of a volt) – logic circuits required a difference of

several thousand times that. Before data can be read by the outside world, it must be converted to a digital signal by a differential amplifier.

Capacitors are like tiny rechargeable batteries; they store charge in the form of free electrons.

This is measured as current when the electrons flow through a circuit. However, this simple cell suffers with a problem caused mainly by the physical size of the components.

In a perfect world a capacitor will retain its charge until something discharges it. In practice though, the charge (and the information

stored) leaks away through the substrate, through the capacitor and through the source-gate junction on Q1: see Figure 5. This behaviour has led to memory cells in DRAMs being compared to leaky buckets.

The actual time taken for a single bit to drop from logic 1 to logic 0 can vary dramatically from cell to cell even on the same chip.

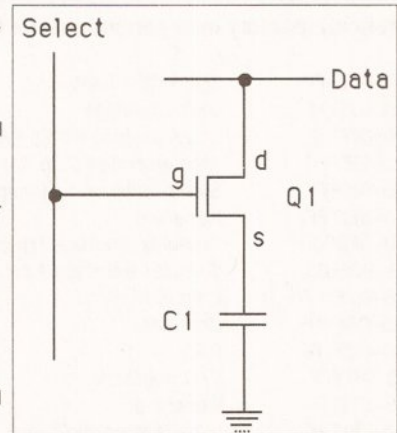

Figure 4: one leaky bucket bit from a Mostek 4096 dynamic RAM

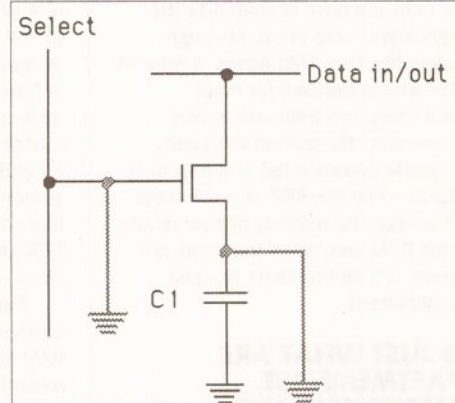

Figure 5: C1 loses charge through the paths of comparatively low resistance

Therefore another circuit constantly checks each bit and tops them up a sequence called RAM refresh. Typically, a refresh time of 2mS is quoted for modern devices. Nevertheless, some DRAMs can retain their charge for up to 45 seconds which is partly the reason a 30 second power down is usually quoted to rid a system of memory resident viruses. **AS**

COMING NEXT MONTH • COMING NEXT MONTH • COMING NEXT MONTH

Next month there's even more on memory. Tie a knot in your hanky or make a note in your digital diary, to make sure you don't forget your copy of *Amiga Shopper* – out on the first Thursday in the month. Oh, and look out for the *Amiga Answers Special* on RAM.

**AMERICAS LARGEST
SUPPLIER OF AMIGA
CUSTOM CHIPS + UPGRADES**

| | | | |
|------------------------------------------------------------------------------------------------------------------------------------------|---------|------------------------------------|--------|
| 8372A (PAL) 1 Meg Agnus | £31.30 | 5719 Gary | £10.44 |
| 8372B (PAL) 2 Meg Agnus | £46.40 | 8362 Denise 1 bright | £13.90 |
| 1.3 Kickstart ROM | £19.70 | 1 x 4/80 Static Column Zip | £15.60 |
| A500 Keyboard-factory new | £35.60 | 8520A CIA (2MHz) Great price | £6.35 |
| A500 PC Motherboard-PAL, populated & tested - complete | £115.40 | | |
| A2000 PC Motherboard-PAL, populated & tested - Includes the 1.3 Rom, 8372A 1 Meg Agnus & Super Denise 8373 installed (factory new) | £301.60 | | |

**UPGRADE YOUR A500 TO THE A500 PLUS
8373 SUPER DENISE - £22.80**
Add productivity mode, superhi-res mode, scan mode, genlock capability & superhi-res capabilities

McCoy PLCC: (Bumdy clone) Agnus chip puller.....£9.50
Amiga Diagnostician: Diagnose up to 28 common problems. Comes with diagnostic software and booklet. Save time & money by locating faulty chips yourself.....£9.86
The Final Test: Diagnostic diskette tests keyboard, display, graphics, Workbench, sound, timing, realtime clock, RAM, etc. (12 diagnostic programs in all).....£6.95
Agnus (PLCC) Bumdy Professional Chip Puller: (Commodore approved).....£7.60
MegaChip 2000 by DKB: Upgrade your A500/A1500/A2000 to 2Mb of chip RAM. Includes 2 meg Agnus, chip puller & "Final Test" diagnostic diskette (no soldering). Same 8372B chip used in A3000.....£173.40
 Buy the MegaChip from us and we'll give you the new Super Denise for.....£17.00
SwitchItt by Global Upgrades Inc. Electronic ROM selector switch for 1.3 or 2.0. Makes all your software compatible. Keyboard or mouse controlled. Does not overlap the 68000 - allows for accelerator (2.0 compatible).....£24.10

UPGRADE TO THE 2.0 OPERATING SYSTEM
***2.0 Upgrade Kit (PAL ed.):** Contains ROM, 1,000 page manual and diskettes...£50.75
***2.0 Upgrade ROM only (PAL):** No manual or diskettes. Ideal for multi-computer owners, schools, businesses, etc.....£27.00

AdRAM 540 for A500 by ICD: Add up to 4 megs of RAM with battery backup internally in your A500. 1 Meg/2 Megs.....£74.20/£95.15
AdSpeed by ICD: Best accelerator in its price range.....£118.90
Flicker Free Video by ICD: Eliminates interlace flicker.....£163.50
Flicker Fixer by Microway (PAL).....£130.50

DO NOT FEAR!

Buying directly from the U.S with your credit card offers you the same protection as it does in the U.K. with the added benefit of saving lots of money. Deal directly with North America's largest distributor of custom Commodore & Amiga parts and chips. The Grapevine Group has been successfully servicing the U.K. and the Continent for 12 years. All our parts and chips are new and guaranteed for 90 days.

DEALERS - SEND YOUR LETTERHEAD FOR SPECIAL PRICING

| | | |
|----------------------------|-----------------------------------------------------------------------------------------------------------------------------------------------------------------------------------------------------------------------------|-------------------------|
| PRICES JUST REDUCED | THE GRAPEVINE GROUP INC. 3 Chestnut Street, Suffern, New York 10901 U.S.A. International Fax: 0101-914-357-6243 Customer Order Line: 0101-914-357 2424 Telephone Hours: 1pm to 11pm Mon-Fri British time | NO VAT NECESSARY |
|----------------------------|-----------------------------------------------------------------------------------------------------------------------------------------------------------------------------------------------------------------------------|-------------------------|

Prices subject to change **International Orders:** If your order is over £40 send or fax front of credit card. **Air Parcel Charges:** All chips - £5.36 Keyboard & PCBoard - £8.40 2.0 Kit - £22.62

T.K. COMPUTERWARE
Tel: 0303-812801

| | | | |
|--------------------------------|--------|--------------------------------|--------|
| SOFTWARE: | | | |
| Database: | | | |
| K-Data | 38.00 | Protect v5.5 | 103.00 |
| Prodata | 56.00 | Prop Write v3.1 | 103.00 |
| Superbase Personal | 27.00 | Quickwrite | 43.00 |
| Superbase Personal 2 | 65.00 | Scribble Platinum | 43.00 |
| Superbase Professional | 165.00 | Transwrite 2 | 32.00 |
| Superbase Professional 4 | 260.00 | Turbo Text | 50.00 |
| Desk Top Publisher | | Wordworth | 90.00 |
| Outline Fonts | 100.00 | CAD: | |
| Pagesetter II | 47.00 | 3D Construction | 45.00 |
| Pagestream v2.1 | 145.00 | Design 3D | 60.00 |
| Proclips | 22.00 | Professional Draw 2 | 90.00 |
| Professional Page v2.1 | 200.00 | UTILITIES: | |
| 3D Construction | 45.00 | BBC Emulator | 36.00 |
| Design 3D | 60.00 | CrossDOS Transfer | 25.00 |
| Professional Draw 2 | 90.00 | Directory Manager | 36.00 |
| Languages: | | Disk Master 2 | 50.00 |
| 3D Construction Set | 40.00 | Doctor Ami | 41.00 |
| AMOS | 35.00 | Quarterback Tools | 57.00 |
| AMOS 3D | 25.00 | GRAPHICS: | |
| AMOS Compiler | 22.00 | Animation Studio | 80.00 |
| Devpac 3 | 60.00 | Deluxe Photolab | 57.00 |
| GFA Basic Compiler | 23.00 | Image 3D Modelling | 170.00 |
| GFA Basic Interpreter | 40.00 | Real 3D | 120.00 |
| Hisoft Basic 2 | 58.00 | Deluxe Paint 3 | 50.00 |
| Hisoft Extend | 15.00 | Deluxe Paint 4 | 65.00 |
| K-Seka Assembler | 38.00 | Deluxe Print 2 | 38.00 |
| Lattice C v5.01 | 175.00 | Deluxe Video 3 | 70.00 |
| Spreadsheet: | | PRINTER RIBBONS: | call |
| Advantage | 77.00 | BOOKS: | |
| DG Calc | 28.00 | Amiga DOS In & Out | 19.00 |
| Maxiplan Plus | 52.00 | Amiga DOS Manual 3e | 23.00 |
| Superplan | 65.00 | Amiga Desktop Video | 19.00 |
| Word Processors: | | Kids & The Amiga | 15.00 |
| Excellence 2 | 100.00 | Learning C for Beginners | 18.50 |
| Kindwords 2 | 37.00 | Amiga for Beginners | 18.50 |
| Pen Pal | 63.00 | Amiga Basic Inside & Out | 20.00 |
| Protect v4.3 | 50.00 | Amiga C for Beginners | 18.50 |
| | | Amiga C Adv. Programmers | 32.50 |

Please phone for details of other Amiga products in stock.
 All prices are in £ and include VAT. Please add £3.00 for UK P&P.
 Telephone order payment by:



or send cheque, Postal Orders or Eurocheque to:
T. K. COMPUTERWARE
STONE STREET, NORTH STANFORD,
ASHFORD, KENT TN25 6DF, ENGLAND

* * * * *

*** Price Busters!! ***

| | |
|-----------------------------------|----------------------------------|
| * Graphics & General | Hardware |
| Advantage | A1500 CPU Case.....169.99 |
| Art Department Pro 2....139.99 | A1500 AccessoriesCALL * |
| Big Alternative Scroller ...34.99 | A1500/2000 40Mb |
| Broadcast Titler 2.....154.99 | Quantum Hard Card.....329.99 |
| Colourburst | 512K RAM with clock29.99 |
| Deluxe Paint IV | 1.5Mb RAM with clock82.99 |
| * Disney Animation Studio..64.99 | Cameron Colour |
| Flow 3.0 | Handy Scanner |
| * Font Grabber - NEW!!.....29.99 | Invision Plus/Live499.99 * |
| * Imagine 2.0 - NEW!!194.99 | Naksha |
| Mediastation.....119.95 | Handy Scanner |
| * Personal Finance | Naksha Mouse |
| Manager | Rendale 8802 Genlock .149.99 |
| * Personal Font Maker34.99 | RGB Splitter |
| Pixel 3D | RocGen Genlock.....84.99 |
| Presentation Master | RocGen Plus.....129.99 * |
| - NEW!! | Podscat Graphics |
| ProDraw 2.0.....89.99 | Tablet |
| * Professional Calc.....129.99 | Touch Screen |
| Real 3D Beginners | for Amiga.....229.99 |
| * Scala.....179.99 | Zydec Trackball.....29.99 * |
| Scala 500.....69.99 | Zydec Amiga Drive.....49.99 |
| Scenery Animator | Zydec A500 |
| * Spectra Colour.....39.99 | 1Mb RAM Card |
| Video Director.....99.99 | Zydec Hand Scanner119.99 |
| * Vidi Amiga.....84.99 | |
| Vidi Colour Solution139.99 | |
| * Vista Pro 2 - NEW!!.....49.95 | |

Music & Sound

| | |
|--------------------------------|---------|
| AMAS 2 - NEW!! | 69.95 * |
| Audio Engineer Plus 2 ..149.99 | |
| Audition 4 | 34.99 * |
| Deluxe Music Const. | |
| Set..... | 49.99 |
| Jam - NEW!!..... | 69.95 * |
| Music X 1.1 | 69.95 |
| Perfect Sound | 39.99 * |
| Stereo Master | 29.99 |
| Soundmaster..... | 84.99 |
| Techno Sound Turbo..... | 29.99 * |

*** Development & Utilities**

| | |
|---------------------------|--------|
| AMOS | 29.99 |
| * AMOS 3D | 22.99 |
| AMOS Compiler..... | 19.99 |
| Anim Fonts 1, 2 & 3 | 29.99 |
| * Blitz Basic | 69.99 |
| Can Do V1.6 - NEW!! | 64.99 |
| * Cross Dos | 22.99 |
| Dev Pac 3.0 | 49.99 |
| * Directory Opus..... | 25.95 |
| Diskmaster..... | 32.99 |
| HiSpeed Pascal | 64.99 |
| * Home Accounts 2 | 36.95 |
| Hyperbook | 42.99 |
| * Quarterback | 39.99 |
| Quarterback Tools | 44.99 |
| * SAS C | 159.95 |

*** FREEPOST or £5 Securicor ***

48 hour despatch (cheques 7 days)

* Cheques should be made payable to Softstore *
 Access and VISA cards accepted

* Softstore, 410 Bath Road, Slough SL1 6JA *

*** 0628 - 668320 ***

*** CALLERS WELCOME ***

* * * * *

LOWEST PRICES GUARANTEED!

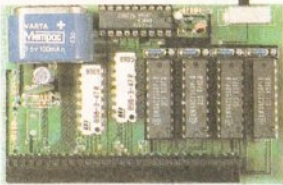

CORTEX 1/2 Mb RAM EXPANSION for the Amiga A500

Essential A500 upgrade - 1Mb Amiga is now standard • Functional equivalent to A501 • Lower power 1Mbit DRAM • Latest technology high-quality components • 'Fatter Agnus' compatible for 1Mb CHIP MEM • Low profile enable/disable switch • Available with or without battery-backed clock/ calendar module.

CLOCK £24.95

£19.95



CORTEX 8Mb RAM EXPANSION for the Amiga A500/A1000

The **ONLY** RAM upgrade approved by Commodore UK • Fully compatible with A500 plus for 10Mb maximum RAM • External fitting (Warranty remains intact) • Through port (covered by blanking plate) • Fully implemented auto-configure • Zero wait states • Compatible with A590 and all major hard disks • Uses 1M x 8bit or 1M x 9bit SIMMs • Complete with its own power supply unit (UK, US, or EURO) • Fully A1000 compatible • RAM test software.

2Mb
£199.00

4Mb
£269.00

8Mb
£399.00

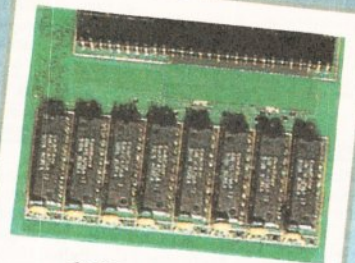

CORTEX 1 Mb MODULE FOR A500 plus

Gives 2Mb CHIP MEM • Functional equivalent to A501 plus • Ultra low power design • Low component count for maximum reliability • Available populated to 1/2MB or 1MB.

1/2 Mb
£29.95

1 Mb
£44.95



8Mb RAM EXPANSION for the Amiga A1500/A2000

Fully implemented auto-configure • Zero wait states • Uses 1M x 9bit SIMMs 2,4, or 8Mb configurations.

2Mb **£175.00**

4 Mb **£245.00** **8 Mb** **£375.00**

GVP IMPACT SERIES 2 HARD DISK WITH RAM (A500HD8+)

52Mb Hard disk system with up to 8Mb of RAM • Factory-fitted Quantum Pro-drive, 11ms access • Uses 1M x 8bit SIMMs (see RAM CHIPS section for prices) • Game switch (hard drive disable) and power supply.

52Mb
£379.00

105Mb
£569.00

Other GVP products available: call for prices



EXTERNAL FLOPPY-DRIVE

High-quality silent mechanism • Through-port • Enable/disable switch.

£49.00

XETEC HARD DISKS Systems available for all Amigas INCLUDING A1000 call for prices

PRICE PROMISE

Cortex will match any genuine price offered by one of our U.K. competitors on goods that are in stock on a like-for-like basis. This offer applies at the time of purchase only and does not apply to prices offered in sales of bankrupt stock, clearance or closing down sales.

2 YEAR GUARANTEE

All product bearing the Cortex brand name carries a 2-year guarantee. Other products in this advertisement carry a 1 year guarantee. All prices include VAT and postage & packaging. All products shipped same day where possible. Allow 14 days for delivery if ordering by cheque. Make cheques/ P.O.'s payable to CORTEX..

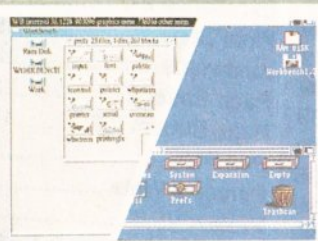

ROM SHARERS

Essential upgrade for all A500 Plus owners • Enables safe and easy switching between 1.3 & 2.04 Kickstart ROMS • Keyboard controlled switching • Has 3 ROM sockets to allow for future expansion.

£29.95

As above but with 3-position slide switch

£23.95

KICKSTART ROMS

V1.3 Kickstart ROM

£29.00

V2.04 Kickstart ROM **IN STOCK**

£39.00



ENHANCED CHIP SET (E.C.S.) UPGRADES

8372A Fatter Agnus **£45.00**

8373 Super Denise **£45.00**

MegaChip 2000 with Super Agnus (allows 2Mb to be fitted to A500/1500/2000)

See 'KICKSTART ROMS' for ROM upgrade. **£199.00**

RAM CHIPS

1M x 8bit SIMMs (for Cortex, GVP etc. 2Mb.) **£75.00**

256K x 4bit DIPs (for A590, 2091 ICD etc) each **£4.00**

1M x 1bit DIPs (for older A2000 cards) each **£4.00**

1M x 4bit Static-Column Mode ZIPs (for A3000) 4Mb **£199.00**



DEPT AS, CORTEX DESIGN & TECHNOLOGY LTD, BRITANNIA BUILDINGS, 46 FENWICK STREET, LIVERPOOL L2 7NB. • 24 HOUR SALES
TELEPHONE: 051-236 0480 24 HOUR FAX: 051-227 2482

The pianist they didn't shoot

Does the Miracle Piano Teaching System strike the right note? Jon Bates braves the shootin' gallery

vary in style from Classical and folk to popular tunes. Before each lesson, the piece is demonstrated and often a small piece of historical background is thrown in. This is

linked to the Arcade section which plays music games to reinforce aspects of pitch, rhythm and fingering. Points such as 'posture at the keyboard' have a jolly picture of a baroque performer playing a synth plus a close-up of the fingers on the keys – all useful stuff. As you learn new notes, the on-screen keyboard is also 'played', showing the note you are playing, although the notation which is on the screen at the same time is not.

For the most part this interactive system is excellent. However, there were certain areas of doubt. I was a bit puzzled by the repetition of finger numbers on notes that are tied – this is rather misleading as it encourages the learner to restrike the note. Also, when there are fingering jumps, these are not indicated on the screen, as is usual with keyboard

teaching. Sometimes progression within the lesson is held back as 'teacher' is a little too fussy about accuracy. In some cases there are flaws in the way that it demonstrates some of the material: eg in one piece it plays some notes incorrectly. If you reproduce this it accuses you of playing random notes.

The on-screen text uses mainly American terminology with not a mention of a crotchet or quaver, using the US terms of whole notes, half notes and quarter and eighth notes. This could cause problems if

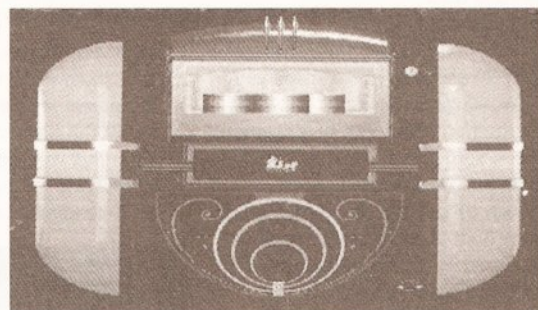

No-one need know you can't play a note. With the jukebox, you can take your pick of the tunes

JARGON BUSTING • JARGON BUSTING

MIDI – Musical Instrument Digital Interface; a universal digital language which connects instruments both to other instruments and computers/other MIDI equipped devices.

Chord – Three or more notes played simultaneously that create a harmony.

Multi-Timbral – The ability of an instrument to play more than one sound simultaneously; usually several different musical parts in one go.

Weighted Keyboard – A keyboard that requires more pressure to play each note. A piano has a weighted keyboard, most synthesizers do not.

Velocity Sensing – The faster you play the note, the louder the note sounds, just like a piano.

Legato/Staccato – Two Italian musical terms meaning smooth and short respectively.

Sequencer – A device that records the data generated by performance, usually MIDI data. It can then play the instrument using this data to repeat the performance.

Quantize – The ability of a sequencer to 'round up' notes so that they are played back in time.

the user has had lessons on other instruments. When I first saw the preliminary system, I was led to understand that this would be corrected for the UK market.

During the lesson, flashcards appear to test your understanding of what you have learnt and you have to answer correctly before the lesson can continue. At any point you can pause from the lesson and either restart the lesson again or continue onwards. At the end of each session it logs the number of mistakes and the nature of them – this is handled by the administration department. What is clever is that it adapts itself to your faults and will come up with exercises to improve areas where you are weak. This is excellent and I'm sure is a pointer to the way in which this system can be developed.

ADMINISTRATION

Any time that you log on or off, the Administration department informs you of your progress in all the departments, ratings and overall average score to date. This is kept

Nintendo's market research has shown that just under 40% of adults would like to play the piano. As such it has launched the Miracle Piano Teaching System – a computer-based piano teacher. How does it work and is it any good?

What you get is a keyboard with four octaves which has MIDI and customised interfaces, built-in speakers, 128 sounds and can be played on its own or become part of a MIDI sequencing system.

The Miracle System is both innovative and fun and is one step nearer the world of home entertainment and education which computer market analysts have been telling us is 'just around the corner'.

The first thing to realise is that you will need at least 1Mb of memory and twin disk drives. It requires access to all three disks and with just one drive it is a real pain to keep swapping disks. Even



Let your fingers do the walking with the Miracle Piano teaching System. The keyboard comes complete with four octaves and built-in speakers

twin disk drive owners could become a mite cheesed off at the loading and waiting time. Since there are many facilities contained in this package and the aim is to teach you to play without tears, a hard drive is really the only way to get a positive benefit from this program; an expanded memory would also help, as with 1Mb it has to keep clearing out data to load up new facilities.

While loading up it plays a slightly quirky version of the American hymn 'Tis a gift to be simple'. You are then presented with a Music Conservatoire with the lid off (literally!). There are various rooms to 'visit' – these correspond to the various functions of the overall course. These are Classroom, Arcade, Studio, Administration, Performance Hall and Practice Room. We'll visit them in turn.

IN THE CLASSROOM

This is the area which will get most use, as this is where the actual teaching takes place. The course is set out in 40 chapters; each chapter can have up to 25 lessons/teaching points all of which are fully explained. You are directed to practise and play games to improve yourself with the program acting as teacher and adviser at every stage.

The pieces are well chosen and

under your own progress chart and on each log in it tells you where you were on your last lesson. It will even print out a certificate of merit when you pass certain stages! Its ability to cope and keep track of multiple users makes it a serious contender for the classroom.

DOWN THE ARCADE

Arcade plays a selection of shoot'em up games designed to improve your skills. There are three games which help you with notation, rhythm and fingering and these are generally amusing and exacting. Scores are logged and count towards your final and overall rating; a form of continual assessment.

'Aliens' is quite exacting and demands that you play and read notes correctly

within a certain time limit. The notes relate to sections of the piece you are working on and if you go wrong you are told about it in no uncertain terms! You cannot pass over this game until your score is good enough. 'Ripchord' has parachutists which float to the ground happily if you correctly hit the three notes of the chord towed along by a helicopter. 'Ducks' is a notation trainer which shoots down ducks on a staff if you hit the correct key. This sort of thing makes learning fun.

PERFORMANCE HALL

On entering the performance hall the piece you perform is matched numerically with the lessons: the piece you learn in lesson 3 is performance piece level 3. Here the multi-timbral aspect of the hardware is used with an 'orchestrated' accompaniment and a lead voice which can make any instrumental sound. You can opt to play left or right hand or both – the default tempo of the piece is also adjustable.

The way in which it sums up your performance is good with advice about the accuracy of the notes. However there seems to be no advice about the touch you use on the keys, which is surprising as the instrument is velocity sensing. Part of acoustic piano teaching is concerned with the pressure applied when striking notes to produce different tones within the piece and this seems to be something that the system has not addressed. This could also be applied to the basics of touch – Legato and Staccato

playing (smooth or spikey notes, if you like) as well as playing loudly or quietly. Definitely areas that the system can cope with but something that it fails to address.

The accompaniments to some pieces could be more faithful to the originals. They quite often use incorrect chord inversions for no particular reason, since it won't affect the playing of the piece and some have unsatisfactory sounds to



Ever wanted to be the pianist they didn't shoot? In the shootin' arcade, maybe the Amiga can save your life

work with. For example 'The Swan' is a well known 'cello solo and uses the sustained sad tone of the 'cello to put the piece over. Why therefore does this version use a tinkly vibraphone? At times the accompaniment misses out notes

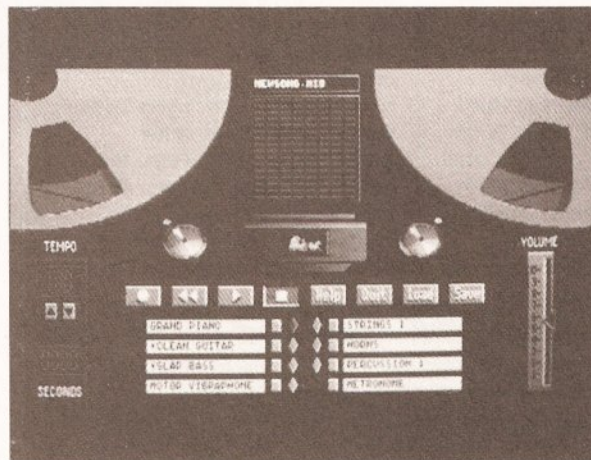

Once you've mastered the keyboard, you don't have to stick with the piano, a range of instruments are at your fingertips

and appears to stumble in places for some pieces.

After each performance you are given a pitch and rhythm assessment which is extremely perceptive and useful. It points out where you played incorrect notes (in measure so and so) and what they were. All is logged on your progress chart.

PRACTICE ROOM

At the end of each lesson, the 'teacher' recommends various practice routines and pieces to try. Unlike Performance you can practise

parts on their own, with or without a metronome rhythm and demonstrations of the piece are given on request. Again an accurate analysis of your faults and suggestions on how to improve are plus points for the system.

STUDIO SOUNDS

This is a simplified sequencer. There are no quantize facilities but you can record on up to 7 tracks although you can't delete any of the tracks at all. The purpose is to give you a taste of multi-tracking using different sounds for each track. It's fun, but basic. The keyboard has 128 voices and you can assign these to any of the tracks. The hardware does not output MIDI until the serial connection with the Amiga is unplugged, therefore data created by the Miracle system cannot be copied, at least not directly.

MIDI MAGIC

MIDI is well catered for but voices do not obey pitch bend and modulation commands and the note range is limited to the four octave keyboard – there are no extra 'hidden' notes that are found on many MIDI instruments. The keyboard can be split with two sounds spread across the instrument, but the only way to do this is using Systems Exclusive data – if you fancy a few hours entering hexadecimal code, be my guest!

Generally The Miracle Piano

Teaching System is very good. However since the hardware is bundled in with the package and there is no way you can use it with any other MIDI keyboard as a teaching aid, it does rather limit the entire scope of the package. I can see that the developers would be wary of putting it out as a set of disks as the pirating opportunities could blow

the idea out of the water. But is a four octave unweighted keyboard sufficient to qualify as a good instrument to learn on?

Although it is a MIDI multi-timbral module, it is not in itself a self-contained instrument. If it had auto features such as drums, bass and chords it might be a little more attractive. If it was purely a MIDI based teaching system, its scope would be tremendous but it could be cloned easily: if you protect the disk you can't, by the nature of MIDI as a common language, protect the

transmission of the data. A keyboard with self-accompanying features could make the system more versatile and stand a higher price.

The manual lists helpful suggestions and points out that there is no substitute for a good teacher. However as a practice aid it is very intelligent and well thought through. It picks up on your weaknesses and encourages you to work hard at them, stressing the need for regular practise. As a sight reading trainer, it is also very useful. The final pieces are about Grade 1 or 2 standard, although the preset tempos may be hard to achieve first time.

This concept could be adapted to teach different styles, improvisation, jazz, rock as well as the basics. There could be theory sections, orchestration exercises and with the prospect of CDTV, the concept could take off in rather a big way with real images, as opposed to graphics.

It has a great future in schools as it can cope with a large roster of pupils and keep tabs on their progress – a bonus for the hard pressed teacher. All it needs is to be able to tie in the practice times to a built-in clock and you will have a record of the pupils' practice time and effort for the week – the Big Brother of all music teachers! **AS**



SHOPPING LIST

The Miracle Piano..... £299
Teaching System
By Mindscape, The Coach House
Hooklands Estate,
Scaynes Hill,
West Sussex RH17 7NG
☎ 0444 831761

**CHECKOUT
MIRACLE PIANO**

Ease of Use ●●●●●
Simple and intuitive.

Features ●●●●●
Excellent and innovative approach to learning an instrument; has possibilities beyond those on offer.

Documentation ●●●●●
Well written and full of useful advice.

Hardware ●●●○○
Sounds could be improved on, although it can be used on its own.

Software ●●●○○
Great, as long as you have a hard disk; twin floppy drives are a necessity.

Overall rating ●●●●○

One or two small points hold this back: once the minor musical idiosyncrasies are ironed out it should do very well. If there was a way to make it work via MIDI it would clean up totally.

FRUSTRATED ?

For Friendly Assistance on the

AMIGA.

Ring 0891 505 105

First 200 callers receive

Free Disks

Spreadsheet offer to all callers.

Calls cost 36p min cheap rate
48p all other times.

THIS IS IT!

C and Assembler programming for the Amiga.

In just 12 comprehensive lessons even beginners can learn how to use COPPER, BLITTER, HAM, OVERSCAN, INTERRUPTS, BOBS, SPRITES, and a whole lot more. By the end of the course, and with a little practice you should be able to write your own programmes, either for fun or for business.

The course, successful running in Denmark for some years, is now available to YOU! Each lesson costs £12.00 and will be sent out monthly on receipt of payment. Two disks are also available at £10.00 each to enhance your enjoyment of the course. Should you pay for all twelve lessons in advance, these disks will be sent to you free - a saving of £20.00!

Please send me the first lesson in DataSchool's correspondence course for:

C programming Assembler

I enclose a cheque for £12.00 per course payable to DataSchool for the first lesson.

Name:

Address:

Send to: DataSchool, PO Box 2550, London N19 5AF. Tel: 071-272 6981.



White Knight Technology

AMIGA Specialists

Phone / Fax
(0992) 714539

Commodore

AMIGA

- A1500 With NEW Workbench 2 £564.99
- A1500 + Colour Stereo Monitor £814.99
- CDTV (+ FREE Lemmings etc.) £474.99
- A3000 25Mhz 50/100 (+ Scala) £ CALL

All Machines are supplied with full Commodore software packages

ALL OTHER COMMODORE HARDWARE SUPPLIED

SPECIAL OFFER

COMMODORE A2088
'PC-XT' BRIDGEBOARD
WHILE STOCKS LAST, ONLY
£149.99

WORKBENCH 2.04

FOR
AMIGA
500/1500/2000
£79.95

AMIGA SOFTWARE ALSO SUPPLIED
(PRODUCTIVITY and LEISURE)
AT COMPETITIVE PRICES

1 Meg Upgrade For A500+
(Gives 2 Meg of Chip RAM) only £49.99
ROM Sharer For A500/500+/1500
Holds 1.3 & 2.0 Roms only £24.99

AMIGA Upgrades

HARD DRIVES

- GVP HD8 Hard Drive For A500 £374.99
- GVP HC8 Hard Drive For A1500 £279.99

68030 ACCELERATORS

GVP Combo 22Mhz Accelerator for A1500/2000. Inc 1Mb of 32-Bit RAM (exp. 13Mb) + SCSI Controller. £549.99

GVP Combo 33Mhz Accelerator for A1500/2000. Inc 4Mb of 32-Bit RAM (exp. 16Mb) + SCSI Controller. £899.99

Microbotics VXL-30 Accelerators for A500/A500+/A1500 & A2000 :-
25Mhz 68030 Version £289.99
40Mhz 68030 Version £399.99
VXL 2Mb 32-Bit RAM (Burst) £249.99
VXL 68882 Co-Processor Kit £149.99

GVP A3050, 50Mhz Accelerator for A1500/2000. 4Mb + IDE Cont. £1599.99

68040 ACCELERATORS

GVP G-Force 68040 Accelerator for A3000 only. 28MHz, 22Mips! £1849.99

PP&S 28Mhz 68040 Accelerator for A3000 only. £1299.99

PP&S 68040 Accelerator for A1500/2000 28MHz inc. 4Mb of 32-Bit RAM £1599.99

GRAPHICS/VIDEO

GVP IMPACT VISION 24-Bit Colour Board (1500/2000/3000) From £1649.99

DCTV (PAL Version) £ 479.99

RENDALE 8802 Genlock £ 169.99

Also supplied: PRINTERS, DISK DRIVES, MONITORS, MODEMS, SCANNERS etc.!

Can't see what you require? Please call to discuss your requirements.

We are available to take your calls 7 days a week, until 10pm!

White Knight Technology

VAT No. 589 7242 82

PO BOX 2395, WALTHAM CROSS, HERTS, EN8 7HQ

ALL PRICES ARE INCLUSIVE OF VAT & POSTAGE. ADD £10.00 FOR COURIER DELIVERY

WE ARE OPEN ALL HOURS

9am-10pm Mon-Sat
10am-6pm Sun

HARDWARE

- A500 Plus & Software£349.00
- A500 512K£299.00
- A1500 & Software£565.00
- 1084S Monitor£237.00

Phone for 2000 & 3000 prices.

JOYSTICKS

- Quickshot II£6.50
- Speedking Autofire£10.50
- Competition Pro 5000 Black£11.90
- Competition Pro Glo Autofire.....£12.95
- New Competition Pro Star Autofire.....£13.25
- Maverick Autofire.....£12.95
- Zipstick Autofire£12.95

LOOK! LOOK! LOOK!

TRACTOR FEED DISK LABELS

500 plain white labels & software to print your own professional labels

Only £9.95

ACCESSORIES

- Amiga Int drive£49.00
- Cumana Ext drive£53.00
- Zydec Ext drive£49.00
- 512K upgrade with clock£27.90
- 512K upgrade no clock£24.90
- 1.5 Meg upgrade with clock£79.00
- 1 Meg Amiga plus upgrade.....£46.99

DISKS with labels

Unbranded Bulk 100% Certified

- 3.5" DSDD37p each
- 3.5" Rainbow44p each
- 3.5" DSHD71p each
- 5.25" DSDD28p each

Branded Disks

- 3.5" DSDD55p each

Please phone for bulk purchase discounts

MISCELLANEOUS

- Mousehouse£1.60
- Mouse Mat£2.50
- Disk Drive Cleaner£1.80
- Amiga Dust Cover£3.50
- Monitor Dust Cover£3.50
- Mouse/Joystick Auto Shift£14.95
- Amiga Light Pen & Software£32.00
- Mega Mouse£14.90
- Squik Mouse£14.90
- Naksha Mouse & Accessories£22.00
- Zy-Fi Amplifier & Speakers£37.95
- Thumb & Finger Trackerball.....£19.99
- Crystal Trackball.....£32.00
- Action Replay Mark III£57.00
- Techno Sound Turbo Sampler£30.00
- 2 Piece Printer Stand£5.70
- Midi Master£26.00
- Wordworth 1.1£77.50

PRINTERS

- Star LC-20£149.00
- Star LC 24-10£214.00
- Star LC200 Colour.....£204.00
- Star LC-24-200 Colour.....£294.00

STORAGE BOXES

- 10 capacity£0.95
- NEW 20 capacity Sony£1.49
- 50 capacity lockable£3.95
- 100 capacity lockable£4.50
- 80 cap Banx stackable/lockable£7.99
- 150 cap Posso stackable/lockable£15.00
- 250 cap stackable/lockable.....£18.99

Orders by phone or post to:
DIRECT COMPUTER SUPPLIES

0782 - 642497

0630 - 653193

0782 - 311471

9am - 5.30pm week

Anytime

Evening/Weekend

54 Spring Road,
Longton,
Stoke-on-Trent,
Staffs ST3 2PX

Prices include VAT
Postage please add £3.30
We accept cheques/
P.O.'s/Visa/Access

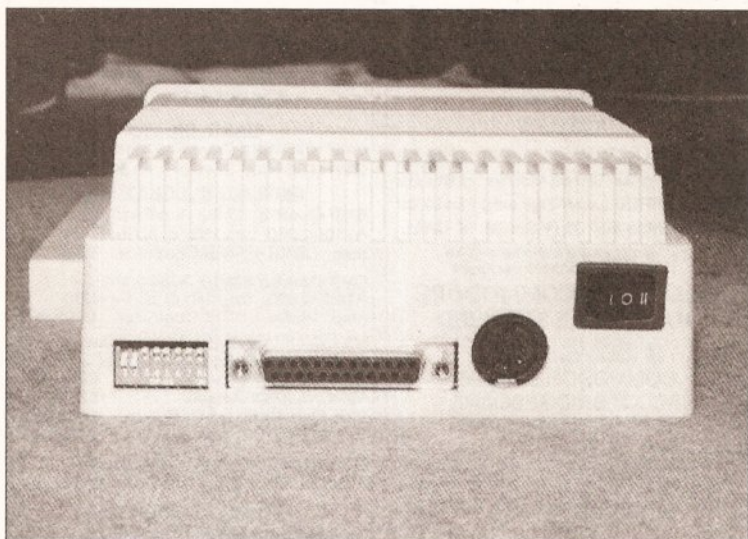

A side view of the Rochard hard drive showing the SCSI port. The manual gives clear instructions on fitting it to your Amiga

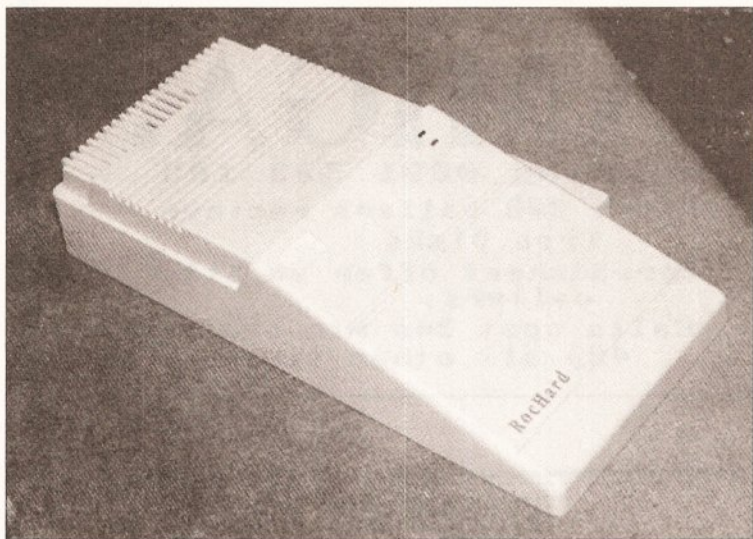

What the well dressed Amiga 500 will be wearing this spring – in familiar Amiga cream, this style would be a welcome addition to any Amiga wardrobe

Solid as a rock

Ian Wrigley tests the RocHard hard drive which looks a likely contender for one of the best value drives around

As far as the Amiga is concerned, Roctec is a fairly new company. It is, however, already beginning to make quite a name for itself as a manufacturer of high-quality, low-cost peripherals for the Amiga: the RocLight floppy disk drives have gained good reviews, and the RocGen Plus genlock was reviewed in *Amiga Shopper* a couple of months ago, when Gary Whiteley gave it a rating of four out of five. So it was with interest that we took shipment of the RocHard (lose points for the dreadful name, boys) hard disk drive for the Amiga 500 and 500 Plus.

FIRST IMPRESSIONS

The RocHard is attractively packaged in a colourful, well-cushioned box. Opening up reveals the drive itself, in the familiar Amiga colour scheme (drab off-cream), a separate power supply, a utilities disk and a thin, 32-page manual.

The drive connects to the Amiga 500 in the usual fashion, by plugging into the expansion port on the left-hand side of the Amiga. The power supply connects to the drive via a DIN plug, and that's all there is to it. It was surprising to find that the drive's power supply has no on-off

switch of its own. Instead, according to the manual, "RocHard automatically senses the Amiga's power," in other words, it switches itself on when you power up your Amiga. Now, there's no reason to think that this is anything other than a good idea, but I must admit that I would have preferred an external power switch as well. I tend to find that I unplug the drive when I'm not using the Amiga, which is a pain to do. The addition of a simple, 10p switch would have given me much more peace of mind.

THE WRITTEN WORD

The manual is clearly written, and explains exactly how to plug in your RocHard. Because the unit can come either ready-assembled or as a kit with you supplying your own disk drive, much of the beginning section is taken up with instructions on how to disassemble the casing and fit a hard drive. There is none of the dodgy English which you often find when manuals have been prepared in a foreign country, and the procedure is explained clearly and concisely.

You can install any of a wide range of hard disks in the RocHard – six different manufacturers and disk models are listed as being

supported. The drive must be a 1-inch, IDE-HDD model. IDE drives tend to be cheaper than SCSI, and are also claimed to be fractionally faster.

As far as the normal user is concerned, there will be no noticeable difference in speed, whether you use an IDE or SCSI drive. If you really want SCSI, an extra module is available as an upgrade to the RocHard, which will allow you to chain SCSI drives, CD-

The unit has two sets of switches on its back panel. One to enable and disable the hard drive and/or RAM, for full compatibility with games, and a set of dip switches which tell the unit whether you're using Kickstart 1.2 or a later version. (If you're using Kickstart 1.2, you won't be able to auto-boot from the hard drive). For some reason the dip switches also determine whether the RAM and disk

The system on test

The system we tested was fitted with a 52Mb Quantum hard drive and 4Mb of extra RAM. However, a range of options are available with more (up to 8Mb) or less memory, and a larger hard drive, if required.

ROM readers, tapestreamers, or whatever, off the back of your Amiga; the actual 25-pin D-type SCSI connector is present in the unit but the driving hardware must be bought separately (although an already-upgraded version will also be sold). You can also add up to 8Mb of RAM, via SIMM modules. Again, the unit is sold in various configurations with none, some or all RAM already installed.

drive are enabled or not, which means that they perform exactly the same job as the other switch. Why? Don't ask me.

INSTALLATION SOFTWARE

The software which comes with the RocHard allows the user to format and partition the hard drive. Partitioning splits the drive up so that it appears as two or more

separate disks on your Workbench; whether you do so or not is entirely up to you, but it can be useful to have a separate boot partition. For example, my hard disk is set up with three partitions: one for Workbench 2.0, one for Workbench 1.3 and one for my files, applications and so on. Because I'm running an A500 Plus, I can determine whether to boot from WB 2.0 or 1.3 by holding down both mouse buttons when rebooting – useful if I want to test programs for compatibility or if (heaven forbid) my Workbench 2.0 partition becomes corrupted and won't boot properly. You can have a maximum of 10 partitions, named DHO: to DH9:, regardless of how many actual hard disks you have. The manual goes through the arguments for whether to partition or not, and explains the advantages and disadvantages clearly.

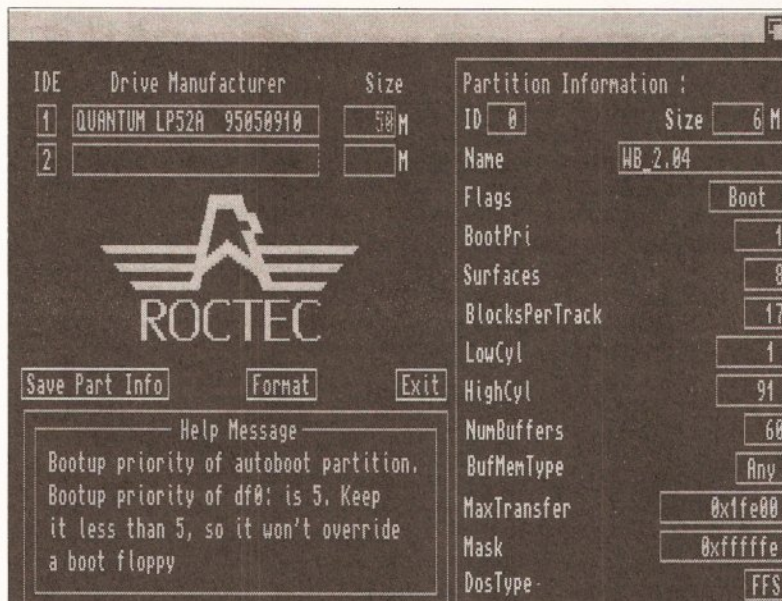

The formatting utility provides on-line help as the cursor moves over a user-alterable setting, the help window displays information on what that setting does

SOFTWARE ON TEST

The supplied software works reasonably well, although it's not the most intuitive I've ever used. The manual takes you through its usage, and will be adequate if you're formatting from scratch. However, it becomes rather less helpful if you're re-formatting and partitioning an already installed disk; I wasn't content with the way my unit was set up when it was supplied, and it took me a good 30 minutes to sort it out to my satisfaction. Of course, this might just have been my obtuseness, but I don't think so. On the plus side, however, you'll probably only ever use the formatting software once, so you'll only have to wrestle with it once.

When setting up partitions, you are given the option to decide

whether each one is bootable or not. If you select 'yes', the formatting procedure includes the copying of Workbench to the hard disk – a far neater solution than expecting the user to manually copy the files across afterwards.

Power users are given the option to get right down into the nitty gritty of partition information, to hack the very best performance out of the disk; the majority of us, though, can happily leave such things as "the number of sectors per track" and "the maximum number of bytes to transfer in one AmigaDOS I/O request" for the software to sort out.

Finally, the software includes the ability to create a special boot disk for Kickstart 1.2 owners which makes the Amiga recognise the hard

disk after it's booted from the floppy. This is about the only way to use a hard disk on a Kickstart 1.2 system, and anyone who hasn't upgraded to 1.3 or 2.0 is strongly recommended to do so (whether you are intending to buy a hard drive or not).

UP AND RUNNING

Once all the formatting and partitioning has been done, all that remains is for you to switch on your Amiga and be amazed at the speed with which it boots up. If you've never used a hard disk-based Amiga, it will be a revelation to you, and you'll wonder how you ever managed with a floppy disk-only system.

My system has more than its fair share of extras to contend with in the startup-sequence, but it still boots up in under 20 seconds. And, of course, you get to use things such as the outline fonts (on a Workbench 2.0 machine) which are such a pain on a floppy-based system that you've probably never bothered to try.

I do have a slight complaint with the unit when booting: occasionally, when turning on for the first time in the morning, the extra RAM fitted in the RocHard isn't recognised. Re-booting solves the problem, and it only occurs when the drive is turned on for the first time in the day, but it does suggest that perhaps power isn't getting to the chips as soon as it should. Roctec has been notified of this glitch, and is working to find a solution and I must admit that hitting Control-Amiga-Amiga as soon as the machine has powered up has become a habit which is no hardship. Still, this is a problem and one which should be addressed.

The unit is also fairly noisy – the fan's whirring can be a bit obtrusive at first, although you soon get used

to it. Whether a fan is actually necessary or not is open to debate; the front of the unit does get slightly warm to the touch, but the fan is actually at the back. The vents are situated at the top rear of the RocHard, rather than on the back panel, which means that one spilled cup of coffee could ruin things for good.

CONCLUSIONS

As this is a one-off review, there isn't much point in quoting actual speed figures as they tend to be rather meaningless without a range of other options to compare them with. However, the RocHard is certainly up there with the faster models – it took less than two seconds to launch *DPaint III*, for example. In general performance it rivals any of the other drives and makes my Macintosh at work seem positively sluggish!

Although RocTec isn't the best known company in the Amiga arena yet, products like the RocHard should soon change that. If you're looking for a hard drive for your Amiga, this should be high on your list. **AS**

SHOPPING LIST

RocHard hard disk drive £379
With 52Mb drive (approx)
Prices vary according to the size of disk drive and expansion RAM fitted

Distributed by Zye Technology
Unit 2, Alpine Works,
Oak Road,
Crawley
W Sussex RH11 8AJ

JARGON BUSTING • JARGON BUSTING

High level format – An AmigaDOS format. Prepares the drive for use with AmigaDOS by formatting it with OFS or FFS.

Low level format – Hard drives are weird beasts and this initial formatting is done by the drive controller, usually only once when the drive is first configured.

OFS – The old filing system dating back to the old days of the Amigas. It works, but it is not suitable for the improved speeds and storage capacities available with hard disks.

FFS – Fast filing system. A new filing system driver introduced with Workbench 1.3. Disk blocks are arranged so that large amounts of data can be read quickly. Reads and writes are speeded up by up to seven times. Directory searching is around ten times faster and the hard disk partition limit is raised to two Gigabytes. Some older hard disk systems cannot boot with FFS.

Prep – Tells the drive what size it is, the interleave factor, filing system type, where the bad blocks lie etc.

CHECKOUT RocHard

Construction ●●●○○
RocHard matches the Amiga perfectly; however, it would have been even better if the fan vent wasn't on the top of the machine.

Speed ●●●●○
As far as speed is concerned it's up there with the best of them.

Documentation ●●●○○
Nothing special – it's adequate, and that's about it.

Usage ●●●●○
Would have got the whole 5 blobs if it wasn't for the RAM problem on initial startup.

Price Value ●●●●○
Pretty damn good, actually.

Overall rating ●●●●○
In my opinion the RocHard hard drive should be high on your list when shopping for a hard drive.

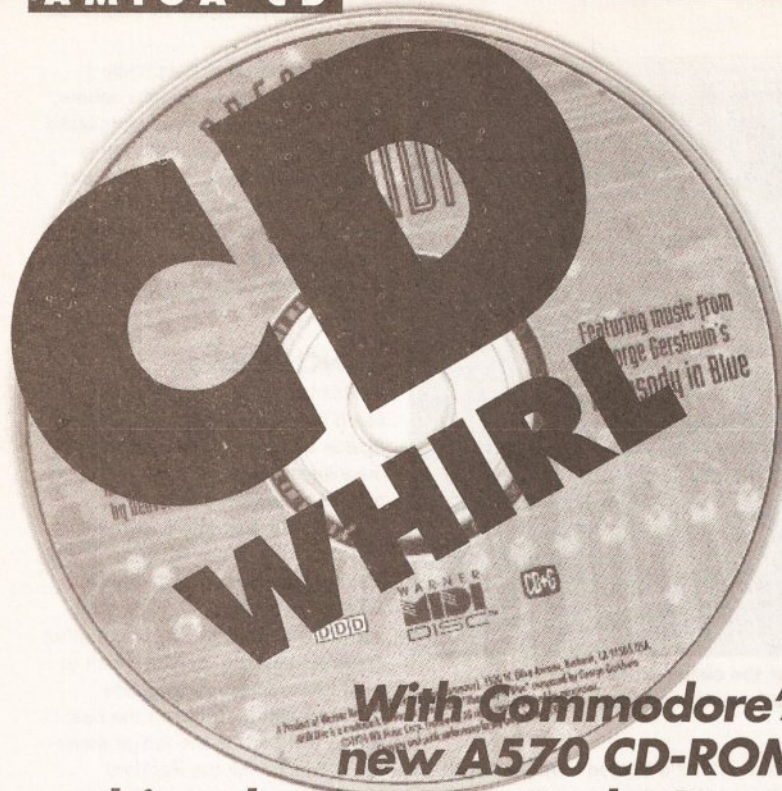

With Commodore's new A570 CD-ROM drive due in May, Andy Storer looks at the hardware options and spins some of the latest releases...

By now, many readers will be wondering whether buying an A570 CD-ROM drive is a viable addition to their Amiga system. But, given the investment involved, you may also wish to consider some other possible alternative CD systems.

Expected to pitch in at just under £300, the A570 certainly looks good value for money compared to CD drives for the PC-compatible market where Sanyo and Phillips are introducing similar specified drives at the same price. But the key to sound purchasing involves more than just the price of the hardware in question. And more than the price of the software if it comes to that. What prospective buyers should bear in mind is continuing software availability. No point in buying a white elephant, is there?

So can we expect to see a flood of non-games CDTV titles? A look through Commodore's most current list of CDTV applications shows the following breakdown of titles by category:

- Arts & Leisure 13
- Education 25
- Entertainment 38
- Music 8
- Reference 15
- Total 99 titles

So, we can safely say that approximately 60% of CDTV disks can be deemed to be of 'serious'

interest. Whether this ratio remains the same is open to question. But are CDTV titles the only disks you can run on a A570?

OTHER WORLDS

There are now well over a thousand CD-ROM titles available for the burgeoning PC CD market and within

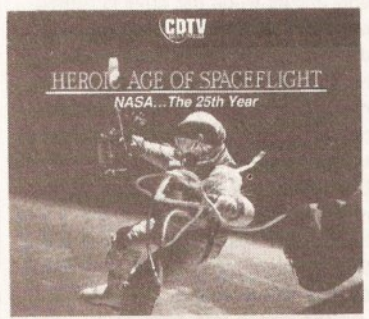
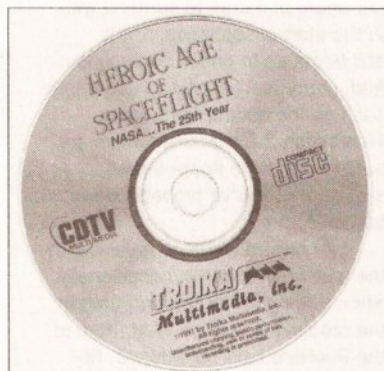

Troika's innovative NASA – the first Amiga CD-ROM to offer moving video

certain constraints it will be possible to run them on the new drive. There are three determining factors:

- The disk must be mastered in either the High Sierra or ISO-9660 standard formats. Fortunately most PC disks are formatted to the latter.
- The disk must contain data your Amiga can read – that's ASCII for text and TIFF, GIF or EPS for graphics. Of course, many Amiga image packages, such as Art Department Professional, and PD utilities offer handling of other graphics formats.
- The data on the disk must be freely accessible and not dependent on custom retrieval software or compression algorithms.

These golden rules aside, it's still best, if possible, to try before you buy – compatibility has always been the bugbear of computing.

Another option is to run a PC

Amiga though so all these options have yet to be thoroughly tested. Rest assured though, in *Amiga Shopper* we'll be bringing you the results of definitive testing just as soon as it's completed (and we manage to get hold of an A570!)

CD-ROMS SET TO SPIN

New Horizons *Pro-Write* CD-ROM is scheduled for release in Spring. The single disk contains version 3.2 of this leading word processor plus *Flow 3.0*, *Design Works 1.0* and *Profonts 1*.

No price is set as yet but along with Texan company, The Station, New Horizon is to offer the disk, along with CDTV unit, 1084s monitor, printer, external floppy drive, modem, mouse and keyboard for the all-in price of \$1995 (approx. £1140). Dubbed The Odyssey, the



The new A570, Commodore's CD-ROM add-on for the Amiga, expected to sell for £300. Even without a PC emulator it should be able to run PC CD titles

emulator board like KCS's, find some PC CD-ROM driver software and run the PC files direct. Since PCs recognise an attached CD-ROM drive as a networked logical device and not a DOS device this should be possible. We know of no-one who has had a chance to test this on an A570 yet though.

SCSI PATHS

However, if you own a PC, or plan to at some future date, or simply manage to come across a good deal, there's another solution to building a vast collection of CD-ROM titles without even considering an A570 drive. Buy a PC drive and hook it up to your Amiga!

The key here is that the device in question must be a SCSI drive and you must have a SCSI hard disk interface. Apart from the linking SCSI cable, you'll also need some CD-ROM driver software. Canadian Prototype Replicas on 0101 519 884 4412 offers its *CDROM-FS* to do just this. For \$50 you get driver software which will work with hard disk controllers for the A590, A2091, and GVP series II and CD drives from Sony, Hitachi, Pioneer and NEC.

It's still early days for CD on the

bundle is being advertised as an 'all-in-one personal workstation'.

NEW CD-ROM RELEASES

Easily the most exciting CDTV release of the year so far, Troika Multimedia's *NASA...the 25th Year*, is the first interactive motion picture available on any CD-ROM platform. Using Commodore's new CDXL format, *NASA* is a 50 minute overview of the early decades of space flight and can be viewed as a movie with the user able to jump directly to an index of a dozen different subjects supplemented by icon-driven text and still graphics.

The digital motion picture, replete with stereo sound, is the most innovative feature of the disk though. The CDXL format produces a quarter screen, 10 frames a second window in the middle of your TV or monitor at surprisingly good resolution. You can watch movies of early aeronautic research, and excerpts from the Apollo, Voyager and Viking missions along with Space Shuttle sequences. The disk is compatible with the A570 drive but will require at least 1Mb of Chip RAM to run the new CDXL format. All this for only \$24.95. Troika is on 0101 703 841 5160. We'll be running a full review next issue. **AS**

AMIGA CDTV

Amiga CDTV is a revolutionary new concept in home entertainment and education, representing leading edge technology. The CDTV player combines a high quality performance CD audio system, advanced Amiga technology and infrared remote control to offer a huge range of interactive applications, from Mega games to music and educational applications, e.g. languages (French, German and Spanish).

The integration of CD audio, graphics, animation, video and text gives you true multi media for corporate and business presentations. Each CD-ROM disk can store an incredible 540MB of data, equivalent to a quarter of a million pages of text.

The Amiga CDTV connects to a standard television in the same way as a video recorder and can be connected to a hi-fi system for high quality audio sound.



SAVE
£139.98

RRP - £638.97

CALCULUS
PRICE

£499.99

AMIGA CDTV GAMES PACK

The best value CDTV games pack around featuring two top quality games in original packaging and also the 530 titles megadisc, FRED FISH all completely free.

THE ULTIMATE GAMES SYSTEM FEATURING:-

- Amiga CDTV player
- Software:-
 - ▶ Welcome disc
 - ▶ Lemmings
 - ▶ Hutchinson's Encyclopaedia
- Infra Red Remote Controller



XENON 2

RRP £29.99

The ultimate arcade action game featuring top chart stereo sounds and artist history.



PSYCHO KILLER

RRP £29.99

Driving down unfamiliar country roads after dark, your worst nightmare comes true!!



FRED FISH MEGADISC

RRP £79.00

530 titles on this one CDTV disk free with this package!!



AMIGA CDTV UPGRADE PACK

The CDTV Amiga Upgrade Pack allows existing CDTV owners to tap into the massive base of Amiga 3.5" games software.

Upgrade Pack contains:- ● CDTV Amiga keyboard ● 3.5 CDTV Amiga external black drive

FRED FISH MEGADISC

530 TITLES ON THIS ONE CDTV DISK WITH THIS PACKAGE!!!

PLUS

WORTH
£79.00
R.R.P.

RRP - £208.99

CALCULUS
PRICE

£149.99



AMIGA CDTV STARTER PACK

The starter pack gives you a full 1MB Amiga compatible system featuring:-

- Amiga CDTV player
- CDTV Amiga keyboard
- Cumana 3.5" CDTV external black drive
- Software:-
 - ▶ Welcome disk
 - ▶ Lemmings
 - ▶ Hutchinsons encyclopedia

FRED FISH MEGADISC

530 TITLES ON THIS ONE CDTV

RRP - £699.99

CALCULUS
PRICE

£629.99

MONITOR NOT INCLUDED

GOLDSTAR COLOUR MONITOR/TV inc

REMOTE CONTROL

- 14" colour TV.
- 40 Channel Program Memory
- 21 Pin Amiga Scart Lead
- Sleep Timer
- Full Remote Control
- Full function on screen display.



Check the amazing value of the Amiga Compatible Gold Star colour monitor/TV. for just £179.99 and you can have the best of both worlds, a top quality remote control TV and... Amiga Monitor.

SAVE
£55

RRP - £234.99

CALCULUS
PRICE

£179.99

PERIPHERALS & SOFTWARE

| | |
|---------------------------------------|---------|
| CDTV keyboard | £49.99 |
| CDTV Tracker Ball (infrared) | £79.99 |
| CDTV Genlock | £149.99 |
| CDTV 3.5" Amiga External Floppy Drive | £79.99 |

Top Ten Software Titles

Word Vista Atlas · Moving Stomach Ache
Tales of Peter Rabbit · Long Hard Day At The Ranch · Wrath of the Demon · Sim City
Defender of the Crown · Snoopy · Xenon
· Bun for Barney

SOFTWARE Top Ten Software Titles with 10% off RRP (Offer open until 30/4/92)



THE NEW AMIGA 1500

The Amiga 1500 system offers total compatibility with the Amiga 500, with an unbelievable level of internal expansion options.

All our Amiga 1500's featured in our advertising, are the latest version, featuring Kickstart 2 ROM and Workbench 2, offering significant enhancements over the previous model.



AMIGA 1500 STARTER PACK



- **AMIGA 1500 'CALCULUS' STARTER PACK** Amiga 1500 Dual Drive, 1Mb RAM Mouse, Manuals and Amiga DOS.
- **THE WORKS - PLATINUM EDITION** A full integrated software package with Word Processor (inc. English Dictionary) Spreadsheet and Database Package.
- **DELUXE PAINT III** Probably the best paint package available, allowing you to display your hidden talents. This award winning software allows you to paint, design or animate.
- **HOME ACCOUNTS** Home accounts with budgeting, forecasting and graphics.
- **ELF** - You will encounter Cornelius the Elf on your travels in the mystical lands of Gooks and Goblins. Weird villainous creatures and devious puzzles test your gameplay techniques and gnostic powers.
- **TOKI** - The arcade sensation that swept the world. Toki has been transformed into a monkey by the evil wizard. He must now try to regain his manhood and rescue his beloved princess Miho. Join Toki on his mythical adventure, full of demons and deadly witchcraft.
- **PUZZNIC** - A puzzle game to top them all. It's fast, furious and devilishly addictive. With 144 levels, the action never stops.

RRP - £699.99

CALCULUS PRICE

£579.99 (£493.60 Ex VAT)

POWERED BY QUANTUM FAST ACCESS HARD DRIVE

AMIGA 1500 HD PROFESSIONAL PACK

Amiga 1500 Dual Drive with 52Mb Quantum Fast Access SCSI Hard Drive Upgrade and Controller Card.

Plus other contents as in the Amiga 1500 'Calculus' Starter Pack.

RRP - £1027.00

CALCULUS PRICE

£829.99 (£706.37 Ex VAT)

Pack contents as with the Amiga 1500 'Calculus' Starter Pack plus the following:- A520 TV Modulator. A TV Adaptor that allows you to use the Amiga 1500 on a colour television.

RRP - £729.99

CALCULUS PRICE

AMIGA 1500 and A520 MODULATOR BEGINNERS PACK

£599.99 (£510.62 Ex VAT)

AMIGA 1500 STARTER PACK & 1084 MONITOR & 1270 INK JET PRINTER

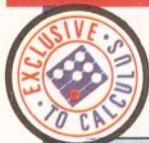

Pack contents as with the Amiga 1500 Starter Pack and 1084 Monitor, plus the MPS 1270 Ink Jet Printer. (Epson FX80/85 compatible Ink Jet Printer.)

RRP - £1109.97

CALCULUS PRICE

£859.99 (£731.89 Ex VAT)

AMIGA 1500 STARTER PACK and 1084 MONITOR

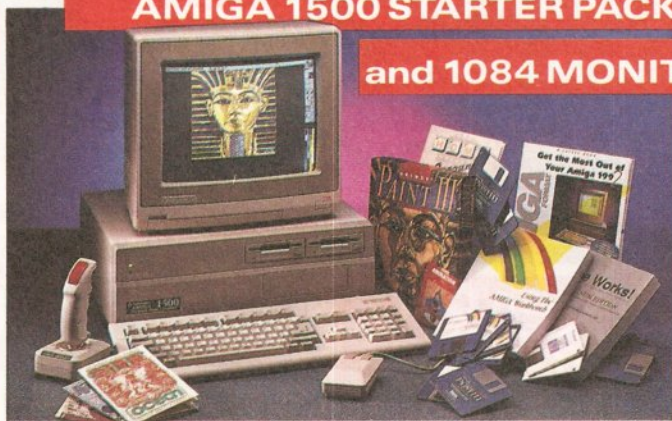

Pack contents include the Amiga 1500 'Calculus' Starter Pack plus the following 1084 14" Colour Amiga Monitor with Amiga Cable.

RRP - £959.99

CALCULUS PRICE

£729.99 (£621.26 Ex VAT)

ON-SITE SERVICE

For total peace of mind - why not take out a 12 months on-site warranty on your new Amiga 1500/2000 system.

£59.99

PHONE 0543 251275... FOR YOUR LOCAL STORE... PHONE 0543 25127

THE NEW AMIGA 2000

PROFESSIONAL RANGE



The Amiga 2000 has been designed as a basic system expandable to satisfy the needs of the home, business or professional user. Our Amiga 2000 XT/AT Emulations offer the very best of both worlds. A combination of the Amiga's amazing sound, graphics, speech and video with the ability to use industry standard MS-DOS business applications. An Amiga 2000 and IBM compatible PC in one box.

VISIT
YOUR LOCAL
CALCULUS
STORE FOR
A FREE
DEMONSTRATION

OVER SEVENTY
STORES THROUGHOUT
THE U.K.
FOR MORE
INFORMATION AND
THE LOCATION
OF YOUR LOCAL
CALCULUS STORE
PHONE

0543
251275

COMPUTER DATABASE
OF CALCULUS STORES

ITEMS HELD IN STOCK MAY
VARY FROM STORE TO STORE

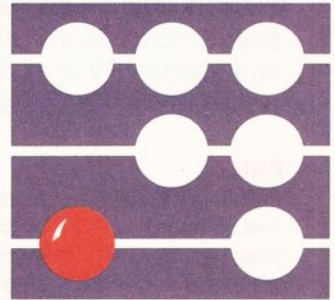

CALCULUS
COMPUTER STORES

AMIGA 2000 XT MS-DOS EMULATION



FEATURES

Amiga 2000 Dual Drive with the A2088 XT Bridge Board and 360K 5.25" MS-DOS Floppy Drive Complete with MS-DOS Operating System Features NEW Kickstart 2 and Workbench operating system. Optional Hard Drive available.

RRP - £1229.00
CALCULUS PRICE
£699.99 (£595.74 Ex VAT)

AMIGA 2000 AT MS-DOS EMULATION



FEATURES

Amiga 2000 Dual Drive with the A2286 AT286 Bridge Board and 1.2Mb 5.25" MS-DOS Floppy Drive Complete with MS-DOS Operating System Features NEW Kickstart 2 and Workbench 2 operating system. Optional Hard Drive available.

RRP - £1449.00
CALCULUS PRICE
£899.99 (£766.00 Ex VAT)

AMIGA 2000 PERIPHERALS

- 52Mb Quantum Fast Access SCSI Hard Drive with SCSI High Speed Controller **£249.99** (£212.00 ex VAT)
- NEW!** 120Mb Quantum Fast Access SCSI Hard Drive with SCSI High Speed Controller **£369.99** (£314.88 ex VAT)
- NEW!** 240Mb Quantum Fast Access SCSI Hard Drive with SCSI High Speed Controller **£739.99** (£629.77 ex VAT)
- 8Mb Microbotics 8UP DIP RAM Board with 2Mb RAM **£169.99** (£144.69 ex VAT)
- 2Mb Additional RAM for Microbotics 8UP DIP **£69.99** (£59.56 ex VAT)
- NEW!** 2Mb Microbotics VXL-32 RAM Board for VXL-30 Board **£199.99** (£170.20 ex VAT)
- 25Mhz Microbotics VXL-30 030 Accelerator Board **£269.99** (£229.78 ex VAT)
- 40Mhz Microbotics VXL-30 030 Accelerator Board **£399.99** (£340.00 ex VAT)
- 68881 FPU Co-Processor for Microbotics VXL-30 Board **£69.99** (£59.57 ex VAT)
- 68882 FPU Co-Processor for Microbotics VXL-30 Board **£129.99** (£110.63 ex VAT)
- A2088 XT Bridge Board with 360K 5.25" Floppy Drive **£129.99** (£110.63 ex VAT)
- A2286 AT Bridge Board with 1.2M 5.25" Floppy Drive **£329.99** (£280.84 ex VAT)

AMIGA 2000 PVP VIDEO PRESENTATION SYSTEM

FEATURES:

Amiga 2000 Dual Drive with
● 52Mb Quantum Fast Access SCSI Hard Drive ● SCSI High Speed Controller ● A2300 Internal Genlock ● Deluxe Paint III ● Scala Presentation Software ● Video Cables and Presentation Video

RRP - £1299.00
CALCULUS PRICE
£1049.99 (£893.60 Ex VAT)



AMIGA 2000 SYSTEM FEATURES

- Dual 3.5" 880K Floppy Drive
- 1Mb Chip RAM ● 1352 Amiga Mouse
- NEW WORKBENCH 2 discs and Manuals
- Power Cable ● Amiga Keyboard

If you require an Amiga 2000 configuration not listed, please contact your Calculus dealer for an unbeatable price quotation.

FREE AMIGA VISION SOFTWARE WITH ALL AMIGA 2000 SYSTEMS
Amiga Vision lets you create multi media presentations and course-ware which combines graphics, charts, motion video and sound. Normal Retail Price £116.33

OUR LOCAL STORE... PHONE 0543 251275... FOR YOUR LOCAL STORE...

KCS POWER PC BOARD FOR YOUR AMIGA



The best of both worlds
in the space of one



Now Available
with or without
MS-Dos
See Below

SEE US AT
AMIGA
SHOPPER
SHOW STAND
D2

Adapter + PC Board
for the Amiga 1500/2000/2500/3000

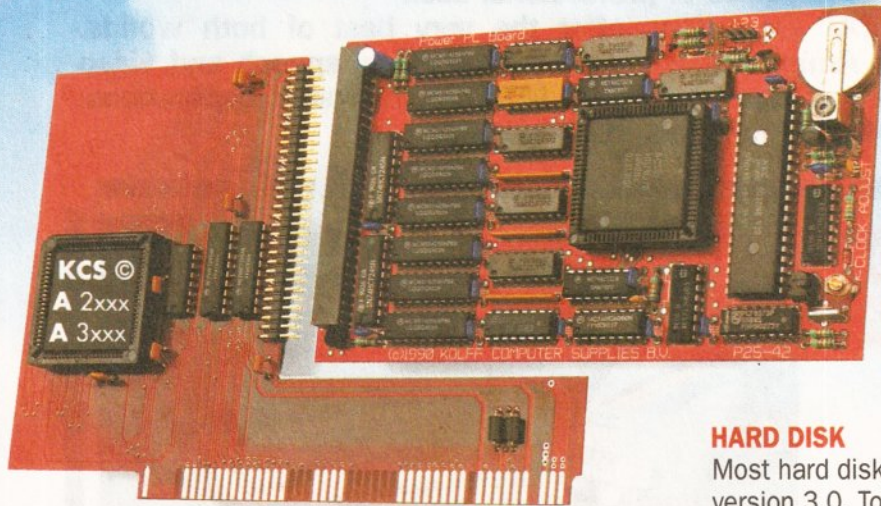

For the Amiga 500

A500P version
now ready
and gives you
total 2Mb Chip
Ram. When
ordering state
which one you
require.

HARD DISK

Most hard disks are supported with
version 3.0. To be sure give us a ring.

The KCS Power PC Board adds 1Mb memory to your Amiga and a real time clock

Think how much 1Mb memory plus a clock costs
Think how much MS-Dos/GW-Basic/Shell/Dos-Help costs

£ __, __
£ __, __
£ __, __

Which leaves the cost of an AMIGA/PC just

For so little outlay the Power PC Board turns your Amiga into an up and running powerful PC, with no hidden costs. The cheapest PC in the world?!

£ __, __

Run heavyweight professional PC software on your Amiga/PC

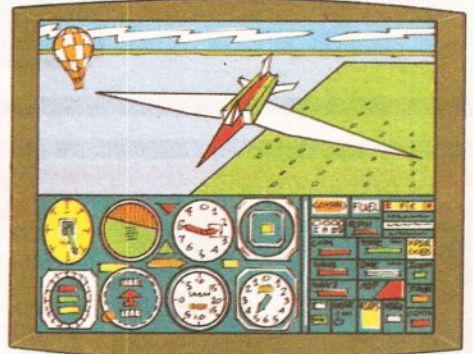

Microsoft flight simulator 4.0

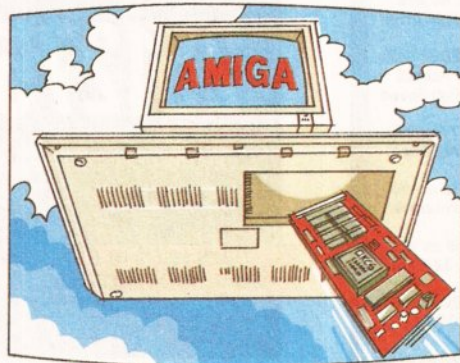

EGA

Will work from the full EGA colour palette. Both EGA and VGA will work on a standard TV or monitor and in most cases without using interlace.

VGA

Version 3.0 of our software comes with VGA colour and mono option. EGA/VGA will work on all standard Amigas irrespective of which chip set you have.

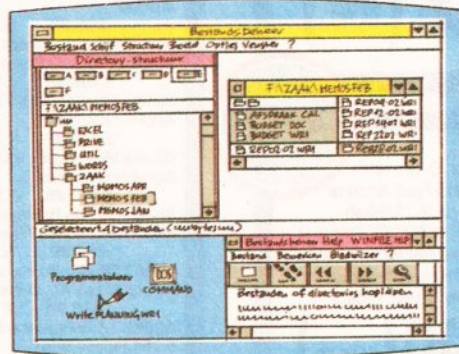

Microsoft windows

Some extra Goodies:

- FLICKER FREE FIXER in PC interlace mode. Will work with all Amigas. Software emulated.
- PROCESSOR SPEED can be slowed down from 100% to as low as 16%, so if you have never reached the highest level in a game, now is your chance.
- KCS PC-MOUSE driver will work with your Amiga mouse.
- PAUSE can be activated at any time during a game or program, allowing you to continue at your leisure.

Technical Specifications:

- Excellent compatibility
- 704Kb memory in MGA/CGA mode
- 640Kb memory in EGA/VGA mode
- 200Kb extra memory ie: MS-DOS RAMDISK (reset proof)
- 1/2Mb extra FAST Ram plus 1/2Mb Ram Disk for normal Amiga use plus real time clock in all modes.
- All future upgrades are software driven
- Processor speed = 11MHz
- Video runs faster than most AT/286 computers
- Disk drive
- Fitted in seconds and does not invalidate your guarantee
- Once fitted forget it - Switch on computer you have Amiga. Reset and load PC disk and in seconds you have a PC. Reset and you have Amiga again.
- Help-Line and excellent Back-up service

PRICE

| | |
|-------------------------------------------------------------------------------|------------------------------------------------------------------------------------|
| Including MS-DOS and on-board memory £219.95 Inc VAT/Carr. | Excluding MS-DOS but incl on-board memory £189.95 Inc VAT/Carr. |
|-------------------------------------------------------------------------------|------------------------------------------------------------------------------------|

BDL

BITCON DEVICES LTD.

88 BEWICK ROAD, GATESHEAD, TYNE & WEAR,
NE8 1RS ENGLAND
TEL: (091) 490 1919, HELPLINE: (091) 490 0202
FAX: (091) 490 1918



Adaptor for 1500/2000/3000 -
£74.95 Inc.

Available from your local computer shop (If they haven't got it - Ask them why not!). Or direct from Bitcon Devices Ltd.

Australia: HPD (Tel) 08 349 8486. Kaotic (Tel) 03 879 7098. Spain: Discover Inf. (Tel) 957 47 89 38. Sweden: Delikatess-Data (Tel) 31-300580. Canary: Customs Chipx (Tel) 928 271064. Denmark: Betafon (Tel) 31 31 02 73. Portugal: Softclub (Tel) 01 352 8452. Ireland: Computer City/Dublin 745250. N. Zealand: Pazac (Tel) 054-82949. All trade enquiries welcome. UK and Overseas (PAL only)

Compatibility is excellent but no-one can guarantee every single program available, therefore if your purchase depends on a particular program, please ask us first or send in a copy of the program. (With suitable S.A.E. if to be returned). Price subject to change without notice.

Wholly Developed And Produced In The Netherlands

OUR EXPERTS TACKLE YOUR REAL-LIFE PROBLEMS

CONTENTS

AT-A-GLANCE

Agenda47
 Animation46, 52
 Assembler53, 68, 73
 Basic52, 66, 73
 Blitter56
 Brother printer46
 C57
 CAD41, 53
 CanDo46
 Citizen printer42
 Compatability42
 Database47, 67, 70
 DeskJet47, 56
 Fonts48, 57
 Genlock43, 52, 71
 Hyperbook46
 IconX43
 Image conversion43, 66
 Keywords41
 Lazarus56
 Light pen68
 Logo57
 MIDI59
 Multimedia46
 Networking57
 Optical character recognition66
 PageSetter48, 52
 PageStream52, 53
 Pen Pal47
 Power supply unit48
 Preferences41
 Professional Page47, 57
 Protext43, 57, 59
 RAM48, 53, 56, 59
 Ranger monitor46
 Robotics47, 57
 Sampler67, 71
 Speaking70
 ST emulator67
 Star printer42, 43, 47
 Startup-sequence41, 59
 Superbase47
 Synth editors46
 Toshiba printer66
 Version48
 Video effects67, 70
 Virus66, 71

AMIGA ANSWERS

GET YOUR AMIGA TALKING

START OUT IN GAMES PROGRAMMING

PRINTER DRIVERS GALORE

MASTERING ROBOTICS

**OPTICAL CHARACTER RECOGNITION
ON THE AMIGA!**

MAKE YOUR OWN MULTIMEDIA MARVEL









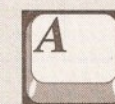

WE GIVE THE GEN ON GENLOCKS

GET YOUR SAMPLING SUSED

PLUS MANY MANY MORE OF

YOUR PROBLEMS SOLVED

SO WHAT DO ALL THOSE ICONS MEAN?

| | | | | | |
|-------------------------------------------------------------------------------------------------------------------------------------------------------------------------------------------|----------------------------------------------------------------------------------------------------------------------------------------------------------------------------------|-----------------------------------------------------------------------------------------------------------------------------------------------------------------------------------------|-----------------------------------------------------------------------------------------------------------------------------------------------------------------------------------------|--------------------------------------------------------------------------------------------------------------------------------------------------------------------------------------|------------------------------------------------------------------------------------------------------------------------------------------------------------------------------------|
|  <p>Beginners: this icon will appear next to any questions which are 'basic' in content.</p> |  <p>General: this icon is used for any general Amiga-related queries.</p> |  <p>Caution: be sure that you fully understand the answer before trying it out.</p> |  <p>Danger: the answer to this question could well invalidate your warranty – or you!</p> |  <p>Hardware: this icon is used to denote questions relating to general hardware.</p> |  <p>Buying advice: we use this icon if the question asks us for buying advice.</p> |
|  <p>Printers: this icon denotes a query about printers, printer drivers and so on.</p> |  <p>Technical: any queries about programming will have this icon next to them.</p> |  <p>Video: this icon relates to any query about using your Amiga with video hardware.</p> |  <p>Music: this icon is for questions about MIDI, sampling, synthesizers and so on.</p> |  <p>Programs: any program-specific queries have this icon next to them.</p> |  <p>Comms: if your question relates to comms, this is the icon that we'll use.</p> |

NO PROBLEM!

Hi, and welcome to the biggest ever *Amiga Answers* section to appear in *Amiga Shopper*, or, for that matter, any Amiga magazine. Rest assured that it will only get bigger. We receive something like 100 queries a week, so as you can see there's plenty of room for expansion.

It's my job to co-ordinate the whole thing: sorting through the questions and sending them off to the relevant chappies for the kind of in-depth answers you've come to expect; and compiling them into the lovingly crafted pages which you see before you.

I call on a wide variety of expertise to make sure you get the answers you need, which is why *Amiga Answers* is so successful. There's Mark Smiddy, industry guru, AmigaDOS-tamer and business applications wizard; Jeff Walker, probably the most knowledgeable Amiga desktop publisher there is; and Jason Holborn, long-time AMOS explorer and PD sampler, as well as good

all-rounder (or should that be all round good guy?).

If it's a question about video, then I'll pass it on to Gary Whiteley, our professional videographer for whom the word 'genlock' means 'mixing Amiga graphics with video for magical results' and for whom the word 'snipwirral' means nothing at all.

Programming queries are dealt with by Paul Overaa, who's not afraid to code in any language, and who doubles as a MIDI maestro to solve your sequencing slip-ups.

Our hardware guru is Jolyon Ralph. This man knows just about everything about disks, both hard and floppy, and what he doesn't know about memory he's probably forgotten.

All in all, a formidable team, supplemented by my own not inconsiderable Amiga suss. Let's face it, if we can't answer your question, it's probably one of the Mysteries of the Universe.

This month we've got plenty of goodies for you to have look at.

The mysteries of *IconX* are revealed; the creation of a multimedia astronomy presentation is outlined, we explain how to link your Amiga to Lego robots, what you need to add titles to your own videos, how to get started writing assembly language games. Furthermore, we tell you just who (or what) is Lazarus, why you need more cache to run *Professional Page*, and how to read printed text into your Amiga. There's also a dynamite tip from Paul Howlett about playing consecutive *Noisetraacker* modules.

So, if you have a problem, send it to us and watch it disappear!

Cheers,

Cliff Ramshaw

GREEN FINGERED AMIGA

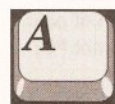

Can you tell me if there is a program available for the Amiga for landscape gardening design. If not, what would you recommend?

Paul Madden
Wellingborough
Northants

As far as I'm aware, no-one has yet come up with a dedicated landscape gardening design program either commercially or in the public domain.

A CAD package such as *X-CAD* would be your best bet, but you'll probably find *Deluxe Paint* more than adequate. *JH*

NO COMPRENDO



I am having trouble using the *Translator* program on the Dictionary disk of the *KindWords 2* word processor.

I've tried various ways to run the program but to no avail.

Michael Ashcroft
Fulwood
Preston

The operation of *Translator* is quite straightforward. You double click its icon and a window appears with two options - Supplemental to ASCII and ASCII to Supplemental.

The 'Supplemental' is your 'user dictionary', the one to which new words get added when using the spelling checker in *KindWords*.

If you add a wrong word and want to remove it, you first have to use the *Translator* program to convert the Supplemental file to ASCII, then load

that ASCII file into *KindWords*, remove the offending word and save it again.

Finally you use *Translator* to convert the ASCII file back to the Supplemental file format. *JW*

PREFERENCE-LESS

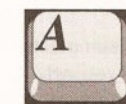

Using the startup-sequence supplied on the Workbench 2.04 distribution

disks for hard disk users, I get the following error when attempting to save any new preference settings:

"Could not find ENVARC:SYS/nnn.xxx". Where nnn.xxx is the name of the prefs file I'm trying to update. The explanations of the commands in the A500 Plus manual are very brief compared to the original, so can you also explain the following commands?

```
makedir ram:T ram:J
Clipboards ram:env J
ram:env/sys
copy >NIL: ENVARC: ram:env J
all quiet noreq
```

Finally, I've seen CD-ROM drives advertised for as little as £299. Would a standard CD-Audio player be suitable?

Chris Aldred
Farnborough

The answer lies not in the startup-sequence, but in the way your Workbench 2 software is installed on your hard drive. I'll explain why in a moment, but you can fix the problem quite simply like this...

Insert your original Workbench 2

disk in DF0: and double-click its icon. Double-click on the Prefs drawer. Now select Show/All Files from the window menu. You will notice an extra drawer (Env-Archive) appears. Perform the same steps on the Workbench 2 partition of your hard drive and you'll probably see Env-Archive is missing. Drag (copy) the Env-Archive drawer from the original disk into the Prefs drawer on your hard disk. Remove the original disk, re-boot the machine and you should find everything is now back to normal.

To explain: ENVARC: is an automatic assignment new to AmigaDOS 2. When the machine boots, AmigaDOS looks on the boot disk and assigns ENVARC: to Prefs/Env-Archive. Since this was missing (or incomplete) on your machine, the assignment does not take place, and therefore the preferences are set to default.

Those commands work as follows: Makedir, as you probably know, creates new AmigaDOS directories. In the new revision it uses the multi-argument parser and one command can create many directories. Under AmigaDOS 1.3 the equivalent series would look like this:

```
makedir ram:T
makedir ram:Clipboards
makedir ram:env
makedir ram:env/sys
```

It's the last two commands we are interested in here as they create the environment handler directory (assigned to ENV: later in the script) and the new ENV/SYS directory reserved for system variables, such as the preferences settings.

The next command line appears somewhat more complex, although in essence it is quite simple. A

JARGON BUSTING • JARGON BUSTING

ASCII - American Standard Code for Information Interchange. It is the data storage method commonly used when we type text files and enables text data to be exchanged between different computers.

CAD - Computer Aided Design applications provide designers with the graphical facilities to design buildings, circuit boards, and so on.

CD-ROM - Compact Disc Read Only Memory is the latest technology in storage devices. A CD can hold over 550Mb of data, compared to around 100Mb for a hard disk and 880K for a floppy disk. The big disadvantage is that users cannot store information on a CD, only retrieve it.

Startup-sequence - A program which is executed every time the Amiga is switched on and after every reset. It sets up the system so that it is usable from Workbench, and may be customised by those who have unusual hardware or software requirements.

simplified version of the command looks like this:

```
COPY SYS:Prefs/Env-Archive J
TO RAM:env ALL
```

and copies the entire contents of the env-archive directory – including the Env-Archive/Sys sub-directory – to the ENV: assignment (still RAM:env at this stage). The Sys sub-directory containing the preferences settings is held in RAM so it can be accessed by the IPrefs daemon (preferences manager) at any time.

Three other extras are notable to this command line:

- >NIL: Output redirection to NIL:, as opposed to the screen. (In other words, 'Shut up COPY.')

- QUIET Don't print any messages. (Really shut up COPY.)

- NOREQ Don't ask for volume. ENVARC: if the assignment doesn't exist. (Look COPY, keep quiet or else.)

The net result of all this is that nothing short of a nuclear explosion would make an error show up. The last switch (NOREQ) is what has caused your problems. Since the ENVARC assignment is automatically connected to SYS:Prefs/Env-Archive, if that directory is not present, COPY would normally throw up a request: "Please insert volume ENVARC: in any drive", but the NOREQ switch suppresses that so you had no hint that something was missing. Since this is not the only problem with AmigaDOS 2, I will be running further tutorials on it in future instalments of *Cracking The Shell*.

As far as CD-ROMs go, you might as well wait for the A570. Audio CD players are good, but nothing like good enough; besides which, the interface is very complex. As an example, CD-ROM for the Commodore C-64 is treated like a tape deck, not a disk drive! **MS**

CITIZEN OR STAR?



I am going to buy a colour dot-matrix printer and am getting all sorts of conflicting advice from shops, which are biased towards selling me the most expensive printer they have.

Essentially I have narrowed my choices down to two types of printer – Citizen and Star. I read a review in *Amiga Shopper* last August which recommended the Citizen Swift 9 as a good quality, robust 9-pin printer, but I have not seen it advertised anywhere near as much as the Star range of printers has been. This leads me to think that maybe Star is better supported, even if it perhaps isn't as good as Citizen.

My local shop only sells Star printers and tells me that it stopped selling Citizen due to the continual trouble which it had with faulty machines being returned to it. It has had no such trouble with Star printers.

I intend to spend between £200 and £300 and am desperate not to make the wrong choice. I have been looking at the Star LC24-200 Colour but was told that another review some months back stated that although 24-pin printers give excellent text, graphics output is worse than 9-pin printers.

I have not been given a

satisfactory explanation as to why this should be the case, but if true, should I be looking at the Star LC200?

**Derek Dodson
Southend-on-Sea
Essex**

Put simply, when used for graphics output 9-pin printers suffer less from the dot-matrix banding effect than 24-pin printers; a technical explanation of exactly why they suffer less would only confuse you further. If you want your printer primarily for printing coloured pictures from art programs, then I recommend you go for 9-pins, not 24.

I can't comment on the return rate your local shop claims for Citizen printers, other than to say that I have had a little 9-pin Citizen 120-D for six years which has had to suffer continual and heavy use, and it has never let me down once.

As far as I can ascertain, the Citizen Swift 9 is basically the same printer as the Star LC200, but with a different case around the outside. The best place to check out printers is at computer shows. Why not pop along to the *Amiga Shopper Show* at Wembley on May 15-17 where I'm sure you'll find many stands able to demonstrate them and show you graphical output from both printers?

JW

GERIATRIC AMIGA



There has been much controversy recently concerning software compatibility

(or rather, the lack of it!) between 1.3 Amigas and the new 2.0-based Amiga Plus. However, as an owner of an even older Amiga 500 based

around the 1.2 release of AmigaDOS, I was wondering if there will be incompatibility problems between my 1.2-based Amiga and software which is written specifically for 1.3/2.0-based machines.

Secondly, I am considering upgrading my machine to an A1500 but I was wondering whether – now that the A500 is 2.0-based – all new A1500s will be 2.0-based. Should I wait for the new 2.0-based A1500 or should I just buy a current A1500 and spend out £80 for the 2.0 upgrade?

**Mr T Finn
Dyfed
Wales**

The differences between versions 1.2 and 1.3 of the Amiga's operating system aren't really that great, so you don't have to worry about any software written to run under 1.3 not working under 1.2. When 1.3 was first launched, there were a few incompatibility problems, but developers were quick off the mark to rectify these incompatibilities and I would be very surprised indeed if you could find a single item of post-1.3 software (commercial, not PD) which does not work under Workbench 1.2.

If a program is written specifically for 2.0, then it definitely won't work under 1.3. Some developers are starting to write for Workbench 2.0-based machines, but such programs are few and far between.

What you must realise is that something like 99 per cent of all Amigas are still either 1.2 or 1.3-based, so developers are highly unlikely to develop specifically for Workbench 2.0 until it establishes itself as the defacto-standard. After all, 2.0-based Amigas are still very much in the minority, so it would be financial suicide for a developer to produce a mass-market product if only one per cent of Amiga users could actually use it!

What you'll start to find is that developers will take one of two possible paths. The first path would be to write their applications so that they can take advantage of the extra facilities which Workbench 2.0 has to offer whilst still being compatible with 1.3 (Both New Horizons' *ProWrite 3.2* and Gold Disk's new *Professional Calc* are very good examples of this).

A second route which developers could follow is to issue two different versions of their programs. This is exactly what HiSoft has done with the latest release of *Devpac*.

If you buy *Devpac*, you'll actually find three disks in the box – one generic, one for 1.3-based Amigas and one for 2.0-based Amiga. **JH**

NURSE PASS THE SCALPEL



I'd like to transplant the innards from my A500 Plus into a new casing. Could you please tell me where I could obtain either an empty A1500 case or a PC case. I have heard that such a conversion kit already exists for the Amiga, but I haven't actually seen it.

**Simon Gordon
Derker
Oldham**

Recasing the A500 isn't just a case (heh heh) of opening up your A500, removing the innards and putting them into a new case – there are other factors to consider. For example, how are you going to line up the connectors from the A500 with those on the A1500 casing? In terms of positioning, the A1500 connectors aren't that much different from the A500, but try to use a PC case and you'll encounter no end of problems. You could extend these using a ribbon cable connected to extra connectors mounted onto the PC casing – this will require a fair bit of soldering. Do you feel up to the job?

Then you have to worry about the problem of what to do with the keyboard. If you were taking the innards from an A1500 and placing them into a PC case, this would not be too much of a problem, but the A500 doesn't have an external keyboard, so you'll need to recase the existing A500 keyboard or make up an interface which will enable you to use an Amiga A1500 keyboard.

Your best bet is to leave this kind of work to the experts, in this case Checkmate Digital. It produces a range of A500 upgrades including the A1500 kit. Not to be confused with the 'real' A1500 (which was launched after Checkmate's unit), Checkmate's A1500 includes a sturdy metal casing and a kit which enables you to mount the A500 keyboard into an external case (which is also made of metal). If you're after a very sturdy system that can take a few knocks, then the A1500 is for you.

A more attractive option is Checkmate's new Hi-Q system which is based around a PC free-standing tower casing. This still wasn't available at the time of going to press, but Checkmate claims that its arrival is only a matter of weeks away. We'll be taking a look at it as soon as it is available, but in the meantime you can find out more by phoning Checkmate ☎ 071 923 0658. **JH**

PICTURE THIS!



I would like to know if any software exists which will enable me to convert

TIFF images from an Apple Macintosh to Amiga IFF format so that I can load these images into Deluxe Paint.

**Chris McFarlane
Walmer Bridge
Preston**

I've got some good news and some bad news for you. First the good news. The two packages that you'll need are ASDG's *Art Department Professional* and the add-on for *ADPro*, *The Professional Conversion Pack*. Now the bad news - *ADPro* needs lots of RAM (at least 2Mb) and it doesn't come cheap (*ADPro* costs £199 and the conversion pack costs £69.95). If you haven't already fainted, then give ASDG's UK Distributor Silica Systems a call ☎ 081 309 1111.

Another option is a program called *RasterLink* which is bundled free of charge with the Amiga Centre Scotland's Harlequin 24-bit card. *RasterLink* fully supports TIFF format files but doesn't have the kind of image processing power that *ADPro* boasts. It used to be called *ImageLink*, but I don't think it's available separately any more. You could try phoning ACS though ☎ 031 557 4242. **JH**

RGB OUTPUT OUT



I have just purchased a Rocgen Plus genlock from Silica Systems because it has an RGB through port and won't spoil the games for the children. I have connected the Rocgen to the Amiga 500 using the genlock's built-in cable and connected my original RGB cable to the SCART socket of my Sony Trinitron TV/Monitor.

The problem is that I get no picture from the RGB output, but I can get composite video output from the genlock which I can connect to the monitor - although this is at reduced quality. If I have both the RGB and video out connected at the same time I get two Amiga displays which fade up and down at the same time.

Silica says that I need a cable with individually grounded RGB signals, though I am not sure. What do you think?

Could you please tell me how the "Key In" line works on the Rocgen Plus? What does it do and how do I operate it?

**Douglas Fielder
Whitehaven
Cumbria**

Starting at the top, I too spoke to Silica to clarify the question of connectors - the people there are still of the opinion that it really is necessary to procure a properly constructed RGB cable to connect from the Rocgen to the monitor.

Having heard their explanation I tend to agree with them - so perhaps you should contact Videk ☎ 081 204 6690 for details of the cost of such a cable. The reason for the reduced quality of the Rocgen's Video Out signal on your monitor is simply that it is a composite video signal, which is actually of lower quality than the regular RGB signal.

I've also found out something about the Key In connector, although unfortunately all I can tell you at the moment is that it is provided for inputting a signal to enable the Rocgen Plus to provide a Chroma Keying function. This will require a new add-on module which is currently only at the prototype stage.

I've also heard that the Rocgen Plus is being updated to provide a better output, amongst other things. So watch this space, as they say. **GW**

PAPER CHASE

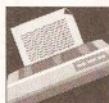

I bought an Amiga 500 a year ago, along with a monitor and a Star LC200 colour

printer. An accompanying leaflet gave the printer driver to be used as EpsonX[CBM_MPS-1200]. The one on the Extras disk is called EpsonX[CBM_MPS-1250] so I used that. Right or wrong?

I am using 11.66in by 9.25in fanfold paper. In Preferences I have set the paper length to 66 lines and the width to 80 characters. The EDS settings in all cases are ON.

I commenced printing with *Protext 4.3*. This I accomplished, but it all came out in one continuous stream. I was under the impression that having set the paper to the top of the paper position and having commenced printing that I would receive the complete documentation in page form; that is to say, after 66 lines were printed the printer would skip over the perforated line and recommence printing at the top of the next page.

Is that the idea, or do I know even less about the business than I thought?

**J O'Rourke
Cheadle
Stoke-on-Trent**

Protext doesn't take an awful lot of notice of your Workbench printer preferences settings, it uses its own rules, set up by using the Config program.

If you type 'config' at the *Protext*

JARGON BUSTING • JARGON BUSTING

Genlock - a way of slaving one video source (eg Amiga) to another (eg video tape) in order to synchronise their signals to allow stable wipes, mixes and other effects including overlay between the two sources.

Operating system - a collection of programs always running which control the basic operations of the computer, such as disk accesses and so on.

Printer driver - a program that sits between any applications program producing output and the printer. It converts any codes describing text and graphics format into a form suitable for a specific printer.

9-pin - a kind of dot matrix printer, which forms a dotted representation of characters on the page. A 9-pin printer has a printhead with 9 vertical pins arranged vertically, so that a vertical slice of the character is printed at once, and the head moves horizontally 9 times to complete the shape.

24-pin - similar to a 9-pin printer, but with a printhead containing 24 pins. The textual output of such a printer is of a higher resolution.

command line you'll be presented with a menu of options. Select the Main Configuration option, and in the next menu that appears select the Layout Options. In this section you'll find all the details pertaining to page length and margins. After setting it up as you want it, press the [Esc] key a couple of times to get back to the first menu, and then Save your new configuration.

The Config program is covered comprehensively in the *Protext* manual, and I suggest you read it through a few times and have a good muck around with all the different settings. I also recommend you upgrade to a later version of *Protext*; version 4.3 is ancient and nowhere near as good as version 5.5. Speak to Arnor about upgrade prices on ☎ 0733 68909.

As for the printer driver, I would imagine that the MPS-1200 bit in the leaflet which came with the Star is a misprint. The MPS-1250 driver should work, but not perfectly. There is a driver called Star9Plus, written specifically for the LC200, on Jamdisk 5. Available for £2 from *Just Amiga Monthly*, 75 Greatfields Drive, Uxbridge UB8 3QN. **JW**

A GAMER WRITES...



How do I transfer icon-less games from floppy to hard drive and give them icons

so I can run them from Workbench?

**Graham Smith
West Yorkshire**

As the saying goes Graham, "If a man was meant to fly, God would have given him wings." The same is true (more or less) for games which are supplied on self-booting disks: they just aren't designed to be run from Workbench. Technically speaking, running a CLI/Shell program from Workbench 1.3 isn't possible without extra help.

Some programs can be forced to

run from Workbench by running them from a script using *IconX* (icon-execute); however, you must first be able to start them from the Shell. I'll illustrate this with an example:

Open a Shell and enter the following commands (see the AmigaDOS series for more help on how to do this):

```
COPY SYS:Prefs/Serial.Info ↵
TO SYS:DirMe.Info
COPY C:DIR TO SYS:
ED DirMe
```

When the ED screen appears enter this:

```
DIR SYS: ALL
```

Now press the [Esc] (escape) key, the letter "X" and [Return]. That exits ED and saves your little script.

Close and re-open the Workbench window. You will notice you now have a new icon which looks like a telephone, but has the name DirMe. Select that icon and select Info from the Workbench menu. You should now notice a box which states the default tool:

```
SYS:Prefs/Preferences.
```

Click just after the letter "s" in Preferences and delete everything back to the ":". Now enter C/IconX. The line should now read:

```
SYS:C/IconX
```

Now click the save gadget to save your changes.

Double-click the new icon; you will see a window appear and the entire contents of your Workbench partition will scroll past. Exactly the same technique can be applied to many CLI/Shell-only programs. Before you try creating an icon, make sure you can run the program from Shell on your hard disk in the first case. **MS**

continued on page 46

FAST, FRIENDLY,
EFFICIENT SERVICE
FROM THE AMIGA
PROFESSIONALS

AMIGA SUPERMARKET

Official government &
educational establish-
ment orders welcome.

LOW COST TV TUNER LOWER PRICE

Use your Monitor as a excellent quality tv for only £49.99. Fully compatible with the Philips & Visto 8833, Mk1&2, Commodore 1084/s/di monitors & Amstrad CPC monitors.
RGB Multisync monitor version available. Please state monitor when ordering
PHILIPS/COMMODORE/AMSTRAD VERSION £49.99 ><
Multisync monitor version with RGB output £69.99 ><

DESK TOP VIDEO PERIPHERALS

| | |
|---------------------------------------|---------|
| VIDI+ RGB Splitter & Vidichrome | £139.99 |
| VIDI & VIDICHROME special price | £84.99 |
| RGB SPLITTER Rombo Electronic type | £54.99 |
| ROCCEN GENLOCK SAVE £££s | £94.99 |
| ROCCEN PLUS GENLOCK | £149.99 |
| SUPERPIC - Colour Digitiser & Genlock | £584.99 |
| SUPERPIC ANIMATE | £684.99 |
| COLOURPIC colour digitiser | £484.99 |
| COLOUPIC ANIMATE | £589.99 |
| CABARET FOR COLOURPIC/SUPERPIC | £28.99 |
| CABARET PLUS | £87.99 |
| DIGIVIEW GOLD the best with a camera | £99.99 |
| REDALE SUPER 8802 SVHS GENLOCK | £599.99 |
| HITACHI MONO CAMERA LOW PRICE | £179.99 |
| VIDEO RECORDING ENHANCER | £37.99 |

UPGRADES & SPARES

| | |
|--------------------------------------|---------|
| KICKSTART 1.3 ROM | £29.99 |
| KICKSTART 2 ROM | £77.99 |
| FATTER AGNUS 8372A | £69.99 |
| 8520A I/O chip | £15.99 |
| 1500/2000 8MEG CARD unpop uses simms | £79.99 |
| 1500/2000 SCSI controller card | £89.99 |
| A520 MODULATOR | £29.99 |
| UPRATED A500 POWER PACK | £44.99 |
| KCS PC BOARD v3 + MSDOS 4 | £204.99 |
| KCS 2000 PC BOARD ADAPTOR | £64.99 |
| ICD ADSPEED 14MHz ACCELERATOR | £189.99 |
| AT ONCE 16MHz PC EMULATOR | £199.99 |
| 256*4 CMOS D RAMS each £4.25 or | £33/meg |
| 1meg * 9 SIMMS 70 or 80 ns | £37.99 |
| 23 WAY PLUG & COVER solder type | £2.99 |
| 23WAY SOCKET & COVER solder type | £2.99 |
| AMIGA INTERNAL replacement drive | £69.99 |
| AMIGA 500 ROM SWITCH roms extra | £24.99 |
| MAINS SUPPRESSOR BLOCK 4WAY | £12.99 |
| 3.5" DISK DRIVE HEAD CLEANER | £4.99 |
| BUDGET REPLACEMENT MOUSE | £18.99 |
| 4 JOYSTICK ADAPTOR | £8.99 |

MICE, JOYSTICKS, ACCESSORIES

| | |
|-------------------------------|---------|
| SQUICK MOUSE | £15.99 |
| NAKSHA MOUSE + OPERTN STEALTH | £24.99 |
| CDTV KEYBOARD - BLACK | £49.99 |
| CD TV TRACKBALL CONTROLLER | £77.99 |
| AMIGA HANDY SCANNER | £99.99 |
| NAKSHA SCANNER | £109.99 |
| CRP A4 GRAPHICS TABLET | £329.99 |
| GRAVIS MOUSE STICK CONTROLLER | £65.99 |
| DELTA 3A ANALOGUE JOYSTICK | £14.49 |
| ZIPSTICK AUTOFIRE | £12.99 |
| PRO 5000 COMBAT | £9.99 |
| PRO 5000 STAR | £13.99 |
| QUICKJOY SUPERSTAR | £13.99 |
| QUICKSHOT TOPSTAR | £19.99 |
| MEGA STAR HEAVY DUTY JOYSTICK | £26.99 |
| NAVIGATOR AUTOFIRE JOYSTICK | £13.99 |
| SPEEDKING AUTOFIRE | £11.99 |
| QUICKJOY PYTHON | £10.99 |
| AMIGA TRACKBALL | £34.99 |
| CRYSTAL TRACKBALL | £39.99 |
| MARCONI TRACKERBALL | £49.99 |
| PHAZER LIGHT GUN PACK | £34.99 |
| GOLDEN IMAGE OPTICAL MOUSE | £38.99 |

**NAKSHA AMIGA MOUSE +
OPERATION STEALTH £24.99**

AMIGA BOOKS

^ = PRICE INCLUDES PROGRAM DISK

| | |
|-------------------------------------------------------|---------|
| AMIGA FOR BEGINNERS | £12.45 |
| AMIGA BASIC INSIDE & OUT | £18.45 |
| AMIGA SYSTEM PRO GUIDE | £32.45 |
| AMIGA ADVANCED SYSTEM PROGRAMMERS GUIDE | £32.45 |
| AMIGA DISK DRIVES I & O | £27.95 |
| AMIGA DOS INSIDE OUT | £19.99^ |
| AMIGA PRINTERS I & O | £31.95 |
| AMIGA DESKTOP VIDEO | £17.95 |
| AMIGA 3D GRAPHICS | £17.95 |
| MAKING MUSIC ON AMIGA | £27.99^ |
| AMIGA GRAHICS I & O | £31.95 |
| AMIGA MACHINE LANGUA | £14.45 |
| AMIGA C FOR BEGINNERS | £17.95 |
| AMIGA C FOR ADVANCED PRORAMMERS | £32.45 |
| AMIGA DOS MANUAL | £19.95 |
| KIDS & THE AMIGA | £15.95 |
| BEST AMIGA TRICKS & TIPS | £27.45^ |
| MAPPING THE AMIGA | £24.95 |
| MACHINE LANGUAGE FOR BEGINNERS | £19.95 |
| ELEMENTARY AMIGA BASIC | £14.95 |
| ADVANCED AMIGA BASIC | £16.95 |
| PROGRAM DESIGN TECHNIQUES ON THE AMIGA | £16.95 |
| FIRST BOOK OF THE AMIGA | £16.95 |
| AMIGA ASSEMBLY LANGUAGE PROGRAMMING | £14.45 |
| USING DELUXE PAINT | £19.95 |
| AMIGA VISION HANDBOOK | £23.45 |
| THE IMAGINE COMPANION | £24.95^ |
| VIDIA PAGESTREAM GUIDE | £4.95 |
| VIDIA PROF PAGE GUIDE | £4.95 |
| HARDWARE REF MANUAL | £21.95 |
| 68000 ASSEMBLY LANGUAGE PROGRAMMING | £24.95 |
| AMIGA ROM KERNEL REFERENCE BOOKS - 3 AVAILABLE - each | £28.95 |
| DELUXE PAINT VIDEO | £19.99 |
| I&O = ABACUS 'INSIDE & OUT' SERIES. | |

SEAL n TYPE KEYBOARD SPASHPROOF SKIN.

Moulded to cover each key, but flexible enough to type thru.
AMIGA 5 00 & PLUS £12.49
1500/2000 £12.99

ANTISTATIC DUST COVERS

AMIGA 500 & Plus £4.99
AMIGA 1500/2000 2pc £12.99

CYCLONE ADAPTOR £12.99

DISKS & DISK BOXES

| | |
|------------------------------|------------------------------|
| 150 SIZE POSSO TYPE BOX | £19.99 |
| 40/50 SIZE LOCKABLE BOX | £6.99 |
| 80 SIZE LOCKABLE BOX | £7.99 |
| 100 SIZE LOCKABLE BOX | £8.99 |
| TDK BRANDED DISKS PACK OF 10 | ONLY £7.99 INCLUDING LABELS. |

SALES: 0274-691115

TV TUNER with NICAM STEREO SOUND.
Very high quality picture & stereo sound.
Built in stereo amplifier. £159.99

EDUCATIONAL COMPENDIUM 6

SPECIAL BOXED SET COMPRISING:
KIDS TYPE,
WEATHER WATCHER,
CALENDAR QUIZ,
WORDS & NUMBERS,
GAME SET & MATCH
WHAT IS IT WHERE IS IT?

**ALL
FOR
ONLY
£39.99**

X COPY PROFESSIONAL V9

Latest version - only £33.99
including Cyclone adaptor.
(Adaptor available separately - £12.99)

NB. Making backups without the permission of the copyright holder is illegal.

DIGIVIEW MEDIATION

DIGIVIEW + DIGIPAIN 3

**+ ELAN PERFORMER
SPECIAL OFFER - £134.99**

MOUSE / JOYSTICK PORT SWITCH NOW £12.99 ><

- * Has sockets for mouse & a joystick.
- * Push button operation
- * Uses no power unlike other types.
- * Compatible with many dongles.
- * Saves wear & tear on mouse port.

SUPER-FI ONE STEREO SYSTEM

- * POWERFUL 12 watts / CHANNEL
- * COMPACT BOOKSHELF CABINET
- * 3" WOOFER + 1" TWEETER
- * BASS REFLEX PORT
- * 30Hz - 20kHz RESPONSE
- * BUILT-IN MAINS POWER UNIT
- * REMOTE VOLUME CONTROL.

SPECIAL OFFER PRICE ONLY £34.99 ><

| | |
|---------------|--------|
| SOUND BLASTER | £44.99 |
| ZYFI | £39.99 |

SUPER-FI TWO STEREO SYSTEM

- * MASSIVE 20 watts/channel.
- * BASS & TREBLE CONTROLS
- * 4" WOOFER, 2" TWEETER
- * BASS REFLEX PORT
- * BUILT IN MAINS POWER UNIT
- * THE ULTIMATE SOUND SYSTEM FOR COMPUTERS, NICAM VCRs, SATELLITE SYSTEMS ETC

ONLY £59.99

MIDI INTERFACE 2

Our unique 5 port Midi interface 2 has In, Out & Thru sockets plus two additional switchable out/thru sockets for ingenious versatility. Complete with free midi lead. Fully compatible with Sequencer One, Music X, Deluxe Music, Tiger Cub, Bars & Pipes etc etc.

NOW ONLY £26.99 ><

| | |
|-------------------|------------|
| MIDI 2+ MUSIC X | £99.99** |
| MIDI 2+ TIGER CUB | £74.99** |
| Extra Midi leads | £1.99 each |

SAMPLER 2

Our Superb sounding STEREO SAMPLER 2 uses a state of the art A/D chip which samples so fast, it captures every detail of the sound. Easily adjusted level control, connecting lead & free stereo sampling software. Fully compatible with all popular sampling software. NOW ONLY £37.99 ><

Special offer.

Sampler 2 & Audition 4 £69.99

>< = PRICE CUT ** = LIMITED OFFER

BACKUP UTILITIES Making backups is illegal without copyright holders permission.
Ami II v3 (Similar to Mac II) £33.99

The original external drive adaptor + software backup utility. Latest version 3 software. Software update for existing users is £9.99 Free user group. Versions for all Amigas.

SOFTWARE SUPERBUYS

| | |
|-----------------------------------|------------|
| A320 AIRBUS | £29.99 |
| ADVANTAGE | £69.99 >< |
| AMI ALIGNMENT | £29.99 >< |
| AMAS 2 | £79.99 |
| AMIGA VISION | £98.99 |
| AMOS | £34.99 |
| AMOS 3D | £25.99 |
| AMOS COMPILER | £22.99 |
| ART DEPARTMENT | £54.99 |
| ART DEPARTMENT PRO | £119.99 >< |
| ASSEMPRO | £59.99 |
| AUDITION 4 | £37.49 |
| AUDIOMASTER 4 | £49.99 >< |
| AUDIO ENGINEER | £169.99 |
| BAR & PIPES | £99.99 >< |
| BBC EMULATOR | £29.99 ** |
| BROADCAST TITLER 2 | £167.99 |
| CAN DO 1.5 | £74.99 |
| CASH BOOK CONTROLLER | £52.49 |
| CLASS OF 90s S/WARE PACK | £99.99 ** |
| CROSS DOS | £21.99 |
| DAY BY DAY | £22.49 |
| DELUXE PAINT 2 | £14.99 |
| DELUXE PAINT 4 | £57.99 |
| DELUXE MUSIC | £49.99 |
| DELUXE PRINT 2 | £29.99 >< |
| DELUXE VIDEO 3 | £74.99 |
| DEVPCAL 3 - new version | £51.99 |
| DG CALC | £39.99 |
| DIGIPAIN 3 | £39.99 |
| DIRECTORY OPUS WITH VIRUS CHECKER | FREE |
| DISK MASTER | £29.99 >< |
| DISK MASTER 2 | £49.99 |
| DISNEY ANIMATION STUDI | £69.99 |
| DOCTOR AMI | £29.99 |
| DR TS TIGER CUB | £49.99 >< |
| DR TS KCS LEVEL II | £199.99 >< |
| ELAN PERFORMER 2 | £44.99 |
| E TYPE | £29.99 |
| EXCELLENCE | £59.99 |
| FINAL COPY | £54.99 |
| FLOW v3.0 | £59.99 |
| FLIGHT SIMULATOR II | £29.99 |
| FLIGHT SIM SCENERY DISKS | £16.99 |
| FONT GRABBER | £37.49 |
| GB ROUTE PLUS | £59.99 |
| GFA BASIC Special offer | £99.99 ** |
| GOLD DISK OFFICE | £79.99 >< |
| HIGH SPEED PASCAL | £74.99 |
| HOME ACCOUNTS 2 | £39.99 |
| HOMEBASE | £24.99 |
| HYPERBOOK | £44.99 |
| IMAGINE | £144.99 |
| INFOFILE | £29.99 ** |
| INTROCAD | £34.99 >< |
| KINDWORDS | £37.49 |
| MACRO 68000 ASSEMBLER | £39.99 |
| MAILSHOT PLUS | £37.49 |
| MICRONA V FLIGHT SIM | £99.99 |
| MUSIC X v.1.1 | £74.99** |
| PAGESTEAM 2.1 | £139.99** |
| PAGE SETTER 2 | £44.99 |
| PEN PAL | £54.99 * |
| PERSONAL TAX PLANNER | £34.99 |
| PIDMATE | £134.99 |
| PROFESSIONAL CALC | £134.99 |
| PRODATA | £74.99 |
| PROFESSIONAL DRAW 2 | £94.49 |
| PROFESSIONAL PAGE | £149.99** |
| PROF PAGE FONTS | £29.99 |
| PROTEXT v5.5 | £109.99 |
| PRO VIDEO PLUS | £174.99 |
| PROWRITE 2.5 | £29.99 ** |
| PROWRITE v3.2 | £89.99 >< |
| QUARTERBACK | £38.99 >< |
| QUARTERBACK TOOLS | £48.99 >< |
| QUARTET | £34.99 |
| SCALA 500 | £74.99 |
| SCRIBBLE PLATINUM | £37.49 |
| SCULPT 3DXL | £89.99 |
| SCULP ANIMATE 4D JNR | £89.99 |
| SEQUENCER 1+ | £phone |
| SONIX | £33.49 |
| SOUNDMASTER | £99.99 |
| STEREO MASTER | £29.99 |
| SUPERPLAN | £69.99 |
| SUPERBASE PERSONAL | £29.99 |
| SUPERBASE PERSONAL 2 | £39.99** |
| SUPERBASE PROF 4 | £199.99 |
| SUPERPLAN | £74.99 |
| SYSTEM 3 | £39.99 |
| TAKE 2 | £69.99 |
| TRANWRITE | £28.99 |
| TURBOPRINT | £37.49 |
| VIDEO EFFECTS 3D | £99.99 >< |
| VIDEO TITLER 3D | £67.49 |
| WORD PERFECT | £139.99 >< |
| WORDWORTH | £78.99 |
| 3D CONSTRUCTION KIT | £37.49 |

MOST EDUCATIONAL SOFTWARE ALSO STOCKED AT DISCOUNT PRICES

AMIGA SUPERMARKET

**TRILOGIC,
UNIT 1, Dept AS5,
253 NEW WORKS RD,
BRADFORD, BD12 0QP**

TEL: 0274 691115 FAX 0274 - 600150

HOW TO ORDER. ALL PRICES INCLUDE VAT Commodore dealer since 1984

BY PHONE: Simply phone us with your Access or Visa number (inc Connect & bank debit cards) for same day despatch. (if goods in stock - most are, & orders are received before 3pm). You are not charged until the goods are despatched.

BY MAIL: Send cheque, (made payable to TRILOGIC), POs, or your c/card number & expiry date, order details, & name & address to the address above.

POSTAGE: Please add nominal post & packing charge of just £1 to orders under £100, or £2 to orders over £100 unless optional Express delivery is required.

OPTIONAL EXPRESS DELIVERY - Recommended for orders over £50.00 in value.

2-3 day delivery - add £3.50

Next Working Day Delivery - add £5.50 (Please allow 2-3 days for remote areas, UK mainland only). Weekday delivery only. Not guaranteed next day.

CALLERS MOST WELCOME: Open mon-fri 8 till 6, sat 8-4pm.

L

AMIGA SUPERMARKET

BIGGEST RANGE IN UK? LOW PRICES FAST SERVICE

CARTOON CLASSICS

BUILT-IN DISK DRIVE
1 MEG RAM
MOUSE
TV MODULATOR
WORKBENCH 2
BUILT-IN CLOCK

LEMMINGS
THE SIMPSONS
CAPTAIN PLANET
DELUXE PAINT 3

LOW COST 3 & 5 YEAR EXTENDED WARRANTIES AVAILABLE. PLEASE SEE BELOW.

AMIGA 500PLUS

* Please phone to check our latest low price.

ONLY £339.99*
with 2meg £379.99*

SUPERB 10 STAR PACK

MICROSWITCH JOYSTICK
10 DISKS, LABELS & BOX
MOUSE MAT
TAILORED DUST COVER

PLUS 10 GREAT GAMES:
DUNGEON QUEST
SOCCER
KID GLOVES
RVF HONDA
POWER PLAY
SHUFFLE PUCK CAFE
TOWER OF BABEL
DATAFORM
E MOTION
GRAND MONSTER SLAM

ALL FOR JUST £39.99

WITH ANY AMIGA PACK.
(Or £55.99 separately. 10 Star Games only - no joystick or accessories - £24.99)

Total value over £275

COLOUR MONITORS

A MONITOR BEST BUY

THE VISTO 8833

- same spec as 8833mk2, stereo sound, with free on site warranty, & leads. **HURRY ONLY £199.99**
PHILIPS CM8833 mk 2 £219.99<
COMMODORE 1084Sdi - new model £239.99<
Add just £40 for TV Tuner when purchased with any of the above monitors.

MONITOR ACCESSORIES

MONITOR PLINTH WITHOUT SHELF £23.99<
MONITOR PLINTH WITH SHELF £33.99<
14" MONITOR TILT/SWIVEL BASE £12.99
MONITOR DUST COVER state monitor £7.99
SCART SWITCH - effectively gives your tv or monitor two scart sockets Enables ANY two scart leads eg Amiga & vcr, to be connected to one scart socket. Fully switched. £19.99

AMIGA TV/ MONITOR LEADS.

AL1 for most Scart tvs except some Goldstar & vcrs £12.99
AL2 for Ferguson MC01/3/5 with 7 or 8 pin din skt £12.99
AL4 for Hitachi/Granada with 7 pin RGB skt £12.99
AL6 for Amstrad CPC monitor - with no sound £11.99
AL6B fowew CPC monitor with stereo sound £12.99
AL7 for 1084 monitor inc audiolead (6pin Din plug) £14.99
AL7P for new 8833/1084s - 9 pin D plug £14.99
AL11 for multisync with 9 pin skt on monitor £11.99
AL11B for multisync with 9 pin plug on monitor £11.99
AL12 for multisync (our lead has 15pin HD skt) £13.99
AL13 for multisync (our lead has 15 pin HD plug) £13.99
MODULATOR EXTENSION LEAD - Moves modulator so it does not protrude & eliminates loose connection. £10.99
MODULATOR SPLITTER - Enables modulator & RGB lead to be connected at the same time - for taping Amiga £16.99
GENLOCK SPLITTER £19.99
TV/ COMPUTER AERIAL SWITCH £8.99
COMPUTER/ AERIAL EXTENSION LEAD 3m £2.49
All leads include audio lead where applicable & are approx 1.8m long. Add £1.50 per metre for longer leads.

HARD DRIVES

DATAFLYER 500 45 £289.99 save £60
DATAFLYER 500 105 £449.99 save £50
DATAFLYER 2000 45 £229.99 save £70
DATAFLYER 2000 105 £359.99 save £90

AVAILABLE NOW (In stock at time of going to press)
DATAFLYER 500 HOUSING & INTERFACE £129.99
DATAFLYER 2000 SCSI INTERFACE £89.99

The Dataflyers are probably the lowest cost, best value Amiga Hard drives you can buy.

PROTAR AMIGA 500 HARD DRIVES

PROTAR A500 HD20 £279.00
PROTAR A500 HD40 £349.00
PROTAR A500 HD50 £369.00
PROTAR A500 HD80 £599.00

MEMORY UPGRADES & OPTIONAL PSU AVAILABLE

GVP HARD DRIVES

GVP SERIES II HD8 52 £369.99
GVP SERIES II HD8 105 £549.99
GVP SERIES II HC8 £159.99
(Scsi controller for 1500/2000, no drive, upto 8 megs ram on board).

PRINTERS

Prices are for b/w versions

CITIZEN 120D+ now down in price £129.99<
CITIZEN 124D - best budget 24 pin b/w £194.99
CITIZEN 224D (24pin - colour option) £224.99
CITIZEN SWIFT 9 (colour option) £177.99
CITIZEN SWIFT 9X B/W wide carriage £257.99
CITIZEN SWIFT 24E (colour option) £269.99
CITIZEN SWIFT 24X wide carriage £379.99
CITIZEN PRODOT 9 - PROF QUALITY £199.99
FOR COLOUR KIT to convert 224D, SWIFT 9, PRODOT 9 & SWIFT 24, to colour, add just £20.00. Add £30 for colour kit for 9X & 24X. (Colour kit contains ribbon & ribbon motor unit)

CITIZEN PROJET INKJET PRINTER £399.99<
300 dpi laser printer resolution & quality; fast 360cps draft, 120cps LQ; 3 fonts; very quiet; HP Deskjet Plus emulation. Automatic sheet feeder included. Optional tractor feeder, font cards & memory cards. Ask for demo, or sample printouts.

SEIKOSHA PRINTERS - ON SPECIAL OFFER

SEIKOSHA SP1900 9pin b/w low cost £114.99
SEIKOSHA SP2415 9pin wide carriage £234.99

STAR PRINTERS

STAR LC20 b/w now down in price £144.99
STAR LC200 colour £209.99
STAR LC24-200 b/w £239.99
STAR LC24-200 colour £299.99

FREE PRINTER CABLE & DRIVER DISK WITH ALL PRINTERS

PRINTER ACCESSORIES

UNIVERSAL PRINTER STAND - open frame type with paper holder for all 80 column printers. £12.99
TWO PIECE PRINTER STAND for any printer £7.99
80 COLUMN PRINTER DUST COVER state printer £7.99
COPY HOLD - FREE STANDING OR CLAMP £16.99
60grm Fan fold 11x9.5" paper in box of 2000 sheets £21.99
A4 60grm white paper in packs of 500 sheets £5.99
AMIGA PRINTER PORT SWITCH - 2WAY £24.99
AMIGA PRINTER PORT SWITCH - 3WAY £27.99
AMIGA PRINTER PORT SWITCH - 4WAY £33.99
Above Printer port switch prices include cable worth £10.99 to connect switch to Amiga. These switches are fitted with sockets identical to the Amiga's printer port - so your printer cables & other peripherals just plug straight in.

PRINTER SHARER - 2WAY inc free lead £27.99
PRINTER SHARER - 3WAY inc free lead £29.99
PRINTER SHARER - 4WAY inc free lead £34.99

AMIGA PRINTER LEADS

AMP1 1.8m long for all parallel printers £9.99
AMP 2 3m long for all parallel printers £12.99
AMP 3 5m long for all parallel printers £16.99
PRINTER PORT EXTENSION LEAD (M-F) £10.99
PRINTER PORT TO SWITCH LEAD (M-M) £10.99

PRINTER RIBBONS (Compatible types)

9 PIN B/W 80 column ribbon - state printer - available for popular Amstrad, Citizen, Panasonic, & Star £4.99
24 PIN B/W 132col ribbon for LC15, Swift9x/24x £6.99
Swift 9 & 24 Colour ribbon (Citizen brand) £15.99
Star LC200 & LC24-200 Colour ribbon (Star brand) £15.99
RIBBON RE-INKING SPRAY - BLACK ONLY £13.99

ALL PRICES INCLUDE VAT

COMMODORE A590+

A590 + (no ram) 20meg Hard drive £279.99 >>
A590 inc 1meg ram £314.99
A590+ inc 2meg ram £344.99
A590 45meg upgrade - easy to fit £199.99
A590 105meg upgrade - easy to fit £299.99

AMIGA 500 1.3 Base Model

Amiga 500, 512k ram, workbench 1.3, psu, mouse, tv modulator & instruction manuals. No extra software. Add £20 for extra 1/2 meg (without clock) **ONLY £289.99**

SPECIAL BONUS PACK.

AMIGA 500 1.3 as above
+ PHOTON PAINT 2 + GFA BASIC+ TEN STAR GAMES PACK - BEST BUY AT £299.99

AMIGA 1500 Wkbench 2 £569.99<

AS ABOVE PLUS 1084S £799.99

With 1meg ram, twin disk drives. + Software pack comprising: Dpaint 3, Home Accounts, The Works, Elf, Toki, Puznic & 'Get the Most from Your Amiga'.

Deduct £60 if software pack not required.

UPGRADE YOUR 1500 OR 2000

8 MEG MEMORY CARD (unpop) £79.99
1MEG SIMMS FOR MEMORY CARD £37.99
DATAFLYER SCSI CONTROLLER £89.99
45meg HARD CARD £229.99
105meg HARD CARD £359.99
PC/AT BRIDGE BOARD & 51/4" DRIVE £499.99
2620 ACCELERATOR, 68030+68882 + 2MEG RAM £429.99
KCS PC CARD + ADAPTOR £264.99

EXTERNAL DRIVES.

ROCLITE RF382C £58.99<

ROCTEC 5 1/4" DRIVE £79.99

CUMANA CAX 354 £58.99<

All are Amiga PLUS & CDTV compatible.

All drives feature thru port & disable switch.

A500 UPGRADE TO 1meg.

No clock £24.99< LOW POWER, 4 CHIP DESIGN, WITH ON/OFF SWITCH. Just plugs in.
With clock £28.99< Does not affect warranty.

Gives you 1 meg in total

AMIGA PLUS COMPATIBLE (=1.5meg)

IMPORTANT. None of these upgrades are any more static sensitive than any other makes.

AMIGA PLUS UPGRADE To 2 megs - £44.99

Just plugs into 1/2 meg slot. No soldering. Warranty unaffected. Gives you 2 megs in total.

Our Extended Warranty & Insurance plan could save you ££s on accident & repair bills.

When you buy any computer, printer or monitor from us, we can offer you a low cost Extended Warranty with Accidental Damage Insurance. Underwritten by a leading UK insurance company. For example your Amiga 500 can be covered for three years from date of purchase for only £44.99, or £64.99 for five years from date of purchase. Covers all repairs & accidental damage, with very few exclusions. Must be taken out within 30 days of purchase. *Atypical Amiga repair costs at least \$45 - & that's at today's prices - so you can't go wrong!*

SALES HOT LINES: 0274 - 691115.



Decode this correctly & we will give you a free Trilogic pen when you place an order..

continued from page 43

ANIM PLEASE



Do you know of an animation player which will enable me to play animations

produced using Deluxe Paint III and IV and release them into the public domain? Also, do you know if an editor is available within the Amiga PD libraries for the range of Yamaha 4-operator synths?

**Gavin Wylie
Carnoustie
Angus**

Both versions of *Deluxe Paint* come with freely distributable animation players which will do the job perfectly well. If you want a more compact player program though, then any player program which supports ANIM-format files should be fine. I'd personally recommend Aegis/Sparta's excellent *PlayAnim* tool which can be found within the Fish collection of disks.

As far as I'm aware, there are only two fully-functioning synth editors available within the PD libraries (*CZED* and *K1EDITOR* on Fish disks 323 and 223 respectively) but neither of these will work with Yamaha 4-operator synths such as the DX-100. If you want to actually pay for a synth editor, then the people to talk to are MCMXCIX ☎ 071 253 3454. *JH*

HE'S MY BROTHER



I am just about to order an Amiga 500 Plus for my daughter. We have a Brother

HR5 printer which we have used with a Dragon and a BBC. At present the budget won't run to a new printer.

As my daughter loves to design and print pictures I wondered if the HR5 would work with the Amiga 500 Plus. Having read your article on printing it seems we need a printer driver. Do you know of one?

We do have trouble with the Brother and the BBC, getting line feeds between the graphics.

**Pauline Hampson
Lawton Heath
Stoke-on-Trent**

The Brother HR5 emulates an Epson FX printer and should work with

Because of the width of the columns, we occasionally have to break listings across two or more lines. Where this has occurred, and you should enter two or more lines without a [Return] between them, we have used the following symbol: ↵

either the EpsonXold or EpsonX[CBM_MPS-1250] driver on the Extras disk. You might need a new lead for it. Speak to your dealer about this when you buy the Amiga 500 Plus. *JW*

MONITOR THE RANGE



I have the opportunity to buy a Commodore Ranger 15 multisync monitor and

I would like to know:

a) Is this monitor compatible with my Amiga 500's standard de-interlaced output? I know it works fine in all resolutions with a flicker fixer fitted.

b) Is this monitor capable of displaying the new ECS screen modes (in particular Productivity)?

c) The monitor has TTL and RGB analogue inputs. Is it possible to connect my VCR to the monitor (as is possible with the 1084 or 8833 monitors) so that I can also watch TV? If so, will I need an RGB switcher? I am a student and do a small amount of DTP work, hence my interest in buying a monitor, as I do not have space for both a TV and a monitor.

**Andrew Kydd
High Wycombe
Bucks**

After getting some help from Commodore Technical Support I can give you the following information: the Ranger will display both normal interlaced (ie 15.6KHz) and de-interlaced or flicker-fixed (31.2 KHz) Amiga signals, depending whether you use the output from the standard RGB port or a Flicker Fixer-type de-interlacer.

With WB2 there is a problem with the Productivity mode on the Ranger which causes the screen to go dark. There is a patch to cure this but it has to be done when Productivity mode is already in operation - making it a little difficult to see what you're doing - though a hot-key setup might help.

You will also need to make up a cable to correctly connect the Amiga to the monitor, unless it already has one supplied. It is important that you check this.

Finally, I'm sorry to tell you that there's no way to connect a VCR to the Ranger, as it has no direct composite video input and the others are unsuitable.

Surely your best solution would be to buy a new TV/monitor with both SCART and video/audio inputs (unless the Ranger is too cheap to refuse). Then you've got a reasonable compromise which doesn't take up too much space and, if you take care with your screen colours, you won't have too many problems with flicker. *GW*

JARGON BUSTING • JARGON BUSTING

ANIM - a method of storing animation frames developed by Spartafilm, whereby only the changes between successive frames are stored, thus saving significant amounts of space, and considerably speeding up the rate at which the animations can be played back.

Interlace - a method used to double the apparent vertical resolution of the picture by alternately refreshing the screen at a slight vertical offset, thus squeezing an extra line between each of the lines of a non-interlaced screen. This is exactly how a TV display works but, because of the fine detail in an Amiga display, it results in an unsightly flicker on images with sharp edges.

Multisync monitor - a monitor which can accept its signal at a variety of frequencies, usually ranging from 15 to 32 KHz. A multisync is useful for displaying signal produced by a flicker fixer or from the VGA graphics card used in many IBM PCs.

PC emulator - a software or hardware addition to the Amiga which will enable it to run programs written for the IBM PC. This can be useful because there is a far greater range of business programs available for that machine. Most emulators are hardware based, and are essentially PC computers in their own right, interfacing with the Amiga.

4-operator synth - a synthesiser which has four independently controllable digital sine-wave generators. The outputs from each of the generators can be mixed and modulated by each other to create a wide variety of richly textured sounds.

MULTIMEDIA MARVEL



I am thinking of making up a multimedia presentation of the

solar system which will provide the user with information on the planets and moons using digitised images, space probe history and some animation sequences. Could you please answer the following questions:

a) I have my eye on Gold Disk's HyperBook (mainly for price reasons). I carried out a small test run using a demo version of HyperBook with Mercury as a test planet, clicking a button here to see a digitised image of Mercury, clicking a button there to read some text. If I use HyperBook, will I be able to produce a stand-alone version of my application which can be freely distributed?

b) The version of HyperBook that I have seems to run in NTSC mode only. Is there any way of getting around this so that I can use the full PAL resolution?

c) I found the information that I have used for this test sample from various publications, digitising images from books, copying out data and condensing some of the text into notes. Will I infringe the copyright of these books if I reproduce some of the information? Most of the information is issued courtesy of NASA so I'm worried about possible copyright hassles.

d) If I pursued this project it would obviously take a long time to produce (9 planets and over 50 moons!). What do you think would be the response of publishers or the

producers of HyperBook if I were to charge something like £5.00 for the set of disks?

**Paul Matthews
St Leonards-on-Sea
East Sussex**

a) *HyperBook* is a great little program, but it is perhaps rather too limited for the application you have in mind. For starters, it doesn't support animation, so you'd have to use an external ANIM file player to play your animations.

You said that you chose *HyperBook* simply because of its price (£99). I personally feel that you'd be much better off with something like INOVATronics' *CanDO 1.5* which costs only £25 more than *HyperBook*. *CanDO* is a very powerful multimedia system which will handle just about any task that you care to throw at it. *CanDO* is handled in this country by Checkmate Digital ☎ 071 923 0658.

HyperBook does come with a stand-alone 'player' program which can be freely distributed, but *CanDO* goes one step further. Using its powerful *DeckBinder* program (which is basically a compiler), you can produce *CanDO* applications which are completely independent of the main *CanDO* program.

b) *HyperBook* can display IFF images in PAL resolution, but the main workscreen is restricted to NTSC mode only. *CanDO* doesn't suffer from any of these restrictions, so go for *CanDO* instead!

c) If you start to copy text directly out of a publication, then you will almost certainly be infringing the copyright of the publishers of the books that you

have mentioned. However, as long as you are only using these publications as a source of raw facts and figures, then I can't see anyone objecting.

Digitising images is a slightly more complex issue. Technically you are infringing NASA's copyright by digitising them, but I'd be very surprised if it was to take any action. Just play it safe by acknowledging NASA's copyright within your application.

d) Once again, I can't see you running into any problems with either NASA or the vendor of the multimedia system which you finally choose. Before you try to sell your application yourself, why not try to sell it to a software publisher which specialises in educational software? If the company takes it on, then it'll handle the job of marketing your program therefore giving it a lot more exposure. If this fails, then why not issue it as shareware? Shareware doesn't guarantee you a return from every copy of the program sold, but I'm sure you'll make something out of it. **JH**

COLOUR DESKJET DRIVER



At Christmas my son bought an Amiga 500 and I bought him a Hewlett-

Packard DeskJet 500C colour printer to go with it.

It has proved impossible to print colour accurately, therefore the printer is useless. I spoke to Hewlett-Packard in Bristol, which told me that the printer is very new and Commodore has not yet written a printer driver for it.

Have you got the answer to our problem?

R Curtis
Brentwood
Essex

Yes. Send £2 to *Just Amiga Monthly*, 75 Greatfields Drive, Uxbridge UB8 3QN and ask for Jamdisk 8. There is a driver for the Hewlett-Packard Deskjet 500C on said disk. I know it works because a few people have recently sent me some pretty pictures output by the Amiga on the DeskJet 500C. **JW**

HARD FAX



I am the proud owner of an Amiga 500 (expanded to 2Mb) which I use for word processing and my children use for games and education. I also have a MicroWriter AgendA which I use as an electronic filofax.

I want to be able to transfer ASCII files from the AgendA to the Amiga and vice-versa. If I can successfully link the two machines together I will be able to use the

excellent MicroWriter keys on the AgendA to input text (faster than handwriting or typing).

MicroWriter Systems produces an AgendA PC pack which links the AgendA to a PC clone, but unfortunately a similar pack is not available for the Amiga. I contacted a third party supplier of the AgendA PC pack and the people there suggested that I get my hands on a program called *A-Term* and run the PC software pack under that. What is *A-Term*? I've never seen it mentioned in *Amiga Shopper* before.

The AgendA has a fully programmable terminal, therefore in theory it should be possible to connect the AgendA to the Amiga via the serial port. Is this correct?

Mark Allen
Belfast

I'm not quite sure what the people to whom you spoke were quite trying to say. The *A-Term* program which they mentioned is simply a terminal emulation program like the one you have on your AgendA. However, if they are saying that you should use *A-Term* to run the PC software, then they're barking up the wrong tree altogether.

If you do need to run the PC software to get your Amiga to interface with the AgendA, then you'll need a PC emulator like the Bitcon KCS Power PC Board. This will basically transform your Amiga into a PC clone, so the AgendA PC pack should work fine under that.

However, if they are saying that all you need is a terminal program such as *A-Term*, this will be considerably cheaper. All you'll need is a PD terminal program such as *NComm* and a PC null modem cable to connect the Amiga to the AgendA via the serial port. Simply connect the two up and then set the terminal programs on both the Amiga and the AgendA so that the protocols are the same and you'll be in business.

The KCS Card will definitely do the job but I'd advise you to call the company which you spoke to again and try to establish precisely what it was advising you to buy before handing over any cash. Just ask whether you need a terminal program or a PC emulator and take things from there. **JH**

LIKE A ROBOT



I wish to use my Amiga A500 to control some very simple robots built

from Lego. I had this up and running on an old Spectrum, but I'd like to use my Amiga instead, thereby teaching my young son how to write programs and not just play games as has previously been the case.

Unfortunately I cannot find the

WIDE FIELD BLUES



When I try to print a line longer than shown on the screen using *Superbase Personal 2 3.02*, the printer stops at the end of the carriage. According to the readme file on the disk, *Superbase* should apply a carriage return to wrap the output when this occurs.

Alan Hunter
Blackpool

This problem seems to be endemic with *Superbase*, because it has been fixed in *Pro 4* by the addition of the `Format$()` command that automatically word-wraps fields up to 4000 characters long. That doesn't help *Superbase 2* users such as yourself, but there is a solution: `MID$()`. This function slices apart chunks of string and prints them, so all you have to do is slice the string into 70 character chunks. Just add the following to your query line:

```
MID$(Details.Invoices,1,70) NEWLINE SPACE$(9)
MID$(Details.Invoices,71,70) NEWLINE SPACE$(9)
MID$(Details.Invoices,141,70)
```

This splits your 200 character field into three lines of up to 70 characters apiece. You may need to experiment with the values a little, but that should be enough to get you started. In the meantime you might find the *Superbase Personal 2* tutorial on Page 132 of some use. **MS**

circuit diagram needed to build an interface unit. Please could you publish or tell me where I could find such a circuit. I would rather build my own, but if I have to pay for one then I will.

Allan Smith
Obingdon
Oxon

What you need is the new Input/Output Port Interface from Switchsoft. It costs just £26.95 and comes complete with 8 outputs and 13 inputs. What's more, it can be easily programmed from Basic, so this certainly sounds like the answer to your dreams. To find out more, give Switchsoft a call ☎ 0325 464423. **JH**

WHICH PRINTER?



Using the likes of *Professional Page* and *Pen Pal* to output letters, billheads and leaflets, which type of printer should I go for?

I require only mono output, but I'd like the graphics to be almost or as good as the letter quality. I have managed to short-list three printers: the Star LC24-200, the Canon BJ-10ex and the Hewlett-Packard DeskJet 500.

Do I really need to buy the most expensive of the three printers I have listed to get the results I need? Will I have trouble finding printer drivers? How reliable are all three in comparison to each other? What are the running costs in comparison to each other?

CR Thorpe
Wallasey
Merseyside

Forget the Star LC24-200, it's an 24-pin impact dot-matrix printer and graphics will suffer from the banding effect.

The BJ-10ex is a portable bubble jet printer capable of 360 by 360 dots per inch graphics. The quality of the output is quite stunning considering it only costs around £200, especially from programs (such as *Professional Page*) which use Compugraphic fonts.

Reliability is a difficult one to appraise as the BJ-10ex is not even one year old yet, but the ink cartridges (about £16, I think they are) are actually ink cartridge and print head in one, so there's absolutely no danger of the print head failing, which is 'the big one' as far as printer repair costs go.

There are firms which will sell you cartridge refill kits, which are obviously cheaper than new cartridges, but Canon advises against this as the print head on the BJ-10ex cartridge wasn't designed to last for ever.

The paper is friction fed, so there is an inevitable amount of banding, but nothing like the stripey effect from a 24-pin impact dot-matrix.

The DeskJet 500 is bigger and more expensive than the BJ-10ex. The ink cartridges for it cost more and last about the same time. The difference in output quality between the DeskJet 500 and the BJ-10ex is something people argue about. Deskjet owners say their output is better, even though it is a lower resolution of 300 by 300 dots per inch. BJ-10ex owners say their output is better. Which probably means there is little or no difference worth talking about.

Although both printers can be used with ordinary bond paper, for best results they require special (and quite expensive) 'coated' paper that causes the ink to dry immediately it touches the paper.

There are good drivers available for both printers from Just Amiga Monthly ☎ 0895 274449. **JW**

HEART PROBLEMS

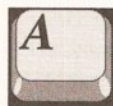

How do I run the demo program Heart.IIBM which is in the Amiga Basic

demos drawer on the 1.3 Extras disk? I have tried absolutely everything but without any success. I realise that the program is for entertainment value only, but I am irritated to think that it is there but I can't use it.

I have DPaint IV running from my A590 hard disk equipped with the extra 2Mb of RAM but the only fonts that I can use are the Karafonts supplied with DPaint on Art disk 1. However, when I try to select them, the font names flash and the font list then displays only a single font - topaz. I phoned Electronic Arts but the people there couldn't figure out what was going on either!

**M.Staples
Rustington
West Sussex**

I'm afraid you're getting things a little mixed up. The file Heart.IIBM is a picture file in IFF format which is used as a demonstration of the LoadIIBM program that is in the same directory. It is not an Amiga Basic program.

Hmm, I'm slightly perplexed by your second problem. It may be worth checking that you've got a couple of files installed on your system. To use any diskfont other than the standard Topaz font (which is actually held in ROM), the file diskfont.library must be installed within the LIBS directory on your hard disk.

You didn't actually specify whether you have a 1.3 or 2.0-based Amiga. If you have a 1.3-based A500, then you'll also have to run the ColorFonts patch program that is included with DPaint to make the program handle ColorFonts correctly. ColorFont support is built into 2.0, so this patch program isn't required.

If all else fails, why not copy the ColorFonts into your FONTS: directory? This way, you'll be able to access all your fonts without having to change directory. **JH**

WHICH VERSION?



Can you please tell me how to get and show the Kickstart version/release

numbers within a C program. I am using SAS C 5.1.0 and have tried using UWORD SoftVer within the ExecBase structure but my program tells me that the version is 2318. I have a 1.3 A500 and know that the version number is 34.5. I also know that the A500P is 37.175, but again SoftVer tells me that it's 2782. This is really frustrating as I can easily show the Workbench version and ID numbers.

**C Brown
Croydon
Surrey**

One simple, though admittedly messy, solution which comes to mind is to have your program make an AmigaDOS 'Execute' call to perform the system 'version' command and re-direct its output to a temporary file (which would be readable by your program).

There doesn't appear to be any documented routines for getting the Kickstart version/revision data via C, assembler or any other language. All we've got to go on then is the fact that the system's 'version' command works (and must, therefore, be collecting the necessary data from somewhere).

I've had no success finding a more direct approach firstly because of the distinct lack of documentation and secondly because the path I was being led to would have kept me occupied for months. **PAO**

DIY CG FONTS?



I have recently bought PageSetter II and would like some more outline fonts to

use with it. I cannot afford the sets of Compugraphic typefaces produced by Gold Disk.

I have access to a large range of Archimedes outline fonts (the format of which I know) and I am quite prepared to write a program (in C) to convert them to Compugraphic fonts usable by PageSetter II. However, to do this I need to know the format of a Compugraphic font. Where can I get this?

Also, do you know if Commodore has yet released the Libraries and Devices programmers' reference manual for version 2 of Kickstart and Workbench? I have the version 2 include files but don't know how to use them.

**JP Travers
Wirral
Merseyside**

The Compugraphic format belongs to AGFA and is not public domain. You would have to pay AGFA quite a lot of money to license it. We're talking telephone numbers here. It would be a lot cheaper to stump up about £80 for the Outline Fonts Pack.

Alternatively you could consider buying PageStream or Saxon Publisher, which support Adobe Type 1 fonts, as well as Compugraphic fonts and Soft-Logik's own outline fonts. There are thousands of shareware and public domain Adobe Type 1 fonts. Alternatively, wait for Professional Page 3.0, which will also support Adobe Type 1 fonts.

Any way you look at it, it means spending money.

Speak to HiSoft ☎ 0525 718181 about the new version 2 Amiga programmer reference manuals. **JW**

BLIND DATE



I do not have a battery-backed clock so I would like to add a couple of lines to

the startup-sequences of programs like DPaint 4 so that they ask for the correct time and date every time the program disk is booted up. How do I do this?

Also, I bought a 2Mb SupraRAM RX memory expansion at the World of Commodore Show. I explained to the Supra representative exactly what was connected to my system (a Roctec second drive and Datel Action-Replay Mk2 cartridge), but he assured me that I would not need an extra PSU to drive the RAM. However, when everything is connected up, my Amiga doesn't always recognise the Supra RAM expansion (about 1 in 10 times).

When I disconnect the Action Replay and switch off my driver though, the RAM expansion works fine. Do I need an extra PSU or is the SupraRAM broken?

**Paul Rose
Radlett
Herts**

The answer to your first question is very easy indeed. Just add the line 'DATE ?' to your startup-sequence and the Amiga will ask you for the current date and time every time the machine is rebooted.

The answer to your second question is slightly more difficult. As far as I'm aware, you shouldn't have any power supply problems with the set-up that you own simply because the SupraRAM RX uses ZIP chips which drain very little power from your Amiga. The Roctec drive drains very little power too, so this only helps to make the situation that bit more confusing. You might want to try investing in a beefier power supply for your A500 anyway - even if this doesn't solve your problems, at least you'll be taking a lot of strain off your Amiga.

If the beefier power supply doesn't work, then try using the three hardware add-ons that you have in various combinations - Roctec and SupraRAM, Roctec and Action Replay, SupraRAM and Action Replay. If you encounter problems with one of these combinations, then get the offending add-on checked out. **JH**

TITLING REQUIREMENTS



My interest is in a computer to put colour titles and graphics on to S-VHS video. At the moment I use a character generator to add black and white titles and my BBC B computer to add graphs,

continued on page 52

JARGON BUSTING • JARGON BUSTING

Basic - Beginners' All-purpose Symbolic Instruction Code is a high-level programming language, combining power with ease-of-use.

C - a compiled language designed primarily for systems programming. It was used to write much of the Amiga's operating system, and is used in the writing of many Amiga applications.

Compugraphic fonts - a Compugraphic font represents the shape of each character within the font as a mathematical equation of the outline. Consequently, as the magnitude of the character is varied in printing, no information is lost and the result always looks smooth.

IFF - Interchange File Format is a means by which data from different graphics or sound sampling programs is saved in a compatible way. It enables data to be exchanged between programs very easily.

IIBM - Interleaved Bit Map is the IFF sub-format in which graphics images are stored.

PSU - Power Supply Unit.

RAM - Random Access Memory, so called because any part of it can be accessed immediately, rather than having to search through from the start of memory to the point of interest. RAM is used to hold programs while they are being executed and temporary data. The contents of RAM are lost when the power is switched off.

FIRST CHOICE
1
COMPUTERS

FIRST CHOICE

LEEDS

TEL: 0532 637988

FAX: 0532 637689

NEW OPENING HOURS

OPEN MON - SAT 9.30AM-5.30PM
SUNDAY OPENING 11.00AM-3.00PM
THURSDAY NIGHT LATE 9.30AM-7.30PM

WEST YORKSHIRES PREMIERE AMIGA AND ATARI COMPUTER STORE

AUTHORISED DEALERS FOR STAR, CITIZEN,
COMMODORE, ACORN, ROMBO & PHOENIX



THE NEW AMIGA A500 PLUS CARTOON CLASSICS PACK

Now complete with:

- * One Mb of chip RAM expandible to 10 Mb of RAM in total
 - * The new Kickstart 2.04
 - * Workbench 2.04
 - * Built in battery backed real time clock
 - * New improved user friendly manuals
- This pack also comes with Lemmings, (the only game ever to get a 100% rating!) The Simpsons, Captain Planet and Deluxe Paint 3 the incredible paint and animation package plus mouse and modulator

NEW LOW PRICE !!

**now only
£334.99 !!**

or £369.99 for 2Mb version

**First Choice Pack
ONLY £29.99 see PAGE 2**

NEW AMIGA 1500 PLUS

New !! The New 1500 Plus Base pack

now complete with the latest 2.04 Kickstart
chip and Workbench 2.04 the 1500 Plus !!

The Base pack is the ideal upgrade machine for those wanting
to upgrade from their present Amiga 500

only £499.99

Amiga 1500 Plus Business & Entertainment Software pack

The same spec. as the base pack but with Deluxe Paint 3, Platinum Works
(the best integrated package available for the Amiga), Home Accounts,
Puzznic, Elf, Toki plus the latest Amiga Format Tips book (2.04 compatible)
and Joystick.

now only £549.99

or £779.99

with 1084SDI colour monitor (UK Spec.)

THE NEW AMIGA 500 & 1500 DELUXE SERIES

The A500 Deluxe is an updated version of the A500 Plus
incorporating the Phoenix ROM sharer with 1.3 chip because some older
software will not run on the new A500 Plus. The A500 Deluxe has been
developed with a built in ROM sharer so you can choose to run either Kickstart
1.3 or 2.04 **making incompatibility problems a thing of the past!** The
Deluxe also Comes complete with the Cartoon Classics software pack.

only £409.99

or £459.99 for 2 Mb version

**The Amiga 1500 Deluxe is an advanced version
of the standard Amiga 1500 Plus**

incorporating the famous Phoenix ROM sharer and 1.3 Kickstart ROM chip. As
with the A500 Deluxe, this enables you to switch between the old and new
operating system to accommodate older software that can only run on the 1.3
operating system.

only £559.99 for base pack version or

£609.99 for the 1500 software pack version

PHOENIX A500 PLUS RAM MODULES

We stock the best name in A500 Plus RAM expansions. These high quality RAM modules will take your
A500 Plus up to 2 Mb of chip RAM without invalidating your warranty.

Unpopulated.....only £17.99

Populated to 512K...only £29.99

Populated to 1 Mb....only £39.99

PHOENIX ROM SHARER

Because some older software will not run on the new 2.04 operating system Phoenix
have designed a high quality ROM sharer. Recognised as being the best on the market,
this ROM sharer features a flexible ribbon connection so that it can be positioned
anywhere within your A500 Plus. Keyboard switchable sharer now available!

**Don't be fooled by cheap low quality alternatives
to Phoenix, treat your Amiga to the best!!**

now only £19.99

or £34.99 for keyboard switchable version

Kickstart 1.3 only £29.99 or Kickstart 2.04 only £46.99

All Phoenix products come complete with a full 2 year replacement warranty

Tel. 0532 637988
Dept As, Unit 8, Armley Park Court, Stanningley Road, Leeds, LS12 2AE

FIRST CHOICE (LEEDS) TEL: 0532 637988

FAX: 0532 637689



Free Delivery on all products!!!

CDTV

Commodore Dynamic Total Vision

Complete with Hutchinsons Encyclopedia, Lemmings and Welcome CD disk, CDTV is a powerful media for both entertainment and education. Capable of handling up to 540 Mb of data, whole encyclopedias can be stored on just one compact disc. The CDTV is also a high quality audio CD player. We also stock a large range of CDTV software all at discount prices

now only £449.99
UK Spec.

New CD Rom for the Amiga A500

The add-on that every one has been waiting for. This high quality CD ROM turns your Amiga into a CDTV

only £279.99

New CDTV key-board

Effectively transforms your CDTV into an Amiga so you can get even more out of CDTV. With the aid of a standard 3.5" disc drive the CDTV will take most of the normal Amiga software from word processing to entertainment

only £49.99

New CDTV Trackerball

complete with 2 joystick ports, this is a must for CDTV owners

only £74.99

FIRST CHOICE PACK

Take the headache out of buying a computer with our ever popular FIRST CHOICE Pack. All the essentials required for the first time buyer. Ideal for any Amiga and great value too!

Comprises:

- * Top quality microswitched Powerplay Cruiser joystick
- * Mouse Mat
- * Dust Cover **only £29.99**
- * 10 Blank Disks
- * **Plus 3 Extra games!!**

GVP & SUPRA DRIVES

GVP Drives for the A500 & I500/2000

Recognised as being probably the best hard drives for the AMIGA. GVP drives come fitted with fast access Quantum drives and 8 Mb of unpopulated RAM.

AMIGA 1500/2000 VERSION 52 meg..£269.99 105 meg..£419.99

AMIGA 500 VERSION 52 meg.....£359.99 105 meg.....£499.99

RAM for GVP H/drives

only £29.99 per 1Mb

Supra 52 Mb Hard Drive for the A500

Using the super fast Quantum drive, these drives also come with Express copy hard drive backup software. The Supra also has Space for 8 Mb of RAM

ONLY £309.99

DISK DRIVES

New Roclite 3.5" Disk drive

The new super slim Roclite has recently received the best review for disk drives in Amiga Format

only £59.99

Cumana 3.5" Disk drive

1 meg external drive. The best name in disc drives now at a super low price. Still the most reliable.

only £57.99

STAR PRINTERS

All Star printers inc ribbons, free std printer cable and 12 month guarantee

The Star LC20

Replacing the famous LC10, the LC20 is faster at 180cps draft and 45 cps NLQ. It's also quieter. The front panel now has push button operation replacing the old LC10 membrane panel. Other spec is similar to LC10.

now only £139.99!!

Star LC200

Colour 9 pin printer with 8 resident fonts and a high speed of 225cps draft and 45 cps in NLQ. A4 Landscape printing

now only £199.99

Star LC24-200

Mono and colour. 222 cps draft and 67 cps LQ. 10 resident fonts. A4 Landscape printing

only £229.99 mono or £289.99 colour

Star XB24-200 Colour

The choice of many professional organisations, this printer comes with one year on-site maintenance. 332 cps draft, 100 cps LQ. 29k buffer exp to 189k. 4 super LQ fonts and 14 LQ fonts

now only £379.99

Star LC24-10

24 pin quality at the price of many 9 pins. 180 cps draft, 60 cps in NLQ, 8k buffer expandable to 37k

now only £189.99

Star printer accessories : Dust covers from £4.99. Printer stand just £7.99 when purchasing printer. Mono ribbons from only £3.69

CITIZEN PRINTERS

All Citizen printers inc. free printer cable and come with a full 2 year warranty!

The Citizen Swift 9 Colour

Unbeatable value colour printer. 4 resident fonts, 192 cps draft and 48 cps in NLQ. Highly recommended. This printer is also available in a wide carriage (136 column) version

only £194.99 (80 col) or £314.99 (136 col)

The New Citizen 224

A replacement for the famous 124D, the 224 now comes with the option to upgrade to a high resolution colour printer. If you want 24 pin quality, you want to print in colour if necessary and you don't want to spend a fortune, the new 224 is an ideal solution. Using the same technology as the Swift 24, the 224 is basically a cut down version. 192 cpi draft and 64 cpi letter quality with 3 built in fonts.

only £214.99 (mono) or £244.99 (colour)

The New Citizen Swift 24e and 24x

(What Micro Best Buy)
The best budget 24 pin printer has just got better!

This must be the best 24 pin colour printer for less than £300. 8k buffer expandable to 40k, 216 cps draft, 72 cps LQ and multilingual too!

only £274.99 (80 col) or £414.99 (136 col)

Citizen printer accessories : Mono ribbons only £4.99, Printer stands £24.99, auto sheet feeders £85.00, semi auto sheet feeders only £15.00

THE STAR SJ48 BUBBLEJET

With Epson LQ and IBM Proprinter emulation. The SJ48 is a revolution in printer technology. The quality is almost as good as an expensive laser printer yet costs less than many 24 pin printers. Portable in size, very quiet, and faster than most dot matrix printers at 100 cps in LQ. Printer cable included

only £229.99

Auto sheetfeeder **£52.99**

THE NEW EPSON 4100

With 512k of RAM as standard from First Choice, expandable to 6 meg. 6 pages per minute, HP2, FX, LQ. GQ compatible. 150 autosheet feeder, 12 months on-site maintenance and printer cable.

only £719.99

Toner cartridge **£59.99**

HEWLETT PACKARD PRINTERS

The HP Deskjet 500 printer allows you to create laser jet quality without the cost. with 100 page auto sheet feeder, printer cable, 3 page /minute speed and

3 year UK warranty

only £339.99

The HP Deskjet 500C

The famous deskjet 500 is now available as a colour printer. With this printer you can get stunning colour output at laser quality

now only £599.99

MONITORS

All our monitors are UK spec

All monitors come complete with a free Amiga lead

WARNING: Before you purchase a monitor make sure it has a full UK specification. You might be buying what you think is a similar monitor at a lower price but it is likely to be a "GREY" import. These monitors do not comply with British safety standards and are not covered by an official warranty

Protar Stereo colour monitor

This monitor uses the same tube as the Philips 8833 MK2 and has a similar specification. The Protar comes with a full 12 month replacement guarantee. This must be the best value medium res. monitor on the market. Amiga cable included. Tilt and swivel stand only £11.99 when purchased with this monitor. Cover only £5.99

only £195.99 UK Spec.

Commodore 1084 SDI Stereo Colour monitor

The perfect complement to your Amiga system. This Colour stereo monitor features 640*256 line resolution and green screen facility. Amiga cable included. Tilt and swivel stand only £11.99 when purchased with this monitor Cover for monitor only £5.99

only £239.99 UK Spec.

Philips Brilliance SVGA Colour monitor with overscan facility

The Brilliance monitor has a high quality Super VGA resolution ideal for making your AMIGA into a professional system. Includes overscan facility, 28 dot pitch and tilt/swivel stand. Monitor cover only £5.99 if purchased at the same time

1500 VERSION £399.99

with Flicker Free Video card

A500 VERSION £499.99

Philips CM8833 MK2 stereo colour monitor

Colour stereo monitor. 600*285 line resolution, green screen facility, one years on site maintenance, cable for Amiga included. Tilt and swivel stand only £11.99 when purchased with monitor. Cover only £5.99

now only £234.99 UK Spec. with F19 Flight Simulator

Goldstar remote control TV/monitor superior to a standard TV set.....**only £189.99**

Commodore 1960 multisync.....**only £436.99**

THE COMPLETE COLOUR SOLUTION

As official dealers for Rombo, we are able to offer this excellent package at a great price. The complete colour solution comes with RGB splitter, Vidi Amiga, Vidi Chrome, power supply and Photon Paint.

now only £129.99

VIDI AMIGA

Framegrabber.

High quality digitizing. Inc Vidi chrome colourising software

only £84.99

TAKE 2

Designed to be used in conjunction with a digitiser or as a stand alone program, this is latest animation package for the Amiga from Rombo. Features include load and save from D. Paint animations and IFF files. Supports HAM graphics.

only £69.99

RGB SPLITTER

Enables you to Colour Digitise in a second. Replaces red green blue filter set. Can be used with Digi view or Rombo products

only £59.99

THE NEW MICROBOTICS ACCELERATOR BOARDS

The VXL is an advanced 68030 accelerator for the Amiga 500/1500/2000 with space for an optional co-processor (CP)

VXL30 25Mhz EC.....only £239.99

VXL 30 40Mhz EC.....only £369.99

68881 co-pro for above.....only £79.99

The VXL accelerator boards can also accept 32 bit RAM to optimise performance. The superfast 32 bit RAM comes as a 2 Mb or 8 Mb daughter board for the VXL.

2 Mb of 32 Bit RAM (60ns)..only £214.99

8 Mb of 32 Bit RAM (60ns)..only £419.99

PANDAAL HAND SCANNER

On test this scanner has proved to be the easiest and most effective scanner that we have used to date having compared it to most of the other major hand scanners on the market. We are able to offer this high quality scanner at a fraction of the normal cost. Complete with the latest improved version of Daata-scan software this scanner is able to pick out text and graphics at up to 400 d.p.i in real time. Daata-scan enables you to easily manipulate the image. Scans in real time up to 64 grey scales. Ideal for desk top publishing and presentation.

SPECIAL OFFER
now only £109.99
or £124.99 with 2 way parallel switcher box

SOFTWARE

FINAL COPY

Superb new easy to use word publisher from the writers of PenPal. With built in outline fonts for top quality output, full graphics import capability (IFF and HAM). Features include Thesaurus, spelling checker and detector, automatic hyphenation, insert date, time, and page number, scale graphics to any size, crop graphics, multiple columns layout, magnified and reduced page view, full post script support and much more. Requires 2 disk drives or a hard drive.

Highly Recommended **only £39.99**

or £95.99 with Cumana 3.5" external drive

PLATINUM Special offer !! WORKS

As recommended by Commodore and taken from the Amiga 1500 Plus pack, we believe this to be one of the best all round integrated business packages on the Amiga. It comes with Platinum Scribble w/p, spell checker, thesaurus, Analyse (a "Lotus 123" compatible spreadsheet with 3D graphics), a database, sideways printing utility and communications software plus the best selling Digma Home Accounts package

only £49.99!!

limited stocks

DIGI-VIEW GOLD MEDIA STATION

The new complete graphics creation presentation package for your Amiga. Comes complete with the famous Digi-View Gold, Digi-Paint and Elan Performer

only £109.99

AMIGA 2.04 UPGRADE

Complete with:

- * Kickstart 2.04 chip
- * Workbench 2.04
- * and full manual set

only £89.99

PENPAL 1.4

This best selling word publisher incorporates many features found only in a desk top publisher. Also includes an easy to use database.

now only £54.99

PAGESTREAM 2.2

The latest version of this powerful DTP package that we recommend. Better than alot of DTP packages on a PC and better than most on a Mac

only £124.99

IMAGINE V2

The latest version of Imagine, the ultimate 3D animation rendering system

only £199.99!

3D Text Animate.....now only **£9.99**

Aegis Sonix.....£39.99

Art Department Pro.....£99.99

Amos Creator.....£34.99

Amos Compiler.....£22.99

Amos 3D.....£27.99

Audio Engineer.....£169.99

Audio Master version 4.....£39.99

Broadcast Titler.....only £159.99

CrossDos.....£19.99

Deluxe Music Costruction Set.....£54.99

Deluxe Paint 3.....now only £16.99

Deluxe Paint 4.....now only £57.99

Excellence word publisher V2.....£79.99

Flexidump printer utility.....£31.99

GB Route Planner.....£29.99

GB Route Plus.....£57.99

Gold Disk Office.....£64.99

Opus Directory.....£34.99

Pagesetter 2 DTP.....£45.99

Platinum Scribble w/p inc spell checker/thesaurus.....now only £29.99

Pro Page professional DTP.....£124.99

Protect 4.3 W/P..... now only £39.99

Pro Video Plus.....£149.99

Quarterback hd backup util.....only £24.99

Quarterback Tools the ultimate Amiga utilitydisk !!.....only £47.99

Sequencer One.....£74.99

SuperPlan Spreadsheet.....£29.99

Vista.....£29.99

Vista Pro (2 Mb required).....£69.99

Walt Disney Animator.....£68.99

Xcopy Pro inc . hardware.....£33.99

WORDWORTH V1.1

The latest version of this highly acclaimed WYSIWYG word publisher. Comes with multiple fonts, powerful thesaurus, large spellchecker, speech synthesis

only £74.99

PERIPHERALS

SUPRA MODEMS

Supra 2400

Get on line with this incredible value fast modem from Supra with auto dial and auto receive. 2400 baud Hayes compatible, V22 BIS. Includes free modem cable and comms software!!

only £79.99

Supra 2400 Plus (9600 Baud)

Even faster than the standard 2400 modem from Supra with auto dial and auto receive. 4600 baud Hayes compatible. V42 BIS and auto adjusting facility to maximise transmission speeds. Includes free modem cable and comms software!!

only £129.99

EMULATORS

New AT Once Plus

emulator turns your Amiga into an IBM AT compatible

now with 16 Mhz clock speed!
only £214.99

GENLOCKS

Rocgen Genlock

with built in mode switch box and auto pass thru function, the Rocgen represents excellent value for money

only 99.99

KCS Power board

Regarded as one of the best emulators on the market, this emulator fits easily into the trap door and also acts as a RAM upgrade. Highly recommended.

now only £184.99

Add £15.00 for MS-DOS 4.01

A500 Plus compatible

KCS Amiga 1500/2000

adaptor..only £59.99

Rocgen Plus

with all the features of the standard Rocgen. Also includes dual control for overlay and keyhole effects, extra RGB pass thru allowing real time graph editing.

only £134.99

DISKS

All Phoenix 3.5" disks are **GUARANTEED FOR A LIFETIME** and are **CERTIFIED 100% ERROR FREE** double sided, double density disks are of the highest quality in magnetic media and are extensively used by duplicating houses

| QTY | Phoenix Bulk | OR | Sakura Branded |
|------|--------------------------|----|----------------|
| 10 | £4.99 | | £6.99 |
| 25 | £11.99 | | £13.99 |
| 50 | £21.99 | | £25.99 |
| 100 | £39.99 | | £44.99 |
| 200 | £72.99 | | £84.99 |
| 500 | £169.99 | | n/a... |
| 1000 | £339.99 | | n/a... |
| | Disk Labels.....500..... | | now only £6.99 |
| | Disk Labels...1000..... | | now only £9.99 |

SUPRA RAM

The ultimate Amiga A500 expansion. Take your A500 up to 9 Mb (10 Mb with the A500 Plus). Fits onto the side expansion port. Auto configures with no software patching.

Please note that when 256⁴ ZIPS are used, the Supra RAM can only be populated to a maximum of 2 Mb. If you use this configuration and want to further increase your capacity you must replace the 256⁴ ZIPS with 1 Mb by 4 ZIPS.

8Mb pop to 1Mb.....£99.99

8Mb pop to 2 Mb using 256⁴zips..... £124.99

8Mb pop to 2 Mb using 1Mb⁴ zips.. £149.99

8Mb pop to 4 Mb.....£209.99

8Mb pop to 8 Mb.....£309.99

512K RAM EXPANSION

Top quality RAM expansions for the A500 complete with battery backed clock and on/off switch. This RAM expansion will not in any way invalidate your Amiga warranty!!

now only £24.99

NAKSHA MOUSE

This famous and best selling mouse comes complete with Operation Stealth, mouse mat, holder and 2 year warranty

only £24.99

ROCTEC MOUSE

This is an excellent high quality mouse for the Amiga. Fully micro-switched mouse. Excellent value and highly recommended.

only £16.99

£19.99 with m/mat & holder

CUSTOM CHIPS

Kickstart 1.3...£29.99

Kickstart 2.04.£46.99

Fatter Agnes..£37.99

Super Denese.£39.99

2 Way Parallel port sharer inc. cable

Many peripherals such as printers and scanners share the Amiga parallel port causing the user to have to swap between the two. Solve this problem with the 2 way sharer box

only £17.99

DRAM CHIPS

256 by 4 DRAM (DILs) ideal for A590 & Supra Hard drives plus many other Amiga RAM applications

QTY

4+ (512K)..now only £3.79

8+ (1Mb).....now only £3.59

16+ (2Mb)..now only £3.29

1 Mb by 8 or 9 SIMM boards

as used in GVP and Cortex boards

only £34.99

4 Mb by 9 Simms (for GVP)

only £114.99 each

1 Mb by 4 ZIPS

as used in Supra boards. 2 1 Mb by 4 ZIPS equal 1 Mb

only £38.99 per Mb

MAIL ORDER WHY FIRST CHOICE ?

Order by telephone quoting your credit card number. If paying by cheque please make payable to **FIRST CHOICE**. In any correspondence please quote a contact phone number and post code. Allow 5 working days for cheque clearance

Mail order Hotline 6 LINES

0532 637988

Prices are subject to change without notice. E&OE.

- * All prices include VAT and Standard Delivery
- * All hardware/computers are genuine UK spec.
- * Free Fast Standard 4 to 7 day Delivery
- * Guaranteed 2 to 3 day Delivery **only £2.00**
- * Guaranteed Next Day Delivery **only £4.50**
- * Open seven days a week for your convenience

PLEASE ADDRESS ALL CORRESPONDANCE TO :

DEPTAs, UNIT 8 ARMLEY PARK COURT, OFF CECIL STREET, LEEDS, LS12 2AE

continued from page 48

which I video directly from a monitor I have had contradictory advice from Amiga dealers regarding the transfer of graphics to video – some state that the A500 is adequate for the job, others that I should get an Amiga 2000. Some say that a £120 genlock is suitable, others that it would cost £400.

I would appreciate any information you may wish to give me, as my only interest is to buy another computer for the above purposes.

Tom O'Callaghan
Mallow
County Cork

There is no reason why an Amiga 500 and a low-cost genlock should not serve your needs – so long as you are happy with the results. Whilst the Amiga 1500 (and 2000) are still seen as the mid-range machines with most potential for expansion, there are now many add-ons for the Amiga 500 which will bring it up to a high level. The main problems with the A500 are an overall shortage of space for expansion and the lack of a video slot.

However, I would suggest a compromise consisting of the cheaper Amiga 500 Plus and a more expensive genlock. With the Amiga 500 Plus you'll get the benefits of the new operating system, though you should seriously consider adding an external hard drive with at least 2Mb of RAM expansion memory on board and possibly a second disk drive. You'll need the RAM to make the most of the graphics capability of the Amiga and the hard disk will both increase your loading and saving speeds and help keep your system tidy. A second disk drive is not absolutely necessary but will be very useful when copying disks and making backups.

You may also want to buy a dedicated monitor, and here I would recommend going for an RGB (SCART connector) model, as this will provide superior quality to an ordinary composite video monitor. Something along the lines of the Commodore 1084 or Philips 8833 or TV/Monitor models with SCART socket will be suitable.

Your other major hardware purchase is going to be a genlock for S-VHS use. These aren't particularly cheap, but you'll need one to get the best out of your video set-up. One that I can recommend is the Electronic Design Y/C Genlock (around £450 from Genlock Ltd ☎ 0257 472887), though you should obviously shop around. A scan through magazines such as *Amiga Shopper* and *What Video* should give

ALWAYS TRY BEFORE YOU BUY

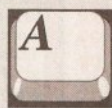

Could you recommend a good combination of printer and DTP or word processing software? My uses would range from neat, good quality letters to multi-column DTP work.

I am currently thinking of buying either *Wordworth* or *PageStream 2.2*. The cheapest I have seen these is £77 and £125 respectively. Around £130 would be my price limit for the software.

As for the printer, I am interested in the Canon BJ-10ex bubble jet, and I have seen it advertised for as little as £230.

Patrick Walsh
Langley
Berkshire

The current version of *Wordworth* doesn't do multiple columns, so you can forget that idea. Before you rush out to buy *PageStream 2.2* you might consider *PageSetter II*, which will almost certainly fit all your needs and costs less than £50.

You'll need extra cash because I notice from your query form that you have only 1Mb of memory. While *PageStream* and *PageSetter II* will run with 1Mb of memory, you'll have little room left for your documents. You should consider another 2Mb of memory.

I've seen the BJ-10ex (highly recommended) selling for under £200 at shows, and as you live quite close it might be worth a trip to the Amiga Shopper Show at Wembley on May 15-17. **JW**

you some ideas.

You'll also be needing some software. A paint and animation program such as *Deluxe Paint III*, or the more recent *Deluxe Paint IV*, will fulfill most of your graphics and animation needs, though you'll also need to buy some disks of typefaces to supplement those which come with your Amiga. There is a great choice available nowadays. You may also want to get hold of a dedicated titling package – there are a good number now available ranging from the appalling to the superb. Unfortunately the price doesn't always reflect the quality. You might consider *BAS* (from Alternative Image ☎ 0533 410044) for a low cost scroller, or something more upmarket along the lines of *Scala 500* or even *Broadcast Titler 2*. **GW**

CARTESIAN DOUBT



I had a go on my friend's BBC machine which was very good as it had the ability

to use true Cartesian co-ordinates, and to plot the origin. Unfortunately, as you've noted in previous articles, Amiga Basic lacks this facility. I then read your reviews of other Basics but nowhere is this point mentioned so... do other Basics allow for Cartesian co-ordinates and the ability to plot the origin? Having plotted a graph how can I save it as an IFF file? I have used the Amiga graphic dump facility but this is not the prettiest of sights.

How can I access the graphics of *Deluxe Music*? I would like to insert sections of my scores into my DTP if possible. Also, when using MIDI with *Deluxe Music* it invariably hangs up – is this due to lack of memory? (I have a standard 500

with 0.5Mb expansion) or is the program inherently unstable?

Ken Moyler
Faversham
Kent

BBC Basic is, in many ways, unusual in that it provided more than one co-ordinate system including a screen-centred Cartesian grid. Most Basics, and that includes those available on the Amiga, do not provide these facilities but they are very easy to implement yourself. To plot the origin of a screen-centred Cartesian system you need to identify the point half way along and half way down the screen.

If your horizontal and vertical screen resolutions are hres and vres respectively then the origin, the point which you will be regarding as (0,0), the centre spot, will be identified by the real co-ordinates $x=0.5*vres$ and $y=0.5*hres$.

To translate the x component of an (x,y) pair on your hypothetical screen-centred Cartesian grid you add the value of the x component to that of the origin just mentioned:

$x=0.5*hres+x$
real Cartesian

For the y component you need to reverse the scale using:

$y=vres-y$
real Cartesian

and then subtract the value of the origin's y component like this:

$y=vres-y-0.5*vres$
real Cartesian

By collecting the vres terms this can be rearranged as follows:

$y=0.5*vres-y$
real Cartesian

In short, this means that as long as the vertical and horizontal screen resolutions are known you can work with screen-centred (x,y) Cartesian co-ordinates and then use these equations to translate your x and y values before they are actually used in the Amiga graphics calls.

An easy way to do this is to create user-defined functions like this:

```
DEF FNxreal(x) = .5*hres+x
DEF FNYreal(y) = .5*vres-y
```

With Basic you are stuck with whatever graphics dump facilities the interpreter/compiler provides – writing your own routines to save generated screen data as an IFF file is not really a feasible option.

Deluxe Music provides no inbuilt facilities for saving its graphics and about the only thing I can suggest is that you try using *Grabbit* or some similar screen stealer program, read the resulting IFF file into *DPaint*, and then save the portion you want as an IFF brush ready for inclusion into your DTP package. To be honest it is years since I've seen the *Deluxe Music Construction Set* package but as far as I remember, although it had very limited MIDI capabilities, it was not particularly prone to crashing. Without more details it is difficult to suggest a cause but, to be honest, I would be surprised if it was due to insufficient memory. **PAO**

LIFE IN THE FAST LANE



In the Amiga column of *New Computer Express* (page 18, issue 109) there

was an article written by Jason Holborn concerning a 16 MHz upgrade for the A500. According to the article, the upgrade was to be distributed in this country by a 'well known PD supplier in Scotland' for just £25, but it seems to have disappeared off the face of the Earth! What has happened to it?

P Meoffis
Burwall
East Sussex

I'm afraid the upgrade you refer to never actually made it onto the market.

The PD supplier in question was actually George Thompson Services which was then based in Darkest Arran (a small island off the coast of the mainland). Unfortunately the chap that used to run GTS, Tony Thompson, has emigrated to the good old US of A, leaving GTS in someone else's hands. As a result, the upgrade has dissolved into vapourware. **JH**

PAGESTREAM PROBLEMS

 When I print DTP on PageStream 2 I often get full lines of graphics missed, usually when the document has a lot of small point text. The printer stops, pauses, then gives a line feed, missing out the required graphics.

I use either the Epson Q or Nec Prinwriter driver, but I have read that neither is such a good driver. What is the best driver I can use? Would a custom driver be an improvement?

Peter Clark
Wigan
Lancashire

Compugraphic fonts and bitmap graphics take up an awful lot of memory when printing at high resolutions. The missing graphics problem with PageStream is almost certainly down to shortage of memory. Try printing the same document out at a lower resolution – say 180 by 180 dots per inch – and see if the problem goes away. If it does, you need more memory to print the document at 360 by 360 dots per inch.

I see from your query form that you've got 1.5Mb of memory. I recommend at least another 1.5Mb.

The Star LC24-200 works fine with the EpsonQ and Nec_Pinwriter drivers, but these are old and very slow. There's a driver called EpsonQPlus on Jamdisk 2 which is (the author says) 2,000 per cent quicker than EpsonQ, plus it supports the 360 by 360 dots per inch resolution, which EpsonQ doesn't. You can get Jamdisk 2 from *Just Amiga Monthly* ☎ 0895 274449. **JW**

CAD CONCERN

 I'm having problems finding a suitable CAD package which could be used for printed circuit board design on my 1Mb A500. I've seen many CAD packages advertised for the PC (*Board Maker 1, Easy-PC, Vultrax 7* and so on), but I can't find any for the Amiga. I wondered if you could you suggest any?

David Micallef
San Gwann
Malta

About the best Amiga CAD package available is X-CAD from Computech (☎ 0702 523966). X-CAD is available in two forms – X-CAD Designer and X-CAD Professional. X-CAD Pro is perhaps a little beyond your needs, but I'm sure you'll find X-CAD Designer more than satisfactory. It costs £115. **JH**

JARGON BUSTING • JARGON BUSTING

Assembler – a program which converts an assembly language program written in words (well, almost) into the machine code numbers that the Amiga's 68000 processor understands. Writing programs in assembly language ensures that the best possible speed and memory efficiency is gained from the machine.

Cartesian co-ordinates – a system of mapping space devised by the French mathematician and philosopher René Descartes. One axis (straight line) is needed for each dimension of space to be measured, and all axes must be at right angles to each other. The position of any point in space can then be defined by its distance along each of these axes from the origin (the point where all the axes meet).

DTP – Desktop Publishing, the process of producing documents for print on a micro computer.

Library – the Amiga has many special features, and programs are already present in the operating system to make use of these features. These programs, or library functions, may (and should) be used by applications programs, obviating the need for each programmer to write a similar set of routines.

DISAPPEARING MEMORY

 Before double clicking on a program's icon I record the available memory in the

Workbench title bar. If I double click and start the program several times rapidly one after another and wait for them to terminate there is always a memory loss. I'd like to know where the memory goes. Is it a bug in the operating system? I am aware that after the first execution the free memory may be reduced due to libraries being loaded.

Niall Davis
W-7528 Karlsdorf
Germany

Without knowing what program you are talking about it is impossible to give you a detailed answer although I think I can safely say that anything which is happening will be due to a flaw in the memory allocation and deallocation routines of the program concerned and not to bugs in the Amiga's operating system.

The memory doesn't actually 'go' anywhere. It is simply that your program asks the system for some memory (the Exec system maintains lists of memory that is not in use) but does not free it (return it) to the system after use. Any memory that is 'lost' is still there but Exec cannot re-allocate it because it thinks it is still required by the program which originally asked for it. **PAO**

PROGRAM CONCERNS

 I currently write budget games for the Commodore 64 and I am looking to upgrade to the Amiga. However before I spend out any money, could you please answer the following questions.

a) What books should I buy?

Bearing in mind that I will have to go from novice to quite advanced programming. These books should also cover both sound and graphics. b) A mouse is not the ideal drawing tool so I will probably need a graphics tablet. I already know about the Podscat and Genitizer tablets, but which would you recommend?

c) Which graphics, sound and programming utilities would you recommend? I am not a composer so something simple on the sound front would be great. What do you recommend for generating sound effects? I assume that most games are written in assembler, but if I do have to write in C, could you please include a list of available C compilers.

d) Which machine should I buy? After much deliberation and counting of pennies, I decided to opt for the A1500 but then Commodore brought out the A500 Plus, making the lower end machine more powerful than the mid-range machines (nice move Commodore!). Presumably this means that the A500 Plus and the A1500 are not completely software compatible. I've also recently heard that the current A1500 and 2000 will be dropped. Is this true? I can't really afford to be left with an obsolete machine, so your advice would be gratefully received.

S Metcalf
Middleton
Leeds

a) If you only intend programming games, then I'd recommend three books – Abacus' *Amiga Assembly Language Programming* (which will teach you how to program in 68000 assembly language), Abacus' *Amiga System Programmer's Guide* (which will teach you the basics of

programming the Amiga hardware in 68000 assembly language) and the *Amiga Hardware Reference Manual* from Addison-Wesley. These are the only three books which I bought and they certainly taught me everything I needed to know!

One thing that you should know before you get stuck into the Amiga is that there are basically two ways of programming it – through the Amiga operating system routines or by hitting the Amiga hardware directly. If you're intending to write fast arcade games, then forget the Amiga operating system and hit the hardware directly. Not only will your programs be faster, but programming the hardware is considerably easier than programming the OS.

b) I think you'll probably find that the mouse will do the job perfectly well. My guess is that the only reason why you don't think the mouse will be up to the job is because you're not used to using one, but buy yourself an Amiga and I'm quite sure you'll change your view. If you do still need a tablet though, I'd recommend the Genitizer.

c) For writing code, you'll need only one package – *Devpac 3* from HiSoft. This is a very powerful 68000 assembler/debugging system that is available for £69.95 from HiSoft ☎ 0525 718181 (Or check out our reader offer on page 140, where you can get it for the reduced price of £65.95). Virtually all games are written in assembler (usually using *Devpac!*) simply because of its raw speed.

For producing the graphics for your games, once again a single package will do the job perfectly. What you need is *Deluxe Paint*. Version IV is the latest release, but you'll find that *DPaint III* will do the job just as well (not only that, but it comes free with the A500!). *DPaint* is available from Electronic Arts ☎ 0753 549442.

For music and sound effects, you're going to need two packages. The first is a Sound Tracker such as *ProTracker*. These very simple to use utilities will allow you to produce music for your games. The best news of all though is that virtually all Sound Tracker utilities are PD, so it's unlikely to cost you more than £2 to obtain a decent one. There's absolutely loads of Sound Tracker utilities available, but I'd advise you to go for *ProTracker*.

What's more, most Sound Tracker clones come with full source code in assembly language to allow you to incorporate the 'modules' (tunes) that you create into your games with a minimal amount of hassle.

Lastly, you're going to need a

continued on page 56



AMIGA 1.3 MEGAPACK - Stocks VERY limited -

RRP £6.99

| | |
|----------------------------------------------------|-------------|
| AMIGA 1.3 VERSION COMPUTER | RRP £349.95 |
| Only version guaranteed to run all Amiga software | |
| 1 MEG UPGRADE BOARD | RRP £29.95 |
| Increases your A500 to a massive 1 Megabyte of RAM | |
| WICKED 50 GAMES PACK | RRP £24.95 |
| 50 great games to get you going! | |
| FIGHTER MICROSWITCH JOYSTICK | RRP £7.99 |
| Essential to play your 50 games | |
| QUALITY MOUSEPAD | RRP £6.99 |

TAILOR MADE DUSTCOVER
16 NIGHTS HOLIDAY ACCOMODATION
 • PLUS • PD DISK PACK CONTAINING
 Wordprocessor • Spreadsheet • Database • Virus Killer • Backup Utility

TOTAL RRP £426.82
 But yours for an unbelievable... **£299.95**

ALL OUR AMIGA PLUSSES NOW COME WITH A MASSIVE 2 MEG OF RAM

PROFESSIONAL VIDI PACK

| | |
|------------------------------------------------------------------------------------------------------------|-------------|
| A500+ CARTOON CLASSICS PACK | RRP £399.95 |
| Complete with Bart Simpson • Captain Planet • Lemmings • D Paint III | |
| 2 MEG RAM BOARD (latest blue pcb design) | RRP £59.95 |
| Increases your A500+ to a massive 2 megabytes of RAM | |
| VIDI-AMIGA Plus VIDI CHROME | RRP £129.95 |
| Frame grabber complete with colour software and filters | |
| VIDI - RGB | RRP £79.95 |
| Electronic colour splitter | |
| TAKE 2 | RRP 99.95 |
| Latest animation package from ROMBO | |
| PHOTON PAINT | RRP £49.95 |
| This is in addition to D Paint III - the choice is yours | |
| QUALITY MOUSEPAD | RRP £6.99 |
| TAILOR MADE DUSTCOVER | RRP £6.99 |
| • PLUS • PD DISK PACK CONTAINING Wordprocessor • Spreadsheet • Database • Virus Killer • Backup Utility | |
| TOTAL RRP £833.68 | |
| But yours for an unbelievable... £499.95 | |

GAMESMASTER PACK

| | |
|-------------------------------------------------------------------------------------------------------------------------------------------------------------------------------------|-------------|
| A500+ CARTOON CLASSICS PACK | RRP £399.95 |
| Complete with Bart Simpson • Captain Planet • Lemmings • D Paint III | |
| 2 MEG RAM BOARD (latest blue pcb design) | RRP £59.95 |
| Increases your A500+ to a massive 2 megabytes of RAM | |
| ASTRA TEN GAMES PACK | RRP £229.78 |
| Datastorm • Dungeon Quest • E Motton • Grand Master Slam • Kid Gloves Powerplay • RVF Honda • Shufflepack Café • Soccer • Tower of Babel (NB All games individually packaged) | |
| WICKED 40 GAME PACK | RRP £24.95 |
| 40 great games to get you going! | |
| 2 FIGHTER MICROSWITCH JOYSTICKS | RRP 15.98 |
| Not one but two quality joysticks | |
| QUALITY MOUSEPAD | RRP £6.99 |
| TAILOR MADE DUSTCOVER | RRP £6.99 |
| • PLUS • PD DISK PACK CONTAINING Wordprocessor • Spreadsheet • Database • Virus Killer • Backup Utility | |
| TOTAL RRP £744.59 | |
| But yours for an unbelievable... £399.99 | |

PROFESSIONAL MUSIC PACK

| | |
|------------------------------------------------------------------------------------------------------------|-------------|
| A500+ CARTOON CLASSICS PACK | RRP £399.95 |
| Complete with Bart Simpson • Captain Planet • Lemmings • D Paint III | |
| 2 MEG RAM BOARD (latest blue pcb design) | RRP £59.95 |
| Increases your A500+ to a massive 2 megabytes of RAM | |
| MUSIC X 1.1 (latest version) | RRP £14.95 |
| Renowned as the best professional package on the market | |
| QUALITY MIDI INTERFACE | RRP £34.95 |
| Now you can hook up to any midi keyboard | |
| 2 x MIDI CABLES | RRP £13.95 |
| Not one but two quality cables | |
| QUALITY MOUSEPAD | RRP £6.99 |
| TAILOR MADE DUSTCOVER | RRP £6.99 |
| • PLUS • PD DISK PACK CONTAINING Wordprocessor • Spreadsheet • Database • Virus Killer • Backup Utility | |
| TOTAL RRP £672.76 | |
| But yours for an unbelievable... £399.99 | |

MONITORS / TVs

All our monitors/TVs come with the following value pack worth over £90 COMPLETELY FREE!
 Value pack comprises:-

| | | | |
|---------------------------------------------|------------|----------------------------------------|-----------|
| GFA BASIC | RRP £49.95 | CLIP-IT PAPER HOLDER | RRP £8.99 |
| The most comprehensive programming language | | MOUSE HOUSE | RRP £6.99 |
| 10 DS/DD DISKS | RRP £9.99 | PLUS • PD DISK PACK CONTAINING | |
| 20 CAPACITY STORAGE BOX | RRP £4.99 | Wordprocessor • Spreadsheet • Database | |
| SCART LEAD TO YOUR COMPUTER | RRP £9.99 | Virus Killer • Backup Utility | |

GOLDSTAR 14" TV/MONITOR

Complete with remote control and sleep timer
 Incredible value for money

TOTAL RRP WITH VALUE PACK £325.79

PROTAR 'VISTO' STEREO COLOUR MONITOR

Improved model of 8833 II made under licence
 Complete with 12 month replacement guarantee

TOTAL RRP WITH VALUE PACK £310.85

PHILLIPS 3332 15" FST TV/MONITOR

High quality FST TV/Monitor with dedicated monitor output
 Infra red remote controlling a host of features
 Complete with 2 year guarantee

TOTAL RRP WITH VALUE PACK £330.75

PHILLIPS 8833/II STEREO COLOUR MONITOR

Simply the most popular monitor on the market
 FREE F19 Stealth Fighter • 12 month on-site service warranty

TOTAL RRP WITH VALUE PACK £390.75

COMMODORE 1084S STEREO COLOUR MONITOR

Dedicated Commodore monitor
 Colour co-ordinated to compliment your Amiga

TOTAL RRP WITH VALUE PACK £390.75

PHILLIPS 2331 15" FST TV/MONITOR

Same specification as 3332 but with Teletext
 Full range 3 speaker sound output
 Incredible value for money

TOTAL RRP WITH VALUE PACK £360.75

But yours for an unbelievable

£199.95

But yours for an unbelievable

£199.95

But yours for an unbelievable

£239.95

But yours for an unbelievable

£249.95

But yours for an unbelievable

£269.95

But yours for an unbelievable

£269.95

AMIGA CDTV STARTER PACK

| | |
|-----------------------------------------------------------------------------------|-------------|
| CDTV PLAYER Complete with remote control, Lemmings etc | RRP £499.99 |
| CDTV KEYBOARD | RRP £49.99 |
| CUMANA SUPER SLIM DRIVE | RRP £79.99 |
| GFA BASIC used with above, transforms CDTV into a fully programmable Amiga | RRP 79.99 |

TOTAL RRP £679.96

But yours for an unbelievat

£549.95

AMIGA 1500 CARTOON CLASSICS SUPERPACK

| | |
|-----------------------------------------------------------------------------------------------|-------------|
| NEW AMIGA 1500 featuring Workbench/Kickstart 2, The Works, D Paint III, Home accts etc | RRP £699.99 |
| ASTRA TEN GAME PACK 10 individually pack games (see A500 Gamesmaster pack for details) | RRP £21.95 |
| GFA BASIC Essential for basic programming | RRP £49.99 |
| CARTOON CLASSICS SOFTWARE | |
| Bart Simpson Vs Space Mutants • Lemmings • Captain Planet | RRP £79.97 |
| 2 FIGHTER JOYSTICKS | RRP £15.98 |
| QUALITY MOUSEPAD | RRP £6.99 |

TOTAL RRP £1082.62

But yours for an unbelievable

£599.95

MEMORY DRIVES & SCANNERS

| | | | | |
|---------------|--------------------------------------------------------------------------------|--------|-------------------|---------|
| MEMORY | 512K RAM EXPANSION WITHOUT CLOCK | £19.95 | WITH CLOCK | £24.95 |
| | 1.5 MEG EXPANSION (Not Plus compatible) | | | £79.95 |
| | 1 MEG EXPANSION (Gives your A500 plus a massive 2MB) | | | £39.95 |
| | 1 MEG EXPANSION WITH THRU-PORT | | | £49.95 |
| | NEW 8 MEG RAM BOARDS FROM POWER Complete with Thru-Port Populated board | | | |
| | with 0Meg RAM £99 • 2 Meg RAM £129 • 4 Meg RAM £189.95 • 8 Meg RAM £299.95 | | | |
| | DIRECT A500 REPLACEMENT DRIVE with instructions | | | £44.95 |
| | POWER PC880E Robust slim drive with anti-click | | | £49.95 |
| | CUMANA CAX 354 SLIMLINE DRIVE | | | £54.95 |
| | POWER PC 880B with Blitz/Virus hardware | | | £69.95 |
| | POWER PC880B+ X-COPY PROFESSIONAL | | | £99.95 |
| | DUAL POWER PC880B complete with Power supply | | | £124.95 |
| | GVP 52 MEG HARD DRIVE WITH RAM EXPANDABLE TO 8MB | | | |
| | 0 Meg RAM £379.95 • 2 Meg RAM £429.95 • 4 Meg RAM £499.95 • 8 Meg RAM £679.95 | | | |
| | GVP 105 MEG HARD DRIVE WITH RAM EXPANDABLE TO 8MB | | | |
| | 0 Meg RAM £579.95 • 2 Meg RAM £629.95 • 4 Meg RAM £729.95 • 8 Meg RAM £899.95 | | | |
| | POWER SCANNER WITH VERSION 2.0 SOFTWARE | | | £99.95 |
| | UPGRADE KIT FOR NON POWER SCANNER UNITS | | | |
| | Complete with hardware interface and new version 2.0 Software | | | £49.95 |

Future World
 computers

ALL PRICES INCLUDE VAT & COURIER DELIVERY

STAR PRINTERS

All our Star Printers now come with the following value pack worth £34.96 COMPLETELY FREE

QUALITY COMPUTER CABLE RRP £9.99
 UNIVERSAL PRINTER STAND RRP £9.99
 200 SHEETS CONTINUOUS PAPER RRP £4.99
 TAILOR MADE DUST COVER RRP £9.99
 16 NIGHTS HOLIDAY ACCOMMODATION
 •PLUS• PD DISK PACK CONTAINING
 Wordprocessor•Spreadsheet• Database•
 Virus Killer•Backup Utility

STAR LC20 MONO PRINTER

9 Pin Dot matrix 180/45 cps
 TOTAL RRP with value pack £268.01

But yours for an unbelievable **£149.95**

STAR LC200 COLOUR PRINTER

9 Pin colour 185/45 cps
 TOTAL RRP with value pack £339.29

But yours for an unbelievable **£209.95**

STAR LC24-200 MONO PRINTER

24 Pin mono printer 220/55 cps
 TOTAL RRP with value pack £386.29

But yours for an unbelievable **£249.95**

STAR LC24-200 COLOUR PRINTER

24 pin colour printer 220/55 cps
 TOTAL RRP with value pack £445.04

But yours for an unbelievable **£299.95**

SERIOUS SOFTWARE

WORD PROCESSORS

QUICKWRITE basic but efficient and easy to use £59.99
 PENPAL Ideal for both beginners & experienced users £79.99
 WORDWORTH Industry standard, the best! £129.99

DATABASE

K-DATA Affordable, reliable & easy to use £51.99
 SUPERBASE PROFESSIONAL £249.95

The ultimate, you can't get better

SPREADSHEET

K-SPREAD 2 Simple & easy to use £63.99
 K-SPREAD 3 Enhanced version of above £81.99
 MAXIPLAN Well known powerful spreadsheet £69.99
 ADVANTAGE Powerful package for business users £99.99

UTILITIES

PERSONAL FINANCE MANAGER
 Get your finances in order! £39.99

HOME ACCOUNTS 2

Suitable for home & small businesses £54.99
 DEVPAC 3 Extremely powerful assembler £69.99

GRAPHICS

AMOS THE CREATOR Become a budding gamesmaker £49.99
 WALT DISNEY ANIMATION STUDIO
 every cartoonists dream £99.99

MUSIC

MUSIC X I.I Special purchase whilst stocks last £49.99
 BARS & PIPES Top of the range for the professional £148.99

ORDERING MADE EASY



BY PHONE

Simply call our Head Office quoting your Access/Visa number on
0234 218060 (5 lines)



BY CALLING PERSONALLY

Simply call in to your nearest FutureWorld store where our fully trained personnel will be more than happy to deal with your requirements.



BY POST

Make cheques, Building Society drafts or Postal Orders payable to
 FUTUREWORLD COMPUTERS LTD
 UNITS 25-27 SERGEANTS WAY
 ELMS INDUSTRIAL ESTATE BEDFORD MK41 0EH

Please write cheque guarantee card number on the reverse of cheque to ensure same day clearance. Cheques without a card number subject to 10 days clearance.

REMEMBER ALL PRICES ARE INCLUSIVE OF VAT & COURIER DELIVERY (UK Mainland only)



FINANCE

Finance available to suit your specific needs. Written details on request
 Instant credit is available in all FutureWorld stores

PREMIER GOLD CARD

- 7 day money back guarantee on goods purchased if not completely satisfied (subject to goods being returned in mint condition)
- 30 day exchange for new policy should a fault occur
- 1 year guarantee giving free collection and delivery service should a fault occur
- Exclusive Premier Gold Card with Personal Membership Number entitling you to special offers
- All this for only £19.95 per item purchased

1 YEAR GUARANTEE

For the whole guarantee period, warranty service will be completely free of charge

TECHNICAL SUPPORT/ON SITE ENGINEERS

Being authorised service centres for AMSTRAD, COMMODORE & STAR, we are equipped to deal with the majority of queries.

FULLY COMPUTERISED ORDERING SYSTEM

This enables our telesales staff to provide up-to-the-minute stock information coupled with efficient dispatch

FULL TESTING PROCEDURE

All computer hardware is tested prior to dispatch maintaining our motto;

Simply the BEST

All goods subject to availability
 All prices correct at time of going to press



SUPER ABC PERIPHERAL PACKS

PACK B

1/2 MEG UPGRADE BOARD RRP £29.95
 2 FIGHTER JOYSTICKS RRP £15.98
 40 CAPACITY LOCKABLE DISK BOX RRP £9.99
 10 DS/DD 3.5" DISKS RRP £9.99
 TOTAL RRP £65.91
SUPER VALUE PACK PRICE £34.95

PACK A

QUALITY REPLACEMENT MOUSE RRP £19.99
 SOLID PERSPEX DUST COVER RRP £12.99
 QUALITY SEMI-SOFT MOUSEMAT RRP £7.99
 TOTAL RRP £40.97
SUPER VALUE PACK PRICE £19.95

PACK C

1 MEG EXPANSION BOARD RRP £59.95
 40 CAPACITY LOCKABLE DISK BOX RRP £9.99
 10 DS/DD 3.5" DISKS RRP £9.99
 3.5" DISK DRIVE CLEANING KIT RRP £7.99
 TOTAL RRP £87.92
SUPER VALUE PACK PRICE £44.95

PROFESSIONAL AMIGA REPAIRS

"Simply The Best" Commodore authorised repair centre

FREE COLLECTION & DELIVERY BY COURIER Make one simple phone call and leave the rest to us!
 GUARANTEED 7 DAY TURN AROUND We guarantee to return your computer WITHIN 7 days of collection

FULL OVERHAUL INCLUDING OVER 50 DIAGNOSTIC CHECKS Your Amiga will look as good as new

3 MONTH COMPREHENSIVE GUARANTEE Our engineers work to the highest standard

ALL INCLUSIVE PRICE We won't con you with hidden extras

FREE 50 GAMES SOFTWARE PACK

For a limited offer we will give you a 50 games pack completely free!

ALL FOR THE INCREDIBLE PRICE OF **£59.95**

NB Personal callers in to one of our stores may deduct £10 from the above price
 We reserve the right to refuse computers that have been tampered with or are beyond economical repair. In this instance a nominal £10 charge will be made to cover carriage costs

EXTEND YOUR WARRANTY TO A TOTAL OF 1 YEAR FOR ONLY AN ADDITIONAL £20.00

YOUR NEAREST *FutureWorld* STORE

- BEDFORD**
70 High Street Bedford Telephone 0234 217070
- NORTHAMPTON**
1-7 College Street Northampton Tel 0604 33996
- WELWYN GARDEN CITY**
16 Church Road Welwyn Gdn City Tel 0707 390029
- WATCH THIS SPACE**
More stores opening soon!

continued from page 53

sound sampler such as StereoMaster (available for £39.95 from MicroDeal ☎ 0726 68020). A sound sampler will allow you to 'grab' sounds from real life (explosions, gun fire, speech and so on). Don't worry: using samples on the Amiga is absolute child's play simply because the Amiga's sound hardware is sample-based anyway.

d) There are rumours that Commodore will drop the A1500 and the B2000, but I personally feel that what the company will actually do is upgrade the specification of both. In the case of the A1500, this will probably take the form of a doubling of the available RAM with all this RAM put over to Chip (giving 2Mb of Chip RAM). It will also undoubtedly come fitted with both the enhanced chip set and AmigaDOS 2.0.

In the case of the B2000, I've heard rumours that Commodore plans to redesign the machine to bring it more in line with the A3000. No specification-type details (or the machine's existence!) have been officially announced, but it wouldn't surprise me if the new 2000 machine came with 2Mb of RAM (once again, all of it Chip RAM) and was fitted as standard with a hard disk and 68020 processor inside an A3000-like case. These are still only rumours of course, but I'd be very surprised if Commodore didn't come up with a machine along these lines.

Choosing between the A500 Plus and the current A1500 is really a matter of taste. You don't really need Workbench 2.0 if you're programming games, so the Plus' enhanced operating system isn't really that tempting.

Despite the fact that it is still 1.3-based, the A1500 is a more expandable and tidier system that comes as standard with a detachable keyboard, so you'll probably find it a more comfortable machine to work with. Even if Commodore doesn't upgrade the A1500 to run Workbench 2.0, a 2.0 Enhancer pack (for about £90) will be released which will enable you to fit the upgrade yourself, so you don't have to worry about the machine becoming obsolete. **JH**

DESKJET COLOUR DRIVER



I enjoyed your article on printers in the March 1992 issue.

You mentioned that you have a collection of Amiga printer drivers. Do you have one for the Hewlett-Packard DeskJet 500C?

David Spence
Belfast
N Ireland

Yes. Send £2 to *Just Amiga Monthly*,

JARGON BUSTING • JARGON BUSTING

Agnus chip – The custom chip dedicated to graphics. The first three versions – 8361, and the 8370 and 8371 Fat Agnus – can access 0.5Mb of Chip RAM. A later version, 8372a, can access 1Mb; while the ones used in A500 Pluses and A3000 can access 2Mb.

Blitter – part of the Agnus chip which can move and alter areas of memory (specifically graphics memory) at very high speed, without intervention from the central processor. It is used extensively for animation.

Logo – a program language designed for educational purposes. It is especially suited to the drawing of geometrical shapes. Some versions are used in conjunction with robot 'turtles'.

Sample – A digital – computerised – representation of a sound. A sample can be sent through a digital to analogue converter (the Amiga has four of these) and be heard as sound. Changing the speed at which the sample is played back changes the frequency (or pitch) of the sound.

Sprite – a graphical shape, moved as a whole around the screen. The Workbench pointer is an example. Some sprites are manipulated by the Amiga's blitter, meaning that they can move very smoothly.

75 Greatfields Drive, Uxbridge UB8 3QN and ask for Jamdisk 8. **JW**

BLITTER IS ALL MINE



I enjoy programming both direct to the hardware and by using the

operating system routines and have some questions. Firstly, how do I get exclusive use of the blitter when running under Intuition. Secondly, I've noticed that programs like *DPaint* put a 'Wait' sprite in place of its normal pointer – how is it done? Lastly, when programming direct to the hardware can I, for example, use the maths libraries for 3D rotation?

Dan Shepperd
Norwich
Norfolk

There is a pair of graphics routines – called OwnBlitter() and DisOwnBlitter() – which can be used to steal the blitter from, and return the blitter to, the operating system. This usage is documented in the *ROM Kernel Manuals* but you need to remember that on the few occasions where this might be necessary you have to be quick – the system uses the blitter extensively and when your task takes control of the blitter in this fashion it locks out all of the system processes, including Intuition.

Most programs which change the pointer do so by setting up a custom sprite definition followed by a call to an Intuition routine called SetPointer(). The Intuition call has this format:

```
SetPointer(window_p, ↓
data_p, height, width, x, y)
```

where the registers used are: AO, A1, D0, D1, D2 and D3 respectively and

where window_p is a pointer to the window that gets the pointer definition, data_p is a pointer to the chip-memory sprite data, height and width are the sprite dimensions and the x/y values are offsets from the current pointer position.

There is a corresponding routine called ClearPointer which resets the default pointer image:

```
ClearPointer(window_p)
register AO
```

As far as your last question is concerned – providing you make provision for properly loading and using the maths libraries within your programs there is no reason at all why you cannot use them for co-ordinate calculation (or anything else) prior to hitting the hardware directly. **PAO**

LAZARUS MYSTERY

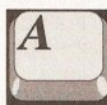

I understand through my manual that my machine is fitted with the Fatter Agnus

chip. To get my machine to recognise the additional 0.5Mb from the A501 I have to solder or alter one of the boards inside. This will invalidate my warranty, which still has nine months to go; is there any company which will do this cheaply for me?

Alternatively, if I got an expansion board populated as Fast RAM, could 512K of this be used as Chip or do I need special memory chips?

Secondly I have just had a disk corrupt on me and have no idea why. It started off when I booted the disk under Workbench and displayed its contents. At this point it appeared that only one file was corrupted, but the problem seems to have spread and the computer

claims this is not a DOS disk.

I checked through the disk with *Master Virus Killer 2.1*, which did not detect anything.

Next I tried *Diskdoctor*, which found two hard errors on the upper surfaces of cylinders 40 and 45 and finally said Lazarus Key 838 already set. What is this? The disk has also been renamed as Lazarus.

I have managed to salvage some of the files to another disk but the Lazarus key 838 messaged appeared again. I have tried putting the original disk through *Diskdoctor* again but to no avail. Can you help me?

S Griffiths
London

This confusion with Chip and Fast RAM is quite common, and as far as the RAM chips themselves are concerned there's absolutely no difference.

The difference between Chip and Fast RAM is determined by where they appear in the physical address space. Chip RAM always appears first as it is accessed by the custom chips to create things like screen displays, sound effects and so on. Fast RAM is not accessed by the custom chips and a program running there will work slightly faster – we're talking in terms of micro-seconds here; a fraction of one per cent in real time.

Extra Chip RAM will enable some programs to store larger sound samples; graphics programs can have more screens open and an A570 requires it, but that's all the difference the extra Chip RAM makes. Quite frankly, unless you actually need the upgrade, which can be carried out by competent specialist dealers for about £20-£30 it's not worth the expense in my opinion.

The problem with *Diskdoctor* is common enough. Cylinder 40 contains some special information called a root track. Every file and directory on the disk links back to that track; and if it fails, you're in trouble.

Diskdoctor searches the links and patches the root track's structure back together again. It isn't a mind reader though – the root track also contains a disk's volume name and if this is corrupt the disk gets renamed Lazarus.

The message Key 838 already set comes from the disk validator and refers to a bit in the disk's bitmap (block allocation table). Every block on the disk – all 1760 of them – owns a bit in the bitmap; and by examining this information, AmigaDOS knows which blocks are free and therefore, how much space is available. Key 838 in this case has already been allocated and the

validator is complaining that it shouldn't be. **MS**

SHARED DEVICES

A a) Can Amiga 500s be networked together to share a hard drive? A company called ASG produces a file sharer, but this isn't quite what we're after. We need to be able to boot up eight Amigas from a single hard drive and then use the drive for spell checking and fonts.

b) Can an 8Mb RAM expansion be shared between eight machines with each being allocated 1Mb?

c) Can Amiga Logo (from Commodore) be linked to TechniLego? If not, is there a way of controlling TechniLego models from the Amiga?

d) Using Protexit 4, I cannot write more than one page of text on my 1Mb A500 without the machine crashing. This also happens on all the school's A500s although it doesn't happen when I try to run Protexit on my brother's 1Mb A500. When I turn off my RAM expansion though, the problem goes away.

A Pickering
Knighton House School
Blandford

a) Networks are jolly expensive things, but about the best one I've seen to date is the SuperLink system from Nine Tiles Computer Systems. It doesn't actually enable you to boot up each machine from the hard drive, but connecting each node to the network is achieved using just a

single CLI command. Give Nine Tiles a ring on ☎ 0223 440099.

b) The simple answer to this is: not yet. Commodore does intend to build support for true 'public' memory into a future OS version, but it's going to be a long time coming.

c) Commodore's Logo cannot control TechniLego models, but it's not that difficult to interface such devices to your Amiga. All you need is the Input/Output Port Interface (£26.95) from Switchsoft ☎ 0325 464423.

d) Were you using the same RAM expansion when you tested Protexit 4 on the A500s belonging to your school? If so, then it seems more than likely that you've got a faulty RAM chip. If this is the case, then I'd advise you to send it back to the company that you purchased it from and they'll either repair it or send you a new one. **JH**

MORE CACHE NEEDED



When using Professional Page 2.0, unless I print my document as soon as

I've finished the damn thing, it won't print it with the Compugraphic fonts.

If I have saved the document on a previous occasion and then at a later date return to try and re-print it, a requester appears saying 'Unable to start Compugraphic font task, characters not already in cache will not be displayed'. It will still print the document, however this is without the Compugraphic fonts.

I appreciate that 1Mb of

memory isn't exactly a vast quantity for such a program, and being honest, with Compugraphic fonts I only manage a single page most of the time, but why will it print when I first create a page but not when I exit the program and return to it later?

I have tried creating another page by using the characters in the original document, and the hard drive (A590) loads the Compugraphic characters in as I hit the keys, but as soon as I try to delete the extra page and send the original page to the printer, it still won't print with Compugraphic fonts.

I'm sick of trying to switch on the CG task in the Compugraphic Font Control requester. It stays on until I try to print, then promptly switches itself off.

I never had this problem with PageSetter II. Perhaps I shouldn't have sold it and bought a second-hand Professional Page from an ad in the mag, even if I did get it for £80.

Professional Page may have more bells and whistles than PageSetter II, but it's a bloody sight more temperamental and I'm not really convinced that it's all down to memory. I hope that you can help me out.

Dave Brandwood
Derker
Lancashire

The 'Compugraphic font task' in question is actually a separate program named CGT and

Professional Page will look for this program in the CGFonts: directory. If it's not there, it can't render Compugraphic fonts to the screen or the printer.

So why does it do it when you first create the document, and then refuse to render Compugraphic fonts upon re-loading Professional Page and the document?

Well, it's because upon re-loading the document Professional Page cannot find, or cannot load, the CGT file.

You plainly have CGFonts: assigned correctly, and the CGT file is obviously in there, otherwise you wouldn't have been able to use the Compugraphic fonts in the first place. So it must be that Professional Page cannot load the CGT file because there is not enough memory left to load it.

Now, before I go any further I should point out that we're talking Professional Page 2.0 here; the latest version (2.1) has done away with the Compugraphic Task (CGT) and the font caches.

Pre-2.1 versions of Professional Page only need to load the CGT file if the characters you want to use are not already in a font cache. While you are working, these caches are held in memory, but upon quitting Professional Page they get saved to disk in the CGCache: directory.

It would seem that your font caches are full to the maximum size specified in the Compugraphic Font Control requester, so Professional Page is 'throwing away' the extra data. One way around this is to increase the maximum disk cache size in this requester, but this needs to be done every time you run Professional Page and is a pain in the bum.

A better way is to edit the font caches, and create new ones, using the supplied CacheEdit program. Clear out all the unwanted characters and fonts - remember that large point sizes take up large amounts of memory, so clear these out unless you really need them - and save new caches that contain only the characters you require of the typefaces you require in the point sizes you require, in the resolutions you require.

Remember that your printer's (Star LC-10C) top resolution is 240 by 216 dots per inch, so create a cache for all the fonts you require in this resolution as well the screen resolution of 75 by 75 dots per inch. There is a section in the manual on using CacheEdit. Read it.

After creating all these caches Professional Page will only need to load the CGT file if you want to render a character that isn't in one of

continued on page 59

THERE'S MORE TO C THAN MEETS THE EYE



Having read the Compiling The PD Cs article in issue 11 I was delighted to find two programs which addressed the problems of Intuition and graphics.

As I am just starting to scratch the surface of C, these little pieces of code gave me two hours of eager typing.

Unfortunately neither piece compiled first time, although, being new to the language, I rather expected this. I spent the next five hours checking the mistakes the compiler spat out and, all in all, there were five errors in program one. Two were due to my typing but the other three were as follows:

```
line 37 - error bin-op expr syntax
line 49 - error bin-op expr syntax
line 60 - undefined INTUITION_VERSION
```

By pure guesswork I added an extra "-" to lines 37 and 49 but trying to solve line 60 was a nightmare. I checked the listing 3 times and couldn't find a problem anywhere, so I started to muck around with the #defines at the beginning of the listing.

All I did was move the #defines down 1 line to leave a clear line between them and the #include statement and hey presto - it worked. Can you tell me

whether these problems are quirks of NorthC?

David Goodall
Sunderland
Tyne & Wear

The listings given in the article you mention were actually taken directly from tested source code. I'll admit that it is not that obvious in the listing but if you look closely at the '-' signs in lines 37 and 49 you'll see that they were in fact decrement operators which are of course written using a pair of minus signs, ie written as '-'. Presumably you had typed them as single minus signs which is why the first two errors occurred.

NorthC, like most non-commercial compilers, has many quirks and its error messages leave much to be desired but, as far as I know, having to move lines around in the fashion you mention isn't one of them and I couldn't get this error in my source code. Much would depend on the exact contents of the final source file you created and this could depend on both the editor used and on what was actually typed (as opposed to what you thought had been typed).

The end result is that it is difficult to say what caused this problem without having a copy of the file in question. **PAO**

OMEGA PROJECTS (EUROPE) LTD

14 DERWENT CLOSE
CULCHETH
WARRINGTON
CHESHIRE, WA3 5DY



0925-763946

FOR ORDERS AND TECHNICAL QUERIES
ALL PRICES INCLUDE VAT

ALL CHEQUES, P.O., ETC SHOULD BE MADE PAYABLE TO OMEGA PROJECTS LTD. WE ALSO TAKE ACCESS, VISA, MASTERCARD & EUROCARD

SOUND ENHANCER

34.95

100% COMPATIBLE WITH ALL SOFTWARE

IF NOT SATISFIED WITH THIS PRODUCT SIMPLY RETURN FOR A NO QUIBBLE REFUND. THIS IS HOW SURE WE ARE THAT YOU WILL BE MORE THAN IMPRESSED. YOU'VE GOT TO HEAR IT TO BELIEVE IT.

IF YOU THOUGHT THAT THE AMIGA SOUND WAS GOOD THEN YOU ARE IN FOR A REAL SHOCK, AS YOU CAN ENHANCE THE SOUND TO NEW HEIGHTS WITH THE BRAND NEW RELEASE FROM OMEGA PROJECTS: LOOK OUT FOR THE REVIEWS

AMI-BACK

The WORLDS fastest, most reliable hard disk back-up utility available for the AMIGA. Backs up to 4 floppy drives (not 2 like the competitors) or to TAPE STREAMER without the need for additional software, has a built-in SCHEDULER. Selective back-up, or Disk Image. Guaranteed, better than any other on the market.

49.95

AMIGA DOS 2.0 COMPATIBLE

150/250Meg SCSI TAPE STREAMER

The ULTIMATE back-up device + FREE copy of AMI-BACK

INTERNAL **499.95**

AMIGA DOS 2.0 COMPATIBLE

EXTERNAL **599.95**

ST-506 HARD DISK INTERFACE FOR A500. FITS IN TRAPDOOR COMPLETE 612K RAM + CLOCK **49.95**

SYQUEST REMOVEABLE HARD DRIVES

The most cost effective drive solution ever for the Amiga.

44 Meg inc. CARTRIDGE £399.95
88 Meg inc. CARTRIDGE £499.95

GVP

IMPACT 500 HARD DRIVE Expandable to 8 Meg ram

52Meg 399.95
105Meg 499.95

ADD 50.00 PER 2 Meg IF ORDERED AT SAME TIME AS DRIVE.

AMIGA 1500 + SOFTWARE **599.95**
NO SOFTWARE **549.95**

SUPRA RAM 500 RX

External memory expansion for Amiga 500 & 500 Plus. Adds up to 8 meg.

1 Meg 119.95 4 Meg 199.95
2 Meg 149.95 8 Meg 349.95

SUPRA HARD DRIVE SYSTEMS

500XP 52MEG 349.95
500XP 105MEG 499.95
PLUS UP TO 8 MEG RAM

GVP SERIES 2 (A1500/2000) SCSI + UP TO 8 Meg of Ram
52Meg 299.95 ADD 50.00 PER 2 meg
105Meg 419.95 IF ORDERED AT SAME TIME

NEXUS (A1500/2000) SCSI + UP TO 8 Meg of Ram
52 Meg 379.95 ADD 50.00 PER 2 Meg
105Meg 519.95 IF ORDERED AT SAME TIME

SUPER CARD-AMI II

THE ULTIMATE & GENUINE DISK DUPLICATOR. FULL UK SUPPORT & UK USER GROUP SET UP

A500 **34.95** A1500/2000

200 WATT PSU

COMPLETE WITH A500 POWER CABLE & OPTIONAL HARD DRIVE POWER LEAD

READY TO PLUG IN AND GO **79.95** FAN COOLED

BARE SCSI (UPGRADE) DRIVES

| | | |
|------------|---------|--------|
| Quantum | 52Meg | 199.95 |
| Quantum | 105Meg | 349.95 |
| Quantum | 210Meg | 639.95 |
| SCSI Case. | inc PSU | 109.95 |

| | |
|------------------------------|--------|
| A3000 RAM 256*4 80ns 1Meg | 69.99 |
| A3000 RAM 1024*4 80ns 4Meg | 299.99 |
| A500 Replacement Int. Drive | 55.00 |
| A1500/2000 Internal Drives | 59.95 |
| A590 CMOS RAM Chips (512K) | 19.95 |
| B2000 18 Pin Drums (2Meg) | 79.95 |
| 256*1 Drums 150ns | 0.99 |
| 1.3 Roms | 34.95 |
| 1Meg x 8 SIMMS (2Meg) 80ns | 79.95 |
| 4Meg x 8 SIMMS (8Meg) 80ns | 299.95 |
| Sound Trap 3 Sampler | 29.95 |
| Mini-Midi Interface | 19.95 |
| 4 Channel Audio Mixer + Mic | 34.95 |
| Sound Trap 3 + Mini-Midi | 47.95 |
| Sound Trap 3 + Audiomaster 2 | 55.00 |
| Sound Trap 3 + Audiomaster 3 | 84.95 |
| Mini-Midi + Music-X | 99.95 |
| Audiomaster 2 | 29.95 |
| Audiomaster 3 | 55.00 |
| 3.5" Ext. Drive (Cumana) | 59.95 |
| 23WAY Connector no hood | 1.49 |
| 23WAY Connector + hood | 1.99 |
| 40 Cap. Disk Boxes | 4.50 |
| 80 Cap. Disk Boxes | 4.95 |
| A500 Dust Covers | 2.99 |
| Mouse Mats (6mm neoprene) | 1.99 |

| | |
|---------------------------------|--------|
| ICD ADIDE40 AT CONT. | 99.95 |
| ICD ADIDE44 AT CONT. | 129.95 |
| ICD ADSCSI 2000 | 99.95 |
| ICD ADSCSI 2080 | 149.95 |
| ICD NOVIA 20i (Fully internal)* | 199.95 |
| ICD NOVIA 40i (Fully internal)* | 299.95 |
| ICD NOVIA 60i | 399.95 |
| ICD FLICKER FREE VIDEO | 199.95 |
| ICD ADSPEED | 159.95 |
| ICD ADRAM 540 | 89.95 |
| ICD ADRAM 560 | 169.95 |

* NO NEED TO REMOVE DFO

CSA MEGA-MIDGET RACER

The UKs biggest selling ACCELERATOR card. For the A500/2000. Offering a modular design allowing you to buy what you can afford then expand later. Up to 38Mhz CPU + 50Mhz Co-pro + 8 Meg 32bit ram + 512K Shadow (STATIC) ram.

68030 accelerator 25, 33, 38 Mhz
Co-Processor socket for 68882 up to 50 Mhz
68000 socket on board for FALLBACK compatibility
Gives you more power than the A3000
Optional DRAM expansion up to 8Meg 32 bit ram
Fits INSIDE A500/1500/2000 easily and quickly
Creates a monster machine for progs like FALCON etc
Cuts Ray Tracing times 30x - 60x for SCULPT etc
Speeds up screen refresh and overall performance
Lowest price 68030 THAT WORKS!!!!

As the ONLY OFFICIAL DISTRIBUTORS for CSA we offer a 50% buy back policy. This means that if you upgrade you won't be stuck with anything.

| | |
|---------------------|--------|
| 25mhz EC68030 | 349.95 |
| 33Mhz EC68030 | 449.95 |
| 25Mhz MC68030 | 449.95 |
| 33Mhz MC68030 | 549.95 |
| 25MhzEC + 68882 | 499.95 |
| 33MhzEC + 68882 | 599.95 |
| STATIC RAM (512K) | 99.95 |
| 2Meg 32Bit ram | 199.95 |
| 4Meg 32Bit ram | 399.95 |
| 8Meg 32Bit ram | 699.95 |
| 25/25 + SRAM + 2Meg | 749.95 |
| 33/33 + SRAM + 2Meg | 879.95 |

Also coming soon from CSA is a BRAND NEW idea to enable people that own the Commodore A2630 Accelerator to increase its speed to a full 50MHZ while retaining full original compatibility. So don't even think about swapping your original card for a faster one until you have seen the performance of

"ROCKET LAUNCHER"

Phone for more details

GVP SERIES II 68030 COMBO CARD

This affordable ACCELERATOR CARD for the A1500/2000 gives your Amiga a new outlook on processing. Complete with CO-PRO, 32 BIT RAM, and SCSI HARD DISK controller.

Allowing transfers in excess of 1.2meg/sec
25Mhz + 1Meg 32 bit ram 599.95
40Mhz + 4meg 32 bit ram 999.95
50Mhz + 4meg 32 bit ram 1499.95

GVP IV24

24 bit professional video adaptor. Features 16 million colours on screen at once. Built in Genlock, F/Fixer, Frame buffer, Frame grabber, and Digital key. Comes with Caligari 3D. Scala IV24, & Macro Paint

1799.00

Panasonic MULTI-SYNC Monitor

+ ICD Flicker Free Video **499.95**

Continued from page 57

them. With careful planning it shouldn't need to load CGT at all.

Ultimately the answer to your problem is either buy more memory or upgrade to version 2.1 of *Professional Page*; or, best of all, do both. **JW**

SOUND QUESTIONS

 I currently use *MasterSound* for making jingles for a local Hospital's radio service. I have just bought a MIDI keyboard and MIDI interface. What I need to know is if I buy an 8Mb RAM expansion, will I have extra sampling time? I have heard that samples are stored in Chip RAM, so can I sample into Fast RAM? Also, which RAM expansion would you recommend? The Cortex or the SupraRAM? Will my PSU be able to cope with 8Mb of RAM? Finally, is AudioEngineer better than Sound Master?

Tuhin Dasgupta
Chiswick
London

You're right in saying that sound samples must be stored in Chip RAM for the Amiga sound hardware to access them, but most modern Amiga samplers get around this limitation by using the 68000 to copy the sample data held in Fast RAM to Chip RAM as it is needed. *MasterSound* too will allow you to grab samples limited in size only by the size of your RAM expansion, so if you already own a sampler that is up to the job.

Both the Cortex and the SupraRAM RAM expansions are jolly fine products with little to separate them, so my advice to you would be to buy the one that you can get cheapest.

If you were installing no more than 2Mb of extra RAM in your machine, then an external power supply wouldn't be necessary, but you'll undoubtedly need one if you're adding the full 8Mb. The Cortex unit comes with a power supply as standard, but you'll have to pay extra if you want to use a power supply

Because of the width of the columns, we occasionally have to break listings across two or more lines. Where this has occurred, and you should enter two or more lines without a [Return] between them, we have used the following symbol: ↵

JARGON BUSTING • JARGON BUSTING

Chip RAM – the area of the Amiga's memory directly accessible by the custom graphics and sound chips. Originally a maximum of 512k, newer machines fitted with the fatter Agnus graphics chip can access 1Mb, enabling smoother animations and more screens to be displayed at once. The new A500 Plus comes with an Agnus chip capable of addressing 2Mb of Chip RAM.

Fast RAM – any extra memory which is not Chip RAM. The custom chips cannot access it, and because such accesses to Chip RAM can block out the central processor and slow down its accesses, Fast RAM is faster.

MIDI – Musical Instrument Digital Interface is a standard devised by electronic instrument manufacturers, allowing a number of synthesisers to be controlled by a single keyboard or sequencer.

Path – the group of directories that the Amiga will search through automatically when a command is typed in at the Shell.

16-bit sampler – a device which converts sound to digital information suitable for processing by the Amiga. Standard Amiga samplers use 8 bits; a 16-bit sampler has a much higher quality, equivalent to the sound produced by a CD player.

with the SupraRAM board.

Technically AudioEngineer is better than Sound Master, but it's not really worth the £200 asking price, especially when you consider that quite a few developers are bringing out 12 and even 16-bit samplers soon which won't retail for that much more (I've been sworn to secrecy by the company involved, but expect to see a very cheap 16-bit sampler soon!). If you really do want a new sampler, then I'd personally go for Sound Master. **JH**

SPANNER IN THE WORKS

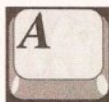

I bought *Protext 5.52* for my Amiga 1500 and up until last week I was delighted

with it. Then I tried to install *The Works! Platinum* for comms use.

Following the hard disk install instructions given with the software, after a short time of activity a message came up on the screen indicating a fault in the procedure.

Due to inexperience on my part I had no choice but to start from the beginning, and after newly installing the hard disk I again followed the instructions to re-install *Protext*.

The process went OK, all disks installed correctly, so I thought I could use all the facilities. But when I came to print out my correspondence a message signalled that it had 'failed to open printer device'.

I contacted Arnor and after a lengthy discussion the people there said that I had a fault in the devs directory. They might as well have spoken in a foreign language. I do not understand.

K Wynn
Mottram Hyde
Cheshire

First of all, Mr Wynn, I strongly suggest you buy a book about the Amiga and read it. Dabs Press publishes one called *AmigaDOS – A Dabhand Guide* which, although it doesn't cover the new operating system (which you don't have anyway), is a nice gentle introduction to the Amiga for beginners. And it's only £14.95. Computer Manuals Ltd ☎ 021-706 3301 should be able to sell it to you.

Now to solve your problem. Looking at the DataFlyer hard disk startup-sequence you sent me, something appears to be seriously amiss because there is only one Assign command, and this has spurious data following it that appears to be part of the parameters for the Path command, not the Assign command.

Furthermore the LoadWB command has somehow had a space inserted between 'Load' and 'WB', and the endcli command has had a space removed after it. All in all your startup-sequence is in a bit of a mess.

Use *Protext* to edit the 'DHO:s/startup-sequence' file. Remove the lines that say:

```
assign ENV:c: sys:system ↵
s:add
Load WB delay
endcli>NIL:
```

and replace them with the following lines.

```
assign ENV: ram:env
assign SYS: DHO:
assign C: SYS:c
assign L: SYS:L
assign FONTS: SYS:fonts
assign S: SYS:S
assign DEVS: SYS:devs
assign LIBS: SYS:libs
```

```
sys:system/setmap gb
path ram: c: sys:utilities ↵
sys:system s: sys:prefs add
loadwb delay
endcli >nil:
```

When you save the altered file (as 'DHO:s/startup-sequence' again) use the *Protext* ASCII Save option from the File menu.

Cross fingers, everything should work as normal now. **JW**

POOR PICTURE



I recently purchased an Amiga 500 Plus but I am disappointed with the graphics.

I have connected the Amiga to three different TV sets and every time the picture sits high and to the left of the screen. Not only that, but the definition is poor – I find it very difficult to read some of the Workbench screen characters and on *Lemmings* it's almost impossible to identify the different characters on the menu!

Is this something I'm doing wrong because I'm a pathetic novice or do I have a computer problem?

Chris Allan
Bradford
W Yorks

No, I doubt the problem is something to do with you being a pathetic novice, as we all have to start somewhere.

From your letter I guess we are dealing with two separate problems here – screen positioning and picture quality.

The screen positioning problem should be easy to solve, as it is most likely caused by the Preferences screen position being set badly. The usual way to sort it out would be to make adjustments to the screen position by using the *OverScan* program in the Prefs drawer of your boot disk.

Use a COPY of your original Workbench Disk, open the Prefs drawer, double click on *OverScan*, then click on Edit Standard *OverScan*. A new screen will appear which has 9 squares on it. If you position the mouse pointer over the centre square and hold down the left button you will be able to drag the position of the screen around.

Watch your TV and decide when you've got it where you want it. Then press the [Return] key and you will go back to the requester. Make sure that the disk is not write protected and then click on Save. The screen should now jump to the position you've just set and remain in the correct place. From now on, every time you start your Amiga with this

continued on page 66

CARTOON CLASSICS MEGA
 AMIGA A500 PLUS

New GORDON

31* MEGA GAME IM

31*

HARWOODS POWERPLAY PACK 1 COMES OF AGE WITH 31* GREAT GAMES & A 1Mb AMIGA A500 PLUS CARTOON CLASSICS WITH THE SIMPSONS, LEMMINGS AND CAPTAIN PLANET PLUS 28* EXTRA GAMES ONLY FROM HARWOODS!!!

ALL OUR AMIGAS ARE UNITED KINGDOM SPECIFICATION AND INCLUDE THE FOLLOWING...

- 1 Mb. Disk Drive
- 1Mb Ram Memory
- TV Modulator
- 4096 Colours
- Multi Tasking
- Speech Synthesis
- 4 Channel Digital Stereo Sound
- Amiga Mouse
- Operation Manuals
- Workbench 2 Disks
- ALL Connecting Cables

PLUS...All OUR Amigas are backed by Harwoods Great Service
[Please see full details in our Ordering Made Easy' panel final page.]



THAT'S RIGHT HARWOODS HAVE PUT TOGETHER THE ULTIMATE AMIGA PACKS YET AGAIN... STARTING WITH POWERPLAY PACK 1 WHICH INCLUDES 31* GREAT GAMES!

Just look at what you get NOW...

- **AMIGA A500 PLUS COMPUTER WITH A FULL 1Mb. OF MEMORY!**
- **THE SIMPSONS, BART vs THE SPACE MUTANTS** - Thats right man! you can play the computer version of this popular TV cartoon. By Ocean.
- **CAPTAIN PLANET** - created from the award winning TV show, now's your chance to save the earths environment with this ultimate adventure... your Eco-Copter is waiting. By Mindscape.
- **LEMMINGS** - Are you as smart as Lemmings are stupid, match your intelligence against their lack of it as you play the 140 levels of the most original game of '91 (European Computer Leisure Awards Winner). By Psygnosis.
- **EDUCATIONAL BASIC LANGUAGE FOR CREATING YOUR OWN PROGRAMS**
- **DELUXE PAINT III GRAPHICS PACKAGE WITH ANIMATION**
- **TAILORED DUST COVER AND MOUSE MAT**
- **AND A SUPERB HIGH QUALITY MICROSWITCHED JOYSTICK,**
- **PLUS... 18 MORE GREAT GAMES, THERE'S SOMETHING FOR EVERYONE...**
- **BLOODWYCH** - Fantasy role-playing game, great interaction with your computer created environment
- **BUBBLE+** - Help the dawdling ghost and the soap bubble, escape from the old deserted manor house
- **CAPTAIN BLOOD** - Astonishing creatures and animated 3D graphics, this is a game you just have to play
- **ELIMINATOR** - A progressive multi stage flying shoot 'em up, on a long winding course, survive if you can!
- **HOSTAGES** - You must get your team and hostages out of the terrorist overrun embassy, without loss of life
- **JUMPING JACKSON** - In a deluge of colour and sound save, the earth from sadness and melancholy music
- **KRYPTON EGG** - A classic Breakout game, 60 screens, separated by 6 combat sequences
- **LANCASTER** - Your mission is to fly the classic WWII bomber on its dangerous raids over enemy territory
- **LOMBARD RAC RALLY** - You drive your 300 bhp Sierra Cosworth through demanding stages of the rally
- **PURPLE SATURN DAY** - Four arcade games, an exciting high speed trip into total cosmic 3D space
- **SAFARI GUNS** - Live the African experience in an animal sanctuary, track the poachers & ivory traffickers
- **STIR CRAZY** (Featuring Bobo) - Bobo & his inmates are planning a stunning trampoline jump prison escape
- **SKYCHASE** - Airborne combat for every simulation fan. In this one or two player game, battle against your MIG flying adversary in your F-16 Falcon.
- **SKYFOX II** - Skyfox II, the only ship fast enough to carry on the Skyfox legend. Fight to blow your federation enemies from the Galaxy, at speeds of 9000 kilometres/second!
- **STRIKE FORCE HARRIER** - Puts you in the cockpit of one of Britains most exiting fighter aircraft. Multiple skill levels let you progress to become an ace pilot
- **TINTIN ON THE MOON** - We've been captured by Colonel Jorgen and he's tring to scupper the moon mission. Come on Tintin, you're the only one who can save us, and be the first on the moon
- **TV SPORTS FOOTBALL** - Strap on your helmet for American football simulation that looks like the real thing.
- **XENON 2 MEGABLAST** - This time it's war! The Xenites are back and have thrown time itself into turmoil.

Our packs always contain Professional Games NOT PD or multi-game disk titles

CARTOON CLASSICS MEGA 31*
 AMIGA A500 PLUS

BUY YOUR AMIGA WITH 2Mb FOR ONLY £40 EXTRA!!!
(ie. 1Mb RAM Expansion)

See Page overleaf for details

*** OUR POWERPLAY PACK 1 PREVIOUSLY CONTAINED 21 GREAT GAMES BUT, NOW WE'RE INCLUDING THESE 10 FANTASTIC BONUS GAMES... BUT ONLY WHILST STOCKS LAST!**

DATASTORM - The fastest shoot 'em up of all time! Defender with a vengeance!!!
DUNGEON QUEST - Ultimate in multisensory gaming! The BEST graphic mysteries!
E-MOTION - 50 levels of multi-coloured puzzles. A challenging emotional experience.
GRAND MONSTER SLAM - Elves, Trolls, Goblins, Orcs, Dragons & Knights do battle!
RVF HONDA - Formula 1 motorbike racing at 170mph on a Honda RC30 racing bike!
DRIVIN' FORCE - For driving maniacs! 12 competitions day or night with 6 vehicles!
PIPEMANIA - Classic puzzle arcade game. So addictive you won't want to put it down!
ROCK 'N' ROLL - Crazy action game accompanied by fantastic Rock 'n Roll sounds!
SKWEEK - Paint the town PINK, kill Schnoreuls and dominate 99 levels of Skweezland
TOWER OF BABEL - Intricate 3D strategy game. Fantastic lighting & shading effects!

...AND HARWOODS ALSO GIVE YOU A SUPERB BROCHURE OFFERING UP TO 16 NIGHTS FREE HOTEL ACCOMODATION IN AN EXTENSIVE SELECTION OF 400 HOTELS AROUND THE UK PLUS NOW A SPECIAL BUDGET FRANCE SUPPLEMENT IS INCLUDED TOO!

Priced at an INCREDIBLE
£399.95
 Including VAT

Finance terms are available (subject to status) for most products; please see our ordering panel at the end of this advert for full details

HARWOOD POWERPLAY PACKS

HARWOOD'S BRILLIANT 1Mb AMIGA 500 PLUS 'MEGA 31' GAMES PACK 2

That's right you get
the fantastic Amiga &
ALL THE EXTRAS
detailed in Harwoods
'Mega 31' Pack 1
AND you also get...

THE PHILIPS CM8833/II STEREO COLOUR MONITOR



For monitor section on page 6
see full details for your choice
of Philips Monitors & Monitor TVs

MEGA 31*

MONITOR PACK

2

PACK TWO

OR... YOU CAN CHOOSE
A PHILIPS MONITOR TV
AT NO EXTRA COST!
See page 6 for FULL
details of this remarkable
Fast Text Monitor TV

**A SPECIAL PACK FROM HARWOOD'S
YOU SEE AND HEAR THOSE GAMES
WITH SUPERB CLARITY**

£629.95 Including VAT

**BUY AN AMIGA
WITH 2Mb FOR ONLY
£40 EXTRA!!!**
(w/ 1Mb RAM Expansion
included)

HARWOOD'S GREAT 1Mb AMIGA 500 PLUS 'MEGA 31' PACK 3

That's right you get the fantastic
Amiga & **ALL THE EXTRAS**
detailed in Harwoods 'Mega 31'
Games Pack 1 (far left) AND...
then you also get...
**THE SUPERB PHILIPS CM8833/II
STEREO COLOUR MONITOR**

Our monitor section
on page 6 gives
full details for your
choice of Philips
Monitors & Monitor TVs



Plus... THE SUPER STAR LC 200 COLOUR PRINTER...



Featuring...
185/40 cps, Full Colour 9 Pin NLQ Dot Matrix Printer
with a FREE Dust Cover and cable to your Amiga.
(See printer panel for details)

**IF YOU WISH, REPLACE THE
LC200 WITH A CITIZEN SWIFT 9
COLOUR AT NO EXTRA COST!!!
OR... IF YOU PREFER A 24PIN
COLOUR PRINTER, JUST CHOOSE
FROM OUR RANGE & ADD THE
DIFFERENCE IN PRICE BETWEEN
STARS LC200 & 'YOUR CHOICE'.
(eg. Citizen 224, add just £50)**

MEGA 31*

**MONITOR AND
PRINTER PACK**

3

PACK THREE

OR... YOU CAN CHOOSE
A PHILIPS MONITOR TV
AT NO EXTRA COST!
See page 6 for FULL
details of this remarkable
Fast Text Monitor TV

£829.95 Including VAT

'IT'S THE- BUSINESS'

A TRULY PROFESSIONAL
PACKAGE SPECIFICALLY
FOR THE BUSINESS
MINDED AMIGA USER.
THIS ONE SHOULD
FULFILL EVERY AREA
OF HOME BUSINESS
YOU'RE LIKELY TO NEED!

THE BUSINESS PACK FROM HARWOODS INCLUDES ALL THE FOLLOWING...

AMIGA 500 PLUS
WITH 1Mb. MEMORY

PHILIPS CM 8833/II
STEREO COLOUR MONITOR

STAR LC200 9 PIN NLQ
FULL COLOUR PRINTER

HOST OF BUSINESS SOFTWARE & ACCESSORIES...
PEN PAL V1.3 (Word Processor)...1Mb.
SUPERBASE II PERSONAL (Database)
SUPERPLAN (Spreadsheet)...1Mb.

A GREAT TEN GAMES PACKAGE

...plus...
THE SIMPSONS
CAPTAIN PLANET
LEMMINGS
DELUXE PAINT III
Now with ANIMATION
MICROSWITCHED JOYSTICK
10 BLANK 3.5" DISKS
DISK LIBRARY CASE
MOUSE MAT
3 TAILORED DUST COVERS

**CARTOON
CLASSICS**

**POWERPRO
PROFESSIONAL
PROFESSIONAL
PROFESSIONAL
PACK**

OR... YOU CAN CHOOSE
A PHILIPS MONITOR TV
AT NO EXTRA COST!
See page 6 for FULL
details of this remarkable
Fast Text Monitor TV

**BUY AN AMIGA
WITH 2Mb FOR ONLY
£40 EXTRA!!!**
(w/ 1Mb RAM Expansion
included)

**IF YOU WISH, REPLACE THE
LC200 WITH A CITIZEN SWIFT 9
COLOUR AT NO EXTRA COST!!!
OR... IF YOU PREFER A 24PIN
COLOUR PRINTER, JUST CHOOSE
FROM OUR RANGE & ADD THE
DIFFERENCE IN PRICE BETWEEN
STARS LC200 & 'YOUR CHOICE'.
(eg. Citizen 224, add just £50)**

Datatorm, Drivin' Force, Pipe Mania,
Dungeon Quest, Rock-N-Roll, E-Motion,
Tower of Babel, Stweek, RVF Honda,
and Grand Monster Slam.

**ADD A CUMANA CAX 354 SECOND DRIVE
FOR JUST £50 TO HELP RUN THOSE
BUSINESS PACKS MORE EFFICIENTLY**

**WE MEAN BUSINESS AT A GREAT
PACKAGE PRICE OF JUST...**

£899.95 Including VAT

HARWOODS LEARN & PLAY

PRIMARY & JUNIOR PACK A

Get your children off to the right
computing start with this software
learn and play pack...

PROF. PLAYS A NEW GAME
PROF. LOOKS AT WORDS
PROF. MAKES SENTENCES
PROF. HUNTS FOR WORDS

Active, enquiring young minds love seeing the
cartoon character called Prof. entertain and teach.
Children take charge of Prof. on the computer,
active learning. Follows National Curriculum(N.C.).

HOMEBASE
Ideal home storage system. Keep household lists,
student records etc. Easy to use "push button" controls.

PRIMARY MATHS COURSE
Around 24 modules in this course from 3 yrs old
right up to secondary level. Follows N.C.

READING & WRITING COURSE
24 module course. Teaching from the computer
and books. For early starters & the dyslexic.

**A GREAT EDUCATIONAL PACK
FOR YOUR CHILDREN AT A
FRACTION OF THE NORMAL COST**

£89.95 Including VAT

HARWOODS LEARN & PLAY

GCSE/'O' LEVEL PACK B

GCSE examination level studies on your
Amiga computer that's fun!

**MICRO ENGLISH, MICRO FRENCH AND
MICRO MATHS**

A set of three complete self-tuition courses to GCSE level
which can also be used for revision work. All programs
adhere to the National Curriculum and were designed
and tested in schools by professional teachers.
Micro French includes "real speech" to help your accent!

PEN PAL - Graphical Word Processor
A fantastic word processor with all the tools you'll need
to create effective written work. Ideal for home work,
projects etc. or for the families letters. Text wraps
automatically around graphics, even as you type!
Includes a built-in database and Forms Manager.

HOMEBASE
Homebase is the ideal information storage program for
things like household lists, student notes, and children's
educational projects. Inc. clearly labelled "push button"
controls and clear comprehensive reference manuals.

**A GREAT EDUCATIONAL PACK
FOR YOUR CHILDREN AT A
FRACTION OF THE NORMAL COST**

£89.95 Including VAT

All our packs contain the new
Amiga A500 Plus.
(1.3 Amigas may still be available
to special order, please enquire.)



Enquiries & Order Line:

0773 836781



Finance Facilities Available*
Please phone us for information and your personal application pack.

GORDON HARWOOD HARWOOD HARWOOD Computers

ALFRETON DERBYSHIRE

The Closer you look,
The Better we look.

*Finance terms are available (subject to status) for most products; please see our ordering panel at the end of this advert for full details

SOUND AND VISION

Words and Pictures

CDTV



IMAGINE, IF YOU CAN, THE CONCEPT OF A NEW, MORE POWERFUL AMIGA...

...WITH 1 MEGABYTE OF MEMORY, AND A COMPACT DISK DRIVE OF ALMOST INFINITE SIZE. A DISK DRIVE SO VAST, IT CAN STORE HUNDREDS OF MILLIONS OF DIGITS OF DATA. THIS DATA COULD BE, SPEECH, ANIMATED PICTURES, DIGITISED STEREO SOUND, COMPUTER IMAGES OR WHOLE ENCYCLOPAEDIAS.... AND MORE.

IMAGINE THIS, AND YOU CAN START TO GRASP THE CONCEPT OF CDTV.

THE INTEGRAL COMPACT DISK DRIVE, IS THE KEY TO THE POWER OF CDTV. ITS STORAGE CAPACITY IS EQUIVALENT TO AROUND A QUARTER OF A MILLION FULL PAGES OF TEXT. THIS WHEN INTEGRATED WITH THE 1 MB OF INTERNAL AMIGA CIRCUITRY, CREATES A SYSTEM, WHICH FROM A CD DISK, CAN GIVE YOU ACCESS TO AN UNIMAGINABLE SPECTRUM OF REAL WORLD IMAGES, NEVER SEEN COMBINED BEFORE. THESE VIVID IMAGES, WITH WORDS AND SOUNDS, GIVE YOU A WHOLE NEW DIMENSION IN HOME EDUCATION, ENTERTAINMENT & INFORMATION TECHNOLOGY. AND... DON'T FORGET, THAT CDTV CAN PLAY IN SUPERB QUALITY, ANY NORMAL AUDIO MUSIC CD, AND IT CAN ALSO PLAY THE NEW CD+G DISKS, WHICH GIVE DIGITAL SOUND AND ON SCREEN GRAPHICS.

ON CD DISKS NOW AVAILABLE, THERE ARE EDUCATIONAL PACKAGES, ENCYCLOPAEDIAS PACKED WITH REFERENCE INFORMATION, STUNNING GAMES, MUSIC SYSTEMS AND MANY OTHER NEW AND VARIED SUBJECTS, INCLUDING WHOLE WORLD ATLAS OR EVEN THE COMPLETE WORKS OF SHAKESPEARE, EACH ON ONE CD DISK!!! **CDTV - NOTHING LESS THAN REVOLUTIONARY**

FREE CDTV STARTER PACK!!!

WHEN YOU CHOOSE YOUR CDTV FROM GORDON HARWOOD, NOT ONLY DO YOU GET OUR LEGENDARY SERVICE, BUT WE GIVE YOU A CDTV STARTER PACK, TO GET YOU EXPLORING YOUR NEW WORLD - STRAIGHTAWAY.

THIS INCLUDES A SUPERB SELECTION OF CD DISK TITLES INCLUDING THE WELCOME TUTORIAL & HUTCHINSONS ENCYCLOPAEDIA, PLUS ... FOUR GAMES, SHERLOCK HOLMES & THE HOUND OF THE BASKERVILLES, SIM CITY, CHAOS IN ANDROMEDA, AND THE ACCLAIMED LEMMINGS, WORTH IN TOTAL ALMOST £170.00. IN ADDITION IS THE INFRARED REMOTE CONTROLLER, AND ALL THE HARDWARE NEEDED TO GET YOU CONNECTED.

ALL THIS FOR JUST £499.95

CDTV IS THE SAME SIZE AND STYLE AS MOST VIDEO RECORDERS, SO IT CAN SIT UNOBTRUSIVELY ABOVE OR BELOW YOUR HOME TV AND/OR HI-FI. AND WITH ITS INFRARED REMOTE CONTROLLER, IT CAN BE OPERATED FROM YOUR ARMCHAIR. BUT PERHAPS MOST IMPORTANTLY, IF YOU ARE A COMPUTER ENTHUSIAST, REMEMBER THAT INSIDE EVERY CDTV, IS AN AMIGA, JUST WAITING TO BE USED. SO LATER ON, YOU'LL BE ABLE TO BUY THE OPTIONAL KEYBOARD AND DISK DRIVE, TO GET INTO THE WORLD OF AMIGA COMPUTING. PRINTERS, DIGITISERS, GENLOCKS AND OTHER ACCESSORIES, CAN ALL BE CONNECTED TO GIVE ACCESS TO MANY OTHER EXCITING FACILITIES, AND ALSO MANY OF THE EXISTING SOFTWARE PACKAGES AVAILABLE FOR THE AMIGA COMPUTER. NEVER BEFORE HAS THERE BEEN SO MUCH POTENTIAL FROM ONE NEW STUNNING SYSTEM, PACKED WITH

TODAYS TECHNOLOGY!

CALL IN AND SEE US FOR YOUR PERSONAL DEMONSTRATION, OR PHONE US FOR YOUR FREE DETAILED CDTV INFORMATION PACK.

CDTV ACCESSORIES Please call for latest availability.

| | | |
|----------------------|---------------------------------------------------------------------------------------------------------------------------------------------------------------------------------------------------|----------------|
| CD 1220 KEYBOARD | AN 89 KEY QWERTY KEYBOARD | £49.95 |
| CD 1252 MOUSE | INFRARED MOUSE WITH BATTERY SAVER. | £49.95 |
| CD 1200 TRACKBALL | INFRARED TRACKBALL, WITH THE OPTION OF DIRECT CONNECTION TO EXTEND BATTERY LIFE. DUPLICATES FUNCTIONS OF 2 BUTTON MOUSE & INCLUDES TWO 9 PIN PORTS FOR STD. JOYSTICKS FOR HOLDING CD WITHIN DRIVE | £79.95 |
| CD 1400 CADDY | PERSONAL RAM CARD CONTAINING 64K OF MEMORY FOR STORING DATA OR AS A BOOKMARK FACILITY WITHIN CDTV | £9.95 |
| CD 1401 MEMORY CARD | A LARGER PERSONAL RAM CARD CONTAINING 512K OF MEMORY FOR STORING DATA OR AS A BOOKMARK FACILITY WITHIN CDTV | £79.95 |
| CD 1405 MEMORY CARD | A LARGER PERSONAL RAM CARD CONTAINING 512K OF MEMORY FOR STORING DATA OR AS A BOOKMARK FACILITY WITHIN CDTV | £249.95 |
| CD 1800 FLOPPY DRIVE | RACK MOUNTABLE FLOPPY DRIVE WITH 880K CAPACITY. CASING ALLOWS ROOM FOR ADDITIONAL HARD DRIVES OR MODEMS ETC. | £99.95 |
| CD 1301 GENLOCK | PAL BASED VIDEO INTERFACE CARD FOR SUPERIMPOSING CDTV IMAGES OVER A VIDEO SIGNAL PROVIDED BY ANY STANDARD VIDEO SOURCE | £149.95 |
| CUMANA 3.5" DRIVE | CDTV COMPATIBLE AND STYLED IN MATCHING BLACK. (Same spec as CAX 354 on page 4 of this advertisement) | |

Many Amiga Accessories & Peripherals (e.g. Printers, Disk Drives, Software etc.) are compatible with CDTV. Please phone us for compatibility information.

HARWOODS AMIGA PRO-GEN

NEW LOWER PRICE

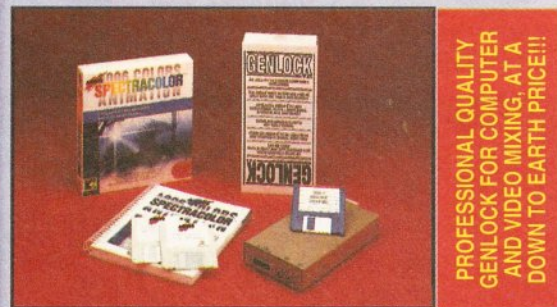

PROFESSIONAL QUALITY GENLOCK FOR COMPUTER AND VIDEO MIXING, AT A DOWN TO EARTH PRICE!!!

Please note the above photograph shows Spectracolor which has now been replaced by Photon Paint 2.0

PRO-GEN Amiga Genlock

The Pro-gen AMIGA Genlock allows you to mix your Amiga display with any PAL video signal whether it is from a VCR, Laserdisk player or a Camcorder. In fact any item of video equipment which outputs a PAL composite video signal. Combined with the Amiga computer the Pro-Gen gives you the facilities of a special effects & video titling suite. Take your own films & give them a professional look by OVERLAYING TITLES or by SUPER IMPOSING YOUR OWN GRAPHICS created in packages like Photon Paint 2.0 or Deluxe Paint. Pro-Gen is supplied with micro illusions superb Photon Paint 2.0 package.

FREE

A powerful Lo-and-Hi resolution hold and modify (HAM) paint program, with overscan (NTSC/PAL) and special effects for your Amiga Computer including all the following...
Contour Mapping: drapes a brush over a 3D "landscape". Pixel intensity values decide the peaks and valleys, while a specially developed ray-tracing algorithm maps the image precisely. **Surface Mapping:** around 3D objects, both geometric and free hand drawn. **Luminance:** sets the light source and intensity. **Shadowing:** automatically with control of size and offset. **Brush Control:** twist, tilt, resize, flip, rotate, bend, adjustable transparency, stretch etc etc. PLUS LOTS MORE! A great program allowing use of 4096 colours. Choice of horiz/vert page print, negatives, anti-aliasing, dithered print, adjustable brightness etc.

How it works:

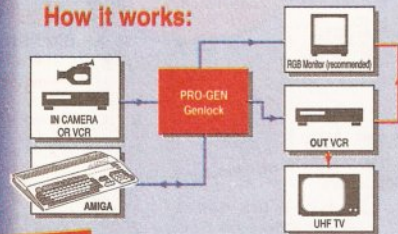

STOP PRESS

PRO-GEN... NOW INCLUDES A VERY VERSATILE MULTI COMPONENT VIDEO TO GENLOCK CONNECTING CABLE KIT. THIS ALLOWS PRO-GEN TO BE USED STRAIGHTAWAY WITH MOST POPULAR VIDEO EQUIPMENT. WITHOUT THE NEED TO HUNT DOWN THE CORRECT CONNECTING CABLES. THIS KIT CAN ALSO BE USED TO CONNECT IN OTHER WAYS... eg. VCR TO VCR etc. A KIT TO START YOU OFF RIGHT FROM THE MOMENT YOU OPEN THE BOX!!!

NEW LOWER PRICE

PRO-GEN with Photon Paint 2.0 ONLY £99.95

Mode Switch-box for Genlocks

Features Include

- Compatible With The Pro-Gen And Rendale 8802
- Supplied With Genlock Extender Cable Worth £9.95
- Switch-box Switches Between Foreground, Background, Video And Computer Modes.

£29.95

AMIGA DRIVES & MEMORY

Cumana CAX354 3.5" External 2nd Disk Drive.

- ☆ Features Include
- ☆ Long connecting cable
- ☆ 1Mb, (880K Formatted) Capacity
- ☆ Enable/Disable Switch,
- ☆ Throughport
- ☆ Access Light
- ☆ Compatible with Amiga 500/1000/1500/2000/3000 and CDTV

£57.95



NOW SUPPLIED WITH A **FREE** 3.5" DISK HEAD CLEANER for optimum reliability

BLACK CDTV COMPATIBLE VERSION AVAILABLE NOW!!!

NEW! GVP 52-105Mb HARD DISK DRIVE WITH MEMORY EXPANSIONS OF UP TO 8Mb.

- ☆ Capacities of 52 or 105Mb available
- ☆ Connects to sidecar bus on L/H side of A500/A500 Plus
- ☆ Autoboots with Kickstart 1.3/2.0, boot enable/disable switch
- ☆ Sockets for up to 8 Mb of RAM expansion
- ☆ SCSI Port allows up to 7 other devices to be connected
- ☆ Supplied with easy to use software
- ☆ 2 Year Warranty Complete with dedicated PSU
- ☆ Mini slot for future expansion capabilities
- ☆ PC-AT Emulator planned to be available for 1992

| GVP PRICES | RAM SIZE | CAPACITY | | Call for... UPGRADE PRICES! |
|------------|----------|----------|---------|--------------------------------|
| | | 52Mb. | 105Mb. | |
| | 0Mb. | £359.95 | £549.95 | |
| | 2Mb. | £429.95 | £629.95 | |
| | 4Mb. | £509.95 | £749.95 | |
| | 8Mb. | £699.95 | £929.95 | |

EDUCATION SOFTWARE

DON'T JUST PLAY GAMES WHEN YOU CAN LEARN WITH YOUR AMIGA TOO!

- MICRO MATHS** - 24 easy to use programs for GCSE ('O' Level) revision or self tuition **£21.95**
- MEGA MATHS** - A 9 level step by step tuition course. For mature beginners, 'A' Level studies & Micro Maths users **£21.95**
- MICRO FRENCH** - GCSE French tuition or revision course. Covers both spoken & written French **£21.95**
- MICRO ENGLISH** - A complete programme of self-tuition up to GCSE standard **£21.95**
- PRIMARY MATHS COURSE** - Ages 3 to 12, Complete 24 Programme Course. **£21.95**
- SPELL BOOK** - Ages 4 to 6, Developed with the help of a Primary School Head Teacher to aid spelling skills. **£17.95**
- PROF: Hunts for Words** - With clues for Prof. and his young audience, children can hunt for words and complete a story. **£24.95**
- PROF: Looks at Words** - You direct Prof. around the screen searching for letters to complete the words. 17 levels of play. **£24.95**
- PROF: Makes Sentences** - Children help Prof. make up sentences by unjumbling sequences of words - great animation. **£24.95**
- PROF: Plays a New Game** - Comes with a story disk, audio tape, and an illustrated reading book. **£24.95**

HARWOODS AMIGA 1Mb PRO-RAM PLUS

ADD MORE POWER TO YOUR AMIGA 500 PLUS WITH A FULL 1Mb. MEMORY UPGRADE!!!

- ☆ 1Mb. RAM expansion for the Amiga 500 Plus
- ☆ Gives a total of 2Mb. of RAM
- ☆ Easily fitted without any dismantling in the trapdoor expansion slot underneath Amiga. DOESN'T invalidate your warranty!
- ☆ Low power consumption 2 Yr Guarantee!

A GREAT NEW OFFER FROM HARWOODS

Only... **£44.95**

0.5 Mb PRO-RAM

- ☆ Compatible with Amiga A500 and 500 Plus
- ☆ Gives A500 a total of 1Mb Memory + Clock
- ☆ Gives 500 Plus a total of 1.5Mb Memory

Only... **£29.95**

AMIGA SOFTWARE

Music-X: The ultimate software for professional MIDI sequencing. The software includes a configurable librarian and a synthesiser patch editor. All you need to recreate a song can be recalled from one performance file including sequences, MIDI routing, sync setup, keyboard maps & synthesiser or drum machine patch libraries. **NEW LOW PRICES - £54.95 or just £74.95 with midi-interface!**

MIDI INTERFACE (5 Port): In, Out, Through plus 2 switchable thru/out. Includes cable. **£24.95**

AMOS: AMOS allows you to access the power of the Amiga with ease. 500 different commands make AMOS a sophisticated development language. The AMOS animation language allows you to create complex animation sequences. 300 page manual and over 80 example programs **£49.95**

Amos Add on Modules: (BOTH require Amos prog.)
Amos Compiler **£229.95**
Amos 3D **£229.95**

SuperBase 4: Most powerful database available for the Amiga. Combines the ease of use of Super-Base 2 with a versatile programming language so that you can tailor your data to your own specific needs for club/business/library records etc. **£229.95**

Lattice C: An ideal tool for the C programmer whether experienced or a novice. The best way to create applications for the Amiga. Fully supports Motorola chipset. Nearly 300 functions optimised to help the user write the tightest possible code. Includes screen editor. Most Amiga C books are based around lattice. (Requires either 2 floppy drives OR a hard disk drive) **£199.95**

Deluxe Paint IV: Latest version of the Amigas first, and still the best, paint and animation package, now including HAM mode. (1 Mb. minimum memory or more recommended) **£79.95**

Vidi, The Complete Colour Solution: Vidi with RGB Splitter, Frame Grabber & Digitiser. Grabs moving colour video into 16 grey scale frames (up to 16 frames in 1Mb. Amiga) and digitises from still colour video source in up to 4096 colours in less than 1 second! Requires home VCR or video camera for grabbing. Requires video camera or VCR with perfect pause for digitising. Now comes with Photon Paint 2.0 **ABSOLUTELY FREE OF CHARGE!!!** **£179.95**

MASTERSOUND: High quality "mono" sampler (best for sampling instruments etc.) **£36.95**

BUY ALL THREE AMOS PROGRAMS FOR JUST £89.95

Pen Pal V.1.3

WORD PROCESSOR/DATABASE
 With Pen Pal you can mix text, 4096 colour graphics & data in ways no other w/p can! It's handling of graphics is unsurpassed: Pen Pal is the only word processor I tested that will automatically wrap text round graphics..

Amiga World, July '90

£79.95

PEN PAL complete WITH 512K Amiga RAM Expansion only...£99.95!



All our packs contain the new Amiga A500 Plus. (1.3 Amigas may still be available to special order, please enquire.)



Enquiries & Order Line:

0773 836781



Finance Facilities Available*
 Please phone us for information and your personal application pack.



GORDON HARWOOD HARWOOD HARWOOD
 Computers

ALFRETON DERBYSHIRE

The Closer you look,
 The Better we look.

*Finance terms are available (subject to status) for most products, please see our ordering panel at the end of this advert for full details

FREE...
Fully Tailored
Dust Cover with all
Dot Matrix Printers

PRINTERS

NEW FREE
ACCESSORIES

All printers in our range include a standard Centronics/Parallel Port for direct connection to Amiga, PC's, Atari ST's, Archimedes etc.

We supply a connection cable to YOUR computer plus a Quality Dust Cover with ALL Dot Matrix Printers



When you are comparing our prices to others make sure that the same essential items are included eg. Printer Lead, Dust Cover, Postage and VAT etc.

GORDON HARWOOD PRINTER STARTER PACK

ALL our Dot Matrix Printers are supplied complete with...
200 Sheets of Continuous Printer Paper
100 Useful Self Adhesive Continuous Labels
Amiga Printer Drivers Disk

FREE
FREE
FREE
FREE

CITIZEN 120D+ 9 PIN MONO - Up to 120/25 cps £149.95
Very reliable low cost printer with interchangeable interfaces for Centronics/RS232/serial type (C64 etc.) Full 2 Year manufacturers warranty

NEW FASTER STAR LC20 9 PIN MONO - Up to 150/38 cps £159.95
Replacement for our most popular Mono Dot-Matrix at a super low price

Multiple font options easily accessible from front panel
Excellent paper handling facilities
Simultaneous, continuous and single sheet stationery
240 x 240 dpi Graphics

STAR LC200 9 PIN COLOUR PRINTER - 185/40 cps £209.95
This is the one in our packs!

80 Column Dot Matrix
240 dpi - 9 Pin COLOUR
16K Buffer, 8 Resident Fonts
Push/pull tractor & rear/bottom feeds
Reverse paper feeds
Micro paper feed, Max. paper width 11.7"
Supplied with colour & mono ribbons
Paper park with auto single sheet loading
Programmable from front panel
12 month warranty

CITIZEN SWIFT 9 PIN COLOUR - 160/40cps £219.95
New super high spec 9Pin colour printer

8K Buffer 4 Fonts
Push and pull tractor built-in
Feed for labels/multi part stationery
240 x 240 dpi Colour Graphics
Best text quality in our 9Pin range
2 Year Citizen warranty

STAR SJ48 INKJET PRINTER £249.95
New super high quality bubble ink jet printer

64 Nozzle ink jet
Emulates Epson LQ and IBM Proprinter for full compatibility
Complete with AC adaptor
Large 28K Buffer
360 x 360 dpi near laser print quality
Optional Ni-Cad battery for mains free operation

STAR LC24/200 24 PIN MONO - 220/55 cps £249.95
Mono version of LC24/200 Colour, same spec except for a smaller 7K buffer

STAR LC24/200 24 PIN COLOUR - 220/55 cps £299.95
Colour version of the LC24-200 Mono.

80 Column Dot Matrix
360 dpi - 24 Pin MONO
30K Buffer (expandable)
10 Resident Fonts
Front Panel Pitch Selection
Push/pull tractor & rear/bottom feeds
Reverse paper feed
Paper park with auto single sheet loading
Micro paper feed, Max. paper width 11.7"
Supplied with mono ribbon
Faster than the old LC24-10
Extra font cartridges available
Program from front panel, No DIP switches
12 month warranty

NEW 24 Pin CITIZEN 224 COLOUR - 160/53 cps £259.95
Brand New, lowest cost colour 24 Pin printer, anywhere!

80 Column Dot Matrix with 4 Fonts
360 dpi - 24 Pin COLOUR
8K Buffer expandable to 32K
Easy to use front panel controls
Push & pull tractor feeds
Complete paper parking facilities.
Supplied with mono & colour ribbons
Full 2 Year Citizen Warranty

NEW 24 Pin CITIZEN SWIFT 24E COLOUR - 180/60 cps £319.95
Brand New, superb specification colour 24 Pin printer.

80 Column Dot Matrix with 7 Fonts
360 dpi - 24 Pin COLOUR
8K Buffer expandable to 32K
Easy to use LCD panel controls
Push/pull & bottom tractor feeds
Complete paper parking facilities.
Supplied with mono & colour ribbons
Full 2 Year Citizen Warranty

NEW FASTER STAR XB 24 PIN COLOUR RANGE XB24-200 & XB24-250 - 275/80 cps £399.95
These NEW top of the range Stars replace the XB24/10 & XB24/15, & offer the best possible quality dot matrix printing

Exceptional print quality
4 x 48Pin super letter quality fonts
14 x 24Pin near letter quality fonts
Buffer: 29K(XB24/200) & 76K (XB 24/250)
360 x 360 dpi Colour Graphics
12mths on-site warranty (UK Mainland)

HEWLETT PACKARD PAINTJET COLOUR A4 INKJET £599.95
Our best quality full colour printer at a realistic price

Parallel/Centronics or Serial RS232 I/F (specify with order, MAC option available)
For presentation graphics/DTP, CAD and technical/scientific applications
A full page of colour graphics in 4 minutes (typical)
Non impact printing, virtually silent, 43dba
Will print transparencies
12 Months on-site warranty (UK Mainland)

STARSCRIPT - 4ppm POSTSCRIPT COMPATIBLE LASER £1099.95
A4 Laser Printer, will connect to PC, Amiga, Atari ST, Macintosh etc.

300 DPI, 2Mb. Upgradable to 5Mb.
Emulations inc: HP Series II, Epson EX800, IBM Proprinter & Diablo 630
Complete with "Starscript" (Stars postscript language emulation)
Serial and Parallel Interfaces
12month on site warranty (UK Mainland)
49 quality fonts built-in
Appletalk for connection to Macintosh
Every desktop publishers dream

SEE OUR LIST OF ACCESSORIES FOR BOTH STAR AND CITIZEN PRINTERS, ALL AT COMPETITIVE PRICES!

All the characters Per Second speeds quoted above are Draft/LQ at 10cpi

PRINTER ACCESSORIES

CITIZEN PRINTER ACCESSORIES:

Citizen 120D+ Sheet Feeder £69.95
Citizen 120D+ Parallel Interface £49.95
Citizen 120D+ CBM C64 Serial Interface £49.95

Citizen 124D 32K Buffer £13.95
Citizen 124D Semi-Auto SheetFeeder £39.95
Citizen 124D Automatic Sheet Feeder £79.95
Citizen 124D Printer Stand £24.95

Citizen Swift 9 Semi-Auto SheetFeeder £39.95
Citizen Swift 9 Automatic Sheet Feeder £79.95
Citizen Swift 9 Printer Stand £24.95

Citizen Swift 9X Printer Stand £34.95
Citizen Swift 9X Automatic Sheet Feeder £139.95

Citizen Swift 24 32K Printer Buffer £13.95
Citizen Swift 24 Semi-Auto Sheet Feeder £39.95
Citizen Swift 24 Automatic Sheet Feeder £79.95
Citizen Swift 24 Printer Stand £24.95

Citizen Swift 24X Auto Sheet Feeder £139.95
Citizen Swift 24X Printer Stand £34.95

HEWLETT PACKARD PAINTJET PRINTER ACCESSORIES:

Hewlett Packard PaintJet
Black Ink cartridge £25.95
Colour Ink Cartridge £31.49
Single Sheet Printer Paper £17.95
Z-Fold Printer Paper £15.95
Transparency Paper: Pack of 50 Sheets £52.95

STAR PRINTER ACCESSORIES:

Star LC-20 Mono Printer Automatic SheetFeeder £74.95

Star LC24-10 Mono Printer 32K Buffer £67.95
Automatic SheetFeeder £74.95

Star LC-200 Colour Printer Automatic SheetFeeder £74.95

Star LC 24-200 Mono/Colour Printers 32K Printer Buffer £34.95
Automatic SheetFeeder £74.95

Star SJ48 Printer Automatic Sheet Feeder £54.95
Ni-Cad Battery £39.95

Star XB 24-200 Colour Printer Pull Tractor £34.95

Font Cartridges - Styles To Be Announced £29.95
128K Centronics Printer Buffer Automatic SheetFeeder £89.95
Dual Bin SheetFeeder £114.95
£429.95

Star XB 24-250 Colour Printer Pull Tractor £34.95

Font Cartridges - Styles To Be Announced £29.95
128K Centronics Printer Buffer Automatic SheetFeeder £89.95
Dual Bin SheetFeeder £174.95
£469.95



GENUINE CITIZEN & STAR REPLACEMENT PRINTER RIBBONS

| PRINTER | PRINTER TYPE | BLACK RIBBON | BLACK RIBBON 'SIX PACK' | COLOUR RIBBON | COLOUR RIBBON 'SIX PACK' |
|-------------------------|--------------|-------------------------------------------------------------------|-------------------------|---------------|--------------------------|
| CITIZEN 120D+ | BLACK ONLY | £4.95 | £24.95 | N/A | N/A |
| CITIZEN 124 | BLACK ONLY | £4.95 | £24.95 | N/A | N/A |
| CITIZEN SWIFT 9 | BLACK/COLOUR | £4.95 | £24.95 | £16.95 | £99.95 |
| SWIFT 24/24E/224 | BLACK/COLOUR | £4.95 | £24.95 | £16.95 | £99.95 |
| STAR LC10/20 | BLACK/COLOUR | £4.95 | £24.95 | £6.90 | £36.50 |
| STAR LC200 | BLACK/COLOUR | £6.95 ZX9 | £36.95 ZX9 | £12.95 ZX9CL | £69.95 ZX9CL |
| STAR LC24/200 | BLACK/COLOUR | £8.95 Z24 | £49.95 Z24 | £14.95 X24CL | £74.95 X24CL |
| STAR XB RANGE | BLACK/COLOUR | £8.95 Z24 | £49.95 Z24 | £14.95 X24CL | £74.95 X24CL |
| STAR SJ48 INK CARTRIDGE | BLACK ONLY | Also compatible with Apple Stylewriter and Cannon BJ10E Bubblejet | | | £14.95ea. |

BOOK SHOP

FOR BEGINNERS & EXPERTS ALIKE

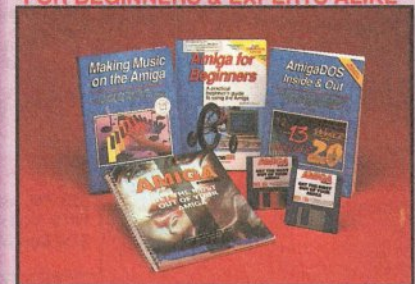

WE ALWAYS CARRY LARGE STOCKS OF THE FULL RANGE OF ABACUS & OTHER BOOKS...Phone us for details!

AMIGA FOR BEGINNERS - VOL. 1 ABACUS BOOKS, £14.95
From unpacking your Amiga to creating your own icons, includes first use of basic and extras disk. NEW revised version covering workbench 1.3 and 2

AMIGA BASIC INSIDE AND OUT - VOL. 2 ABACUS BOOKS, £18.95
Definitive step by step guide to programming Amiga's in basic.

AMIGA MACHINE LANGUAGE - VOL. 4 ABACUS BOOKS, £14.95
Practical guide to learning 68000 assembler language.

AMIGA DOS INSIDE AND OUT - VOL. 8 ABACUS BOOKS, £23.45
Guide to Amiga DOS & CLI. NEW Edition Inc. WB 2.0 (includes Free Help Disk)

AMIGA HARDWARE REFERENCE MANUAL-Addison Wesley, £21.95
Written by technical experts at Commodore Amiga Inc, USA... the people who designed your Amiga. Hardware level machine code programming at advanced level. New revision now also includes Kickstart 2.

AMIGA, BEST OF TRICKS & TIPS Vol. 17, £32.95
A complete set of tricks and tips that enable you to do MORE with your Amiga and as simply as possible. (Includes Free Disk)

GETTING THE MOST FROM YOUR AMIGA, £9.95
From Future Publishing, the producers of Amiga Format Magazine and fully updated for 1992 OR...

available with 2 HELP DISKS INCLUDED £13.95

NOW INCLUDING TEN FREE GAMES PACK TOTALLY FREE!

MONITORS & MONITOR TV's

Harwoods stock a complete range of both Monitors & Monitor TV's to give you your perfect solution to the type of display to buy.

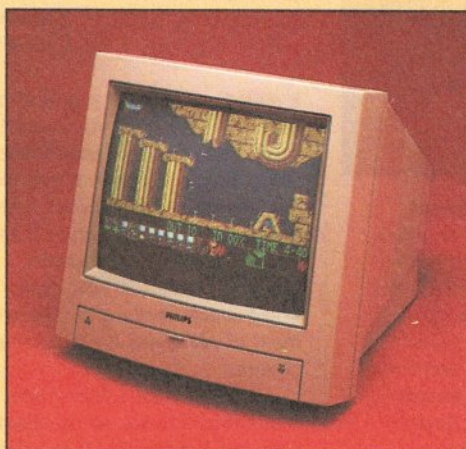

PHILIPS CM8833/II Stereo High Resolution Colour Monitor

The ever popular 14-inch Philips CM 8833 MkII. Its versatility means you not only get excellent colour graphics & text performance with a wide range of personal computers, but when connected to a VCR, you get an amazing 600 pixel TV picture. With the 8833 MkII, Harwoods give you the complete set up, to get you going straight away... Monitor, RGB picture and Stereo Audio Cables, Tailored dust cover, and a full 12 Months on site service warranty.

★RGB/AD, TTL, Composite. Video & stereo audio inputs Can be used as a TV with VCR or Tuner Also as a Video Camera display monitor Retractable stand
★Twin Stereo Speakers Headphone Jack Socket FREE lead for your computer FREE 12 Month on site service warranty.

THE MOST VERSATILE STEREO COLOUR MONITOR AVAILABLE

£249.95

CBM 1084S STEREO COLOUR MONITOR.

Commodore's Own Stereo High Resolution Colour Monitor with...
★RGB/AI/TTL, Composite. Video/Audio Inputs Can be used as TV with VCR or tuner. Twin Speakers for stereo output Supplied with cables for A500, CGA PC, IC16-64-128.

£269.95

It's important to remember that most TV Monitors, are still first and foremost televisions, meaning that their average 400 pixel tube display 50% lower resolution than a monitor cannot be guaranteed to display 80 column text clearly without risking eye strain. If choosing a Television Monitor ensure it has the latest 2000 character tube capability, meaning it can handle the Amigas' 80 characters, by 25 line output clearly.

NEW!!! PHILIPS 15" FASTEXT TELETEXT REMOTE CONTROL 60 CHANNEL MONITOR TV. BRAND NEW

SUPERB DEFINITION PHILIPS MONITOR TV. IDEAL FOR AMIGA OR CDTV USERS, GIVING FOR THE FIRST TIME TRUE MONITOR QUALITY FROM A FULL FEATURE TELETEXT TV AT AN AFFORDABLE PRICE!!! JUST LOOK AT THE FEATURES... Direct Scart Connector for Amiga, CDTV, VCR OR SATELLITE RECEIVER RGB/AD, Composite Video & audio inputs FULL TELETEXT FACILITIES (FOR THIS FACILITY EXTERNAL AERIAL SHOULD BE USED) Headphone Jack Socket FULL TWO YEAR GUARANTEE 2000 CHARACTER HIGH DEFINITION FST TUBE SUPPLIED WITH LOOP AERIAL REMOTE CONTROL FREE lead for YOUR computer (IF YOU WOULD LIKE THE MONITOR TV IN OUR PACKS 2, 3, AND POWERPRO, AT NO EXTRA COST, TO REPLACE THE 8833/II, SIMPLY ADVISE US AT THE TIME OF ORDERING)

ONLY...
£269.95

10 FREE GAMES WITH YOUR TV OR MONITOR WHEN PURCHASED SEPARATELY (ie. These games are already included within Harwoods Amiga Packs 2, 3, & Powerpro...see details on pages 1 & 2 of this advertisement!!!)

AMIGA ACCESSORIES

MIDI INTERFACE (5 Port): In, Out, Through plus 2 switchable thru/out. Includes cable. **£24.95**
Vidi, The Complete Colour Solution: Vidi with RGB Splitter, Frame Grabber & Digitiser. Grabs moving colour video into 16 grey scale frames (up to 16 frames in 1Mb. Amiga) and digitises from still colour video source in up to 4096 colours in less than 1 second! Requires home VCR or video camera for grabbing. Requires video camera or VCR with perfect pause for digitising. Now comes with Photon Paint 2.0 FREE!!! (see Pro-Gen future for full software details)

KCS POWERBOARD IBM PC EMULATOR ★Allows you to run many popular IBM PC compatible software titles on your Amiga or Amiga A500 Plus Hercules, CGA & Monochrome Video Support, Supports Both 3.5 Inch & 5.25 Inch Diskettes
★Fits into A501 RAM Slot, 8088 XT Processor, Clock/Calendar Included, Acts As 512K RAM Exp. When In Amiga Mode, Includes MS-DOS 4.01, Shell & GW-BASIC, DOS-Help, & On-Board Memory Supports A590 Hard Drive, Mouse Driver Software Included. **£219.95**

KCS POWERBOARD AS ABOVE BUT WITHOUT: MS-Dos 4.01, GW-Basic, Shell, **£189.95**

NAKSHA 400dpi SCANNER **£114.95**
Switchable between 200dpi and 400dpi
Supports up to 32 grey shades with adjustable contrast
Supplied with EXPRESS-IT! software, image utility allows you to save in the format best suited to your favourite package.

SUPRARAM RX 500 (512K to 8Mb. RAM Expansion)
The RAM expansion giving massive memory WITHOUT dismantling your Amiga, thus avoiding the possibility of invalidating your warranty. Easily connects to sidecar with bus 'pass-through' for HD's etc.
2Mb. RAM Version £199.95 4Mb. RAM Version £329.95 8Mb. RAM Version £549.95

NAKSHA MICROSWITCHED MOUSE **£24.95**
GOLDEN IMAGE OPTICAL MOUSE **£32.95**
COMPETITION PRO JOYSTICK 5000 Black **£7.95**
ZIPSTICK JOYSTICK **£12.95**
COMPETITION PRO STAR JOYSTICK **£14.95**
The ONLY joystick to obtain a 100% rating from a magazine review!
3.5" DISK HEAD CLEANER **£2.99**



BLANK DISKS with labels
10 Genuine SONY 3.5" branded **Only £9.95**
50 Genuine SONY 3.5" branded **Only £39.95**
10 Unbranded with library case 3.5" certified **Only £7.95**
200 Unbranded 3.5" certified **Only £72.50**

Easy Ordering

Before you choose from whom to purchase, please phone us. We are always happy to discuss your requirements, and answer any queries you may have...

- ORDER BY PHONE:** Phone our Order Hotline with your Access, Visa, Mastercard, Switch or Lombard Creditcharge Card quoting number & expiry date (Dixons, Curry, NASCR and other 'store' cards are Lombard Creditcharge and are accepted by us).
- ORDER BY POST:** Make cheques, bankers building society drafts or postal orders payable to GORDON HARWOOD COMPUTERS. (Personal/business cheques take 7 days to clear from day of receipt whereupon your order will be despatched). Please send Name, Address, and most importantly if possible, a Daytime Telephone Number along with your order requirements. Please check you are ordering from one of our latest advertisements before posting (phone if you require confirmation). Please remember that for example many September publications appear during August, therefore prices you see may have changed (either up or down).
- FREE POSTAL DELIVERY:** FREE within 14 working days, UK Mainland only. OR: **COURIER SERVICE.** Add £5.95 per major item for next working day delivery, UK Mainland most regions.
- EXPORT ORDERS:** Most items are available at TAX FREE PRICES to non UK residents when visiting /export shipment. Please contact us for ordering information.

REMEMBER AFTER YOU'VE BOUGHT FROM HARWOODS, WE'LL STILL BE HERE...

- TECHNICAL SUPPORT:** You will be given our Exclusive Technical Support Phone Number to call should you require any help or advice on the operation of the system you have purchased.
- 12 MONTH WARRANTY:** Items proving faulty within 30 days of purchase are replaced with NEW UNITS unless otherwise stated. For the whole guarantee period, warranty service will be completely FREE OF CHARGE.
- COLLECTION FACILITY:** Any computer, monitor or printer requiring warranty service can be collected from your home FREE OF CHARGE during the guarantee period (UK Mainland only) and a FAST turnaround is GUARANTEED by our OWN ENGINEERS!
- FREE TESTING PROCEDURE:** All computers are tested prior to despatch, and all items are supplied with mains plug and leads as required - just connect up and use straight away.

REMEMBER WE'RE NOT JUST ANOTHER MAIL ORDER COMPANY...

All listed prices are what YOU PAY, and there are NO HIDDEN EXTRAS. VAT and postage are included, and prices are correct at time of going to press (Pack details may vary from time to time). Offers are subject to availability and to being the latest advertised packs and prices. Our offers are NOT supplied on a trial basis. **E&OE.**

FINANCE FACILITIES...

tailored to suit your needs. Written details on request. Gordon Harwood Computers offer facilities to purchase using our budget account scheme. APR 36.8% (Variable). Available to most adults of eighteen years or over, subject to status. Simply phone or write and we will send you written details along with an application form. Applications, required in advance, available to full time U.K. mainland residents and overseas British forces personnel. Showroom visitors, please ask for details of our in-store "Instant Account". Written quotations on request. If you are already the holder of a Lombard Credit Charge Card you can use this to purchase from us (subject to your personal card limit)

VISIT OUR SPACIOUS SHOWROOM: Please pay a visit where our full range of advertised products, at the SAME COMPETITIVE PRICES, & MORE, is on sale. ALL UNDER ONE ROOF, in pleasant surroundings at our purpose built showroom (See note below map). There's plenty of FREE parking close by.

OPENING TIMES: 9.00 until 5.00 Monday to Saturday 9.00 until 1.00 Wednesday. Closed on Sundays

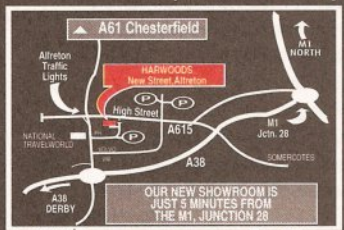

GORDON HARWOOD HARWOOD HARWOOD Computers

GORDON HARWOOD COMPUTERS
DEPARTMENT **ams** /G3, NEW STREET, ALFRETON, DERBYSHIRE. DE5 7BP
TEL: 0773 836781 FAX: 0773 831040



Apple™ in Alfreton...

For the professional user, Gordon Harwood provides the outstanding Apple™ Macintosh™ range of computers. These superb systems are available at surprisingly competitive prices! *CALL US ABOUT OUR LIMITED PERIOD FREE PRINTER OR MONITOR OFFERS* As your quality assured Apple™ Authorised Dealer, systems are available through our showrooms only. Please visit us for your personal introduction to this exceptional range of friendly yet powerful graphical computers. *Offers open during 'Special Promotional Period' whilst stocks last!



Apple, the Apple logo, Macintosh and Classic are trademarks of Apple Computer, Inc. All other trademarks are acknowledged.

continued from page 59

disk you'll always have the screen where you want it.

You don't say how you were connecting the Amiga to the various TVs, so I'm assuming that it's via a modulator. Whilst many people find this method acceptable (on cost grounds) it's not really the best way of viewing your Amiga's picture, as you have discovered.

You may get better pictures if you make adjustments to your TV's contrast, colour and brightness controls, or use the modulator's Composite Video output into a VCR connected to your TV instead of using the RF output direct to the TV set.

If you can't make any of these improvements then I recommend you consider buying a proper RGB monitor if you can, for example an Philips 8833 or Commodore 1084S, or a TV/monitor with a SCART input, as this will vastly improve your picture quality. **GW**

CHARACTER WITNESS



I have typed some documents which I would like to scan into my Amiga

500 Plus using a fairly cheap hand scanner. I require some sort of optical character recognition to take place and would like to know of any and all ways of doing this on my Amiga.

At the end of the day these typed documents will have to be in my computer in ASCII format.

**Alexander Kerr
Downton, Wiltshire**

COMING NEXT MONTH • COMING NEXT MONTH

Watch out next month for another Amiga Answers special. As an addition of our two part feature on RAM, which starts this month on page 24, we will be answering everything you've ever needed to know about memory. Don't forget now, will you?

In a nutshell, Optical Character Recognition (OCR) software turns a scanned image of text into a text file readable by a word processor. And yes, it does exist. The best OCR systems on the PC typically cost about £750.

An American company called Migraph has developed some OCR software for the Amiga, called, funnily enough, *Migraph OCR*. It will read any standard black-and-white Amiga ILBM file created by any Amiga hand scanner or flatbed scanner, plus it can import TIFF and IMG format files created on other computers.

After 'reading' the image it converts and exports the text to a normal ASCII text file.

I've not managed to get my hands on a review copy yet, but the specification sheet makes for impressive reading. Migraph OCR is pre-trained on more than 20 typefaces, including Courier, Helvetica, Times, Bookman, Letter Gothic and Artisan.

Additional typefaces can be learned and it can be taught to recognise defaced characters and special symbols such as Greek characters or maths symbols.

It recognises proportional and

non-proportional fonts; typeset, typewritten, laser printed and NLQ dot-matrix quality text; and point sizes from 10-18pt - smaller point sizes can be recognised when scanned at 400 dpi.

It supports American and foreign characters and includes lexicons (linguistic databases) for English, German, French and Dutch.

On top of all this it will enable you to save any graphics on the scanned image as ILBM or TIFF files.

As you've seen from the PC price of OCR software, this kind of power does not come cheap. The good news is that *Migraph OCR* will run on any Amiga, work with images created with any Amiga hand scanner, and costs only £265, a third of the cost of equivalent software for the PC. The bad news is that it requires at least 2Mb of RAM and a hard disk.

If you want to scan A4 pages with a hand scanner you might also need to buy a scanning tray to make the job of scanning the two vertical halves of the page a lot easier. There is a Migraph scanning tray that comes complete with *Merge-It* software, and this will set you back another £99.

Speak to the UK distributor, Golden Image ☎ 081-365 1102 for more details about Migraph products. **JW**

disk but exactly the same thing happened again. I've had this problem for quite a while now. Can you help?

**Joe Hedley
Tyne & Wear**

It sounds to me as if your Workbench disk is infected with the *Lamer II* virus. This is a very nasty little fellow which seems to interfere with the operation of the Workbench Diskcopy command. Like most viruses, *Lamer II* also enjoys writing spurious read/write errors all over disks, which could, I believe, explain why so many of your disks are becoming corrupt.

Thankfully the *Lamer II* virus is pretty simple to kill. All you need is a copy of a decent virus killer such as *KDVIII (Kill Da Virus III)* which is available from all good PD suppliers.

When you get your virus killer, turn off your machine before using it and then boot from the disk which it arrives on - don't try backing up this disk first with your Workbench disk as you could well infect the *KDVIII* disk as well.

Once it's up and running, go through every disk that you own, removing any viruses that you find. Don't put commercial game disks through a virus killer, though - the vast majority of games use their own custom bootblocks, so if the game works then there's a 99% chance that the disk isn't infected anyway. **JH**

'ALLO TOSH



I have been offered a Toshiba P351 24-pin printer. Could you tell me which

printer driver to use and whether this printer will print graphics using Professional Page 2.1?

**JR Harris
Horder
Co Durham**

On the Extras disk, in the 'devs/printers' drawer, you will find drivers for both the Toshiba P351C and P351SX. Try the Toshiba with *Professional Page* and both these drivers and see if it works. **JW**

PORT CONTROL

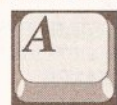

Are there any control words which I can use from Basic to turn the printer

port into an input port, ie turn any output pin into an input pin for controller applications or to read the input from a sound sampler?

**C Savage
Millon
Cumbria**

If you are after 'BBC Basic style' hardware port control then forget it

JARGON BUSTING • JARGON BUSTING

Database - an applications program that enables information to be stored and retrieved in a structured manner. Information can be categorised according to a user's preference, and searched for according to user-specified criteria.

Hand scanner - a hand-held device which will convert an image on paper into the IFF graphics format on the Amiga for subsequent processing.

Optical character recognition - a process whereby text can be scanned in from a page and converted to a form suitable for the computer. Normally, images scanned using a hand-scanner are converted to the IFF graphics format. In order for the computer to be able to interpret the data as text, this must be converted to ASCII format, a complicated process whereby the software has to recognise the patterns of each letter, being aware of the different patterns inherent in different typefaces.

SysEx - System Exclusive is a category of MIDI message containing information specific to a particular type of synthesiser. It is usually used to perform such operations as modifying the parameters of a voice on a synthesiser.

Virus - a small program that can lie hidden in memory or on a disk, duplicating itself on to any disks inserted in the machine, and generally causing havoc. There are many virus killers available in the public domain designed to deal with this menace.

DISK PROBLEMS



I recently bought a copy of your sister magazine Amiga Format for the twin

coverdisks containing Sequencer One and The Graphics Workshop. I managed to run Sequencer One after successfully copying the disk by using the Shell Diskcopy command.

I then tried to use The Graphics Workshop but all I got was a requester informing me that the disk had a read/write error. I then tried to repair the disk using the Diskdoctor command but - although the machine told me that the files on the disk had been saved - when I tried to use the disk all I got was a 'NDOS' (Not DOS) message from the system.

Later I tried to copy a program disk of my own, but although Diskcopy started, the machine just seemed to hang. After resetting my machine, I tried to copy a different

because none of the Amiga Basics offer anything similar. Having said that I ought to point out that parallel port control from Basic is an area that is quite poorly documented and I must admit it is not something which I have ever had reason to experiment with. Such things are bound to be possible, for example by using a mixed code Basic/assembler approach, but unless you are used to 8000 coding and the Amiga's O/S this wouldn't be a particularly easy thing to become involved with. **PAO**

AUDIO ANGST

 I have a problem concerning audio playback from my A500 and Fidelity CTM monitor. In TV mode both audio and vision are fine, but in monitor mode I get no audio. Whenever I connect the A500 to a stereo system the sound ports check out OK, so that's not the problem.

The continuity on my Trilogic AL1 lead check out fine - pins 2, 6 are the audio pins and pin 4 is the common.

Can you tell me which pins the audio leads should be connected to in order to reach the CTM audio circuit?

Lee Bailey
Preston
Lancashire

I contacted Trilogic, which assured me that if the AL1 lead was all OK when it would definitely work with the Fidelity CTM, as this is one of the monitors they used to test the leads with. So the problem may lie with a faulty cable.

A possible alternative is that an IC chip near the SCART connector on your monitor has gone faulty, though this would apparently cause the monitor to be usable only in the RGB mode - which doesn't apply in your case.

You've already proved that the audio output of your Amiga is OK, so the only possibilities are that either the cable or the monitor is faulty (or in the worst case, both).

You could contact Trilogic (☎ 0274 691115) with a view to replacing your cable. If this doesn't do the trick then you will have to consider getting your monitor looked at.

I have tried to track down the audio connections but unfortunately I was not able to come up with anything, because Fidelity closed down around three years ago and it no longer has a Technical Department (obviously) to fire such questions at.

I should think that Trilogic would be able to help with this information too. **GW**

DATABASE ON THE CHEAP



I write loads of letters and I like to keep in contact with everyone whom I converse with.

Retaining everyone's details in a book is a real pain for numerous reasons so I've decided that I'd like to use my computer instead. Could you recommend a PD or commercial database program that will allow me to store and printout names and addresses.

Stuart N.Hardy
Sheffield

Just about any PD database program would be more than suitable for your particular requirements although I'd recommend *Ami-Base II* which is available from 17-bit Software (☎ 0924 366982). **JH**

PRO-24 PROBLEMS



In *Amiga Shopper* issue 9, you reviewed the public domain ST emulator

for the Amiga. According to the article, the ST version of Steinberg's *Pro-24* ran on it. However, when I tried it myself, I couldn't get *Pro-24* to send anything down the serial port. I want to be able to use data disks with bank loaders for a DX-7 and Roland D110, but they presently don't work under the ST emulator. I've tried running the emulator under both 1.2 and 1.3. What am I doing wrong?

Another problem I've found is that the emulator seems to crash when I change resolutions. Is this a problem with my Amiga?

Mark Granger
Crawley
Sussex

Although quite a few ST programs will load fine under the PD ST emulator, very few of them seem to run exactly how they should.

In the case of *Pro-24*, you've found the one big fly in the ointment which stops the emulator being particularly useful. Because the ST's MIDI ports are separate from the machine's serial port, you'll find that the vast majority of ST MIDI software won't run.

My advice to you would be to treat yourself to a copy of a PD program called *MIDICom*. This little gem of a program will enable you to both receive and transmit SysEx dumps from just about any MIDI device and store them on standard Amiga disks.

I too had quite a few sound banks for my Korg M1 on an ST disk for use with Steinberg's *Satellite* utility (bundled with *Cubase*). Unfortunately, *Satellite* wouldn't run under the ST emulator either, so I thought I'd try a little experiment. What I did was to copy the *Satellite* banks across to an Amiga disk and then I tried to transmit them to my M1 using *MIDICom*. To my surprise, they worked fine!

As long as the bank loading

utility that you use doesn't add its own data to the dumps that it receives, you should find that your DX-7 and D110 dumps will work fine with *MIDICom* too (after all, the SysEx information transmitted by your synths will remain the same no matter which computer is receiving it).

For a copy of it, contact the PD library AmigaNuts United. It's at 169 Dale Valley Road, Southampton, SU1 60X. **JH**

TROUBLE WITH TEXAS



My printer is a Texas Instruments Omni 800 model 850XL. I bought it second-

hand, without an instruction manual, however on writing to Texas Instruments I received a manual by return post.

I have tested the printer and the DIP switches and it is all working. My problem is getting a printer driver to use with it. The only ones which give me any kind of understandable response are EpsonQ and generic, but these are limited in that they only give basic print - that is to say, no italics, no underline, no bold, and graphics are a non-starter.

Can you help?

James McGough
Townhead
Strathclyde

Hmm. Tricky one. The Omni 800 model 850XL has its own set of escape codes designed by Texas Instruments. These escape codes are 'almost but not quite' totally Epson compatible. In other words, the majority of the escape codes are the same, and only a few are different.

The 850XL is actually a 9-pin printer, so you'll not get much sense out of EpsonQ, which was written for 24-pin printers. Try the EpsonXOld or EpsonX[CBM_MPS-1250] drivers. There's a good chance that you'll get bold, italics and underline out of these.

Graphics output is difficult because the 850XL has mostly

different resolutions to Epson 9-pin printers. However its two lowest resolutions are 60 by 72 and 120 by 72 dots-per-inch. The EpsonXOld driver uses 60 by 72 resolution when set to Density 1, and the EpsonX[CBM_MPS-1250] driver uses 120 by 72 on Density 1, so you might get some joy there.

But the 850XL's highest resolution is 144 by 144 dots per inch, and Epson printers do not support this resolution, so the Epson drivers won't work. Nor will any other driver on the Extras disk, and I'm afraid I know of no specific driver for the 850XL. **JW**

FLIPPING IMAGES



I have just bought an Amiga 500 Plus and would like to connect a video

signal to it to do special effects such as mirror image, multi-image, picture flipping and so on. I have been told that it can only be done on an Amiga 1500 or 2000 with the

SAMPLER SCARCITY



I have just purchased an Amiga and would appreciate any

information you could give me regarding the possible existence of professional quality samplers for the Amiga. I know of such products for the Atari ST, priced between £250 and £450, but so far I have been unable to locate such samplers for the Amiga.

Anon

When you say 'professional quality' I presume you mean either 12-bit or 16-bit sampling. The good news is that a company called SunRize Industries has produced both 12-bit and 16-bit sampling cards for the Amiga. Neither are available yet in the UK but they should, with luck, be arriving within the next few months.

The 16-bit board is however likely to be relatively expensive because it is a stereo unit which supports MIDI, SMPTE, DAT and CD hook up. With a signal-to-noise ratio as good as a compact disk it is likely to attract a lot of professional interest. If you contact Zone Distribution ☎ 081-766-6564 the people there should be able to give you additional technical details.

PAO

CORNER TIP

This piece of advice comes from Paul Howlett of Southampton. It comes in response to R Price's letter in *AS10* asking if there was a program to play *Noisetracker* modules so that the second module loads as the first one plays, thus being ready to play straightaway. Paul writes:

"I have just the program: it's called *IntuiTracker*. It has a feature called *Musique non-stop* which does just what Richard asks. As well as that, it can run in the background in *Workbench* and it can display a spectrum analyser, volume, speed and tape-player like controls. It can even play your modules in a random or pre-programmed order."

IntuiTracker can be found on *Amiganuts United* disk 974, which also contains other good *Soundtrackers* and *Rippers*.

Thanks for the tip-off, Paul, £5 will be on its way to you shortly.

Invision program. Is there any way I can do this with my Amiga 500 Plus? Also, how do I go about connecting my Super VHS machine?

Rambo Ragu
Bradford
W Yorks

I'm afraid that whoever told you that you could only do the video effects you require on an A1500 or 2000 was pretty much correct.

The *Invision Plus* hardware is one way of doing some of these effects, although there is no way of doing real-time flips and tumbles on a live image – the picture can be simply inverted, mirrored, recoloured and so on, all at reduced picture quality.

For further information you might like to see my review in *Amiga Shopper* Issue 8. The only other way I know of doing these things in real time with an Amiga is to use a *Video Toaster* – but this only fits Amiga 1500 or 2000s and does not currently work with the UK video system (known as PAL).

There are, of course, other ways of making a picture flip and tumble on the Amiga but you'll have to grab it in from video first (using a digitiser) and then manipulate it with a program like *Deluxe Paint IV*, *Animagic* or *EFX3D*, all of which produce an animation of the picture

for playback, none of which work in real time. And they all need lots of memory to work on large, hi-res or HAM images.

There are also other, non-Amiga ways of carrying out the effects which you require but you'll need extra video hardware such as a vision mixer and framestore with effects. I'm afraid this is beyond the scope of my answer here as it moves us into the expensive world of video production equipment.

To connect your Amiga to your Super VHS machine you'll require a genlock which can output S-VHS video signals. There are a number of these currently available and you'll see them advertised in magazines such as this one and others such as *Camcorder User*. **GW**

ENLIGHTENED PEN



I would like to write a light pen driver in C and have purchased a kit from Maplin

Electronics. I believe the two registers I need are somewhere in the Agnus chip and wonder if you'd be good enough to point me in the right direction.

AG Bowler
Folkstone
Kent

VPOSR (\$DFF004) and VHPOSR (\$DFF006) are the two registers you are talking about – these provide the high-order and low-order pen position bits but you'll also need to write a 1 into bit 3 of BPLCON0 (\$DFF100) to enable the light pen latch. All the register and light pen connection/use details that you require can be found in the *Amiga Hardware Reference Manual*. **PAO**

HARD DISK HASSLES



I own an A590 hard disk and – like a good boy – I try to back it up regularly using

Lake Forest Logic's *The Disk Mechanic*.

My hard disk is three quarters full so it is of vital importance to me that my drive works correctly.

However, as I've inadvertently managed to wipe my hard disk clean several times (usually whilst trying to validate a floppy disk but forgetting to highlight it), I always seem to have great difficulty trying to put the information back on to my drive from my backups.

My question is this: can you recommend a much better hard disk backup utility? I've had no end of problems with *Disk Mechanic*, so I'd be grateful if you could suggest a more reliable backup utility.

Going Mad
Wickford
Essex

You're right, *Disk Mechanic* is a lousy program. I tried using it on my 90Mb SCSI drive but encountered pretty much the same type of problems that you describe.

The backup utility that I would recommend is called *QuarterBack* and is available from HB Marketing ☎ 0753 686000. *QuarterBack* is a pretty simple little program, but it gets the job done quickly and efficiently. **JH**

BROADCAST NEWS

I purchased *Broadcast Titler 2* for my A500, and it works perfectly well from the floppy disk. But when I installed it on my GVP hard drive and tried to run it from its icon it just crashed the computer. I did notice that the message "Newcon Mount Failed Code 16" was displayed.

I've made sure that the startup-sequence contains the *FastMemFirst* command, as recommended.

Can you advise what the problem might be? My suppliers can't help and despite two faxes to *Innovision Technologies* (the makers of *BT2*) I have had no response.

RA Thorne
Henley

Well, I've tried all I could think of to emulate your *BT2* crash on my Amiga 2000, but the only way I could cause this was to use *NoFastMem* to turn OFF the Fast memory – the opposite to *FastMemFirst*. I checked my startup-sequence and I wasn't using *FastMemFirst* anyway – but *BT2* still worked OK.

"Newcon Mount Failed Code 16" made me wonder whether your startup-sequence contained the command *Mount Newcon* – but I

removed this from mine, rebooted and still had no problems.

In fact, I stripped down my startup-sequence back to basics but all to no avail. The only other problem I could cause was to remove *IconX* from the *BTitler2* drawer – resulting in a message to the effect that there was an error whilst opening *IconX* (which is needed to load the program).

You don't have a shortage of memory, so that won't be causing the problem. Did you install *BT2* correctly by using the *HDInstall* program supplied, or did you do it by hand, as the program copies all the required files to the designated drive?

Check the *BTitler2* drawer contents and compare them with the floppy disk. Does everything look OK? You should also check that all the files in C:, Devs:, Libs:, and L: on the floppy are present in the corresponding places on your hard-disk. But *don't* copy the files from the floppy to the hard-disk unless you are absolutely sure what you are doing – you could end up replacing a vital file with a version unsuited to your current setup.

If none of this helps, delete the entire *BTitler2* drawer from your hard disk and re-install from scratch using the *HDInstall* program, following the instructions if necessary. If this doesn't work you might have a defective copy of the program and should get it changed. **GW**

MASTERING CODE



I have owned an Amiga for eighteen months and have used it mainly for games. Now I want to learn machine code. I am fairly

continued on page 7

JARGON BUSTING • JARGON BUSTING

HAM – Hold And Modify is an Amiga graphic mode enabling all 4096 colours to be displayed at once, with certain restrictions.

IconX – a handy little public domain program which will enable a Shell script (a collection of Shell commands held in a file) to be executed via clicking on an icon via the *Workbench*.

Light pen – a pen-like device which can be connected to the Amiga and used on the screen as a pointing device. It works by detecting the blip of light produced on the screen as the display is created by a rapidly moving scanning dot (which traverses the whole screen every 50th of a second). By noting the time at which the blip is detected, the computer can calculate the position of the light pen.

PAL – one of the main TV colour coding systems (with the exception of France's SECAM system), which is in use around the world and was developed in Britain. PAL refers to Phase Alteration Line. In fact, there are several hybrid PAL systems in use, all of which are slightly different.

SCSI – Small Computer Systems Interface is the standard used for connecting hard drives, CD ROM drives, tape back-up units and so on to computers.

POWER COMPUTING

Optical Hard Disk



External

Optical 128MB + 5 disks (eq. to 600MB) **£1275**

Optical 128MB + 10 disks (eq. to 1GB) **£1450**

A500 requires a suitable SCSI Host adaptor, not supplied

Internal (A1500/A2000)

Optical 128MB + 5 disks (eq. to 600MB) **£1075**

Optical 128MB + 10 disks (eq. to 1GB) **£1250**

SCSI Controller Card for A2000/A1500 **£199**

24 Bit Colour Card

16 million colours
GVP Impact Vision **£1655**

Rambrandt **£1500**

Harlequin 1MB **£1275**

Harlequin 2MB **£1399**

Harlequin 2MB **£1520**

Harlequin 4MB **£1599**

TV Paint 24 bit paint program **£899**

TV Record **£169**

TV Display **£79**

Power Scanner Packs

Power Scanner, 512K of RAM with clock **£114**

Power Scanner + PC880B **£159**

Power Scanner + Dual Drive **£209**

Power Scanner, 512K of RAM + Pro Page **£249**

Power Scanner, 1MB of RAM + Pro Page **£270**

Videon v3.0

Digitize and display all 4096 colours in high resolution

Digitize directly from colour video sources (VCR's, video cameras, video disc)

Dynamic hi-res without interrupting multi-tasking

24 bit compatible (Digitize 16.7 million colours)

68030 compatible

Videon v3.0 **£199**

Microgen Amiga Genlock **£199**

Videon 3.0 & Microgen **£389**

New PC880B

Now with X-Copy Professional!

Power Computing have teamed up with **Cachet** of Germany to bring you the **ultimate** in disk backup systems.

The new **PC880B** Drive can be used directly with the X-Copy Professional 'Cyclone' software without any extra cables or interfaces. This gives you the power and reliability of the proven 'Cyclone' backup software with the convenience of the **PC880B** floppy drive.

So now you can have two backup systems 'Blitz' and 'Cyclone' available at the touch of a button! and the **PC880B** still has our unique switchable anti-virus mode, preventing all write accesses to the bootblock of your floppy disks!

If you already own a **PC880B**, and the Cyclone copier, a hardware upgrade is available to take your drive up to the latest specification.

New **PC880B** with Blitz & X-Copy Professional software **£99.95**

New **PC880B** (Cyclone compatible) ***£79.95**

Cyclone Hardware Upgrade for existing **880B** owners **£15.00**

*This drive is available only to REGISTERED owners of X-Copy Professional. You must provide proof of purchase of X-Copy Professional.

SPECIAL UPGRADE OFFER!

If you consider your scanner system to be inferior to the Power Scanner, we will happily upgrade your software and interface for only **£49.95**

Power Scanner is compatible with most scanning heads.

A500

Amiga 500+ **£399**

Amiga 500+, 2MB **£445**

Amiga 500+, 20MB Internal hard drive **£600**

Amiga 500+, 52QMB GVP hard disk **£780**

A1500, A3000 also available **£POA**

Monitors and printers also available **£POA**

Chips

256K x 4 DRAM **£5** 4MB x 8Simm **£150**

1MB x 1 DRAM **£5** 1MB x 8Simm **£30**

8372 Fatter Agnus **£39** 1 x 4 Zip **£24**

A3000 Static Column RAM **£24**

Miscellaneous

Power Mouse **£15**

Optical Mouse **£29.95**

Replacement optical mouse mat **£9.95**

A500 Dust Cover **£9**

Maxell multi colour branded disks (10) **£9.95**

Floppy disk **£POA**

Blitz Amiga

Back up disks at lightning speed
Stops all external drives from clicking
Contains anti-virus from being written into the bootblock **£25**

PC Emulators

KCS PC Power Board **£235**

KCS A2000 Power Board, includes MS-Dos 4.01, GW Basic, Shell, Dos-Help & on-board memory **£209**

Without Dos **£179**

Adaptor for A1500/A2000/A3000 **£69.95**

Progressive Peripherals 68040 Accelerator Board

25MHz Motorola 68040

Built-in maths co-processor

Expandable up to 32MB of RAM

Software compatible with all 68040 family processors

Many more features

0MB RAM **£1449** 16MB RAM **£2109**

4MB RAM **£1569** 32MB RAM **£2525**

8MB RAM **£1689**

Bare SCSI Hard Drive

52 Quantum **£199** NEC 45MB **£179**

105 Quantum **£299** NEC 100MB **£279**

(suitable for GVP Combo or GVP HC or Nexus HC)

Send your order to Power Computing Ltd, Unit 8 Railton Road, Woburn Road Industrial Estate, Kempston, Bedford MK42 7PN
Ring your credit card order through on **0234 843388 (10 lines)** or fax your order on **0234 840234**. Technical Helpline **0234 841882**

All prices include VAT, delivery and are subject to change. Specifications are subject to change without notice. Next day delivery £4.50 (U.K. mainland only), all trademarks acknowledged.

continued from page 68

competent in Workbench, and can work well with the Shell. Do I need any books on the Amiga's operating system or anything like that and if so which ones would you recommend?

When I load up some disks I get an error message saying "Can't find Disk Validator". I can get around the problem by copying the disk validator from Workbench into the disk's L directory. Is there anything wrong with my disks? Have they been infected with a virus?

**Phillip Thomas
Stvechale
Coventry**

You've not said whether or not you have any previous programming experience so I'll assume that you haven't.

I've got to be honest – I suspect that machine code on the Amiga is going to scare the hell out of you. This is not because the 68000 instruction set is particularly difficult to understand – it is because, in order to write 68000 code for the Amiga, you need to know about the Amiga's operating system, its library arrangements, and a million other things besides.

This doesn't however mean that it would be an impossible task but you really will need to put a lot of effort into it. As well as coming to terms with the writing of 68000 code itself you'll need to get hold of, and read, as much of the Amiga's technical documentation as you can find.

The Addison Wesley *ROM Kernel Manuals* are the official Amiga guides and these together with the Bantam Books *AmigaDOS Manual* (which contains in-depth AmigaDOS programming info) provide the most complete descriptions of the system. The trouble is that these books are written for users who are, to a large extent, already used to programming complex systems. Most Amiga users, however, do not fall into this category but fortunately a lot of easier-to-read, but less comprehensive, technical books (from Abacus, BSB Books and so on) have appeared which bridge this very gap.

It is impossible to recommend a single book (or even a few) without knowing quite how much programming experience you have, so I think the only useful advice I can give you is to get down to your local Amiga shop and look at the various offerings – then choose one that

JARGON BUSTING • JARGON BUSTING

AmigaDOS – the most basic part of the Amiga's operating system – the collection of programs that take care of the general running of the machine. The acronym DOS stands for Disk Operating System. AmigaDOS concerns itself with device-handling: control of the keyboard, basic screen output, disk drives, printers and so on.

Bitplane/bitmap – a bitplane is an area of memory where every binary bit corresponds to a pixel on the screen. One bitplane represents a monochrome image, several can be overlaid (a bitmap) to represent a colour image.

Kernel – the group of programs at the very centre of the operating system. Many useful routines are contained here which can be used by other programs. The name comes from the analogy of a nut – the Kernel is the centre, the Shell is the outside through which the user gains access.

Library – the Amiga has many special features, and programs are already present in the operating system to make use of these features. These programs, or library functions, may (and should) be used by applications programs, obviating the need for each programmer to write a similar set of routines.

68000 – the Motorola-produced chip which acts as the Amiga's 'brains', more properly called the CPU or central processing unit.

seems reasonably understandable to you.

As far as your disk validator problem is concerned it is impossible to say what the problem might be without seeing the disks concerned.

There are some viruses which can affect the disk-validator but as far as I'm aware they re-write, rather than destroy it. This being so I suspect that the problem is simply that the validator was not on the disks concerned in the first place.

PAO

VIDEO WIPES



If I buy Broadcast Titler 2 can I use it to perform video wipes and fades? If so,

please explain how. If not, should I buy the Video Tech VEC1060.

Could you also please explain how to use Anglia PD fonts with BT2?

**MI Pickering
Scarborough**

In the sense of true video wipes and fades, the answer has to be no, you can't use *Broadcast Titler* for this. But there are some things which you could do by using your Rendale 8802 genlock which might provide similar effects. For instance, you could start with a Colour 0 blank screen (which would be transparent to video when genlocked), then make a sliding transition to a new page with a non-colour 0 background – thus wiping out the video with a keyed graphic screen!

Wiping yes, fading no. The nearest you'll get to a fade is to dissolve the Amiga picture out dot by dot to a blank colour 0 image, thus eventually getting a full key through

to video. As you know, the 8802 cannot do fading, so you'll have to find an alternative solution. According to the manufacturer's specifications (fade to colour, single wipe, picture processing and audio mixing) the VEC 1060 may fulfil this need, though I am not familiar with it so cannot comment further. Alternatively, you may consider upgrading your genlock to a more recent one with fading (and perhaps wiping) facilities.

With regard to Anglia PD fonts, there is a utility called *Convert* provided with *BT2* which lets you change any standard Amiga bitmap font (including Colorfonts) to the proprietary .btf format fonts used by *BT2*, though the results will not be anti-aliased as the supplied BT fonts are.

Alternatively, there are other programs, such as *Innovision's BT2 Font Converter* or *ZEN Computing's AntiA* (both reviewed in *Amiga Shopper 8*) which will anti-alias (smooth the edges) and convert all non-Colorfont Amiga fonts.

BT2 Font Converter's .btf fonts can be used directly with *BT2* (but not other programs) whilst *AntiA's* Colorfont output can be used with any Amiga program which accepts them, and also converted to *BT2* format using the standard *Convert* program. **GW**

DATABASE TO DISK



At the moment I am writing a database program in Amiga Basic and for

speed the records are located in RAM: but just before I quit the program I would like to copy the records from the ramdisk to df0: or df1..

ELOCUTION LESSONS



The ability of the Amiga to speak is one of its amazing qualities, but using SAY I can't manage to alter the voice. I type in 'f', 'm', and different pitches and speeds but nothing changes. I still get the same robot-like voice. Can you

please give me precise details on what I should type to alter the voice?

**Mark Hoime
London**

There shouldn't be any problem in altering the voice characteristics and I suspect that if your options aren't working then it is simply that they are being ignored because you've not presented them properly. The basic format of the SAY command is this:

```
SAY [<options>] <text string> | <filename>
```

where the angle brackets indicate parameters that you are expected to type with the square brackets signifying an optional item. There are six possible options: m for male voice, f for female voice, r for a robot voice, p<num> for pitch, s<num> for speed and x for specifying that a filename, rather than a text string, is to be used. These options must be introduced by a dash and each option must also be delimited (separated) by spaces.

Here's a couple of examples:

```
SAY -m -p80 "this is your Amiga speaking"
SAY -f -p160 "this should sound different"
```

Now if, with the last set of parameters, you wanted to SAY the words in a text file you'd need also to specify the x option like this:

```
SAY -f -p160 -x df0:sometestfile
```

PAO

Can you tell me how to do it without leaving Amiga Basic.

Pierre van Heumen
Gorinchem
Holland

Presumably you are using a random-access file which enables you to both read and write bytes from variables defined in FIELD statements.

The easiest way to copy the data from the RAM file is to open the real (the disk stored file) random-access file on df0: (or df1: whatever) and then use GET/PUT statements to transfer the records from the RAM version to the file permanently stored on disk.

You really only need to update those records which have changed (by the way, this to a large extent is the purpose of using random-access files in the first place) so your program should make an internal note of records as they are used and restrict its copy operations to changed records only.

It is possible however that you may be able to open your files directly on df0:/df1: yet still avoid the time penalties associated with lots of read/write operations. Try specifying a larger file buffer size when you open your files – the default buffer size is only 128 bytes but Amiga Basic allows you to specify a buffer of up to 32767 bytes using this syntax:

OPEN mode, [#]filename, ↓ filespec, [file-buffer-size]

I think you'll be surprised with the difference that a 32K file buffer size can make (relative to a 128 byte buffer size) – in theory it will reduce the number of time consuming 'real' read/write file operations by a factor of 256. **PAO**

VIRUS CONCERN

A When I boot up my hard disk with the **KDVIII** virus checker installed in my startup-sequence, a message appears informing me that a **TTV/BGS9** Virus has been detected in RAM and killed. However, **VirusX 3.1** doesn't seem to spot it when I run that instead of **KDVIII**. Could you please tell me about this virus, its effect and how I can remove it from my hard disk?

MT Seward
RAFO Masirah
Sultanate of Oman

The **BGS9** virus is what is known as a 'link virus'. That is, instead of living in the boot block of a disk (this type of virus cannot infect a hard disk), the **BGS9** virus works by attaching itself to certain system files (usually

the disk-validator or AmigaDOS commands in your C directory)

This type of virus cannot be detected by a conventional bootblock virus checker (hence the reason why **VirusX 3.1** doesn't know about it, although later versions of Steve Tibbett's program can detect link viruses), so what you need is a virus checker that can hunt down and kill link viruses. By far the best I've seen is John Veldthius' **Virus Checker** version 5.26. **JH**

AMSTRAD ACTION



Could you please show me how to wire up a lead which will allow me to use

the colour monitor which came with the Amstrad CPC range of computers with my Amiga 500. As you can appreciate, converting my old Amstrad monitor to work on the Amiga could save me a lot of money.

S Bassett
Lowestoft
Suffolk

No sooner said than done. To connect your Amstrad monitor to your Amiga, you'll need four things – one male 23-pin D-style connector, a 6-pin DIN connector, a length of 5-way shielded cable and a soldering iron.

You'll have to contact a specialist Commodore parts supplier such as HRS (☎ 021 789 7575) for the 23-pin connector, but the other items should be readily available from all good electrical parts suppliers (Tandy and so on).

The wiring of the lead is fairly simple and is shown in the diagram above and to the right. **JH**

FUNKY TELLY



I have an old(ish) Telefunken TV with a SCART connection. However,

I don't know which pins are which. Can you advise me so that I can connect my Amiga? Do the SCART pin uses vary from company to company and model to model?

Peter Alexander
Oxford

Regular readers may have started to think I'm being paid by Trilogic to keep mentioning it, but I can assure you that it's not true. What is true is that every time I call the company to check about problems like this the people are always very helpful and can give me an answer one way or the other. In this case they say that their AL1 lead should work with your Telefunken (though they didn't plan it that way – it just does). Why not call Trilogic yourself ☎ 0274 691115 and order an AL1?

Yes, SCART socket

Amstrad Monitor Socket

As viewed from the rear

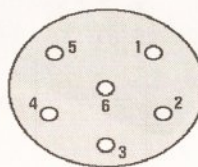

Amiga RGB Connector

As viewed from the rear

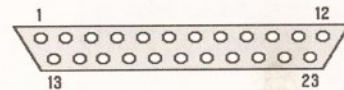

AMIGA

MONITOR



Connect up and use an Amstrad CPC colour monitor with your Amiga

configurations do vary from manufacturer to manufacturer – this is why some SCART cables won't work with some SCART monitors. **GW**

SPECTRUM FAN



I recently obtained a PD ZX Spectrum emulator which I hope to use to run my

large collection of Spectrum software. The emulator's documentation claims that I need an Amiga sound sampler like Omega to load games from tape.

Having little knowledge of samplers, I carried out a little research. Most samplers seem to cost at least £50, which is far too much for my purposes. Do you know of a much cheaper sampler that would work with this emulator?

Robert Stringer
Godalming
Surrey

There are samplers available for as little as £25, but I'd recommend you steer well clear of these budget units. The problem is that many use cheap components which keeps the cost down, but does nothing for the sound quality obtainable from the sampler. If you try to use a cheap sampler with the Spectrum emulator, you'll almost certainly encounter loading errors. The chances of this happening will be cut down substantially if you buy a decent sampler. I'd personally recommend MicroDeal's MasterSound for this task simply because of its low price (£39.95) and its exceptionally good sound quality. **JH**

ROLLING SCREENS



When using my RocGen Plus genlock I have problems with some disks (such

continued on page 73

JARGON BUSTING • JARGON BUSTING

Boot block – the first two sectors of an AmigaDOS disk, located at track 1, side 0. The bootblock is used to describe the filing system in use and can contain a special program to 'boot' (load and execute after the machine is switched on or reset) certain disks. This is how most simple viruses get into the system.

RAM disk – an area of memory that is treated as if it were a floppy disk. The RAM disk sizes itself so that it is never any larger than it needs to be, with the advantage that files can be stored and retrieved much more quickly, though all information is lost when the power is switched off.

Random access file – a method of storing information such that any item of data can be retrieved immediately. The alternative is a sequential file, in which all preceding information must be searched through before the required item can be retrieved. A random access file is like an LP record, where the needle can be positioned on any track instantly; a sequential file is like a tape which must be fast-forwarded to the track of interest.

Sound sampler – a hardware device which converts sound into a digital signal suitable for processing by the computer. The resulting sample represents the sound by taking a number of 'samples' of the sounds volume at various instants of time. The quality depends on the number of samples taken in a given period of time, and in the number of binary bits (usually eight in the case of the Amiga) used to store the volume of the sound at each instant.

**COMMODORE
1084S STEREO
MONITOR**
Including FREE lead
ONLY £219.00

**PHILIPS 8833 MK II
STEREO MONITOR**
Including Free Lead
ONLY £219.00

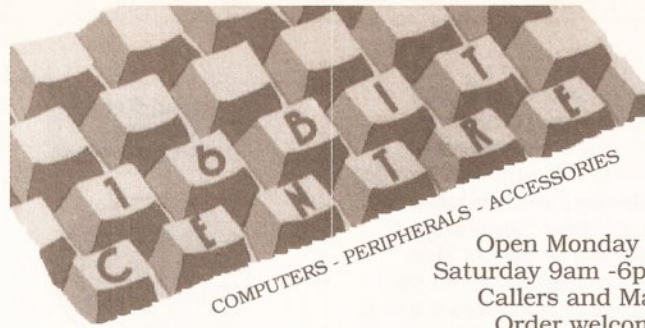

COMPUTERS - PERIPHERALS - ACCESSORIES

Open Monday to
Saturday 9am -6pm
Callers and Mail
Order welcome
Easy parking

**KCS POWERBOARD
PC Emulator
For Amiga A500**

ONLY £179.00

**AT ONCE AMIGA
PC 286 AT EMULATOR
FOR A500**
ONLY £159.00

HARD DRIVES

240 MEGS AVAILABLE ON ALL DRIVES
EG 1500 £689.00, A500 £729.00

**GVP SERIES II
1500/2000**
52Mb Quantum
Space for 8Mb RAM
£265.00

**GVP SERIES II
1500/2000**
105Mb Quantum
Space for 8Mb RAM
£419.00

**GVP SERIES II
A500**
52Mb Quantum
Space for 8Mb RAM
£359.00

**GVP SERIES II
A500**
105Mb Quantum
Space for 8Mb RAM
£485.00

SUPRA 500XP
52Mb Quantum
Space for 8Mb RAM
with 1Mb free
£319.00

SUPRA 500XP
105Mb Quantum
Space for 8Mb RAM
with 1Mb free
£459.00

AMIGA A500 FUN PACK

Amiga A500 Plus, Mouse, Modulator, Manuals, Workbench, Joystick, Disk Box, 10 Disks, Dust Cover, Dpaint III, 1Mb RAM, PLUS 13 GAMES Lemmings, Simpsons, Captain Planet, Safari Guns, Bubble Ghost, Tin Tin, Purple Saturn Day, Jumping Jackson, Hostages, Bobo, Krypton Egg, Shuffle Puck Cafe,

ONLY £399.00 inc VAT

A500 CARTOON CLASSICS Only £319.00

AMIGA A500 MAX PACK

Amiga A500, Mouse, Modulator, Manuals, Workbench, Joystick, Disk Box, 10 Disks, Dust Cover, Dpaint III, 1Mb RAM PLUS 20 GAMES Safari Guns, Bubble Ghost, Tin Tin, Purple Saturn Day, Jumping Jackson, Hostages, Bobo, Krypton Egg, Xenon 2, Super Ski, Shuffle Puck Cafe. Not all games are listed.

ONLY £369.00 inc VAT

Please phone for other Amiga Packs

SOFTWARE

| | | | |
|-----------------------------------------------------------------|---------|-----------------------|---------|
| DELUXE PAINT III..... | £15.00 | PIXEL 3D V2..... | £79.00 |
| AMOS + EXTRAS DISK..... | £32.00 | QUARTERBACK..... | £27.00 |
| BROADCAST TITLER II..... | £149.00 | PRO-WRITE V3.2..... | £69.00 |
| TV SHOW..... | £35.00 | X CAD 3D..... | £269.00 |
| DIGIVIEW MEDIA STATION..... | £105.00 | PHOTON PAINT 2..... | £25.00 |
| LATTICE C V5.10..... | £149.00 | FINAL COPY (NEW)..... | £39.00 |
| PAGESETTER V2..... | £42.00 | VIDEO EFFECTS 3D..... | £109.00 |
| PAGESTREAM V2.2..... | £122.00 | DRAW 4D PRO..... | £109.00 |
| PAGESTREAM FONTS..... | £49.00 | O/BACK TOOLS..... | £45.00 |
| TV TEXT PRO..... | £79.00 | WORDWORTH..... | £72.00 |
| CROSS-DOS V4, Multi-format file transfer..... | £19.00 | | |
| HITACHI VIDEO CAMERA. Ideal for use with DigiView..... | £199.00 | | |
| PEN PAL, Excellent easy to use word processor..... | £53.00 | | |
| IMAGINE 3D V2.0 Animations & ray-tracing..... | £189.00 | | |
| ART DEPARTMENT PROFESSIONAL V2.05..... | £119.00 | | |
| ALL IN ONE, Word Pro, Midi Music, Paint, 3 games c/w video..... | £115.00 | | |
| VIDEO EASE, Video titling package..... | £35.00 | | |
| BARS + PIPES PROFESSIONAL..... | £189.00 | | |
| AMOS COMPILER, Compile your Amos programs..... | £23.00 | | |
| THE WORKS PLATINUM. Integrated package..... | £45.00 | | |
| SUPERJAM Jamming software..... | £85.00 | | |
| DOS 2 DOS Multi format file transfer software..... | £28.00 | | |
| WALT DISNEY ANIMATION STUDIO..... | £65.00 | | |
| REAL 3D BEGINNERS..... | £99.00 | | |
| REAL 3D TURBO/PROFESSIONAL..... | £269.00 | | |
| PROFESSIONAL PAGE V2.1 (new) with tutorial video..... | £125.00 | | |

HARDWARE

| | |
|-----------------------------------------------------------|---------|
| ROM V2.04 AND ECS DENISE NOW IN STOCK..... | P.O.A. |
| FRAMEGRABBER PAL real time colour frame grabber..... | £450.00 |
| AUDIO ENGINEER 2 PLUS sampling hardware & software..... | £174.00 |
| SOPHUS S5 Stereo sound sampling hardware/software..... | £49.00 |
| AMIGA COMPATIBLE DISK DRIVE on/off & through port..... | £57.50 |
| NAKSHA CLONE MOUSE high quality replacement mouse..... | £19.50 |
| SOUND MASTER Stereo sound sampling hardware/software..... | £105.00 |
| NAKSHA SCANNER Excellent scanning quality..... | £105.00 |
| TV TUNER for Philips and Commodore monitors..... | £79.00 |

PRINTERS

| | |
|----------------------------------------------------------------|---------|
| STAR LC-24/200 COLOUR inc. free lead..... | £269.00 |
| STAR LC200 9 pin colour inc. free lead..... | £185.00 |
| STAR LASER 4 high quality laser printer inc. free lead..... | £679.00 |
| CITIZEN SWIFT 24E 24 pin colour printer inc free lead..... | £269.00 |
| CITIZEN 224 COLOUR 24 pin colour printer inc free lead..... | £239.00 |
| CITIZEN SWIFT 9 COLOUR 9 pin colour printer inc free lead..... | £189.00 |
| CANON BJ10 E/EX bubble jet printer inc free lead..... | £229.00 |
| STARJET SJ48 bubble jet printer inc free lead..... | £225.00 |
| HP DESKJET 500 inkjet inc free lead..... | £349.00 |
| HP DESKJET 500 COLOUR inkjet inc free lead..... | £575.00 |
| CITIZEN 224 MONO 24 pin mono printer inc free lead..... | £209.00 |

MEMORY

| | |
|--------------------------------------------------------|---------|
| SUPRA RX500, 8Mb board for A500 with 1Mb..... | £95.00 |
| SUPRA RX500, 8Mb board for A500 with 2Mb..... | £119.00 |
| SUPRA RX500, 8Mb board for A500 with 4Mb..... | £199.00 |
| SUPRA RX500, 8Mb board for A500 with 8Mb..... | £299.00 |
| MICROBOTICS 8M Ram Board for A1500/B2000 with 2Mb..... | £155.00 |
| EXTRA 2 Mb OF RAM FOR MICROBOTICS..... | £75.00 |
| A500 512K RAM WITH CLOCK AND SWITCH..... | £29.00 |
| A500 PLUS 1MB RAM UPGRADE..... | £39.00 |
| ROM 1.3/2.0 Sharer..... | £17.00 |

MODEMS & FAX

| | |
|-------------------------------------------------------------------|---------|
| B/Bandit 2400 Modem, V21, V22Bis & MNP 5 (speeds up to 4800)..... | £139.00 |
| Supra 2400 Plus, MNP5 & V42 Bis (speeds up to 9600)..... | £165.00 |
| Supra 9600 Modem. Speed up to 38000..... | £399.00 |
| Supra 2400 Plus Internal Modem for A1500/B2000..... | £159.00 |

Call for latest Supra Amiga/Fax/Modems new in

AMIGA A1500

The A1500 inc. Philips or CBM 1084s monitor, Twin drives, Dpaint3, The Works Platinum, Home Accounts, 3 Games + Joystick **ONLY £759.00**
AMIGA A500 part exchange available - please phone

ACCELERATORS

| | |
|---------------------------------------------------|---------|
| Microbotics Accelerator VXL-30, 25MHz..... | £222.00 |
| Microbotics Accelerator VXL-30, 40MHz..... | £351.00 |
| 68882 Floating Point Co-processor for VXL-30..... | £132.00 |
| GVP 68030 25MHZ WITH 1 MEG RAM..... | £519.00 |

HOW TO ORDER:
Either call our number below with your credit card details, or send cheque/PO or credit card details to our address. Cheques made payable to
THE 16 BIT CENTRE
Prices subject to change without notification.

All prices include VAT and Courier Service

16 BIT CENTRE

Units 15-17,
Lancashire Fittings Science Village
Claro Road, Harrogate HG1 4AF

**EXTENDED WARRANTY
AND MAINTENANCE
CONTRACTS AVAILABLE
ON ALL ITEMS. PLEASE
CALL FOR FURTHER
DETAILS**

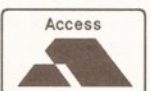

Tel (0423) 531822/526322

continued from page 71

as *Red Sector Demomaker* and the *Big Alternative Scroller Demo* causing the screen to roll. Can this be rectified?

The rolling problem only occurs when the connected camera or video is turned on. Before that all the programs behave normally.

I intend to buy *Scala 500* (or a similar program) but this would be no use to me if the screen rolls during genlocking. Can you tell me if it will be as stable as, say, *Deluxe Paint III*?

Have you any experience of the chromakey attachment for the *RocGen Plus*?

Finally, when military aircraft fly by outside while I am using the genlock I have been getting GURU messages referring to 'abnormal conditions' on the screen. Do you have any ideas what causes these?

A Ross
Castle Douglas

All the problem disks you mention are autobooting demos, some of which override the normal AmigaDOS environment (illegal clock timing and so on). This causes problems with some genlocks – and from what you say the *RocGen Plus* appears to be one of them. But don't blame the genlock, it's the software's fault for not following the rules.

One thing which is worth trying (and is, in fact, obligatory with most genlocks) is to have the genlock switched on and being fed with video before you boot up your Amiga. Otherwise the rolling problems you describe (caused by the Amiga being unable to sync to a stable signal from a genlock which is receiving no video timing information) will likely persist.

As far as I am aware, you shouldn't experience any of the rolling problems you mention with *Scala 500*, as it doesn't bend the DOS rules.

The *RocGen Plus* chromakey unit is still under development, though by now you should be able to get further information from Zye Technology ☎ 0293 538666, as this company will be distributing the device.

Have you tried asking the MoD about this? Sorry – just joking, it's probably top secret why your genlock conks out when aircraft fly by! Seriously though, perhaps the answer lies in some kind of mega electromagnetic field produced by radar or other hi-tech equipment in the plane.

Beyond that, I think there's not too much you can do beyond improvising some kind of electronic screening for your entire installation – which probably isn't at all practical!

GW

JARGON BUSTING • JARGON BUSTING

Assembler – a program which converts an assembly language program written in words (well, almost) into the machine code numbers that the Amiga's 68000 processor understands. Writing programs in assembly language ensures that the best possible speed and memory efficiency is gained from the machine.

Disassembler – a program that does the reverse of an assembler – it converts machine code numbers back to assembler mnemonics, aiding programmers who want to see how a program works or, more likely, see why a program they have written doesn't work.

Guru – a message from the Amiga system saying that a fatal error has occurred. The message appears in a large, flashing red box and includes two numbers which are of use to programmers trying to ascertain why their programs have failed.

Shell – a method of communicating with the Amiga's operating system via the keyboard rather than the more usual mouse and windows method of Workbench. The Shell is the interface which 'surrounds' the Kernel, the central part of the operating system. The terminology comes from Unix-based systems.

ASSEMBLING CODE

 I have recently purchased the **Datel Electronics Amiga Action Replay Mark III** which as you probably know comes with an assembler and a disassembler. I have done some assembly language (CESIL) work in school and didn't know whether this would work or not. Of course after trying it, it didn't! Can you help me by supplying:

- The instruction set for Amiga assembly language and an explanation of each instruction.
- Some information about the d0-d7, a0-a7, pc, and the sr (sequence control?), registers.
- Some small, simple examples programs and details of how to execute them using the Mark III.

Andrew Kilgore
Londonderry
Northern Ireland

I suspect that the CESIL instruction set you've been taught about is a simple one designed especially for teaching purposes. The Amiga uses the Motorola 68000 processor and you'll need to learn how to write 68000 code before being able to do anything useful with the *Datel Mark III* assembler. In theory we could help but the trouble is that it would literally take a year of *Amiga Shopper* issues to do it – we'd need a hundred magazine pages just to describe and document the processor and the instruction set properly!

Go down to your local bookshop, or public library if funds are tight, and get hold of a general 68000 programming book. *68000 Assembly Language Programming* by Kane, Hawkins and Leventhal (published by Osborne/McGraw-Hill) is quite good but there are plenty of alternatives

available. That will start you off as far as the processor and instruction set is concerned but you'll also need assembler orientated help with the Amiga's operating system and again all I can really suggest is that you read as many books/manuals as you can. You'll find assembler examples in a number of Abacus books, in the *Rom Kernel Manuals*, and of course you will find plenty of material available from public domain libraries. *Amiga Shopper* also provides a certain amount of assembler code (for a recent example see issue 9).

Remember however that the *Mark III* assembler is not a macro assembler and so all macros used within the code examples that you experiment with will have to be removed and the corresponding instructions written out explicitly.

PAO

NO SENSE

 I recently bought an external drive from Power Computing but I've encountered a problem which I hope you can help me with. When I try to use the drive with games that come on two or more disks, the game doesn't seem to recognise the second disk when I place it in my external drive even when the game asks for the disk to be placed in any drive. What is going on?

Michael Ross
Litherland, Liverpool

It doesn't sound to me that your software is at fault. If the game you are trying to run asks for a disk to be inserted into any drive, then you should be able to use your second drive. Does your Amiga always recognise a disk when it is inserted into the drive when you're using

Workbench? If it doesn't, then I'd guess that there's a problem with the drive itself. If this is the case, then send it back to Power and I'm sure the company will either repair it or send you a new one. If disks are always recognised from Workbench in your second drive, then you'll just have to put your problems down to poorly written games software. JH

BEGIN PROGRAMMING



I am new to the Amiga 500 Plus and wish to start programming. What

book would you recommend on programming for beginners, and is it easier to use AmigaDOS or BASIC? Do you need any special software to do this or can you just use Shell?

AD Ormston
Basingstoke
Hants

Almost everyone starts by using Basic as their first language and I'd suggest you do the same because the AmigaDOS script language is rather specialised and not really suitable as a vehicle for learning about programming. Prior to the release of the A500 Plus, Microsoft's Amiga Basic interpreter was included as part of the system software – since the Basic manual had some beginners tutorials in it, you could have made a start without having to fork out any extra cash.

Unfortunately, with the A500 Plus this is no longer the case and to program in Basic you will need to buy a Basic interpreter (and/or compiler). There are several available including HiSoft Basic, GFA Basic, and also AMOS (another Basic-flavoured language).

In your early programming days, though, you ought to stick with a Basic (such as the HiSoft offering) whose core facilities are 'Microsoft flavoured'. The reason is simple – Microsoft style Basic is pretty much a standard in the world of computers and what you'll learn will stand you in good stead not just with Basic on the Amiga but with Basic on most other machines.

Pop down to your library before buying any Amiga specific books. You'll find loads of beginners Basic books – these, though not Amiga specific, will provide explanations as to what Basic programs consist of, what variables are, how INPUT and PRINT statements are used to collect/display information and so on. I think that you'll be surprised at how much more sense the interpreter/compiler manuals themselves make afterwards. These manuals will also provide details of some Basic/Amiga-system books that are orientated towards, or suitable for, the Basic software that you've chosen to use. PAO

ASTROLOGY

TEACH YOURSELF with our **STARTER PACK**
Comprises a simple program to calculate a horoscope,
an introductory booklet & 2 self-teaching programs
(how to interpret the horoscope):

Only £12.50 - No previous knowledge required
Payment by Access/Visa, Cheque etc.

Or send for free catalogue of our wide range of programs for
PROFESSIONAL ASTROLOGERS isae (36p - about 9" x 7")
Progression, transits, harmonics, midpoints, etc.

Superb graphics, 5000 year ephemeris, etc (from £25).

Also **GRAPHOLOGY, NUMEROLOGY**, etc

ASTROCALC

(DEPT AS), 67 Peascroft Road, Hemel Hempstead,
Herts. HP3 8ER, England. Tel: 0442 251809

BUILD YOUR OWN ROBOT

with the **NEW AMIGA INPUT/OUTPUT PORT**
Now you can use your Amiga to control
electric motors, sensors, anything.

£26.95

- * Cheapest I/O port available.
- * 8 outputs, up to 13 inputs.
- * Includes full instructions

"I used it to control a time lapse cine camera...so
simple to operate from a basic program" G.R. Turner.

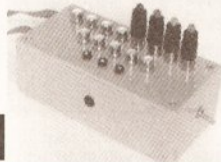

JUST ARRIVED

AMAZING SENSOR & CONTROL EXPERIMENTERS KIT £24.95

SPECIAL OFFER £3 OFF IF PURCHASED WITH I/O PORT
6 Electronic projects which plug into the I/O port. No soldering required. Includes software and
FREE "Guide to Amiga Interfacing". Projects include motor, light bulb, relay & much more.

"Bought for my son, it has enabled him to gain an understanding of the interaction
between computers and the outside world." P.H. Morgan

**UNCONDITIONAL
GUARANTEE.**
If not completely
satisfied, you may
return any product
within 30 days
for a full refund.

By mail: please send cheque payable to Switchsoft.
By phone: ring Switchsoft mail order line on **0325 464423**.
Prices: include P&P in UK. Overseas: please add £3.



Dept AS05/92
26 Ridgeway, Darlington,
Co. Durham DL3 0SF



**ANALOGIC
ANALOGIC
ANALOGIC**

**Analogic Computers
(UK) Ltd**
152 Latchmere Road
Kingston-upon-Thames
Surrey KT2 5TU

Telephone
Mon-Fri 9am-7pm
Sat 9am-5.30pm
081-546 9575
Tel/Fax:
081-541 4671

COMPUTERS SPECIAL OFFERS

Amiga A500 Plus

Cartoon Classics Pack.....£349.95 ... **1 Meg** **£379.95** ... **2 Meg**

MONITORS

Protar Visto C14M colour monitor +cable + 1 yr replacement warranty£220.01
Philips 15" TV/monitor (model 3332), remote control + scart cable£239.01
Philips 15" TV/monitor (model 3331), as above plus Teletext£269.01

ACCESSORIES

Amiga 512K RAM + clock..£24.95
Amiga Plus 512K RAM.....£34.95
Amiga Plus 1 Meg.....£54.95
Amiga/Atari Squik Mouse .£14.95
Amiga Scart Cable.....£14.95

Mouse Mat£4.95
Dust Cover.....£4.95
Super Pro Zipstick£14.95
Amiga Power Supply£44.95
10 Blank Disks.....£5.95

AMIGA A500 REPAIRS

Without diagnostic fees

★ Fixed charges ★ Fast turnaround

★ We provide pick-up service

for repairs

for only **£5.00 + VAT**

£49.95

* All prices include VAT and **NEXT WEEK DAY DELIVERY** subject to availability
★ Fixed charge for repair does not include disk drive replacement nor keyboard
* All prices subject to change without notice
★ We reserve the right to refuse any Amiga repair



DATAPLEX COMPUTERS LTD.

129 Bath Road,
Slough,
Berkshire,
SL1 3UW
Tel: 0753 535557

19 High Street,
Old Town,
Swindon, Wilts
Tel: 0793 488448

**SHOWROOM
open:**
Mon - Fri
9.30 - 5.30
Saturday
9.30 - 4.30

**MAILORDER
Consumables
add £2.50**
Hardware
add £9.00
(courier)

Prices including VAT

AMIGA A500 PLUS (CARTOON CLASSIC PACK)

Includes new A500 Plus with
1Mb RAM, Lemmings, The
Simpsons, Captain Planet,
Deluxe Paint III

£330 inc VAT

AMIGA A500 (FIRST STEPS)

Amiga A500
Plus educational software

£435 inc VAT

AMIGA A1500 new version

A1500 Accounts Plus pack
including Puzznick, Toki, Elf,
Operating Systems Software,
Home Accounts,
Platinum Works,
Deluxe Paint III + manual

£560 inc VAT

ADDITIONAL PACKS

Amiga A500 Plus Cartoon Classic
with 10 extra games£359
A500 Basic Pack (stand alone old version)
plus 10 extra games plus Photon Paint
plus GFA Basic.....£295

ACCESSORIES

512K Ram + clock.....£35.00
1 Meg Ram + Clock.....£115.00
A500 Power Supply Unit.....£39.00
Naksha Mouse plus Operation Stealth.....£29.00
1Mb upgrade for A500 Plus.....£49.00
14" screen filter.....£17.00

MONITORS

Philips CM8833 MK II Colour Monitor + FREE Lead

£210 inc VAT

PRINTERS

Star LC20 Mono.....£135
Star LC200 Colour (9 pin).....£188
Star LC24 200 (24 pin mono).....£209
Star LC24 200 Colour (24 pin).....£258
Panasonic KXP1124i.....£235
Panasonic KXP 1123.....£185
Citizen 120D +.....£125
Citizen Swift 24E + Colour Upgrade.....£290
Citizen Swift 9 + Colour Upgrade.....£195
Starjet Bubblejet Printer, S348.....£229
Canon BJ10EX.....£234
HP Deskjet 500 + Leads.....£352
HP Deskjet 500 (colour).....£587
Sheetfeeder.....£58

All above come complete with leads

AMIGA HARD DRIVES / HARD CARD (GVP SERIES II)

FOR A1500
52Mb h/card (0-8Mb).....£275
120Mb h/card (0-8Mb).....£445
FOR A500
52Mb h/driver (0-8Mb).....£365
105Mb h/driver (0-8Mb).....£525

Upgrade the above with 1Mb SIMM module £39

VORTEX AT ONCE PLUS

PC Emulator for A500, A500 plus and A1500
£199 inc. VAT

AMIGA DRIVES

1 Meg 3.5" internal.....£55
1 Meg 3.5" external (Cumana).....£57

AMISPEED

AmiSpeed brings you:

A2630 accelerator with 68030/688882 both
running at 25 Mhz. Including 2MB 32-bit RAM

for 795 pounds including TurboBench!

Big Agnus 1 MB chip RAM for 59.95

Quantum LPS HD 105 meg for 549.95

Buy Quality Goods At Wholesale Prices!

Send Eurocheques made payable to Dave

Engbers to: Post box 33098, 3005 EB

ROTTERDAM / HOLLAND or call

01-031-10-4184553 if you feel the need for

speed! Includes Full warranty/docs/P&P!!

TEAR THIS PAGE OUT NOW

Throw it in a post-box and have the chance to win up to £1,200 worth of RAM expansion. We have 20 upgrades to give away, courtesy of memory purveyors WTS Electronics.



So what's it all about?

The Amiga Shopper Show, Wembley, May 15-17 that's what.

We want to make it the only place for serious users to be this year. So why not complete the form and tell us what you want to see...

Yes, the Amiga Shopper Show will be taking place at the Wembley Exhibition Centre on May 15, 16 and 17. As well as exciting new releases and unbelievable bargains, we'll have a whole load of seminars to help you get even more serious about your Amiga.

There will be opportunities to talk to the editorial team and have your say on where your magazine is going. Of course, our expert panel will be there too, providing solutions to all your technical queries. And we'll be inviting a number of guest speakers to come along to demonstrate specific items of hardware and software in use.

To help us make this the Amiga show of the year, why not take the time to fill in the form and tell us what you want to see?

On which of the following subjects would you like to see forums:

- Desktop publishing
- Video
- MIDI and music
- Programming

- Business software
- Education
- Workbench and AmigaDOS
- Communications

Please list the three companies you would most like to see exhibiting new products at the show:

- 1) _____
- 2) _____
- 3) _____

Now list the three products (hardware or software) you would most like the manufacturers to provide a Question and Answer forum on:

- 1) _____
- 2) _____
- 3) _____

At any rate, please fill in your name and address in the space provided below so that we can call your name and give you your prize during the show!

Name

Address

Postcode

Please tick here if you do *not* wish to receive direct mail from other companies

AMIGA SHOPPER SHOW SPECIAL QUESTION

Go on – ask us a question, any question, and you could win a prize. As part of our on-going bid to make this the best Amiga show ever, we're going to have our expert panel hosting *Amiga Answers* forums during all three days. But there's one thing that *Amiga Answers* needs, and that's a whole lotta questions – so get writing. We'll be drawing your submissions out of the Editor's extremely huge baseball cap at the show, and if you're there when we do you'll be walking away with a fabulous prize from WTS Electronics: there's four 2Mb AX500 expansions up for grabs, four 1Mb trapdoor expansions, and twelve 0.5Mb trapdoor expansions.

Oh, and don't be put off by the thought of your question becoming lost among the deluge – any which we don't get around to answering at the Show will be dealt with in the *Amiga Answers* section of forthcoming issues.

OK, I get the picture, what I'd really like to know from you chaps is...

WIN LOADSA MEMORY – FREE!

5

TOP TIPS FOR GETTING THE MOST OUT OF THIS PAGE...

- Answer the questions
- Fill in your special Show section
- Tear out the page and fold it up
- Chuck it in the post
- Come to the Show. Job done

3. Fold back here

2. Fold back here

Amiga Shopper Show
FREEPOST
Bath
BA1 2XF

NO STAMP
REQUIRED
IF POSTED
IN UK

1. Fold back here

Checkmate - The Amiga only Developers
Try WorkBench 2.0, It's well worth the upgrade.



Graphics - 24 Bit cards for everybody

AVideo 24 + TVPaint only £ 599.00

The new king in 24 bit graphics, with these features:-
768x580 resolution in 24 bit or double buffered 12bit
TVPaint 1.6 paint software, same as Harlequin.
Overlay Amiga graphics on top of AVideo image.
Works with any external Genlock.
Full IFF 24 bit support and now JPEG!

**AVideo 24 Graphics
+ TVPaint 1.6**



Yes this is possible on the AVideo, PIP static 24 bit display, on any screen. This facility works with workbench 2.0 Flicker Fixer Compatible.

Hardware - Best Prices in Town

A500 Expansion Cases

| | |
|--------------------------------------------------------------|----------|
| CDL A1500 Expansion system for the A500 - New Low Price. | £ 169.00 |
| CDL A2000 Internal Slot, for CDL A1500. | £ 69.00 |
| CDL A590 Kit for fitting A590 complete with drives internal. | £ 69.00 |
| CDL 200Watt power supply, never run out of power | £ 79.00 |
| GVP Products for A1500,A2000,A3000 and A500 in HiQ upgrades. | |

SCSI / 8mb RAM Drive systems.

A2000 version 0k Ram, 52mb Quantum £ 299.00

A500 version 0k Ram, 52mb Quantum £ 399.00

Add £ 200 for 105mb version, Ram £ 90.00 per 2mb

HiQ Tower System shipping NOW!!

converts A500 to full B2000 Specification

Only £ 399.00

Fusion 40, runs in HiQ Tower £ 1295.00

Ring For a Catalogue on all of these products and much more!

HiQ 68040 Power System

The Ultimate Amiga system ever put together.

Forget Captain Diamond.

The HiQ Paint and Animation System.

comes as standard with:-

Hiq Tower System with Amiga Plus Motherboard.

Complete WorkBench 2.04 Operating system

2Mb Chip Ram, and 4Mb of 32 Bit Fast Ram.

Fusion 40 running at 28MHz = 20 mips

105Mb SCSI hard Disk and Controller.

AVideo 24 , TVPaint 1.6, + DPaint III + Lemmings

ONLY £ 2999.00 inc VAT

Checkmate



Tel +44 (0)71-923 0658
Fax +44 (0)71-254 1655
BBS +44 (0)71-923 2608
80 Mildmay Park
London, N1 4PR, UK

AMIGA REPAIRS

JUST £44.95 inc.



- ★ Commodore registered
- ★ Over 10 years experience with Commodore computers
- ★ 20 qualified technician engineers at your disposal
- ★ We will undertake to repair your Amiga 500 computer for just £44.95 including parts, labour, VAT and post & packing
- ★ Some computers should be repaired within 24 hours of booking in.
- ★ Prices include full service check, overhaul, soak-test and replacement of power supply unit if necessary
- ★ Repairs to keyboard and disk drive also included (£25 extra if these units are unrepairable and require complete replacements)
- ★ All repairs covered by a 90 day warranty

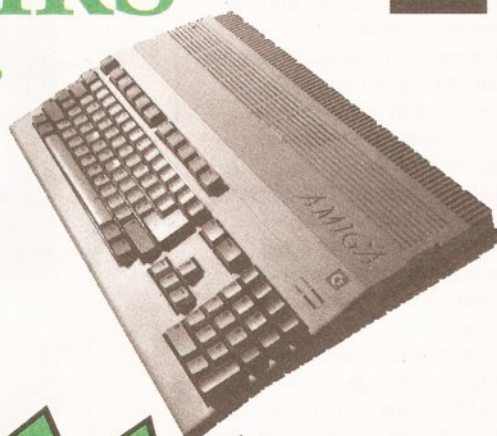

Upgrade your Amiga from 512K to 1Mb of memory for just £25.00
SPECIAL EXCLUSIVE OFFER:
If you submit your computer to ourselves for repair, enclosing this advert along with just an additional £25, we will supply and fit a 512K memory expansion at no extra cost.

How to take advantage of this exceptional offer: simply send or hand deliver your machine to the workshop address detailed right, enclosing payment and this advert and we will do the rest. (If possible please include a daytime telephone number and fault description).

* If you require 24 hour courier to your door, please add £5 else your computer will be sent back by contract parcel post.

WTS ELECTRONICS LTD

STUDIO MASTER HOUSE
CHAUL END LANE
LUTON, BEDS, LU4 8EZ
Telephone (0582) 491949 - (4 lines)

WTS reserve the right to refuse machines that in our opinion are tampered with, to an extent beyond reasonable repair

In this month's DTP column Jeff Walker gives you some expert tips on publishing your own newsletter. Forget the books on the subject, it's all here...

Press for service

This month, we're going to discuss aspects of designing newsletters and fanzines. Producing a newsletter on your desktop can be as complicated or simple as you want. On the one hand you can fiddle about for ever, 'expressing yourself' and making adjustments until you consider it to be a perfect work of art, or you can work to a system and to produce it quickly while still retaining character and good design.

At the end of the day both techniques produce decent newsletters, but the second method is far quicker and has the beneficial side-effect of creating a 'style' that, once your newsletter has established itself, will become instantly recognisable as yours.

To save space I'll use the word 'newsletter' to mean both newsletters and fanzines as they are basically the same thing aimed at different types of readership. As usual, my choice of publishing package is *Professional Page*, although everything in this article could equally be applied to *PageStream*, *PageSetter II* and *Saxon Publisher* because for the most part we'll be discussing basic page design.

To start with, a newsletter needs a first page, the page on which you put the title of the publication. You have two choices – a magazine style front cover that is mainly illustration, or a newspaper style front page on which the main story is published. Both need special treatment. We'll talk about magazine covers first.

GET NOTICED

The main job of a magazine style cover is to attract attention to itself and to tell the prospective reader what is inside. The odds are that it is sitting on a magazine shelf in a shop along with a hundred or more other magazines, so it has a lot of competition. OK, your newsletter probably won't ever make it into a

newsagent's, but that is no excuse to produce bad front covers.

There are a number of elements that make up a front cover – the masthead (the name/logo of your newsletter), the illustrations, and the cover lines (the text that says what is inside).

The masthead needs to be unique and instantly recognisable, but you should not make it too intricate. While a lovingly crafted and clever logo might look great on a

the top of the page. On a newsagent's shelf you will have noticed that the magazines usually overlap one another so that only the left-hand side of the cover is visible. This is why most mastheads are positioned at top left. Alternatively, and for the same reason, the logo may run down the entire left hand side of the cover. Your newsletter won't suffer this problem so you needn't let it concern you. Having said that, Joe Public is so used to

will feel more comfortable if it looks the same on every issue.

Not strictly part of the masthead, but something that is always best positioned close to it, is the issue number and price of the newsletter. Again, decide on a style for it – keep it simple and make it easy to see so that readers don't have to search for it – and put it in the same position on every issue.

ATTRACTING ATTENTION

Now we come on to the main content of the cover, the illustration. Front covers should be easy to understand – readers should be able to take in the whole thing in one quick eyeful, you shouldn't force them to have to stare at the cover for 30 seconds or more to see what it is all about.

You will do yourself no favours by making prospective readers look longer; if they have to look at the cover for more than five seconds before understanding the message conveyed, there is a danger they'll begin to think that maybe they won't understand what's inside either.

The easiest way to achieve simplicity is to stick to one subject and one illustration. The illustration needs to be instantly recognisable; it's no good going for a simple design if the picture itself is confusing and difficult to understand.

The cover picture needs to reflect the content of the newsletter, and if you are having just the one illustration then this should be related to the main story inside. Don't be tempted to use an illustration for something that isn't the main story just because it is 'pretty' – if you must do this then turn that story into the main, or 'lead', one.

The chances are, however, that perhaps you don't have a main story in particular. Or maybe you have a number of stories which you feel are important enough to have on the front cover. In which case you'll want to have more than one illustration and some text on the cover about

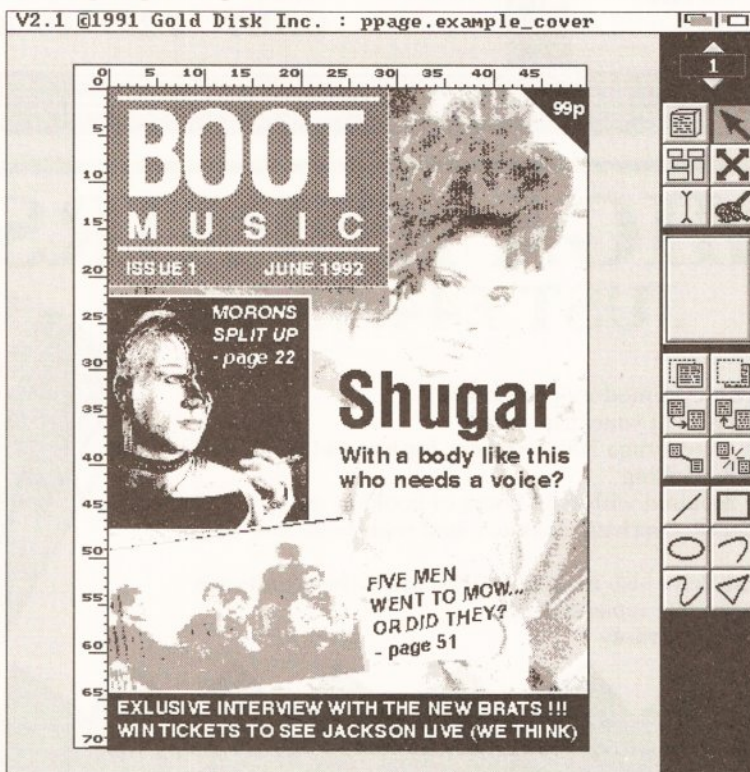

The job of a magazine front cover is to sell the magazine, so use your best stories and most attractive pictures. But keep it simple to understand

T-shirt or hanging on the wall in an art gallery, on a front cover it is bound to clash terribly with the rest of the page, making it difficult to see. Keep to a simple design. Use a classic typeface in preference to a fancy one, and if you are using colour restrict yourself to two or three primary shades.

Mastheads always look best at

seeing mastheads in those positions that your publication will appear more professional if you put your masthead there.

Once you've decided where to put it, leave it there. Don't move it around every month or week or however frequent your newsletter is. And don't fiddle with it. Once it's designed, it's designed. Your readers

the other main stories.

You need to step carefully here because it is so easy to go over the top. The safest method is to choose one story as the main illustration and then have a box somewhere that encloses the secondary text and illustrations for the others. Or you could leave out the secondary illustrations and just have the text.

THE COVER STORY

There's no need for me to go into any greater detail here as the cover on this magazine is a classic example of the 'many stories' technique. Although each *Amiga Shopper* cover is obviously different, the basic design remains fixed from month to month. At the top we have the the masthead, at the bottom a special panel for attracting attention to special features.

Below the masthead we have a single illustration related to the month's main story. Running over the top of the illustration are two cover lines. The main one, in larger type, is there to attract attention; like a news headline it needs to say something about the subject while at the same time not giving the whole game away – it's the mystery that hooks the prospective reader and forces them to pick up the magazine for a closer look. When they've picked it up the cover line in the smaller typeface is ready waiting for them with a few more details.

As a general rule of thumb, the more detailed the illustration, the fewer cover lines should be used over the top of it – lots of detail in the picture and lots of cover lines will end up looking a right mess from a few feet away. A way around this is to put the cover lines into panels, although you have to be careful not to obscure too much of the illustration.

Down the left of the *Amiga Shopper* cover we have some panels that are designed so that they stand out and are completely readable even if the magazine is half obscured on the shelf. In this case it is like a mini contents page, but you could just as well use two or three illustrations here, with a cover line or two each. For 'many story' covers you could do a lot worse than copy this general design.

MAN BITES DOG!

Newspaper style front pages are a completely different kettle of fish and, contrary to what you might think, they are actually much more difficult to design than magazine style covers.

A newspaper front page depends almost entirely on the headline to attract attention to itself. That headline has to interest or intrigue the reader so much that he feels



Like magazine covers, newspaper style front pages have to sell the paper. Don't have more than two stories on the front page, and give the main story the biggest headline

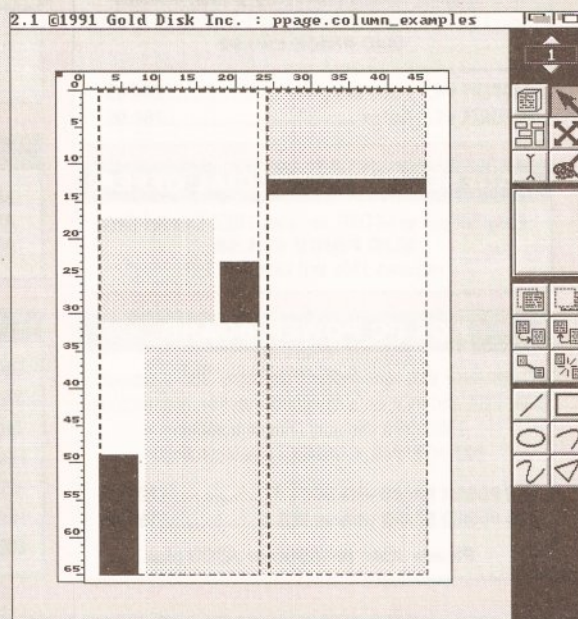

Two-column page layouts tend to restrict your design options. You only have two widths of illustration available, plus all the way across the page of course

forced to pick it up and read the first paragraph of the story. And that first paragraph has to interest or intrigue the reader so much that he feels forced into buying the newspaper there and then.

Headline and first paragraph writing is a great skill. Most newspapers will have an expert whose job it is to write these two elements, even if the rest of the story has been written by someone else. It's a difficult skill to learn, many books have been written on the subject over many years, and even today a newspaper is fortunate if it manages one 'perfect' front page in 10.

Your newsletter, however, won't need to sell itself so heavily because it probably won't have any competition, so you can stick to the general front page design principles and not worry too much about composing perfect headlines and first paragraphs.

The initial obstacle to get over is the danger of the masthead clashing with the headline. It's best to put the masthead in some kind of panel that is obviously separate from the rest of the page, or if the masthead stretches all the way across the page then a simple rule below it will be enough.

If there is more than one story

on the front page, then the point size of the headline will reflect the importance of each story. The most important story gets the biggest point size, the least important the smallest. In general, the most important story should be higher on the page than less important stories.

If you are going to use pictures on your front page then treat them like headlines – if possible, the most important story gets the biggest picture, unless you have a spectacular picture for a lesser story, in which case don't hesitate to put it on the front page but use a smaller headline for it than the lead story. You needn't worry too much about the composition of front page pictures as normally it will be the lead headline that dominates the page.

MOVING INSIDE

With the basic design of the front cover sorted out we can move on to the editorial pages.

If your newsletter is more than four pages you probably need a table of contents. Many newsstand magazines will devote a page or a spread to the contents, not because there is so much in the magazine but because this will be the first place a reader looks after taking a magazine from a shelf.

Like the front cover, the job of this kind of contents page is to sell the magazine. The main guideline here is to keep it simple and make it easy for readers to see if there are any articles that they are interested in. Remember that the more space you devote to an article on the contents page, the more importance you are giving to it.

In a newsletter that doesn't have to sell itself on a shelf you are wasting space with a fancy contents page. Stick to a panel somewhere on the first or second inside page (page 2 or 3). All you need is the title of the article, the number of the page the article starts on, and maybe a sentence or two that describes what the article is about. If you want you can include the author's name in this description.

To make it easy to read use plenty of white space and use the same font for all the article titles and page numbers; the short descriptions should be in a smaller point size, and you can use a different typeface if you like, but again, use the same font for all the descriptions.

The size and shape of your contents panel will depend upon, and have to fit into, your basic page design, which is something that should be consistent throughout the newsletter.

For an A4 sized newsletter you can choose between a two, three

MJC COMPUTER SUPPLIES

Suppliers of Discount Software since 1984

Educational, Local Authority and government orders welcome. European orders please call or write for a quotation. All goods subject to availability, prices subject to change without notice. E&OE.

Prices include VAT and delivery by post.

Courier delivery available on request.

Please allow 5 days for cheque clearance.

TO ORDER: Credit card orders can be placed by calling the telephone number below - or send a cheque/PO's made out to MJC Supplies to:

MJC SUPPLIES (AF)

Unit 2 The Arches, Icknield Way,
Letchworth, Herts. SG6 1UJ.
Tel: (0462) 481166 (6 lines)

NAKSHA UPGRADE MOUSE

280 DPI quality replacement mouse - pack includes mouse house, mat and Operation Stealth game.

MJC PRICE £21.95

NEW - A500 PLUS 1Mb Expansion

1Mb expansion for the A500 Plus - fits in the trapdoor taking your memory to 2Mb - no internal fitting

MJC PRICE £44.95

SUPRA 500RX EXPANSIONS

New memory expansion for the A500 - plugs directly into the HD expansion port - NO INTERNAL CONNECTOR REQUIRED

| | | |
|-------------------------|-----------------|----------------|
| SUPRA 500 RX 1Mb | (expand to 2Mb) | £99.95 |
| SUPRA 500 RX 2Mb | (expand to 8Mb) | £149.95 |
| SUPRA 500 RX 4Mb | (expand to 8Mb) | £209.95 |
| SUPRA 500 RX 8Mb | (expand to 8Mb) | £309.95 |

CUMANA CAX 354 DISK DRIVE

Quality brand name 3.5" second drive includes thru port, disable switch and FREE Virus X Utility

MJC PRICE £54.95

NEW ROCLITE RF382C DISK DRIVE

New super slimline, super quiet second drive.

MJC PRICE £57.95 (cream only)

GVP PRODUCTS

GVP A500/500 Plus 52Mb Hard Disk: features on board Ram expansion to 4/8Mb with high speed Faastrom controller. Autobooting, includes excellent easy to use installation software.

MJC PRICE £369.95

GVP 286 PC EMULATOR: for use with the A500 Hard Drive. 286 speed running at 16Mhz.

MJC PRICE £279.95

GVP S II Hard Drive (A1500/2000): Quality Quantum drives running as fast as 11ms plus the excellent GVP controller board, with the ability to add up to 8Mb memory (SIMMS).

52Mb version £289.95
NEW - 120Mb version £429.95

SIMM MODULES - £69.95 per 2 meg

SUPRA A1500/2000 MEMORY BOARDS

SUPRARAM memory cards with space for up to 8Mb

| | |
|-------------------------------|---------|
| SUPRARAM with 2Mb fitted..... | £149.95 |
| SUPRARAM with 4Mb fitted..... | £199.95 |
| SUPRARAM with 6Mb fitted..... | £259.95 |
| SUPRARAM with 8Mb fitted..... | £299.95 |

AMIGA WORDPROCESSORS

Kind Words 2 (not A500 Plus)£29.95

PenPal£54.95

WORDWORTH v1.1 - SPECIAL OFFER£74.95

PROTEXT - VERSION 5.5

Latest version of this best selling word processor for those wanting serious processing power, includes new 110 000 word dictionary and Thesaurus (1 meg).

MJC PRICE £99.95

PROTEXT V4.3 - new low price£44.95

PRODATA V1.2 Amiga£64.95

PAGESETTER 2 - SPECIAL OFFER

Easy but powerful DTP, includes FREE Clip Art Disk
MJC PRICE £34.95
requires 1Mb and kickstart 1.3

KCS PC POWER BOARD

PC emulator that runs faster than many 286's supports CGA, EGA and VGA on a standard monitor, also includes 1Mb extra memory. Fits in trapdoor.
NO INTERNAL CONNECTION REQUIRED

KCS POWER BOARD with DOS 4.1£209.95

KCS POWER BOARD without DOS£184.95

Please state for A500 or A500 plus.

VIDI AMIGA

NEW - TAKE 2

New Animation package from Rombo
MJC PRICE £69.95

VIDI COLOUR SOLUTION

Vidi Colour package - including Vidi Digitiser, Vidichrome software and free Photon Paint
MJC PRICE £79.95

RGB SPLITTER - for use with Vidichrome or Digiview. (includes PSU)
MJC PRICE £54.95

COMPLETE COLOUR SOLUTION

Package includes Vidi Amiga, Vidichrome and the RGB Splitter for a complete colour digitising outfit.
NOTE: For best colour pictures you require a video camera or perfect still frame VCR.

MJC PRICE £129.95

Complete Col Solution + Take 2 £179.95

VIDEO TITLING/PRESENTATION

Big Alternative Scroller.....£42.95

Broadcast Titler II.....£159.95

Broadcast Font Pack.....£89.95

Broadcast Font Enhancer Pack.....£89.95

ZVP VIDEO STUDIO

Great Video Production package
(1 Meg + 2 drives)

MJC PRICE £89.95

RENDALE 8802 GENLOCK

Quality Genlock offering both Foreground and Background modes.
MJC PRICE £159.95

ROCGEN PLUS GENLOCK

Includes dissolve control.
MJC PRICE £139.95

AMOS - The Creator

AMOS V1.2 - The Language.....£32.95

AMOS COMPILER.....£19.95

AMOS 3D.....£21.95

MISCELLANEOUS

Deluxe Paint 3 Video Tutorial.....£17.95

Stereo Master.....£29.95

Techno Sound Turbo.....£29.95

Hisoft Highspeed Pascal.....£69.95

Maxiplan Plus.....£34.95

Home Accounts 2.....£36.95

DELUXE PAINT 4.....£59.95

AMIGA EDUCATIONAL

FUN SCHOOL -

probably the best selling Educational Software for the Amiga - great sound and graphics and now conforms to the National Curriculum (FS3 & FS4)

Fun School 2 - 8 programs per pack

Fun School 2 under 6.....£12.95

Fun School 2 6 to 8.....£12.95

Fun School 2 over 8.....£12.95

Fun School 3 - 6 programs per pack

Fun School 3 under 5.....£15.95

Fun School 3 5 to 7.....£15.95

Fun School 3 over 7.....£15.95

NEW - Fun School 4 - 6 programs per pack

Fun School 4 under 5.....£16.95

Fun School 4 5 to 7.....£16.95

Fun School 4 7 to 11.....£16.95

All Fun School programs will work with a standard 512k Amiga and the new A500 Plus.

KOSMOS Answerback Junior Quiz -

includes 750 general knowledge questions and game reward£14.95

Answerback Senior Quiz -

as above but for age 12+£14.95

Factfiles - add-on question packs for the Answerback Quiz:

Factfile Spelling (6-11).....£7.95

Factfile Arithmetic (6-11).....£7.95

KOSMOS Language Tutors: with a vocabulary of over 2500 words + the ability to add your own - up to GCSE level:

French Mistress.....£14.95

German Master.....£14.95

Spanish Tutor.....£14.95

Italian Tutor.....£14.95

KOSMOS Maths Adventure: The latest offering from Kosmos covers the National Curriculum maths using a series of four games. There are four difficulty levels and a record of performance can be kept and printed out. (6-14)£17.95

LCL SOFTWARE

Primary Maths Course (3-12).....£19.95

Micro Maths (GCSE level).....£19.95

Micro French (GCSE level).....£19.95

Micro English (GCSE level).....£19.95

Reading and Writing Course.....£19.95

PRISMA Prof Plays A New Game (4-9)

Designed to teach youngsters a sight vocabulary of 63 words, the pack includes 5 easy reading books and an audio cassette.....£19.95

SOFT STUFF Magic Storybook (5-14)

Five animated stories featuring great sound and graphics plus the ability for children to "edit" the stories adding different sounds and graphics - even make up their very own story! (1 meg)£23.95

HOORAY FOR HENRIETTA (age 5-12)

Making maths fun - covering the four basic maths operations with 8 skill levels and a parent section for customisation.....£17.95

HENRIETTA'S BOOK OF SPELLS£17.95

Further information on our Educational range is available in our Educational Supplement - on request

VISA

Remember - prices include VAT & delivery!

Access

and four-column design. Each has its pros and cons.

There is a guideline to do with columns that you'd do well to adhere to. I've seen many newsletters over the years – both amateur and professional – and a lot of them make the mistake of not considering column boundaries when placing pictures on page. Pictures look best if they fit between columns exactly. So, for example, on a two-column page you have two widths of picture available – the width of one column and the width of two columns.

If a picture doesn't stretch all the way across a column you are left with an awkward white space. Many amateur publishers will fill this space with text, usually by running the main body copy around the picture. On the whole this is not a good idea. Often it makes the text difficult to read because the width of the column has been reduced drastically and the reader will unconsciously have to adjust to the new look of the text. And just when they've made that mental adjustment the copy goes back to full column width and they have to adjust again.

If you must stop illustrations part of the way across a column, use the white space that is left for a caption – remember that unless a picture is

need something in that column then pull out a short and pithy quote from the text on that page and set it in the narrow column in a larger point size between quotation marks. This is known as a 'call-out'. There's one below right on this page.

For two-column pages you need to set your main text in a 12pt font with 2pt of leading. A smaller font will make the text difficult to read because there will be too many words on each line, and if you use less than 2pt leading with a 12pt font the lines of text will be so close together that readers may skip lines when transferring the eye from the

end of one line to the beginning of the next.

In general, the wider the column width (known as the 'measure'), the larger the point size and the more leading should be used.

The three-column page is the most common magazine style. This is because you get a greater number of picture widths while retaining a width of column that won't make the text difficult to read. You can stretch pictures across one, two or all three columns, plus you have the option of one-and-a-bit and two-and-a-bit widths, using the leftover white space for captions.

For this width of column you should use 9pt, 10pt or 11pt for your main text. Leading can be anything from 1pt to 2pt – 1pt leading will make the page look 'busier' but will also make it slightly more difficult to read.

If three columns isn't flexible enough, you can go up to three-and-a-half columns. For this design you reduce the width of each column slightly and position two together, then a gap, then the other column. The gap can be used for captions, call-outs, and even small tables and figures.

The benefit of this design is that you can have one column, one-and-a-bit, two column, two-and-a-bit, and full measure pictures, and if you position them correctly the left and right edges of the pictures always line up with column boundaries. But because the text columns are narrower you run the risk of the copy being difficult to read because you can only get, on average, five or six words per line at 10pt. For this reason you should use a 9pt font (or a narrow 10pt one), which is about as small as you can go for main body text, although you can usually get away with 8pt for captions.

If you want to pack a lot on to each page of your newsletter, thus making it fewer pages and cheaper to reproduce, then four columns will serve you well. Using something like 9pt Times you can get about 1,300 to 1,400 words on an A4 page with no pictures. Such pages look daunting to the reader, however, so you will need at least one illustration, figure, table or panel on every page to make it look a bit friendlier. Even then you can count on 1,000 words per A4 page.

"If you feel you need something in that column, pull out a short and pithy quote..."

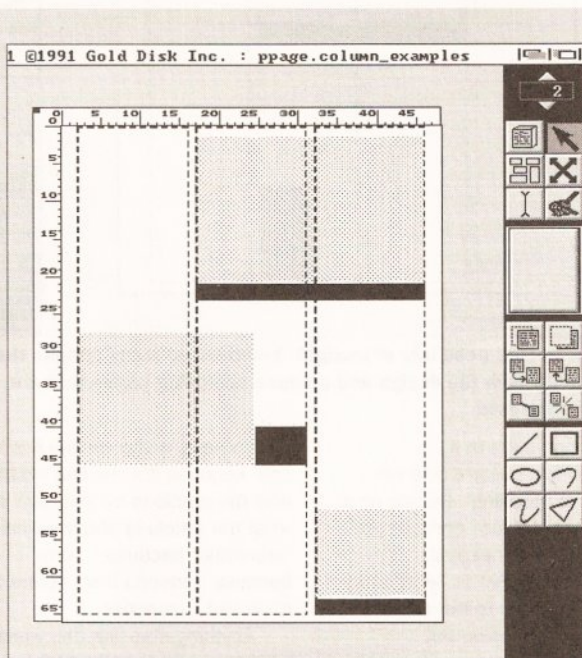

Three-column page layouts are what most magazines use because they are flexible design-wise and provide a decent measure of column for 9pt, 10pt or even 11pt text

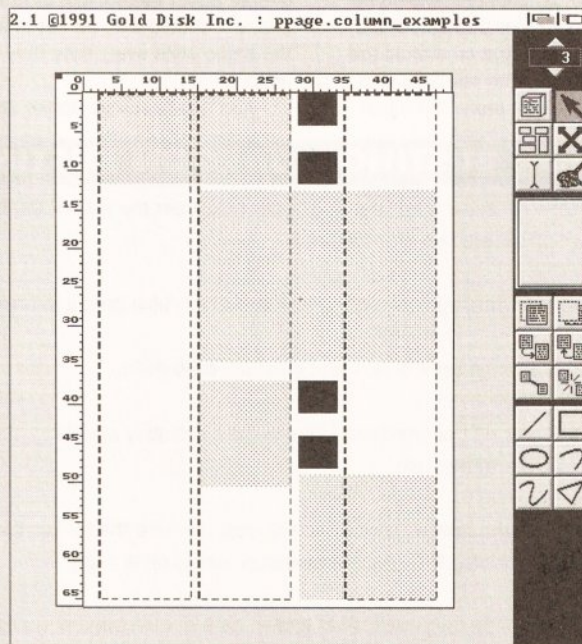

Two-column page layouts tend to restrict your design options. You only have two widths of illustration available, plus all the way across the page of course

purely illustrative (that is, it is not conveying any information) it should always have a caption, as should all tables and figures.

Because you only have two choices of picture width on two-column pages this design is the easiest to work with – put simply, you have fewer decisions to make. The price you pay is the risk of looking boring, but if your newsletter is a business or technical publication two columns will make it look the part better than three or four columns will.

Remember that the two columns don't have to be the same width. One idea is to make one column about twice the width of the other and put the text in the wide column, reserving the narrower column for any associated pictures, tables and captions. If the text on that page doesn't have any pictures or tables, don't worry, just leave that column empty. If you really feel that you

POSITIONS PLEASE

Once you've decided on how many columns your pages are going to have you can set up a blank page in your DTP program, with all the boxes positioned correctly on the page and regular sized boxes ready to import pictures into.

But a word of warning here. Many printers insist on imposing their own top and bottom margins in order to feed in and feed out the paper. If you have one of these printers then you need to bear this in mind when setting up your page dimensions.

For argument's sake let's say that your printer imposes a half-inch top and bottom margin – one inch in total – and you are using A4 paper. In this case you should subtract that measurement from your on-screen page height. So click on the A4 button and then click in the page height gadget and subtract one inch (or 6 picas if, like me, you always work in picas).

You will have to imagine the

margins. Work right from the top of the page, all the way to the bottom, remembering that when you print it out there will be half-an-inch above and below what you actually see on the screen.

Likewise, some printers, typically lasers and inkjets, impose a small left and/or right margin. Whatever that measurement is (your manual should tell you; if not, measure it) subtract it from the page width when setting the on-screen dimensions.

When positioning columns you should leave about a sixth of an inch (one pica) or quarter of an inch between them.

Another decision you will have to make is whether you want lines in the gutter between the columns or not. If you are flush justifying your text, gutter lines will never be needed, but you can have them if you like them. If you are setting your text left justified (ragged right edge), then gutter lines are compulsory if your columns are close together, however if the gap between columns is approximately 2 picas or greater you can get away without the gutter lines.

You only need gutter lines in between columns, not to left of the left-most column, nor to the right of the right-most column. The line weight should be a hairline if possible, half-a-point at the most.

THE OTHER SIDE

When designing a newsletter which is going to open as a normal magazine would do, so that you have a left-hand page and a right-hand page, you need to remember that the whole spread is what will get seen, not merely the individual pages. So you have to think about the facing page while designing each of them.

For instance, if you had an article, or part of an article, on the left-hand page and it included lots of pictures, then you'll have to 'balance' the spread by having some pictures on the right-hand page as well.

Remember to leave an adequate margin on the right of left-hand pages and the left of right-hand pages so that text doesn't get lost in the fold when the newsletter is bound - 2 picas is plenty for anything that is up to 60 pages saddle-stitched (folded and stapled). If you are using those plastic edge-binding strips that you slip sheets of paper into and they pinch them all together, you'll need to leave much more space in the gutter, at least half-an-inch, maybe three-quarters (3-5 picas), depending on how wide the strip is.

STICK TO A STYLE

Above all, make sure you decide on a style for all elements of your

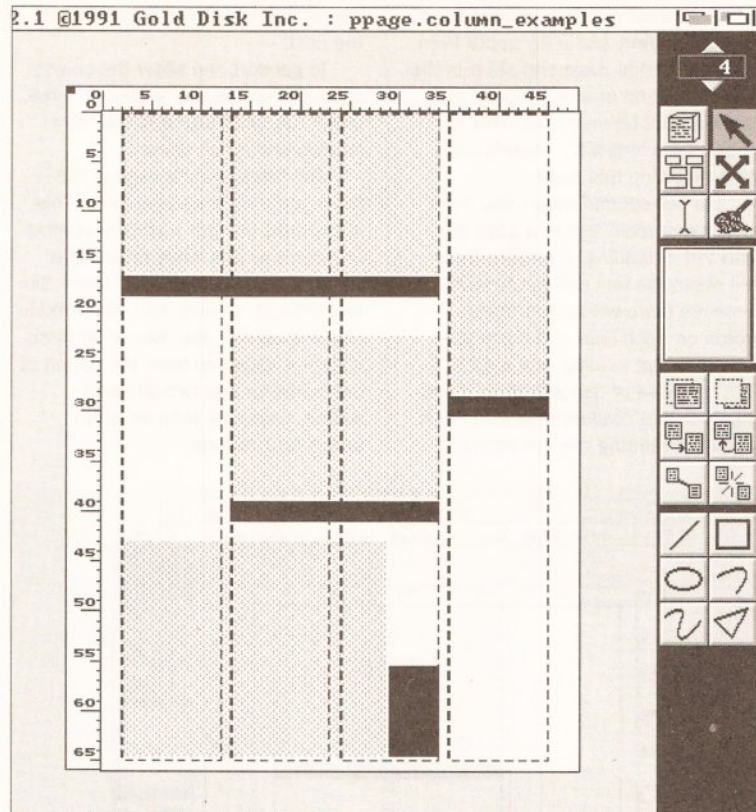

Four column layouts need lots of thought. You have so many options that it is easy to go potty with the design and produce confusing pages that are difficult to understand

newsletter, and stick to it.

For instance, every article will have a title or 'heading'. Decide on a typeface and point size and use the same font for each heading.

If you have a main or 'lead' story or article, then stick to the same typeface for the heading but increase the point size by 30 to 50 per cent if you like; this will help to give it more importance than the other articles.

Likewise, all captions should be set in the same font throughout the whole newsletter. And so should the bit on the page which refers to who wrote the article or story; if it's just

the author's name we call it a 'by-line' because it's the line which says who the article is by, if it also says what the article is about we call it a 'standfirst' because ... erm ... because it stands first, before the main text, I suppose.

Anything else like this which tends to happen quite a lot in your newsletter - such as bibliographies, for instance, or panels which tell the reader exactly where to get further details about the subject of the article - should also be set in exactly the same style every time they are used.

And sub-headings, those short

lines of text that break up different parts of an article. If you are going to use them, decide on a style for sub-headings and use that style for every sub-heading in the newsletter. If you don't like sub-headings you could use a dropped capital instead, or even a blank line, but don't use horizontal rules as these will make the reader think the article stops there.

A good way to invent your own style is to trot down the newsagents and pick up 10 magazines or so - see if they have any out-of-date ones that they'll sell you at a reduced price, you're not interested in the content, you want to study the design of the pages. Get out your ruler and measure things. Make a note of what you like best and copy it. It's not really stealing, honest. Well, if you copy the complete design of just one magazine it would be stealing, but if you mix and match different ideas from different magazines you'll end up with something that looks like nothing else.

SEARCH FOR PERFECTION

Don't expect to get it right first time. After each issue is published take a look at your newsletter and make a note of where the design can be improved. (In the trade we call this a 'post-mortem' because we are pulling a 'dead' issue apart to find out what is wrong with it.)

After six or seven issues, make all the improvements in one issue. Then make notes again. After that make the improvements after another six or seven issues. Don't fiddle with the design every issue, you might enjoy doing it but your readers won't like it.

Always remember that your ultimate aim is to make the content of your newsletter as readable as possible. If you can make it look pretty as well, then you are doing your job properly, but readability is paramount. A redesign should not decrease the readability of the newsletter; if it does, it was a bad decision and you should go back immediately to your previous design.

Once you've got all these decisions made about columns, headings, pictures, sub-headings and so on, you won't have to make those decisions every time you lay out a page. In the long run, this leaves you more time for having fun and expressing yourself, which is what it's really all about.

And for heaven's sake don't take it too seriously. There will always be more people who think your newsletter is bad than those who think it is good. Take no notice, they're only jealous.

Well, that's my excuse anyway, and I'm sticking to it. **AS**

JARGON BUSTING • JARGON BUSTING

Drop capital - An initial letter set in a larger type than the rest of the body text, which covers two or more lines.

Pica - A unit of typographical measure. There are twelve points in one Pica.

Layout - The arrangement of text and graphics on a page.

Point - The basic unit of typographical measure. Roughly speaking, there are 72 points to the inch.

Gutter - Usually the space between facing pages where the fold or the binding is, but also the space between columns on a page.

Spread - A pair of facing pages. Also known as a double page spread, or, for short, 'dps'.

Body text - The main text of the document, excluding headlines.

THE PROFESSIONAL AMIGA GRAPHICS SLIDE SERVICE

- SUPERB QUALITY 35MM SLIDES FROM JPEG, 24 bit IFF, IFF, TIFF & COLOUR POSTSCRIPT. PLEASE CALL FOR DETAILS.
- PRECISION PIN REGISTER GLASS MOUNTED SLIDES FROM £3.50 FOR 5 DAY SERVICE OR £5 FOR 48 HOUR SERVICE.
- HIGH RESOLUTION 4000 LINE IMAGES, NO SCANLINES OR CURVATURE DISTORTION & 16.7 MILLION COLOURS.
- 35mm OR 5" x 4" FORMAT. WE CAN ALSO SUPPLY ANY SIZE COLOUR PRINT FROM A4 TO BILLBOARD SIZE.
- WE PRODUCE 35mm SLIDES FROM MAC OR IBM PC IMAGES.
- OUR MINIMUM ORDER IS £15 PLUS VAT AND P&P. PAYMENT BY CHEQUE OR CREDIT CARD WITH ORDER.

Call THE PRESENTATION HOUSE on 031 556 7047.

THEMATIC CLIP ART

Each disk contains between 115 and 270 original, high quality, images for use with Amiga art and DTP programmes - Deluxe Paint, Pro Page, Wordworth, Penpal, etc.

1. Pets
2. Castles, cottages and churches
3. Trees
4. Signs and symbols
5. Wild Animals

£6.99 each - Buy 3 or more for £6 each - Over 900 images for only £30
Inclusive of 1st class P&P.



Please make cheques/PO's payable to ARTWORKS.

1, Pond View, Wootton, Ulceby, S.Humberside. DN39 6SF ☎ 0469 588138

Orders normally dispatched within 48hrs or immediately after cheque clearance.



Be An X-CAD Pro !!!

By Using X-CAD SYMBOL LIBRARIES from COMPUTECH SERVICES.

(Official UK sales for all XCAD products.)

- ARCHITECTURAL
- ENGINEERING
- ALL XCAD PRODUCTS, PROGRAMS & PERIPHERALS
- HYDRAULIC
- COMPLETE X-CAD SYSTEMS Based on A2000 and A3000
- ELECTRICAL

PRICE MATCH

Before you try anyone else ring us for the best prices on XCAD products!!!

Currently 48 library disks available. We are constantly adding to the libraries. We are the official UK sales for all XCAD products, programs and peripherals, plus the latest Imagine 3D Rendering Package. Why not upgrade your current X-Cad system with a digitising tablet Pod Scat P.T. 30/30 or Cherry A.3.

Please write or telephone and ask for our latest price list for Amiga hardware and software.

Computech Services, 87 Victor Gardens, Hawkwell, Hockley, Essex SS5 4DY.
Fax/Phone: (0702) 205165



Please enquire about range of Sega Consul and Games



AMIGA DESKTOP VIDEO

THE SPECIALIST IN VIDEO GRAPHICS

COMPLETE MAIL ORDER SERVICE WITH HELPFUL ADVICE
COMPUTERS - SOFTWARE - GENLOCKS - MEMORY

Product Guide Available

GALAXY GRAFIX
FREEPOST, SWANSEA SA2 9ZZ
Telephone 0792-297660



Send for full details now.

Existing Amiga owners send 3 x 1st class stamps for our Info Disk.

Why buy a scanner?

When we can do it for you. Pictures scanned in colour or grey scale and saved for use with DTP/painting/word processor software.

| Picture size | Qty | 1-4 | 5+ |
|--------------|-----|------------|------------|
| Up to 7"x5" | | £2.00 each | £1.75 each |
| Up to 10"x8" | | £3.00 each | £2.75 each |

Note: the picture size refers to the size of the SUBJECT you require scanned, not the whole picture. Determine your requirements and price them accordingly. Always state your requirements clearly. Prices include disks and P&P. Please state:

- screen mode required e.g. low resolution
- number of colours e.g. 32, 64, HAM
- software you will be using the scans with

All pictures will be returned. Allow 7-10 days for delivery.

PD/Shareware Clip Art

Many items of various clip art previously available in the Public Domain for IBM PC's and converted by us for use with the Amiga. To our knowledge previously unavailable for the Amiga.

- Disk 1** - Assortment black and white. Animals, office, insects etc.
- Disk 2** - 25 elaborate text boxes, flashes, sunbursts etc, question marks, exclamation marks etc. 100 different borders.
- Disk 3** - Decorative Dropcaps. 26 Olde English. 26 floral motif.
- Disk 4** - US Navy/Marine. 55 pics Aircraft carriers, ships, aircraft, medals etc..

£3.00 per disk. All 4 £10.00 P&P incl.

Cheques/POs payable to:
USKVALE COMPUTER SERVICES

P.O. Box 14, Caldicot, Gwent, NP6 3YJ.

Tel: (0633) 880889.

OPTION 2000

Complete Systems & Software
Clumber House, 56 Clumber Street,
Kirby - in - Ashfield, Notts NG17 7NG Tel/Fax
(0632) 720659

BOOKS

| | |
|---------------------------------|--------|
| Amiga for Beginners | £9.00 |
| Best of Amiga Tips/Tricks | £16.00 |
| Amiga Basic Inside & Out | £14.00 |
| Amiga C for Beginners | £11.00 |
| Amiga C for Advanced | £19.00 |
| AmigaDos inside & out | £14.00 |
| Desktop Video Power | £16.00 |
| Amiga Graphics inside & out | £8.00 |
| Amiga Machine Language | £11.00 |
| Making Music Amiga Book & Disk | £22.00 |
| Amiga Printers inside & out | £22.00 |
| Amiga 3D Basic Graphics | £7.00 |
| Using Arexx Amiga Book & Disk | £22.00 |
| AmigaDOS Quick Reference Book | £7.00 |
| Amiga User Interface Guide | £12.00 |
| Amiga hardware Reference 3rd ed | £14.00 |
| Superbase, The book | £10.00 |
| Visionary Handbook | £17.00 |

| | |
|-------------------------------|---------|
| Gold Disk Type Publisher Pack | £29.00 |
| Gold Disk Type Video Pack | £29.00 |
| Outline Fonts | £96.00 |
| Pagesetter 2 | £53.00 |
| Pagestream 2.1 UK | £176.00 |
| Professional Page 2.0 | £141.00 |
| Saxon Publisher 1.1 | £172.00 |
| Saxon Script Pro | £62.00 |

| | |
|----------------|---------|
| Showmaker | £188.00 |
| Turbo Text | £50.00 |
| Video Director | £119.00 |
| Videoscape 3D | £56.00 |
| Video Titler | £75.00 |

WORDPROCESSORS

| | |
|------------------|---------|
| Final Copy | £48.00 |
| Kindwords 2 | £44.00 |
| Pen Pal | £72.00 |
| Protext 5 | £102.00 |
| Prowrite v3.2 | £84.00 |
| Quickwrite | £36.00 |
| Transwrite | £34.00 |
| Wordperfect v4.1 | £143.00 |
| Wordworth | £79.00 |

SOUND & MUSIC

| | |
|-------------------------------|---------|
| Aegis Soundmagic | £109.00 |
| Audiomaster 4 | £50.00 |
| Bars & Pipes | £95.00 |
| Bars & Pipes Professional | £181.00 |
| Deluxe Music Construction Kit | £58.00 |
| Harmoni | £48.00 |
| KCS Level II 3.5 | £283.00 |
| MIDI Connector | £42.00 |
| Sonix | £43.00 |
| Tiger Cub | £67.00 |

EDUCATION

| | |
|------------------------|--------|
| Distant Suns 4 | £48.00 |
| Fun School 2 (under 6) | £17.00 |
| Fun School 2 (6 to 8) | £17.00 |
| Fun School 2 (over 8) | £17.00 |
| Fun School 3 (under 5) | £21.00 |
| Fun School 3 (5 to 7) | £21.00 |
| Fun School 3 (over 7) | £21.00 |
| Fun School 4 (under 5) | £21.00 |
| Fun School 4 (5 to 7) | £21.00 |
| Fun School 4 (7 to 11) | £21.00 |
| French Mistress | £17.00 |
| German Master | £17.00 |
| Italian Tutor | £17.00 |
| Japan World (CDTV) | £49.00 |
| Maths Adventure | £21.00 |
| Micro English | £22.00 |
| Micro French | £22.00 |
| Micro Maths | £22.00 |

BUSINESS AND ACCOUNTS

| | |
|----------------------|--------|
| Cashbook Combo | £49.00 |
| Cashbook Controller | £37.00 |
| Day by Day | £19.00 |
| Desktop Budget | £35.00 |
| E Type | £25.00 |
| Final Accounts | £25.00 |
| Flow | £53.00 |
| Gold Disk Office | £79.00 |
| Home Accounts | £19.00 |
| Home Accounts 2 | £34.00 |
| Mailshot Plus | £31.00 |
| Personal Tax Planner | £31.00 |
| System 3 | £37.00 |
| System 3E | £49.00 |

SPREADSHEETS

| | |
|---------------|--------|
| Advantage | £81.00 |
| DG Calc | £25.00 |
| K Spread 4 | £86.00 |
| Maxiplan Plus | £48.00 |
| Superplan | £48.00 |

UTILITIES

| | |
|-----------------------------|---------|
| Aegis Visionary | £48.00 |
| All In One | £39.00 |
| Alter Image Video F/X | £96.00 |
| Amiga LOGO | £48.00 |
| A Talk 3 | £35.00 |
| Amiga Vision | £72.00 |
| Deluxe Video 3/ Deluxe | £94.00 |
| Photo Lab | £29.00 |
| Directory Opus | £29.00 |
| GB Route Plus | £65.00 |
| Hyperbook | £48.00 |
| Mavis Beacon Teaches Typing | £27.00 |
| Presentation Master | £160.00 |
| Promotion for Videoscape | £48.00 |
| Proscript | £24.00 |
| Scala 500 | £80.00 |
| Scala | £211.00 |

DATABASES

| | |
|--------------------------|---------|
| Superbase 4 Professional | £160.00 |
| Superbase Personal 2 | £48.00 |
| Superbase Personal | £34.00 |
| Prodata 1.2 | £81.00 |

DESKTOP PUBLISHING

| | |
|--------------------------------|--------|
| Comic Setter | £35.00 |
| Gold Disk Type Designer Pack | £29.00 |
| Gold Disk Type Decorative Pack | £29.00 |

TERMS AND CONDITIONS:

All prices are inclusive of VAT at the current rate and UK postage and packing. All products are offered subject to availability. Please make all cheques payable to OPTION 2000 and allow 5 working days for clearance. All prices are correct at time of going to press but please note that prices may be subject to change.

A night at the opera

This month Gary Whiteley goes into another dimension with Pxlxl 3D2.0 and presents the AVideo card

It seems that hardly a week passes without another new, cheaper, and more useful gadget appearing for Amiga video and graphics users. The gizmo in question this time is a new RGB display device from a French company called Archos.

As soon as I'd heard of its existence I had an AVideo card sitting in my grubby little paws. But that's only half the story. There are, in fact, two versions – in 12 and 24-bit forms (that's 4096 and 16 million colours). The cost? £299 for the AVideo 12 and £599 for the AVideo 24 – which is quite reasonable when you find out what's included!

So what's the big deal about these new devices? Well, the great thing is that with an AVideo board installed in any Amiga (except the A1000) it's possible to display 12-bit or 24-bit graphics (depending on the AVideo model) directly on to an RGB monitor (including 1084 or 8833 monitors) in resolutions up to 768 by 580 – ie PAL overscan. The benefit of this is that the quality of output is much higher than the composite video output of devices such as the DCTV, or the Video Toaster, can be. Even so, you'll have to have a high quality RGB to video encoder or genlock to reap the benefits if you want to record the output to video.

Because the image is held in its own framebuffer and memory area, the AVideo does not interrupt the Amiga graphics processes. As a result, standard Amiga graphics can be displayed over AVideo images, rather like a genlocked graphic over a video signal. This happens on your RGB screen, meaning that any standard Amiga graphics (including animations) could be played over any 12 or 24-bit background, or output through any decent genlock!

Both boards come with a variety of software for painting, image display and manipulation and AVideo control and installation. The AVideo 24 is also provided with a complete version of TV Paint, while the AVideo 12 has AVPaint and a demo of TV Paint (which can work in 12-bit).

In both cases the AVideo fits into the Denise socket of the Amiga, which means the computer has to be

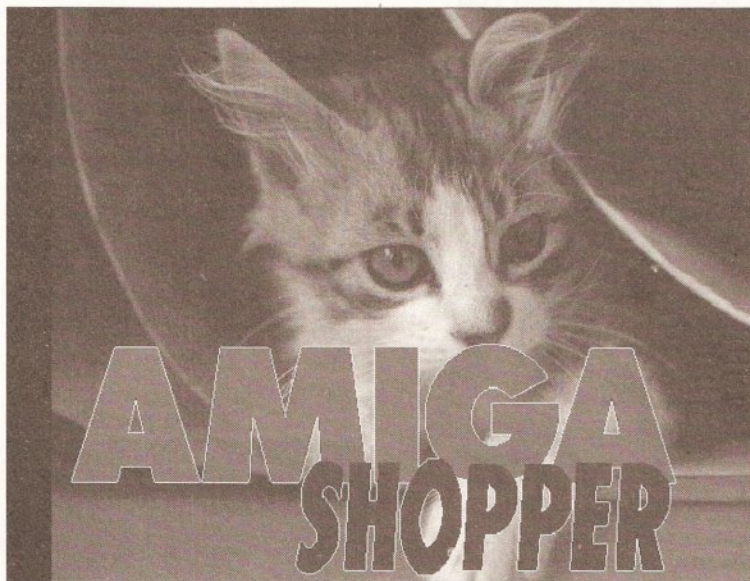

Graphics are easily superimposed over 12 or 24-bit images held in AVideo's framebuffer. The results can be recorded on to video tape using a genlock

cannibalised a little, something which may not appeal to those whose machines are still under guarantee or worried about damage to their Amiga. It also means that the device will not work with any future Amigas without a Denise slot.

Installation is straightforward. Simply extract the Denise chip from its socket, plug it into the vacant space on the AVideo card, then plug the AVideo into the Amiga. Mind you, you'll have to dismantle your Amiga to get at the Denise socket! If you're worried about installing it, Checkmate Digital will do it for free if you pay the return carriage of your Amiga.

If you have an Amiga with a video slot I'm not sure how the AVideo card might interfere with whatever you may have plugged in there, though I can tell you for sure that the Video Toaster refused to run while the AVideo card was installed. I can also tell you that the card fits snugly

into an Amiga 1500/2000, with barely enough space between the power supply chassis and the mother board to accommodate it.

A CLOSER LOOK

With the AVideo now installed let's have a closer look at the software.

All four of the disks contain relevant programs which can be auto installed on to hard disk, though they could be used from floppy. There are also several read-me files (in English and French) which give an overview of some of the software. These are adequate for installing the AVideo card, though they don't go into great detail about the bundled software.

The first thing to do every time the AVideo card is used is run a program called AVideo, though this could be done automatically from the Startup-Sequence. But the first time the AVideo card is used it must be set up by using the AVTune program to ensure that the card is attuned to the Amiga host. This procedure is similar to the HAME tuning – click on an arrow until the screen graphics are sharp and clear, with no jittering. Save the resulting .prefs file, adjust your Startup-Sequence to include the AVset command, and every time the system is booted the tuning will be done automatically.

THE SOFTWARE

I wasn't able to review a complete AVideo 24 package so the rest of this review is based around the AVideo 12 – though in many respects

AVIDEO'S TECH SPECS...

- AVideo 12 – 12-bit framebuffer/display device
- AVideo 24 – 24-bit framebuffer/display device (or 2 x 12-bit buffers)
- Software – includes
 - TVPaint V1.6 (AVideo 24)
 - TVPaint Demo (AVideo 12)
 - Opera – an Arexx-driven presentation program
 - AVPaint – 12/24-bit basic paint software
 - Utility programs
- Output via RGB connector for optimum display quality
- Plugs into Denise chip socket

THE FUTURE OF AVIDEO?

An interesting application for the AVideo boards could be 12 or 24-bit animation, as a non-interlaced 768 x 580 resolution 12-bit image can theoretically be loaded into the AVideo in only 3/50th of a second, though at the moment restrictions in the Amiga hardware mean that this cannot be achieved. But in the future, and with the right hardware, who knows what we might see?

VIDEO DIGITIZER II

DATEL DATEL DATEL DATEL DATEL



DATEL DATEL DATEL DATEL DATEL



ONLY
£89.99

NOW YOU CAN DIGITIZE PICTURES FROM ANY VIDEO CAMERA OR VCR

- Completely newly designed interface that plugs into the expansion connector of the Amiga 500 or internal connector of the Amiga 2000.
- Standard phono video input 0.5 to 2.0 volts to take signals from TV, video or camera.
- Control brightness, contrast and throughport on A500 version.
- Frame grab in 1/50 second, record update up to 3 frames per second.
- Single or continuous update in 4, 8 or 16 grey levels.
- Play frames backwards or forwards up to 15 frames per second.
- Save Raw, IFF or sequence files.
- Automatically adjust for maximum number of frames according to memory available.
- Display 256 x 256 pixels, but optional 320 x 256 IFF Save. Screen editing features Cut, Copy, Brush, Paste and Undo. Effects menu to reverse pos/neg, compress, etc.
- Second display editor controls sequence production: Record, Play, Insert, Clear, Delete Frames.
- Set start and end position number of frames saved, number frames, step backwards and forwards, loop, etc. Time lapse feature adjustable in 1 second increments to 1 hour between each frame. Ideal for capturing flowers opening, sky movements, special effects, etc.
- Separate player programs included to insert into your own program disks. Hard disk transfer program.
- Please state A500 or 2000 version when ordering.



NOW WITH FULL COLOUR OPTION

WITH THE ADDITION OF THE RGB SPLITTER, TO THE VIDEO DIGITISER II YOU CAN OBTAIN COLOUR IMAGES IN ONLY 1 SECOND!!

- The Splitter unit plugs alongside the Digitiser and a lead is supplied to couple the two units together.
- Full adjustment of Red, Green and Blue signals together with a saturation control enabling you to take full control over any image.
- The Splitter is switched in software and comes complete with Digitiser Colour Software.
- You can select single continuous colour or B/W input. Files can be saved in Raw 4096 colour format, 8 or 32 colour IFF files or 16 shade B/W IFF.
- Features include full palette control editing of frame and colour retouch calculator.
- Input from camera, camcorder or video recorder (paused). No more messing with colour filters.

RGB COLOUR SPLITTER
ONLY £79.99

BUY VIDEO DIGITISER II PLUS
RGB COLOUR SPLITTER FOR
ONLY £149.99

HOW TO GET YOUR ORDER FAST!

TELEPHONE [24Hrs] **0782 744707** CREDIT CARD ORDERS
ORDERS NORMALLY DISPATCHED WITHIN 48 Hrs. ALL CHEQUES/POSTAL ORDERS MADE PAYABLE TO...



DATEL ELECTRONICS LTD.



GOVAN ROAD, FENTON INDUSTRIAL ESTATE, FENTON, STOKE-ON-TRENT, ST4 2RS, ENGLAND.

FAX 0782 744292 TECHNICAL/CUSTOMER SERVICE 0782 744324

A/F VIDIGI



i m i t e d

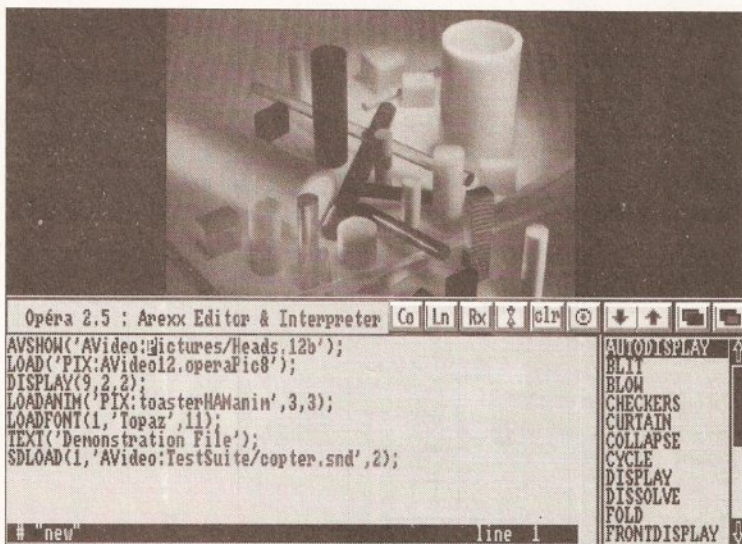

OperaCompo is for devising your own presentations, which can include 12 or 24-bit graphics, Amiga graphics, animations, sound, text and drawing the two systems are identical.

Once tuned and running it's obviously time to check out the rest of the software. But first make sure that you have ARexx installed in your Amiga, as you'll need it to run most of the AVideo programs.

THE OPERA FAMILY

With the exception of *TVPaint*, this pair of programs is the most interesting of the supplied software. OperaCompo is an ARexx interpreter used to translate text file scripts of Opera commands into AVideo commands while OperaPlayer runs in the background and plays the Opera scripts which you have created.

By using OperaCompo it's possible to build up an entire script for manipulating Amiga images and animations, loading and displaying framebuffer images, adding and controlling text and sound (8SVX and Soundtracker files), making wipes and transitions between Amiga images and adding simple graphics.

In many ways the results from OperaCompo are similar to those produced by programs such as Director, Scala and other presentation programs, though the user interface and many of the results are completely different. For instance, it is possible to load and play a HAM animation over a 12 or 24-bit background, while replaying a Soundtracker music file. Or make a sophisticated slide show with Amiga images and 12 or 24-bit images. There is a lot of scope for creation with OperaCompo, though it does take a while to understand what all the various functions do.

OperaCompo provides a screen where script commands are written in a text window. These can be typed in directly (if you know the rules) or input interactively by selecting a function from the side menu and following the subsequent requesters. On-line help can be provided to guide you, though at the moment this is only available in French, so you'll have to experiment a lot, and guess what is going if you can't understand Amiga instructions in French.

In fact, experimentation is the rule with OperaCompo, at least while

you're learning. It's easy to use, but strict about having the commands properly formatted and the error messages don't help much beyond telling you that something went wrong. Only trial and error gets you there in the end.

There are numerous functions to select, and many have adjustable parameters for size, speed, display time, transition length etc. While 12 or 24-bit images can only be faded up and down or cut together in sequence it is possible to do some quite sophisticated transitions on other images.

There's a heap of tutorial files that you can use to learn from. They provide a variety of examples. One, called AnimTest, plays a nice animation of a waiter in a French cafe. Others show off the range of wipe patterns and transitions, play sounds and show animbrushes.

A number of operations can be made using text, utilising standard Amiga bitmap fonts. Textfiles can be displayed, or specific captions entered and programmed into sequences. I found that text was the most difficult feature, though

perhaps due more to my partial understanding of the French help files than a problem with the program and I did manage to get some results in the end.

However, Opera is a new program and there is more work to be done. It is quite extensive and works pretty well, but if some of the annoying problems such as not being able to quit the program without rebooting were solved, I think AVideo users would have a very useful tool to complement their display cards.

THE AV FAMILY

The AV programs are a suite of utilities for software installation, tuning up AVideo, converting 24-bit images to 12-bit versions and controlling the AVideo card. Only the last program, AVCMD, needs a

mention, as the others are all straightforward to use. It can be used to load and show 12 or 24-bit files or issue direct commands to the AVideo card – for instance as a way of flushing out the buffers or reset the card.

AVPAINT / AVPAINT1.3

This is a basic paint program supplied in two versions – one for WB2 owners, the other for 1.3-ers. I gave each a good test drive and decided that AVPaint is not so special, as paint programs go. It does the job but suffers from a few bugs and inconsistencies which mar its overall performance. The range of tools is OK, though there are a few good features offering picture compositing effects and text handling.

For reasons which I couldn't

Requirements:

- For TV Paint – 68030 accelerator and at least 4Mb RAM.
- For AVPaint – 68030, 2Mb chip and 2Mb RAM recommended, running under AmigaDOS 2.XX, though works with 1Mb chip RAM and 2Mb RAM and 68000 minimum under 1.3.

In general – some kind of accelerator and at least 4Mb RAM will be extremely helpful, though the accelerator is not obligatory (except for TV Paint). As always, a hard disk will be more than useful, considering the average size of 12 and 24-bit images (often 500K plus) and the amount of disk swapping you'd otherwise need to do. You'll also need ARexx (though WB2.XX owners have it included with their Amigas).

JARGON BUSTERS • JARGON BUSTERS

12-bit/24-bit graphics – Graphics are composed of bitplanes of 2 colours each. 12 bitplane graphics can have up to 4096 colours (2 to the power 12) and 24-bit up to 16.8 million colours.

ARexx – A scripting language for the Amiga allowing programs which utilise ARexx ports to be linked together for input, output and other information exchange.

Composite Video – A video signal including chrominance (colour hue and saturation) and luminance (brightness) information in one combined signal.

Framebuffer – A hardware device for storing an image, often up to very high quality, usually for use with video effects hardware.

Genlock – A way of slaving one video source (eg Amiga) to another (eg Video Tape) in order to synchronise their signals together to allow stable wipes, mixes and other effects including overlay (key) between the two sources.

HAM – Hold And Modify – the Amiga's 4096 colour graphics mode.

Overscan – A full size video image with enough spare all round to ensure that the full video screen is safely filled.

PAL – Phase Alternation Line – the television standard used in the UK and around 50 other countries.

RGB – Red, Green and Blue components of a video signal – provides higher quality than composite video.

WYSIWYG – What You See Is What You Get

determine, AVPaint will load some IFF24 files and not others. It will also load raw RGB files and 12-bit IFF files which have previously been converted from IFF24 files using the AVRemap program. It wasn't a question of memory - I had 9Mb on board at the time. Even images which were of similar resolution were

picture directly to disk it's possible to save it from the AVideo's framebuffer. However, I would like the running time to be longer - simply because by the time you managed to load a picture and have started messing with the program it throws you out again. Ten minutes would have been a more realistic

POST HYPNOTIC SUGGESTION

As a final thought, whilst considering AVideo's use of ARexx I remembered that I'd been told that Digital Vision's Scala program could use ARexx commands, though it hadn't been documented at the time. Whilst I wasn't able to test Scala and AVideo running together under ARexx (as I didn't know any of the Scala commands) I reckon that the potential is there for an impressive combination of Scala graphics running over 12 or 24-bit backgrounds. Actually, the potential is there for any program which runs ARexx to interface with the AVideo cards. Only time will tell.

treated differently. But most images did load, as long as they were in the right format.

AVPaint does not load 'normal' IFF pictures, eg DPaint images - they have to be converted to 24-bit files first.

Most of the usual painting tools are present, although there is no filled freehand tool or snap to grid. AVPaint is obviously faster with a faster processor, but it's not too slow on a straight 68000 machine, though loading and saving the large picture files produced could inspire you to make a cup of tea while you wait.

TVPAIN / TVPAINT DEMO

There's a demo version of TV Paint included with the AVideo 12, and a fully working 1.6 version with the AVideo 24.

All the features you'd expect in a top quality paint program are included - and a lot more as well.

Remarkably, this is the same program which can cost more on its own for other graphics cards than a whole AVideo 24 package does. But one important difference between this version and the others is that you can't carry out real-time 24-bit painting with it. While you are able to view the fruits of your labours by toggling the screen-mode to 24-bit, you can only paint in 12-bit. This looks pretty cool anyway, but it obviously isn't the real thing as far as WYSIWYG is concerned. But at this price?...

The demo version provided with the AVideo 12 is frustrating not because it draws the word DEMO across the screen, but because it closes down after about three minutes, forcing you to restart it. It also doesn't save. Now, this protectiveness makes sense, because even if you can't save a

time limit.

A full review of TV Paint is beyond the scope of this article (see AS11 for a review of the Harlequin version) but suffice to say that TV Paint looks like a very exciting product! **AS**

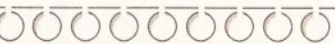

SHOPPING LIST

AVideo 12 £299
(including software)

AVideo 24 £599
(including software & TV Paint V1.6)

by Checkmate Digital Ltd
80 Mildmay Park,
London N1 4PR
☎ 071 923 0658

CHECKOUT AVideo 12

Documentation ●●○○○

Only adequate, but could do with improving and/or translating. Mostly provided on disk for printing out yourself.

Ease of use ●●●○○

Would be easier with clearer manuals and more explanations of software functions, rather than being left to frequent experimentation.

Features ●●●●○

Plenty of features, some better than others, but all with potential.

Usefulness ●●●●○

Great for those requiring low cost, high quality Amiga output.

Price Value ●●●●○

Nearest competitors are DCTV and HAM-E.

Overall rating ●●●○○

I would have liked to award four blobs, but I felt that both the Denise mounting and the lack of serious documentation were letting down these potentially blockbusting display devices.

PIXEL 3D 2.0

A NEW PERSPECTIVE ON 2D

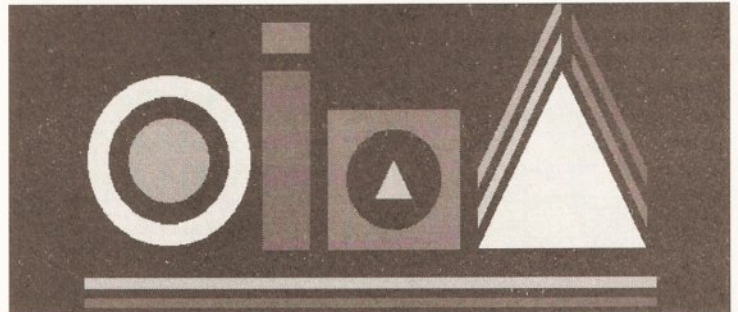

Want to turn this bitmap image into a 3D object? If so, then look no further, Pixel 3D 2.0 could be the package to take your idea from conception to the next dimension

No matter how you look at them, 3D objects are complicated. Not just because they consist of multiple points and faces which are joined in three dimensional space, but because making them can often be a heck of a difficult job. You'll require highly developed skills, such as a good eye for modelling in the 2D wire-frame world of the computer and a clear notion of how you're going to get from idea to 'solid' object. You'll also require patience during lengthy image rendering times and while you iron out creases from your objects and your technique.

One prerequisite for good 3D work is an object modeller which you are comfortable with, as it's here that you'll spend much of your time struggling to turn your concept into virtual reality.

Unfortunately, this plethora of programs has spawned many different object formats - which are often incompatible. For instance, it's not possible to load Modeller 3D objects into Imagine, or Lightwave 3D objects into Sculpt. The reasons for this are historical - there is no standard IFF 3D file format. Here programs such as Pixel 3D 2.0 come

into their own for converting from one object format to another.

There have been usable converters, such as Syndesis' Interchange, but until Pixel 3D all objects had to be created either in a modeller or, if you were really devoted, by using programming and file generation methods. Only when Pixel 3D brought bitmap tracing to us did things get more interesting. It became possible to digitise a logo, for instance, clean it up with a paint program and extrude it into a 3D object. Good as it was, the original Pixel 3D could only extrude bitmaps and save the resulting objects.

Times have changed and there are now newer formats and greater needs. The Amiga 3D community has become more demanding. Turbo cards and 24-bit are here and we want to play with the big boys. Enter Pixel 3D 2.0 - a beefed up program to help us dream in 3D.

3D TO 3D

If you are an old hand at Amiga 3D you'll realise how frustrating it can be to know that you have a perfectly good object ("I've got one here that I made earlier, Blue Peter fans")

continued on page 89

PIXEL 3D'S TECH SPECS...

- Turbo, Non-turbo and Demo (!) versions supplied.
- Converts any IFF bitmap image (in up to 32 colours) to 3D objects.
- Supports Lightwave, Sculpt 3D, Imagine, Turbo Silver, VideoScape 3D, 3D Professional and DXF AutoCad (for use with some PC programs).
- Inter-format conversion.
- Beveling, spin, extrusion, colour/height mapping and smoothing.
- Point and face reduction, polygon flipping, doubling and division tools.
- Impressive interactive view window.
- Accelerator and at least 1.5MB memory recommended.

"INCREDIBLE!....."

... the only word needed to describe the greatest sampling tool ever released to the public! (Dance Music Report, USA).

THE ESSENTIAL AMIGA MUSIC ACCESSORY ZERO-G DATAFILE AMIGA

SAMPLE LIBRARY FOR DANCE MUSIC IN IFF FORMAT FOR MUSICIANS - DJs - PROGRAMMERS - DANCE PRODUCERS

Produced by one of the UK's leading dance music pioneers:
Ed Stratton, alias **MAN MACHINE** (Rhythm King), a.k.a.
JACK 'N' CHILL (Virgin Records)

There's a huge buzz in the music industry, at the moment about the Zero-G dance sample library - and now it's available for the Amiga!.....

The ZERO-G data disks offer a huge selection of superb quality sound samples from the already famous Zero-G professional library saved in IFF format for use in most Amiga music and sequencing packages:

A series of TEN 5-disk volumes - first two volumes out now!....

ZERO-G DATAFILE AMIGA VOL.1 - BREAKBEATS 1
72 killer rhythm loops for today's most happening dance styles
ZERO-G DATAFILE AMIGA VOL.2 - VOCAL HOOKS 1
Hundreds of totally cred streetwise vocal gems - hits/hooks/FX

WHAT THE HI-TECH MUSIC MAGS SAY ABOUT THE ZERO-G DANCE SAMPLE LIBRARY

"Unreservedly excellent...The most comprehensive dance sample resource currently in circulation... Ammunition from the front line!...An unbelievably valuable addition to your sample library..." (Music Technology, UK) "As a source of sounds and inspiration, Zero-G really works!" (Home & Studio Recording, UK). "Why spend loads of money and countless hours searching for your own samples when someone with an ear for credible material and a proven track record has already done the hard work for you?" (Streetsound Magazine, USA, about Zero-G samples). "Incredible!... vocals so fierce you have to hear them for yourself... The voice samples I've never heard anywhere before. Whether you're a producer, remixer, engineer or a DJ with a sampler, this is a must for your sample collection" (DMR Dance Music Report, USA) "An invaluable tool for the professional sound technician." (DJ Magazine, UK). "Stratton knows his business!" (International Musician). "All the raw material needed to assemble house or techno tracks to a very high standard...given Ed Stratton's ear for what works." (Sound-On-Sound, UK).

Coming Soon in the ZERO-G series, a further 8 volumes....

Sci-fi & Techno FX Vols 1+2 (games programmers take note!); Dance Percussion (inc. human beatbox); Misc. House FX (inc. pro-quality scratching); Spoken Drop-Ins (inc. robots/alien); Classic Dance Drum Machines (inc. TR808 + TR909); Breakbeats Vol. 2; Vocal Hooks Vol. 2.

Each volume comes with comprehensive instruction manuals and indexing and full technical helpline support is provided. As you purchase additional sets in the Datafile range, you'll see your library of sounds and effects develop into a powerful and unrivalled reference source fulfilling all your sample requirements, and unequalled in quality and ease of use.

CAN BE USED WITH ALL OF THE FOLLOWING:

| | | |
|-------------------------------|----------------------------------------|-------------------------------------------------|
| SEQUENCER ONE SuperJAM! | BARS & PIPES PRF TFMX 1&2 | DIGITAL MUSICIAN DYNAMIC DRUMS |
| INSTANT MUSIC MUSIC-X | KCS SONIX | GMC (Game Music Creator) MASTER SOUNDTRACKER |
| OCTAMED QUARTET | AUDITION 4 MUSIC COMPOSER | MED (Music Editor) NOISETRACKER |
| AUDIOMASTER III INTERSOUND | OKTALYSER DMCS (Deluxe Music Const) | PROTRACKER ETC. ETC..... |

The entire Zero-G library is also available on 3 standard CDs (1000 samples on each) for sampling into any hardware samplers - £49.95 each or £129.95 for all three.

To order Zero-G Datafile Amiga 1 or 2, or the CD versions, call our 24-hour order line on: **0442 870681 (Access/Visa/Amex) or Fax us on 0442-877266.**

TIME+SPACE, PO Box 306, Berkhamsted, Herts HP4 3EP, England

Please send me: Zero-G Datafile Amiga Vol.1. "Breakbeats 1" @ £29.95
 Zero-G Datafile Amiga Vol.2. "Vocal Hooks 1" @ £29.95

I enclose a Cheque/Postal Order to value of £ _____ made payable to "TIME+SPACE" or: Please debit my Access/Visa/Mastercard/Amex credit card:

NUMBER: _____ EXP. DATE: _____

ADDRESS: _____

POSTCODE: _____ TELEPHONE: _____

(ALL PRICES INCLUDE V.A.T. and post) DELIVERY: Orders despatched within 14 days of receipt of payment. UK: post free, International Order: please add

£5.00 Air-mail £10.00 Express Air-mail.

AN 040 FOR LESS THAN AN 030

We Can Sell You A 28Mhz 040 With 4 Megs £1275 with Nearly Four Times The Speed Of An 030 If You Want A Fast Hard Card To Go With It We Sell Nexus Cards At Trade Price So Take Your Own Drive Across.

SPECIALS ON C.S.A. 030 CARDS.

33MHZ WITH 33 CO-PRO £399 2 MEG £199 4 MEG £325 8 MEG £499

PROGRESSIVE PERIPHERALS 040'S

28 Mhz With 4 Meg And Sesi £1699 For 2000/1500
28 Mhz With 4 Meg For 3000 £1399
64 Meg 32 Bit Dram Boards Available 4 meg Increments

G.V.P. 030 ACCELERATORS

40Mhz With 4 Meg And Sesi £999 or 50 MEG With 4 Meg And Sesi £1399
A500 40 Meg 030 With 52 Quantum £750 With 105 Drive £900

HARD DRIVES ALL AMIGAS

For Speed, Ease Of Use And Portability We Offer The Syquest Removable 88 Meg At £450 88Meg Cart £120 Any Amiga We Recommend The Nexus Or The Icd 2000 Hard Cards For Speed With Accelerators

SAVE HUNDREDS OF POUNDS

When You Buy An Accelerator From Us Costing Over £1000 We Can Offer You A Choice Of One Of The Following At Trade Price Saving You Hundreds In Some Cases. Limited To One Item Per Accelerator Card So You Can Get The Speed

VISTA PRO - SCUPLT 4D PRO - IMAGINE 2.0
TURBO SILVER - 3D PRO - DPAINT 4 - REAL3D TURBO

24 BIT GRAPHIC CARDS

Avideo 24 With Tvpaint £599 (Needs An 030) all Amigas
Gvp Impact Vision £1550 All Amigas
Visiona 24 Bit 130 Mhz Super Graphics Card With 40 Nansec Video Ram
2 Or 4 Meg Versions Start At £2495 2000/1500/3000

A500/1500/2000 RAM SPECIAL

Everything On One Board Up To 8 Megs Ram A Co-Pro And Sesi Interface-Plugs In The 68000 Socket - Board with 2 Meg Ram At A Silly £149
WORKBENCH 2.04 KIT, ROM AND MANUAL £79 P&P £4.50
SUPER DENISE ROM £40 MULTISTART THREE ROM SWITCHER £39
MEGACHIP 2 MEG AGNUS CHIP RAM CONVERSION £199
SEND FOR OUR CATALOGUE WITH OVER 2000 ITEMS

ACCELERATORS UNLIMITED

P.O. BOX 87, LYTHAM ST ANNES, LANCs, FY8 5SP

TEL 0253 795796 FAX 0253 736035

Open 10am To 5pm Monday Thru' Thursday

Mail Order Only-Overseas Welcome



Turbo Tales

No. 2 of a series of 94.



The Klingon Cruiser had by sheer luck jumped out of Hyperspace just 300 miles from the Enterprise; they hosed in some metal and scored two Phason hits on the Engine room before Sulu got her out of range....

As usual, the Screens were down. As usual, James T. and the crew were in an ongoing deep frown situation, and Scotty couldn't hold 'er....

"Spock, we're in deeeeeeep sh**," said Kirk. "The deepest, Captain," replied Spock, with his usual attention to detail. "Let's get to the other end of the Galaxy with the utmost dispatch." Sulu punched in the numbers, but it was no

use - the Trimensional Navigation Computer had been reduced to the mental age of seven by the passage of a Phason beam on its way to the Engine room. Jumping around the Galaxy without Trimensional Axes could stuff you into the heart of a planet... As the Klingon vessel ranged up on the Enterprise, all eyes turned to Spock. "There's still a chance, Jim," he said. "Around the ship on Ethernet there are some twenty AMIGAS, all totting FUSION-FORTY Accelerators and AMIGANET. I'll configure a Neural Net to calculate the Trimensional Axes - we should do 400 MIPS, no problem." Spock set to, but in moments the Klingon Cruiser was back within striking range, its Commander on the comms screens making the usual demands. However, all was not lost: the ever resourceful Chekov cut a deal with the Klingon, trading the FUSION-FORTY boards and a few copies of REAL 3D for a couple of second-hand Ion-Propulsion Motors. Chekov figured that while the Klingons got down to some Serious Rendering, Enterprise could slip away and make repairs. The rest, as mankind looks forward to StarTrek 17, will be History... thanks to the FFabulous

FUSION-FORTY from RCS

(Boldly going where no Accelerator has gone before...)

20 MIPS and 4MB of RAM - just £1395.00 at your Dealer.

The F40 is a 68040 Accelerator for A2000 Amigas, currently the fastest available in the Galaxy. Three times faster than the quickest '030 board but it still costs less. How can that be? It's not logical....

HYDRA SYSTEMS

Red Lane, Kenilworth, UK. CV8 1PB Tel: 0203 471111 Fax: 473333

CUT OUT AND KEEP

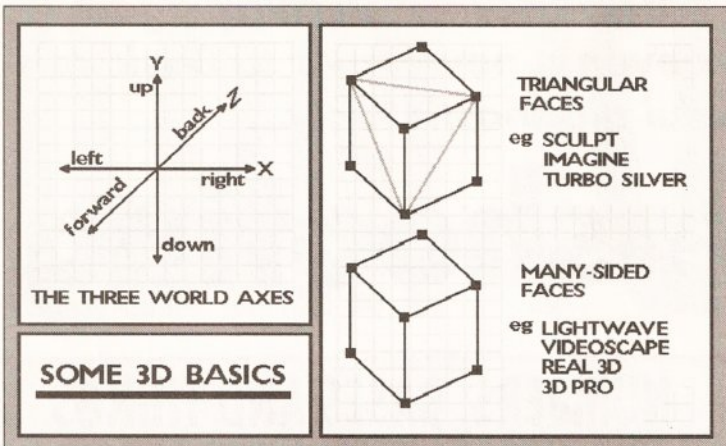

Showing the world axes according to the Cartesian system (published by Descartes in 1637) and two methods of covering an object with faces

The results of extruding a bitmap image. Each colour of the image is set to extrude to a different length

continued from page 87

which, to all intents and purposes, has become useless because it won't work with your new version of WizzoModelMaker, or whatever 3D program you are now using.

Pixel 3D 2.0 may solve your conversion problems, as it can load objects from several popular formats, convert and save them in the format of your choice. In doing so, it is possible to make changes to the structure of the object, such as reducing the number of points, turning triangular faces into many-sided faces, making single-sided polygons into double-sided polygons and making sure that all the polygons are correctly aligned. Such changes are useful for reducing the chances that the converted object may have holes in it and for increasing rendering speed - objects with fewer points and faces generally render faster. So while programs such as Lightwave 3D (supplied with the Video Toaster) will load Sculpt 3D objects (made of many triangular faces), it is desirable to convert the object to a Lightwave or Videoscape 3D object (made of many-sided faces) so rendering will be faster.

2D TO 3D

So, Pixel 3D was a breakthrough because it could turn 2D bitmap images into 3D objects. But it was limited to extruding. The new version can do lots more - take a look at the Tech Spec box for more details.

How does it work? First, take a bitmap image in up to 32 colours (from a paint program, for instance), that is on a Colour 0 background. Import it into Pixel3D 2.0. If the normal default settings are in use, a flat model of the image will be produced. This may be all you need - you could extrude this object in your 3D program. But this is just the tip of the iceberg!

It's easy to make more complex shapes by changing a few parameters in the Configuration requester. Perhaps you want to

make bevelled lettering (where all the edges of the letters have been sliced back at 45 degrees to the front face). Or maybe you want to spin a flat image into a rotated object. How about a multicoloured object whose colours control the depth of extrusion - eg an easy-to-make 3D bar graph? Or one where the colour intensity in the bitmap affects the extrusion depth? There's even an option to produce a fractal object from a bitmap - with the height of the surfaces linked to the colour intensity of the image! All this is simple to do with Pixel3D 2.0, but fiendishly difficult to describe.

Pixel3D 2.0 will retain all the colour of the original image, though for display purposes it will use only 64 colours to represent the object and its shading on screen.

Pixel 3D 2.0 will also recognise ARexx scripts (this requires ARexx to be running on your Amiga), enabling repetitive conversions or constructions to run under Arrex control.

3D IN 2D

Once you have loaded an image or object into Pixel3D 2.0 it will appear in the view window. This is another great part of the program - click on the object and it can be rotated in space by using the mouse. Once

rotated it will be redrawn as soon as you let go. Great for making sure that everything is as you want it to be. And not too sluggish either, even on an unaccelerated Amiga.

It is possible to zoom in or out or rotate the new object by using the arrow gadgets beneath the view window. By toggling Move the object can be moved relative to the origin (X=0, Y=0, Z=0), shifting the object's axis. A numerical readout shows exactly where you are at any time. The way in which the object is drawn can be set from a choice of combinations, comprising Wireframe, Solid (hidden lines removed), Shaded and Coloured.

UNDER TEST

I converted objects to and from most of the supported formats and found that I only had a couple of (apparently) major problems. One concerned a particular object which I had made using Imagine. I re-made it and had no further trouble, so maybe it was something to do with the orientation of the object's axis (Imagine is perverse in that it places the Z axis where the Y axis would normally be). A more serious fault surfaced when it appeared that Imagine objects generated by Pixel 3D 2.0 would not render correctly

with Phong shading enabled. I called Axiom Software in the States to explain the problem. The solution is to make use of the Merge function in Imagine - it's not a problem with Pixel 3D 2.0, more the way that Imagine handles some objects. Problem solved - thanks guys! The ARexx functions work fine too. It does take practice to understand everything that goes on, but in my opinion it is worth it, as you will be repaid later on. **AS**

SHOPPING LIST

Pixel 3D 2.0 (inc VAT)..... £99.95
by Axiom Software
Available from:
HB Marketing Ltd,
Unit 3, Poyle 14,
Newlands Drive,
Colnbrook,
Slough SL3 0DX
☎ 0753 686000

**CHECKOUT
PIXEL 3D 2.0**

Documentation ●●●●○
Informative, with good examples, though some omissions.

Features ●●●●○
Extensive - more than enough for most.

Ease of use ●●●●○
Simple and effective.

Speed ●●●●○
Even faster with the accelerated version.

Price Value ●●●●○
The only slight drawback (sells for \$70-\$80 in USA).

Overall rating ●●●●○

No real competition for Pixel 3D 2.0's usefulness, unless you're a Real 3D user. Great time saver for 3D users and well worth the investment. By the way, if your friends like it there's a fully working, though non-saving, demo also included on the disk. So they can try before they buy.

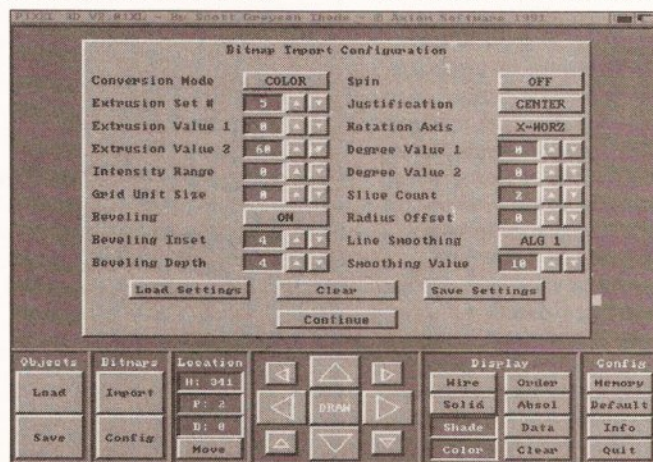

The configuration requester is used for setting the parameters which will affect bitmap image manipulation by Pixel 3D 2.0

If you thought MIDI programming was difficult then think again – this month Paul Overaa shows how even a newcomer to Basic can create useful diagnostic tools...

MIDI trouble-shooting

Almost everyone meets the odd MIDI snag at some point. You connect up your Amiga, MIDI interface, and other equipment, switch on and bingo – it doesn't work as expected, or not at all!

What could be wrong? If the sequencer isn't recording it could be wrongly set up. It could be the synthesizer feeding the sequencer or a lead may be faulty. In more unfortunate cases there may be a hardware fault on the Amiga's serial port, on the MIDI interface, or in one or more pieces of MIDI equipment.

It's not too difficult to plan out a course of fault-finding action – ask yourself what faults could fit the known facts... and try to find ways of eliminating each fault from your investigations.

As with most things, a bit of commonsense goes a long way and it does pay to start by considering those things which, from past experience, seem likely candidates. If, for example, you have four MIDI units chained together driven by a sequencer, yet only the first appears to be receiving any MIDI signals, you ought to realise that there is a good chance that the cause is related to the lead between the first and second MIDI units.

GO BY YOUR INSTINCTS

As a fault-finder your first instinct should be to check the connections between the first two MIDI units and make sure that not only have the correct MIDI sockets been used but that the connectors have been properly pushed in. Once satisfied that no silly slips in these areas have been made you might consider that the lead between those first two units is to blame. Look at the DIN connectors (dirt and grime could create a poor contact – an easy and quick check to make).

If the connectors on the lead look OK, you should, having eliminated other likely alternatives, be led to the conclusion that there is at least a 'high probability' of the lead having an internal break somewhere. A reasonable next step would be to swap that suspect lead for another one. The object of the exercise now being to attempt to prove (by eliminating the fault) that

the connecting lead was to blame, or to disprove it (by showing that changing leads made no difference). These commonsense-driven arguments will usually lead to the right conclusions quickly but it is important to realise that you should always go for the obvious potential causes first: needless to say – rank outsiders, such as there being three separate cases of hardware faults, should not really be entering your mind during early investigations!

There are times when the problem may not be so easily solved. Perhaps you are transmitting program change messages, or transmitting control sequences, which do not seem to be having any effect. In many such cases it helps to get away from your sequencer and generate the equivalent messages using your own diagnostic or MIDI utility programs. There are many occasions where 'home-grown' MIDI programs can be of use – programs which can generate program change messages, MIDI time clocks, or short SYSEX messages, frequently come in handy. Similarly a program which can read incoming MIDI data and tell you about the types of messages which are arriving can be used to good effect! It turns out that all of these are very easy to do and over the last few months it has become obvious from your letters that some help in these areas would be welcome.

Real-time MIDI programming, such as is required by a sequencer, can be difficult. Accurate time-stamping of events often means getting involved with low-level serial port control (eg using the Amiga resource pathway which allows you to hit the hardware directly).

There are a surprising number of MIDI communications applications where these types of programming skills are unnecessary. Believe it or not, there are many useful MIDI diagnostic utilities that can be written with just a few lines of Basic and this in fact is exactly the area I'd like to look at this month.

What I want to do is provide a few no-frills explanations of some fundamental ideas which hopefully, everyone who has AmigaBasic (or an alternative Basic) will be able to get something useful out of! None of the code fragments or example programs

NUMBERS, BASES AND THINGS THAT GO BUMP IN THE NIGHT

In the decimal number system 10 different symbols (the digits 0-9 inclusive) are used to represent numbers. Each digit in a number is ten times more significant than the digit to its right, and ten times less significant than the digit to its left. This 'ten times' relationship that exists between the digits of all decimal numbers is obviously a fundamental part of the decimal numbering system – if, for example, we consider the number 374 and write a full description of what each digit means we can see that it is just a convenient way of expressing this sum...

$$(3 \times 100) + (7 \times 10) + 4$$

Going one better than this and, bearing in mind that any number raised to the power zero is unity, you can express each effective digit term as a product of one digit and a power of 10 like this...

$$3 \times 10^2 + 7 \times 10^1 + 1 \times 10^0$$

For decimal numbers 10 is known as the 'radix', or base, of the numbering system but many other bases are possible. Computers use binary, ie base 2, numbers which consist of strings of 0s and 1s and again if you think of a binary number in terms of its explicit radix = 2 representation it's easy to see the relationship between the binary and decimal number systems...

$$1011 \text{ binary} = 1 \times 2^3 + 0 \times 2^2 + 1 \times 2^1 + 1 \times 2^0 \\ 8 + 0 + 2 + 1 = 11 \text{ decimal}$$

By writing out what the binary number means in full it becomes quite easy to see that 1011 binary is the decimal number eleven!

Computers use binary numbers internally because the two digits 0 and 1 relate directly to the possible states of bits within the memory hardware of most computer systems. Binary numbers are then intimately involved with a great many computing applications but, since they are not that easy for us humans to work with (because long strings of 0s and 1s are easily misinterpreted) a related radix scheme is often used as an alternative.

Hexadecimal numbers use a radix of 16 and the sixteen symbols used are the digits 0-9 plus the letters A-F. Each column in a base 16 number therefore represents some power of the base. For example the decimal number 16 itself is written as 10 hex, because...

$$10 \text{ hex} = 1 \times 16^1 + 0 \times 16^0 \\ 16 + 0 = 16 \text{ decimal}$$

Similarly 1F hex would be...

$$1F \text{ hex} = 1 \times 16^1 + 15 \times 16^0 \\ 16 + 15 = 31 \text{ decimal}$$

The fact that the bases of the binary and hexadecimal numbering systems are power related (2 to the power of 4 equals 16) produces a special, and very useful, relationship between these two numbering systems – it allows one hexadecimal digit to represent four binary digits. Best of all the binary <-> hex conversion process is very easy to understand once you've learnt the following table...

| binary | hex | binary | hex |
|--------|-----|--------|-----|
| 0000 | 0 | 1000 | 8 |
| 0001 | 1 | 1001 | 9 |
| 0010 | 2 | 1010 | A |
| 0011 | 3 | 1011 | B |
| 0100 | 4 | 1100 | C |

continued on page 91

are going to be too complicated but they will require a working familiarity with both binary/hexadecimal number conversion and bit-orientated AND/OR operations. To avoid cluttering the main Basic text I've dealt with these issues separately and the following discussions therefore assume that you are already binary and hex literate!

TRANSMITTING DATA

When using the SER: device from Basic the complexities of the Amiga's serial port are relatively transparent. All the programmer has to remember is that Preferences needs to be used to set suitable serial port characteristics, namely, a baud rate of 31250 with no parity or handshaking, and just one stop bit.

File handling from AmigaBasic, and most other Basics, is straight-

terminal newline character).

There are several ways of transmitting longer messages but the easiest approach is to build up the messages using CHR\$() with Basic's string concatenation operator (+). To transmit a two byte program change message, I'd need to send a program change status byte followed by the patch number. The channel-n/patch-p message takes this form...

| Status byte | Data byte |
|-------------|-------------------------|
| 1100 mnm | binary pppp pppp binary |

Providing that we remember that MIDI channel numbers 1-16 are transmitted as the numbers 0-15 and patch commands 1-128 are represented by the numbers 0-127, it is easy to work out which bytes need to be transmitted. If we wanted to transmit a patch number = 5

LISTING 1 • LISTING 1 • LISTING 1

```
SUB PlayChord(type$,rootnote,channel) STATIC
  IF type$="major" THEN RESTORE MajorChord
  IF type$="minor" THEN RESTORE MinorChord
  READ count
  FOR I= 1 TO count
  READ interval
  PRINT#1,FNNoteOn$(rootnote+interval,channel)
  NEXT I
END SUB
```

forward. Basic's sequential file handling input/output conventions are that you 'output TO a file' or 'input FROM a file' -so to open the serial device for sending serial data this statement could be used...

```
OPEN "SER:" FOR OUTPUT AS #1
```

To make sure MIDI data is sent at once (and not buffered), it is best to explicitly set a buffer size of 1 byte. This modified form does the job...

```
OPEN "SER:" FOR OUTPUT AS #1 LEN=1
```

With the serial device open, all that's needed is a way of sending MIDI messages. The easiest way is to place them in a string variable or expression. Let's suppose that I wish to transmit a MIDI real-time stop message (which is a single byte whose value is decimal 252, ie FC hex) - Basic has a number of string conversion functions but the most useful for current purposes is CHR\$(). This converts a numeric argument into a 1 byte character string. If I use it in conjunction with Basic's PRINT# statement like this...

```
PRINT# 1, CHR$(252);
```

MIDI stop message will be transmitted (the final semicolon prevents Basic from transmitting a

command on MIDI channel 2 we'd need to incorporate the numbers 4 and 1 respectively into the general message just described. The binary, hex, and decimal forms of the required numbers are as follows...

| Prog Change | Status Byte | Channel | Data Byte | Patch Number |
|-------------|-------------|---------|-----------|--------------|
| 1100 | 0001 | binary | 0000 | 0100 |
| C | 1 | hex | 0 | 4 |
| ie | 193 | decimal | | 4 |

and so the message which needs to be transmitted is this...

```
PRINT# 1, CHR$(193) + CHR$(4);
```

Most programmers however prefer to use hex values for status bytes and, in the above example, this would be done by re-writing the fragment as...

```
PRINT# 1, CHR$(&Hc1) + CHR$(4);
```

Why use hex? Because working out decimal values for the status bytes makes it harder to see what the status byte represents. The 1 value in the above status byte C1 hex tells you that the byte refers to a channel 2 MIDI message, and the C tells you that the status byte refers to a program change message. The same information is there when the status byte is in decimal form...

continued from page 90

| binary | hex | binary | hex |
|--------|-----|--------|-----|
| 0101 | 5 | 1101 | D |
| 0110 | 6 | 1110 | E |
| 0111 | 7 | 1111 | F |

To convert a hexadecimal number into binary form you just replace each hexadecimal digit with its group of four binary digits. To convert a binary number to its hex form you peel off (from right to left) groups of four bits and replace them with the corresponding hex digit!

So, to convert CF hex to the binary equivalent you'd replace each of the two hexadecimal symbols with the binary equivalents like this...

CF hex = C F
1100 1111 = 11001111 binary

To go the other way you take groups of four bits from the binary number and replace them with the corresponding hex digits. The binary number 1111000010101010, for example, could be translated to hexadecimal form as follows...

1111000010101010 = 1111 0000 1010 1010
F 0 A A = FOAA hex

Using (and converting between) binary, hex and decimal number systems is not that difficult but it does take practice. Familiarity with hex and binary number forms is also essential for understanding how the bitwise logical operations provided by most high-level languages work. For this month's MIDI instalment I've used logical AND and OR - these perform operations based on these two truth tables...

| X | Y | X AND Y | |
|---|---|---------|-----------------------|
| 0 | 0 | 0 | |
| 1 | 0 | 0 | |
| 0 | 1 | 0 | Logical AND Operation |
| 1 | 1 | 1 | |

| X | Y | X OR Y | |
|---|---|--------|----------------------|
| 0 | 0 | 0 | |
| 1 | 0 | 1 | |
| 0 | 1 | 1 | Logical OR Operation |
| 1 | 1 | 1 | |

Being able to 'picture in your mind' what these tables mean is a big advantage - if you AND two operands together then only the bit positions where both operands have a bit set to 1 will produce a 1 in the result. With the OR operation you'll get a 1 in the result when either (or both) of the bits in that position in the corresponding operands are set to 1.

The bit pattern for FO hex for instance is 11110000 so ANDing any value with FO hex will force the lower four bits of the result to zero - the value FO hex is called a mask because it 'masks out' certain bit positions. You'll find examples of this type of use in this month's instalment. The OR operation is also useful because it can force bit positions to take particular values. You'll find an example in the main text where a MIDI channel number is combined with a general MIDI message code to create a complete status byte.

One last thing... AmigaBasic, like most Basics, requires hex numbers to be identified by using an &H prefix. Hence in AmigaBasic FO hex would be written as &HFO, FAA hex would be &HFAA, and so on.

I don't really like to see programs littered with CHR\$() type statements. A useful idea, as far as constant values are concerned, is to isolate the characters transmitted so that they are no longer embedded in the main code. One approach is to place any required definitions at the start program. The definition...

```
REM define constants...
message$=CHR$(&Hc1) + CHR$(4)
```

might, for instance, be used later as:

```
PRINT# 1, message$;
```

You don't have to use constant values in the PRINT# expressions. To send a two byte message consisting

of the numerical values X and Y we could use something like:

```
PRINT# 1, CHR$(X) + CHR$(Y);
```

If X=&Hc1 and Y=4, the same message as described earlier would be transmitted.

GOING LOOPY...

The variable approach is useful when used as part of a Basic FOR/NEXT loop. To send all 128 channel program change messages on MIDI channel 2 I could use this loop:

```
X=&Hc1
FOR Y=0 to 127
PRINT# 1, CHR$(X) + CHR$(Y);
NEXT Y
```

To send the program change patch 5 message on all sixteen MIDI channels I'd use a loop to modify the status byte value:

```
FOR X = &HC0 TO &HCF
PRINT# 1, CHR$(X) + CHR$(4);
NEXT X
```

If all program change messages on all channels were to be sent a double loop, this would do the job...

```
FOR X = &HC0 TO &HCF
FOR Y=0 TO 127
PRINT# 1, CHR$(X) + CHR$(Y);
NEXT Y
NEXT X
```

In general, it is better to use meaningful variables names. In a real program the above fragment might be written as something like...

```
FOR STATUS = &HC0 TO &HCF
FOR PATCH = 0 TO 127
PRINT# 1, CHR$(STATUS) + CHR$(PATCH);
NEXT PATCH
NEXT STATUS
```

As well as binary <-> hex <-> decimal conversion, budding MIDI programmers need to be happy about extracting part-values from a byte. Given a channel message status byte, for instance, we'll often need to be able to identify the channel and the message type. Channel numbers can be obtained from a status byte by masking out the upper four bits of a byte by ANDing with &HF, like this...

```
channel=ASC(status$) AND &HF
```

Similarly masking out the lower four bits (by ANDing with &HFO) will give the isolated MIDI message class in the top four bits of the number...

```
messagetype=ASC(status$) AND &HFO
```

Sometimes the alternative situation will occur and you'll want to build up a status byte from the component channel and message type values. Here the values are combined by ORing, so to create and send a Note-On status byte we would OR &H90

with the channel number and transmit the value using this...

```
PRINT# 1,CHR$(&H90 OR channel);
```

To transmit a complete Note-On message we'd follow the status byte with a number and a velocity value...

```
PRINT# 1,CHR$(&H90 OR channel)
+CHR$(note)+CHR$(velocity);
```

The string part of these types of fragments are useful and easily turned into user-defined functions (UDFs). Here's one which sends a complete MIDI Note-On message on a specified channel, this time using a fixed velocity value of 64...

```
DEF FNNoteOn$(note,ch)=CHR$( &H90 OR
(ch-1))+CHR$(note)+CHR$(64)
```

Subtracting one from the channel

middle C root) on that channel. When the left mouse button is pressed the major chord is cancelled and changed to C minor, and, when the left mouse button is pressed again that minor chord is also cancelled. Not what you'd call an 'earth shattering' MIDI program but it does illustrate how such ideas can fit together in a real program...

Once you know how to transmit one type of MIDI message, you can apply the same type of principles to any MIDI message. Having to work with binary and hex numbers takes some getting used to at first, but it is particularly important for MIDI programming.

As with most things the solution to any difficulties in this area is to practice - have a look in your synthesizers MIDI implementation chart or manual, see which messages the synthesizer can

LISTING 2 • LISTING 2 • LISTING 2

```
REM
REM User-defined functions...
DEF FNNoteOn$(note,ch)=CHR$(&H90 OR (ch-
1))+CHR$(note)+CHR$(64)
DEF FNNoteOff$(note,ch)=CHR$(&H80 OR (ch-
1))+CHR$(note)+CHR$(64)
REM Constants...
MajorChord: DATA 3,0,4,7
MinorChord: DATA 3,0,3,7
root=60
REM
REM Main program code...
OPEN "SER:" FOR OUTPUT AS 1 LEN=1
INPUT "Please enter MIDI channel ";channel
CALL PlayChord("major",root,channel): GOSUB CheckMouse
CALL CancelChord("major",root,channel)
CALL PlayChord("minor",root,channel): GOSUB CheckMouse
CALL CancelChord("minor",root,channel)
CLOSE 1
END' Logical end of program
REM
REM Subprograms and subroutines...
SUB PlayChord(type$,rootnote,channel) STATIC
IF type$="major" THEN RESTORE MajorChord
IF type$="minor" THEN RESTORE MinorChord
READ count
FOR I= 1 TO count
READ interval
PRINT#1, FNNoteOn$(rootnote+interval,channel)
NEXT I
END SUB
REM
SUB CancelChord(type$,rootnote,channel) STATIC
IF type$="major" THEN RESTORE MajorChord
IF type$="minor" THEN RESTORE MinorChord
READ count
FOR I=1 TO count
READ interval
PRINT#1, FNNoteOff$(rootnote+interval,channel)
NEXT I
END SUB
REM
CheckMouse: IF MOUSE(0)<>-1 THEN CheckMouse
RETURN
REM
```

LISTING 3 • LISTING 3 • LISTING 3

```
OPEN "SER:" FOR OUTPUT AS 1 LEN=1
FOR channel = 1 TO 16
CALL PlayChord("major",root,channel)
NEXT channel
GOSUB CheckMouse
FOR channel = 1 TO 16
CALL CancelChord("major",root,channel)
NEXT channel
CLOSE 1
END' Logical end of program
```

number lets me use conventional channel numbers from 1 to 16 rather than having to work in terms of the internal representations (ie the values 0-15). Here is the alternative function to turn a note off...

```
DEF FNNoteOff$(note,ch)=CHR$( &H80 OR
(ch-1))+CHR$(note)+CHR$(64)
```

It's possible to use these functions in all sorts of ways. I could, for example, use DATA statements to define chords by adopting the convention that my data statements consisted of a note count followed by the values of the harmony intervals (from some unspecified root note). Descriptions could be built up so...

- MajorChord: DATA 3,0,4,7 : REM three notes - root, major 3rd, and fifth

- MinorChord: DATA 3,0,3,7 : REM three notes - root, minor 3rd, and 5th

and it would be possible to write a subprogram to play the notes of a chord on a specified MIDI channel. Listing 1 gives an example...

In listing 2 I've put these ideas into an example which asks the user to provide a MIDI channel value, and then plays a major C chord (with a

recognise, and write a few of your own UDF based programs - this experimentation will help you understand what happens to your music at the nuts and bolts level.

Here's a couple of suggestions to get you started:

To write a program which transmits a C chord on all sixteen MIDI channels you could change the code in the main program of listing 2 to that shown in listing 3...

Alternatively you could create a MIDI Patch (program change) transmitter based on this user-defined function...

```
DEF FNSendPatch$(patch,ch)=CHR$(
&HC0 OR (ch-1))+CHR$(patch)
```

At this stage we come back full-circle to the subject of MIDI fault finding. The bottom line is that by being able to understand and generate your own MIDI test data you will be in an infinitely better position than the user who regards MIDI communications as some sort of 'electrical magic'.

COMING SOON...

Next month I'm going to continue these Basic discussions by looking at the opposite problem... reading and decoding MIDI data as it arrives at the serial port. **AS**

LOWEST PRICES

BCS SPRING OFFERS

CDTV £445

★ OFFER 1 ★

Philips CM8833 Mk II + on-site maintenance + F19 Flight Sim + lead **£928**

★ OFFER 2 ★

A500 Plus Cartoon Classics Pack + Philips CM8833 MUII Lead + F19 + On-site maintenance. **£575**

★ OFFER 3 ★

A500 Cartoon Classic Pack + Cumana External Drive **£400**

★ OFFER 4 ★

NEW BANX STACKABLE BOXES
80/90 Cap£8.95
130/150 Cap£16.95

DISKS DISKS DISKS

100% certified error free

50 3.5" DS/DD£22.50
100 3.5" DS/DD£37.00
150 3.5" DS/DD£52.50
200 3.5" DS/DD£68.00
400 3.5" DS/DD£138.00
500 3.5" DS/DD£160.00
1000 + Call for spot prices
Prices include VAT & free delivery & free labels

New 100 capacity 3.5" lockable boxes & disks

No quibble lifetime guarantee

50 3.5" DS/DD + 100 cap lockable box...£25.50
100 3.5" DS/DD + 100 cap lockable box...£40.50
150 3.5" DS/DD + 100 cap lockable box...£56.50
200 3.5" DS/DD + 2 100 cap lockable boxes...£74.00
400 3.5" DS/DD + 4 100 cap lockable boxes...£147.00
500 3.5" DS/DD + 5 100 cap lockable boxes...£174.50
All prices include VAT & free delivery & free labels

DISKS + STACKABLE BANX BOXES

50 3.5" DS/DD + 80 Cap Banx Box...£31.00
100 3.5" DS/DD + 80 Cap Banx Box...£45.00
200 3.5" DS/DD + 2 x 80 Cap Banx Box...£85.00
500 3.5" DS/DD + 5 x 80 Cap Banx Box...£199.00
Prices include VAT/Labels/Delivery

5.25" DS/DD Disks21p each
5.25" DS/HD Disks39p each

3.5" DS/HD Disks 60p each

100 3.5" DS/HD...£61.00 INC. P&P

150 Cap 3.5" Posso Box.....£15.50
60 Cap 3.5" Stackable Box....£10.00

3.5" 10 Cap boxes.....£0.85 each
3.5" 40 Cap boxes.....£4.10 each
3.5" 100 Cap boxes.....£4.50 each
5.25" 50 Cap boxes.....£5.10 each
5.25" 100 Cap boxes.....£5.90 each

PRINTERS

Star LC - 20£150
Star LC - 200 Colour.....£205
Star LC - 24 200 Colour.....£265

AMIGAS

A500 Plus 2Mb Cartoon Pack.....£405
A500 Plus 1Mb Cartoon Pack.....£345
Class of the 90's£450
A1500£650
Amiga A500 Basic Pack.....£299
A500 Basic Pack.....£299

ACCESSORIES

Amiga Daatascan Professional.....£145.00
1/2Meg + Clock.....£29.00
1000 Labels.....£8.00
Cumana Drive.....£58.00
1000 Tractor Labels.....£10.00
Amiga Mouse£14.00
Mouse Mat.....£2.50
Stingray Joystick£13.50
A590 Hard Drive.....£280.00
Printer Lead.....£8.00
A590 + 2Mb Ram£370.00
Zipstick£11.00
A500P 1Mb Upgrade.....£57.00
A590 Hard Drive.....£265.00
1 meg A500 Plus Upgrade.....£59.00

ORDER HOTLINE:

0273 506269 / 0831 279084

All prices include VAT. Add £4 delivery unless stated. Add £10 next day. Cheques will be held for clearance.

Call or send cheques / postal orders to:

**BCS Ltd.,
349 Ditchling Road, Brighton,
East Sussex, BN1 6JJ**

All offers subject to availability. E&OE

Due to shortages of 3 1/2" DSDD disks, prices may change without notice



WINNER OF COMPUTER SHOPPER MAGAZINE BEST CREATIVITY SOFTWARE NON PC 1991

ZONE DISTRIBUTION



Dr.T's MUSIC SOFTWARE

Dr T's produce more AMIGA music software than any one else. They support their products with regular updates giving you new exciting features. Buy any Dr T's product in the knowledge that it will offer good value, features and support. Notation packages, sequencers, editors and more for novices and professionals alike. As their authorised UK distributor only ZONE are able to fully support all Dr T's products and supply updates, upgrades etc to all REGISTERED USERS. Ring or write for free information and advice.

Dr T's Phantom is a very reliable and accurate device that acts as standard Amiga MIDI interface and a SMPTE timecode reader/writer. It couldn't be easier to synchronize your music to video or audio tape



Phantom™ Synchronization for video and audio is easy!

£249

- High quality MIDI interface
- Bit accurate SMPTE with offset
- 24, 25, 30 and 30 drop
- MPE compatible
- Store configs. to disk
- Supports KCS, Presenter, Showmaker and Bars & Pipes
- Protection from crosstalk & Dropouts.
- Works with any Amiga

SAVE £6 000 with X-oR

Believe it or not X-oR is a complete editor/librarian for over 120 synths and MIDI devices from all the big (and small) manufactures. Even at just £50/editor this represents over £6,000 worth of editors in one package for just £219. Not to mention X-oR's extensive librarian facilities, MPE compatibility (real time voice edits thru KCS), randomisation and a constantly updated profile list is it hardly any wonder X-oR is so popular.



Attention all MUSIC X owners upgrade your MUSIC X to the new KCS 3.5 for just **£149**

* Saving £130 off KCS 3.5 rrp of £279. This is a limited offer subject to availability. Music X disks must be returned to qualify. Call for full details. To utilize all the KCS features 2mb RAM is recommended

KCS is the most powerful MIDI sequencer available for the Amiga. Its ease of use, reliability and rock steady timing have made it many friends. Regular updates also make it the best supported. Now with even more features like realtime graphic editing and notation, the new KCS 3.5 is the only choice for the serious Amiga musician.

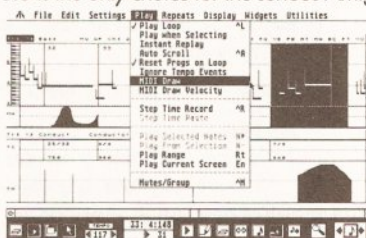

AMIGA FORMAT



92 % Dec 1991

Read the rave reviews in Sound on Sound, Amiga Computing, Amiga Shopper, Amiga Format

- Graphic Tape Recorder interface
- TIGER realtime Graphic editing
- Full quantise and loop record
- Multi program environment
- Notation display/ printing
- Draw/edit data in realtime
- Supports SMPTE thru phantom or MSPP
- Variable resolution up to 384ppq
- Automix, on board MIDI Mixer
- 48 tracks/126 seq/16 songs
- Supports full SMPTE and MSP

THE BEST SUPPORT FOR THE BEST MUSIC SOFTWARE IN THE WORLD

All trademarks acknowledged

5, Abbeville Rd, London SW4 081 766 6564 (3 lines)

Exclusive distributors for Dr T's, Band in a Box, Blue Ribbon, Trycho Tunes and more.

Please rush me information on your products
NAME ADDRESS POSTCODE COMPUTER

The extremely polite Phil Harris kicks off with a look at BBS etiquette before homing in on modems, escaping the clutches of BT and taking a wander around the End Zone

Mind your language

This month we're taking a closer look at your modem, in particular the Hayes command set. We're also making one of our regular visits to a BBS: this month it's the turn of The End Zone in Lancashire. Finally we're examining Mercury and how it can save you money.

First off though we take a quick look at BBS etiquette, exactly what you should and should not do while visiting your favourite BBS.

BBS ETIQUETTE

When calling a BBS it is important to remember that you are a visitor on another person's computer and behave accordingly. Most boards have a few rules designed to make the BBS a pleasant place, and these should be followed.

The majority of BBS callers use their modems to obtain the files which are available easily and cheaply. A BBS relies on a constant stream of new and interesting software to keep popularity up and it is always a good idea to try and upload a new file once in a while. The sysop will appreciate it and so will the other users.

Try and take a look at the messages available on the system every now and again, it doesn't take long and very often you'll be able to help someone out and maybe make some new friends as well: try to keep your language clean, a wide range of people read BBS messages and many will be offended by strong language.

KEEP IT CLEAN

Always try and exit the BBS "cleanly", don't just hang up. This can sometimes cause the board to "hang", preventing other users from getting through. Sometimes it is unavoidable - if you do have to hang up, try and go back on to leave a message for the sysop to let him know what happened.

One of the most important things to remember is that the sysop of a BBS usually runs it in his spare time for pleasure, not profit. He does not have to run the system. At the very

least you should leave him a message once you have been made a full member, thanking him and if at all possible making some constructive comments about the board. Most sysops will respond favourably if you do.

If at all possible try paging the sysop occasionally and have a chat with him/her, they can often be quite helpful and are always friendly.

So to summarise:

Do:

- Upload new files when you can
- Offer constructive criticism
- Show your appreciation of the sysop
- Respect the sysop's wishes
- Use Smileys etc, when the meaning of a comment could be misunderstood
- Take a look at the message areas

Don't:

- Drop the carrier, exit properly
- Try to crash the system or "hack" into areas where you aren't wanted

Setting up modem options from within NComm. Some of the commands may seem rather complex, but never fear, if they're new to you, *Amiga Shopper's* here to help you out with a guide to those Hayes commands (see page 97)

- Page the sysop continually
- Deliberately annoy other callers

Above all, it is important to remember that sysops are human too!

JARGON BUSTING • JARGON BUSTING

BBS - A Bulletin Board System. A BBS is simply an electronic noticeboard. Callers to the system leave messages for other users to see, or can download and upload files for other people.

Download - To transfer a file from a BBS to your own computer. Boards will usually limit the amount of time you have to spend downloading files, although many boards reward uploads with longer download times. Even if this is not the case, you should try and upload a new file every now and again, to keep the board fresh and show your appreciation to the sysop.

Hayes - A standard for commands for modems. Allows automatic dialling, answering etc.

Mailbox - The place where a person's Electronic Mail is stored.

Modem - A MODulator DEModulator. A modem is used to translate digital signals from your computer to and from audible signals that can be transmitted down a telephone line.

Terminal - A software package which allows you to communicate with a modem. Features vary but all include a transfer protocol of some sort.

Transfer Protocol - A method of ensuring error-free transmission of files. A transfer protocol is a system for checking and acknowledging sections or "packets" of a file, each packet is re-sent until it arrives correctly, ensuring each program transmitted arrives in good condition. There are many protocols available, XModem and ZModem being the most common.

Upload - To transfer a file from your own computer to a BBS.

HAYES COMPATIBILITY

One of the most useful facilities available in modern modems is Hayes compatibility. Modems which feature a Hayes compatible command set allow automatic dialling, answering, mode selection and all sorts of other goodies. The majority of modern modems will feature Hayes compatibility but older and cheaper modems may not. Before buying your modem, it's a good idea to check whether or not it has got Hayes compatibility. If not, then be prepared for a bit more work.

Hayes compatibility is not essential, however. It is perfectly possible to use a modem manually with most comms packages although Hayes compatible modems are well worth getting if you can afford the little extra they cost.

HAYES COMMAND SET

Hayes compatible modems work using series of commands which are typed at the keyboard of your computer and used to remotely dial, answer and so on. Most communications packages (NComm for instance) enable you to set initialization and dialling strings which contain the required commands and are used automatically to control your modem.

Command mode is entered by typing AT followed by a number of options, for instance D to dial a number or B to set the mode. The AT part of the string need only be entered once, so to set the mode and dial a command string such as ATB5D0813901244, <RETURN> could be used. The command entered is stored in a 40 character internal buffer and can be reused if required (see below).

Not all commands start with AT though, a few command buffer orientated one do not, and they are also listed below.

SOME OF THE HAYES COMMANDS AVAILABLE

Hayes commands are a standard way of setting up your modem. Here are some of the more important ones and what they do.

● **ATA: Answer immediately.**
This command will cause the modem to try and answer an incoming call. It is useful for connecting to another modem without the need for a BBS system. The other person simply dials your telephone number, and when you hear it ringing you type ATA, the modem will answer the phone to establish the link.

● **A/: Repeat the last command.**
Repeats the last command string you entered. The command buffer is only cleared by a new AT command or oss of power.

● **A%: Display what is currently stored in the command buffer.**
The command buffer is not cleared so A/ can still be used.

● **ATBn (eg. ATB5): Set the mode.**
This command is used to determine the speed of operation of the modem and whether the modem is originating calls or answering them. The exact numbers available will vary depending on the speed of your modem but the most common ones shown in figure 1 opposite.

● **ATCn (eg. ATC0): Carrier on/off.**
This command controls the status of the carrier signal. Issuing the command ATC0 will turn the carrier off -this will have the result of hanging up during a call. Having done this though, the carrier will not turn on again until a ATC1 (carrier on) or ATZ (reset) command is issued.

The ATC1 command turns automatic carrier control on, it also turns the carrier on immediately. It is best to turn the carrier off using the hang up command (ATH). The default for this option is carrier on.

● **AT&Cn (eg AT&C1): Carrier detect line mode.**
With this option set to 1 (the default)

the carrier detect line indicates the presence or absence of the carrier, otherwise the line is permanently active.

● **ATD (eg. ATD0813901255): Dial.**
Puts the modem into originate mode and begins to dial. There are several options available within the dial string which effect its operation, see DIALLING.

● **ATEn (eg. ATEn): Command echo on or off.**
ATE0 disables command echoing, whereas ATE1 turns it on. With command echoing any commands entered will be "echoed" back to the terminal.

● **ATHn (eg. ATH0): Directly controls the relay used by the modem to seize and drop the line.**

turned off; if it is one, the speaker is turned on until the carrier is detected, allowing you to listen to the call being made. If a value of three is used the speaker is always on.

● **ATO: Go on-line.**
Used to return to a line having left it with a valid escape sequence (see below)

● **ATP: Sets the modem into Pulse dialling mode.**

● **ATQn (eg ATQ0): Determines whether result code should be sent or not, if n is 0 they will be.**

● **ATSr? (eg AT3?): Returns the value contained in one of the modems registers.**
The registers available will depend on your modem but some examples are shown in REGISTERS.

● **ATSr=n (eg. ATS12=10): Sets the value of the specified register (r) to n.**

● **ATT: Sets the modem into tone dialling mode.**

● **AT&Tn (eg. AT&T1): Performs a self test.**
After running this test the number of errors found will be returned. Values less than 10 are OK.

● **ATVn (eg. ATV1): Sets result codes (see below) to either verbose (n=1) where result codes are returned using words, or terse (n=0) which uses digits.**

● **ATXn (eg. ATX2): Controls the result code set used.**
Either basic (n=0), Extended (n=1) or 255-Extended (n=2)

● **ATZ: Terminates any link with another modem and resets all parameters to their default values.**

FIGURE 1: MODEM SPEEDS AND MODES (ATBn command)

The example settings shown below are for a 2400 baud modem supporting V21, V22, V23 and V22bis.

| | | | |
|------|------------|-----------------------|-----------|
| n= 0 | V22 alt B | 1200 baud Full duplex | Originate |
| 2 | V21 | 300 baud Full duplex | Originate |
| 3 | V22 alt B | 600 baud Full duplex | Originate |
| 4 | V22 | 1200 baud Full duplex | Originate |
| 5 | V22bis | 2400 baud Full duplex | Originate |
| 6 | V23 mode 2 | 1200 baud Half duplex | Host |
| 16 | V22 alt B | 1200 baud Full duplex | Answer |
| 18 | V21 | 300 baud Full duplex | Answer |
| 19 | V22 alt B | 600 baud Full duplex | Answer |
| 20 | V22 | 1200 baud Full duplex | Answer |
| 21 | V22bis | 2400 baud Full duplex | Answer |
| 22 | V23 mode 2 | 1200 baud Half duplex | Terminal |

● **AT&Dn (eg. AT&D2): Data terminal ready line mode.**
Controls the operation of the DTR line, with the following options:
• n=0 Modem ignores DTR line
• n=1 Modem enters command state when DTR line goes from on to off

ATH0 (or just ATH) is used to hang up the modem at the end of a call.

● **ATI n (eg. ATI2): Returns selected product or setup information.**
For instance ATI2 will return details of the current settings of the modem,

FIGURE 2: RESULT CODES

BASIC SET (ATV0)

| Numeric | ASCII | Meaning |
|---------|------------|-----------------------------------------|
| 0 | .OK | Command completed successfully |
| 1 | CONNECT | Carrier detected |
| 2 | RING | Ringing signal detected (incoming call) |
| 3 | NO CARRIER | Carrier has been lost |
| 4 | ERROR | Incorrect command entered |

EXTENDED SET (ATV1)

| As above plus | | |
|---------------|--------------|---------------------------|
| 5 | CONNECT 1200 | 1200 baud connection made |
| 9 | CONNECT 600 | 600 baud connection made |
| 10 | CONNECT 2400 | 2400 baud connection made |

255-EXTENDED SET (ATV2)

| As above plus | | |
|---------------|--------------|------------------------------------------------|
| 21 | CONNECT 7512 | 75 baud receive, 1200 baud transmit connection |
| 22 | CONNECT 1275 | 1200 baud receive, 75 baud transmit connection |

Note:
No matter which set of codes are used, a 300 baud connection will always be reported using CONNECT.

• n=2 Modem hangs up line and enters command state when the DTR line goes off
• n=3 Modem resets completely when the DTR goes off

it's mode, the number of stop bits etc.

● **ATMn (eg. ATM2): Controls the audio monitor.**
The action depends on the value of n. If n is 0, the speaker is always

The default mode is 2.

ESCAPE SEQUENCES

Escape sequences are used to force the modem from on-line modem to command mode. An escape sequence is made up of three escape characters which are usually "+" although this can be changed (see register S2).

When an escape sequence is used, it must be preceded and followed by a guard time during which no characters must be transmitted. The length of the guard time is determined by the value in S12.

After an escape sequence has been used to enter command mode the ATO command can be used to return on-line.

continued on page 97

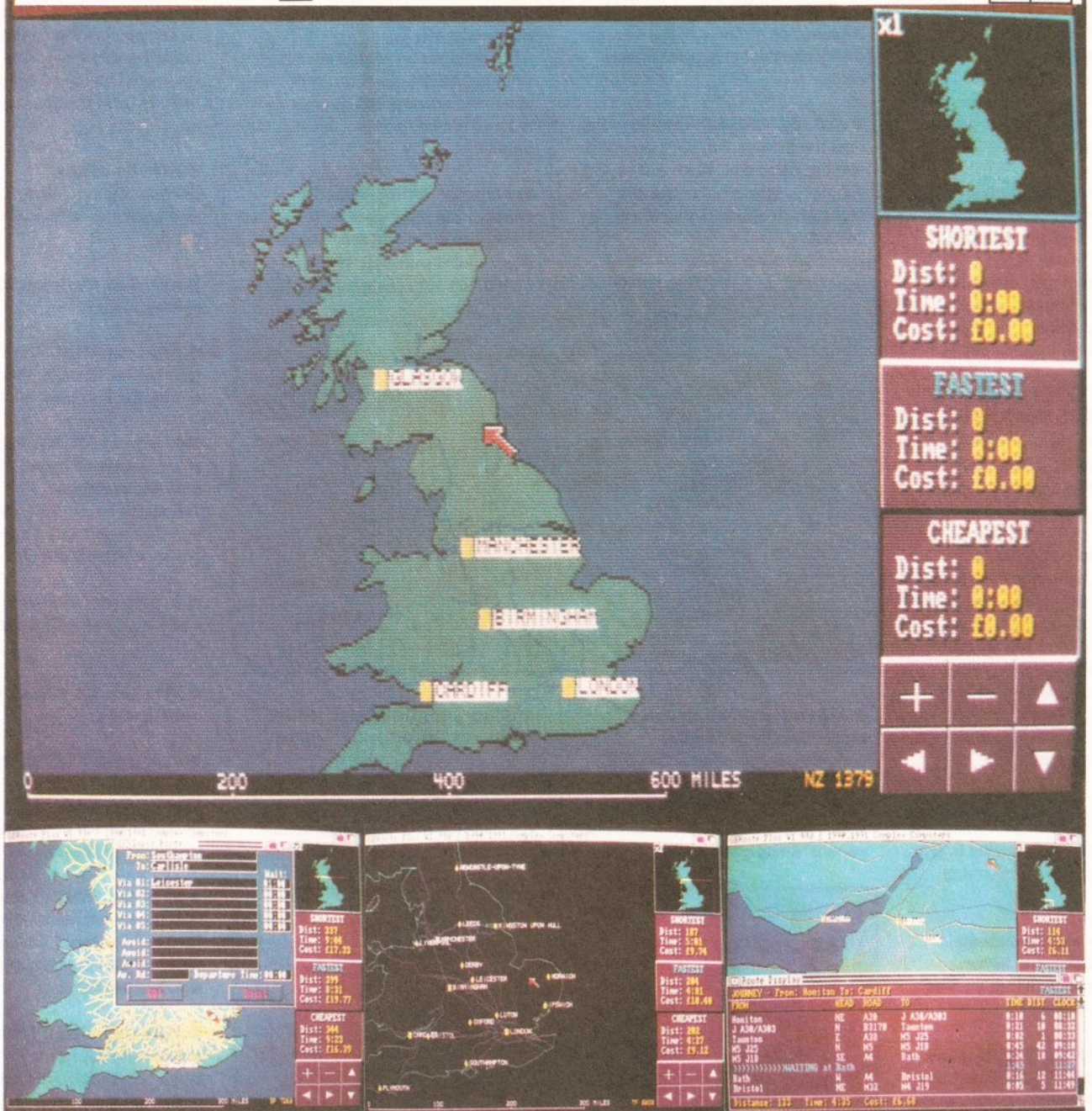

£79.95 Inc Vat
1 Meg Required

GBRoute Plus Route Planner for the Amiga

£79.95 Inc Vat
1 Meg Required

GBRoute Plus for the Amiga computer has been carefully designed to assist the United Kingdom motorist plan easily and efficiently journeys almost anywhere in the UK. GBRoute Plus will not only find routes but will also cost, time and distance a journey in a matter of seconds, allowing the user to then print out a route or graphical map in either black and white or colour. There are many other features within the software designed for ease of use many of which allow the user to customise the program to suit the individual driver.

Features include:-

- * Over 25 Million possible routes
- * Calculate shortest, fastest and cheapest routes
- * Includes Motorways, A roads and B roads
- * Includes Cities, Towns and many Villages
- * 5 Via options, 3 Avoid places and avoid road
- * Colour and wireframe map graphics
- * Interlace display
- * Supports colour and black and white printers
- * Map scrolling and zooming facilities

Features Include:-

- * Motorway service stations included
- * Road Bias facility for six classes of road
- * 10 levels of magnification to a 1 mile scale
- * Mileage scale bar
- * National grid coordinates
- * Colour palette requester
- * ARexx support - over 50 commands
- * Vector mileage calculator
- * 3D look user interface

Dealers Contact:

1. Leisure Soft
2. HB Marketing
3. Laser Distribution
4. Centresof/IBD
5. SDL

Amiga Shopper:
"The original GB Route was great, but Complex has so enhanced it, that its virtually perfect."

GBRoute Plus is available from most good Amiga dealers

Telephone: 0706 224531 - Fax: 0706 225320

Complex Computers-2 The Arcade, Waterfoot, Rossendale, Lancs BB4 9AF



continued from page 95

RESULT CODES

Hayes modems return a series of "result codes" which help you and your software determine what is happening. There are three sets, BASIC, EXTENDED and 255-EXTENDED and the result codes for these are shown in figure 2 on the previous page. Which set of result codes to be used is determined using the ATV command.

DUPLEX MODES

There are three types of "DUPLEX", communications modes which modems can operate in. *Full Duplex* means that transmission of data can take place in both directions simultaneously. In *Asymmetric Duplex* mode, only one device can transmit at full speed at any one time, but the other can transmit at a much lower speed (such as V23, 1200/75 baud). Finally, in *Half Duplex* only one device can transmit at a time.

PRECISION DIALLING

Dialling is performed using the ATD command followed by the number you wish to dial. There are also several other options which allow you to control the dialling more precisely.

● R - Reverse mode

This option is used to allow a modem to autodial an originating modem. Its main use is for connecting to modems which do not have an auto answer mode.

● P,T - Pulse & tone dialling mode

Controls the type of dialling to be used, which one should be used depends on the type of telephone exchange you have.

● W - Wait for secondary proceed

This is used mainly for private exchange and waits for a proceed tone. For example, if a 9 must be dialled to get an external line, the dial string would be ATD9W0812341234. This would dial the 9, wait for the proceed tone and then continue dialling.

● , - Pause

A comma in a dial string inserts a delay of n seconds where n is obtained from register S8 (see REGISTERS). The first comma after a digit will have a minimum delay of 4 seconds and can be used instead of the W option to allow for connection to an outside line, or Mercury exchange.

● ; - Return to command state

Placed at the end of a dial string it causes the modem to return to command state after the number has been dialled.

THE END ZONE

From time to time, I plan to visit a few BBSs to give you a better idea of what is available. This month it's the turn of the End Zone. I first encountered The End Zone when I was setting up my own BBS and the sysop, Adam, proved to be extremely friendly and knowledgeable. Since then the board has gone from strength to strength and currently boasts a 1.2Gb hard drive and loads of files to go on it. I'm happy to say, that despite this increase in size, he's still as helpful and friendly as ever.

The board is not exclusively devoted to the Amiga, it also covers PC, Archimedes and other machines. But around half the callers are Amiga owners and there is an impressive array of public domain Amiga software available for download. Unfortunately Amiga owners are shirking their duty somewhat and not uploading as much software as Adam would like. I'm sure this will change in the future though.

```

Dialing End Zone...
Number: 0524 752245
Speed: 2400
Comment: (none)
Script: ncomm:scripts/endzone.script
Config: (none)
Macros: (none)
Retries: 0
Next: (Select from menu)
Esc/Abort Space/Next Del/Remove
  
```

Going on-line - when you dial End Zone from within NComm 1.921, the above information appears

HERE FIDO

As with all good boards The End Zone is part of Fidonet and features the usual echomail areas, including some of the more obscure areas such as Police Questions and International Recipes, so whether you're planning on

joining up with the forces or even an evening to impress a special person, you know where to look!

ONE OF THE GANG

The End Zone also operates an entirely voluntary membership scheme. Paid-up members are given unlimited time on-line and unlimited downloads. Members can also obtain any software on the board by sending a disk to Adam, he will copy the software and return the disk free of charge. All this for just £10 a year!

INTO THE KITTY

The money from the membership goes towards improving the board, for instance buying a new hard drive and in particular towards getting a new line - so, you can be sure that it's all in a good cause. One thing you'll notice about the board is that it's very busy. It can often take a while to get through but there are quiet periods, 5am being the quietest!

GIVE IT A GO

So if you haven't already, why not try giving The End Zone a ring and take a look at one of the most exciting boards around at the moment. The End Zone can be found on 0524 752245. Leave me a message if you do, and don't forget to mention *Amiga Shopper* when you register.

Message Areas:

| | |
|----------------------------------------|----------------------------------------|
| 1 ... Private Mail | 2 ... Local Amiga Chat |
| 3 ... Local PC Chat | 4 ... Local Archimedes Chat |
| 5 ... Local Atari St Chat | 50 ... Security Watchdog Message Area |
| 100 ... Netmail Messages | 102 ... European Amiga Microcomputer D |
| 103 ... Communications | 104 ... Modems |
| 105 ... IBM Computers and Compatibles | 106 ... Bulletin Board Advents |
| 108 ... 'C' Programming | 109 ... DESQView Multitasker |
| 110 ... UK Remote Access Support | 111 ... Hard Disk Problems |
| 112 ... Cinema/TV/Satellite Discussion | 113 ... Acorn Archimedes Microcomputer |
| 114 ... Telix Communications Package | 115 ... Comms HelpLine |
| 116 ... SOS/SDM Files Info | 117 ... Virus News/Discussion |
| 118 ... HST Modems | 119 ... Driving/Motoring |
| 120 ... For Sale/Wanted | 122 ... Recipes and cooking tips |
| 123 ... Computer security | 124 ... BiModem Users |
| 125 ... Desk top publishing | 126 ... European files info |
| 127 ... Police Questions | 128 ... Hardware Interest |
| 129 ... International Recipes | 130 ... Law related micro chat |
| 131 ... Pascal programmers | 132 ... Public Domain Software |

More(Y/n/-)?

All manner of files are to be found when you dial End Zone from within NComm

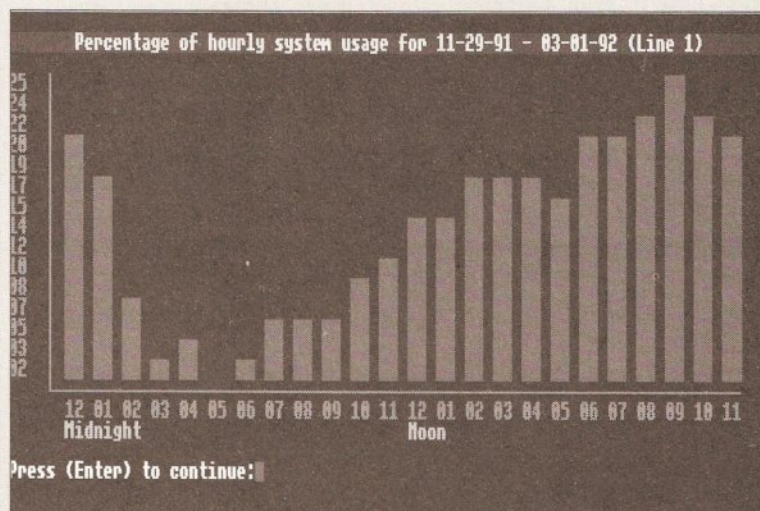

A graph showing the daily usage of the BBS, obviously 5am is the best time to call - "the early bird catches the worm", as they say

REGISTER MANIA

Hayes compatible modems contain a range of registers which are used to store various values used to control the modem. Here are a few of the more useful ones:

● S0 Autoanswer off/on (Number of rings)

This register contains the number of rings which are allowed before the modem answers the phone. A value of 0 means that the modem will never answer the phone.

● S1 Incoming ring count

Used internally to count the number of incoming rings.

● S2 ASCII value of escape code

The ASCII value of the character which is to be used as an escape character, usually 43 (+).

● S6 User defined

This register can be used for anything the user wants, although not particularly useful for most people there are times when it could be used to temporarily store information.

● S7 Wait time

The time (in seconds) that the modem will wait between the end of a dial command or an auto answer before it will give up and return to command mode.

● S8 Pause time

The length of time in seconds that a pause in a dial string will wait for.

● S12 Escape code guard time

The time that must be left clear before and after an escape sequence before the system goes into command mode.

There are many more registers in the majority of modems, but most will not be used during normal use.

SAVE MONEY THE MERCURY WAY

The biggest bane of any comms fan's life is the telephone bill incurred in the pursuit of that elusive file. There are ways of cutting costs. A faster modem is the most obvious choice, the faster the modem the less time spent downloading files and the less it all costs.

The other obvious way of cutting bills is to escape the clutches of BT. Currently the only way to do this is to change to Mercury Communications and this isn't anywhere near as difficult as it might sound at first.

THE UP SIDE 8-)

First off, let's dispense some myths. Mercury do not have their own lines, they lease BT lines. This means that

once you have a Mercury account you can call almost anywhere that you can with normal BT equipment. I say almost because there are some calls you can't make, in particular local calls in some places.

No special equipment is needed to use a Mercury line. It is possible to purchase a special Mercury phone which includes a magic blue Mercury button although this is by no means essential - we'll be telling you how to get around this later.

All that is required to use Mercury is a Mercury PIN number. One of these will cost you just under £9 a year. A Mercury PIN number is a unique ten digit number which identifies any calls you make. This means that you can use it anywhere with any phone and the calls will be billed to you.

Using your PIN number couldn't be easier, simply press the Mercury button on a phone and then dial your PIN number and then the telephone number you wish to call. That call will be routed via Mercury taking advantage of their cheaper rates (roughly 20% cheaper than BT). Mercury also use one-second billing as opposed to BT's Unit, which makes things even cheaper.

The other major advantage of Mercury is the option of monthly,

fully itemised bills, at no extra cost. This will allow you to keep track of your calls much more easily.

THE DOWN SIDE 8-(

Of course there has to be disadvantages. Firstly, not all exchanges can offer the Mercury service although the majority can and the list is getting longer by the day.

Secondly, you still have to pay the BT line rental but for people who make regular long distance calls the savings are still considerable.

The third disadvantage is the use of the Mercury button and PIN number. When using a modem it is a real pain to have to press the blue button, enter your PIN and then set the modem dialling. At first sight it would seem there is no way around this, but *Amiga Shopper* is here to help.

MERCURY DIALLING THE EASY WAY

When you press the blue button on a Mercury telephone all it does is dial 131. This tells the exchange that you wish to go via Mercury. After a short time a tone will be heard and you then dial your PIN. Then you dial the telephone number as normal.

LATE NEWS • LATE NEWS • LATE NEWS

Guru 10 (0524 752245) has undergone another upheaval since we last mentioned the board. The faithful Amiga has broken down again and the board has been moved to a PC. The board has certainly livened up though, despite the change of software and a Fidonet address has also been obtained so things are beginning to look up.

So, to avoid the need for a blue button simply dial 131, wait, then dial your PIN. Obviously this makes using Mercury with a modem much easier, particularly as you can use commas to add delays. Just set up a dial string such as ATD131,1234567890,0812431856 and away you go.

Most comms packages will allow you to set up a dialling prefix which is dialled every time you ring a number. Programming this with your 131 and your Mercury PIN would ensure that all your calls go via Mercury.

All that remains is to mention that I don't work for Mercury and have no financial interest in the company, I just enjoy saving money. Mercury can be contacted on 0800 424 194. And if anyone wishes to try out Mercury for free my PIN number is..... NO CARRIER

GOING VISITING

There are an enormous range of BBSs out there, and occasionally you need a guide. Although I won't be covering a specific board each month, I do intend to occasionally visit a board which really stands out. The End Zone is one of those boards. All the gen on the End Zone can be found on page 97, if you haven't already read it, that is.

NEXT MONTH

Next month I'll be taking a look at automating your comms work using the scripting facilities of *NComm*, a light hearted look at the range of modem users you're likely to find haunting the BBSs and for beginners, how to get the most out of your comms package. See you then. **AS**

Philip Harris can be contacted as piharris@compulink.co.uk or as "PHILIP HARRIS" on Guru 10 BBS (0738 52063).

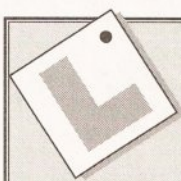

FRONT PANELS A BEGINNERS GUIDE

Modern modems usually have a bewildering array of lights along the front panel which flash on and off at seemingly random intervals. Not wanting to leave you bewildered, we've come up with a guide to all those lights.

DTR - Data Terminal Ready. This light is lit when the terminal to which the modem is attached is ready to send or receive data. The DTR is usually taken high at the start of the session and remains so until the end of the call.

RTS - Request To Send. When this is high (lit) the computer is signalling to the modem that it can accept another character.

CTS - Clear To Send. The modem uses this line to tell the computer that it is ready to receive another character. When the modem is ready, the line goes high and the LED lights. The CTS line is used to facilitate "hardware handshaking" to prevent missed characters, and is especially important on fast (>2400 baud) modems.

DCD - Data Carrier Detect. This LED is lit when the modem detects a carrier, which signals that a connection has been made. It stays on until the connection is broken.

TXD - Transmitted Data. This LED flashes once for every character transmitted, including characters typed while in command mode.

RXD - Received Data. Flashes briefly every time a character is received from the remote computer.

OL - On-line. This light shows when the modem is using the telephone line.

AA - Auto Answer. Lights when the modem is in auto answer mode. Surprisingly this is only found on modems which have the ability to enter auto answer mode.

POWER - Errm, yes well.

Oh yes, do remember that not all of the above lights will be shown, some older modems get away with a lot less.

AMOS ACTION

Anyone can write games using AMOS. Read on to find out how you too can get in on the action!

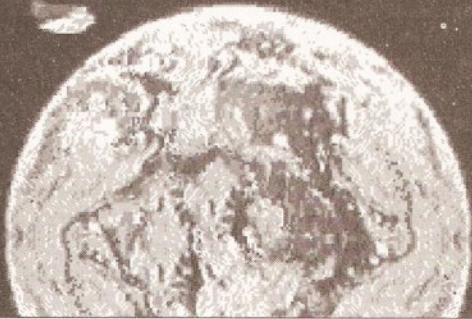

So you want to write a game using AMOS, eh? Our new AMOS columnist Jason Holborn shows you how to achieve this dream

Games aren't usually the domain of *Amiga Shopper*, but the AMOS column is the exception. Don't worry – we're not going to bore you with endless reviews of AMOS-produced games or anything as dull as that. Instead, we'll show you how you can write games using nothing more than your Amiga, a copy of AMOS and *Amiga Shopper*.

During its two years of existence, AMOS has been applied to many programming tasks from tracking down faults in cars to more conventional programs such as databases and word processors. But about 98% of AMOS owners bought AMOS for one thing only – games programming. There's no doubt that AMOS is a powerful language, but using AMOS for anything other than games is like driving a Ferrari F40 which is stuck in first gear – a total waste of the power at your fingertips!

Over the coming months we'll be showing you just how simple it is to write games with AMOS. We're not promising to turn you into the AMOS equivalent of Jez San or Andrew Braybrook, but I'm sure you'll find

games programming very rewarding. No introduction to programming games would be complete with just a look at how games work. It's all very well knowing how to scroll the screen and move sprites, but there are other aspects which can make or break a game. So, we'll be covering virtually every aspect of this ancient art from designing good-looking sprites, to using sampled sound effects, designing maps and more besides. Stay tuned – I think you'll find the coming months a real eye-opener!

HOW GAMES WORK

Games programming has always been seen as something of a mystical art grasped only by the chosen few, but in fact games aren't as complex as you might think. Fact is, all games are based around the same theory. Once you've grasped this and you feel confident enough to put it into practice (by writing AMOS source code!), you'll be churning out games faster than you imagined.

All games are based around a loop which performs all the functions that must be performed for the game to run. In the case of an arcade

SPRITES MASTERCLASS

Professional games development has come a long way since the days of the back-room programmers. Back in those days the programmer was responsible for virtually every aspect of a game's design and implementation. These days though, programmers stick to programming while the job of designing the game, drawing sprites and backgrounds and writing the game's soundtrack are all delegated to specialist game designers, graphic artists and musicians respectively.

Problem is though, unless you can find a friend who is either nifty with the pixels or a talented songster, all this work is left down to you. In this, the first in a series of tutorials, we'll be showing you the techniques which the professionals use to make their games look and sound great. This month we start with the much underrated art of sprite design.

1 Before you sit down in front of your Amiga and boot up AMOS, the first thing to do is to have some idea of exactly what you're trying to achieve. Tinkering around in the AMOS sprite designer can produce some nice sprites, but it's a very time consuming process. A much better bet is to get your hands on a pen and a piece of paper and draft out a few rough ideas first, developing these ideas until you get a sprite that you're happy with. It's not important whether you can draw or not – even the worst scrawls are fine as long as you can make out the basic shape of the sprite you are designing.

If you're designing a sprite based around a real life object (a car or a tank, for example), it's worth popping down to your local library for a couple of books which contain illustrations that you can work from. The car sprite was actually drawn from a photograph of a Sierra Cosworth that I took myself. I know the shape of a Cosworth pretty well, but I wouldn't have been able to faithfully produce a decent sprite without some source material to work from.

Designing imaginary objects such as space ships and aliens is slightly more tricky. After all, unless you want to use Space Shuttles and Saturn 5 rockets in your shoot'em up, there's little in the way of source material. It's not a good idea to copy sprites from sci-fi films simply because of copyright hassles. It's also very uncool if someone recognises your alien attack fighters from some tacky 1950s B-movie. If you do use somebody else's spaceship design, at least modify it so that its origin can't be spotted!

How do you go about designing spaceships? This is where the pen and paper really comes into its own. You don't have to mess around selecting different icons, you can let your imagination run riot. Start off with a basic shape and then try changing different aspects of the sprite – the shape of the nose cone, the size of any wings etc.

2 The next step is to transfer it on to your computer. AMOS does come with its own sprite designer, but I must admit that I rarely use this to actually draw sprites from scratch. It's fine for building up sprite banks, but a much better tool to use for the process of drawing sprites is good old *DPaint*.

Before you start drawing away, you must ask yourself a couple of questions. First, how many colours will your game use? 8? 16? 32? Second, how many of these colours will be available for sprites? This is one mistake



Designing sprites based around real life objects is considerably easier if you've got some decent source material to work from *continued on page 100*

game, each time this loop is completed, the screen is redrawn once so the faster you can get AMOS to execute this loop, the faster your game will run. There is a point where the Amiga's screen redraw rate won't be able to keep up with your program (on a PAL machine, there's no point redrawing the screen more than 50 times per second!), but, although AMOS is pretty rapid, you're unlikely to find this a problem unless you code large sections of your game in assembler. Even then, you should always tie screen redraws in with the vertical blanking period of the screen using the AMOS 'WaitVBL' command. If you don't use WaitVBL, any objects that you have moving onscreen will appear to flicker terribly.

LOOP THE LOOP

So what does the main game loop actually do? The best way to understand this bit of trickery is to imagine a game slowed down to just a single loop per second (most well-programmed commercial games run at about 25 frames per second). At the start of the loop, the first thing to happen is the joystick being checked. If it is being pushed in a particular direction, the X and Y values of the player's sprite ('sprite' can refer to 'true' hardware sprites and software sprites like Bobs) will be updated to reflect the sprite's new position. It isn't redrawn - this comes later.

Once the player's sprite has been updated, the next step is to update the positions of any other sprites on the screen - aliens for example. If you're writing something like a Galaxians game, all your aliens will follow a set path which must be defined within your program - 20 steps left, 20 steps down, 20 right, 20 up etc. This fixed attack pattern is soon learned by the player though (eg an arcade game where an entire attack wave can be wiped out simply by sitting in one position, merrily blasting away?), so if you want to add more of a challenge to your game, it doesn't take a lot of effort to add a bit of intelligence to your sprites. More on this in a future AMOS column though!

The positions of all the sprites in your game have now been updated, so all that remains is to redraw them. This can be handled automatically by AMOS, but I prefer to turn off Bob redrawing and handle this manually. Once all the Bobs have been redrawn, the loop checks to see if any of the sprites have collided. Obviously you're not that worried about all sprite collisions - aliens bumping into other aliens, for example - so if a collision has taken place, the loop jumps to a routine which sorts out the collisions you don't want to know about from those

that you do, then acts upon them accordingly (eg if one of the player's missiles collides with an alien, an explosion will be drawn).

Now all that remains is to update the score. If no collisions are detected, the game will carry on as normal, but if a player's missile strikes an alien, points will be added.

So there you have it, the main game loop in all its glory. Obviously there are many other steps which need to be considered - what happens if the player's ship has been hit, for example? - but the bare bones are there. All that now remains is to add the meat to those bones by writing the AMOS code which will handle all the above tasks.

THE MAIN GAME LOOP

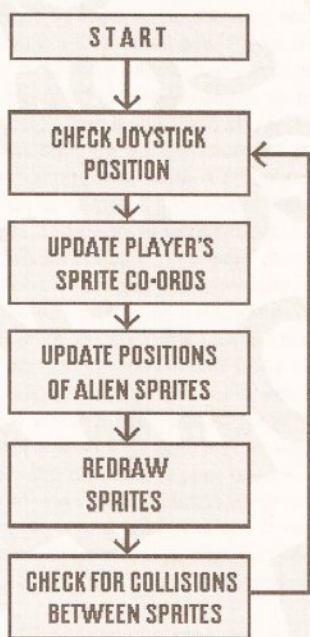

The main game loop contains all the routines that must be executed for a game to run

As it stands, this is a pretty daunting task, but you can make things somewhat easier by breaking each step down into subroutines.

AMAL ACTION

Writing games in assembler is hard work, but AMOS users are spoilt rotten. Many operations that assembler programmers write from scratch are handled automatically by AMOS - interrupt driven music, sprite animation, double buffering etc.

One of the most powerful aspects of AMOS is AMAL, its under-rated animation language. AMAL programs run much faster than their AMOS equivalents so it's worth using AMAL as much as possible when writing a game. What's more, AMAL routines run under interrupt, so you can set them up and running and then virtually forget about them. If you're writing a game which requires the screen to be scrolled, a very

continued from page 99

that many budding games programmers make. It's all very well to design a sprite which uses all the colours available on your game's screen, but you'll soon find this extremely limiting. After all, what happens if you want to change the colour of the background? Answer - Your sprite changes colour too.

It's worth allocating colour registers to different aspects of your game's screen - if you used a 32-colour screen, for example, you might allocate the first sixteen colours to all your sprites and bobs and the second sixteen colours to the background. Once this is done, stick to it.

3 Now we can start to draw our sprites. I always start off by drawing a black outline of the sprite like that shown in step.1 of my car sprite illustration. Because you're using one colour to trace out the shape of your sprite, it's considerably easier to correct any mistakes that you might make. If you jump straight in with lots of colour, you'll find that making corrections takes a lot longer at this stage.

When drawing the outline, try to include as much detail as you can so that you can dump your rough sketches once the outline is complete. Don't get too detailed though - as long as you can make out the basic shape and a few of the more outstanding features then this'll be more enough. Details like individual nuts and bolts on an aircraft wing aren't really needed - concentrate instead on the more important details like the shape of the windows in your car, the air-inlets on your spaceship etc.

4 Once the basic outline of your sprite is there, you can start to add in some colour. At this stage we're not that worried about shading - that comes later - but what is important is to add the basic colours that make up your sprite. In the case of our car sprite, there's really only four basic colours - one for the bodywork, one for the glass in the car's windows, one for the car's underside and tyres, and another for the rear indicator cluster. These four basic colours will do for the meantime, as they serve only to add more depth to the sprite, making the process of adding shading that bit simpler.

5 The final stage of actually drawing our sprite is to add detail to the rather flat sprite we have so far. Shading can be added simply by creating a range of colours (try not to use more than four colours per range though!) using DPaint's 'SPREAD' and 'RANGE' tools. Then, simply by layering the shades in series, a greater feeling of depth can be added. This method of shading works particularly well when you're trying to design a spite that has rounded edges or is cylindrical in shape - the fusillage or an aircraft, for example.

6 Once your sprite is finished, all that remains is to port it into AMOS. If you bought yourself a copy of the AMOS Compiler, you'll already have a copy of Aaron Fothergill's 'SpriteX', a vastly upgraded version of the AMOS sprite designer. One of the most useful aspects of SpriteX is the built-in sprite grabber which allows you to load in an IFF picture (such as the one we produced with DPaint) and literally 'grab' out sections of the image and assign them to positions within an AMOS sprite bank.

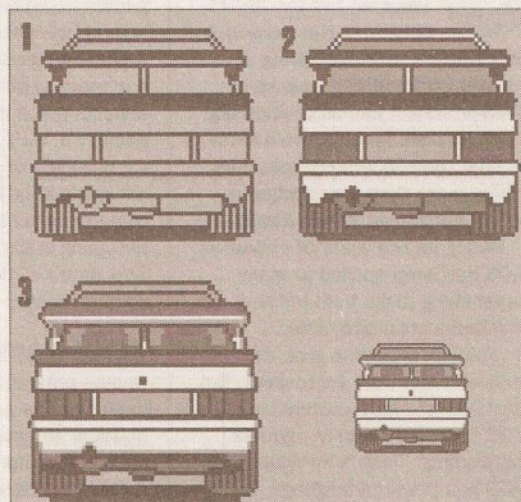

Always start your sprites with an outline and then add in the basic colours followed by any shading and details required

Those of you who aren't lucky enough to own SpriteX can still do the same job using the separate AMOS Sprite Grabber utility included on the AMOS Extras disk. You'll probably have to load the sprite bank that the Sprite Grabber produces into the AMOS Sprite editor for a bit of cleaning up, but once this is done your sprites are ready for use.

HELP!

If you've got a problem with AMOS, why not put your mind at rest by writing in to *Amiga Shopper*? Send your letters to: **AMOS ANSWERS, Amiga Shopper, 30 Monmouth Street, Bath, Avon BA1 2BW**

the process of keeping track of the screen scrolling and the player's ship automatic. The code printed below was from a game called 'Moon Patrol' which I wrote within the first few weeks of receiving AMOS.

```
' AMAL control programs for ↓
main ship and background scroll
' Works on standard 320 by ↓
256 (PAL) resolution screen
hs$=" Let RD=4;Let X=0"
hs$=hs$+" A:Pause;If J1&8=8 ↓
Jump B;If J1&4=4 Jump C;Jump F"
hs$=hs$+" B:Let RX=RX+4;Let ↓
RD=4;If RX=320 Jump D;Jump G"
hs$=hs$+" C:Let RX=RX-4;Let ↓
RD=-4;If RX=0 Jump E;Jump G"
hs$=hs$+" D:Let RX=0;Jump G"
hs$=hs$+" E:Let RX=320;Jump G"
hs$=hs$+" F:If RD=4 Jump B;If ↓
RD=-4 Jump C;Jump A"
hs$=hs$+" G:Let X=RX;Jump A"
```

```
sh$=" Let RY=160
sh$=sh$+" A:Pause;If J1&8=8 ↓
Jump B;If J1&4=4 Jump C"
sh$=sh$+" If J1&2=2 Jump D;If ↓
J1&1=1 Jump E;Jump H"
sh$=sh$+" B:Let A=32769;Jump H"
sh$=sh$+" C:Let A=1;Jump H"
sh$=sh$+" D:Let RY=RY+2;If ↓
RY>216 Jump F;Jump H"
sh$=sh$+" E:Let ↓
RY=RY-2;If RY<26 ↓
Jump G;Jump H"
sh$=sh$+" F:Let ↓
RY=216;Jump H"
sh$=sh$+" G:Let ↓
RY=26;Jump H"
sh$=sh$+" H:Let ↓
X=RX+176;Let ↓
Y=RY;Jump A"
```

```
Channel 0 to ↓
Screen Offset 1↓
; Pointer to ↓
screen to be ↓
scrolled
Channel 1 to Bob ↓
1; Pointer to ↓
player's ship bob
Amal 0,hs$
Amal 1,sh$
Amal On
```

simple AMAL program is all that is needed to get the screen scrolling in the direction that you want automatically. Without the help of AMAL, you'd have to add an extra routine to your main game loop that handled screen scrolling, increasing the time that it takes for the main game loop to be executed still further. Using AMAL can speed up your game considerably, so always try to use AMAL before you decide to write a routine using AMOS' native commands.

Take for example a game like Defender. You don't want the player's ship to move - this just sits

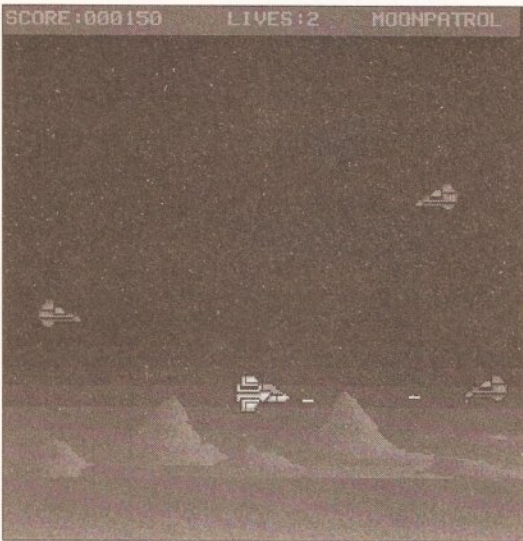

When writing a game, try to use AMAL as much as possible. AMAL is ideally suited to handling the scrolling of screens and the player's sprite control

The game is looking a bit long in the tooth

in the centre of the screen while the attacking ships and the background move around it. Because the screen is being scrolled, if you're using Bobs, the player's ship must be moved to cancel out the screen's movement. So, if the screen moves two pixels to the right, the player's ship must be moved two pixels to the left to keep it centralised. If the direction of scrolling changes, so does the direction of the player's ship - if the screen moves two pixels to the left, so the player's ship must move two pixels to the right.

Something like this can be handled perfectly by AMAL, making

these days, but I still use much of the code extensively. It's far from perfect, but as foundations for more powerful routines, it serves its purpose. If you're feeling adventurous, try adding inertia to the scroll so that it slows down before changing in either direction.

Don't worry too much about the technicalities of scrolling screens and moving Bobs at this point in time. Those of you that already know AMOS will be able to put it to work straight away, but I'll be explaining in detail how to scroll screens and start using sprites and bobs in the next issue of *Amiga Shopper*. **AS**

AMOS ANSWERS

If you're having problems with your bobs and your copper lists don't compute, then write in and tell us. Jason Holborn is the man with the answers.

THE FINAL FRONTIER...

After many months of reading the AMOS column in *Amiga Shopper*, I've finally bought myself a copy of AMOS, the AMOS Compiler and 3D extension. I'm trying to write a 3D game based around the *Star Wars* arcade machine. I've managed to design some nice looking space ships but coding the game is proving to be a problem. I've worked out how to display and move objects on the screen, but I need to be able to move the player's viewpoint to give the impression that the player is actually flying in 3D space. How do I do it?

L Humphries
Melksham, Wiltshire

Moving yourself around within 3D space is just like moving any other object. AMOS 3D refers to your viewpoint as Object 0, so just use the same movement commands as you would for all your objects but tell them to act upon object 0 and you won't go far wrong.

TOME SYNDROME

Please can you help. I'm trying to write a sideways scrolling shoot 'em up but I've stumbled across a problem which looks set to stop my mega-game earning me the millions of pounds that I so deserve. When I started writing the game, the background consisted of nothing more than just a 320 by 200 pixel low resolution screen that was scrolled using the AMOS 'Screen Offset' command. Unfortunately, this looks rather dull. What I'd rather have is a background that changes as the player progresses through the levels. I think the AMOS Map Editor is the answer, but I can't find any mention in the AMOS manual of any commands that will allow me to use these maps within my own programs. Please help before I tear all my hair out!

C Hemphenstall
London

You're right, the AMOS Map Editor is the most efficient answer to this problem. Unfortunately, the

commands to actually handle AMOS maps aren't actually built into the interpreter, so they can't be used directly. Your best bet is to get your hands on a copy of Aaron Fothergill's TOME extension which is available for just £24.99 from Shadow Software. Failing that, all the code you need can be obtained by ripping out the Tame routines from the AMOS demo game *Magic Forest*.

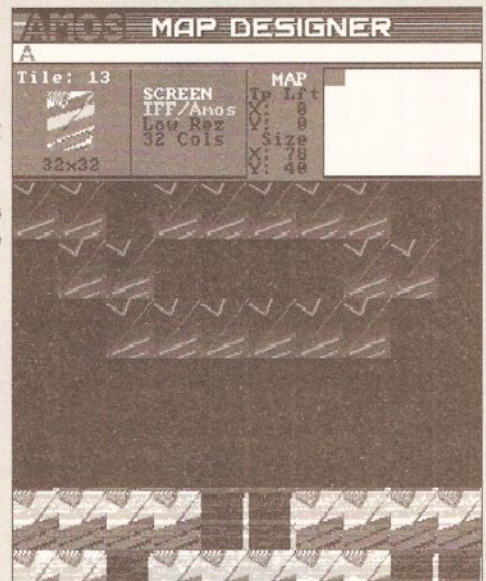

The current release of AMOS doesn't directly support the AMOS Map Editor, but all the code you need to handle maps can be found by ripping the Tame routines out of the AMOS demo game *Magic Forest* pieces

PRINTER PROBLEMS

I hope you can help me. I have written a database in AMOS to catalogue my disk collection. It does all the usual things a database should do such as search and print etc. The problem I have is that I cannot find any info in the AMOS manual to detect whether a printer is connected to the machine the program is running on. If you try to print when the printer is either not ready or just not connected, my program just hangs. Please help!

P Compton
Fareham, Hants

Simple! Providing that you're accessing the printer using the OPEN PORT n,"PRT:" command ('n' being the port number), just read the value of the =PORT function. If a value of -1 is returned, then you can print. If 0 is returned, then the printer is either not ready or not connected.

NEW CD ROM Drive for your
A500/A500 Plus with 2 FREE
CD's ONLY £299



DIAMOND TV Monitor
The best available £249 INC VAT
OR ONLY £229 when purchased
with a computer!

YOU'VE
SEEN IT IN THE
PRESS NOW SEE IT AT
DIAMOND - COMING
SOON A590.

DIAMOND

COMPUTER SYSTEMS LTD

DIAMOND'S SALE HAS BEEN EXTENDED TO MATCH HUGE DEMAND

1Mb RAM  1Mb RAM

PACK

THE CARTOON CLASSIC PACK
AMIGA 500 PLUS
COMPRISING

Lemmings,
Captain Planet,
Bart Simpson,
+Deluxe Paint III,
+ All AMIGA standard
features, Mouse etc.

ONLY **£325.00** INC VAT
Or with 8833 Mk II Monitor
+F19 Promotion
ONLY **£545.00** INC VAT
**WE CANNOT BE BEATEN
ON PRICE**

LIMITED STOCK

2Mb RAM  2Mb RAM

PACK

THE DIAMOND CLASSIC PACK
AMIGA 500 PLUS
COMPRISING

Lemmings,
Captain Planet,
Bart Simpson,
+Deluxe Paint III,
+ All AMIGA standard
features, Mouse etc.

ONLY **£369.00** INC VAT
Or with 8833 Mk II Monitor
+F19 Promotion
ONLY **£589.00** INC VAT
**WE CANNOT BE BEATEN
ON PRICE**

LIMITED STOCK

1Mb RAM  1Mb RAM

PACK

**EVERYTHING BUT THE
KITCHEN SINK PACK**
AMIGA 500 PLUS
COMPRISING

Lemmings, Captain Planet, Bart Simpson,
+Deluxe Paint III,
+ All AMIGA standard features, Mouse etc.
+
Mousemat, Dust Cover, Joystick, 10x3.5" disks,
1 disk storage box, Speedball II, Shadow Of
The Beast II, Car Vup, Corporation, Xenon II,
Back To The Future II, Cadaver, Line Of Fire,
Teenage Mutant Ninja Turtles, St Dragon.

ONLY **£369.00** INC VAT
Or with 8833 Mk II Monitor
+F19 Promotion
ONLY **£589.00** INC VAT
**WE CANNOT BE BEATEN
ON PRICE**

LIMITED STOCK

AS SEEN
ON TV

1Mb RAM  1Mb RAM

PACK

HOME OFFICE PACK
AMIGA 500 PLUS
COMPRISING

Lemmings, Captain Planet, Bart Simpson,
+Deluxe Paint III,
+ All AMIGA standard features, Mouse etc.
+
The Home Office Kit
+
Seikosha 9 Pin Printer

ONLY **£469.00** INC VAT
Or with 8833 Mk II Monitor
+F19 Promotion
ONLY **£669.00** INC VAT
ADD **£75.00** FOR COL PRINTER
**WE CANNOT BE BEATEN
ON PRICE**

LIMITED STOCK

1Mb RAM  1Mb RAM

PACK

BUSINESS PACK
AMIGA 500 PLUS
COMPRISING

Lemmings, Captain Planet, Bart Simpson,
+Deluxe Paint III,
+ All AMIGA standard features, Mouse etc.
+
The Home Office Kit
+
High Quality Oki 24 Pin Printer

ONLY **£579.00** INC VAT
Or with 8833 Mk II Monitor
+F19 Promotion
ONLY **£779.00** INC VAT
ADD **£75.00** FOR COL PRINTER
**WE CANNOT BE BEATEN
ON PRICE**

LIMITED STOCK

1Mb RAM  1Mb RAM

PACK

**CAPTAIN DIAMOND'S
D.I.Y. PACK**

Comprises the Cartoon Classic Pack and a
choice of 10 games from the following list.

Datostorm, Grand Monster Slam, Kid Gloves,
Powerplay, RVF Honda, Shufflepuck Cafe,
Soccer, Tower Of Babel, Dungeon Quest,
Emotion, Speedball II, Shadow Of The Beast II,
Car Vup, Corporation, Xenon II, Back To The
Future II, Cadaver, Line Of Fire, Teenage Mutant
Ninja Turtles, St Dragon, Gazza II, Gunship,
Judge Dredd, Man United, Netherworld,
Predator II, Double Dragon II, Toyota Celica GT
Rally, Rick Dangerous II, Ultimate Golf.

ONLY **£375.00** INC VAT
Or with 8833 Mk II Monitor
+F19 Promotion
ONLY **£599.00** INC VAT
PERSONAL CALLERS ONLY
NO MAIL ORDER

LIMITED STOCK

The NEW Adventures Of CAPTAIN DIAMOND



DIAMOND



**P/X Your old 500
for a new Amiga 1500
for ONLY £299**

**NEW CD ROM Drive for your
A500/A500 Plus with 2 FREE
CD's ONLY £299**

CAPTAIN DIAMOND'S 500 EXTRAS PAGE

ROCTEC PRODUCTS

Hard Drive For A500. simply the best in our opinion

External hard drive with streamline plastic casing for perfect fit to A500. Autoboot + Autoconfig with Kickstart 1.3 and above. Supports up to 2 IDE Hard Drives + 7 SCSI Drives or devices with the SCSI External Port. Expandable to 8Mb SIMMs memory with 2Mb, 4Mb increments. External power adaptor unit included. Games Switch to disable HDD and memory or disable HDD only for full games compatibility. Quiet + reliable operation with cooling fan. User friendly installation + easy upgrade.

ROCHARD HARD DRIVES FOR YOUR AMIGA

| NOW WITH SCSI I/F OPTION | IDE | SCSI |
|--------------------------------|------|------|
| OMb Rochard IDE Card Ok..... | £179 | £199 |
| OMb Rochard IDE Card 2Mb | £229 | £249 |
| OMb Rochard IDE Card 4Mb | £279 | £299 |
| OMb Rochard IDE Card 6Mb | £329 | £349 |
| OMb Rochard IDE Card 8Mb | £379 | £399 |

| | | |
|----------------------------------|------|------|
| 52Mb Quantum Hard Disk Ok..... | £349 | £379 |
| 52Mb Quantum Hard Disk 2Mb | £399 | £429 |
| 52Mb Quantum Hard Disk 4Mb | £449 | £479 |
| 52Mb Quantum Hard Disk 6Mb | £499 | £529 |
| 52Mb Quantum Hard Disk 8Mb | £549 | £579 |

| | | |
|-----------------------------------|------|------|
| 105Mb Quantum Hard Disk Ok..... | £449 | £529 |
| 105Mb Quantum Hard Disk 2Mb | £499 | £599 |
| 105Mb Quantum Hard Disk 4Mb | £549 | £659 |
| 105Mb Quantum Hard Disk 6Mb | £599 | £729 |
| 105Mb Quantum Hard Disk 8Mb | £649 | £789 |

**All Rochard drives and controller cards
come with a 2year warranty**

GENLOCKS

| | |
|--------------------|---------|
| Rocgen | £89.95 |
| Rocgen + | £124.95 |
| Rendale 8802 | £119.95 |
| G2 | £575.00 |
| G2+ | £999.00 |

EXTERNAL FLOPPY ROCTEC DISK DRIVES

| | |
|--------------------------------|--------|
| UltraSlim Roelite | £54.95 |
| Slimline Roctec | £49.95 |
| CDTV DRIVE | £64.95 |
| AMIGA internal floppy | £39.95 |

GVP SERIES 2 HARD DISKS

52Mb ONLY £369.00
105Mb ONLY £529.00

Perfectly matched in colour + style to the AMIGA 500p. 11ms access drive. 1" high drive by Quantum. Room for up to 8Mb of RAM expansion. Cut Off switch for games Expansion 'Mini Slot'. External SCSI port Dedicated PSU and fan. 2 years free warranty. Add **£65.00** per extra 2Mb RAM

| | |
|----------|---------|
| 52Mb Ok | £369.00 |
| 2Mb | £434.00 |
| 4Mb | £499.00 |
| 6Mb | £564.00 |
| 8Mb | £629.00 |
| 105Mb Ok | £529.00 |
| 2Mb | £594.00 |
| 4Mb | £659.00 |
| 6Mb | £724.00 |
| 8Mb | £789.00 |

MONITORS

PANASONIC Multisync monitor **£299** High Res 21" colour **£1599**
Microway Flicker Fixer **£149** CBM Flicker Fixer **£199**
PHILIPS 8833 MkII colour monitor
+ F19 promo and free lead & Dust cover only **£229**

DISKS

We sell over 1,000,000 of our own high quality branded diskettes. Because our name goes on the disks we ensure that the quality meets our exacting standards. We normally source Sony Bulk because of their high clip rate. Clip Rate is the amount of oxide that a disk can lose before it becomes unuseable.

DIAMOND DS D/D 135 T.P.I. 3.5"

1-49 50-99 100-199 200-500 500+
£0.40 £0.39 £0.38 £0.37 £0.36

50 disks in 100 capacity lockable box **£22.95**
DIAMOND HD 3.5"

1-49 50-99 100-199 200-500 500+
£0.59 £0.58 £0.57 £0.56 £0.55

Storage Boxes 3.5" 5.25"

100 capacity **£4.95 £4.95**

150 capacity Passo stacking box **£15.99**

Cleaning Kits (Limited Offer) 3.5" 5.25"

Disk drive cleaning kits **£0.99 £1.99**

**ARE YOU
GETTING IT?**
OUR NEW CATALOGUE
IS OUT NOW! POP INTO
YOUR NEAREST
DIAMOND STORE FOR A
FREE COPY WITH ALL
THE LATEST
SOFTWARE



DID YOU GET A SHOCK LAST CHRISTMAS

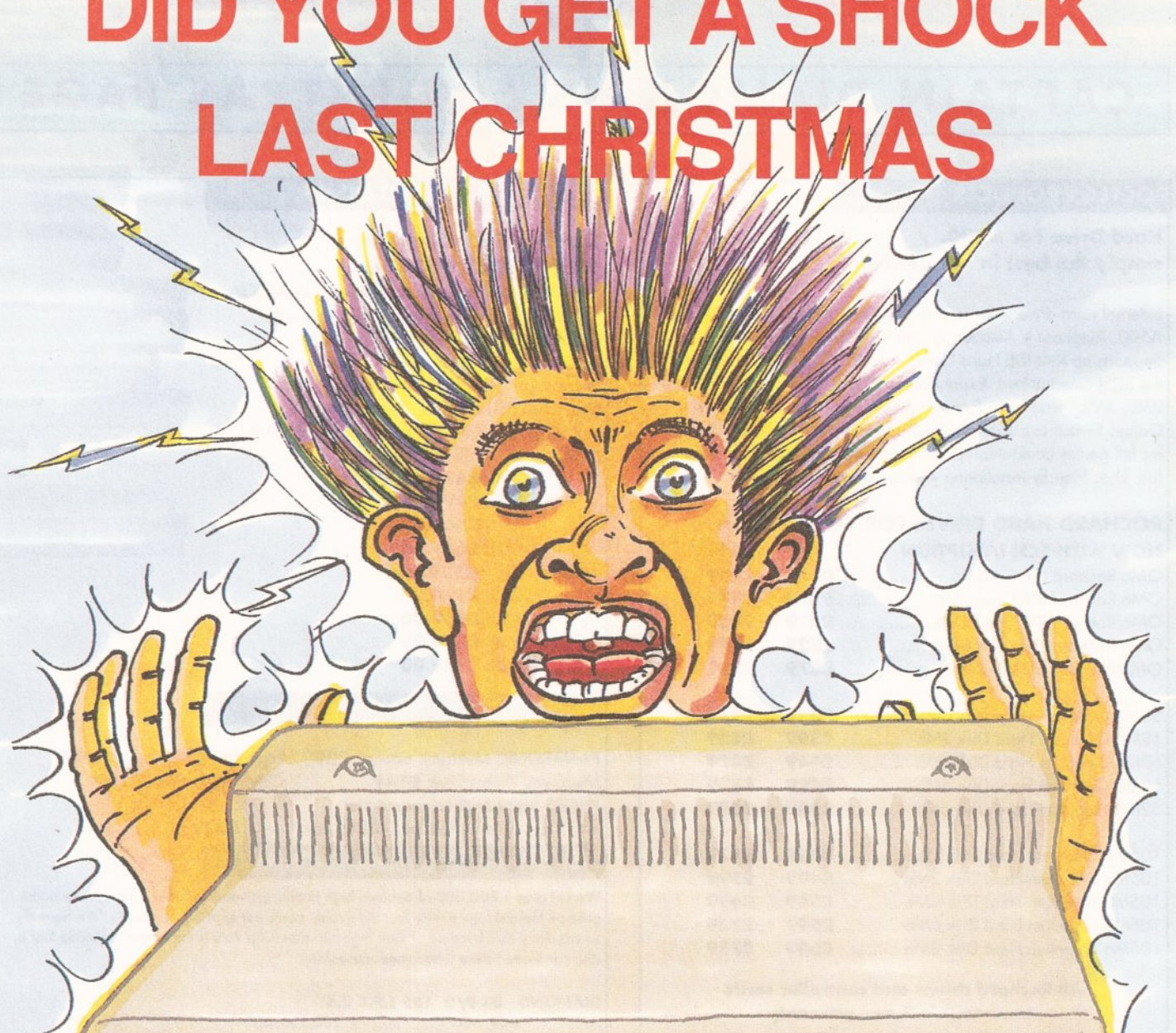

Last Christmas nearly 20,000 fake Philips 8833 MKII monitors were imported into this country by some unscrupulous retailers looking to make a quick buck out of you, the British public.

Be warned these monitors were electrically unsafe and do not comply with British safety standards.

If your regular supplier fobbed you off with inferior goods go back and demand a refund. Note, product codes on the rear of all genuine UK monitors ended in either 05G or 55G, if yours did not, then you haven't got the real Mc-Coy. 10G was manufactured for the Dutch market and 20G was designed for the Far East, neither are safe working on a British power supply. Get it checked before it's too late!!!...

DIAMOND ONLY EVER SUPPLY GENUINE UK STOCK

British Standard Philips 8833MKII Monitor with F19

Promotion only £229 inc Vat at Diamond

**WANT A 1500
With Workbench 2.04?
GOT A 500
SWAP IT FOR ONLY £379.95**



**NEW DIAMOND 21" FST
TV/MONITOR,
SURROUND SOUND.
ONLY £399**

CAPTAIN DIAMOND'S 1500 & 3000 CENTRE

| AMIGA 1500 Specials | 0Mb P/X | | 2Mb P/X | | 4Mb P/X | | 6Mb P/X | | 8Mb P/X | |
|-------------------------------------------------|-----------------------------------------------------|-------|---------|-------|---------|-------|---------|-------|---------|-------|
| | £ | £ | £ | £ | £ | £ | £ | £ | £ | £ |
| A1500 GVP 52Mb +8833 Mk II Monitor | £839 | £669 | £899 | £729 | £959 | £789 | £839 | £849 | £1079 | £909 |
| A1500 GVP 105Mb + 8833 Mk II Monitor | £1039 | £869 | £1039 | £929 | £1159 | £989 | £1039 | £1049 | £1279 | £1109 |
| | £978 | £808 | £978 | £868 | £1098 | £928 | £978 | £988 | £1218 | £1048 |
| | £1178 | £1008 | £1238 | £1068 | £1298 | £1128 | £1178 | £1358 | £1418 | £1248 |
| | P/X = part exchange Amiga 500 For Amiga 1500 | | | | | | | | | |

all Mk II Monitors come with
F19 Promotion

AMIGA 3000

The NEW
Commodore AMIGA 3000

25MHz processor, 100 Mb hard disk,
4Mb Fast RAM, 2Mb Chip RAM.
+ SCALA + Deluxe Paint IV,
CM 1960 M/SYNC MONITOR
£3295.00 INC VAT

AMIGA 1500 SPECIAL PROMOTION Comprising The NEW AMIGA 1500 PACK

Amiga 1500, 52Mb 9ms access hard disk driven by the NEXUS SCSI hard disk controller with 2Mb of RAM which can be expanded in 2Mb steps to a maximum of 8Mb. The NEXUS also comes with a suite of storage software utilities. Flashback, Powerbench, SmartCache, Spoolit, DiskSurgeon, InstantFormat, MemoryDoctor. Utilities to enhance the control of your SCSI hard disks

All DIAMOND 1500's Come With The New Workbench 2.04

Software with the machine comprises Deluxe Paint III, The Works, Home Accounts, 3 Games (Puzznic, Toki and Elf), and a book entitled "Get The Most Out Of Your AMIGA"

ONLY **£899**

Or with 8833 Mk II Monitor + F19 Promotion ONLY **£1099**

Or with Multisync Monitor and CBM Video Card (Flicker Fixer) ONLY **£1349**

PROGRESSIVE PERIPHERALS

68040 Board for your A1500/2000

50MHz Clock Speed

0Mb RAM **£1499**

4Mb RAM **£1599**

8Mb RAM **£1699**

FUSION 40 68040

THE LEADER IN ACCELERATOR CARDS
WITH 4Mb ON BOARD RAM

GVP PRODUCTS FOR THE AMIGA 1500 & 2000

| 25MHZ ACCELERATOR | 40MHZ ACCELERATOR | 50MHZ ACCELERATOR <small>FASTEST Q30 AVAILABLE</small> | IMPACT II HC8 | 150Mb STREAMER | IMPACT VISION 24 |
|--------------------------------------------------------------------------------------------------------------------------------------------------------------------------------------------------------------------------------------------------------------------------------------------------------------------------------|-------------------------------------------------------------------------------------------------------------------------------------------------------------------------------------------------------------------------------------------------------------------------------------------------|---------------------------------------------------------------------------------------------------------------------------------------------------------------------------------------------------------------------------------------------------------------------------------|-------------------------------------------------------------------------------------------------------------------------------------------------------------------------------------------------------------------------------------------------------------------------------------------------------------------|---------------------------------------------------------------------------------------------------------------------------------------------------------------------------------------------------------------------------------------------------------------------------------------------------------------------------------|----------------------------------------------------------------------------------------------------------------------------------------------------------------------------------------------------------------------------------------------------------------------------------------------------------------|
| 22MHz 68030 CPU 68882 25MHz maths co-pro 1Mb 32-bit RAM installed Expands to 13Mb. SCSI HD on board controller | 33MHz 68030 CPU 68882 40MHz maths co-pro 4Mb 32-bit RAM installed Expands to 16Mb. SCSI HD on board controller | 50MHz 68030 CPU 68882 50MHz maths co-pro 4Mb 32-bit RAM installed Expands to 32Mb. AT HD controller | Wide range of drive sizes 52Mb and 105Mb options Sockets for 8Mb RAM Uses easy to install SIMMs Supports virtually any SCSI device | Over 6Mb per min. backup Comes with GVP TapeStore software Mounts in the 5.25" drive bay Optional external casing Includes 1 DC150 cartridge | 768X576 PAL resolution Supports composite video, S-VHS and RGB signals Broadcast quality genlock Software included |
| This low-cost, quality 68030 accelerator, memory upgrade, SCSI device and 68882 maths co-processor board offers the perfect introduction to low cost upgrades for the AMIGA. It is supplied with 1Mb 32bit RAM, upgradeable to 13Mb 32-bit RAM. This card runs approximately 7 times faster than the standard AMIGA 1500/2000. | This fast 68030 accelerator, memory upgrade, SCSI device interface board delivers uncompromising speed and performance without a high price. It can take 16 Mb 32bit RAM installed along with 68882 maths co-processor. Runs approximately 11.5 times faster than the standard AMIGA 1500/2000. | The fastest accelerator card and memory upgrade available from GVP. Featuring a 68030 CPU running at 50MHz, on-card expansion to 32Mb RAM and a SCSI hard disk interface all on one card. Makes your AMIGA run approximately 13 times faster than the standard AMIGA 1500/2000. | This is the equivalent of the HD8+ hard drive, but for the AMIGA 1500 and 2000 models. It features the same unmatched facilities and performance giving unrivalled power. With GVP's innovative custom chip design, easy and user friendly installation and software, the HC8 is both powerful and simple to use. | This high-performance media back up tape streamer device for the AMIGA uses industry standard DC150 cartridges. With backup speeds in excess of 6Mb per minute, the GVP WT150 is a fast and efficient backup method to offer peace of mind for serious users. The WT150 tape streamer requires SCSI interface such as IMPACT II | This is the very latest 24-bit Professional Video Adapter. It features 16 million colours, built-in genlock, flicker fixer, frame buffer, frame grabber and digital key. Supplied with Caligari 3D modelling and rendering software, SCALA IV24 video titling software, plus Macro Paint 24-bit paint package. |
| ONLY £599 | ONLY £1099 | ONLY £1499 | 52Mb version £295 105Mb version £425 | ONLY £739 | ONLY £1785 |

SUPRA 8Mb BOARD FOR 1500/2000

Bareboard **£89**
Add **£69** for 2Mb Add **£138** for 4Mb
Add **£207** for 6Mb Add **£275** for 8Mb

NEXUS BOARD

Bareboard 0Mb HD 0k RAM ONLY **£149**

| RAM | 0Mb | 2Mb | 4Mb | 6Mb | 8Mb |
|----------|------|------|------|------|------|
| No HD | £149 | £199 | £249 | £299 | £349 |
| 52Mb HD | £299 | £349 | £399 | £449 | £499 |
| 105Mb HD | £399 | £449 | £499 | £549 | £599 |

CAPTAIN DIAMOND 3000 "BASHER PACK"

The New Commodore Amiga A1500,
V2.04 WORKBENCH with twin 3.5" floppy drives,
Multisync Colour Monitor, CBM Flicker Fixer (video card), 68030 40MHz Processor, 105Mb hard drive with 5Mb RAM and S/W, Deluxe Paint III, The Works, Home Accounts
+ 3 Games - Puzznic, Toki, Elf.

ONLY **£2399** INC VAT (REASONABLE MONEY?)

AMIGA 1500 With Workbench 2.04

Software with the machine comprises Deluxe Paint III, The Works, Home Accounts, 3 Games (Puzznic, Toki and Elf), and a book entitled "Get The Most Out Of Your AMIGA"

ONLY **£549**

Or with 8833 Mk II Monitor
+ F19 Promotion ONLY **£769**

Or with NO SOFTWARE ONLY **£499**

Or with NO S/W + MONITOR ONLY **£719**



CAPTAIN DIAMOND'S EXTRAS PAGE

IVS TRUMPCARDS

ONLY £79.95

The IVS Trumpcard is the top selling SCSI hard drive controller. Representing the latest in technology directly from the USA, it is the only controller to support IBM, Amiga and Apple Macintosh partitions on one hard disk. This allows you to run software for the three main hardware platforms on one machine. Only one computer can do this.

HARD DISK DRIVES

FASTER DRIVES FOR LOWER PRICES.

| QUANTUM | IDE | SCSI |
|-----------------|---------|---------|
| 52Mb | £169.95 | £179.95 |
| 105Mb | £269.95 | 279.95 |
| 2 year warranty | | |

SYQUEST

| | | |
|----------------------------|--|---------|
| Removeable cartridge drive | | |
| 44Mb 28ms | | £299.00 |
| TRUMPCARD for above add | | £69.95 |

CAPTAIN'S CHIP SHOP

| | | |
|--------------|---------------------------|---------|
| 4X256K DRAMS | For A590'S etc | £3.99 |
| 1X1MB DRAMS | For 8up/Supra etc | £3.99 |
| 1x9Mb SIMMS | For NEXUS/GVP/Rochard etc | £34.99 |
| 4x9Mb SIMMS | For GVP/NEXUS etc | £159.95 |
| CIA CHIPS | | £14.95 |
| 1.3 ROM | | P.O.A. |
| ROM Sharer | | £24.99 |

These prices do not include fitting; however if you don't want to fit them yourself then this can be performed by one of our Qualified Engineers at any of our branches.

SPARES AND REPAIRS

Internal A500 Disk Drive **£41.95**
Fatter Agnus **£74.95** fitted by one of our Qualified Engineers
C.I.A. chips **£14.95**. A500 fixed repair cost **£44.95**

**ARE YOU GETTING IT?
NEW DIAMOND BROCHURE
AVAILABLE FOM YOUR LOCAL DIAMOND SHOP**

**NEW SUPERSTORE OPENING SOON IN
BIRMINGHAM!**

DOT MATRIX PRINTERS

| | | | |
|--------------------|---------|---------------------|---------|
| STAR LC20 | £124.95 | ZA 200 COLOUR | £299.95 |
| CITIZEN 124/D | £179.95 | ZA 250 COL | £379.95 |
| STAR LC 24/10 | £179.95 | NEW SP2400 SEIKOSHA | £129.94 |
| STAR LC 200 | £173.90 | PANASONIC KXP 1123 | £159.95 |
| STAR LC 24/200 COL | £269.95 | OKI 380 | £199.95 |
| SWIFT 9 COLOUR | £179.95 | SWIFT 9X | £259.95 |
| SWIFT 9 | £169.95 | SWIFT 24X | £379.95 |
| NEW SWIFT 24E COL | £269.95 | NEW SWIFT 224 | £229.00 |
| XB 24 200 COL | £379.95 | NEW SWIFT 224 COL | £239.95 |
| XB 24 250 COL | £469.95 | NEW SEIKOSHA 24 PIN | £209.95 |

INK JET PRINTERS

| | | | |
|----------------|---------|--------------|---------|
| HP PAINTJET | £529.95 | CANON BJ10EX | £229.95 |
| HP DESKJET | £349.95 | CITIZEN PN48 | £269.95 |
| HP DESKJET COL | £579.95 | STAR SJ48 | £229.95 |

LASER PRINTERS

| | |
|--------------------------------------|----------|
| OKI 400 | £569.95 |
| HP III P | £784.95 |
| Toner if purchased with above 1 only | £59.95 |
| OKI LASER 800 0.5Mb | £999.95 |
| OKI LASER 800 Dual bin 0.5Mb | £1199.95 |
| OKI LASER 830 Postscript 2Mb | £1099.95 |
| OKI LASER 840 Postscript 2Mb | £1399.95 |

DATA/PRINTER ETC CABLES

| PARALLEL PRINTER LEADS | MONITOR LEADS | | |
|--------------------------|---------------|------------------------------|--------|
| 1.8M Printer Cable | £9.95 | AMIGA > CBM 1084/S | £9.95 |
| 2.0M Printer Cable | £11.95 | AMIGA > PHILIPS 8833 Mk II | £14.95 |
| 3.0M Printer Cable | £14.95 | AMIGA > PHILIPS 8833 Mk I | £9.95 |
| 5.0M Printer Cable | £19.95 | AMIGA > MULTISYNC | £9.95 |
| 10M Printer Cable | £29.95 | AMIGA > TV | £14.95 |
| Centronics to Centronics | | Please state TV make & model | |
| cable for data boxes etc | £9.95 | | |

PRINTER PAPER

High Quality Micro Perforated
60 gsm 1000 sheets of tractor feed **£9.95**
60 gsm 1000 sheets of tractor feed **£14.95**

**PRINTER
STARTER PACK**
CABLE, BOX OF
PAPER, STAND,
SPARE RIBBON
ONLY
£29.95

DIAMOND SHOPS AROUND THE U.K.

DIAMOND COMPUTERS
144 FERRY ROAD
EDINBURGH
TEL: 031 554 3557
FAX: 031 554 3557

DIAMOND COMPUTERS
232 TOTTENHAM COURT
ROAD
LONDON - W1
TEL: 071 580 4355
FAX: 071 580 4399

DIAMOND COMPUTERS
(HEAD OFFICE)
84 LODGE ROAD
SOUTHAMPTON
TEL: 0703 232777
FAX: 0703 232679

DIAMOND COMPUTERS
1022 STOCKPORT ROAD
MANCHESTER
TEL: 061 257 3999
FAX: 061 257 3997

DIAMOND COMPUTERS
406 ASHLEY ROAD
POOLE - DORSET
TEL: 0202 716226
FAX: 0202 716160

CORPORATE SALES
TEL 0703 333184
FAX 0703 232679

DIAMOND COMPUTERS
1045 HIGH ROAD
CHADWELL HEATH
ROMFORD
TEL: 081 597 8851
FAX: 081 590 8959

DIAMOND COMPUTERS
443 GLOUCESTER ROAD
BRISTOL
TEL: 0272 522044
FAX: 0272 521738

CONTACTS:
SHARON/DAWN/BARBARA
EDUCATION/GOVERNMENT
ORDERS ACCEPTED

TERMS STRICTLY 14 DAYS
30 DAYS ADD 2%
60 DAYS ADD 5%

HOW TO ORDER

Simply telephone through your order, giving your Access or Visa card number, or send a cheque or postal order to your Local Dealer. MAIL ORDER No. 0703 232777
Prices include VAT unless otherwise stated. Minimum Courier Service £10.00
Allow 10 working days for cheque clearance. Bankers drafts clear on the same day.
All prices are correct at time of going to press but may change without notice.

POSTAL SERVICE FROM OUR ROMFORD BRANCH ONLY

THE DIAMOND PRICE PLEDGE

If, whilst buying goods from us, you can show us a better price for the same goods in stock from one of our U.K. competitors then we will match that price

Even if our prices have increased we will honour the price in this advertisement on items in stock as long as you bring it with you

This Pledge applies only to customers relying on this advertisement before the end of the month of publication. It does not apply to competitors prices offered in closing down or stock clearance sales.

Swap your April Amiga Format VISTA cover disk and upgrade to **VISTAPRO 2**

£39.95

NORMAL PRICE £69.95

VISTAPRO 2.0 OFFERS

- The most complete final image control of any landscape simulator
- Add oak, pine, palm, cactus, sage brush trees in varying mixes and density.
- Add large or small buildings, roads and sunsets.
- Direct support for DCTV, FireCracker, HAM-E and ARREX

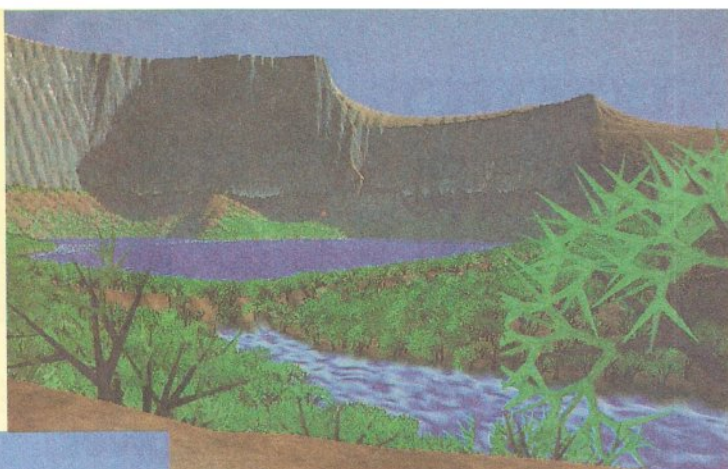
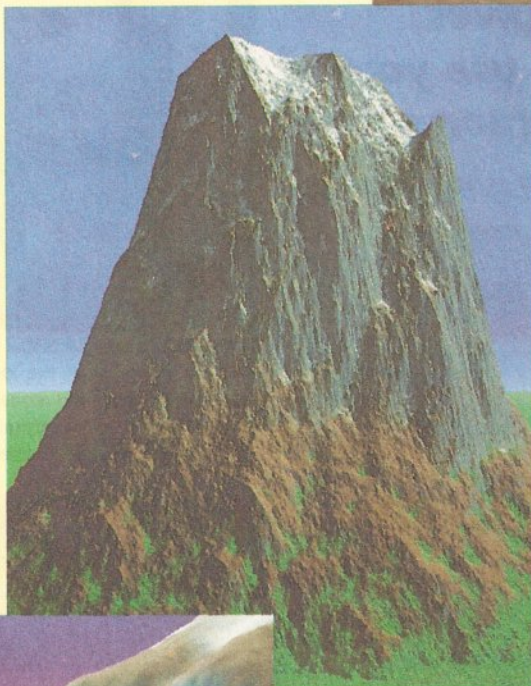

Other packages that can be purchased under the special Amiga Format VISTA cover disk offer are:

TERRAFORM - modify your VISTA and VistPro landscapes or create your own. Add dams to rivers, run roads up mountains, flatten or build up mountains, make craters etc. **£29.95**

MAKEPATH - a motion editing tool. Create complex animation sequences, control acceleration, banking and pitch. Works with both VISTA and VistaPro images. **£29.95**

Scenery Disk X001 - part of Mars equatorial region, Valles Marineris, Pavonis Mons, Acraeus Mons, Tharsis Tholus, Lunae Planum, Syria Planum, Sinai Planum **£19.95**

36 different scenery disk sets of various locations in the USA including Grand Canyon. Ask for list with order

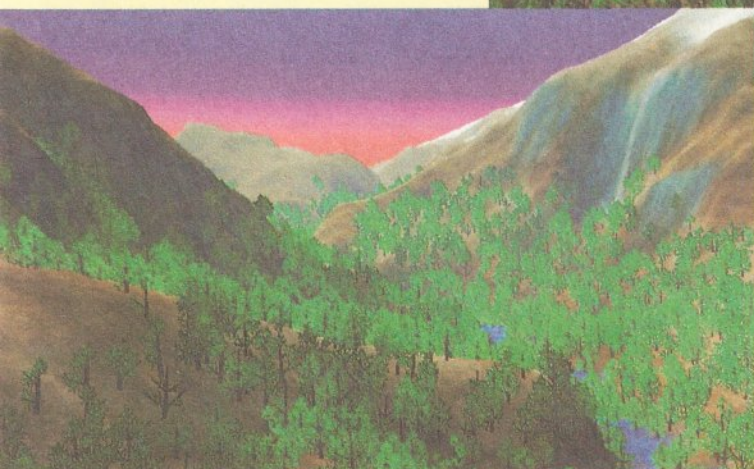

Original Virtual Reality Labs. VISTA Manual for your Amiga Format April Cover disk **£4.95**

NOTE: To take advantage of these update offers, you **MUST** send in your April Amiga Format VISTA diskette and £1-00 post/package with your order (your diskette will be returned with your order).

VISTAPRO 2 control panel

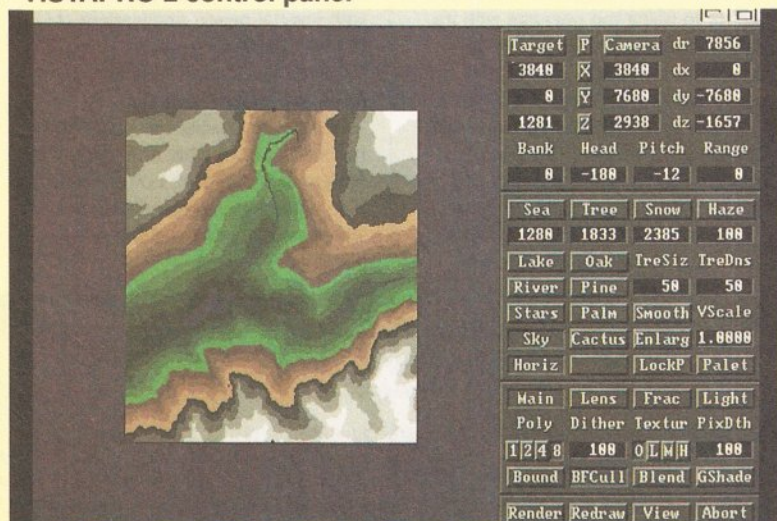

VISTAPRO 2 now supports user definable backgrounds and foregrounds. For instance a foreground might be a shot from inside a light plane cockpit looking out of the window. A background might be a particularly nice cloud photo or astronomically-correct night sky rendered with Distant Suns 4.0

NOTE: VISTAPRO 2 needs 3mB or more. If you own an accelerator card VISTAPRO 2 will take advantage of it.

Cheques to be made payable to:
Genisoft Ltd

Unit 3, Poyle 14, Newlands Drive, Colnbrook, Slough, Berks., SL3 0DX

ACCESS and VISA accepted - 48 hour despatch (cheques 7 days). Overseas customers add £2.50 postage. ALL prices include VAT.

Remember - you MUST include your free VISTA cover disk from the April issue Amiga Format

You missed the April issue of Amiga FORMAT - DON'T WORRY
Send this coupon to Amiga Format Back Issues, Future Publishing,
The Old Barn, Somerton, Somerset, TA11 7PY. Fill in your name
and address and enclose a cheque or PO for £5 made out to Future
Publishing Ltd. Order code: HB04

Name: _____
Address: _____

Education Forum

Wilf Rees reports on Tekno Amiga and TouchWindow, and gives handy advice on how to use your Amiga to produce silk screen prints

Ever wondered how to produce quality prints from digitised images when you don't have decent printer? This month's tutorial describes how. What's more, this month we've got a review of TouchWindow which could be a revolution for the less nimble fingered among you and Tekno Amiga, the kit to get you on the road to becoming an electronic genius.

TOUCHWINDOW

TouchWindow gives you the ability to perform functions normally carried out by mouse or keyboard with a finger on the monitor's screen.

The supplied software enables easy installation and calibration. A stylus is supplied with the package which may be used to achieve accurate positioning of a selected point. However it is not essential, as touch works equally well.

I tried the screen out with several pieces of software, all of which ran, some more successfully than others. *Deluxe Paint* was not too brilliant in that the defaulting grid had a similar effect to using the package with its own grid turned on, meaning that drawing with fine detail was just not possible. It was clever in the way in which it implemented the menu bar, enabling automatic pull-down of menus without the need to press another button as per the mouse.

The principal criticism I would level at it is that the screen sits

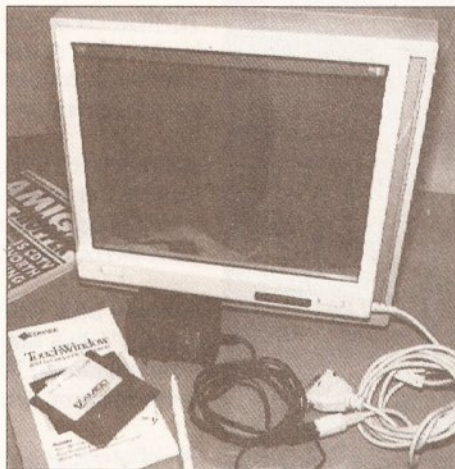

TouchWindow is attached to your monitor simply by using self-adhesive velcro tape

approximately 5 to 15mm away from the actual screen of your monitor, dependant on the degree of curvature of its screen. This can be confusing at times, as the parallax from the changing position of your viewpoint alters the position of exactly where you think you should be touching.

There is no doubt that this hardware will have a huge impact with special needs applications. I tried it with *Maths Adventure*, reviewed last month, and it was ideal. Any special schools, or schools with special units, will find this device invaluable in making their Amigas perform even better. It will also appeal to younger children where manipulative skills are less developed.

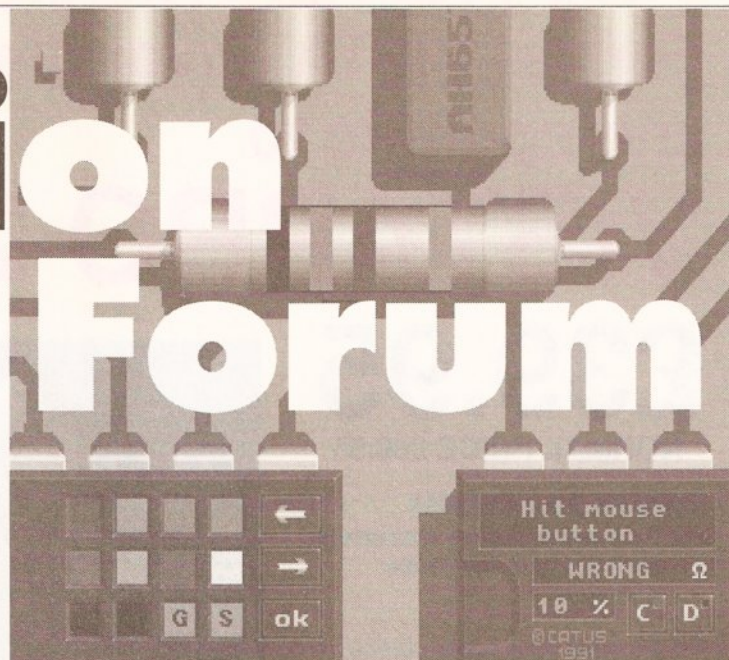

One of the neater facilities available with Tekno Amiga is this super program to help with the identification of resistor values. The colour bands are entered using the mouse and the palette. Then you can use the program either as an information service, or as a tester to check your knowledge of resistor values

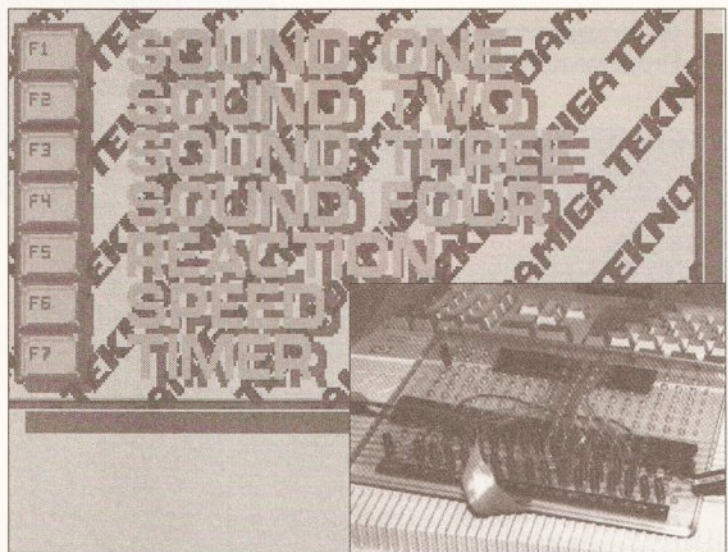

Tekno Amiga - each of the sound menus contains four sampled sounds which can be triggered using the experiment board. (Inset - the perspex experiment board which can be used to mount electronic components)

TEKNO AMIGA

It is so nice to come across hardware and software which attempts to present complicated procedures in a more understandable way, and Tekno Amiga does just that. It addresses the issue of introducing electronics and electronic applications.

Tekno Amiga's three manuals comprise of a handbook explaining how to assemble the interface, a basic book of electronics, and a software guide. These are best read in this order, as assembly of the interface requires concentration. It is not particularly difficult, but it does demand careful reading. The parallel interface end has a glass fibre PCB with two ICs, a couple of resistors, a capacitor, and a surface mounted parallel connector. These come ready

built. The tricky bit involves the clean cut end of the ribbon cable which leads away from the PCB.

The ribbon has to be opened up at the cut end and attached to the perspex experiment board by trapping the cable in the springs which have been screwed into the experiment board in a prescribed manner. The manufacturer recommends placing a strip of sticky tape along the opened wires to avoid pulling out of the ribbon. It sounds fiddly, but it is quite easy, and once the interface has been assembled we can connect it to our Amiga. One end goes to the parallel port, one to the joystick port; and the business bit, the experiment board, sits at a convenient place ready for action.

The best thing now is to sit down with a coffee, put up your feet and

JARGON BUSTING • JARGON BUSTING

Light-Box - An enclosed box which contains an ultra-violet lamp, used to chemically 'fix' light-sensitive emulsion.

Light-Sensitive emulsion - a two part emulsion, sensitive to ultra-violet light. Areas not fixed within the life of the emulsion can be washed out.

Process Colours - The colours known as process yellow, cyan and magenta, plus black. Used to create coloured images by mixing.

Registration Marks - Reference marks put on to an image with multiple facets. When aligned, all of the facets will be correctly superimposed.

Screen Printing - A process of creating images by forcing ink, using a rubber squeegee, through tightly stretched fabric, fastened to a wooden frame.

PROJECT POWER

It has always been a problem to obtain hard copy of any quality from a good Amiga screen image. Many schools have assorted colour printers, usually the Integrex 132, or if you are luckier, the HP Paintjet.

Schools often have to compromise on price, and a 9- or 24-pin dot-matrix with a colour kit is often the only option. Despite the hype from the dot-matrix manufacturers, the colour kits are just a novel add-on – once the ribbon has been used a few times the yellow becomes contaminated by the other colours. Being cost-conscious, and wanting to achieve quality, we need to find an alternative method.

In your Art & Design department you will no doubt have some screen printing facilities. You may have photo-emulsion based imaging, which allows you to transfer images onto a silk-screen using a light sensitive emulsion and an ultra-violet light-box. The following section will explain how, with a bit of care and experimentation, you can obtain excellent results without the need to utilise a colour printer at all.

Let's start by selecting an image. It ought to be in colour. On two opposing corners of your picture, draw a right-angle to help later on with registration.

Using your digitising gear, produce a high quality digitised copy of the image. Set the software to employ the highest level available. The outcome varies widely according to the quality and level of light on the surface of the image. Too much light and you get a bleached, pale outcome; too little and the colours are not clearly defined. The nature of the light is also important. Ordinary light bulbs are poor substitutes for daylight. Move your gear near a window, or splash out on some daylight bulbs – the investment will warrant the difference in the quality. I use *DigiView 4*, and have achieved superb results, simply by following this practice. Watch the angle of the beam of your lights: it's too easy to get a flare from the bulb, especially if the surface of your image is slightly glossy.

Digitise the pic, and save the file as IFF. Then take the image and load it into *Art Department*. *Art Department* will enable you to separate the three process colours, plus black, from any image.

COLOUR PROCESSING

What do we mean by process colours? Take a look at a copy of a daily newspaper which uses colour pictures. At the side of the page you will find several coloured rectangles, printed in a vertical line. These are the colours which, when combined, produce colour images. There are usually three plus black. *Art Department* separates these from your digitised picture and saves them as separate files, labelled according to their colour.

You now have four files, each representing the constituent element of a photographic colour image. Print each of the colours as a black print. Ensure you record which process colour each print represents. You can do this by writing it on each printout. Here is where the clever trick comes. Take the prints to a photocopier, and instead of white paper, fill the paper carrier in the photocopier with clear acetate. Set the density to maximum, and copy each of the process tones on to the acetate. Silk screens should have been pre-coated with light-sensitive emulsion.

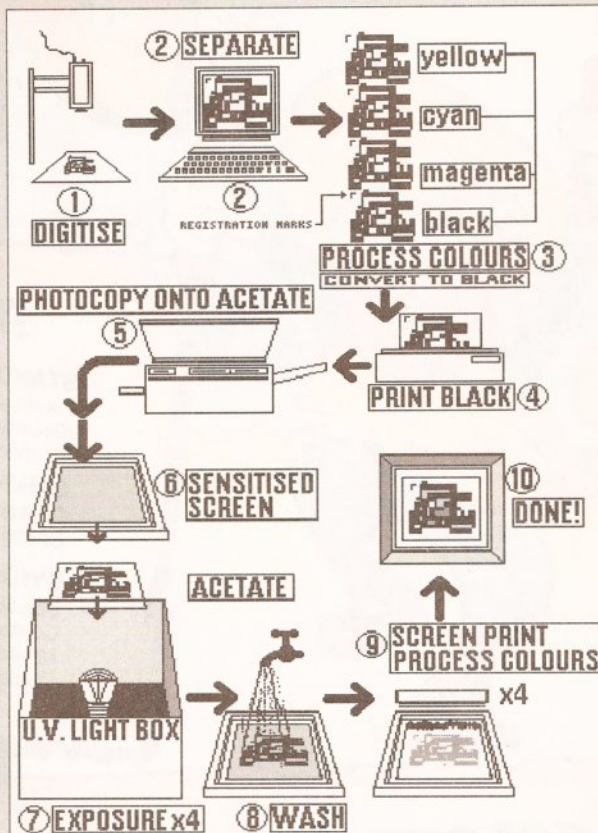

The process to make a screen print from a photograph:

- 1 Digitise as normal in colour. Add registration marks.
- 2 Take the file to software which allows colour separation.
- 3 Convert all of the process colours, including black, to black images, not forgetting to label them by colour.
- 4 Print out all of the images as black prints.
- 5 Take the prints to a photocopier, and insert some acetate sheets in the paper-holder, instead of white paper. Transfer each of the four images on to the acetate.
- 6 Prepare 4 screens by coating with light-sensitive emulsion.
- 7 Expose screens in Ultra-violet light-box.
- 8 Wash out all of the emulsion which has not been fixed.
- 9 Using process colour inks, screen each of your colours in turn. Experiment with the transparency of the inks, and also with the order in which you print them. You can even use different colours to really create exotic effects.
- 10 The completed print can now go into your portfolio.

Place them, with the acetate, into the light-box, and transfer the image on to the screen. After washing out the fixed image, we have four silk-screens, each with an image representing one of the four process colours required to produce a printed image by silk-screen.

This is where you realise the importance of the registration marks, as, in order to ensure the four prints lie accurately on top of each other, you use the registration marks to align each subsequent print.

Experimenting with the transparency of the process inks enables you to alter the quality, as will the order in which you print the colours. The choice can be made between oil-based, or water-based inks.

You can also *not* use the appropriate process colours, which will give you some really wild images, or, try mixing them! You don't have to have a dedicated light-box (mine's made out of an old cupboard turned on its end, with an ultra violet bulb stuck in it!), and in fact it is possible to use ordinary daylight. What we end up with, however, are images transferred to a different medium, but essentially computer generated – so the outcome is greater than the sum of the individual parts, thanks to that wonderful, and versatile machine, the photocopier.

So, if you are into innovation, or have found a unique way of making the Amiga perform new tricks, let me know.

PROJECTS PLEASE!

If you want to see your work in print put it on a disk, and send it to me at: Education, Amiga Shopper, 30 Monmouth Street, Bath BA1 2BW. Do include some documentary material to help me understand the nature of your work, and how you used the Amiga to resolve it.

Amiga Basic extender which introduces extra commands. A program called Resistance enables quick calculation of resistor values by inputting colour codes; Closed Circuit is another program which plots the flow of current in a closed circuit with a moving picture.

The package has a place in any school. It is probably most appropriate for ages around 10 to 15, but if any of you parents are struggling to decide what to buy your son or daughter for a gift which has real educational value, look no further than Tekno Amiga. And do you know what is the most amazing feature of all? The whole kit including manuals costs £72, which I think is excellent value. **AS**

SHOPPING LIST

TouchWindow £276
 Software Driver for TW..... £29.38
 Manufactured by Edmark
 Tekno Amiga..... £72.30
 Manufactured by Catus AB

Distributed in UK by:
 HB Marketing, Unit 3,
 Poyle 14, Colnbrook
 Berks SL3 0DX
 ☎ 0753 686000

DYNAMITE



AMIGA A500 PLUS PACKS

STANDARD

Latest enhanced Amiga from Commodore with 1MB of RAM, Kickstart and Workbench Version 2.04. Complete with mouse, TV modulator, manuals etc.

£299.99

CARTOON CLASSICS

Contents as standard pack plus the following:- The Simpsons • Captain Planet • Lemmings • DeLuxe Paint III

£324.99

DYNAMITE HEROES PACK

Latest enhanced Amiga from Commodore with 1MB of RAM, Contents as Cartoon Classics Pack plus:- Robocop • Batman-The Movie • Indiana Jones • Ghostbusters II • Microswitch Joystick • Dustcover • Mousemat

£339.99

COLOUR MONITORS

DYNAMITE EXCLUSIVE

PHILLIPS 3332 15" FST TV/MONITOR

High quality FST TV with dedicated monitor output. Complete with remote control, sleep timer, cable and a 2 year guarantee!

PLUS FREE F19 STEALTH FIGHTER

All this for the DYNAMITE price of

£239.99

PHILLIPS 8833 MKII DEDICATED STEREO MONITOR

Complete with cable

£229.99

COMMODORE 1084S STEREO MONITOR

Complete with cable

£229.99

ART • VIDEO • SOUND

| | |
|---------------------------------------------------------------------|---------|
| DELUXE PAINT II - a bargain! | £9.99 |
| DELUXE PAINT III - upgradeable to IV | £19.99 |
| SPRITZ PAINT - joyful to use! | £9.99 |
| FANTAVISION - special effects generator | £14.99 |
| COMIC SETTER - create your own colour comic | £19.99 |
| POWER SCANNER - 100-400 dpi, 64 greyscale | £99.95 |
| * FREE SPRITZ PAINT WITH POWER SCANNER WHILE STOCKS LAST! | |
| VIDI - AMIGA + VIDI CHROME - start frame grabbing | £79.99 |
| ROMBO RGB SPLITTER - Can also be used with DIGIVIEW | £59.99 |
| COMPLETE COLOUR SOLUTION - everything you need + PHOTON PAINT | £129.99 |
| MUSIC X JUNIOR - brilliant for beginners | £19.95 |
| 4 PORT MIDI + MUSIC X JUNIOR - excellent combo | £29.95 |
| MUSIC X - latest version for the professional | £49.95 |

KLONDIKE DEALS

DYNAMITE COMPUTERS
DIG DEEP FOR
THESE SPECIAL
BARGAINS....

| | |
|------------------------------------------------------------------------------------------------------------------------------------------------------------------------------------------------|--------|
| CARTOON CLASSICS SOFTWARE PACK Bart Simpson .v. Space Mutants • Lemmings • Captain Planet | £19.99 |
| 'SCREEN GEMS' SOFTWARE PACK Back To The Future II • Nightbreed • Shadow Of The Beast II • Days Of Thunder | £19.99 |
| OFFICIAL COMMODORE A501 1/2 Meg Upgrade | £29.99 |
| ASTRA TEN GAME SOFTWARE PACK RRP £279 DataStorm • Dungeon Quest • E-Motion • Grand Monster Slam • Kid Gloves • Powerplay • RVF Honda • Shuffle Pack Café • Soccer • Tower Of Babel | £19.99 |
| GFA BASIC 3.5 INTERPRETER RRP £49.95 | £14.99 |

COMPUTERS

THE PRICE BLASTERS

DISK DRIVES

FREE DYNAMITE DISK DRIVE STARTER KIT WITH EVERY DRIVE PURCHASED FROM THIS SECTION!
 Starter Kit comprises:- 3 1/2" disk drive cleaner kit • Pack of ten 3 1/2" disks • 40 capacity lockable disk box

3 1/2" INTERNAL

DIRECT A500 replacement drive, no modifications required £49.99

3 1/2" EXTERNAL

PC880A POWER DRIVE featuring anti-click £49.99

CUMANA CAX 354 slimline drive £54.99

PC880B POWER DRIVE featuring Blitz/Virus hardware £69.99

DUAL PC880B POWER DRIVE with built in power supply £119.99

GVP SERIES II HARD DRIVE

GVP Series II HD8 + 52Mb hard disk £359.99

GVP Series II HD8 + 105Mb hard disk £539.99

2Mb RAM for above £39.99

STAR/CITIZEN PRINTERS

CITIZEN 120D+ RRP £233.83 £114.99
 144/30 CPS, 4K Buffer, 2yr guarantee

STAR LC20 RRP £233.83 £129.99
 150/38 CPS, Multiple Fonts, 240x240 dpi

CITIZEN SWIFT 9 RRP £280.83 £169.99
 192/48 CPS, colour kit option, 2 yr guarantee

STAR LC200 COLOUR RRP £304.33 £184.99
 185/40 cps, with colour & mono ribbon

CITIZEN 224 (New) RRP £316.88 £214.99
 192/80 cps, colour kit option, 2 yr guarantee

STAR LC24-200 MONO RRP £351.33 £219.99
 220/55 cps, 24 pin 360 dpi, 7K Buffer expandable to 39K

CITIZEN PN48 (New) RRP £381.88 £249.99
 Portable A4 notebook printer with 'laser quality'

STAR LC24-200 COLOUR RRP £410.88 £259.99
 220/55 cps, 24 pin colour, 30K buffer

CITIZEN SWIFT 24e RRP £428.88 £269.99
 216/80 cps, colour option, 2 yr guarantee

ACCESSORIES

Parallel Printer Cable £3.99

Universal Printer Stand £3.99

500 sheets of continuous paper £4.99

Colour kit option for Swift 9/224/24e £34.95

ACCESSORIES & EXTRAS

Pack of 10 blank 3 1/2" DS/DD disks £4.99

Box of 50 blank 3 1/2" DS/DD disks .. £19.99

512K RAM expansion (Plus compatible) £19.99

512K RAM expansion with clock £24.99

1Mb RAM expansion (upgrades Plus to 2Mb) £49.99

Amiga dustcover + Resolution 101 game £4.99

Quality replacement mouse £12.99

40 capacity lockable disk box £3.99

80 capacity lockable disk box £5.99

150 capacity 'stronghold' box (lockable) £17.99

6mm quality mousepad £2.99

HOW TO ORDER

Call us NOW on **0234 214212** 

Send cheque or postal order to
 DYNAMITE COMPUTERS
 Dynamite House
 44a Stanley Street
 Bedford MK41 7RW

NB Please write cheque guarantee card number on the reverse of cheque to ensure same day clearance (cheques without card number subject to 10 day clearance)

Call into our showroom for a fast and friendly service

Retail/Queries 0234 364428



DELIVERY CHARGES*

£2.95 for orders less than £100
 £4.95 for orders over £100
 Next day express service £7.50

*Charges applicable to UK mainland only

PLATINUM SERVICE CARD

Only £19.99!

Features: •Next day courier delivery
 •30 day exchange for new
 •1 year guarantee giving free collection and delivery should a fault occur

DYNAMITE

ALL PRICES INCLUDE VAT at 17.5%

TO PLACE YOUR ORDER PHONE THE DYNAMITE HOTLINE

0234 214212

DYNAMITE HOUSE, 44a STANLEY STREET, BEDFORD

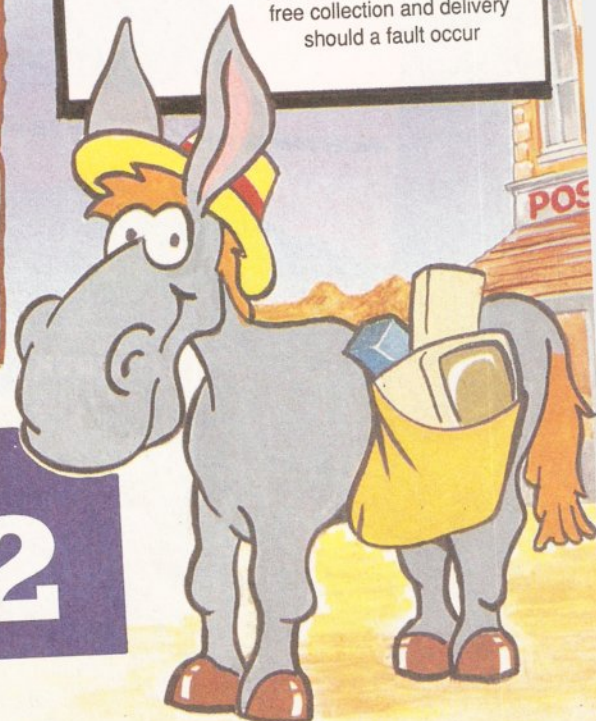

YOUR GUIDE TO A NEW WORLD OF PC LEISURE

PC Format is the UK's leading PC leisure magazine and is devoted entirely to helping you get more out of your leisure time with the PC. Issue 7 is out on March 26 and fast-forwards you into the exciting world of

video. We'll show you how to liven up your home videos with titles and graphics, and how to get video images on to your PC.

The rest of the magazine is packed with everything needed to keep you entertained: comprehensive game reviews, incisive and thought-provoking profiles, plus essential regular columns on shareware, music, CD-ROM, problem solving, playing tips and much more. Don't miss it.

April 1992 ■ Issue Seven

PC FORMAT

The Modern Guide To Personal Leisure Computing

TAKE CONTROL!

How to liven up your videos with the help of the PC

WIN
ROLE-PLAYING BOOKS AND COPIES OF EYE OF THE BEHOLDER II WORTH MORE THAN £1,000

24 PAGES OF GAME REVIEWS
Cruise for a Corpse, Star Trek, D/Generation, and many more

NEW JOYSTICKS REVEALED
We rate the latest weird and wonderful joysticks

TITUS THE FOX
An exciting platform romp through Marrakesh in Titus' playable preview

EGATREK
Battle it out in deep space with this shareware game

No Coverdisk?
Then ask your newsagent for one. 3.5-inch disk with this copy.

PLUS: more revealing insights about Origin ■ news from the biggest US computer music show ■ Q&A, public domain, playing tips and more

3.5-inch disk with this copy - also available with TWO 360k 5.25-inch disks £2.95

9 770963 552007 04

Future PUBLISHING
Your guarantee of value

For all this and more, make sure you get issue 7 of PC Format on March 26 and enter a new world of PC entertainment

Future PUBLISHING

Your guarantee of value



EXPAND YOUR AMIGA

QUALITY PRODUCTS
at affordable prices
W.T.S. ELECTRONICS LTD



STOP PRESS!
Kickstart 2.04 £55
Hi-res Denise £39
Kickstart switchboard £24.99
IN STOCK NOW

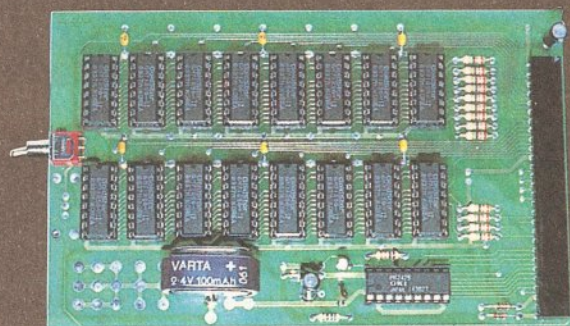

A500 PRO-RAM BOARD 1/2 MEG UPGRADE

- Latest design incorporates chipmem option at no extra cost
- Increases computer memory from 1/2 Megabyte to 1 Megabyte
- Allows all 1 Megabyte software to run. Now Commodore A500 standard
- Direct replacement for Commodore A501, 16 Chip Technology for complete compatibility.



British Made

£25.00 without clock **£28.00** with clock

UPGRADE TO AMIGA 500 PLUS

☆ Upgrade the standard Amiga 500 to ECS chipset A500 plus capability ☆

- | | | |
|----------------------------------|-----|--------------------------------------------------------------------------------------------------|
| ★ KICKSTART 2.04 | £55 | • Upgrades your existing Kickstart to that of the new A500 plus |
| ★ HIGH-RES DENISE | £39 | • Upgrades your graphic chip capability to that of the A500 Plus inc. anti-flicker |
| ★ 8372 FATTER AGNUS | £49 | • Enables you to access 1Mb of chip memory with standard modification |
| ★ 8375 2MB FATTER AGNUS | £65 | • Enables you to access a full 2Mb of chip memory when fitted in adaptor board |
| ★ 2.04/1.3 KICKSTART SWITCHBOARD | £24 | • Overcomes software compatibility problems at the flick of a switch |
| ★ KICKSTART 1.3 | £36 | • Allows existing A500 Plus owners to run old software when used in conjunction with switchboard |
| ★ A500 PLUS 1MB UPGRADE | £45 | • Upgrades A500 Plus memory to 2Mb chip memory. |

- | | |
|----------------------------------|-------|
| ★ GVP 52MB A500 HARD DRIVE | £369! |
| ★ GVP 52MB A500 HARD DRIVE + 2MB | £424 |

500AX 2Mb - 8Mb MEMORY EXPANSION

| | | | |
|-----------------|----------------|-----------------|----------------|
| 500AX 2Mb | £179.00 | 500AX 8Mb | £380.00 |
| 500AX 4Mb | £244.00 | | |

SUPRA MODEMS

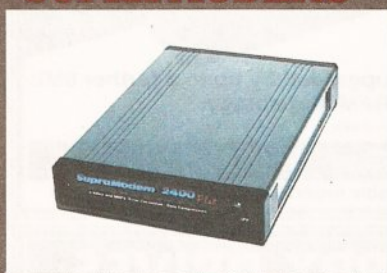

- 100% Hayes compatible
- Tone Pulse auto dial/answer
- RS232 Interface
- Internal diagnostics
- Programmable number storage

| | |
|----------------------|----------------|
| Supra 2400 | £119.00 |
| Supra 2400 MNP | £159.00 |
| Supra 2400 + | £174.00 |

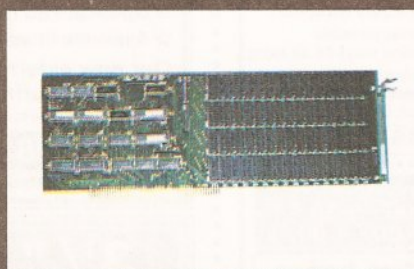

A2000 MEMORY UPGRADES

| | |
|---------|----------------|
| 0Mb ... | £109.00 |
| 2Mb ... | £149.00 |
| 4Mb ... | £189.00 |
| 8Mb ... | £269.00 |

CUMANA 3.5" EXTERNAL DISK DRIVE



- High quality
- High specification
- Anti click
- Long moulded cable

£54.00

| | |
|--------------------------------------------------------|----------------|
| A500 Internal replacement drive | £44.00 |
| Kickstart 2.04 kit includes full manuals + disks | £129.00 |
| GVP 52Mb Hard Drive A2000 | £279.00 |

A500 HIGH CURRENT POWER SUPPLY

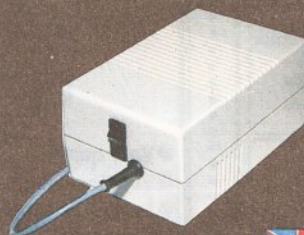

- Allow addition of many peripherals without damage to computer or power supply
- Switch mode design

£44.95



British Made

☆ All prices include P&P & VAT ☆ Please add £5.00 if you require 24 hour courier to your door or parcel post will be used ☆ 12 month warranty ☆

W.T.S. ELECTRONICS LTD, Chaul End Lane, Luton, Beds.

Tel: 0582 491949

Evesham Micros

**JOINT WINNER OF
COMPUTER SHOPPER'S
'Best Customer
Service'
- AWARD FOR 1991 -**

PRICES INC. DELIVERY & VAT @ 17.5%
Express Courier Delivery :
(UK Mainland Only) £6.50 Extra

HERE TODAY ~ HERE TO STAY

Evesham Micros First. First for choice, prices and service. Established for over eight years, with a strong financial status and secure future. Our Computerised Telesales Order Processing investment means fast, efficient service. Well appointed Retail Showrooms with large product range on display. Our huge Customer database, high percentage of repeat custom and personal referrals underlines our popularity. REMEMBER - when you need us, we will still be here. Our extensive expansion program means we could eventually be there as well ...

HOW TO ORDER



Call us now on

0386 765500



TELESales OPENING TIMES :
9am - 7pm Monday-Friday

9am - 5.30pm Saturday
10.00 - 4.00 Sunday



Send Cheque, Postal Order or
ACCESS/VISA card details to:

Evesham Micros Ltd.

Unit 9, St Richards Road
Evesham, Worcs. WR11 6XJ



ACCESS / VISA
Cards Welcome



Government, Education & PLC orders welcome

Same day despatch whenever possible

Express Courier delivery (UK Mainland only) £6.50 extra

Please note that 5 banking days must be allowed for
cheque clearance. Immediate clearance on Building
Society cheques or Bank Drafts.

Mail Order Fax: 0386-765354

RETAIL SHOWROOMS

New showroom opening times:

Mon-Sat. 9.00 - 5.30
& Sunday 10.00 - 4.00

Unit 9 St Richards Road, Evesham
Worcestershire WR11 6XJ

☎ 0386 765180
fax : 0386 765354

5 Glisson Rd, Cambridge CB1 2HA

☎ 0223 323898
fax : 0223 322883

Corporate Sales Dept. • IBM dealer

251-255 Moseley Road,
Highgate, Birmingham B12 0EA
Tel: 021 446 5050 • Fax: 021 446 5010

Corporate Sales Dept • Easy Parking

320 WITAN GATE
MILTON KEYNES MK9 2HP

☎ 0908 230 898
fax : 0908 230 865

TECHNICAL
SUPPORT

☎ 0386-40303
Monday to Friday, 10.00 - 5.00

**12 MONTHS WARRANTY
ON ALL PRODUCTS**

All details correct at time of going to press • All goods subject to availability

AMIGA 500 SOLDERLESS RAM UPGRADES

**512K
RAM/CLOCK
UPGRADE**

ONLY £22.99
INC. VAT AND DELIVERY

ALSO WITHOUT CLOCK
FOR ONLY :
£17.99

☆ CONVENIENT ON / OFF MEMORY SWITCH ☆ AUTO-RECHARGING
BATTERY BACKED REAL-TIME CLOCK ☆ COMPACT, ULTRA-NEAT DESIGN

**'A500 PLUS'
1 MB RAM
UPGRADE**

**THE FASTEST AND EASIEST WAY TO
UPGRADE YOUR A500+ TO 2MB RAM!**

Simply Plugs into trapdoor expansion area ☆
Increases total RAM capacity to 2Mb 'ChipRAM'
☆ RAM On/Off Switch ☆ Compact unit size ☆
Only 8 low power RAM IC's ☆ High reliability

ONLY £42.99

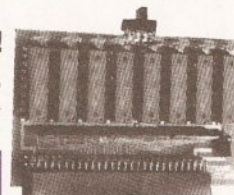

UPGRADE
TO 2MB FOR
ONLY £79!

1.5MB RAM BOARD

Fully populated board increases total RAM in A500 to 2Mb! ☆ Plugs
into trapdoor area, & connects to 'GARY' chip ☆ Includes Battery-
Backed Real-Time Clock ☆ Socketed RAM ICs on 512K / 1Mb Versions

Unpopulated RAM board with clock £ 34.95

with 512K installed.....£ 54.95 with 1Mb installed.....£ 69.95

RAM Board with 1.5Mb FASTRAM installed £ 79.00

N.B.: The expansion board
requires Kickstart 1.3 to
operate - Kickstart 1.3 upgrade
available from us for £29.95

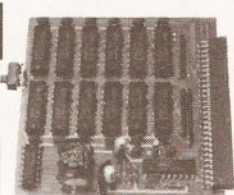

'MEGABOARD'

With our MEGABOARD, you can further
expand your A500's memory to a total of
2MB without disposing of your existing
512K upgrade (must be 4 x RAM-chip
type, or not exceeding 9cm in length).

**CONNECTS TO YOUR
512K RAM UPGRADE
TO GIVE 1.5MB**

ONLY £54.99

MEGABOARD needs Kickstart 1.3 to operate
(Kickstart 1.3 upgrade available from us for
£29.95). Installation requires connection to the
GARY chip. Easy to follow instructions provided.

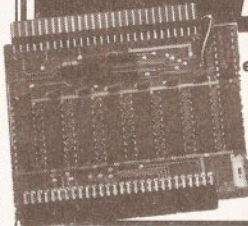

A500 EXTERNAL 8MB RAM UNIT

NEW

- ☆ Very low power consumption
- ☆ Styled to match the Amiga
- ☆ Throughport for further expansion
- ☆ RAM access LED & RAM test/run switch
- ☆ Optional PSU (Allows Amiga to power other devices)
- ☆ Available fitted with 2Mb, 4Mb or fully populated with 8Mb

Our new external unit allows the A500/A500+ to be upgraded by up to a further 8Mb
auto-configuring FASTRAM using the latest 'ZIP' DRAM technology.

N.B. Any memory fitted to this unit is in addition to that on your machine already, to a maximum of 8Mb.

With 2MB fitted... £119.99 With 4MB... £179.99 With 8MB... £289.99

Partially populated units expand to 8Mb with 2Mb modules, available separately at only £89.99 per 2Mb

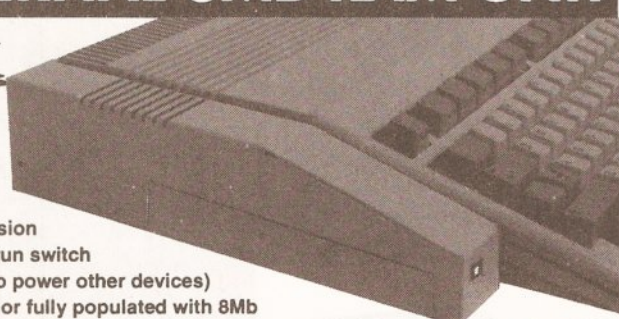

3 1/2" EXTERNAL FLOPPY DRIVES

AMAZING LOW PRICE!

£47.99

including VAT & delivery

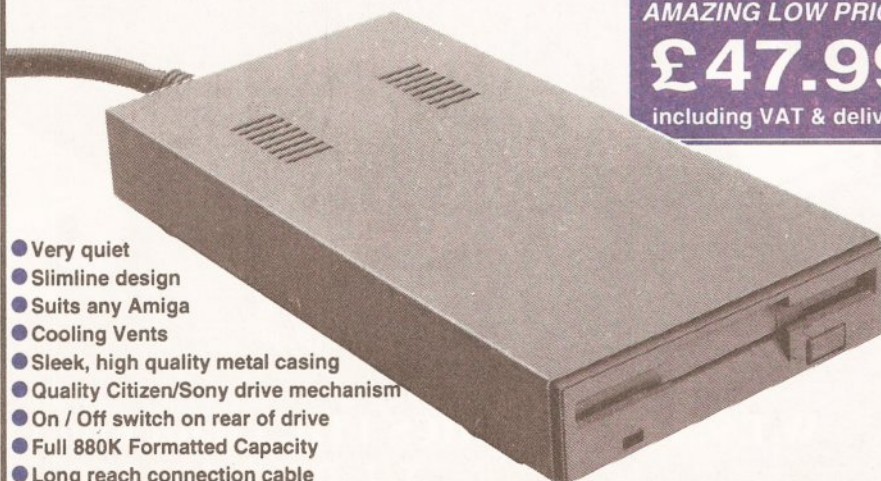

- Very quiet
- Slimline design
- Suits any Amiga
- Cooling Vents
- Sleek, high quality metal casing
- Quality Citizen/Sony drive mechanism
- On / Off switch on rear of drive
- Full 880K Formatted Capacity
- Long reach connection cable

Ladbroke Computing International

**33 Ormskirk Road
Preston
Lancashire
PR1 2QP**

**Telephone:
(0772) 203166
Fax:
(0772) 561071**

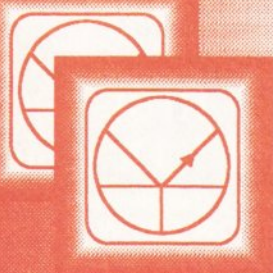

Ladbroke Computing are the longest established Atari dealer in the UK. We have developed an extensive customer service policy which means that we test all Hardware prior to despatch to ensure that goods arrive in working order. Although our prices are not always the cheapest we do endeavour to offer consistently good service and backup. This isn't just our opinion, we were voted "Best Dealer 1989" by the readers of ST World magazine, not for "the number of boxes shifted", but for quality service.

All prices are correct at copy date 13/03/92 (while stocks last), and are subject to change without prior notice. Please phone for up to date prices. All prices include VAT & delivery (in mainland UK), there are no hidden extras (WYSIWYG). Next day courier delivery is available for an extra £7 (Mainland UK). All prices available on Mail Order. Shop prices may differ. Shop & Mail order premises: 33 Ormskirk Road, Preston, Lancashire, PR1 2QP. Open Monday to Saturday 9:30am to 5:00pm. Phones answered from 9:00am. Dealer enquiries welcome. Ladbroke Computing International is a trading name of Ladbroke Computing Ltd. All trade marks recognised.

Due to limitations of space we cannot list all our products please phone for Diskboxes from £6.99, Amiga Workstation £49.99, ICD Ad-Speed £189.99, Dustcovers from £3.99, Phone for details of our repair service (ST & Amiga) Repair quote £15. Phone for more details.

Golden Image

£24.99

£19.99 without software

The NEW Golden Image *Brush* Mouse

- 150 Dpi resolution
- Opto/Mechanical Mechanism
- 500mm/SEC Tracking speed
- Includes Deluxe Paint III software
- Switchable between ST/Amiga
- Direct mouse replacement

Hand Scanners

- Golden Image Hand Scanner £149.99**
A 100, 200, 300, 400 Dpi hand scanner with 64 halftone levels for three different halftone mode settings and one letter mode. The scanner comes complete with the acclaimed Touch Up software and Deluxe Paint III Art package.
- Jin Scan Hand Scanner £119.99**

Golden Image Drive

- Digital Track Counter
- Daisy chain "through" connector
- Data enable/disable switch
- Only £59.99 including P&P

GVPII Hard Drives

GVPII A500 Hard drives include injection moulded styling, Internal RAM expansion to 8Mb via SIMM boards, Capacities from 52Mb, 3.5" 11ms Quantum mechanism, Internal Fan, Game switch and mini slot for future expansion.

- GVP 52Mb £379.99**
GVP 105Mb £559.99
GVP 52Mb + 2Mb Simms £449.99
GVP 52Mb + 8Mb Simms £689.99

RAM

Golden Image 512K Upgrade with clock £27.99

Phoenix 1Mb Board (A500 Plus only) £49.99

CDTV

£479

Phone for: Ultimate Basketball, Falcon F16, Fun School 3, Dr Wellman, Defender of the Crown, Chaos in Andromeda, Psycho Killer, World Vista, Advanced military systems, Illustrated Holy Bible.

Printers

- Star SJ48 Bubblejet £239.99**
Star LC-20 £139.99
Star LC-200 colour £199.99
Star LC-24/10 £189.99
Star LC-24/200 £229.99
Star LC-24/200 colour £289.99

All Star printers include 12 months on site warranty. All printers include ST/Amiga/PC compatible Centronics cable.

Monitors

- Protar Visto Col Mon £219.99**
Includes cable and 12 months on site replacement warranty.
Philips 15" Cube TV £ 269.99
A 60 channel, FST, Fasttext scart input TV which gives near monitor quality. Includes scart cable.

Disks

- 10 bulk disks £4.94**
40 Bulk disks £18.80
100 Bulk disks £41.13
80 disk box £7.99
250 disk box £19.99



Mice

- Golden Image Opto Mechanical Mouse, 250Dpi, switchable between ST/Amiga £17.99**
Golden Image Optical Mouse, 250Dpi, Mouse mat, no moving parts for greater reliability, switchable between ST/Amiga £34.99
Jin Mouse, High quality replacement mouse. £12.98

Atari Lynx 2

- Lynx 2 (Console only) £79.99**
Lynx soft cases £9.99
New Battery pack £9.99
Phone for: Klax, Ultimate chess, Robotron, Shanghai, Chips challenge, Xybots, Roadblasters, Chequered flag, Ninja gaiden, Paperboy, Turbo sub, Xenophobe, Qix, Robo squash, Tournament cyberball, Ms Pac Man, Bill and Teds excellent adventure, APB, Warbirds, Scrapyard dog, Stun runner, Hard drivin, Sime world, Electrocop.
- Lynx 2 Power supply £11.99**
Comlynx cable £6.99
Lynx 2 survivor £5.99

Sega Megadrive £105
Includes Keypad controller.
Phone for Games



AMIGA
SHOPPER
SHOW

WEMBLEY EXHIBITION CENTRE • MAY 15 - 17

It'll save you
serious money



Be the first to



YOU CAN'T AFFORD TO MISS IT!

Book your tickets now and save even more money with our special early booking discount. Instead of £6 you pay £4.95 – or £2.95 for under 14s. Return the form straight way to guarantee your show ticket.

YES! I would like to order advance tickets to the Amiga Shopper Show and save £1.05 a ticket.

Please send me ____ adult tickets at the special discount price of £4.95.
Please send me ____ under-14 tickets at the special discount price of £2.95.

Total payment: £.....

Method of payment (please circle) Access/Mastercard Visa Cheque PO

Credit card number _____ Expiry date _____

Please make all cheques payable to AMIGA SHOPPER SHOW

Name

Address.....

.....

Postcode.....AS05

Send this form to: AMIGA SHOPPER SHOW, PO Box 2, Ellesmere Port, South Wirral, L65 3EA
This offer closes on May 8th.

DATA PROTECTION ACT: The information on this form will be held on computer for the use of Future Publishing and its subcontractors.

Credit card *hotline*

see the new *Amiga*

Rumours have been circulating for months about a possible new affordable Amiga – and now you can be among the first people to see it for yourself. Commodore has announced that the official launch of the new machine, called the A600, will be at the Amiga Shopper Show on May 15-17.

The announcement confirms that the Amiga Shopper Show is the premier event of the spring. Also being launched at the show is the A570 (formerly the A690) CD-ROM drive for the A500.

Dozens of hardware and software companies, book publishers and dealers will be at the show. This is just part of the list: Commodore, Ashcom, AdventureSoft, Bitcon, Bruce Smith Books, Citizen, Computer Books, Connect, Cortex, Digita, Evesham Micros, FMG, Fujitsu, Future World, GVP, Gasteiner, Golden Image, George Thompson Services, Harde Cache, HiSoft, JAM, Kador, Media Ware, New Dimensions, Pacific Digital, Power Computing, Precision, Progressive Peripherals, Rombo, Silica, Supra, Videk, WTS, Zone Distribution... and many, many more.

As well as the exhibitors, Amiga Shopper will be hosting a series of seminars on topics ranging from programming to DeluxePaint. And there will be question and answer sessions with the Amiga Shopper experts, and a chance to talk about the magazine to the team which produces it.

If you've ever fancied experiencing virtual reality, the Amiga Shopper Show will be your chance, with the opportunity to lose yourself inside an incredible computer generated world. And gamers will have the chance to win prizes for getting the high score on the latest games from Ocean, US Gold,

Psygnosis, Electronic Arts and many others in the Amiga Power Games Arcade.

New launches, lots to see, great bargains, informed seminars, stunning entertainment: the Amiga Shopper Show is the best day out for Amiga owners this year. So order your tickets now using the form on the left or dial the credit card hotline number. Either way, you save money, and you'll get a full show guide sent to you before the event!



SOFTWARE

See the latest products from the likes of Digita, HiSoft and Precision. Test them out for your self, then pick the one you want...

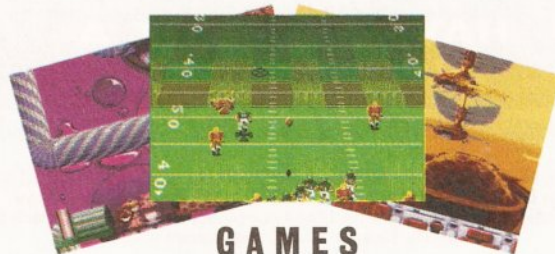

GAMES

The Amiga Power games arcade will feature only the latest and best games – and you'll have the chance to play them yourself.

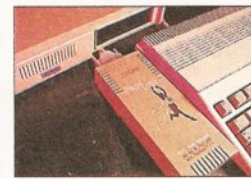

HARDWARE

Powerful hardware which will transform you Amiga will be on display and on sale, including devices from Supra, GVP, Gasteiner and more...

OPENING HOURS The Amiga Shopper Show is being held at the Wembley Exhibition Centre, London, on these dates:
Friday May 15th, 9am - 5.30pm ● **Saturday May 16th, 9am - 5.30pm** ● **Sunday May 17th, 9am - 4pm**

051-356 5085

NEW
LOWER
PRICES!

AMIGA PACKS

NEW
LOWER
PRICES!

ALL PRICES INCLUDE VAT. ALL ORDERS OVER £100 ARE SUBJECT TO £5 UK DELIVERY CHARGE. ORDERS OVER £100 RECEIVED BEFORE 2PM ARE USUALLY DESPATCHED THE SAME DAY FOR DELIVERY ON THE NEXT WEEK DAY. ORDERS UNDER £100 ARE SENT 1ST CLASS RECORDED POST. ALL PRODUCTS ARE UK STOCK AND CARRY A FULL 12 MONTH COMMODORE WARRANTY. PLEASE RING US BEFORE ORDERING TO CHECK STOCKS AND CURRENT PRICES.

All Amiga packs include the A500 PLUS & A1500 PLUS.

AMIGA A500+ 1MB CARTOON CLASSICS Amiga A500 computer, supplied with 1MB ram built in, Kickstart V2, expansion to 2MB ram possible via "trap door", mouse, tv modulator, manuals, Workbench V2 etc disks, plus the following top selling software titles : Lemmings, The Simpsons, Captain Planet and Deluxe Paint 3 **£349.00**

AMIGA A500+ 2MB CARTOON CLASSICS Amiga A500 computer, supplied with 1MB ram built in and an extra 1MB expansion board (giving a total of 2 megabytes of ram), Kickstart V2, mouse, tv modulator, manuals, Workbench V2 etc disks, plus the following top selling software titles : Lemmings, The Simpsons, Captain Planet and Deluxe Paint 3 **£389.00**

AMIGA A1500+ BASE A1500 computer with 1MB ram and now with Kickstart V2 and Workbench V2 software, detachable keyboard, 2 x 3.5" 880k disk drives built in, mouse and all manuals. The Amiga A1500 accepts A2000 peripherals. The A1500+ base pack is supplied with no software. Please note that the A1500 does NOT have a modulator. **£509.00**

AMIGA A1500+ PACK A consists of A1500+ base pack and the following software : Platinum Works, Deluxe Paint Version 3, Populous, Simm City, Battle Chess, Their Finest Hour (Battle of Britain) and 2 books **£559.00**

AMIGA A1500+ PACK B consists of A1500+ base pack and the following software : Platinum Works, Deluxe Paint Version 3, Home Accounts, Elf, Puzznic, Toki and Getting the Most Out Of Your Amiga book **£559.00**

Hard Disk Drives

A500 HARD DISKS

GVP Series II 52Mb Hard Disk £379.00
GVP Series II 105Mb Hard Disk £549.00

Protar 20Mb Hard Disk £275.00
Protar 50Mb Hard Disk £369.00
Protar 80Mb Hard Disk £595.00
PHONE FOR OTHER PROTAR SIZES

A1500 HARD DISKS

GVP 52Mb Hard Card £289.00
GVP 120Mb Hard Card £469.00
GVP 200Mb Hard Card £849.00

PLEASE PHONE FOR PRICES ON RAM UPGRADES ETC FOR ANY OF THE ABOVE HARD DISK DRIVES.

Colour Monitors

PROTAR VISTO C14M

- * 14" Colour monitor
- * Stereo speakers
- * 600 x 285 pixel resolution
- * RGB / Composite inputs
- * Green screen switch
- * Free with Amiga lead
- * Improved version of 8833 II
- * 1 year REPLACEMENT warranty

only £ 219.99

Accessories

512K ram expansion + clock £29.99
External disk drive £59.00
Squick replacement mouse £14.99
Amiga A500 dust cover £8.99
Mouse Mat £3.50
Cruiser Joystick £8.99
Zipstick Joystick £9.99

PRINTERS

ATTENTION ALL CITIZEN PRINTER BUYERS!

We are offering, to all buyers of Citizen printers some very special offers:

1. CITIZEN PRINTER STARTER PACK. The pack comprises of : 3.5" disk full of printer drivers for the ST, Amiga & PC; 200 sheets of fanfold tractor feed paper; 200 fanfold tractor feed address labels; 5 tractor feed envelopes all for only £12.99.

2. CITIZEN COLOUR PRINTING KIT. This kit enables you to upgrade either the Swift 9, Swift 24E or 224 to a full colour printer. The kit comes with a colour ribbon. Normally retailing at around £40.00, we are offering, while stocks last, the chance to buy this colour kit for only £19.99.

NEW LOW PRINTER PRICES

Citizen 120D+ (9-pin, 144 cps draft, 30 cps NLQ) £129.00
Citizen Swift 9 (9-pin, 192 cps draft, 48 cps NLQ) £189.00
Citizen 124D (24-pin, 144 cps draft, 48 cps LQ) £189.00
Citizen Swift 224 (24-pin, 192 cps draft, 64 cps LQ) £229.00
Citizen Swift 24E (24-pin, 216 cps draft, 72 cps LQ) £289.00
Citizen Swift 24X (24-pin, 15" carriage) £399.00

Star LC20 Mono (9-pin, 180 cps draft, 44 cps NLQ) £159.00
Star LC200 Colour (9-pin, 180 cps draft, 45 cps NLQ) £220.00
Star LC24-200 Mono (24-pin, 200 cps draft, 67 cps LQ) £260.00
Star LC24-200 Colour (24-pin, 200 cps draft, 67 cps LQ) £295.00

Canon BJ10EX Bubble Jet (ink jet, now EPSON compatible) £265.00
Hewlett Packard DeskJet 500 (ink jet, 3 pages per minute) £389.00
Hewlett Packard Deskjet 500 Colour (NEW! full colour inkjet) £619.00

HAVE YOU GOT A V1.3 AMIGA?

DO YOU WANT VERSION 2 KICKSTART & WORKBENCH?

If so, we now have in stock the new VERSION 2 UPGRADE KIT. The kit consists of the Kickstart 2 Rom, Workbench 2 software (including the Extras disk and the Fonts disk) and the Workbench 2 full manuals. Easy to fit and requires no soldering.

£ 79.99

1MB Ram Upgrade

If you want to expand your Amiga A500 Plus to a total of 2MB then why not fit the new 1Mb Ram Board? This extra ram will unleash the full graphics capabilities of the A500 Plus and is ideal for many other applications such as sound sampling, data storage etc... It's simple to fit, without any modification, and will not invalidate your computers warranty.

£49.99

FOR USE WITH THE A500 PLUS ONLY

ROM Switcher

Some older software will not run on the new Amiga A500 Plus with Kickstart V2.04 Rom but they do run on the older V1.3 A500s.

We are now stocking the Phoenix Rom Switcher which means, once installed, you can switch between Kickstart 1.3 and 2.04 giving you all the benefits of both Amigas and solving those incompatibility problems. It can be easily installed to the A500 Plus and comes supplied with Kickstart V1.3 Roms. Included in the kit is a microswitch which can be mounted virtually anywhere to enable toggling between the two Rom versions.

£49.99

FOR USE WITH THE A500 PLUS ONLY

SOFTWARE

LEMMINGS £7.99
THE SIMPSONS £7.99
CAPT PLANET £7.99
DPAINT 3 £19.99
ALL 4 TITLES £34.99

IF YOU WISH TO ORDER WITH US, THEN PLEASE SEND YOUR CHEQUES, BANKERS DRAFTS, POSTAL ORDERS, CASH ETC TO OUR MAIL ORDER ADDRESS (PLEASE MAKE CHEQUES PAYABLE TO BEST PRICES) OR RING OUR MAIL ORDER HOTLINE ANY TIME BETWEEN 8.00AM AND 8.00PM, 7 DAYS A WEEK, (OUR LINES ARE PERSONALLY MANNED - THIS IS NOT AN ANSWERPHONE) AND USE YOUR CREDIT CARD. ALL ORDERS OVER £100 SUBJECT TO £5 DELIVERY CHARGE.

VISIT OUR SHOWROOM

**CHIPS COMPUTER CENTRE, 53 RUGBY ROAD,
WORTHING, WEST SUSSEX. BN11 5NB.**

TEL : (0903) 700804.

OPENING : MON TO FRI 10AM TO 6PM. SAT 9.30AM TO 5.30PM
FINANCE / CREDIT FACILITIES (SHOP ONLY).
PART EXCHANGE CONSIDERED (SHOP ONLY).
NEW AND USED ST, AMIGA & PC EQUIPMENT ON DISPLAY
ALL TYPES OF SOFTWARE (BUSINESS / LEISURE / EDUCATIONAL).
REPAIRS UNDERTAKEN. TRAINING. INSTALLATION. ON-SITE WARRANTIES.



MAIL ORDER ONLY

**BEST PRICES (DEPT AS), 53 RUGBY ROAD,
WORTHING, WEST SUSSEX. BN11 5NB.**

TEL : (0903) 700714.

OPENING : 7 DAYS A WEEK 8AM TO 8PM
ALL PRICES INCLUDE VAT. ALL ORDERS OVER £100 ADD £5 FOR NEXT WEEKDAY
COURIER DELIVERY. ORDERS UNDER £100 ARE SENT BY POST.
NOTE - CREDIT CARDS ARE SUBJECT TO VERIFICATION BY CARD ISSUERS.
GOODS USUALLY SENT OUT THE SAME DAY WHEN
CLEARED PAYMENT IS RECEIVED BEFORE 2PM.
PERSONAL CHEQUES REQUIRE 7 DAY CLEARANCE.

All prices include 17.5% VAT. Free delivery ONLY on orders under £100. All prices / specifications / special offers subject to change without notice.

ALL OUR TELESALES LINES ARE PERSONALLY MANNED AND OPEN FROM 8.00AM UNTIL 8.00 PM - 7 DAYS A WEEK

Digital diaries too expensive?
Mark Smiddy creates a diary
system using AmigaDOS

Cracking the shell

Over the past few months I've concentrated on AmigaDOS's more sublime features but it's time to take a break from all that and explore what is possible with this amazing and often underrated system. In the last few years digital diaries have sold in ever-increasing numbers, so why don't we have a go at coding one ourselves for free?

Since you already have a computer you may as well use it, but "real" database programs are rarely cheap and usually too powerful for simple applications - such as a telephone book. The flat-file database described here is crude by commercial standards but boasts the following features:

- Completely menu driven
- Sort records on any record column
- Search and display a record on any sub-string
- Database can be edited directly with any text editor (or ED)
- Delete any record group
- View any group of records

The entire program (actually it's a series of modules) is much too large to explain and list entirely in one issue; instead, the feature will expand over the next few months as each module is added.

Each module will be described in detail showing how it has developed. However, I know how annoying part works can be, so the basic feature presented here has basic editing and reporting facilities built in.

All the scripts for the program are compatible with AmigaDOS 2, but they do not take advantage of any extra facilities in the new system.

THE MENU SYSTEM

The main part of AmigaDOS Database is its front-end menu system. This allows anyone with little or no knowledge of AmigaDOS to operate the system without fuss. All commands can be operated by selecting the first (highlighted) letter and pressing return P for print; S for sort and so on. However, many commands also take parameters. View for instance takes one or two

The task of deciding which parameters are required is handled partly by the main menu module and partly by the view module; more of which in a future instalment.

HOW IT WORKS: DATABASE

1. This is the key to the main menu, although under normal circumstances you won't even see it. Database is normally started without parameters so it displays its menu.

Experienced users also have the option of giving a command directly as is shown below:

```
1>DATABASE P ; print ↵
database now
```

or

```
1>DATABASE S 20 ; Sort ↵
database from column 20
```

The key breaks down into three sections.

JARGON BUSTING • JARGON BUSTING

Database - A collection of one or more records.

Flat-file - A simple type of database where every item of information must be stored in each record.

Record - A collection of one or more fields.

Empty field - A field which does not contain any data. It is quite common to use empty fields in databases where optional data notes perhaps can be entered.

- View entire database
- Outputs to printer
- Compatible with AmigaDOS 2
- Imports and Exports to and from Superbase

Quite impressive for a program written entirely in the machine's DOS batch language, I think you will agree. But even if you have a database, this application will show you how to control many parts of AmigaDOS in previously unexplored avenues.

parameters as the starting and finishing numbers. These can be supplied as part of the command line, for instance:

```
Command: V 2 5
```

displays records 2 to 5 inclusive. However if a parameter is not supplied the module will prompt for it automatically. For instance:

```
Command V
View record #:
```

LISTING: DATABASE

```
1. .key Command,d1,d2,d3,d4,↵
d5,d6,d7,d8,d9,option/k.↵
2. .bra {
3. .ket }
4. .def option "{d1} {d2}.↵
{d3} {d4} {d5} {d6}.↵
{d7}{d8} {d9}"
5. if "{command}" EQ ""
6. SKIP menu
7. Endif
8. if "{command}" EQ "A"
9. delete >NIL: T:Temp
10. execute S:AddData.↵
{option}
11.endif
12.if "{command}" EQ "D"
13. execute S:DelBlock {d1} {d2}
14.endif
15.if "{command}" EQ "V"
16. execute S:ViewBlock.↵
{d1}{d2}
17.endif
18.if "{command}" EQ "F"
19. execute s:FindData.↵
{option}
20.endif
21.if "{command}" EQ "E"
22. ED s:Data
23.endif
24.if "{command}" EQ "S"
25. execute S:SortData {d1}
26.endif
27.if "{command}" EQ "L"
28. TYPE >RAM:data{$$}.↵
S:DATA OPT N
29. MORE RAM:data{$$}
30.endif
31.if "{command}" EQ "P"
32. execute S:PrintData
33.endif
34.if "{command}" EQ "Q"
35. ASK "Are you sure y/N?"
36. if warn
37. echo "Thanks for using.↵
AmigaDOS DataBase*nPlease.↵
come again..."
38. QUIT
39. endif
40.endif
41.LAB Menu
42.echo "**e[33mAmigaDOS.↵
Database*n*e[I(c) 1992.↵
Mark Smiddy*e[31m*n"
43.echo "**e[7m*e[I(A)*e[0mdd.↵
a record"
44.echo "**e[7m*e[I(D)*e.↵
[0mdelete records [Start @.↵
#][End @ #]"
45.echo "**e[7m*e[I(V)*e.↵
[0miew records [Start @.↵
#][End @ #]"
46.echo "**e[7m*e[I(F)*e.↵
[0mind a record [Search.↵
string]"
47.echo "**e[7m*e[I(E)*e ↵
[0mdit database directly"
48.echo "**e[7m*e[I(S)*e ↵
[0mort database [Column.↵
#]"
49.echo "**e[7m*e[I(L)*e.↵
[0mist entries by number"
50.echo "**e[7m*e[I(P)*e.↵
[0mrint database"
51.echo "**e[7m*e[I(Q)*e.↵
[0mUIT"
52.echo "Command: " noline
53.execute >NIL: s:database ?
```

- Command: The single letter command.
 - d1...d9: Nine data elements (or arguments)
 - Option: A reserved variable
- 2-3.** Set the BRA and KET characters to { and } respectively (because I happen to like them like that).
- 4.** Sets the Option variable to the contents of d1...d9. This is reserved for the FindData and AddData

14. Control only reaches here if the test at Step 12 was unsuccessful and continues directly at Step 15.

15-17. Open the ViewData block. This works just like DelData described above.

18-20. Open the FindData block. These work like AddData, passing any automatic data in the Option variable.

21-23. Open the ED block. The ED

30. Terminates the List block. Control will continue from here when MORE exits.

31-33. Operate the PrintData block. Control does not resume at Step 33 unless the test at Step 31 is unsuccessful.

34-40. Looks after the Quit section, thus terminating the program rather nicely.

The block 35-39 just stops users from accidentally exiting.

If they enter N at the prompt, execution falls off the end of the program and the script runs itself again.

41-51. Display the menu. Several escape sequences are used here, viz:

- *e[Tabulate
- *e[7m Inverse video
- *e[0m Normal video
- *e[33m Foreground orange (blue in AmigaDOS 2)
- *e[31m Foreground white

52. Displays the command prompt. Note the use of the NOLINE switch to suppress the automatic line feed character.

53. More trickery. EXECUTE is used to call the Database module and display its command line in interactive mode; which is also suppressed by the re-direction to NIL:.

The result is you can enter commands at an invisible prompt!

user a chance to alter the printer setting. (Usually you would use this feature to set NLQ mode or the margins.) If Y is pressed the WARN flag is set; otherwise it is cleared and this is tested for...

3. ... here. If the user entered Y (run preferences) control continues at Step 3; otherwise it jumps to Step 5.

4. Launch the Preferences tool and go straight to the Printer screen. AmigaDOS 2 users should replace

LISTING: SORTDATA

```

1. .key Col
2. .bra {
3. .ket }
4. .def col 1
5. ECHO "Sorting*nPlease.
wait..."
6. FAILAT 11
7. STACK >NIL: 16000
8. if error
9. echo "Out of memory...*
nCan't sort, sorry"
10. else
11. SORT S:data RAM:data{$$}
COLSTART={col}
12. COPY RAM:data{$$} S:data
13. endif
14. FAILAT 10
15. STACK 4000
16. execute s:database

```

modules described later.

5-7. This is provided as a time saver. Under normal circumstances when Database is launched, the Command variable will be empty, that is equal to "" and this causes the program to skip immediately to the menu starting at Step 41.

8. If the command variable equals A (add) control continues at Step 9, otherwise it continues at Step 11.

9. Control only reaches here if the Add selection has been made. This line deletes a temporary file created by the AddData module.

Re-direction to NIL: is used to suppress the error message when the file does not exist. (This could be tested with IF EXISTS... but that's just overkill.)

10. Calls the AddData module directly passing any automatic data entered by the user. (Automatic data is collected in the Option variable at Step 4).

11. Marks the end of the AddData control block. Control only reaches here if the test at Step 8 was not successful.

12. Opens the DelData block and tests for the delete option. If the key has been pressed, control resumes at Step 13; otherwise it branches to Step 14.

13. Calls the Deldata module passing up to two parameters collected in D1 and D2.

screen editor is opened; which is the only way to Add, Delete and Edit data with the modules listed this month. Note that ED is called directly within the script unlike most commands which execute a new script.

24-26. Open the SortData module. One optional automatic parameter is passed in D1

27. Open the List by number module

LISTING: PRINTDATA

```

1. ASK "Position paper,
ready printer and press.
Return"
2. ASK "Do you want to
check/alter your
printer setup?"
3. if warn
4. SYS:Prefs/preferences
printer ; AmigaDOS 2 use.
Prefs/Printer
5. endif
6. ECHO >RAM:title{$$}
"AmigaDOS Database on:"
noline
7. DATE >>RAM:title{$$}
8. JOIN RAM:title{$$}
S:Data AS RAM:
Printfile {$$}
9. FAILAT 11
10. COPY >NIL: RAM:PrintFile.
{$$} to PRT:
11. if error
12. echo "Your printer
is not responding!*n
Please check *On-Line*
is on; paper loaded; and
cable connected"
13. endif
14. FAILAT 10
15. Execute S:DataBase

```

if L was passed as a command parameter.

28. Copies the entire database to a file in the RAM disk, but adds line numbers to each record - a good way to view and edit blank records.

29. Displays the temporary data file a screen at a time.

HOW IT WORKS: PRINTDATA

1. This is a cheeky trick to force AmigaDOS to pause until you press a key and display a message at the same time. ASK is conventionally used to collect a yes or no answer as in Step 2.

2. Stops the script and gives the

GOTTA PROBLEM?

If you get stuck with AmigaDOS or there is anything specific you would like to see, drop a line to: Mark Smiddy, Amiga Shopper, 30 Monmouth St, BATH, BA1 2BW. Sorry, no personal correspondence. You can EMail me on CIX @ SMIDOID.

this with SYS:Prefs/Printer as noted in the comment.

5. Marks the end of the control block started at Step 3.

6. Creates a new file in RAM which will form part of the printout.

7. Appends the current day, date and time to the print header.

8. Merges the printfile header with the entire database and creates a new file in RAM.

9. Raises the failure level from 10 to 11.

10. Prints the entire database. If something goes wrong (say your printer is not switched on) COPY will fail with an ERROR condition. This is prevented by raising the fail condition to 11 in Step 9; and ambiguous error messages are absorbed by directing output to NIL:.

11. This line checks for the ERROR condition. If COPY failed as described above, control continues at Step 12. Normally it just jumps straight to Step 13.

12. Displays a helpful error message and suggests what might be going on. Much nicer than Error during copying or some such thing.

13. Marks the end of the control block opened at Step 11.

14. Resets the failure level to 10 (default).

AmigaDOS 2 Master class

The Pest

When was the last time you forgot an important appointment? Moreover, if you keep a diary do you remember to check it every day? Isn't it just too easy to get engrossed in a computing session and forget you had to nip to the dentist for a filling... This little AmigaDOS 2 specific program will check your appointments every time you start or reset your machine. In a few seconds it will calculate the current date and check your schedule for any due appointments. Although it would be possible to construct a similar script for AmigaDOS 1.3, it would slow down the Startup-sequence too much due to the extra complexity required. Also, your machine must be fitted with a real-time clock.

All you have to do is construct a file of appointments in the S: directory under the name: Reminders. The format is as follows. Each reminder must fit on one line and must contain the date in AmigaDOS format, for example DD-MMM-YY.

The following are acceptable:

01-Mar-92 - Go to Mr Andrews for inspection at 10:00
Buy flowers for P's birthday: 02-apr-92

whereas these are not:

Monday: Dentist
3-2-1992 Take car to Bob for oil change
Go to Amiga Shopper show: 15/5/92

HOW IT WORKS: THE PEST

1. Create an auto-executing macro for EDIT using DTA and DFA. This will be used to extract just the date portion from the DATE's output. More of that later.
2. Get the current day, time and date and send it to the file: T:Today
3. Use the macro created at Step 1 to create a new file ENV:Now which contains the date string in the correct format. Here's how it works:

DATE's output file contains a string which might look like this:
Monday 2-Mar-92 12:30:04

The EDIT macro removes just the days name and the time like this:

DTA/ / or Delete Start After the next space. Removes the day's name including the trailing space. Our example date now looks like this:

2-Mar-92 12:30:04

DFA/ / or Delete From After the next space. Removes the time starting with the space after the date to the end of the line. This produces the final output to file, viz:

2-Mar-92

4. Now for another little bit of AmigaDOS 2 trickery. This line creates a file in T: containing the reminder title and the date. For instance:

```
== Reminders for: 2-Mar-92 ==
```

But hang on - where does the date come from? Look at the line more closely. Notice how the date appears at the position \$now. In other words \$now is replaced by the contents of the global environmental variable, now. This variable was created right under AmigaDOS's nose in Step 3. EDIT's output file is called ENV:now.

5. The same kind of trickery is used here. The reminder file (S:Reminders) is searched for any lines containing the current date. Any lines containing that date are appended to the print file T:pf created at Step 4. The actual date is retrieved at run-time from \$Now. (This is possible in AmigaDOS 1.3 but is much more complex to achieve.)
6. This line opens a conditional test. The WARN flag will be set if the date doesn't match any dates in the schedule file. If this is the case, control continues at Step 7; if not (a date was found) control passes to Step 8.
7. Displays a short confirmation to let you know your day is free from appointments.
8. If control reaches here directly from Step 7, it passes to Step 10, does not pass go and does not collect £200. If control came from Step 7 (a date was found) it continues at Step 9.
9. Opens MORE and displays all the appointments/reminders for that day. RUN is used to start more so the Startup-sequence can continue and launch Workbench while you study your calendar.
10. Closes the script.

The Pest - append to S:User-startup

The Pest - AmigaDOS scheduling program by Mark Smiddy

```
; add these lines to the end of
S:User-Startup
1. echo >T:Autol "DTA/ /*nDFA/ /"
2. date to T:today
3. edit T:today to ENV:now with T:Autol
4. echo >T:pf "==" Reminders for: $now
   ==*n"
5. search >>T:pf s:Reminders "$now" nonum
6. if warn
7. echo "Nothing in reminder diary
   today..."
8. else
9. run more T:pf
10. endif
```

15. Calls the main Database program without parameters so it re-displays the menu.

HOW IT WORKS: SORTDATA

1. Defines a key with a single parameter. This is passed by the Database module as the column start.
- 2-3. Re-define BRA and KET to { and }.
4. Force the COL variable to contain 1 if no value was supplied.
5. Displays a simple message. Sorting can be quite time consuming on large databases. This just lets the user know what's happening
6. Raises the failure level to 11 in case STACK fails...
7. ...here. SORT is a very stack hungry command (it needs a lot of memory) so STACK attempts to allocate 16000 bytes four times normal. If the attempt fails an error is produced (but sunk to NIL:) and the ERROR flag is set...
8. ...which is tested here. If STACK failed to allocate the required amount of stack space control continues at Step 9; if all went to plan control jumps to Step 10.
9. Reports the error and allows control to resume at Step 10.
10. If control gets here from Step 9 (failed), it jumps to Step 13. If it gets here from Step 8 (all OK), it continues at Step 11.
11. Sorts database to a temporary file in RAM. An optional column start parameter is supplied (default 1).
12. Copies the database disk.
13. Marks the end of the control block opened at Step 8.
14. Resets failure level to default.
15. Resets the stack to its default setting of 4000 bytes - not strictly necessary but it frees up some RAM.
16. Calls the main Database program without parameters so it re-displays the menu.

CONCLUSION

So there you have it the first part of your very own database program and your own appointment scheduler. A digital diary written entirely in AmigaDOS! See you next month (make a note of the publication date in your scheduler so you don't miss the next part). **AS**

The **AMIGA** Collection

FORMAT

Spring a few surprises!

The world's best-selling Amiga magazine is bringing you treat after treat over the coming months, in the form of complete, top-name, full-price programs to help you get more fun and satisfaction out of your Amiga. Don't miss out: look out for them at a newsagent near you!

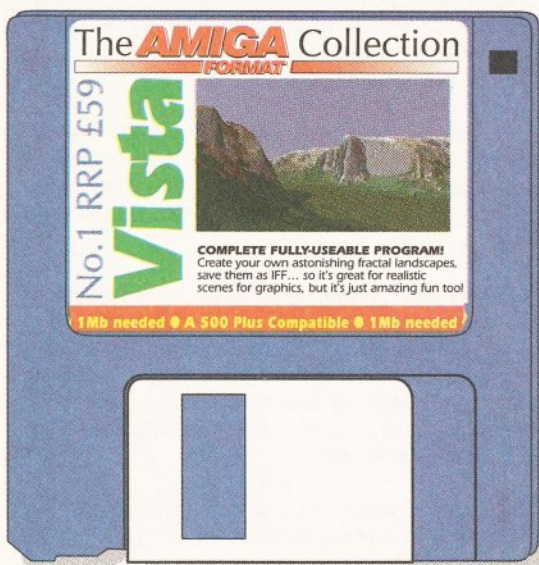

April - no fooling! out now!

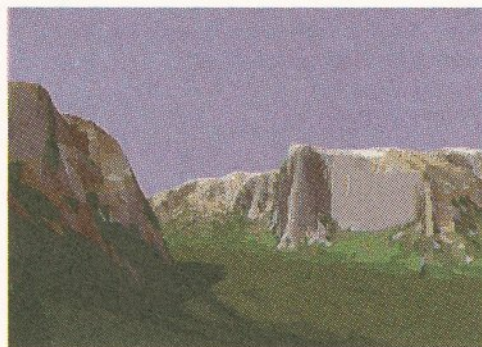

The complete program is Vista, worth £60, one of the most fascinating and enjoyable programs that there is for your Amiga: it allows you to create whole artificial landscapes, for use in graphics or just for fun!

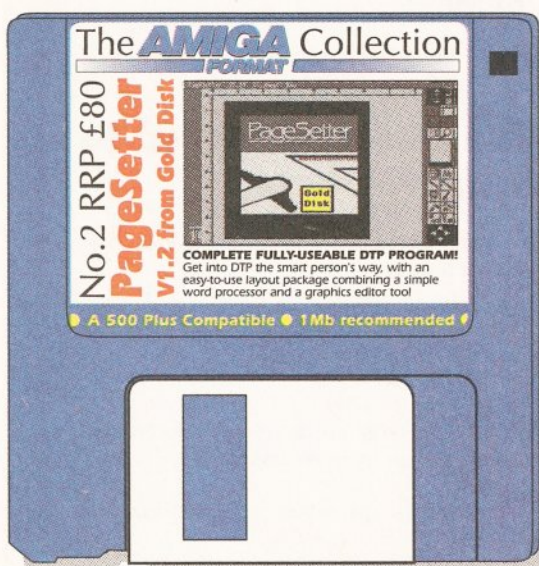

May - going nuts! out 9th April!

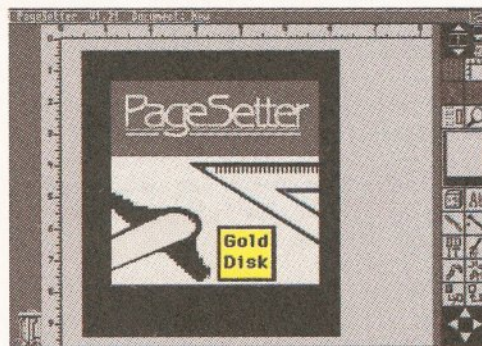

The second program in the Amiga Format Collection series is PageSetter 1.2, worth £80, an easy starting point for anyone who's ever wanted to have a go at DTP. It includes a simple word processor and a graphics program, too!

GASTEINER

Tel: +44 081-365 1151
Fax: +44 081-885 1953

Trade & Educational
Orders Welcome

Technologies

Credit Cards
Welcome

Personal Callers
Welcome

Presenting an outstanding range of products from **GASTEINER**

THE TRACK BALL



Excellent quality three button track ball with click & hold. Smooth, precise, and priced at

£39.95

OPTICAL MOUSE

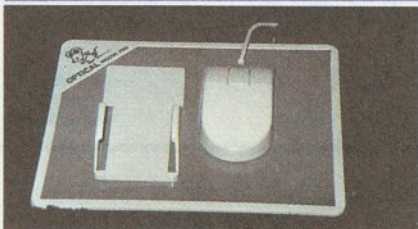

Fast 300dpi resolution ideal for DTP. Includes pad & holder. 600mm/sec tracking speed

£35.00

Auto Mouse/Joystick Switch



Allows selection of mouse or joystick

£17.95

POWER SUPPLY

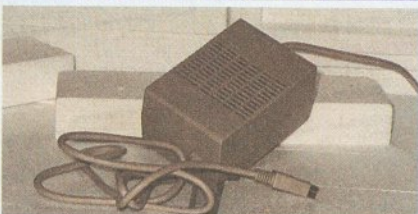

for A500, original Commodore

£34.95

1.3/2.0 Kickstart Switch **£19.95**

Boot Selector for

A500/A2000

£17.95

CORDLESS MOUSE

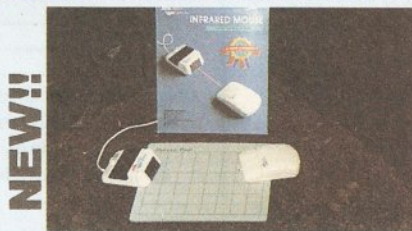

NEW!!

Fully rechargeable with long 6ft transmission distance.

£49.95

OPTO-MECH MOUSE



High resolution 300dpi mouse, with micro-switch buttons. Smooth and reliable. Long 6ft cable.

£19.95

Extra durable replacement mat for Optical Mouse

£9.00

SCANNER



U.K.'s best selling scanner - 400dpi, 256 Greyscale, with Touch-Up software and Merge It (lets you scan full A4 page)

£169.00

OKTAGON 508



NEW!!

MEMORY MASTER



A New Age fast RAM expansion for Amiga 1500/2000/2500/3000, with 2Mb memory.

£129

Expandable to 4/6/8 Mb.

ALF 2008



NEW!!

Universal HardDisk controller. Fully configurable, highly adaptable, totally compatible.

Controller **£129**

+2MB **£189** +6Mb **£309**

+4MB **£249** +8Mb **£369**

RAM UPGRADES

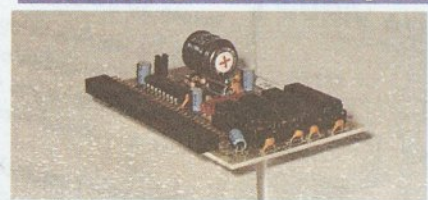

A500 1/2 Mb RAM Upgrade **£26**

A500 2.5 Mb RAM Upgrade **£99**
with clock

A500+ 1/2 Mb RAM Upgrade **£39**

A500+ 1 Mb RAM Upgrade **£79**

HardDisk Controller - Autoboot/ PC Partitions/ SCSI-2/ 1Mb/s / Fully multitasking/ login & password protection/ A-MaxII support

Controller **£169**

Controller+

2Mb **£229** 6Mb **£349**

4Mb **£289** 8Mb **£409**

GASTEINER Unit 3 Millmead Business Centre, Millmead Road, London N17 9QU

All trade marks acknowledged. Prices and specifications may change without prior notice. Prices include VAT but do not include delivery.

Telephone:
(0543) 473131

GLOBAL

Telephone:
(0543) 473131

MEMORY UPGRADES A500

| | | |
|--------------------------------------------------|---------|--------|
| 512K no clock | 16 chip | £19.99 |
| | 4 chip | £23.95 |
| 512K with clock | 16 chip | £24.99 |
| | 4 chip | £27.95 |
| 1Mb thru board | | £59.95 |
| (To use with 512K upgrade to give 1.5Mb upgrade) | | |
| 1.5Mb with clock | | £69.95 |

MEMORY UPGRADES A500 PLUS

| | |
|--------------------------|--------|
| 1Mb (Populated to 1/2Mb) | £39.99 |
| 1Mb (Fully populated) | £59.95 |

ROM SHARER 2.04 → 1.3

| | |
|-----------------------------------------------------------|--------|
| Rom Sharer | £29.99 |
| Enables A500 Plus owners to run A500 compatible software. | |
| Will need 1.3 Kickstart | £39.00 |

DISKS

| | | |
|------------|------|----------|
| 3.5" DS/DD | 100+ | only 33p |
| | 50+ | only 36p |
| | 1+ | only 39p |

Prices include VAT. P&P EXTRA please enquire when ordering. Prices and specifications are subject to change without notice. E. & O.E.

ACCESSORIES

| | |
|--------------------------------|------------|
| Mouse ST/Amiga replacement | £14.99 |
| 20 Cap. Disk Box 3.5" | £2.99 |
| 40 cap. lockable disk box 3.5" | £4.50 |
| 80 cap lockable disk box 3.5" | £5.99 |
| 100 cap lockable disk box 3.5" | £6.99 |
| Dust covers Am/ST | £3.99 |
| Dust covers printer/monitor | from £5.99 |
| Mouse mat 6mm | £2.99 |
| Mouse mat 9mm | £3.99 |

Leads and ribbons - most requirements can be supplied - please telephone for quote.

SERVICES

| | |
|--------------------|---------|
| Fitting and repair | £P.O.A. |
|--------------------|---------|

SIMMS

Amazing pricing on the following.
Can you beat these prices?

| | |
|--------------------|--------------|
| 256K x 8/9 (1/4Mb) | Only £10.00 |
| 1Mb x 8/9 (1Mb) | Only £30.00 |
| 4Mb x 9 (4Mb) | Only £120.00 |

CHIPS & BITS

| | |
|--------------------|--------|
| 256K x 1 DRAM | 90p |
| 256K x 4 DRAM | £3.95 |
| 1Mb x 1 DRAM | £3.95 |
| 1Mb x 4 DRAM | £25.00 |
| 4Mb x 1 DRAM | £25.00 |
| 8372A Fatter Agnus | £POA |
| 1-3 Kickstart | £39.00 |

SUPRA 500 RX EXTERNAL MEMORY EXPANSION

| | | |
|--------|-----|--------------|
| 500 RX | 1Mb | Only £145.00 |
| | 2Mb | Only £185.00 |
| | 4Mb | Only £269.00 |
| | 8Mb | Only £419.00 |

Only 1" wide. Plugs directly onto the side of your Amiga - it only takes a few moments to fit.

Phone now for your best deal around.

FLOPPY DRIVES

| | |
|---------------------------------|--------|
| 3.5" DS/DD external drive | £49.99 |
| 3.5" DS/DD internal replacement | £44.00 |

Quiet, slim, high quality mechanisms.

HARD DRIVES

As we supply nearly all makes please state the make and model on your enquiry/order and we will supply at "The market price". Please call for confirmation of price and delivery.

SUPRA MODEMS

Get to those software bill boards; or anything you want down the phone - ready to go on line.

| | |
|-----------------|---------|
| Supra 2400 | £119.00 |
| Supra 2400 Plus | £174.00 |

2400 Plus has error correction and data compression. Both include:

- ★ RS232 interface
- ★ Internal diagnostics
- ★ Programmable number storage
- ★ Tone pulse autodial/answer
- ★ 100% Hayes compatible

QUALITY GUARANTEE

All products are made using leading edge technology to the highest standards and are fully guaranteed.



GLOBAL COMPUTING
Yoxall, Burton-upon-Trent, Staffs DE13 8NR
Telephone: (0543) 473131

KILL DA VIRUS

A professional virus killer that recognises more than 138 viruses.

Features:

- ★ Three versions included from a title bar clock version through a custom screen 3D gadget version (KDV5).
- ★ Brainfile which is being updated through PD channels and of course on Newsflash so you will always have an updated version
- ★ Store your bootblocks on disk so you can restore them when your bootblock is destroyed by a nasty boot virus (Saddam etc etc.)

- ★ Checks your memory and will kill any live virus to avoid further spreading on healthy disks. Any unknown bootblock will be analysed with a 'learn' option so next time it can be identified.
- ★ User friendly menus so easy to work with.
- ★ Full support of Kickstart 2.0 and hard disks.

CODE 9881 PRICE £14.95

POWERPACKER PROFESSIONAL v4.0

You can't pump up a disk, but with POWERPACKER you can compress its contents into less than two-thirds of the space otherwise required for storage - on a floppy disk or hard drive.

- ★ **POWERPACKER** uses sophisticated "crunching" algorithms to reduce the sizes of files, allowing an average of 40% more material to be stored on the medium of your choice.
- ★ **POWERPACKED** programs load "auto-decrunch" and run which access packed files at the click of an icon, so you can get full and quick use of them without decrunching.
- ★ **PPMORE** A fully-fledged screen text reader with options for string search and sending an on-screen image to a graphics printer.
- ★ **PPANIM** Plays a crunched anim file. Tremendous savings possible for storing and playing your animations.
- ★ **PPTYPE** Formats a crunched text file to the printer, including pagination and perforation skips.
- ★ **PPDECRUNCH**, a utility that restores files to original sizes.

POWERPACKER PROFESSIONAL © 1990 By Nico Francois

- Features:
- ★ **Make your files 70% smaller!** Crunch (compact) executable/datafiles and make your files to 70% smaller. With the help of the PPloadseg utility, which you can install on your (hard) disk, you now can even crunch libraries and devices.
 - ★ **Extra Powerpacker utilities**
PPmore >> Displays packed ascii files
PPshow >> Displays packed IFF pictures
PPanim >> Displays packed animations

- ★ Comes with 2 new libraries Powerpacker and a new requester library with even more features and better menus.
- ★ Crunchfactor even better than version 3.0b
- ★ Detects Data or Command files
- ★ Full Arexx Support
- ★ Improved Menus and Colour Table
- ★ Special Kickstart 2.0 version included

CODE 9880 PRICE £14.95

Please send me: (please indicate)
Prices inclusive of postage & packing

- Powerpacker Professional v4.0 £14.95 9880
- Kill Da Virus £14.95 9881

TO ORDER:

By post: Send your cheque or credit card details, including expiry date, to DATABASE DIRECT, FREEPOST, Ellesmere Port, South Wirral L65 3EB. (No stamp needed if posted in UK).

By phone: Phone our 24 hour hotline on 051-357 1275

By fax: Order by fax on 051-357 2813

Name..... Signed.....

Address.....

Daytime tel. no.....

● LISTINGS ●

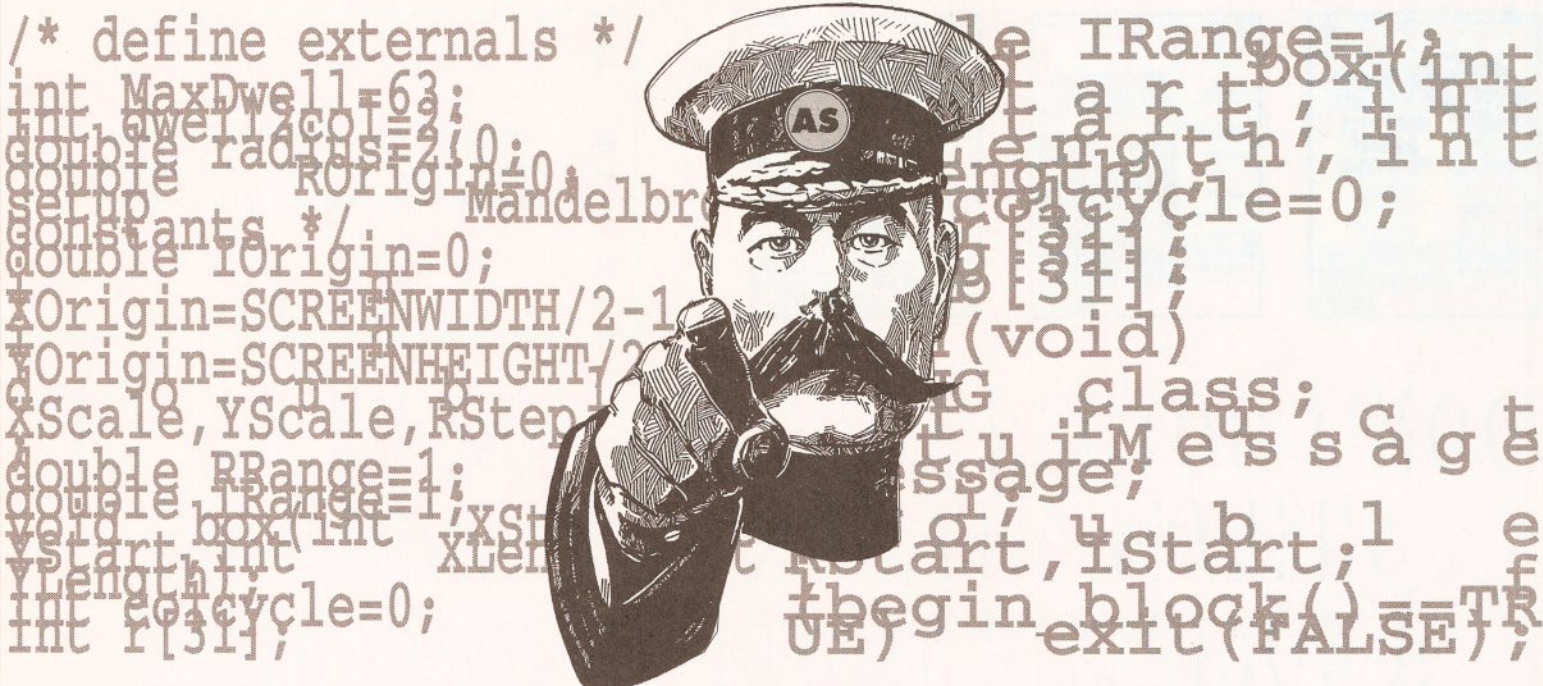

YOUR MAGAZINE NEEDS YOU!

...or rather, your fellow readers do – why not let other Amiga owners share your wondrous creations? We're after your program listings and we'll pay you £20 for any we publish.

Programs can be in any Amiga language. They should be sent on an AmigaDOS disk, along with source code if assembled or compiled.

Enclose a stamped addressed envelope if you want them back.

Send your lovingly-crafted entries to: Listings, Amiga Shopper, Future Publishing, 30 Monmouth Street, Bath, BA1 2BW.

And prepare for fame and fortune.

```

/*externals */ define double IRange=1;
int MaxDwell=63; void start_box(int
double radius=2;0; x_start, y_start, int
double ROrigin=0; y_length, int
Mandelbrot setup int r[31];
constants */ int r[31];

```

Missing the complete set? – well get your back issues NOW while you can



- 1 **SOLD OUT**
- 2 Buying a paint package plus reviews of Pagestream, Colourpic, Sequencer 1, KCS Powerboard, and Scala.
- 3 Accelerating the Amiga plus reviews of Bars & Pipes, Daatascan, ATOnce, DynaCADD and BASIC languages.
- 4 **SOLD OUT**
- 5 Amiga Answers Special plus reviews of Spectracolor, Superbase 4, Touch-Up, Action Replay, VideoCenter Plus and more
- 6 **SOLD OUT**

DON'T BOTHER LOOKING FOR US ON THE SHELVES ANYMORE – IT COULD BE A COMPLETE WASTE OF YOUR TIME!

FILL IN THE COUPONS BELOW OR CALL OUR CREDIT CARD HOTLINE ON 0458 74011

YES, YES, YES! I WISH TO SUBSCRIBE TO AMIGA SHOPPER
PLEASE SEND ME THE NEXT 12 ISSUES.

Please tick the subscription you require

- UK £14.95** **EUROPE £33.25** (Airmail)
 REST OF WORLD £50.30 (Airmail) **WORLD £27.60** (Surface)

Total amount payable £

NAME

TELEPHONE NO

ADDRESS

POST CODE

METHOD OF PAYMENT *please tick*

- VISA/ACCESS** **CHEQUE**

CARD NO

EXPIRY DATE

AS/MAG/13

Please make cheques payable to FUTURE PUBLISHING LTD and send together with this card in an envelope to the following address:

AMIGA SHOPPER, FREEPOST, SOMERTON TA11 7BR

Offer closes May 7th

YES, YES, YES! I WISH TO PURCHASE THE FOLLOWING BACK ISSUES
OF AMIGA SHOPPER AND/OR BINDER

Please tick the issues you require

- BACK ISSUES £1.75 EACH** 2 3 5 7 8 9
 10 11 12

BINDER £4.95 Total amount payable £

NAME

TELEPHONE NO

ADDRESS

POST CODE

METHOD OF PAYMENT *please tick*

- VISA/ACCESS** **CHEQUE**

CARD NO

EXPIRY DATE

Please make cheques payable to FUTURE PUBLISHING LTD and send together with this card in an envelope to the following address:

AMIGA SHOPPER, FREEPOST, SOMERTON TA11 7BR

but better still, book up for the year ahead – and never miss out again!

7 Buying a 3D graphics package, setting up a DTP system, learning BASIC and MIDI music. Reviews of Vista Pro and a font designer

8 A hardware and add-on buyer's guide special, tons of tips for Professional Page and an in-depth look at the HAM-E colour system

9 The definitive guide to the A500 Plus, downloading satellite images, choosing sequencers, using video and ProPage 2.

10 Special graphics issue featuring the Amiga's top art packages. Audition 4, Sound Enhancer and desktop video directing with Showmaker

11 Insight into CDTV, a comprehensive guide to printer preferences, 24-bit graphics, reviews of Genesis, Turbo Print and Stereo Master

12 Drive guide special – all the facts and advice on hard drives, quality video output with Impact Vision-24 card, DCTV graphics and more

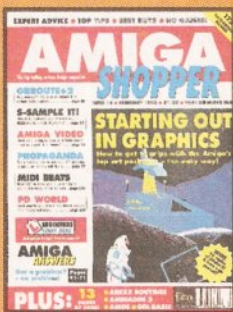
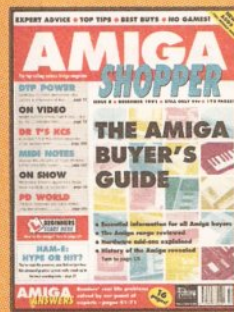

SUBSCRIBE NOW! AND SAVE HASSLE, DISAPPOINTMENT AND SHOPPERLESS MONTHS...

WE SELL LIKE THERE'S NO TOMORROW SO GET YOUR FUTURE ISSUES TODAY!

You get all these benefits when you subscribe .

- You save time
- You save trouble
- You guarantee your copy
- You get it delivered

Subscribe now to ensure your copy each month. For just £14.95 you will get the next 12 issues delivered direct to your home .

... all for just £14.95!



Keep your copies of *Amiga Shopper* safe and protected right from the very start!

only
£4.95 EACH

Use the order form on the opposite page to place your order

MEMORY EXPANSION

SUPRA 500RX Manufactured out of Albany, U.S.A. **SUPRA** offer the ultimate in Fast Ram expansion units. Built to the highest technical specifications they offer full auto configuration and quick easy fitting onto the side expansion port. Additionally they can be populated up to a total of 8 meg using 1 MBx4 zips. **8Mb pop to 1 Mb*.....£99.99** **8Mb pop to 2Mb*.....£124.99** **8Mb pop to 2 Mb.....£169.99** **8Mb pop to 4Mb.....£224.99** **8Mb pop to 8 Mb.....£369.99**

*These boards are populated using 256 x 4 zips, a cost effective way of expanding your system if you are unlikely to require additional expansion greater than 2Mb. The other configuration use 1x4 zips, a more expensive chip but you are able to expand easily right up to 8 Mb. Remember it's only the chips that are different, all SUPRA boards are the same.

PHOENIX A500 Plus 2 meg RAM upgrade modules

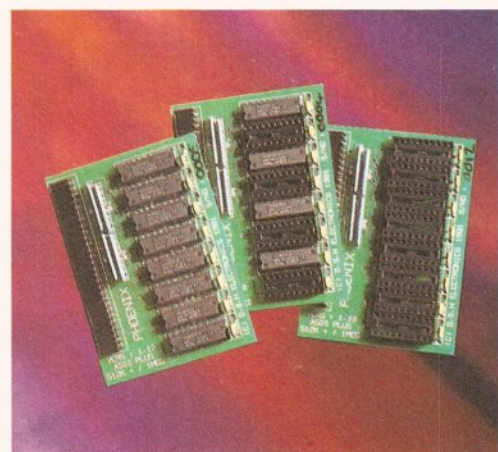

PHOENIX RAM Modules will expand your chip RAM up to 2Mb using the trap door expansion port. Chip RAM is required to unleash the full graphics capabilities of the Amiga 500 Plus. If you are running out of memory or just thinking of expanding your Amiga 500 Plus system then upgrading has never been cheaper. Designed and built to exacting standards in the U.K. all our boards carry a full 2 year no quibble replacement guarantee.

PHOENIX 1 Mb Fully populated Ram board£39.99
PHOENIX 1Mb unpopulated Ram board£19.99

PHOENIX Kickstart ROM sharer

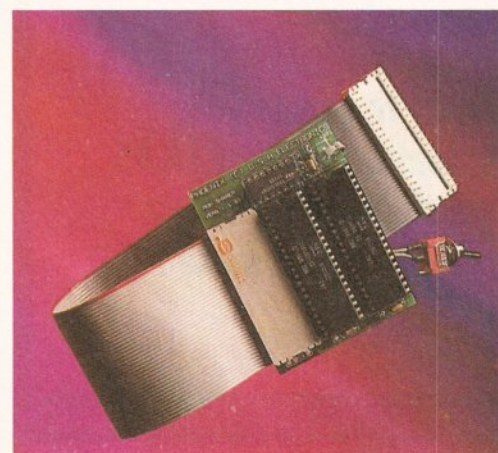

Because some older games and business software will not run on the new Kickstart 2.04 ROM PHOENIX have designed a sharer for both ROM chip sets. Switchable between 1.3 and 2.04 you can get all the benefits of the latest A500 Plus without the drawback of losing your old software. Fits all Amiga 500/1500/2000.

Kickstart ROM Sharer.....£24.99
(ROM Chips not included)
Kickstart 1.3 ROM.....£29.99
Kickstart 2.04 ROM.....£49.99 IN STOCK!

If you're upgrading your Kickstart 1.3 Amiga to 2.04, then you may encounter problems if your machine has a revision 3 or 5 motherboard. Not if you use the new Rev 3/5 PHOENIX ROM Sharer. Fits just as easily and is ready to accept the 2.04 chip without the hassle of any tricky motherboard modifications you may have to make.

Kickstart Rev 3/5 Rom Sharer.....£27.99
(ROM Chips not included)



PHOENIX

WHEN IT'S TIME TO
EXPAND
 YOUR AMIGA

AMIGA RELEASE 2



NOW IN STOCK !£99.99

The long awaited upgrade kit for 1.2/1.3 owners from Commodore has finally arrived and is selling fast. We have managed to secure one of the largest stocks of this product in the whole of the UK. The package comprises 2.04 ROM chip, all Workbench software (Install disk, Workbench 2.04 disk, Fonts disk and Extras.) a huge fully bound highly informative instructional/technical manual covering every aspect of the 2.04 operating system plus additional "Getting Started" manual, a step by step guide to Workbench 2.04. This is THE essential upgrade kit direct from PHOENIX. Please note that due to the excessive weight of this item, we have to charge £2.50 P+P on all orders.

ORDER HOTLINE

TEL . 0532 311932

FCC DISTRIBUTION, UNIT 19, ARMLEY PARK COURT,
 STANNINGLEY ROAD, LEEDS LS12 2AE.
 TEL (0532) 311932. U.K. Sales
 TEL. (0532) 319061 Trade / European Sales
 TEL. (0532) 319061 Technical Helpline

All prices include V.A.T. and free U.K. delivery
 Next day delivery by courier £4.50
 Please make cheques / P.O. payable to
 F.C.C. Distribution Ltd.

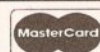

CHIPS

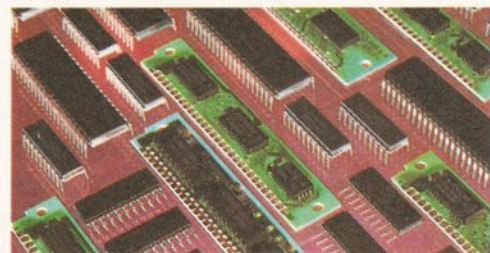

As importers of high specification semiconductor technology, PHOENIX are able to offer these products at very competitive prices.

| AMIGA CUSTOM CHIPS | | MEMORY | |
|-----------------------------|--------|--------------------------|--------|
| Kickstart 1.3 ROM..... | £29.99 | 1MbX9-80 Simms..... | £34.99 |
| NEW Kickstart 2.04 ROM..... | £49.99 | 256x 9-80 Simms..... | £12.99 |
| NEW Super Denise 8373..... | £39.99 | N.B. 2 Simms = 1/2 Meg | £24.99 |
| Fatter Agnus8372A..... | £45.00 | 1MbX4-80 Zip..... | £19.99 |
| Gary..... | £19.99 | N.B. 2 Zips = 1 Meg..... | £38.99 |
| Paula..... | £P.O.A | 256x4 DRAM..... | £3.49 |
| CIA 8520A..... | £9.99 | N.B. 8 DRAM's = 1Mb | |

These chips cover practically every popular memory expansion system on the market for the Amiga ie. GVP, SUPRA, Microbotics etc. Ring our technical helpline if you need advice.

HARD DRIVES

GVP Hard Drives for the Amiga 500, 1500/2000 series PHOENIX are pleased to offer the stunning range of GVP Hard Drive, the fastest Hard Drive Controller for the Amiga. Features Game Switch, external SCSI port, FAASTROM SCSI Driver, GVP's custom VLSI chip and internal RAM expansion up to 8 meg! All units use high specification fast access QUANTUM Hard Drives units.

AMIGA 500/500 Plus
A500-HD8+ 52 MEG (Unpopulated).....£374.99
A500-HD8+ 105 Meg (Unpopulated).....£569.99
AMIGA 1500/2000

Series II 52 Meg Hard Disk and RAM card.....£289.99
Series II 105 Meg Hard Disk and RAM card.....£475.99
 Increasing the memory expansion of these units is easily achieved by using 1 Mb x 9 Simms boards. See under the heading "CHIPS" for price details
Commodore A590 20 Meg.....£274.99

For the Amiga 500/500 Plus. Not quite in the same performance bracket as the GVP range but nevertheless a good solid performer. Can be easily expanded to 2 Mb of RAM using 256 x 4 DRAMs.

HARD DISK MAINTENANCE SOFTWARE

Quarterback.....£24.99
 This great fast backup system lets you retain the integrity of your data in the event of a system crash, virus or anything that may possibly corrupt your valuable data. **ESSENTIAL PURCHASE!**
Quarterback Tools.....£47.99

A great little utility to optimise your hard drive, unfragment your files and keep your system working at top speed.

EXTERNAL DISK DRIVES



PHOENIX Deluxe Drive.....£54.99

This sleek, high quality external drive is an essential add on to any Amiga system. All PHOENIX drives feature extremely quiet operation by utilising a high quality Sony/Citizen drive mechanism. Full 1 Mb unformatted / 880k formatted capacity. Long reach cable with enable / disable switch. Thru port for daisy chaining of drives. 12 month replacement warranty.

Roctec RocLite.....£59.99 **Cumana CAX 354.....£57.99**
SONY BRANDED DISKETTES

"The original, from the inventor". Because of the large amount of inferior quality discs on the market, the only way to make sure you don't lose your valuable data is to use the highest quality magnetic media.

Box of ten discs including labels.....£7.99

AMIGA SHOPPER

SPECIAL OFFER

Start programming with our special offers

AMOS

**SAVE
£14**

AMOS is the best-selling version of BASIC for the Amiga. It offers powerful graphics commands and an easy-to-use editor, allowing you to create powerful programs simply. There are many AMOS programs in the public domain to learn from, plus our monthly column.

Only £35.95

DEVPAK 3

For achieving sheer speed on the Amiga, you need to use machine code. And there's no better way to generate it than using Hisoft's acclaimed Devpac 3 assembler. An absolutely vital utility for programmers everywhere.

Only £65.95

**NEW
VERSION**

AMOS COMPILER

**SPEED
FOR
£21.95**

For those occasions when AMOS simply isn't fast enough, the AMOS Compiler transforms your programs into speed fiends! Your existing AMOS programs will run without alteration at a considerably faster rate. Essential for serious work.

Only £21.95

HISOFT PASCAL

Programmers have been anxiously waiting for this – Hisoft's version of the popular Pascal language. An extremely powerful language, it is easier to learn than C while offering many of the same facilities. An ideal choice when upgrading from BASIC.

Only £89.95

**SAVE
£10**

Please send me the following programming products:

AMOS (£35.95) AS012 Devpac 3 (£65.95) AS014

AMOS Compiler (£21.95) AS013

Hisoft Pascal (£89.95) AS105

Total: £.....

Method of payment (please ring) : Visa Mastercard Cheque PO

Make all cheques payable to **Future Publishing Ltd**

Card No: _____ Exp date: _____

Name

Address

.....

.....

Postcode

Send to: Future Publishing, The Old Barn, Somerton, Somerset
TA11 7BR

Mark Smiddy describes how Superbase can be effectively used to keep track of what's on your video cassettes

What's on the box?

What a great invention the video was; no more arguing over who watches what on TV. Fine, if you get round to watching the video the next day but many people keep films for weeks or longer. Very soon recordings start to get lost among the video detritus, or worse still, overwritten by *Neighbours*. This month I'll be showing you how to create a database to keep track of what's on which video and make sure those recordings never get lost.

This example will demonstrate how Superbase can be used to access three files at once; including a set of graveyard data. Although the application may seem a little mundane the techniques are anything but.

DATABASE 1: The Subject data

As a nice easy start, this database only contains two fields: an index and a subject classification. It may seem pointless, but consider in the main database only two characters will be used to access a 30 character descriptive field.

Open a new file (VSubjects) and define the two fields as follows:

| Name | Attributes | Format |
|---------|------------|-------------|
| CODE | TXT | REQ IXU 2 U |
| Subject | TXT | REQ 30 |

Remember, by convention, the names of any indexed field (of fields) are written in upper case letters. This makes them easier to pick out when you come to use them. Note the code field has a UNIQUE index.

Now enter a few records in the following format:

| | |
|------|-----------|
| CODE | Subject |
| AC | Action |
| AD | Adventure |
| CM | Comedy |
| HR | Horror |
| SP | Soap |

and so on; you can enter as many classifications as you wish.

DATABASE 2: The Video data

The second database in this example is also graveyard data. This proves you can have as many graveyards as

you like, all accessed by a single main database. The format, of VData is similar to the first one:

| Name | Attributes | Format |
|------|------------|-------------|
| CODE | TXT | REQ IXU 6 U |
| Time | NUM | REQ 999 |

Notice here again, the CODE field must be unique. It is possible to get Superbase to assign a value to it automatically by applying a constant formula such as this:

`"V" + LTRIMS (STR$ (SER ("vdata")))`

- SER("VData") – Returns a unique number for each record in the file.
- STR\$() – Converts a number into a string suitable for a text field.
- LTRIM\$() – Removes the leading spaces left behind by the STR\$() function.

This formula suffers from an important problem: the number returned by SER() follows the current global numbering format usually 2 decimal places. Therefore when you

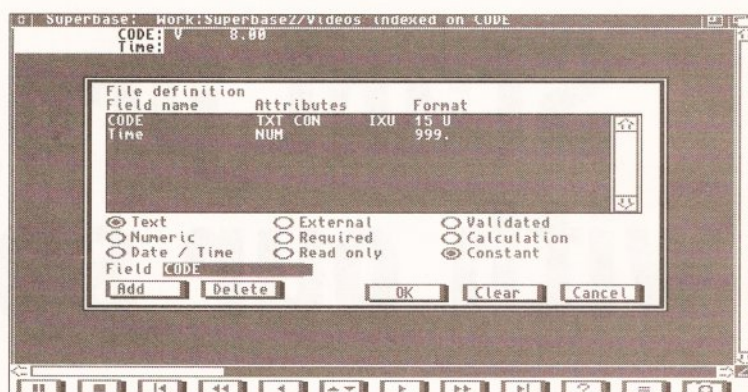

Entering the video with Superbase Personal – the database contains graveyard data which can all be accessed by a single main database

enter the data you will get records numbered like this: V12.00, V13.00, V14.00. Unfortunately there isn't a way around this in the calculation; just set the global number format to suppress decimal places.

DATABASE 3: The Programme data

The important part of this application is the main database: the one that ties the whole thing together, and,

not surprisingly, perhaps, it's also the most complex. Here's the file definition of the Progs database:

| Name | Attributes | Format |
|---------|------------|-----------------|
| Title | TXT | REQ 30 |
| Cert | TXT | VAL 2 |
| Recd | DAT | dd mm yy |
| Length | NUM | 999 |
| SUBJECT | TXT | VAL REQ IXD 2 U |
| VIDEO | TXT | VAL REQ IXD 6 U |

At first glance it looks a lot worse than it really is. In fact, the only complex parts are the input validations. I'll come to those shortly, but notice both the indexed fields are non-unique even though they will reference to unique index. The reason for this will become clear as you start to enter the data.

CERTIFICATE VALIDATION

Most films have a viewing certificate which is intended for viewers' guidance, so it seems appropriate to include them in the database. Eg: PG, U, 12, 15, 18. Validation formula should only accept those values. However, if you enter the validation using the standard requester, Superbase complains: "Can't do this... data types don't match." Why? Look at the result:

```
Cert.Progs = "U" OR Cert.Progs = J
"PG" OR Cert.Progs = 12 OR Cert.J
Progs = 15 OR Cert.Progs = 18
```

Superbase knows U and PG are text strings and 12, 15 and 18 are numbers but it does not check which type of data is required until you click OK. The work around is simple, just enclose each of the numbers in

BEGINNERS

Q: Why does Superbase need to know the size of some fields?

A: Superbase uses a common system of fixed length records which allows it to skip through records very quickly by simply adding the length. Because of this, it must know the exact size of each field in the definition. Many fields, dates and numbers for instance, take up a fixed amount of space no matter what format you use. Text fields on the other hand can be any size and the program must know what this will be in advance so it can allocate just enough space.

Q: What is the file definition?

A: It's just a housekeeping file. It's where Superbase keeps a variety of information about the file such as the number and type of fields, also any validations and calculations that are associated with them. The file definition is automatically loaded when you load a Superbase file.

BEGINNERS

START HERE

BEGINNERS

Q: Why does Process... reorganise need a separate file?

A: Superbase reorganises a file by copying all the active fields from the original file to the new file. If it attempted to re-shuffle data in the original, a crash would destroy all information.

Q: What is graveyard data?

A: A database that contains unchanging (static) data. Graveyard files are accessed by active files in during relational reports and lookups. Typical examples are product codes in a stock database or the film classifications in the videos database described here.

Q: Why has each file an index?

A: Superbase and most other systems just work that way. Indexes provide a very fast method to locate data and avoid the hassle of having to sort the entire database every time you add a new record.

continued on page 134

PROTEXT 5.5

"You won't be lost for words" . . .

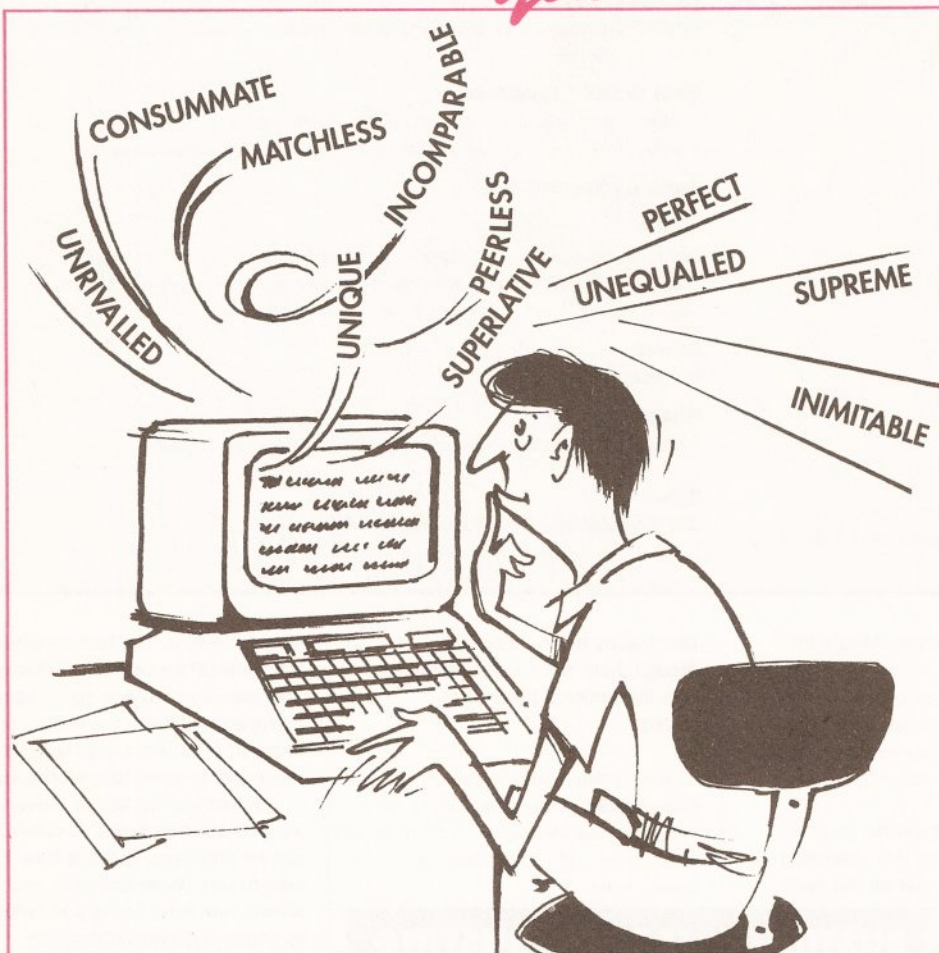

"it's bloody brilliant"

"one hell of a performer"

"if you need a professional word processor Protext is perfect"

"nothing else available comes close"

ST FORMAT

COMPUTER SHOPPER

AMIGA COMPUTING

ST APPLICATIONS

PRODATA 1.2

New version of Prodata now with pull-down menus, mouse or keyboard operation, automatic record numbering, merge database, instantaneous filtering, prologue form, edit fields in any order, 2-across label printing. Full details available from Arnor.

Price: £85+VAT, upgrade from v1.1 £30+VAT.

PRICES (including VAT and delivery)

For Commodore Amiga, Atari ST or TT.

Prottext 5.5 £152.75

Upgrade from 5.0 to 5.5 £30

Upgrade from 4.2/4.3 to 5.5 £60

Please return your original disks when upgrading

French or German spelling dictionary £35.25

When upgrading please return any extra spell checking dictionaries for a free update to the revised version.

☆ Both Prottext 5.5 and Prodata require 1Mb of memory



. . . with Prottext 5.5 because the pop-up thesaurus will provide you with inspiration whenever you need it. With words provided by Collins the thesaurus has 43,000 main entries and 827,000 responses!

Prottext 5.5 introduces enhanced text formatting options. Automatic hyphenation lets you produce a well-spaced page layout without the bother of manually putting in soft hyphens. Prottext determines the correct hyphenation points by algorithms and look-up tables. Elimination of widows and orphans is also provided. You will no longer need to worry about those infuriating single lines at the top or bottom of pages. Prottext formats the text to avoid these as you edit the text. Extra blank lines at the top of a page can be suppressed.

New document analysis features provide a wealth of information about your text. You can examine a list of all the words used - alphabetically or by the number of occurrences. Other statistics shown include average word length, average sentence length and a table of the number of lines on each page.

Plus many more improvements . . .

- ☆ Enhanced file selector with different sorting methods, bulk copy and erase.
- ☆ Prodata users - mail merge directly from Prodata files, no need to export.
- ☆ Mail merge: nested repeat loops.
- ☆ New window-based help facilities.
- ☆ Improved line drawing.
- ☆ Spelling checker finds repeated word and missing capital letters.
- ☆ Conversion to and from WordStar 5.5 and Microsoft RTF
- ☆ Full printed documentation of new features.

Of course Prottext still includes . . .

Choice of pull-down menu or keyboard operation, extensive printer font support and proportional formatting while editing, up to 36 files open, split screen editing, characters for 30 languages, index and contents, footnotes, newspaper column printing, file sorting, macros, indent tabs, mail merge programming language, exec files and the fastest search and replace around. Altogether the most comprehensive word processing software for your Amiga or ST.



SUMMARY OF VIDEO DATABASE DEFINITIONS

VSubjects

| Name | Attributes | Format |
|---------|---------------|--------|
| CODE | TXT REQ IXU 2 | U |
| Subject | TXT REQ | 30 |

VData

| Name | Attributes | Format |
|------|---------------|--------|
| CODE | TXT REQ IXU 6 | U |
| Time | NUM REQ | 999. |

Optional "CODE" calculation

"V" + LTRIMS (STR\$ (SER ("vdata"))))

Progs

| Name | Attributes | Format |
|----------|-------------------|----------|
| Title | TXT REQ | 30 |
| Cert | TXT VAL | 2 |
| Recorded | DAT | dd mm yy |
| Length | NUM | 999. |
| SUBJECT | TXT VAL REQ IXD 2 | U |
| VIDEO | TXT VAL REQ IXD 6 | U |

Field "Cert" Validation

Cert.Progs = "" OR Cert.Progs = "U" OR Cert.Progs = "PG" OR Cert.Progs = "12" OR Cert.Progs = "15" OR Cert.Progs = "18" ELSE "Should be: U, PG, 12, 15 or 18."

Field "SUBJECT" Validation

LOOKUP (SUBJECT.Progs, CODE.VSubjects) ELSE REQUEST "Can't find that subject", "Please enter another", 20, a%, SUBJECT.Progs, 60, CODE.VSubjects, Subject.VSubjects

Field "VIDEO" Validation

LOOKUP (VIDEO.Progs, CODE.Vdata) ELSE REQUEST "Video code not in file", "Please choose one...", 20, a%, VIDEO.Progs, 30, CODE.Vdata, Length.Vdata

Summary Report Query

Fields:

FIELD ON "VSubjects" REPLICATE ("=", 79) NEWLINE UL TRIMS (Subject.VSubjects) UL OFF NEWLINE NEWLINE ON "Progs" Title.Progs, ("Cert.Progs"), Length.Progs mins, Recorded.Progs, Code.Videos

Report:

Not used, leave this blank.

Filter:

(CODE.Vdata = VIDEO.Progs AND CODE.VSubjects=SUBJECT.Progs)

Order:

CODE.VSubjects, Cert.Progs ASCENDING

continued from page 132

quotes and the final validation begins to take shape:

```
Cert.Progs = "U" OR Cert.Progs = "PG" OR Cert.Progs = "12" OR
Cert.Progs = "15" OR Cert.Progs = "18"
```

What's missing? As you will have noticed, the file definition does not provide this field should it be required. Indeed, many television programmes are difficult to judge. However, if this validation were left as it stands, the validation formula would fail because there is no provision for the null string. Also, to kill two birds with one stone, let's add a helpful aide-memoire to guide the operator. The completed validation looks like this:

```
Cert.Progs = "" OR Cert.Progs = "U" OR
OR Cert.Progs = "PG" OR Cert.Progs = "12" OR Cert.Progs = "15" OR
Cert.Progs = "18" ELSE "Should be: U, PG, 12, 15 or 18."
```

KEY VALIDATION

The subject and video list can get quite extensive, so we'll use the LOOKUP requesters discussed last month. For the SUBJECT code the following will be used:

```
LOOKUP (SUBJECT.Progs, CODE.VSubjects) ELSE REQUEST "Can't find that subject", "Please enter another", 20, a%, SUBJECT.Progs, 60, CODE.VSubjects, Subject.VSubjects
```

When you enter an incorrect or blank code, a requester will pop up to show a list of valid codes and a short description of each. Much the same

can be applied to the video's file:

```
LOOKUP (VIDEO.Progs, CODE.Vdata) ELSE REQUEST "Video code not in file", "Please choose one...", 20, a%, VIDEO.Progs, 10, CODE.Vdata
```

If you spotted the subtle structure difference between this validation and the last one, pat on the back.

Don't worry if you missed it though, here's the same validation with the optional parameter added:

```
LOOKUP (VIDEO.Progs, CODE.Vdata) ELSE REQUEST "Video code not in file", "Please choose one...", 20, a%, VIDEO.Progs, 30, CODE.Vdata, Length.Vdata
```

Now you see it. The last parameter in the LOOKUP requester is optional and allows you to add some specific explanatory data to the validation request; but it isn't required and, in this case, is down to preference.

Before looking at the queries, it's worth examining how this database can be improved. But this time it's over to you. As an exercise, you should now have enough knowledge to create a graveyard data file containing these and create a more friendly input validation for the BBFC codes. Hint: you will need to create another index on the current file.

VIDEO REPORTAGE

A basic report can be constructed quite quickly using the Query function to produce the following (the report line is not used here):

Fields:

Title.Progs, Subject.VSubjects, CODE.Vdata

Filter:

CODE.Vdata = VIDEO.Progs OR CODE.VSubjects=SUBJECT.Progs

Order:

CODE.VSubjects, Title.Progs ASCENDING

Perhaps the most important part of this query is the relational join between the three files; and once again, the convention of using capitalised field names for indexed fields proves its worth. It is important to note that the join here is achieved with AND not OR as recommended in the manual; this filter maintains the relational join between the files.

You can narrow the search down

JARGON BUSTING • JARGON BUSTING

Database – A collection of one or more records.

Empty Field – A field which does not contain any data. It is quite common to use empty fields in databases where optional data notes perhaps can be entered.

External Field – In *Superbase*, an external field is a field which refers to an object on disk: a picture, text file or even a sound. The field itself must contain the name (and path if there is one) to the external file.

Field – A blank area in a database record used to hold data. Fields are usually categorised by the type of data stored in them: text, dates etc.

Flat-file – A simple type of database where every item of information must be stored in each record.

Index – A list of pointers. A normal index holds one pointer for every non-unique indexed record in the database. A unique index contains one value (key) for every record in the database.

Key – An index pointer. Put simply, a value calculated from a field's contents. A collection of keys is called an index.

Query – *Superbase's* name for a report.

Record – A collection of one or more fields.

Relational database – A more powerful form of database where information can be retrieved and collated from two or more database files.

Relational operator – A comparison operator usually used to test for true or false. Typical examples are: = (is equal to) and > (is greater than).

Required Field – Some data must be entered here. Typical uses for these are peoples' surnames, postal towns that sort of thing. Indexed fields should usually be made required. Unique Indexed fields must be required or calculated.

by adding other parameters to the filter, but these must come *after* the relational join. For instance, say you were a science-fiction fan and wanted to locate all the tapes with sci-fi films or programs on them. Assuming the code for sci-fi was SF, the following would do the job:

```
(CODE.Vdata = VIDEO.Progs AND ↓
CODE.VSubjects=SUBJECT.Progs) AND ↓
CODE.VSubjects = "SF"
```

The relational join is picked out with brackets in this example for two reasons. First, it aids clarity; second, it reminds you which part can be edited and which must remain as is.

What remains is to get the report into some sort of sensible order where relevant data is retrieved from

all three files and presented on screen or to the printer. The previous attempt will do, but the following is more powerful. Using the same Filter as before, define the field list so:

```
FIELD ON "VSubjects" REPLICATE ↓
("=",79) NEWLINE UL TRIMS ↓
(Subject.VSubjects) UL OFF NEWLINE ↓
NEWLINE ON "Progs"Title.Progs, ↓
("Cert.Progs"), Length.Progs ↓
mins", Recorded.Progs, Code.Videos
```

Now define the Order line as:

```
CODE.VSubjects, Cert.Progs ASCENDING
```

which ensures a reasonable sorting order for the files.

The Fields line breaks down like this:

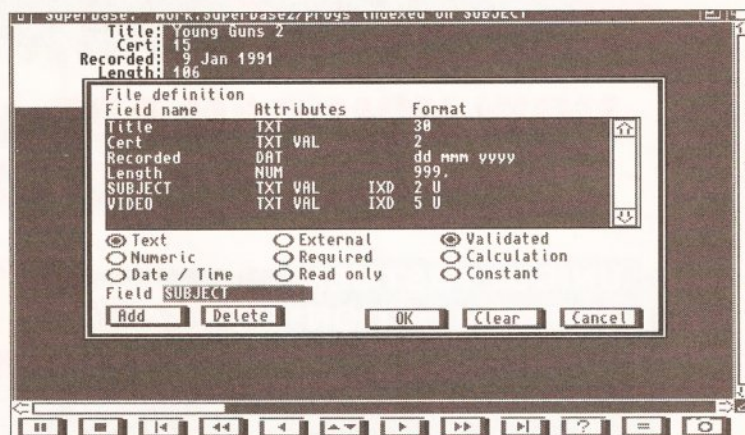

When you enter the data, it is useful to include categories such as length of the film, certification, date recorded – all help for easy retrieval

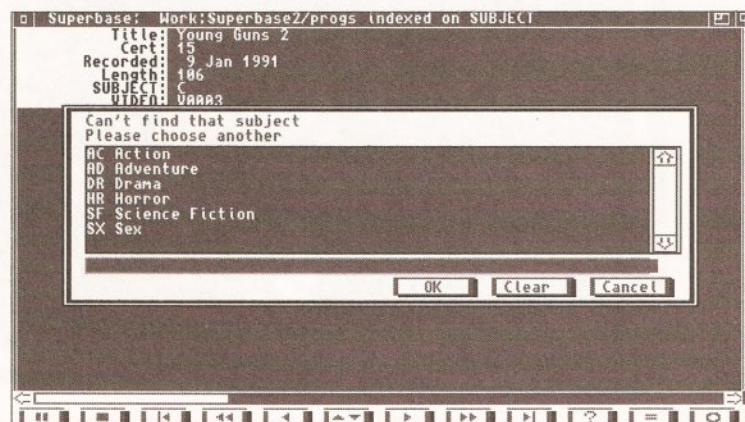

With this database those long forgotten recordings can be searched by subject... if you're looking for action or adventure, they're never far away

Last Month's Query

Last time I left you with an unusual file query and, as promised, here is a description of how it works. You may remember the idea was to use query to produce a cleanly laid out report without the advantage of a forms designer or reporting language found in Superbase Pro 4. Here it is again:

```
FIELDS FIELD ON "Albums" NEWLINE REPLICATE ("*",79) NEWLINE "Album:" ↓
Title.Albums, @40"Media: "Type.Albums @55"By: "Artist.Albums NEWLINE ↓
NEWLINE ON "Tracks" Title.Tracks,@40(" Time.Tracks ")
```

```
FILTERCODE. Albums = ALBUM.Tracks
```

```
Order Title.Albums, Title.Tracks ASCENDING
```

and here's how it works:

- FIELD** – Suppresses the automatic field titles which would otherwise mess up the display.
- ON "Albums"** – Inform *Superbase* to only perform the following operations when the albums name changes.
- NEWLINE** – Print a blank line.
- REPLICATE ("*",79)** – Print a line of 79 asterisks.
- NEWLINE** – Print another blank line.
- "Album:"** – Print the message Album: and follow it with...
- Title.Albums** – ...the contents of the Title field in the Albums database.
- @40** – Move the cursor to column 40 and...
- "Media: "** – ... print the message Media: followed by...
- Type.Albums** – ... contents of the type field in the Albums database then...
- @55** – ... move the cursor to column 55 and...
- "By: "** – ... print the message By: followed with...
- Artist.Albums** – ... the Artists name from the Albums database.
- NEWLINE NEWLINE** – Print two blank lines and stop.
- ON "Tracks"** – Now perform the following operations when field data in the Tracks database changes. (The previous ON operator is still active but has no effect because the album name only changes once in a while):
- Title.Tracks** – Print the contents of the title field in the Tracks database (the current track on the current album) then...
- @40** – ...move the cursor to column 40 and...
- "("** – ...print an open bracket followed with...
- Time.Tracks** – the length of the current track the time field from the Tracks database. Finally...
-)"** – print a closing bracket to keep it nice and neat.

FIELD – Suppress Superbase's automatic display of the field names this report is self-contained as it is.

ON "VSubjects" – Ensure the following operations are only carried out when data in the VSubjects file changes.

REPLICATE ("=",79) – Print a line of equals signs. 79 is just enough to cross the screen or a printer without causing a line feed.

NEWLINE – Print a blank line.

UL – Switch underlining ON.

TRIM\$ (Subject.VSubjects) – Remove the trailing spaces from the contents of the current Subject name and display it. If TRIM\$() is not used, the underlining carries across the entire field width and that looks messy.

UL OFF – Switch underling off and...

NEWLINE NEWLINE – ... print two more blank lines. This provides some space between the subject heading and the film titles about to appear.

ON "Progs" – Now use the following instructions when data in the Progs file changes...

Title.Progs – Print title of recording...

"(– ...followed by an opening bracket...

Cert.Progs – ...include the film or program's optional BBFC rating and...

)" – ...close the brackets.

Length.Progs – Now print the length of the recording and...

"mins" – ... follow that with the phrase "mins" (notice the leading space is relevant here).

Recorded.Progs – Now pop add the date the recording was made and...

Code.Videos – ...the video it currently resides on.

FOR MY NEXT TRICK...

Next time I'll be taking a parting look at *Superbase Personal* and giving some more examples of how this amazing system is still one of the best available. In the meantime, experiment with the options available under Process...Query and see what sort of information you can retrieve from this database. Or experiment with Lookup requesters to make the system more appealing to amateur users. Until then, may your all your files be secure and your gurus be few... **AS**

MORE MEMORY POWER!

NOW YOU CAN ADD UP TO 1.5 MEGS TO YOUR AMIGA AT THE LOWEST PRICES EVER!!

**UNIQUE FASTMEM/
CHIPMEM OPTION***

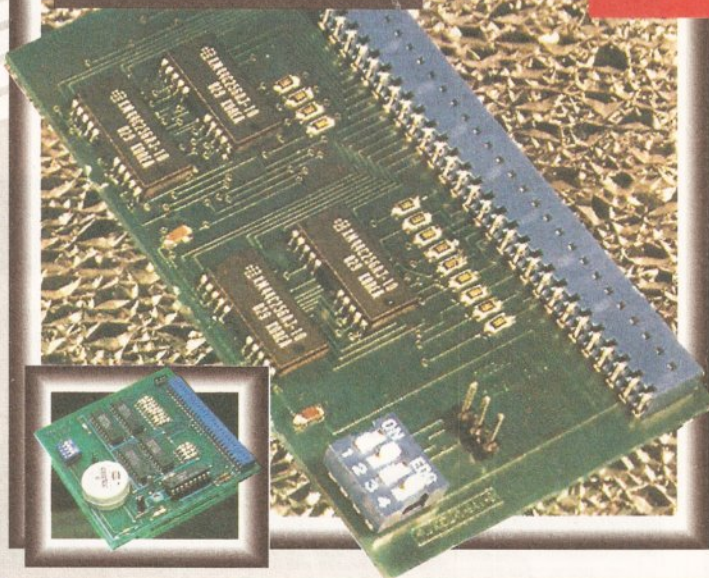

PRO-RAM PLUS™

- THE FIRST RAM UPGRADE CARD TO OFFER THE UNIQUE FASTMEM OR CHIPMEM OPTION AT THE FLICK OF A SWITCH*. NOW YOU CAN HAVE THE EXTRA SCREEN HANDLING ABILITY OF THE A2000 - PLUS LOTS MORE!!
- Simply plug into your Amiga A500 and upgrade to a full 1 Meg in minutes!!
- Features the latest 1 Meg DRams. Low chip count means very low power consumption. No bigger than a Credit Card!!
- Top quality high grade PCB and connector to give unmatched reliability - 12 months guarantee.
- Switch to enable/disable plus "ChipMem" option* (02 Agnus).
- Now you can run ALL Amiga 1Meg programs.
- Also available with clock/calendar option.
- Easily fitted into the slot under any A500 - does not affect warranty.

NOW ONLY £24.99 STANDARD VERSION
£29.99 FOR CLOCK VERSION

RAM-MASTER II™

- IF YOU NEED EVEN MORE POWER THEN THE RAM-MASTER II™ IS FOR YOU!!
- Adds an extra 1.5 Megs to your A500 (giving a total free memory of 2 Megs).
- Uses the latest 1 Meg DRams resulting in extra low power consumption.
- Ram-Master II needs Kickstart 1.3 onwards.
- Complete with onboard clock/calendar.
- Top quality connections used throughout.
- Comes with 12 months guarantee.
- Easily fitted into the slot under your A500 - requires no soldering (the cover of your A500 must be removed for fitting "plug in" connector #)

NOW ONLY £79.99 WITH 1.5 MEGS OF RAM
ONLY £39.99 FOR CARD WITHOUT RAM

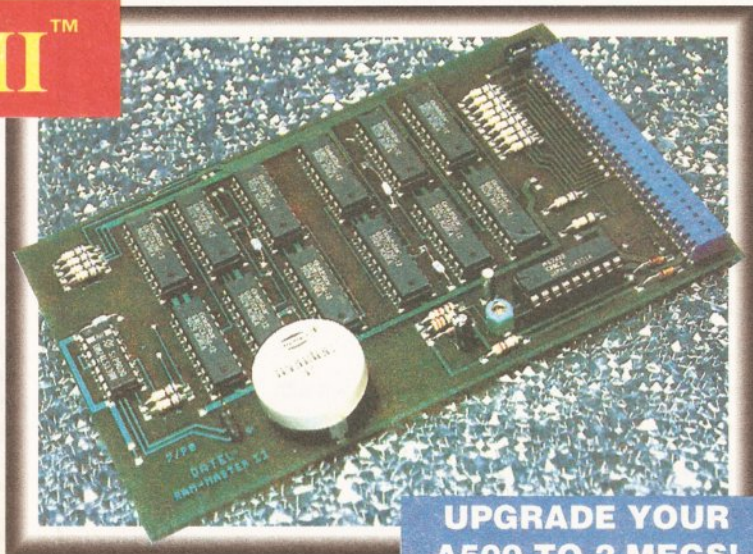

**UPGRADE YOUR
A500 TO 2 MEGS!**

ATTENTION ALL A500 PLUS OWNERS

IF YOU HAVE AN AMIGA A500 PLUS THEN WE CAN OFFER A PLUG IN RAM UPGRADE TO BRING YOUR MACHINE UP TO A FULL 2 MEGS OF CHIP RAM

- Simply plug in - no modifications.
- Uses low power surface mount chips.
- Does not affect warranty.

**1 MEG RAM BOARD
ONLY £79.99**

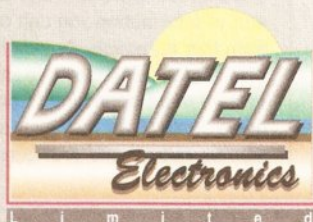
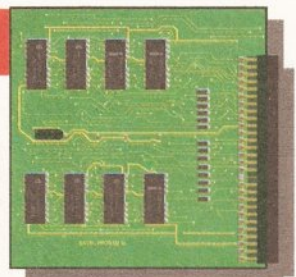

HOW TO GET YOUR ORDER FAST!

TELEPHONE [24Hrs] **0782 744707** CREDIT CARD ORDERS

ORDERS NORMALLY DISPATCHED WITHIN 48 Hrs. ALL CHEQUES/POSTAL ORDERS MADE PAYABLE TO...



DATEL ELECTRONICS



GOVAN ROAD, FENTON INDUSTRIAL ESTATE, FENTON, STOKE-ON-TRENT,
ST4 2RS, ENGLAND. FAX 0782 744292 TECHNICAL/CUSTOMER SERVICE 0782 744324

DATEL LONDON SHOP



222, TOTTENHAM COURT RD,
LONDON, W1. Tel 071 580 6460

10

Top tips for the Shell

Yes, you can be sure of Shell with Amiga Shopper. Come with us and take a look under your Amiga's bonnet at the power that drives the operating system of your high performance machine

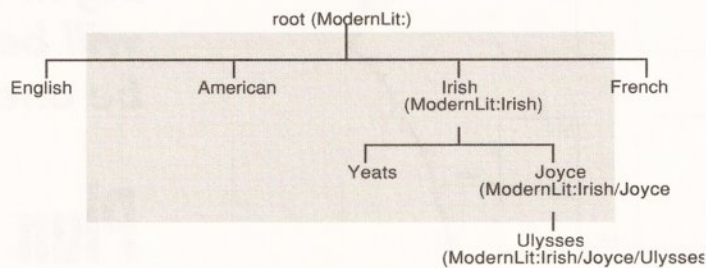

Top tip 2 – Directories are organised in a hierarchical structure often called a 'tree'. In fact, the shape is more like an upside down tree, with the root at the top. The AmigaDOS path to the directories is shown in brackets

character) as part of the command. If the directory is above the current one in the hierarchy, then the '/' character must be used before the directory name to instruct AmigaDOS to look one level up. Alternatively, the ':' character tells AmigaDOS to look from the root directory on the disk. Precede this with the name of another disk, and AmigaDOS will look there instead for the required directory.

Getting a list of the files held in the *Joyce* directory, held in the *Irish* directory, all on the disk *ModernLit*, would be done as follows:

```
Dir ModernLit:Irish/Joyce
```

It is possible to specify which files you want to list by the means of a wildcard. Represented by the '#?' characters, a wildcard means 'any characters'. The **Dir #?** command will behave exactly as normal, but the **Dir #?.iff** will only list those files whose names end with '.iff'.

4 CD – this command changes the current directory (the one which will be listed with a simple **Dir** command, and which is named as part of the AmigaDOS prompt). Followed simply by a '/' character, it will move one

level up in the directory hierarchy. Followed by a ':', it will move to the root directory of the current disk.

A directory name can also be specified with **CD**, but if it is anything other than directly below the current directory in the hierarchy, then a path to it must be specified.

5 Makedir – creates a new directory inside the current one. The name of the new directory is specified as part of the **Makedir** command, but must be separated from it by a space. The newly created directory will initially be empty.

6 Copy – this command, funnily enough, copies files. Following the command comes the source file, then, after a space, the destination where the copy should be placed. Both source and destination can be specified with full AmigaDOS paths. If the name of the destination file is omitted, then the source file name is used. In this case, wildcards can be used to copy several files with only a single command:

```
copy grabs:#?.iff article:
```

7 RAM: – this is the RAM disk, behaving like an ordinary disk but

much more quickly and with the information held in memory. If you are using a single drive machine, it is useful to copy often used commands into RAM: so that you won't have to insert the Workbench disk whenever you use one of these commands.

RAM: can also be used as an intermediary store when copying groups of files from one disk to another on a single drive system.

8 List – this is an advanced form of the **Dir** command. As well as listing the files in a directory, it will display the status information and size of each file.

The command has many other possibilities. Its output can be sent to another file by use of the command **To** following it, followed itself by the name of a destination file. The options are too complex to go into here – refer to *Cracking The Shell* for more details.

9 Startup-sequence – this is a text file containing a number of AmigaDOS commands. This type of file is known as a script. It behaves in a similar manner to a program when run. Each of the commands in the file are executed in turn, as if a user were typing them one by one at the keyboard. Think of it as a way of creating your own AmigaDOS commands by joining together existing ones.

The startup-sequence is a specialised script which is executed every time the Amiga is switched on or reset. It performs various set-up functions, such as telling the Amiga which nationality of keyboard to use, and where to look for certain, often used files. It is possible to modify the startup-sequence, although it's advisable to make a back-up first, using the **Copy** command (only ever do this with a *copy* of your Workbench disk, as tampering may stop your Amiga from booting up altogether).

10 Ed – is the AmigaDOS text editor. It is like a very simple word-processor, and is mainly used for creating and altering script files such as the startup-sequence. Just type **Ed** at the prompt to use it. **AS**

Some operations on the Amiga are made so much easier by using the Shell. Some operations just can't be done any other way. Using the Workbench is all very well, but it's only once you click on that Shell icon that you can really get your hands dirty and find out exactly what is going on.

Here we provide a brief introduction; if you need more information don't forget our regular *Cracking The Shell* column, which covers just about every conceivable use of AmigaDOS.

1 Files – a file is a collection of information stored on a disk. It could be a program, or simply a group of data for use by other programs. Each file has associated status information stored with it, which records such things as when the file was last altered and whether or not it is a program file. All of the Shell commands are held on disk as program files.

2 Directories – these are the Shell equivalent of Workbench drawers. They are arranged in a hierarchical, tree-like fashion, and may contain further directories and files.

At the top of the hierarchy is a directory termed the 'root'. It is denoted by the ':' symbol. The root directory of another disk is specified by the disk name followed by a colon. A directory further down the hierarchy is specified by supplying its name after the colon. If the directory is not immediately 'below' the root, then any intervening directories must also be named, each of them being separated by a '/' character.

3 Dir – an AmigaDOS command that produces a listing of all the files held in a directory. Normally, the listing is given for the current directory – the one named in the Shell's prompt. Any directories held within the current one are marked '(dir)'.

It is possible to get a listing of files in a different directory by using that directory's name (and those of any others between it and the current one, all separated by the '/'

This is where

From Friday 15th to Sunday 17th May at the Wembley Exhibition Centre, the biggest ever Amiga show will be taking place. Everyone who's big in the Amiga world will be there. Will you be one of them?

Plan your visit to Amiga heaven

BEING THERE: THIS IS HOW

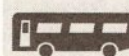

Numbers 83, 92 and 182 come to Wembley Arena. 18 comes to the Triangle (5 minutes walk). 297 (alight at Wembley Park Station) and 245 (alight at Bridge Road) serve the complex.



To Wembley Park by Metropolitan or Jubilee line. To Wembley Central by Bakerloo line (peak hours).



To Wembley Central from Euston or Broad Street. To Wembley Stadium from Marylebone.

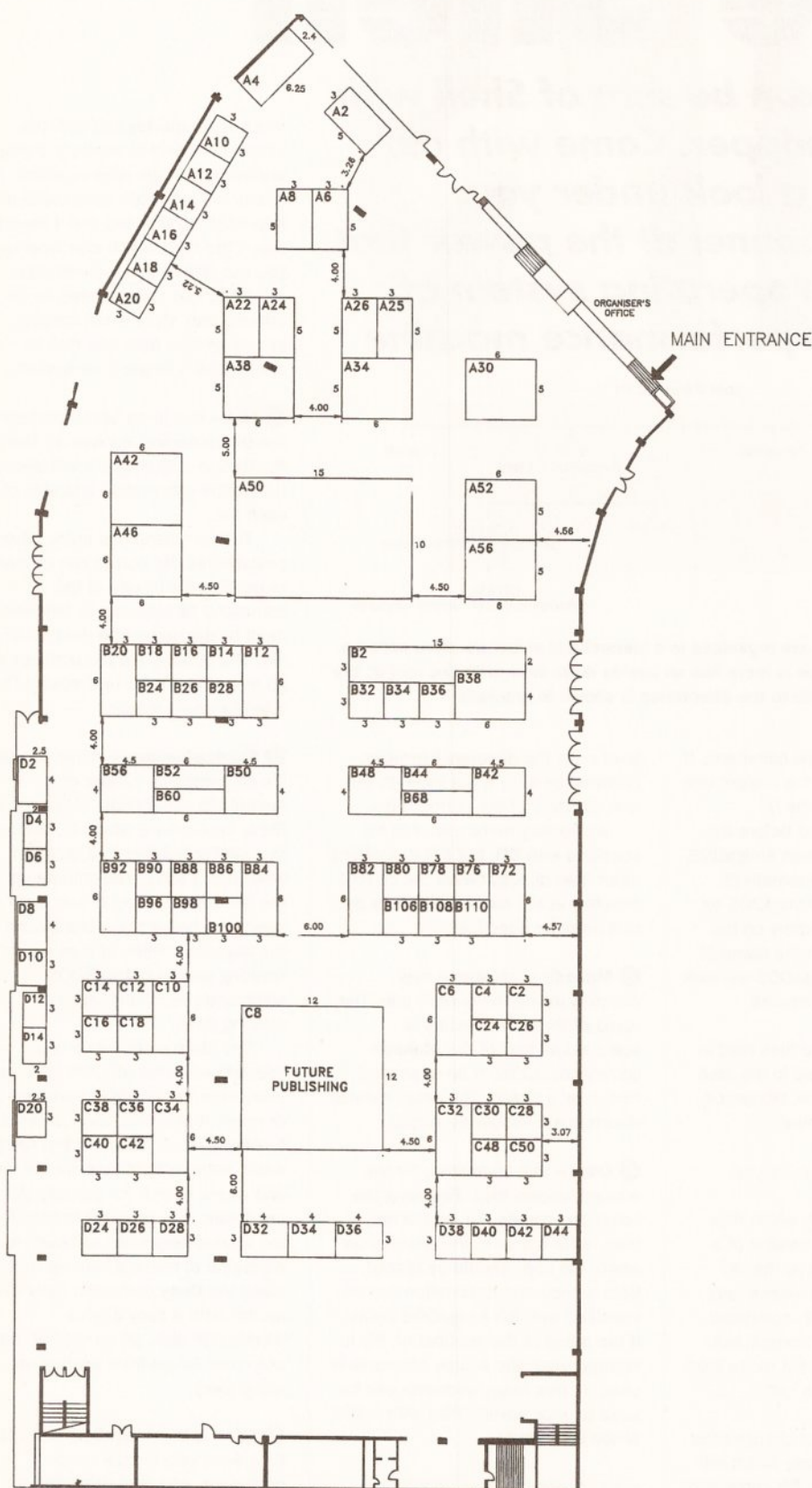

It's at, baby

WHO'S WHERE...

| Company | Stand |
|-------------------------|-------------|
| 16/32 | C16 |
| Adventure Soft | D6 |
| BCA | |
| Bitcon | D32 |
| Bruce Smith Books | B60 |
| Care Electronics | D4 |
| Checkmate Digital | A24 |
| Citizen | A20 |
| Commodore | A50 |
| Computer Books | B52 |
| Computer Express and | |
| Computer Mates | B48 |
| Connect | A25,D34,D36 |
| Cortex | D10 |
| Database Direct | B68 |
| Dial A Disk | C14 |
| Digit International | C32 |
| Dynamite | B106 |
| Evesham Micros | C34 |
| FCC | A14 |
| FMG | A3 |
| Fujitsu & Comp Exp | B12 |
| Future Publishing | C8 |
| Future World | A52 |
| GVP | A26 |
| Gasteiner, Golden Image | B50 |
| George Thompson | A4 |
| Hard and Soft | B58 |
| Harpers | B18 |
| Hi Soft | A6 |
| JAM | A2 |
| Kador | B74 |
| Logic Sales Ltd | C26 |
| Mail Order | B32 |
| MC Dist | B84 |
| MD Office | B72 |
| Nasa Promotions | D12 |
| NC Entertainments | B56 |
| New Dimensions | D14 |
| Pacific Digital | C2 |
| PD Soft | A1 |
| Power | C6 |
| Precision | B38 |
| Progressive Periph | A36 |
| RGB | D28 |
| Rombo | B82 |
| Ross Moller | A8 |
| Silica | B2 |
| Siren Software | B14 |
| Snap | D2 |
| Supra | A30 |
| Swift Micros | C28 |
| Syntronix | A22 |
| Videk | B44 |
| Waxride | C10 |
| We Serve | A10 |
| WTS | B16 |
| Zone Distribution | A34 |



The Amiga Shopper Show will be your chance to...

- See the amazing new Amiga 600 – the future of Amiga computing
- Take a spin on Commodore's revolutionary A570 CD-ROM drive and judge CDTV for yourself
- Try out the very latest in hardware and software innovations from the likes of GVP, Supra, Progressive Peripherals and Software, HiSoft, and many more
- Pick up bargains, bargains, and even more bargains at incredibly cheap prices
- Get your technical problems

- solved by the unrivalled experts of the *Amiga Answers* panel and win up to £1,200 worth of memory in the process (see p75)
- Find out how to get the very best from your set-up in a series of seminars by industry experts
- Meet the *Amiga Shopper* editorial team and tell us just where you think the magazine ought to be going
- Meet Damien Noonan of *Amiga Format* and Matt Bielby of *Amiga Power*
- Slip into the Amiga Power Arcade for some serious games!

AMIGA SHOPPER

SPECIAL OFFER

Get on line with our Amiga Shopper modems

HYUNDAI HMD2401

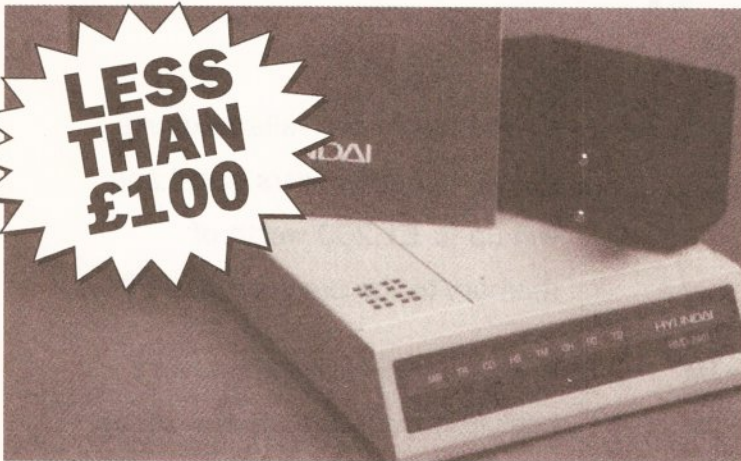

**LESS
THAN
£100**

This excellent budget modem (RRP £129+P&P) is capable of respectable speeds - up to 2,400 baud. It supports the V21, V22 and V22bis protocols. To use it you'll also need a serial cable, and of course some comms software!

Only £99.95

CONNECTIONS M5024/5



**SAVE
£180!**
RRP £469+£10P&P

If you want higher speeds, the Connections Interdial M5024/5 includes MNP4 error correction and MNP5 data compression, giving effective speeds of up to 4,800 baud. Again, you'll need comms software and a serial cable.

Only £299.95

I'd like to go on-line. Please send me a modem at your special discount prices:

Hyundai HMD2401 at £99.95 including VAT and P&P

CODE:AS010

Connections Interdial M5024/5 at £299.95 including VAT and P&P CODE:AS011

Total: £

Method of payment (please ring) : Visa Mastercard Cheque PO

Make all cheques payable to **Future Publishing Ltd**

Card No: _____ Exp date: _____

Name

Address

.....

.....

Postcode

Send to: Future Publishing, The Old Barn, Somerton, Somerset
TA11 7BR

GVP

GREAT VALLEY PRODUCTS

QUALITY AMIGA PERIPHERALS WITH A 2 YEAR WARRANTY

Silica Systems are pleased to present the GVP range of peripherals. GVP are the world's largest third party manufacturer of peripherals for the Amiga range and have a reputation for high specification, quality products. The company was founded only three years ago by a man who understands the Amiga - Commodore's ex-Vice President of Technology. He, along with a team of Amiga experts including other ex-Commodore staff, understand the add-on requirements of Amiga owners better than anyone. Not only do GVP provide peripherals that Amiga owners want, they also offer peace of mind, with a 2 year warranty on the products they manufacture. So, if you are looking for the very best in Amiga peripherals, look no further than GVP.

A530 ACCELERATOR

- 40MHz 68030EC processor
- Hi-speed SCSI interface with 52, 105 or 240Mb hard drive
- Accommodates up to 8Mb of 32-bit RAM
- Optional 68882 Maths Co-Processor
- Optional PC-AT emulation



FOR THE AMIGA 500

ACCELERATOR + HD + RAM UPGRADE

Plugging a GVP A530 Accelerator into your A500 will boost its speed from 7.14MHz to a blistering 40MHz. The A530 is available with either 52, 105 or 240Mb hard drive and can be upgraded to include an additional maths Co-Processor, 8Mb of 32-bit FAST RAM and much more through GVP's unique "mini-slot".

| | | |
|------------------|---------------|-------|
| 40MHz-0/52Mb HD | Ref: HAR 0962 | £749 |
| 40MHz-0/105Mb HD | Ref: HAR 0905 | £529 |
| 40MHz-0/240Mb HD | Ref: HAR 0986 | £1099 |



NEW! OPTIONAL PLUG-IN 16MHz PC286 EMULATOR

- 16MHz 80286 processor
- 287 Maths Co-Processor socket
- 512K of PC RAM plus the use of Amiga RAM
- Supports Hercules, CGA, EGA/VGA (monochrome) and T3100 video modes
- Runs MS-DOS (3.2 and upwards) plus thousands of other PC programs

This powerful 286 emulator module simply plugs into the "mini-slot" of the GVP HD8+ or A530 (without invalidating the warranty). The emulator has full access to the Amiga's resources and allows you to run PC and Amiga programs at the same time, giving you two computers in one.

£249
Ref: EMU 0500

52/105/240Mb LIGHTNING QUICK HARD DRIVES

New State-Of-The-Art 1" Internal Quantum hard drives, with a 1,100K per second (11ms) transfer rate making this the fastest hard drive available for the Amiga.

LEADING EDGE TECHNOLOGY

High-tech custom VLSI, Faast ROM chips and DMA style design, ensure that no other Amiga hard drive will out perform the GVP HD8+.

8Mb RAM SOCKETS - UNPOPULATED

Inside every drive there are sockets to expand the Amiga's RAM by 8Mb.

USES EASY-TO-FIT 1Mb/4Mb SIMMS

Memory upgrades. Please order MEM 3632 at £39.95 per Mb for up to 4Mb. To upgrade to 8Mb, please order 2 MEM 3849 at £199.95 per 4Mb SIMM.

CUT-OF SWITCH FOR GAMES

Features a special games switch to 'cut off' the drive for games that won't work with a hard disk. Most other drives require unbolting from the Amiga.

"MINI SLOT" EXPANSION

This unique slot has been built-in to allow expansion to be made without using any risky "pass-through" techniques. See PC286 emulator above.

EXTERNAL SCSI PORT

Add up to 6 external SCSI devices, e.g. CD-ROM, tape streamers, additional hard drives, removable media, scanners, etc.

DEDICATED PSU + FAN

Following Commodore's recommendations, the GVP HD8+ is supplied with its own external power supply and cooling fan.

FULLY COMPATIBLE

Fully compatible with all Amiga 500's (inc. PLUS) and versions of Kickstart.

FREE 2 YEAR WARRANTY

WHAT THE PRESS SAY
'Superb build, excellent aesthetics and blinding speed make this the best A500 hard drive' ... - AMIGA SHOPPER
'GVP claims this is the fastest hard drive in the world and none of our tests could prove that wrong.' - AMIGA SHOPPER
'Overall: Untouchable. THE choice' - AMIGA SHOPPER
'Still the best hard drive' ... 92% - AMIGA FORMAT

52Mb HARD DRIVE

FOR THE AMIGA 500

INCLUDES MANY UNIQUE FEATURES NOT FOUND IN ANY OTHER AMIGA DRIVES



105Mb
£499
REF: HAR 0905

240Mb
£799
REF: HAR 0942

GVP HD8 + 52Mb HD

£379

ALL PRICES INCLUDE VAT Ref: HAR 0852

ALL PRICES INCLUDE VAT - DELIVERY IS FREE OF CHARGE IN THE UK MAINLAND

FOR ALL AMIGAS

AMIGA 1500 + 2000 + 3000 PRODUCTS



SOUND SAMPLER

- 8-bit stereo sampler
- Plugs into parallel port
- MIDI support for song input
- Extensive editing features
- Works with all Amigas

A low-cost sound and music solution for the semi-professional and audio hobbyist. It consists of a small, high quality 8-bit stereo sound sampler that connects into the parallel port on any Amiga 500, 1500, 2000 or 3000 computer. Combined with one of the fastest, most powerful and easy-to-use sound and music editing programs available.

MUS 2500 **£59.95**

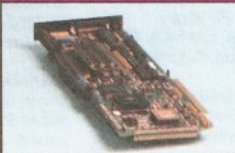

G-FORCE 30-25/40/50

- 68030/68030EC processor
- 25/40 & 50MHz clock speeds
- 68882 Maths co-processor
- Expands to 16Mb 32-bit RAM
- 32-bit SCSI controller on board

These fast 68030/68030EC accelerators with memory upgrade and SCSI interface board deliver uncompromising speed and performance without the high price. Each board comes complete with a 68882 maths co-processor and ROM upgrade as standard.

| | | |
|-----------|---------------|-------|
| 25MHz/1Mb | Ref: LPG 0110 | £599 |
| 40MHz/4Mb | Ref: LPG 0430 | £999 |
| 50MHz/4Mb | Ref: LPG 0533 | £1399 |



IMPACT II HC8

- Factory installed Hard Drives
- 52, 120, 240 & 420Mb options
- On-board 8Mb memory sockets
- Controls up to 7 SCSI devices
- Easy to install SIMMS

These are the equivalent of the HD8+ hard drive, but for the 1500 and 2000 models. Not only are they some of the fastest hard drives available, but they also incorporate an unpopulated 8Mb RAM expansion board.

| | | |
|-------|---------------|-------|
| 52Mb | Ref: HAR 1352 | £299 |
| 120Mb | Ref: HAR 1420 | £449 |
| 240Mb | Ref: HAR 1540 | £699 |
| 420Mb | Ref: HAR 1542 | £1299 |



IMPACT VISION 24

- 768 x 580 PAL Resolution
- Supports composite video, VHS and RGB signals
- Broadcast quality genlock
- Now with RGB splitter

This is the very latest 24-bit Professional Video Adaptor. It features 16 million colours on screen at once, built-in genlock, flicker fixer, frame buffer, frame grabber and digital keyer. Impact Vision 24 comes supplied with Caligari 3D modelling and rendering software, Scaia IV24 video tiling software, plus Macro Paint 24-bit paint package.

VID 7024 **£1699**

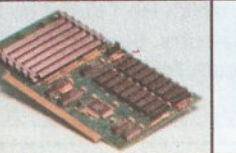

RAM 8

- Up to 8Mb of FAST RAM
- Upgrade in 2Mb increments
- Supports industry standard RAM chips
- Diagnostic software included
- Fully auto-configuring

A simple and convenient 8Mb RAM expansion board for the Amiga 1500 and 2000. Using industry standard RAM chips, the RAM-8 offers an easy way to upgrade your 1500 or 2000 in 2Mb increments. The RAM 8 is fully auto-configuring and is supplied with peace-of-mind diagnostic software.

RAM 2800 **£99**



SYQUEST 44/88Mb

- 44 or 88Mb removable media
- 20ms access time
- Work with all standard SCSI controllers
- External case available for A500 or A3000 users

GVP are now offering Syquest drives with or without their HC8 controller. They are available in 44 and 88Mb capacities and have a 20ms access time. Each drive comes complete with one removable cartridge. Syquest drives give complete storage flexibility, offering a quick and easy way to add extra storage to your system.

| | | |
|------|---------------|------|
| 44Mb | Ref: HAR 1554 | £449 |
| 88Mb | Ref: HAR 1678 | £599 |

SILICA SYSTEMS OFFER YOU

- FREE OVERNIGHT DELIVERY:** On all hardware orders shipped in the UK mainland.
- TECHNICAL SUPPORT HELPLINE:** Team of technical experts at your service.
- PRICE MATCH:** We normally match competitors on a "Same product - Same price" basis.
- ESTABLISHED 12 YEARS:** Proven track record in professional computer sales.
- BUSINESS + EDUCATION + GOVERNMENT:** Volume discounts available for large orders.
- SHOWROOMS:** Demonstration and training facilities at our London & Sidcup branches.
- THE FULL STOCK RANGE:** All of your requirements from one supplier.
- FREE CATALOGUES:** Will be mailed to you with offers and software/peripheral details.
- PAYMENT:** By cash, cheque and all major credit cards.

Before you decide when to buy your new Amiga products, we suggest you think very carefully about WHERE you buy them. Consider what it will be like a few months after you have made your purchase, when you may require additional peripherals or software, or help and advice. And, will the company you buy from contact you with details of new products? At Silica Systems, we ensure that you will have nothing to worry about. We have been established for over 12 years and, with our unrivalled experience and expertise, we can now claim to meet our customers' requirements with an understanding which is second to none. But don't just take our word for it. Complete and return the coupon now for our latest Free literature and begin to experience the "Silica Systems Service".

MAIL ORDER HOTLINE
081-309 1111

SILICA SYSTEMS

MAIL ORDER: 1-4 The Mews, Hatherley Rd, Sidcup, Kent, DA14 4DX Tel: 081-309 1111
 Order Lines Open: Mon-Sat 9.00am-6.00pm No late Night Opening Fax No: 081-309 0608
 LONDON SHOP: 52 Tottenham Court Road, London, W1P 0BA Tel: 081-580 4000
 Opening Hours: Mon-Sat 9.30am-6.00pm No late Night Opening Fax No: 071-323 4737
 LONDON SHOP: Selfridges (1st Floor), Oxford Street, London, W1A 1AB Tel: 071-629 1234
 Opening Hours: Mon-Sat 9.30am-6.00pm Late Night: Thursday until 8pm Extension: 3914
 SIDCUP SHOP: 1-4 The Mews, Hatherley Rd, Sidcup, Kent, DA14 4DX Tel: 081-302 8811
 Opening Hours: Mon-Sat 9.00am-5.30pm Late Night: Friday until 7pm Fax No: 081-309 0017

To: Silica Systems, Dept AMSHP-0592-68, 1-4 The Mews, Hatherley Rd, Sidcup, Kent, DA14 4DX

PLEASE SEND ME A GVP COLOUR BROCHURE

Mr/Mrs/Miss/Ms: Initials: Surname:

Address:

..... Postcode

Tel (Home): Tel (Work):

Company Name (if applicable):

Which computer(s), if any, do you own?..... 68B

Find your local group

1520 Plotter Group (ICPUG) Contact John Bentley ☎ 06286 65932.

16-32 Micro Programming AMOS, bimonthly fanzine, PD, (Fish->590) Membership 100FF/£10 Contact F Moreau, 132 rue Jean Follain, 50000 Saint-Lo, France ☎ 31 52 20 02

Amiga Artists Club 34 Roundhay Mount, Leeds LS8 4DW. For Amiga artists, musicians and coders. Pirates not welcome. Free. ☎ KAM on 0532 493942, 5-8pm.

Amiga Beginners' Club 110 Whitehill Park, Limavidy, Co. Londonderry, BT49 0QG. Club to help newcomers. Bi-monthly club disk, and a small PD library. Membership £2 for a single disk, or £20 for every issue.

Amiga Helpline Service DTP, PD, Help/problem service. Free membership. Beginners welcome. Send stamp for more info to: G Keenan, 21 Skirsa Pl, Glasgow G23 5EE.

Amiga Musicians' Club Membership gets you a disk with 50 IFF samples a month for 12 months. Also sample service. Membership £30. Contact Gavin Wylie, Guthrie Street, Carnoustie, Angus.

Amiga Users' Klub, Windsor House, 19 Castle St, Bodmin, Cornwall PL31 2DX. Meets every Friday from 6.30-9pm, to expand members' knowledge of Amiga and to help solve people's problems. Contact Jack Talling.

Amiga Users Group - FYLDE Advice on Amiga, technical support, discussions, workshops, tuition. £10 year, £6 6 months. Contact A Wilkinson, 25 Glen Eldon Rd, Lytham St Annes, Lancs ☎ 0253 724607.

Amiga Video Producers' Group Meets quarterly in Swindon. For info pack send SAE to J Strutton, 8 Rochford Cl, Grange Park, Swindon, Wilts SN5 6AB ☎ 0793 870667.

If your group isn't mentioned, fill in the form at the bottom of the page to let us know about you

Amiga Witham Users' Group 85 Highfields Rd, Witham, Essex CM8 1LW. Tips and Basic programs. K Anderson ☎ 0376 518271.

Amigaholics Club Free membership. Own disk magazine. For further information contact Kevin Bryan ☎ 071-580 2000 Ext 240 or 29 Wolfe Cres, Charlton, London SE7 8TS.

Amigamania Quarterly newsletter (tips, advice etc), quality PD, discount hardware, software and accessories, free advice. Annual membership fee £7. Contact S Green, 9 St Lukes Walk, Hawkinge, Kent CT18 7EF

Amos Programmer Club Free membership, swap AMOS programs and PD, disk magazine and help for new users. Contact Gareth Downes-Powell, 6 Brassey Avenue, Broadstairs, Kent CT10 2DS

AMOS Programmers' Exchange Free membership. Swapping software and ideas. Help available. J Lannig, 7 Majestic Rd, Hatch Warren, Basingstoke, Hants RG22 4XD

AMOS User Group Swap ideas, help on any AMOS subject, swap PD and own creations. Contact Andy ☎ 0323 26790

Avon Micro Computer Club Graphics and animation, business and the chance to speak to professional users. £3 per annum. Contact Roger: 95 Downend Rd, Horfield, Bristol ☎ 0272 513224.

Basic Programmers' Group 68 Queen Elizabeth Dr, Normanton, West Yorks WF6 1JF. Encourages the use of Basic, exchanges

ideas and assists beginners to the language. Free newsletter Mark Blackall ☎ 0924 892106.

Camberley User Group Lectures, competitions, advice, meetings, free membership. For more info contact F Wellbelove ☎ 0252 871 545

Champion PD Club PD at 30p, newsletters, advice, help and more. Membership £10. Contact: Steve Pickett, 31 Somersset Close, Catterick, N Yorkshire, DL9 3HE.

Chester-le-Street 16-Bit Computer Club Ground floor function suite, The Civic Centre, Newcastle Road, Chester-le-Street. Club meets Mondays from 7.30-9.30pm to look at software, exchange advice and swap tips. Contact Peter Mears ☎ 091-385 2939.

CDTV Users Club Exchanging views on software and hardware. Contact Julian Lavanini, 113 Fouracres Rd, Newall Green, Manchester M23 8ES.

Chic Computer Club Full details with an SAE to STAMP, Chic Computer Club, PO Box 121, Gerrards Cross, Bucks. Contact Steve Winter ☎ 0753 884473.

Club Amiga Membership £10 a year for PD software and a 24-hr helpline service (091-385 2627). For more info send SAE to Chris Longley, 5 Bowes Lea, Shinye Row, Houghton Le Spring, Tyne and Wear.

Club Futura Advice to programmers and beginners. Send SAE for info to G Holland, 16 Hermiston, Monkseaton, Whitley Bay, Tyne & Wear NE25 9AN

Comp-U-Pal Australian group for users in the outback. Newsletter, helpline, PD library. Membership A\$24. Comp-U-Pal, c/o MDA, PO Box 29, Knoxfield 3180, Victoria, Australia.

Computer Club 16 Laton Rd, Hastings, East Sussex ☎ 0424 421480. A 16-bit club dedicated to being computer enthusiasts. Membership costs £15 per year.

Disabled Group (ICPUG) Contact David Bate, 71 Bedford Rd, Bootle, Merseyside L20 7DN.

Edinburgh Amiga Group Membership £5, includes free advice and PD. Contact Neil McRea, 37 Kingsknowe Road North, Edinburgh EH14 2DE with SAE.

Hereford Amiga Group Membership free, help, exchange of PD and shareware. Lotus Turbo 2 Quad Player Championship. Contact John Macdonald, Alma Cottage, Allensmore, Hereford HR2 9AT ☎ 0981 21414.

Independent Commodore Products Users' Group Biggin Hill Library, Church Rd, Biggin Hill, Kent. Meets most Thursdays from 7.45-9.45pm. Lectures and open nights. ☎ John Bickerstaff after 8.30pm 081-651 5436. Also national network of user groups. Contact individual groups for details on activities, cost, meetings etc:

Andover ☎ R Geere 0264 790003
Anglesey ☎ N Massey 0407 765221
Ayr ☎ J Smith 0292 261408
Cardiff ICPUG ☎ I Kelly 0222 513815
Coventry ☎ J Orange 0203 689635
Dublin ☎ G Reeves 010 353 12 883863
Durham ☎ S Harvey 68 Wood Vue, Spennymoor, Co Durham DL16 6RF
Edinburgh ☎ 031 557 4242
Leeds ☎ R Eyre 0532 487691
Macclesfield ☎ P Richardson 0298 23644
Merseyside ☎ G Titherington 051 521 2553

Mid Thames ☎ M Hatt 0753 645728
Solent ☎ A Dimmer 0705 254969
SouthWest ☎ P Miles 0297 60339
Stevenage ☎ B Grainger 0438 727925
Watford ☎ M Pryor 0442 864 234
W Riding ☎ K Morton 0532 537318
Wigan ☎ B Caswell 0942 213402

Imagine Users' Group To encourage use of Imagine and other ray tracers. Affiliated to US group. Object library. Membership free. Contact Brian Walker, 16 Cambridge Road, Newton Cambridge CB2 5PL.

Kent Youth Computer Group Computer fair visits, programming, video and DTP work, monthly newsletter. 30p entry/evening. Meetings Sundays 6.30-9pm at the D Bowen Youth centre, Kingsnorth Road, Ashford, Kent TN23 2LY. ☎ 0233 629804

Maritime Amiga Club Maritime computing, interact with seafarers ashore on Amigas. Contact CDR K Osei, GN Ships Refit Office, 51 Rue de la Bretonniere, 50105 Chrebourg, France. ☎ 33 33225447

Northern Ireland Amiga User Newsletter, free PD library. Send SAE for further info. £5 annual membership. Contact: S Hamer, 98 Crebilly Rd, Ballymena, Co Antrim BT42 4DS

Norwich Masked Heros SAE for info. Free membership. Contact Zorro, 278 Aylsham Rd, Norwich, Norfolk NR32RG ☎ 0603 409899

Pennine Amiga Club 26 Spencer Street, Keighley, West Yorkshire BD21 2BU. Free membership, free advice and a newsletter. Contact Neville Armstrong ☎ 0535 609263.

Public Domain User Group Swaps PD, provides advice. SAE to 12 Oxford Road, Guildford, Surrey GU1 3RP.

Rye Computer Club Swap/meet at the Rye Community Centre. For info contact Oliver Campion, 71 The Mint, Rye, E Sussex TN31 7DP ☎ 0797 222876

Serious Amiga Users Membership £5, £1 admission. Contact J Kucak for more: ☎ 0706 290387. Fortnightly meetings 7.30-11 at the High Crompton Conservative Club.

Sherlock PD Quarterly disk mag, help and advice for beginners. 50p/disk. A Doyle, 44 Milton Street, Warrenpoint, Co Down N Ireland

Slim Agnus 115 Brocks Drive, North Cheam, Sutton, Surrey SM3 9UW. Meet last Thursday of month. PD library, BBS, advice from Amiga experts. Contact Philip Worrel.

Software Exchange Service 13 Bournville Lane, Stinchley, Birmingham, West Midlands B30 2JY. Michael Pun ☎ 021-459 7576.

Southampton Amiga Nutters club SAE for more info to D Collins, 6 Bentley Green, Harefield, Southampton SO2 5GB

Warpdrive (friends of Amiga) Amiga help-line, PD library, bi-monthly disk mag, free drinks, competitions and infosheet. £15 a year. Contact B Scales 110 Burton Ave, Balby, Doncaster DN4 8BB ☎ 0302 859715

WCPSPA! Help available. PD disk of your choice and newsletter every month. PD at £1. Membership fee £25. For information contact A Jamieson ☎ 0749 677609

Wrexham District Computer Club PD, library, equipment loan. 10p to join, 50p to get in. Memorial Hall, Wrexham every Thursday, 7-10pm. Contact Paul Evans, 3 Ffordd Eifed, Rhosnesi, Wrexham, Clwyd LL12 7LU.

Your Amiga Club Helplines, PD, social evenings, classes, club mag. Fee: £12, family £15. Contact P Higgins ☎ 0424 892269. The Old Chapel, Church Rd, Catsfield Battle, Sussex TN33 9DP

GET YOURSELF LISTED

If you run a user group which isn't listed on this page, fill in the form below for your free entry. Send it to **Amiga Shopper User Groups List, 30 Monmouth Street, Bath BA1 2BW**. We reserve the right to refuse entries.

AS13

Group name

Contact name

Contact telephone number

Contact address

.....

.....

Place of meetings

.....

Time of meetings

Type of activities

.....

.....

Membership fee

85p **IS your AMIGA your best 'AMIGO'?** **85p**
A500 & A500 plus compatible. WE CAN HELP!
A SMALL SELECTION FROM OUR VAST AMIGA PUBLIC DOMAIN LIBRARY

STARTER PACK (Superkillers, Wordwright + Amiga spell, SID copy util, label maker, Icon maker + more) 8 disks£5.95
HOME BUSINESS PACK (Wordprocessor, Spellchecker, database, home banking, memopad + more) 8 disks£5.95
C PROGRAMMING PACK (C compilers, C utils + debugger, QED editor, C manual, Rom Kernel Ref.) 9 disks£6.75
EDUCATION PACK (Evolution, Draw map, German tutor, Speak & spell, Chemistry periodic table) 5 disks£3.99
RED SECTOR DEMO MAKER PACK (Bob, Font & Vector Editors, Program & Utils disks) 5 disks£3.75(NP)
MUSIC MAKING PACK (MED, Noisetacker, Psound player & samples, sound modules) 8 disks£5.95
GAMES PACK (Arcade Classics, Adventure Game, Trading Game, Star Trek, Puzzle Game, Super Quiz) 10 disks£7.50
SOUND & VISION PACK (3D demo Enigma, Ray traced Anim Juggler, Technotronics, Madonna + more) 8 disks£5.95

U860 Sid, Label Maker, disk utils
U2000 Superkillers (latest virus killers)
U737 MessyDols (read PC disks)
U2010 PC Emulator
U647 ICONS (cover 300)
B700 Home Banking, Turbo Backup
BP10 Home Management Pack (3 disks) £2.25
E75 Learn & Play (2 disks) £1.70
SL861 Invisible World (Creepy crawlies)
G847 Mental Images (Gridrunner, Invaders)
SOUND SAMPLES (Licenceware) SGI-FI, DRUMS, GUITARS, ATMOSPHERICS + lots more £2.50p each or £8.00 for pack of 4.
Disks are Virus checked.
 Order £10.00+ and choose 2 free PD disks
MAIL ORDER:- Disks despatched within 48 hrs of receipt of order. Comprehensive brochure returned with order. OR send an S.A.E. for brochure only. P&P UK 75p Europe £1.00 World £2.00. Cheques & postal orders payable to 3 AMIGOS.
3 AMIGOS, DEPT AS12, 16 MARSETT WAY, LEEDS LS14 2DN. Tel. Enq. welcome after 6.30pm TEL (0532) 733043

FREE PD Software
Six 100 Page Magazines
Technical Advice - Discounts
£19 a year includes £1 joining fee.
FREE PD CATALOGUE DISK ON JOINING. We support all CBM Machines and PC compatibles.
1991 back issues £2.50 each.
SAE for details to Jack S. Cohen
PO Box 1309 London N3 2UT.
Call for overseas rates.

ICPUG

CALL
081-346-0050
 after 6.00pm

For a fast, reliable but foremost friendly service.



STAR TRONICS

AMIGA PD
 1-9 disks £1.20
 10 - 15 disks 99p
 15+ 90p

FREE PROGRAMS
 Order 10 get 1 FREE
 Order 20 get 2 FREE
 Order 25 get 3 FREE

061 370 9115
 No minimum order.
 All orders sent out the same day.

DEMOS
 DE001 Red Sector Demo Maker
 DE006 Ghost Writer
 DE008 Speech Toy
 DE009 Abnormal Demo
 DE015 Predators (2 disks)
 DE017 Wave Sailing (2 disks)
 DE019 Robocop 2
 DE245 Odyssey (4 disk)

UTILITIES
 UT046 Pendle Europa
 UT051 Amibase V3.76
 UT057 A64 Emulator
 UT114 ASS MenuMaker
 UT145 Vogue Util's (Brill)
 UT179 CLI Tutorial +
 UT190 Video Graphics (3 Disks)
 UT214 Amateur Radio (6 Disks)
 UT237 Work Bench 2 (A500+) only
 UT253 D-Copy 2

GAMES
 GA008 Pipeline
 GA030 Tennis
 GA067 Truckin (2 disks)+
 GA086 Assassins 1-20+
 GA180 Star Fleet +
 GA182 Killer Cars +
 GA204 Chess Tutor II +
 GA205 A500+ Games Pack +
 GA207 Cars Sharp +

MUSIC
 MU017 Digital Concert (2 to 6)
 MU025 Star Trekker
 MU034 Queen (2 Disks)
 MU055 Pro Tracker V3.00
 MU072 Mozarts Flute Concerto
 MU077 Puma Tracker (Brill)
 MU058 Mozart (2 Disks)
 MU054 EFX Music Creator

GRAPHICS
 001 M-Cad
 003 Print Studio +
 005 Clip-Art 1 to 13 + Original set uncut
 024 Colour Fonts (5 disks)+
 028 Walt Disney Clip-art+
 033 Graphics Utils +

BUSINESS
 BU004 Clerk (Brill)
 BU005 Genealogy
 BU007 Bankin'
 BU016 Text Plus V3.00
 BU019 Analyticalc V2.00
 BU021 Amicash V1.0+
 BU025 House Hold Inventory
 BU026 Textengine +
 BU031 BBase (Database)+

AMOS
 APD014 IFF Pics No1 (Brill)
 APD031 Screen Designer
 APD033 Pink Goes Ape
 APD036 Amos 1.3 Update
 APD101 Auto Player V1.10
 APD123 Deadline
 APD205 R.Draw V1.48
 APD303 Litter Busters
 APD329 Fruit Machine II

SETS
 SPD001 Beginners 1. (5 disks - £5.80)
 SPD002 Beginners 2. (5 disks - £5.80)
 SPD003 Clip-Art 1. (4 disks - £4.60)
 SPD004 Clip-Art 2. (4 disks - £4.60)
 SPD005 Games 1. (5 disks - £5.80)
 SPD006 Games 2. (5 disks - £5.80)
 SPD007 Clip-Art 3. (4 disks - £4.60)
 SPD008 Educational 1 (4 disks - £4.60)
 SPD009 Educational 2 (4 disks - £4.60)
 SPD010 Edu/Science 1 (4 disks - £4.60)

StarTronics
 4 Arnold Drive,
 Droylsden, Manchester
 M35 6RE

ACCESSORIES
 3.5 50 cap box£4.95
 3.5 100 cap box.....£5.90
 Banx Box£9.00

DISK SPECIAL OFFER
 Sony Bulk£4.90
 KAO Bulk£4.99

+ = Compatible with Plus

Postage & packing 70p
Add £3.15 per item for disk box. Please submit payment by cheque or postal order

FREE FISH 1 - 580
TBAG 1 - 060

QUALITY DOESN'T HAVE TO COME AT A PRICE!

ANIMATIONS
 Planetside 1M (CDTV animation)
 At The Movies 1.5M (+)
 At The Movies 2 (4) 1M NB £3.50
 Anti Lemmin' (2) (2 drives) 2M (+)
 Mr Potato Head 1 1M (+)
 Mr Potato Head 2 1M (+)
 Buzzed! (3) (2 drives) 3M
 Rollerball (2) 1M
 In Bed With Madonna 1M (+)
 Gulf War Conflict 2M
 Robocop Digimovie 1M (+)
 Woman In Red (+)
 Spiderman 1M
 Knight Anim 1M (+)
 The Boings 1M (+)

EDUCATION
 T.C. Dinosaurs (interactive book)
 Learn and Play (2) (+)
 Typing Tutor
 Train Construction Kit (+)
 Elements (+) (periodic table info)
 German Tutor (+)
 Spanish Tutor (+)
 Colour It! (+)
 Space Maths (+)
 Treasure Search (+) (with speech)
 Power Logo (+)
 Storyland 2 (+)

UTILITIES
 Form Designer (+)
 Cassette Labeller (+)
 Amicash (+)
 DPaint Fonts & Surfaces (+)
 Amibase Professional (+)
 Text Plus V3.00 (+)
 Video Applications (2) (+)
 MessySid 2 (+)
 Amateur Radio 1 (+)
 Pacman Copier (+)
 Hard Drive Utils (+)
 Spectrum Emulator (with snd) (+)
 Spectrum Datadisk 1 (+)
 Atari ST Emulator (2 drives)
 PC Emulator (+)
 Last Hope (file recovery progs) (+)
 Med V3.2 (+)
 Med Music Disk (+)
 RSI Demomaker V2 1M
 RSI Demomaker Instructions
 Cult TV Guide
 Home Applications (2) (+)
 Desktop Publisher (English) (+)
 Clip Art Pack (5) (+) NB £4.50
 Starchart (+)
 600 Business Letters (+)
 King James Bible (4) (+) NB £3.50
 Crossword Creator (+)
 DPaint Cartoon Brushes (+)
 Tarot 2 (2) (+)
 Business Card Maker (+)
 Pascal Compiler
 Calc V1.2 (spreadsheet prog) (+)

GAMES
 Jetman
 Atic Atac 1M (+)
 Frantic Freddy
 Dragons Cave (+)
 Ghost Ship
 A500 Plus Game Pack (21 of 'em)
 Truckin' (2) (+)
 Killer Cars (+)
 Raphael's Revenge (+)
 Card Sharp (+)
 Quizmaster (+)
 Raid (+)

DEMOS & MUSIC
 Silents Blues House (2) (+)
 Hardwired (2)
 Anarchy Digital Innovation
 Divina Technofright (+)
 PMC Alpha Omega (+)
 Total Recall The Demo (+)
 Amos 3D (+)
 Silents 'Ice' (+)
 Bruno's Box 3 (2) (+)
 The Four Seasons (2) (+)
 Alcatraz Odyssey (5) 1M NB £4.50
 Utah Saints Remix (+)
 Andromeda Decaying Paradise (+)
 Charly (+)

SLIDESHOWS
 Terminator 2 (2 drives) 1M
 Divine Visions (2) (fantasy) 1M (+)
 Kim Wilde (+)
 Betty Boo (+)
 Robocop 2
 Advance HAM 1M (+)



Just 95p Per Disk!

THE SERVICE
 SAME DAY DESPATCH BY FIRST CLASS POST

FREE NEWSLETTER WITH SCREENSHOTS AND REVIEWS OF LATEST PD TITLES.

FREE PRIZE DRAW FOR COMMERCIAL TITLES DETAILS BY RETURN

ORDER MORE THAN 10 DISKS AND PICK A FREE DISK AND GET FREE P&P TOO!

WHEN ORDERING!
 PLEASE INCLUDE 60p TO HELP WITH POSTAGE & PACKAGING

I CAN'T SEE THE DISK I WANT!
 WE WILL PROBABLY HAVE IT! JUST GIVE US A CALL. IF WE DON'T WE WILL GET IT FOR YOU. AT NO EXTRA COST!

Blank Disks inc Labels, Post and Packing just £5.50

A500 Plus Owners just look for the (+) sign! CAT disk 75p or FREE with orders over 5 disks gives detailed reviews on 100's of disks!

When ordering please make **CHEQUES** and P/O's payable to:
NEURAL IMAGES
 Department AS4
 4 Flint Walk
 HARTLEPOOL
 Cleveland TS26 0TE
 TEL (0429) 263508



Q: HOW MANY PROGRAMS CAN YOU GET FOR £30?

A: 30!

Public Domain is your essential monthly guide to the world of free software. For as little as a pound you can pick up games, utilities, even fully-fledged business packages for your Amiga.

- Hundreds of programs reviewed and rated each and every issue
- In-depth features that tell you all you need to know
- A program-packed coverdisk crammed full of PD and shareware to astound you
- For only £2.95 you could save yourself hundreds

DON'T MISS ISSUE SIX ON SALE 2ND APRIL

Yet another superb magazine from Future Publishing, the company that brings you Amiga Format, ST Format, Amiga Power, Amiga Shopper, PC Plus, PC Format, PC Answers...

Future PUBLISHING

AMIGA · PC · ST
PUBLIC DOMAIN
AMIGA · PC · ST

THE WORLD OF FREE SOFTWARE - YOUR MONTHLY GUIDE

ISSUE 6 • £2.95
MAY 1992

THE LATEST PD, SHAREWARE & LICENCEWARE REVIEWED

MIND YOUR OWN BUSINESS!
 Get started and save a fortune using shareware and PD...PAGE 19

SAVE SERIOUS MONEY WHEN USING YOUR MODEM
 Cut on-line costs by following our 10 bill-busting tips ...PAGE 54

AMIGA · PC · ST PACKED WITH GREAT PROGRAMS

COVER DISK 6

AMIGA PC
 Zaxx: An addictive puzzle game
 SoundMaster: Plus sound modules
 Make: Latest version of this virus killer
 Important - read the instructions! See page 6 for details
 *Revised disk © Bob Norton Computing

ST
 Robots: Attractive and winning action game
 ST Writer Editor: Top word processing tool
 Bioomatic: Sound module program (ST)
 module program (ST)

GET SOUNDS FOR £1
 How public domain can be music to your ears ...PAGE 69

£1000 WORTH OF MODEMS TO BE WON!
 ...PAGE 75

APOGEE REVEALS ITS SECRETS
 The greatest shareware games outfit and their amazing success ...PAGE 49

Future PUBLISHING
 Your guarantee of value
 9 770963 826009

FULL DETAILS OF DISK ON PAGES 6-9

Shopper Reader Ads

... Or how you can reach thousands of fellow Amiga owners for only £5

WANTED

Swap PD with me! Over 100 disks to offer. All virus free. Send list and SAE to Andrew Weavers 20 Geraints Way, Cowbridge, South Glamorgan, CF7 7AY.

SC51 Hard Drive (bare) 40 meg or over in good order. Must be compatible with Dataflyer 500 controller reasonable price. ☎ Terry 0323 844105.

PD swaps, one for one. I have over 175 titles in my collection. Send your list to Trevor James, 229 Barking Road, East Ham, London E6 1LB.

FANZINES

Amiga Journal - Fanzine with coverdisk. More than a Diskdrive, more than a fanzine! Try a copy. It's only £1.75 from: David Black, 369 Wanstead Park Road, Ilford, Essex IG1 3TT.

Highland Amiga magazine new bi-monthly disk. Packed with games ideas utilities, more than just a magazine only £1.50 inc P & P. Write now to D Paulin, 255 Drumossie Avenue, Inverness IU2 3SX.

New Dual Impact - the ultimate disk magazine. Two disks packed with brilliant Amigaware: utilities, music, etc. Send £3 to C Aubrey at 16 Sanctuary Fields, North Anston, Sheffield S31 7DD.

FOR SALE

Full image grabbing/manipulation set-up (virtually unused). Including Amiga 2000 (upgraded to 3Mb), Commodore 1084 colour monitor, Hitachi CTV camera, copy stand and lights, Digiview Gold 4.0, DigiPaint and Photon Paint, software and accessories etc. £1050.00 ono. ☎ 0742 754982 (daytime).

CCS Laser Printing Services. Have your Amiga documents printed at laser quality. Propage, Prodraw, Pagesetter and Pagestream files accepted. We will also undertake to DTP ASCII documents to your specification. ☎ 0323 767065 10am-4pm

Supa RAM Board 4Mb fitted for A1500 or A2000 £160. ICD advantage hard disk controller £60. F19 Stealth Fighter £10, 688 Attack Sub £10. Blitzkrieg £10. Xenomorph £8. ☎ Cambridge 213704.

A590 20Mb hard drive with 1Mb RAM fully formatted and ready to plug in and go, boxed with manuals and system disk £200. ☎ Stephen Hall 0224 740795

Pace modem Intelligent V21-23, includes software, leads, Robocop II, Kickoff and six others, plus X-copy 2. £155 for all or trade for KC5 board or similar. Will split. ☎ 0285 653027 - Ben.

Amiga 500 Plus with accessories only 3 months old complete with flight of intruder £280 ono (will pay carriage). ☎ 08675 3618 (Oxford area).

Amiga A1500, Phillips (M8833) Mk2, 3Mb Ram. All under warranty boxed, as new. Much software, some books. £700 the lot. ☎ 0242 235758 (evenings).

Commodore A590 hard drive 20Mb with 2Mb of ram installed. Including Ram test software and setup disk plus all manuals £220 ono. Please leave message on answerphone, if necessary. ☎ Tony Glover 071 9269129 (work) or 0705 596018 (home)

Star LC-200 colour printer, only 2 months old, good as new, leads, instructions included. Still under guarantee. £150 only. Ilford, London ☎ Julian on 081 518 5678.

Real 3D version 1.4 pro turbo edition worth over £300, but will sell for £180 or swap for hardware. ☎ 0733 555888 ext 2251 or 2252 office hours - Robert.

A500 immaculate condition, 1Mb PC880B second drive, two joysticks, mouse, lots of games, Workbench, Photon, Paint, magazines, lots more! all boxed and with manuals. ☎ 0727 53732 £350 ono.

Amiga A2000 new with quantum 40Mb HD A2091 HD controller 2630 accelerator card maths co-process 5Mb ram and mouse manuals disks £1,500. ☎ 0202 625018.

Amiga 500 3Mb RAM Fatter Angus Commodore monitor mouse, manuals, boxes £499.00 ono. 50Mb Tiny Tiger HD SCS1 and parallel ports manual software boxes £199.00 ono together only £599.00. ☎ 0908 317620

Commodore 10845 Monitor £185, power. Computing dual external drive (new) £100 and Datel Genius Digitizing tablet £99 all items in original packaging. ☎ Bob on 0375 375811 for quick sale.

Supradrive 500XP 52Mb quantum 2Mb populated using four 4*1Mb dRAM-chips so no need to replace them when expanding, lots of utilities £300 ono. ☎ Eamon 071 708 1163 after 6pm please.

Original Amiga software Thunderhawk £15. Robocop £14 Alien Breed £12. PGA Tour Golf £12. Jimmy White Snooker £15 list available. 50 John Kennedy House, Rotherhide, Old Road, London SE16 2QF.

CDTV inc keyboard, trackball, external floppy drive, loads of software (inc CD's) £625 ono Epson FX80 Dot Matrix printer little used, bargain at £40. ☎ 0297 20479 ask for Paul Dommert.

Complete video setup Amiga 1500 42Mb HD 3Mb RAM. Piendale 8802 Vidi Amiga/Pigb Technosound Turbo, DPaint IV. Divided III PIXMate Shirekilo caption designer. Cost £1786 Sell £1100, as new. ☎ Bob 0438 728461 evenings.

Amiga 500 1/2 Mb expansion board with battery backed clock, £22. Deluxe Paint III, boxed with manual,

£20, Captain Planet £5, Simpsons £5. ☎ John on Luton 0582 424317 (offers taken).

Amiga 500 WB1.3 1Mb Chip RAM GVP Impact II 42 Meg HD + 2 Meg RAM, Phillips 8833 mon, Star LC200 colour printer. Second floppy drive, 2 joysticks, mouse, software worth £1000+. Books, magazines £2000 ono. ☎ Kevin Williams 0344 55978 any time.

Checkmate expansion unit £100 datel action replay Mk2 £30. Datel video Digitiser II £45 all in excellent condition ☎ 0286 4773 after 5pm.

RAM chips for Commodore A590 hard drive £50 two megs. Deluxe Paint III. New, unused, already have it, due to upgrade £25 ☎ evenings after 6pm - York 0904 421968.

Complete colour solution digitizer including joystick splitter and camera to digitizer lead £130, star LC24-200 colour printer with lead (boxed) £200. ☎ Malcom on 0842 750855.

AT Bridge Board with 5.25" disk drive, £200. Also UGA card, £50 and 32meg hard card, £100. All suitable for B2000 or A1500. ☎ 071 272 9297.

Nexus hard card. Bare supports SCS1 and AT drives. up to 8Mb memory in Simms. Offers? W.H.Y? ☎ Steve on 081 317 1645.

Pandall datascan hand-scanner with version 2 software complete with power supply and interface. 6 months old. Boxed. As new condition £70. ☎ J Havard Preston 0772 883061.

Graphics Tablet Summa sketch large 12" x 12" approx active area, graphics tablet. Complete with Stylus manuals etc. All boxed as new. Only £250. ☎ Mr D Howarth 061 973 4646 after 6pm.

Amiga A500, 1Mb external drive, Epson FX850 with sheet feeder, joysticks, Games, Amos, Photon paint. All boxed with manuals. ☎ for details. Worth £1004, sell for £600 ono. 0296 713314.

A5000 Accelerator card 68020/68881 combination with 4 megs 32-bit RAM on board list, price £554 asking £30, Sculpt Animate 4D - full blown ray tracing package £160. ☎ 0302 859851 - Dean.

Amiga A1500 PHC 2 x 3.5" drives 1Mb Chip RAM, Fatter Angus, 3 games, point 3 works! Platinum, joystick, mouse, mat, bracket, dust cover, disk box, 25 disks £575 ono. ☎ 051 426 0138.

Mini megs fast RAM. Uses exp port. Pop to 1Mb, expand to 2Mb max. Small size 5 1/4 x 3 1/2 x 5/8. Uses Amiga PSU. Full auto configuration £75. ☎ John Mills 0245 250821 (eves)

It's only £5 to sell your used hardware and software in Amiga Shopper

Sell your excess hardware and software with *Amiga Shopper* Reader Adverts. Just fill in the form and send it to us along with a cheque (made payable to Future Publishing) or postal order for £5. But **BE WARNED**. This magazine is not a forum for selling pirate software or other illegal goods. Software must include all issue disks, manuals

and a signed statement that all other copies have been destroyed. Please advise us if you are offered pirate or copied software by advertisers. All ads are accepted in good faith. The editor reserves the right to refuse or amend ads. We accept no responsibility for typographical errors or losses arising from the use of this service.

Trade ads will not be accepted, including anyone advertising the sale of PD software.

Name Issue 13

Address (not for publication)

Postcode

Date

Tel.

Tick one box to show required section heading

For sale

Wanted

Personal

Fanzines

Use one space for each word. Only the words in this section will be printed.

| | | | |
|--|--|--|--|
| | | | |
| | | | |
| | | | |
| | | | |
| | | | |

Return with your cheque to:
Reader Ads,
Amiga Shopper,
30 Monmouth
Street,
Bath,
Avon BA1 2BW

Unfortunately we cannot guarantee insertion in a particular issue.
 I have read and understood the conditions for the inclusion of my ad.

Signature

Do you really need to spend over £100 on a word processor, or will a PD or shareware offering do the job? That's just one of the questions Ian Wrigley answers in this month's PD World

Word processing on the cheap

This month, as well as the usual round-up of what's best in the way of PD and shareware, I've been looking at freely-distributable word processors. It seems to me that you'd be mad to pay vast sums of money on a commercial program if there's a shareware or PD version about that will do the same job for you – so that's what I've been looking for. And those (like me) who need to watch the pennies could well be pleased with the result...

The PD and shareware arena still seems a little quiet at the moment; even demos seem to be a little thin on the ground. But there's still a reasonable amount of stuff around, if you look hard enough. Apart from my investigation of budget word processors, I've looked at several programs which come guaranteed to brighten up the grey days until summer comes.

FIRST THOUGHTS

Before looking at the word processors available, let's consider some general points. First of all, you ought to consider what you want the program to do. If you're only going to be using it for writing programs or dashing off short notes, do you need to bother with a word processor at all? An editor like MicroEMACS (or even ED), both of which come free with your Amiga, will probably do just as good a job.

Printer support is a major factor when choosing a word processor. If you're using the Kooky 750, which has its own printer control codes, then you may find that commands such as 'bold' and 'underline' produce unexpected results unless the word processor allows you to edit the printer control codes which are sent. On the other hand, it would be rather nice if the program came set up for something like Epson emulation, since virtually every printer can be persuaded to emulate

an Epson machine.

None of the PD word processors can cope with importing graphics – but then, neither can many commercial programs. If it's pseudo-DTP that you're after, you'll have to look elsewhere. However, I found that when it comes to word processing power, some of the PD and shareware applications available can give many of the commercial programs a good run for their money.

THE TEXT ON TEST

To check the word processors, we devised a simple test. We used a 4,000-word ASCII file (which had, as a matter of fact, been created on a Mac and then transferred to the Amiga).

The file had some strange ASCII characters, due to the translation process – an en-dash on the Mac, for instance, is translated to a strange-looking graphic.

We loaded and then altered the file in each of the programs, as well as creating other documents from scratch, to see how the programs coped.

We also felt it was necessary to take into account the number of new Amigas being sold, and the fact that many owners of standard A500s will be upgrading to Workbench 2.0 and the Enhanced Chip Set. It was therefore felt that programs which wouldn't work with Workbench 2.0 should not be included in the test.

continued on page 148

Where to get it

There are two main ways to get hold of Amiga PD and shareware: from a bulletin board or from a PD library.

The advantage of using a bulletin board is that often the latest software is uploaded as soon as it's available. On the down side, you need a modem to connect (check out the *Amiga Shopper* modem offer for a couple of low-priced units); you'll also have to pay phone charges (and sometimes a BBS connect charge, too).

There is a growing number of bulletin boards with a reasonable range of Amiga software available for download. For instance, check out 01-for Amiga (071 377 1358) and the Cheap Amiga BBS (081 644 8714). On the other hand, you could join up to CIX (short for Compulink Information eXchange), which has not only Amiga software but also conference and file areas for loads of other machines, as well as hundreds of conferences on subjects not remotely connected to computers. Many of the *Amiga Shopper* writers have CIX accounts, so you can get first-hand advice on your problems, too. For more details, give CIX a ring on 081 390 8446 (voice) or 081 390 1244 (modem).

If you don't want to use a bulletin board, you'll be getting your software from a PD house. Many advertise in *Amiga Shopper*, and there's a comprehensive list at the end of this article. Expect to pay between 99p and £2.50 or so per disk.

BEGINNERS

What is PD?

PD is a general term which many people use (incorrectly) to refer to all freely-distributable software. In fact, PD (which stands for public domain) software is only one branch of this area; the other main one is shareware. Essentially, PD software may be copied and used by anyone, although some authors place restrictions such as the PD library not being allowed to charge more than a certain fee for the disk. Shareware, on the other hand, should be considered as commercial software, which you can obtain on a 'try before you buy' basis. If you like the software, you are morally obliged to send the author the requested fee. This is normally only a few pounds or dollars; it won't break your bank, it will encourage the author to write more software



BEGINNERS START HERE

BEGINNERS

and it often entitles you to free upgrades, a

printed manual or similar inducements.

Can I give other people copies of PD and shareware?

Yes – if you have a program which you like, be sure to give it to as many other people as possible; that way, as many folk as possible get to hear about it. However, if you've registered a piece of shareware, make sure that you don't give anyone the registered copy: that is yours alone, and should be treated like any other piece of commercial software. For example, *Text Plus*, reviewed this issue, has a frequently-appearing requester asking you to register. That is the version you should pass on – not the registered version, with the requester removed.

SIMPLY THE BEST! ALL THE FRESH FISH 1 - 610

- FF-524 SNAP V1.62:** Cut and paste graphics or text from other applications. Uses the Amiga clipboard device.
- FF-533 BOOT GEN V3.4:** Easily create a boot menu by simply entering the names of up to ten programmes and Boot Gen will do the rest.
- FF-535 KEY MACRO V1.12:** A keyboard macro programme configurable via a text file, that also supports hot key programme execution. You can map up to 8 functions to each key including keys such as cursor keys and the return key etc.
- FF-543 PIC SAVER:** A screen grabber that will save pictures in IFF format.
- FF-561 TOOLS DEAMON V1.0:** A useful utility that makes it easy to add programmes to the tolls menu on workbench 2.0.
- FF-562 DEGRADER V1.0:** Degrades your machine to try and get badly written programmes to work. Locks out fast memory turns of cache and burst modes traps privilege errors forces pal or NTSC screens etc. Survives reset.
- FF-563 DISKEY V2.1:** A sector orientated disk monitor with lots of useful features like disassemble, user friendly ASCII or HEX editing facility and extensive search options. Useful for salvaging data from damaged disks or learning about the Amiga's inner workings.
- FF-572 MULTIPLT XLNC:** An intuitive data plotting programme featuring flexible input options, arbitrary text addition, automatic scaling, zoom, and slide with clipping at boundaries, a range of output file formats and publication. Quality printed output. Workbench printers are supported via transparent use of the PLT device. Postscript and HP laserjet are directly supported.
- FF-573 MULTIPLAYER:** Music player that will play over 15 types of module including SoundTracker, NoiseTracker and MED.
- FF-579 BINTOHUNK:** A utility to convert a raw data file (text, bitmapped graphic etc) into an Amiga hunk format object file that can be linked using Blink.
- FF-580 WORLDDATABANK V2.2:** Using a database of co-ordinates compiled by the CIA and made available under the freedom of information act, this program plots world maps in cylindrical or spherical projections with various degrees of magnification. Includes the largest available data file for detailed mapping of even small sections of the globe. Disk includes source code.
- FF-589 TERM V1.9c:** A telecommunications program with some nice features, including an ARexx port, external process communications, XPR support, Programmable function keys, postscript downloading to laser printer, phone book, Programmable panel buttons, public screen support etc documentation in English and French. Requires dos 2.0 an update to Term 1.8A
- FF-593 & FF594 ANALYRIM:** An integration of the AnalytCalc spreadsheet and the RIM-5 database management system 2 meg of ram needed of which 750K must be contiguous.
- FF-597 ICON TOOLS:** Four programmes to manage some aspects of icons using the intuition interface and allowing operation on many icons at one time by shift clicking etc.
- FF-598 DX100:** Editor/Librarian for the Yamaha DX100, DX21 AND DX27 synthesizers.
- FF-598 FB-01:** Editor/Librarian for the Yamaha FB-01 with lots of features.
- FF-598 TX81Z:** Editor/Librarian for the Yamaha TX81Z and DX11 Synthesizers. Provides voice and librarian features similar to the FB-01.
- FF-601 PP:** Patches Amiga Dos and makes decrunching of PowerPacked files completely transparent. Which means that any programme may work directly with PowerPacked files without having to decrunch them first.
- FF-602 MATHSADV:** An adventure programme that will educate as well as have fun to play.
- FF-603 NOTIFY:** A suite of Rexx programmes that can be used to issue messages or run commands automatically on certain days and or certain times.
- FF-604 RINGWAR:** A classic arcade game of reflexes with vector graphics.
- FF-604 MIDISTUFF:** A package of 8 tools that use the midi library.
- FF-605 HDCLICK:** A programme selector/hard disk-menu. Programmes can be started easily by clicking on gadgets which can be defined by the user.
- FF-606 SPELL CHECK:** A programme which aids you in learning foreign words. You enter the words and translation and the computer will quiz you on them.
- FF-607 DOS CONTROL:** A new directory tool that combines the functionality of many separate tools allowing you to control the operation of your Amiga with a single programme.
- FF-608 VERTEX:** A 3D object editor that differs from other 3D editors in many ways. You can choose any view, including perspective, to select points and examine objects. The view can be rotated, positioned and scaled at will by either typed in values or using the mouse which makes the editor fast and responsive.
- FF-609 CRYPTO KING:** A game for all those that like to solve cryptograms.
- FF-610 ATCOPY:** A programme to copy files from the Amiga side of a system equipped with a PC/AT bridgeboard to the PC side using wild cards. Copies directly through the shared memory. Supports CLI and Workbench usage. This is an upgrade to version 2.2 on disk 458 which now includes an ARexx port.
- FF-610 PCEXECUTE:** A little programme that allows you to execute programmes on a bridgeboard without opening a PC window.

THE FRED FISH BOOK.

A fully descriptive book with 128 pages with full sorted index. Covers disks 1 to 560.
Only £4.99 inclusive.

UTILITIES & GAMES

- UT-014 AMIGA SYSTEMS TEST:** Tests keyboard, mouse, disk drive, memory - both chip and fast - screen resolutions, clock, sprites and more.
- UT-017 WORD WRITE:** A nice word processor along with 2 other utilities Label Print & S-Calc
- UT-044 M-CADD:** Computer aided design program with lots of drawing tools and load/save feature.
- UT-064 COMPLETE C MANUAL V2.0:** 4 disks each one about 98% full. A must for anyone wanting to learn C. Executable examples along with the source code to take you through screens, gadgets, windows etc. On disk documentation shows how to use a compiler, how to link code etc a very useful tutorial.
- UT-072 BANK'N V1.5:** An excellent utility for keeping track of your bank account, produces reports on income and expenditure so you can see where the money is going. Handles multiple accounts.
- UT-097 NORTH C V1.3:** (2 disks) a complete C compiler along with libraries and all.
- UT-108 PRINT STUDIO:** Will print text with different options. Will also print/save screens and windows or parts of, alter colour palette etc.
- UT-139 DRAWMAP V2.30D:** An upgrade of the excellent map drawing utility.
- UT-151 BOOT X V4.1** An excellent (probably the best) easy to use Amiga virus killer **UT-152** is the same programme but set up for the Amiga Plus.
- UT-157 TEXTPLUS V3.0:** A full featured word processor.
- UT-165 UEDIT V2.3:** Another useful word processor that's easy to use.
- UT-172 TEXT ENGINE V2.1 & AZSPELL:** A very nice wordprocessor along with a very good stand alone spell checker.
- UT-185 LABEL MAKER V1.3:** Brilliant, allows you to create and print full 3.5" disk labels with graphics and in colour too. Nothing is static you can move text and graphics around at will. Full load and save features.
- UT-188 MESSY-SID II:** Converts Data files between Amiga Dos and MSDos.
- UT-189 AMIBASE PROFESSIONAL:** An easy to use data base program and upgrade to the very popular Amibase.
- UT-192 HARD DRIVE UTILS:** Various utilities for backing up and repairing data on your hard drive those fortunate enough to have a hard drive.
- UT-197 & 198 THE A64 PACKAGE II:** Probably the best Commodore 64 emulator available. Updated to be Amiga Plus compatible.
- UT-201 GRAFIX UTILS 1:** QuickFlix, Slate, RTap, VideoDataBase, Combine Anim, Split Anim, Anim Build & anim Info.
- UT-202 GRAFIX UTILS 2:** Tesselatr, Plasma, Plans & Plotxy.
- UT-203 GRAFIX UTILS 3:** PicBase, Agraph & Freepaint.
- UT-204 GRAFIX UTILS 4:** TitleGen, Image LAB, ShowFont, Vlot and Jpeg.
- UT-206 BBASE II:** A database with a professional look, full features and easy to use.
- GA-109 PETERS QUEST:** Can you rescue your girl friend by completing the twenty levels.
- GA-112 DITRIS:** A two player Tetris clone and very good too.
- GA-126 CARD SHARP:** A collection of Solitaire type card games professionally presented.
- GA-128 NAPOLEONIC WARFARE SIMULATOR:** For all those would be Generals.
- GA-129 MIND GAMES:** A collection of 21 games, a couple of which do not work on the plus but the disk is still well worth having.
- GA-130 DIPLOMACY II:** A good strategy game for 2 to 7 players.
- GA-132 SURVIVOR:** A graphics adventure. Good graphics, very well presented.
- GA-134 WASTELANDS:** An impressive 3D graphic adventure.
- GA-135 PARACHUTE JOUST:** Fight over a parachute whilst free falling from a plane. Worth getting just for the animation sequence at the end.
- GA-136 & GA-137 STAR TREK TRIVIA:** An excellent quiz game based on the new generation.
- GA-139 NU GAME:** A vertical smooth scrolling shoot em up and very good too.
- GA-140 ADVENTURES:** A collection of 6 text adventures Atlantis, Safari, Star Trek, Grungy Towers & Ring World.

ALL CHEQUES, BANKERS ORDERS PAYABLE IN POUNDS STERLING TO UNIQUE COMPUTING AND DRAWN ON A BANK IN THE U.K.

1-4 Disks £2.00 per Disk
5-9 Disks £1.75 per Disk
10+ Disks £1.50 per Disk

MINIMUM FOREIGN ORDER 6 disks
EUROPE PLEASE ADD 50p per disk
REST OF THE WORLD ADD £1.00 per disk

Above prices apply to P.D., Fish & Shareware. Licenseware is as quoted. All prices include postage and packing. Please send orders to:

UNIQUE COMPUTING Dept A/S
114 Salters Road, Gosforth
Newcastle upon Tyne NE3 3UP, England

Telephone or Fax 091 2847976

DEJA-VU LICENSEWARE £3.50 PER DISK INCLUSIVE

- LPD-001 COLOURING BOOK:** A nice colouring in program with several nursery rhyme pictures. An excellent program for young children.
- LPD-002 ARC ANGELS MATHS:** An educational game to help kids with their maths.
- LPD-004 THINGAMAJIG:** Kiddies jigsaw type program with 24 pictures to choose from and a difficulty level. 1 meg.
- LPD-005 JUNGLE BUNGLE:** A very good graphic adventure written with children in mind.
- LPD-008 WORK AND PLAY:** 3 educational programs for kids. Click Clock, Fun Times Tables and Lets Go Shopping. 1 meg.
- LPD-010 THE WORD FACTORY:** A neat spelling game for the kids. 1 meg
- LPD-015 ARC ANGELS SHAPES:** Fun for the kids. Build colourful pictures from predefined shapes. 1 meg.
- LPD-016 REVERSI II:** A new improved version of the old classic board game Othello.
- LPD-025 THE MISSION:** An excellent text adventure by Jim McBride.
- LPD-029 BIG TOP FUN:** A top quality educational program, three games based on circus acts. 1 meg.
- LPD-030 SHYMER:** A very nice adventure game for children. Based on the island of nursery the must sort out the rhymes that have become mixed up.
- LPD-037 ROCKET MATHS:** A game designed to aid children with their maths. Various levels of difficulty may be set.
- LPD-039 MAGIC FOREST II:** Version 1 was given away free with Amos. This program is far superior and continues the story set by version 1. 1 meg.
- LPD-041 RESCUE:** A 3D adventure in which you must solve a murder. You can click on objects and examine them for clues etc. Excellent game.
- LPD-042 X-STITCH:** Prints out your pictures in the form of a cross stitch pattern for embroidering.
- LPD-044 FORMULA 1 CHALLENGE:** A very comprehensive racing car game for one to four players.
- LPD-045 MUSIC BOX:** A music programme created with children in mind simply place the notes on the staves. There are a choice of instruments to use and also a selection of tunes already created.
- LPD-047 DIRTY CASH:** An excellent fruit machine game with all the normal features like hold, gamble nudge etc.
- LPD-052 LC24/200 FONTS:** Fonts to download to your 24 pin printer along with an editor so you can create your own.
- LPD-057 KIDDIES CLIP ART:** Lots of good quality clip art designed with children in mind. Can be used in your favourite graphics package.
- LPD-061 THE FINAL CHAPTER:** A 3D interactive graphic adventure. I did not get very far but the bit I did was quite impressive.
- LPD-065 POWER PLANNER & DIARY CHECKER:** A database in which you can store telephone numbers and addresses etc also a diary to help keep track of appointments
- LPD-067 CYADONIA (CYAD II):** The follow up to Cyad with improved graphics and even more devious puzzles. Very addictive.
- LPD-069 MAGICAL MIXUP:** This one is addictive. A type of jigsaw puzzle where a picture is broken up into pieces and you have to put it back together again. Lots of pictures and various levels to suit young and old.
- LPD-070 PAINTBOX:** A nice painting programme for children with 16 pictures to paint and the facility to draw your own.
- LPD-071 BATTLECARS:** An excellent car racing programme for 1 or 2 players use your money to buy specialist tyres, weapons etc before you start. Features split screen so players can keep tabs on each other.
- LPD-072 MONSTER ISLAND:** At last a simple role playing game for children.
- LPD-073 AMOS DATABASE:** An easy to use database ideal for keeping track of your CD/Record/Video collection etc. Full documentation is included on disk along with a sample file. An impressive database.
- LPD-074 SOUR GRAPES:** A 3D isometric game controlled by joystick. Collect grapes and make bottles of wine but watch out for the Kikkynacks who will do anything to stop you.
- LPD-075 VIDEO LAB:** The first Amos video titling programme that saves the expense of a genlock and associated software but still manages to do a pretty good job.
- LPD-077 POWERBASE V2.1:** A powerful database with lots of features and easy to use. A very professional looking programme that impressed me at first sight.
- LPD-079 MUSIC ENGINE:** This one is for Amos programmers it gives the ability to play MED, Octamed, NoiseTracker, GMC and sonix music from Amos without having to first convert it to ABK.
- LPD-081 POOLS PRO:** A very easy to use programme that will try to help you win those magic millions. You feed in the data and try and increase your chances of winning.

FLETCHER VIDEO FONTS

With six disks in each pack there are simply loads of various sized fonts some 8 colour fonts some 16 colour font brushes ideal for video titling or your favourite art package and only £15.00 per pack.

- FF-P1 FLETCHER COLOUR FONTS PACK (1)
FF-P2 FLETCHER COLOUR FONTS PACK (2)
FF-P3 FLETCHER COLOUR FONTS PACK (3)
FF-P4 FLETCHER COLOUR FONTS PACK (4)
FF-PA FLETCHER MONO FONTS PACK (1)

continued from page 146

This, and ignoring the really basic attempts, actually left us with three word processing programs:

Textengine, *Text Plus* and *Wordwright*.

All offer different levels of user control and sophistication; one of them could well be exactly what you need – without you having to spend a fortune on a commercial package. Read on and see...

TEXTENGINE V3.0

Digitz disk Util 277

First up is a fairly basic program from Nicholas Harvey. *Textengine* carries a £5 shareware fee, and there's no excuse not to register, since Nicholas lives in Surrey, not some far-flung corner of Guatemala.

Launching the program (from either Workbench or Shell) produces an attractive screen; a dark blue main area, with lighter blue menu bar

and a set of icons down the left hand side. *Textengine's* icons are a neat touch – they represent a number of common operations, such as loading and saving files, so that you are saved the bother of remembering which menu to

select in order to perform these functions.

On the menu bar is a copyright message, the version number of the program and a display telling you which printer driver you are using.

Unfortunately, this didn't seem to work on my machine – the program insisted on believing that I was using the generic driver whichever one was actually selected from

Workbench Preferences. Perhaps that's because I was running WB2.0?

The actual features available in the program are fairly limited – restricted to type style, wordwrap or not, word

count, cut and paste, centre line and a few 'prefs' options. Notice that I said "cut and paste" – there's no copy option available, for some unexplained

reason. (Many things go unexplained, as a matter of fact, since the documentation only runs to four pages.)

There are a few other anomalies

to the program: for example, the 'Tab' key simply produces a space character rather than a tab or a number of spaces (although importing a document seemed to translate tab characters into a string of spaces with no trouble).

The fact that the keys continued to auto-repeat for a short time after I had stopped pressing them was extremely annoying, especially since all navigation around the document has to be done with the cursor keys; clicking on a character with the mouse doesn't move the cursor to that point in the document.

The 'Centre line' option doesn't appear to work properly; every time it's issued it just seems to add a few more spaces to the beginning of the line. Also, it is sometimes impossible to add characters to the beginning of a line if it's already full of text – the words at the end don't wrap around to the next line. But the most serious complaint is that the program will let you load one file on top of another without warning you that you should save first; an omission which could well mean that you lose work by accident.

On the plus side, the program has a decent range of type effects: bold, underline, italics, superscript and the like.

Textengine can cope with 50K of text, which works out at about 8,500 words – which should be plenty for most users. Text scrolls rapidly, and there's no noticeable delay when adding words or lines to the beginning of a large document. When text is entered, it appears as black on white – this provides a nice contrast to the normal blue background (and if you don't like the colour scheme, a 'palette' Prefs requester is provided which allows you to change the appearance of all four colours used).

Printer control is at the mercy of your Prefs printer driver; and since *Textengine* wouldn't believe that I was using anything other than the generic driver, this meant that not all the text effects were available.

Printing out the test document produced some interesting effects: the en-dash translated to a character which made the printer go into subscript mode. And since there is no 'search and replace' facility available, I wasn't easily able to translate the characters into a standard dash. Still, it's a job which can be done by hand if necessary – and it will only be a problem for people who want to use *Textengine*

to edit files produced on another machine.

All in all, *Textengine* is probably not the best program to write your next novel on, but it's a perfectly reasonable application for the odd letter or memo, and should suit those who don't want to get too involved in the complexities of printer control codes and the like.

Program rating.....6/10

TEXT PLUS V3.0

PDSOft disk V261

Text Plus comes to us from German author Martin Stepler, who requests a £15 shareware fee. And if you like the program, you're sure to send the fee, since until you obtain your registered copy, a requester appears with incredibly annoying regularity, reminding you that the program isn't registered. I'm sure that many people pay up because of this, but it doesn't help when you're trying to decide whether or not you like the program – you find yourself starting to really hate it, regardless of how good it really is.

And *Text Plus* certainly is good: it's incredibly fully-featured, with just about every option that a word processor should have. It knocks spots off some of the commercial packages which cost well over twice its

registration fee, and in some areas *Text Plus* can even give commercial programs such as *Protext* a run for their money.

Launching *Text Plus* (from the CLI or by Showing All Icons and double-clicking if you're in Workbench 2.0 – there's no pretty icon) reveals a starkly black-and-white screen; no pretty colours here! (Although selecting a block of text – about which more later – highlights it in blue.)

The menus are large, to say the least: the Project menu, for instance, has 16 items, and most of the menus have at least a couple of sub-menus available.

The first thing that you should do is print out the documentation – which consists of a well-written 21 or so pages – and study it. This is really the only way to get a full appreciation of what the program can do – just playing with it doesn't give anything like a full flavour.

All of the standard features are present in the program – things like block copy, paste, delete and so on. But virtually everywhere there are extra little additions: under the Block menu, for instance, you can load,

continued on page 150

"Don't be put off by Text Plus' annoying This is a shareware requester!"

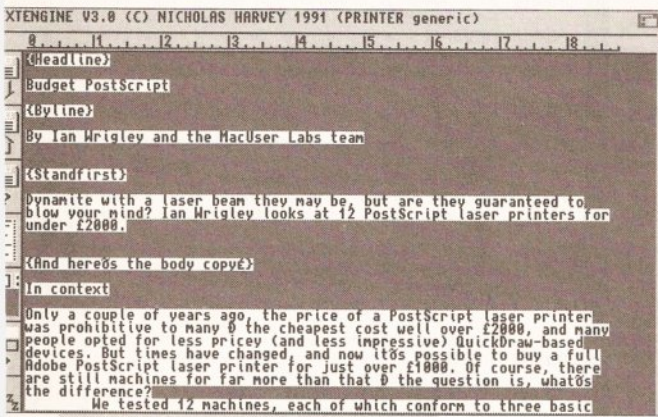

Textengine is the simplest of the three programs, but it does have some nice touches – such as icons on the left of the screen

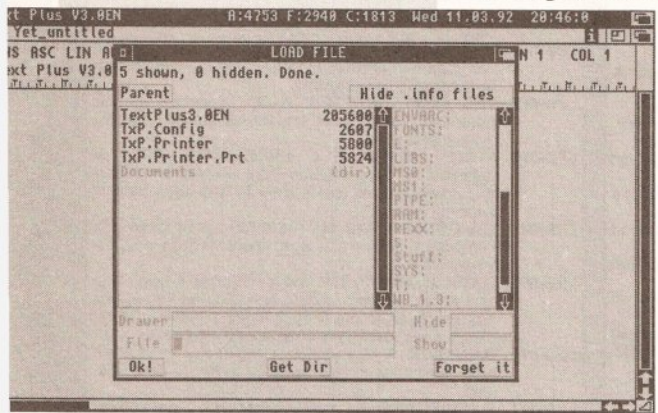

Text Plus has one of the best 'Load file' requesters that I've seen in a long time. Other programmers, please note!

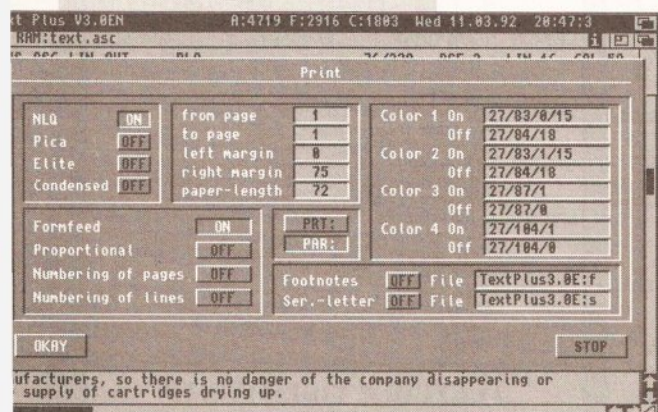

When 'Print' is selected from *Text Plus'* menu, this requester appears. There are more options on this requester than some programs have in total!

Crazy Joe's

Amiga Public Domain Software

PD GAMES! PD GAMES! PD GAMES!

- 117 MONOPOLY (NP) popular old board game
 135 CARD & BOARD GAMES (NP) Cluedo + solitaire games
 195 ELECTRIC TRAIN SET (NP) for when the kids are asleep!
 315 RETURN TO EARTH (P) "Elite" type space trading game
 496 HOLY GRAIL* (NP) excellent text adventure
 648 STAR TREK (USE) (2)* (NP) graphic adventures
 680 LEARN & PLAY (2) (NP) maths, words and colouring for kids.
 727 RICHTER'S STAR TREK (2) (P) best version to date
 766 TREASURE HUNT (NP) pirate treasure map game for kids
 957 PIPELINE (P) assemble your pipe to keep the oil flowing
 962 DRIP! (P) rust the pipes, avoid the nasties arcade game
 987 SNAKEPIT (P) nice "Caterpillar" clone
 991 JEOPARD* (P) 2 player game of world conquest
 1004 GAMES DISK 9 (P) including Tetrix Metalical
 1113 WET BEAVER GAMES (P) funny demo plus Ping Pong
 1230 DRAGON CAVE (P) Sokoban type game with excellent gfx
 1520 BALLOONACY* (P) bomb the buildings & land your balloon
 1539 MEGABALL (P) the best breakout game around!
 1544 SEVEN TILES (NP) futuristic football game like Speedball
 1577 FRUIT MACHINE* (NP) pirate fruit machine simulator!
 1584 MISSILE COMMAND (NP) stop incoming missiles
 1591 QUIZ MASTER* (NP) excellent trivia game
 1670 WHEEL OF FORTUNE (P) based on the TV show
 1711 MENTAL IMAGE GAMES DISK (NP) 3 brill games!
 1715 FRANTIC FREDDIE (NP) C64 favourite platforms & ladders
 1720 CABARET ASTEROIDS (NP) faithful version of the classic
 1746 WORD GAMES VOLUME 1* (P) exercise the grey matter
 1747 WORD GAMES VOLUME 2* (P) and not the joystick!
 1748 STRATEGY GAMES* (NP) serious stuff including Sea Lance
 1749 TRUCKIN' (2) (2D)(P) run your own trucking company
 1832 POM POM GUNNER* (P) WW2 arcade action - our No. 1 game
 1879 SEA LANCE* (P) Trident submarine simulation
 1882 SIMPSONS GAME (P) help Bart in this S.E.U.C.K. game
 1883 BIONIX II* (P) never-ending shoot'em up!
 1905 J NICKLAUS COURSES 1 data disk only!
 1916 AIR ACE II (P) excelent WW1 shoot'em up
 1926 NAPOLEONIC WARFARE SYSTEM* (P) war game empire
 2011 TWINTRIS* (NP) 1 or 2 player Tetris clone - very good!
 2013 ZEUS (P) simple but addictive puzzle game
 2016 DOWNHILL CHALLENGE (NP) fun on the ski slopes
 2018 WIZZY'S QUEST* (NP) wizard fun! excellent game!
 2049 MATHS DRILL (NP) maths exerciser for all ages
 2050 INSIDERS CLUB* (NP) good stock exchange simulation
 2051 ATIC ATAC* (NP) explore and collect arcade game
 2052 SHAPES (P) addictive puzzle fun!
 2057 BATTLE PONG* (NP) 1 or 2 player arcade classic
 2155 GHOST SHIP (NP) 3D arcade adventure
 2167 LLAMATRON (NP) Jeff Minter classic!
 2177 J NICKLAUS COURSES 2 data disk only!
 2178 SKY FLYER excellent new SEUCK game!
 2183 REVENGE OF MUTANT CAMELS Minter's back!
 2184 TOMCAT great shoot'em up!
 2185 QUIK & SILVA (*NP) smashing platform game
 2187 SKATE TRIBE (NP) skateboard frenzy!
 2188 CARD SHARP (P) solitaire collection
 2192 STORYLAND 2 (P) excellent kids adventure
 2196 ASSASSINS 14 (NP) Columns/China Challenge II
 2198 21 GAMES all A500+ compatible!

USEFUL SOFTWARE

- 81 UEDIT PROCESSOR (NP) 1663 DYNAMITE BRUSH
 119 AMIGA MCAD (P) FONTS (P)
 410 DPAINT CARTOON BRUSHES 1858 202 UTILITIES (NP)
 442 DPAINT FONTS DISK (4) (P) 1878 TEXTPLUS WORD PROC. (P)
 458 HAM RADIO UTILITIES (5) (NP) 1880 DCOPI & UTILITIES (NP)
 571 JAZZBENCH (NP) 1884 EQUINOX INTRO WRITER*(NP)
 580 DOPE INTRO MAKER (NP) 1886 MED V3.10 (NP)
 591 BUSINESS CARD MAKER (P) 1893 DICE V2.06A (NP)
 632 MSH (MESSYDOS) (NP) 1896 DESK BENCH (3) (NP)
 642 C MANUAL 1906 PAGESETTER CLIP ART
 661 PROGRAMMING (8) (P)
 DISK 1 (NP) 1914 SLIDESHOW CONSTRUC. (NP)
 682 SOUND APPS. (2) (NP) 1951 KING JAMES BIBLE (3) (P)
 684 VIDEO APPLICATIONS (2) (P) 1954 CELTICS DEMO MAKER (NP)
 901 THE COMMS DISK (NP) 1987 QUICKBENCH* (NP)
 1022 AMOS UPDATE 1.32 (P) 1990 NIGHTFLYERS UTILS. IV (NP)
 1095 DATABASE WORKSHOP 2004 TURBO IMPLODER V4.0 (P)
 (2) (P) 2012 DRAW MAP V2.3D (P)
 1097 DPAINT CLIP ART (2) (P) 2058 VECTOR BALL EDITOR* (NP)
 1099 VIDEO GRAPHICS (4) 2168 MESSYSID
 1117 GENEALOGY* (P) 2174 ANTI-VIRUS V3.14 (P)
 1228 ST EMULATOR (GERM.) (NP) 2176 KIDS PAINT (P)
 1273 C-LIGHT (P) 2180 TEXT ENGINE (P)
 1450 NEW SUPERKILLERS (P) 2181 AMIGA FOX DTP (P)
 1451 ELECTROCAD V1.4 2182 WINDOWS BENCH (NP)
 DEMO (P) 2186 PERM CHECK (P)
 1452 AMIBASE (P) 2189 PRINT STUDIO V1.25 (P)
 1536 NORTH C (PACKED) 2190 PICTURE CONVERTORS
 1537 NORTH C (UNPACKED) (2) PACK
 1545 SPECTRAPAINT V3.0 2195 BBASE 2 (P)
 1550 FLEXY-BASE V2.0 (NP) 2197 UNICOPY V1.0 (P)
 1569 LANGUAGE TUTOR (NP) 2200 LITTLE BENCH (PLUS ONLY)
 1606 DATABASE MASTER 2.0 (NP) 2201 PC EMULATOR DEMO (P)
 1629 SPECTRUM EMULATOR (NP) 2202 TARTO 2 (2) (NP)

MUSIC DISKS

- 61 J M JARRE - DEFINITIVE (P)
 407 CD PLAYER DEMO* (P)
 713 FLASHI - QUEEN (2) (P)
 724 TECHNOTRONIC REMIX (P)
 746 CRUSADERS BACTERIA (P)
 941 S/TRACKER JUKEBOX (NP)
 976 SCOPEX BEAST SONIX (NP)
 1026 DIGITAL CONCERT VI(NP)
 1292 CRUSADERS: GENESIS (NP)
 1685 DEPECHE MODE MUSIC (P)
 1694 ART OF MED MUSIC DISK
 1695 SEAL CRAZY REMIX* (NP)
 1713 SPACED OUT VOLUME 1
 1714 SPACED OUT VOLUME 2 (P)
 1716 I THINK WE'RE ALONE (P)
 1717 EVERYBODY DANCE
 NOW (P)
 1718 DOING THE DO (P)
 1755 AMAZING TUNES 2 (3)* (NP)
 1993 CATS SING KYLIE! (NP)
 2006 SAMPLE SENSATIONS* (NP)
 2008 MOVE ANY MOUNTAIN* (P)
 2059 VIVALDI 4 SEASONS (2)*(P)
 2159 CHARLY (P)
 2160 WHAT CAN U DO FOR
 ME? (P)
 2199 SHAMEN REMIX (P)

SLIDESHOWS

- 282 FORGOTTEN REALMS (P)
 617 NEIGHBOURS SLIDESHOW
 725 DIGGY PIGGIES (2) (NP)
 742 MADONNA SLIDESHOW (P)
 814 VIZ SLIDESHOW (P)
 891 CREEPSHOW (P)
 899 MADONNA S/SHOW 2 (2)* (NP)
 968 GORZONE S/SHOW (X) (P)
 1051 TOTAL RECALL S/SHOW (NP)
 1085 COMIC SLIDESHOW (X) (NP)
 1103 SPORTS ILLUSTR. GIRLS (P)
 1263 RICHTER S/SHOW (S)
 (2D) (P)
 1277 DIVINE VISIONS (2)*(NP)
 1279 FORGOTTEN REALMS '90 (P)
 1708 INVISIBLE WORLD (P)
 1719 YABBA DABBA CARTOONS (P)
 1781 REFLECTIONS (NP)
 1835 NIGHTBREED
 SLIDESHOW (P)
 1876 REFLECTIONS 6 (P)
 1901 LEEDS UNITED S/SHOW (P)
 1919 DEBBIE HARRY (2) (2D)(NP)
 1984 TERMINATOR S/SHOW (NP)
 1986 ALIENS SLIDESHOW (NP)
 1991 AQUARIUS IMAGES (P)
 2179 MAG. FIELDS ART DISK

BLANK DISKS

Call for latest prices!

DISK BOXES

- 10 capacity99p
 40 capacity£4.99
 80 capacity£6.99
 100 capacity£7.99

**MICROBOTICS M501
 512K UPGRADE
 With clock, 16 Chip
 A500/A500 Plus
 £25.99**

**A500 PLUS
 1MB UPGRADE
 Takes A500 Plus
 to 2 Meg!
 £45.99**

ACCESSORIES

- MASTERSOUND SAMPLER.....£34.99
 KEYBOARD COVER£2.99
 PRINTER COVER£4.99
 MONITOR DUST COVER£4.99
 MOUSE MAT£2.99
 2 PIECE PRINTER STAND£4.99
 CENTRONICS PRINTER CABLE ..£6.99
 MODULATOR EXT'N CABLE ...£12.99
 ACTION REPLAY III (PLUS OK).....£56.99
 NAKSHA MOUSE.....£26.99
 ROCTEC DISK DRIVE.....£59.99
 CUMANA DISK DRIVE.....£59.99
 1000 DISK LABELS£12.99
 STEREO AUDIO LEADS.....£3.99
 DRIVE CLEANING KIT.....£1.99
 FURRY MOUSE COVER£3.99
 PRINTER RIBBONS.....VARIOUS

**We stock
 Deja Vu
 Licenceware
 Full details on
 request**

HOW TO ORDER

Please send cheque/p.o. payable to
 "Crazy Joe's" to:
**CRAZY JOE'S
 DEPT. AS13
 145 EFFINGHAM STREET
 ROTHERHAM
 S.YORKSHIRE S65 1BL**

**CREDIT CARD ORDERS
 (0709) 829286**

**FAX YOUR ORDER ON
 (0709) 878308**

DISK PRICES

1 to 9 disks
£1.25 each
 10 or more
99p each

POSTAGE
 INCLUDED IN PRICE IN UK
 Europe, Eire...Add £2.50
 Rest of world...Add £4.00
 Overseas orders sent air mail
Payment in Sterling please!

Send a stamped addressed envelope
 for our FREE list!
 Loads of titles to choose from!

VISIT OUR SHOP

We stock commercial games,
 accessories, blank disks, etc.
**Open Monday to Saturday
 9.30am - 5.30pm
 CALLERS WELCOME**

KEY TO SYMBOLS USED

(2) = NUMBER OF DISKS
 * = 1Mb ** = 2Mb, ETC.
 (2D) = 2 DRIVES (X) = ADULTS ONLY
 (P) = A500 PLUS COMPATIBLE
 (NP) = NOT A500 PLUS COMPATIBLE

DEMOS AND ANIMATIONS

- 747 POPEYE MEETS THE BEACHBOYS (P) very funny!
 773 SHARK ANIMATION* (NP) deadly ray-tracing!
 825 BUBBRAIN 1 (S) (X) (NP) great 2 disk demo + naughty bits!
 895 A TRIP TO MARS (NP) demo with a difference
 906 MADONNA CARTOON ANIM* (NP) short digitised animation
 935 MADONNA: HANKY PANKY (P) excellent Madonna sample
 1033 AT THE MOVIES** (NP) loves of a squirrel?
 1188 FILLET THE FISH (P) funny cartoon
 1229 BUBBRAIN 2 (NP) good as the first one? you judge!
 1238 EVIL DEAD DEMO (X) * (NP) get them before they get you!
 1453 MORE AEROTOONS* (P) 2 Schwartz classics
 1540 AMY. Vs. WALKER ANIM* (NP) Eric Schwartz at his best!
 1541 BATMAN ANIMATION* (P) funny Schwartz animation
 1552 MAGICIAN ANIMATION 2* (P) simply magic!
 1560 PHENOMENA ENIGMA* (P) superb gfx and music
 1628 DO THE BART, MAN* (NP) a must for all Simpsons fans!
 1701 TRON ANIMATION (2) * (P) based on the film
 1707 DECAY: SIMPSONS DEMO* (P) should appeal to everyone
 1753 LIFE OF BRIAN (2) (P) sample from the film
 1841 ANIT LEMMIN' DEMO (2) (NP)** for Lemmings fans with 2 Meg
 1850 THE WALL (6) (2D) (NP)* mammoth Pink Floyd six disk!
 1856 BETTY BOO ANIM/SLIDESHOW (P) doing the Amiga
 1885 ROBOCOP ANIMATION * (P) digitised from the film
 1900 SILENTS: ICE DEMO (NP) superb music and graphics
 1902 VIRTUAL WORLD* (NP) 3D filled vector demo
 1943 WINDSURFER ANIMATION (2) (P)* very good
 1947 MR POTATO HEAD (P)* funny cartoon antics
 1948 MR POTATO HEAD CHIPS ARE UP! (P)* more adventure
 1956 CREATURE COMFORTS DEMO (NP) from the TV adverts
 1982 3D PINBALL ANIMATION* (P) beautiful ray-tracing
 2193 4 STROKE ENGINE ANIM (P) technical animation

PD GAMES PACKS

**GAMES PACK 1
 (Some 1Mb - not A500+)
 37 titles including
 Invaders, Tetris, Asteroids, Missile
 Command and many more!
 8 DISK SET ONLY £7.95!**

**GAMES PACK 2
 (1Mb only - not A500+)
 Arcadia, Crossfire, Twintris,
 Balloonacy, Wizzy's Quest.
 5 DISK SET ONLY £4.95!**

**GAMES PACK 3
 (Any Amiga - A500+ compatible)
 Dragon Cave, Drip!, Zeus,
 Megaball, Air Ace II
 5 DISK SET ONLY £4.95!**

**GAMES PACK 4
 (Not A500+ compatible)
 Card & Board games, Shapes, Frantic
 Freddie, Serene II, Mental Image Games
 5 DISKS SET ONLY £4.95!**

continued from page 148

save and even print just the selected block.

Navigation around the text is either by cursor keys or by scroll bars – both vertical and horizontal. Clicking anywhere on the screen moves the text to that point – something which should be standard but which, in *Textengine*, is not implemented. However, this is where I found a major annoyance with the

different style when output to the printer. So, for example, you can edit the printer config file so that any text in colour 3 will be output as superscript, any text in colour 4 as double-width and so on. (Of course, if you have a colour printer then you can define text in the different colours to actually be coloured.)

Because the printer control codes sent when you define text to be bold, italic or whatever can be altered, you aren't restricted to just

Selecting 'Print' produces a requester which once again reminded me of the Macintosh (it's fairly clear that Martin has been heavily influenced by the Apple Mac when designing his program). Things such as the text width, style (NLQ, Pica, Elite or Condensed), the page length, which pages to print, the name of the mail-merge file to use (if you want to use one) and so on are all selectable before printing is started – yet again, a feature which

say, is a little selective about just which commands it will undo), the fact that up to ten windows can be open on-screen at once, and so on and so on.

If you want a professional, fully-featured word processor but don't want to spend a fortune, take a look at *Text Plus*; don't be put off by the annoying "This program is shareware" requester – registering will get rid of it.

Program rating.....9/10

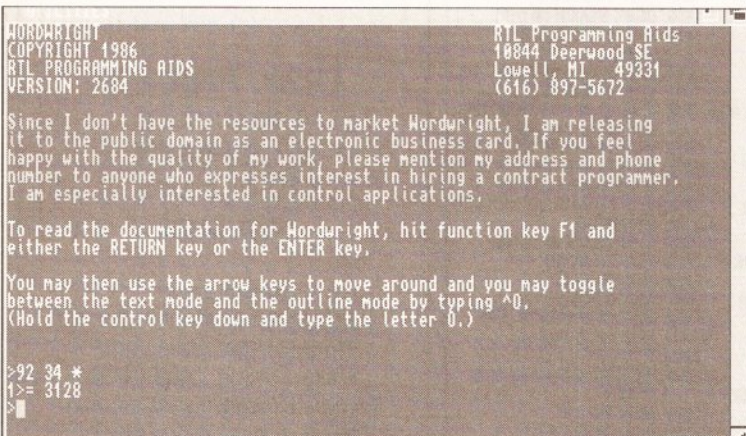

Wordwright's utilities screen gives access to things like the built-in calculator; notice the Reverse Polish Notation method of entering calculations

program: if you click on a character and move the mouse, *Text Plus* assumes that you're trying to define a block. Now, clicking and dragging is a great way to mark blocks – and is, indeed, the standard method on computers such as the Mac. But I found that the amount of movement required to start the block marking procedure was so minuscule that I kept doing it by mistake – which meant that I was forever having to select 'Delete mark' from the Block menu. This is a real pain; as someone used to navigating documents with the mouse, I found myself getting more and more frustrated. Please, Martin – fix this!

The program is configured using two separate, ASCII files – which *Text Plus* itself can, of course, edit. (In fact, the program can save files as ASCII, ANSI or in its own format.) You are supplied with default config files, including a printer file for Epson-compatible devices, and both are well commented so you can easily customise them to your own requirements. The general configuration file is the only one which might cause some problems – the comments are in German! However, most options are easily worked out, and you can resolve any queries with a little trial-and-error experimentation.

Only three different type styles are available from the 'Styles' menu: Bold, Underlined and Italic. However, type can also be displayed in four different colours; and each of these colours can be set to produce a

the three styles in the Style menu: if, for instance, you never use underline but often want text to be double-width, just edit the 'Underline' codes in the config file to produce double-width instead. The printer config file also includes an editable translation table, so odd foreign characters can be printed out by converting a keyboard-generatable character to the foreign character required during printout.

more programmers should incorporate.

It is, in fact, the relatively minor features which really made me think that this program is truly professional: the ability to automatically insert the date into a document, an auto-save feature, a menu-bar clock which also tells you how much free memory is available, an 'Undo' feature (which, I should

Instructions to Wordwright such as the amount of space to leave in the left-hand margin and the number of lines per page are entered into the document; the instructions appears in yellow (but you can't see that...)

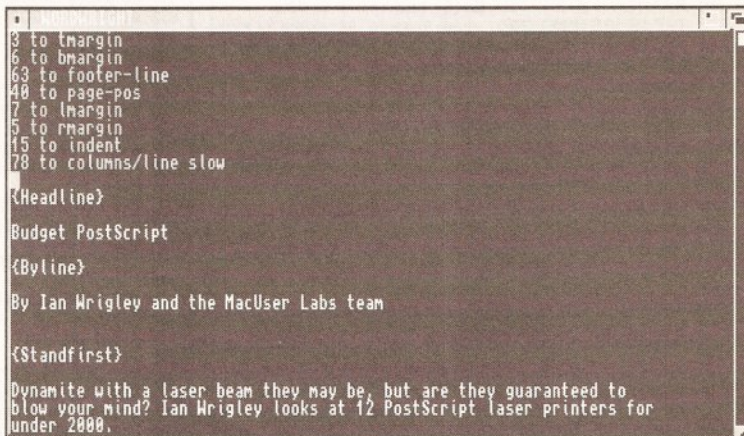

WORDWRIGHT
PS Soft disk V28

Software Expressions disk V084 *Wordwright*, by an American who goes under the name 'RTL Programming Aids', is unique in a number of ways – not least the fact that it's public domain, rather than shareware. According to the programmer, "since I don't have the resources to market *Wordwright*, I am releasing it to the public domain as an electronic business card." All he (or she) asks is that you consider RTL if you are considering hiring a contract programmer (although presumably this only applies in the States...)

Because the program is American in origin, it only takes up the NTSC-sized portion of the screen; the text window is resizable, but only down to a little over two-thirds of the screen depth. Shame.

Wordwright is unique in other ways, too. It is, according to the documentation, "a collection of four integrated packages, a word processor, an outliner, mail merge, and a set of general purpose utilities." The "general purpose utilities" come in the form of a separate command window, accessed by hitting the [Esc] key.

The command window allows you to do things like produce a memory dump, access any DOS commands, set up the printer control codes and use the built-in calculator. This

| At a glance guide to cheap word processing | | | |
|--------------------------------------------|------------|-----------|------------|
| | Textengine | Text Plus | Wordwright |
| TEXT EDITING | | | |
| Multiple documents | No | Yes (10) | No |
| Timed autosave | No | Yes | No |
| DOCUMENT FORMATTING | | | |
| Ruler | Yes | Yes | No |
| Headers/footers | No | No | Yes |
| Footnotes | No | Yes | No |
| Page numbering | No | Yes | Yes |
| Line numbering | No | Yes | No |
| PRINTING | | | |
| Customise control codes | No | Yes | Yes |
| Character translation | No | Yes | No |
| EXTRAS | | | |
| Outliner | No | No | Yes |
| Table of contents generator | No | No | Yes |
| Access to DOS commands | No | No | Yes |
| On-line help | No | Yes | Yes |
| Macros | Yes | Yes | Yes |
| PRICE | | | |
| Shareware fee | £5 | £15 | Free |

continued on page 153

PENTIRE PD

10A HAG HILL LANE, TAPLOW, MAIDENHEAD,
BERKS SL6 0JH (0628) 666641

● 99p per disk ● 5 or more 85p each
P&P 90p per order. European add 25p per disk
Worldwide add 50p per disk

THE TOP 50 PD CHART AS COMPILED BY PENTIRE PD: OUR BEST SELLING UTILITIES

| | | |
|------------------------------|-------------------------------|------------------------|
| 1. Jazzbench | 18. Spectrapaint | 33. Lex Check |
| 2. Cli Tutorial | 19. Dope Intro Maker | 34. NoiseMon |
| 3. R.I.M | 20. Messysid | 35. C-Light II (2) |
| 4. Textplus | 21. Ghost Writer | 36. Words (2) |
| 5. Icon Mania | 22. R.S.I Vector Editor | 37. Sysinfo |
| 6. Quickbench | 23. Slideshow Const Kit | 38. Hack Pack (2) |
| 7. C64 Emulator (2) | 24. 100 Utilities | 39. Designer Disk (3) |
| 8. Menu Maker | 25. Clip Art (4) | 40. T.V. Graphics (2) |
| 9. Soundtracker Utilities | 26. Text Engine | 41. Bootblock III |
| 10. Flexibase | 27. Talking Colouring Book | 42. Drums & Pipes |
| 11. R.S.I Demo Maker | 28. Darkstar Vol 2 | 43. Invoice Printer |
| 12. Tetra Copy | 29. R.S.I. Font Editor | 44. P.D. Comms (2) |
| 13. UEdit | 30. ESA Utilities | 45. Coders Club (6) |
| 14. Learn-Play (2) | 31. Spectrum Emulator | 46. Pascal |
| 15. Quick Copy | 32. Ham Lab | 47. Quickstart III (2) |
| 16. Music Creator | | 48. Hard Drive Utils |
| 17. Visicalc | | 49. ARP |
| | | 50. Multi-fax |

1000 titles listed on
our catalogue inc.
a range of glamour
disks

We also stock
Fred Fish and T-Bag
collections

CATALOGUE DISK 75P
CONSTANTLY UPDATED

BLANK DISKS
£4.99 FOR 10 INC LABELS

ALL DISKS
STILL ONLY
99p EACH

Anglia PD

(*) = 1 Meg

(P) = Works on A500 and A500 Plus

Catalogue Disk (P)
only 70p - Includes a
super Scenery
Generator!

DESKTOP VIDEO PACK (P) 4 DISKS £3.96

Outstanding collection for video producers, includes Rolling Credits, Slideshow, Video Backgrounds, Special Effects, Pattern Generator and more!!!

HOME MANAGEMENT PACK 3 DISKS (P) £2.97

Calendar, Mortgage, Spreadsheet, Grammar, Mileage, World Time, Budget, Chequebook, Database, Typing Tutor, Typewriter, Grocery, List Maker, Home Banking.

CLIPART PACKS 1, 2 OR 3

EACH PACK = 5 DISKS £4.95
3 different packs of 5 disks, all full of the very best clipart for DPaint etc. (P)

FONT PACK 1 OR 2 EACH PACK = 5 DISKS \$ £4.95

2 different packs of 5 disks, pack 1 contains: Publisher fonts, various fonts, fonts disk 2, Cosmopolitan fonts, large fonts (loads of great fonts for DPaint etc.) (P)

ANGLIA COLOURFONTS (P) 5 DISKS £4.95

5 disks full of original colour fonts produced here at Anglia. These are 16 colour fonts - not cut and pasted! They are produced in the same way as the chisel font supplied with DPaint and the Kara range of commercial fonts! They are typed straight in and work with DPaint and TV Text.

UTILITIES PACKS 1, 2, 3 OR 4

EACH PACK = 5 DISKS £4.95
4 different packs with all the utilities you will ever need! Pack 1 contains: Chet Solace disk (26 utilities), Diskmaster v3.0, Darkstar Utilities 2, 3 & 4.

EDUCATION PACK 1 (P) 5 DISKS £4.95

German, Globe, Geotime, Drawmap, Evolution, Clouds, Formula, Airfoil, Gravity Sim, Weather, Wave Maker, World Data Bank and more!!! (This pack is one of our best sellers and is incredible value for money).

ASTRONOMY PACK (P) 4 DISKS £3.96

Star Chart, Amigazer, Deepsky, Gravity Well, Grav Sim, Orbit, Planet.

PRINTER USER PACK (P) 4 DISKS £3.96

Essential for all printer owners! Includes, Label Designer, Label Printer, Printer Driver Generator, Print Studio, Plus More!

FRACTALS PACK (*) (P) 4 DISKS £3.96

If you want to explore fractals then here's everything you'll need! : CPlot - SMan - Mandelbrot - Polysys - CPM - ZPlot - Fractal Lab - Mandamin - Mandelblitz - Polysysexamples - Julia - FCS - Mandelmountains

PUZZLES PACK II (*) (P) 2 DISKS £1.98

Superb new pack for fans of crossword type puzzles, includes: Wordsearch - Reader - Wordhat - Wordgame - Crosswords - CWP - Scrazzle - Dizearch

SIMULATIONS PACK (*) (P) 5 DISKS £4.95

All of the best PD simulations in one pack! Metro - Be a city planner, King Oil - you are J.R.! - Nuke - Nuclear arms race, Impetium Romanum - Grab ancient Mediterranean power, Sealance - Save the world with your nuclear sub, Truckin - Run your own truckin company, DC10 - Learn to fly a DC10 jet, Lore of Conquest - Two players: take over the galaxy! Insiders Club - Superb stockmarket simulation, Air Warrior - Take you pick from a huge range of aircraft with this excellent flight simulator!

EASY BUSINESS PACK (P) 5 DISKS £4.95

All programs included are powerful but easy! Includes: Text Engine V3 (The very latest wordprocessor), Spread V1 (Spreadsheet), QBase (Simple Database), BBase II (Good Database), Bank (Great accounts package), X-Spell (Spell checker), Print Studio, Business card maker.

INTERMEDIATE BUSINESS PACK (P) 5 DISKS £4.95

Wordwright (Wordprocessor including Mail Merge and Macros!), S-Calc (Good Spreadsheet), Amibase Pro 2 (Stunning PD Database - New!), Amigaspell (Spell Checker), LS Label (Infinite label control), Messysid V2 (Amiga File Management + PC File Transfer), Amiga Fox (Desktop Publishing)

DISK EXPERT PACK (P) 5 DISKS £4.95

If you want to learn more about your Amiga, get this pack! You'll be a disk expert in no time! Includes Power Packer (Easy file compactor), Sid (Brilliant CLI Replacement Tool!), Iconmania (Change any icon in seconds), Fixdisk, Viruschecker V5.3, D-Copy (Copies, Repairs, Formats and more), CLI Tutorial (All you need to know) and 202 other utilities!!!

"C" PROGRAMMERS PACK (P) 6 DISKS £5.94

A complete "C" language and superb instruction manual provide all you need to learn the "C" language, includes North C (2 disks) and the C Manual (4 disks)

MED V3.2 MUSIC PACK (P) 4 DISKS £3.90

MED is widely recognised as the best music package, PD or otherwise! This pack contains V3.2, the latest version complete with loads of digital samples, a disk full of MED music scores and some great MED music to load and play! Listen to what your machine is capable of!

500+ CLASSIC GAMES PACK (P) 5 DISKS £4.95

All of the best original arcade games which work on all Amigas! Includes: Missile Command, Scramble, Space Invaders, Pac Man, Asteroids and loads more!

CARD & BOARD GAMES 2 (P) 4 DISKS £3.96

Includes Chess, Sorry!, Cluedo, Patience, Draughts, Othello, Dominoes, Mastermind, Pontoon and many others!

HARD DISK USERS PACK 3 DISKS £2.97

Easy Backup, Mr Backup, DSD Park, Kwick Backup, Click Dos II, Fix Disk, FMS Disk, Sectorama, Disk Perf, AHDM (A hard disk menu)

Please note all pack disks may be bought singly at 99p!

SINGLE DISKS AT ONLY 99p!

BUSINESS

B301 Bank (Excellent home banking package) (P)
B303 Flexibase (Good DBase with form designer) (P)
B321 Amigafax (English Desk Top Publishing) (P)
B322 600 Business Letters (Superb! - Ready to use) (P)
B324 Q Base (The perfect database for beginners) (P)
B314 Business Card Maker (Design Your Own)

B330 Amicash (P) (Superb new bank account manager)
B331 QED (P) (Very good wordprocessor for beginners)
B332 U-Edit V2.6H (P) (Latest and greatest word pro)

B333 Amibase Professional 2 (P) (Now PD! - Super database)
B334 (P) Appointments (never miss one! Let your Amiga behind you)

B336 (P) Calendar Maker (easy to make + print - includes excellent calculator!)

B337 (P) Findex (an easy database with good search facilities).

B338 (P) Calc V1.2 (very nice spreadsheet with enough features for anyone)

B327 (P) Text Engine V3 (great looking wordprocessor, easy yet powerful)

UTILITIES

U402 Master Virus Killer v2.1 (The best Virus Killer)
U413 Sid v1.6 (makes you a master of CLI) (P)
U416 Cli Tutorial (Learn all about it) (P)
U427 Demolisher Utilities (over 200 utilities on one disk) (P)
U437 D-Copy (P) (As good as X-Copy)
U471 X Copy III (PD version of commercial prog: Save £30!!)
U478 Typing Tutor (New! Great features) (P)
U494 Pascal (2 disks - brilliant language) (P)
U495 Viruschecker V5.3 (P) (The latest - For the plus too!)
U496 Messysid V2 (P) (Reads and writes PC disks)
U497 AS00+ Utilities (P) (For the AS00+ only!)
U498 TurboTile (P) (Add subtitles to your videos!)
U499 S-Movie (P) (Smooth scrolling video titler)
U4004 (P) Pools Predictor (significantly improves your chances)
U4005 (P) Turbo Imploder (squeeze loads more onto a disk)
U4006 (P) Fancy disk label designer (the best around, in colour too!)

U4007 (P) Disk Optimiser (brilliantly simple! Any disk loads up to 15 times faster)

GAMES - (=IMEG)

G6012 Backgammon (P) (Great version of a great game)
G6013 Chess Tutor (P) (improve your skill) includes a full chess game!

G6014 Ultimate Card Games (P) (Cribbage, Hearts, Bluemoon, Patience and Solitaire)

G6015 Super Skoda Challenge (P) (New car race game)
G6017 Star Trek Next Generation (P) (Strategy Game)
G6018 Dominos and Connect 4 (P) (Good versions of the originals)

G6019 AS00+ Games (P) (21 Games for the Plus!)
G6021 (P) Tanx (great fun! get it now - you won't be disappointed)

G6022 (P) Cluedo (100% accurate version of the board game)
G6023 (P) American Football Simulator (very addictive)
G6077 Amigoids (The best Asteroids Game) (P)
G625 Drip! (*) (You must get this classic game!) (P)
G624 Blizzard (*) (PD's best shoot em up) (P)
G689 Pom Pom Gunner V2 (Latest - New levels) (P)

CHILDRENS

C701 Learn + Play (2 disks - super education for 4-10yrs) (P)
C704 Simon Says/Space Maths (P)
C705 Treasure Island X marks the spot - with speech!
C706 Snakes + Ladders (Classic board game fun)
C707 Pair It (*) (Match the cards - great fun!) (P)
C708 Crossfire (*) (Hectic arcade game) (P)
C709 Pixie Kingdom (2 disks - save the pixies) (P)
C710 Number Fumbler (sliding block puzzle) (P)
C712 Colour Pad (New colouring book for youngsters) (P)
C713 Peters Circus (P) (Lots of fun platform game)
C714 Storyland II (Brilliant kids game)

C715 (P) Composer (simply superb music maker for 12yrs +)
C716 (P) Snake in the Grass (great game for under 12s)
C717 (P) Frogger! (frantic frog fun for under 10s)
C718 (P) Centipede (wonderful graphics, brilliant game for ages 8 to adult!)

WIRRAL P.D.

WIRRAL P.D., PO BOX 4, BIRKENHEAD,
MERSEYSIDE L43 4FW Tel: 051 651 0646

THE BEST OF AMIGA PUBLIC DOMAIN AND SHAREWARE

MEGA MUSIC

M065 GUNS 'N' ROSES superb*
M061 TIFFANY I think w're alone now (A+)
M066 MADONNA Vogue + Justify my love
M020 KAKTUS + MAHONEY 2 Disk set of fantastic music (2) (A+)
M026 LAST TRAIN TO TRANSCENTRAL
M033 M.C. HAMMER can't touch this * (A+)
M009 VANNILIA ICE ice ice baby! Excellent * (2) (A+)
M062 CHARLY great rave track (A+)
M049 VIVALDI THE FOUR SEASONS classic Stuff (2) (A+)
M063 SPACED OUT VOL. 2 (A+)
M034 FASHION DAVID BOWIE
M028 PET SHOP BOYS it's a sin + others (A+)
M019 THE POWER REMIX by Snap
M010 AMIGA CHART 5 great sampled music

G064 BALLOONACY bomb all the buildings to land your balloon (+)

UTILITIES

U066 ASSASSINS BOOT UTILS
U009 SID directory util great
U017 JAZZ BENCH workbench alternative
U001 COMPLETE C MANUAL (4 disks)
U070 DOPE INTRO MAKER
U003 LIST MAKER make lists?
U080 MESSY SID messy dos with sid (A+)
U050 SPECTRUM EMULATOR plus util
U075 DATABASE MANAGER (A+)
U021 CLIP ART (4 disks) (A+)
U004 FONTS AND SURFACES great for dpaint (A+)
U071 ELECTROCAD circuit board designer (A+)
U077 AMIGA ADDRESS BOOK easy to use address database

GAMES

G027 WET BEAVER excellent ping pong and sound fx (A+)
G008 DRIP very addictive painter game* (A+)
G018 BLAST shoot em up
G001 STAR TREK (Richter) the best (A+) D
G042 ZEUS great puzznic clone very addictive (A+)
G048 GOLDEN FLEECE classic text adventure (A+)
G021 AMIGOLDS plus tanks, rollerpede and more
G056 COMPILATION 7 card games and more
G022 WHEEL OF FORTUNE up to 3 players family fun (A+)
G009 PARANOID breakout clone

DEMOS + SLIDESHOWS

D008 PHENOMENA ENIGMA the very best demo around * (A+)
D041 THE INVISIBLE WORLD S/Show fantastic pictures Get it! (A+)
D010 THE VIZ SLIDESHOW (A+)
D043 MILLER LITE AD...he ain't heavy (A+)
D044 MORE AEROTOONS (A+)
D051 YABBA DABBA DO SLIDESHOW..Fred, Wilmer and friends (A+)
D001 ANNIE JONES SLIDESHOW (neighbours) (A+)
D021 FILLET THE FISH very funny animation (A+)

(A+) Denotes A500+ compatibles

THESE ARE JUST A FEW OF THE MANY DISKS IN OUR LIBRARY

* = 1 Meg () = No of disks D = 2nd drive required
1-9 disks £1.00 each, 10 and over 80p each
Price is per disk NOT per title.

"NO NONSENSE SERVICE" ALL ORDERS DESPATCHED SAME DAY
NO MINIMUM ORDER RING FOR FREE CATALOGUE

Make all cheques payable to: ★★ WIRRAL P.D. ★★

Postage = 50p on all orders Europe = £1.50 Rest Of World = £2.50

anglia anglia

anglia anglia

FISH DISKS IN STOCK 350-600 ONLY 99P EACH!

DEJA-VU IN STOCK 1-80 £3.50 EACH!

PUBLIC DOMAIN SOFTWARE

ANGLIA PUBLIC DOMAIN LIBRARY
(Dept ASH), 115 Ranelagh Road, Felixstowe, Suffolk, IP11 7HU

Access

VISA

CREDIT CARD ORDERS

TELEPHONE 0394 283 494

Simply phone your order through or send a cheque/postal order. Please add 60p to cover post and packing.

DTBS 10TH ANIVERSARY SALE

DTBS (formerly trading as Adamsoft) has been in business for 10 years. Our first (VIC 20) sale was made in May 1982. In this fast moving industry many new companies have appeared on the scene and many have disappeared again after a short trading life. Very few of the firms that were trading in 1982 are still around today. We intend to be around for many years to come. Buying by mail order can be risky, but not when you deal with DTBS.

For most of our existence we have been the major UK supplier of Abacus Software products. Unfortunately, over the past 2-3 years other distributors have muscled in, using their near-monopoly supply agreements with the book trade to force up prices well above those charged in the USA. We are trying to change this situation, and dealers that buy from DTBS will normally offer lower prices. But for restrictive supply agreements between U.S. book publishers and certain large U.K. book distributors, shop prices could be much lower.

For a limited period we are offering selected Abacus books to Amiga Shopper readers at reduced prices (bookshop prices in brackets). This offer ends on 14th May.

| | | | | | |
|------------------------|-----|----------|----------------------|-----|----------|
| Amiga for Beginners | £12 | (£15.45) | BASIC Inside & Out | £18 | (£22.95) |
| Amiga Machine Language | £14 | (£18.45) | Best Tricks & Tips | £20 | (£27.45) |
| C for Beginners | £14 | (£18.45) | DOS Inside & Out | £18 | (£22.95) |
| Printers Inside & Out | £25 | (£32.45) | Making Music | £25 | (£32.45) |
| Using Arexx | £25 | (£32.45) | Desktop Video Power | £20 | (£27.45) |
| Graphics Inside & Out | £22 | (£32.45) | 3D Graphics in BASIC | £12 | (£18.45) |

VIDEOS (VHS Format) £14.95 each

| | | |
|---------------------|-----------------------|-----------------------|
| Amiga Primer | Animation Video Vol 1 | Amiga Graphics Vol 1 |
| Desktop Video Vol 1 | Hot Rod your Amiga | Animation Video Vol 2 |

CDTV PRODUCTS

| | | | |
|------------------------------|-----|------------------------------|-----|
| Fred Fish Collection Vol 1.2 | £30 | Fred Fish Collection Vol 1.3 | £45 |
| CD Remix | £27 | Learn French with Astrix | £39 |
| Town with No Name | £29 | Animals in Motion | £29 |
| Illustrated Sherlock Holmes | £27 | Murder Makes Strange | £27 |
| Basketball | £29 | Eye of the Eagle | £29 |
| Peter Rabbit | £34 | Wrath of Demon | £27 |
| American Vista | £45 | Illustrated Bible | £27 |
| World Vista | £45 | Illustrated Shakespeare | £27 |
| Hound of the Baskervilles | £29 | Women in Motion | £29 |

Send SAE for full list of books and software and details of any product. We will be sending details of other special offers to those on our mailing lists, and will add your name to the list on request.

Access and Visa accepted. Prices include postage in U.K. CDTV post free overseas. Europe add £1 per item for books and videos. Outside Europe add 20%.

DTBS (Dept AS592)

18 Norwich Avenue, Rochdale, Lancs OL11 5JZ
Tel/Fax 0706 524304

AMIGA REPAIRS & SPARES

| | | | |
|-------------------|--------|----------------|--------|
| 8371 Meg Agnus | £35.00 | 5721 Buster | £16.00 |
| 8372A 1 Meg Agnus | £50.00 | ROM V1.2 | £30.00 |
| 5719 Gary | £24.00 | ROM V1.3 | £30.00 |
| 8364 Paula | £35.00 | ROM V2.04 | £45.00 |
| 8362 Denise | £29.00 | 41256 Dram | £3.00 |
| 8373 Denise | £39.00 | 414256 Dram | £7.50 |
| 8520 CIA | £17.00 | 68000 MPU | £24.00 |
| Workbench V2 Kit | £83.00 | MSM 6242 Clock | £12.00 |

Many other parts available

| | |
|--------------------------------------------------------------------|---------|
| Genuine Amiga 500 service manuals now in stock | £19.99 |
| A very limited stock of A500 + Rev 8A boards | £160.00 |
| (Rev 8A boards require Gary, Paula, Denise, ROM, MPU and 2 x 8520) | |
| Amiga Modulator | £28.00 |
| A500 Internal Drive | £55.00 |
| 1 Meg Ram + Clock | £33.00 |
| A500 PSU | £45.00 |
| 1 Meg Ram | £30.00 |
| Amiga Mouse | £30.00 |
| 1 Meg Ram for A500 Plus | £54.00 |
| Boot Selector | £20.00 |
| ROM Selector | £30.00 |

All prices include postage and packing. Fast Amiga repairs - Phone for details.

ACE Repairs, Dept AS, Outways Farm, Pelynt, Looe, Cornwall PL13 2NW (0503) 220282



P D MAJIK

PUBLIC DOMAIN & SHAREWARE

DISK PRICES

| | |
|-------|----------|
| 1-9 | £1.30 EA |
| 10-21 | £1.15 EA |
| 22+ | £1.00 EA |

POSTAGE & PACKAGING INCLUDED!!

FIRST CLASS POST
9AM - 9PM 7 DAYS A WEEK

DISK CATALOGUE

£1.00 FREE
WITH ORDERS
OVER £6.00

END OF YEAR BONUS FOR ALL CUSTOMERS!
DETAILS ON CATALOGUE DISK.

GAMES

| | |
|-----------|------------------------|
| GA0013 | NO MANS LAND (1 MEG) |
| GA0014 | BLIZZARD |
| GA0021 | LAZER ZONE |
| GA0031 | CROSSFIRE |
| GG302 (P) | STARTREK (2) |
| GG303 (P) | AS ABOVE |
| GG320 (P) | STONE AGE (1 MEG) |
| GG322 (P) | ESCAPE (1 MEG) |
| GB008 (P) | THE HOLY GRAIL (1 MEG) |
| GB014 (P) | STOCKMARKET (1 MEG) |
| GB017 | SURVIVOR |
| GB023 (P) | MORIA (RPG) (1 MEG) |

UTILITIES

| | |
|-------|------------------------------|
| U217 | TEXTENGINE 3 |
| U224 | SPECTRAPAINT |
| U225 | MED 3.11 |
| U227 | CROSSWORD CREATOR |
| U250 | EASY PRINT |
| U257 | VIDEO GRAPHIC TOOLS |
| U266 | VIRUS KILLERS |
| U267 | MAJIK UTILS 2 |
| U243 | AMIGAFOX (DTP) |
| U269A | ANALYTICAL (SPREADSHEET) |
| U269B | ANALYTICAL (SPREADSHEET) (2) |
| U272 | AMIBASE (DATA BASE) |

(P) Plus compatible
(2) No. of disks

THE ABOVE DISKS ARE JUST A SMALL SELECTION FROM OUR LIBRARY

PLEASE MAKE ALL CHEQUES AND POSTAL ORDERS TO
P.D.MAJIK

P.D.MAJIK

199, NELSON STREET,
NORWICH, NORFOLK NR2 4QJ
PHONE (0603) 628906



BULK DISKS DISKBOXES

| | 3.5 DS/DD | Capacity | Size | |
|------|-----------|----------|------|------|
| 25 | 10.99 | 40 | 3.5 | 3.99 |
| 50 | 20.50 | 80 | 3.5 | 4.99 |
| 100 | 36.99 | 120 | 3.5 | 6.49 |
| 250 | 84.99 | | | |
| 500 | 164.99 | | | |
| 1000 | 317.99 | | | |

* OUR DISKS ARE FULLY GUARANTEED AND ARE COMPLETE WITH LABELS.

>>> SPECIAL <<<
120 Capacity Box & 100
3.5 DS/DD Disks **£42.49**

PAPER - TOP QUALITY

| | | |
|---------------------------|-------|-------------|
| Fanfold with Micro Perfs. | 1000 | 2000 |
| 11x9.5 | 60gsm | 7.99 13.99 |
| 11.66x9.25(A4) | 70gsm | 10.49 18.49 |
| 11.66x9.25(A4) | 80gsm | 11.99 20.49 |
| 11.66x9.25(A4) | 90gsm | 13.99 23.99 |



**SNAP
COMPUTER
SUPPLIES LTD**

**HOTLINE
0703 457111
Fax: 0703 457222**

RIBBONS - POST FREE

| Top Quality compatible brands | 2 off | 4 off |
|----------------------------------|-------|-------|
| Citizen 120D/LSP10/124D Swift 24 | 2.50 | 2.30 |
| Citizen Swift 24 Colour | 15.00 | ea |
| Epson FX/MX/RX80/FX800/LX800 | 3.20 | 3.00 |
| Epson LX80/86 | 2.00 | 1.80 |
| Mannesman Tally | 3.50 | 3.20 |
| Panasonic KXP 1080/81/82/1123 | 2.90 | 2.70 |
| Panasonic KXP 1124/1140 2.60 | 2.60 | 2.40 |
| Star LC10 Mono | 2.80 | 2.60 |
| Star LC10-4 Colour | 5.90 | 5.70 |
| Star LC24-10 | 2.80 | 2.60 |
| Star LC24-10 Colour | 12.50 | ea |
| Star LC200 | 3.20 | 3.00 |
| Star LC200 Colour | 11.50 | ea |
| Star LC24-200 | 2.80 | 2.60 |
| Star LC24-200 Colour | 12.50 | ea |

ACCESSORIES - POST FREE

| | |
|---------------------------------|-------|
| Amiga External Drive | 54.99 |
| Amiga 512k Upgrade, Clock | 23.99 |
| Amiga 512k Upgrade, No Clock | 21.99 |
| Mouse Mat | 2.99 |
| Mouse Holder | 2.99 |
| 2 Piece Universal Printer Stand | 6.99 |
| 3.5 Disk Clean Kit | 2.99 |
| Roll 1000 3.5 Disk Labels | 8.99 |

SNAP COMPUTER SUPPLIES Ltd.

Unit 16, The Sidings, Hound Rd, Netley Abbey, Southampton. SO3 5QA

All products are subject to availability - All prices include VAT. Please add £2.99 P & P for disks & boxes, £3.99 for paper. E.&O.E.

continued from page 150

calculator works in Reverse Polish Notation (RPN), which could take some getting used to. (This, and a comment in the documentation about stack size, suggests that the program was actually written in Forth.)

The outliner, as well as being useful in its own right, means that the program can automatically generate a table of contents for the document. As long as you have created a new 'section' at each new topic, the contents can be automatically generated simply by giving the command 'contents' at the end of the document.

Document control in *Wordwright* is based on the principle of embedded commands; these are displayed in yellow on the screen, and allow you to set options such as the text width, where headers and footers should be placed, the location for page numbers and so on.

As with the calculator, RPN is used, so you must grow accustomed to entering the number and then the command – "10 set-tab" to set a tab position to the tenth column, for instance. The documentation isn't as clear on this point as it might be (although in general it's extremely well-written), but browsing through the manual, which itself contains many embedded commands, should clear matters up.

As with *Text Plus*, it's the smaller but really neat features which make you love this program: like, for instance, the fact that creating a hanging indent is incredibly simple. And the fact that a screen-saver is built in.

Wordwright's mail merge facilities are far more powerful than those in *Text Plus*. They include the ability to set both string and integer variables, and to perform calculations on the integers. Conditional merging is supported – which means that different phrases or figures can be inserted into different letters, depending on a variable's value – and a set of control commands such as a 'begin ... repeat-until' loop enable you to decide which letters are printed. The only limitation on the file of data to be merged is that it must be entered in the same order that the document will request it.

Printer control is via the 'setup' command, entered while you are in the utilities window. This takes you through a set of 20 or so questions about which control commands to use to make the printer change styles, fonts and so on. This is not as flexible as *Text Plus's* config file method – you have to go through all the questions even if you only want to change one value – and

Wordwright doesn't have the facilities for character translation tables, but most users won't find this too limiting.

Now on to the gripes: first off, the dreadful colours of the screen. Yes, colours can be altered (although, surprisingly, *Wordwright* doesn't allow you to alter its palette

of the three, with its Reverse Polish Notation method of entering parameters, but also provides some features that even *Text Plus* is lacking, such as a contents generator and conditional mail merging. As always you pay your money and you take your choice...

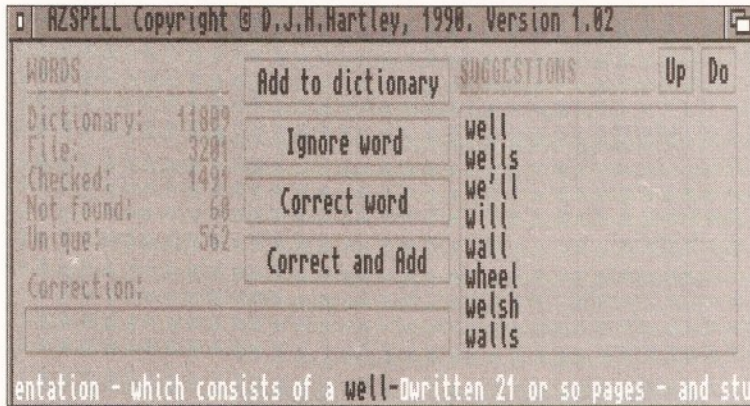

AZspell – the text running across the bottom of the window shows exactly where a mis-spelled word occurs – much better than just being given a suspect word with no idea of its context

from within the program), but the initial white-on-bright-yellow text on the menu bar is totally unreadable, as well as being incredibly ugly. A palette control is certainly something that should be added in the next version of the program!

Slightly more seriously, it's possible to lose edited text with no warning. Going from the edit screen to the command window, the typing 'Edit' to get back, rather than [Control][E], will result in your work disappearing. It's imperative that a program warns you before work is deleted; one major loss of work is enough to put you off any program which doesn't.

It is also not possible to have two different documents open at the same time – there's only one text window. (Although if you have enough RAM I suppose that you could also just multi-task and run the program a second time.)

Program rating.....8/10

SUMMING UP

The three word processing programs each offer the user different things – each with their own advantages.

Textengine is an unashamedly basic wordprocessor, with little to offer the power user but, on the other hand, little to baffle the beginner.

Text Plus is an incredibly professional program; it's surprising that it isn't being sold as a commercial product, but that the author has opted to release it as shareware – and you're going to have to pay the shareware fee, as the frequent conscience-nudging requester is just too annoying to live with.

Wordwright is the most 'techie'

UTILITIES

AZSPELL

Digitz disk Util 277

An essential add-on to any word processor is a spelling checker – and *AZspell* is one such. It's freely distributable (there's no shareware

found that it didn't work too well, and that it's easier to do it manually – if, for example you're running *AZspell* from your RAM disk, open a Shell or choose 'Execute Command' from the Workbench menu and type 'Assign *AZspell*: RAM:'. In fact, it's a good idea to run the spelling checker from the RAM disk if you've got enough memory installed; the access speed is far faster than from a floppy or even a hard disk.

Double-clicking on the program's icon produces a simple requester which asks you for the name of the file to be checked. Remember to type in the whole path – even if the file is in the same drawer as *AZspell*. If you don't, you get a rather unhelpful message saying "File not found. AmigaDOS error No 205" – no suggestion as to how to cure the problem.

Assuming that you could remember the file's name, a window appears with the text from the file running along the bottom. If an unknown word is found, the text stops, the word is highlighted and a selection of suggestions is produced. You can then either ignore the word, correct it or add it to the dictionary. You quickly get the hang of what to do (the instruction file provided is perfectly adequate), and the fact that you see the mis-spelled word in

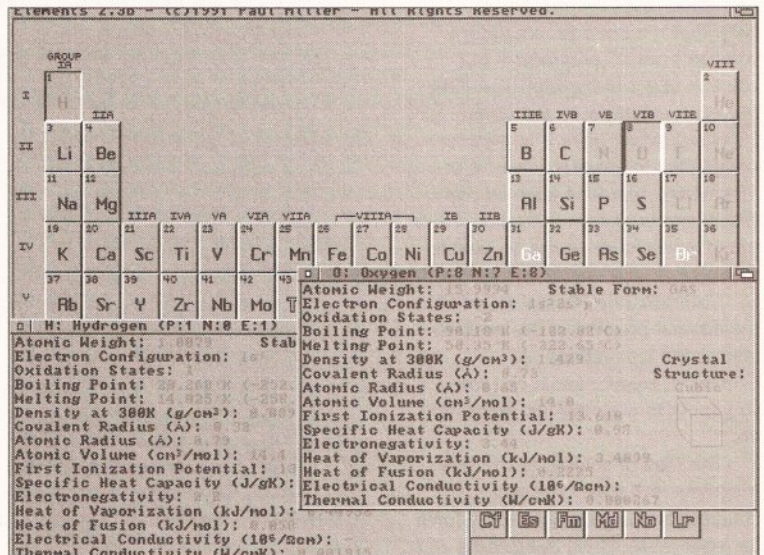

Elements – a great little program for any would-be Mr Hydes out there... No more searching in dusty old text books (see page 154 for full details)

fee, although it's not actually public domain), and is supplied with a ready-created 12,000-word dictionary, although the author, Danny Hartley from Clwyd, makes no claim to its accuracy. You can, if you wish, build up your own dictionary from files which you know contain only correctly-spelled words.

To run the program from any disk other than a dedicated floppy requires that you assign the logical device '*AZspell*:' to the drawer which contains the program; although a program is supplied to do this, I

context is very helpful.

Checking a 3,200-word test file took about ten minutes, although I found that I was adding quite a lot of words to the dictionary during that time; a few more large files and things would go much faster, since the dictionary would contain far more words.

I do have one complaint with *AZspell*: the way it handles punctuation, in particular single quote marks, can be annoying. If you have, say, the phrase 'And so to bed', surrounded by single quotes,

the spelling checker will query the word bed' - ie, the word bed followed by a quote mark. You can, of course, tell the program to ignore it - or even to add it to the dictionary - but I would have preferred some option to ignore quote marks. Perhaps Danny will make this alteration in a future version.

Once you have checked a file, you can run the extra program AZmerge to add your new words to the main dictionary. And that's it: an easy-to-use, efficient program which can be thoroughly recommended to anyone whose current word processor doesn't include a spelling checker.

Program rating.....8/10

MESSY SID II

PD Soft disk V490

SID has, as any fool knows, been around now for some time, and version 2 is imminent. For those who aren't acquainted with the program, it's a tool which gives you a kind of graphical version of the Shell, with which you can navigate around a disk, read, execute, delete, copy and rename files, compress and decompress them and so on and so on.

MessyDOS has also been doing the rounds for a while; it's a utility which allows you to read PC-formatted disks on your Amiga. Note that it's not a PC emulator - you can't run PC programs - but you can use it to transfer data files from one computer to the other. (Amiga Shopper uses it to transfer Amiga files to the Mac since, with MessyDOS, text files such as this article can be put on a PC disk which the Mac would otherwise be unable to read.)

Unfortunately, MessyDOS isn't the easiest program in the world to install; the instructions are somewhat cryptic, and it can take you hours to work out just what to do.

The idea of combining the two programs is a good one, and congratulations must go to Jeff Tullin for making the whole thing come together. According to his documentation files, someone tried it before, but this version contains far more utilities than the previous attempt.

Messy SID II is supplied as a self-booting disk, which has all the relevant commands and utilities in its c: directory. All you need to do is boot from the disk and wait; first VirusX checks to make sure that the disk is not infected, then SID starts up.

Checking through the various directories on the disk, it's clear that loads of utilities have been included. These include PowerPacker (which is required to read much of the

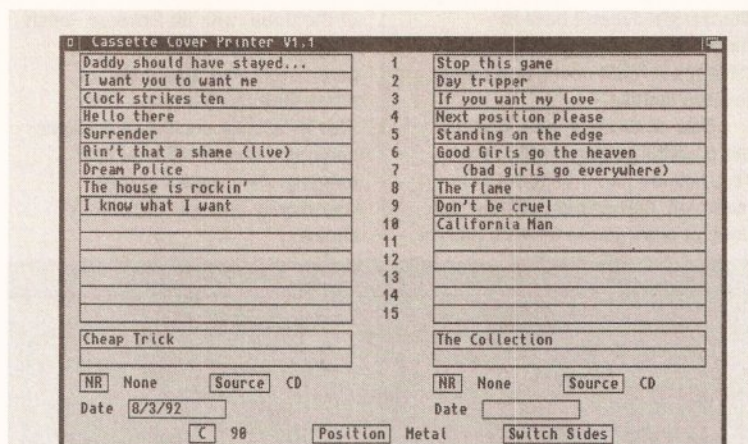

Cass - a simple, effective program for tidying up your cassette collection. No more trauma when you can't find that Kylie track...

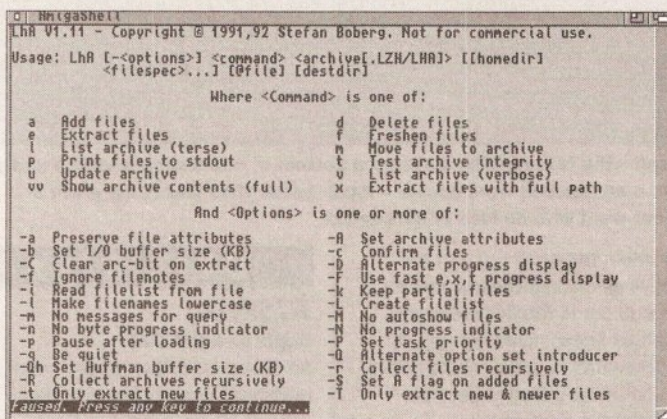

LhA - this may be one of the fastest compression utilities available, but its on-line help isn't the clearest in the world!

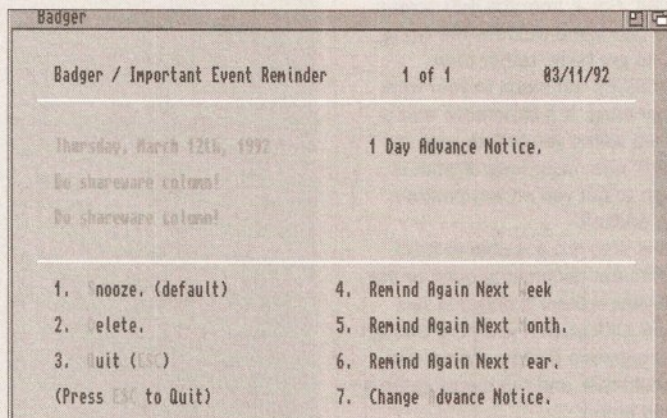

Badger - for those of us who are on the forgetful side, Badger is perfect. Remember to pay the shareware fee, though - the program will only work for 30 days if you don't!

documentation), Iharca (a file compressor), Last Hope (a file recovery utility) and many more. Indeed, the disk is 99% full, with only 1K of free space left over.

If you need to be able to access data stored on PC disks, and you can't afford the time to mess about installing MessyDOS from scratch; or if you just want a good collection of utilities (including MessyDOS and SID), then this is the disk for you.

Let's hope that it will be updated when SID v2.0 makes its appearance...

Value for money.....8/10

QUICKIES

ELEMENTS

Fish disk 593

Supplied by Unique Computing

Elements is a shareware program written by Paul Miller for those studying (or working in the field of) chemistry. When run, it produces a display of the Periodic Table of Elements; clicking on any element displays information about that element, and shift-clicking on a further element displays information about chemical bonds between the two. There's also info available on things such as sub-atomic particles,

and general table row and column data.

The program is compatible with Workbench 1.3 or 2.0, automatically sensing which it's running under, and works in both interlaced and non-interlaced modes. However, when running in non-interlaced mode some of the data is not available (due, presumably, to the fact that the text wouldn't fit on the screen). There is even a 'quiz mode', where you are asked questions about selected elements. The disk contains Swedish and German data files, as well as the default English version.

If you're studying Chemistry, get your hands on this; it's worth it for the sheer amount of information it contains!

Program rating.....9/10

CASS V1.1

Fish disk 579

Supplied by Unique Computing

This program, written by Jorn Clausen, has one simple task in life - to create labels for cassette boxes. It doesn't claim to be incredibly sophisticated, or to create amazing text effects. But hey - who cares?

Using Cass is a simple matter of typing in the track and artist names, clicking on buttons like 'Source' to cycle through the available possibilities (in this case CD, Phono, Tuner, DAT, Computer et al), and then printing the thing out. Output can either go straight to your printer, or to a disk file as T_EX data (for those who have an Amiga T_EX program).

The author says that he's sure the labels will be the right size, although he's only checked this out on his Star printer. Well, I can certainly confirm that they look fine on my Canon BJ10ex, so it's likely that they'll be fine on most machines (the program addresses the PRT: port, so your Preferences printer driver is used).

True, this is not the most exciting program on the market. But at least, now, my cassette collection looks a damn sight better!

Program rating.....7/10

LHA VI.11

Fish Disk 593

Supplied by Unique Computing

LhA is a relatively recent entrant to the world of data compression; it is compatible with the MS-DOS LhArc utility, as well as the Amiga's LhArc (one of the most popular Amiga utilities).

Unfortunately, the price that you have to pay for using this powerful, fast archiving routine is that it is the most complex I've seen. Sure, once you've worked out exactly which command to use to extract an

AMIGANUTS UNITED
 169 DALE VALLEY ROAD, HOLLYBROOK, SOUTHAMPTON, SO1 6QX.
 AMIGANUTS UNITED AUSTRALIA - 199, TAYLOR ST, TOOWOOMBA,
 QLD, AUSTRALIA 4350. WORLDWIDE DISTRIBUTORS OF THE
 DEDICATED AMIGA CODERS CLUB DISKS. EUROPEAN DISTRIBUTOR
 FOR THE T.BAG DISKS. Numbers 1 to 63 NOW AVAILABLE.

ALL ARE V2 COMPATIBLE - V2 COMPATIBLE PROGS ALSO DENOTED IN OUR CATALOGUE. MAIL ORDER ONLY - IF MAKING AN ENQUIRY, PLEASE ENCLOSE S.A.E.

INTO MUSIC? Then the eight channel Midi compatible OctaMed V2 is for you! Contains full notation with notation editor, (staves), print facility plus 16 track display for Midi users. It also has its own built in sampler. All this for £20.00 (note that you do not need a Midi keyboard to use this excellent music program).

THE OCTAMED MANUAL IS HERE!!!

Not just a copy of the instructions already on your disk but a complete authorised re-write which will show you what an excellent utility it is. Parts also cover the earlier Public Domain med program as well.

Send for your copy now! **ONLY £9.95**
ALL ORDERS FOR THE MANUAL WILL INCLUDE A FREE AMIGANUTS CATALOGUE DISK

ARE YOU INTO CODING? - NEW TO COMPUTING? - The Amiga Coders Club is for you! If you want to learn how to assemble that strange looking code, you need us. Amiga Coders Club are now being sold worldwide, so why not find out why they are so popular for yourself? Each issue contains loads of source ready to assemble and is also packed with help, tips, contacts, letters plus advice. ACC is published monthly and is available for the low price of £4.00 per issue. Our special introductory compressed ACC Disk 1 to 4 IS ONLY £2.00, so order your copy now!

Subscribe to ACC for the year, (12 issues) and get your 12th ISSUE FREE!! If you live in a European country then send £44.00 plus £5.50 for postage. If you live outside Europe, then you must send £44.00 plus £10.89 for postage. We will send you each issue as soon as it's ready, (applies to issue 14 onwards). PLEASE NOTE THAT ISSUES RELEASED PRIOR TO ACC 14 MUST BE PURCHASED SEPARATELY.

Postage for all EC countries, (including U.K), Add 50p - non EEC £1.50. Orders from overseas customers must be by bank draft, postal or Eurocheque. (sorry but we do not accept credit card orders as these would push up prices). The new 1992 catalogue is available now! £1.50 (don't forget to add postage).

DELTRAX PD
 TEL: 0492 515981
 OVER 1500 DISKS TO CHOOSE FROM

| () = No of Disks | No of * = No of Meg | P = Plus compatible |
|-----------------------------------|-------------------------------|-----------------------------------------|
| U4 Utilities | U152 Amibase Pro II v1.2 (P) | S27 Doctor Who Demo (P) |
| U14 Clerk | U154 Spectra Paint v3.2 | S30 WWF Wrestling * (3) (P) |
| U22 Relational Database | G4 Megaball (P) | S32 Fraxion Divine 1 & 2 * (2) |
| U42 Disk Salvage | G5 Star Trek 1 (2) (P) | S35 DPaint Slides |
| U47 C Language Manual (3) | G9 Flaschbier (P) | S36 Neighbours Slides |
| U50 Dope Intro Maker (NP) | G14 Holy Grail (NP) | S37 Tobias Richter Slides (2) |
| U54 Quickbench Plus (Plus only) | G22 Card Games (P) | S40 Robocop Slides (P) |
| U57 Genealogy * (P) | G23 SuperTwintris (P) | MUSIC |
| U58 Anti-Filks | G33 Whizzy's Quest * (P) | M10-39 ST-01-ST-30 (individual) (P) |
| U59 Windows Bench (2) (P) | G34 Return to Earth (P) | M45 Protracker 1.1a (NP) |
| U60 MessySid II (P) | G35 Llamatron 512K * (NP) | M48 8 Channel Soundtracker (NP) |
| U61 MS-DOS | G36 Monopoly (NP) | M49 Star Trekker 1.3 (P) |
| U86 Journal * | G39 Bug Bash (NP) | M77 Med v3.2 Music Editor (P) |
| U87 Spectrum Emulator (NP) | G43 Downhill Challenge (NP) | M84 Mylie "Shocked" (NP) |
| U88 Crossword Designer | G44 Dragon Cave (P) | M92 Monty Python Songs 1 (P) |
| U91 M/Cad (P) | G48 Mayhem (P) | M99 Classical Music 1 (P) |
| U95 Electrocad (P) | G49 Mechlight RPG (P) | M131 Silents "Blue House" (2) (NP) |
| U96 Amibase v3.76 (P) | G55 Scum Haters (P) | M150 Pink Floyd - The wall (6) (2D) (P) |
| U99 Amigabook Workshop 1 (P) | G58 Sea Lance * (P) | M182 Masters At Work 2 (P) |
| U100 Catalogue Workshop 2 (P) | G59 Klondike Card Game (P) | DEMOS |
| U102 Hard Disk Utilities | G61 Survivor RPG (P) | D32 Budbrain Megademo II |
| U103 Amateur Radio (6) (P) | G62 Air Ace II (P) | D89 Amiga 2000 Genlock Demo |
| U104 Bank'n (P) | G64 Adventure Solutions 1 (P) | D97 Monkey Island Demo |
| U105 Amicash (P) | G64 Adventure Solutions 2 (P) | D104 Turrican II Demo |
| U106 Q Base/Spread (P) | G65 Merv The Merciless (NP) | D108 Cronics Total Destruction |
| U111 Analytical * (2) (P) | G66 Snakepit (P) | D138 The Silents "ICE" (P) |
| U112 Flexibase v2.0 (P) | G68 Games Cheat List v1.0 (P) | D143 End of Century 1999 |
| U124 Business Card Maker (P) | G70 Parachute Joust (NP) | D223 Death Star Megademo (2) |
| U129 Word Wright (P) | G71 Crystal Caverns (P) | D283 Complex Universal Insanity |
| U130 TextPlus v2.0 (P) | G73 Zeus - The Game (P) | D283 Hypnotic Hammer II (NP) |
| U131 U-Edit (NP) | G75 Pick-up-a-Puzzle * (P) | D287 Amiga Lemming Demo |
| U132 TextPlus v3.0 | G76 Chainsaw Death * (P) | D304 Utopia "Total Confusion" |
| U133 600 Business Letters (P) | G79 Baloonacy (P) | ANIMATION |
| U134 QED Text Editor (P) | G82 Black Jack - Cards (P) | DA13 Gymnast Animation (P) |
| U135 Amigafox DTP v1.1 (P) | G84 Peters Quest (NP) | DA36 Harry Meets An ST Owner (P) |
| U139 A64 Emulator (NP) | G88 Amigaman Games Collection | DA199 Maxim Overdrive (2) (NP) |
| U140 Transformer v3.3 (NP) (2) | G90 Shapes (P) | DA227 Magician v2.0 (P) |
| (+U61) | G92 Star Trek - T.N.G. * (P) | DA238 Starwars Animation II (P) |
| U141 iBeM Emulator (P) (+U61) | G95 Dragon Tiles (P) | DA246 Iraq Vs UK Animation (P) |
| U143 ST Emulator (NP) | SLIDESHOWS | DA258 Camouflage * (P) |
| U145 Text Engine (P) | S5 Tate Gallery | DA262 Real Pinball 3D (P) |
| U146 Master Virus Killer v2.2 (P) | S7 Ham Slides | EDUCATION |
| U147 PD Copy v3.0 (P) | S19 Madonna Slides | E6 Learn and Play (P) |
| U149 C64 Games Disk 1 (NP) | S22 The Simpsons Slideshow | E7 Word Games Vol 1 |
| U150 C64 Games Disk 2 (NP) | S24 The Addams Family (P) | E10 Typing Tutor (P) |
| | | E11 Talking Colouring Book (P) |

PRICES:
 1-9 disks £1.50
 10-24 disks £1.25
 25+ disks £1.00

POSTAGE AND PACKING:
 + 60p..... per order UK
 + 25p..... per disk Europe
 + 50p..... per disk R.O.W

Overseas orders welcome. Payment in sterling please.
 Catalogue disk £1.00 or FREE with every order. Fredfish catalogue disk £1.00. Blank disks - please ring for current prices. Please make cheques with bankers card number/postal order payable to: DELTRAX PD

We also stock:
 Fredfish 1-530 and TBAG 1-54

DELTRAX PD, (AS)
 36 BODELWYDDAN AVENUE,
 OLD COLWYN,
 CLWYD LL29 9NP

All disks are VIRUS checked and TESTED prior to despatch.

digitz

P.O. Box 144, Mexborough,
 South Yorkshire S64 9SL
 Tel: (0709) 571748
 9am - 9pm Mon-Sat

OVER 2200 PUBLIC DOMAIN DISKS TO CHOOSE FROM.

We carry the complete Fred Fish, T-BAG, Topik, Macro, Scope, N.Z.A.U.G., AMOS P.D., & Deja Vu Licenseware.

DISK PRICES
 1-9.....£1.25 each
 10-19.....£1.10 each (+1 disk free)
 20 or more.....£1.00 each (+2 disks free)

Catalogue disk with game 50p Fish Lists on disk 50p

10 Blank disks £4.50
 10 Blanks + box £5.50

Licenseware £3.50 each,
 £5.50 for a two disk set.

All Licenseware is supplied with the official Deja Vu label, and a free single disk case.

Please make cheques/P.O's payable to Digitz

★ ALL MAJOR CREDIT CARDS ACCEPTED ★

No minimum order, same day despatch
 We pay the postage (UK)

European orders please add 20p per disk.
 Rest of world please add 50p per disk.

PD BUSINESS PACK
 A500 Plus compatible. Includes a text editor, spell checker, databases, spread sheet, copier etc.6 disks £6.00

GAMES PACK
 A500 Plus compatible. Includes Air Ace 2, Tricky, Go-Moku, Nestor, Tiles, Ball, Sys and Euchre5 disks £5.00

JUNIOR GAMES PACK
 Includes Drip, Frog, Ladybug, Pac, Shark, Galactic Worm, Cat & Mouse & Five In Line.....5 disks £5.00

HAM RADIO PACK
 Full of Ham Radio utilities6 disks £6.00

UTILITIES
 KING JAMES BIBLE4 disks of text
 BBASE II V5.....friendly data-base
 600 BUSINESS LETTERS.....templates
 TEXTENGINE V3.....tidy text editor
 HAVEN VOL 1 & 2.....hardware mod docs
 SID V1.6.....the best directory util
 OPTI UTILS 2with diskmaster v3.2
 PCQ PASCAL.....a pascal compiler
 PERM CHECK.....dinky pools program
 A68K68000 assembler
 D-COPY V2.0.....disk copier
 KWICKBACKUP.....hard disk backup
 ZEROVIRUS & BOOTX V4.40.good killers
 A64a C64 emulator
 ST EMULATOR.....English version
 TEXTPLUS 2.2Enice word processor
 AMIBASE V3.67.....very good database
 ELECTRO CAD.....design your circuits
 M-CADamiga cad program
 C MANUAL V2.00.....all you need for C
 MED V3.20.....new version music editor
 ANALYTICALCpowerful spreadsheet
 UNICOPY.....neat disk copier
 MESSYSID II.....handles PC files
 SUPER-DUPER.....a copier that knows
 INSANITY TOOLS.....203 utilities

IMPLODER V4good cruncher
 HAM RADIO UTILS17 disks to choose
 N-COMM V1.921.a very good comms disk

MUSIC
 BRUNOS MUSIC BOX2 disks - amusing
 AMIGA DEUSgreat classical sounds
 MANIC RAVES2 disks - good beat
 STAR TREK2 disk comedy
 JOURNEY INTO SOUNDand so it is
 LOONY TUNES.....neat gfx & catchy beat
 VOGUE CD PLAYER...looks and sounds good
 VIVALDI2 disk classical
 BABY SITTIN BOOGIE .funny sampled song
 FLASHING BYTESbrilliant

ANIMATIONS
 BUZZED (3meg).....brill 3 disks
 VIETNAM CONFLICT (1 meg) ..plane combat
 AT THE MOVIES 2 (1/4 meg)4 disk fun
 THE LEMMINGS (1meg) .anim with a moral
 ATF AGILITY (1 meg)antics in the sky
 PUGGS IN SPACEcute little alien
 SHUTTLECOCK (1meg)very amusing
 TERMINAL (1meg)doctor help
 THE BOINGS (1meg) .cute ray traced guys
 CONGAMAN (1meg)beat dem drums
 DOCTOR A (1meg)good sculpt anim
 THE DATING GAME (3meg) ..animal antics

GAMES
 STORYLAND 2.....activity adventure
 BOUNCE N BLASTbrilliant
 JETMANtidy arcade game
 WORLDgood text adventure
 EAT MINEaddictive boulderdash
 ESCAPE (1meg)great game tidy gfx
 LABYRINTH 2roleplay adventure
 KIDS PAINTneat paint package
 NADROJin d & d style
 QUIK AND SILVA.....a real addictive game
 ARCADIA.....good Amos breakout
 ETHOStidy text/gfx adventure
 PROPERTY MARKETmake your millions

MAHJONGnice gfx good game
 STAR TREK2 disk space voyage
 SHAPES (1meg).....addictive puzzle
 OUCH.....clobber those moles
 MEGABALL.....a great game of breakout
 CARD SHARPpatience rules
 LAZER-ZONE.....arcade blast em!
 DUNGEON DELVER..2 disk arcade adventure
 HOLLYWOOD TRIVA.....an interesting quiz
 CHESS PUZZLEuse those grey cells
 PIXIE KINGDOM2 disk arcade quest
 SEA LANCEstrategy at sea
 POM POM.....a very good blast em game
 TWINTRIStetris for two
 LLAMATRON.....a great jeff minter game
 PROJECT 1blast the enemy
 SEVEN TILES.....futuristic football
 BLIZZARDan arcade type space game
 JEOPARD (1meg)classic strategy

SLIDE-SHOWS
 THUNDERBIRDS.....a must for fans
 WRESTLEMANIA.....muscle filled 2 disk
 THE INVISIBLE WORLDvery interesting
 DEMONS IIIgreat music & pics
 HYPERDISK 1good pics and story
 AMEGA PARTY GRAPHICS...neat comp piccys
 APOLS DIGISHOWtidy digitised pics
 NEPTUNE PIX.....2 disks of satellite pics

DEMOS
 HARDWIRED (1 meg).....cool 2 disk demo
 CDTV ATTACK.....2 disks - great sounds
 GUARDIAN DRAGON..tidy gfx from Kefrens
 SKIZZO (1meg)entertaining 2 disk
 INFINITE DREAMScool demo
 PULLING THE TRIGGER (1meg)love this
 BEATLES DEMO (1meg).....unusual 2 disk
 REBELS MEGA II.....neat gfx
 DIGITAL INNOVATIONSnice one anarchy
 DECAYING PARADISE (1meg) ..great vectors
 RED EMPATHY (1meg).....2 disks great gfx

continued from page 154

archive, you can just write it down and refer to it in future. But working out just what to use is the tricky bit...

Still, *LhA* is likely to become one of the more widely used utilities in the future, due to its speed, so it's certainly worth getting hold of a copy.

Incidentally, next month I'll be comparing all of the popular data compression programs, complete with speed tests. Stay tuned...

Program rating.....8/10

BADGER

Fish Disk 543

Supplied by Unique Computing

Badger is a \$15 shareware program for those of use who need to be constantly reminded to do things. It is really only for people with hard disks; although you could use it on floppy-only machines, it isn't

particularly recommended, because it will slow your startup down too much.

To activate the program, just put it somewhere on your hard disk, and add the command 'badger -s' to your startup-sequence somewhere after your clock has been set. Then, every time you start your Amiga up, you will be presented with a list of things which you asked to be reminded about. You can set the program so that the list is only presented when you start your Amiga for the first time on any day, or so that every time you reboot the list appears. Items can be added or removed at any time by double-clicking on *Badger's* icon, and the amount of warning that you get for an event is selectable between 0 days (the item only shows up on the day itself) and 45 days (even I don't need to be hassled that much!).

The program is protected in a

neat way - if you don't register within 30 days of first running the program, it will refuse to continue to work, and an annoying requester will appear, tying up your machine for 20 seconds or so every time you try to run it. Of course, you could just reset your clock so that less than 30 days appear to have passed; but

since this program relies on knowing the current date, that's just a tiny bit pointless!

All in all, *Badger* is a neat little program, worthy of a place on the hard disk of any forgetful Amiga owner. (If you can remember to order the disk, that is...)

Program value.....7/10 AS

NEXT MONTH • NEXT MONTH

Next month I'll be taking a look at all of the data compression packages available, and we'll be printing speed tests so you can see just which is the best for your needs.

I'll also be leafing through the growing number of disk magazines available for the Amiga; so if you know of any good ones, or if you run one yourself, make sure that you send me the latest issue! You can reach me c/o Amiga Shopper, Future Publishing, 30 Monmouth Street, Bath BA1 2BW, or on CIX as 'Iwrigley' and CompuServe as '100016,320'. Don't forget, if you know of any good PD or shareware that you think I should be looking at, let me know!

UK PD HOUSES

Amiga Mouse PD

182a High Street
Margate, Kent
☎ 0843 228166

Amiganuts United

169 Dale Valley Road
Hollybrook
Southampton
SQ1 6QX

Akore Shareware

7 Fishergate Point
Lwr Parliament Street
Nottingham NG1 1GD
☎ 0800 252221

**AMOS PD Library
(also Deja Vu)**

25 Park Road
Wigan WN6 7AA
☎ 0942 495261

Anglia PDL

115 Ranelagh
Felixtowe
Suffolk IP11 7HU
☎ 0394 283494

Blitterchips

Cliffe House
Primrose Street
Keighley BD21 4NN
☎ 0535 667469

CanDo PD Library

128 Portland Crescent
Stanmore
Middlesex
HA7 1NA
☎ 081-204 3954

CLS

PO Box 7
Bletchley
Milton Keynes
MK2 3YL
☎ 0908 640763

Crazy Joe's

145 Effingham Street
Rotherham
South Yorks S65 1BL
☎ 0709 829286

EdLib

Scotland Farm
Stockwood Road
Brislington
Bristol BS4 5LU
☎ 0272 723489

Electriclown

90 Notley Road
Lowestoft
Suffolk NR33 00G
☎ 0502 566752

EMPD

54 Watnall Road
Hucknall
Nottingham NG15 7LE
☎ 0602 630071

Essex Computer Systems

118 Middle Crockerford
Basildon
Essex SS16 4JA
☎ 0268 553963

George Thompson Services

Cucumber Hall Farm, Cucumber
Lane
Essendon
Herts AL9 6JB
☎ 0707 664 654

Goldstar Computers

PO Box 2
Tyldesley
Manchester M29 7BN
☎ 0942 895320

ICPUG

PO BOX 1309
London N3 2UT
☎ 081-346 0050

Kernow Software PD Library

51 Ennors Road
Newquay, Cornwall

Lazerdisk

57 Adamthwaite Drive
Blythe Bridge
Stoke On Trent ST11 9HL

NBS

1 Chain Lane, Newport
Isle Of Wight PO30 5QA
☎ 0983 529594

Office Choice (OC-PD)

Suite 14 Avon House,
Town Centre Cumbernauld G67
☎ 0236 737901

PD Soft

1 Bryant Avenue
Southend-On-Sea
Essex SS1 2YD
☎ 0702 612259

Public Dominator

PO BOX 801
Bishop's Stortford
Herts CM23 3TZ
☎ 0279 757692

Riverdene PDL

30a School Road
Tilehurst
Reading
Berkshire RG3 5AN
☎ 0734 452416

Scanner Disk Magazine

Telescan Computer Services
Handsworth Road
Blackpool FY5 1SB
☎ 0253 22296

Sector 16

160 Hollow Way
Cowley, Oxford
☎ 0865 774472

Seventeen Bit Software

PO BOX 97
Wakefield
West Yorks WF1 1XX
☎ 0924 366982

Software Express

Hebron House, Sion Road
Bedminster
Bristol BS3 3BD
☎ 0272 637634

Softville

Unit 5, Stratfield Park
Elettra Avenue,
Waterlooville
Hants
PO7 7XN
☎ 0705 266509

Start Computer Systems

Barbican House
Bonnersfield
Sunderland SR6 0AA
☎ 091 564 1400

Unique Computers

114 Salters Road
Gosforth
Newcastle on Tyne NE3 3UP
☎ 091-284 7976

Vally PD

PO BOX 15, Peterlee
Co Durham SR8 1NZ
☎ 091-587 1195

Virus Free PD

23 Elborough Road
Moredon, Swindon
Wilts SN2 2LS
☎ 0793 512321

Workbench PD

1 Buccleuch Street
Barrow-In-Furness
Cumbria LA14 1SR
☎ 0229 870000

CITIZEN

ALWAYS A GOOD IDEA

Silica presents some great offers on the award winning range of high quality matrix printers from Citizen. Each Citizen printer is built in the UK to exacting standards, ensuring superb reliability and output. Our confidence in Citizen's quality is such that we are pleased to include a 2 year guarantee with every printer. Plus, if you buy a Citizen printer (not inkjet) from us, we will give you the Silica Systems Printer Starter Kit (worth £29.38), **FREE OF CHARGE!**

- FREE DELIVERY**
Next Day - Anywhere in the UK mainland
- FREE STARTER KIT**
Worth £29.38 - With every Citizen printer (excluding inkjet) from Silica.
- 2 YEAR WARRANTY**
Silica offer a 2 year warranty (including the printer head) with every Citizen printer from Silica.
- WINDOWS 3.0**
Free Windows 3.0 driver. Included with the Silica Starter Kit.
- FREE COLOUR KIT**
With every Produt 9 and Swift 24e printer.
- FREE HELPLINE**
Technical support helpline open during office hours.
- MADE IN THE UK**
Citizen printers are manufactured to high standards.

DOT MATRIX PRINTERS

INK JET AND NOTEBOOK

LOW PRICE 9 PIN PRINTER



144 CPS **80 COLUMN**

- Citizen 120D+ - 9 pin - 80 column
- 144cps Draft, 30cps NLQ
- 4K Printer Buffer + 2 Fonts
- Parallel or Serial Interface
- Graphics Resolution: 240 x 240dpi
- Epson and IBM Emulation
- Pull tractor & bottom feed
- **FREE Silica Printer Starter Kit**

£115
+VAT= £135.13 ref: PRI 2120

RRP £199
SILICA STARTER KIT £25
TOTAL VALUE: £224
SAVING: £109
SILICA PRICE: £115

The Citizen 120D printer comes supplied with a parallel interface as standard. If you require a serial interface instead, please state ref: PRI 2125 when placing your order with Silica.

9 PIN PRINTERS

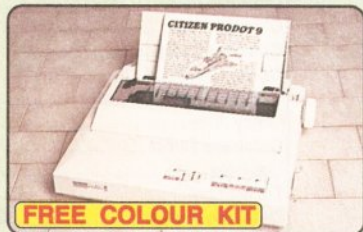

FREE COLOUR KIT

- 300 CPS** **80 COLUMN**
- Citizen Produt 9 - 9 pin - 80 column
 - 300cps Draft, 60cps NLQ
 - 8K Printer Buffer + 3 Fonts
 - Parallel Interface
 - Graphics Resolution: 240 x 240dpi
 - Epson and IBM Emulation
 - **FREE Colour Kit**
 - **FREE Silica Printer Starter Kit**

RRP £189
SILICA STARTER KIT £25
TOTAL VALUE: £214
SAVING: £25
SILICA PRICE: £189

£189
+VAT= £222.08 ref: PRI 2319



- 192 CPS** **80 COLUMN**
- Citizen Swift 9 - 9 pin - 80 column
 - 192cps Draft, 48cps NLQ
 - 8K Printer Buffer + 3 Fonts
 - Parallel Interface
 - Graphics Resolution: 240 x 240dpi
 - Epson and IBM Emulation
 - Colour Option available
 - **FREE Silica Printer Starter Kit**

RRP £239
SILICA STARTER KIT £25
TOTAL VALUE: £264
SAVING: £75
SILICA PRICE: £189

£189
+VAT= £222.08 ref: PRI 2209

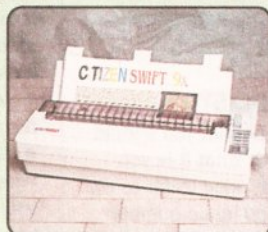

- 192 CPS** **136 COLUMN**
- Citizen Swift 9x - 9 pin - 136 column
 - 192cps Draft, 48cps NLQ
 - 8K Printer Buffer + 3 Fonts
 - Parallel Interface
 - Graphics Resolution: 240 x 240dpi
 - Epson and IBM Emulation
 - Colour Option Available
 - **FREE Silica Printer Starter Kit**

RRP £299
SILICA STARTER KIT £25
TOTAL VALUE: £324
SAVING: £105
SILICA PRICE: £249

£249
+VAT= £292.58 ref: PRI 2309

24 PIN PRINTER



NEW! LIMITED OFFER



FREE COLOUR KIT

- PRINTER + SOFTWARE + COLOUR**
- Citizen Swift 24e - 24 pin - 80 column
 - 216cps Draft, 72cps LQ
 - 8K Printer Buffer + 6 Fonts
 - Parallel Interface
 - Graphics Resolution: 360 x 360dpi
 - Epson, IBM & NEC P6 Emulation
 - **FREE Colour Kit**
 - **FREE Silica Printer Starter Kit**
 - **FREE Lotus Ami 1.2 Word Processor and DTP package**
 - **FREE Adobe Type Manager V1.15**

RRP £369
COLOUR KIT £36
SILICA STARTER KIT £25
LOTUS AMI 1.2 WP/DTP PACKAGE £95
ADOBE TYPE MANAGER V1.15 (Fonts) £79
TOTAL VALUE: £606
SAVING: £337
SILICA PRICE: £269

£269
+VAT= £316.08 ref: PRI 2544

24 PIN PRINTERS



NEW!

- 192 CPS** **80 COLUMN**
- Citizen 224 - 24 pin - 80 column
 - 192cps Draft, 64cps LQ
 - 8K Printer Buffer + 4 Fonts
 - Parallel Interface
 - Graphics Resolution: 360 x 360dpi
 - Epson and IBM Emulation
 - Colour Option Available
 - **FREE Silica Printer Starter Kit**

RRP £299
SILICA STARTER KIT £25
TOTAL VALUE: £324
SAVING: £136
SILICA PRICE: £199

£199
+VAT= £233.83 ref: PRI 2484

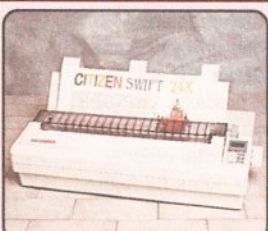

- 192 CPS** **136 COLUMN**
- Citizen Swift 24x - 24 pin - 136 column
 - 192cps Draft, 64cps NLQ
 - 8K Printer Buffer + 4 Fonts
 - Parallel Interface
 - Graphics Resolution: 360 x 360dpi
 - Epson, IBM and NEC P6 Emulation
 - Colour Option Available
 - **FREE Silica Printer Starter Kit**

RRP £499
SILICA STARTER KIT £25
TOTAL VALUE: £524
SAVING: £185
SILICA PRICE: £349

£349
+VAT= £410.08 ref: PRI 2574

INKJET PRINTER



- 360 CPS** **80 COLUMN**
- Citizen Projct - inkjet - 80 column
 - 360cps Draft, 120cps NLQ
 - 50 Nozzle Head - Whisper Quiet 47dB(A)
 - 8K Printer Buffer + 3 Fonts
 - Optional HP Compatible Font cards
 - Parallel Interface
 - Graphics Resolution: 300x300dpi
 - **HP Deskjet plus emulation**

RRP £496
TOTAL VALUE: £496
SAVING: £137
SILICA PRICE: £359

£359
+VAT= £421.83 ref: PRI 2090

NOTEBOOK PRINTER



- 64 CPS** **80 COLUMN**
- Citizen PN48 Notebook Printer
 - Non-impact Printing on Plain Paper
 - 53cps LQ - 4K Buffer + 2 Fonts
 - Rear and Bottom Paper Loading
 - Parallel Interface
 - Graphics Resolution: 360 x 360dpi
 - Epson, IBM, NEC P6 & Citizen Emulation
 - Powered From Mains, Battery or Car Adaptor
 - **FREE Silica Printer Starter Kit**

RRP £325
SILICA STARTER KIT £25
TOTAL VALUE: £350
SAVING: £101
SILICA PRICE: £249

£249
+VAT= £292.58 ref: PRI 2100

FREE STARTER KIT WORTH £25 +VAT



FREE!
This starter kit will help you to get you up and running with your new dot matrix or notebook printer when you buy it from Silica Systems.

- 3 1/2" Disk - Amiga & ST Drivers
- 3 1/2" Disk - Driver for Windows 3
- 2 Metre Parallel Printer Cable
- 200 Sheets of Continuous Paper
- 100 Continuous Address Labels
- 5 Continuous Envelopes

ACCESSORIES

- SHEET FEEDERS**
PRA 1200 1200 £71.38
PRA 1215 1240/224/Swift 9/24 £88.70
PRA 1225 1240/224/Swift 9/24 £82.80
- ORIGINAL RIBBONS**
RIB 3520 1200/Swift 9 Black £2.91
RIB 3940 Swift 9/24 Black £7.15
RIB 3924 1240/Swift 24 Black £4.78
RIB 3936 224/Swift 9/24 Colour £15.63
RIB 3240 PN48 Single Strike £3.61
RIB 3240 PN48 Multi Strike £3.61
- SERIAL INTERFACES**
PRA 1189 1200 £35.45
PRA 1209 Swift 9/24/240/224 £32.25
PRA 1709 Swift 24/24x/24 £36.30
- COLOUR KITS**
PRA 1236 224/Swift 9/24/24x £35.25
PRA 1240 Swift 9/24x £35.25
- 32K MEMORY EXPN**
PRA 1753 1240/224/Swift 24 £13.10
- PRINTER STAND**
PRA 1242 1240/224/Swift 9/24 £24.83
PRA 1274 Swift 9/24x £30.66
- PN48 ACCESSORIES**
PRA 1140 PN48 Battery £31.70
PRA 1155 PN48 Cable Extn £ 7.95
PRA 1162 PN48 Car Adaptor £ 7.95

All accessories prices include VAT and free delivery

SILICA SYSTEMS OFFER YOU

- **FREE OVERNIGHT DELIVERY:** On all hardware orders shipped in the UK mainland.
- **TECHNICAL SUPPORT HELPLINE:** Team of technical experts at your service.
- **PRICE MATCH:** We normally match competitors on a "Same product - Same price" basis.
- **ESTABLISHED 12 YEARS:** Proven track record in professional computer sales.
- **BUSINESS + EDUCATION + GOVERNMENT:** Volume discounts available for large orders.
- **SHOWROOMS:** Demonstration and training facilities at our London & Sidcup branches.
- **THE FULL STOCK RANGE:** All of your requirements from one supplier.
- **FREE CATALOGUES:** Will be mailed to you with offers and software/peripheral details.
- **PAYMENT:** By cash, cheque and all major credit cards.

Before you decide when to buy your new printer, we suggest you think very carefully about WHERE you buy it. Consider what it will be like a few months after you have made your purchase, when you may require additional peripherals or software, or help and advice. And, will the company you buy from contact you with details of new developments and products? At Silica Systems, we ensure that you will have nothing to worry about. We have been established for over 12 years and, with our unrivalled experience and expertise, we can now claim to meet our customers' requirements with an understanding which is second to none. But don't just take our word for it. Complete and return the coupon now for our latest Free literature and begin to experience the "Silica Systems Service".

MAIL ORDER: 1-4 The Mews, Hatherley Rd, Sidcup, Kent, DA14 4DX Tel: 081-309 1111
Order Lines Open: Mon-Sat 9.00am-6.00pm No late Night Opening Fax No: 081-309 0608

LONDON SHOP: 52 Tottenham Court Road, London, W1P 0BA Tel: 081-580 4000
Opening Hours: Mon-Sat 9.30am-6.00pm No late Night Opening Fax No: 071-323 4737

LONDON SHOP: Selfridges (1st Floor), Oxford Street, London, W1A 1AB Tel: 071-629 1234
Opening Hours: Mon-Sat 9.30am-6.00pm Late Night: Thursday until 8pm Extension: 3914

SIDCUP SHOP: 1-4 The Mews, Hatherley Rd, Sidcup, Kent, DA14 4DX Tel: 081-302 8811
Opening Hours: Mon-Sat 9.00am-5.30pm Late Night: Friday until 7pm Fax No: 081-309 0917

To: Silica Systems, Dept AMSHP-0592-55, 1-4 The Mews, Hatherley Rd, Sidcup, Kent, DA14 4DX
PLEASE SEND A CITIZEN COLOUR CATALOGUE

Mr/Mrs/Miss/Ms: Initials: Surname:

Address:

Postcode:

Tel (Home): Tel (Work):

Company Name (if applicable):

Which computer(s), if any, do you own?

MAIL ORDER HOTLINE
081-309 1111

SILICA SYSTEMS

BUYING ADVICE FOR SHOPPERS

Whether buying over the phone or at a local store, here's our advice on how to get what you want

BUYING IN PERSON

- Where possible, always test any software and hardware in the shop before taking it home, to make sure that it works properly.
- Make sure you have all the necessary leads, manuals or other accessories you need.
- Don't forget to keep your receipt.

BUYING BY PHONE

- Be as clear as possible when stating what you want to buy. Make sure you confirm all the technical details of what you are buying. Some things to bear in mind are version numbers, memory requirements, other required hardware or software and compatibility with your particular model of Amiga (that is, make sure you know which version of Kickstart you have).
- Check the price you are asked to pay, and make sure that it's the same as the price advertised.

- Check that what you are ordering is actually in stock.
- Check when and how the article will be delivered, and that any extra charges are as stated on the advert.
- Make a note of the date and time when you order the product.

BUYING BY POST

As with buying by phone, you should clearly state exactly what it is you are buying, at what price (refer to the magazine, page and issue number where it's advertised) and give any relevant information about your system set-up where necessary. You should also make sure you keep copies of all correspondence both to and from the company concerned.

MAKING RETURNS

Whichever method you buy by, you are entitled to return a product if it fails to meet any one of the following three criteria:

- The goods must be of 'merchantable quality'.
 - The goods must be 'as described'.
 - The goods must be fit for the purpose for which they were sold. If they fail to satisfy any or all of the criteria, then you are then entitled to:
 - Return them for a refund.
 - Receive compensation for part of the value.
 - Get a replacement or free repair.
- When returning anything, ensure that you have proof of purchase and that you return the item as soon as possible after receiving it. For this reason it is important that you check the hardware or software as soon as it is delivered to make sure everything you ordered is there and works as it is supposed to.

HOW TO PAY

Paying by credit card is the most sensible way, whether buying in person, by post or on the phone, because you may be able to claim the money from the credit card company even if the firm you ordered from has gone bust or refuses to help sort out your problem.

Otherwise, you should pay by crossed cheque or postal order – never send coins or notes through the mail.

GETTING REPAIRS

Always check the conditions of the guarantee, and servicing and replacement policy, so that you know what level of support to expect. Always fill in and return warranty cards as soon as possible, and make sure that you are aware of all the conditions contained in the guarantee.

BUYING PD

Even though PD software is relatively inexpensive, you should still apply the guidelines set out above, making sure that you confirm all orders as clearly as possible.

Shopping around is still important when buying PD because different houses charge different prices for the same disks. There is no set pricing structure for disks, but bear in mind that PD houses are, in theory, supposed to be non-profit making operations. **AS**

A CHECK LIST FOR MAIL ORDER BUYING

- 1 Make sure you know exactly what you want. Draw up a checklist of the specifications you are looking for and what you want it to be able to do. Check with the suppliers that their product matches your list
- 2 Will the product you have in mind work with your existing set-up, and anything else you are planning to buy?
- 3 Can you see a demonstration? Many products are on display at computer shows around the country.
- 4 Are there any hidden extras? Does it need 1Mb to run, or a hard disk?
- 5 What technical support is provided by the supplier? Does the manufacturer offer after-sales advice? Check before you buy.
- 6 Check the guarantee terms. How long is the free warranty? What does it offer?
- 7 Draw up a list of these details and make them a condition of your order.
- 8 Check the price and delivery details when you order, and make a note of them.
- 9 Note down when you placed the order and who you spoke to.
- 10 When it arrives, check everything carefully. If anything is missing, don't use the product at all – contact the supplier. If it doesn't work, make the obvious checks such as the fuse. If it still doesn't work don't try to fix it – contact the supplier.

ADVERTISERS INDEX

| | |
|-----------------------------|------------|
| 1st Choice (Leeds)..... | 49-50 |
| 3 Amigos..... | 14 |
| 16 Bit Centre..... | 7 |
| A.R.K..... | 2 |
| ACC Unlimited..... | 8 |
| Ace..... | 15 |
| Amiga Format..... | 12 |
| Amiganuts..... | 15 |
| Amispeed..... | 7 |
| Analogic..... | 7 |
| Anglia PD..... | 15 |
| Arnor..... | 13 |
| Artworks..... | 8 |
| Astrocal..... | 7 |
| BCS..... | 9 |
| Best Prices..... | 12 |
| Bitcon Devices..... | 3 |
| Calculus..... | 35-3 |
| Checkmate..... | 7 |
| Complex Comp..... | 9 |
| Computatech..... | 8 |
| Cortex..... | 2 |
| Crazy Joes..... | 14 |
| Database Direct..... | 12 |
| Dataplex..... | 7 |
| Dataschool..... | 3 |
| Datel Electronics..... | 85, 13 |
| Delta Pi..... | 2 |
| Deltrax..... | 15 |
| Diamond..... | 102-10 |
| Digit..... | 9, 1 |
| Digitz..... | 15 |
| Direct Computers..... | 3 |
| DTBS..... | 15 |
| Dynamite..... | 110-11 |
| Evesham Micros..... | 114-11 |
| FCC Distribution..... | 13 |
| Firecrest..... | 2 |
| Futureworld..... | 54-5 |
| Galaxy Grafix..... | 8 |
| Gasteiner..... | 12 |
| Genisoft..... | 10 |
| Global Computing..... | 12 |
| Grapevine..... | 2 |
| Harwoods..... | 60-6 |
| Hobbyte..... | |
| Hydra Systems..... | 8 |
| ICPUG..... | 14 |
| John Slater..... | 3 |
| Ladbroke Computing..... | 11 |
| Merlin..... | OB |
| MJC Supplies..... | 8 |
| Neural PD..... | 14 |
| Omega Projects..... | 5 |
| Option 2000..... | 8 |
| PC Format..... | 11 |
| PD Magik..... | 15 |
| PD Soft..... | 15 |
| Pentire PD..... | 15 |
| Power..... | IFC, 17, 6 |
| Public Domain..... | 14 |
| Roctec..... | 1B |
| Silica Systems..... | 141, 15 |
| Snap..... | 15 |
| Softstore..... | 2 |
| Startronics..... | 14 |
| Swift..... | 1 |
| Switchsoft..... | 7 |
| The Presentation Group..... | 8 |
| Time & Space..... | 8 |
| TK Computers..... | 2 |
| Trilogic..... | 44-4 |
| Unique Computing..... | 14 |
| Uskvale..... | 8 |
| We Serve..... | |
| White Knight..... | 3 |
| Wirral..... | 15 |
| WTS Electronics..... | 77, 11 |
| Zone..... | 9 |

CDs & PDS...K&P...T&P

Credit Card Hotline 0702 466933

PD Soft (AS13) 1 Bryant Ave, Southend-on-Sea, ESSEX, SS1 2YD



NEW AMOS PD DISKS

- ADP151 UNDERSTANDING AMOS The Amos Tutorial Program Disk. A MUST
- ADP333 AMERICAN FOOTBALL You are the coach of London & have 5 seasons to win the Amosbowl.
- APD340 KARATE WORM By Mark Potter, various levels with jumping, kicking & throwing Weapons, Another cute & unusual game.
- APD343 SAVE THE TREES By Mark Potter, Move around the screen in your tank rolling over any body trying to chop the worlds trees down.
- APD347 THE JOTTER small collection of utilities. NOTEBOOK. A straight forward & easy to use note book program. SHOPPER. Enter prices, Quantities to build up a list, Also gives to a running total.
- APD350 STORY BOOKS 2 is cute activity adventure where you have to kill the evil witch.
- APD356 POWERBASE V2.0 This is an easy, friendly and Powerful database which can handle 10,000 records.

VARIOUS UTILITIES

- V013 PLAY & READ (2) A collection of education programs for the under 7 year olds.
- V016 FISH TANK SIMULATOR A program that simulates an aquarium. Visually pleasing.
- V028 SPELLCHECKER Current glossary over 9,000 words. You can add more words as you go alone.
- V029 HOUSE HOLD INVENTORY Means of maintaining all your house hold possessions.
- V041 DPAINT ART Contains loads of pictures for you to mess around with. Loads into your Dpaint.
- V048 TV & VIDEO GRAPHICS (8) Packed with background screens for your video productions. Different types of graphic styles. Peel takes an IFF picture and peels it down the screen, & more.
- V086 VIDEO PRODUCTION (2) Both disks are packed with video & genlock utilities.
- V109 PRINT STUDIO Excellent for printing pictures or text. An excellent program for all printer owners.
- V191 MASTER VIRUS KILLER Virus checker & killer. With excellent colours. Includes search disk.
- V193 THE EMULATOR Cover (Various) (2) Formats which includes CP/M, IBM-PC & ST. IBM & ST Programs requires two disk drives.
- V194 MR.BACKUP HD An excellent Hard disk backup program. Backs up all or any part of the drive.
- V195 GRAPHIC CHANGE Exchange graphics between Amiga, Atari & PC.
- V215 DISKMASTER V3.2 Copies files from one disk to another. DISKALYX Corrects & repairs.
- V261 TEXTPLUS VERSION 3.0 This disk is not just an update but completely New Word processor.
- V262 DUPLICATION & BACKUP Super Turbo Backup Copy & Copy. Four new copiers to backup your originals for safe keeping.
- V277 FORTRAN -77 V1.3c Compiler, linker & run time support library. F470
- V279 CROSSWORD CREATOR A program that creates crosswords. UPDATED VERSION.
- V284 MCAD PROGRAM The Object Drawing Program for the Amiga to CAD.
- V285 EDUCATIONAL : TYPING TUTOR A Simple typing which measures your speed on the keyboard.
- V291 POSTSCRIPT INTERPRETER V1.5 Down load any Post Script fonts to your printer. Like a laser printer.
- V298 NORTH C.V1.3 This is the most famous C.V. Europe on the Amiga. Includes all files required.
- V301 EYE OF THE BEHOLDER HINT BOOK Inc introduction, background, Maps, Strategy & Solution.
- V304 CHAOS STRIKES BACK HINT BOOK Inc introduction, background, Maps, Strategy & Solution.
- V306 A-GENE V3.125 Latest version of the Family tree program in CU Amiga.
- V311 JACK NICKLUS COURSE DISKS (5) A selection of Extra courses designed with the construction kit.
- V323 ANALYTICAL SPREAD SHEET (2) This is the best spread sheet program to date on the Amiga.
- V327 SOUND TRAKER CONVERTER Load in a sound traker tune & save on executable file.
- V330 RED SECTOR EXTRAS DISK 1 On this disk are 2 point Fonts, 16 Point fonts, vector stars, Star fields & music Space Journey Lorna. By the deadzone Troopers.
- V331 RED SECTOR EXTRAS DISK 2 On this disk are 10 logos, little Logos, Vector Stars, Starfields, Bob Animis, actor Objects, Vector Ball Objects & various Fonts.
- V332 AMIGA PUNK PROGRAM Predict which one will win with this horse prediction program.
- V333 KING JAMES (4) This version of the Bible by King James has been typed onto disk & packed on (4) 1/2 IBM Transformer V3.3 This is the latest version of the IBM Emulator disk.
- V340 VIDEO EMULATOR DATA DISK 1 Adventure Classics needs v2.6 or v4.43
- V340 TSB VECTOR DESIGNER The Special Bosses resets the TSB Vector designer V1.1. This program will relate filled vector objects, line vectors & Bobs.
- V341 CLIP ART COLLECTION 2: (8) more disks ill packed with excellent clip art.
- V342 VIDEO EDITOR (2) Replaces the CU Command line makes life very easy. Recommended for all.
- V350 BUSINESS CARD MAKER Design your own business cards on the Amiga
- V354 PDS UTILITIES NO 13 FREECOPY, Removes selected games copy protection so that the user can still them on his/her hard disk. DCAT, Can create your own disk catalogue. SCENERY Creates some excellent fractal based land scapes. NUKE.
- V358 GENESIS LANDSCAPE Sculpt or Mould any 3d land scape in various types & sizes, Shareware.
- V361 PDS UTILITIES 14 : MODCONVERT, Program. CISE PLAYER, Program. MULTI PLAYER, Program. V360 MINDWORKBENCH V1.0 (2) An excellent Workbench II replacement for all v3.3 users. Recommended.
- V365 RED SECTOR MODULES (MUSIC) : Various music modules for use with the RSI Demo Maker.
- V366 600 BUSINESS LETTERS There are over 600 standard business letters on this disk. Can be used as are, or insert some parts into your own letters/text.
- V390 VIDEO SCREEN TOP PUBLISHING PROGRAM The first rigous PD Desk Top Publishing program. Includes various extra features over the old Word processor, Test itior, Graphics editor & loads more.
- V392 AMICASH The best banking program that i've ever used on the Amiga, easy controls.
- V393 PDS UTILITIES NO 15 : BOOTGAMES, The idea is to stall one of two games onto your disks bootlock. Breakout Breaker, Very simple to use. BOOTGEN, Another boot block program. BOOTPIC, This program will install any IFF picture to your disks bootlock. TRAINER MAKER.
- V394 CHEMESTIC, A program that draws molecules using the collette model. Excellent effects.
- V395 EDIT WORD PROCESSOR V2.6h This is an excellent Word Processor with various learn modes, auto customization, Hypertext, On line help, A teach dede, Split windows, Copy, Paste, Undo & More.
- V396 PDS UTILITIES NO 16 : DATEAEST, Excellent table processor. A nice menu driven system.
- V397 MANDELBROT ADVENTURE KIT A well done 3d/3d Generator with full source Code.
- V399 PDS UTILITIES NO 17 : STITCHERY, A niting item program & MOVIE, Video production scroller.
- V400 RAY TRACER CONSTRUCTION KIT A Ray cer for the Amiga computer. Load Workbench first.
- V401 MINDWORKBENCH V1.0 (2) An excellent Workbench II replacement for all v3.3 users. Recommended.
- V403 AMOS UPDATE V1.32 This is the latest MOS update for the Amos Programmer.
- V410 PDS UTILITIES NO 1 : PRINTING UTILITIES Type, PPSHOW, ABFD, View, Tiny Print, FASTJET, A gram for Deskjet 500 users you want to use the software enhanced graphic set. GWINP II.
- V411 NCCOM V1.921 The latest version of that excellent Word processor. Best Demo program.
- V413 WORKBENCH 2 & WORK STATION This is just another workbench one. It's a collection of files with the Workbench Theme. (2)
- V415 VIDEO SCREENS II Excellent back ground lures for video production work.
- V417 SUPERBENCH & EXTRAS (2) An excellent re-entric disk with more utilities than the original WB.
- V420 CURSOR BASIC COMPILER Compile any logic Basic program with this utility disk.

C: COMMANDS

- C423 C: COMMANDS This disk is filled with utilities which can be used in StartUp-sequences.
- C424 PDS UTILITIES NO 18 Utilities include, Antiflicker program, Said to stop the flicker in High Res. Atari ST Emulator, Program to turn your amiga info on ST.
- C431 IMPLODER V4.0 This is the latest version of the best cruncher. Reduces file size for storage on hard drives over your own collection disks.
- C433 ANIMATION STUDIO An excellent Animation creator for you to make your own.
- C438 OPTI UTILITIES V2.0 This disk is packed with some excellent hard disk utilities.
- C439 AMIGA C: MANUAL This manual is the complete C: manual for the Amiga & describes open & work with all parts of the C: system. It also contains various examples, some simple & some more complex all the way through the disks a tutorial is there for help out. (4)
- C443 SPECTRUM EMULATOR V1.2 By KGB Main updated features is it now has sound ability.
- C444 PRINTER DRIVER UPDATE DISK III Now contains instruction how to install them. All previous drivers included on this disk. Over 90
- C445 JRCOMM V1.02 This is the latest version of the excellent modern based computer program.
- C455 LAND BUILDER A fractal generating program to generate landscapes.
- C456 PRINTING UTILITIES NO 2 : LABELBASE V3.0 An Excellent data base program this is very easy to use. Recommended. Various other good utilities.
- C458 NIB COPIER Another copying program. Please check the copyright of the program that you intend to copy. Very good new version. (2) Drives P-Reader and much much more. Excellent disk.
- C468 DIGITAL ADDRESS BOOK Collect & save your address lists on computer. Shareware.
- C475 P-SUITE V1.4 A collection of programs collect P Write, P Merge, P Sort, P Copy, P Draw, P-Reader and much much more. Excellent disk.
- C479 CHESS & CHESS UTILITIES A collection of chess related Puzzles, Programs & Utilities.
- C483 THE RIPPER GUIDE A collection of help-full utilities for people who rip pictures & sounds.
- C484 ADVERTISE SOLUTION (2) Another good collection of advertising solutions for various games.
- C486 DWB RENDER Another ray tracing prog.
- C488 A-RENDER v3.0 Another Ray tracing prog.
- C489 AMIBASE II This is the latest updated version of the excellent database program. now includes various excellent new features.
- C490 MESSY SID II This is the latest version. It will read MS-Dos disks and transfer any text files & from the PC disk / Your Amiga. So you can do work on an IBM or an Amiga and swap text between them.
- C491 TEXT ENGINE V2.1 Another excellent word processor program Simple but will do the job
- C492 JANI RIPPER V1.7 & JAM CRACKER V1.0 A music editor & major utilities. Also contains an excellent music ripper program.
- C493 DESKVIEW V (3) This is an excellent Workbench replacement with special utilities. (3)
- C497 BEATRIX POTTER CLIP ART An excellent collection of clip art for any DTP program or Dpaint.
- C498 THE SOUND ENGINE V2.0 By Simon I., Z (Midi), J-Ham cracker, future Composer, Sound monitor, Noise/Practicer, Startrækker, Delta, sound system, david Whioaker & Noisepacker.
- C499 STAR CHART V1.2 This is an excellent star plotting program with some interesting features.
- C500 THE SOUND ENGINE V2.0 By Simon I., Z (Midi), J-Ham cracker, future Composer, Sound monitor, Noise/Practicer, Startrækker, Delta, sound system, david Whioaker & Noisepacker.
- C509 MED V3.2 This is another update to the Ultimate sound music program.
- C510 LUTTEBENCH This workbench replacement is the first one for the new Amiga 500+ computer.
- C515 THE RAY TRACER V1.0 A very complete C:64 Emulator. Actually runs faster than 64. Runs 64 basic. Transfers disks from your original 64 disk drive with a shareware lead in.
- C517 VIDEO & AMIN : VIDEO DA A program for keep track on your video tape collections. RTAP lets you lay out your video tapes on mini machines.
- C518 IMAGE LAB Performs many effects from simple averaging to fast fourier transforms. Tools On Top, Does loads, colours & gray bar generation.
- C519 STILLSTORE Used to create over the shoulder graphic inserts like the 90 clock news.
- C520 GRAPHICS : AGRAPH Creates colourful slides, bar and line graphs. PICBASE Shows reduced versions of all of your IFF pictures on clip / hard drive.
- C521 PLOTTING & GRAPHICS: PLOTXY A powerful full featured plotting package. PLANS, A well done computer aided drafting program.
- C522 ARP V1.3 : Common V1.4 Makes many im- portants files for Amiga users. Makes your system easier to use. Includes full source developers guide.
- C523 DICE C COMPLIER Matthew Dillons full featured powerful C compiler & environment system. (2)
- C525 LABEL MAKER V1.3 An excellent disk printing program with various new features.
- C526 DRAW MAP V3.1 Will now generate any 16 colour palette with user defined colours. Includes larger maps with national boundaries, improved help and printing (2) 1/2 Mb. IBM version on disk V2/3
- C528 PDS UTILS:20 : SUPERDUPR, Another excellent disk copy program. Latest update with new feature. Diskspaced & FullView.
- C529 FRACTAL & SCULPT 4d: Tree 4d, Creates sculpt 4d trees with leaves. Colour 4d, IFSGen & Plasma.
- C530 BUDGET A program to help managing personal finances. This is an update to disk V2/80.
- C536 CATALOGUE UTILITIES A collection of utilities used to catalogue disk / video / tape collections (2)
- C543 DISK STATION (2) An excellent workbench replacement with full source code.
- C546 KIDS PAINT A painting program designed for children. Includes various colours and speech.
- C547 RADBENCH V1.4 Another workbench replacement / Enhancement disk.
- C549 ELECTROCAD V1.4 Another Updated on the new Amiga program for creating Amos.
- C550 KEFRES POWER UTILITIES newTopez, Power Fonts, Create, Edit or change any 8x8 or 16x16 fonts. Window, Change size of dos windows.
- C551 THE SUPER KILLERS V2.3: BOOT X V4.40 This is the best virus killer to date kills over 232 virus & may be more, includes Various excellent killers. Including V3.0 Virus Killer II v2.0 V2.37
- C552 PRINT UTILITIES DiskII, HyperCat, Label print, Super reltab, LabelBase III.
- C553 SHADOW UTILITIES Raster Blaster II, Simplesinal & Text Writer v1.0.
- C554 R.S.I. MUSIC MODULES 2/3 Another selection of music from Red Sector.
- C556 RED SECTOR HELP DISK Another disk to help you use the Red Sector Demo creator.
- C557 TOO SEXY UTILITIES A very large selection of utilities including, V-Checker, Print Studio, Super Duper & Nuke. Far to many utilities to list.
- C559 JUNA TRAKER V.9 Another good sound tracker close. Used to create the music from Toki.

AMIGA PD COPIERS

- 1749 SCRAMBLE The Original Remember that old classic well is now on the Amiga. The Shoot em up.
- 1870 PATIENCE'S & DOMINOS The famous card game. This is the best version to date.
- 1964 AMIGA COLUMNS Famous conversion of the original game columns. Tetris variant
- 1977 POM POM GUNNER Shoot down the incoming world war II air planes.
- 1981 TRUCKING ON A truck traveling adventure trading game. An excellent simulator. (2)
- 1984 AIR WARRIOR The first real flight simulator on the amiga with various Air planes to fly.
- 1986 JETMAN Another spectrum classic converted to the amiga. It's JetPac.
- 2022 SEA LANCE The first Silent Service type sub war game within our amiga PD collection. BEST GAME OF 1991 BY AMIGA FORMAL ISSUE 30
- 2054 ATAC A rendition of the game from the Original Spectrum computer.
- 2161 ETHOS GAME An excellent new role playing / Strategy game. Load through workbench.
- 2162 BATTLE OF BRITAIN WAR GAME 2 Strategy war games which both need loading through WB.
- 2164 DUNGEON ON NADROJ This is the best of the 2000+ puzzles. DORICOR V2.0 Imports what have played in a long time. Recommended for all.
- 2170 NUO GAME A vertically scrolling shoot em up where you must battle through various motherships.
- 2171 WESTLANDS An excellent game, viewed in most Magazine with very good reviews.
- 2173 CARD GAMES Various card games filled with Bobage, Blue moon, King, Patience & Hearts.
- 2177 MISSION X : RAID II This is a shoot em up game in the style of SWIV & 1943. Very good game
- 2178 SURVIVOR An excellent space based adventure game in the Aliens theme. Nice colourful graphics & recommended by all here at PD-Soft.
- 2179 ADVENTURES IN HELL A collection of six games, Jedi, Star trek, Atlantis, Ring & Indication.
- 2180 SKODA CHALLENGE An excellent 4 player horrid game written in Amos. Simple but good fun.
- 2185 BATTLECRAS This is one of the best PD Games on the Amiga to date. Solid 3d graphics. travel around, track down the other cars and destroy.
- 2199 PARACHUTE JOUST Another excellent game where you are falling down to earth, you must take the Parachute from the other player by hling him, there an excellent graphical ending for the losing player.
- 2218 THE BEAST Similar game play to the classic chess. Take your side and trap the beast. Very good.
- 2219 NAPOLEONIC WAR SIMULATOR v5.0 Excellent program sent direct by the author.
- 2220 STRATEGIC GAMES Eternal Rome, Lords of Hosts, in Moonshine. Excellent collection.
- 2221 MIND GAMES 21 of the best Mind games to challenge your mind not your shooting games.
- 2224 EYE OF THE BEHOLDER 2 & 3, 4, 5, 6, 7, 8, 9, 10, 11 & 12 of the beholder adventure game packed on three disks.
- 2226 SHARPE RIFLE A nice produced quiz game with a choice of subjects. DOWNHILL SKING
- 2227 SNAKE PIT, CHINA, CHALLENGE & RUBIK
- 2273 BACKGAMMON, PUSHERO & PUZZLE PRO
- 2278 CARD SHARP A very professionally present ed selection of solitaire type card games.
- 2279 SUB ATTACK v1.0 Control the torpedoes & sink the enemy ships as they sail past. LANDMINE.
- 2313 REVENGE OF THE MUTANT CARTEL By Jeff Minter The ride of a life time with mutant carnels that spill plutonium death. Now PLUS Compatible.
- ADP229 AMOS FRUIT MACHINE II By Gary Hunt. This program is as near as possible to the type of fruit machine you find in any snook hall or Pub / Arcade. Features include: Numbers, Heds, Winspins, superwins, Bronze / Silver / Gold Pots, Skill Shots, Stop a win, Cashpot, Gamble & collect.

LATEST FRED FISH DISKS

All Fred Fish disks are Workbench driven but know-age of CU/Shell may be required to run some of the programs. Most programs will work with V1.0 & 1.4 full details can be found on our Credit Card disks.

- F563 BASE II V5.0 A simple database program using an intuitive interface. Sorts & searches for information, fast sorting. Search & is easy to use.
- F578 SPICE3 A circuit analysis program which has been modified to run on the Amiga.
- F579 OCTAMED V1.000 A music editor which was originally designed for making music for programs (demos, games, etc.) but works well as a stand-alone music program as well. OCTAMED is the 8-channel version of MED.
- F580 WORLD DATABANK v2.2 Using a data base from the CIA, this program will plot world maps.
- F583 SUPERPELL A global spelling checker that checks your spelling no matter what program you are typing under. Works with any word processor, dictionary, which you can edit, add or replace completely.
- F589 TERM v1.9c A telecommunications program written for AmigaOS release 2.1. Kickstart 37.17.5 & Workbench 37.67 or higher required. Features include full configurability.
- F590 SUPERDUPER A very fast disk copy & formatter. Can make up to four unverified copies from a ram buffer in 36 seconds. Verified copies from a ram buffer take 67 seconds for one destination drive, plus 34 seconds for each additional destination. This is version 2.0.
- F593 ANALYTRIM (2) An integration of AnalyCalc spreadsheet & RIM-5 Database management
- F601 PP V1.4 Use this Patch to load Power Packer files into any standard word processor, in text Plus or Ledit.
- F602 MATHS ADV A simple game where you the young adventurer, must try to escape the Kings Math's adventure. After each room the questions get harder.
- F603 DYNACADD A demo of DynaCadd from Ditek Information. DynaCadd is a professional 2d & 3d cad package. Requires the next two disks in the set (3)
- F603 ICONTRACER Turns your V1.3 icons into the same colours & images as the new V2.0 amiga's.
- F604 RINGWAR A classic arcade game of reflexes. The vector graphics are similar to asteroids & Tempest.
- F606 AUTOGRAPH Collects & graphical displays info on auto mileage. Includes MPG, Cost per mile & more. PR-FONT, Prints a sample of the next font in the font set. SPELL-CHECK, Aids you in learning foreign words. version 1.4
- F607 ANIMFAVER Video production utility to fade screens in & out.
- F608 VERTEX A 3d object editor that differs from other 3d editors in many ways. View any perspective.
- F609 AUTOPOPT Software switch which makes possible to use a trackball in the mouse port. BASEE II v5.3 Database which, includes fast sort, search & easy controls. BOOTPIC Install any IFF pic as a Bootlock.
- F610 ATOMIC Copy files from one side of a bridge board to the Amiga side. PCXECUTE A small program to execute programs on a Bridge board without opening a PC window.

C: COMMANDS

- A2 C: PROGRAMS, Alb, Ar, Frobj, Shell, Yacht, Make, Emacs, TUTORIALS, Animate & Gadgets.
- A3 C: COMMANDS, Xrel, 6bitcolor, Chop, Cleanup, Ctrl, Error, Hello, Kermil, Scales, Skewb, BASIC, Animate, Crazy Eights, PROGRAMS, Disassem.
- A8 C: COMMANDS, Browse, Crunch, Icon, Exec, Deccran, Dump, Smack, BASIC, Addressbook, Ball, Clacid, Jic, Colour Art, DDraw, Many others.
- A11 C: COMMANDS (4), Two many to list. Loads of interesting programs. Also ASSEMBLER PROGRAMS.
- A19 C: COMMANDS, Solve, Gadgets, Household, Waveform, DiskLib, Subscripts, String & Boolean.
- A20 C: COMMANDS, Compor, Decoder, Bobbed, Deconvolve, K, Smedley, Keyboard & Joystick.
- A21 C: COMMANDS, Torped, SnapShot, Sand, Prop Gadget, ExtraHalfBright & Anisript, Ect.
- A22 C: COMMANDS, Cycles, ShowPrintII, Animations, Garden & basiscors, Ect.
- A24 C: COMMANDS, Moose, Bman, QuickFix, Daisy, BoingMachine, Monoloco, BNTtools & Code.

STAR TREK SELECTION

- AT05 Klingon D7 Cruiser fires torpedoes while passing. NCC-1864 reliant Very good.
- AT10 ENTERPRISES Leaves the Star station dock. NCC 1701-A. The classic animation.
- AT12 THE THWOK NCC 1860 Patient & the NCC 1701-A-Enterprise. MENSCH ROBOTER
- AT18 THWOK 0 Anim NCC 1860 Avenger & NCC 1701-A-Enterprise. NCC 1089 Grissol.
- AT22 APPROACHING VESSELS Animation, Binary Field Wireframe landscape by Richter
- AT23 STAR TREK FLEET MANEUVER NCC-1940 over & by onimatic disk (IMB)
- AT33 THE PROBE II Animation & BRID OF PREY Animation from Star Trek. KLINGONHIT
- AT34 LEAVING SPACE OFFICE Animation, DOCKING Animation from star trek. ATTACK MODE Bird of Prey Scout hit in attack mode.
- AT40 STAR TREK THE NEXT GENERATION This game is by Terry A. Mc Intosh v1.47
- TOB1 THE ULTIMATE STAR TREK (2) Game by Tobias Richter. Now with English instructions.
- 2222 STAR TREK THE NEXT GENERATION This is the latest quiz game based on the Next generation (2)
- 3 SMAUG156 The Star Trek game by Jimbo Barbers American version 1Mb and (2) disks
- AMUSE19 TREK73 A strek trek Battle Simul-ator where you can attack klingons & Romulans
- 3567 STAR TREK INFORMATION A Data base of all the original series. Very Detailed.

MEGA DEMOS

- 1988 RAY OF HOPE II This is one of the best graphical mega demos we have seen he at PD-Soft.
- 2028 IBB MANGAD This production has been called DEMO OF THE MONTH NOV 91 by all here at PD-Soft. Excellent Sound, music & Graphics.
- 2137 WILDFIRE Reviewed in most of the popular magazines. Brilliant with plenty of innovative parts.
- 2174 HYPNAUTIC HAMMER A fantastic fast moving Animating Mega Demo with great effects.
- 2250 ODYSSEY - ALCATRAZ (5) This is another of the brilliant mega demos from this onrths releases.
- 2259 HARDWORLD - CRONICS (2) The best are back & heads the charts with one of the best.

ERIC SWARTZ SELECTION

- 1700 ANTI LEMMINGS Anim requires (2) 2Mb
- 1703 THE DATING GAME Anim requires (2) 2Mb
- 1794 VOLT CONTEST features a helicopter & the stealy jet plane. Hell try to keep up. (IMB)
- 1842 SHUTTLE COCK Animation (IMB)
- 181 LATE NIGHT & TERMINAL ANIM (IMB)
- 2013 AGILITY Animation disk (IMB)
- 2021 VIETNAM CONFLICT Animation (IMB)
- 2133 GOLF WAR CONFLICT An Excellent Anim.
- 2307 AMY AT THE MOVIES II This is one of the latest animation from Eric Schwartz. (4) 1Mb ONLY.
- 2311 AMY vs THE WALKER II This is one of the latest animation from Eric Schwartz. (3) Mb
- 2384 AMY AT THE BEACH (2) Probly the best animation by ES to date. Excellent 3Mb

GAMES SELECTION

- 1073 TETRIS ORIGINAL This is the closest game to the original tetris computer game. A Classic
- 1420 TETRIS This is the best 2 Player Tetris game.
- 1454 MEGA BALL An excellent Arkanoid game
- 1486 SOLITAIRE & SOLITAIRE RAYNO Two very excellent & addictive card games.
- 1735 TETRIS This is the best version of Tetris on the amiga with a 3 play option.
- 1735 ASTEROIDS 'THE ORIGINAL' Another old classic. Remember that Classic.
- 1747 LLAMATRON GAME 2001 By Jeff Minter Brilliant stuff & An excellent production.

EASY ORDERING INFORMATION & ORDER FORM

ORDERING BY POST:
When ordering disks please tick the boxes to the left of the disk numbers (Any coloured pen, Hi-Lighter or just plain white ink). After selecting the disks/software that you require, Please fill in your Name & Address on the order form provided. Cut out or Photocopy this advert. Hand written orders are accepted, & Post to the address Above. Cheques & Postal orders should be made payable to PD-SOFT. If you have ordered before please tick the account number box.

ORDERING BY TELEPHONE:
The telephone hotline is open six days a week from 9am to 7pm (Week days) & from 10am - 4pm (Saturdays). Just quote your Credit card number, Name, Address, if you have ordered before, Day time telephone Number, Disk Numbers & Where you are ordering from like which Magazine!

FLETCHER FONT PACK : 5

£15.00 PER PACK : 6 DISKS

Six disks packed with a varied assortment of coloured fonts in many colours, shapes & sizes. For use with Dpaint programs or any Video production utilities. This pack has some totally outstanding fonts and for only £15 they give you over 70 fonts to play with. Best produced & totally stunning.

OTHER FLETCHER FONTS PACKS ARE: FFF1, FFF2, FFF3 FFF4 & FFF5 All colour font packs, 6 disks each. FFF4 & FFF5 Both are mono font packs, 6 disks each

| NAME | ADDRESS | POSTCODE | A/c No | TELEPHONE | | | | | | | | | | | | | | | | | | | | | | | | | | | | | | |
|-------------------------------------------------------------------------------------------------------------------------------------------------------------------------------------------------------------------------------------------------------------------------------------------------------------------------------------------------------------------------------------------------------------------------------------------------------------------------------------------------------------------------------------------------------------------------------------------------------------------------------------------------------------------------------------------------------------------------------------------------------------------|--------------|------------------|--------|-----------|--|--------------|--|---------------|-------|---|----------------------|-------|---|----------------------|-------|---|------------------------------|--------|---|------------------------------|--------|---|------------------|-------|---|-------------------------|-------|---|--------------------------|-------|---|---------------------------|--------|---|
| CREDIT CARD NUMBER (MASTERCARD or VISA) EXPIRY DATE | | | | | | | | | | | | | | | | | | | | | | | | | | | | | | | | | | |
| Total PD Price £ | | Total PD Disks # | | | | | | | | | | | | | | | | | | | | | | | | | | | | | | | | |
| <table border="1"> <thead> <tr> <th></th> <th>AMOUNT PRICE</th> <th></th> </tr> </thead> <tbody> <tr> <td>THE MOUSE PAD</td> <td>£2.99</td> <td>E</td> </tr> <tr> <td>THE AMIGA DUST COVER</td> <td>£2.99</td> <td>E</td> </tr> <tr> <td>5 DISK CLEANING KITS</td> <td>£2.99</td> <td>E</td> </tr> <tr> <td>DISK LABELS Single / Min 5.0</td> <td>£0.03p</td> <td>E</td> </tr> <tr> <td>ROLL OF 1000 SICK LABELS 3.5</td> <td>£10.99</td> <td>E</td> </tr> <tr> <td>2M PRINTER LEADS</td> <td>£6.49</td> <td>E</td> </tr> <tr> <td>DISK BOX (40) 3.5 INCH.</td> <td>£4.99</td> <td>E</td> </tr> <tr> <td>DISK BOX (100) 3.5 INCH.</td> <td>£7.99</td> <td>E</td> </tr> <tr> <td>512K UPGRADES Inc a Clock</td> <td>£34.99</td> <td>E</td> </tr> </tbody> </table> | | | | | | AMOUNT PRICE | | THE MOUSE PAD | £2.99 | E | THE AMIGA DUST COVER | £2.99 | E | 5 DISK CLEANING KITS | £2.99 | E | DISK LABELS Single / Min 5.0 | £0.03p | E | ROLL OF 1000 SICK LABELS 3.5 | £10.99 | E | 2M PRINTER LEADS | £6.49 | E | DISK BOX (40) 3.5 INCH. | £4.99 | E | DISK BOX (100) 3.5 INCH. | £7.99 | E | 512K UPGRADES Inc a Clock | £34.99 | E |
| | AMOUNT PRICE | | | | | | | | | | | | | | | | | | | | | | | | | | | | | | | | | |
| THE MOUSE PAD | £2.99 | E | | | | | | | | | | | | | | | | | | | | | | | | | | | | | | | | |
| THE AMIGA DUST COVER | £2.99 | E | | | | | | | | | | | | | | | | | | | | | | | | | | | | | | | | |
| 5 DISK CLEANING KITS | £2.99 | E | | | | | | | | | | | | | | | | | | | | | | | | | | | | | | | | |
| DISK LABELS Single / Min 5.0 | £0.03p | E | | | | | | | | | | | | | | | | | | | | | | | | | | | | | | | | |
| ROLL OF 1000 SICK LABELS 3.5 | £10.99 | E | | | | | | | | | | | | | | | | | | | | | | | | | | | | | | | | |
| 2M PRINTER LEADS | £6.49 | E | | | | | | | | | | | | | | | | | | | | | | | | | | | | | | | | |
| DISK BOX (40) 3.5 INCH. | £4.99 | E | | | | | | | | | | | | | | | | | | | | | | | | | | | | | | | | |
| DISK BOX (100) 3.5 INCH. | £7.99 | E | | | | | | | | | | | | | | | | | | | | | | | | | | | | | | | | |
| 512K UPGRADES Inc a Clock | £34.99 | E | | | | | | | | | | | | | | | | | | | | | | | | | | | | | | | | |
| 50+...Disks £1.50 | | | | | | | | | | | | | | | | | | | | | | | | | | | | | | | | | | |

CATALOGUE Tired of boring catalogue disks? Get the unique, easy to use Database Disks. This contains details of over 4,500 disks & are all available direct from stock. A multitude of options including Search & you can search on any field. IBAS, AM, FALX, SMAUG, Scope, Agglonr, APDC, Panoroma, Amicus, Silk, Joe Larson, TUG, NZALUG, TOKI & Licenceware. **£1.50**

COMPLETE The Complete Fred Fish has been professionally printed, bound & includes a sorted index as the new disks are released. Please note that the updates are only available from PD-Soft. FRED FISH is a collection of Amiga Games, Utilities & Much More. Each disk is £4.99 totally packed with programs. All Fred Fish disks come with full instructions.

REMEMBER PD-SOFT STOCKS ALL THE FRED FISH DISKS, ALL OF THE TIME.

Any other disks Required, (Inc Budget Software, Pollysoft Licenceware & Fletcher Font Packs), **TOTAL PRICE £**

PRODUCTS

PRODUCT LOCATOR

HARDWARE • HARDWARE • HARDWARE • HARDWARE • HARDWARE • HARDWARE • HARDWARE • HARDWARE

Welcome to the *Amiga Shopper* Buyer's Guide, your regular guide to what's hot and what's not in the Amiga market place. It's designed as a simple-to-use yet comprehensive guide which will help you to make the right buying decisions. It may not include each and every product ever produced for the Amiga (that would take up virtually the whole of *Amiga Shopper!*), but rest

assured that all major brands and models are here.

The Buyer's Guide will run each and every month and as new products are released and others discontinued, we'll be updating it accordingly. This month we bring you what is possibly the most comprehensive guide to hardware for the Amiga owner. Next month we'll be listing Amiga software...

AMIGAS

| Model | Price | Memory | Total Chip | Total Fast | Processor | Speed (MHz) | Hard Disk (Mb) | Floppies | Comment |
|---------|-------|--------|------------|------------|-----------|-------------|----------------|----------|---------------------------------------------------------|
| A500 | £399 | 1 Mb | 2 Mb | 10 Mb | 68000 | 7 | No | 1x880k | Base machine. Recently upgraded to OS 2.0 |
| A1500 | £999 | 1 Mb | 1 Mb | 9 Mb | 68000 | 7 | No | 2x880k | More expandable than A500 |
| A2000HD | £1299 | 1 Mb | 1 Mb | 9 Mb | 68000 | 7 | 40 | 1x880k | Exactly the same as A1500, but now includes hard disk |
| A2500 | £7??? | 1 Mb | 1 Mb | 9 Mb | 68020 | 16 | 40 | 1x880k | Same as A2000HD, but comes with processor card |
| A3000 | £3160 | 2 Mb | 2 Mb | 16 Mb | 68030 | 16/25 | 50/100 | 1x880k | Available in several hard disk/processor configurations |

Note: A500 and A1500 now denote 2.0-based machines. A2500 only available in the US.

HARD DRIVES

| Model | Supplier | Price | Machine | Capacity (Mb) | RAM Expansion | Rating | Issue |
|---------------|-----------------|-------|---------|---------------|---------------|--------|----------|
| Impact II+ | Silica | £399 | A500 | 50/110 | 8 Mb | **** | 1.2,8,13 |
| A590 | Commodore | £399 | A500 | 20 | 2 Mb | *** | 1.2,8,13 |
| DataFlyer500 | Trilogic | £350 | A500 | 48 | - | ** | 1.2,8,13 |
| 500XP | Surface UK | £489 | A500 | 40 | 2/8 Mb | **** | 1.2,8,13 |
| FastTrak | Third Coast | £599 | A500 | 40 | - | *** | 8 |
| Novia 30i | Power Computing | £399 | A500 | 20/30 | - | *** | 8 |
| Prima | Power Computing | £499 | A500 | 50/100 | - | **** | 8 |
| Trumpcard | Third Coast | £399 | A500 | 40 | - | *** | 8 |
| Protar HD | Protar | £299 | A500 | 20 | 8 Mb | **** | - |
| Impact IIHC+8 | Silica | £299 | A1500→ | 40-300 | 8 Mb | **** | 1.2,13 |
| DataFlyer2000 | Trilogic | £350 | A1500→ | 48 | - | *** | 1.2 |
| WordSync2000 | Surface UK | £450 | A1500→ | 52 | - | **** | 1.13 |
| A2091-40 | Commodore | £200 | A1500→ | 40 | - | ** | 8,13 |
| Nexus HC | Power Computing | £350 | A1500→ | 40 | 8 Mb | **** | 8,13 |
| SysQuest | Omega Projects | £690 | SCSI | 88 | - | **** | 8 |
| OpticalDrive | Power Computing | £1199 | SCSI | 128 | - | **** | - |
| TapeStreamer | Omega Projects | £600 | SCSI | 150 | - | **** | - |

NOTE: Trumpcard can be used on both A500 and A1500+

EXTERNAL DRIVES

| Model | Supplier | Price | Machine | Size | Capacity | Disable Switch | Rating | Issue |
|----------------|---------------------|-------|---------|--------|----------|----------------|--------|---------|
| PC880B | Power Computing | £55 | Any | 3 1/2" | 880K | Yes | **** | 8 |
| RF332C | Silica Systems | £60 | Any | 3 1/2" | 880K | Yes | **** | 0.1,2,8 |
| RF542C | Silica Systems | £80 | Any | 5 1/4" | 880K | Yes | **** | 0.1,2,8 |
| A1011 | Commodore | £100 | Any | 3 1/2" | 880K | No | *** | 0.1,2,8 |
| Zydec | Evesham Micros | £55 | Any | 3 1/2" | 880K | Yes | *** | 8 |
| CAX354 | Cumana | £75 | Any | 3 1/2" | 880K | Yes | **** | 0.1,2,8 |
| 3A-1D | Golden Image | £65 | Any | 3 1/2" | 880K | Yes | **** | 0.8 |
| AEHD | Applied Engineering | £140 | Any | 3 1/2" | 1.52 Mb | No | **** | 8 |
| Internal2000 | Power Computing | £50 | A1500→ | 3 1/2" | 880K | No | **** | 8 |
| DualDrive | Power Computing | £120 | Any | 3 1/2" | 2x880K | Yes | **** | 0.1,2,8 |
| Floptical Disk | Digital Micronics | £650 | Any | 3 1/2" | 20 Mb | Yes | **** | 8 |

NOTE: PC880B comes with built-in disk copier. Floptical Disk not yet available in UK.

RAM EXPANSIONS

| Model | Supplier | Price | Machine | Size | Max Size | Power Supply? | Fitting | Rating | Issue |
|--------------|-----------------|-------|---------|--------|----------|---------------|---------------|--------|-------|
| 500RX | Surface UK | £198 | A500 | 2 Mb | 8 Mb | Optional | Expansion Bus | **** | 5 |
| ProRAM Plus | Datel | £25 | A500 | 512k | - | - | TrapDoor | *** | 8 |
| RAM-Master 2 | Datel | £100 | A500 | 1.5 Mb | - | - | TrapDoor | *** | - |
| V2000 | Virgo | £104 | A500 | 2 Mb | - | - | TrapDoor | **** | - |
| Zydec1.5 | Zydec | £79 | A500 | 1.5 Mb | - | - | TrapDoor | **** | - |
| BaseBoard | EPD | £300 | A500 | 4 Mb | - | - | TrapDoor | **** | - |
| Ashcom512k | Ashcom | £35 | A500 | 512k | - | - | TrapDoor | **** | 8 |
| Ashcom1.8Mb | Ashcom | £155 | A500 | 1.8 Mb | - | - | TrapDoor | **** | - |
| Cortex2 | Cortex | £199 | A500 | 2 Mb | 8 Mb | Yes | Expansion Bus | **** | 8 |
| GVP Series2 | Silica | £159 | A1500→ | 2 Mb | 8 Mb | - | Card | **** | - |
| A2058 | Commodore | £159 | A1500→ | 2 Mb | 8 Mb | - | Card | **** | 8 |
| AdRAM2000 | Power Computing | £179 | A1500→ | 2 Mb | 8 Mb | - | Card | **** | 8 |
| Cortex2000 | Cortex | £175 | A1500→ | 2 Mb | 8 Mb | - | Card | **** | 8 |

PROCESSOR ACCELERATORS

| Model | Supplier | Price | Machine | Processor | Speed | Max 32-bit RAM | Maths Co-pro | Rating | Issue |
|----------------|-----------------|-------|---------|-----------|--------|----------------|--------------|--------|-------|
| Turbo68000 | Bytes&Pieces | £45 | A500 | 68000-16 | 16 MHz | - | No | ** | - |
| AdSpeed | Silica | £173 | A500 | 68000-16 | 16 MHz | - | No | **** | 3,5 |
| VXL-30 | ZCL Ltd | £409 | A500 | 68030 | 25 MHz | 8 Mb | Yes | **** | - |
| 2000/40 | Marcam | £1937 | A1500→ | 68040 | 50 MHz | 32 Mb | Yes | **** | - |
| A3001 | Silica | £1799 | A1500→ | 68030 | 50 MHz | 32 Mb | Yes | **** | 3,5 |
| G-Force | Silica | £1999 | A3000 | 68040 | 28 MHz | - | - | **** | - |
| FusionForty | Power Computing | £1999 | A1500→ | 68040 | 50 MHz | 32 Mb | Yes | **** | - |
| CSA MegaMidget | Bytes&Pieces | £389 | A500 | 68030 | 33 MHz | 8 Mb | Yes | **** | 3,5 |
| A5000-16 | Solid State | £295 | A500 | 68020 | 16 MHz | 4 Mb | Yes | **** | - |
| B5000-25 | Solid State | £595 | A500 | 68020 | 25 MHz | 16 Mb | Yes | **** | 3,5 |
| B5000-40 | Solid State | £1162 | A1500→ | 68030 | 40 MHz | 32 Mb | Yes | **** | - |
| Harms Pro30 | Bytes&Pieces | £1099 | A1500→ | 68030 | 28 MHz | 4 Mb | Yes | *** | 3,5 |
| A2630 | Commodore | £1200 | A1500→ | 68030 | 25 MHz | 4 Mb | Yes | **** | - |

NOTE: Although some 68030 cards appear to run faster than their '040 equivalents, this may not necessarily be the case. All '040 cards will run faster internally.

SCANNERS

| Model | Supplier | Price | Machine | Type | Colour | Resolution | Rating | Issue |
|-----------------|-----------------|-------|---------|-----------|--------|------------|--------|-------|
| Sharp JX-100 | Silica | £695 | Any | Hand Held | Yes | 200dpi | **** | - |
| GeniScan | Datel | £130 | Any | Hand Held | No | 400dpi | *** | - |
| GoldenImage | GoldenImage | £150 | Any | Hand Held | No | 400dpi | **** | 5 |
| Sharp JX-300 | Silica | £3600 | Any | FlatBed | Yes | 300dpi | **** | - |
| Pandaal Scanner | Pandaal | £180 | Any | Hand Held | No | 400dpi | **** | 3 |
| PowerScanner | Power Computing | £99 | Any | Hand Held | No | 400dpi | *** | 11 |

PRODUCT LOCATOR

PRODUCTS

DIGITISERS

| Model | Supplier | Price | Realtime | Colour | Realtime Colour | Animation | Rating | Issue |
|----------------|-----------------|-------|----------|--------|-----------------|-----------|--------|-------|
| DigiView 4 | Silica | £150 | No | Yes | No | No | **** | - |
| ColourPic | JCL | £399 | Yes | Yes | Yes | No | **** | 2 |
| VIDIAmiga | Rombo | £130 | Yes | Yes | No | Yes | **** | 5 |
| Videoon | Power Computing | £200 | No | Yes | No | No | *** | - |
| FrameGrabber | Marcam | £599 | Yes | Yes | Yes | Yes | **** | - |
| VideoDigitiser | Datel | £80 | Yes | Yes | No | No | **** | - |

SOUND SAMPLERS

| Model | Supplier | Price | Stereo | Volume Adjust | Resolution | Rating | Issue |
|-----------------|----------------|-------|--------|---------------|------------|--------|-------|
| StereoMaster | MicroDeal | £40 | Yes | Yes | 8-bit | **** | 11 |
| TechnoSound | New Dimensions | £35 | Yes | No | 8-bit | **** | 5 |
| Audio Engineer | HB Marketing | £199 | Yes | Yes | 8-bit | **** | 5 |
| Perfect Sound 3 | HB Marketing | £60 | Yes | Yes | 8-bit | *** | 10 |
| SampleStudio 2 | Datel | £70 | Yes | No | 8-bit | ** | - |
| Sound Master | HB Marketing | £130 | Yes | Yes | 8-bit | **** | - |
| MicroSampler | Datel | £25 | Yes | No | 8-bit | * | - |
| SoundTrap 3 | Omega Projects | £30 | No | No | 8-bit | **** | 3 |
| AMAS 2 | MicroDeal | £100 | Yes | Yes | 8-bit | **** | - |
| StereoSampler2 | Trilogic | £40 | Yes | Yes | 8-bit | **** | - |
| GVP DSS | Silica | £60 | Yes | Yes | 8-bit | **** | 3 |
| AD1012 | HB Marketing | £TBA | Yes | Yes | 12-bit | **** | - |
| AD1016 | HB Marketing | £TBA | Yes | Yes | 16-bit | **** | - |
| Audition 4 | HB Marketing | £49 | Yes | Yes | 8-bit | **** | 10 |
| Audio Sculpture | SMG | £49 | Yes | Yes | 8-bit | ** | 12 |

NOTE: AD1012 and AD1016 are for A1500→ only

GENLOCKS

| Model | Supplier | Price | Fade | Dissolve | S-VHS | RGB Pass thru | Rating | Issue |
|------------------|-----------------|-------|------|----------|-------|---------------|--------|-------|
| MicroGen | Power Computing | £199 | Yes | Yes | No | Yes | **** | - |
| MiniGen | ASAP | £99 | No | No | No | No | ** | - |
| RocGen | Silica | £117 | Yes | Yes | No | No | **** | 8 |
| RocGen+ | Silica | £199 | Yes | Yes | No | Yes | **** | 10 |
| A8802 | Marcam | £200 | No | No | No | Yes | *** | - |
| A8802S-VHS | Marcam | £600 | Yes | Yes | Yes | Yes | *** | 10 |
| A8806 | Marcam | £900 | Yes | Yes | Yes | Yes | **** | - |
| GST Gold | Third Coast | £550 | Yes | Yes | Yes | Yes | **** | - |
| VideoCentre2 | G2 | £1170 | Yes | Yes | Yes | Yes | **** | - |
| VideoCentre3 | G2 | £1999 | Yes | Yes | Yes | Yes | **** | 7 |
| VideoMaster VM-2 | Power Computing | £799 | Yes | Yes | Yes | Yes | *** | 1 |
| Videocomp G-100 | Silica | £1800 | Yes | Yes | Yes | Yes | **** | 3 |
| ImageMaster | Neriki | £1150 | Yes | Yes | Yes | Yes | *** | - |
| ProGen | Gordon Harwood | £130 | No | No | No | Yes | *** | - |

MICE

| Model | Supplier | Price | Ergonomics | Resolution | Rating | Issue |
|-----------------|----------------|-------|------------|------------|--------|-------|
| CBM Mouse | Commodore | £35 | *** | *** | *** | - |
| Naksha | Naksha UK | £28 | **** | **** | **** | - |
| Optical | Golden Image | £52 | **** | **** | **** | - |
| Opto-Mechanical | Golden Image | £26 | **** | *** | **** | - |
| Beetle | Gasteiner | £30 | **** | **** | **** | - |
| TrueMouse | Evesham Micros | £18 | **** | *** | *** | 2 |
| Daatamouse | Pandaal | £40 | **** | **** | **** | 1 |
| LogiMouse | Logitech | £27 | *** | **** | **** | - |

COLOUR CARDS

| Model | Supplier | Machine | Price | Type | Colour Palette | Max Resolution | Rating | Issue |
|-----------|-----------|---------|-------|--------|----------------|----------------|--------|-------|
| HAM-E | Checkmate | A500 | £299 | Pseudo | 24-bit | 368x580 | **** | 8 |
| DCTV | Silica | A500 | £499 | Pseudo | 24-bit | 368x580 | **** | 12 |
| GVP IV-24 | Silica | A1500→ | £1799 | 24-bit | 24-bit | 910x576 | **** | 12 |
| Harlequin | ACS | A1500→ | £1400 | 24-bit | 24-bit | 910x576 | **** | 11 |

NOTE: A500 devices can be used on all Amigas

TOUCH TABLETS

| Model | Supplier | Price | Size | Resolution | Rating | Issue |
|-----------------|--------------|-------|-------|------------|--------|-------|
| Podstat PT-3030 | HB Marketing | £179 | 9x12" | **** | **** | - |
| Genitizer | Datel | £130 | 9x6" | **** | **** | - |
| Cherry Mk4 | Cherry | £450 | 9x12" | **** | *** | - |

DOT-MATRIX PRINTERS

| Model | Supplier | Price | Pins | Speed(CPS) | Fonts | Buffer | Rating | Issue |
|----------|----------|-------|------|------------|-------|--------|--------|-------|
| P20 | NEC | £351 | 24 | 115 | 8 | 8K | **** | 4 |
| L24d | Citizen | £292 | 24 | 109 | 3 | 8K | **** | 4 |
| Swift 9 | Citizen | £280 | 9 | 121 | 3 | 8K | **** | 4 |
| Swift 24 | Citizen | £428 | 24 | 121 | 5 | 8K | **** | 4 |
| LX850 | Epson | £269 | 9/24 | 106 | 3 | 4K | *** | 4 |
| LQ400 | Epson | £269 | 24 | 121 | 3 | 8K | **** | 4 |
| LQ550 | Epson | £375 | 9 | 109 | 4 | 8K | *** | 4 |
| LC200 | Star | £304 | 24 | 91 | 4 | 16K | **** | 4 |
| LC24 | Star | £304 | 24 | 130 | 5 | 16K | **** | 4 |
| ML380 | Okí | £386 | 24 | 127 | 3 | 8K | **** | 4 |

SUPPLIER LIST • SUPPLIER LIST • SUPPLIER LIST • SUPPLIER LIST • SUPPLIER LIST • SUPPLIER LIST • SUPPLIER LIST • SUPPLIER LIST

| | | | | | | | | | |
|-----------------------|-------------------|-------------------|-------------------|----------------------|--------------|---------------------|--------------|--------------------------|--------------|
| ACS | 031 557 4242 | Cumana | 0483 503121 | Gordon Harwood | 0773 836781 | Okí | 0753 31292 | Star | 0494 471111 |
| App.Engineering | 0101 214 241 6060 | Datel Electronics | 0782 744707 | HB Marketing | 0753 686000 | Omega Projects | 0925 763946 | Surface UK | 081 566 6677 |
| ASAP | 0724280222 | Digital Micronics | 0101 619 431 8301 | JCL Business Systems | 0892 518181 | Pandaal Marketing | 0234 855666 | Third Coast Technologies | 0257472444 |
| Ashcom | 0530 411485 | EPD | 0602 841640 | Marcam Ltd | 081 941 6117 | Power Computing | 0234 273000 | Trilogic | 0274 678062 |
| Bytes & Pieces | 0253 734218 | Epson | 0442 61144 | MicroDeal | 0726 68020 | Protar | 0923 54133 | Virgo | 0276 676308 |
| Checkmate Digital Ltd | 071 923 0658 | Evesham Micros | 0386 765500 | Naksha UK | 0925 56398 | Rombo | 0506 414631 | WTS Electronics | 0582 491949 |
| Citizen | 0895 72621 | G2 Video Systems | 0252 737151 | NEC | 081 993 9831 | Silica Systems | 081 309 1111 | ZCL Ltd | 0543 251275 |
| Commodore | 0628 770088 | Gasteiner | 081 365 1151 | Neriki | 081 900 1866 | SMG | 0274 562999 | | |
| Cortex | 051 236 0480 | Golden Image | 081 518 7373 | New Dimensions | 0291 690933 | Solid State Leisure | 0933 650677 | | |

WIN • WIN • WIN • WIN • WIN • WIN • WIN • WIN

FREE - £600 worth of genlock must be won!

Yep, it's true, those generous folk at Marcam have donated a Rendale Super 8802 - all you have to do is answer three easy peasy questions

This month's competition gives you the chance to win a professional quality genlock and really get volatile with video.

A genlock enables you to combine ordinary video images with graphics from your Amiga. Its use has been made popular by the TV music series *The Chart Show*. The genlock up for grabs here, kindly donated by Marcam, is worth £600 - a tidy piece of kit that would look at home in any video pro's studio.

Reviewed back in issue 10 by Gary Whiteley, the Rendale Super 8802 will accept either PAL composite or S-VHS video input, and provides a good range of effects including fades and 16 straight-edged style wipes. Because the unit works with S-VHS, it is possible to get results of a much higher quality than some cheaper genlocks.

As you can see from our question panel to the right, we've gone a little topical with our challenge this month. We don't want facts from you this time, we want predictions. Who's going to win the General Election? Opinion at the *Amiga Shopper* office is divided, to say the least, but perhaps you have it sussed. If you think you've got your finger on the pulse of the nation (or think you can make a lucky guess), get your answers to the questions

down on a postcard or the back of a sealed envelope and pop in the post.

Because of the nature of the competition, we can only accept entries postmarked with a date before the April 9 - so get your skates on! Send your entries to: Genlock Election Jape *Amiga Shopper* 29 Monmouth Street Bath BA1 2DL **AS**

THE CHALLENGE

QUESTION 1

Who is going to win the 1992 General Election?

- a) Labour
- b) Conservative
- c) Liberal Democrats

QUESTION 2

What will be the winning margin?

- a) 1-20 seats
- b) 21-100 seats
- c) Over 100

QUESTION 3

Which party's spokesman, speaking live on Radio 4, said, "A 'p' on education is a 'p' well spent"?

- a) Conservative
- b) Labour
- c) Liberal Democrats

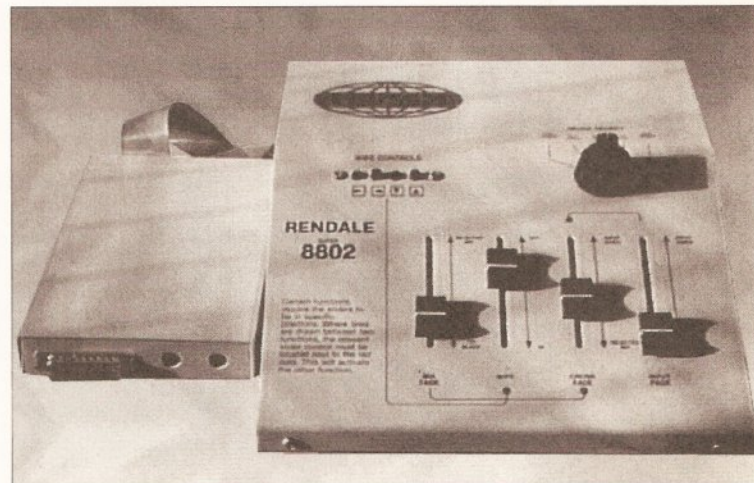

Get into video titling with the Rendale Super 8802 genlock from Marcam - your holiday videos will never be the same again!

ANOTHER WINNER

Barry Evans of Tunbridge Wells is the lucky winner of our CDTV competition. For all you unlucky others the answers go like this:
 1) Camelot castle was in Tintagel.
 2) Merlin was the magician.
 3) Guinevere was Arthur's wife.

CALLING ALL GFA BASIC WINNERS

(or, it's the *Amiga Shopper* You're fired-Ed admin cock-up corner) if you were one of our GFA Basic winners, could you please get in touch with your full names and addresses as soon as possible.

GUARANTEE YOUR COPY OF AMIGA SHOPPER - RESERVE IT AT YOUR NEWSAGENT

Please reserve/deliver me a copy of **Amiga Shopper**

Name _____

Address _____

TO THE NEWSAGENT - *Amiga Shopper* goes on sale the first Thursday in each month. It's by Future Publishing and available from your local wholesaler.

IN NEXT MONTH'S ISSUE

We'll be back on May 7 with another bumper serving of *Amiga Answers* and course after course of succulent morsels for your delectation. Here's what's on the menu:

- Hand scanners - DTP maestro, Jeff Walker sorts out the best from the rest in this definitive five page round-up.
- Mark Smiddy concludes his in-depth intro to Amiga memory with a comparative assessment of all the expansions on the market.
- Food for thought with the first article in our DIY artificial intelligence series. PLUS: How to build a neural network in AMOS!
- Spaghetti junctions!! - we unravel a new networking system.
- PLUS: Part Two of our animation series - how to add sound and music to your creations. So, until then, Pasta La Vista! (and pass us the brandy)

External World of Amiga



- RocKey** Chromakey & special video effects device for Amiga

- RocLite** The World's slimmest external drive for Amiga or CDTV, **with anti-virus and no clicking functions**

- RAM Cards** Available in 512KB, 1MB and 2MB versions for A500 and A500 Plus

- RocTec Mouse** Hi-resolution replacement mouse

- RocGen** A full-featured, budget-priced hobbyist's genlock with adjustable fade and overlay effects

- RocGen Plus** This high-specification, semi-professional genlock sports extra features for the discerning film-maker:
 - adjustable overlay, dissolve and keyhole effects
 - video and RGB pass-thru
 - dual-controls for pin-point accuracy and support for external keying

- RocHard** A new concept in hard disks means you will never get left behind:
 - supports SCSI or IDE hard drives (40MB up)
 - expandable to 8MB of RAM in 4 easy stages
 - compatible with A500 and A500 Plus
 - autoboot and Autoconfig compatible
 - safe and efficient switched-mode power supply
 - can be used solely as an 8MB RAM expansion
 - game switch ensures complete compatibility

Hong Kong Office
ROCTEC ELECTRONICS LTD.
 9/F Win Win Ind. Bldg.,
 18 Lee Chung Street, Chai Wan,
 Hong Kong.
 Tel: (852) 897 3869 Fax: (852) 558 8099

Trade Inquiries
ZYE Tel: 0293 538 666
 Fax: 0293 538 414

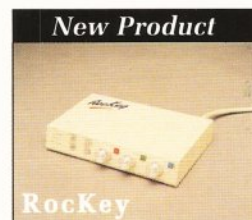

'Perfect Prices' on a Profusion of Peripherals

NEW LOW, LOW PRICES!
SUBJECT TO AVAILABILITY

That's right - now you've bought your Amiga you can add lots of EXTRAS to make your set up complete - Printers, Monitors, Additional Storage Devices, Scanners, Memory Upgrades and lots more are all available at Merlin Express... RIGHT NOW and at the RIGHT PRICE TOO!



- NEW STAR LC 20 MONO** £139.99
Replacement for the ever popular LC10, this new printer is 25% FASTER - 150/38cps & has new push button controls. Released for Europe approx 12mths ago so it's well proven.
- LC 200 COLOUR** £199.99
9 Pin Dot Matrix, 240 x 240dpi, 185/40cps
- LC 24/200 MONO** £229.99
24 Pin Dot Matrix, 360 x 360dpi, 220/55cps
- LC 24/200 COLOUR** £269.99
24 Pin Dot Matrix, 360 x 360dpi, 220/25cps
- NEW XB 24/200 COLOUR (+)** £379.99
24 Pin Dot Matrix, 360 x 360dpi, 275/80 cps, 29K Buffer, exceptional 4x48 pin dpi super letter quality fonts, 14x24 pin dpi near letter quality fonts. QUALITY PRINT ALL THE WAY!
- NEW XB 24/250 Wide Carr. COL. (+)** £454.99
Specification as the XB 24/200 above but with a massive 76K buffer, featuring a wide carriage for applications that need it.
- NEW STARJET SJ-48 Inkjet (+)** £239.99
Near silent printer similar to the BJ10e Bubble but with Epson LQ/IBM Proprinter emulations. 360dpi, 100cps, 28K Buffer.
- LASERPRINTER 4 (+)** £749.99
Fully HP-IP & Epson compatible, 300dpi, 1Mb. memory (exp. to 5Mb.) serial/parallel, 14 fonts, RISC processor, with a full 12 Months on site maintenance warranty included.
- LASERPRINTER 4 STARS SCRIPT (+)** £1069.99
As above, but with Stars Postscript, 2Mb Mem, 14+35 fonts, AppleTalk Interface, 1yrs on site maintenance warranty.
- STAR PRINTER ACCESSORIES**
- | Printer | LC10/20/200 | LC24-200 | LC24-10 | XB24-200/250 |
|------------|-------------|----------|---------|--------------|
| Sht Feeder | £69.99 | £69.99 | £69.99 | £99/£149 |
| Buffer U/G | N/A | £32.99 | £64.99 | £32.99 |
| Font Cards | N/A | £27.99 | £54.99 | £27.99 |
- Please state printer model when ordering

MERLIN EXPRESS ARE STAR REGISTERED DEALERS



- CITIZEN**
Authorised Dealer PLUS
- 120D+ MONO** 9 Pin Dot Matrix £139.99
SWIFT 9 MONO 9 Pin Dot Matrix £189.99
SWIFT 9 COLOUR 9 Pin Dot Matrix £219.99
NEW CITIZEN 224 MONO £219.99
24 Pin Dot Matrix, 360 x 360 dpi, 160/53cps
NEW CITIZEN 224 COLOUR £249.99
Colour Version of the New 224 Mono above
NEW CITIZEN SWIFT 24E COLOUR £279.99
24 Pin Dot Matrix, 360 x 360 dpi, 180/60cps
PN 48 'NOTEBOOK' PORTABLE (+) £269.99
CITIZEN PRINTER ACCESSORIES...
- 120D+ Cut Sheet Feeder** £74.99
124D, Swift 9/24 Semi-auto Sht. Feeder £44.99
124D, Swift 9/24 Auto-Sheet Feeder £94.99
124D, Swift 9/24 Printer Stand £24.99
124D, Swift 24 - 32K RAM Expansion £13.99
Font Cards Swift 24 (6 Different Sorts) £39.99ea
- PLEASE PHONE FOR MODELS NOT LISTED!!!

TWO YEAR WARRANTY



- MANUFACTURERS ORIGINAL GENUINE RIBBONS**
- | Printer | Mono | Colour | 5 Pack |
|------------------|-------|--------|--------|
| Star LC10/20 | £4.75 | £19.95 | £5.95 |
| Star LC200 | £6.49 | £29.95 | £12.49 |
| Star LC 24/200 | £6.99 | £32.99 | £12.99 |
| Star XB Printers | £6.99 | £32.99 | £12.99 |
- CITIZEN GENUINE RIBBONS**
- | Printer | Mono | Colour | 5 Pack |
|-------------------|-------|--------|--------|
| 120D+/Swift9 | £4.99 | £22.95 | |
| 124D/Swift24 | £4.99 | £22.95 | |
| Swift9-24/224/24E | | | £16.45 |



- PHILIPS**
Televisions, Monitors and Accessories
- PHILIPS CM 8833/II COLOUR MONITOR**
14" Stereo Colour Monitor with Green Screen Switch AND...
FREE LEAD & DUST COVER
With 12mths. on site maintenance **£234.99**
Great Value...
- COMMODORE 1084S 14" Stereo Medium Res.** £269.99
- NEW! PHILIPS TELEVISION/MONITORS**
A great alternative to a dedicated monitor that allows you to watch TV programmes too!
- BRAND NEW PHILIPS RANGE OF TV SETS WITH ALMOST MONITOR QUALITY OF OUTPUT TOO! CHOOSE FROM THREE MODELS...**
All with superb quality reproduction when used as a monitor or TV!
2300 Character High Definition FST specifically designed for use as a both a high quality TV and a monitor. Full two year warranty!!!
- PHILIPS 3332 - 15" remote control with sleep timer** £239.95
PHILIPS 2331 - 15", spec as 3332 but with Teletext £279.95
PHILIPS 2341 - 17" version of the 2331 with Teletext £339.95
- MONITOR ACCESSORIES:**
Monitor Dust Cover £5.95
AVT300 TV Tuner £79.95
Univ. Monitor Stand £12.95
- PHILIPS Tilt/Swivel Stands...**
• CM8833 Mki £14.95
• CM8833 MkII £14.95

Commodore AMIGA

AMIGA 1Mb 500 PLUS CARTOON CLASSIC PACKAGE INCLUDING ALL THE FOLLOWING...

NEW Amiga 500 PLUS Keyboard with 1Mb RAM and a 1Mb 3.5" Disk Drive, Mouse, TV Modulator, Leads, Manuals, Workbench Disks etc. and featuring...

4096 Colours, Digital Stereo Sound, Multi Tasking, Speech Synthesis and more!

£339.99
But only while stocks last

MORE AMIGAS

AMIGA CARTOON CLASSICS + CM8833 Mk II MONITOR Including all necessary leads **£569**

AMIGA CARTOON CLASSICS + CM8833 Mk II MONITOR + STAR LC 200 COLOUR PRINTER Including all necessary leads **£764**

OTHER AMIGA COMBINATION PACKS ALSO AVAILABLE - Phone

AMIGA 1500 COMPUTER PACK
BRAND NEW 1500 Pack - Ideal for both home and business!!!
Central Processing Unit (CPU) 1mb. RAM, 2 x 3.5" Floppy Disk Drives, 8 Expansion Slots to take all Amiga 2000 Peripherals.
Keyboard and Mouse...
With Numeric Key Pad, 4 Cursor Keys, 2 Button Amiga Mouse.

NEW VERSION WITH ROM 2.04

AMIGA 1500 CPU/KEYBOARD (As detailed) £549.99
AMIGA 1500 (As detailed) + 1084S Monitor £814.99
AMIGA 1500 (As detailed) + CM8833/II £779.99

PHONE FOR OTHER PACKS...
ALL AT INCREDIBLY LOW PRICES.

ALL Merlin Prices include VAT @ 17.5%

ORDERING
Just telephone our 24 Hour Order Hotline using your Access/Visa or Switch Cards, or send a cheque/postal order with your requirement details, delivery address & daytime telephone number (cheques need clearance unless issued by a Bank/Building Society for you).

DELIVERY
Small items are despatched by post to all UK Mainland addresses unless otherwise discussed. Hardware is dispatched by courier service (up to 25kg) as follows: **NET WORKING DAY**, add £7.50 to order, **TWO WORKING DAYS**, add £6, for **SPECIAL SATURDAY DELIVERY**, add just £12. (Please note courier service applies to MOST UK Mainland addresses.)

WARRANTY
Hardware proving faulty within 30 days will be exchanged for NEW (subject to condition etc). After 30 days and within 12 months from purchase, faults will be rectified by the relevant manufacturers' repair agent and returned to you by courier. Software and small items carry various warranties, please ask for details.

COLLECTION
Merlin Express Limited are predominantly a mail order company, but we welcome customers to our trade/collection counter who wish to pick up goods from us. Why not pay as a visit, we are always pleased to help you with your enquiries.

B F P O & EXPORT
Merlin are happy to supply BFPO and export markets for which VAT is normally deductible. Delivery charges vary from UK rates and, as products carry UK warranties only, faulty items will be returned to Merlin by the customer and re-delivery charges will apply.

PLEASE NOTE...
Whilst every effort is made to ensure information in this advert is correct, you should always confirm any offers, prices, availability etc. prior to placing your order. We endeavour to supply goods as shown and will ONLY change details should it be made necessary by our suppliers etc. As our advertising is booked so far in advance Merlin therefore reserve the right to alter product specifications, withdraw any product/offer/service or update prices (and that can be up to 0% down), without prior notice. Merlin guarantee never to supply anything that has been subject to change without you, the customer, being informed of and agreeing to that change. Please ALWAYS confirm details PRIOR to placing your order. All our currently advertised offers supersede previously advertised offers and goods are NOT supplied on a trial basis.

PRINTER FREEBIES...

WHEN YOU BUY YOUR PRINTER FROM MERLIN, YOU ALSO GET ITEMS WE THINK ARE ESSENTIAL... ABSOLUTELY FREE! CHECK OUR COMPETITORS' OFFERS & MAKE SURE YOU GET THE SAME WHEN COMPARING PRICES!

WITH EVERY PRINTER (EXCEPT THOSE MARKED WITH AN (+)) YOU WILL GET THE FOLLOWING INCLUDED FREE OF CHARGE...

A FREE QUALITY DUST COVER
A FREE TWO PART PRINTER STAND
A FREE LEAD TO YOUR AMIGA
(Worth over £25 if bought separately)

(any printers marked (+) get all the same FREE items EXCEPT a dust cover)

STARTER PACKS

- CITIZEN STARTER PACK**
200 - Sheets of Continuous Paper, 5 - Continuous Envelopes, 100 - Cont. Address Labels, 1 - Amiga/Atari ST Printer Driver 3.5" Diskette
when purchased with a Citizen Printer **£9.99**
(£17.95 if purchased separately)
- AMIGA STARTER PACK**
Mouse Mat, Dust Cover, Ten Blank Disks in a Plastic Library Case, Good Quality Microswitched Joystick
when purchased with an Amiga **£17.99**
- AMIGA 10 GAMES PACK**
Not PD Software!!! **£24**



- GVP Impact Series II HD8 Hard Drives**
GVP's Amiga hard drives have a reputation for quality and reliability with an excellent specification. Simply plugs into your Amiga A500 or 500 Plus side port. GVP Hard Drives can be supplied unpopulated or populated to 2Mb, 4Mb, or 8Mb using a combination of plug-in SIMMS memory chips.
- GVP 52Mb. Standard Unpopulated **£359.99**
 - GVP 105Mb. Standard Unpopulated **£549.99**
 - Population to 2Mb (2x1Mb SIMMS) **£69.99**
 - Population to 4Mb (4x1Mb SIMMS) **£139.98**
 - Population to 8Mb (2x4Mb SIMMS) **£339.99**
- GVP PC EMULATOR FOR AMIGA'S**
Fits internal mini-slot of GVP Series II 52/105Mb H/Drives. Includes 16MHz 286 CPU and is compatible with MS DOS 3.2 or later. Runs lots of DOS applications software including Windows... **£269.99**

SECOND DRIVES

- MERLIN 3.5" DISK DRIVE** £56.99
3.5" Second Disk Drive, Enable/Disable Switch, Slim Design, 880K Formatted Capacity. No external power supply is needed. Through-port. THIS IS ONE OF OUR BEST SELLERS!
- ROCLITE 3.5" DISK DRIVE, ULTRA SLIM & LIGHT** £59.99
Available in Ivory or Black, CDTV compatible too!
- COMMODORE 1011 3.5" 2ND DRIVE** £79.99
CUMANA 3.5" CAX 354 DRIVE £57.99
Enable/Disable switch, Throughport, Extra Long Cable.
- COMMODORE A590 20Mb. HARD DISK DRIVES**
Unpopulated **£279.99** Populated to 2Mb **£369.99**
Populated to 1Mb **£329.99** (CBM memory NOT cheaper w/g)

MEMORY UPGRADES & ROM SHARER

- NEW 1Mb. MEMORY EXPANSION FOR AMIGA 500 PLUS...**
Simply fits into trapdoor under your Amiga 500 Plus to give you a total of 2Mb. of available memory. DOESN'T affect Commodore Amiga Warranty!
- OR JUST £39.99 IF PURCHASED WITH AN AMIGA COMPUTER!**
- NEW AMIGA 500 PLUS ROM SHARER**
This Product INVALIDATES the Amiga Warranty! BUT...you will be able to run old A500 1.3 software!!! Requires a set of 1.3 chips (available separately)
- SET OF 1.3 ROM CHIPS (to fit above)**
System chips to be used with the above to convert your 500 Plus back to the old 1.3 operating system!
- £44.99**
£22.99
£29.99

Phone for Amiga Software from 15% to 25% Discount + Specials!

AMIGA SUNDRIES

- MOUSE MAT** High quality, save your mouse from dirt! **£3.95**
DUST COVER HIGH QUALITY vinyl covers for hardware. **£5.95**
Amiga keyboard, printers, monitors etc. etc. each
- DISK STORAGE BOXES** High quality, smoked perspex lid fully lockable, complete with dividers in two capacities.
40 CAPACITY 3.5" Disk **£4.99** 80 CAPACITY 3.5" Disks **£6.99**
- DISK LIBRARY CASES** Plastic case for 10 disks, 3.5" **£0.99**
- PRINTER STANDS** 2 Part plastic, paper fits under **£9.99**
- MERLIN WIZARD STICK** Great quality microswitched joystick, robust & long life, superb control. Other joysticks top heavy!
AMIGA 500 CONTROL CENTRES Metal Stand **£19.95**
Keyboard, Monitor, 2 Disk Drives to stand on your desk.
- NIKSHA SCANNER** The one you've been waiting for! **£109.99**
NIKSHA MOUSE - Free Operation Stealth while stocks last **£29.99**
NIKHA MOUSE Budget priced... but GREAT quality! **£16.95**
- AMIGA SOFTWARE...** Games, Educational and Business software is always available at discounted prices please phone & ask for prices.
- AMIGA BOOKS...** Covering everything Amiga! Phone for details.
REPAIRAL **W£9.99** (or just £59.99 if bought with h/w)
PLUS: LOTS OF OTHER ACCESSORIES TOO MANY TO LIST!!!

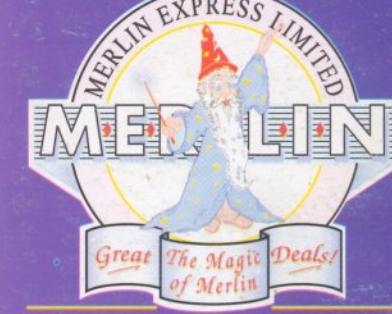

MERLIN EXPRESS LIMITED
DEPT. UNIT C7, THE ROPEWALK IND. CENTRE,
STATION ROAD, ILKESTON, DERBYSHIRE, DE7 5HX.

Telephone: 0602 441442 FAX: 0602 440141

24 HOUR ORDER LINE 441442

SWITCH VISA

NEW LINES

pretar
Great quality and backed by REPLACEMENT warranty!

Philips CM8833/II colour television set under £1000
Attractively improved & internal screening altered to avoid TV interference.

£219.95
With 1 year on site REPLACEMENT warranty!

GOLDSTAR
NEW 14" PORTABLE TV/MONITOR
Features on screen graphics, Full Remote Control, Signal Enhancer and CW Amiga Scan/Cable 1 Year Warranty PRICE BREAKTHROUGH!

£199.99

AMIGA CDTV
A range of CDTV accessories are now coming on line, please phone to check availability.

CDTV KEYBOARD 88 Key QWERTY, plugs into the CDTV. **£49.95**
CDTV MOUSE Two way infrared remote control. **£39.95**
Includes battery saver feature

CDTV TRACKBALL Infrared remote control with sockets for two standard joysticks or standard mouse

CDTV 3.5" DRIVE Allows loading of compatible Amiga software. Rack mountable. 880K capacity. **£99.95**

ROCLITE 3.5" DRIVE CDTV compatible in matching black. **£59.95**