

Acorn User

THE ALTERNATIVE FOR POWER COMPUTING

WWW.ACORNUSER.COM

VIRTUAL CALL CENTRE

Killer App for bigger better businesses

Wakefield Show Report

Find out what happened at the Show

Digital Video



Getting RISC OS into moving pictures

Best Blogs

What can be done with a Blog

**Plus even more
great articles . . .**

Sponsored by danemere street | CREATIVE - "Creative Communications"



ISSUE 260 JUNE 2003 £4.20

Liquid Silicon

• Computers & Music Hardware • Upgrades • Software • Cables etc •

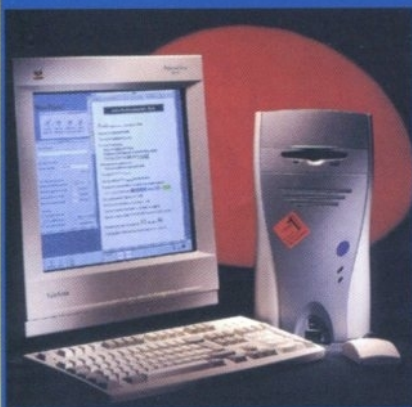

Call us for your nearest UK dealer for the POSum point of sale systems and the EBMS business management solutions.

Microdigital Computers

Omega Standard (small) Tower (145W PSU)	£1355.00
Omega Midi Tower (240W PSU, 3x 3.5" & 4x 5.25" bays)	£1399.00
Omega Desktop (240W PSU, 3x 3.5" & 3x 5.25" bays)	£1402.00

Options when purchasing:

Optional 300W PSU upgrade for Midi/Desktop cases	£44.65
30Gb drive instead of 20Gb	£25.85
45Gb drive instead of 20Gb	£62.27
60Gb drive instead of 20Gb	£105.75
128Mb instead of 64Mb	£16.45
256Mb instead of 64Mb	£30.55
512Mb instead of 64Mb	£81.07
CD rewriter & software	£145.70
Ethernet card (10/100BaseT)	£52.85
Floating Point coprocessor	£TBA
SCSI 1/2 controller card	£80.99
SCSI 1/2/3 controller card	£115.99
Single board PC (needs processor (below) and Windows) (for Midi & desktop cases only)	£680.30
Fitted with 64Mb as standard – see memory options above for larger replacements.	
Cyrix M111 processor, 650MHz	£46.35
Intel Celeron processor, 700MHz	£53.40
Intel Celeron processor, 800MHz	£73.60
Intel Celeron processor, 700MHz	£86.00
Intel Pentium III processor, 1GHz	£206.65
Cooling fan (below 1GHz)	£7.05
Cooling fan (Above 1GHz)	£9.40
Windows 98 OEM	£93.99
XScale coprocessor (1GHz)	£210.30

RiscStation Computers

R7500 Lite	£598.00
R7500 Lite+	£656.75
R7500 NetWorx	£480.50
R7500 NetWorx HD	£539.30
R7500 Scorcher	£797.50
R7500 Scorcher Twindeck	£833.00
Osaris	£180.00
Osaris Plus pack	£210.00
Osaris Classroom pack	£857.50
Portable	£1173.00
Portable with docking station	£1465.00
Games pack (with a system)	£47.00

Castle computers

Iyonix (128Mb, 40Gb, CD system) (While stocks last)	£1269.00
Iyonix (128Mb, 80Gb, CDRW system) (While stocks last)	£1319.00
Iyonix (512Mb, 100Gb, CDRW system) Price until 30/4/03	£1419.00
Two slot backplane for taking podules	£49.00
USB to Parallel converter	£25.00

Please ask for modems and USB peripherals.

iiyama CRT Monitors

1352 (15" FST)	£101.20
1403 (17" FST)	£117.45
Pro 1413 (17" NF)	£177.30
Pro 413 (17" NF)	£199.10
1451 (19" FST)	£173.20
Pro 452 (19" NF)	£267.05
Pro 454 (19" HBNF)	£321.45

505 (21" FST)	£552.65
Pro 512 (22" NF)	£566.25
Pro 513 (22" NF)	£471.05

iiyama LCD Monitors

3814 (15" LCD)	£246.65
3817* (15" LCD)	£287.45
3819* (15" LCD)	£397.60
3835* (15" LCD)	£438.40
4314* (17" LCD)	£424.80
4315* (17" LCD)	£552.65
4332* (17" LCD)	£656.00
4611 (18" LCD)	£634.25
4612* (18.1" LCD)	£647.85
4636 (18.1" LCD)	£769.00
4637 (18.1" LCD)	£799.95
4821* (19" LCD)	£799.95
4831 (19" LCD)	£835.00
5131* (20.1" LCD)	£1195.00
5311 (20.8" LCD)	£3149.00
5611 (22.2" LCD)	£5499.00

* Also available in black.

LCD speaker options (ask for more details):

OSP1-1	£58.75
OSP1-1B black	£58.75
OSP2-1	£76.40
OSP2-1B	£76.40

Screen protection sheets (15", 17" or 18.1") £60.50

Touchscreens

15" CRT	£660.00
17" CRT	£815.00
19" CRT	£941.90
22" CRT	£1195.00
15" LCD	£919.90
18" LCD	£1246.60

Projectors

LPX100 LCD	£1531.80
DPS110 DLP	£1681.40
DPX110 DLP	£1980.60



Confused? Need more info? Just ask!



Discs (e.g. 20x black discs – £6.28)
Batteries (e.g. 4x AA Xtra alkaline – £2.24)
Also Audio & Video Tapes, Mini discs, CDRs, DAT tapes etc.



Liquid Silicon

Personal Accounts	£44.00
Photodesk Olympic	£127.95
Prophet 3+ Pro	£179.00
Quake	£22.00
R-Comp Internet Suite	£73.95
Schema 2	£121.50
SiteWriter	£58.95
Sleuth 3	£65.95
TBA Games CD	£20.00
TechWriter Pro+	£209.95
TEK	£29.95
WebFX3D	£24.50

Books & Manuals

RISC OS Manuals CD	£29.95
--------------------	--------

Buying a new system shortly?

Order your RiscStation Portable now and get a free ethernet cable (straight or cross-over up to 10m) plus free carriage.

Order your Omega now and choose from any of the following games offers :

Abuse	£20.00
Chaos Engine	£15.00
Descent 1 & 2	£28.00
Heretic & Hexen	£25.00
Quake	£18.00

No deposits required. Games offer subject to stock levels and may be discontinued at any time. Exact prices and configurations will be agreed beforehand.

Memory Upgrades

Please call to check current prices.

Risc PC/A7000/RiscStation/Mico SIMMs:	
16Mb FPM	£28.20
64Mb EDO (works in Risc PCs)	£39.00
128Mb EDO	£77.55
2Mb VRAM	£89.95

Music & Sound Section

Please call for other musical items

MIDI interfaces:

MIDI Max II internal 1x1x1	£93.95
Parallel Port 1x1x1 (back in stock)	£92.95
RiscStation MIDI drivers & cable	£17.95
RiscStation XG card & cable	£116.95
RiscStation XG card, cable & keyboard	£245.95
Sibelius 6	£99.95
Sibelius 7 Student	£319.95
Sibelius 7	£520.95
Sibelius 2 for PC/Mac is also available	
Sound module serial port driver	£37.95

Other Hardware

10/100BaseT ethernet card (RCI/Simtec)	£89.00
Cordless keyboard & optical mouse	£79.99
Cordless Mouseman Optical PS2/USB	£54.95
Mouse (Genius/STD Acorn-compatible)	£19.95
Mouse (PS/2 Logitech)	£14.99
PS2MouseMini adaptor for older machines	£18.95
Printers	£Call
Risc PC second slice (no PSU)	£95.00
RISC OS 4 (fitting & Select available)	£109.95
RiscStation second serial port	£10.95
Scanners	£Call
StrongARM & RISC OS 3.7 upgrade	£269.00
StrongARM & RISC OS 4 upgrade	£299.00
ViewFinder card (32Mb)	£240.00

Other Software

Abuse	£20.00
C/C++ (26/21-bit version)	£195.00
CD Burn	£55.95
Chaos Engine	£19.50
DataPower 2	£165.00
Doom+ CDs	£30.00
Descent CDs	£25.00
Desktop Repton 3 CD	£15.95
EasiWriter Pro+	£139.95
FastSpool+	£17.50
Grapevine	£24.95
Heroes of Might & Magic 2	£32.00
Krisalis Collection Gold CD	£25.95
OHP 2	£37.95
Oregano CD	£57.50
Other Worlds CD	£17.95
Ovation Pro	£138.95

Second hand machines and components:

These machines have mainly come from schools and businesses. As such there are various brandings, labels, markings, scratches, very occasional broken bits (e.g. front flaps) on the cases. All machines have been generally cleaned and air dusted inside to get rid of most of the dust, however the cases have not been meticulously cleaned as this would take a long time and increase the prices considerably. Any machines which have PC cards are usually 486 cards, but as these are basically worthless, their value has not been taken into account (and they might not have all the software on the disc to work them anyway). Get free carriage if you also take a monitor (the 'b' indicates an additional £10 carriage charge). Keyboard, mouse and mains cable included. Single slice machines do not have backplanes unless specified. Ethernet cards etc. can be taken out if not required. There is a three month warranty on these machines and they are supplied 'as seen', so to speak. All details are subject to change and please check availability before ordering.

A7000, RISC OS 3.6, 8Mb, 406Mb HD, 10BaseT ethernet card, fan	£60.00b
A7000, RISC OS 3.6, 18Mb, 406Mb HD, 10BaseT ethernet card	£60.00b
A7000, RISC OS 3.6, 20Mb, 406Mb HD, Combi ethernet card	£60.00b
A7000, RISC OS 3.6, 20Mb, 406Mb HD, Combi ethernet card, backplane & fan	£70.00b
A7000, RISC OS 3.6, 20Mb, 406Mb HD, Combi ethernet card, CD drive & fan	£70.00b
A7000+, RISC OS 3.71, 16Mb, 163Mb HD, 10BaseT ethernet card	£70.00b
A7000+, RISC OS 3.71, 24Mb, 203Mb HD, 10BaseT ethernet card	£70.00b
A7000+, RISC OS 3.71, 16Mb, 1225Mb HD, 10BaseT ethernet card	£80.00b
A7000+, RISC OS 3.71, 24Mb, 1225Mb HD, 10BaseT ethernet card	£80.00b
A7000+, RISC OS 3.71, 24Mb, 1225Mb HD, Combi ethernet card	£80.00b
A7000+, RISC OS 3.71, 24Mb, 406Mb HD, 10BaseT ethernet card, CD drive	£80.00b
A7000+, RISC OS 3.71, 16Mb, 1221Mb HD, 10BaseT ethernet card, CD drive	£90.00b
A7000+, RISC OS 3.71, 24Mb, 1623Mb HD, 10BaseT ethernet card, CD drive & fan	£95.00b
RPC 610, RISC OS 3.5, 4+1Mb, 203Mb HD, backplane, Impression, EasiWriter, Eureka	£80.00b
RPC 610, RISC OS 3.5, 16+1Mb, 203Mb HD, Combi ethernet card, PC card	£110.00b
RPC 610, RISC OS 3.5, 36+1Mb, 515Mb HD, 10BaseT ethernet card, PC card	£130.00b
RPC 610, RISC OS 3.5, 20+1Mb, 203Mb+327Mb HDs, CD drive, 16-bit soundcard	
HCCS IDE card, Combi ethernet card & AccessNT, PC card, 2 slices	£190.00b
RPC 710, RISC OS 3.5, 40+1Mb, 203Mb HD, Combi ethernet card	£120.00b
RPC 710, RISC OS 3.7, 16+1Mb, 203Mb HD, 10BaseT ethernet, Cumana CD drive	£150.00b
RPC 710, RISC OS 3.7, 16+1Mb, 203Mb HD, 10BaseT ethernet card, CD drive	£150.00b
RPC 710, RISC OS 3.7, 16+1Mb, 203Mb HD, Combi ethernet card, CD drive, PC card	£150.00b
RPC SA, RISC OS 3.7, 16+1Mb, 203Mb HD, Combi ethernet card	£280.00b
RPC SA, RISC OS 3.7, 16+1Mb, 203Mb HD, Combi ethernet card, PC card	£280.00b
RPC SA, RISC OS 3.7, 16+1Mb, 406Mb HD, Combi ethernet card	£290.00b
RPC SA, RISC OS 3.7, 12+1Mb, 203Mb HD, Combi ethernet card, Cumana CD drive	£300.00b
RPC SA, RISC OS 3.7, 16+1Mb, 203Mb HD, Combi ethernet card, CD drive, PC card	£300.00b
RPC SA, RISC OS 3.7, 20+1Mb, 203Mb HD, Combi ethernet card, CD drive	£300.00b
RPC SA, RISC OS 3.7, 20+1Mb, 203Mb HD, Combi ethernet card, CD drive, PC card	£300.00b
RPC SA, RISC OS 3.7, 20+1Mb, 203Mb HD, Combi ethernet card, Cumana CD drive	£300.00b
RPC SA, RISC OS 3.7, 20+1Mb, 203Mb HD, Combi ethernet card, CD drive, PC card	£300.00b
RPC SA, RISC OS 3.7, 64+1Mb, 203Mb HD, 10BaseT ethernet card, CD drive	£310.00b
RPC SA, RISC OS 3.7, 12+1Mb, 2014Mb HD, Cumana CD, 10BaseT ethernet, PC card	£320.00b
RPC SA, RISC OS 3.7, 16Mb, 406Mb HD, Ultimate card & CD drive, Combi ethernet card,	
XOB Teletext card, backplane	£350.00b
Two slot backplanes	£10.00
Combi/10BaseT ethernet cards	£30.00
Internal IDE CD drives	£Call
Second hand monitors:	
PC SVGA 14"	£20.00b

FREEPOST EH2725
Kirkcaldy, Fife, KY2 5BR
United Kingdom

Tel: 01592 592265 Fax: 01592 596102

email: sales@liquid-silicon.com

http://www.liquid-silicon.com

We will attempt to match or beat any advertised price - even special offers.
Our free catalogue contains over 2000 items.
Please ask for a copy or visit our web site for latest prices.

All prices INCLUDE VAT & UK carriage
Official orders, foreign orders and callers welcome.



Price Drop!

ViewFinder Pro

Up to 2048x1536x32K colours @ 72Hz
& 1920x1440x16M colours @ 74Hz

£175 inc VAT

Optima Video Editing Suite

Complete Professional Video Digitising & Editing System (RiscPC)
Internal Video Hard Disc, Removable backup storage, PAL encoder,
EDL creation capability, Widescreen (16:9) capability,
Visual Logging/Database package.

RRP £5450, S/H £1700†

Special Offer

Pocket Reader OCR pen

£40† +£5p&p

Offers from  **4D**

Network Card

10baseT & 2
for RPC/A7000

Special offer £45

PC Card clearance! DX4/100 RPC cards

£25† +£5p&p

Quantity discounts available

10/100 Switching Hub 8 port.....	£60	32bit C/C++ (Still 50% off!).....	Limited stocks £103
15" LCD Relisys 1024x768.....	£280	ZIP 100MB SCSI S/H (External £120).....	£65
15" Widescreen LCD 3 inputs, picture-in-picture	£320	S/H 24i16 1MB.....	£270
17.4" LCD Dual input 1280x1024 Back in!	£535	Two port USB KVM inc cables.....	£80
IDE CDRW 12836 inc CD Burn.....	£130	Two port MyHopper2 KVM inc cables.....	£85
IDE CDRW BURN Proof 321040 inc CD B. .	£140	Canon S400 4 Ink tanks inc driver.....	£120
Acorn A4 laptop.....	£260†	Canon S750 4 Ink tanks inc driver.....	Special offer £200
Wireless networking no USB needed!.....	from £60	Psion 5MX (Ericsson MC218).....	£260†
20GB IDE Hard Disc.....	£85	HP 5L laser 600dpi 1MB (refurbished) new drum/toner	£120†
80GB IDE Hard Disc (7200rpm).....	£125	250MB ZIP drive IDE.....	£100
120GB IDE Hard Disc (7200rpm).....	£150	1GB JAZ drive SCSI External.....	£180†
160GB IDE Hard Disc (7200rpm).....	£200	S/H RiscPCs.....	NOW from £90†
EDO RAM 32MB £30 64MB £45 128MB £85		RiscPC slices.....	from £30
FPM RAM 64MB £50 128MB £90		Acorn compatible Mice.....	Special offer from £20

IYONIX 

Purchase your Iyonix from CJE and get the 'CJE IYONIX bonus'!

For details please phone or see: <http://www.cjemicros.co.uk/iyonix/>

Now from £1249

Finance: If you need to finance your purchase please contact us.
Payments over three months to three years. Competitive APR!

CJE prices include VAT. Iyonix delivery £20



All CJE prices **INCLUDE** VAT @17.5%
& UK mainland delivery, unless otherwise stated.
Official orders welcome. E&OE. Prices subject to change & stock.
Items marked † are sold by 4D (Fourth Dimension) and have no VAT

CJE Micro's & 4D
78 Brighton Road
Worthing
West Sussex
BN11 2EN

Acorn User

THE ALTERNATIVE FOR POWER COMPUTING WWW.ACORNUSER.COM



VIRTUAL CALL CENTRE

Killer App for bigger better businesses

Wakefield Show Report

Find out what happened at the show

Digital Video

Getting RISC OS into moving pictures

Best Blogs

What can be done with a Blog

Plus even more great articles...



Next issue on sale: 26th June 03

Published by



28a Middle Hillgate
Stockport SK1 3AY UK
enquiries@acornuser.com
www.acornuser.com

Tel: (+44/0) 161 429 8902
Fax: (+44/0) 161 429 0685

Printed by The Manson Group, St Albans

Editor Rob Donaldson

Designed by Mark Atkinson & John Caldwell

Finance Manager Michelle O'Neill

Distribution COMAG (01895 444055)

Advertising Steve Turnbull

Managing Director Sharon Henderson

Subscriptions:

(+44/0) 161 429 8902

E-mail: subscrip@acornuser.com

Annual (13 issue) subscription rates:

£46.99 (UK) £51.99 (EU) £63.99 (World)

Copyright © 2003 Tau Press Ltd

No material may be reproduced in whole or in part without written permission. While every care is taken the publishers cannot be held responsible for any errors in articles, listings or advertisements and the views of the contributors do not necessarily reflect the views of the publishers.



If you know someone who is Blind or partially sighted Acorn User is available on Audio format. Full information is available from The Talking Newspaper Association, National Recording Centre, Heathfield, East Sussex TN21 8DB. Tel 01435 866102

Internet services provided by Spellings Computer Services
www.spellings.net

Editor's Comments

Due to other commitments it is almost impossible for me to personally attend shows. This is a shame because the couple I have attended in the past I have enjoyed. Sometimes they can be very interesting and it seems to me that on this occasion the Wakefield Show was very interesting indeed. But I wasn't there, so I thought I would hand my column over to Steve Turnbull who was there, in the thick of it:

This is not going to be a description of all the different products and product enhancements of those companies who attended the show, we have a Show Report for that and probably a fair proportion of the News too.

Instead let us look at what seems to be happening in the market as a whole: We are heading for a crux.

On the one hand the market seems to be imploding, the number of companies actively operating in the market seems to be decreasing. This is frankly because the people who run the companies, for better or worse, have been as die-hard as the enthusiasts who make up the buying public (within the market itself).

For this reason the number of active companies has been held at an abnormally high level simply because the business owners wanted to be in the market. They were not taking the necessary, business decisions and getting out while the getting was good.

This causes a lot of pain and anguish, both personally and from a business viewpoint. Businesses have to be run properly otherwise they crash and burn. But it is personally painful for a dedicated RISC OS person to let something they care about go.

On the other hand there have been forces building up within the successful RISC OS companies. These activities whether business- or development-wise are coming to fruition and it is all happening at the same time.

It is a crux, it could be explosive or it could fizzle out. Knowing what I know about the various things that are going on I expect the former. An explosive expansion in a number of sectors which will drive those businesses forward and take RISC OS with them.

What we end up with after that I cannot really say. Here's to the RISC OS supernova.

Steve Turnbull

8 News

The latest news from the world of RISC OS and power computing

15 Graphics

How to design for the real world

16 Show Review

Who, what, where, when and why at Wakefield

21 Virtual Call Centre

Killer App for the world of business on RISC OS

28 Digital Video

Is it really true that RISC OS can't do it?

33 Blogger

It's the latest thing but is it hype or valuable?

36 S-base

Final installment in which refinements are made & are fall at the best

40 ECDL

Learning to use computers if you're a teacher

41 Education News

All the latest news about the RISC OS and the education market

44 Education Feature

Software develop educational software for RISC OS, this is the whole set

46 Subscriptions

get your copy of Acorn User before the shops!

48 Free Ads

get what you need at a cheaper price

49 Letters

Find out what others think about the most important RISC OS issues

50 Advertisers Index

Need access to a PC but don't have space for a new monitor, keyboard and mouse?

Step 1 - Specify a PC base unit if you don't have one....

We can supply of-the-shelf or custom PC base units to your specification, and are happy to provide a comprehensive no-obligation quotation suited to your needs - please contact us for a competitive quote!

Step 2 - Add our Keyboard Controlled Switch

This miniature switch allows keyboard, monitor and mouse to be shared between two machines. Rated to 1920x1440 display and supplied complete with all cabling (UL2919 rated) and comprehensive instructions

Enhanced for RISC OS machine - if it hasn't got our name outside the box it doesn't have our modifications inside the box!

Supplied as a pack including our PS2MouseMini interface: £99.95inc
Above pack when purchased with PC base unit: £90inc

Keyboard controlled switch alone: £89.95inc
Professional 4- and 8- port switches available (example 4 port £160 inc UL2919 high-quality cabling)

Step 3 - Attach your existing RiscPC/A7000 and monitor

Add a networking pack if required...
... and switch between the two with a couple of keypresses!

NEW!
lyonix compatibility pack
£34.95inc

(not to the same scale as the PC!
The switchbox is about the same size
as 2 kitchen matchboxes)

Memory Corner: Compact Flash: 32MB=£16.75; 64MB=£26.00; 128MB=£44.00; 256MB=£85.50; 512MB=£190.00; SmartMedia: 32MB=£12.75; 64MB=£23.25; 128MB=£46.00; MultiMedia Memory Card (MMC): 32MB=£16.75; 64MB=£37.85; Secure Digital (SD): 32MB=£27.85; 64MB=£44.00; 128MB=£87.00; USB Flash Memory Drives: 32MB=£23.00; 64MB=£35.00; 128MB=£59.00; 256MB=£110.00; 512MB=£261.00; 1GB=£560.00

We can supply other memory, hard-drives, cables, interfaces, bespoke microcontroller design etc - please contact us for details.....

Hand track trackballs: Standard corded £14.95; Laser corded £19.95; Laser designed for use in presentations etc - they will not cut materials but care

EEK!

UPS

NET100

Our PS2MouseMini interface allows you to use PS/2 PC mice with your RISC OS machine.

Over 2000 sold!
Only £18.95inc

- 3 button PS/2 mouse £5.95inc
- Genius wheel mouse £12.95inc
- Genius optical mouse £17.95inc
- Genius wireless wheel mouse £19.95
- Genius Optical Wireless mouse £29.95

Device above require PS2MouseMini for use on RiscPC.

STD Standard Mouse (3 button mouse, no need for adaptors etc)
£19.95inc

Multimedia Keyboard (includes RISC OS drivers)
£24.95inc



A sensibly specified uninterruptable power supply

- 650VA rated
- Up to 45 minutes backup
- AVR (will boost or buck mains voltage if out of tolerance)
- 320 Joule mains spike protection
- RFI filtering
- Filtered and protected modem sockets
- Supplied with cabling to attach to 2 machines/devices

£64.95 + £10 carriage = £74.95inc



- 10/100BaseT Network interface card for RiscPC/A7000
- Provision for access to 10 or 100 Megabit networks
- Several hundred KBytes of FLASH memory for drivers
- Provision to modify FLASH contents for other drivers
- Lower latency than conventional 10 Megabit cards
- High integration brings affordable networking

Only £69 + del + VAT = £89inc
Pack to link RISC OS to PC (Net100, PC net card, crossover cable) = £110inc

RISC OS link pack (2xNET100, xover cable) = £185inc
High performance network switches: 5 port = £45inc

8 port = £75inc
Lanman98 = £41inc
Cables and other networking devices available

Wireless Networking

A Range of Wireless networking devices allowing RISC OS and PC machines to be networked without having to lay cables etc. All products comply with IEEE802.11b and interwork with other compliant systems.

Wireless USB adaptor: plugs into RISC OS machines fitted with Simtec USB card. Stack based on acclaimed NET100 code.

Wireless USB adaptor: £79.95. PC version (no RISC OS drivers) £69.95

Wireless Access Point / Bridge / Media Converter: This versatile device allows single machine or groups of machines fitted with network cards to be integrated into a wireless network.

Wireless Access Point / Bridge / Media Converter £99.95inc

Wireless PCMCIA Card: For use with Portable machines: £59.95inc

Wireless Broadband Router: Please ask for details

cordless (pictured) £29.95. PS2MouseMini interface required. Laser trackballs are should be taken not to look into the laser beam. Please observe warning labels etc.

In association with: www.

RISCOS-USB.com



Simtec USB card

Provides USB expansion to RISC OS machines

£79 + del + VAT = £99.95inc
4 port hub £10 with card (£20 alone)



Epson 1660 scanner

USB scanning at true 3200x1600dpi

Scanner only £179.00
TWAIN and scanning software £35
SPECIAL OFFER: Scanner, USB card and
FREE TWAIN and Scanning Software: £278



HP USB Printers

High quality printers which attach to the Simtec USB card.

HP3820 USB printer: £120inc
HP5550 USB printer: £170inc

Complete with RISC OS drivers.

COMING SOON with USB from STD
USB Pen drives; USB MP3 players;
Zip drives; Joysticks; SEN interfaces



Stuart Tyrrell Developments
PO Box 183, OLDHAM OL2 8FB
Tel: 0845 458 8803 / 01706 848 600
Fax: 0870 164 1604 (national rate)

Email: info@stdevel.co.uk
<http://www.stdevel.co.uk>
All prices include VAT and P&P
Switch/Visa/Mastercard welcomed.

All trademarks acknowledged. E&OE

ArtWorks 2 released

ArtWorks 2 is the latest version of the most popular advanced vector graphics application for RISC OS, originally from Computer Concepts.

Released at this year's Wakefield Show, *ArtWorks 2* is the first complete version of ArtWorks to be produced and published by MW Software. It is also the first version to run natively on Castle's XScale-powered Lyonix computer. *ArtWorks 2* comes with the full set of plug-in modules previously released independently by MW Software. Attractive upgrade offers are available to existing ArtWorks users. Please note that *ArtWorks 2* requires RISC OS 3.5 or higher. It works fine with RISC OS 4, Select and RISC OS 5.

ArtWorks 2 is available for only £169 (inc VAT, plus postage) but this includes the upgrade to version 2.1 when it becomes available.

Upgrades from ArtWorks 1.7 vary between £50 and £125 (inc VAT, plus postage), depending on the set of plug-in modules already purchased. More detailed pricing information and online ordering links can be found by clicking on the "Ordering" tab on the MW Software web site home page.

After this initial release, MW software are now working on the next version, which will be more feature-rich as opposed to merely 32-bit compatible. Some of the announced new features coming in ArtWorks 2.1:

- Page rulers.
- A Skew tool to accompany the Rotate and Scale tools.
- Control of both width and height of arrowheads.
- User-defined dash patterns.
- Configurable default font, font size, join style.
- Control over the distance of text fitted to a curve from the curve.
- Control over the starting offset of text fitted to a curve.
- A print setup tool to select the area of the page to be printed (useful when proofing small parts of a large size document) including the ability to set numeric printing offsets.
- warning about unused sprites in the sprite pool when saving a document.

- Create a new document by choosing from a menu of several standard documents.
- Improved control over graduated fill arrows.
- Text export from text areas.
- Saving JPEGs that are embedded in ArtWorks files.

MW Software have also requested ideas for improvements from the many users of the original Artworks, and are compiling a list of possible new features which may make it into ArtWorks 2.1 or a later revision. A selection of these are:

- Graduated transparency
- Multi-page handling
- CMYK sprite/CMYK TIFF export
- PNG and JPEG export
- Arrowheads that end with line ends (rather than continuing from line ends as it currently happens)
- Interactive help (at least for the Toolbox)
- Document cleaning option to remove unused sprites and colours
- Path style panel from which a combination of path attributes (line width, line colour and so on) can be applied with a single click

More information on *Artworks 2* can be found on the MW Software Website at www.mw-software.com

Alpha not Omega

Microdigital have announced a RISC OS laptop based upon Intel PC hardware and "Virtual Risc PC" from the people who brought us VirtualA5000. With no sign of the long-awaited Riscstation laptop, this may be the only viable solution to those wishing to use RISC OS on the move.

The "Alpha" laptop costs £850+VAT +delivery and comes bundled with Windows XP home edition, RISC OS 4 (licensed from RISC OS Ltd) and a range of Windows and RISC OS software. Full specifications are:

- 2GHz Intel Celeron CPU
- Memory. 256MB SODIMM PC2100 DDR expandable up to 1GB (2 connectors)
- Video memory, 64MB shared memory system
- 13.3 inch TFT display with a

- maximum resolution of 1024 x 768 supporting 16 million colours
- Storage devices include 15GB Hard disc, 24x Speed CD ROM, 3.5 inch floppy disc drive
- Interfaces are 1 x parallel port ECP/EPP, 1 x PS/2 connector, 1 x video out via 15 way D connector, 2 x jack socket for line out and microphone, 1 x ethernet RJ45 socket, 1 x modem RJ11 socket, 2 x USB sockets
- There is an 86-key keyboard with embedded numeric keypad, 15 functions keys including RISC OS and Windows menu key. Plus:
 - Integrated touchpad pointer
 - 100Mbit built in Ethernet via RJ11 socket
 - Internal 56k internal modem
 - Full duplex 16bit stereo wave table sound together with built-in stereo speakers
 - 8 cell Lithium Ion rechargeable battery
 - 100v-240v mains adaptor

Physically its dimensions are 308mm(w) x 254mm(d) x 37.5mm(h), and weight 3.2kg including batteries. You also get a carrying case with shoulder strap.

While the Alpha provides an impressive range of connectivity options, it's still unclear how many of these can, and will be able to be used from within the RISC OS "soft" PC environment (such as USB, Networking and so on) and your news editor didn't get an answer to these questions when asking the company themselves at the Wakefield show.

At the Wakefield show, Microdigital did state that their long-overdue Omega was due to ship "within days", although two weeks after the show, when Acorn User went to press, we had not heard of any shipments being received.

New features in RISC OS Select 3 RISC OS Ltd have released full details of the features that will be present in Select 3, the next release of RISC OS. We previewed some of the select features in a previous news slot, but new to the party are the following:

Cut and paste: Both keyboard and mouse can now be used to select text in all writable icons provided by the Window Manager. Such icons can be used with the standard clipboard operations to cut, copy and paste icon contents around.

Images Filer windows: The Filer can now display images as thumbnails, allowing photo albums and other image collections to be browsed more easily. **Improved 'buttons':** Action buttons, as well as groups and other 3D-style icons have been improved and may be made round or given colours. Support for button styles is a 'plug in' interface and other clients may provide different button renderings.

Alpha-channel sprites: A new class of sprites has been created for alpha-channel sprites. These sprites can be used wherever the standard sprite operations would be used through system sprite rendering calls. Alpha-channel sprites allow each pixel to have variable translucency, which means that sprites can blend better to their backgrounds.

Recycle bin: Files deleted by the user can, optionally, be sent to a recycling bin from which they can be retrieved if necessary. A new !Recyclone application provides the rubbish bin into which files deleted by the user will be placed. A configuration tool is provided to allow the bin to be expired and its location changed.

Improved !Paint: The Paint application has been updated to support the new alpha-channel sprite format provided by Select 3. Paint can create sprites with alpha-channels, add an alpha-channel to an existing sprite, and allow editing of the alpha-channel.

Paint's user interface has also been brought up to date, with a separate attached toolbox for each sprite (similar to !Draw) so each sprite has its own "working set" of toolbox settings. Shortcuts for zoom and select colour have been added along with a new colour display area. The menu tree has been revised to be more logical and Style Guide compliant.

Paint makes better use of the ImageFileConvert system in Select 3 and can directly load any filetypes supported by ImageFileConvert (PNG, JPEG, Clear, ICO, BMP and so on). Paint allows saving of an image in JPEG and PNG format as well as sprite.

A good number of bug fixes and performance improvements have also been added along with usability features such as a true graphic brush display and better clipboard support.

New !NetLights application displays network activity on the iconbar.

!Draw can now import any type handled by ImageFileConvert where the type can be converted to a type which is handled natively by Draw. This means that PNG files, Artworks, BMP and other images types can now be imported.

Contact:
RISCOS Ltd,
3 Clarendon Road,
Cyncoed,
Cardiff,
CF23 9JD
Tel: 029 2049 2324
Fax: 029 2049 2326

Castle unveil Linux on Iyonix

In addition to RISC OS 5, Castle's Iyonix PC is now able to run ARM Linux. Linux for the Iyonix PC is supported by a port of kernel version 2.4.19, although work is already underway to support 2.5, for which changes will be contributed to ARM Linux.

The current version is very much in development, and does not yet support all of the Iyonix PC's hardware. In particular, it requires booting from an NFS or RAM Disc, but presents a usable and stable Linux system. As with ARM Linux on previous RISC OS machines, Linux is presently booted from within RISC OS.

Castle provides a pre-built kernel, patches, and bootloader for parties interested in developing or experimenting with Linux for Iyonix at www.ionix.com/linux.html

Technical support is available, please see Castle's Linux support pages at www.ionix.com/linux/support.html

Given Castles' Iyonix is the world's only X-Scale based desktop computer, it's looking to position the machine as a valuable development platform for people developing code for other X-Scale based hardware such as PDAs and mobile phones.

Wakefield show busiest in years

This year's Wakefield show was the busiest show for a number of years. Held over one day instead of two, to reduce costs for both the organisers and exhibitors, meant long queues on the door, and a packed auditorium for almost the entire duration of the doors being open.

Many exhibitors had long queues forming to purchase software upgrades and see new hardware on offer, while

two lucky punters walked off with a Microdigital Omega. See the show report later in this issue for the show news in full.

APDL revives more software

APDL have taken on the marketing and distribution of several former Clares Micro Supplies software titles, many with new lower retail prices.

Topographer is an application both for general use and the Geography curriculum where it allows children (and teachers) to have lots of fun while learning all about maps, contour lines, valleys, rivers, and so on. In fact *Topographer* covers virtually all items found on Ordnance Survey maps.

The real breakthrough with *Topographer* is its 3D section that allows you to convert a 2D map into a 3D model on screen. Imagine turning a set of flat contour lines into a 2D map into a 3D model that clearly shows the hill, you define where you look from, and what you look at.

Topographer also covers aspects of the IT and Maths curriculum with its modelling capabilities. Its key features include:

- Easy and quick entry of all symbols (over 100) onto 2D map
- Easy entry and editing of contour lines using specialised routines
- Definable widths for roads and rivers
- Wooded areas which translate into impressive 3D landscapes
- Map can be saved as Draw file and printed if required
- Definable map size and scale can be linked to the national grid references
- Zoom option that is independent of the scale
- Powerful 3D mode giving a true representation of the landscape
- Definable viewing coordinates, height and angle (numerically or graphically)
- Stunning 3D models that can be saved as a sprite file for use in other applications

Schema 2 is the award-winning spreadsheet previously published by Clares Micro Supplies. Boasting a huge number of professional features, it's also somewhat easier to use than many of the Windows and Mac OS offerings. Full details are available through the

Free delivery ● No minimum order ● VAT included ● Same day despatch

Keepink money in the bank!

● 100% Guaranteed ● 100% Full of Ink ● 100% recycled by us

PACK OF 6 FOR £8.50!!

Compatible Cartridges

Example:

For Epson

6 x TO13	C20/C40	black	£8.50
6 x TO14	C20/C40	colour	£15.00
6 x TO19	880	black	£8.50
6 x TO20	880	colour	£15.00
6 x TO26	Photo 810	black	£24.50
6 x TO27	Photo 810	photo	£26.44
6 x TO28	C50/C60	black	£24.50
6 x TO29	C50/C60	colour	£26.44
6 x TO321	C70/C80/C82	black	£29.08
6 x TO322	C70/C80	cyan	£32.31
6 x TO323	C70/C80	magenta	£32.31
6 x TO324	C70/C80	yellow	£32.31
6 x TO36	C42	black	£24.68
6 x TO37	C42	colour	£29.32
6 x TO40	C62/CX3200	black	£24.68
6 x TO41	C62/CX3200	colour	£26.44
6 x TO422	C82	cyan	£32.31
6 x TO423	C82	magenta	£32.31
6 x TO424	C82	yellow	£32.31

For Canon

6 x BC121Bk	2100	black	£9.93
6 x BC121C	2100	colour	£11.75
6 x BC124Bk	5300	black	£13.75
6 x BC124C	5300	colour	£18.75
6 x BC13Bk	i550	black	£24.91
6 x BC13C	i550	cyan	£22.44
6 x BC13M	i550	magenta	£22.44
6 x BC13Y	i550	yellow	£22.44

For Xerox

6 x 8R7971	(H100) M750	black	£24.68
6 x 8R7972	(Y010) M750	cyan	£24.68
6 x 8R7973	(Y102) M750	magenta	£24.68
6 x 8R7974	(Y103) M750	yellow	£24.68

NEW C42



As Low As...
£4.94

NEW C82



As Low As...
£5.82

C6615 42ml



Now only...
£11.50

C6578 45ml



Now only...
£15.94

Recycled Cartridges

Example:

For Lexmark printers

12A1970	Z42/Z52.53	black	£13.50
12A1975	Z42/Z52.53	black	£14.50
12A1980	Z11.Z31	colour	£14.95
12A1985	Z11.Z31	colour	£15.25
12A1990	Z22/Z32	photo	£16.50
13619HC	1000/1020	colour	£14.95
13400HC	1000/1020	black	£13.50
15M0120	Z45/Z52.53	colour	£15.94
15M0125	Z45/Z52.53	colour	£16.94
17G0050	Z12/Z22.32	black	£13.50
17G0060	Z12/Z22.32	colour	£14.95

For Hewlett Packard

51625	400/500	colour	£12.50
51626	400/500	black	£9.80
51629	600	black	£9.89
51633	310	black	£9.80
51641	820	colour	£12.95
51645	930/970	black	£9.49
51649	600/610	colour	£14.75
C1816	660/690	photo	£15.94
C1823	710/810	colour	£13.95
C4844	2000	black	£14.95
C6614	610/640	black	£10.25
C6615	810/840	black	£11.50
C6578	930/959	colour	£15.94
C6625	840/843	colour	£14.95

For Canon

BC-01	BJ-10	black	£8.95
BC-02	BJC-250	black	£8.95
BC-05	BJC-250	colour	£12.49
BC-20	BJC-2100	black	£10.49
BC-23	BJC-5000	black	£10.55
BX-3	FAX B100	black	£9.49

**Just Need Ink?
Call us!**

inkcycle

Just Need One?

Example:

for Epson			
1 x S020089	£3.10		
1 x S020093	£1.80		
1 x S020108	£1.80		
1 x S0200187	£1.70		
1 x S0200191	£3.00		
1 x TO13	£1.70		
1 x TO14	£3.00		

USBee a fool not to get one!!!

- Replaces up to 176 floppies*
- No power supply needed
- Plugs straight in to your USB port
- Massive storage capacity
- PC or Mac compatible
- Stores MP3 files
- Stores Sound, Movie or Photos
- Handles ANY data file
- Fit it to your keyring
- Weighs only 13 grams
- Smaller than a cigarette lighter!



*256Mb version
Win98 requires driver
(download from www.usbee.co.uk)

32Mb	£27.95
64Mb	£47.95
128Mb	£87.95
256Mb	£147.95

that's only 58p per Mb!

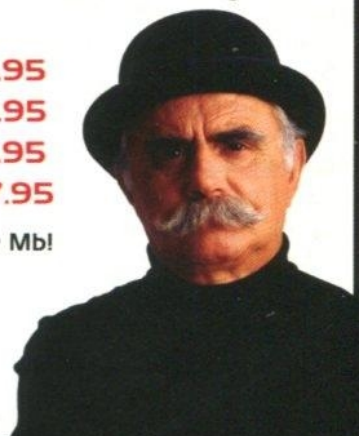

Please visit our website for up to the minute prices

www.inkcycle.co.uk

FREEPHONE : 0800 652 7086

Broadband ADSL internet

www.not.ms

Looking for something different?

- * Block of real IP addresses
- * No blocked ports or protocols
- * Fixed cost permanent link
- * Fast installation

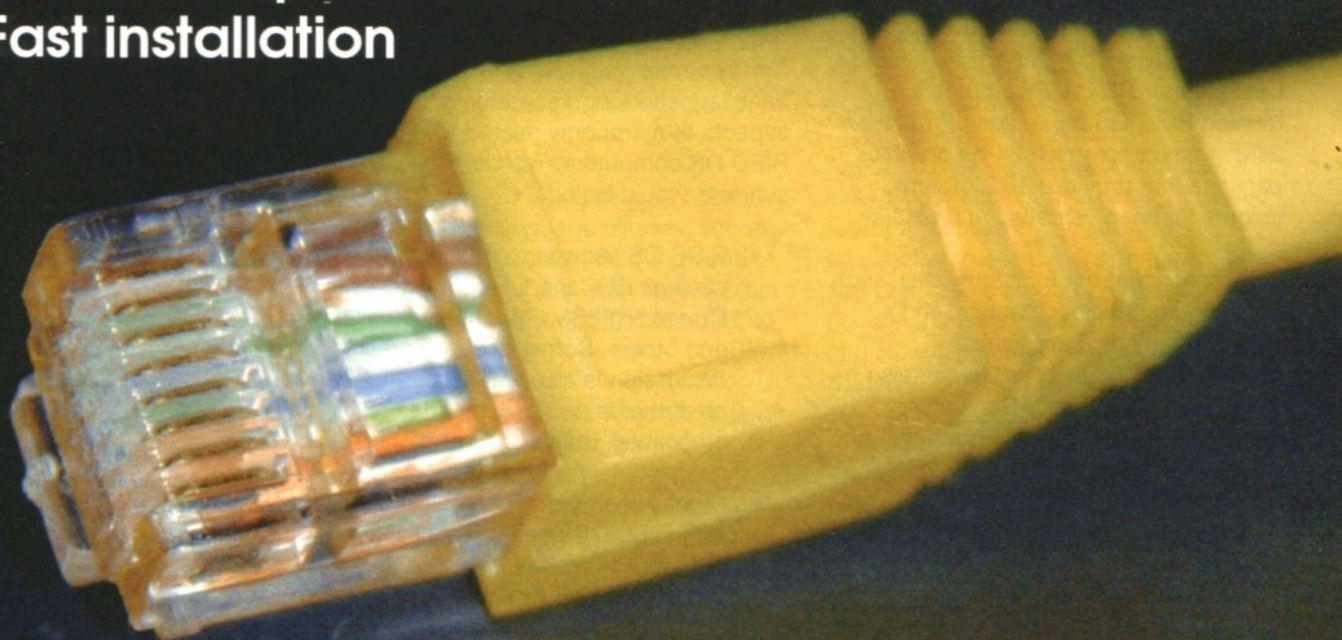

100M

ADSL

LAN

Are you well connected?

www.aaisp.net.uk

APDL/ProAction page on the APDL web site; but important details are:

The *SchemeEx* converter is now included as standard

A macro manual is being put together, and will be supplied free to people who purchase from APDL; a charge will be made to others

The new price is just £59; but due to the weight of the manual, purchases from outside the UK will attract a £2 postage cost.

ProArtisan 24 is the latest development in the hugely successful Artisan series. Designed for RISC OS computers running RISC OS 3.5 or later, *ProArtisan 24* is a no compromise 24-bit graphics package that provides 16.7 million colours for image creation and display.

This means that the tools provided, such as chalk, watercolour, pastels, and so on, closely mimic their natural counterparts. These brushes can also be used to render intricate Draw paths, resulting in Draw images rendered in any brush type. If you add to this:

- the ability to load and manipulate full or selected areas of Kodak Photo CD images in 24 Bit colour
- loading of foreign file types such as JPEG, TIFF, PhotoCD, and others
- an exceptional clone spray for photo retouching
- a full range of sprite cutting and pasting facilities with soft edges
- realistic textures
- a full range of image processing filters
- a frisket in conjunction with an 8 bit mask via highly intuitive interface for colour picking
- StrongARM and RISC OS 4 compatible

With all of this together you have a very powerful image editing and processing tool. The new price is just £29, and there is a £1.50 carriage charge for orders outside of the UK. For more information on both packages, e-mail info@apdl.co.uk; call 020 8778 2659 or write to APDL, 39 Knighton Park Road, Sydenham, London SE26 5RN.

MellDI upgrade

A new version of *MellDI*, the MIDI sequencing package for RISC OS, has been released. *MellDI* is now into its eighth year of release (and tenth year of

development). Version 1.15 fixes a number of outstanding bugs and also adds new features. These include:

- Improved garbage collection and song integrity checking
- Wider range of tempos supported
- Controllers can be mapped on MIDI Thru (e.g. Expression->Filter cutoff)

Further information and upgrades can be found on the *MellDI* Web site:

www.melidi.co.uk *MellDI* is available for purchase from Liquid Silicon
www.liquid-silicon.com

New Astronomy mailing list

A new e-mail discussion list has been launched for discussion of all aspects of astronomy related to RISC OS computers. Typical subjects would include:

- RISC OS astronomical software such as ROCchart, Copernicus, Orrery, NightSky, MoonTool, XEarth and others. Software development discussion is also welcome, and if an author is on the list (and is amenable), bug reports and suggestions for improvement.
- Processing of astronomical images with RISC OS graphics applications such as Photodesk, Composition, ChangeFSI and others.
- Hardware projects, such as telescope control from RISC OS computers, and using a webcam for astronomical imaging.
- Mathematical astronomy using RISC OS software.
- Porting of open source astronomical software to RISC OS.

All levels of expertise are welcome, from beginners to advanced to astronomers of the armchair variety. And you don't have to own a telescope. The group has a home page at
www.smartgroups.com/groups/roast

You do not need to access this web site in order to join the list, you can just send an e-mail to:
roast-subscribe@smartgroups.com

Two databases become 32-bit
They say RISC OS software is like buses...you wait ages for an upgrade then two come along together. This month sees both *DataPower 2* and *Impact 3* make the transition to be 26/32-bit neutral which means they will

run on both RISC OS 3 and 4, and RISC OS 5 on the Lyonix PC.

R-Comps' *DataPower 2* release includes DPGraph (DataPower's charting add-on) and also the complex client/server modules that allow *DataPower 2* to work in a network environment.

DataPower 2 is a powerful, relational database system, with industry standard SQL support and a friendly "DTP-style" approach to laying things out. This makes it an ideal choice for home or business use. It works on RISC OS 3.1 to RISC OS 5 and there is a database "reader" is available for Windows.

Existing *DataPower 2* users can upgrade to the 32-bit version for £40 which includes joining the Registered User Scheme. More details from:

R-Comp, 22 Robert Moffat, High Legh, Knutsford, Cheshire WA16 6PS

Tel: (+44) 01925 755043
Fax: (+44) 01925 757377
Web: www.rcomp.co.uk

Meanwhile *Impact 3* from The Fourth Dimension at version 3.20 has had a number of minor bug-fixes and improvements, including password checking of cards. And *LabPrint* has also been upgraded to be 26/32bit neutral.

If you want to upgrade from version 3.xx to the latest version (v3.20) cost £25 by returning your original disc. To join the *Impact 3* mailing list for *Impact 3* related discussion, please go to
www.cjemicros.co.uk/4d/Circle/

4D hope to be able to continue to support and improve *Impact 3*. Any suggestions for new features, improvements and bug reports can be posted to the mailing list.

Impact 3 is an easy to use, fully relational database suitable for any application where data must be stored and retrieved quickly and easily. A database can be created and used within a few minutes of installation, by simple drag and drop methods.

The program presentation conforms to conventional standards, and data cards can contain familiar desktop features such as radio and option buttons, pop-up menus and action buttons making it the ideal database for the busy office,

home or school.

Impact 3 is available at the special price of £75 inc UK postage from the normal price of £96 (no VAT). Multi-user licences are available.

Contact:

The Fourth Dimension, 78 Brighton Road, Worthing, BN11 2EN, England.

Tel: +44 (0) 1903 523222

Fax: +44 (0) 1903 523679

Email: 4d@cjemicros.co.uk

Web: www.cjemicros.co.uk/4d/

USB galore

Following the plethora of USB product announced last month, this month sees two significant additions to the range of USB devices now available to RISC OS users.

Collaboration between Surftec and Stuart Tyrrell Developments, and another between STD and Explan sees the release of the *DigiFlash2* card and USB to Parallel Port Interface, both for the Simtec USB podule.

DigiFlash2 is a dual-format card reader enabling both CompactFlash type 1 and SmartMedia cards to be read and written. The readers are compatible with the FAT filing systems used by most digital cameras, MP3 players and other devices that use Compact Flash or SmartMedia cards. The reader may also be used on PC machines in order to allow file transfer.

Digiflash2 comes complete with RISC OS drivers and full instructions, and costs £59.95 inc VAT and delivery. The Simtec USB card is available for £89.00 inc VAT and delivery.

Unfortunately, the product only works with the Simtec USB stack, which leaves Castles' Lyonix users high and dry, although Castle have stated they are working on Mass storage USB drivers which would allow many devices such as digital cameras and card readers to work on the Lyonix PC.

Digiflash2 for the Simtec USB interface and the Simtec USB interface itself are available immediately from Surftec and Stuart Tyrrell Developments. Further details regarding Digiflash may be found at www.digiflash.co.uk

The USB parallel port interface plugs into the USB podule on the computer and offers a second parallel port. This allows the use of printers with Centronics

parallel interfaces to be driven from a USB card, while using their standard RISC OS driver (a special USB driver is not required).

Although the Simtec USB card has supported printers with built-in USB ports since its release, this interface allows users who already have, for example, a parallel port-based inkjet printer; to add a parallel port based laser printer via the Simtec USB interface. Documents may be printed to either printer via the standard RISC OS drivers without the need for switch boxes or similar.

Many printers of the same or differing type may be used on a single machine, using multiple interfaces. Informal tests show data transfer over a USB interface to be somewhat faster than the internal standard parallel port. In addition this method offers a solution for those users who have struggled with compatibility issues when using both a printer and another peripheral device (Zip-drive, scanner or card-reader) from their existing parallel port.

The interface costs £13.95 + carriage + VAT = £19.95, and is available, along with Simtec's USB card from Stuart Tyrrell Developments and ExPLAN. Customers who purchase a printer from Explan may add a pack comprising Simtec USB card and Parallel Port Interface for only £99.00 inc carriage and VAT.

Contact:

Stuart Tyrrell Developments, PO Box 183, Oldham, OL2 8FB

Email: info@stdevel.co.uk

Tel: 0845 458 8803

Fax: 0870 164 1604

ExpLAN Computers Ltd., P.O. Box 32, Tavistock, Devon, PL19 8YU

Tel: 01822 613868

Fax: 01822 610868

Email: sales@explan.co.uk

Web: www.explan.co.uk

I am a camera

Photodesk Ltd have also released details of their *CameraDesk* USB software to allow images to be transferred from a range of USB cameras.

It currently supports the entire range of USB Canon cameras and the Simtec USB card. The utility is

fully compatible with *Photoshow* and *Photodesk* software and shows the entire contents of the camera as a filer window or as a clipboard of thumbnails if used in conjunction with *Photoshow*. *CameraDesk* will be offered at £49.00 or as a bundle with a Simtec card and *Photoshow* for £125.00. Canon cameras are also available from *Photodesk* Ltd

Photodesk have also announced the availability of the 32-bit version of *Photodesk*, thanks to much work by Dave Ruck from the ARM Club. Upgrades are available for £40.

Contact:

Photodesk Ltd., 1 The Courtyard, Southwell Business Park, Portland, Dorset DT5 2JS

Tel: +44(0)1305 822753

Fax: +44(0)1305 860483

Stuck with your old backdrop?

PinWay is a new pinboard type application for RISC OS 3.10 to 5. Its main features are:

- Create and display up to 8 pinboards.
- *PinWay* pinboards can be auto-saved when the computer is shutdown, the program is quit or the user manually clicks 'Save'.
- As well as normal Filer type objects such as Applications, Files and Directories which can be dragged to the *PinWay* pinboard, Command-type objects which execute RISC OS commands can also be created on the pinboard.
- Files from most other applications can be saved direct to the *PinWay* pinboard. Just drag a 'save' icon from another application to a blank part of the *PinWay* pinboard.

If you drop the 'save' icon from most other applications on to a directory icon that has previously been placed on the *PinWay* pinboard, it will be saved to that directory and not the pinboard.

PinWay can be downloaded from www.bapfish.org.uk along with a selection of other RISC OS software.

Accounting Software

Twice Winner of Acorn User Best Business Software Awards

Prophet3+ professional

- Customer Relations Management
- Invoice/Order Layout Editors
- Stock Control
- Simple Ledgers
- VAT Control
- Multi Currency
- Accountants Reports
- Lifetime Licence
- Loved by its users!

- RISC OS
- Iyonix
- Virtual Acorn



Accountz.com Ltd 2003

* Boxed in Slip Case with CD + printed Manuals £200
 * CD version (HTML/PDF e-manuals) £150

Accountz.com Ltd • Hostmoor Avenue Ind Est • March • Cambridge • PE15 0ND
 08700 111747 • Fax 01354 680432 • sales@accountz.com • www.accountz.com

Campkins CAMERA CENTRE

May Specials - Latest Clearance List

NIKON COOLPIX 5000 INC MB5000 GRIP £679-99	OLYMPUS C100 £99-99	OLYMPUS C120 £119-99
NIKON COOLPIX 3000 £199-99	OLYMPUS C1 ZOOM £129-99	OLYMPUS C960L £129-99
NIKON COOLPIX 2500 £199-99	PENTAX EL100 £99-99	FUJI M601 £299-99
OLYMPUS C300 ZOOM MDx3x ZOOM £199-99	CANON S30 £379-99	CANON G2 £479-99
CANON S40 £429-99	FUJI 1400 £129-99	FUJI 2800 £199-99
FUJI 2600 £179-99	FUJI A201 £129-99	FUJI 4800 £249-99
FUJI 6900 £489-99	CANNON POWERSHOT A30 £199-99	NIKON 885 £329-99
CANON A100 £149-99	PENTAX OPTIO330RS £299-99	MINOLTA DIGIMAX X £249-99
KODAK DC3200 USED £59-99	SONY MAVICAFD73 USED £125	OLYMPUS C3030 £299
NIKON 880 USED £250-00	SAMSUNG DIGIMAX 35 £90	KYOCERA S4 £299-99 INC FREE 32MB EXTRA
SPYPEN £40-00	16MB SMART MEDIA £5-00	OLYMPUS C40 £399-99

LATEST MODELS ARRIVING DAILY

We still accept 35mm Reflex Systems in exchange

11 Rose Cresent **TEL: 01223 364223**
 Cambridge CB2 3LP email: sales @ campkinscameras.co.uk

FOR ALL YOUR
RISC OS
COMPUTER AND
I.T. SUPPORT
REQUIREMENTS

Check out our Web site
for the latest special deals
on RISC OS computers

www.microbit.demon.co.uk

664 Foleshill Road
Coventry CV6 6GR
Tel: 024 7666 1001
Fax: 024 7666 2999
Mobile: 0771 425 1011
E-mail: sales@microbit.demon.co.uk
Web: www.microbit.demon.co.uk

MICROBITS

NOW AVAILABLE
CAMERA
DESK



Plus Upgrade to Photodesk
32-bit compatible

OHP 32-bit compatible
NOW AVAILABLE

chris@photodesk.ltd.uk
telephone 01305 822753

PHOTODESK LIMITED

Graphic design in the Real World

Over the past few months I have been giving you ideas and pointers about how to kick-start your own creative processes. One common method that graphic designers use to spark ideas is to look at what other designers have done. That's why many keep scrapbooks or files of "good ideas."

I'm not talking about stealing, but rather exploring someone else's solution and assessing whether a similar approach might suit your job in hand. Almost always your finished project is very different; looking at other work simply serves as a catalyst, something to set you off on your own path.

With this in mind I thought it would be interesting to look at some design work I've done, real jobs which eventually went into print, and show you how I arrived at the end result. All projects start with a brief. That is, a description of what the job is, and that's a starting point to creativity. It's often as uncomplicated as, for example, "Design a logo for a plumbing company," but the brief contains the kernel of the solution. You can start by talking it out in your head: what simple image could represent a plumbing company? That will lead you to your first solution, which may well be rejected, but getting a start is very important.

One job I had recently was designing a logo for The British BMG Federation, "BMG" standing for banjo, mandolin and guitar. My first thoughts were how to represent the three instruments in a simple graphic way. What common attributes do the various instruments have? I reasoned they were all stringed instruments, and all had tuning pegs, which gave me the first visual hook. I sketched out some tuning pegs in a loose manner.

Trouble was, it wasn't clear what they were (lollipops?) and I couldn't be specific about the number of pegs, since banjos have four pegs, guitars six, and mandolins eight. Still, it was a start, and led me to my next thought. The strings of each instrument are wound onto the peg,



and I thought if I used that as part of the logo it would include all three instruments.

The B R I T I S H
BMG 
F E D E R A T I O N

I felt I was getting closer, but it still wasn't right. To many it would still be unclear, it looked a bit like a capstan with a ship's hawser attached. Back to the drawing board.

I decided to look at the actual instruments, and wondered how I could represent them all but in a simplified way. One problem was that they're different sizes and put together side by side the trio would look lopsided. But what if they were lying on their side? This turns the disadvantage of their varying sizes into an advantage, because if they were lying one in front of the other, you would be able to see parts of all three. Exploring this idea, I arrived at an arrangement of silhouettes.



I knew I was onto the winning idea, but I thought it could be better. I decided against enclosing it within a coloured box, but using the juxtaposition of the main colour and the white background to delineate the strong shapes of the instruments' profiles. To my mind, that was it. I believed I'd successfully conveyed the main focus of the organisation within a simple graphic image and

fortunately, as this is not always the case, my clients agreed.



Another client was Castle Music, who asked for a new logo. This was easier, because at least there was a single, instant image which comes to mind: a castle! I decided that the quickest route into the problem was the most obvious, and started exploring graphic images of castles. First I included their office, an actual castle, into the design, only to be told that they were moving soon, so they'd rather not use that.

So I started toying with images of turrets. The first one, I decided, didn't hit the mark. Sticking with the turrets idea, I drew roughly a row of turrets, incorporating the name of the company.



It still wasn't there, but looking at this idea led me to a slightly different way of thinking; what if we could use the image of a chess piece, a castle? Again I used Draw to sketch a simple representation of a chessboard castle, and I felt this was the one. I reminded me of illustrations from book jackets of the 1950s, so I created lettering to emphasise that connection, and at last the logo looked finished.



These two examples should show you how ideas are sparked off ideas, and by exploring one ideas path, however lame, another, better idea can result.

Nigel Gatherer
graphics@acomuser.com

Wakey WAAAAKEY!

The 2003 Wakefield RISC OS show took place on Saturday 10th May. The show had been scaled back to a one day event for the first time for quite a few years, but retained the same venue.

MicroDigital, or at least, MicroDigital and their partners, managed to dominate the topics of conversation at the show. The seemingly endless waiting for Omega systems to be delivered to actual customers meant the show was guaranteed to be yet another "high noon" in that arena, and the announcement by MicroDigital of a PC laptop running Virtual Acorn and RISC OS 4 signalled the end of the constant squabbling over the licensing status of Virtual Acorn.

MicroDigital's Alpha laptop features a 2GHz Celeron processor. Whilst this is hardly leading the pack in CPU power even for a laptop, it should still produce very usable performance, and indeed was demonstrated running 1024x768 screen resolution in 32,000 colours on its 13.3 inch TFT screen.

MicroDigital boldly describe the Celeron as producing emulated RISC OS performance "equivalent to a 300MHz StrongARM computer". However, examination of various benchmarks from Virtual Acorn on various Celeron laptops suggested that, as always, the actual performance will vary extensively depending on what you're doing. For example, hard disk access under Virtual Acorn is vastly improved over the original Risc PC, but the emulator compares very poorly indeed for processor intensive tasks that don't require much access to main memory; more like an ARM710 Risc PC than a StrongARM one.

There have been suggestions that the Alpha package includes enhancements where the RISC OS environment takes advantage of specific aspects of the PC laptop's hardware, thus outperforming existing Virtual Acorn installations on similar hardware. However, no specific information was available about these enhancements, and the laptop hardware does seem just the same today's common PC laptops.

Indeed, the hardware emulated is an ARM710 Risc PC rather than a StrongARM one. This does have advantages in itself, however, because

there is a large quantity of RISC OS software that will work on an ARM7 (even an emulated one!), but not on a StrongARM. Emulating a StrongARM instead might have produced some speed increases, but a far less capable software portfolio.



One thing made very clear was that there were no plans for this remarkable "RISC OS 4 plus Virtual Acorn" combination to be made available for installation as a software product for those who already have their own PC laptops. The licensing



agreement reached between Virtual Acorn, MicroDigital, RISCOS Ltd and Pace requires MicroDigital to pay RISCOS Ltd for each computer sold, and also for the RISC OS 4 Virtual Acorn combination to be licensed and tied ("copy protected"?) to run on the specific



laptop sold to each individual customer. This is achieved via code specific to the hardware.

As might be expected, the announcement prompted a withering storm of different viewpoints. (This was probably further encouraged by the sight of Alpha laptops on a wide variety of stands, including Virtual Acorn, APDL, MicroDigital themselves, and even RISCOS Ltd). Some were quick to dismiss a PC laptop using emulation as a second best solution, laughable to those used to real RISC hardware directly available to the user; but others saw the availability of RISC OS 4 on a laptop as being a major step forward.

Many other users have already bought a PC laptop on which to run Virtual Acorn, and are unlikely to buy a second one just to get an operating system upgrade. (MicroDigital do claim to be aiming mainly at expanding RISC OS usage outside the existing market). Even so, the Alpha definitely looked like flavour of the month for anyone keen to run RISC OS on a laptop, particularly given that RiscStation were not at the show, and that their PR guru was earlier said to be "leaving RISC OS" following revelations about the actual status of the RiscStation portable project.

As for the long-delayed Omega, it seemed that a breakthrough had finally been reached, even if ordinary customers could not take away their computers on the day of the show. (While MicroDigital asked for substantial deposits for anyone ordering an Omega as early as 2000, it wasn't until a few weeks before this show that they had begun invoicing deposit holders for the full amount).

RISCOS Ltd had received an Omega of their very own on which to test RISC OS 4 and RISC OS Select, and MicroDigital were prepared to license RISC OS 4 for the Omega by paying RISCOS Ltd for each machine sold (as was the case with the MicroDigital Mico, the RiscStation desktop, and Castle's old RISC OS 4 computers), so the rather nebulous "contractual issue" cited by MicroDigital had apparently been resolved.

Despite loud denials from the rumour boards believing that the Omega "next week" promises would continue indefinitely, your correspondent confirmed with his own eyes that exactly two Omega systems did indeed leave the show, as the prizes (one visitor and one exhibitor) for the show prize draw. The exhibitor

prize went to The ARM Club, and the visitor prize went to Peter Bell. Alongside that good news, there was also bad news on the Omega front. Apparently the promised 100Mbit network card was not yet ready (unlike the Lyonix, which has much faster 1000Mbit networking built in, the Omega requires an additional PCI card for ethernet networking). The floppy disk drive didn't work either, transferring software is slightly more trouble when one has neither a floppy drive nor ethernet.

There were also worries about the stability of the demonstrated ("production") machines in high resolution screen modes, and about the extent to which 2D graphics acceleration (essential on any modern computer system to avoid jerky window movements in high resolution screen modes) is actually implemented. Finally, MicroDigital admitted that USB was not yet working.

In the few weeks before the show, the sceptics, like a small flock of very hungry goats, had been hounding MicroDigital about issues like these. Their main concern was that some see the Omega as "more expandable" than the Lyonix, but the expansion options may still not be available even if the computer is; they thus tend to see the Omega as a much-updated StrongARM Risc PC rather than a true competitor to the Lyonix, and cite rumours of timing problems with XScale on Omega as an indication that things may stay that way.

David Atkins of MicroDigital had a robust response to these criticisms, saying that they did in fact have an XScale-based Omega working in MicroDigital's laboratories, but there were a few minor problems with it, and they weren't demonstrating it at Wakefield because no-one understands what MicroDigital show to them at RISC OS events. Likewise, the network card, SCSI card and other add-ons were said to be very close to completion, but MicroDigital had chosen not to demonstrate them.

MicroDigital's publicity effort continued to "think differently". The Alpha's launch was accompanied by a striking colour A2 leaflet whose innards revealed a bigger than life size photograph of their portable showing RISC OS with the visible date only nine days before the show.

Even more striking, more than half of

MicroDigital's stand was occupied by three high performance motorbikes in racing colours, relevant because of David Atkins' new biking hobby, and adjacent MicroDigital dealer Paddy Reid's illustrious past in racing (he won the Manx TT in the Queen's Silver Jubilee year). The allocation of space seemed rather bizarre to some, but it did



give a quite surprising and pleasing air of glamour to see pronouncements about RISC OS performance given against a foreground of "serious hardware" of a totally different type. I've attended more MicroDigital events than anyone who doesn't work for MicroDigital, and I must say no-one can doubt that David Atkins has a sense of style.



Meanwhile, over in the blue corner, Castle had their usual large stand populated by Lyonix computers, USB printers and USB scanners. Castle had deluged us all with announcements in the days and weeks preceding the show, it is now very hard to suggest that there is anything missing from the Lyonix. The



addition of greatest interest is UDMA, giving a huge speed increase for disk access times.

Another area where Castle were claiming a first for a next generation RISC OS computer was SCSI, with the existing Acorn podule SCSI card demonstrated fully working on their stand. Jack Lillingston said that this would soon be joined by third party podule SCSI cards (including Castle's own), as well as third party PCI SCSI cards, the latter might take "a bit longer".

Castle could rightly gloat (but didn't!) that floppy disk drives, networking and fully functional 2D acceleration had been working on the Lyonix since late 2002, while their main competitor still seems to be struggling with these nearly halfway through 2003.

Lyonix owners had been left out of the numerous announcements made at the show by Stuart Tyrrell Developments about drivers for various mass storage USB devices, these were only for owners of Simtec USB cards in older computers. (Surftec, also involved in USB devices for RISC OS, decided not to exhibit at the show; Simtec gave a theatre presentation showing exactly what their cards could do, but didn't have a stand).

Undaunted, Castle were not only demonstrating the printing, scanning, keyboard, mouse and hub devices already supported by the Lyonix, but also promising their own USB mass storage device driver for imminent release. This would give access not only via USB card readers for CompactFlash, SmartMedia, MMC and MemoryStick, but also all sorts of other devices, including digital cameras directly.

Castle had also been participating in the move forwards from previous squabbles about licensing conditions. Although no details could be confirmed at the show, an arrangement to remove RISCOS Ltd's concerns about the version of RISC OS on the Lyonix was said to be right around the corner.

Castle themselves were keen to stress their positive approach, mentioning their contribution of Popup !Printers for RISCOS Ltd to make available for free download by their customers. Castle's Jack Lillingston said he hoped that this exchange of technologies would become a two-way thing, when prompted, he said he did hope that Castle and RISCOS Ltd could work together to make this include some Select features on Lyonix.

However, Castle have always hinted that their RISC OS 5 is ahead of Select in some areas, and perhaps see it as impractical to merge these two radically different operating systems with totally different approaches to common "under the bonnet" problems. So the form taken by any possible co-operation remains very unclear.

Not too far away from the Castle stand was the Aemulor stand, with their Lyonix showing off how much 26-bit software can now be run under emulation, and how fast! While I do still know Lyonix owners who have one or two slightly more unusual applications they really need that aren't yet "Aemulor OK", the list of popular applications that still won't run now seemed to be pretty much non-existent.

Neil Spellings and programmer Adrian Lees were also testing software that show visitors wanted to make Lyonix compatible; and even looking at how to fix software on the spot! One beneficiary who wasn't a visitor, but was lucky enough to have his stand right next door, was Robin Edwards of Serious Statistical Software.

Testing revealed that 1st, 1st Jr, and 1stL from SSS will indeed run using Aemulor, but with some key facilities failing; the Aemulor team thought these problems would be pretty easy to fix, and took away the software to work on it. Robin's statistics software goes far beyond my needs, but new features at the show provided improved facilities relating to confidence intervals of ratios of proportions. (Or so I was told!)

The Aemulor stand also doubled as a "Spellings Computer Services" stand, and it was good to see that effort had been put into making the stand a good advert for their spam email filtering service. Buying a dozen large tins of a fine meat product and arranging them in a 2D pyramid may not be the most extravagant marketing approach (especially when compared with motorbikes), but it certainly caught the eye.

By contrast, some exhibitors had stands that were much reduced on previous years, and also seemed to put less into presentation. Particular examples were Cerilica, who have recently cut down on the size of their operation, and Photodesk Ltd. From what I saw, both

seemed to have a single computer, a single exhibitor, and very little else.

Admittedly, Cerilica are reducing the size of their operation, and Chris Hornby had announced on his Web site that he would be unable to be at the show due to a commitment made far in advance;



but even so, I expected rather more from companies who have had very impressive stands (whether by

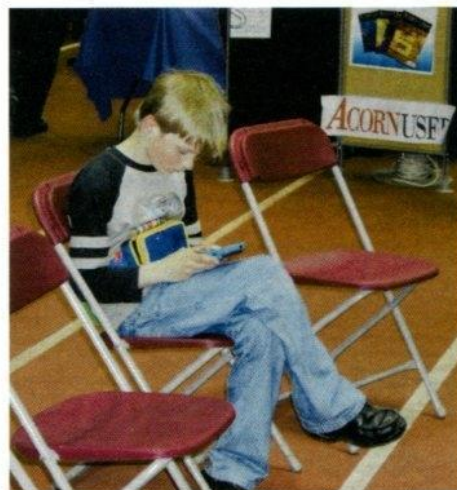

technology and design, or by a profusion of posters, literature and demonstrations) in the past.

It was good news, though, that both of these companies were releasing products at the show, with Cerilica



formally unveiling Vantage 1.10 for the first time, and Photodesk selling both the essential Lyonix-compatible version of their bitmap graphics package (Photodesk 3.05), but also an Lyonix-

compatible and enhanced version of the presentation package OHP2 (OHP 2.5).

Photodesk Ltd were also selling CameraDesk, which allows images from specific digital cameras to be downloaded to a RISC OS computer via USB. The version at the show was only compatible with the Simtec USB card, but versions for the Castle USB card and the Lyonix were said to be under preparation.

With all this going on, we should certainly hope for a more impressive display from Photodesk Ltd at the next show. Their competitors in the market for RISC OS presentation software were certainly snapping at their heels, with the Really Good Software Company releasing Lyonix-ready versions of NoticeBoard Pro and other products on their own stand on the far side of the hall.

The graphics package receiving far more attention than any other piece of software at the show was ArtWorks 2. Martin Wuerthner's small stand was besieged from fairly early on in the show, but it wasn't until about lunchtime that I noticed there was a formal queue, two wide and ten or twelve deep, waiting their turn to speak to him.

Three or four hours later, I looked again; the queue was identical in size and shape, but was now made up of different people. The message was quite clear; we may all have viewed ArtWorks as "dead software" two or three years ago, but Martin's steady pace of development, and the huge performance improvements seen with Artworks 2 on Lyonix, mean that a huge number of ordinary RISC OS users still see it as the graphics software in which they should invest. Needless to say, I didn't manage to speak to Martin at the show, but I had little doubt that the sales made had more than covered the stand cost and the air fare from Europe.

One exhibitor who was quite happy to admit that the takings had dwarfed the expenses was Jonathan Duddington, accompanied by his wife (in charge of finances and recording who had bought what). Pluto 3 is the Lyonix-compatible version of the endlessly popular news/mailreader Pluto. However, much like all other Pluto releases, it also includes major improvements requested by users, and not related to compatibility



Quest is a small and highly innovative agency whose team has over 15 years of experience in all sectors of design, marketing and publishing.

The question is: is your current image communicating the exact message that you want it to communicate? If not you have to ask yourself how much of the market place is being driven off and is unavailable to you.

Whatever your goals and aspirations our unique results driven attitude will ensure that you meet your strategic targets.

Please contact one of our Directors: Sharon Henderson or Steve Turnbull for inspiration.

Advertising

Strategic Marketing

Corporate Identity

Brochures

Publishing

Copy Writing

New Media

PR

Design Direct

28A Middle Hillgate
Stockport SK1 3AY

T] 0161 429 8902 F] 0161 429 0685

W] www.questdp.co.uk e] sales@questdp.co.uk

blackcatpc

Shuttle PCs

Available from P4 Celeron 1.7GHZ Thru Athlon 2.8 to P4 3.0GHZ. Ram up to 1GHZ, APG Graphics to suit or onboard choose your own spec, e.g Hard drive, CD/DVD/CDRW, Floppy zip, LS120, comes with AGP, PCI (1) Expansion slots, 4X USB 2.0 (2 front + 2 rear), 3X Firewire (1 front + 2 rear, Network, 5.1 Sound +SPDIF, TV out...



Very quiet

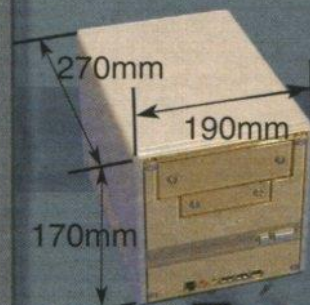

Space Saving

Basic spec ready configured... prices from £398 inclusive

Numerous optional extras:

- from coloured front panel
- parallel port add on
- wireless LAN module,
- memory card readers
- Matching ftt screens
- even carry bags...

prices from £398 inc vat

please call us on 01243 866 053

9am - 7pm, 7 days a week...

We now have in stock the NEW 'ASUS TERMINATOR' mini pc.



blackcatpc

with specific systems. Little wonder that Jonathan was selling many dozens of Pluto upgrades!

The competing software was easily found on R-Comp's stand. Once again R-Comp had an extensive stand with an extensive array of RISC OS computers, including an Lyonix and a development Omega side by side! There were Lyonix-compatible versions of DialUp, NetFetch, Quake, Messenger Pro, Webster XL, Grapevine and at least a couple of other applications.

The games arcade seemed reduced to a single computer, leaving some of the youngest visitors to the show either loyally playing their ARM-powered handhelds in the new-fangled rest area (which got more popular as the day wore on!), or in one case playing Chuckie Egg at the WROCC's stand. The latter also featured a working Domesday system, very interesting as a piece of history even though both it and its content had aged a lot in two decades.

I've mentioned RISCOS Ltd earlier in this report, but it is worth mentioning briefly that their stand seemed far more popular than at the last show on which I reported. RISC OS 4.36 (also known as RISC OS Select 3) had struck a chord with just about everyone, and a stream of visitors wanted to know more. It was good to see the steady progress on Select finally paying off, 4.36 was already in use by a range of early beta testers by the time of the show, and a CD release was promised to follow within a few weeks. The stand featured some RISC OS systems familiar from earlier shows, but also an Omega running RISC OS Select.

Exhibiting for the first time at the Wakefield Show was Peter Naulls of the UNIX Porting Project (also well known for his involvement in the Drobe RISC OS Web site and various other projects), demonstrating some of the many UNIX applications now available on RISC OS, and selling a budget CD to help get people involved. Sharing the stand was CocoGnut, a relatively cheap RISC OS application for accessing shared files via the peer-to-peer Gnutella network. Both sides of the stand were positive signs that the RISC OS market is not isolated from what is being developed in the outside world, but can benefit from it.

Even taking into account the fact that the

show had shrunk from two days to one, the enthusiasm for it seemed overwhelming. Those arriving exactly on



time for the opening faced a twenty minute wait just to get into the exhibition hall due to the long queue (perhaps more than two volunteers manning the front



desk would have been a good idea, since advance tickets weren't available).

Almost every single stand seemed to be



busy for the whole duration of the show (and there were a great many stands I haven't even mentioned). Indeed, I only managed to make my own purchases by



the age old technique of waiting until the "show is closing in five minutes" announcement was made, and then descending upon the relevant stands in a

great hurry.

There had indeed been some controversy over the decision to hold a one day show rather than a two day one, but a narrow majority of exhibitors who expressed their opinion well in advance preferred the shorter event in order to save money on hotel bills and other expenses; and the Sunday at the previous year's show had been especially quiet for almost the whole afternoon. On balance, a one and a half day show might have been the best option, given the huge popularity of the one day show, but such a thing would probably not be practical!

The success of the show was clear from the number of visitors turning up, the hefty sales made by almost all exhibitors, and the number of new, albeit controversial, items on sale or under preparation. It is very noticeable that RISC OS internet newsgroups and web forums no longer seem to discuss RISC OS versus Windows, or car analogies, or even the existence or otherwise of various deities. Instead, the entire market has taken instant and deeply entrenched positions on Lyonix versus Omega, emulation versus real ARM hardware, RISC OS Select versus RISC OS 5, Castle USB versus Simtec USB, and so on.

Just watching the adherents of each of these viewpoints shout down their opponents with angry determination is proof enough that new enthusiasm has been put into the market by the entry of so many new projects. Even though many see competition of this sort as being a waste of what could be achieved if everyone worked together, there is as yet no proof that increased competition, however bitter, may not do some good even to such a small market. (So long as it goes hand in hand with some co-operation as well, as we've seen).

With these slightly contradictory thoughts in mind, I left Wakefield 2003 feeling more positive than when I had left Wakefield 2002. Now it's up to the exhibitors and organisers to put negative thoughts behind them, and make Wakefield 2004 an even bigger success, it is very clear that the RISC OS community still has the enthusiasm for it!

dgs
dgs@argonet.co.uk

Making that call

Call Centres, don't you love them? Well now the RISC OS community has joined the fray. We now have a call centre system that is RISC OS powered. But don't panic, this one does have a few differences and it won't be ringing you in the dead of night asking you to buy the latest gizmo or insurance policy. The Virtual Call Centre is different.

Here at City Audio Services, and before, I've been working in audio for years, and in that time have used everything from the BBC Micro onwards. As soon as possible, CAS went digital for its editing, indeed several series for BBC World Service, plus many other items, have been mastered on Risc PCs. I have also done a fair amount of voice work. And a fair chunk of that has been for the visually impaired. One of the things I have read onto tape (yes all of it, word for word) was the Disability Discrimination Act, the DDA.

The fundamental concept of the DDA is that no-one may unreasonably discriminate against the disabled even unintentionally. So, for example, if a bank provides its mortgage terms and conditions on a paper document, it would be discriminating if it failed to give a visually impaired customer equal access to the information. How that is done is not prescribed and a reasonable response might be anything from making a braille or tape copy of a document to having staff read it word for word to the client. But potentially it means vast quantities of printed information should be easily accessible to people who simply cannot read printed text.

So the idea of the Virtual Call Centre was born, the idea being to use computers to provide a permanently on and cost-effective way to access vast quantities of audio information using the most common tool available to the visually impaired, the telephone. Being RISC OS-oriented, the attractions of the system were for me beyond question: it is robust, reliable and I could write code for it without an overly massive learning curve. I also already had several machines and a stock of useful bits and pieces like audio cards.

Since then the concept has developed to the point where it is now functioning out in the big wide world. We recently went public with the launch on BBC Radio 4's 'In Touch' programme of a site offering

audio books on CD, its prime target being those who cannot see sufficiently to read print.

In fact the hardware is all sitting here, as I write, humming away next to me. And the little LCD panel in front of me tells me the last five calls came from London, Dundee, Motherwell, a mobile which could be anywhere and a caller who withholds the number. Those callers rang in to listen to brief extracts of audio books on CD, and to place orders as and when they wish.

The man behind 'Best Audio Books', Stefan Novak, is himself visually impaired and has always operated his business through mail order. When, through mutual contacts, he heard about what I was developing he asked if it could help him. What he thinks of it, I leave to him to say (see panel), but from my perspective it was not only the kind of application I wanted to support, but a great opportunity to work with a real client to develop the system into a fully working application.

So what is it exactly? Yes it's a call centre, but it is a virtual one in the sense that it has no real people, just recorded voices. It isn't a tedious pre-selection system to route the caller to the right operative. That's not the idea, the idea is that the caller can be routed to any one of as many audio files as you want to load onto the system. In fact with current hard drives, the system could handle half a million hours of audio. I'm not saying that's sensible, but it could be done, and a caller could access any of it.

The Virtual Call Centre (VCC) is designed to offer a more complete and less expensive way to make audio versions of text available than sending cassettes or CDs by post. But that is not its only application as the book site illustrates. The cost of DDA compliance for all services, commercial and public, is potentially significant. VCC offers a less expensive but more extensive way to meet obligations under the DDA. For the caller it offers a way to access information at any time, ideally via an 0800 number, without anything more sophisticated than a normal tone-dial phone.

In practice VCC is a combination of hardware and software. The front end is a sort of voice-only modem: it uses a

commercially available telephone front end known as a DAA (not to be confused with the DDA, the Government Act) to connect to the telephone circuitry. Crucially this approach sidesteps issues of CE compliance as the device is already certified for connection to telephone systems. Then comes some bespoke hardware to separate and manage the audio signals and to interface the dial-tone system and hook control to the computer's parallel port.

The lines themselves are brought in via ISDN modems for two main reasons. First ISDN offers Multiple Subscriber Numbering (MSN), which means the same actual lines can be dialled using up to nine different numbers. This might sound odd, but it means the system can tell which MSN line is being used, and respond accordingly. For example we publish one number for the book club, but Stefan has another number to access the order records. Second, the ISDN circuits provide detailed and relatively easily accessible call data, not just MSN but also Caller ID, call alerting signals and call clearance notification, very useful.

In terms of the VCC software, what began as a simple idea turned into a substantial package. Not all of it is as complete as I intend it to be in due course, but the core code is viable (I won't say it is finished, I do keep adding bits) and very stable. The hardware is now also proven, though again it is likely that each new build will see minor changes and improvements integrated into the board designs as they are developed.

The VCC system breaks down into several distinct operational elements. The first part is the call manager and router which reads incoming data from the ISDN device and routes the call appropriately. Each ISDN line provides two telephone lines but the manager can handle many ISDN modems and thus control many systems. This code also provides some logging and display functions for the system manager.

The next stage is the core engine, a system for managing multiple layers of choices, handling the input codes and ultimately playing back whatever is required. This is quite easy for the site manager to use as it is based upon simple structures and templates. But the

Ligra Broadband

www.ligra.net

*Looking to save money
on your internet
access?*

*Want a faster, more
reliable connection?*

*Packages from the home user to
the business user with speeds
up to 2Mb*

*If your exchange isn't enabled
yet and you can't get ADSL, we
can offer ISDN as well*

**For more
information, visit
the web site or call
01206 331844**

**Datawyse Systems Limited
enquiries to sales@datawyse.net**

Domain names

Domain registration with forwarding

2 year registrations

£20 +VAT .CO.UK, .ORG.UK,
.ME.UK

£40 +VAT .COM, .NET, .ORG,
.NAME, .BIZ

£65 +VAT .UK.COM, .GB.COM,
.UK.NET, .GB.NET

Includes :

Domain registration fees

DNS Hosting

Email forwarding

URL forwarding

.COM, .ORG and .NET long-term

1 year only £25

5 years £100

10 years £180

Extras :

POP3 mailboxes £10

Mailing list £50

Auto-responder £20

Transparent forwarding £10

Web hosting

Domain registration with hosting

Take above prices and add :

+£25 +VAT 1Mb site

+£45 +VAT 5Mb site

+£70 +VAT 10Mb site

All hosting includes :

Domain registration fees

DNS Hosting

Web site hosting

PHP4

SSI (Server Side Includes)

Web Extras :

Search Engine Registration £25

CGI-BIN £20

Domain transfer £10

All prices exclude VAT @ 17.5%

We can also design your site - ask us for a quote!

Spellings Computer Services
www.spellings.net

domains@spellings.net
Tel. 07785 935497
45 Hillview Close
Purley
Surrey. CR8 1AU

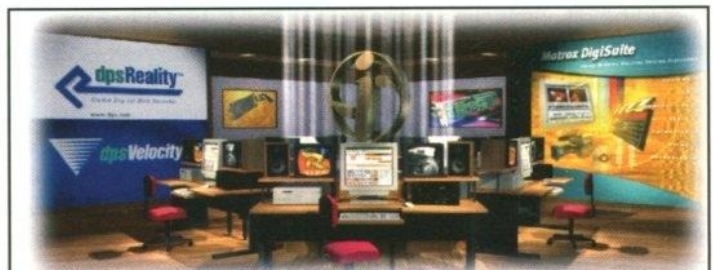

Matrox RT.X100

New Professional Editing Solution for DV25 & MPEG2,
Premiere, DVDit!LE, LigosLSX & Title Express **£839** incl. VAT

Complete realtime edit systems from £1749 inc VAT

NEW AVID XpressDVPro £1,527.50 XpressPro systems from £2700.00
XpressDV v3.5 from £893.00 while stocks last! XpressPro upgrades £317.25

NEW Product Bluefish444 HD & SD uncompressed 10bit SDI
Bluefish444 is Digital Voodoo for Windows, full range at zenvideo.co.uk

NEW In-sync Blade 2 DV NLE software with realtime effects £470.00

AVID - DPS - INCITE - MATROX - PINNACLE

Ulead DVD Workshop AC-3 **£289.99** incl. VAT

Tel. 0161 877 5991 www.zenvideo.co.uk



Offers from Icon Technology

EasiWriter and TechWriter now come on CD complete with documentation in both EasiWriter format and HTML. Also included are extra utilities, stationery and examples.



EasiWriter Pro+ CD £79.00 inc.

Upgrade from !Writer (RISC OS 4)
or EW 4.08 for £40.00 inclusive

- Powerful easy to use multi-column word processor.
- Reads and writes MS Word with 100% elimination of Macro viruses.
- Built-in Table editor.
- Reads and writes HTML and RTF.
- Reads Impression 'Text with styles' documents.

TechWriter Pro+ CD £104.00 inc.

NEW Upgrade from EasiWriter Pro+
for just £25.00 inclusive



All the power of EasiWriter Pro+ with:

- Built-in equation editor. Write equations as easily as you type text. In-line $ax^2 - bx - c = 0$ or displayed:

$$x = \frac{-b \pm \sqrt{b^2 - 4ac}}{2a}$$

- Writes TeX.

Icon Technology Ltd, Church House, Church Street, Carlby, Lincs. PE9 4NB.
www.IconTechnology.net 01 778 590563

SuSE Linux Business Solutions

COLLABORATION CO-OPERATION COMMUNICATION

ALL YOU NEED FOR EFFICIENT TEAM WORK!



NEW!

SuSE Linux Openexchange Server 4 is a proven groupware and electronic messaging solution facilitating teamwork and productivity. A centralised electronic communication Server, which is accessed via intuitive web interfaces on client workstations, and enables better communication and planning for the whole company.

A professional design incorporates familiar communication tools with important business management tools - including task management, shared calendars, shared address books, knowledge management - thereby enabling more efficient time management.

- Groupware, Email-server and Webmail client in one package
- Easy to use Web Administration Tool
- Works with MS Outlook, Eudora, Netscape, and Evolution clients
- Configurable spam filtering using SpamAssasin
- Centralize management, address books, schedules, appointments, and more
- Synchronize with Palm OS and PocketP

This modular all-in-one communication solution can yield savings of up to 63% in all types and sizes of organisations!

For our evaluation programme visit

WWW.SUSE.CO.UK/OPENEXCHANGE

or contact us at

INFO@SUSE.CO.UK

SuSE Linux Ltd.

Appleton House · Hammersmith · London W6 9JG
Tel: 020 8846 3918 · Fax: 020 8748 0538
sales@suse.co.uk · www.suse.co.uk



THE DATA STORE



- CASTLE, RISCSTATION AND MICRODIGITAL DEALER
- RISC OS 4
AUTHORISED INSTALLER

A large range of software and peripherals for all RISC OS computers stocked in our showroom in Bromley - pop in and see us or order by mail, fax, email or telephone!

SIBELIUS

THE MUSIC NOTATION SOFTWARE

The Data Store now provides the official
Customer Support service for Sibelius Acorn programs.

Annual Subscriptions from £47 - please phone for details

SIBELIUS 7 now only £399 inc VAT

SIBELIUS 7 STUDENT only £249 • SIBELIUS 6 only £99

(SIBELIUS 2 FOR WINDOWS/1.4 FOR MAC now £525)

We also stock Graham Jones' excellent music scanning package
SHARPEYE - £60 inc VAT

6 CHATTERTON ROAD BROMLEY KENT BR2 9QN
Tel 020 8460 8991 • Fax 020 8313 0400

Web <http://www.the-datastore.co.uk/>

Email info@the-datastore.co.uk

Open **MONDAY - FRIDAY (except WEDNESDAY) 10.00-5.30**
SATURDAY 10.00-1.00 (1.00-5.30 by appointment only)

code behind it is quite complex as it not only has to interpret the site manager's settings, it also has to handle a great many possible scenarios such as callers not pressing keys when expected, needing to be reminded of options, perhaps being able to repeat menu lists and so on.

All of this functionality is automatic, the VCC has built-in system audio files which are used to guide the caller through the routine functions and to make suitable responses. The system also plays back the target information, which may be anything from a single audio file to a complex file list, and finally the system offers configurable exit options after the playback so the caller can be offered choices as to what to do next.

At first sight the requirement is to be able to play back large audio files. It does that: any format including MP3, with or without spool functions. But it does much more. It will play back any sequence of files enabling variable output to be constructed from sentence elements, either those built in or from those supplied for the site, there's a whole management methodology behind this too! It will play back files demanded by a variable. For example a VccClock application can be run in the background which updates the clock variable with the file list necessary to speak a clock. The VCC will use it whenever the variable is called.

A script file facility allows the system to work from text files. There are several versions of this, one is used to define the file lists for Best Audio Books. The function not only provides a powerful way to deliver large amounts of audio, it also means that external applications can alter the files and provide new lists in a dynamic way.

For example an application has been written to offer bus timetable information which may be altered via a live feed of real-time running data. Another variant is the questionnaire script tool. This allows the site designer to implement a question and answer routine. Indeed this has been used to good effect for taking orders for Best Audio Books.

And there is a further option which allows the VCC to be driven by external applications entirely. This means that without taking the risk of modifying core code a customer could have more

complex systems implemented to their own requirements. To prove this function it was used to implement a remote access facility so that Stefan can dial in and listen to any orders. I'm pleased to say the system has proved very effective.

Inevitably I haven't described out substantial parts of the system and I won't list them all. But some I think are too important to omit:

The first of these is security. Any part of a site may optionally be protected by a security pin code. Thus Stefan's order line might be accessed by someone dialling the number by mistake but they would never get to the data held there: the odds would be, I think, something like 10 to the power 17 to one against. Nor can the system be hacked, it simply isn't accessible by any hacker-accessible route.

The second is language. Currently the whole system is in English: not just the content but also the extensive library of system audio files which are used to tell the caller what is happening and what is going on. Clearly it is just as easy to load the system with audio files in another language, but the system language would remain English. To allow for this, the site can be switched at any point to a different system audio library. So provided those audio files are installed, the whole site simply switches language as required.

I am pleased with the way the system has evolved and I am extremely pleased with the way it is performing in use: not just the way it handles the calls, but the relative ease with which sites can be modified and updated. The intention now is to begin offering the system to a bigger public.

Who would be the right customer for this application? Any business or other organisation that needs to provide what is currently visual text information as audio information because UK law says that they have to, they can't avoid the law even by pleading an unintentional breach. The VCC system provides a practical and cost effective way of complying with the law.

VCC is an application that probably won't reach the front pages of the computer press, but it is an essential application that a vast range of businesses across the UK (and beyond, similar legislation

exists in the USA and other countries) must have. It could easily reach the front pages of the business press.

Here at CAS we can offer a complete hosting service: with experience of recording for many clients including the BBC, and of recording in most of the world's languages, plus of course we have the software. We would be happy to speak to anyone who has need of such a service. And we'd be especially pleased if the caller is a devotee of RISC OS and understands why we use it.

If you would like to experiment with the book site and see how it works for yourself, you can simply call 01634 841903. To speak to me, Julian Coleman, at CAS call 07714 125311.

Thanks to the many

In the course of this project I have had to ask the RISC OS community for help, and many people have given that help without any benefit. I'd just like to say how much I appreciate the assistance so freely given from RISC OS enthusiasts. I'd like to think this project will be able to help sustain the platform and its supporters.

*Julian Coleman
cas@argonet.co.uk*

Voice synthesis

I am frequently asked whether the system uses voice recognition and/or synthetic speech. It doesn't use either. Voice recognition is still too fallible and research suggests many users do not like it anyway. Text to speech is either too poor and synthetic sounding, or too expensive. Either way, and despite advances, it isn't a better answer. VCC uses dial tones for input and recorded speech for output.

Case in point

Audio Book Choice has been in operation since 1996 and we send to our customers a regular update of an audio tape listing many new and back-list audio book titles. Like myself, all of our customers are visually impaired hence the need for the information in an audio format. However, now that many visually impaired people (VIP's) have computers that talk we can also send information by e-mail or on computer disk.

The audio cassette has been the most popular way of receiving information but

the audio cassette is a recording medium rapidly coming to the end of its life. It became time to think of other alternatives to advertise audio books to our clients.

Recording every issue on audio tape and mailing out to our listeners is quite costly. Also the general length of our tapes was around 60 minutes which meant we were limited to how many books we could advertise. New listeners are hearing about us every week but they may miss titles that came out a month or so previously.

Although we could advertise our titles each month on standard compact disc this also would be quite costly, however, this was considered a possible option at some stage.

I then thought about the telephone and its uses and the fact that many people are happy using the phone whereas many of us are still not comfortable using computers and even more so going online. The phone can be used anywhere and calls can be quite cheap or perhaps make the use of free weekend or evening calls. While these ideas were forming I came into contact with Julian Coleman of City Audio Services and, developing the concept he was already working on, VCC became our system of choice.

It became possible that customers could just call one number, which is not a premium rate call, and not only hear about latest audio books but actually listen to an excerpt of around 2 minutes at the same time became a very attractive idea. Plus we were able to offer a book of the month together with eight genres for listeners to browse at their own leisure.

A sighted person can visit a book store in the high street and browse through the shelves and once they have selected titles that catch their interest they can flick through the book to get a feel for the written word. This in the main cannot be done with audio books.

Best Audio Books offers listeners the title, author, reader (the person who has recorded the book), duration, price and a brief synopsis followed by an excerpt which can be either listened to, or skipped to listen to the next title. Once listeners have chosen titles to buy they can go to the option to place their order and just wait for their books to arrive. All

of the titles on the system which can be purchased are available on compact disc so give the best audio quality possible. This new way of listening to audio books has proven extremely popular and we will be adding new titles on a regular

basis together with new ideas for the system in the future.

*Stefan Novak
Manager, Audio Book Choice*

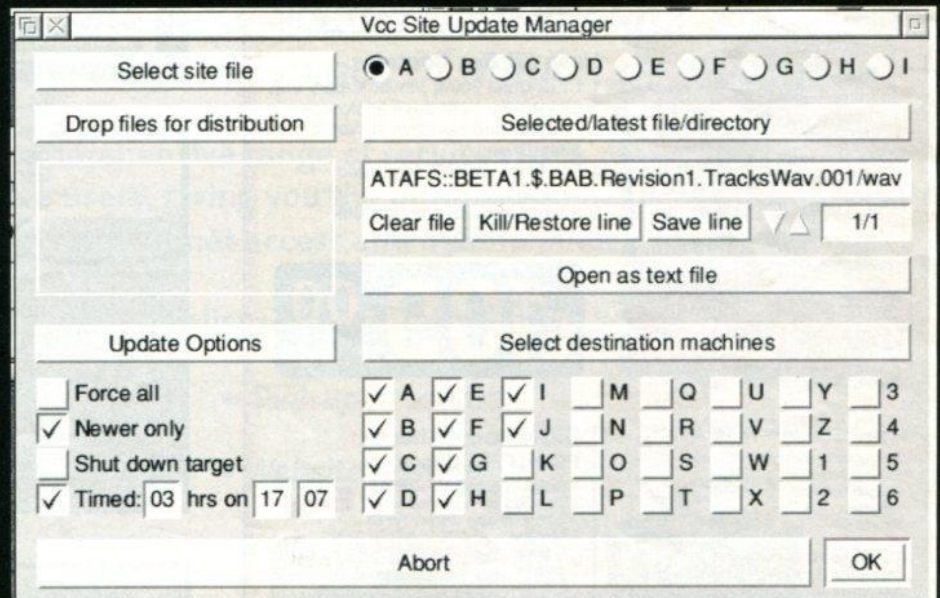
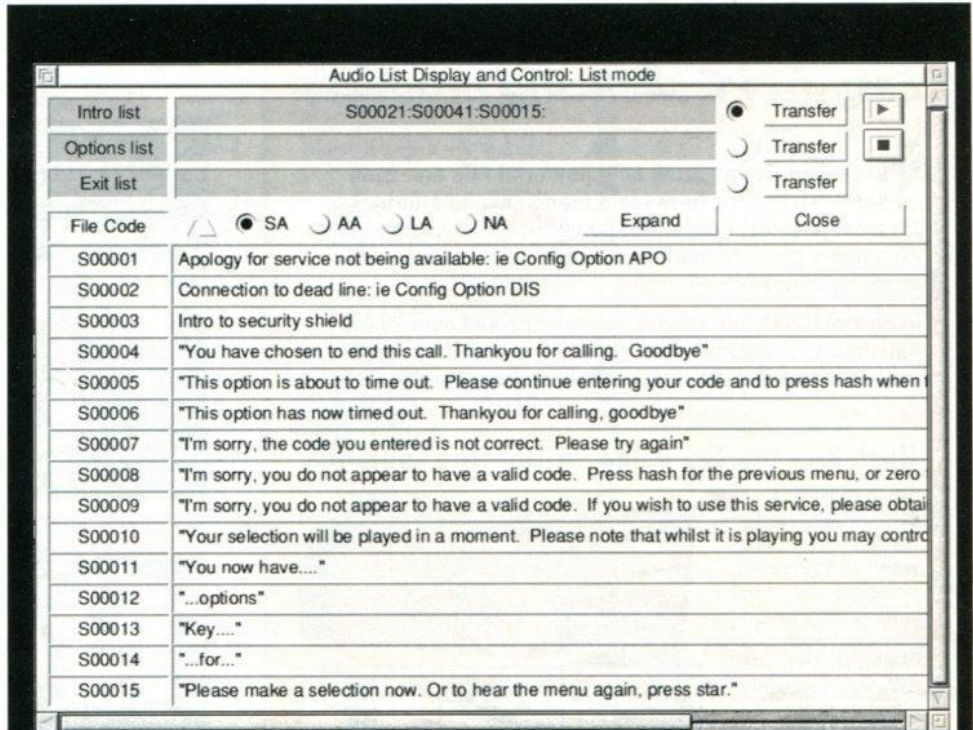

AudioMgr: There is a system for managing and using audio files built in to VCC. This template helps build file strings for use wherever you want them.

Site Mgr: The site manager utilities help transfer your new site or changes to the wider network, this system will copy large numbers of files to selected destinations at a pre-set time.

Silence is Golden!

JUST ARRIVED
DIGN HOME THEATRE
HI-FI PC CASE

Easy-fit PC silencing products

These days, it's amazing how powerful PCs are. Even supermarket PCs have more than enough performance for most peoples' needs! But power has a downside - faster computers produce more heat, requiring more fans which mean more noise!

With more than three years' experience and over 20,000 satisfied customers to date, Quiet PC specialises in offering innovative products to fix the problem permanently.

Hush Kit - the Top Value "All-In-One" solution

When making a PC quiet, the best result always comes when all sources of noise are addressed simultaneously. Now it's easy! The Hush Kit contains five of our most effective products all packaged in one convenient box. For any Athlon or Pentium III owner, this kit is the one PC accessory you can't be without.



Hush Kit Box Contains:-

1. Ultra-Quiet 300W power supply unit
2. SilentDrive hard drive enclosure
3. Temperature-sensitive sticker for SilentDrive
4. Fan Mate variable fan speed controller
5. Silent Motherboard Heatsink
6. Ultra-Quiet CPU cooler

"(The Hush Kit) has made a bigger difference than I thought possible! My PC is literally 2 feet away from me and I can hardly hear the thing. Possibly the best PC purchase I have ever made. Thanks!!"

...Nigel Green, Oxford.

Visit www.quietpc.com for our full product range.

£109.00 + VAT

AcoustiCase™ Midi ATX (no PSU)

- Acoustically-controlled PC case
- Pre-cut adhesive backed acoustic materials for easy assembly
- Unique sound absorption properties



£99.00 + VAT

DIGN Home Theatre PC (HTPC) Cases

- Stunning quality & aesthetics
- Standard HiFi dimensions
- Programmable display (VFD)
- Infra-red receiver module
- Available in silver, black & gold
- Front USB & Firewire ports

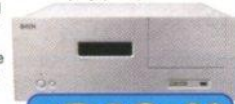

£219.00 + VAT

www.quietpc.com 0870 321 0295

Quietpc.com™



Acousti

DIGN

ZALMAN

NPS

QTechnology™
The Ultra Quiet power supply

Wardlaw Surveys

Authorised Acorn Dealer;
for all your needs from supply,
service, repair and full after-sales.

Wardlaw House, Kirkhall,
Inverness IV5 7PB
Tel/Fax: 01463 831214

Liquid Silicon

Supporting all RISC OS and Acorn users...
...around the world.



FREEPOST EH2725
Kirkcaldy, Fife, KY2 5BR
United Kingdom

Tel: 01592 592265 Fax: 01592 596102

sales@liquid-silicon.com
www.liquid-silicon.com

Not 'Arf

mice • connectors • leads • keyboards • advice



Stuart Tyrrell Developments
PO Box 183, OLDHAM OL2 8FB
Tel: 0845 458 8803 / 01706 848 600
Fax: 0870 164 1604 (national rate)
Email: Info@stdevel.demon.co.uk
<http://www.stdevel.demon.co.uk>

WebChange

The website maintainer's tool

WebChange is a support tool for website designers and maintainers. It is particularly suited to those who prefer to edit their HTML by hand, in programs such as StrongEd or Zap. Features include:

Wildcarded Find and Replace
Newline and Case Conversion
Embed Dates, Sizes and Files
Add or Strip Extensions
Script Language

And much, much more...

WebChange costs just £15, and can be ordered by sending a cheque or postal order to:

Soft Rock Software
124 Marissal Road
Henbury
Bristol
BS10 7NP

(please supply a valid email address when ordering)

Alternatively, you can order securely online at:
<http://www.webchange.co.uk/ros/purch.html>

Coming soon: a 32 bit Iyonix compatible version!



78 Brighton Road
Worthing
West Sussex
BN11 2EN



The Fourth Dimension

* Hardware

* Software

* Repairs

* Upgrades

Tel: 01903 523222
Fax: 01903 523679

Open Mon - Sat,
9.00am - 5.30pm

* Games

* Upgrades

* Refurbished
Hardware

sales@cjemicros.co.uk

<http://www.cjemicros.co.uk/>

DIGITAL CAMERAS

Canon

Model	Price
A70	£245
IXUS II	£299
IXUS V3	£299
IXUS 400	£365
S45	Free Case £365
S50	Free 128mb Caru £445
G3 + 128MB + Free Case	£499
EOS 10D	£1249

KYOCERA

FINECAM S5	£349
------------	------

FUJIFILM

A202	£129
A203	ECALL
A204	ECALL
A303	ECALL
S304	ECALL
F410	£359
F700	ECALL
S602	£489
F700	ECALL
S2 Pro + 1GB	£1819

Konica

KD310	£225
KD400	£299
KDS/n	£399

PENTAX

OPTIO S	£299
33L	£239
330RS	£295
430RS	£365
550RS	£469

Nikon

Model	Price
2100Z	£175
3100Z	£245
4300	£349
4500	£469
SQ	ECALL
5700	£785
D100	£1479

OLYMPUS

C220z	£149
C350z	Free Case £209
MJU 400	£359
C720z	£249
C730 + Olympus Case	£379
C750z + Olympus Case	£375
C50z + Extra 64MB	£415
C5050z Free 256mb Card	£479
E20P Premium Kit	£1129
MJU 300	ECALL

MINOLTA

S414	£259
Xt	ECALL
F100 (Indigo only)	£285
F200 + Charger Kit	£299
F300	£369
7i	£619

SONY

P32	£169
U20	£189
P72	£249
P8	£299
P92	£329
P10	£369
V1	£459
F717	£579
F77	£299

Canon POWERSHOT

G3 + 128MB CARD + CASE
£499



FUJIFILM S602

+ FUJI CASE + 128MB CARD + NIMH KIT
£529

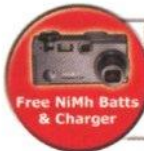

MINOLTA DIMAGE F200 4.0 MEGAPIXEL 3 X ZOOM
£305



OLYMPUS C-50 5 MEGAPIXEL 3 X ZOOM
£415



Canon IXUS 400 128MB + CASE + CARD READER
£401



OLYMPUS MJU 300 3.2 MEGAPIXEL 3 X ZOOM
£WOW



Canon A70 + 128MB CARD + NIMH BATT'S KIT + CASE
£280

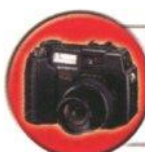

OLYMPUS C-5050 TAKES XD CARD
£499

MEMORY CARDS

COMPACT FLASH 64 MB	£16
COMPACT FLASH 128 MB	£25
COMPACT FLASH 256 MB	£45
COMPACT FLASH 512 MB	£90
COMPACT FLASH 1 GB	£199

SD 32 MB	£20
SD 64 MB	£25
SD 128 MB	£45
SD 256 MB	£70

SMARTMEDIA 32 MB	£10
SMARTMEDIA 64 MB	£15
SMARTMEDIA 128 MB	£25

SONY MEMORY STICK 64 MB	£35
SONY MEMORY STICK 128 MB	£60
"CLONE" MEMORY STICK 64 MB	£30
"CLONE" MEMORY STICK 128 MB	£55

XD 32 MB	£13
XD 64 MB	£24
XD 128 MB	£45
XD 256 MB	£75

MEMORY DEALS

1GB IBM MICRODRIVE	£169
64MB COMPACT FLASH TWINPACK	£30
128MB COMPACT FLASH TWINPACK	£45

64MB SMARTMEDIA TWINPACK	£25
128MB SMARTMEDIA TWINPACK	£45

64MB SD MEDIA TWINPACK	£45
128MB SD MEDIA TWINPACK	£80
256MB SD MEDIA TWINPACK	£140

POWER

4 X 2000amh NIMH AA's	£12
4 X AA's + FAST CHARGER	£15
4 X AA's + 2HR CHARGER	£25
LI-ION 70 MIN CHARGER (can be used from car) for Canon, Fujl, Nikon, Sony	£69

PRINTERS

EPSON 890 + EXTRA INKS	£140
EPSON 915	£169
EPSON 925	£229
EPSON 950	£339
FUJI DYE SUB	ENEW
SONY DPP-EX5	£219

SCANNERS

MINOLTA SCAN DUAL III	£259
MINOLTA SCAN 5400	£519
MINOLTA MULTI PRO	£1949
NIKON COOLSCAN IV	£549
NIKON COOLSCAN 4000	ECALL
NIKON COOLSCAN 8000	ECALL

CARD READERS

USB ONE MEDIA FORMAT	£19
USB 6 IN 1 READER	£19
USB DUAL READER	£15
PCMCIA ADAPTER C/F	£10
PCMCIA ADAPTER FOR ALL XD MEDIA	£39
	£19

30 CASTLE STREET, CLITHEROE, LANCASHIRE, BB7 2BX

FAX: 01200 444 225

OPENING HOURS: 9 TO 5



E. & O. E. PRICES SUBJECT TO CHANGE. GOODS SUBJECT TO AVAILABILITY.

The complete, professional internet company for a reliable service and peace of mind

Merula offers a comprehensive range of services to business and home users, giving you the options you need for reliable and secure internet access and maintenance.

We provide a range of specialist services, including:

- ADSL (broadband)
- Dial-up accounts
- Virus filtered email
- Website hosting
- Spam filtering
- Website filtering

If you are interested in any of our services or require further information about costs, set-up requirements and the availability of Broadband in your area, we are more than happy to help.

for details simply visit our website at www.merula.net, email us at netsales@merula.net or call us on 0800 298 2375



MERULA

Free Adverts

• Acorn items for sale:

[1] Single slice RiscEPC. ARM610; 6MB RAM; 1MB VRAM; 420MB HD; Cumana CD-ROM; RISC OS 3.50. Original mouse, keyboard, manuals and boxes.

(2) Two slice Risc PC. StrongARM SA-110; 64MB RAM; 2MB VRAM; 2GB HD; 24-speed CD-ROM; RISC OS 3.70. Original Mouse, keyboard, manuals and boxes.

(3) Psion Series 3c PDA. 2MB RAM; Mains adaptor; Leather Case; PsiRisc Acorn link software. All original boxes and manuals. (4) Cumana SCSI2 Podule.

(5) CJE 5x86 PC second processor card for RiscPC. 133MHz, 512k cache. Comes with PCPro software.

(6) Computer Concepts LaserDirect4 laser printer plus podule. All software and original manuals.

(7) Epson GT9000 A4 flatbed SCSI scanner. Original boxes and manuals.

(8) Software (all boxed with manuals and bits): Artworks; Eureka v3; Ovation Pro; Impression 2; Fireworkz Pro; Mr Clippy; ImageFS 2; SparkFS; Keystroke; PCSound Professional; Win95FS; WMF IT; Clip IT; ImageMaster; ANT Internet Suite 2; Compression; ArcFax; Virtualise; Font Directory 2; Touch Type; PublishArt; PublishArt 2. Any reasonable offers for all items (or combination of items) above. P&P charged at cost or available to collect.

Contact Jon Aylwin 029 2041 0678 or jon@aylwin.org.uk

• Two Master 128s, 3 disc drives, 1 Cub Monitor, 2 mice, software, £50 buyer collects. East Kent Coast. Phone 01303 873364.

• Wanted: All Acorn A3000s, A3010s, A3020s, A4000s, A5000s, A4s, Risc PC 600 & 700s, StrongARM Risc PC's, Kinetic Risc PCs. Anything considered.

Can travel. 07930 507815 or 07775 776217.

• Acorn A5000 including monitor etc plus additional software including Advance suite. Any sensible offer considered. Contact Robert on 0191 5191231 or at robertvardill@beeb.net

• Wanted: Irlam Instruments Videodesk editing system. Any other video editing card suitable for use with a Risc PC also considered. Please contact chris@acdale.demon.co.uk

• Eagle M2 multimedia card; replay video production, HQ video stills, digital stereo sound sampler, full MIDI IN/OUT/THRU facilities, RISCPC compatible. Offers around £160. Multimedia software; Midiworks, Prosound, Cineworks (includes AppleFS) and Genesis Professional £35 each plus postage or £120 for all three. Eagle M2 plus all four packages £250 plus postage. Enquires or offers 0151 547 3993 or email aokai@tiscali.co.uk

• A two foot stack of Acorn User magazines for sale, complete with cover discs, from Sept 1994 to end 2001. Also other Acorn magazines and discs. Best offer secures this 12kg pile. Tel. Coventry, 02476 319519

• Wanted: All Acorn A3000s, A3010s, A3020s, A4000s, A5000s, A4s, Risc PC 600 & 700s, StrongARM Risc PC's, Kinetic Risc PCs. Anything considered. Can travel. 07930 507815 or 07775 776217.

• Acorn A5000 including monitor etc plus additional software including Advance suite. Any sensible offer

considered. Contact Robert on 0191 5191231 or at robertvardill@beeb.net

• Wanted: Irlam Instruments Videodesk editing system. Any other video editing card suitable for use with a Risc PC also considered. Please contact chris@acdale.demon.co.uk

• Eagle M2 multimedia card; replay video production, HQ video stills, digital stereo sound sampler, full MIDI IN/OUT/THRU facilities, RISCPC compatible. Offers around £160. Multimedia software; Midiworks, Prosound, Cineworks (includes AppleFS) and Genesis Professional £35 each plus postage or £120 for all three. Eagle M2 plus all four packages £250 plus postage. Enquires or offers 0151 547 3993 or email aokai@tiscali.co.uk

• A two foot stack of Acorn User magazines for sale, complete with cover discs, from Sept 1994 to end 2001. Also other Acorn magazines and discs. Best offer secures this 12kg pile. Tel. Coventry, 02476 319519

• For Sale, 586 PC CARD for Risc PC, by Aleph1, includes PC Pro 3, also Windows 95 or 98, cost over £300 pounds, will accept £90 or near offer, Radcliffe, Manchester, please phone 0161 280 3375 or email, j.jackh@ntlworld.com

• Kinetic RPC, 258MB, 60GB, 24x8x8 CDRW, 2 slot backplane, SCSI32 32/16 bit SCSI card, 2 keyboards, 2 Mice. Cost £1772. Sensible offers please. Manchester, tel: 0161 628 6546 after 7.00pm

Acorn User Free Ads Service

Your name: Your phone number:

Why not take advantage of our free reader ad service? Fill in your details on this coupon (24 words maximum, one word per box below) and send it to Free Ads, Acorn User, 28a Middle Hillgate, Stockport SK1 3AY or by e-mail to: freeads@acornuser.com. Only one ad per reader please, private sales or wanted only.

Although we try to publish every ad we receive, we can make no guarantees; publication is entirely dependent on space and time constraints.

Please fill in your name and telephone number below - these will not be published but enable us to contact you in case of any queries. Make sure you include your own town/county in your ad to help potential buyers with their purchasing decision.

Getting into Digital Video

The subject of capturing and editing video on RISC OS is one that is encompassed in a very simple summary: It's not easy. In fact it is almost impossible.

But almost impossible means slightly possible, and slightly possible means that there is something that can be done about it even if the route is tortuous and requires sacrificing to the dark side.

In the first of this two part article we are going to look at the hardware involved in getting proper digital video capture from a modern camcorder in the most RISC OS-friendly way.

We will look at the camera, in fact review one of the most popular camcorders currently on the market, and also look at another of those mini-PCs that is so small you could carry it around in a plastic bag, HKI Systems TX2.

So without further ado let us look at some hardware.

Canon MV650i

The MV650i is a very neat, very compact, camcorder with almost every square centimetre either a door into the inside or a control on the outside. And for a unit in the £600 price range it does very nicely indeed. One thing to watch out for is that with camcorder and digital camera prices they change so fast that most advertisers often don't put a price in their adverts, you really do have to give them a call.

The unit has a 2in LCD viewfinder which is sufficient for most purposes although perhaps a little bit on the small side. Hinged at the front it folds out as expected and then can be rotated to the angle you want including 180 degrees. In that position the image is actually mirrored, giving the impression that you are looking into a mirror as you view yourself. There is an option to turn the mirror effect off in which case what you see is effectively what the camera is seeing and recording.

Despite the modest size of the LCD display you get a lot of information including battery charge level, time remaining on the tape (or card memory), time code, record status and so on.

The unit is so compact that it will fit into when packing any reasonably sized pocket or bag, or for your holiday there's

no worries about throwing out more than perhaps your toiletry bag. Not only that but the size also means that you really can tote it around in your hand without difficulty and, in tests, children as young as five have no trouble using it (beyond the ability to get the main object actually in view and keeping it there).

While a very solid unit it is not too heavy (see note on children above) though weight cuts both ways, a solid machine tends to be easier to keep steady while a lighter one may be all over the place. However if you want very solid images and own a tripod, there is the mount on the bottom that you would expect.

The majority of the controls for the MV650i are located around or under the LCD panel which allows you to hold the camera in your right hand and manipulate the controls with your left ... which is actually quite awkward if you are right-handed. The unit, like most of these types, are designed to be held in the right hand. I'm generally happy with that apart from this weird situation of being required to use my left for controlling the unit.

There are three groups of controls: Right/bottom looking at the left side, are the menu and menu control thumbwheel. Pressing the menu button brings up the top-level menu for the camera, the thumbwheel allows you to select and option you want and press to click for select. You can view the menu on the big LCD screen or in the viewfinder.

Above the LCD bay are the four video tape controls for when you are in replay mode. These also double up on other functions. Becoming available only when you open the LCD display are another five controls and also the backup battery bay. These controls are used for special effects, in-camera editing, timed recording and so on.

Under the LCD bay is the space for the memory card. The camera can take still pictures as well and these are stored on the card, along with the pre-stored images for mixing with video, you can do blue screen combinations of images. As a stills camera the system works well and you can transfer stills on to the video tape as well.

For power the back of the camera has the removable battery pack, and also the

port for charging the battery or simply running the camera from mains power if you have that option. The viewfinder raises up to engage and disengage the battery pack. To charge the battery you do have to have it mounted on the camera which might be inconvenient but that's the price you pay for a good small camcorder.

On the right side of the camera, where your controlling hand is located there is a small group of main controls and also the DV tape slot.

These controls are the Camera (record mode)-Off-Playback control, this has a little latch to prevent accidental switching on and off. Next to this is the record button to start and pause movie recording. Above this is the control to switch between tape and card.

At the top is the single image photo button and slightly forward of that is the wide-angle/telephoto control. The zoom facilities are a 22X actual zoom along with a 440X digital zoom. These two are fully integrated and switch smoothly from one to the other, digital zoom is not really to be recommended in still image land but here it seems to work very well.

The tape bay opens neatly at the bottom, although you will almost certainly have to take it off a tripod if it is on one. At the front there is an accessory shoe on which you can mount a light or a bigger microphone which Canon dealers will be delighted to sell to you.

Apart from the lens (obviously) the front of the camera has the flash for the stills, the infra-red receiver and the stereo microphones. There is also yet another covered bay with three connectors in it. These are for an external microphone, headphones and the mini-USB socket. This socket is for transferring images from the memory card, of course the PC software has lots of extras for editing and such like but basically it is just a mass storage device.

The final and probably most important features are located at the front bottom under yet another door and these are the DV and S-Video in/out sockets. These are what you use to get the video through your system, you can record from the camera to a video recording device or to another DV device.

Designing stunning graphics has never been easier...



Get the latest version of the platform's most popular
advanced vector graphics package!

Suitable for RISC OS 3.5 or higher.
Tested with RISC OS 4, Select and 5.
Tested on RiscPC, Omega and Iyonix.

Create stunning graphics using
advanced features like

- multiple **transparency** types (mix, stained glass, bleach)
- multi-column **text areas**
- user-defined dynamic **pattern fills**
- dynamic **blends** and **replications**
- **moulds** and **perspectives**
- **Sprite/GIF/TIFF** and **SVG** export
- Draw and EPS import and export
- linear and radial fills, Undo/Redo
- ... many more ...

Many applications including Impression, OvationPro, OHP and PhotoDesk can directly render ArtWorks files*. Alternatively, export in standard Draw format for use with all applications supporting the Draw format.

*without transparency; requires latest version of free ArtWorks Viewer utility

ArtWorks 2 Full Version	£169
ArtWorks 2 upgrade from ArtWorks 1.7	£125
ArtWorks 2 upgrade from ArtWorks pre-1.7 ...	£140

Please enquire for details of upgrade offers for existing plug-in modules customers.
All prices include VAT. Please add £4 for p&p. Make cheques payable to Martin Wuerthner.

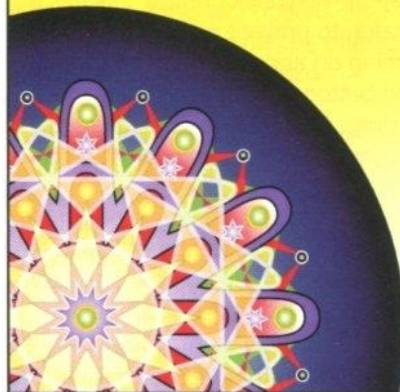

Mandala design
created by Henk
Huinen using
ArtWorks 2

MW Software
Martin Wuerthner

martin@mw-software.com

Mannheimer Str. 18
67655 Kaiserslautern
Germany

<http://www.mw-software.com/>



High Speed Computing

Order your RISC OS
Machine today...

We specialise in all your RISC OS
needs for individual customers or
small businesses.



 **RiscStation**
RISC Based Technologies

MicroDigital

IYONIX 

Call us for friendly advice or
visit our website

We also stock a wide range of
RISC OS Software and accessories.

- P.O. Box 519 • Doncaster
- South Yorkshire • DN4 0GE
- sales@etcsystems.co.uk

TEL: 01302 337559

FAX: 01302 337564

www.InternetCamerasDirect.co.uk



FUJI Finepix S304
3 megapixels
£278 incl VAT & delivery



FUJI Finepix A202
2 megapixels
£128 incl VAT & delivery



FUJI Finepix F401
2.1 megapixels
£298 incl VAT & delivery

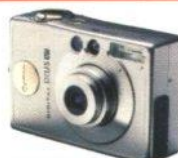

CANON Ixus V3
3.2 megapixels
£338 incl VAT & delivery



NIKON Coolpix 2100
2 megapixels
£178 incl VAT & delivery



OLYMPUS µ[mju] 300
3.2 megapixels
£298 incl VAT & delivery



FUJI Finepix 2800
2 megapixels
£198 incl VAT & delivery

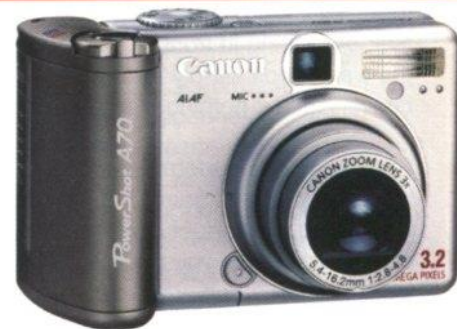

CANON Powershot A70
3.2 megapixels
3 x optical zoom
£268 incl VAT & delivery

For even more choice from our extensive range of digital cameras, please visit our website where you can compare and contrast digital camera specifications side by side: www.internetcamerasdirect.co.uk

DIGITAL CAMERAS

MAKE & MODEL	CAMERA	+32MB CARD	+64MB CARD	MAKE & MODEL	CAMERA	+32MB CARD	+64MB CARD
Canon Powershot A200	£145	£160	£166	Nikon Coolpix 3100	£248	£263	£269
Canon Powershot A300	£178	£192	£199	Nikon Coolpix 3500	£308	£323	£329
Canon Powershot G3	£508	£523	£529	Nikon Coolpix 4300	£350	£426	£438
Canon Powershot A70	£268	£283	£289	Nikon Coolpix 4500	£468	£483	£489
Canon Powershot S45	£408	£423	£429	Nikon Coolpix 5000	£698	£713	£719
Canon Powershot S50	£468	£483	£479	Nikon Coolpix 5700	£788	£903	£909
Canon Digital Ixus 400	£378	£393	£399	Nikon Coolpix 775	£178	£193	£199
Canon Digital Ixus V3	£338	£353	£353	Nikon Coolpix 885	£278	£293	£299
Canon EO5 10D	£1299	£1314	£1320	Olympus C300z	£278	£269	£279
Casio GV20	£248	£263	£259	Olympus Camedia C-350 zoom	£218	£232	£233
Casio Exilim S2	£178	£200	£210	Olympus C4000z	£298	£309	£319
Casio Exilim S3	£268	£290	£300	Olympus C50 Zoom	£418	£432	£443
Casio Exilim Z3	£308	£330	£340	Olympus C5050 Zoom	£510	£521	£531
Casio QV2900ux	£308	£323	£229	Olympus C700	£378	£389	£399
Casio QV4000	£368	£383	£389	Olympus C730	£412	£423	£423
Casio QV5700	£488	£503	£509	Olympus E20	£1,098	£1109	£1119
Casio QVR 4	£318	£340	£358	Olympus Mju 300	£298	£312	£323
Fuji Finepix 2800	£198	£209	£219	Olympus W-10 digital voice recorder and digital camera	£148	—	—
Fuji Finepix 30i	£278	£289	£299	Oregon Scientific D5R228	£98	£113	£119
Fuji Finepix 6800	£318	£329	£339	Oregon Scientific D59300	£148	£170	£188
Fuji Finepix A202	£128	£142	£152	Oregon Scientific Dshot III	£58	£69	£79
Fuji Finepix A203	£188	£202	£213	Pentax 33L	£238	£253	£259
Fuji Finepix A204	£158	£172	£183	Pentax Digibino DB100	£198	—	—
Fuji Finepix A303	£226	£240	£251	Pentax Optio 330RS	£303	£303	£309
Fuji Finepix F401	£298	£309	£319	Pentax Optio 430RS	£348	£363	£369
Fuji Finepix F410	£368	£382	£393	Pentax Optio 550	£458	£480	£490
Fuji Finepix F601	£398	£409	£419	Pentax Optio S	£298	£320	£338
Fuji Finepix M603	£398	£412	£423	Ricoh Caplio RR10	£218	£240	£258
Fuji Finepix S304	£278	£292	£303	Ricoh Caplio RR30	£208	£230	£248
Fuji Finepix S602	£498	£509	£519	Ricoh Caplio RR230	£158	£180	£190
Fuji M603 + Philips DVDR880	£798	£812	£823	Samsung Digimax 101	£98	£120	£138
Iconica Revlo	£118	—	—	Samsung Digimax 201	£118	£140	£158
Kodak CX4210	£118	£139	£158	Samsung Digimax 240	£158	£180	£198
Kodak CX4230	£148	£170	£188	Samsung Digimax 410	£328	£343	£349
Kodak DX4330	£198	£220	£238	Samsung Digimax V4	£288	£310	£328
Kodak L5443	£298	£320	£338	Sony Cybershot DSC-F77	£358	£392	£410
Konica KD300Z	£358	£380	£398	Sony Cybershot DSC-P5	£398	£432	£450
Konica KD100	£88	£110	£120	Sony Cybershot DSC-P8	£318	£352	£370
Konica KD220Z	£138	£150	£168	Sony Cybershot DSC-U10	£185	£219	£237
Konica KD3000	£238	£253	£259	Sony Cybershot DSC-U20	£208	£242	£260
Konica KD400	£318	£340	£358	Sony Cybershot DSC P2	£298	£332	£350
Konica KD500Z	£408	£430	£448	Sony Cybershot DSC-P31	£178	£212	£230
Kyocera Finecam S4	£318	£340	£358	Sony Cybershot DSC-P32	£188	£222	£240
Kyocera Finecam S5	£378	£400	£418	Sony Cybershot DSC-P52	£228	£262	£280
Minolta Dimage 7i	£938	£953	£959	Sony Cybershot DSC P7	£358	£392	£410
Minolta Dimage 7i	£628	£643	£649	Sony Cybershot DSC-P72	£278	£312	£330
Minolta Dimage E223	£158	£179	£198	Sony Cybershot DSC F717	£798	£832	£850
Minolta Dimage F200	£298	£320	£338	Sony Mavica MVC FD200	£328	£362	£380
Minolta Dimage F300	£378	£400	£428	Vivitar ViviCam 3625	£98	£120	£138
Minolta Dimage S414	£268	£283	£289	Vivitar Vivicam 3825	£248	£270	£288
Minolta Dimage X	£235	£256	£275				
Nikon Coolpix 2100	£178	£193	£199				

- FREE** next working day delivery*
- FREE** JASC after-shot software worth £14.99 with every camera
- FREE** 60 digital prints with all cameras over £500
- FREE** mini tripod worth £8 with every camera
- Extended warranties** from only £20

* We are usually able to despatch goods as long as the order is received by 2.00pm, stock permitting

www.**icd**photos.com
share & print

AMATEUR **Photographer**
ONLINE DIGITAL LABORATORY OF THE YEAR WINNER 2003

NO LENGTHY DOWNLOADS TO GET STARTED

1 Upload digital images to on-line album.

2 Store, share or order prints.

3 Prints delivered direct to your door.

FREE 30mb on line photo album storage

FREE registration

FREE 60 digital prints with every purchase over £500

www.icdphotos.com

READERS AND ADAPTERS	
Fuji Z10 USB Smartmedia reader/writer	£29
Sandisk Compact Flash adapter	£15
SMART MEDIA	
Fuji 16MB	£8
Fuji 32MB	£13
Fuji 64MB	£24
Fuji 128MB	£45
Sandisk 16MB	£9
Sandisk 32MB	£13
Sandisk 64MB	£26
Sandisk 128MB	£48
COMPACT FLASH (TYPE I & II)	
Fuji 16MB	£14
Fuji 32MB	£17
Fuji 64MB	£24

Fuji 128MB	£42
Sandisk 16MB	£15
Sandisk 32MB	£17
Sandisk 64MB	£26
Sandisk 128MB	£45
Sandisk 256MB	£85
IBM 340MB microdrive	£110
IBM 1GB microdrive	£208
MULTIMEDIA CARDS	
Sandisk 16MB	£15
Sandisk 32MB	£24
Sandisk 64MB	£44
SECURE DIGITAL	
Sandisk 16MB	£22
Sandisk 32MB	£26
Sandisk 64MB	£38

MEMORY STICKS	
Sony 16MB	£29
Sony 32MB	£42
Sony 64MB	£62
Sony 128MB	£98
XD PICTURE CARDS	
Fuji 16MB	£9
Fuji 32MB	£16
Fuji 64MB	£29
Fuji 128MB	£50
BATTERIES AND CHARGERS	
4 x 1200 mAh	£6.50
4 x 1800 mAh	£11.50
4 x 1200 mAh & mains charger	£16.50
4 x 1800 mAh & mains charger	£20.50

FOR ALL THESE GREAT DEALS AND MORE VISIT OUR WEBSITE

call **0870 752 2566**

QUOTE REF: CAM165M

or fax 01484 845 947 or e-mail sales@internetcamerasdirect.co.uk



* Secure on-line ordering at internetcamerasdirect.co.uk we use a 128 bit model to encrypt your credit card details within the browser on your PC. The details are not decrypted until downloaded onto our server. This is the most secure model. InternetCamerasDirect.co.uk, Unit 14, New Mill, Brougham Road, Marsden, Huddersfield HD7 6AZ

All prices include vat (and delivery for orders over £100). Prices subject to change

These cameras do, in fact, have a huge ability to perform editing on the camera itself but it's not something I feel I would ever do. Sitting in front of a computer is the way to edit simply for the convenience if nothing else.

So how does it perform? Very well indeed our testers found it quite simple to use, the plethora of controls were all quite logical once you understood the logic of them and it was an enjoyable experience. The quality of recordings is enough to make it worthwhile if you are the sort of person who likes to make videos. And I find myself attracted to it.

HKi Systems TX2

A few months ago we looked at one of the HKi Systems mini-PCs, why did we look at a PC? Simply because nowadays to sensibly use new printers and other peripherals it is frankly easier to get a PC and network to your RISC OS machine. Using PCs as server devices certainly puts them in their place as well.

HKi can supply their PCs with anything from Windows 95 up to XP, but they will also install Linux if you prefer. The machine we have on test this time around is the TX2. This is a much chunkier unit than the previous machine and is not quiet, in fact it's quite noisy. But then again no noisier than a full size PC.

But this one will sit comfortably on your desk, or hanging in a bag from the table and it just will not get in the way.

It has a superb array of connectivity located all around the outside of the box with a DVD player in the base. There are four USB ports, network, firewire, audio, as well as the expected mouse, keyboard and video connectors.

As an adjunct to a RISC OS system it makes a perfect addition for use with R-Comp's connectivity software.

Geoff Graham



No software

The RISC OS position with digital video is bleak in the extreme, basically there is no software at all that can do the job of editing.

Uniqueway's Empire was a personal editing system based around the Acorn Replay format. Replay was (and is) a very effective format and, as usual with Acorn products, well ahead of its time. But as a proprietary format on a minority platform devised by someone who's gone on to other things, it hasn't received much attention in the world of digital video. And neither has Empire. We spoke to Paul Middleton about it a few months ago and whether there was any chance of Empire getting refurbished and he explained it was highly unlikely.

Origin Systems have the professional offline editing package, Optima, it is in use by professional organisations including the BBC. But its use is fading as other offline editors on more common and faster platforms take over. I spoke to Nic Blinston about Optima and DV. Again the possibilities were not good, Optima is also built around Replay, and involves the use of image digitising and so forth to get into that format.

Also Optima is an offline editor, this means that what it actually produces is a set of editing instructions which then are fed into an online editing system which creates the final cut. Optima is not designed to produce a final output itself.

But again there is, at present, no way of converting from DV to Replay. DV is a proprietary format and money is needed to buy the licence. A lot of money.

Don't despair however, there is at least one way of editing while sitting at your RISC OS computer and we will look to see what other options are available.

Get blogging

If you missed the last issue of the magazine you will have missed what blogging is all about so we will have a quick reprise:

A blog is a web page made up of usually short, frequently updated posts that are arranged chronologically; like a "what's new" page or a journal. The content and purpose of a blog varies greatly from links and commentary about other web sites, to news about a company, person or idea; to diaries, photos, poetry, mini-essays, project updates, even fiction.

Blog posts are like instant messages to the web.

Many blogs are personal, "what's on my mind" type musings. Others are collaborative efforts based on a specific topic or area of mutual interest. Some blogs are for play. Some are for work. Some are both.

You provide Blogger with a template of your page (or use one of several pre-designed ones) that indicates where you want your posts to appear. When you want to publish something, you simply enter it in a form on the Blogger site. When you're ready, you hit a "Publish" button that will automatically send your new page to your web server.

If you're more sophisticated, your template can even contain script, such as server-side includes, ASP, or Cold Fusion pages, and that script will still be processed after the Blogger content is inserted.

The basic Blogger service is completely free. There is also a subscription version of Blogger, called Blogger Pro.

So this month we thought, just to round up on our little look at the next big thing on the Web and some of the best Blogs on the Web. Although we have concentrated on Blogger there are other Blog systems around and about on the Web. Just take a browse around.

Chuck Olsen's Blogumentary
<http://chuckolsen.blogspot.com/>
 Chuck is enthusiastic about movies and also running about Time Square asking people if they know what a Blog is.



What is the Matrix

<http://matrixessays.blogspot.com/>
 Jumping on the band wagon? Certainly. Does the Matrix have good scientific background? Probably not but then again it's about philosophy and big guns, not science.

OSIL8

<http://web.0sil8.com/episodes/pressnothing/>
 The latest episode of OSIL8 is called Press Nothing to Continue. It's an innovative marriage between Blogger and Tellme, a telephone information service. What happens is that Blogger is forced to output a version of XML called VXML, from which a blog can be heard over the phone. There is no weblog to see, you have to call a phone number to hear it.

U2Log

<http://www.u2log.com/>
 "I can't believe the news today. / Oh, I can't close my eyes and make it go away. / But that's ok." It's news about the biggest band in the world, U2. Surf on over and watch the days run away



like horses over the hill. Bloggers are very often about your favourite things, (move over Big Brovaz).

Senior Citizen

<http://seniorcitizen.blogspot.com/>
 From rants on Oxford students and Gnutella, to posts about a new telescope and an online cheese comparator. This site is also not really for the mild of heart or the young it pulls no punches and the language is ... natural. Still it can be a source of interesting links and even more "interesting" commentary.



The Daily Brad

<http://www.bradlands.com/dailybrad/>
 Bradford Lee Graham says, "Matter was neither created nor destroyed in the creation of this website, although one hopes the universe was dented, just a bit." This is a very funny site, go there and enjoy it. After you've had your daily dilbert.



Living colours

<http://vanderwoning.com/living/blog.html>
 Some say that you have to come face to face with death in order to truly appreciate life. Kaycee is currently receiving chemotherapy for leukemia, and living with cancer has given her a different perspective on the world that it is worth reading up on.

Rob Donaldson
 editor@acomuser.com

Buy the **Jive** CD
ACES

From HMV and all good
record shops from
09th June '03



For more information contact:
band@jiveaces.com

Right Recordings (Cat. Number: right 022)

how is your business?

QCC is a commercial consultancy that adds value to your business by;

- **Helping you get Investment**
- **Improving your infrastructure**
- **Arresting decline and turning businesses around without taking away your control**

1. Start Up or Growth.

You may require finance. The fundamental truth is that investment brokers will not normally look twice at any proposal they receive.

Therefore your business plans must be fully developed so that they can stand up to the most severe scrutiny and enable you to obtain the finance you need.

Our Service.

We work closely with Investment Brokers and Banks. We fully understand their needs and ensure that your business plan complies. More importantly we guarantee that the plan will truly reflect your business and will flush out any major stumbling blocks that you are going to encounter before you run into them.

2. Suffering from growing pains?

When an organisation grows quickly it often creates an imbalance between product volumes and the administration required to deliver them. The truth of this situation is that sales will suffer if you don't put the administration in place, but net profits will suffer if it is done wastefully.

Our Service.

With your help, we implement an organisation structure which guarantees that all your resources are 100% aligned to deliver your Valuable Final Product. This puts you back in control, it highlights where your administrative gaps are and how to fill them, and even gives you an understanding of which roles you need to fill first as your organisation grows.

3. Do you know why performance is declining?

The truth is that the answer is always simple and can always be fixed, and to fix it at this stage before the situation gets worse means that you can hang on to control of your company.

If you wait too long, you may not.

Our Service.

We operate a straightforward, understandable set of steps which result in a fully recovered business which wastes no resource, knows exactly why it went into decline and knows how to avoid any future decline and to grow successfully.



QUEST COMMERCIAL CONSULTANTS

Birmingham

215 Gristhorpe Road Selly Oak Birmingham B29 7SP
Tel: 0121 472 0684

Manchester

28a Middle Hillgate Stockport Cheshire SK1 3AY
Tel: 0161 429 8902 Fax: 0161 429 0685

e-mail: nickb@questdp.co.uk

Part 16: Falling at the last

All the major aspects of printing with S-Base were covered in the previous episode in this series on S-Base programming. This time around, which is very definitely the last time, we are going to look at one way of customising the zone display, and we will round up with an overview of what has been created here. What we will not be doing is looking at the printing and there is a very particular reason for that which I will talk about later.

But first things first: In the "medium" display we have all the actual real-world objects, like books, DVDs, videos and so on. But they are all mixed together and using the standard zone routines there is no way of identifying them.

A nasty way of sorting it out would be to add the "media" name in brackets at the end of the listing. We can do this, it's messy and it doesn't really help much. If there were a lot of entries in this list it would still be like wading through mud.

Instead we want to have a way of listing only the books or only the videos or only the DVDs. This is surprisingly easy to achieve.

On an interface level all we need to do is add three icons to the format of the

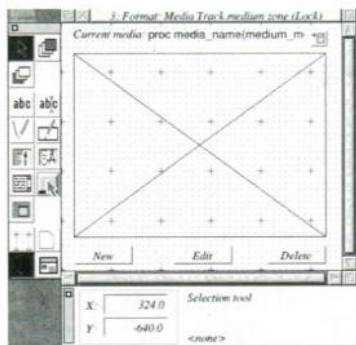

fig I

medium zone (Figure I). We have a prompt which tells us what the field is about and a field which contains a routine call to display the currently selected "media" which we are displaying and finally a menu pop-up which allows us to select and change the required "media".

On the programming level, within the "medium" procedure resource we have to create a specific variable which I have

```
def proc medium_init
  medium_curiten=-1
  din s medium_items[MEDIUM_MAXITEMS]
  medium_media=-1
  return TRUE
enddef
```

fig II

called **medium_media**. This variable contains -1 if we want to display all media and, if we only want one type of media, it contains the ID of the media record required. Figure II shows this being set in the initialisation procedures of "medium".

The code is already in place that for a standard Zone list that if a button is clicked that is not "generic", control is passed to a routine in the zone's dedicated code specifying the button that has been clicked.

Figure V shows the code that calls up a menu when the "media menu" pop-up is clicked. But that menu is not one we've looked at before.

Previously we created a standard menu generator in "control" that produces a menu of all the entries in a zone plus an item at the top which asks you if you want to create a new entry.

This is a good solid piece of code and works well. It has one major drawback, it is not flexible. You get the entry list and the option to add, no more and no less. At this point we wanted something different. We did want the entry list but something else at the top.

Initially I was thinking that we did not want any additional items at the top but realised we needed an "All media" entry. The user can choose individual media or all of them.

At this point there is a standard action you can do and technically it's called "abstraction", which in one definition means a "taking an idea away from the concrete" or "stripping an idea down". The idea of this routine is to create a menu of entries and have a special entry at the top. The concrete application of it is to have that top entry as "Add new [whatever]".

What we do is "abstract" the core code and create a new routine to provide the functionality we are already using. We mustn't break the existing code so our routine "control_menu_maker" remains outwardly the same but all the code is taken out of it and replaced by a call to a new routine which does all the work. You can see the old routine at the top of Figure III, with its new internal code.

The new routine has additional

parameters which make it more versatile, we allow the calling routine to specify whether the top item is greyed out, and what text it should be. There is no default text, it must be specified, as it is in the old routine's calling code.

```
def proc control_menu_maker(zh,zn,zc)
  local zlabel=@trin(ctrl_zones[zn].label)
  local zs="(Add new "+proc toupperfirst(zlabel)+")"
  proc control_menu_maker_a(zh,zn,zc,FALSE,zs)
enddef

|-----|

def proc control_menu_maker_a(zh,zn,zc,gre,i)
  local mqh=ctrl_zones[zn].mqhandle
  local mh=ctrl_zones[zn].mhhandle
  local zname=@trin(ctrl_zones[zn].name)
  local zlabel=@trin(ctrl_zones[zn].label)
  local qq=0

  menu dispose mh
  menu new mh,zname,zlabel
  ctrl_zones[zn].mhhandle=mh

  delay on
  query clear mqh
  query run mqh

  if (@text(mqh)=0) then menu insert mh,i
  ffor qq=0 to @text(mqh)-1
    delay 100*qq/@text(mqh)
    load zname,@get(mqh,qq)
    if qq=0 then menu insert mh,i+"|"
    menu insert mh,@trin(@filefield(zname,"name"))
  next
  delay off

  if (grey) then menu set protect mh,0

  ctrl_cmenuzh = zh
  ctrl_cmenuzn = zn
  ctrl_cmenuzc = zc
  menu set mh
enddef
```

fig III

The final result, Figure III, is that the existing code is not broken but now we have a new routine (with proven code) to generate the entry list menu and the ability to change the top wording. In our case to "All media".

So, by this stage, we have the ability to bring up a menu of "media" names along with an option to select all of them.

However there is no menu select handler for any of the zones so we have to go up

```
Handler: Media Track zone menu select
local zname=@trin(ctrl_zones[ctrl_cmenuzc].name)
@exec("proc "+zname+"_zonemenuselect(ctrl_cmenuzh,ctrl_cmenuzn)")
```

fig IV

the levels of code and go to the Zone handler set, add a menu select handler and put some code in it. Figure IV shows the code, it is exactly the same as the menu select handler for cards apart from the name of the zone routine that is called.

Figure V shows the zone menu select code which is similar to other menu select code, in this case it is used to set the value of **medium_media**. If the top item is clicked we set it to -1, otherwise we find the record number of the menu item clicked (this is part of our standard code and is available automatically) we load the record, get its ID and store that.

```

def proc medium_zoneclick(zh,e)
  local lh=@elementhandle(zh,"list")
  local sh=@selectedhandle(lh)
  case (e)
    when "media menu"
      local zn=proc control_find_zonename("media")
      proc control_menu_maker_a(zh,zn,medium_zonenum,FALSE,"All media")
    endcase
  enddef
def proc medium_zonemenuselect(zh,zn)
  local zr=0,ms=@menuselect(0),zj=medium_media
  local mn=medium,na=media
  case (zn)
    when media_zonenum
      case(ms)
        when 0
          medium_media=-1
        otherwise
          zr=proc control_getzone_mqentry(zn,ms)
          load media,zr
          medium_media=media.id
        endcase
      if (zj<>medium_media)
        card update zh,"media"
        proc medium_zonerefill
      endif
    endcase
  medium=mn
  media=na
enddef

```

fig V

Once that is done we look to see if the value of **medium_media** has changed, if it hasn't we do nothing but if it has we refill the zone list.

Another little issue popped up at this point: *What if we were displaying one type of media and it got deleted?* Luckily we already have the code in place to

```

def proc medium_media_delete(zr)
  local na=media
  local zh=proc control_getzone_handle(medium_zonenum)
  load media,zr
  if ((medium_media=media.id)|| (medium_media=-1))
    medium_media=-1
    card update zh,"media"
    proc medium_zonerefill
  endif
  media=na
enddef

```

fig VI

make fixing this potential inconsistency very easy. "Medium" is a client of "media", which means that messages about what's happening in "media" get passed to "medium" including deletions.

```

def proc medium_zonerefill(zh,qh)
  local nt=medium
  local qx,lh=@elementhandle(zh,"list")
  selector delete lh,0,@entrycount(lh)
  query clear qh
  query run qh
  qx=0
  while (qx<@entrycount(qh))
    load medium,@qget(qh,qx)
    if (medium_media=-1)
      selector insert lh,@trin(medium.name)
    else
      if (medium_media_id=medium_media)
        selector insert lh,@trin(medium.name)
      else
        query delete qh,qx,1
        qx=-1
      endif
    endif
    qx+=1
  endwhile
  card update zh,"list"
  medium=nt
enddef

```

fig VII

All we have to do is check whether a media deletion affects the current display and if it does then re-draw the display. Also, if the media being deleted is the

currently selected one reset **medium_media** to be -1 and redraw. (Figure VI)

Finally we come to the actual redraw step, the bit that re-fills the zone list depending on the current setting of **medium_media**. This is shown in Figure VII, the key points to note are that the `for..next` loop has been dispensed with and replaced by a while loop. This is because we have to play dirty with the query containing the list of records to be displayed.

We run the query as normal and get a full list of all the records that can be displayed, using the while loop to cycle through each query entry and using **qx** to index the query we take each record in turn and load it up.

If **medium_media** is -1 it means that we are displaying everything so we just add the record name to the selector. However if **medium_media** is an ID we check it against the **media_id** of the record. If it is the same we add the record name to the selector as expected.

If it isn't we have to delete the record

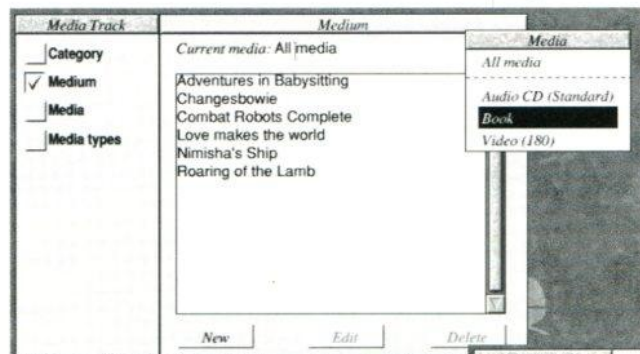

from the query and also (very important) decrement the loop variable as well because there is one less entry in the query. This is why we can't use a `for..next` loop.

This works very well indeed and gives exactly the result we want. Figures VIII and IX show the process in action.

Winding up
What we have is the implementation of a

very thorough skeleton of code for building good database systems in S-Base for RISC OS. If you have an understanding of BASIC you won't find S-Base too hard though it can take a little while to get used to it.

There is much in S-Base that I haven't touched on however with these basics you should be able to create any application you want. These are only ideas of course and there is nothing to stop you from programming in your own way. It is a database programming language and it doesn't hold your hand, this is raw programming. But it does protect you from the intricacies of Wimp programming.

As I mentioned towards the beginning of this article I have not implemented the printing system, I shall now explain why: This application is a dud, it actually doesn't do what I wanted it to do. And I only really discovered that when I came to put in real data. It doesn't need a complete re-write but it needs more work and a bit of fiddling. When I'll get the chance to do that I'm not really sure.

In addition to this there are practical problems which need to be addressed: Where new record cards have been created as a result of menus they have been created as "dynamic" objects so if we try to hang another menu off them they disappear. This makes the nesting creation of records impossible and the application becomes a pain to use

instead of being easy. The cards need to be created as static (but scared) which will make them behave properly.

But then, as they say in all the best text books, I will leave that as an exercise for the reader. Have fun.

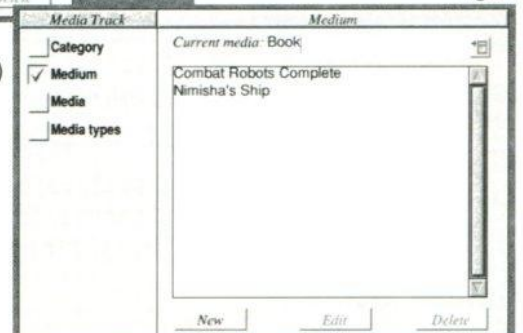

fig IX

Steve Turnbull
stevet@acornuser.com

Call us for latest news about 32bit
lyonix-compatible upgrades

All products are compatible with StrongARM and RISC OS 4
Some products are enhanced for RISC OS 4
All prices include VAT and UK carriage (where applicable)



HERE IS THE NEWS...

22 Robert Moffat, High Legh, Knutsford, Cheshire WA16 6PS • Tel 01925 755043 • Fax 01925 757377 • <http://www.rcomp.co.uk/>

Please note - R-Comp prices now include VAT

Rcomp

rcomp@rcomp.co.uk

Grapevine

The definitive Internet chat software!
to communicate via MSN and IRC!

£25

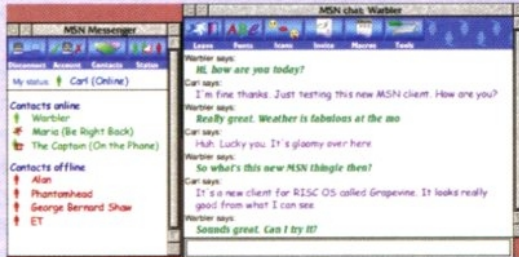

Have live conversations with friends
and family anywhere in the world
when you are online!

Web Authoring

HTMLEdit 5 Studio (Whole Suite) . . . £115

HTMLEdit Studio contains:

HTMLEdit V5 . . . £55

WebsterXL . . . £30

Web Designer's Toolkit v2+ . . . £30

WebSpell (HTML-aware spelling checker) . . . £15

Also Available:

SiteMaster 2+ . . . £35

Internet Utilities

R-Comp Internet Suite £75

First class software to get you online!

Consists of DialUp 2, Messenger Pro 2 & WebsterXL
(described below). Available with a 56k Modem and Account
for £115



for £115.

DialUp v2 - New! £25

Internet connection software

NB. £20 to MPro owners, or £15 if you own WXL



Upgrade from DialUp v 1 for £12 / £12.50



Messenger Pro 2 £37

• Easy to set up and use,

• Flexible view options

• Offline and Network (£45) and Server (£100)



WebsterXL £30

• Support for advanced Web technologies

• Support for frames, tables, CSS and JavaScript

• Includes 128-bit SSL —shop with confidence!

• Uses plug-in interface to support Java, Flash etc.



22 Robert Moffat, High Legh, Knutsford, Cheshire WA16 6PS • Tel 01925 755043 • Fax 01925 757377 • <http://www.rcomp.co.uk/>

Interactive
Rcomp

rci@rcomp.co.uk

Network-in-a-Box

New Product!

Network-in-a-Box gives you all you need to network up
RISC OS and Windows computers, and share printers/internet.
Containing 2 network cards, cables, the Internet/Print sharing
box, software and 5 printed, step-by-step manuals
covering both RISC OS and Windows. £289

ADSL-in-a-Box

New Product!

Similar to above, but for ADSL and without the
shared printing. Everything you need to network a
RISC PC/A7000 and Windows PC for ADSL £265

UniPrint NEW - out now!

"Universal" Network Printer Driver . . . £35

The holy grail for RISC OS printing is to be able to print to any
printer, no matter what type, how cheap or how it is connected.
Now you can. Well, over a network anyway!

The software allows you to print to any printer connected (and
working) to a WindowsPC on your network. That £50 USB
inkjet? No problem. An expensive Photo Printer? Again, no
problem. Make that ageing PC/laptop work for your RiscPC,
and forget your printing woes!

More Cable broadband and ADSL
kits available at a wide range of prices!

100Mbit Network Card - NEW!

High speed 10 and 100Mbit card £89

Price includes VAT and delivery. Available NOW.



THE REALTIME STRATEGY GAME

TEK is available now!

£30

European Computer Driving Licence®



**You know how
to use a computer....
can you prove it?**



**For more information
please contact your
local ECDL Test Centre
www.ecdl.co.uk/centresearch**

Tel: 01793 417530
Fax: 01793 485866
e-mail: ecdlengq@hq.bcs.org.uk

www.ecdl.co.uk/au



ECDL is a registered trademark of the European Computer Driving Licence Foundation Limited.
The Programme is co-ordinated in the UK by The British Computer Society.

Have you got your E111

The European Computer Driving Licence (ECDL) is the European-wide qualification which enables people to demonstrate their competence in computer skills. Strictly speaking, as you can see from the example questions below, it is not Windows-specific, it is just the training organisations that use Windows to do the training.

There is no practical reason why a training company or individual shouldn't use RISC OS and its applications to train in or apply for the ECDL.

The ECDL is designed specifically for those who want to gain a basic qualification in computing to help them with their current job, develop their IT skills and enhance their career prospects. No prior knowledge of IT or computer skills is needed to study the ECDL.

The ECDL syllabus is designed to cover the key concepts of computer use, its practical applications and their use in the workplace and society in general. It is broken down into seven modules, each of which must be passed before the ECDL certificate is awarded.

Candidates obtain, usually from a test centre, a logbook listing all the modules. As they pass each module, the accredited testing body will sign the

logbook. The modules may be taken in any order and over any period of time (up to three years), even all at once, offering maximum flexibility. When all the modules have been successfully completed, the logbook is exchanged for a certificate.

The seven modules that make up the ECDL are:

- Basic concepts of IT
- Using the computer and managing files
- Word processing
- Spreadsheets
- Database
- Presentation
- Information and Communication

Benefits of taking ECDL

ECDL is designed to help people at work and at home. It will confirm to potential employers that the person has a professionally recognised, relevant and up-to-date qualification and it will assist in raising familiarity with the technology and its uses.

ECDL is not like any other qualification, although it utilises the positive aspects of the best. It is fast becoming the most widely recognised qualification in the field of work-related computer use,

because it is targeted at the full spectrum of the population, and because of the support and monitoring of the organisations behind it.

For teachers ECDL is very important with so much curricula emphasis on ICT. To back this up the training organisation Aston-Swann has developed the European Computer Driving Licence (ECDL) for Educators a comprehensive seven-module training programme designed specifically to help Teachers, Support Staff and ICT Coordinators develop practical computing skills for teaching and learning in the classroom.

Creating lesson plans using a word processor, managing classroom data using a spreadsheet, and effectively searching for classroom resources, are just a few of the very practical skills that can be acquired.

Designed to improve efficiency and to reduce workload, the new courseware is suitable for educators regardless of age and experience and can be delivered either face-to-face, as a self-study option, or as a combination of the two. The programme is particularly flexible and will accommodate the varying levels and phases of education suitable for In Service Training (INSET) and Continuing Professional Development.

ECDL Module 3: Word Processing

Sample Question 1

Your task is to prepare a circular letter giving notice about an upcoming annual general meeting of your local tennis club. In the test you are asked to create the letter, to apply various formatting actions to it; and to carry out a mail merge operation so that the circular can be delivered to all the members of the tennis club.

1. Open the word processing application. (1 Mark)
2. Open the document test31 from your Candidate Disk. The document is an unedited version of the circular. (1 Mark)
3. Save the document to your Candidate Disk using the file name agm (1 Mark)
4. Select all the text in the document and change the font in the document to Arial. (1 Mark)
5. Centre align the word Agenda. (1 Mark)
6. Apply bullets of your choice to the Agenda items (text starting with Election and finishing with New Club House Proposals.) (1 Mark)
7. Change the font colour of Agenda to Blue. (1 Mark)
8. Change the font size in the entire document to 14-point. (1 Mark)
9. Save the document and print 2 copies to an output printer if available, or as a print file to your Candidate Disk. (1 Mark)
10. Mail Merge: Use the file agm as a form letter. (1 Mark)

11. Open the file addrlist from your Candidate Disk. It contains an address list that is going to be used as a data source and merged with the agm form letter. (1 Mark)

12. Enter three merge fields into the agm document: Substitute the three text lines Mary Smyth, [upper left corner of the document]

2 Fitzwilliam Road,

Dublin 4.

with the following fields in the document.

Name

Address

City

13. Merge the address list with the agm document to create the mail-merged document. (1 Mark)

14. Save the merged document as mrge31 to your Candidate Disk. (1 Mark)

15. Save all the documents and close the application. (1 Mark)

Sample Question 2

Your task is to prepare a garden centre information sheet providing instructions about watering plants. In the test you are asked to edit the information sheet, to apply various formatting actions to it; and to create a simple table.

1. Open the word processing application. (1 Mark)
2. Open the document test32 from your Candidate Disk. The text is an information sheet, which needs to be formatted. (1 Mark)
3. Save the document to your Candidate Disk using the file name garden (1 Mark)
4. Select all the text in the document and change the font to Times New Roman. (1 Mark)
5. Change the font size of the entire document to 12 points. (1 Mark)
6. Make the word Water in the final paragraph bold. (1 Mark)
7. Indent the heading, Gardening for Amateurs, to start at 3 cm to the right of the left margin (1 Mark)
8. Right align the first paragraph, beginning A weekly in the document. (1 Mark)
9. Create a header in the document and add the centred text Gardening Tips. (1 Mark)
10. Create a table with three columns and four rows after the last paragraph. (1 Mark)
11. Set the line widths in the table at 1 point. (1 Mark)
12. Complete the table with the following text inserted: (1 Mark)

Daily Watering	June	July
Plants	Once	Twice
Shrubs	Once	Twice
Grass	Once	Once

13. Centre align all the text in columns 2 and 3 in the table. (1 Mark)

14. Save the garden document and print 2 copies to an output printer if available, or as a print file to your Candidate Disk. (1 Mark)

15. Close the application. (1 Mark)



Doing the bus stop

A teacher on the Isle of Man has come up with a novel use for the next generation of mobile phone technology. Information technology teacher Alex Townsend is using his 3G handset to provide a wireless broadband internet connection for schoolchildren.

The Manx Telecomputer Bus has 21 computers on board, taking computing training to every school on the island. The O2 phone network has used the Isle of Man to test 3G technology, which promises fast net services, video clips and picture messaging on mobile phones.

The Telecomputer Bus first hit the road in 1998 and the vehicle is more than 20 years old but access has improved since the appearance of the 3G phone. "We use it to travel around the Isle of Man, bringing the big computer room experience to little primary schools," explained Alex Townsend.

In the past, the bus would have connected to a school's net connection using a cable. But this could be quite slow as the connection was shared with other pupils on the island. So Alex thought of using his 3G handset instead and tried it out. "I found the speed was so impressive that I thought 'if it can do this for one computer, what could it do for the 21 machines on the Computer Bus?" Despite sharing the connection, the speed has been impressive: "The service that children are getting through this phone is actually quicker than on their desktop machines in the school."

A waste of time and money?
400 million has been spent on a flagship government programme to transform Maths teaching in primary schools. But reports are coming through that says that standards have not really improved despite the money spent.

Nine-year-olds who had worked with the national numeracy strategy for two years were, on average, only two months ahead of those taught before its introduction, researchers at King's College, London, found. The scores of the least able were actually worse!

Meanwhile, another new study from Oxford Brookes University shows that, despite the rise in 11-year-olds' national test scores, reading and reasoning tests

set by the National Foundation for Educational Research suggest that standards remain unchanged.

Worrying signs across the pond

With individual State budget deficits in the US soaring to near record levels, school technology programs from coast to coast are being slashed as policy makers and school leaders struggle to make do with sharply limited resources.

California, Indiana, Oregon, Texas, and West Virginia are some of the many states where school officials have been forced to cut back or eliminate programs that supply new computers, internet access, and instructional resources to students.

Technology is not being singled out with art and foreign language classes, school counsellors and nurses, field trips and athletic programs, and even core subject area teachers and textbooks also feeling the pinch.

But given the tough new requirements of the No Child Left Behind Act (NCLB), some observers fear cuts to critical technology infrastructure programs will limit educators' ability to track and analyze student performance data, making it difficult to meet the law's intended goal. This marks the first time in the US where a severe economic downturn has directly affected the use of computers in education.

Teachers and education specialists are saying that they will be able to tell just where American society places the importance of technology in relation to teacher salaries, school supplies, textbooks, and other basic necessities as the budget shortfalls start to be felt.

In Wisconsin, budget shortfalls are expected to exceed \$3.2 billion over the next two years, Governor Jim Doyle has asked the state legislature to cut short the state's Technology for Educational Achievement (TEACH) programme. According to TEACH budget and policy analyst Mahrie Peterson, at risk is approximately \$35 million per year in block grants and an additional \$4 million in training resources used to boost technology infrastructures and school computer access throughout the state.

Meanwhile, in West Virginia, Governor

Bob Wise has proposed cutting nearly \$5 million for the purchase of computers and other technology equipment used to support the state's 281,000 students.

Perhaps most worrying for education watchers is the \$2 million in potential deductions to the West Virginia Education Information System (WVEIS), a 13-year-old technology infrastructure that has allowed educators to collect data on student achievement, standardized test scores, and school financial records, including administrative costs. Were it not for WVEIS, the state would have a difficult time in meeting the rigid reporting and accountability demands established by NCLB.

About 70,000 students in Oregon have already lost access to an Internet-based research database that lets them tap into articles from newspapers, magazines, and periodicals around the world. Not a good sign in the week where an analysis of history teaching of World War II in the US is summarised as the war started in 1941 and Japan lost!

State education officials have said they plan to lobby for more funding before a final budget is passed. Still, a \$250 million estimated shortfall headed into 2004 doesn't bode well for their chances.

The National Education Association has collected examples of how states and school districts have responded to the worst fiscal crisis many have faced since World War II. Here are some examples: In the high-poverty city of Baltimore, the budget crunch has seen the termination of a national pilot program designed to help parents work their way off welfare by assisting in after-school programs for their children.

In Oklahoma, 1,000 students no longer have a ride to school, as bus routes have been cut to deal with the shortages. More than 1,000 teacher positions and hundreds of support staff have been eliminated. In fact, money is so tight that some educators have doubled as school bus drivers, stepped in to mop dirty floors, and even donned hair nets to help serve school lunches.

Pam Turnbull
educ@acomuser.com

TMT SYSTEMS LIMITED

USB accessories
Flash drives
Hubs
Card readers
Lights
Wholesale & Retail

SPECIAL OFFER

4 PORT HUB PLUS 32mb FLASH DRIVE
£22.00

4 PORT HUB PLUS 64mb FLASH DRIVE
£28.00

£2.00 P&P (prices include vat)

www.tmteshop.co.uk
tel: 01234 270 505

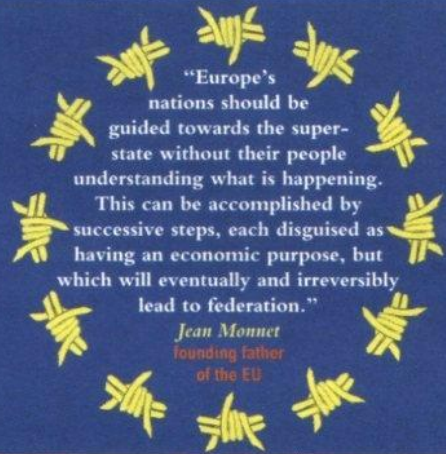

"Europe's nations should be guided towards the super-state without their people understanding what is happening. This can be accomplished by successive steps, each disguised as having an economic purpose, but which will eventually and irreversibly lead to federation."

Jean Monnet
founding father
of the EU

The time has come for all good Acorn people to come to the aid of the Country

National Referendum on the new EU Constitution

Thursday June 12th
at a polling station near you.

Books and booklets *etc.* about the growing menace of the EUSSR available from:

SMP Ltd, FREEPOST ANG10972

Cambridge CB1 2BR

Tel: 01223 504871 fax 01223 512304

email: PF.SMP@dial.pipex.com



RISC OS is now available on many different platforms.

When you buy a new computer you can check to make sure it has a fully licenced copy of RISC OS on it, by looking for this label on the computer.

RISCOS Ltd is the only company authorised to licence RISC OS.

The un-licenced use of any version of RISC OS is strictly prohibited.

Any product that does not have this label is not using a licenced copy of RISC OS.

For any queries please contact

RISC OS Ltd

3 Clarendon Road, Cardiff, CF23 9JD

Tel: +44 (0) 2920 464020 Fax: +44 (0) 2920 492326

email: admin@riscos.com

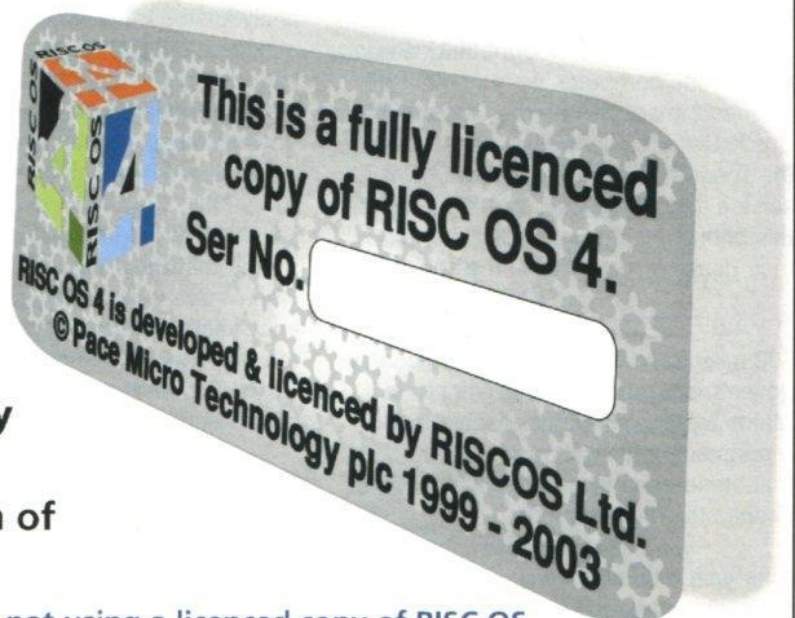

ARM Aemulor



The 26-bit emulator

for

IONIX 

Available now

£50 + vat

Use 26-bit applications on RISC OS 5

Tested OK so far:

Artworks, Impression, Photodesk, TopModel, Eureka, TableMate, StrongEd, Zap, Topographer, Wordworks, Powerbase, Vantage, Hard disc companion, Datapower, Vector, and many more...

www.aemulor.com

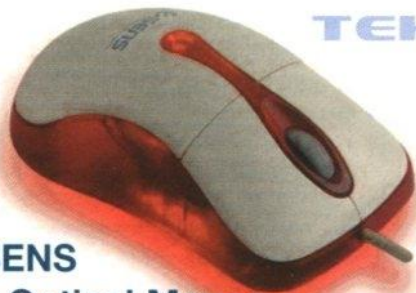

TEKGIA

E SENS M5 Optical Mouse

Now only £14.99 plus £2.50
postage and packaging.

The ergonomic shape of the E SENS M5 comfortably fits your right or left hand.

On Acorn computers, the scroll wheel operates as a button. To have it operating as a scroll wheel requires an STD driver.

Features

Size	120 x 67 x 40mm
Weight	75 grams
Cable length	160 cm
Interface	PS/2, USB

Make out cheque to Tekgia for £17.49 and send to:

Tekgia
The Triangle
Exchange Square
Manchester
M4 3TR

Telephone: 08709 909 709 Fax: 08709 909 749

Email: info@tekgia.com

Web site: www.tekgia.com

Introducing the Cappuccino & the MiniPC Range

Is it a laptop..? Is it a PDA..? Is it a big ugly beige box to bang your knees against under your desk..? In a word NO. It's something different. HKI are proud to bring to market this new range of PCs. We know they caused quite a stir at the business start-up event in the docklands on the 19th/20th of October and you may well have seen us there on stand 124. We also know we were too busy to answer everyone's questions at the time. So this page is to help you catch up with what you missed at the show.

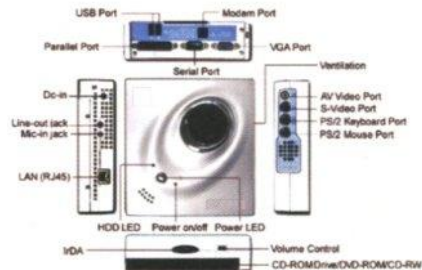

COMPATIBILITY

Because it is a fully functional PC and not a PDA it will run a wide range of Microsoft operating systems. It is compatible with Windows 98 SE, ME, NT 4.0 Workstation, 2000 Professional, & Windows XP, and yes it will even take Linux too. So whatever your operating environment this little chap will fit right in.

SPACE.

This computer allows you to save space. The TX-1 is of astonishing design & tiny dimensions. Measuring an amazing 156mm x 146mm x 50mm. However, size does not diminish its features. It is a fully featured PC that is ideal for any area that is low on free space: - a compact office, an exhibition stand, for training seminars, school computer rooms, hotels, internet cafés, work and home environments.

LIGHT

With the unit weighing around 1140g, the total "travel weight" of the TX-1 is approximately 1620g: Power adapter (480g) + computer (1140g). This allows you to travel light. When coupled with a projector this makes it excellent for demos, presentations, exhibitions, shows & computer based training seminars

PORTABILITY.

You can carry all your data in this Computer because with 30 GB of internal disk space there is no need for zip drives, memory sticks, floppies, Jaz drives or complex office synchronization features.

POWER

The external power supply is no different from those that you see on many portable devices. Except that the power supply for the cappuccino is a standard size and gives you the 100v-240v range enabling you to plug it into US, UK, European and continental power supplies through the use of the normal everyday socket adaptors.

THOUGHTFUL DESIGN

Because it has TV out, you don't even have to buy a screen for home, you can plug it into your TV or Video Amp using the TV-out socket. Thus you can save yourself the cost of a screen. S-VHS/Composite video cable comes supplied.

PROCESSOR

With the brains of the espresso packing a 1.3GHz CPU (either as Pentium III or Tualatin Celeron) you have comparable power with any standard desktop.

MEMORY

A quite impressive little machine which still manages to fit 256Mb of ram inside. This is plenty enough to run all your standard windows applications and operating systems.

Call us to discuss your MiniPC needs. T:020 7426 4890
or e-mail info@hki-systems.co.uk

HKI systems **020 7426 4890**
www.hki-systems.co.uk
info@hki-systems.co.uk

All about Softease

Programming is an art that has very solid fundamental rules. Some programmers are better than others and some programmers do more planning than others. Possibly one of the best programmers in the RISC OS market is Geoff Titmuss.

He's a programmer that plies his art in the way that most other programmers wish they could. He designs his programs thoroughly, using formalised methodology, before he goes near the code.

It was way back in the early '90s that Geoff decided to write a word processor/DTP package that was logical and easy-to-use. Which was how the original TextEase was born and the system he wrote it on was RISC OS.

The natural progression was the inclusion of speech which proved particularly useful for developing literacy skills. Textease can be set to speak as you type, part words, single words, sentences or the entire document which has given teachers remarkable results, especially in younger learners and those students with special needs.

Textease evolved still further into Textease Multimedia, allowing video, sound, links and animations to be used as well as the ability to save as HTML for Web page creation. With the National Grid for Learning and the increasing importance of the Internet within education, Textease Multimedia has become the standard against which the others are measured. With the latest refinements and features added to take this product into the new millennium came its new name, Textease 2000.

The use of ICT across the spectrum of subjects in education sees a new exciting range of products from Softease and a new flagship product emerging, Textease Studio. The Studio is an essential selection of ICT tools designed to simplify teaching of the curriculum in schools. The Studio consists of Textease 2000 (the latest version of Textease Multimedia), Textease Primary, Textease Spreadsheet and Textease Database.

Each component of this educational toolbox can be used as a stand alone application or as a fully integrated, single piece of software; the Textease Studio. Studio Plus further adds Paint, Turtle,

Branch and Presenter products to this list.

Textease 2000



Textease 2000 is the original 'click and type' word processing and desktop publishing package. Suitable for all writing and

publishing tasks at school and at home, its ease of use and configurability make it as ideal for 5 year olds as it is for adults.

As a word processor Textease 2000 has all the usual features you'd expect and more, including the power of 'drag and drop' text editing and 'check as you type' spell checking. The fully configurable word banks aid word association and improve literacy skills by linking words, pictures, sounds and video.

Using Textease 2000 as a desktop publisher allows you to incorporate digital photos, images and clip-art (all easily selected from the picture browser) into your documents.

Creating multimedia presentations is straightforward. Just build on the word processing and desktop publishing skills learned so far, and then add videos, sounds and animation. If you want to produce more sophisticated presentations you can, for example, link pages together, add your own buttons to start videos and animations and even record your own commentary.

Softease Database



Softease Database lets you to set up a database quickly and easily whether you are using it to complete a class survey or collating and graphing the results of a scientific experiment.

As much of the data layout and report functionality has been based on Textease, Database gives you the flexibility you'd normally expect from a desktop publishing package.

You can publish results directly from your database to the Web or send them directly via e-mail. Database is the ideal

tool to manage your digital photo, video and sound libraries using the external link facility.

Data analysis is simple using powerful search, sort and querying facilities. Chart plotting is easy. Database allows you display your charts within desktop published documents and reports. With data still dynamically linked to your database you can change it and your report will update too.

Softease Spreadsheet



Spreadsheets affect every area of the curriculum where it adds a new dimension to learning. Ease of use is the

key to Softease Spreadsheet. Calculations are quick and easy using the intuitive function facility.

As you'd expect with a Softease program you can lay out one or more spreadsheets on a page. You can add text around the spreadsheets and charts, producing complete documents without having to embed your spreadsheet within another package. Spreadsheet is also WYSIWYG (What You See Is What You Get) when it comes to printing your work, making it ideal for producing work sheets or writing up experiments.

Textease Studio



Textease Studio, comprising Textease 2000, Spreadsheet and Database, is a suite of powerful ICT tools designed to meet the basic requirements of all UK curricula.

All the component programs have been designed to integrate fully with each other, making Studio a unique suite of software. A key benefit of this design is that once you've mastered one of the tools you are well on the way to mastering the others.

Each product within the Studio is fully configurable, allowing progression from the youngest of primary school children to adult users.

Softease Branch



Softease Branch is a branching database program that allows pupils to sort and classify information in a fun and imaginative way. By providing

"yes" and "no" answers to questions which they formulate themselves, pupils learn to classify information and gradually build up a database. This provides an ideal introduction to the techniques used, for example, in the classification of plants or animals.

Answering the questions gradually builds up a tree, which can be viewed on-screen, together with the question/answer pairs that lead to this point. If larger trees are created, the poster printing facility enables the whole tree to be printed onto A4 sheets, for assembly into a classroom poster.

Since Branch incorporates all the power of Textease 2000, full multimedia functionality can be added to your branching database. With a wide range of Textease 2000 desktop publishing features available, you can customise your branching database with interesting backdrops and text-based explanations.

Softease Paint



Paint has been designed to develop children's creativity, while at the same time developing their understanding of colour. Stamps and special

brushes facilitate the creation of sophisticated images relatively easily, boosting pupils' self esteem and confidence in their abilities.

Paint includes a selection of realistic media to work with: these include paint, watercolour, charcoal, felt-tip pens, crayons, stamps, tubes and picture brushes. There are many effects which can be used including smudge, blur and clone; these can be combined with the symmetry tools to draw an image many times simultaneously.

There are special tools such as "red eye" removal, or the "region tool" to draw around an object on the page before adjusting its contrast or brightness or turning it into an irregular mask.

Softease Turtle



Softease Turtle is a very flexible control program which handles all aspects of turtle graphics. It starts with the simple movement of a single

object, and progresses to complex programming and control over multiple objects.

At the easy level, the on-screen buttons are used to control the movement of a traditional turtle, optionally leaving a path trail of graphics.

Sequences can be pre-set and run as scripts to create repeating patterns. This introduces simple programming and control concepts to students. Embed scripts within other scripts for a powerful, yet simple programming language.

Any Textease object can be named and used as a turtle, whether it is a simple shape, a photograph or clip-art. Control as many of these turtles as you wish, to demonstrate more complex programming, provide an interesting multimedia show, or as an ideal way to create animations.

Softease Languages



Textease Language Packs are an additional software tool for students learning modern foreign languages.

It works with Textease 2000, Textease Studio and Textease Studio Plus and enable students of all ages to create documents, spell-check their work and have the text spoken back to them in the language of their choice.

The spell checker and auto-accent options intelligently give suggestions where required, or place the correct accent on the characters within foreign words as they are typed. Simply type the word using the non-accented letter and Textease will add the accent for you. (If there is a choice of accents Textease will display these in a list). All menus and dialogues are changed to the language in use. This makes these products invaluable for the teaching of modern languages in schools.

Softease Presenter



Build your presentation using the familiar interfaces of any Softease program. Any work created originally in

Textease 2000 can be used directly in Softease Presenter so presentations can be built up from digital photos, video, sound, text and clip-art.

The program also fully integrates with Softease Database and Softease Spreadsheet, making it very easy to include graphs and tables within your presentation.

While presenting, you can draw attention to key items by circling them with the pen tool. Alternatively, you can hide items so they can be revealed by clicking, thus providing scope to expand or shrink the presentation as it progresses.

Softease Resources



Softease National Curriculum Packs have been created to help teachers cover key areas of the National Curriculum. Each

pack contains activities which utilise one or more components of the Textease Studio range. Videos, Word Banks and Multimedia make each of the packs both stimulating and educational. The Packs are supported by comprehensive Teachers Notes and Students Activity Sheets.

An extensive range of Softease National Curriculum Packs will become available throughout the year covering a number of the key stages and subjects. As always, a selection of our free resources are easily downloaded from our Web site.

The Softease National Curriculum packs are topic-based sets of activities and resources matched to the National Curriculum programmes of study.

Pam Turnbull
educ@acornuser.com

Subscriptions



Issue 259

May 2003
Wakefield Show Preview
What's a Blog?
RISC OS Academy reviewed
MPEG3 Music player review



Issue 256

February 2003
Aemulor, how it does what it does
Sending spam? How to do it legally
Using RISC OS to create websites
USB how new devices are connected
S-Base: Getting in touch with reality



Issue 253

December 2002
RISC OS 5 in detail
Web marketing, how to really do it
Web hosting, what it really means
S-Base

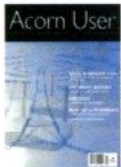

Issue 258

April 2003
Wireless USB from STD
SWShow report in full
Fido Net more bite than bark
S-Base gets into print

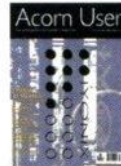

Issue 255

January 2002
The full Lyonix review
Business Internet Connections
USB Programming
lyonix and the future



Issue 252

November 2002
ADSL & SDSL explained
Computer crime, doing the dirty
USB -- making connections
S-Base

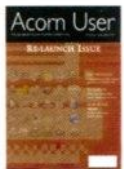

Issue 257

March 2003
Re-issue issue
Using modern printers
Wireless LAN revealed
Mini PC reviewed
And even more besides

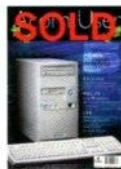

Issue 254

Christmas 2002
lyonix PC - the Cook Report
Viral marketing how you use it
RISC OS vs Windows, more in the difference
USB - Mike Cook on the programming



Issue 251

October 2002
Learning about Web marketing
Getting termites into the program
Making connections with USB
Converting to RISC OS from Windows
S-Base and Dr Wimp

Please subscribe me for:

Annual subscription (13 issues)

	New	Renewal	
UK	<input type="checkbox"/> AUN0306Y	<input type="checkbox"/> AUR0306Y	£45.99
EU	<input type="checkbox"/> AEN0306Y	<input type="checkbox"/> AER0306Y	£51.99
World	<input type="checkbox"/> AWN0306Y	<input type="checkbox"/> AWR0306Y	£63.99

8-issue subscription

	New	Renewal	
UK	<input type="checkbox"/> AUN03068	<input type="checkbox"/> AUR03068	£29.99
EU	<input type="checkbox"/> AEN03068	<input type="checkbox"/> AER03068	£34.99
World	<input type="checkbox"/> AWN03068	<input type="checkbox"/> AWR03068	£40.99

4-issue subscription

	New	Renewal	
UK	<input type="checkbox"/> AUN03064	<input type="checkbox"/> AUR03064	£15.99
EU	<input type="checkbox"/> AEN03064	<input type="checkbox"/> AER03064	£17.99
World	<input type="checkbox"/> AWN03064	<input type="checkbox"/> AWR03064	£20.99

I wish to pay by:

- Cheque (payable to Tau Press Ltd)
 Postal order (payable to Tau Press Ltd)

Non-UK subscribers can still use credit cards to subscribe.

- Please tick here if you require a receipt
 Please tick if you do not wish to receive mailings from other companies

Please send me the following issues:

<input type="checkbox"/> Issue 260, May 2003	£4.80	£5.30	£6.90
<input type="checkbox"/> Issue 259, May 2003	£4.20	£4.70	£6.30
<input type="checkbox"/> Issue 258, Apr 2003	£4.20	£4.70	£6.30
<input type="checkbox"/> Issue 257, Mar 2003	£4.20	£4.70	£6.30
<input type="checkbox"/> Issue 256, Feb 2003	£4.20	£4.70	£6.30
<input type="checkbox"/> Issue 255, Jan 2003	£4.20	£4.70	£6.30
<input type="checkbox"/> Issue 253, Dec 2002	£4.20	£4.70	£6.30

NAME

ADDRESS

TELEPHONE NUMBER

E-MAIL

Post your completed Acorn User subscription/back issues form to:
Acorn User, Tau Press, 28a Middle Hillgate, Stockport, Cheshire SK1 3AY
Have a query? E-mail subscrip@acornuser.com.

High Speed Computing

Order your RISC OS
Machine today...

We specialise in all your RISC OS
needs for individual customers or
small businesses.



RiscStation
RISC Based Technologies

MicroDigital

IYONIX

Call us for friendly advice or
visit our website

We also stock a wide range of
RISC OS Software and accessories.

- P.O. Box 519 • Doncaster
- South Yorkshire • DN4 0GE
- sales@etcsystems.co.uk

TEL: 01302 337559

FAX: 01302 337564

Discreet, Powerful and Fully Featured

Intel Solution
1.8 to 3.0 GHz
256Mb to 2Gb 333MHz DDR RAM
40 to 120Gb HD
1 x AGP, 1 x PCI
4 x USB, 2 x Firewire
LAN/Broadband
5.1 sound card w/ digital out

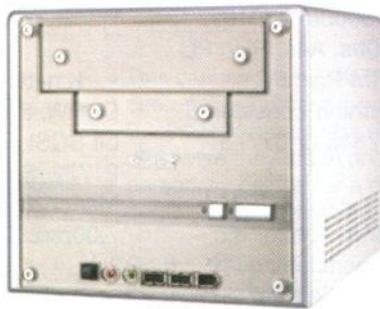

AMD Solution
XP 1900 to XP 2700
256Mb to 2Gb 266MHz DDR RAM
40 to 120Gb HD
1 x AGP, 1 x PCI
4 x USB, 2 x Firewire
LAN/Broadband
5.1 sound card w/ digital out

Choose from a basic eniCube/CPU/RAM to complete systems
Or build your own from our new DIY section

Options include: Modem EL Fascia System Fan Cathode Tube Heatsink Powder Coating and more...

Individual and hand-built, our Shuttle XPC solutions are constructed from carefully selected components. Choose from our stock machines or customise your own; the Shuttle XPC will provide a great result for those who think that style should not compromise content.



Also available: SS51G and SN41G2 systems

Visit: www.enigine.com
Call: 020 8554 0746

Text: 'AUBrochure' to 07736 35 35 83
(include house number and postcode!)

***enigine**
bespoke computer solutions

Copyright 2002 Enigine Ltd. See site for terms and conditions

The eniCube: small footprint, big performance.

Free Adverts

• Acorn items for sale:

[1] Single slice RiscEPC. ARM610; 6MB RAM; 1MB VRAM; 420MB HD; Cumana CD-ROM; RISC OS 3.50. Original mouse, keyboard, manuals and boxes.

(2) Two slice Risc PC. StrongARM SA-110; 64MB RAM; 2MB VRAM; 2GB HD; 24-speed CD-ROM; RISC OS 3.70.

Original Mouse, keyboard, manuals and boxes.

(3) Psion Series 3c PDA. 2MB RAM; Mains adaptor; Leather Case; PsiRisc Acorn link software. All original boxes and manuals. (4) Cumana SCSI2 Podule. (5) CJE 5x86 PC second processor card for RiscPC. 133MHz, 512k cache. Comes with PCPro software.

(6) Computer Concepts LaserDirect4 laser printer plus podule. All software and original manuals.

(7) Epson GT9000 A4 flatbed SCSI scanner. Original boxes and manuals.

(8) Software (all boxed with manuals and bits): Artworks; Eureka v3; Ovation Pro; Impression 2; Fireworkz Pro; Mr Clippy; ImageFS 2; SparkFS; Keystroke; PCSound Professional; Win95FS; WMF IT; Clip IT; ImageMaster; ANT Internet Suite 2; Compression; ArcFax; Virtualise; Font Directory 2; Touch Type; PublishArt; PublishArt 2. Any reasonable offers for all items (or combination of items) above. P&P charged at cost or available to collect.

Contact Jon Aylwin 029 2041 0678 or jon@aylwin.org.uk

• Two Master 128s, 3 disc drives, 1 Cub Monitor, 2 mice, software, £50 buyer collects. East Kent Coast. Phone 01303 873364.

• Wanted: All Acorn A3000s, A3010s, A3020s, A4000s, A5000s, A4s, Risc PC 600 & 700s, StrongARM Risc PC's, Kinetic Risc PCs. Anything considered.

Can travel. 07930 507815 or 07775 776217.

• Acorn A5000 including monitor etc plus additional software including Advance suite. Any sensible offer considered. Contact Robert on 0191 5191231 or at robertvardill@beeb.net

• Wanted: Irlam Instruments Videodesk editing system. Any other video editing card suitable for use with a Risc PC also considered. Please contact chris@acdale.demon.co.uk

• Eagle M2 multimedia card; replay video production, HQ video stills, digital stereo sound sampler, full MIDI IN/OUT/THRU facilities, RISCPC compatible. Offers around £160. Multimedia software; Midiworks, Prosound, Cineworks (includes AppleFS) and Genesis Professional £35 each plus postage or £120 for all three. Eagle M2 plus all four packages £250 plus postage. Enquires or offers 0151 547 3993 or email aokai@tiscali.co.uk

• A two foot stack of Acorn User magazines for sale, complete with cover discs, from Sept 1994 to end 2001. Also other Acorn magazines and discs. Best offer secures this 12kg pile. Tel. Coventry, 02476 319519

• Wanted: All Acorn A3000s, A3010s, A3020s, A4000s, A5000s, A4s, Risc PC 600 & 700s, StrongARM Risc PC's, Kinetic Risc PCs. Anything considered. Can travel. 07930 507815 or 07775 776217.

• Acorn A5000 including monitor etc plus additional software including Advance suite. Any sensible offer

considered. Contact Robert on 0191 5191231 or at robertvardill@beeb.net

• Wanted: Irlam Instruments Videodesk editing system. Any other video editing card suitable for use with a Risc PC also considered. Please contact chris@acdale.demon.co.uk

• Eagle M2 multimedia card; replay video production, HQ video stills, digital stereo sound sampler, full MIDI IN/OUT/THRU facilities, RISCPC compatible. Offers around £160. Multimedia software; Midiworks, Prosound, Cineworks (includes AppleFS) and Genesis Professional £35 each plus postage or £120 for all three. Eagle M2 plus all four packages £250 plus postage. Enquires or offers 0151 547 3993 or email aokai@tiscali.co.uk

• A two foot stack of Acorn User magazines for sale, complete with cover discs, from Sept 1994 to end 2001. Also other Acorn magazines and discs. Best offer secures this 12kg pile. Tel. Coventry, 02476 319519

• For Sale, 586 PC CARD for Risc PC, by Aleph1, includes PC Pro 3, also Windows 95 or 98, cost over £300 pounds, will accept £90 or near offer, Radcliffe, Manchester, please phone 0161 280 3375 or email, j.jackh@ntlworld.com

• Kinetic RPC, 258MB, 60GB, 24x8x8 CDRW, 2 slot backplane, SCSI32 32/16 bit SCSI card, 2 keyboards, 2 Mice. Cost £1772. Sensible offers please. Manchester, tel: 0161 628 6546 after 7.00pm

Acorn User Free Ads Service

Your name: Your phone number:

Why not take advantage of our free reader ad service? Fill in your details on this coupon (24 words maximum, one word per box below) and send it to Free Ads, Acorn User, 28a Middle Hillgate, Stockport SK1 3AY or by e-mail to: freeads@acornuser.com. Only one ad per reader please, private sales or wanted only.

Although we try to publish every ad we receive, we can make no guarantees; publication is entirely dependent on space and time constraints.

Please fill in your name and telephone number below – these will not be published but enable us to contact you in case of any queries. Make sure you include your own town/county in your ad to help potential buyers with their purchasing decision.

Cost of ownership

The mindless adoption of PCs across the board in schools has been something that has annoyed a lot of people. One of those people is David Foss who has been a RISC OS user for many years. However it didn't just annoy him, he decided to do something about it.

In fact David has enquired of every local authority in the country exactly how much they are paying to maintain the PCs in the system. Some of them wouldn't tell him but some did and the following letter (with some details omitted for length and restricted content) was sent out those who took part.

David gave us a copy of the letter and when we suggested that we would like to reproduce it he had no objections, only a few concerns about some of the authorities who did not want the information bandied about. We have endeavoured to follow the restrictions of those authorities where appropriate.

Anyway we hope that you are interested in this information, it may be preaching to the choir, but it's worth having your favourite opinion backed up by some facts. So from here we will hand over to David Foss:

SURVEY OF COST OF MAINTENANCE OF PERSONAL COMPUTERS

Thank you for assisting in the compilation of this unofficial survey. I hope it will provide you with food for thought as you draw your own conclusions about its contents.

This survey of the comparative costs of maintaining Reduced Instruction Set Computing Operating System, Apple Mac OS and Windows computers using an average cost per computer per annum commenced in mid-2000. It was completed in late 2002 and I am sending you this copy of the results because you responded positively or negatively to my original request for information.

This exercise has been purely to make available information on a topic on which there has been remarkably little investigation overall considering the enormity of the amount of money which is spent on Information Technology.

My only personal comment is that, speaking as a taxpayer, I am deeply disappointed that the cheaper, British Reduced Instruction Set Computing Operating System has been virtually ignored completely. Instead huge amounts of taxpayer's money have been lavished on the support and development of American technology in computers, the inherent instability and unreliability of which has saddled the British taxpayer and customers with huge annual maintenance bills.

However, I stress that this is a personal layman's observation which I realise will not be acceptable to anyone whose knowledge of computers is limited to Windows. Nevertheless, I do agree with the comments of Mr B Stubbs of Sexey's School, Bruton, Somerset which utilises both RISC OS and Windows platforms. He said, in an article in the magazine 'Computer Shopper', "You have to have a vision of what IT is for, not keeping up with the latest hardware and throwing money at it. It should serve, not be the master. The more you go to the Microsoft side, the more you need support - a whole industry has grown up of people who make their money from people who don't know how to keep their computers going."

This extract from an e-mail expresses an attitude shared by most of the refusers:

"Dear Mr Foss

"Your letter of ... has been passed to me as the Council's Head of ICT services ... I must decline to provide any figures for [council name omitted] because they are meaningless out of context.

"Yours faithfully [etc]"

"This e-mail is sent for the recipient only and may not be disclosed further without the express consent of the sender."

The response to an e-mail requesting this express consent received this reply:

"You have given me no indication of any purpose for which you wish to use my comments or for which you wish to classify our refusal. I do not understand the purpose of your request nor do I understand whom you represent (individual, company or special interest group).

"Therefore I regret the restriction on disclosing my response still stands. [sign off etc]"

The purpose of quoting the above reporting restriction is [to] demonstrate that I have abided by the requests of the responders who, nevertheless, sought anonymity. Those Councils who did give a figure of costing but issued a copy of the above restriction will find their identity has been protected.

An interesting aspect of the survey is the almost total dependence on the American Windows Operating System which is highly expensive to maintain when compared with the British RISC Operating System. The latter was a feature in education in past days and still is where schools wish to keep costs to a minimum and have been able to resist pressures from the outside to turn to Windows. An example of costs submitted by such a school is included for the purpose of comparison although the sample is too small for official acceptance of the figures.

From a High School in Worcestershire who wrote in reply to my request for details of RISC OS cost:

"Not sure I can help but I will try if I can. Firstly [my] school went down the PC hole some time back, the last of the RISC OS stuff went nearly two years ago.

"The yearly IT budget used to be sub £2000, this covered consumables, text books, software and hardware. We had around 100 Acorn machines, very few above A4000 spec of which 60 were networked. Replacement network cards and computers were obtained second-hand, network cable was sourced from the car boot. These days we're flush with NGFL money, so are shackled into a disgraceful PC managed service courtesy of a departing deputy head. This costs £100 per machine per annum. It prevents you from being able to install any software or change any system settings. It doesn't cover any form of hardware failure, that's out problem to fix/buy replacements. All the dull stuff like backups/basic user management and print queues is ours - wood! And to top the fun, we're only allowed 30 odd 'operational changes'; so better ration these software installations and no changing printers if you can avoid it.

"The maths of buying a PC box comes out at about £1000 per machine so we lease the stuff and now have a huge lease expense to worry about every year, all because we have to have 1 computer per 7 students which equates to over 200.

"And at the end of the lease we still have to buy them off, if we want them."

I hope that you will find these figures of some interest and relevance. So far as I, personally as a taxpayer and customer, am concerned, I find great sadness in the rejection by administration and business in the United Kingdom of the cheaper, more reliable and efficient British Operating System in favour of the hugely expensive-to-maintain and far less reliable American one.

Yours sincerely

David Foss

foss.family@argonet.co.uk

We are going to omit the full detail on the survey, David did provide a table of every local council that replied and the type of reply he got, including the type of calculation done to find out the cost of ownership. There are several standards in this respect.

So let's just look at a general overview of the costs bearing in mind the RISC OS cost was less than £20 per machine. The lowest PC cost quoted was £50 with the council concerned using its own calculation method. The highest was £1398 (per machine don't forget), using one of the recognised calculation methods. The average was in the region of £400-£500 per machine per annum.

Some other information was provided by another respondent who probably

wanted to include it as a comparison for their £800 per machine, but it is of definite interest to us. A MORI poll has concluded that cost per user in IT across various sectors are:

542	<i>Construction industry</i>
887	<i>Other services</i>
1115	<i>Retail/wholesale</i>
14,000	<i>Computer services</i>

That last figure is not a typo but one probably has to consider different types of system and the support perceived as required.

David had a few more things to say at the end:

On a personal note, I made reference in my introductory letter to the fact that enormous amounts of taxpayers money has been lavished on the support and development of American technology in computers, the inherent instability and unreliability of which has saddled the British taxpayer and customers with huge annual maintenance bills.

The practical result of failing to develop the British RISC Operating System is the formation of the popular view that the American Microsoft Windows System, albeit hugely expensive to maintain and support as the figures in this survey indicate, is the only desktop computer operating system available.

Hereunder is a very lucid expression of this generally accepted view as submitted by one of the respondents:

"The decision to select the IBM PC-compatible/Windows computer platform is based on the following criteria:

- The hardware (as opposed to Microsoft's software) is non-proprietary and is available

from a very wide range of competing suppliers which serves to drive down prices, guarantee availability and avoid dependence on one hardware supplier.

- The IBM PC-compatible/Windows computer platform is dominant nationally and globally which means that a wide range of software is cheaply and readily available and, as a result of its global dominance, software is increasingly developed for this platform alone.

- Microsoft's products are the de facto standard in both the public and the private sectors which helps with staff recruitment, facilitates the ready transfer of skills and helps to reduce training requirements.

- The use of Microsoft software computer packages in schools means that students gain skills that are readily transferable to the world of work.

- Most software packages for teaching and learning are produced in this format.

- Virtually all management and administrative packages used in schools run on the IBM PC-compatible/Windows platform.

- The platform seems likely to be dominant for the foreseeable future and is, therefore, well suited to provide a stable and sustainable ICT environment for schools. The RISC OS operating system does not appear to fulfil any of these criteria, nor does it seem likely to be capable of doing so in the foreseeable future, if ever. It could not, therefore, be recommended to schools as a viable alternative to their current provision."

That's what David Foss and some of his correspondents think. But what do you think? Let us know.

Accountz.com	14	Icon Technology	23	RISCOS Ltd	42
Andrews & Arnold	11	InkCycle	10	Softrock Software	26
Black Cat PCs	19	Internet Cameras Direct	31	Spellings Computer Services	22, 43
British Computer Society (ECDL)	39	Jive Aces	34	St Matthews Publishing	42
Campkins	14	Liquid Silicon	02-03, 26	Stuart Tyrrell Developments	06-07, 26
Castle Technology Inside & Outside Back		Merula	27	SuSE Linux	23
CJE Micros	04, 26	Microbits	14	Tekia	43
Danemere St	Editorial Sponsor	MW Software	30	TMT	42
Datastore, The	23	Photodesk	14	UK Digital	27
Datawyse	22	QCC	35	Wardlaw Surveys	26
Enigine	47	Quest Design	19	Zen Computers	22
ETC Systems	30, 47	Quiet PC	26		
HKi Systems	43	R-Comp Interactive	38		

IYONIX



engineered from the inside out

EARLY SUMMER SPECIAL OFFER

£1399

inc vat
delivery £20

Get your hands on the IYONIX pc MAX, one of the superb new range of RISC OS computers from Castle. It is packed with a huge 100GB hard drive, a massive 512MB of DDR RAM a super-fast CD burner, and bags of great software.

The new IYONIX pc features an XScale processor using the ARM instruction set. It runs at a breathtaking 600MHz - more than 250% faster than the current StrongARM processors. Plus it has accelerated high resolution graphics of up to 2048 x 1536 pixels in 16 million colours, a UDMA100 hard drive and 200MHz DDR memory.

So spring into action now - this special offer ends on 30th June 2003!

Tel: 01728 723200

www.iyonix.com



There is also a wide range of monitors, printers, scanners and other peripherals. Call now for details!

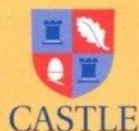

Castle Technology Ltd
Ore Trading Estate
Woodbridge Road
Framlingham
Suffolk IP13 9LL

Tel: 01728 723200
Fax: 0800 783 9638
E-mail: sales@iyonix.com
Internet: www.iyonix.com

FREE!
C/C++
development
suite
worth
£230

IYONIX PC MAX SPECIAL OFFER SPECIFICATION

MEMORY/HD/CDRW SPECIFICATIONS

Hard drive 100GB
CDRW 48-speed write, 24-speed re-write, 48-speed read
Floppy drive Standard 3.5" supporting ADFS, DOS and Atari from 360K to 1.6MB
Memory 512MB 64-bit 200MHz DDR RAM

CASE - MicroATX midi tower

2 x 5.25" bays
3 x 3.5" bays (1 hidden)
4 x PCI slots
Dimensions(mm) 360H x 185W x 402D (must stand min 65mm from wall)

'Soft On' switch on front
'Reset' recessed on front

PSU

Input 115-230 volts 50-60Hz
250Watt PSU with silent mode
On/off switch

MOTHERBOARD FEATURES

Size MicroATX
Processor 600MHz XScale 80321
Sound CD quality AC97, 16bit soundblaster compatible
Unique ID MAC address
PCI signalling 3.3v
Video Resolutions of up to 2048 x 1536 pixels in 16 million colours

EXTERNAL PORTS

2 x RS232 Serial ports
10/100/1000 base twisted pair networking port
Audio in socket
Microphone socket
Audio out/Headphone socket
Video
4 x USB (2 front, 2 rear) - USB-to-parallel cable also available

INTERNAL CONNECTORS

2 x IDE connectors UDMA100 supporting 2 drives per connector (1 occupied)
32-bit EASI module expansion socket (2 slot backplane required)
FDD connector (occupied)
DDR RAM socket (occupied)

PCI EXPANSION

2 x 64-bit; 2 x 32-bit
(1 - nVidia Geforce 2 MX400 graphics card,
1 - USB 1.1 expansion card USB,
2 - unoccupied for customer use)

OPERATING SYSTEM

RISC OS 5 held in 4MB FLASHROM
(field upgradeable)

KEYBOARD

UK 105 key, soft-touch, membrane USB keyboard

MOUSE

3 button USB mouse

SOFTWARE

Writer + Fireworkz Oregano 2
MessengerLITE Dialer CDBurn Lite
+ many other applications and demo software

IYONIX and the IYONIX logo are trademarks of Castle Technology Ltd. RISC OS is © Pace Micro Technology plc. XScale is a registered trademark of Intel Corporation. All other trademarks acknowledged. E&OE

**Other specifications available:
call 01728 723200 or visit
www.iyonix.com**



CASTLE

**Gives
you a
taste
for
the
web**

Oregano²

**The best RISC OS
web browser.
New version out now with
great new features**



CASTLE

Download a FREE trial version from
www.castle.uk.co

**or call 01728 723200
Freefax 0800 783 9638**

Order now!

Castle Technology Ltd, Ore Trading Estate,
Woodbridge Road, Framlingham, Suffolk IP13 9LL UK
email: sales@castle.uk.co www.castle.uk.co
E&OE