

RISC OS '99
Showguide

The best-selling RISC OS magazine in the world

ACORN USER

Power Modelling

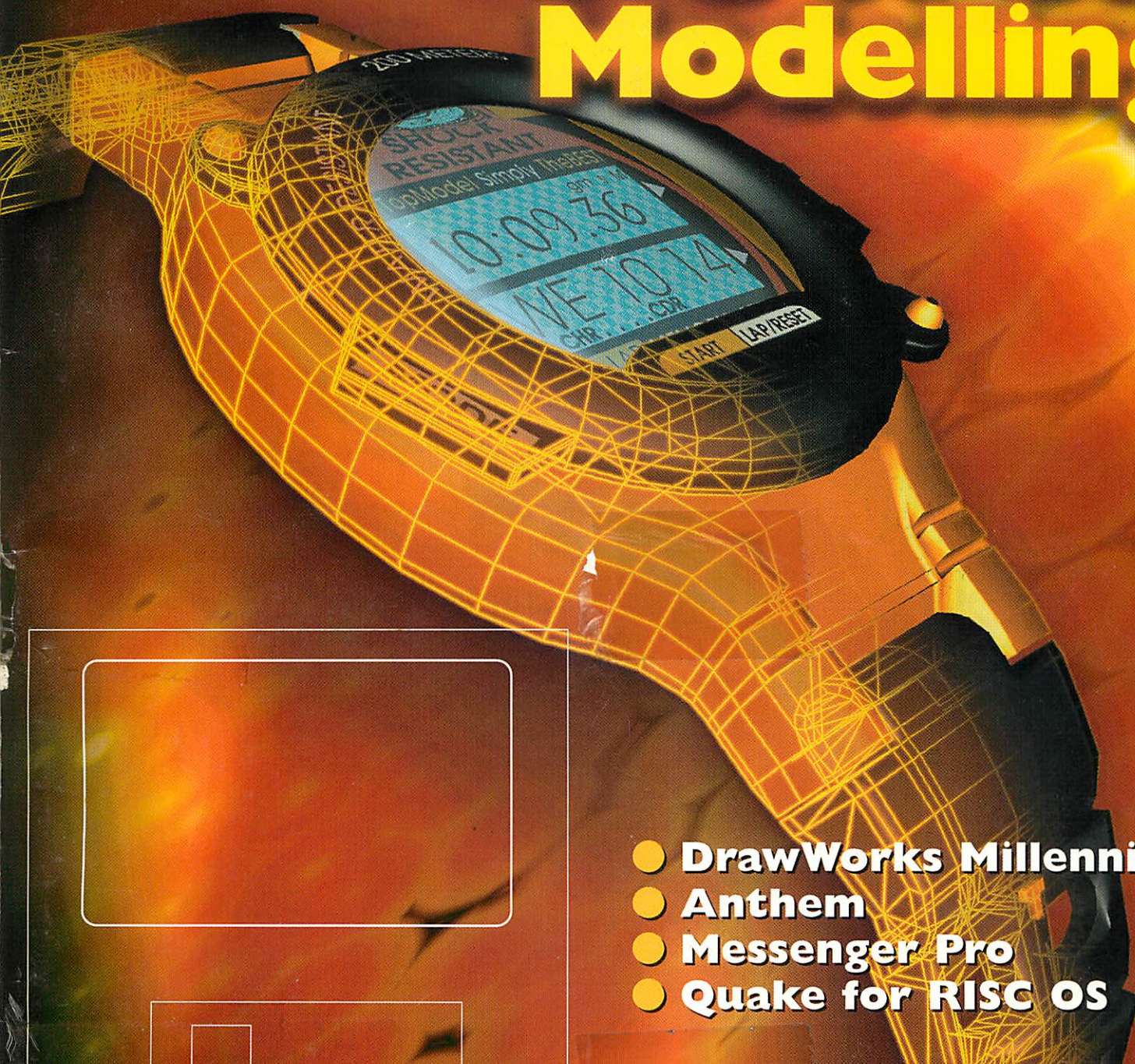

- DrawWorks Millennium
- Anthem
- Messenger Pro
- Quake for RISC OS

  11>

P R E S S 9 770263 745116

ISSUE 213 NOVEMBER 1999 £4.20



computers

Information
Computing
Technology

the complete solution from just **£299**



Risc PC 233T

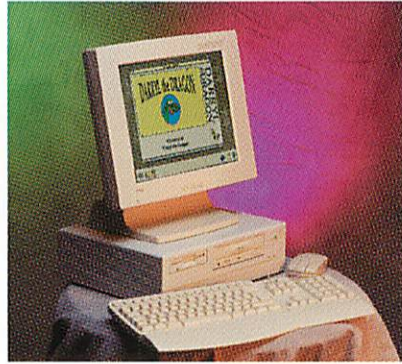

A7000+



Sprinter networked computer



Upgrades

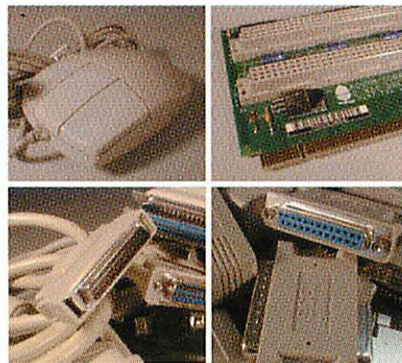

Spares and accessories



Technical support

Check out our new website at
www.castle.org.uk

for the latest prices on
hardware and peripherals
plus special offers and
technical updates!

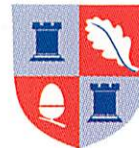

CASTLE

Computers for Education
Business and Home

Call 01728 723200
Freefax 0800 783 9638

Castle Technology Limited
Ore Trading Estate
Woodbridge Road Framlingham
Suffolk IP13 9LL UK
email: acorn@castle.org.uk
<http://www.castle.org.uk>

To receive more details on any or all of
our products and services please
complete this tear off slip and send,
email or fax it to:

Castle Technology Ltd
FREEPOST ANG 8148
Framlingham
Woodbridge IP13 9ZZ

Email sales@castle.org.uk
Freefax 0800 783 9638
Telephone 01728 723200

Please send me further information
on the following products: (tick boxes)

- A7000+
- Risc PC
- Network Stations
- Hardware upgrades
- Spares for Acorn computers
- WWW and Internet products

Name _____

Position _____

Establishment _____

Address _____

Postcode _____

Telephone _____

Fax _____

E-mail _____



CASTLE

Computers for Education
Business and Home

November 1999

ACORN USER

Features

- 20 RISC OS 4**
More about installing the new operating system – caveats and cautions
- 22 Reflex action**
Who does the repairs under Acorn's guarantees? And will they still do it?
- 39 RISC OS '99**
Find out all about the fantastic new show taking place this October – be there

Regulars

- 6 News**
Latest news on the 600MHz StrongARM, new Psion and faster Acorn machines
- 13 Comms**
Home networks, RISC OS Internet security, tracking webcams and Net traffic
- 15 Graphics page**
Returns again with news on Cerilica Vantage, Publish Art and our new columnist
- 16 Public domain**
New ways to create Web pages easily, the moon's phases and ANT help
- 19 Cover disc**
What's in it for you? This month we have a special version of DrawWorks
- 32 Game show**
Interviews with Martin Piper and Andrew Rawnsley plus news on Quake for RISC OS – at last!
- 78 Subscriptions**
Take advantage of our fantastic subscription offers and get yours today
- 81 Letters**
Your chance to get your news, views and opinions into print about the RISC OS world
- 82 The Regan Files**
Mike Glover and Bob Pollard interviewed about their life with TechWriter

Reviews

- 26 TopModel2**
Starting an extended review of the 3D application with a lot of features
- 48 DrawWorks Millennium**
Andrew Green looks at an updated design package giving new life to Draw
- 56 Irlam i16**
Need sound input but not video – this could be the card for you
- 58 Mercurial Messenger**
When a product goes from freeware to commercial it had better be good
- 64 Anthem**
Gareth Moore falls in love with R-Comp's MIDI sequencer

Hands on

- 54 OOP**
More on how to use the powerful object-oriented programming approach
- 74 Run the Risc**
Beating out a significant set of sounds for the budding drumming superstar
- 76 Rambles**
Mike Cook explores another set of interesting hardware questions

- Free ads.....Page 62
- Advertisers' Index.....Page 72
- Contact us.....Page 72
- Back issues.....Page 78
- Subscriptions.....Page 78

Education

- 69 Education news**
Pam Turnbull lets us know what's new in the world of education
- 70 Education reviews**
Tudor times and medieval moments plus maps and contours examined

Next month

Second half of the TopModel review; Digital cameras; Noticeboard Pro; Photodesk plugins; Compo and much much more

December issue on sale 28th October

Published by



Media House, Adlington Park, Macclesfield SK10 4NP
e-mail enquiries@acornuser.com
http://www.acornuser.com/
Tel: (01625) 878888 Fax: (01625) 859808
Printed by Apple Web Offset, Warrington

Editor Steve Turnbull
Deputy Editor Dunstan Orchard
Production Manager Alan Jones
Art Editor Anthony Broughton

Contributors

Simon Anthony, Alasdair Bailey, Ian Burley, Mike Cook, David Dade, Andrew Green, Richard Hallas, Gareth Moore, Max Palmer, Jill Regan, Greg Scott, Pam Turnbull, Paul Vigay

Account Manager David Bradforth
Ad Production Dunstan Orchard
Finance Manager Charlie Moran
Subscription Manager Richard Siggee
Circulation Director Darren Whiteman
Distribution COMAG (01895) 444055
Managing Director Steve Turnbull

Subscriptions:
0870 6060424

E-mail: subscrip@acornuser.com
13 issue subscription rate: £45.99 (UK),
£51.99 (EU), £63.99 (World)

Acorn User is available as speech from the
Talking Newspaper Association UK

©1999 Tau Press Ltd.

No material may be reproduced in whole or in part without written permission. While every care is taken, the publishers cannot be held legally responsible for any errors in articles, listings or advertisements and the views of contributors do not necessarily reflect the views of the publishers

Internet Services provided by Argonet, www.argonet.co.uk



0% Interest FREE credit (6 months) or LOW cost finance available on all new systems.

6 months Interest Free Credit On All Systems inc peripherals, software and 2/3 yr optional warranties (minimum spend £800 inc Vat)

RiscStation Risc Based Technologies **R7500**

Network 50 mip
Arm7500 system with built in Midi, sound sampler, 10baseT network port, High speed serial & parallel ports, RISC OS 4

Major Software Bundle

Network base only £399 + Vat (£468.83)
Network 14" system £479 + Vat (£562.83)
Network Plus base only £499 + Vat (£586.33)
Network Plus 14" syst. £579 + Vat (£680.33)

See www.riscstation.co.uk for more details

R7500 50 mip PCI
based system with Midi, sound sampler, 10baseT network port, High speed serial & parallel ports, RISC OS 4

Major Software Bundle

Base only £579 + Vat (£680.33)
14" monitor system £649 + Vat (£762.58)
15" monitor system £675 + Vat (£793.13)
17" monitor system £725 + Vat (£851.88)

See www.riscstation.co.uk for more details

SA233" T" Web Wizard

34Mb/8G/DvdCD/17" mon/Stereo Spk, Ant Internet & Java with a 56K modem for only **£1145 + VAT (includes RiscOS 4)**
On L.C.F. for only £34.00 per month

233Mhz SA RiscPC Offers
RPC SA bases from £850 inc VAT or **£22.00/month via L.C.F. * AND we will match or beat your best offer**

We can supply any combination or configuration you require.

A7000 + Series Machines

A7000+ Classic 29 Mips RO3.7 8M / 1G HD /no CD £449.00 (£527.58)
A7000+ Classic 29 Mips RO3.7 16M / 2G HD /24x CD £499.00 (£586.33)

A7000+ Odyssey NETWORK
50 Mips RO3.7 (4.0) 16M £525.00 (£616.88)
A7000+ Odyssey CD
50 Mips RO3.7 (4.0) 16M / 4G HD / 40x CD £549.00 (£645.08)

A7000+ Odyssey Primary or Sec. Pack
50 Mips RO3.7 (4.0) 16M / 4G HD / 40x CD £599.00 (£703.83)

A7000 + Odyssey Surf
50 Mips RO3.7 (4.0) 16M / 4G HD / DVD £699.00 (£821.33)

Above prices do not include monitors see separate price list

RISC OS 4
£99.00 +vat
(£116.33) place your order now

Fitting & data transfer, if required, £25 inc vat (£15 with new HD). Stock Available NOW

Casio QV100
Digital Camera
PC s/w only £170.00
exc vat (£199.75)

Acom & PC s/w
£255.00 (£299.63)

HARD DRIVES AND SUB-SYSTEMS *WHY PAY MORE???*

A3000/A3010		A3020		A4000/A5000/A400			RPC / A7000 / RiscStation			
	Ex. VAT	Inc. VAT	Ex. VAT	Inc. VAT		Ex. VAT	Inc. VAT			
170Mb	£85	£99.88	£49	£57.58	210Mb refurb	£25	£29.38	512Mb	£50	£58.75
340Mb	£99	£116.33	£65	£76.38	420Mb	£40	£47.00	2.1Gb	£60	£70.50
512Mb	£115	£135.13	£79	£92.83	540Mb	£49	£57.58	4.3Gb	£70	£82.25
810Mb	£125	£146.88	# £99	£116.33	730Mb	£80	£94.00	6.4Gb	£80	£94.00
1Gb	£135	£158.63	# £109	£128.08	1.2Gb	* £95	£111.63	8.4Gb	£89	£104.58
2Gb	£150	£176.25	# £125	£146.88	2.1Gb	* £100	£117.50	10.1Gb *	£100	£117.50
3Gb	£155	£182.13	# £130	£152.75	3.2Gb	* £105	£123.38	16.8Gb *	£115	£135.13
4Gb	£175	£205.63	# £149	£175.08	4.0Gb	* £115	£135.13	25.0Gb *	£200	£235.00

A3000/A3010 version includes CD ROM i/f which can also be used in A3020 or A4000.
For external A3000 i/f add £20.00 +VAT # includes partitioning software

* inc. internal removable HD & CD ROM i/f.
For partitioning software only deduct £25.00 + vat (£29.38)

* requires RISCOS 4 or Partitioning software for RISCOS 3.5 / 3.6 / 3.7 only £25.00 + vat (£29.38)

All monitors inc 3 yrs wty unless specified

MONITORS

	Ex VAT	Inc VAT
14" SVGA 0.28 (3yr on-site)	£79.00	£92.83
14" SVGA 0.28 Multi-Media	£99.00	£116.33
15" SVGA 0.28 (3yr on-site)	£99.00	£116.33
15" SVGA 0.28 Multi-Media	£129.00	£151.57
17" SVGA 0.28 (1yr RTB)	£129.00	£151.57
17" SVGA 0.28 (3yr on-site)	£149.00	£175.08
17" SVGA 0.28 m-media(3yr)	£179.00	£210.33
19" SVGA 0.26 (1yr RTB)	£270.00	£317.25
19" SVGA 0.26 (3yr on-site)	£329.00	£386.58
21" SVGA 0.25 (3yr on-site)	£540.00	£634.50
38" SVGA (1yr on-site)	£1450.00	£1703.75
15" Iiyama Vision Master 350	£125.00	£151.27
17" Iiyama Vision Master FST	£235.00	£276.13
17" Iiyama Pro 410	£269.00	£316.08
19" Iiyama Pro 450	£415.00	£487.63
21" Iiyama Pro Diamondtron	£659.00	£774.33
AKF53 Multisync 14" 1yrRTB	£160.00	£188.00
AKF50 Multisync 14" 1yrRTB	£195.00	£229.13
AKF12 PAL 14" refurb 90 days	£65.00	£76.38
AKF52/53 M/sync refurb 90 days	£99.00	£116.33
AKF60 SVGA 14" refurb 90days	£65.00	£76.38
Multisync A300/A3000 cable	£8.50	£9.99

ACORN TRACKBALL & MOUSE

£29.79 + VAT

Removable Drives

IDE Drives		SCSI Removable Drives	
Zip 100 int	£65.00 (£76.38)	Zip 100m int	£85.00 (£99.88)
Zip 250 int	£85.00 (£99.88)	Zip 250m ext	£135.00 (£158.63)
Parallel Drives		PD650/CD	£139.00 (£163.33)
Parallel drives include Acom Software		Nomai 750	£165.00 (£193.88)
Zip 100	£99.00 (£116.33)	Jaz 2G int	£235.00 (£276.13)
Zip 250	£159.00 (£186.83)	Jaz 2G ext	£235.00 (£276.13)
Jaz 1G	£239.00 (£280.83)		
Jaz 2G	£299.00 (£351.33)		

SCSI HARD DRIVES

540Mb # limited supply	£50.00	(£58.75)
1Gb	£60.00	(£70.50)
2Gb (5400 rpm)	£90.00	(£105.75)
2Gb (7200 rpm) #	£100.00	(£117.50)
4.3Gb (5400 or 7200rpm)	£140.00	(£164.50)
9.1Gb (7200rpm)	£199.00	(£233.83)
18.6Gb (7200 rpm)	£399.00	(£468.83)

For EXT. SCSI I case £50.00 + VAT (inc. cable)
For EXT. SCSI II case £55.00 + VAT (inc. cable)

THE BEST PRINTER PRICES

(Please ring for latest prices)

	Ex VAT	Inc VAT
Canon BJC 1000 colour	A4 £77.00	£90.48
Canon BJC 2000 colour #	A4 £89.00	£104.58
Canon BJC 2000 Scan # 1	A4 £158.00	£185.65
Canon BJC 4650 colour #	A3 £228.00	£267.90
Canon BJC 4650 Scan # 1	A3 £275.00	£323.13
Canon BJC 7000 colour #	A4 £169.00	£198.58
Epson Stylus 440 colour	A4 £85.00	£99.88
Epson Stylus 640 colour	A4 £99.00	£116.33
Epson Stylus 850 colour	A4 £195.00	£229.13
Epson Stylus 1520 colour	A3 £350.00	£411.25
Epson Stylus Photo 700 #	A4 £135.00	£158.63
Epson Stylus Photo EX #	A3 £265.00	£311.38
HP 420C	A4 £65.00	£76.38
HP 610C colour	A4 £75.00	£88.13
HP 85C/86C colour	A4 £200.00	£235.00
HP LASERJET 1100	£249.00	£292.58
HP LASERJET 2100 PS	£579.00	£680.33
Photo drivers for #	£58.72	£69.00
Scanner drivers for #	£29.79	£35.00

FREE Acom driver by request

CD-ROM WRITERS

Prices Start from £170.00 + VAT

2x2x6x	£149.00	(£175.08)
4x4x16x	£199.00	(£233.83)
CD-BURN	£49.00	(£57.58)
CD-SCRIBE 2	£49.00	(£57.58)

6 Drive 40x SCSI CDROM Towers £499 (£586.33)

SCSI 8x Autochanger £85.00 + vat (£99.88)

CD-ROMS

IDE		SCSI	
48x	£39.00 (£45.83)	40x	£65.00 (£76.38)
80x	£35.00 (£41.13)	32x	£55.00 (£64.63)
8x	£30.00 (£35.25)	8x	£30.00 (£35.25)

For external IDE or SCSI I add £50.00 + VAT (inc. cable)
For external SCSI II add £55.00 + VAT. (inc. cable)
IDE driver for RiscOS 3.5 £15 + vat
IDE int. fitting kit £5 inc. Int. SCSI fitting kits from £10 + vat

Removable Drive Media

	ex VAT	inc VAT		ex VAT	inc VAT
100Mb Zip	£8.00	£9.40	5.2Gb DVD RAM	£25.00	£29.38
Zip 5 pack	£35.00	£41.13			
250Mb Zip	£12.76	£14.99	CDR CD-ROM	£1.28	£1.50
120M LS 120	£7.00	£8.23	CDR 10 pack	£10.00	£11.75
650Mb PD	£19.00	£22.33	CDR 25 pack	£21.28	£25.00
750Mb Nomai	£38.00	£44.65	CDR 80min 10 pck	£12.00	£14.10
1Gb Jaz	£58.00	£68.15	CDR 80min 25 pck	£25.53	£30.00
2Gb Jaz	£69.00	£81.08	CDRW CD-ROM	£5.00	£5.88
1.5Gb Syquest	£58.00	£68.15	CDRW 10 pack	£40.00	£47.00

Desktop FAX MODEMS

56k x2/V90 3Com USR	£118.30	£129.00
56k Flex/V90 (Rockwell)	£55.32	£65.00
ISDN modem (external)	£99.00	£116.33
ANT Internet Suite	£94.05	£110.51
Webster XL	£21.28	£25.00
Java CD	£33.19	£39.00
ArcFax Fax software	£26.38	£31.00

Interface Adapters

EESOX SCSI 32-bit DMA	£84.26	£99.00
Storm SCSI 8-bit (A30x9 int)	£88.00	£103.40
Storm SCSI 16-bit (podule)	£96.00	£112.80
Storm SCSI 32-bit DMA (podule)	£128.00	£150.40
Powertec SCSI3 32-bit DMA (podule)	£170.00	£199.75
Simtec 8-bit (A3000/A3010)	£55.00	£64.63
Simtec 16-bit (AX00/A5000/RPC)	£45.00	£52.88
APDL 16-bit DMA	£45.00	£52.88
APDL Blitz 32-bit DMA	£99.00	£116.33
Removable IDE or SCSI housing unit	£20.00	£23.50
High speed serial cards single	£67.23	£79.00
High speed serial cards dual	£75.75	£89.00
High speed serial cards triple	£84.26	£99.00

3 yr Warranty on ALL Acorn MEMORY why Pay More??

High Quality MEMORY NEW LOWER PRICES

	Ex VAT	Inc VAT
A310 4Mb Upgrade	*£35	£41.13
A310 RISC OS carrier board	*£19	£22.33
A310 MEMC1a upgrade kit	£20	£23.50
A400/1 1Mb Upgrade (per Mb)	£25	£29.38
A3000 1-2Mb Non-Upgradeable	£15	£17.63
A3000 1-4Mb Upgrade	£35	£41.13
A3000 Serial Port Upgrade	£19	£22.33
4-8Mb Up. (A310, 440, 3000*)	£55	£64.63
A3010 1-2Mb Upgrade	£20	£23.50
A3010 1-4Mb Upgrade	£45	£52.88
A3020/4000 2-4Mb Upgrade	£40	£47.00
A5000 2-4Mb Upgrade	£45	£52.88
A5000 4-8Mb 25Mhz* & 33Mhz	£55	£64.63
NEW A540 4Mb	£45	£52.88
FPA10 for A5000 or Arm 3 Card	£45	£55.88
Replacement VIDC or IOC chips	£20	£23.50
* rework if required	£25	£29.38

RiscOS 3.11 Rom upgrades
£25.00 exc Vat (£29.38)

RISC PC MEMORY

	Ex VAT	Inc VAT
Also for A7000		
8Mb SIMM	£10.00	£11.75
16Mb SIMM	£20.00	£23.50
32Mb SIMM	£42.00	£49.35
32Mb high clearance	£53.00	£62.28
64Mb SIMM	£85.00	£99.88
128Mb SIMM	£160.00	£188.00
1Mb VRAM	£38.30	£45.00
2Mb VRAM	£76.00	£89.30
1-2Mb (exchange)	£66.00	£77.55

33 Mhz Arm 3 upgrade SPECIAL

with FPA socket	£45.00	£55.88 inc.
FPA 10 (25Mhz)	£84.26	£99.00 inc.

RPC 16 bit audio & mixer £59 inc
RPC audio mixer £35 inc

NETWORKING

ETHERNET INTERFACES

	Ex. VAT	Inc VAT
A3000 int. 10base2 or T, Access+	£89.00	£104.58
A400/A5000 10base2 or T Access+	£89.00	£104.58
A400/A5000 10base2 & T Access+	£99.00	£116.33
A3020 10base2 Access+/ext. MAU	£99.00	£116.33
A3020 10baseT Access+/ext. MAU	£99.00	£116.33
Risc PC/A7000 10base2 & T Acc+	£99.00	£116.33
Risc PC/A7000 10base2 Access+	£89.00	£104.58
Ant Access+ ROM upgrade	£10.00	£11.75

Cables

2M	£3.00	£3.53
3M	£5.00	£5.88
5M	£6.00	£7.05
10M	£10.00	£11.75
20M	£15.00	£17.63

State 10base2 or 10baseT
any size made to order

Network Hubs (more available)

	Ex VAT	Inc VAT
8 Port 10 base	£39.00	£45.83
8 Port 100 "special"	£125.00	£146.88
8 Port 100/10 Auto	£149.00	£175.08
18 Port 10 16T+ 2BNC	£75.00	£88.13
16 Port 100/10 Auto	£249.00	£292.58
16 Port 100/10 Auto (inc 3 port switch)	£299.00	£351.33
24 Port 100/10 Auto	£389.00	£457.08
24 Port 100 "special"	£349.00	£410.08

We supply and / or install all
network components please
ring for your requirements

NETWORKING SOFTWARE

Topcat site licence	£489.00	£587.50
NTfilter site licence	£97.00	£113.98
Omniscient site licence	£489.00	£587.50
Lanman98 single user	£35.00	£41.13
Win95FS single user	£35.00	£41.13
Lanman or Win95FS 10 user site licence	£110.00	£129.25
Lanman or Win95FS 20 user site licence	£156.00	£183.30

MICE & KEYBOARDS



High Quality
Acorn ERGO
Mouse £12.00
(£14.10)

	Ex. VAT	Inc. VAT
Acorn Trackerball/Mouse NEW	£29.79	£35.00
Acorn Original Mouse	£25.00	£29.38
Acorn ERGO Mouse NEW	£12.00	£14.10
A7000 replacement Mouse NEW	£12.00	£14.10
Ergo (std) Risc PC Keyboard	£21.28	£25.00
Ergo curved Risc PC Keyboard	£29.78	£35.00
A400/A5000 replacement K/bd	£59.00	£69.33
A400/A5000 Ergo Keyboard	£69.00	£81.08

Replacement Floppy Drives

A3000/400/500 £29.00+vatt (£34.08)
A30X0/4000/5000 floppy allows
cross - formatting of HD and DD
discs £29.00+vatt (£34.08)

POWERED SPEAKERS

	Ex. VAT	Inc. VAT
60 watts with PSU	£13.50	£15.86
240 watts with PSU	£21.00	£24.68
Subwoofer system	£42.00	£49.35

Character Mouse Mats

Southpark Kenny	£4.99
Southpark Cartman	£4.99
Disney Mickey, Pooh, Donald, etc	£4.99
X-Files (four types)	£4.99
Garfield or novelty	£4.99
Standard mat £1.00 / Econ. £0.65	

Switch Boxes

2-1 with cable	£15.00	£17.63
2-1 Auto with cable	£15.00	£17.63
4-1 with cable	£19.00	£22.33
2-1 Monitor/K'board	£29.79	£35.00

R-Comp CD-ROM Software

ABUSE	£22.00	Quake (due soon)	£33.00
Descent	£27.00	Syndicate	£26.00
Doom+ Trilogy	£30.00	Towers of Darkness	£30.00
(£32.50 with book)		(Hexen Triple)	
Heroes of Might and Magic 2	£32.00	Doom secrets Book (CTA Special)	£10.00

Consumables

Premier Quality Ink Refills

Single refills (1x22ml)	£6.00 inc
Twin refills (2x22ml)	£10.00 inc
Triple refills (3x22ml)	£14.00 inc
Tri- Colour (C.M.Y)	£15.00 inc
Quad-Colour (C.M.Y.K)	£20.00 inc
125 ml	£21.00 inc
250ml	£38.00 inc
500ml	£50.00 inc
1 litre	£70.00 inc

All sizes available in C.M.Y.K

FLOPPY DISKS @ 20p!!

	Ex VAT	Inc VAT
DD Re-label Acorn fmt 10	£2.00	£2.35
DD Re-label Acorn fmt 100	£17.02	£20.00
HD bulk Acorn or PC 10	£2.00	£2.35
HD bulk Acorn or PC 100	£17.02	£20.00
HD Branded 10 pack	£3.00	£3.53
20 cap Disk Box	£1.69	£2.00
40 cap Disk Box	£2.54	£2.98
100 cap Disk Box	£2.98	£3.50
Mouse cleaner	£4.99	£5.86
3.5" Floppy head cleaners	£2.50	£2.94
CD-ROM cleaner	£4.25	£4.99

Printer Ribbons, Inkjet

Cartridges,
New/Recycled Laser Toner Carts
Prices available on request

ARCSHARE

Acorn networking for PCs
£29.95 exc Vat £35.19 inc Vat
see network section for Cards etc

StrongARM Rev "T"

£259.00 inc VAT

(with any Hard Drive / Memory
purchase)

RiscPC PC Cards

DX2-66	£145.00 inc VAT
DX4-100	£195.00 inc VAT
586-100 (Acorn)	£290.00 inc VAT
586-133 (CJE 512)	£300.00 inc VAT

We can repair/upgrade your
machine(s) and monitors at
competitive prices please ask
All Acorn's, BBCs & PCs

Refurbished RiscPCs

Available now refurbished RiscPC
Systems with AKF60 Monitors
only **£499 + Vat**

COLOUR SCSI SCANNERS

All scanners inc Acorn Software



P'ilel Mustek 600dpi	£99.00	(£116.33)
Mustek A4 600dpi	£119.00	(£139.83)
Mustek A4 1200dpi	£149.00	(£175.08)
Epson GT7000	£199.00	(£233.83)
Epson GT7000P	£249.00	(£292.58)

Imagemaster & Twain also available
separately

(All Prices below include VAT)

THE BARGAIN BASEMENT

Acorn Software Bin

Acorn Pocket Book..Schedule	£10.00
Alone in the Dark	£29.00
Arm Tech Labeller	£9.00
Arm Tech ClipArt (various per pack)	£8.00
Birds of War	£20.00
Boxing Manager	£8.00
ChildPlay (desktop)	£14.95
ColourSep (Colour Separation Software)	£8.00
Creator 2	£25.00
D'File Font Pack (Academy)	£10.00
D'File Font Pack (Balmoral)	£10.00
D'File Font Pack (FreeStyle Script)	£10.00
D'File Font Pack (Manhattan)	£10.00
D'File Font Pack (Mastercard)	£10.00
D'File Font Pack (Old Towne 536)	£12.00
Diary +	£9.00
Drifter	£30.00
FIRE and ICE	£15.00
Frak (for RPC)	£13.00
Galactic Dan	£10.00
Game ON (for RPC/ A7000)	£15.00
Global Effect	£25.00
Guile	£10.00
HERO QUEST	£15.00
Imagery Art Package	£25.00
Jahangir Khan Squash	£8.00
KV (Platform Game)	£8.00
My World Support Disc Ancient Egypt	£12.00
My World Support Disc Ancient Greece	£13.00
Nuclides II and Elements II (save £5.00)	£25.00

Quest for GOLD	£5.00
RAMplify	£17.95
Revelation 2	£29.00
Shuggy	£14.95
SilverBall	£9.99
StrongGuard	£25.00
T.A.N.K.S.	£16.95
TURBO DRIVER - Epson Stylus	£45.00
Visual Backup	£15.00
Wavelength	£12.00
World Class Leaderboard (GOLF)	£10.00
Zool (on HD)	£10.00

Acorn CD-ROM Software

Crystal Maze	£15.00
D'File PDCD 3 or 4	£5.00
D'File PDCD 5	£10.00
Hutchinson Encyclopedia	£39.00
Robert Duncan Cartoon KIT	£39.00
TopicArt CD	£5.00
Tots TV ABC	£15.00
YITM Electricity and magnetism	£15.00
YITM Elements	£15.00
YITM Materials	£15.00
YITM (all three titles)	£35.00

CD General Resource Titles

10000 Clip Art (Draw Format)	£5.00
550 fonts	£5.00
Symphony Music collection	£5.00
Internet Clipart (new)	£25.00
COREL DRAW 5	£29.00

1/2 price (or less) Book Bargains

Dabhand Guide "Budget DTP"	£3.00
Dabhand Guide "C" ver 3	£8.50
Dabhand Guide "C" ver 2	£3.00
Dabhand "Graphics on the ARM	£7.50
Dabhand Guide "Impression"	£7.50
Internet info server	£20.00
SQL	£17.50

Various Hardware bargains

A3010 2Mb bases from	£85	£99.88
A3020 2Mb bases from	£125	£146.88
A4000 2Mb bases from	£150	£176.25
A5000 4Mb bases from	£225	£264.38
A7000 4Mb bases from	£275	£323.13
A4 Portables (6 months wty)	£500	£587.50
RPC bases from	£435	£511.13
SVGA Monitors Various from	£45	£52.88
Pioneer SCSI 4x 6x stack	£139	£163.33

We have a large collection of
Budget PC software suitable for
RPC Pc Emulators and PC clones
inc, Education, Home, games an
utilities please ring for list

Alternative PC Bases

i.e. Siemens Nixorf Pentium
200 MMX from ONLY £249.00
+ VAT ring for latest prices.

HOW TO ORDER

BY MAIL or PHONE: Cheques or P.O.s should be
made payable to "CTA DIRECT".
CREDIT CARD / SWITCH please give name,
address, tel. no, card no, expiry date, issue no.
BY EMAIL: sales@cta.u-net.com
OFFICIAL ORDERS by MAIL or FAX please
Carriage charges inc. ins. & packaging charged at cost
Small items (under 2kg).....no more than £6 + vat
One box of items totalling upto 25kg.....£6.50 + vat
Computer systems.....£13 + vat
All prices are correct going to press. E&OE
All goods are fully guaranteed but not supplied on
approval

600MHz StrongARM

Intel has started to make some noises about introducing next-generation StrongARM technology, calling it a 'quantum leap in performance without trade-offs in low-power capability.' Today's StrongARM processors deliver over 200MHz and draw just 650mW power. Intel say's the mid-range performer in its new StrongARM processor line-up will deliver twice the performance with one-third the power consumption, at 45 percent less voltage.

Intel will implement an ultra-low power 32-bit RISC architecture, helped by Intel's new 0.18µ fabrication process. 600MHz will deliver 750MIPS performance and yet the 500mW power consumption barrier will remain un-touched. The family will range between 150MHz, consuming 40mW power, to the 600MHz part consuming 450mW power, less than a tenth that of a typical Intel or third party Pentium compatible at the

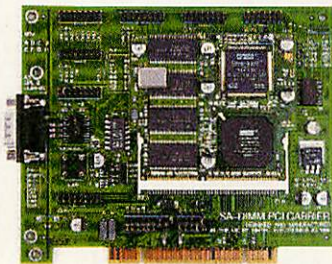

same clock speed.

Intel also point out that compatibility with the current ARM architecture has been agreed, suggesting that the new chips won't lack the 26-bit operational mode currently required by RISC OS.

If true, this is excellent news for the RISC OS market since the conversion from 26-bit to 32-bit addressing is the most serious problem facing the RISC OS Ltd programmers. It would mean that the existing operating system should work without further modification – giving more breathing space for the necessary future changes to RISC OS.

Next-generation StrongARM technology features the Intel Super Pipelined RISC

Architecture implementation, including a seven-stage integer and eight-stage memory pipeline for dramatically faster processor clock rates. Integrated caches have been

expanded to further enhance performance. 32Kb 32-way associative instruction and data caches and a 2Kb 2-way associative mini-cache will be implemented. These caches represent significant increases over the current-generation StrongARM architecture implementation.

The Internet and voice recognition are used by Intel as an indication of the importance of the new chips. Intel gives the example of a palm-size device capable of taking dictation. It requires about 250MIPS for voice recognition, enough all by itself to push the performance envelope of today's processors. Since it would be impractical for a single function like voice recognition to consume all of a device's available processing capacity, it's clear that more headroom is vital.

Among other applications, these performance advances will enable developers to build a whole new class of faster programmable, intelligent Internet access devices capable of simultaneously supporting multiple windows for TV and digital video content.

RISC OS in Rwanda

We've all heard the horror stories from the central African state of Rwanda in the news since 1994. Ethnic tribal rivalry resulted in the slaughter of possibly millions. At last the region is getting back to a semblance of normality, enabling various aid and redevelopment agencies to carry out their work there.

ExpLAN Computers of Tavistock in Devon, is well known for its Church links and the company's Paul Richardson was part of a five-person team from two churches in Devon who went out this summer to provide assistance to a group of churches headed up by Pastor Sadike Zacharie. They took with them an A4000 and an A7000 for use in producing small print-runs of Bible teaching materials. As far as he knows, Richardson successfully installed the first RISC OS computer in Rwanda. Apparently, there has been a rapid increase in the demand for Bible-teaching resources in Rwanda.

ExpLAN equipped the computers with their own *HolyBible* software in French, the official language of Rwanda. It's also possible the text will eventually provided

in the native Kinyarwanda language. Requests were also made to other RISC OS developers for specific items needed. Every company approached gave the products requested, either free of charge, or at specially reduced prices. Computer Concepts gave two copies of Impression Style, EFF some keyboard drivers, Argonet offered internet software and David Pilling, fax and SparkFS software. Other contributions were made by Interconnex, IFEL and Castle Technology. Richardson was able to train about two dozen Rwandese to use the equipment, including a PostScript laser printer. "It's important to remember that they must continue to keep this system running," explained Richardson. "I have no doubts as to the ease of use and long lifetime of RISC OS computers and the laser printer will continue to operate for many years on the level of finance available in Rwanda."

Life may be getting back to normal, but there are still dangers to be faced: "We only got accosted by one bandit, and that was in the centre of the capital city. I think he was after the A7000 he spied on the back seat of the car."

Psion leaps to generation 7

Just a couple of months after announcing the refreshed Series 5mx, Psion has announced a new, bigger and more powerful StrongARM-powered sibling, the Series 7. Psion has also announced the opening of a Psion user-dedicated Internet portal at <http://www.planet.psion.com>, complete with free Internet service designed specifically for Psion users.

Since the Series 3/Acorn Pocket Book generation, Psion has now skipped two even-numbered generations. Number 4 was supposed to be considered unlucky in some Eastern countries – 6 has been skipped too. But the Series 7 itself looks rather familiar. In fact, it's a consumer-version of the Psion netBook which the company announced at the same time as the Series 5mx.

Both the Series 7 and netBook are larger than the Series 5, sport 60x480 resolution colour touch screens and are driven by StrongARM processors; the netBook gets a 190MHz SA and the cheaper Series 7 a 133MHz processor. You also get a full-size PCMCIA Type II slot and a voucher is included for a special offer on a Psion Dacom Gold Card PCMCIA modem. A Lithium-ion rechargeable battery pack is also part of the specification, which Psion claims will last two to three times longer than that in your typical notebook PC, which could translate into 6-10 hours of continuous use; the best part of a working day, if you like.

16Mb system memory is standard,

expandable to 32Mb and along with the PCMCIA slot, there is a CompactFlash for extra non-volatile storage.

IrDA-compliant wireless infra-red networking is built in alongside a serial port. The Series 7 weighs in at 1.15Kg. At £699.95 inc.VAT, it is priced to compete with the mid-to-high end specification Windows CE market.

At the time of writing, the Psion netBook's price wasn't known, though estimates suggest £800+VAT. For the extra £140 (inc.VAT), you get nearly twice the processor power, 32Mb RAM as standard, plus Java and Ethernet support. It could be a

tough choice between the two for some.

Meanwhile, Planet.Psion is a free Internet service for Psion users provided in conjunction with Line One, a fast-growing ISP in the UK. Slightly amusing is the fact that the Planet.Psion Web site is mostly designed in shades of grey and is devoid of design features, like frames, superfluous graphics and animations, which would tax Psion's existing EPOC Web browser. Planet.Psion will also function as a central news and information service for Psion users. Users can register with the service, which includes up to five mailboxes and 10Mb of Web space, online.

\$13 million for E-14

Element14 Ltd – the company which likes to describe itself as “a start-up formed from the remains of Acorn Computers Ltd” – has raised \$13 million in financing and revealed more details about its future plans to produce an innovative DSP (digital signal processor) chip family under the code-name of FirePath. The financing deal is said to be the largest for a chip-design company start-up in Europe. The company also speaks of its ambitions to emulate the success of ARM Ltd.

E14 will use the money for operational expenses as it expands its architecture and chip design teams in Bristol, where earlier this year the company acquired design

engineers from the 64-bit Chameleon CPU design group of ST Microelectronics. “The simplicity of the architecture is the key. We’re taking a RISC-like approach to the design of DSP,” said Stan Boland, chief executive officer of Element14.

He added: “We’ve been assembling the company over the last three to six months by bringing together engineers from Acorn and a CPU design team from STM. It means we’ve got excellent silicon, software and systems expertise. The plan is to produce a chip in summer 2000 as an evaluation platform for the architecture.”

Like ARM, E14 will design its chips but let others license the technology and make the final product.

RISC OS around the home

The great thing about having one is that a butler can be summoned to where you happen to be. This hints at why Octopus Systems has named its new home information system product "TeleButler".

The package combines Octopus Systems' *Caller ID* and *Teletext* products originally designed as separate Acorn computer peripherals and allows caller information to be displayed on any TV in your home using a dedicated channel.

A special "information channel" is generated by the computer and available on Channel 9. The system is able to display the caller's name and number when the telephone rings, the number dialled on any telephone extension in your home, the name of the person being called, when the telephone is in use and

when the call has finished.

It can also display a customised TV and Radio guide listing your favourite programmes, plus other useful information you may wish to link to in other RISC OS applications. Octopus see the product as appealing to all sorts, but especially home workers.

The *TeleButler* system can be bought as a complete package priced £285 inc. delivery and VAT, or you can build it up item by item, though separately the total cost is higher. For more information, check the Web at <http://www.octosys.co.uk/tb>

octosys.co.uk/tb Octopus systems is on tel: 01473 728943

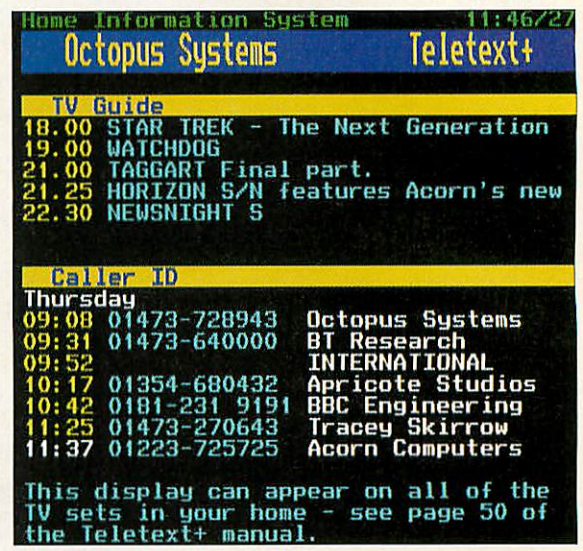

GIF worries return

We thought this story was dead and buried. We were wrong. It's back and it's beginning to scare some software developers and users in the RISC OS and other software platforms.

Five years ago, Unisys - a large US computer firm which invested in patented technology intellectual property, woke up to the fact that the Internet was making one of its patents rapidly increase in value. This was the LZW (Lempel Ziv Welch) loss-less image compression algorithm used in a variety of image-related application programs and image file formats, including the popular TIFF (Tagged Image File Format).

Even more popular than TIFF is GIF, commonly known as the Compuserve Graphic Image File format. GIF uses LZW compression and the GIF format, along with the JPEG format, forms the basis for Web page imaging on the Internet.

At the end of 1994, Unisys let it be known that they would be seeking licence fees from those people its legal advice had defined as commercially liable through the use of LZW compression in file formats like GIF. The announcement caused a

storm of protest as it directly challenged the notion of the Internet as being a largely free entity. There was also confusion as to who was actually liable - end users, BBS operators, Web site owners: all feared the consequences.

The uproar seemed to cancel out the licence issue and once the noise had died down, Unisys' LZW claims were forgotten by most. In fact, Unisys continued to pursue its claims a little more discreetly, but targeted bigger firms like Microsoft and IBM. Now, five years later, Unisys has issued further press releases indicating that it is continuing to pursue un-licensed use of the LZW algorithm.

Unisys points out that it recently succeeded in defeating resistance from Corel Corporation, a major developer of graphics software, over the issue through legal action. Several hundred big name software companies have quietly paid their licence fees, but there are thousands of others and many can't afford the apparent minimum \$5,000 charge. Many of these companies are in the RISC OS sector.

Unisys also warns that users'

ignorance of their software's licensed status is no excuse. While stressing that most licence arrangements with ordinary end-users will not require any fees at all, Unisys still wants anyone using LZW-based technologies to check that their software is licensed. It reads a lot like veiled threats to any GIF user.

Five years ago, as soon as the original Unisys/LZW furore made the headlines, enthusiasts rebelled and invented their own, improved alternative to GIF and called it PNG - officially called Portable Network Graphics and cheekily nick-named PNG is Not GIF. It's a recognised Web graphics file format supported by many browsers, including some RISC OS ones like *Fresco*, *Acorn Browse* and *ArcWeb*, for example and it is totally free of any licensing concerns. PNG is widely supported, but GIF continues to rule alongside JPEG. Now maybe PNG will come to the fore after all.

For more information on LZW licensing, check <http://corp2.unisys.com/LeadStory/lzwfaq.html>

The official PNG Web site is at: <http://www.cdrom.com/pub/png/>

3.5" IDE Hard Discs

	Drive	Plus i/face
210 Mb	£39	£81
420 Mb	£49	£87
540 Mb	£57	£105
1.2 Gb	£69	£116
2.1 Gb	£76	£123
2.5 Gb	£79	£126
3.2 Gb	£82	£129
4.2 Gb	£89	£136
6.3 Gb	£95	£144
10 Gb	£117	£164
12.7 Gb	£139	£186
17.7 Gb	£191	£238
18.8 Gb 5"	£197	£244

'Plus i/face' price includes an APDL fast IDE interface.

Part-exchange available if you need a bigger drive. Please phone for prices.

2.5" IDE Hard Discs

	A3020	3010/3000
30 Mb	£36	£79
80 Mb	£49	£97
120 Mb	£53	£103
170 Mb	£60	£110
210 Mb	£66	£116
250 Mb	£72	£122
330 Mb	£79	£129
420 Mb	£86	£136
512 Mb	£93	£143
1.8 Gb	-	£149

A3010/3000 includes APDL IDE interface, A3020 includes fitting kit Larger sizes and HD+CD available

Blitz

ideA

Is here!

The ultimate super fast IDE interface for your Risc PC. Over 7 Mb per second!

SCSI Hard Discs

210 Mb	£29
420 Mb h/h	£49
1 Gb	£74
4.2 Gb h/h	£149
4.2 Gb	£159
8.7 Gb h/h	£229

IDE CD ROM drives

Internal

Drive with all cables and drivers for RO 3.6+ where required

36x	£47
40x	£49

Drive including APDL IDE interface

36x	£94
40x	£96

External

Drive in case with power supply and including an APDL IDE interface. Probably the best way to fit a CD to a pre-RISC-PC machine.

36x	£151
40x	£153

CD ROM driver software

Works with most ATAPI CDs eg. Pioneer Goldstar, Panasonic, Lite-on, Mitsumi, Sony, Hitachi, NEC, Toshiba, Sanyo, etc. Includes CDFS for use with RO 3.5. Intended for RPC but can be used with an A5000. Only £8 or £7 with a drive

RiscPC and A7000 RAM

8 Mb	£8
16 Mb	£25
32 Mb	£47
32 Mb High Clearance	£52
64 Mb from	£79
128 Mb from	£139
2 Mb VRAM	£69
1 Mb to 2 Mb exchange	£47

Datafile PD CDs

PD CD - 3	£6.50
PD CD - 4	£8.50
PD CD - 5	£6.50

Public Domain, Shareware and other low cost hardware and software for RISC-OS computers



APDL

UK SHAREWARE



Prices include VAT and UK carriage except hard drives add £5 for internal drives, £8 external This is only a fraction of what we have available. We also have thousands of discs PD and Shareware and around 500 discs of Acorn format clip art. For a full catalogue on 800K or 1.6Mb disc please send 50p or two 1st class stamps or see our web site.



APDL, 39 Knighton Park Road, Sydenham, London SE26 5RN

Phone: 0181 778 2659 Fax: 0181 488 0487 www.apdl.co.uk/



APDL Public Domain, Clip Art and other CDs

- APDL PD-1 Issue 4 £12.50** The best PD CD from the best PD library. Over 1,800 programs and utilities, more than 100 novels, etc. No games, clip art, music, or other non-serious stuff.
- APDL PD-2 Issue 4 £12.50** Around 700 games and novelties, over 250 games cheats and over 200 demos, plus over 2,000 music files and more than 550 digitised sound samples.
- DTP-1 and DTP-2 £14.50** Each have over 500Mb of clip art files, all ready to use in Acorn Draw, Sprite or Artworks format. Ideal for use in education.
- DTP-3 £17.50** Third highly acclaimed APDL clip art CD. Over 720Mb of material. Great for schools or anyone who needs a huge collection of clip art at a sensible price.
- DTP-1 plus DTP-2 plus DTP-3, just £34.50**
- DTP-4 £19.50** Our latest clip art CD. Over 12,000 images, plus more than 400 Artworks files and 170 high quality colour pictures. All catalogued complete with thumbnails
- Games CD 1 £7.90** A collection of twenty of the best PD games of all types. Ready to run direct from the CD on almost any machine. Hours of fun for an unbeatable price.
- Games CD 2 £7.90** Our Games Collection No. 1 CD was so popular we've done it again. Another twenty of the best best games at a real budget price.
- Skullsoft Collection £9.90** A great budget priced games CD from APDL. Full versions of three popular games from Skullsoft, !Arya, !Xenocide and !Plig
- Soft Rock Collection £9.90** Six classic games from Soft Rock Software, plus a new version of !Trellis, the adventure game creator/interpreter with two adventures
- Fantasy Pictures £7.90** By request from our customers, the pictures from the Fantasy section of the APDL catalogue. Lots of Sword 'n Sorcery pics and many others
- Education Resources £16.50** A CD ideal for schools. All the things we know you want. Over 5,000 Acorn format clip art images, 100's of e-texts, over 300 useful programs, and more.
- Earth in Space £9.90** Pictures, databases, information on stars, planets, moons, space missions, etc. etc. A massive amount of data at a realistic price.
- Earth Data £9.90** Geographical database with a huge variety of data and statistics on every country. Simple menu-based interface. Including !Earthmap
- New Ergane £7.90** Translating dictionary program by David O'Shea with dictionary files for over 50 languages, although some are limited to a few hundred words.
- Generation Design collection £16.50** Now with eight games. AlfaXL5, Pharaohs Secret Tombs, Last Cybermoch, Sea Trek, Caves of Confusion, Robocat, Gold Run and Jewels of Jezabar.

APDL ideA fast IDE interface

- No complicated setting up. It's self-configuring so just plug it in!
- Uses DMA (Direct Memory Access) on Risc PC. Over twice as fast as the built in IDE interface or others which don't use DMA.
- Includes CDFS and ATAPI CD drivers for many popular CD ROMs.
- Four devices, any combination of CDs and hard drives.
- Up to 8 partitions, so you can have large drives on pre RO 3.6 machines
- Software in flash EEPROM for easy update (including VProtect).
- Supports the new range of Syquest SparQ low cost 1Gb removable drives.
- Connectors are available for external drives or CD ROMs
- Fits A310, A400, A5000, A540, A7000 and any RiscPC.

All these features for the incredibly low price of just £52
A version for the A3000, A4000, A3010 or A3020 is available with all the above features. Supports two internal and two external devices - £62

APDL Paralell Port Syquest drive

The 1Gb SparQ drive is the ideal solution for backing up larger hard drives where old technology like a Zip drive just isn't realistic. Big enough to hold lots of data, and with our software you aren't restricted to just RISC-OS 3.6+ but can use it on any machine with a bi-directional printer port including the A5000, A3010 etc. as well. With Acorn and DOS driver software. just £199

Ancestor +

We've promised it before, but it's available at last! The long awaited successor to Graham Crow's highly popular genealogy program Ancestry, previously sold by Minerva. Upgrades from Ancestry 1 and Ancestry 2 available. Can use Ancestry 1 files and we're working on a converter for Ancestry 2. Only £59

ACE 586 PC cards

Available with from just £199 with trade in against your old card, which makes it even cheaper. Good performance for Windows at a sensible price. 128K to 512K cache upgrade (fits most cards with socketed processor) £99

General software

- Faster PC - £20** The alternative XT PC emulator. Works on any model with 2Mb RAM from A3000 to Strong ARM RPC.
- PowerBase - £15** Popular extremely powerful but very easy to use database. With examples, tutorials and printed manuals. Better than most products costing many times the price. Does everything that 99% of database users will ever need.
- MenuBar - £15** The very best pull-down menu system. An absolute essential for any hard disc user. You can switch between up to 30 different menu bars. Incredibly easy to set up, add items to menus, move them, etc.
- Tiger - £15** Lets you use very long descriptive filenames. Unlike some products this is very robust as it works in parallel with the filer so can't corrupt discs.
- WorkTop - £15** Switch between up to 30 different environments with a single mouse click. Stars the tasks you require, opens directories, loads files, changes screen mode. Just like moving to another computer. An essential productivity tool.
- Joy Connect joystick podule** Works with most games. Podule with one joystick £42 Extra joysticks £4 each.
- Connect 32 fast SCSI** We have a limited number of these very fast interfaces (up to 7.5 Mb/sec) at only £99

Data Safe - A new concept in backup and data security

A new idea from APDL, Data Safe consists of an external case to hold a 3.5" IDE hard drive, connected to your machine's printer port. This gives a large capacity portable drive, movable between machines and locations. Ideal for backup, secure data storage and transport. The filer has all the features of our ideA card so you can partition drives, password protect partitions, etc. Great for schools. Supply your own drive or we'll fit one for you.

Data Safe Super has the drive fitted in a removable drawer. You can fit a similar drawer to your Risc PC (best if you use our IDE card) and then just unplug the drive from the RPC and transfer data to another machine using the Data Safe.

Prices start at £104 or with 3.2Gb drive just £185 6.3 Gb only £199

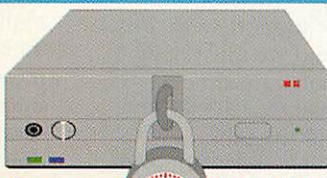

Data SAFE

Faster A7000+

Castle Technology Limited (CTL) has announced a faster A7000+ which incorporates the latest 50mips (million instructions per second) ARM 7500FE processor. The new A7000+ Odyssey benefits from raw processing power boosted by over 70 percent from the previous model's 29mips.

The extra oomph also translates into better screen mode options, ranging from a full 16 million colours in 640x480 mode, through to a 1024x768 mode in 32,000 colours and a huge 1280x1024 mode in 256 colours. Performance and usability also gets a

boost through CTL's adoption of RISC OS 4 as a no-cost option to the standard RISC OS 3.71.

RISC OS 4 can, in certain circumstances, accelerate performance by almost 50 percent. Free bundled software includes Icon Technology's *EasiWriter Professional* and Colton Software's *Resultz* spreadsheet package.

The Odyssey is available in a number of configurations for networking, Internet access, and so on, with prices (without monitor) starting at £525+VAT. CTL is currently offering

discounts on monitors until the end of November.

Customers who order a new Acorn computer (Risc PC or A7000+) from Castle, or one of its dealers, can choose a 14in monitor for an extra £50+VAT, a 15in unit for £75+VAT or a 17" monitor for £125 +VAT.

All these have digital controls and a 0.28mm dot pitch screen, plus a 3 year warranty. 14in flat screen LCD monitors are also available at £550+VAT.

Jack Lillingston, CTL's managing director, commented: "Castle have taken up the challenge to continue the development of the Acorn range of computers.

The Odyssey is just the first in a series of improvements that we have been working on. Castle will release details of further technological developments before Christmas 1999". CTL, tel: 01728 723200, fax: 01728 621179, e-mail: sales@castle.org.uk, Web: <http://www.castle.org.uk>

Wacom's pen and mouse

Acorn users have used Wacom graphics tablets for years. Now Wacom is widening its market from a core clientele of mainly professional graphics artists to the general consumer market with its new Graphire mouse and pen set. In the box you get a 1,000dpi A6 format graphics tablet, a cordless pressure-sensitive pen and a cordless mouse with a wheel button. The pen has 512 levels of pressure, which is half that of the more up-market Wacom Intuos tablet range, but still promises to satisfy the majority of uses.

The mouse has no ball or internal

rollers to get dirty, so its operation should be smooth and glitch-free for life. Both input devices communicate with the tablet using a

low-power radio communication system and neither require batteries.

A choice of USB or serial connection is offered and the Graphire will be available from October, priced £84.99 inc. VAT.

RISC OS support software

will be required and we must hope that the existing software support can be adapted easily for the RISC OS market. The UK distributor is Computers Unlimited, tel: 0181 358 5857. Wacom on the Web: <http://www.wacom.co.uk>



Acorn searches made easy

AcornSearch, is set to become the 'Yahoo!' of the Acorn world. It's a search engine dedicated to the Acorn/RISC OS area of computing. It can search through Web, FTP, and News items, helping to filter out other non-relevant material and return clearer results.

The engine itself now indexes over 7,500 items, over some 170 individual sites. Users can submit their RISC OS related homepages by sending an e-mail to g0tai@acornsearch.com with their website in the subject of the message. Developers may be interested to know that the engine scrapes the web pages for downloadable files (for the file search engine) and may wish to read the instructions provided at <http://www.acornsearch.com/submit.html>

Eizo's budget monitor

A year ago, you'd be doing well to find an up-to-date 17in monitor of any description under £200+VAT. Today, several manufacturers are offering models at nearing the £150+VAT mark. Eizo is not noted for budget-priced product, preferring to concentrate on high-end feature-rich models instead. But now the company has announced a budget model of a sort. The list price of the Eizo F520 is £239+VAT, which makes it a mid-price 17in unit.

However, you do get features which

are unusual for this price point, including a short-neck tube which saves on space, 0.26mm dot pitch screen instead of the usual budget-priced 0.28mm specification and TCO '99 radiation emissions compliance. Maximum refresh rate at 1024x768 resolution is 89Hz. Options include a modular USB hub and add-on speakers and microphone. Eizo monitors are distributed in the UK by PDS, tel: 01483, 719500, Web: <http://www.pds.co.uk>

Game Boy ARMed and dangerous

It has been revealed that Nintendo has chosen an ARM processor to power its successor to the highly successful, multi-million seller, Game Boy hand-held pocket game console. Code-named Game Boy Advance, the new device is designed to be configured with the aid of add-on modules as a mobile phone, providing Internet communications for software downloading and e-mail. A digital camera add-on is planned too.

Multi-player real-time games will include the ability to see the face of your opponent. The new Game Boy will have the capability of running current Game Boy games using an emulator, but new

games specially developed for the 'Advance' unit will not be backwards compatible with the existing Game Boy.

A special feature will see the new Game Boy working in tandem with Nintendo's still-secret next-generation 'Dolphin' home entertainment console. The 'Advance' unit itself will have a 240x160 pixel TFT LCD display, have a capacity of 20 hours of continuous use and weight about 140g. Don't hold your breath, however, the first production units, which will ship in just less than a year's time, will be for Japan only, though the rest of the world is scheduled for Christmas 2000.

Vacancies at Oregan

We've mentioned their recruitment needs in the news pages before, but Oregan Networks Ltd continue to have several full time job vacancies for software engineers with RISC OS experience. According to Oregan, positions available will require working on-site at the Oregan Networks Leicestershire offices, with involvement in a number of Internet STB (set top box) related projects.

Qualifying for the jobs is quite tough:

At least a BSc/BEng Degree within a suitable discipline, excellent knowledge of C and the Acorn or ARMTools compilers, experience of developing RISC OS-based WIMP applications, some experience of porting C code to the RISC OS platform and some knowledge of Unix, networks and Internet technologies is an advantage.

If you're interested, e-mail nbourne@oregan.net, or telephone 01530 563311.

In brief

Freeze your machine

Having been involved with Acorns for longer than I care to remember, sometimes, this news item reminded me of those wire-infested gadgets for your BBC Micro you used to be able to buy in order to stop games at critical moments, change the lives memory value to 'infinite' and then proceed to become a champion Elite player or suchlike.

Like Arm's Tech's new product, called *Freeze*, these games cheat devices were designed around the ability to freeze the state of the host computer and then enable the entire memory contents to be saved out as a file and tampered with as necessary.

Freeze can save the state of a machine and restore it back at any time, but Arm's Tech appears to have developed the application more for convenience than games cheating. Using *Freeze*, a long boot sequence can take less than 5 seconds. You can, freeze as many different sessions as you like and re-load them when needed. *Freeze* is a shareware program and the full registration costs £10. For more information, contact Arm's Tech via the Web at: <http://aglaee.imag.fr/ArmsTech/GUS/Freeze.html>

David Watkins

It is with sadness, shock and surprise that we have learned that Dave Watkins, who was the last editor of *Archimedes World*, had passed away. Dave was a familiar and enthusiastic figure among the small band of people who make up the core 'Acorn press'.

He endured a difficult time keeping *Archimedes World* going while its then publishers were negotiating to close or sell it. *Acorn User's* own publishing company, Tau Press, eventually acquired the magazine and it was merged with *Acorn User*. We will miss Dave's thoughtful but laid back presence at press meetings. Our thoughts are with his family.

Icon Technology

New Pro+ version of Easiwriter and Techwriter now available

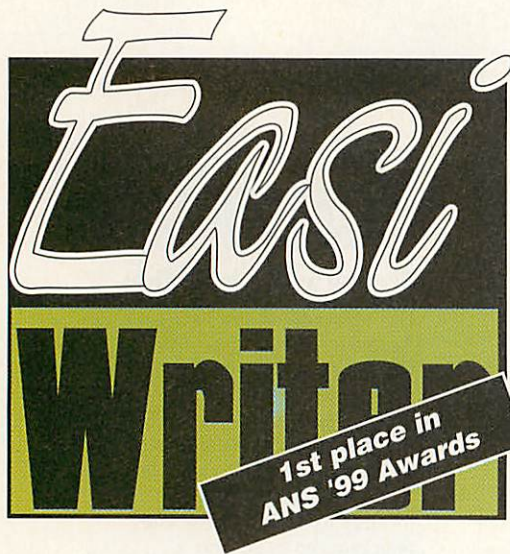

EasiWriter professional

- Powerful, fully featured, multi-column word processor.
- Reads and writes MS Word 6, 7 & 8 (Office 97/98).
- IMPRESSION text files with styles are imported complete with formatting.
- Reads and writes HTML. Splits large documents with automatic generation of forward/backward links and contents.
- Reads RTF (Rich Text Format).
- Creates Hypertext documents.
- Built in Table Editor.
- Automatic bulleted and numbered lists.
- Mail merge.
- Automatic numbering of Lists, Sections etc.
- Powerful spell checker.
- Style editor.

EasiWriter professional
£119.84
Easiwriter Pro+
£139.00 (offer)

$$A = \frac{1}{n} \left\{ \sum_{k=1}^n Z_k - B \sum_{k=1}^n x_k \right\}$$

TechWriter professional

"Its great! At the risk of writing advertising copy for Icon Technology, no piece of software on any platform has made me grin with delight as I discover new features as much as TechWriter has." Archive

- All the features of EasiWriter professional plus a powerful easy to use equation editor.
- Writes TeX.
- Saves equations as GIF's (using InterGif) when writing HTML.
- Used by the Mathematical Association to produce the Mathematical Gazette.

TechWriter professional
£178.59
Techwriter Pro+
£199.00 (offer)



**Reads and writes
Microsoft® Word**

New! Pro+

Text flow over graphics

Paragraphs can contain multiple graphics which can be left and right aligned with text flowing over them. Allows drop caps.

Java enabled

Run Java Applets inside an Easi/Techwriter window

Plus...

Over 100 new user definable keyboard shortcuts, runs animated GIFs and Animator files, 300/360 dpi equation resolution when saving as Word.



Upgrade your StartWrite or TalkWrite to EasiWriter professional for just £60.00 inclusive.

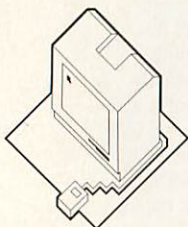

Icon Technology Limited

Church House • Carlby • Stamford • Lincs • PE9 4NB

Phone and Fax 01778 590563

<http://www.icontechnology.net>
email: sales@IconTechnology.net

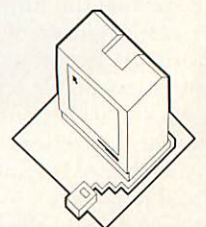

Net gains and losses

Andover.Net operates Websites offering on-line Internet resources for Website builders. It also hosts the advertising space that pays for free use of these tools. Their Internet traffic report monitors the flow of data around the world checking response time and packet loss, expressed as a Traffic Index. Get it at <http://www.InternetTrafficReport.com>

The MediaBuilder site offers free clip-art, animated GIF library, icons, borders and backgrounds, as well as free TrueType fonts and image creation tools. The 3D Text Maker at <http://www.3DTextMaker.com/>



A bit more work needed perhaps?

can produce headlines and banner graphics which can be edited and tweaked in another online tool called *GIFWORKS*, which for Acorn machines needs a JavaScript Browser such as *WebsterXL* or *Fresco 2.03*.

Button Maker can convert an existing Web-published image into a bevelled button with an optional sharp drop shadow. Animated banner GIFs can be created with your own text with a number of moving effects. Their Dingbats font face mapper needs using with care, as its HTML won't display correctly on an Acorn Browser. If you must use the face attribute, only use ``, as no other fonts can be expected.

MediaBuilder offers an interesting selection of browser-independent tools for Web graphics creation, but the image quality isn't brilliant, and most actions take quite a time to achieve. Much better results would probably be obtained using one of the low-cost packages such as *DrawWorks* for Acorns or *Xara3D* and *WebStyle* for the PC.

Andover.Net MediaBuilder
<http://www.mediabuilder.com>

YoUR List of sites to visit

<http://www.alant.demon.co.uk>
Alan Brown's Postscript Printer Description files for distilling pdf files, his Acorn software and Simpsons guide.

<http://www.archchancellor.demon.co.uk/>
Edward Noakes' RISC OS software and coding tips, his selection of other authors' Acorn software and Angband links.

<http://www.suit-u-sir.com/riscos/comp.html>
The computer adventures of Simon E. John, including his JavaScript digital clock, Perl and Java demos.

<http://www.bitsmart.com/acorn>
Bryn Evans' collection of scripts and information for using Acorn *!Connect* with free ISPs, also Interesting sites for Schools.

<http://mars.spaceports.com/~kez/>
Kez's Corner (thankfully not Korner); Kerry Floyd's site includes Acorn

games to download, desktop sillies and Java chat page.

<http://welcome.to/benbrook/>
Ben Brook's site contains images and info on the range of Acorn machines, links and a beginner's guide to Acorns.

<http://www.bravenet.com>
Free tools for Webmasters including Web forums, reasonably discreet hit counters, guestbooks, mailing lists and E-mail forms.

<http://www.argonet.co.uk/mabel/programs/html3/>
!HTML by Richard Goodwin is a very comprehensive macro-inserter for creating Web pages with your favourite editor.

Contacting AU

David Dade at:
comms@acornuser.com

In brief

More Net-work

During the day Ian Jeffray designs digital set-top TV software, but his home interests include Formula 1 Grand Prix, *ARM Linux*, and writing Acorn software. His FreeUK Web site features well-illustrated information on setting up small home Ethernet networks with Acorns and PCs. Topics discussed on his "Basic home networking" pages range from choosing cable types through allocating IP addresses to networking software configuration of both Acorns and PCs.

Basic home networking
<http://www.jeffray.freeuk.com/networking.html>

Keep track with Camtrack

Hans de Jong plays a lot of tennis, but his other leisure moments in The Netherlands are taken up by RISC OS programming. CamTrack is his latest project, which fetches and stores images from WebCams - those peeping Internet eyes that show you what's happening right now in places all over the world.

Camtrack initiates periodic Web fetches and stores the images where you want them. In concert with David Thomas' *NetFetch* and your Internet software, up to 50 separate WebCams can be scheduled. There's a good selection at "Around The World in 80 Clicks" at

<http://www.steveweb.com/80clicks/index.htm>.

CamTrack
<http://home.planet.nl/~hjang>

Security breach

There has been much recent e-discussion about Secure Sockets Layer connections; the encryption of data sent via Web browsers for e-commerce purposes. UK-based users of Acorn *!Browse* have the 40-bit standard, but the full 'strong' 128-bit encryption is not available. *ANT@ Suite* and *Voyager Fresco* owners have been champing at the bit for any level of secure transfer. You can test the strength of whatever SSL version you may or may not have 'found', at a number of Web sites including the Harvard University FAS site at

<http://www.fas.harvard.edu/security/test.html>

Acorn User Awards 1995
Best product
runner up - PublishART

**iSV
Products**

Acorn User Awards 1995
Best business software
runner up - TableCalc

Acorn User Awards 1996
Best network software
runner up - SerialNET

Tel 01344 455769 email atimbrell@aol.com
http://members.aol.com/isvproduct/

Acorn User Awards 1997
Best graphics software
Winner - DrawWorks2

**DrawWORKS
Millennium**
DISM MOBBKE

Designed for the real world
© ISV products 1999

**Have you tried DrawWorks SE
on the cover disk yet?**

**Want more features?
Then get DrawWorks Millennium
at only 75% of the normal rrp**

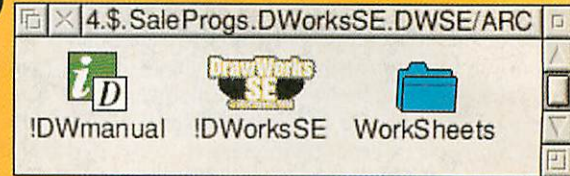

**Normal Price
£61.50**



**Offer Price
£46.50**

"...the best software...excellent...really makes a complete package...this is the right purchase." Acorn User

"...a Vantage beater..."
Christopher Jarman

"...the best new CD-ROM for RISC OS that I've seen for a very long time...extremely useful...this is the company's best value product to date. Buy it without hesitation." Risc User

"...convenient and user friendly...very effective...superb value for money."
Acorn Publisher

**DrawWorks Vector/Bitmap graphics package
Over 2100 superb outline fonts
Over 1000 pieces of high quality clip art
Mr Clippy clip art manager
Dr Fonty font editor with PC expert
Over 420Mb of applications & resources**

**Over £150 worth
of software on 1 CD**

OTHER AMAZING HALF PRICE SPECIAL OFFERS ON CD-ROMS

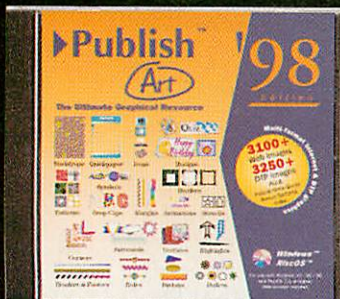

Over 6000 graphics
for both PC and Acorn
computers on CD

**Original RRP £31.50
SALE PRICE £16.50**



Over 2100 fonts &
loads of font related
utilities on CD

**Original RRP £31.50
SALE PRICE £16.50**

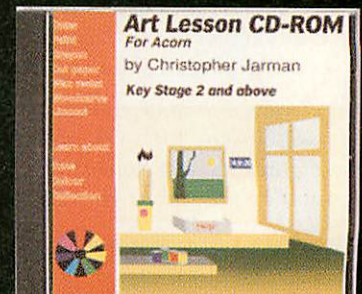

The complete guide to
painting, drawing and
more on CD

**Original RRP £21.50
SALE PRICE £11.50**

All quoted prices (unless stated)
are for single users versions only.
Special offers relate to single
user versions only.

Overseas orders please add £2.00 carriage
All details correct at the time of going to press E&OE
NDT & Typography are trademarks of ISV Products. All other trademarks are acknowledged
This advert was produced using NDT fonts
and DrawWorks Millennium

**iSV
Products**

iSV Products
86 Turnberry • Home Farm
Bracknell • Berks • RG12 8ZH
Tel 01344 455769

Graphics back

Well, after a break of a few months, the graphics page makes a welcome return to *Acorn User*, with a new column editor at the helm. In fine tradition, I'd like to start things off with a brief introduction to myself. I'm Andrew Green, RISC OS user and graphic designer, in that order.

I run a graphic and Internet design agency, *Article Seven*, based almost entirely around an antiquated-but-lovely Risc PC machine. I'm not alone in doing this – it's always refreshing to hear of other graphic designers working with RISC OS equipment, many with great success.

The focus of my business is, admittedly, Internet design, meaning that for some tasks (CSS and Flash to name the primary two), I need to resort to using a PC. It's an uncomfortable experience: I find the RISC OS development environment second-to-

none, which is why I choose to only use alternative platforms when I absolutely *have* to.

Article Seven is just over two years old now, which I'd like to think constitutes proof that it is possible to run a professional graphics business without needing to be Macintosh-based. And, despite the loss of Acorn, I can't help

feeling that the next few years are likely to prove very interesting for RISC OS graphic design, with the eventual release of *Cerilica Vantage* and

Millipede's new *Imago* motherboard.

If RISCOS Ltd can secure a future for our operating system, engineering for hardware independency and the ability to use faster processors than the current StrongARM, the platform could well find a new niche in this very market, which in turn would be extremely good news for the whole RISC OS community.

user-interface for them. One example is *Vantage's* graduated fills. Most art packages allow fills to graduate from one colour to another, and some allow more than two colours to be used in the fill.

I've yet to see one that can perform such a blend using anything other than a straight line – except *Vantage*, which allows graduated fills to follow any curve you like, and radial fills to use shapes other than simple concentric circles.

Watch this space.

Cerilica Ltd

<http://www.cerilica.com/>

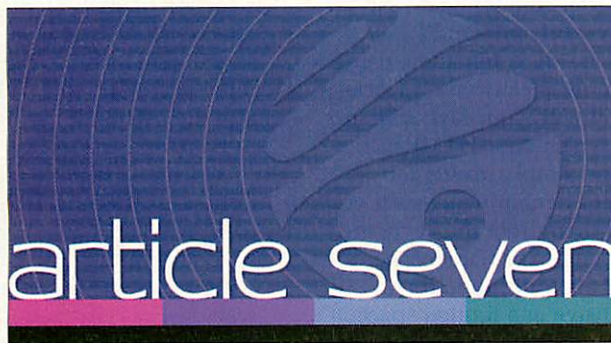

Vantage progress

It's painfully slow, but there are signs that a finished release of *Vantage*, the new vector art program for RISC OS, is finally on the horizon.

Pre-release copies have been available for some time now, but these lacked several key features which prevented the package from being truly comparable, in design terms, to its only real rival, *ArtWorks*.

Although many of the features promised by the application have been written and working for a while, it's apparently been a slow process to incorporate them smoothly into the package proper, and to provide a full

In brief

Publish Art

iSV Products have acquired the distribution rights to the *Publish Art* clip art library, following the closure of its previous distributor, *Smart DTP*. The library features over 15,000 images, in a variety of vector and bitmap formats (all RISC OS compatible, of course), and costs £20 for a single-user license. More information can be found on the iSV Products Website.

<http://members.aol.com/isvproduct/>

Print and publish

Micro Laser Designs have launched an electronic mailing list for those involved with, or interested in, printing and publishing using the RISC OS platform. The list covers many design-related issues that aren't necessarily specifically concerned with printed media, and has already found a comfortable niche alongside the likes of the *Photodesk users'* list and the *Ovation Pro users'* list. To subscribe, e-mail listserver@mld.co.uk with *subscribe print+publish* in the subject line of your message.

Your work here!

One of the most pleasurable aspects of RISC OS culture, for me, is the sense of community it affords. To that end, I'd be more than happy to mention any on-line portfolios of work any of you have – just e-mail me the URLs or write to the *Acorn User* office.

Similarly, I hope to be able to kick-start the *Pic of the Month* feature again: let's see those entries coming in. The prize of *Phantasm* is no longer available, so printed offerings will receive a £10 cheque instead.

Contacting AU

Andrew Green:
graphics@acornuser.com

HTML3

By far the most actively pursued aspect of computing these days is the Internet; The Global Information Super Highway. Sometimes however, Acorn users must be wondering why they seem to be stuck on the hard shoulder while Bill Gates' station wagon rushes past in the fast lane.

Luckily there are a great many enthusiastic RISC OS programmers writing Internet utilities and applications to make life slightly more luxurious for Acorn owners. Of course, the more people who become 'wired up', the more people think they'll have a go at producing their own 'home page' on the World Wide Web.

Some die-hard Internet boffins might argue that coding in raw HTML (Hyper-text markup language – the language of the WWW) is relatively straightforward and the only 'real' way to write web pages. It can however, be daunting to the novice newcomer and even some of the old die-hards can come unstuck when trying to remember the syntax of that elusive or obscure tag.

Although RISC OS users haven't gained the sophistication of large scale packages such as *DreamWeaver* or *PageMill* on other platforms, there are a number of excellent utilities to make life that little bit easier for RISC

OS web designers.

One such utility which deserves a mention is HTML3 by Richard Goodwin. Richard is a professional web designer – and like all serious programmers decided to write an application to make his job easier – thus the birth of HTML3.

The idea behind HTML3 is simple; It's essentially a macro inserter containing a vast library of useful and handily organised HTML commands. Being a macro inserter means that it works in conjunction with your favourite text editor (in which your HTML is written) and simply inserts the relevant tags or commands as if you had typed them from the keyboard.

It's difficult to explain all the features of an application this comprehensive in a limited space, but you'll find that just about every combination of HTML design is catered for, ranging from tables, form creation, links, image insertion, entity insertion and a comprehensive



selection of styles, fonts, colours and effects. There is also support for server side includes (SSI) management and third party addons – although Richard has thought of most options himself.

As can be seen by the range of options in the 'effects' window (below) – and this is just one of several comprehensive control windows – virtually every aspect of web design is catered for, including a range of preset functions to simplify complex effects.

The accompanying picture demonstrates two of the preset effects showing colour and size variations using a user defined sentence of text. The resulting raw HTML code is also shown in the larger *Zap* window.

A lot of HTML consists of shared routines so that you can combine different styles or effects from a common pool of pre-defined sources. For example, many of the text input fields are accompanied by a little 'claw' icon, allowing the text to be grabbed from other sections of HTML3 or from custom presets – such as your e-mail or web address.

The effects window.

HTML3 is a worthy addition to any collection of RISC OS Web design tools and makes an ideal mid-way complement between hand-designing Web pages using a text editor and some of the more powerful, but ultimately limiting, WYSIWYG page layout editors.

HTML3 is available to download from Richard Goodwin's site at <http://www.goodwin.uk.com/richard/programs/>

Tidbits update

As mentioned in the September issue, an impressive looking spreadsheet called *Isis* is being developed by Nicholas Marriott of Alpha Programming. As I write, a second RFC (Request For Comments) version has just been released. Nick has obviously been busily coding for the past few months because it has loads more features and options than the original version. Keep an eye on <http://www.alphapro.demon.co.uk/Acorn/isis.html> for updates.

Another useful little app I have permanently installed on my computer has recently been updated and is even nicer than the original is

MoonTool. This is a simple little application which displays the current phase of the moon in a small window.

It's a new moon as I write this. However, the latest version – updated from Eduoard Poor's original by Musus Umbra, aka Adny includes several new features, most notably the fact that the moon is now displayed from the correct viewpoint for the northern

hemisphere (Eduoard lived in New Zealand).

Download it now from <http://www.argonet.co.uk/users/musus/> and check out when the werewolves will start howling...

A screenshot of the MoonTool application window titled 'Phases (UTC)'. It displays a list of moon phases with corresponding moon icons and dates. The current phase is 'Last New Moon' on '11:09 11 Aug 99'.

Phase	Date
Last New Moon	11:09 11 Aug 99
First Quarter	01:47 19 Aug 99
Full Moon	23:49 26 Aug 99
Last Quarter	22:19 2 Sep 99
Next New Moon	22:03 9 Sep 99

AntUtils

One of the benefits of writing this column for *Acorn User* is that I can occasionally give myself a gratuitous pat on the back and take a look at one of my own applications. A lot of people ask me about this application so I thought it was time to explain some of the thinking that went behind it and to reveal some of the features that casual observers might have missed.

AntUtils originated from my wish to make the ANT Internet Suite (AINS) that little bit better and fix some of the shortcomings in the early versions. As I'm one of those eager people who tend to check e-mail about every five minutes while I'm online web browsing – in the hopes that someone might have sent me a message in the few short moments since I checked the last one, I initially wanted an application to automate this process and tell the suite to fetch e-mail every, say, five minutes and newsgroups every ten.

ANT's official recommendation at the time was to set up task alarms using the standard *Alarm* application but I disliked this because it was less than elegant and could sometimes throw up un-friendly errors if the

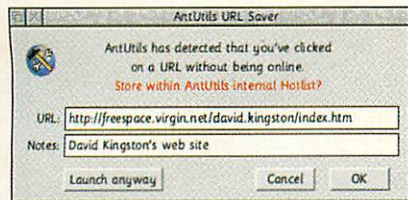

Help2

Another useful application to undergo an overhaul in the last month is *Help2* by Rik Griffin of Squeaky Software. This is a replacement for the interactive Help application originally supplied with RISC OS.

The biggest benefit over the original is that the help text is displayed relative to the cursor position rather than in a bulky window. This works in a similar way to the Windows help system on "computers that we don't talk about". Again, loads of options allow you to set it up exactly how you want, changing the font style, size and background colour.

One very useful feature is the ability to filter out help requests from common applications such as *Zap*, Filer windows or any other application that you're familiar with. This makes it much more appealing to people who want the occasional help on more complex applications while avoiding the irritating message that pops up when you're trying to type some text into an editor window.

Help2 can be downloaded from <http://www.cheesey.demon.co.uk/help2.html>

As always, these and more RISC OS applications can be found by visiting my comprehensive RISC OS links page at <http://www.vigay.com/riscos/links.html>

ANT Suite wasn't actually loaded when it decided to activate the task alarm.

Over the following few months it evolved into a general purpose application to handle anything I thought was remotely Internet-related – as can be seen from the choices window:

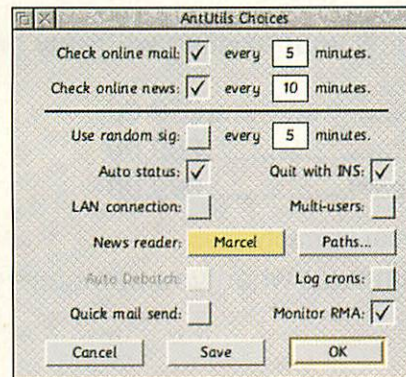

This is far removed from the original version which only had the two options for checking mail and news. It can now work across a LAN, automatically quit itself when the AINS quits, work with *Pluto* as well as *Marcel* and even attempt to fix some of the DLL crashing problems that early versions of the AINS suffered from.

The current version is also capable of toggling on and off Javascript in the latest version of *Fresco*, as well as altering *Fresco*'s identification text in an attempt to fool "designed for Microsoft Explorer" Web sites into

allowing access to RISC OS users.

I've also added a feature for quickly creating an HTML page containing graphics images in a specified directory as thumbnails. I've tried to make the whole thing as flexible as possible – simply because I know most people like to tailor their Internet requirements to their individual needs.

Another criteria for the application was to make it as small as possible so that it can still be used on older machines with only 4Mb of memory. When I have needed to increase the wimp slot size to accommodate a new feature, I've usually added several other new features as well so as to get the best 'value for memory', so to speak. One of the newest features (and one, with hindsight, I don't know why I didn't add ages ago) is the ability to enter some text and *AntUtils* will automatically launch *Fresco* to take you to any of up to 15 different (user definable) search engines on the Internet.

Another new feature is what I call "URL capturing when offline". Basically this allows *AntUtils* to intercept a click on a URL, perhaps in an e-mail message, when you are offline and give you the option of storing it for later examination or to attempt to load it anyway (just in case you visited it just now and it's been stored in *Fresco*'s cache).

Although most of *AntUtils*' features are customisable from the choices window, more advanced users can edit the 'messages' file within *AntUtils* itself. This will allow you to edit things like whether or not you can have multiple copies running, the action of the select and adjust buttons on the icon bar, whether or not to perform an immediate news or e-mail check as soon as *AntUtils* is loaded, or a host of other lesser used options.

No doubt by the time this issue hits the shelves I might have added yet even more features, so whiz along to <http://www.vigay.com/riscos/comms.html> to download a copy – and get those suggestions coming in if you have any more ideas that I may have missed out.

Contacting AU

Paul Vigay:
pdpage@acornuser.com

Reflex

Electronics

The Official Service & Support Centre for all Acorn products

Extended Warranty

Purchase extended warranty or renew your existing warranty on all Acorn computers.

<i>A7000 and monitor (one year)</i>	£59.00
<i>Risc PC and Monitor (one year)</i>	£89.00
<i>S.A. Risc PC and monitor (one year)</i>	£99.00

Reduced rates available for 2nd and 3rd year warranty

Free inspection / service of your computer when you purchase our extended warranty.

Acorn Repairs

<i>Acorn Computer repairs from</i>	£70.00*
<i>Monitor repairs, prices from</i>	£45.00

We also offer part exchange on Acorn computer PCBs and PSUs (ask for prices)

*includes BBC Bs, Masters, A3xxx series, All Archimedes, A4, A4000, A5000, Risc PC & A7000.

Acorn Original Spares

We are the sole UK authorised distributor of Acorn Spares.

<i>Acorn Original Mice (£ P.O.A A7000 mice)</i>	£15.99
---	---------------

We also carry spares of many other Acorn items, such as Power Supply Units, Floppy drives, keyboards, master battery packs etc..

Please call 01438 317200 for a full price list or to place spares orders.

All prices exclude VAT and delivery. E.& O. E.

All the Acorn Support you need...

Call now on 01438 311299, spares 01438 317200

***Fax 01438 311286 <http://www.reflexel.demon.co.uk>
service@reflexel.demon.co.uk***

Reflex Electronics Service Limited, Unit 18,
Gunnels Wood Park, Gunnels Wood Road, Stevenage, Herts, SG1 2BH.

DrawWorks SE

DrawWorks SE (DWse) is a bolt on addition to *Draw*, and is a cut down version of *DrawWorks Millennium*, iSV's professional level graphics package.

DrawWorks Millennium itself is reviewed on page 48 of this month's magazine, and in an effort to enhance

the review iSV were kind enough to provide this cut-down version of their software. This is a fully functional program, complete with saving and so on, but it is obviously lacking some of its larger brothers features.

DrawWorks Millennium is supplied on CD and is over 420Mb in size, so I

didn't have much hope of squeezing on the cover disc, even with the help of ArcFS. If you have RISC OS 3.5 in your computer please note that *DWse* cannot be used on your machine. *DWse* can however be used on RISC OS 3.1, 3.6, 3.7 and of course RISC OS 4. The full version (*DrawWorks Millennium*) can be used on RISC OS 3.5 with no problems).

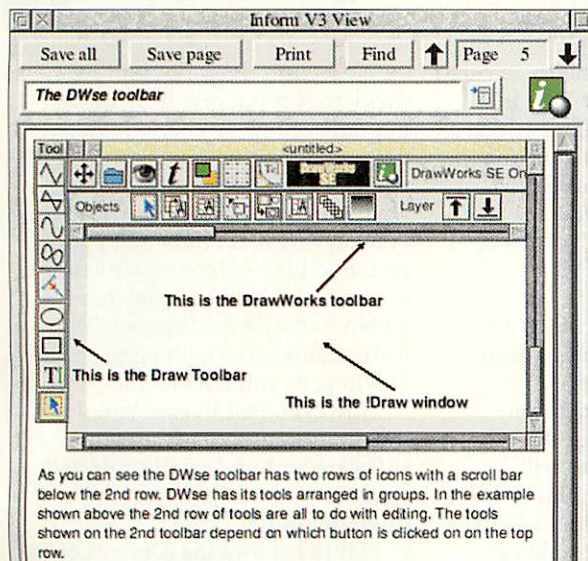

As you can see the DWse toolbar has two rows of icons with a scroll bar below the 2nd row. DWse has its tools arranged in groups. In the example shown above the 2nd row of tools are all to do with editing. The tools shown on the 2nd toolbar depend on which button is clicked on on the top row.

If you try clicking on a tool on the bottom row character with a small text icon you will see two tools next to the equivalent to Draw's 'F'.

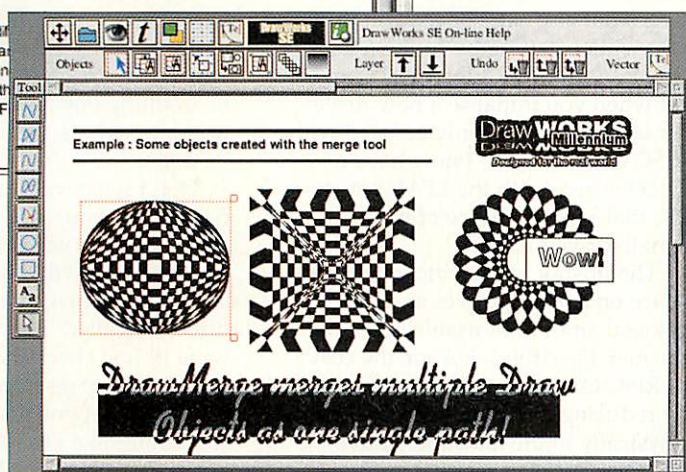

ArcFixer

This program, by Paul F. Johnson, is really for people who do most of their Web downloading on a PC. Some Websites still use the standard Acorn extensions for archives such as .spk and .arc. While these cause no problems for Acorn browsers, it's a different story on most PCs.

When IE or Netscape hit these extensions, they normally download to the screen a pile of gibberish which can't be dearchived.

This small command line program fixes these gibberish files into something which *SparkFS* (and presumably *ArcFS*) can handle. Just download the archive and save as text - very neat



Disc information

The software on the cover disc has been compressed using *ArcFS 2* from VTi, and are opened by running a copy of *ArcFS* then double-clicking on the archive to open it. There is a copy of *ArcFS* on each disc. Most software will run straight from the archive, but some programs may need to be copied out of the archive before being run, uncompressing them in the process. Any program that saves a file to disc, for instance, will be unable to do so into the archives on the disc.

Faulty disc?

If your disc is faulty, test whether it will verify by clicking with Menu on the floppy drive icon and choosing Verify.

If it fails to verify or is physically damaged you should return it to Acorn User, Media House, Adlington Park, Macclesfield SK10 4NP.

The *Acorn User* cover discs have been checked for viruses using *Killer* version 3.001 from Pineapple Software.

It was almost a year ago that I first road-tested the emerging RISC OS 4, and now the world is a very different place – even the sprites have changed. After so long a gestation period just how well does RISCOS Ltd's offering hold up to the original Acorn (RIP) promise? From my point of view the answer is very well, in fact better than expected.

Every upgrade has its problems and yet even though I've only been using the new OS for a month now, from the start I would not have gone back to the old system – this one is just too good not to use all the time. This article is not a review of the product as that is too big a task. This is a guide to getting going and why it's a good idea to do so.

The task of upgrading the chip set is similar to, but less problematic than that of installing and setting up a new StrongARM processor. The procedure is as complex but it's less likely to fail, so if you managed the StrongARM upgrade by yourself you can expect to handle this too.

A few questions

Do you have a CD-ROM drive? All the software is on a CD and so without one you won't get anywhere. CD-ROM drives can be had for £30 or so, which means that

A new disc

Choose your new drive with care, it is probably a good idea to avoid Western Digital drives as they have had problems in the past coping with earlier RISC OS filing systems.

As far as I am aware any other type of IDE drive will do. I know little of SCSI drives, but IDE is far less expensive, is what the machine uses normally and it is very fast these days.

The installation CD comes with a new version of *HForm* which gives the option of using long filenames. Harddisks always come pre-formatted and so you only need to use the 'Initialise' and not the 'Format' option to get them going – even when changing the settings.

For large drives enter 999999999 or larger for the number of cylinders as there is still a bug in the software which RISCOS Ltd does not have the licence to fix as yet. If you just accept the default numbers which *Hform* gives you then you will 'only' be able to format drives up to 7Gb or so.

Steppi the

now would be a good time to get one or even upgrade to a 48X speed device. (Though these fast drives do tend to whine and take longer to get up to, and slow down from, their top speed). Speed is not a problem for the upgrade task however, my 2X speed drive had no trouble at all.

Do you want to use long file names? Here you have a choice about the answer. The new Filer in RISC OS 4 can do many things which adds on to what OS3.7 has done for years and at first it may look as if this is all OS4 can do, but there is a new and massively powerful feature in the Filer which is not obvious unless you know about it.

New RISC machines, post OS 3.5, can use large discs (very large discs), but not at anything like high efficiency. In the September *Acorn User* I talked at length about the LFAU and how the old Filer will allocate a larger and larger chunk of disc to a file as the size of the drive increases – a function which almost wipes out any extra space you think you will be getting by fitting a large drive. In RISC OS 4 the LFAU can be set when you initialise a new drive for use (it can then only be used with RISC OS 4 though). I now have a 17.2Gb drive with the LFAU set at 2K, that is half the size of most 'small' drives' LFAU.

The upshot is a terrific increase in space on existing drives and a colossal amount of usable space on the new big drives. For me the cost of RISC OS 4 is covered twice over by reducing the number of drives physically in the machine. I have even been able to remove my backplane – thus further reducing the load on the power supply and increasing its life expectancy at the same time.

Starting work

As with the StrongARM upgrade the software side of the upgrade must be done first, but before doing anything, check that your system already works perfectly. If the machine has problems before the upgrade it is

tricky to sort out pre- from post-upgrade errors. To check that there is nothing wrong with your hardware you can simplify matters by doing what the install program will do for you anyway and remove *all* your favoured boot-up configurations and everything which you may have added to the Tasks directory. The instructions leave nothing to chance – as long as you read them.

However, just in case you don't, it is important to back up your software and un-install protected programs before you start the upgrade proper.

Figure I shows the contents of the CD. Double-click on *!RO4INSTAL* and you will see the window below which is self-explanatory and should be examined by any PC Windows upgrade writers to see how it should be done.

Don't whatever you do put the contents of your task directory back yet. If you did not remove them yourself they will have been moved anyway and placed in a new directory called *'InactiveRes'*, so don't wipe it! Just check that everything still works by resetting the computer, for a moment you should see something like Figure I, next turn off again. The big shock here is the new start up screen. Acorn is dead, Pace live. Assuming all is well it's time to

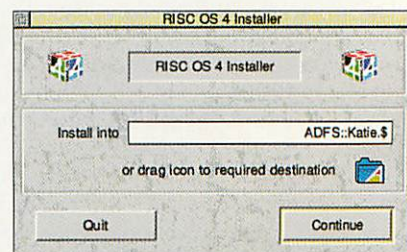

ng up pace

Simon Anthony installs RISC OS 4

do the hardware mods.

Another big shock was seeing my first set of Flash ROMs. These are nothing like the ROMs of old, being so small that they need a daughter board to get the pin-outs of the chip to fit the old holes. The chips themselves stick out at the left-hand end of the boards, (you get two of them).

However, by the time you read this, it is quite possible that the next batch of chips will be the normal large beasts which look like the RISC OS 3.x chips we already have. The first release of the chip-set as Flash ROMs comes with a StrongARM Compatibility sheet. This small print A5 single page holds dark secrets which may cause a good deal of hair

pulling and may even result in a phone call to the extremely helpful OS4 help line. In essence it warns that the Flash ROMs can cause 'instability in the system'. Nah I thought and popped them in, and it didn't work. My machine hung-up even before booting, showing a solid green screen. I didn't think that my system was overly loaded with hardware add-ons as the warning sheet hinted, but it turned out that my old CD drive did something odd to the power lines which the new chips didn't like. Other culprits could have been 'high speed' PC cards, large chip count

memory boards and some combinations of podules and backplanes.

Removing one of my two 32Mb SIMMs also cured the problem and allowed a full boot with the CD-ROM installed, but I'd rather have 64Mb so I took off the CD for the moment and put the second SIMM back. My SIMMs are not matched, which, had they been, would probably have avoided the problem.

If you have decided to use the new filing system facilities then you'll probably want a new, larger harddisc. Before charging off to get a new drive please note that there is a hidden problem with RISC OS 4's massive ability to handle files, and that is your problem of finding them.

PC users have had to cope with this for a long time and I don't think they have a good solution yet. RISC OS users have had fewer files until now and have also had a decent Filer to find them with, but now I fear finding one file in a directory containing hundreds will irritate a lot of people. Anyway, this is a solvable problem with care and planning, and so I would firmly suggest getting a new drive. You can put the old one in your old Acorn and give it to the kids – once you have transferred the data that is.

After fitting the chips you are told to do a Delete-reset. This will also reset the clock, oddly to 1995 as did OS3.7. Don't forget to reset the clock to 1999 or all your new directories

CDF\$::RISCOS4.\$					
CONTENTS	WR/	1834	Text	14:56:11	19 Jul 1999
Y2K	/		Directory	14:12:52	18 Jul 1999
XTRAAPPS	/		Directory	14:12:47	18 Jul 1999
RECOVERY	/		Directory	14:12:44	18 Jul 1999
PLUGINS	/		Directory	14:12:40	18 Jul 1999
IMAGES	/		Directory	14:04:37	18 Jul 1999
FREESOFT	/		Directory	13:54:00	18 Jul 1999
DISCIMAGE	/		Directory	13:53:28	18 Jul 1999
3RDPARTY	/		Directory	13:53:26	18 Jul 1999
!RO4INSTAL	/		Application	15:57:11	09 Jul 1999



Figure 1: What you get after installing RISC OS 4

and files will be five years old. In-depth reviews of the new facilities of RISC OS 4 will soon be published, but with luck you should have your own set of chips in and working by then. I urge you to do so, order now to shorten the wait for a noticeably faster, even more responsive, feature packed and, most importantly, stable and intuitively usable computing tool.

END

Contacting me

Simon Anthony
sranthony@innotts.co.uk

Reflex Electronics Ltd have had close links with the Acorn market since their foundation in 1995. The Stevenage-based company was originally set up as a manufacturer of printed circuit boards for the electronics industry. David Hughes, former production engineering manager at Acorn, founded the company along with Iain Dacre, an expert on the workings of the financial world who had spent a number of years working overseas.

After about a month, the two founders were joined by David Lumley, another ex-Acorn employee who had been responsible for quality control and also repairs, both in and

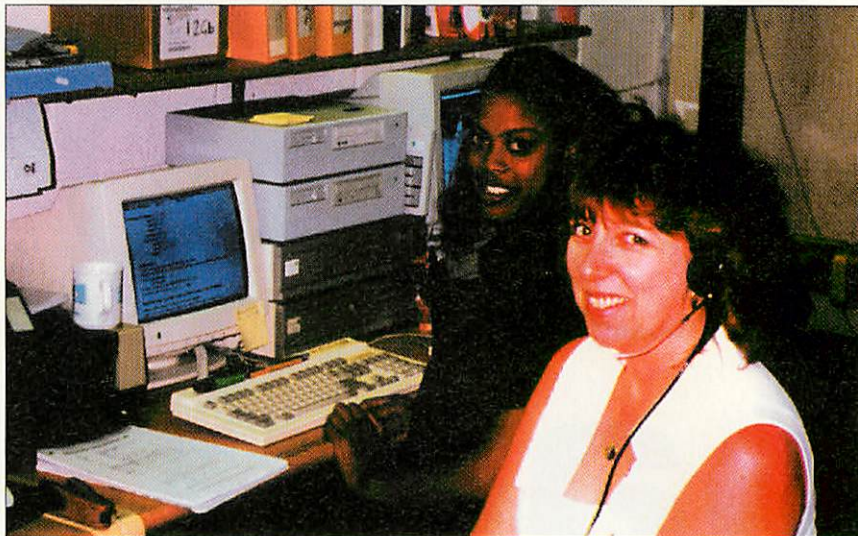

Reflex

*Alasdair Bailey
acts on reflex*

out of warranty. David brought with him considerable expertise at a time when Acorn were looking for someone to really take control of the servicing/maintenance side of the operation.

The servicing side of Reflex started out in a small area of the manufacturing unit, but within three months the decision was made to take over the neighbouring building and form a dedicated service company. Service and repair quickly became a large part of the Reflex Electronics Group's business. Numerous Acorn staff moved over as Reflex's relationship with Acorn bore fruit and more and more warranties and on-site service contracts were administered by Reflex.

Who?

Reflex Electronics Servicing are perhaps the best kept secret of the Acorn world. Prior to 'Black Thursday' last year, almost all of their

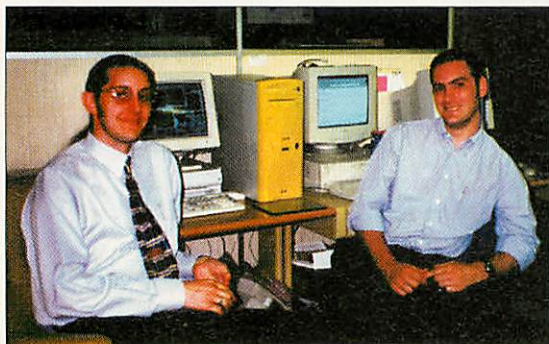

action

servicing/repair work was carried out under contract with Acorn. This meant that when Reflex answered a call with regard to honouring an Acorn product warranty, they would answer as if they were Acorn, so the customer would often have a fault fixed without even realising they were speaking to Reflex rather than Acorn themselves. This sort of system is common in industry and still goes on with the 'Computers for Schools' support line which is manned by Reflex.

In the early days, Reflex mainly serviced the Acorn-badged Olivetti JP360 printers and A4000 power supplies. However, Acorn's "wise" decision to use the Liteon AKF18 monitors with the A5000 series meant that Reflex were inundated with repairs.

A modification was eventually sanctioned by Acorn which was then applied by Reflex to all faulty monitors that came through the door. Some of you will no doubt

remember these notorious models which were plagued by dry joints that heated up and often caused smoke to rise from the back of the monitor.

Today, more than 30 people are employed at the Stevenage site, which is currently being modified to include a reception area along with improved communications between the two adjoining units. During busy times, the company receives up to 30 calls an hour which are all dealt with by four dedicated personnel.

Some may wonder why Reflex are located in Stevenage when they had such strong links with Acorn. The reason is simple: both founders lived in Stevenage so it was really the only sensible option.

At one point relocating the firm in Cambridge was considered but when the factory unit next door became available there was no longer any need to move. Besides, some ex-Acorn people found a 15 mile journey into Cambridge took far longer than the 40 or so down to Stevenage. Acorn's decision to abandon the desktop market will not

really be felt at Reflex for a couple of years yet. The warranties and on-site support contracts which Reflex deal in are mainly done on a two, three or five year basis which gives the company plenty of time to find a new direction if need be. However, Reflex do remain committed to the Acorn market. They have taken on all the spares formerly stored at Acorn and are now offering to repair Acorn kit directly, rather than through sub-contracts with Acorn.

David Lumley, Operations Director at Reflex was keen to stress that they would be continuing to support the market place, "We're all still Acorn people" he remarks during the interview.

Reflex are indeed true Acorn people, the company is still run using RISC OS software for all

manner of applications, including day to day word-processing needs along with the comprehensive customer database and goods in/out system.

However, two PCs are in use but only in the accounts department and spares stock keeping where, unfortunately, the required software just isn't available for RISC OS.

Reliability

The old adage that Acorn kit is more reliable than the PC alternative is backed up by the experiences of those at Reflex. A brand of PC, which Reflex recently carried out warranty repairs to, showed a failure rate of about 10%. Compare this to a failure rate of only about 2% with the A5000 series once the monitor problem was remedied and you can see why some

schools just keep on using their old Acorn kit.

David Lumley has a theory which goes towards explaining this observation: "The thing about an Acorn machine is that when they're put together they go through what's called 'DRAT testing' – (Design Reliability Assurance Testing) where all the components have to go through vendor approval, and units were tested in an environmental chamber where they would be subjected to drastic changes in temperature and humidity.

"With a PC, a bloke will buy that power supply for it one week but he'll change his supplier next week...they never have the design reliability testing, so it's obvious Acorn machines have to be more reliable."

David Hughes, managing director, continues: "As a manufacturing site, we were never allowed to change any of the components without permission from Acorn – in fact the test software was designed so it would throw it out".

He goes on to describe how Conner once changed the firmware on one of their harddisc drives without changing the revision number on the outside. This resulted in the test software saying an unknown drive had been fitted and rejecting them.

Another reason cited for the reliability of Acorns is that the operating system is completely housed in ROM. On a PC, meddling children or poorly written software can easily mess things up in the Windows registry and the like. This means that many of the problems with PCs are purely software issues.

It must be a pain for a repair company to be working with such a reliable product, during the interview someone joked "We wish

Caring for your computer

When sending in an item for repair ensure that it is packed securely – not in bin bags.

No display on monitor? It sounds silly but before raising the alarm, make sure you've done the following:

- Check that no leads have become disconnected;
- Check settings on the monitor, changing contrast to one extreme can reduce display to a blank screen;
- Restart the computer with the shift-key held down;
- Restart the computer with the delete-key held down;
- Try a different monitor on computer if available;
- Try the troublesome monitor on another computer;

Computer asking you to insert a disk that was used during the last session?

Before saving a Desktop boot, make sure the computer hasn't seen any media that you don't want it to remember on subsequent boot-ups. A safe procedure to prevent this is to restart your computer before saving the desktop boot.

Computer crashing on boot-up?

Check the following:

- Turn on with the shift key held down, OK this time?

Y: Something loading from *!Boot* sequence is causing a problem, remove files/commands until the problem goes away. Perhaps run *!ResetBoot* after backing up your existing *!Boot* structure.

N: Hardware problem, turn on with the delete-key held down – OK this time?

Y¹: Re-boot computer for a second time – OK this time?

Y²: Your computer is now fixed.

N¹: something in the boot sequence (not necessarily within *!Boot* itself) is changing the CMOS and the computer doesn't like it!

N²: Hardware problem. Send to Reflex for repair.

If experiencing problems with RAM recently added to your machine, verify with the supplier that the specification of the RAM is correct for the computer (as detailed in the Welcome Guide).

Computer locks up when deleting/copying files on an IDE harddisc formatted larger than 2Gb?

- Configure ADFSBuffers to 0K. If this doesn't fix the problem, format the harddisc again with version 2.50 of *!HForm*.

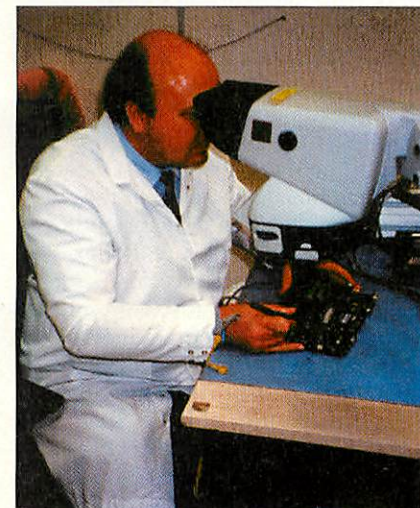

they weren't so reliable!"

So, we know that Acorns are very reliable when compared to your average PC. However, experienced users also know that there have been plenty of common faults in the hardware over the years. The problem described earlier with the AKF18 monitors must weigh-in at number one, with various power supply unit problems following a close second.

The early Risc PCs featured a mere 70 watt power supply in the base model, this was not quite sufficient once users started to add extra drives and expansion cards. Furthermore, a faulty diode meant that Reflex saw these machines come flooding in for repair until Acorn standardised on the higher power unit.

Acorn also benefited from the partnership with Reflex. On a monthly basis, a report on the top ten causes of failures was sent back to Acorn in order for them to consult their suppliers and manufacturers and see that problems were rectified. One example of this process working well was the problem which early Risc PCs suffered whereby a part in the hinge on the door flap was too weak and often snapped. This was promptly rectified by Acorn who changed their moulding in order to beef up the offending component.

Not just Acorn

Almost since the start, Reflex have been looking after more than just Acorn kit. Most of the other support contracts have in fact stemmed from their dealings with Acorn. For example, Reflex coordinates all technical support for Tesco's Computers for Schools venture. Their work with the Acorn-branded monitors has resulted in warranty repairs on Iiyama monitors whose UK arm is also based in Stevenage.

This extra business should ensure that Reflex are able to continue supporting the Acorn/RISC OS range for some time to come. With the future now looking quite bright for RISC OS based hardware, Reflex were in negotiations to offer technical support to RiscStation Ltd as well as having their engineers trained in fitting the RISC OS 4 upgrade.

Those in charge at Reflex seem to share the opinion that RISC OS as a platform will be with us for some time to come: "So long as everyone

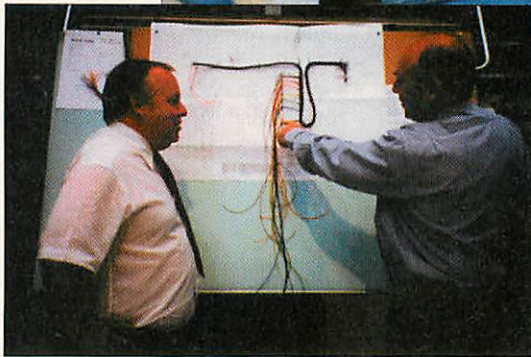
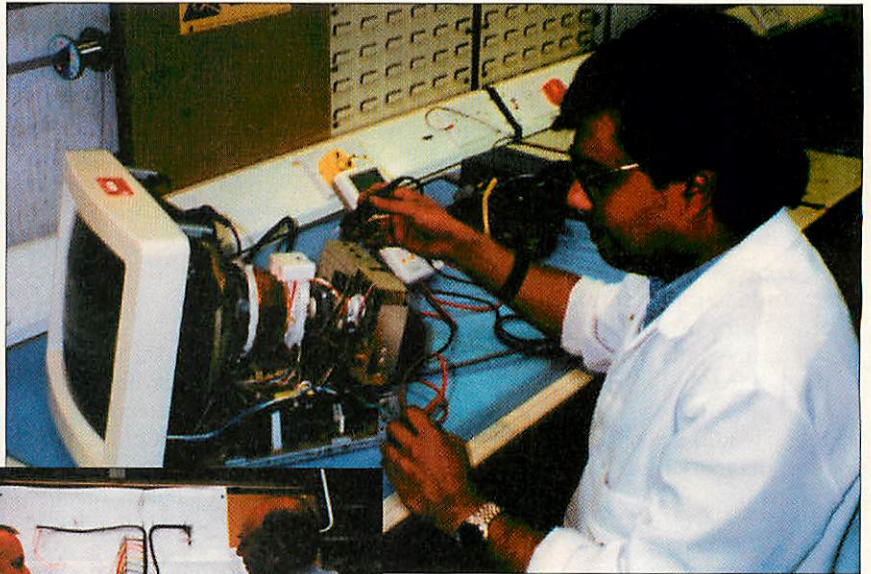

who is really interested gets behind the manufacturers, why not? We don't have to sell millions of computers all round the world, we're not going to beat Bill Gates and his PC market, but I believe there's a strong enough contingent and enough applications out there for RISC OS to have a reasonably bright future".

During my visit, Iain Dacre, Commercial Director, was arranging for a new telephone system to be installed. It's worth pointing out that the company were doing their utmost to avoid using a touch-tone-based call handling system. Iain commented that he felt they were very impersonal yet nobody seems to sell the traditional systems anymore.

This policy is sure to win custom, there's nothing worse than calling to see how a repair is going and coming up against a brick wall of "Press 1 if your computer won't turn on... Press 2 if your monitor is on fire...".

Strange fixes

During their short history, Reflex have come across many strange objects inside machines. Two notable examples are a packet of mints which had perhaps been left in the case on the production line and also some primary school playing cards which a child had posted into a floppy disc drive! Some customers' apparent lack of care for their computers also strikes the staff at Reflex from time to time. Occasionally, machines will be sent in packaged only

in a bin bag, hardly sufficient protection for a piece of kit that's worth over a grand. Certain users attempts to upgrade their computers also provoke concern amongst staff; an 8Mb RAM upgrade for an A5000 was once seen held in place by huge amounts of hot-melt glue.

Reflex are often willing to give out free advice even if it doesn't result in your computer coming in for a repair. Take their Website for example, it contains plenty of information on diagnosing and fixing problems which is unavailable elsewhere. The company were also willing to let us include hints for good computer care in this article, some of which can be seen in the panel.

Hopefully, the Reflex Electronics Group will continue to grow and fly the flag for RISC OS kit in industry for many years yet. Following Acorn's withdrawal from the market, Reflex are now more than willing to handle individual repairs out of warranty, as well as administering and auctioning existing warranty commitments under the Acorn name. It is worth pointing out though that your local dealer may also still carry out a range of repairs. Many thanks to all the people at Reflex for their cooperation and assistance in writing this article.

END

Company details

Name: Reflex Electronics Group Ltd.
 Address: Units 17/18 Gunnels Wood Park, Gunnels Wood Road, Stevenage, Herts. SG1 2BH
 Tel: 01438 311299
 Fax: 01438 725158
 E-mail: support@reflexel.demon.co.uk
 Web: http://www.reflexel.demon.co.uk/



THE DATA STORE

Serving the RISC OS community

Authorised Installer

The first major event of the post-Acorn world, RISC OS 4 is now shipping. Compatible with RiscPC and A7000(+), it provides a whole host of improvements for the new millennium plus great new bundled software! Stand up and be counted as a supporter of our favourite operating system – place your order today!

£116.33

plus £25 fitting and data transfer if required



SIBELIUS

THE MUSIC NOTATION SOFTWARE

The Data Store now provides the official Customer Support service for Sibelius Acorn programs.

To celebrate this, we've reduced the price of Sibelius 7 and we're offering one year's technical support free with every copy sold up to 30th September.

Our specially priced PCs for Acorn Sibelius users moving to Sibelius for Windows are still available. Please call for details.

Junior Sibelius!	£ 55.00
Sibelius 6	£105.00
Sibelius 7 Student	£320.00
Sibelius 7	£525.00
Optical Manuscript	£275.00
Sibelius for Windows/Mac	£595.00



We stock copies of Acorn User and have various back issues dating from April 1998 onwards priced £3.95 or £4.20. Please contact us for availability.



Just a few examples of the effects that FontFX 6 can produce...

FontFX **FontFX VERSION 6**
Border effect Grow and shrink feature

FontFX
User-definable shadow length and direction

FontFX **FontFX**
Rainbow fill option 3D shadow effect

For further details or to download FontFX Lite, please visit our web site

£31.95 inc. VAT and postage
Site licenses and upgrades available
Please phone for details

Connected to the Net?
Then why not visit us online?

THE DATA STORE *Online*

Company information, directions to our showroom, contact details, information on the range of Data Store Software, online price lists, downloads, Sibelius Software information and lots more...

POINT YOUR BROWSER TO...

<http://www.datstore.demon.co.uk/>



6 CHATTERTON ROAD BROMLEY KENT BR2 9QN

Telephone (020-8) 460 8991 • Facsimile (020-8) 313 0400

Web <http://www.datstore.demon.co.uk/>

Email info@datstore.demon.co.uk

(all prices in this advertisement are inclusive of VAT at 17.5%)

3D splendour

Part I of Max Palmer's *TopModel2* review

TopModel, the 3D modelling application from Sincronia, has been around for a number of years. While the development of many applications of a similar vintage has long since ceased *TopModel* has continued to evolve and promises to do so for a good while yet. Given this state of change and the length of

time since it was last reviewed, now seems an appropriate moment to revisit this elegant, graphical workhorse.

While one of the application's strengths is its innovative approach to modelling, it is also, paradoxically, one of its weaknesses. The user interface in the original version of *TopModel* was cluttered, hard to get to grips with and restricted the user to 16 and 256 colours. *TopModel2* brought a vastly improved look and feel. However the interface still breaks many of the rules laid down by the RISC OS Style Guide.

As a result of this maverick approach many users, while wooed by *TopModel2*'s power and elegance, have struggled to get the most from the software and expressed a desire for a series of tutorials to help them get started. Indeed, it was one such posting on the *TopModel* mailing list a few months ago which, by way of the weird and wonderful fashion in which electronic-based discussions seem to wander, prompted the idea for a series of tutorials in *Acorn User*, the result of which are set to grace these pages over the next few months.

But before we begin the series, I would like to take those RISC OS users, both new and old, on a guided tour of *TopModel* in the hope that I might whet the appetite and fuel the thirst for the third

dimension. The latest, publicly available version of *TopModel2* stands at 2.14c, the one reviewed here.

Improvements over previous releases include new transparency options, extra keyboard shortcuts, flat shaded movement mode, the ability to save resources and scaling options on multiple copies, among many others.

Existing users may upgrade older versions of *TopModel2* for around £30, alternatively they can acquire a 'free' upgrade to 2.14 when they buy the latest plug-in - *TopFonts* - which ships on CD-ROM. The latter costs a shade under £60 and is pretty much an essential purchase if you need the capability to produce 3D text, albeit with some restrictions (which I shall discuss later).

As yet, the only other plug-in that is available for purchase is *TopDeform*, which provides a number of different methods of distorting meshes. However, as some of you who went to the Wakefield Show might already know, *TopBones* and *TopAnimation* are coming along nicely and should hopefully be with us in the near future.

Out of the box

Installation of *TopModel* is now, thankfully, much easier than it once was. Gone are the days of the horrendous Gordian protection system, which caused many users havoc, especially when upgrading. In its place stands a much more logical installation program. Just double-click on the program to start, type in your name, drag the directory icon to the location you wish to install *TopModel* in and then click *install*.

In addition, *TopModel* comes with a utilities disc, this provides a number of very useful stand-alone programs to convert *TopModel* files to and from other graphics formats, plus with a few example files. Finally, the resources disc provides extra example

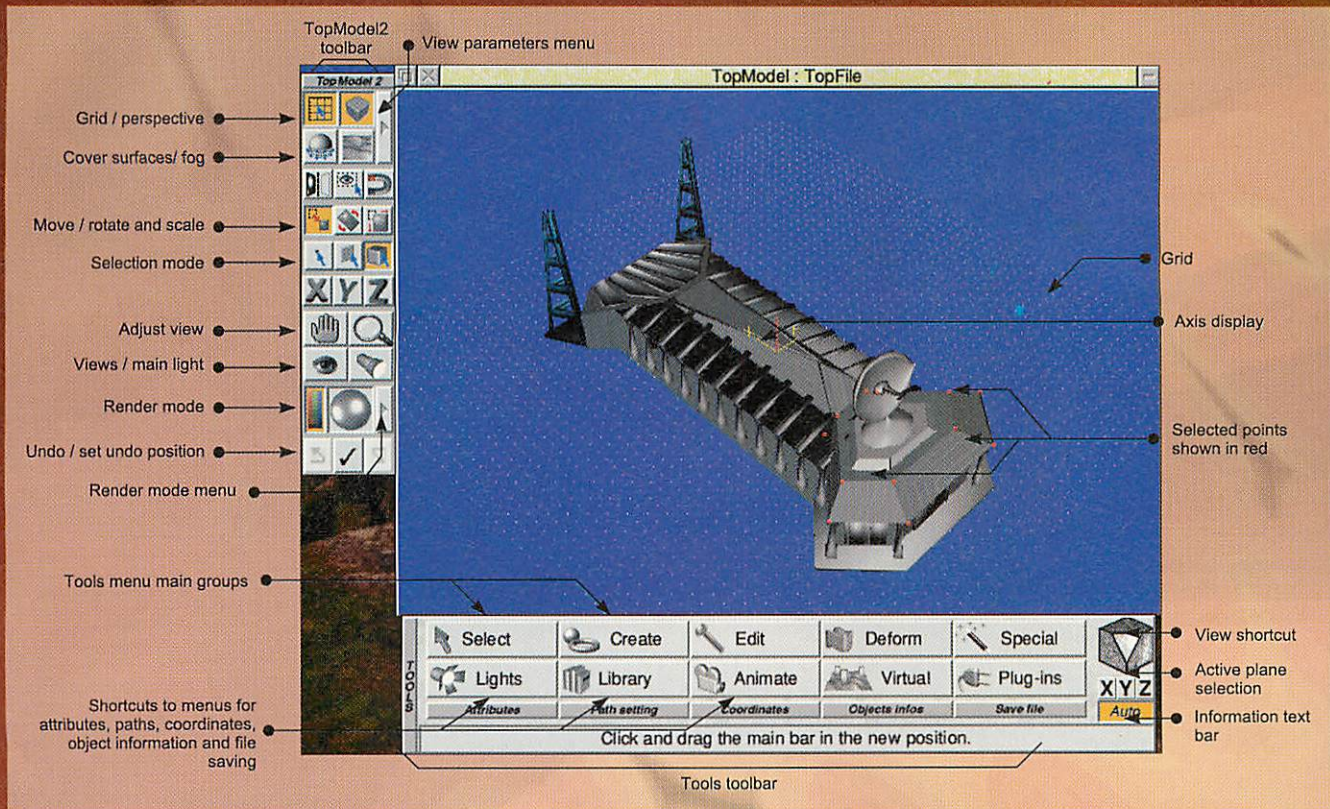

Figure 1: TopModel2's user interface

files and three tutorial scenes.

In addition to the above, *TopModel* ships with a manual. While the manual is fairly comprehensive at 120 pages, including sections on each of the tool groups and a step-by-step tutorial, it suffers from being written by a non-native English speaker which makes it hard to follow in places.

This is unfortunate since the operation of some of the more complex tools is difficult to explain and I would urge Spacetech or Sincronia to consider revising a number of sections to improve the flow and clarity. The manual *has* been updated since the first release. If you're still struggling with the first edition contact Spacetech to get an update.

On launching *TopModel*, you are presented with the memory setup window which prompts you to configure the amount of memory that is reserved for storing points and polygons. Once done, the main *TopModel* application springs to life, installing itself on the right hand side of the iconbar and presenting a single pane with two toolbars, one below the pane and another to the left, reminiscent of *Artworks* (Figure 1). It is worth noting that the main pane has no window furniture for resizing or scrolling the work area, however, the size of the main window may be changed by dragging the bottom and right-hand edges of the window.

While this approach is a bit unusual for a RISC OS application, once you get used to it, it works well. If the default style and layout doesn't meet with your approval, you may adjust a number of properties of the application, for example the background colour, using the preferences window – accessed from the iconbar icon menu. These preferences may be saved as the defaults for future sessions. Unlike

many other three dimensional modelling applications, *TopModel* provides only a single view of the scene being edited.

In most packages three or four simultaneous views are displayed, namely two orthogonal elevations, a plan view and an isometric view. While the *TopModel* approach may seem a bit daunting at first, it works well and provides a more natural modelling environment, you can

Breakdown of tools toolbar groups.

- Select:** Provides a number of modes by which selections can be made, including selection by colour, point or primitive. Also contains tools for creating and arranging groups.
- Create:** Tools for creating basic objects and primitives.
- Edit:** Supplies tools for manipulating objects once created. Tools for copying, mirroring and joining points can be found within this group.
- Deform:** Contains tools for distorting a selection. Namely, linear distortion, bezier distortion, torsion and bevelling.
- Specials :** Encapsulates a series of lesser-used tools for manipulating objects, for example inverting/repairing polygon normals, sub-dividing polygons and joining points to create new polygons. Also contains the sweep and extrude tools.
- Lights:** Governs the creation of extra lights (radial, point and spot).
- Library:** Provides access to pre-defined object libraries. Thumbnails of objects can be dragged directly into the view to add them to the scene.
- Animation:** Basic animation controls.
- Virtual:** Simple console for navigating through a scene.
- Plug-ins:** Leads to a sub menu listing all available plug-ins.

adjust the view to suit the creation/placement of an object or quickly check the scene from any angle.

Having said this, in practice the vast majority of modelling will be carried out using a plan or elevation of the scene. With this in mind Sincronia have provided an icon at the right hand side of the lower (main) toolbar, a picture of a cube with one corner missing, that may be clicked on to automatically switch the view to one of eight different directions, depending on the face of the cube selected and mouse button used.

For example, select-clicking on the top face of the cube would provide a view of the scene from the top, looking down, while adjust-clicking would provide a view of the scene from the bottom, looking up. Just below the cube are three buttons, labelled X,Y and Z that may be used to select the active plane. Alternatively, a fourth button – cunningly labelled 'auto' – delegates the decision to *TopModel*.

"Hang on a minute. What's all this talk of an active plane?", I hear you cry. The term 'active plane' describes the plane in which we are working and is used to overcome the problem

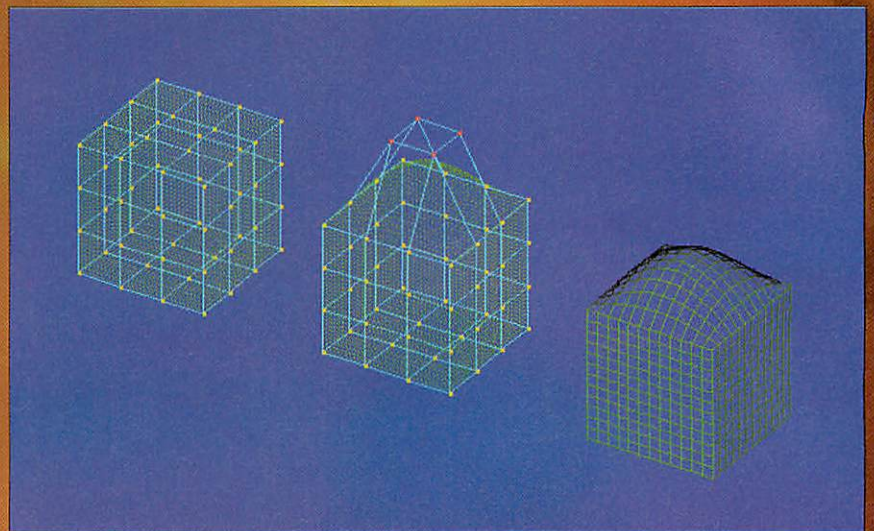

Figure III: Bezier cube (from left to right) : Before distortion, during distortion (using bezier control points to control surface shape) and after conversion to polygons

of manipulating objects in a three dimensional world when we only have a two dimensional, monitor screen, representation of that world.

For example, imagine we had somehow managed to create a model of a table with a cup on top and were viewing it in 3D in *TopModel*. For some reason or another, we decide that we're not happy with the position of

the cup and would like to move it from one corner of the table to another. One method of doing this would be to switch to a plan (top) view of the table and then adjust the position of the cup. However, if the currently active

plane were selected to be the horizontal plane, that is to say the same plane as the plane in which the surface of the table top lies, we could simply select the cup and drag it around within our current view, safe in the knowledge that our cup was only moving about on the surface of the table, rather than up, down or any other direction.

In this example the active plane has constrained any adjustments that we make to the horizontal plane (within the scene), in spite of the fact that we might have been dragging the cup in a vertical direction in the display. While this may seem pretty confusing, you'll never really notice the active plane in action since in practice virtually all the adjustments you make to objects within your scene will seem perfectly natural, which is the whole idea.

To the left of the active plane and view selection controls are a group of buttons that each lead to a new pane representing a group of related tools. When selected, the pane replaces the main pane options, presenting the user with another group of options or tools. To go back up a level you simply select the cross (close window icon) in the left-hand corner of the pane, a bit like navigating a directory structure using Adjust clicks.

Below these buttons are another set of thin buttons which represent short cuts to five pop-up menus. Finally, at the base of the tools-toolbar is a context sensitive help display which helps explain the action of any tool the pointer might be hovering over.

While the tools-toolbar mainly deals with options for creating and manipulating objects, the *TopModel2* toolbar, to the left of the main pane, presents options for interacting with the scene and adjusting the properties



Figure II: Realtime display modes include (top left to bottom left): coloured wireframe, flat-filled, gouraud shaded and phong shaded

of the display. For example, there are short cuts for entering the selection mode, as well as tools for adjusting the current render style, display options and for manipulating your viewpoint.

As you may have gathered, there is an vast array of tools available in *TopModel* - too many to cover in detail. For this reason I have decided to present a brief overview of the principal tool groups in the accompanying text box, and will concentrate on a few of the more commonly used and useful features in the main text. The tutorial series that starts in the Christmas issue will provide a more in-depth look at some of the functions not covered here. The idea for now is to outline the kind of things that are possible in *TopModel*, and some that are not.

Although *TopModel* is perfectly happy running in a 16 colour mode, I would strongly recommend using a minimum of 256 colours, or - if VRAM permits - a 32 thousand colour mode. In addition, *TopModel* supports a number of different render styles, each of which gives slightly better on-screen results, at the expense of redraw speed (Figure II).

Unlike some modelling applications, all of the rendering modes allow real-time, interactive modelling. That is to say, you may create and edit objects in any of the rendering modes, including the perspective mode.

However, from a practical point of view it is much easier to select points and edit objects using a wire frame display, even on a StrongARM equipped machine. Once you have finished an edit you may then switch mode to preview your results. A relatively recent and useful addition to the options that greatly aids this process is the flat-shaded movement mode.

This setting allows you to edit your scene in wireframe mode and then preview a 'solid' version of the scene whenever you rotate, zoom or



Figure IV: Example objects created using the sweep tool

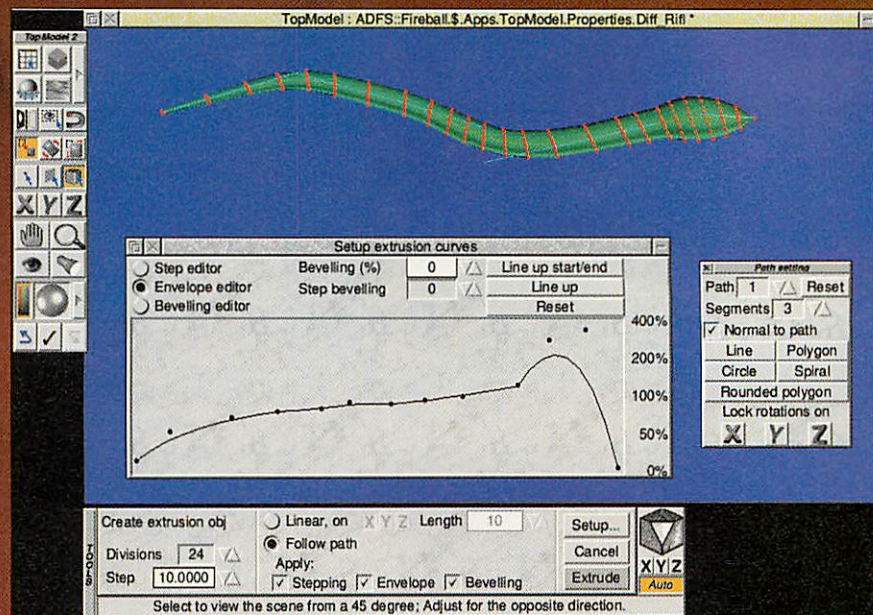

Figure V: The extrude tool can be used to create the body of a snake by extruding a profile along a path, using a user-defined envelope

translate your viewpoint. This is particularly handy if you use the keyboard and mouse shortcuts - Control+Select for zoom, Control+Adjust for rotate.

Object manipulation

While talk of rendering modes is all very well, it doesn't matter a jot if you can't create anything to place in your view. Fortunately, *TopModel* offers ample options for this purpose. At the lowest level there are tools for creating the basic primitives, namely: cubes, spheres, cylinders (encompassing pyramids), tori (doughnut-shaped objects), pipes, paths, surfaces and polygons. Furthermore many of these tools support creation of both polygonal and bezier forms.

The latter are essentially objects which describe a surface and have control points which may be moved to distort their shape. Once you are happy with the result the bezier representation of the object may be converted into a polygonal model, with a selectable level of detail, as shown in Figure III. While these objects sound a bit esoteric (and they are) they allow distorted, smoothly curved variants of common shapes to be created, which might otherwise be difficult to produce.

My only niggle, other than trying to grasp the sheer range of possible applications, is that the bezier shapes are often composed of a number of pieces which pull apart when using the primitives selection tool. While this behaviour is fair enough, it feels slightly inconsistent, since I would expect the primitive tool to select the whole of the bezier shape, rather than

part of the object. On occasion I have also had difficulty converting a mesh to polygons and keeping it as polygons. However, this problem has usually been solved by repeating the conversion.

It would be great to have enough time and patience to model everything we need to make our perfect scene, in reality though, time is precious and some tasks too complex or tedious to contemplate doing ourselves. Furthermore, the growth in the Internet has led to the creation of a number of Web and ftp sites which contain an impressive array of pre-made, ready-to-download, 3D meshes.

Fortunately, to ease our dilemma, the creators of *TopModel* have produced a couple of utilities for converting a few of the more popular 3D geometry formats into *TopModel* files, including the ubiquitous DXF format. In addition, the library option on the Tools toolbar provides access to a series of predefined object categories, from which individual objects may be selected and dragged directly into a scene.

Finally, it is possible to import sprites as heightfields and extrude (give depth to) shapes created in *Draw*. Unfortunately though, the triangulation algorithm used to 'fill in' shapes with polygons can often produce mixed results, particularly with complex shapes, yielding objects which may require some manual editing within *TopModel*.

This is particularly true of objects which contain holes. While the import of drawfiles is a very useful feature, it could be improved a lot. Hopefully Sincronia will oblige and

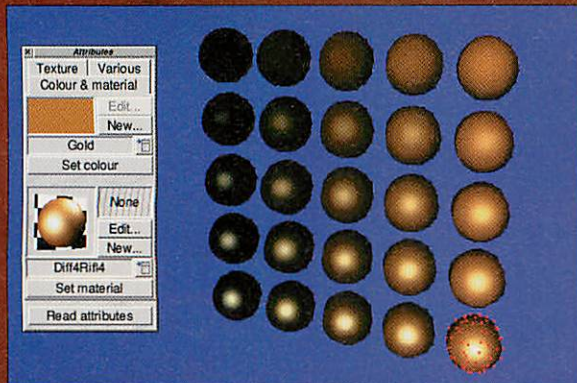

Figure VI: The illustration shows the effect that different bevel styles have on the appearance of some of the fonts supplied with the plug-in TopFont

turn what is a useful, if somewhat unpredictable feature, into a truly powerful tool.

Aside from the creation of simple shapes or the import of models, *TopModel* provides a number of high-level tools which permit the creation of more complex shapes and structures, using primitives as a basis. Of these, those that are likely to be used most often are the sweep, bevelling and extrude tools.

One typical application of the sweep tool would be to create a rotationally symmetrical object, say a vase. To do this, you would create an outline (cross section) of the vase using the line tool, then position the profile at the appropriate distance from the origin and invoke the sweep tool, using a 360 degree sweep, covering – for the sake of example – 18 divisions.

By adjusting the number of divisions, steps and envelope even more complex shapes may be created, a number of examples of which are shown in Figure IV. Furthermore, the

sweep can be performed using a bezier curve, yielding an editable bezier surface, which can be further adjusted to create even more complicated objects – powerful stuff, yet extremely easy and quick.

The extrude tool permits you to take an object or, more commonly, a cross-section, and smear it in one direction to

produce an elongated version of the object. For more dazzling results, you can also opt to use a predefined path from the paths menu and set up an envelope, the latter will be used to apply a scale factor to the cross section during the extrusion, while the path defines the trajectory along which the profile will be drawn out.

Circumstances in which the extrude tool might be used include creating a hosepipe or the body of a snake (Figure V), or perhaps, in the case of a simple linear extrusion, a plinth or curbstone. There are a number of tools in *TopModel* that, while not strictly object creation tools, are very useful for creating interesting shapes. These tools are collectively known as deformation tools and are split between the standard tools that come with *TopModel* and the deformation tools that are supplied with the plug-in *TopDeform*.

Their actions range from simple linear distortion of an object, to complex torsion distortion which is unwieldy to use. The most useful of

the standard tools are bezier distortion and the new bevelling tool.

When invoked, the bezier distortion tool divides the bounding volume of the selected points into 64 rectangular zones (each axis is subdivided into four). Each corner of a zone has a bezier control point which may be selected and moved to distort the shape of the overall volume.

The resulting spatial deformation is then applied to the selected points contained within the volume. Once you are happy with the results you can elect to permanently apply the distortion, or alternatively you can cancel the operation. This tool is ideal for bending and twisting a shape to produce a more organic or curvaceous look.

Bevelling is the most recent addition to *TopModel's* stable of distortion tools. Although some of the other utilities provide support for bevelling, this new distortion tool makes the process of creating objects with complex edges much simpler. A selection of pre-defined profiles are available for use, including rounded, gothic, base relief and cut-off edge styles (see Figure VI for examples of bevel styles applied to fonts).

You can even modify existing styles or create your own, although I feel the user interface to the edit window could be improved to make this process easier.

Having said that, despite its quirks, this tool is a great addition to *TopModel's* already impressive feature set and is yet another example of Sincronia's commitment to continually enhancing *TopModel's* power.

Well I'm afraid I've run out of room for now – I did say there was a lot to cover. Next month I'll continue the review by seeing how *TopModel* copes at adding a touch of realism to objects, and how Sincronia have planned for the future by taking the plug-in route. Do join me then. **END**

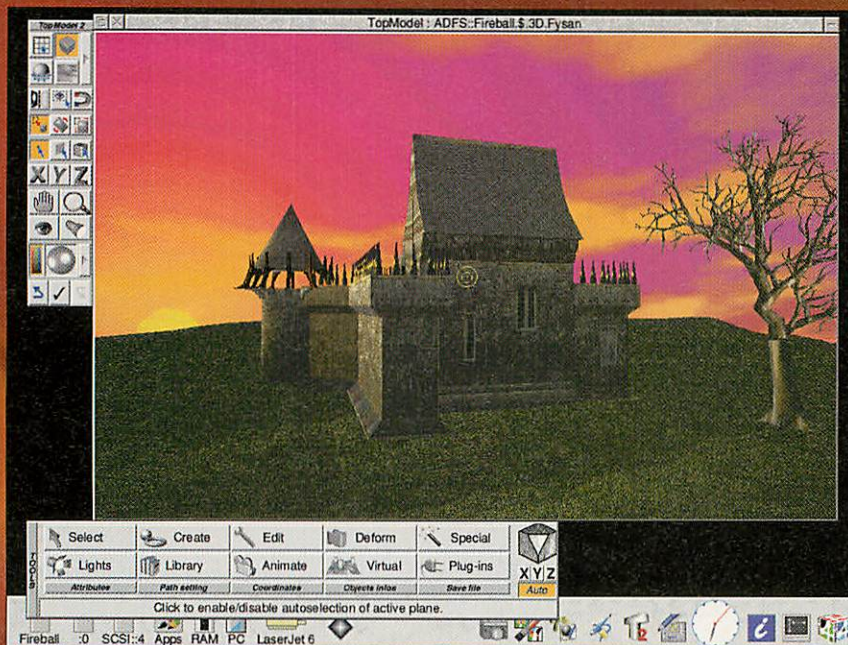

Product details

Product: TopModel2
 Price: £152.75
 Product: Top3DFonts (Plug-in)
 Price: £58.63 (includes CD collection2 and free v2.14 upgrade)

Product: TopDeform (Plug-in)
 Price: £28.79
 Supplier: Spacotech, 1 The Courtyard, Southwell Business Park, Portland, Dorset DT5 2JS
 Tel: (+44/0) 1305 822753
 Fax: (+44/0) 1305 860483
 E-mail: sales@spacotech.co.uk
 Web: www.spacotech.co.uk/topmodel/

Plustek OpticPro A4 1200x600 inc. Acorn S/W & Slide unit **£180**

Plustek OpticPro 1200x600 inc. Acorn S/W **£140**

Epson Scanner GT7000 SCSI 1200x600 with S/W £260 inc Film unit £325

PC Card **5x86** 133MHz 512k Cache **£225** NEW Price

With Part exchange:- **£90** CJE586 128k, £125 Acorn 586 & £170 DX2/66

Second Hand 100MHz cards from £100

IIYAMA 17" Visionmaster Pro 0.25mm ag £350

32 Speed IDE CD ROM Drive £60

CD ReWriter SCSI Yamaha 4416 with S/W (needs SCSI interface) £345

Acorn C++ **HALF PRICE** £125

RiscOS PRMs Vol 1-4 **HALF PRICE** £55

56K V90 Modem £80

RiscPC backplane £30 A7000 Backplane £30

8.4GB IDE IBM/Quantum Fireball Hard Disc £135

Everything for Acorns!

Wide range of spares and consumables stocked:-

PSUs for all Acorns, Batteries for A5000, A310, A4 & Master, A4 Chargers, Mice, Cables Internal & external many types, Keyboards new & refurbished.

Floppy Drives 5.25, 3.25, 800K & 1.6MB, Ink & Toner Cartridges for many Printers and much more...

Data transferred from old formats. BBC DFS, ST506, Pan.PD. Syquest 105MB/270 drives etc.

Second Hand RiscPCs

600s from £480, StrongARM from £800 (when available)

A7000s From £350

A7000+'Foundation' or 'Extreme' £825

StrongARM Upgrades

Revision 'T' Now available

£292

RiscOS 4 £120

Fitting & HD reformatting Service

£25 or £15 with New Hard Drive

Courier collection & return also available.

100MB Zip Drives from £85

NEW 250MB Zip Drive SCSI Ext. £185, Printer Port version with S/W £215, Int. IDE £165

17.2GB IDE Hard Disc £280 18.2GB SCSI Hard Disc £680

Acorn Access+ Interfaces RiscPC NIC 10b2&T **£110**, 10b2 only **£80**

Access+ A3020/4000 10b2 £90 A3000/3020/4000 10b2&T £90

DRAM SIMMs for RiscPCs 32Mb £60, 64Mb £95 & 128Mb £200

Acorn Advance Wordprocessor, Spreadsheet, Database & Graphs **£58**

EAGLE M2 Video & Audio Digitiser RRP £387 S/H £250

S/H Acorn
A4
£550



All prices **INCLUDE** VAT @17.5%

& Delivery. Official Orders Welcome E&OE

Prices subject to change & stock.

CJE Micro's
78 Brighton Road
Worthing
West Sussex
BN11 2EN

CJE4DV34 Tel 01903 523222 Fax 01903 523679 sales@cje.co.uk http://www.cje.co.uk

StrongARM Compatible Game Compendiums

Saloon Cars Deluxe £25 Holed Out Comp. £25 Chocks Away Comp. £25

Upgrades available from £6

Other StrongARM Compatible titles

Anagram Genius £20, Cataclysm £20, Chopper Force £30, Cyber Chess £30,

Demon's Lair £20, Drifter £30, Groundhog £12, Logic Mania £20,

Pandora's Box £20, StuntRacer 2000 £25, WimpGame £20.

The Fourth Dimension,
78 Brighton Road,
Worthing, West Sussex
BN11 2EN

Tel: 01903 213361

Fax: 01903 523679

Email: 4d@cje.co.uk

Web: www.cje.co.uk/4d/

Prices and specifications are correct at the time of going to press. All prices are fully inclusive. E&OE.



Quaking

Alasdair Bailey
reveals that
game

boots

The time has come at last, *Quake* is finally with us! My predecessor first announced plans for the conversion way back in the spring of 1997 and now the product is finally on sale. Well, that's all true except for the fact that this is not actually the completely native engine re-write we've been waiting for from Martin Piper, but rather a smartened-up version of Peter Teichmann's freeware RISC OS player app.

As far as we can tell, the freeware player will remain available while the slightly enhanced version is sold along with CDs containing the game's huge level files. This means that it is still possible to get a fully working copy of *Quake* on your Acorn by purchasing a copy of the PC version on the High Street then downloading the freeware player app from the Internet.

R-Comp are still committed to improving their version but seem eager to get some form of product onto the market as soon as possible. This is not necessarily a bad thing, it will gain them some revenue for the PC version CDs which have been waiting in storage for almost one and a half years now. In this



Martin Piper - so he does get out of work occasionally



Quake: at last, proper 3D movement comes of age as does proper multi-player support

issue, we have exclusive interviews with Martin Piper and Andrew Rawnsley so that you can get both angles on this RISC OS debacle which is finally coming to a peaceful end. There's also a full review of the R-Comp product.

Martin Piper

AU: Tell us a little about the problems which slowed your conversion of the *Quake* engine.

MP: Where do I start? Like a lot of other RISC OS coders I also have a proper job, at Argonaut Software in London, which pays the bills. For what seems like a long time now the project I'm working on (*Alien Resurrection* for the PSX) has been taking nearly all of my time. Last year I also ended up

in hospital after collapsing at work due to working too much and stress.

I decided back then to re-evaluate my priorities and not work 14+ hours a day on maintaining my day job and RISC OS stuff. After all I don't want to kill myself.

AU: How close to completion is your conversion of *Quake*?

MP: I would need a week all to myself to finish off the code but since I can't take a holiday at the moment that isn't going to happen.

AU: What sort of performance do you estimate your conversion would have achieved once fully optimised on a 233MHz StrongARM processor?

MP: Well I can't give exact figures

because I don't have a 233 SA but those who have seen the speed an early version was getting would tell you it's noticeably faster than *ArcQuake*. I couldn't comment on that because I haven't seen the latest version of *ArcQuake* myself but it's entirely possible. Probably because I've had the time to completely redesign and implement a new rendering pipeline which is much faster on the ARM chip architecture than Carmack's original code.

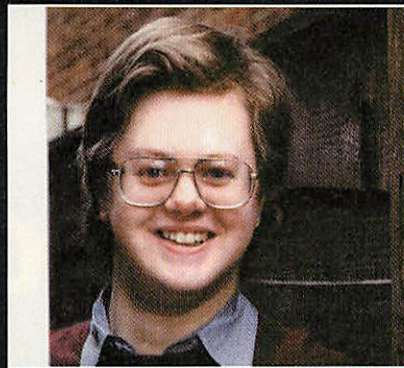

Andrew Rawnsley, the self-made king of RISC OS gaming

AU: Did you have any extra features planned for your *Quake* engine over and above those in the PC version?

MP: Yes. Because of the way the renderer was designed *Quake* would use a separate device driver module for the screen device. In simple terms this means that I can add a high colour rendering mode or support PCI 3D acceleration just by adding a new device driver module. The beauty of this is that if a machine came out that did actually use extra processors or had fast floating point the device driver would just need to be changed, not the entire game.

AU: Will TBA Software be releasing any more products for RISC OS?

MP: Yes we want to do some more games. Probably using a version of our new 3D engine technology that was developed for *Quake*.

AU: Many thanks for your time, we wish you every success with your work at Argonaut.

MP: Thank you for the interview. Hopefully *Aliens* will be finished soon and I can get back to my normal life.

Andrew Rawnsley

AU: Why did RCI end up publishing the RISC OS version of *Quake* when TBA had been working on the engine for quite some time?

AR: TBA had been working to produce a *Quake* 'player' from scratch with the TBA TAG engine. While this was a good stop-gap solution, it was only suitable for 'techie' users, who would be happy to buy the

game from one place, and the driver from the other.

Following *Doom*, we had a good relationship with the PC publishers, GT, who practically force-fed us the *Quake* packs. They were worried that with just the driver available, piracy would be rife, as people would buy the RISC OS driver (out of loyalty) but rip off the level data.

One of the big points about dealing with us (as far as GT were concerned) was that we would buy the PC kits off them, and only sell the full product. This minimizes piracy, and provides an effective route to market. TBA were to get a very healthy royalty per copy sold.

AU: At what point and for what reasons did you adopt a version of the freeware engine rather than the TBA engine?

AR: We finally made the decision in May/June this year. Readers should remember that we purchased the *Quake* packs right at the start, on the assurance that the TBA *Quake* driver would be ready for the Wakefield show - 1998. That was over a year ago. Given that the units are how GT make their money on the deal, they aren't cheap, and we've had endless copies holed up in a warehouse for 12 months, all paid for!

Since then, many of you will know that I have become significantly involved in RISCOS Ltd. Given that we (R-Comp) were already well out of pocket on *Quake*, my

necessary investments in RISCOS Ltd made life rather uncomfortable.

For the previous year, we had had repeated promises of demo versions, and full releases always "in 2 weeks". These never happened, and while I am very sympathetic to Martin's health problems (for goodness sake, I've had enough of them myself) I would have preferred a "it'll be 6 months" or whatever. This made things very frustrating, and I gradually began to lose hope of ever releasing the product.

I contacted Peter Teichmann who developed the freeware version. I make no comment on the legitimacy of the freeware release - the *Quake* sources are still officially unreleased, and access to the source still costs a lot of dollars. However, this release of *Quake* allowed people to play the game when they otherwise couldn't, and was released well before anyone else got involved, and as such it was important for the market.

Anyway, Peter was very helpful, and prompt with delivery of demo versions. We sent him all the resources needed to produce a player that would run the extra expansion packs supplied with our pack, and Peter rapidly returned a working version. Since then, there have been various bugs fixed.

AU: Why should users buy your pack for £20-25 rather than obtaining the PC version at a high street store for £15 and using the freeware engine?

AR: The version we supply will be enhanced above the freeware



Quake - bigger than an eclipse on a cloudy day

The bots are back.

"...should be in every platformer addict's collection" – *Acorn User*

"Fine attention to detail", "...infuriating puzzles!" – *Acorn Gaming*

OUT
NOW!

botkiller 2

FROM THE MAKERS OF ANKH AND EXODUS



- 25 levels packed with action and tricky riddles
- 5 exclusive pieces of music written by Marco Bahn of ANKH fame
- Dozens of different game elements that have to be investigated
- 5 different areas with detailed graphics
- 6 types of totally different robots
- a wealth of extras to pick up
- a shop to purchase items
- completely programmed in **superfast ARM** machine code
- runs on **any** RISC OS computer with a HD floppy and 4 MB RAM

ARTEX
ART EX



WAG Software and Artex Software.

visit www.artex.oaktree.co.uk

Order now! Send a cheque for £15 to Wag Software, 5 Queens Close, East Markham, Nr. Newark, Notts, NG22 0QY

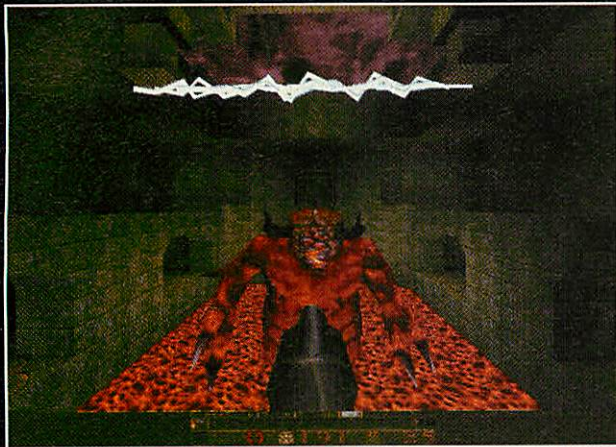

Quake II: not yet out for RISC OS, sadly, there are no plans for a release yet

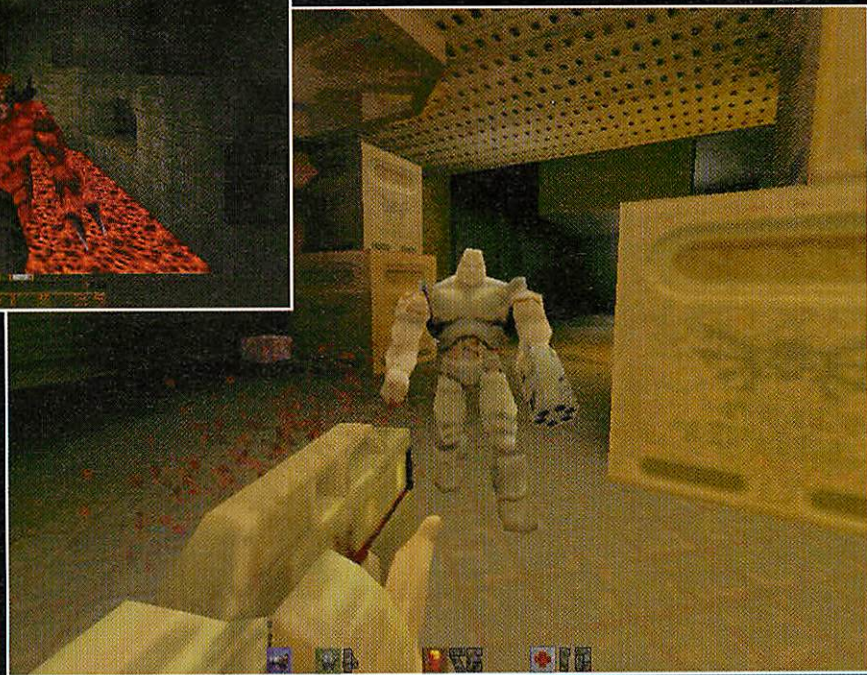

"What did you call me?"

version: Support for Malice and Q-Zone; Much improved front-end; Proper installation. *Quake* installation is a non-trivial process, thanks to the files being compressed and split on the CD; and the game will store more information about configuration and so on.

A lot of people have asked for a good front-end and this is very important to us. Improving the installation is also necessary and is actually the biggest thing delaying release.

I'm trying not to use the 'support the market' line, but it is a fact that dealers require significant margins on games, and with that in mind there is no way that we can drop the price too far.

We would hope to release a *Quake+* upgrade at some point, which also contributes to the drop in price. This may be TBA's *Quake* if it is ever finished, or we may optimise the game ourselves. I cannot see this happening for quite a while, but it is something that I would like to see happen. I feel that the game ought to run smoothly and well on a 233Mhz SA.

AU: What's next on the RCI release schedule?

AR: Your readers know that we're working on *F16* but this is proving tough. The game is up and running, and the resolution and detail are impressive, but the frame rates are low. Peaking at 8fps at the moment, there's a lot of

optimisation required.

In some ways I feel that we have swamped the market with titles, so we won't be releasing products quite as rapidly as we did last year. In football metaphor, it was necessary to get our first team up and running immediately, and we can now add players as required. Rest assured that these players *will* be added! I would, however, like to see some of last year's titles sell before releasing more new titles which steal the limelight!

AU: Thanks for taking the time to complete this interview, we look forward to seeing all these new conversions you're keeping secret from us!

AR: No problem! But which conversions? <cough> <grunt> Ah, yes Alasdair, those conversions...

A brief history of 3D walkabouts...

Ever since *Wolfenstein 3D* was released on the 5th of May 1992, what we now know as 3D walkabouts have gone from strength to strength. This genre of

games basically involves moving around a simulated world killing anything that obstructs you and solving a few puzzles along the way. The progression from those early days through to the current state of the art on the PC, the *Quake III* engine test is illustrated well by the screenshot below.

ID Software (and John Carmack, 3D engine coding guru) are almost the unrivalled masters of this domain, there have been others such as *Duke Nukem 3D* and *Half Life* but none of these have yet made it to RISC OS. R-Comp have stated that a *Duke Nukem 3D* conversion would be possible in theory but they fear that its 18 certificate would cripple sales on such a small platform.

Quake reviewed

R-Comp are now selling the *Quake Resurrection* pack along with a player application for StrongARM Risc PCs for an as-yet unannounced price in the £20 to £25 region. This pack contains three CDs containing level data, one for *Quake* and one for each of *Malice* and *Q!Zone*. *Malice* and *Q!Zone* are both third party modifications to the original game and are bundled with the RISC OS release in a similar fashion to other R-Comp

conversions. They each constitute complete new level sets so are considered separately here.

Quake

Quake is a first-person 3D shooter from id Software, producers of such smash-hit first person games as *Wolfenstein 3D* and the *Doom* series. Sensible game plots have never been id's strong point so I'll spare you the details on this one. All you need to know is that some guy by the name of *Quake* has started pumping his baddies through slippgates (read: teleporters) into some military bases.

Playing *Quake* is a completely different experience to *Doom* or other earlier incarnations of this genre. The game's engine (the bit that does all the clever stuff) is far more advanced and allows for such things as jumping, freedom of vision (your character can look all around, and is not restricted to looking solely in the direction of travel) and last but not least, proper 3D levels which can now have floors overlapping each other.

As well as featuring a very nice engine, the gameplay itself is also very good. The game offers a very nice range of weaponry including a grenade launcher and a rocket launcher, two of my personal favourites. The super nailgun is a lethal weapon if there ever was one but unfortunately the supply of ammo is somewhat limited in most levels. That's not a bad thing though, in fact it is perhaps one of *Quake's* strong points because there isn't always loads of ammo lying about so it's necessary to conserve it at times. Your adversaries in *Quake*

are both imaginative and well-drawn. The mixture of close range nasties which need to get right up to you to cause damage and long range ones makes gameplay challenging in places. The situation often arises where you'll get attacked by monsters on the ground at the same time as having things fire down at you from above. Add to this the all-new ghost-type nasties which fly about while spitting down on you and you'll get some pretty interesting situations.

The level designers have used this range of monsters to give a very challenging gaming experience. Certain creatures will even reincarnate unless physically blasted to bits by a rocket or grenade.

One of *Quake's* main down sides is that the monsters still jump out in front of your gun. This does get a little tiresome after playing through other games of this nature. Why, oh why, don't they hide and use cover to their advantage rather than just waiting to be killed? This has been achieved in games on other platforms to great effect and it really does make the game feel that bit more realistic.

Quake features a nice system of power-ups. Different grades of armour may be gathered up along with a massive health bonus which grants the user 200% health (how this works in real life, I don't know). The other bonuses such as the bio-suit to protect from drowning and the 'Pentagram of Protection' also add a little something to the game.

However, the most noteworthy bonus has to be 'Quad Damage', this affords the bearer's weaponry four times as much punch as is normally experienced. This renders the lower-grade weaponry such as the double-barrelled shotgun useful once again later on in the game. Plus, it's bloody good fun to be able to strafe with the super nailgun and wipe out a whole room full of baddies then continue merrily on your way.

Quake's levels are organised into episodes, each of which features a fitting finale leading up to the final level where you're pitted against the mother of all baddies, Shub Niggurath. I won't spoil this bit but when you come to it, perhaps try methods other than simply discharging all your ammo at the beast.

No review of *Quake* would be complete without a mention of its multi-player capabilities. OK, so *Doom* included multi-player support but *Quake* really is an exhilarating experience when played against fifteen or so mates over a network. The game is just so flexible and the add-on system allows for far more tactical game play thanks to the addition of 'capture the flag' and paintball-type variants.

The RISC OS conversion of *Quake* currently supports a range of network play options but, unfortunately, it lacks compatibility with *WinQuake*, the PC multi-player version commonly played over the Internet. Serial cable, modem and network play are supported as is Internet play on servers which don't rely upon *WinQuake*.

In addition to its support for third party levels, *Quake* also features its very own variant of the C programming language: *QuakeC*. This allows for the addition of comprehensive new features to the game. Most are only useful in multi-player situations but a few such as weapon modifications and bots (simulated human opponents) can be put to ample use, even without access to more than one computer. This feature along with *Quake's* excellent multi-player experience must be what has made the game so popular in the PC market and is sure to affect the RISC OS gaming community too.

Not all additional levels and *QuakeC* patches will work with the RISC OS conversion of *Quake*, but most well-written ones will be fine. Be sure to check out the selection at Acorn Arcade's own *Quake* site should you buy the game.

The current RISC OS implementation of *Quake* is currently available in two forms. There's the freeware player app which is on slightly dodgy legal ground and also R-Comp

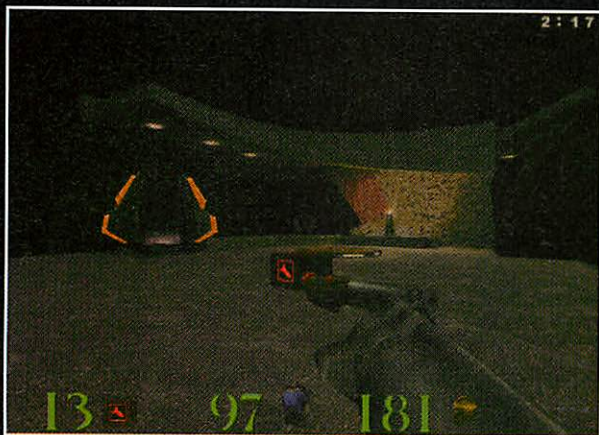

Quake III: still undergoing testing on the PC, you'll have grandchildren by the time this one's playable on your Acorn. A Pentium III 450 and a meaty graphics card is needed before it will even consider running on the dark side.

Interactive's own commercial product which is basically the freeware player bundled with legitimate level files in a deal sanctioned by the original publishers, GT Interactive. You'll have to pay a little more for the R-Comp product over the price of buying the PC pack on the high street. However, you will benefit from a proper installer, technical support, windowed play, a slightly improved engine and compatibility with *Malice* and *Q!Zone*, both of which are well worth acquiring.

It looks like we're stuck with this situation until Martin Piper has time to complete his implementation of *Quake* for RISC OS. Unfortunately, the R-Comp product is currently only playable in low resolution and lacks the improvements over the original PC incarnation which we've seen in other R-Comp conversions. Development is still continuing though. At the time of writing, the engine does have a tendency to crash every now and again but the game is still playable albeit with regular quicksaves.

Malice

Malice is billed as a completely new game based upon *Quake's* engine and it is, more or less. Almost every aspect of the gameplay is changed including all weapons, monsters and levels.

The basic plot behind *Malice* goes something like this: you're a hired mercenary working for the interests of a huge corporation by the name of B.O.S.S. Your work for them entails killing lots of bad guys. Haven't we been here before?

Unlike its host game, *Quake*, *Malice* treats the player to a nicely made full screen intro sequence before the game kicks off. The movie gives the player a good overview of the storyline as well as having a subtle stab at the original game through a scene where your *Quake* character is blown away by our new heroine, *Damage*. Unfortunately, the intro movie uses the game engine for real-time rendering rather than a dedicated movie player so things can get a little slow.

The new monsters offer a rather refreshing change after defeating the populous of *Quake*. The weapons also provide for

some light refreshment with a nice flame-thrower (fire extinguishers also provided) and a decent shotgun thrown in for good measure. The need to re-load some weapons manually adds to the realism but can be annoying if you like your rounds fast.

Another major feature of *Malice* is the addition of 'toyz' – don't worry, I can't stand people replacing s with z to make things sound cool either. These are bits of kit which will come in handy during your assignment with B.O.S.S. There are five 'toyz' at your disposal, one of the most original being a probe which may be piloted around the level scouting out enemy positions prior to your assault. I won't list the others here but they do add to the game in a special way and the additional keys to cycle through and use them are also a boon.

A couple of the more dubious items to be found in *Quake* and other games of this genre have been stripped away for *Malice*. For starters, the *Mega-health* bonus is gone, hands up those who understand how one may pose 200% health! The *Pentagram of Protection* and *Quad Damage* will also be missed by some but have been removed for the simple reason that they act against fair play in the eyes of the authors.

Overall, *Malice* is a very worthwhile addition to this pack and it could almost be argued that it's more playable than *Quake* itself. However, it is worth pointing out that the game runs a little slower than *Quake* but this isn't a major issue unless you have a real problem with playing on a slightly lower resolution.

Q!Zone

Q!Zone doesn't go quite as far as *Malice* in altering the game's play

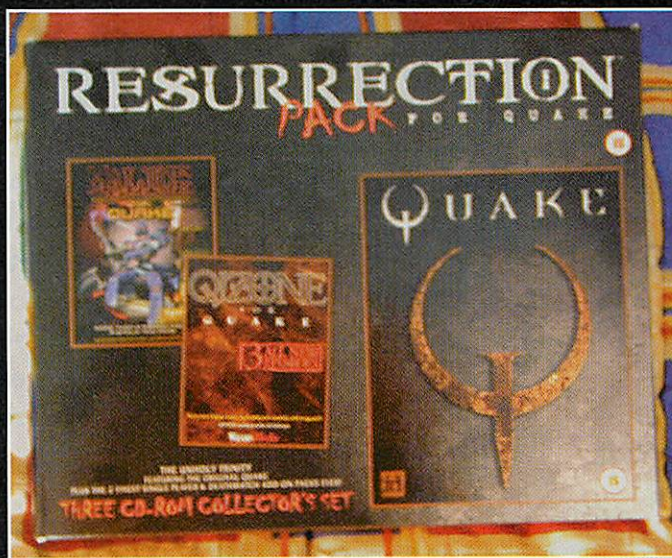

Quake jumps on the resurrection bandwagon – only 2,000 years late!

and feel. In the trade, it's referred to as a *partial conversion* because unlike *Malice* (a *total conversion*) not every aspect of the game is changed.

The changes do include a completely new set of levels, four new monsters and also one new weapon.

Q!Zone's levels do play well but their design is perhaps a little inferior to that seen in *Quake*. The new weapon replaces the rather under-powered standard nailgun with a nice little number which fires spiky discs. It might not sound much but they do bounce around corners – a definite bonus over the old nailgun. The other weapons remain unchanged from the original game.

The new monsters aren't really much to write home about. Many are brightly coloured and whether this is through diet or breeding, it does make them look odd alongside the surviving *Quake* monsters.

Q!Zone is definitely worth a look. Perhaps play through the slightly superior *Malice* and, of course, *Quake* first though.

END

Product details

Product: Quake Resurrection
 Price: around £20-25
 Supplier: R-Comp Interactive, 22 Robert Moffat, High Legh, Knutsford, Cheshire WA16 6PS
 Tel: 01925 755043
 Fax: 01925 757377
 E-mail: rci@rcomp.co.uk
 Web: <http://www.rcomp.co.uk/>

Pushing forward the frontiers in RISC OS
internet & web authoring software

Rcomp

New Release



Messenger

**An E-mail and News
Client for RISC OS
Professional Edition**

£30

The only RISC OS Internet software with the
GOOD NET-KEEPING seal of approval

SiteSeer £25
Web grabbing software for offline viewing

HTMLEdit Studio
Next generation WWW
authoring for RISC OS

£105
All the tools you need

Our RISC OS web authoring solutions set ne
standards in power and ease of use

The Studio edition provides

HTMLedit 4+	Java support, sound and music, link and image checking, syntax colouring and OLE	£53
Enhanced Web Toolkit	Visual frames, tables, animations, maps, palette control, Draw file conversion	£30
WebSpell	Full HTML-aware spelling checker	£15
Webster XL	Browser with frames, tables, forms, sound and JavaScript	£25

SiteMaster Price now
The Web Site Management
System for RISC OS Computers **£30**

Now with automatic up-loader for
getting changes online fast

Interactive
Rcomp



anthem * **£70**
inc. VAT

The RISC OS MIDI Sequencer

Anthem is a feature packed, easy to use MIDI
sequencing package for RISC OS computers
It employs a powerful and acclaimed new object-
oriented (phrases of music) song structure that
allows the musician flexibility in arrangement, and
ease of editing unparalleled by any other RISC OS
sequencer.

*We believe our prices
are simply unbeatable*

Existing Sound & Music Products include
PC SoundPro 2 £35, MIDI Synthesizers,
Sound Cards, MIDI Cards, Parallel/Serial
Port MIDI, MIDI Support....

DOOM
FINAL
New!

Extra Levels Pack £15 inc.
Requires Doom or Doom+

Other Games Titles

Heretic & Hexen (Towers of Darkness Pack)	£32.50
Heroes of Might & Magic 2	£35.00
Descent	£30.00
Doom+	£32.50
Syndicate+	£29.00
Abuse	£25.00

Distributors for ARTEX: Ankh, Exodus
PRO ACTION: Various titles

22 Robert Moffat, High Legh, Knutsford, Cheshire WA16 6PS
Tel: 01925 755043 Fax: 01925 757377 Email: rcomp@rcomp.co.uk rci@rcomp.co.uk

The RISC OS 99 SHOW

Organised by

The **ARM Club**

Sat 30th October 10.00 to 17.00

Sun 31st October 10.00 to 16.00

Queen's Stand, Epsom Downs Racecourse Surrey

Sponsored by



ACORNUSER



RiscStation
RISC Based Technologies



ACORN USER

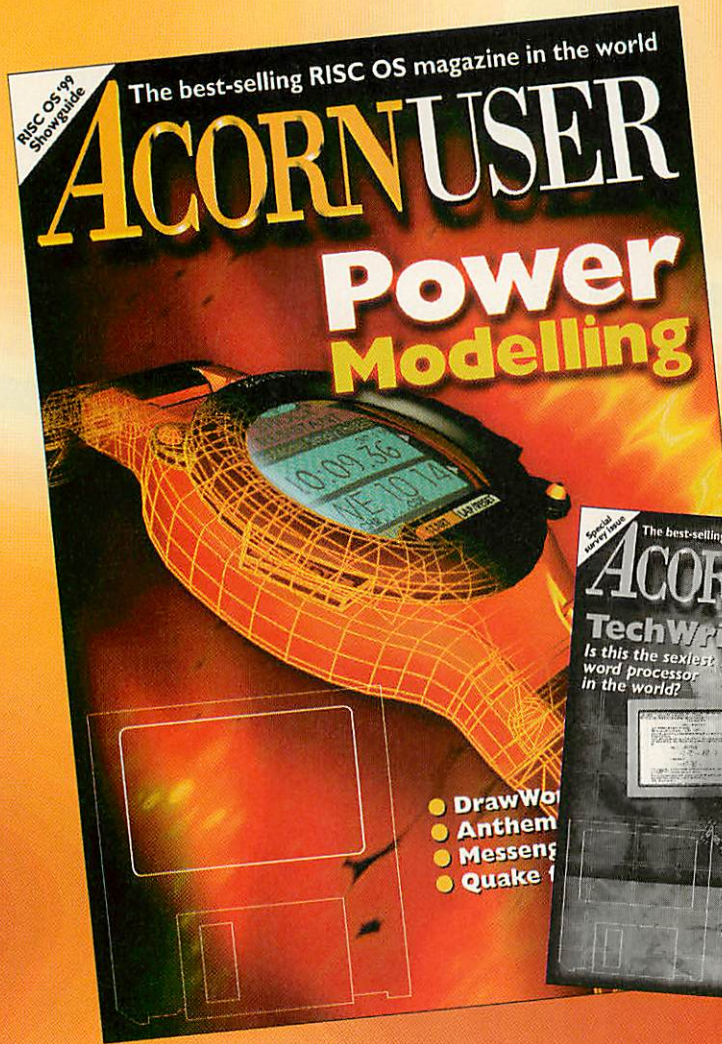

- Helpful tutorials
- Useful reviews
- Real news
- More pages

Acorn User has always been the flagship magazine of the RISC OS market, it reveals trends, new releases and authoritative,

rumour-free information that you don't get anywhere else.

Make sure you get yours and stay on top of the RISC OS revival.

Subscribe now!

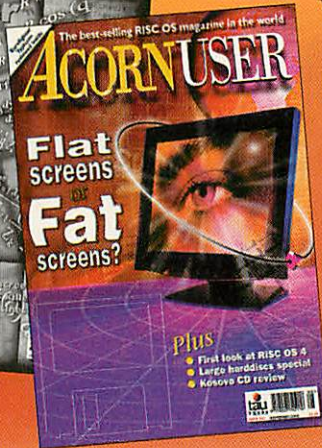

Please forward to: Acorn User, Tau Press, Media House, Adlington Park, Macclesfield, SK10 4NP

Name.....

Address.....

.....

.....

.....Postcode.....

Country.....

Ref: RISCOS/1

Credit card billing address if different from above.....

Annual subscription	8 Issue subscription	4 Issue subscription
<input type="checkbox"/> UK £45.99	<input type="checkbox"/> UK £29.99	<input type="checkbox"/> UK £15.99
<input type="checkbox"/> Europe £51.99	<input type="checkbox"/> Europe £34.99	<input type="checkbox"/> Europe £17.99
<input type="checkbox"/> Rest of World £63.99	<input type="checkbox"/> Rest of World £40.99	<input type="checkbox"/> Rest of World £20.99

Yes! I wish to subscribe to Acorn User.

I would like to pay by:

- Cheque/postal order (made payable to Tau Press Ltd)
- Credit card (Visa/Access/BarclayCard/Mastercard/Eurocard/Connect)

Card No,

Name on card.....

Expiry date ___/___ Signature

The RISC OS 99 SHOW

The last year has been a difficult one for the RISC OS market and if you were that way inclined it would look like the death knell had finally sounded for the most user-friendly operating system in the world.

But the non-appearance of the Phoebe Risc PC 2 and the disappearance of Acorn have instead resulted in the re-birth of a market long-suppressed by Acorn's unwillingness to take chances and invest in the future.

What has happened is that the operating system has been licensed and RISC OS 4 released – along with a roadmap for future developments that will finally break free of the hardware stranglehold that has always made Acorn machines so expensive to buy.

Simply plugged into existing hardware (the Risc PC, A7000 and A7000+) RISC OS 4 gives increased speed and great new features, but coupled with the new machines being released we can once again jump into the

mainstream of power computing.

At least three companies are releasing new hardware: firstly, two affordable machines based on the ARM7500 chip (now being allowed to run at full speed) and bringing new industry standards with them – the USB system for plugging in peripheral devices and PCI to allow PC-cards to be slotted straight in. These two options alone open the RISC OS world to vast amounts of previously unusable hardware.

Then there is the Risc PC replacement motherboard that promises to take the system to new heights of power by removing the bottlenecks and providing virtually unparalleled video and audio power.

Along with this new hardware is the software: Companies such as R-Comp, Icon Technology, Cerilica, Spacotech and many others provide the software that we have used and still use – but they are not resting on their laurels. More software is being released every month, as well as

upgrades to existing products.

Then there are the user groups: The ARM Club, of course, are still going strong as is the Association of Acorn User Groups, run by Neil Spellings, with its ever increasing number of associated clubs, combining and providing benefits to all the RISC OS clubs across the world.

It's true that the last year has taken its toll, there have been victims of the uncertainty, whether individuals who have turned to the other side or businesses who did not adapt fast enough.

There are those who dubbed the attempts to raise Phoebe from the ashes of Acorn as the Phoenix. But it's not any small group of individuals who are rising up, it's the RISC OS market as a whole – that's you and me – who are the real Phoenix, for coming out of those dark days and making RISC OS live on.

Welcome to The ARM Club's RISC OS '99 Show.

Steve Turnbull
Editor, Acorn User magazine

How to get there

Directions from M25 Junction 8

- Exit at Junction 8 and head northbound on the A217 Brighton Road dual carriageway – signposted A217 Sutton & London.
- Continue northbound through Lower Kingswood and straight ahead at the next two roundabouts – still signposted A217 Sutton and London.
- After 2.8 miles from the M25 take the third exit (straight ahead-ish) at the Tadworth roundabout – still signposted A217 Sutton and London.
- After 1.0 mile turn left at the traffic lights at Burgh Heath on to Reigate Road –

- signposted A240 Epsom and Kingston (there is a Shell petrol filling station on the lefthand side just the other side of the traffic lights).
- Follow this road across a set of traffic lights (after which the road starts going downhill) and after 0.9 mile turn left on to Yew Tree Bottom Road – signposted B284 Epsom Downs (immediately after the keep left arrows where the main road continues bearing round to the right).
- After 0.5 mile take the second exit at the roundabout on to Grandstand Road – signposted Grandstand

and Ashtead.

- After a further 0.6 mile both the Epsom Racecourse Grandstands and Queens Stand are located straight ahead adjacent to another roundabout (the Queens Stand is on the right and is more modern) – nearby car parking will be signposted and marshalled.
- Beware – the A217 is a dual carriageway with a 40mph speed limit and there are two separate police speed cameras located along this stretch of road.

By train

Nearest mainline station is Tattenham Corner

The RISC OS 99 SHOW

ASSOCIATION OF ACORN USER GROUPS

ACORN USER

The biggest and best magazine in the RISC OS market. Packed with news, reviews and special features. Come to our stand and see what we have on offer for the show. Back issues will also be available, as well as the opportunity to subscribe to the magazine.

Acorn User, Tau Press, Media House, Adlington Park, Macclesfield, Cheshire SK10 4NP

Tel: 01625 878888
 Fax: 01625 859808
 E-mail: enquiries@acornuser.com
 Web: <http://www.acornuser.com/>

AKALAT PUBLISHING

ALEPH ONE

We continue to supply Acorn computers with the ability to run Windows (and DOS) applications. We offer both Second Processors for Risc PCs and are constantly developing software to support them. Podule Cards are also available for A3x0, A4x0 and A5000 machines. Special Offers are usual at Shows like this!

Aleph One Limited, The Old Courthouse, Bottisham, Cambridge CB5 9BA

Tel: 01223 811679
 Fax: 01223 812713
 E-mail: sales@aleph1.co.uk
 Web: <http://www.aleph1.co.uk/AcornProd/>

APDL

APDL will have their full range of Acorn CDs, including clip art, PD, games and others, plus hard drives, interfaces, and CD-ROM drives, all at special show prices. You will be able to see the DataSafe parallel port IDE drive system and several new products (hardware and software).

APDL, 39 Knighton Park Road, Sydenham, London SE26 5RN

Tel: 0181 778 2659
 Fax: 0181 488 0487
 E-mail: info@apdl.co.uk
 Web: <http://www.apdl.co.uk/>

APRICOTE STUDIOS

Apricote Studios will be demonstrating their ever popular accounting applications: Personal Accounts 4 and Prophet3+ professional. They are also hoping

to have a new version of Personal Accounts ready for the show which should fulfil a number of 'wishlist' items requested by users (unfortunately the ability to print bank notes has not been completed, but they should save you from paying bank charges by telling you if you are likely to become over-drawn!). Apricote Studios will be situated in the RiscStation Village.

Apricote Studios, 2 Purls Bridge Farm, Manea, Cambs PE15 0ND

Tel: 01354 680432
 E-mail: info@apricote.com
 Web: <http://www.apricote.com/>

ARCHIVE

Archive Magazine, the subscription magazine for RISC OS users. New subscribers (£25 for 12 issues) can have a FREE CD (worth £12) which contains huge amounts of RISC OS-related information, several volumes of back issues of Archive, utility programs, PD, etc. Alternatively, try the next four issues for only £4, so that you can see just how good it is.

Archive Publications, 18 Mile End Road, Norwich NR4 7QY

Tel: 01603 766922
 Fax: 01603 460736
 E-mail: paul@archivemag.co.uk
 Web: <http://www.archivemag.co.uk/>

CASTLE

The Castle stand will feature a wide range of Acorn and other related products. Castle's new build specification Risc PCs in various guises will be available to purchase.

The new A7000+ Odyssey will also be on show. As usual Castle will also be demonstrating its wide range of Scanners, CD Writers and other peripherals and upgrades.

Castle Technology Ltd, Ore Trading Estate, Woodbridge Road, Framlingham, Surrey IP13 9LL

Tel: 01728 621222
 Fax: 0800 783 9638
 E-mail: jack@castle.org.uk
 Web: <http://www.castle.org.uk/>

CJE MICROS

CTA DIRECT

CTA will have a number of new products for sale. This will include new RISC OS machines, hard drives, CD-ROMS, CD-ROM re-

writers, memory for all RISC OS machines, mice, keyboards, MKII Trackball, printers consumables, and many other items. The team looks forward to meeting you at the show.

CTA Direct, 168 Elliott Street, Tyldesley, Greater Manchester M29 8DS

Tel: 01942 797777
 Fax: 01942 797711
 E-mail: sales@cta.u-net.com
 Web: <http://www.cta.u-net.com/>

RISCSTATION

On show will be the new range of machines including the R7500, the first RISC OS PCI machine, and the RiscStation Network machines. A network of machines running the latest software bundles will be on demonstration. Also the unveiling of new products and enhancements for all RISC OS machines.

RiscStation Ltd, 168 Elliott Street, Tyldesley, Greater Manchester M29 8DS

Tel: 01942 797777
 Fax: 01942 797711
 E-mail: sales@riscstation.co.uk
 Web: <http://www.riscstation.co.uk/>

CUMANA/CANNON COMPUTING

At RISC OS '99 we will be dedicating the stand to 'Thin Client Technology'. We will be requesting anyone who is in educational circles to come along to the stand to see Citrix and TopCat running both RISC OS and Windows on new and old Acorn/RISC OS machines.

We will also have all of our general products for sale with a bargains being offered at the show.

Cumana, Whitegate, Dunmow Road, Hatfield Heath, Bishops Stortford, Herts CM22 7ED

Tel: 01279 730800/730900
 Fax: 01279 730809
 E-mail: sales@cumana.co.uk
 Web: <http://www.cumana.demon.co.uk/>

ELECTRONIC FONT FOUNDRY

EFF offers a huge library of high quality fonts, including a wide range of educational, specialist and foreign typefaces and font converting software: EFF TrueType Translator, EFF PostScript Translator and EFF Font Table. The new CD, EFF2 Professional Typography, with 800 fonts in Acorn and Windows format, will

be available at the show.

Electronic Font Foundry, 11 Silwood Road, Ascot SL5 0PY

Tel: 01344 875 201
 Fax: 01344 875 202
 E-mail: sales@eff.co.uk
 Web: <http://www.eff.co.uk/>

ICON TECHNOLOGY

Icon Technology will be showing TechWriter and EasiWriter the powerful, yet easy to use, word processors which have been voted first and second best word processors on the Acorn platform and best commercial software.

- Reads and writes Microsoft Word 6, 7 and Office 97/98
- Style Editor
- Automatic Tables and Lists
- Imports Impression text files complete with formatting
- Reads and writes HTML NEW: EasiWriter and TechWriter Pro+ with improved graphics, text flows round pictures, also runs Java applets and animations.

Show offers will be available.

Icon Technology Ltd, Church House, Carlyb, Stamford, Lincs PE9 4NB

Tel/Fax: 01778 590563
 E-mail: sales@IconTechnology.net
 Web: <http://www.IconTechnology.net/>

IRLAM INSTRUMENTS

JONATHAN DUDDINGTON

Speak software speech synthesiser will 'talk-as-you-type' and read out text for proof-reading. Pluto is a text database and powerful Internet news and mail reader. It can be used to replace Marcel, Posty/NewsAgent and so on

E-mail: jsd@argonet.co.uk
 Web: <http://www.argonet.co.uk/users/jsd/>

MILLIPEDE ELECTRONIC GRAPHICS

The highlight of the Millipede stand will be the Imago Concept Motherboard. Mechanically compatible with the Acorn Risc PC, Imago forms the basis for a number of products to be produced by Millipede. Imago exploits the latest technology to propel RISC OS computing into new and exciting territory. Not to be missed.

E-mail: richard@millipede.co.uk
 Web: <http://www.millipede.co.uk/>

The Companies involved

Theatre timetable

	Saturday	Sunday
11:00	Castle Technology	Castle Technology
12:00		
13:00	RISCOS Ltd	RISCOS Ltd
14:00	RiscStation Ltd	RiscStation Ltd
15:00	TopModel	

R-COMP/R-COMP INTERACTIVE

R-Comp will be showing latest versions of its ever expanding range of Internet and Web authoring products. Visitors should expect some exciting new developments, including new versions of WebsterXL and Messenger Pro.

Check out RCI's range of sound and music products, including the powerful Anthem sequencer, for quality and value. Special show offers on graphics tablets too. Oh, and of course, there will be at least one great new games release, but that goes without saying!

R-Comp Interactive, 22 Robert Moffat, High Legh, Knutsford WA16 6PS

Tel: 01925 755043
Fax: 01925 757377
E-mail: rci@rcomp.co.uk
Web: <http://www.rcomp.co.uk/>

REALLY GOOD SOFTWARE

Launched at the Wakefield Show, NoticeBoard Pro will be featured on our stand; alongside the rest of our range including Picture Book 2, the Triple 'R' Education titles and Notes.

Really Good Software Company, 39 Carisbrooke Road, Harpenden, Herts AL5 5QS

Tel/Fax: 01582 761395
E-mail: sales.rgsc@argonet.co.uk
Web: <http://www.argonet.co.uk/users/sales.rgsc/>

RISCOS LTD

Visit the RISCOS Ltd stand to see the latest developments on RISC OS 4. Upgrades will be available to take away at £99 + VAT for Risc PC and A7000/A7000+ users. Join The Foundation for £30 + VAT (£25 + VAT for ex-Clan Members if you bring your membership card along).

Get the RISC OS World wallchart for just £4.50, listing all the companies offering products and services for your favourite operating system. We've got RISC OS 4 - have you bought yours yet?

RISCOS Ltd, 3 Clarendon Road, Cyncoed, Cardiff CF3 7JD

E-mail: paul@riscos.com
Web: <http://www.riscos.com/>

SIMNETT

SOFTEASE

SPACETECH LTD

Spacotech are showing their range of studio-quality graphics software for RISC OS including Photodesk3 with layers. The Digital Art CD-ROM by David Cowell, featuring bitmap and vector graphics tutorials is shown as well as his brand new second CD shown here for the first time. Watch out for the latest in Digital cameras from Olympus including the new C2000 Zoom 2.1 Megapixel compact also a new tiny megapixel camera and a multi-mega pixel replacement for the C1400XL!

PhotoReal drivers for the Canon BJC7000/7100 and BJC2000 will be shown. OHP, the presentation maker for RISC OS is demonstrated with some new features. Some attractive show discounts are offered.

Spacotech Ltd, 1 The Courtyard, Southwell Business Park, Portland, Dorset DT5 2NQ

Tel: 01305 822753
Fax: 01305 860483
E-mail: sales@spacotech.co.uk
Web: <http://www.spacotech.co.uk/>

THE ARM CLUB

Organisers of this year's show, The ARM Club, will be on hand with membership offers, club products (including the latest PDCD3), help and advice. A year's membership of the leading user group costs only £15 (£12 renewal) and includes four issues of our magazine, Eureka. Watch out for special show offers, or just pop along for a chat!

The ARM Club, FREEPOST The ARM Club

Tel: 07050 679262
Fax: 07050 679263
E-mail: info@armclub.org.uk
Web: <http://www.armclub.org.uk/>

WARM SILENCE SOFTWARE

WSS will be showing new versions of much of their acclaimed software, including CDROMFS (updated to handle Packet written UDF discs), CDBurn, LanMan98 and a new NFS client.

E-mail: robin@wss.co.uk
Web: <http://www.wss.co.uk>

"Many thanks for an excellent publication which I enjoy reading and which gives the most help of any of the magazines on computing which I read"

P. Tucker, Jersey

Acorn Publisher

Isn't it time you treated yourself to the best?

Write, phone or email us now for more information or visit our stand at RISC OS '99. First issue of volume 6 due out October 1999.

AKALAT 
AKALAT Publishing
P.O. Box 231, Barton, Bedford MK45 4HQ.
Tel. 01582 881614 fax 01582 881614
Email: akalat@kbnnet.co.uk

The **RISC OS** **99** SHOW

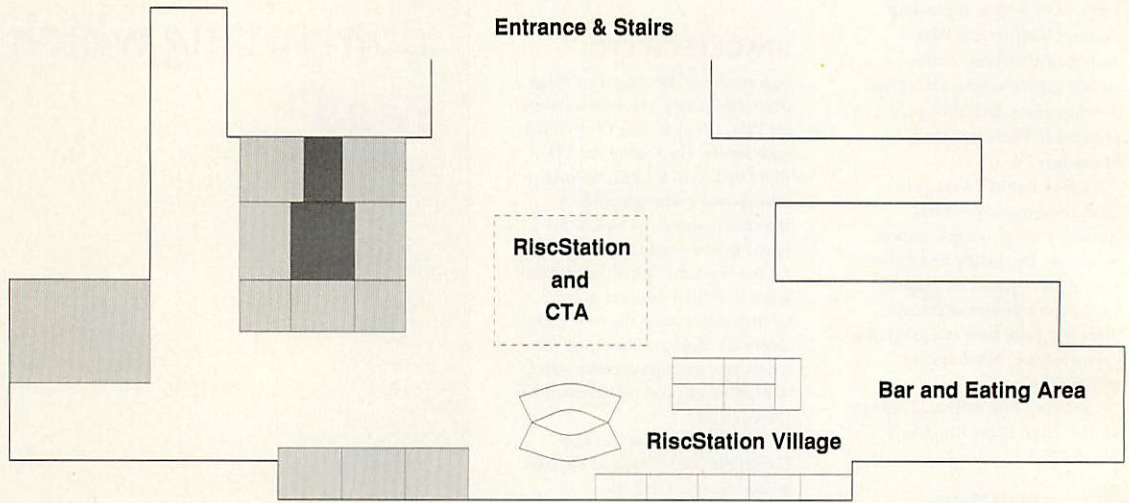

The RISC OS '99 Show - Lower Floor

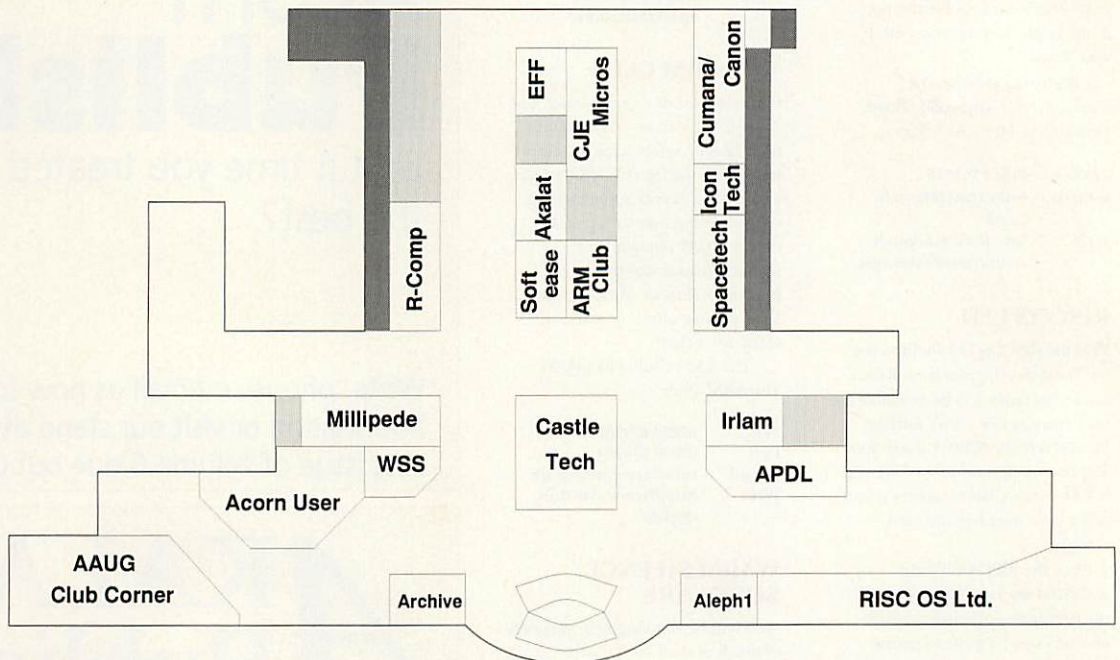

The RISC OS '99 Show - Upper Floor

The RISC OS 99 SHOW

RISC OS Awards

In the best traditions of the RISC OS world you have the opportunity to vote six categories – how you interpret them is up to you and you don't have to put an entry if you have no answer.

Send in your answers to *RISC OS Awards, Tau Press, Media House, Adlington Park, Macclesfield SK10 4NP* or hand them in to the *Acorn User* stand at the show before midday on Sunday Oct 31st.

- | | |
|---|-------|
| Best Dealer | |
| Best Non-game software release in 1999 | |
| Best Non-game hardware release in 1999 | |
| Best Game release in 1999 | |
| Most popular RISC OS personality | |
| Best Non-game release ever, for RISC OS | |
| Best Game release ever, for RISC OS | |

Elvis Lives!

But does he read **Archive Magazine**??

Archive contains...

- Hints & tips
- Articles for learners
- Information for the more technical
- Readers' comments
- Averages over 45,000 words per issue
- Over 70 pages of articles



To: **Archive Publications**, 18 Mile End Road, Norwich, NR4 7QY.
Phone: 01603-441777 Fax: 460736 Email: info@archivemag.co.uk

Please send me the next two issues of Archive FREE OF CHARGE on the understanding that (a) I have not subscribed to Archive before, (b) I have not taken advantage of any other such free trial offer, and (c) if I do decide to take out a subscription (£25 in UK, £30 Europe, £38 elsewhere), these two magazines will be the first of the twelve issues for which I will be paying.

Name: _____

Address: _____

Or email your address to: Paul Beverley, paul@archivemag.co.uk

**Send no money – just
send your address.**

RiscStation

Risc Based Technologies



The future starts here . . .

Specifications

RISC OS 4
16 Mb EDO Memory
4 Mb Flash Memory
4.3Gb EIDE Hard Drive
40x Atapi EIDE CDROM

Onboard

4 x 32 bit PCI Slots
2 x High Speed IDE Port
2 x Serial Port
1 x IO baseT Network
1 x Parallel Port
1 x Infrared Port
1 x PC Style Gameport
1 x Microphone Port
1 x Audio Line In Port
1 x Headphone Port
1 x PS2 Style Keyboard
1 x 3 Button PS2 Mouse
Midi In/Out/Through

Casing

Micro Desktop layout or
Tower configuration

Software

Full RISC OS 4 retail
pack as standard

DrawWorks Millennium
Fireworkz Professional
PipeDream 4.5
EasiWriter Professional

Ankh
Botkiller 2
Frak !

More titles yet to be
confirmed as well as an
extensive shareware
and demo collection

PCI Upgrades

(Available soon)

StrongARM Card
MultiProcessor SA Card
PC Card
32bit SCSI Card
100 baseT Network Card
MPEG Decode/Encode
ATA 66 IDE Card with
multi I/O expansion
USB Ports
Int. 56k & ISDN Modems
3DFX Voodoo GFX Card
Video Digitiser

Other Upgrades

32 Mb Flash ROM
SoundCard Wavetable

. . . and so much more

From £579 + VAT

For more information contact your local RISC OS
dealer or RiscStation on +44 (0) 1942 797777



€120

incl VAT & delivery

See <http://www.riscos.com>
for ordering details

Draw for designers?

The drawfile in RISC OS is a godsend – a standard way of communicating vector information from one package to another, that doesn't have the fragmented nature of EPS, and manages to maintain bezier curve information (unlike WMF).

Unfortunately, actually having to use *Draw* on more than a purely casual basis can result in bleeding from the ears. iSV's latest incarnation of their illustration software, *DrawWorks Millennium*, promises to



Figure I: The DrawWorks Millennium toolbar

alleviate this, by operating as a welcome adjunct to *Draw*, and providing a vastly improved feature-set to boot.

The software comes on a CD and includes a wealth of subsidiary applications from the iSV stable: the love-it-or-hate-it clip-art manager, *Mr Clippy*; the outline font editor, *Dr Fonty*; 2100 high-quality outline fonts with an associated installation manager and viewer, a selection of vector and bitmap clip-art, together with one of the best help systems I've seen for any collection of software. All in all, this is a huge package.

At the core of the product, though, is the new version of the *DrawWorks* application itself. *DrawWorks* provides an additional set of functions to *Draw* – it isn't a

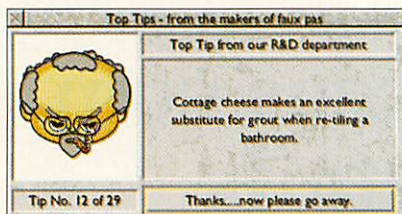

Figure II: Top Tips

Andrew Green takes a look at an updated package providing new life to Draw

complete vector art package in its own right. Nevertheless, these functions range from the trivial to the impressive, and by making use of the *Draw* interface, iSV can guarantee a certain amount of familiarity with the way the software can be expected to work.

Running *Draw* with *DrawWorks*

loaded produces an additional toolbar (Figure I) at the top of the window.

This toolbar disappears when the input focus is

in another application's window, and if you move or resize the *Draw* window, the toolbar hovers in its original place for a while and then jumps to the new position.

This is hardly a problem, but can be a little disconcerting at first, and emphasises the parasitical relationship between *DrawWorks* and its host, *Draw*. Happily, though, the toolbar can be dragged away from the main *Draw* window if required.

Toolbars and tools

DrawWorks splits its functions into a number of principle areas: File, View, Text Style, Object Style, Grid Settings, Select and Edit, and a couple of special ones I'll describe later. The top row of the *DrawWorks* toolbar is used to navigate between these areas, whereas the bottom row features the actual functions in each. Sensibly, the bottom row features a horizontal scrollbar to allow access to buttons that don't fit into the window

you're using. Many of the functions to which *DrawWorks* provides toolbar access are functions of *Draw* itself – but having a simple system to get at quickly with the mouse can be extremely useful.

DrawWorks' Select and Edit toolbar provides shortcuts for copying, grouping, interpolating, and adjusting the stacking order of any selection you've made, allows quick access to line editing functions (change line to a curve for instance), and allows certain operations to be undone.

It would be useful if the toolbar greyed-out functions that aren't available in the current context. Similarly, many of *DrawWorks*' path editing buttons, such as the (very useful) ability to enter the X,Y coordinates of a point, cannot operate when creating a path, only when editing it subsequently. This is a minor user-interface niggle, but would help with the responsiveness of the package as a whole.

There are other quirks to *DrawWorks*' user interface – not least of which is the 'Top Tip' the package provides on startup (although this, thankfully, can be turned off). The File toolbar, which provides access to



Figure III: The file import mechanism

import and export features, includes an 'Insert Named File' button to allow non-drag-and-drop insertion of elements to a page, which would appear to be contrary to the typical

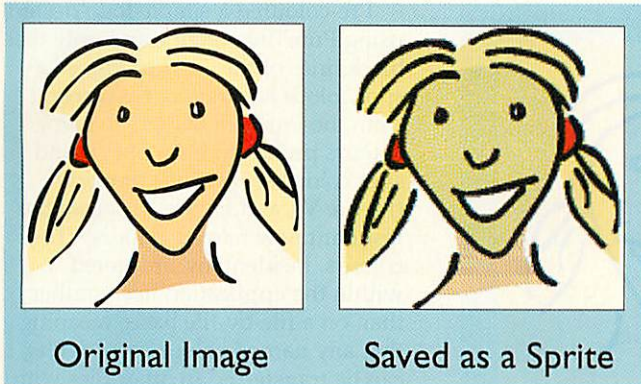

Figure IV: The results of exporting as an anti-aliased sprite

RISC OS ethic (although *Edit* has it too) – it's nevertheless a feature which works very successfully, should anyone want to use it.

Import and export

The toolbar provides a convenient way of importing foreign file formats into *Draw*, through the use of an additional dialog window for drag-and-drop purposes. It's a somewhat non-standard method, as dropping documents into the main window would be the conventional way of achieving the desired result, and all this further underlines the status of *DrawWorks* as an add-on to an existing program.

That said, it's hardly a great inconvenience for being able to achieve easy file import without needing programs such as *ImageFS*, and works very well for most of the formats it claims to. I had no problems importing TIFFs, WMFs or BMPs this way. I did, however, struggle greatly with the import of anything beyond the simplest of EPS files (even ones *ArtWorks* manages to cope with).

Some files rendered correctly, while reporting an error, and other files rendered incorrectly, or not at all – regardless of whether the EPS included a preview image or not. However there is a patch on iSV's Website that improves EPS import and export.

Sadly, *DrawWorks*' EPS export

facility is also troubled. It's a great shame about that, as the ability to deal with EPS images would initially have appeared to be one of *DrawWorks*' great strengths. EPS files are a standard way of delivering vector images from one package or platform to

another – although they come more-or-less in just as many varieties as there are packages which handle them.

I tested an EPS exported from *DrawWorks* in a number of Windows applications (perhaps a Mac would have been a more useful real-world test of this, however), and some packages coped well, others didn't. *FreeHand* and *Flash* rendered the file admirably, *PageMaker* gave up and just displayed the dreaded grey box (indicating that it couldn't build a successful preview image), and *Ghostscript* failed altogether, reporting errors in the PostScript code.

The patch to *DrawWorks* available from the iSV Products Website was unable to help with the files I tried, unfortunately.

iSV say that this problem is not theirs, the output is based on Adobe's own documentation but there have been undocumented changes in the various target applications. What's certainly the case, is that *DrawWorks* suffers from the same problem *ArtWorks* does, in that its EPS export facility doesn't ever include a preview image within the file. *DrawWorks* contains tools to allow the creation of sprites, GIFs and JPEGs from any selection on the canvas. Sprites and GIFs can be anti-aliased (JPEGs sadly can't), but it's first necessary to drop down to a 256-colour screen mode to achieve

this – images acquire a strange yellow hue if you don't.

Certain colours respond very poorly

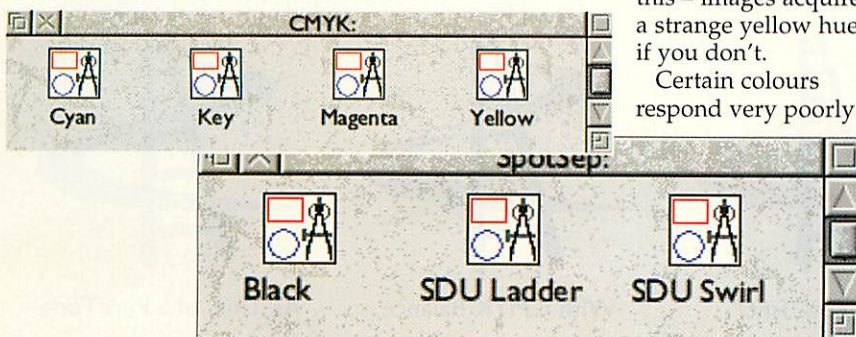

Figure V: CMYK and Spot colour separations windows

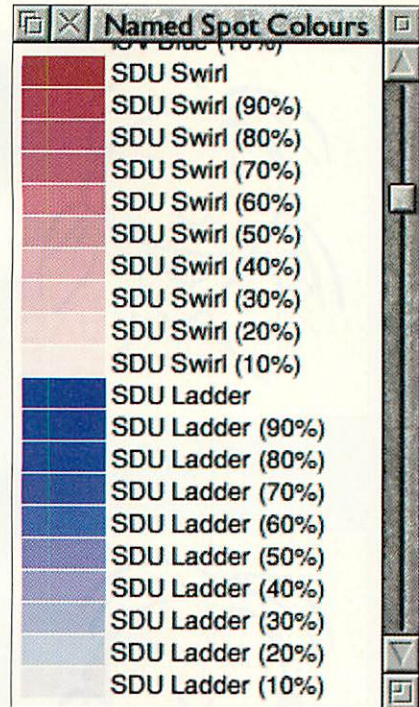

Figure VI: Auto-generated tints of named colours

to this approach – Figure IV shows the result on two test images. The girl's green face is an artefact of the dithering required for a 256-colour image.

Because *Draw* can't edit bitmap images, except for scaling and rotating effects, *DrawWorks* conveniently introduces a bitmap OLE (Object Linking and Embedding) tool. Any sprite image selected when using the tool is exported to *Paint* or, with a bit of preferences jiggery-pokery, *Photodesk* – and when returned retains its original position, scale and rotation (this will soon work for JPEGs as well).

This is a strong feature for an illustration program, and emphasises the way in which RISC OS applications can be expected to work happily alongside each other.

Colour editing

DrawWorks provides an excellent range of colour generation, selection and manipulation tools in its own special toolbar, that push this application into the *Actually Very Useful* category. To begin, the program comes with a set of colours named *PureTint* pre-installed – colours which bear an uncanny resemblance to Pantone, without any noticeable trademark infringement. A very happy coincidence indeed.

The application also provides a straightforward method of introducing named colours to *Draw*, any of which can be treated as an individual spot colour. Sadly,



Figure VIII: Printing on tinted stock

PureTint colours don't seem to respond as spot colours which would initially have appeared to be their primary use – however there would be a silly increase in separations if the colours overlapped.

Nonetheless, *DrawWorks* can create new named colours from a selection (and, very usefully, generate 10% tints of such colours automatically), creating spot colours from a specific PureTint tone is made easy, allowing PureTint tones to be used for more general colour purposes.

Although *DrawWorks* refers to named colours as 'Named (Spot) Colours', it doesn't seem to be the

case that named colours *have* to be treated as spot colour separations. The application provides two methods of generating separation files – as standard CMYK components, or as spot colour separations. Named colours appear in both, but only named colours can appear in the latter.

The separations thus generated appear in their own pseudo-filer window, and thoughtfully the software allows grey component compensation – meaning that the muddiness that can occur when equal values of cyan, magenta and yellow are combined is largely avoided.

I re-coloured a simple logo design using PureTint colours, and only the black lines of the swirl produced a spot colour separation. Converting from the PureTint colours to named colours produced both CMYK and spot colour separations properly (Figure V), and Figure VI shows the resultant new named colours. These colours, incidentally, are stored within the application itself, rather than on a file-by-file basis, meaning that any named colours you define can be transferred to other files with supreme ease.

Further colour tools include the ability to adjust the contrast, brightness and tint of any selection, including the ability to colour an entire selection as tints of a further colour. There's also a few bizarre options available as standard (tinting a selection to seemingly-random PureTint tones, or psychedelic colours, for example), but in general all these tools work magnificently – and work on non-JPEG bitmaps too, such that *ArtWorks*-like contone effects can be achieved with ease even on non-greyscale bitmaps. I wouldn't recommend random colours on a bitmap, though.

Figure VII shows a few transformations applied to the same logo. Happily, the Undo function seems to work on all of these tools – allowing for easy experimentation with settings – unless you're transforming a bitmap, which probably has everything to do with the complexity of such an operation and the size of *Draw's* undo buffer.

Not so happily, the program consistently decides to de-select any objects to which a transformation is applied, meaning that multiple transformations require re-selecting everything. Again, this is hardly a big deal – but it could eventually prove to be infuriating.

Special features

The package offers a method of simulating the results of printing objects on coloured paper, together with a simple technique for

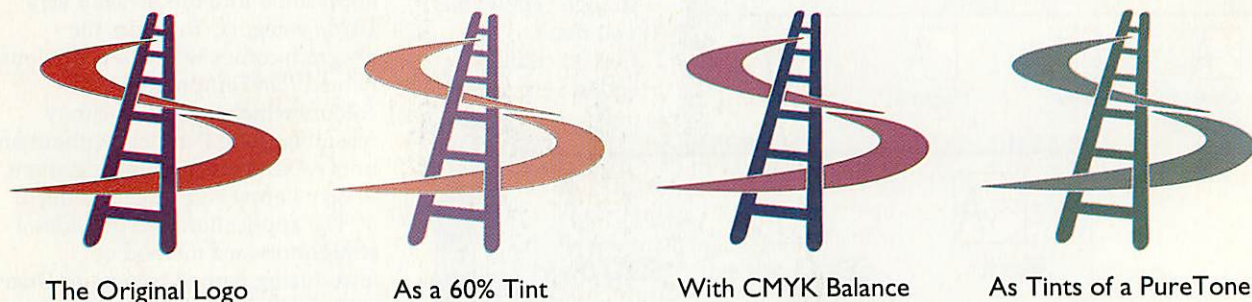

Figure VII: Some colour transformations

The Acorn Software Network

BUSINESS AND UTILITIES

Ant Internet Suite II	110.51
ArcFax	35.00
ArcFS2	29.37
ARCshare	49.95
Artworks	104.69
CD Burn	58.75
Complete Animator	94.05
DataPower 1	110.00
DataPower 2	166.32
DaVinci 90	81.08
Digital Symphony	56.95
Disc Doctor	28.45
Disc Rescue	45.00
Draw Works Designer	31.50
Easy C++	116.32
EasyFont Pro	59.95
Eureka 3	110.51
FastSpool+	17.62
Fireworkz Pro	166.31
Font Directory Pro	65.00
FontFX6	29.95
Game On! 2	15.00
Holy Bible (Illus.) BP(KJV)	82.25
HTML Edit 4	53.00
ImageFS 2	44.59
IMaster & TWIN Driver	35.00
Impact Pro	139.53
Impression Publisher	136.41
Impression Style	83.54
LanMan98	41.12
MelDI	129.00
MIDI Synthesizer	46.94
Midi Works	151.95
OHP (Presentation)	29.95
Ovation Pro	158.62
Prille port Zip driver (Argo)	34.08
PC Pro2	39.00
Personal Accounts V4	49.00
Photo Link	65.55
Photo Real (Canon/Epson)	65.86
Photodesk 3	299.50
ProArtisan 24 (RPC Only)	89.95
Prophet 3	179.77
Rhapsody 4	94.95
Schema 2	121.50
Sibelius 6	116.00
Sibelius 7	599.00
Sibelius 7 Student	345.00
Sleuth 3	116.32
SparkFS	25.00
StrongGuard	25.00
Studio Sound	113.95
Tablemate Designer	60.00
TopModel 2	145.11
Turbodivers (Can/HP/Eps)	54.69
WebSpider	40.00
WebTool for ANT Suite 2	29.38
WIMP Basic	44.99
Win95FS	41.12
XStitch 2	35.00

EDUCATION

Animated Alphabet, Talk	33.43
Arc Venture (various)	39.01
Aztecs, Age 7-11	50.17
Calabash Pirates	25.98
Crystal Rain Forest	50.17
DataSweet 3	69.33
Dazzle +	83.71
Dinosaurs (10/10)	13.49
Doodle	32.37
English (10/10)	13.49
Essential Maths (10/10)	13.49
Essential Science	13.49
Expl with Flossy the Frog	28.79
First Logo	38.95
Freddy Teddy's Adventure	23.50
French (10/10)	13.49
Fun School 3/4 (various)	24.99
Geography (10/10)	13.49
German (10/10)	13.49

Granny's Garden	28.79
James Pond Run. Water	27.00
Maths (Geometry) (10/10)	13.49
Maths (Number) (10/10)	13.49
Mega Maths	24.99
Micro Maths	24.99
My World 2 + 2	54.70
Naughty Stories Vols 1-6	44.65
New Teddy Bear's Picnic	36.78
Nursery Rhyme Time	33.43
Oxford Reading Tree 3	44.65
Pendown DTP	65.85
Playdays age 3-8	23.40
Playground (Freddy teddy)	23.50
Smudge the Spaniel	25.98
Spelling & Punctuation	13.49
Splosh+ (1-5 users)	51.70
Table Aliens	27.85
TinyDraw/TinyLogo	29.37
Tizzy's Toybox	47.94
Watch Magic Grandad	30.13

GAMES

Alone in the Dark	34.99
Anagram Genius	20.00
BHP Brutal Horse Power	28.49
Birds of War †	30.00
Black Angel	30.00
Carnage Inc.	22.50
Chocks Away Compend.	25.00
Cobalt Seed	23.74
Crystal Maze, age 7+	28.45
Cyber Chess	31.50
Darkwood	20.70
Demon's Lair	20.00
Drifter (DD/HD)	31.50
Dune II (CD - £31.50)	26.60
Dungeon †	27.00
E-Type 2 †	30.00
Eclipse Collection	22.49
Enter the Realm	25.00
Exodus	25.00
Fire and Ice	23.39
Global Effect	27.00
Groundhog	12.00
Haunted House	25.00
Holed Out Compendium	20.00
James Pond 2+	16.20
Logic Mania	27.00
Morph	25.00
Pandora's Box	25.00
Patience Addict	19.95
Play It Again Sam 3	24.95
Play It Again Sam 4	35.00
Real McCoy 2/3/4 (each)	35.00
Real McCoy 5	31.50
Rick Dangerous	15.26
Saloon Cars Deluxe	31.50
Scrabble	26.59
Shuggy	25.95
Shovy 3D	20.00
Silver Ball	12.00
Simon the Sorcerer	27.00
Small †	21.20
Spobleoid Fantasy	30.00
Stereoworld	22.50
Stuntracer 2000 †	35.00
Supersnail	25.00
The Time Machine	25.00
Virtual Golf	31.50

CD BUSINESS & UTILS

Arm Club PD CD 1	19.00
Arm Club PD CD 2	15.00
Artworks ClipArt 1 or 2	20.08
Bitfolio 7	42.74
Font Emporium	29.95
PDCD4 (Datafile)	15.00
PDCD5 (Datafile)	15.00
ProArtisan 2	98.93
Risc Disc Vol.1	15.00
Risc Disc Vol.2	20.00

Risc Disc Vol.3	25.00
Rob Duncan Cartoon Kit	42.74
Task Force Clip Art	33.20
Tekkie Disc (PRM's etc)	47.50

CDROM EDUCATION

Ancient Egyptians	42.30
Ancient Lands	50.53
Anim Talking Alphabe	33.43
British Isles from the Air	42.30
Castles	42.30
Crystal Rain Forest 2	50.17
Dangerous Creatures	50.53
Dinosaurs	50.53
Era of the 2nd WW	81.08
Garden Wildlife	42.30
Guardians of Greenwood	58.16
Hutchinson's Encyclopedia	52.82
Illustrated Shakespeare	29.32
John Cabot & Merchant V.	42.30
Kingfisher Micropedia	76.38
King Arthur	58.69
Kiyeko with Acorn reader	36.43
Map Detectives	50.17
Musical Instruments	50.53
My 1st Incred. Amaz. Dict.	41.13
Number Time 2	28.99
Oxf. Talking Infant Atlas	22.32
PB Bears Birthday Party	41.13
Perspectives Francais	81.08
Romans	42.30
Science Explorer	66.96
Seashore Life	42.30
Science In Action	13.73
Settlements	81.08
Space Exploration	13.73
Survival: Mysteries of Nat.	42.30
The Way Things Work	50.53
The World's Weather	52.87
Tizzy's Toolbox	44.65
TOTS TV	19.95
Ultimate Human Body	50.00
Understanding the Body	42.30
Vikings	42.30
World of Robert Burns	93.94

CDROM GAMES

Abuse	25.00
Ankh	25.00
Crystal Maze	28.45
Doom Trilogy	35.00
Dune II	31.50
Heroes of Might & Magic II	35.00
Simon the Sorcerer	32.40
Syndicate	29.00
Wizards Apprentice	24.95

1500 titles Available!!

Some dealers may not stock all titles

Minimum delivery £ 2

Credit Cards and Official Orders welcome. E&OE

All Prices Include VAT @ 17.5%

New & Featured software

Shovy 3D
New Game
£20

OVATION Pro
with Colour supp.
THE DTP package
now £145

ACORN C/C++
RRP £249
Offer £125

Touch Type
Typing Tutor
Offer price £25

Elements
Physics CD
Offer price £25

Key :

NRPC Not for RPC
† Separate RPC version

Many titles abbreviated for advert

Order from a participating dealer

CJE Micro's / NCS

Tel 01903 523666 Fax 01903 523679
email sales@cje.co.uk

CTA Direct

Tel 01942 797777 Fax 01942 797711
email sales@cta.u-net.com

The Data Store

Tel 0181 460 8991 Fax 0181 313 0400
email sales@datstore.demon.co.uk

Liquid Silicon

Tel 01592 592265 Fax 01592 596102
email liquid@cableinet.co.uk

Uniqueway

Tel 01222 464020 Fax 01222 440071
email sales@uniqueway.co.uk

Davyn Computer Services

Tel 01924 254800 Fax 01924 254036
email sales@davyn.demon.co.uk

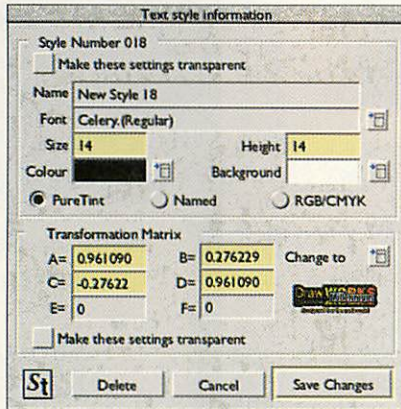

Figure IX: The text style definitions window

compensating the colours of the objects so that they retain their original tones on such paper (as much as is possible). Figure VIII shows this in action.

Unfortunately because *Draw* can't compensate well for the difference between screen representation of CMYK colourspace and the real thing, it's always possible that the end result would suffer a marked difference in colour from the screen appearance.

A further boon to *Draw* users is the incorporation of text styles, which can be defined from the current selection, and applied to any subsequent text object. The style system even accounts for shape transformations such as rotation and scaling (although the syntax for manually defining these could take some learning). There are also tools for applying kerning to any selection of text, and to generate a text spiral – which to create by hand would be a chore of the highest magnitude.

In that vein, *DrawWorks* offers a great many distortion and transformation features through its *DrawWorks Millennium* 'Special' toolbar. Instant drop-shadows can be added to a selection – including floor shadows and 'in the air' shadows – although the shadows thus generated don't have soft edges.

That's hardly surprising, but if the program were able to achieve this with the ease it currently offers, it

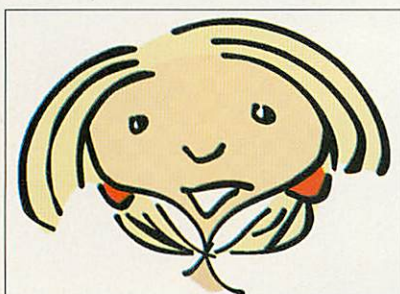

Figure X: Instant Elaine-from-Ally-McBeal

would be worth the asking price alone. Well, nearly, anyway.

The bulk of the Special toolbar is dedicated to the purpose of distorting objects according to defined, and definable, parameters. Objects can be moulded along a path, subjected to 3D transformations (such as being projected onto a sphere), scrunched, curved, mirrored, distorted to a bump map, and generally beaten senseless in the name of design.

Figures X and XI show a couple of the effects easily applied this way. These features are a great strength of the package, and offer a degree of flexibility and experimentation hard to beat.

The verdict

Although graphics professionals would be by-and-large disappointed with the limitations of the package imposed by its reliance

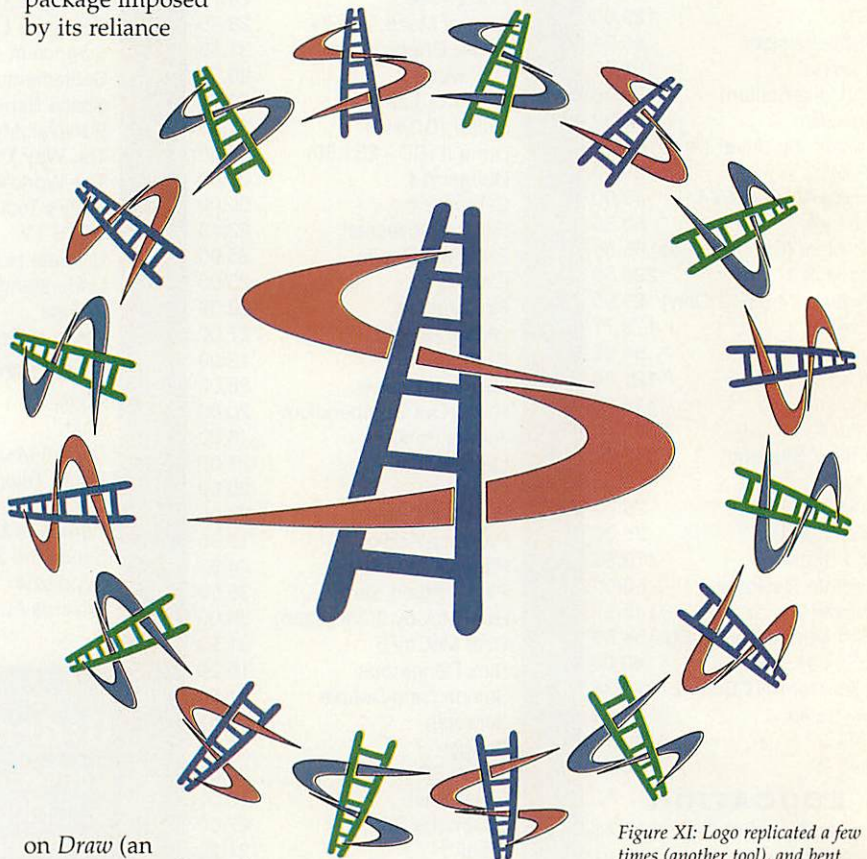

Figure XI: Logo replicated a few times (another tool), and bent along a circular path. Alternate logos had the 'swap red and green' colour effect applied.

on *Draw* (an abomination of a path editor, weak undo capabilities and complete lack of screen anti-aliasing – none of it *DrawWorks*' own fault), together with frustration at some of the features of the program that fail to work correctly in many places, such as the export of EPS files or bitmap images, there's enough in this package that delivers interesting and useful results to make it worthwhile.

If you simply need a program for illustration purposes on a more occasional basis, there's plenty that

DrawWorks offers to make use of *Draw* just that little bit more enjoyable, more productive, and frankly more of a viable proposition.

In combination with something such as *ArtWorks*, *DrawWorks* could come into its own. Its distortion and colour toning capabilities are very useful additions to your repertoire, and the application provides enough features that *ArtWorks* doesn't to make it a sound investment.

There's no doubt that the package represents phenomenal value for money, especially when you consider the extra software, and the huge number of fonts, supplied with the core program. User interface irritants and troublesome features aside, this new version of *DrawWorks* has much to recommend it. **END**

Product details

Product: DrawWorks Millennium
 Price: Normal price £61.50, current offer price £46.60
 Supplier: iSV Products, 86 Turnberry, Home Farm, Bracknell, Berkshire, RG12 8ZH
 Tel: 01344 455769
 E-mail: atimbrell@aol.com
 Web: <http://members.aol.com/isvproduct/>



Hard drives from only £11.75!

Computer systems

RISC PC 233MHz, 4Mb, 1.7Gb	£949	We can build a system to match your requirements (eg extra memory or larger hard disc). Please ask for a quote.
RISC PC 233MHz, 4Mb, 1.2Gb, CD	£979	
RISC PC 233MHz, 10Mb, 1.2Gb, CD	£1249	
RISC PC Web Wizard	£1350	
A7000+ Peak Performer	£880	

Memory Lane

A310 4Mb*	£52.87
A400/1, per Mb	£22.32
A310 4-8Mb	£99.87
(Assumes machine has a MEMC1a)	
400/1 4-8Mb	£99.87
A3000 1-2Mb	£5.87
A3000 1-4Mb	£41.12
A3000 to 8Mb*	£99.87
A5000 2-4Mb	£45.82
A5000 4-8Mb*	£99.87
A3010 1-2Mb	£23.50
A3010 1-4Mb	£45.82
A3020 2-4Mb	£34.07
A4000 2-4Mb	£34.07
RISC OS 3.11	£29.37
MEMC1a	£41.12
*Carriage/fitting	£22.32

RISC PC, A7000/+

Use FPM for the RISC PC and A7000, and EDO for the A7000+

	FPM	EDO
8Mb	£11.75	£11.75
16Mb	£25.85	£23.50
32Mb	£49.35	£44.06
32Mb HC*	£63.45	--
64Mb	£116.32	£123.37
128Mb	£217.37	£217.37

*=High Clearance.

VRAM (RISC PC)

1Mb	£43.47
2Mb	£78.72
1-2Mb u/g	£47.00
1Mb*	£25.85
2Mb*	£45.82
1-2Mb u/g*	£29.37

*For non-StrongARM machines

8Mb upgrades designed and manufactured by IFEL

Printers

Epson	
Stylus 440 Colour	£116.32
Stylus 640 Colour	£139.82
Stylus 850 Colour	£229.12
Stylus 1520 Colour	£405.37
Stylus Photo EX	£311.37
Stylus Photo 700	£158.62
Stylus Colour 900	£340.75
Canon	
BJC250	£99.87
BJC4400 Photo	£165.67
BJC 4650 A3 Colour	£264.37
BJC5000	£233.82
BJC6000	£222.07
BJC7000	£198.57

Monitors

Iiyama	
15" Vision Master 350	£158.62
17" Vision Master 403	£280.82
17" Vision Master Pro410	£316.07
19" Vision Master 450	£481.75
19" Vision Master Pro450	£487.62
21" Vision Master 502	£787.25
21" Vision Master Pro510	£809.57

Other types of monitor available from around £100.

Spares & repairs

We can repair Acorn machines and supply/fit upgrades.

Removable drives

Iomega	
SCSI Zip ext 100Mb	£99.87
Parallel Zip ext	£99.87
SCSI Zip ext 250Mb	£151.57
250Mb ZIP cartridge	£14.68
Software parallel zip	£29.37
SCSI Jaz 1Gb ext	£222.07
100Mb Zip cartridge 10pk	£88.12
1Gb Jaz cartridge 3pk	£205.62

25MHz ARM3 £57.57

400 dpi A5 scanner (256 grey scale), suits any machine fitted with a backplane.
Only £34.07

A3000 & A5000

Special offers

A3000: Upgrade to a 170Mb hard drive for £92.82 and buy a 4Mb RAM upgrade for just £22.32

A5000: Upgrade to 8Mb and second 500Mb drive, £180.95

Other sizes of drive available. Offer subject to availability. Price includes collection, fitting and delivery. (UK mainland only).

Switch boxes	2-way	£17.62
	3-way	£19.97
	4-way	£22.32

Guarantee

The warranty varies from one product to another, up to three years in some cases. Many items also carry our no-quibble 14-day money back guarantee. Please ask for details. Statutory rights unaffected.

RISC OS

4
£116.32

SPECIAL OFFER

Buy RISC OS 4 and purchase an 8.4Gb Fujitsu hard drive for just **£85 + VAT (99.87)**

Hard discs

NB Check out the Bargain Box below!

2.5" IDE A3000 A3010 and A3020

170Mb	£57.57
210Mb	£76.37
340Mb	£81.07
510Mb	£96.35
810Mb	£135.12
1Gb	£141.00
1.3Gb	£139.82
2.1Gb	£152.75
3.2Gb	£164.50

The A3020 will require partitioning software for drives larger than 510Mb £29.37

Other drive sizes available. Part exchanges considered.

3.5" IDE A4000 A5000, A300, 440/1

420Mb	£47.00
540Mb	£57.57
1Gb	£69.32
2.1Gb	£76.37

The A4000/A5000 require partitioning software for drives over 510Mb £29.37

RISC PC/A7000

540Mb	£57.57
1Gb	£69.32
2.1Gb	£76.37
4.3Gb	£84.60
6.4Gb	£99.87
8.5Gb	£111.62

In order to use an IDE drive, the A3000, A3010, A300 and 400/1 machines require an IDE interface (i/D). The cost of this varies depending on the features required. Example price: 170Mb for A3000/A3010 inc. i/f £92.82

Not sure what's required to fit a hard disc? Confused by the different options? Just ask for our **free data sheet**.

£81.07

170Mb hard drive system. Suits any machine fitted with a backplane. Limited stock.

Bargain Box

NB Many of the items in this section are second hand, and the list is constantly changing. Therefore please ring to check availability before placing an order.

3.5" IDE drives (Type, Qty, Price)		
40Mb NEC	2	£11.75
50Mb Quantum	1	£12.92
60Mb Conner	1	£14.10
80Mb Western Digital	1	£17.62
110Mb Conner	1	£19.97
130Mb Seagate	2	£23.32
160Mb Seagate	2	£25.85
160Mb Conner	2	£25.85
170Mb Seagate	1	£25.85
200Mb Conner	1	£30.55
200Mb Western Digital	2	£30.55
230Mb Conner	1	£31.72
250Mb Fujitsu	2	£35.25
250Mb IBM	2	£35.25
250Mb Western Digital	1	£35.25
260Mb Seagate	2	£35.25
730Mb Quantum	5	58.75
2.5Gb Western Digital	2	£72.85
3.2Gb Fujitsu	1	£84.60
8.4 Gb Fujitsu		£104.57

An IDE interface suitable for most of the above drives can be purchased for only £29.37 when bought with one of the above drives. Larger units (>500Mb) may require partitioning software when used on pre-RISC PC machines. Please phone for details. A mounting bracket is an additional £1.76. Example price: 40Mb Seagate with interface and mounting bracket £42.88.

Various

1Mb A3010 computer	£125.00
Hewlett Packard SVGA monitor	£65.00
Both the above, only	£150.00
Strong ARM inc RO3.7	£273.77
170Mb Hard Disc for A310	£81.07
1-2Mb A3010	£17.62
4Mb A3000 ram upgrade	£23.50
A3000 PSU	£17.62
400/1-Rise PC floppy drive	£23.50
Mouse A300-Rise PC	£14.10
Mouse A7000/A7000+	£17.62
RISC OS 3.11	£29.37
RISC OS 3.70	£45.82
RISC OS carrier board A300/400	£11.75
Input/Output (I/O) card	£34.07
A5000 2-4Mb ram upgrade	£23.50
Backplane for Rise PC	£34.07

Various Cont.

Backplane A7000	£45.82
Rise PC PSU (Second user)	£70.50
Alsystems SCSI 2 card	£111.62
PC Keyboard	£17.62
Keyboard encoder A300-A4000	£45.82
PLCC extraction tool	£2.35
ROM extractor tool	£2.35
56K modem	£69.32
Fan kit (300 series)	£8.22
Fan filters (pack of 5)	£3.52
486 clip-on cooling fan	£7.05
Dongle Dangle	£7.05
VIDC (New)	£34.07
VIDC (Second user)	£8.22
IOC (Second user)	£8.22
ARM3 25Mhz	£57.57
540Mb 3.5" SCSI drive	£58.75

Last month, we saw how virtual functions were used to achieve run-time polymorphism, or what is known as "late binding". This is opposed to normal "early binding" – events and function calls which occur at compile-time.

Virtual functions give greater flexibility, because the object type to be called is not resolved until run-time. You might recall that we handle virtual functions via a base class pointer, and that the function to be called is governed by the type of object it points to (which may be a derived type). Because this can't always be assessed at compile time, the object-function link must be made at run-time.

Virtual functions allow the programmer to define from a single foundation class, a "chain" of derived class types which can all be accessed as if they were equivalent (Figure I). This is a direct application of the "one interface, multiple methods" philosophy of OOP which is used in a moment for the project.

Pure virtual functions

It is often the case that we don't need to access the base class, and that it is used as a template for subsequently derived types, each with their own redefinition of virtual functions. To ensure that all derived classes do provide their own version, we use a pure virtual function within the base class. It has no definition, just the prototype and parameter list. Here is an example:

```
class base
{
public:
virtual void check(int value)=0;
};
class tens : public base
{
int n;
public:
void check(int value)
{ if(value>n)printf("greater than\n"); }
};
```

To declare a virtual function as pure, we add "=0" to the end of the

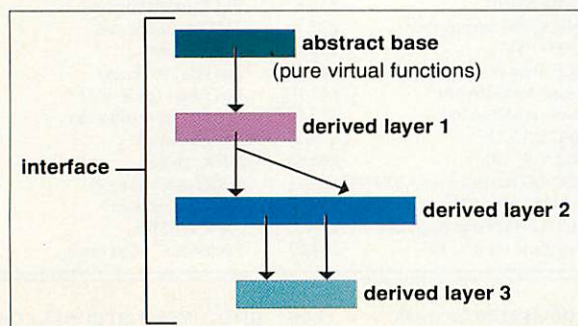

Figure I: A common interface to derived class types

Ooops

Greg Scott continues
his foray into OO
programming



function prototype. If we hadn't provided a new version of *check()* in the *tens* class, a compile-time error would have resulted.

Because the base class contains a pure virtual function, we call it an *abstract class*. Instances of an abstract class can't be created because pure virtual functions do not have function definitions. However, pointers and references to an abstract class are allowed, and by reassigning pointers to derived objects, run-time polymorphism is achieved.

Project Matrix

Our project is a Matrix Class Library in C++. C++ lacks any native support for matrices whatsoever, so it make sense to account for them. Matrices are used in many scientific fields, from fluid dynamics to population modelling. Although a description of a matrix was given in the earlier stages of development (found on past coverdiscs), Figure II illustrates some of the basics.

So, on to the system design of things. At this stage we must consider the objects which we shall use to represent different entities within our library. Square Matrices – where the number of columns and

rows is the same – are most common, but we must allow facilities for extending classes to cater for individual needs.

Our class structure will eventually follow the diagram shown in Figure III. All class types will be derived from the abstract matrix class. By using this

$$\begin{pmatrix} 2 & 0 \\ 0 & 2 \end{pmatrix} \text{ } 2 \times 2 \text{ matrix}$$

$$\begin{pmatrix} 0 \\ 2 \end{pmatrix} \text{ } 2 \times 1 \text{ matrix}$$

matrix types (rows x columns)

$$\begin{pmatrix} 3 & 1 \\ 1 & 3 \end{pmatrix} + \begin{pmatrix} 2 & 0 \\ 0 & 2 \end{pmatrix} = \begin{pmatrix} 5 & 1 \\ 1 & 5 \end{pmatrix}$$

addition (add corresponding elements)

$$\begin{pmatrix} 3 & 1 \\ 1 & 3 \end{pmatrix} \times \begin{pmatrix} 2 & 0 \\ 0 & 2 \end{pmatrix} = \begin{pmatrix} 6 & 2 \\ 2 & 6 \end{pmatrix}$$

multiply (times row by column)

Figure II: Simple matrix operations

system of inheritance, all classes within the library belong to a single, root interface, so run-time polymorphism can easily be facilitated.

You will also notice the inclusion of the coordinate derived types. Matrices by themselves cannot be used to great effect, they can only alter and operate on themselves. To make proper use of matrices, we need to incorporate external data. Commonly, particularly in mathematics, matrices are used in conjunction with coordinates in two or three dimensional space.

Readers of the old *Info pages should remember countless graphical demos making use of matrices in this way, and we shall do the same. Two dimensional coordinates are treated as 2 x 1 matrices, and three dimensional coordinates as 3 x 1 (see Figure IV).

Let's take our first look at some real working source code. We'll start with the definition of the abstract matrix class.

```
class matrix
{
protected:
```

daisy

```
float x1,y1;
char *name;

public:

matrix() { name=0; } // name to 0,
no name.
virtual display_as_text()=0;
virtual input_text_values()=0;

name_it(char *str){ name=str; }
};
```

The first thing to notice about this base class is that no elements are declared as private. This should, by now, make perfect sense – private elements are not directly available to a derived class.

The variables *x1*, *y1* and *name* are the three protected members of the matrix class. These variables will be found in all subsequent derivations, which implies that all matrix types will have at least two elements and a naming facility. Notice the use of floating point variables.

The public functions laid out by the base class act as an interface to

programs making use of the matrix library. A simple constructor is included to act as a default for later classes – some readers may have questioned the role of a constructor function within an abstract class (instances of which cannot be created).

The two pure functions are used to display and change each of the values of the matrix. They are declared as pure (with no definition) because at this stage the size or content of the matrix is not declared, so no provisions for input or output can possibly be made. The thing to appreciate is that by declaring the functions at the base of the structure, all following class types will make use of these function names – a re-occurrence of the one interface, multiple methods philosophy.

The last function declared is used

4, 2	$\begin{pmatrix} 4 \\ 2 \end{pmatrix}$
2-D coordinate	2 x 1 matrix
2, 4, 12	$\begin{pmatrix} 2 \\ 4 \\ 12 \end{pmatrix}$
3-D coordinate	3 x 1 matrix

Figure IV: Coordinate and Matrix equivalents

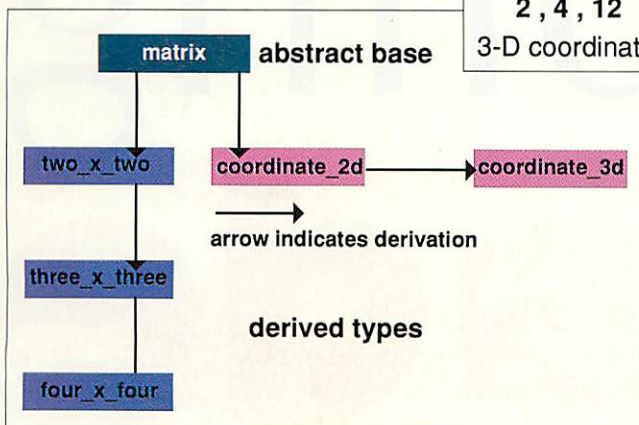

Figure III: Class structure for the Matrix Class Library

to name the matrix itself, a feature which could be helpful if the library were used, say, in a teaching environment.

Before considering the next layer in the class structure, C++'s input and output facilities must be explained, because the library will make use of them.

C++ I/O

Without spending too much time on the subject, C++ I/O is based around streams. Streams were used to an extent in C, to distinguish between types of input and output. C++ uses streams to achieve all interfacing – file, keyboard – any input and output devices.

For text I/O, we must make use of the *cout* and *cin* functions, both defined in the *iostream.h* header (which is now included in our source code) these make use of operator overloading to provide an elegant interface. The logical shift operators '<<' and '>>' are overloaded for output and input respectively. Here are some output examples:

```
cout << "Hello, Acorn World!";
```

Writes 'Hello, Acorn World!' on screen

```
cout << "OOP\nArticle number 5";
```

The \n adds a new line.

```
cout << "Text can be " << "Separated";
```

Writes 'Text can be Separated'.

The overloaded shift operator makes this new form of output far easier to comprehend than the old *printf()* method. To output the contents of a variable we need only specify its name instead of string constants:

```
cout << "The variable value was " << n;
```

Input is achieved using *cin* and the opposite shift operator:

```
cin >> x1;
```

Gets a value (after enter is pressed), stores in *x1*.

```
cin >> x >> y;
```

Gets two values, stored in *x* then *y*.

This is a much more attractive method than the C's *scanf()* implementation. It used to be that the address of a variable was required for input. The new characteristics of C++ means there are now ways around this syntax.

The Matrix Class Library will not use more complicated forms of text input and output.

END

One of Irlam Instruments' recent releases is a sound sampler, called i16. It fills a gap for those who want this facility, but do not need anything as comprehensive as Irlam's video/audio product 24i16. It comprises an expansion card plus software on floppy disc, and can be used to save analogue sounds from any normal stereo or mono source, such as CD players, radios, microphones and computer sound outputs.

It can also handle digital audio (from DAT recorders for instance), and will run in Risc PC, A7000, A5000, and A300/400/500 machines with RISC OS 3.10 or later. Minimum system requirements are 2Mb RAM and a harddisc. Captured sound samples can be stored as Wave files or in Replay format.

Like all Irlam products, i16 is easy to install and use. It has an on-screen manual, currently being expanded - the

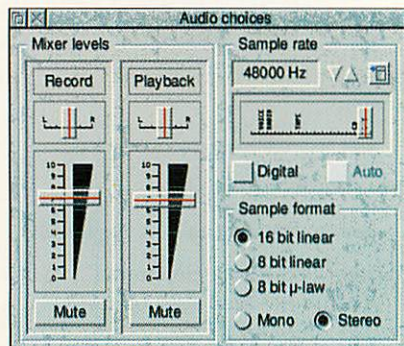

Figure 1: Settings for a sampling run in the Audio Choices window

tiny screen text is unreadable, but any or all of its pages can be printed out to A4. Limited space on the expansion card dictated 3.5mm stereo sockets for analogue input and output, and an additional socket is provided for the computer's headphone output.

Phono sockets are used for digital input and output signals. A MIDI connector is provided for a possible future expansion, but has no function at present. Mono inputs are accepted from the left channel only, but play back through both channels.

i16 has two windows, shown here. One handles various options, and the other collects the sound samples. The first, headed 'Audio Choices', has sliders to adjust the signal levels for recording and playback modes separately. Above each slider is a stereo balance control.

The sampling format can be chosen from 16-bit linear, 8-bit linear or 8-bit logarithmic. 16-bit is the industry standard, used in CDs and DAT recordings. 8-bit linear gives audibly poor sound, but needs only half the memory. 8-bit logarithmic takes the same memory as 8-bit linear, but gives better sound quality.

Sampling for quality

The fidelity of the recorded sound depends on the sampling rate, which is the number of times per second that the sound wave amplitude is measured. A well-established rule states that the sampling rate must be at least twice the highest frequency to be sampled, for accurate

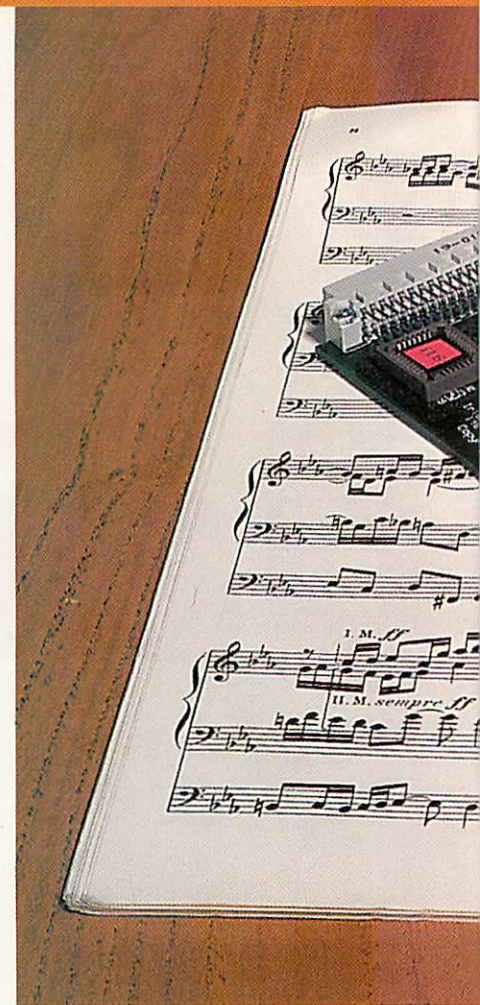

reproduction. This applies to random noise, but music may contain steady tones, which theoretically require sampling at three times their maximum frequency.

The industry standard rate is 44,100 per second, which allows frequencies up to 14.7KHz to be rendered precisely. With a maximum sampling rate of 50,000, i16 can handle 16.7KHz, giving excellent sound reproduction. In fact only a

Sampling made

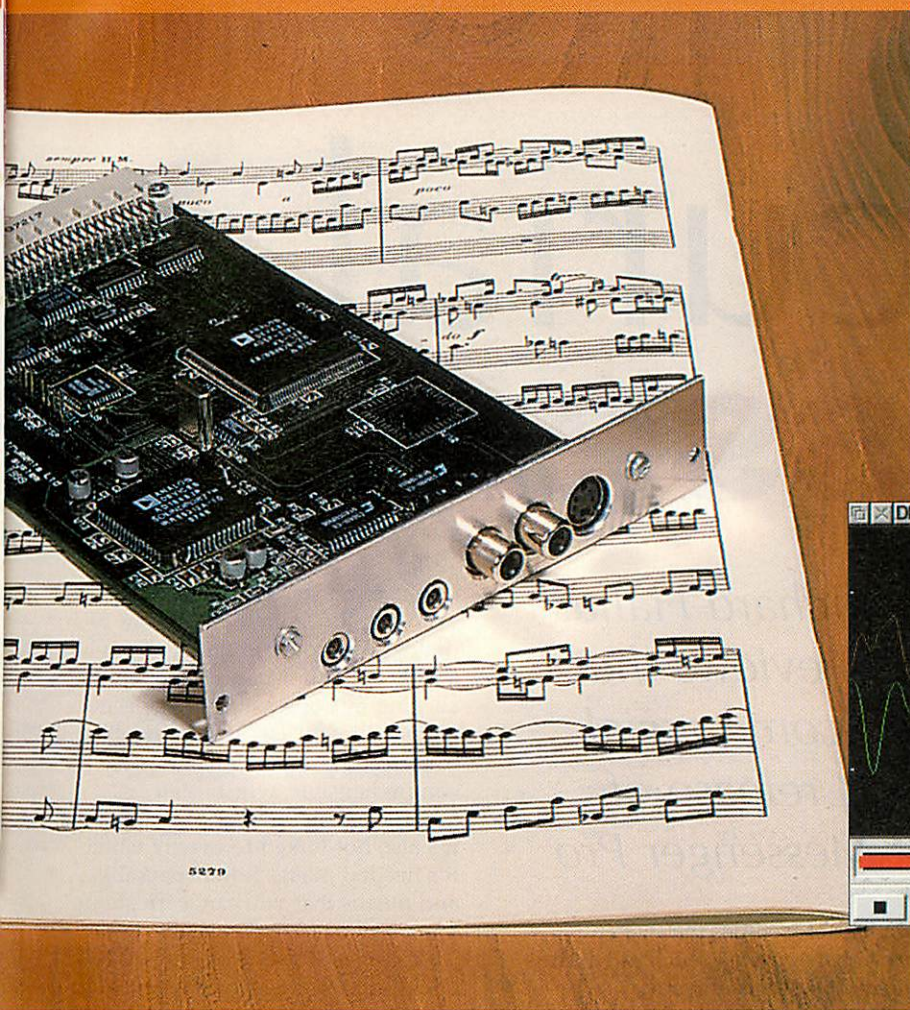

Photo: The i16 expansion card, resting on a score of Max Reger's *Phantasie und Fuge Op29* for organ. This piece, and other genres, were used in the i16 listening tests. (Photo: Trevor Attewell)

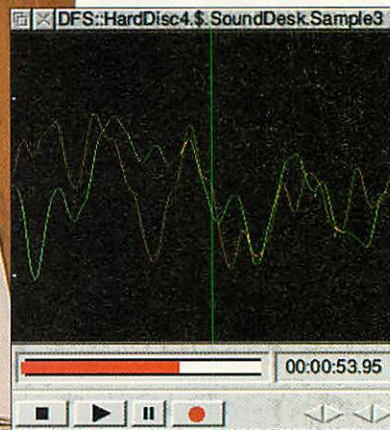

Figure II: A recording in progress, showing left and right waveforms. Note the small white 'peak program meters'.

very few youngsters can hear tones above about 18KHz.

In i16 the rate can be selected either by dragging a slider, or by selecting it from a menu. In the latter case the choice is made either by clicking on a number, or by selecting a named source, such as 'voice' or 'CD'.

It is tempting to use the highest rate for everything, but that demands about 200K of harddisc space per second, and would be wasted on speech, for example. The second window has a display similar to that of an oscilloscope, showing

*Trevor Attewell
makes some
16-bit sounds*

the incoming left and right sound waveforms. Two small indicators, on one edge of the display, follow the peak positive and negative waveform levels very rapidly, but fall back slowly. They make it easier to avoid clipped peaks, which might result in distortion.

Below the window a red bar indicates the length of a recording in progress. The precise timing is shown separately in minutes and seconds. Above and below the red bar are black lines which can be dragged to limit the recording, or the playback, to any chosen start and/or end point. There are also nudge buttons which can be used to make fine adjustments.

These timing additions appeared in the latest version 1.03, reviewed here. They make it possible to define the desired sample accurately from a longer section saved previously. Under

this window are the usual controls, Stop, Play, Pause and Record.

But how's the sound?

Sound cards in a computer are subject to noise pickup, some from the mains, and a lot more from high-speed digital signals, especially in Risc PCs with StrongARM, as used for this review. i16 is built on a four-layer board, with separate analogue and digital copper screens between layers. This improves quality on unscreened cards, but cannot be a complete cure. Experimenting with the layout of external cables may also help.

Finally, for those who like to see actual measurements, the overall frequency response relative to 0dB at 1KHz was -10dB at 20Hz, -3dB at 50Hz and -1.8dB at 20KHz. Noise was better than -50dB at the standard output of 1mW into 600 ohms.

END

Product details

Product: i16
 Price: £149 + VAT (£3.50 p&p)
 Supplier: Irlam Instruments Ltd, Brunel Science Park, Brunel University, Kingston Lane, Uxbridge, Middlesex, UB8 3PQ
 Tel/Fax: 01895 811401
 E-mail: sales@irlam.co.uk

easy

Mercurial messenger

Although the RISC OS platform is not exactly renowned for its widespread support of all the latest Internet standards, one area in which it has always fared surprisingly well is its e-mail and newsgroup-handling software.

One of the earliest pieces of really comprehensive and well-written Internet software for RISC OS was *Newsbase*, the freeware e-mail and news database application which for a long time formed the backbone of most users' e-mail setups.

Newsbase, though, only stored the messages themselves; in order to actually read them, you needed a newsreader application. There were a few of these, but the best was undoubtedly *Messenger*, which was one of the most professional-looking pieces of free software ever to grace the RISC OS platform.

If, like me, you are one of those people who considers *Messenger* a favourite piece of software, then prepare yourself for a new favourite, because *Messenger Pro* is finally here. And if you're not one of those people, it's about time you checked this software out.

Getting going

Let's start with the bad news. *Messenger Pro* is now a commercial product which, surprisingly enough, means that you have to pay money for it. Luckily, you get a lot for your money. What's really remarkable to my mind is that *Messenger* was ever free in the first place.

I started off by talking about *Newsbase*, and that was important because *Messenger* used to rely on it. However, one of the most significant improvements in *Messenger Pro* is that *Newsbase* is no longer needed. *Messenger Pro* can now do all the work of filtering and storing messages itself, so not only does that make for a tidier solution, but it also allows *Messenger Pro* to offer a

Richard Hallas reviews the commercial release of *Messenger Pro*

number of facilities that weren't previously possible, such as editing queued messages directly.

On the other hand, if you're a long-term *Newsbase* user with a sprawling e-mail setup that you don't want to be forced to change, *Messenger Pro* can carry on using *Newsbase* instead of its own database system. *Messenger Pro* now comes on a single floppy disc in a standard R-Comp plastic wallet with lo-tech packaging and a brief printed guide. This explains how to install the software, and the basics of its use, but the main online documentation is provided in *StrongHelp* format and is one of *Messenger's* great strengths.

With software as complex as *Messenger Pro*, it's not reasonable to

expect to master (or indeed even use) every facility from the start, but each dialogue window in the program has a little blue information icon, and clicking this opens the appropriate page in *StrongHelp*. This online help is both comprehensive and comprehensible, which is an admirable combination. The fact that it's also hot-linked to exactly where it's needed makes it indispensable, and means that you can learn about *Messenger Pro* as you use it.

Messenger Pro works with all RISC OS Internet software packages, so it doesn't matter whether you have the *ANT Internet Suite*, *Voyager*, *Termite* or a set-up based on freeware software. Installation is a delightfully simple operation (particularly so given the inherent complexity of Internet software). You do need to read and follow the installation guide, but the process has been made about as automatic as possible.

Many users will previously have used *Newsbase*, and if a *Newsbase* set-up is present, *Messenger Pro* will allow you to use it. Moreover, if you decide that you want to use *Messenger Pro's* own database functions instead of *Newsbase*, then it

58

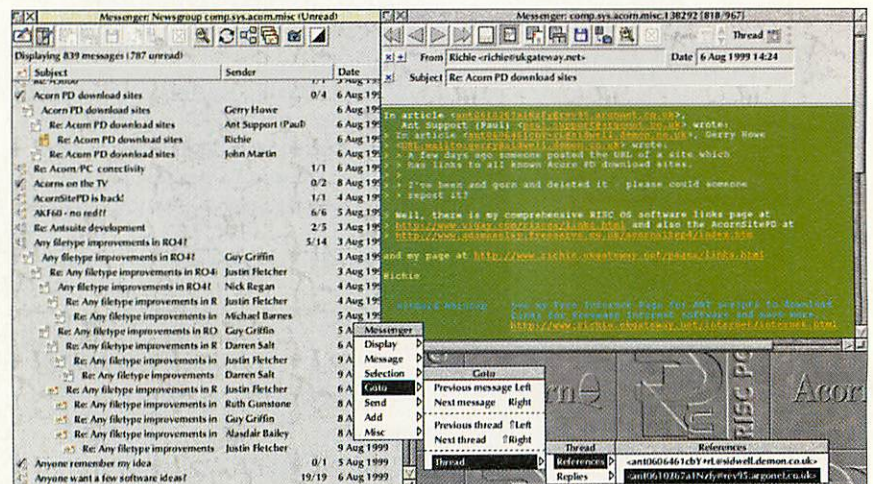

Threads: *Messenger Pro's* ability to group related messages into threads, and handle them in a helpful way, is second to none

is able to import your entire collection of e-mail and news messages as part of the installation process. So, both the installation and the transition to a new system are made only minimally painful, and this ease of installation is something that counts very strongly in *Messenger Pro's* favour.

Untangling the string

Messenger Pro is a multi-user system, and very powerful. Even if there's only one of you, having multiple e-mail identities can be useful, and clearly a multi-user system is very helpful in a classroom environment. (Educational users may also like to know that an online version of *Messenger Pro* is available at a small extra cost).

If all you want is a single e-mail address, though, you can forget that the multi-user facilities are there, as a default user is set up as part of the installation process. Regardless of whether you set up multiple users, you can also create archive groups for backing up messages of your choices, or for keeping archives of e-mails from mailing lists or whatever.

Once you're set up, it's time to open a group of messages. The presentation of *Messenger Pro's* windows is very attractive and helpfully laid out, and the comprehensive button bars have brief online help to remind you what everything does. Icons indicate the status of messages (read, unread, deleted, for attention, replied to, attachments included), and there are many viewing and sorting options, all of which can be fully customised for each group (be it e-mail or news).

One of *Messenger Pro's* great strengths, though, is its handling of article threads. If you're not familiar with this concept, it relates to messages on the same subject, where someone has started a discussion and other users have replied to it at different times. *Messenger Pro* handles such threading superbly. It collapses all messages relating to each subject into a single line, so that all you see initially is the name of the topic (along with the number of messages relating to it).

Double-click on the entry and it opens up to show all the messages in the thread, and each one is indented to an appropriate level so you can see at a glance which of them relate to each other. Superb. Also, when reading any message, a pop-up menu shows exactly which other references and replies relate to the current

Tip for ANT users

If you want to use *Messenger Pro* with the *ANT Suite* instead of *Marcel*, you'll also want to set up your software so that *Messenger Pro* is launched when you double-click on the E-mail & News icon in the ANT front-end. It's easy to do this.

Find the *InetSuite* application on your harddisc, and Shift+double-click it to open it up. Look inside the *Internet* directory, then inside *Files*, and find a text file called *InetPanel*. Make a backup copy, just in case. Now load *InetPanel* into a text editor; you'll see an entry for each of the icons in the front-end window. Simply edit the mail&news line so that it points to *Messenger Pro* rather than *Marcel*. In my version of the file, the line reads:

```
mail&new BOOT InetApps:Apps.Tools.!Messenger
```

(The BOOT bit is optional, and just means that *Messenger Pro's* *!Boot* file is executed when the *ANT Suite* starts up.) Resave the file, quit and reload the *ANT Suite*, and you should find that you have a convenient short-cut to *Messenger Pro*.

message, allowing you to navigate between them easily. This is all excellent stuff, and makes *Messenger* by far the best threaded newsreader I've ever used.

In a vaguely similar vein, the display of the messages themselves is very helpful because you can view text quoted from other messages in a variety of colours. This is excellent for distinguishing who's saying what in a heavily-quoted section of text. *Messenger Pro* also supports Jonathan Duddington's *Speak*, and can read different quoting levels in different voices. Headers, signature and URL information within messages is also shown in different colours - URLs can be launched with a single click.

Messages can be bounced, forwarded, archived off to folders, dragged out to other applications, read aloud and otherwise manipulated. The only major action which is not part of *Messenger Pro* is the actual editing process when creating or replying to messages. As with most other RISC OS newsreaders (except *Pluto*) this is left to the user's personal choice of external editor. I favour *Zap* with Darren Salt's HTML mode, but some users prefer *StrongEd*.

Once you've written a message and are ready to send it, *Messenger Pro* offers spell-checking facilities, and will also (optionally) warn you if you have broken any 'netiquette' protocols. If you want to attach files to your message, just drag them to the same window where you enter the message subject and recipients. *Messenger Pro* can handle messages in MIME and UUencoded formats.

What's the score?

One of the most innovative things about *Messenger Pro* is its concept of *scoring rules*. The idea is that

messages can be given priorities according to a set of rules that you define; so, if you know that e-mails from a particular individual require a more urgent reply than e-mails from other people, you can set things up so that that person's e-mails appear first, for example.

Scoring rules can be quite complex, and can be used in combination with threaded displays (each thread receiving the total score value of the messages within it), so you could theoretically perform simple automated e-mail surveys by setting up a few scoring rules and leaving *Messenger Pro* to do the hard work. It's a fairly complex system, and not for the faint-hearted but powerful. (Daunted users can safely ignore it.)

Along similar lines, *Messenger Pro* also offers message filtering if you use its own internal database system. (*Newsbase* offers similar facilities if that's what you use). This allows messages to be killed before they're even read, or siphoned off into more appropriate archive groups. Filtering is quite powerful, but if all you want to do is send messages from a particular address to a particular archive folder, *Messenger Pro* has a built-in mailing list facility which is easier to use.

Shortcomings

Currently *Messenger Pro* has a small number of shortcomings, although none are serious. For instance, while the status icons alongside e-mail messages are very helpful, I find them quite hard to distinguish from one another; ironically, the older icons used in the pre-*Pro* version of *Messenger* were very much clearer, and it's a shame that they weren't retained. More seriously, the search

facilities are rather basic. What happens is that you enter some search criteria and a new message group is created to contain the results.

That's fine as far as it goes, but there are two major limitations. Firstly, the found messages are aliases to the originals, and there's no way to work on the originals themselves.

While this avoids irretrievable errors, it doesn't allow you to do things like physically moving messages between folders or deleting unwanted messages. Secondly, you can only search using one criterion at a time, which is very limiting, and there's no easy way to search for outgoing e-mails to specific people, because you can't search for the recipient of a message.

Overall

So, should you buy *Messenger Pro*? If you only use freeware Internet software, the answer is a definite yes, because it's better than anything else and isn't expensive. If you use a

commercial Internet suite you may feel a bit cheated off at having to pay out again, but it's definitely worth it in terms of price and performance.

ANT users in particular are strongly advised to get *Messenger Pro*, as the bundled newsreader, *Marcel*, looks decidedly amateurish by comparison. The only people who should really hesitate are those users who have already bought Jonathan Duddington's e-mail/newsreader package, *Pluto*.

Here, a cross-grade is probably not worthwhile unless you need specific facilities that *Pluto* doesn't provide (*I'll back that up, I use Messenger Pro for work where I need multiple identities, but for personal mail I use, and prefer, Pluto - Ed*).

To my mind, there is little doubting that *Messenger Pro* is the superior of the two products: *Pluto* doesn't do "proper" thread-handling and isn't a multi-user system. Also, it doesn't offer *Messenger Pro*'s compatibility with existing *Newsbase* setups. I've been using the latest *Pro* version for several weeks, and the

earlier freeware version for years before that, so I feel confident in saying that the package is solid, reliable and a delight to use.

Not only is it my favourite e-mail package for RISC OS, but it's also the best such package I've used on any computer. If I had to choose between *Messenger Pro* and, say, *Outlook Express*, I know which I'd pick (and it wouldn't be the Microsoft offering).

END

Product details

Product:	Messenger Pro
Requires:	4Mb RAM (8Mb recommended); RISC OS 3.1 or later; Internet connection and appropriate software
Price:	Single user £30; Online/network version £40; Site/network licence £100;
Supplier:	R-Comp, 22 Robert Moffat, High Legh, Knutsford, Cheshire WA16 6PS
Tel:	(+44/0) 1925 755043
Fax:	(+44/0) 1925 757377
E-mail:	rcomp@rcomp.co.uk
Web:	http://www.rcomp.co.uk/



Stuart Tyrrell Developments

ParaFS

RED HOT Networking.



Works with all machines fitted with a bi-directional parallel port (A300/A4000/A5000/A4/A7000/RiscPC).
Implemented as a filing system for transparent file-sharing across machines.
No need for cumbersome and slow transfer programs.
Typically achieves access speeds of well above 100K/sec!

"I found ParaFS easy to install and straightforward to configure and it has worked without a hitch. I like it."
Philip Perry, Archive 12.10.
£29.95 with a RED HOT connection cable, or £22.95 for the program alone.

Mouse Interfaces, Trackballs etc

PS2Mouse Use PS/2 mice on your Risc OS machine £24.95
PC Phantom Joystick for above (4x auto fire, throttle etc) £31.95
PS2Mouse+ With through port to keep Acorn mouse £39.95
Touchpad Mouse replacement. Use with PS2Mouse+ £29.95/£34.95
Trackball Large heavy ball. No interface - plug straight in! £34.95
Mouseball Replacement heavy mouse ball, 21mm £2.00

Game Interfaces, Joysticks etc.

PCJoy Analogue joystick interface gives you a gameport! £39.95
PC Phantom Joystick for above (4x auto fire, throttle etc) £31.95
Tigon Alternative joystick for above. £21.95
Solo Budget joystick interface for atari-style digital sticks. £14.95
Apache Joystick for above (microswitched) £9.95
Python Alternative for above (non-microswitched) £6.95
Ninterface Joypads (single/double) £23.95/£31.95
Obsolete Drivers Disk for old joysticks/joypads etc £7.95

Access Products

PS2Mouse+ also has switch inputs - ask for details! £39.95
Holdfast Joypad Robust joypad for use with Solo £24.95
Switch input leadset for Solo (simulate mouse/keyboard) £9.95
Keyswitch+ Switch keyboard replacement (advanced order) £49.95

Easy Sharing!

Share devices between a RiscPC and PC using our range of quality switches. All include cables.

Keyboard, PS/2 mouse and serial switch (ideal if your monitor has two inputs) £39.95
15HD to 5x BNC monitor cable for above £19.95
Keyboard & Monitor switch £39.95
Keyboard, Monitor and PS/2 mouse switch £49.95
Printer (1 machine->2 devices) £17.95
Printer (2 machines->1 device) £22.90
Many other combinations are available - call for details.



SWITCH BOXES!

STU
Stuart Tyrrell Developments
PO Box 183, OLDHAM OL2 8FB
Tel: 01705 848 800 (9am-9pm)
Fax: 01705 164 1604 (national rate)
Email: info@stdevel.demon.co.uk
http://www.stdevel.demon.co.uk

Phone, Fax or email for a free product information flyer!

All prices include P&P
Delta/Visa/Mastercard welcomed.
All trademarks acknowledged. E&OE.



ACORN MIDLANDS SHOW

Supporting users in Central and North England

Saturday 20th November 1999

**The National Motorcycle Museum,
Birmingham**

Doors open from 10am until 4.30pm

Adults £2.50
ARM Club members £1.50
Children under 16 FREE (accompanied by an adult)

- Latest products ● Charity Bring & Buy
- Special show discounts ● Demo your programs
- Hobbyist/Games area ● Meet fellow enthusiasts

(Refreshments available)

Free bus shuttle from train station

Phone: (01785) 714535

Email: ralph@armclub.org.uk
http://www.armclub.org.uk/shows/midlands

Century House
Market Street
Swavesey
Cambs. CB4 5QG
Tel/Fax 01954 208208
sales@eesox.com

eesox

Eesox have some offers too good to miss...

...so check out our web-site now...

www.eesox.com

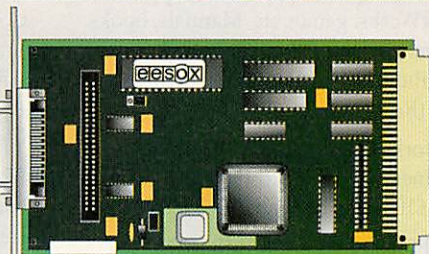

**Eesox SCSI
Card
£99.00
Incl. VAT**

**INTERNAL DVD-RAM
DRIVES NOW ONLY
£389.00
DVD
RAM**

See our new web-site for details on all our products

CD-REWRITERS

CD-ROM DRIVES

DVD-RAM

SCSI CARD

GRAPHICS TABLET

AUDIO

SOFTWARE

HARD DRIVES



Liquid Silicon

32-bit MIDI Sequencer

MELIDI

Powerful
Flexible
Easy to use drag & drop
Controller maps (e.g. tempo and velocity) easily alterable by drawing with the mouse
Patterns can be linked to reflect changes made to other patterns
Handles System Exclusives
Multitasking playback
Supports any MIDI interface, including parallel and serial
Up to 192 MIDI channels and no track limit
Free demo disc available
Now available - £129.00

Recent/New Releases

- Abuse - £23.00
- Descent CDs - £28.00
- Heroes of Might and Magic 2 - £32.00
- Heretic & Hexen CD - £32.00
- OHP CD (Spaceteck) - £28.95
- Photodesk 3 - £279.95
- Sunburst - £12.50
- Syndicate Plus CD - £26.50



Discs (example 10x white discs - £4.60, 50x black discs - £15.10, 5x HD red/blue/green/white discs - £2.49)
Batteries (e.g. 4x AA Xtra alkaline - £2.18, 1x 9V alkaline - £1.84)
Audio & Video Tapes - £Various

FREEPOST EH2725
Kirkcaldy, Fife, KY2 5BR
United Kingdom

Tel: 01592 592265 Fax: 01592 596102

email: Liquid@cableinet.co.uk
<http://www.cybervillage.co.uk/acorn/liquid/>

Computers & Music Hardware • Upgrades • Software • Cables etc •

We supply a range of CCD and laser bar code scanners and include with these our IBarReader driver software which allows bar codes to control most desktop software.



Further information is available. Complete systems from £137.83



Our bar coding software produces Draw files of the following formats: EAN 8, EAN 13, UPC A, ISBN, ISSN, Code 39 (Normal and Full ASCII), Telegen and Binary.

Further information is available. IBarCoder - £69.33

Computer Systems

- These prices do not include monitors, unless specified.
- Risc PC 8+0Mb 2Gb HD - £879.00
 - Risc PC 32+2Mb 8Gb, DVD CD - £1089.00
 - Web Wizard - 32+2Mb, 8Gb HD, DVD CD drive, speakers, Result, EasyWriter Pro, 56K modem, ANT Internet Suite with Java - £1220.00
 - A7000+ Odyssey CD - 16Mb, 4Gb, 40x - £655.00
 - A7000+ Odyssey Primary/Secondary - 16Mb, 4Gb HD, 40x CD & software - £713.00
 - A7000+ Odyssey Surf - 24Mb, 4Gb, DVD CD, 56K modem, ANT Suite - £831.00
 - "Sprinter" NC system - 10baseT, 16Mb, 14" monitor, keyboard & mouse - £444.00
 - MicroDigital Mico - From £586.00
 - RiscStation R7500+ - From £675.00

Monitors

- (Either bought with computer or separately):
- Iiyama 350 (15") - £170.00
 - Iiyama 403 (17") - £283.00
 - Iiyama Pro 410 (17") - £319.00
 - Iiyama 450 (19") - £467.00
 - Iiyama Pro 450 (19") - £483.00
 - Iiyama 502 (21") - £749.00
 - Iiyama Pro 510 (22") - £772.00
 - Iiyama Pro-Lite 36a 14.1" LCD - £687.00
 - Iiyama Pro-Lite 38a 15" LCD - £910.00
 - Iiyama Pro-Lite 38b 15" LCD - £945.00
 - Iiyama Pro-Lite 39a 15" LCD - £1599.00
 - Iiyama Pro-Lite 46a 18" LCD - £2469.00
- Touchscreen monitors coming soon - please ask for further details

PC cards

- 5x86-100 with PC Pro 3 - £285.00
- PC Pro 2 - £38.95
- PC Pro 3 - £70.50
- PC Sound Pro 2 - £39.95
- Win95FS - £39.95
- Windows 98 CD - £100.00

Psion Series 5mx

- 16Mb, with PC connection kit - £429.95
- Parallel link - £34.95

Memory Upgrades

- Please call to check current prices. Other upgrades are available.
- A3000 1-4 Mb - £64.60
 - A3010 1-4 Mb - £66.00
 - A3020/A4000 2-4 Mb - £49.00
 - A5000 2-4 Mb - £55.00
 - A300, 400, 5000 4-8 Mb - £128.00
- Risc PC/A7000 FPM SIMMs:
Call for EDO SIMM prices
- 16Mb - £26.60
 - 32Mb (not original RPCs) - £49.75
 - 32Mb (high clearance) - £73.50
 - 64Mb - £79.85
 - 128Mb - £180.00
 - 1Mb VRAM - £45.00
 - 1-2Mb VRAM swap - £55.00
 - 2Mb VRAM - £92.00

Music & Sound Section

- Please call for other musical items
- MIDI interfaces:
- DMI 50 dual MIDI card (2x2) - £119.95
 - DMI 50XC - £239.95
 - XG upgrade for DMI 50 - £197.95
 - 16-bit sampler for DMI 50 - £92.75
 - MIDI Max II internal 1x1x1 - £92.75
 - Parallel Port 1x1x1 - £92.75
 - Synth 8 or Basic Synth - £46.95
 - Synth Plus - £56.65
 - Music & Sound Prog. Guide - £16.95
- Other hardware:
- Fatar SL 750 - £450.00
 - Fatar SL 850 - £600.00
 - Fatar SL 1100 - £800.00
 - Fatar SL 2001 - £1050.00
 - Irlam 116 sound sampler - £118.00
 - Digital-upgraded Irlam sampler - £177.00
 - MIDI upgrade for Irlam sampler - £Call
 - Sound Byte Recorder - £37.50
 - Yamaha YST-M8 speakers - £45.50
 - YST-M20 DSP speakers - £89.75
 - YST-MS28 speakers & subw. - £79.95

- YST-M100 speakers - £117.00
 - YST-MSW5 subwoofer - £59.00
 - YST-MSW10 subwoofer - £71.20
 - Yamaha MU10 sound module - £169.00
- Other software:
- MediaPack - £23.95
 - MIDI Support - £18.50
 - ProSound - £116.95
 - Rhapsody 4 - £94.95
 - Junior Sibelius - £49.00
 - Sibelius 6 - £99.95
 - Sibelius 7 Student - £119.95
 - Sibelius 7 - £625.00
- Sibelius for Windows is also available
- Optical Manuscript - £259.00
 - Sound module serial driver - £37.95
 - Studiosound - £116.95

Other Hardware

- Dual fast serial card - £90.00
- Ethernet card (Combi NIC slot) - £116.30
- Hard drives & kits - £Call
- RPC second slice (no PSU) - £90.00
- RISC OS 4 (fitting available) - £120.00
- StrongARM upgrade - £275.00

Other Software

- Ankh - £23.00
- ANT Internet Suite 2 - £112.00
- Brutal Horse Power - £26.00
- DataPower 2 - £165.00
- Doom+ CDs - £30.00
- EasyWriter Pro - £129.00
- Empire Soccer 94 - £22.00
- Exodus - £21.00
- Frank - £14.95
- Impression Style - £88.00
- Impression Publisher - £135.00
- Inferno - £9.50
- IXRC - £14.99
- Qvation Pro - £160.50
- Personal Accounts 3 - £43.00
- Photodesk Light - £125.00
- Prophet 3 - £160.00
- Schema 2 - £116.00
- Sleuth 3 - £110.50
- Textbase - £54.50
- TopModel 2 - £145.00

Books & Manuals

- RISC OS 3 PRM - £104.00
- The Tekkie CD - £45.00

Catalogue

Our free catalogue contains over 2000 items. Please ask for a copy.

We will attempt to match or beat any advertised price - even special offers.

All prices INCLUDE VAT & UK carriage
Official orders and callers welcome. Finance available.



- Risc PC 700 (4 years old) 450Mb hard drive, 20Mb RAM, std. monitor, BJC4100 colour printer, Irlam colour mobile scanner, Impression, ArtWorks etc. E-mail: charlescollis@hotmail.com
- For Sale, A3010 4MB, 80MB HD, 24X CD ROM, HP 320 printer. No monitor. £200. Tel: 01925 571203 (Warrington)
- Risc PC 600, 20+2Mb RAM, 540Mb HD, AKF60, CD-ROM, ScanLight 256, speakers, lots of software including Ovation Pro, ArtWorks, Personal Accounts 4, SimCity 2000, Exodus, StarFighter 3000. £400. Tel: 01923 779141. (Watford). Andy Dickson.
- Acorn Risc PC 600 system 16Mb RAM, 1Mb VRAM, 420Mb hard drive, 16bit sound, 24xCDROM, 486sx33 PC card, two slot backplane, AKF60 colour monitor, all clean and faultless. £400 inc P&P. Tel: 0151 677 9585
- Acorn User magazines plus some discs from 1991 - any offers? 01548 843 852 (Devon)
- Acorn Master 512 computer with monitor, discs and ROMs in good working order, free to a good home. Ring 0151 355 3855 (Cheshire)
- ARM 610 processor, £35. 32Mb NEC SIMM £35; 200 HD Floppy discs pre-labelled £55; Elite £25; Starfighter 3000 £25; Tel: Christian 01285 659782
- A5000, Learning Curve software plus Advance, Multiscan monitor. All original manuals boxes etc. Excellent condition. Also dot-matrix printer. Offers. Telephone 01429 836372 or e-mail: robert@vardill.demon.co.uk
- WANTED: HyperStudio, version 3 or later. Contact Alan at alan@rileyave.freereserve.co.uk
- For sale: A5000, 40Mb HD, 4Mb RAM, monitor, BJC 600 colour printer, Scanlight hand-held scanner, 56k modem, Impression, Eureka, Pipedream, DrawWorks, games etc. Manuals, books and magazines. All in very good condition. Offers please. Tel: 0118 988 6391 (Reading)
- Artworks Clip-art 1 & 2, £25; Image Outliner £20; 1st Word Plus £10; Genesis Plus £10. Tel: Christian 01285 659782
- Risc PC 600 2-slice, 40+1MB RAM, 850MB & 1.7GB HDs, CD-ROM, RAPIDE card, 5x86 100MHz PC card, 16bit sound u/g, AKF60, speakers, parallel port zip drive, lots of software inc. PcPro3, Impression Publisher, Easy C++, Java, games. £800 ono. Tel: Damian 01225 318584 or e-mail ee6dflg@bath.ac.uk
- A3010, 14in colour monitor. Original manuals, disks and boxes. including Easiword word processor plus games. Excellent condition. £150. Phone after 5pm (Birmingham).
- Sibelius 7 music processing software. Latest version complete with manual, keystrip. Exactly the same as a brand new copy but half the price, £250 Steve (0113) 226 4912, Leeds.
- For sale: A5000 with 40Mb HD, 14in Acorn monitor + original software, Impression Style & Lemmings 1 & 2. Hewlett Packard Deskjet 500 mono printer. The lot for £100 + postage. Contact ianstuart@tesco.net
- Acorn A410, 4Mb RAM, colour monitor, 210Mb IDE HD, external CDROM, Publisher, Speak etc. Good condition with manuals + BJ10ex printer. £100 E-mail: mark@kruspe.in2home.co.uk (Carlisle)
- Holed Out Compendium, E-Type Compendium, E-Type 2, Black Angel, Virtual Golf, £15 each. Compendium: ARtCtulate speech, Cyber Chess, Apocalypse, Aldebaran £20. Tel: Christian 01285 659782
- FREE to anyone who will collect. Old computers with monitors, discs, software, books: BBC Master, Texas 99, Sanyo, RM Nimbus. 01455 552250 (Leics, M1 junction 20) Foster.
- A5000 2Mb RAM, 80Mb HD, monitor, Citizen Swift 200 colour DM printer: £200 ex-carriage. Will deliver free within 100 miles of Lancaster. Tel: 01524 34600 (Lancaster) Robin, after 7:00pm
- BBC Master, manuals, monitor. Single & double density disc drives, joystick, boxed games. Mini Office II and manuals, ViewSpell, OverView. Assorted games, educational discs, Beebug mags, blank discs. Reasonable offers accepted.
- A5000 kit incl 14in monitor, 80Mb+350Mb HD. All manuals, some software, clip-art and freebies. Exc cond. £250 ono. May deliver. Tel 01296 426684 (Aylesbury).
- A7000, 8Mb RAM 515Mb HD & CD-ROM drive. AKF65 monitor, keyboard and mouse, plus software: £250. Tel: 01553 675339, after 7:00pm

Acorn User Free Ads Service

Why not take advantage of our free reader ad service? Fill in your details on this coupon (25 words maximum, one word per box below) and send it to Free Ads, Acorn User, Tau Press Ltd, Media House, Adlington Park, Macclesfield SK10 4NP or by e-mail to: freeads@acornuser.com. Only one ad per reader please. Although we try to publish every ad we receive, we can make no guarantees;

publication is entirely dependent on space and time constraints. We may also publish free ads on the cover disc if magazine space is short. Please fill in your name and telephone number below - these will not be published, but they enable us to contact you in case of any queries. Please include your town/county in each ad to help other readers with their purchasing decision.

Your name:.....Telephone no:.....

ALL PRICES INCLUDE VAT

Desktop system prices include delivery!

Mouse mat & !Printers setup included

(UK mainland)

A7000+ Classic Computers *

A7000+ Classic, 8Mb, 1GB HD£527.58
A7000+ Classic CD,16Mb, 2GB HD, 24xCD£586.33

All above are 29MIPS 7500FE Processors

A7000+ Odyssey Computers *

A7000+ Network,16Mb£616.87
A7000+ CD 16Mb, 4GB HD,40xCD.....£645.08
A7000+ PRIMARY, 16Mb,4GB, 40x CD£703.83
A7000+ SECONDARY 16Mb,4GB, 40x CD£703.83
A7000+ SURF 24MB, 4GB, dvdCD, 56K Modem £821.33

All above are 50MIPS 7500FE Processors

RiscPC SA 233Mhz (T) Computers *

Risc PC 233T, 8Mb£880.08
10Mb HD 2Gb, 32x CD, Speakers£1045.75
34Mb HD 8Gb, dvdCD, 56K modem,£1350.07
Any other specification can be custom built.....£POA

All Acorn machines will include EasiWriter & Resultz

* See bottom of advert for monitor prices

All above Acorn machines come with OS 3.7



Place your orders now for RISCOS 4
£99.00 + vat
(£116.33 inc vat)

Fitting and installation service available

RiscStation

Risc Based Technologies

Now available
through us.

Specification

ARM 7500FE 56 Mhz (50 MIPS with floating point)
16Mb 60ns EDO (RAM) Max 256Mb - Fast memory option
4Mb flash memory containing RISC OS 4 + utilities
4.3Gb EIDE Hard drive
CD ROM 40x Atapi EIDE
Case - Micro ATX in Desktop or Mini-tower configuration
Operating System RISC OS 4

I/O Devices

1x 10baseT Network port with Wake on LAN
1x Parallel port, 2x Serial port
1x Onboard Infrared port
2x High speed IDE ports (4 IDE devices)
Midi In/Out/Through ports
16 bit Stereo Sound Sampler & Mixer
1x PC Style Game Port
3x Audio Connections - Line in/Mic in/Headphone 4x 32bit PCI slots
PS2 Style keyboard
3-Button PS2 Style Mouse

Software

Includes all RISC OS 4 distribution software
EasiWriter Professional

Prices Start from **£680.33** (base unit)

Visit us at RiscOS '99 October 30th & 31st Stand A

See our demos of Citrix, TopCat and the ability of using
older machines with Thin Client Technology.
Ask for your FREE 'ICT Planning' Document at the show.

Registered
Developer



AUTHORISED RESELLER
CITRIX



THIN CLIENT TECHNOLOGY

AUTHORISED RESELLER
CITRIX The Acorn NC
(Network Computer)

'Sprinter' - NC (Network Computer)
client station with 16Mb RAM,
QWERTY Keyboard,
Mouse & 14" monitor



(Ideal for Acorn RiscOS software, Windows PC software
when used with Citrix and also Internet & Web browsing)

£379.00 + VAT (£445.33 inc.)

[Please note : NCs require connection and configuration to
host server, locally or remotely]

****Hot News****

New RiscStation NetworX computer
£ 468.83 inc vat - Call for more information

PERIPHERALS & ACCESSORIES

CD-R/W and CD-ROM Drives - All Prices include VAT

CD-R SCSI, (Panasonic 7503 8x24) Internal drive£314.31
CD-R SCSI, (Panasonic 7503 8x24) External drive£417.13
CD-RW SCSI, (Yamaha 4416) Internal drive£269.08
CD-RW SCSI, (Yamaha 4416) External drive£356.90
CD-R - Blank Writable CD's (Trust 80min pack of 10)£9.99
CD-RW - Blank Re-Writable disc (Trust)£3.50
!CDBlaze CD-R/W Software for Acorn£69.30
Oscar Encore - Parallel port External CD-ROM drive£198.58
Panasonic 32 speed internal atapi CD£81.08

All
CDR/W
Drive
prices
include
a copy
of
!CDBlaze

Monitors - All Prices include VAT

14" Viewsonic£101.34
15" Viewsonic£120.43
15" Viewsonic Stereo£185.00
17" Viewsonic E70£199.75
15" Iiyama Vision Master 350 FST 0.28dp£146.88
17" Iiyama Vision Master 403 FST 0.26dp£269.08
19" Iiyama Vision Master 450 FST 0.26dp£468.83
60 Watt Speakers£9.40
200 Watt Speakers£17.63

Call us now on Tel +44 (0)1279-730800/730900 Fax +44 (0)1279-730809. sales@cumana.co.uk, www.cumana.demon.co.uk

Cumana is a trading name of : Cannon Computing, Whitegate, Dunmow Road, Hatfield Heath,
Bishop's Stortford, Hertfordshire, CM22 7ED. AU Nov 99.

Without Prejudice. All Registered Trademarks acknowledged. Partners: Nigel D. & Sara L. Cannon.

All prices are UK £ sterling &, unless otherwise stated, include VAT, exclude delivery. E&OE.



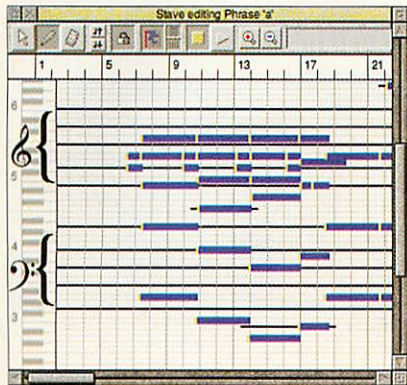

Figure III: Stave roll editor

section, it would be really nice if we could use the same phrase (a bass line, say) multiple times and have just one master copy which would change all the other instances if modified.

Anthem lets us do this incredibly easily through a part and phrase hierarchy. In Anthem each musical 'phrase' is in turn assigned to a 'part', and it is the part which is placed on the timeline - each phrase is used in one or more parts.

The part adds extra commands to its underlying phrase, perhaps instructing it to repeat a number of times or change the MIDI channel. A repeating bass line only needs to have its main theme entered once since it can be placed repeatedly in different keys, all simultaneously editable.

Parts can also assign an instrument (selectable from any bank), volume, stereo pan, reverb and more - you can even choose the quantisation level per part, allowing you to set how much the phrase is forced onto the beat. You can also choose to play just a particular section of a phrase if you wish.

Next up in the Anthem hierarchy are the actual tracks you place parts

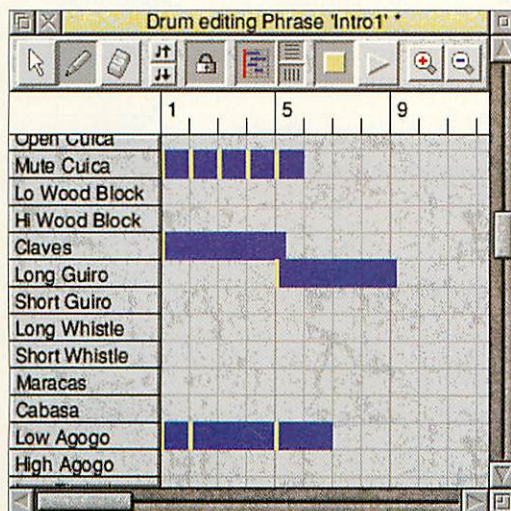

Figure IV: Drum roll editor

on, which in turn can overrule both parts and their underlying phrases by forcing the same channel, instrument and MIDI control settings. You're unlikely to want to simultaneously set controls at all three levels of phrase, part and track, but in Anthem you are given the freedom to choose the method which you find easiest.

You can also mix and match methods within a piece, using some tracks for single instruments while reserving others for a variety of contents. It's incredibly flexible - and, importantly, intuitive.

Using Anthem

The main window in Anthem (Figure I) shows the various parts placed on the tracks, and offers multiple routes to the editing windows. Anthem has five basic editing modes, and it's no surprise that these include the standard piano roll editor (Figure II). This is a scrolling window with time along the horizontal axis and pitch along the vertical one - horizontal bars represent notes of varying pitch and duration.

You can drag notes around and adjust their length, as you'd expect, and create and delete them. A vertical piano keyboard is shown to help identify notes, although there is also a live monitor box showing details about the current pointer position. Any number of resizable graphs can be attached to the bottom in order to edit extra parameters such as pitch bend and note velocity (which you can also edit by double-clicking a note and using the sliders that appear).

You just draw on the graphs to alter the values, or touch the scale to zoom in or out. It's all so wonderfully easy - powerful and very configurable without adding any unwanted complexity. You can also thin out certain events automatically if they're too dense (moving a pitch bend wheel can generate a lot of data).

You can switch to a stave roll editor (Figure III), which is a sort of halfway house between traditional music notation à la Sibelius (which Anthem does not directly support, although you can import and export to and from Sibelius via standard MIDI files) in which the piano roll is

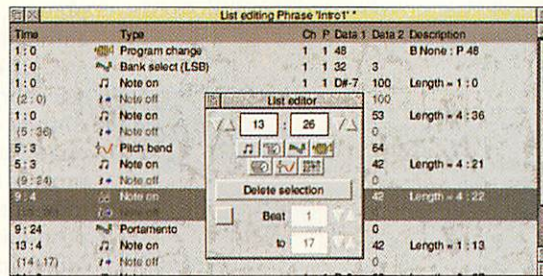

Figure V: Event list editor

still used but now horizontal stave lines are drawn at the appropriate pitch, along with treble and bass clefs (no other clefs are supported). Ledger lines are added as appropriate.

I actually found it a bit confusing initially because of the non-standard spacings (even though I can read music without trouble), but if you're transcribing manuscript music by hand it could make things very much easier once you get used to it. Along similar lines there is also a drum editor (Figure IV). In this mode the keyboard or staves are replaced with a list of percussion instrument names, indicating which drum is linked to a particular pitch by your MIDI instrument.

If you like looking at the raw MIDI data or if you have ever seen a music tracker editor you'll be at home with the list editor mode (Figure V). In this view each event in the phrase is listed by itself on a separate line, with all the data associated with that event displayed in adjacent columns. Note on and off events are grouped into pairs for ease of editing, but the real power of this mode is to add in non-note MIDI commands.

You can add quite literally anything here that your synthesiser supports - or at least you can long as it does not require a System Exclusive message, which Anthem does not currently support. In practice this is not a problem, however, since unless you're doing something very advanced with a suitably powerful synthesiser you're not likely to require it - and if you ever do you could always send the

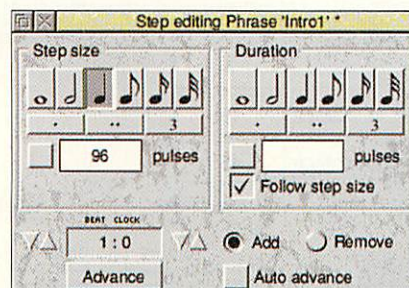

Figure VI: Step editor

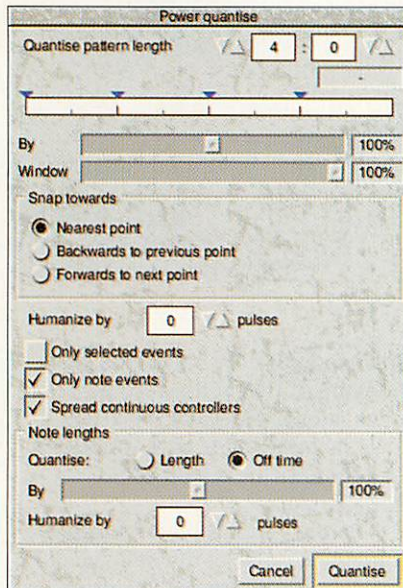

Figure VII: Power quantisation

necessary configuration settings from a separate application, such as *ArmEdXG*. If you don't know that you need SysEx then you almost certainly don't.

Anthem is particularly intelligent in knowing about various MIDI events, using descriptive text as well as command numbers wherever possible, and you can easily drop in new events by clicking on one of the options in the associated tool panel.

It's not until you try to edit an existing event, however, that you realise quite how clever *Anthem* is – instead of forcing you to fiddle with raw values *Anthem* instead pops up a context-sensitive window which lets you edit the value via an intelligible list of options, or to adjust magnitudes with a slider if you wish. Not only this, but different event types have different icons, making it easier to read the display. If only all sequencers were this user-friendly!

The final editing mode is the step edit mode (Figure VI), which lets you add to an existing phrase or create a new one by playing an instrument – but not in real time. You can also use this mode to remove the notes that you play if you wish.

As well as manual editing of

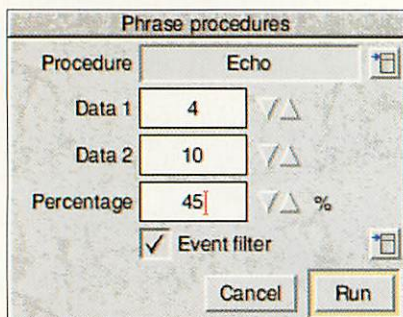

Figure VIII: Phrase processing

phrases you can also apply automated procedures from an impressively large selection, including what *Anthem* calls 'power quantisation' (Figure VII), a process whereby notes are moved to nearby note positions so as to correct minor imperfections in a performance or to add a particular feel to a piece.

The options, which include a clickable quantise point display (like a ruler in a desktop publisher) cover virtually everything you could ever want to do. Other options include adding echo (Figure VIII), legato and humanisation effects, and all procedures can use event filters to decide just what they are applied to.

Recording

So what about actually getting some music into the phrases to edit in the first place? You could just keep clicking away in one of the editors, but the most obvious method is to record a live performance from a MIDI instrument such as a keyboard.

Anthem provides the usual niceties such as an optional metronome and the ability to hear any existing tracks at the same time, and, as you would hope, its recording is very accurate. Recording really is exceptionally easy – just hit the record button and you can play for as long as you like (there's no need to set an end point if you don't want to).

Once you're finished just hit stop and choose where to store it. You can also record over existing phrases if you want, either replacing or preserving existing data. And if you're not much of a performer you can use *Anthem's* step recording mode to enter notes at your own pace. *Anthem* also offers intelligent options such as the ability to combine sustain pedal and note events to produce a clearer, more intelligible score.

MIDI files are a standard music file format, and *Anthem* does a very good job of loading them – it's surprisingly fast and it can even analyse them and split them up into phrases and parts. Very clever! You can also drag an existing *Anthem* saved song file into a phrase list window and all the phrases from that song are added into the pool for the current

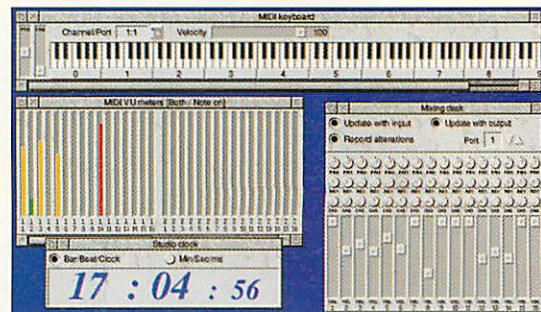

Figure IX: Studio gadgets

piece – the ultimate example of powerful drag-and-drop!

Anthem's main window features not only the track display and gadgets to move parts around, but also an associated set of icon shortcuts and a transport toolbox which controls playback. All the usual stop, play and wind buttons are present, along with repeat, solo and synchronisation options.

The toolbox can be detached if you wish, and the main and piano roll windows intelligently follow playback with a cursor or by scrolling. You can also set repeat points and flags, or use some of the various gadgets available, including VU meter monitors, a studio clock display and an on-screen keyboard (Figure IX).

Best of all, though, is a comprehensive mixing desk which can not only be used to dynamically alter settings during playback but can also be used to record those live changes, making fiddly final song settings a dream to configure.

Special tracks

Anthem divides time into bars, beats and pulses. You can add a special time signature track to your song which lets you change time signature as often as you like, but because phrases are not themselves attached to a particular point in time this won't affect any phrase editor display – in fact the only thing it really affects is the metronome. You

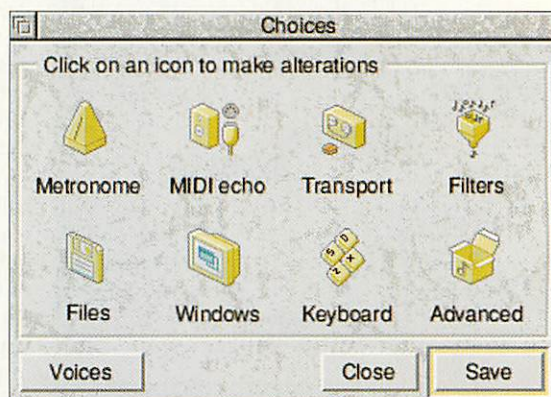

Figure X: Configuration

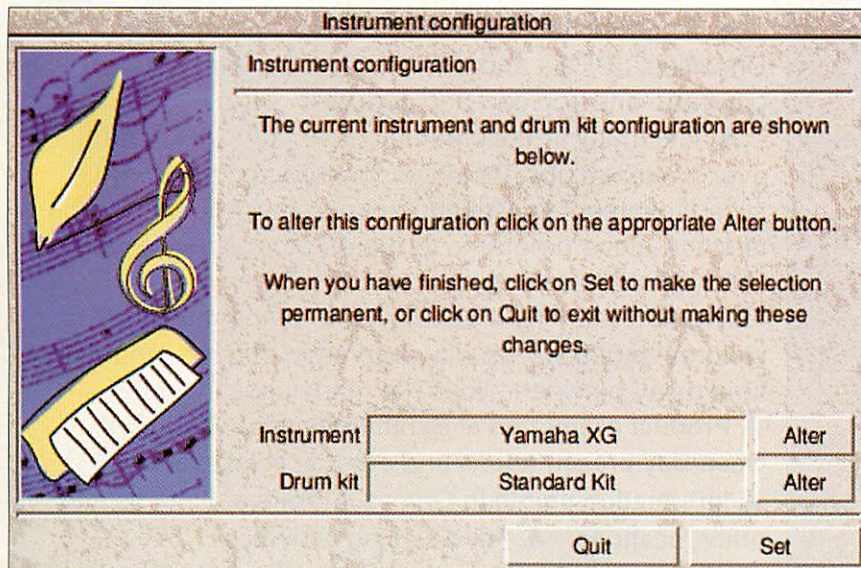

Figure XI: Setting up instruments

can also add a master tempo track, governing the playback speed of the song. The tempo can change as often as you like, or you can disable the track and use a global setting. However, you can't specify gradual speed changes other than by entering each individual tempo separately.

There is one other special track which provides one of *Anthem's* crowning glories. It is an audio track. You can drag samples here and they will become special audio phrases and parts, and you don't even have to make sure that samples are recorded at the same rate as *Anthem* corrects for this automatically.

Using this facility you can add in a vocal line or drop in a looped bass sample or whatever it is you require. You are limited to just one audio track but even so this is a really great feature. *Anthem* stores a link to the audio file on disc so file space isn't wasted, and different segments of the same sample can be used within a song in the same way that different

segments of a MIDI phrase can be used by different parts.

Be warned, however, that it gives a big speed hit, so if you have a complex MIDI track then you may need a StrongARM to be able to play back a CD-quality sample at the same time. 22KHz mono samples seem to work fine on an ARM710, however. If you're using samples of tuned instruments – and you tell *Anthem* the pitch of the original recording – you can choose the playback note for each part that uses the phrase.

Sugar on top

Anthem has plenty of configuration setup options (Figure X), including provision of a wide range of instrument definition files (Figure XI), although some of the relatively minor options annoyingly aren't saved by the 'save' button.

Anthem supports up to four separate MIDI ports (physical connections) but unfortunately it currently only lets you choose one instrument definition file to apply to all ports, which is a bit limiting if you have a lot of MIDI hardware. The author has indicated that he will be improving this soon.

During the time I spent reviewing *Anthem* various updates have appeared, adding new features I requested. As a result I now have very few criticisms of the package since virtually all of the complaints I had have been fixed!

This bodes exceptionally

well for any future purchasers of the software, and although there are inevitably still some bugs remaining they rarely get in the way.

From its attractive, modern imagery through to its intuitive interface *Anthem* is consistently well-designed. It is so intuitive, in fact, that you really can get by without needing to read the supplied ring-bound manual. At 120 pages it may look intimidating, but it isn't – it is one of the best-written manuals I have ever encountered, and its length is simply a result of the surprisingly large number of features packed into *Anthem*. It's well worth browsing through because wherever you look you are almost guaranteed to find some new shortcut or quicker way of working.

Anthem also supports interactive help, so if you don't mind waving your mouse pointer around then you can pick up a lot using this method, too. MIDI sequencers can often have nasty learning curves, but *Anthem* is a model of good design and a shining example of how RISC OS can provide a wonderfully intuitive experience.

Many of the more esoteric and rarely-used options are almost hidden away, and yet they are found without effort when you actually want them. Each time I use *Anthem* I seem to discover a new set of features that I'd previously missed simply through not having looked for them.

Anthem is a triumph. Five years of development have resulted in a stunningly good product. There is a danger that to enthuse about something too much will engender a degree of suspicion, but *Anthem* really is that good. At £70 (including VAT) it is extremely low priced for a product of its capabilities. If you do any work with MIDI music you really owe it to yourself to give it a go – in fact at that price I'd suggest that it makes sense to buy it even if you already own a different MIDI sequencer! **END**

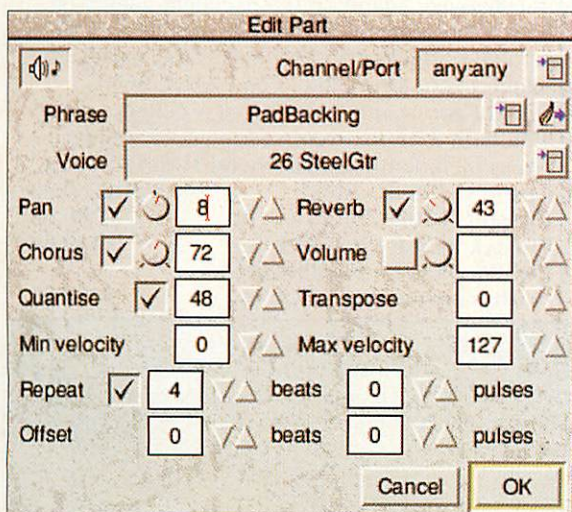

Figure XII: Editing part settings

Product details

Product: Anthem
 Price: £70 inc. VAT. Overseas customers must add £5 delivery. Site licence £170 inc. VAT.
 Supplier: R-Comp Interactive, 22 Robert Moffat, High Legh, Knutsford, Cheshire, WA16 6PS
 Tel: 01925 755043
 Fax: 01925 757377
 E-mail: rci@rcomp.co.uk

NoticeBoard Professional

NoticeBoard Pro is one of the most advanced programs for creating and running stand-alone rolling displays and slideshow presentations on RISC OS computers

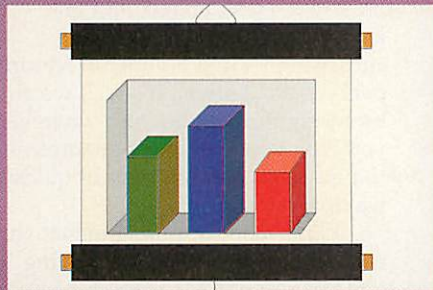

Single user: £37.00
Site licence: £110

NoticeBoard Pro is a powerful yet easy to use design and presentation system that will run on all RISC OS computers from 3.10 up.

▲ Programs can be created using Sprites, ArtWorks, Drawfiles, JPEGs and the new Cerilica Vantage program, and you can add sound!

▲ The many in-built features give complete control over presentations, including forward and backward slide movement in slideshow programs, and production of stand-alone programs to run on other computers and with digital projectors.

NoticeBoard Pro enables you to present a series of pictures and/or words with automatic or user-controlled time delay between slides. Its many uses include:

- ▲ Product promotion at Exhibitions, etc.
- ▲ School Open Day presentations and other special events
- ▲ Information points in Offices, Libraries, Schools and other locations
- ▲ Fund-raising activities

The only limits are the size of your hard drive and your imagination!

The Really Good Software Company

39 Carisbroke Road, Harpenden, Herts UK AL5 5QS
Tel/Fax: 01582 761 395 E-mail: sales.rgsc@argonet.co.uk
No VAT. Post & packing for UK and Europe add £1.50
Other countries £5.00

Monitors

Iiyama 15" 350	£145.00
Iiyama 17" (S702GT) .28dot	£279.00
Iiyama 17" 400 Pro .25 dot	£359.00
CTX 14" Digital Scan	£125.00
CTX 15" Digital Scan	£145.00
CTX 17".28 70Khz Digital	£259.00
CTX mons have (3 year on-site warranty)	
Many other models available	

Switch Boxes

Parallel 2 way (25w 'D' skts)	£16.99
Parallel 4 way (25w 'D' skts)	£19.99
Serial 2 way (9w 'D' skts)	£19.99
Monitor+Keyboard 2 way	£19.99
Suitable cables and other boxes available, please ask	

VGA to PAL TV Converter

The VGA Converter allows the output of any Acorn running in a VGA or SVGA mode (or PC comp) to be displayed on a TV or recorded onto a video recorder. Please ask for more information.

Price £159.00 inc vat



Colour Printers

Epson Stylus Colour 440	£105.00
Epson Stylus Colour 640	£135.00
Epson Stylus Colour 850	£199.00
HP Laserjet 1100 (laser mono)	£289.00

Virus Protection

Pineapples Virus Protection Scheme has been running for over six years and is still being updated with new viruses on a regular basis. New software versions are sent out to members every four months and the total number of viruses which can be removed is well over 200. The latest version is now scanning at up to four times faster than previous versions despite coping with many more viruses.



Joining fee just £28.20

'If you're interested in virus protection, join the Pineapple Virus Protection scheme and buy Killer. Accept no alternative - 'Acorn User Feb 96
Inexpensive multi-user licences

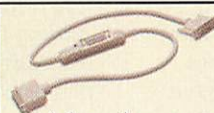

Parallel to SCSI adapter

A brand new product from Pineapple providing an inexpensive alternative to a SCSI card when using SCSI scanners. The SCSI adapter plugs into the parallel port (with a 'through' printer connector), and can be used directly with SCSI scanners. Works with A3010/3020/4000/5000/A7000/RiscPC (inc StrongARM).

Price just £59.00 inc vat



Colour Scanners

The new Epson GT7000 is great value and the Photo version with transparency adapter gives excellent quality on both transparencies and negatives. Our new SCSI parallel port adapter cable makes this excellent scanner very affordable. The Plustek 9636T parallel port scanner also gives excellent quality with built in transparency adapter. All scanner prices include Imagemaster and Twain software.

Epson GT7000 - SCSI	£259.00
Epson GT7000 Photo - SCSI	£299.00
Plustek 9636P - Parallel Port	£139.00
Plustek 9636T - Parallel Port (with transparency adapter)	£189.00

Pineapple Software

Suite 1, 310 Green Lane, ILFORD
Essex IG1 1XT

Tel 0208 599 1476 Fax 0208 598 2343

email: sales@pineapple.demon.co.uk

www:- http://www.pineapple.demon.co.uk

Terms:- All prices include

17.5% vat. Carriage £5 on most hardware. Small items £3 (or less). Phone for quote outside UK. Official orders, cheques and all major credit cards accepted at no extra charge.



Studio24Pro

'Many Acorn User front covers have been created from scratch using this program alone, concrete proof of the power of this creative tool' - Acorn User Mar96

New low price - £59.00 inc vat

Intranet resourcing

Hertfordshire County Council has launched Hertfordshire Learning Grid a network offering educational resources for students and teachers including a range of popular education CD-ROMs. This is one of the largest educational intranets so far to be linked to the government's National Grid for Learning.

One of Hertfordshire's content suppliers is Granada Learning who have put together an *Intranet Content* solution available to any LEA. The Hertfordshire solution consists of 34 CD-ROMs covering Science, Geography,

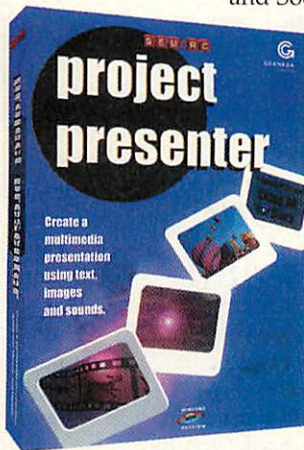

History, Religion Education, Personal and Social Education, Modern

Foreign Languages, Business Studies, Physical Education and the Environment. Stored on the County Council's LEA Web server, resources are accessed by all connected schools within the authority. Meanwhile Granada Learning's Internet Odyssey and Odyssey Indexes enable teachers to select specific activities to suit pupil's individual needs and to make the

most of the resources on the Internet.

Eye catchers

Struggling with your ICT planning? Then take a look at Project Presenter from SEMERC (0161-827 2927). Designed for Key Stage 2 and above, this meets all the requirements of Unit 6A (Multimedia Presentation) in the Qualifications and Curriculum Authority's ICT Framework Document.

Make as simple to use as possible all you have to do is drag and drop pictures, video clips and sound files into the file window and choose the length of time you want each to be displayed. You can make the presentation more professional by selecting a transition between images from a dissolving screen to raindrops.

Now all you have to do is move

forwards and backwards through the presentation by clicking on the on-screen arrows. Simple. If needed a switch can be used instead of a mouse and there is a closed-loop continuous presentation option available too.

The QCA document recommends that children should use a program to organise, refine and present information in different forms while being sensitive to their audience. SEMERC assures us that Project Presenter does just that while ensuring that students are aware of the relevant technical vocabulary and the key idea that software can include a range of media. Prices start at £29 for a single-user version.

A case in point

The Headteacher at Sutton-on-Sea County Primary school, Chris Flanagan, is waving the flags for ArgoSphere since he has been successfully using the service in school for over a year: "At the time (and still) the interactivity of the site stood it apart from the rather static and dull examples of many education sites."

What impressed him was that teachers can download activities locally to run on the school Intranet, ensuring that the environment in which the children learn is safe and secure. Downloading also helps save money

and allows teachers to adapt activities for different lessons. However, his personal favourite is Test Maker which lets you create tests on whatever subject you want.

"For now the Internet is rather like a large stone – it is only just beginning to roll and the National Grid for learning has been the lever which has overcome its mass to get in rolling into schools. Sites such as ArgoSphere reveal something of the real potential of the Internet." You can access ArgoSphere for yourself on www.argsphere.net

In brief

Making learning fun

Education Minister Charles Clarke and TV personality Loyd Grossman have been lending their support to a campaign bringing American-style children's museums to the UK.

The Kids' Clubs Network, the national charity for school age childcare, has launched a project aimed at encouraging museums in Britain to develop fun, interactive exhibits teaching children about science, technology and the arts. Loyd Grossman is chairman of the Campaign for Museums, and Mr Clarke launched the project with a visit to the *Museum of Me*, in Bargehouse Street, on London's South Bank. Other museums are coming on board too with the Children's Discovery Centre in Stratford, Lewisham's Horniman Museum, Quarry Bank in Dudley, Thetford Partnership in Norfolk, Royal Cornwall Museum, Truro and the Sheffield Children's Centre already signed up.

Morale and standards

Most people believe the status of teaching as a profession has fallen in recent years, according to recent opinion poll conducted by Gallup for The Daily Telegraph. It reported that 70 per cent of adults felt teachers had a lower status than when they were at school while only 21 per cent believed teaching now had a better reputation.

In addition 69 per cent thought the Government had "not made much difference". One in five believed Labour had succeeded in delivering higher educational standards while 6 per cent believed standards had fallen. Views were mixed about long-term standards with 45 per cent of seeing the standard of education in schools today as "better", while 47 per cent believed that standards had declined.

Almost half of the people surveyed by Gallup felt children now did more homework than they themselves had, compared with 36 per cent who believed today's children did less homework.

Diary date

BETT 2000 - The Educational Technology Show
12-15 January 2000
Grand Hall, Olympia, London
Admission: Free
Contact: 01203 426458
www.education-net.co.uk

Find your way around

Don't know your OS from your contour? Pam Turnbull looks at a package to help

Created to support and extend the BBC Schools TV series, *Zig Zag: Village, Town and City* stands very well on its own.

Its manual is very nicely set out allowing you to cherry-pick activities to practise the skills of making maps and plans, using symbols, giving directions, as well as using co-ordinates and grid references. Alternatively, you can explore a Village, Town or City and discover the same range of activities but related to a different environment and to different levels of complexity.

You are advised to start with the *Village* and here (as in the town and city) you'll find four locations to visit. Choose the school, for instance, and there are three activities: take a child from the hall to Class 1 and then the playground using a plan map, match an aerial view of the classroom to a plan and finally design your own classroom. The latter two activities were very popular, though not as easy as children initially thought.

Items have to be moved and rotated using the Turn button and it led to some good ideas for work off the computer. In addition when they are designing their own classroom (nice small class sizes too) there is an *Ask your teacher button*, this allows a teacher to view their proposed layout and make suggestions or print off the

screen before the children move on.

The Village Bus Stop asks you to match symbols with buildings you can see in the picture of the village. This is further developed in the Town Supermarket and the City Tourist Office activities. Staying in the Village for a while, the Pond offers you fun and games with a Duck or a Frog. Both introduce the concept of the four compass points as you guide the creatures around the pond. Again this is developed further in the Town Church and City Railway Station activities.

Final stop in the village is at the Farm and here children work on three activities reading co-ordinates, reading letter/number co-ordinates and writing co-ordinates. This is all very

straightforward though the tractor activity becomes tedious very quickly. My only niggle is that you enter co-ordinates throughout the program by choosing a letter and digit from a list, which in itself is fine. However,

having decided on A 2 as your first point, you'll have to re-enter both elements even if your next point is A 3. Just change the 3 and nothing happens, there is no error message or friendly advice and the program doesn't clear the boxes to encourage you to enter elements afresh each time. Children (and adults) found this very frustrating. The graphics are very attractive and though sound is

minimal and all instructions are written rather than spoken it is a very easy program to use. You will need to plan carefully which activities to use as some require more additional information and work than others. In particular, the Town Supermarket where you plan the ideal car park layout. This works best as a follow-up activity having analysed and discussed parking patterns and needs.

A range of attainment levels are addressed and some activities are quite challenging. From the basic N S E W instructions at the Village Pond, the Town Church requires children to use the four compass points to find places in relation to one fixed point.

This then leads to a second activity where they have to find places from a variety of different points on the plan. This can be quite difficult, for instance, *north of the church* may not be at the top of the map. This is taken further at the Railway Station in the city where the eight points of the compass are used to find the route a train must take around Britain.

A lot of thought has gone into this package providing everyday problems children can relate to, plus a range of maps and plans. The manual too comes with suggestions of the type of questions children and teachers should be asking, as well as extension ideas for the activities on the computer or whole-class discussion. Some excellent ideas, well executed. **END**

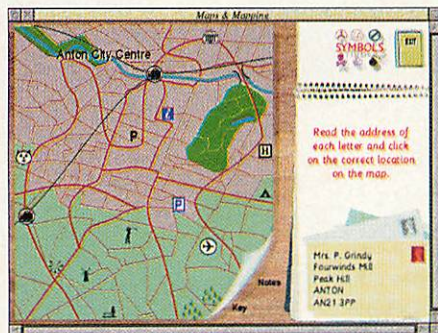

Product details

Product: Zig Zag Maps and Mapping
Ages: 7-11
Price: £34
Supplier: Logotron, 124 Cambridge Science Park, Milton Road, Cambridge CB4 0ZS
Tel: (+44/0) 1223 425558
Fax: (+44/0) 1223 425349
E-mail: info@logo.com
Web: www.logo.com

This CD-ROM contains a range of original documents, photographs of artefacts, maps, illustrations and video clips from the Hampshire County Council archive. In this product they have created two separate programs using their archive material pertaining to the medieval and Tudor periods. In addition there is a manual and online guide to the work of the Hampshire Record Office and how and why archives and conservation work is undertaken.

The applications have been written using *Textease* with all links spoken when clicked. The *Textease Browser* (you don't have to have a copy of *Textease* to access these programs) allows you to alter the scale, save and print pages as well as keeping track of the pages you've

such as what the place looks like now. The alternative chapter on town life is divided further into sections on *Domesday and Town Charters*, and *Shops, Trade and Industry*. The former provides information on what Domesday and town charters were using images of original documents and even a list of the Domesday questions asked of the populace.

If you are interested in manorial life there are sections on the lords and the bishops using the original documents (with translations) to describe and explain what was happening in 14th and 15th century Hampshire. Although these all relate to one specific county, the parallels are clear with the rest of the country and should inspire you to access information from your local county record office. *Textease* has been used

and Elizabeth I. There is some general information but this is not an in depth study of the Tudors but rather concentrates on their relationship with Hampshire.

Henry was very fond of Portsmouth due to the naval connection, but the section also covers Henry and the dissolution of the monasteries. There is also a nice case study of Bramley Church and how it has changed and survived through the ages.

Everyday inhabitants of the area are not covered, as documents only usually survive concerning the rich and famous. Two of these are John White and his mentor Thomas Wriothesley.

Both families profited during the Tudor period and while the Whites did well from the dissolution of the monasteries, Wriothesleys spent time in the Tower of London for their Catholic beliefs.

The three properties covered are Elvetham Hall, Bramshill and The Vyne. Using original letters and accounts you can tell just how expensive entertaining royalty was. The program is also more helpful with its advice telling you to increase the view of the Bramshill four-poster to 200% for a better view of the carvings.

The three towns covered are understandably Portsmouth, Southampton and Winchester. Using a range of maps, hotspots have been added to make these maps and plans interactive. These can then be explored and compared to see who our major trading partners were and what has survived through the intervening years.

This is a unusual but useful resource and if you want more information HRO have resource packs entitled *Medieval Realms* and *Life in Tudor Times* which complement the resources on the CD-ROM and cost £15 each. **END**

Times are a-changing

Pam Turnbull surveys a new package to make sure your Tudor and medieval knowledge is up to scratch

accessed so far. Certain pages will advise you to alter the scale – using the eye or magnifying glass icons – to zoom into certain images to get a closer look at the wood carvings or how the roof has been designed.

Starting with Medieval Hampshire I found four chapters to choose from: Medieval Towns, People, Religion or Manors.

The Medieval Town section itself is sub-divided into two further chapters, *How were towns defended?* and *What was life in medieval towns like?* Using original drawings and photographs of artefacts, additional information is given in the text, or you are asked to access the labels on a drawing to see more detailed sketches and find more information,

well and I particularly liked the video clips of early twentieth century farming methods and their comparison to medieval farming.

For more detail on everyday life, the chapter on medieval people looks at households using the surviving wills and inventories from the time as well as the place of women in society. Then there are further chapters on religion and in particular monasteries, abbeys and parish churches.

Tudor Hampshire follows the same design, but here chapter headings are: Three Tudor monarchs, Two Tudor Men, Three Tudor Houses and Three Tudor Towns. In particular, this program concentrates on the reigns of Henry VIII, Mary I,

Product details

Product:	Zig Zag Maps and Mapping
Ages:	7-11
Price:	£34
Supplier:	Logotron, 124 Cambridge Science Park, Milton Road, Cambridge CB4 0ZS
Tel:	(+44/0) 1223 425558
Fax:	(+44/0) 1223 425349
E-mail:	info@logo.com
Web:	www.logo.com

ADVERTISERS' INDEX

Acorn Midlands Show	60
Akalat	Showguide
APDL	9
Archive	Showguide
Artex	34
Cannon Computing	72
Castle Technology	OBC, IFC, 73
CJE.....	31, 51
CTA.....	4, 5, 73
Davyn	72
Desktop Projects	80
Eesox	61
Icon Technology	12
IFEL.....	53
iSV	14
Liquid Silicon.....	61, 73
Pineapple Software.....	68, 73
Printmaker	73
ProAction Software	72
R-Comp.....	38
Reflex	18
RGSC	68
RISCOS Ltd	47
RiscStation	Showguide
Spacotech	IBC
STD	60
The Data Store	25, 73
Uniqueway	73
Wardlaw Surveys.....	73

Contacting us

Editor:	editor@acornuser.com
Enquiries:	enquiries@acornuser.com
Advertising enquiries:	advertising@acornuser.com
Web master:	webmaster@acornuser.com
Subscriptions:	subscrip@acornuser.com
Free Ads:	freeads@acornuser.com
Letters:	letters@acornuser.com
News:	news@acornuser.com
Comms page:	comms@acornuser.com
Graphics page:	graphics@acornuser.com
PD page:	pdpage@acornuser.com
Business page:	bizniz@acornuser.com
PC page:	pcpage@acornuser.com
Music page:	music@acornuser.com
Games page:	games@acornuser.com
Education page:	educ@acornuser.com
Rambles:	rambles@acornuser.com

To advertise in
ACORNUSER
contact
Dave Bradforth on
01625 878888

SOFTWARE



The lizard that never dies™ is back, in the ultimate collection of Repton games for RISC OS computers. Featuring Repton 1, 2, 3 & 4 for just £15 + £3 p&p!

ProAction Software

Interactive
Recomp

WEST YORKSHIRE

THE CHOICE OF EXPERIENCE **For the best service in Yorkshire (we think)**

CALL US! for A7000, RiscPC & Pocket Book II
Visit our Showroom

Open 9.30 to 5.30
Mon, Tues, Weds, Sat.
9.30 to 7.30
Thurs & Fri.

DAVYN
Davyn Computer Services
Printers, Ribbons, Ink Cartridges, Refills
Expert Advice & After Sales Service
Mail Order Master Card, Visa, Switch Ring for Prices
Service & Repair to all Equipment
Full Range of Acorn Hardware & Software (We operate the Acorn Finance Schemes)
Full Range of Educational Software
Tel. 01924 254800 Fax. 01924 258036
e-mail sales@davyn.demon.co.uk

Acorn **RISC PC** **hp** **HEWLETT PACKARD** **CITIZEN** **Canon**

How to find us

WE ARE HERE
The 'Workshop'
off Princess Street
Sandal
Wakefield
WF1 5NY

SOUTH EAST

CANNON COMPUTING

Acorn Educational Reseller

Key independent Educational suppliers of customised 'switch on and go' Acorn Computer systems, associated peripherals for 15 years.

We specialise in the installation, supply & configuration of complete intergrated multi-platform networks.

Please see our main page advert for more details of some of our products.

CITRIX

CUMANA
The best name in memory

Whitegate, Dunmow Road
Hatfield Heath, Bishop's Stortford
Hertfordshire. CM22 7ED
Tel +44 (0)1279-730800 (Cannon)
Tel +44 (0)1279-730900 (Cumana)
Fax +44 (0)1279-730909
www.cannonco.demon.co.uk
www.cumana.demon.co.uk

BUREAU SERVICES

P·R·I·N·T·M·A·K·E·R

www.printmaker.co.uk/



ACORN FRIENDLY SCREEN PRINTERS
LARGE FORMAT INKJET PRINTING
AND VINYL GRAPHICS BUREAU

Contact Chris Mercier 14-16 Eldon Terrace Reading Berkshire RG1 4DX

sales@printmaker.co.uk

0118 956 7947

HIGHLANDS

Wardlaw Surveys

Authorised Acorn Dealer,
for all your needs from
supply, service, repair
& full after sales.

Tel/Fax: 01463 831214

CARDIFF

UNIQUEway

SOUTH WALES' ONLY DEDICATED ACORN
DEALER AND ACORN CENTRE OF TECHNOLOGY



Technical Support - Repairs - Hire - Internet Connections

Low cost finance available on all systems.



3 Clarendon Road, Cyncoed, Cardiff CF3 7JD
Tel 01222-464020 Fax 01222-440071
<http://www.uniqueway.co.uk>

SCOTLAND

Liquid Silicon

Computers & Music Hardware • Upgrades • Software • Cables etc.



Registered
Developer



Authorised
Installer



RISC OS 4 (DIY) £120.00
Fitting (ROMs only) £10.00
Fitting (ROMs, hard drive
reformatting and software
transfer) From £25.00

Carriage on machines is extra.
Please call for details of any extra
charges on high-spec machines.

FREEPOST EH2725
Kirkcaldy, Fife, KY2 5BR
United Kingdom

Tel: 01592 592285 Fax: 01592 596102

email: Liquid@cableinet.co.uk
<http://www.cybervillage.co.uk/acorn/liquid/>

LONDON



FOR SIXTEEN YEARS, PUTTING THE
EMPHASIS ON THE VERY BEST SERVICE...

THE DATA STORE

Visit our well-equipped showroom just 30 minutes from
Central London. For more information, look for our
full-page advertisement elsewhere in this issue.

6 CHATTERTON ROAD BROMLEY KENT BR2 9QN

Tel (020-8)460 8991 • Fax (020-8)313 0400

Web <http://www.datstore.demon.co.uk/> • Email info@datstore.demon.co.uk

LONDON & ESSEX



Pineapple Software



Pineapple have been in the Acorn marketplace for over eleven
years and have been running the Virus Protection Scheme for
over seven years. We specialise in building RiscPCs to your
specification and we also supply scanners, printers, harddrives
or anything else you may need for your Acorn system. We also
undertake repairs and upgrades to Acorn computers.

Open 0900 - 1730 Mon - Fri

Suite 1, South Park Business Centre
310 Green Lane, Ilford, Essex IG3 9JS
Phone 0181 599 1476 Fax 0181 598 2343

email: sales@pineapple.demon.co.uk
<http://www.pineapple.demon.co.uk>



SUFFOLK



CASTLE TECHNOLOGY



Full range of Acorn Computers
Comprehensive back-up service

Call 01728 621222 or
fax us on 01728 621179

Ore Trading Estate Woodbridge Road Framlingham Suffolk IP13 9LL
e-mail: sales@castle-technology.co.uk
Web: <http://www.castle-technology.co.uk>

NORTH WEST

CMA DIRECT

168 Elliott St.
Tyldesley
Gtr. Manchester
M29 8DS

Acorn Dealer and RiscOS Centre of Excellence
Acorn Spares and Repairs

All Acorn Machines available on 0% finance

Installation, Networking
Repairs on a no-fix
no-fee basis.

See Main Advert on
Pages 4 & 5

Tel. 01942 797777 Fax 01942 797711

Drums along

Mike Cook
beats it out

the mersey

Following on from last month's look at an eight channel A/D (Analogue to Digital converter) let's see what we can do with it. For starters here's how to make a MIDI drum kit. Those of you with very long memories will no doubt recall the December 86 issue of *The Micro User* where I described a simple drum kit. This was simple because it only sensed if a drum was hit and this was used to make a sound from the sound chip in the Model B.

Nowadays a MIDI system will give a much better quality of sound, not only that but the thing with MIDI is that as well as signalling a drum has been hit it also has to be told how hard it's been hit. This changes not only the volume of the sound but also the nature of the sound itself. For example, a cymbal makes a different sound if gently tapped as against being given a hefty thwack, it's not just louder. This means that any electronic drum kit circuit has to not only detect a hit but also measure the size of it.

First we need a transducer that produces an output, proportional to how hard it is hit. Next we need a circuit that monitors the signal from each transducer and sends the appropriate MIDI command whenever it detects a voltage peak. This means that the

A/D converter has to be continuously driven, a simple but time-consuming task. That's why it is best to use a micro controller, however unlike our standard PIC circuit this only requires a MIDI output, see Figure I. As you will see there is just a single bit output used to generate the MIDI signal through a PNP transistor.

The A/D converter uses four of the controllers I/O pins leaving lots of free lines. I have used two of these to allow you to change the MIDI mapping – which drum pad produces which noise. With two switches you get a total of four different mappings, if you add another two switches to pins 12 & 13 you can get sixteen different mappings, enough for anybody I think.

There is no need to use pull-up resistors here as the internal pull-up resistors are enabled in the software. As we saw last month the multiplex inputs of the A/D in the single-ended mode are not altogether straightforward, therefore I have renumbered the drum pad inputs to reflect the channel number that will be generated.

As in my earlier design I have used some piezo-electric transducers which are available very cheaply from Maplins. In fact they have various different sizes of transducers but the smallest and cheapest

work as well as any of them. They can cost as little as 20p in a sale and are normally less than 40p each. Looking at the output of these on a storage oscilloscope shows that you can get voltage peaks of around 20V from just a simple tap with a finger.

Fortunately the input stages of the A/D converter are clamped with diodes to the power rails, so no damage will occur if an over or under voltage is fed in. The signal goes both positive and negative and surprisingly enough you get a bigger positive signal from the black wire of the sensor.

While you can feed the sensors directly into the A/D you get better results with the circuit shown in Figure II, note you need eight of these. Basically what it does is to take the piezo-electric pulse, rectify

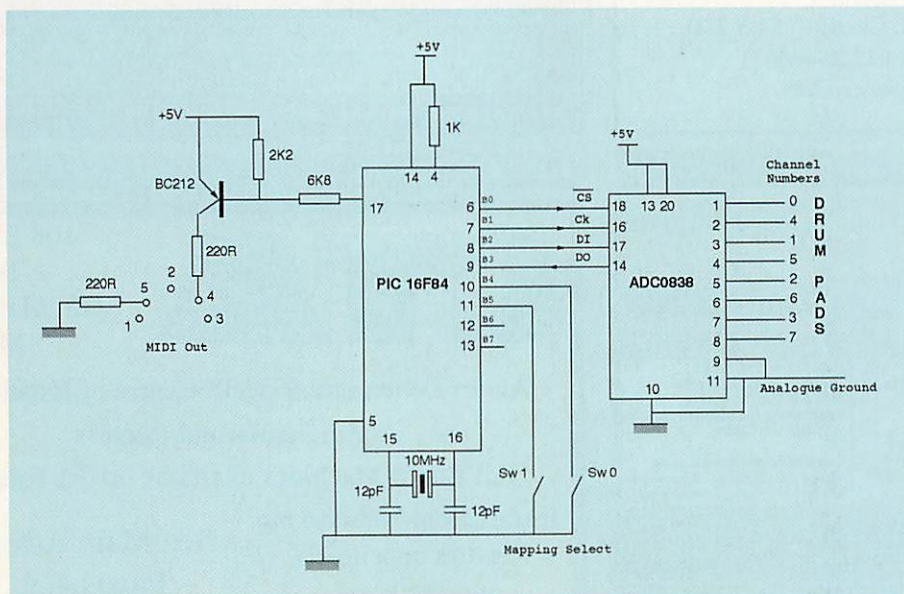

Figure I: The MIDI Drum Kit

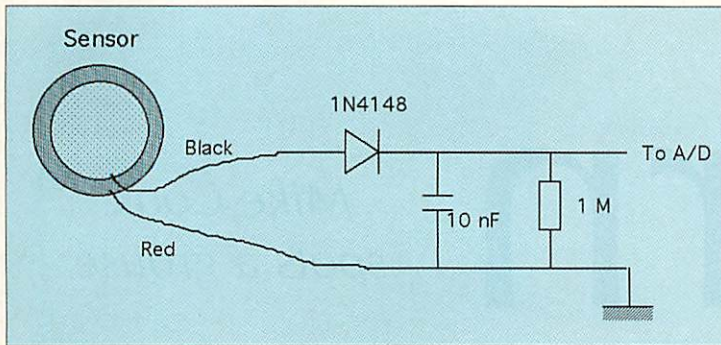

Figure 2: The sensor circuit

it and by using a capacitor holds the voltage long enough for it to be measured.

The resistor ensures that the voltage decays, ready for the next hit. You might want to alter these values to get the best out of your system. This is because the exact mechanical arrangement will alter the voltage shapes. You should increase the resistor value for a longer hold time and reduce it for a shorter one.

While you can hit the transducers directly, it is generally too sensitive if you do. Therefore, you need some sort of sandwich arrangement like that in Figure III. Mount the transducer on a solid base of wood with a little glue, then fix a pad of rubber over the top. It is best to mount each transducer separately to prevent the hitting of one pad triggering another. Music shops sell drummer's practice pads that could be easily converted.

Now on to the software, which is not quite as straightforward as you might think or, perhaps, hope. The basic idea is that the voltage from each sensor is measured in turn, and compared against a threshold value held in memory. If the new input is bigger by at least three units than last time it was measured we know something is happening on that input.

The software then branches to the Play routine which continues to read that one input until it reaches a peak or starts to fall. At that point we know the pulse has reached its maximum extent and the A/D reading is now proportional to how hard the pad has been hit. Now we have all the information to send to the MIDI system so we send three bytes off.

The first byte is the combined message *note on* and *Channel 10*. On a MIDI system any note sent on channel 10 is treated as a drum, so we have no need to send any sound defining message. This byte works out to be a hex value of 99, note for channel 10 (decimal) the channel bit pattern is 1001 and not the 1010 you might expect, this is because musicians can't cope with the concept of channel zero so every number is out by one.

The second byte is the number that indicates the pitch of the note to play or, in the case of drums, the drum sound. This

depends first of all on what sensor is hit and secondly on what the mapping switches are set at. The mapping switch inputs are shifted one place to the right to give a number that increases in steps of eight.

If you are adding extra mapping switches you will need to change the value that is used in the AND instruction to 38h

for three switches or 78h for four switches. The mapping switches number is added to the channel number and a look-up table routine is used to return the resulting drum sound number. This look-up table routine is called *map* and is placed at the end of the code and is very easily changed to any mapping you require.

The final number sent to the MIDI system is the velocity or A/D measurement. This is only a seven bit value in the MIDI system and so our eight bit reading is converted into the required range by shifting it one place to the right. Note in the case of MIDI drums you never need to send a MIDI *note off* command as you do with other instruments.

Well that's it for the simple system but what about enlarging it. The most obvious one is to add another A/D converter to allow sixteen drum pad inputs. You can do this by paralleling up all the input signals to the converter (pins 16 to 18), and feeding the output (pin 14) to one of the spare PIC controls. You will also, of course, need to modify the software to read the two serial bytes at once.

You can get commercial MIDI drum kits but they will set you back at least £1000 so there is an opportunity of saving yourself some money. The other great advantage is that you can practice drumming with headphones on giving innocent passers-by the minimum of inconvenience.

END

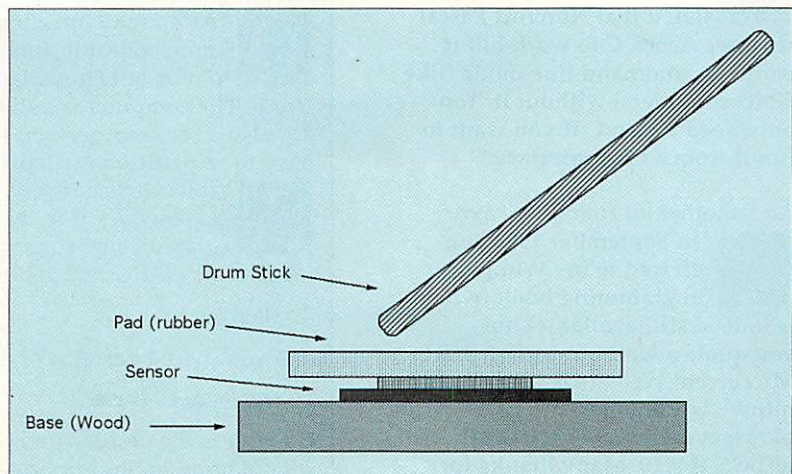

Figure 3: The sensor sandwich

Rambles though Acorn

Mike Cook
spots a grouse



Maybe I should call this column *Grumbles Through Acorn Wood* because something else has been worrying me lately. It's software that is being too helpful in installing itself. It's not so much as a problem with RISC OS as on other machines but it's creeping in. The other week I was asked to try a free internet service provider, nothing to lose?

Except once I had inserted the software CD and clicked on the icon all reference to my original provider had been wiped, and I had to spend ages reinstalling preferences and scripts to get back to my machine's original state. I know developers are convinced that once you have their software you will want no other but they are wrong. I find this practice both ignorant and cynical.

First a bit of feedback from Tarquin Mills:

 "In August's 1999 Rambles in answer about Pascal it is stated that Norcroft Pascal requires Acorn C to work but it works in command line mode (like GNU compilers) without it. You only need Acorn C if you want to run it from a GUI interface."

And another bit from Ray Favre:

 "In September 1999 you referred to my Wimp Programming book (which is indeed still available) but you quote a well-out-of-date URL. My current Website is <http://www.argonet.co.uk/users/rayfavre/> or tel: (+44) (0)1895 444410. Many thanks for the mention."

Stuart Nundy wants to listen to the radio:

 "I've been aware of the RiscTV hardware produced by Irlam for some time, but I was wondering whether you also know whether it is possible to obtain an FM radio receiver, for a Risc PC, as well? I'm not desperately interested in TV but would be in a radio card. I understand that Irlam do produce an external FM tuner that plugs into the serial port.

"The problem with this is that, firstly, I already have an external modem that uses the serial port, and I don't want to be constantly swapping leads and, secondly, the Irlam tuner does not utilise the internal sound system of the Risc PC, but requires a second pair of powered speakers. I don't really fancy more and more leads and objects

extending around the computer. Ideally, therefore, I'm after an internal solution - an expansion card. Any suggestions?"

 One product springs to mind DeskFM by Yellowstone, costing £59 incVAT. I reviewed this in May 1997, and it's still available. Yellowstone, tel: 01582 656000, or e-mail: sales@yellowstone.co.uk

Dave Braine is having trouble with the Net:

 "I have access to the Internet via a PC. Could you tell me how I can run Acorn files, on my Risc PC 600, that I've downloaded on the PC?"

 Most RISC OS files on the Web are encoded using Spark (SparkPlug or SparkFS) you simply copy the files onto your harddisc and drag them onto the icon. Alternatively use

Robin Hutchinson has lost something but has not looked under the bed:

 "Although I am a long-term RISC OS user I am not that knowledgeable about details so please could you advise me how to reinstall Draw. I get a missing file message when I try to run Draw. The computer is a Risc PC with StrongARM upgrade and RISC OS 3.7, also a 586 co-processor. I have the discs of 3.7 but would rather not have to re-partition my harddisc."

 While Draw has been moved in and out of ROM over the years, in version 3.7 it is in the ROM so is difficult to loose. However, there is a module that could be disabled which would give an error message. Press F12 and get into command line mode. Then type:

*Unplug

and you should get a list of disabled modules. If Draw is among them type:

*RMInsert !Draw

Go back to the desktop and double-click on the icon in the Apps folder should bring up the application.

ArcFixer by Paul F Johnson which is hopefully on this month's cover disk.

James Scott has acquired the reputation as an expert, now he has to live up to it:

Q "My Headmaster, forever at the cutting edge of technology, has just given up the pleasures of working with an Amstrad 8512. As he thinks that I am the school's computer whizz-kid, he has asked me to try to save his work. Therefore, it would do me no harm if I could succeed in recovering his *Locoscript v.1.2* text files from the Amstrad which are, obviously, stored on the 3 inch CF2 Amstrad floppy disc.

"I have an Acorn 310 with RISC OS 3 but can see no obvious way to connect the two to allow the 310 to read the Amstrad files. How do I do this? Is there an Acorn external floppy disc reader for the Amstrad disks? By the way, if it will help, I also have BBC Micro, an Amstrad PC2086/30, an Acorn 3000 and 3010 and a Cyrix 686 333+ PC."

A As far as I know there is no 3in drive interface available for any Acorn product anymore - though they were available once and a reader may have one. You would need to write a software disc driver as well as make any hardware changes. A company called Officeland - based in Poole, Dorset - may be able to help e-mail: pcwusers@lds.co.uk or phone (+44/0) 1202 666155.

Finally a nice change in the modern world of the internet and word processors, a handwritten letter from Sion Evans:

Q "I recently bought a StrongARM upgrade, and while I am delighted with it, when I try to access files off the floppy disc I get a disc error message.

However, I can access them from my A310. Another question is how can I access mixed format CDs such as audio CDs with video clips.

"Finally I was wondering if anyone knows of a utility to enable various sounds to be played when various actions are performed like

Robert Beech is having a problem with faxing:

Q "Using a Risc PC 600 and a Dynalink 56k modem supplied by Argo with David Pilling's *ArcFax* I can usually send a fax, but the failure rate when some people (not all) try to send me a fax is becoming serious. All starts well the sender gets a message saying *No acknowledgement received*. All I get is his identification on the screen and occasionally about 2 cm of fax. I have sent David Pilling a debug file but he cannot help.

"Now, I believe, in addition to your Acorn expertise, you are involved with Pace. A Pace Solo modem is not cheap, but would be worth it if it solved my problems. Would it reliably receive faxes from anywhere? Could I connect a Pace Solo in parallel with a couple of telephones and my existing modem and, if so, would voice callers hear bells and whistles or would the Solo be sufficiently selective?"

A To start off with the Pace that makes modems is Pace Micro Communications, the Pace I work for is Pace Micro Technology although started by the same person they have been totally separate companies for a long time. Anyway late in August PMC went into voluntary liquidation so there is likely to be a flush of surplus modems on the market.

That aside, there can be many things affecting reception of faxes. For a start there are two classes of fax modem: Class 1 and Class 2. In fact most modems are capable of operating in both modes. The difference between them is that with Class 2 all the protocol is handled by the software in the modem whereas Class 1 has the software in the computer in control. This means that the Class 2 protocol is a fixed, rigid thing where as Class 1 can cope with all sorts of additions and extensions.

As it is the software that decides what mode to put the modem into, it is likely that you could still have the same problem with another modem. While it is most likely that this is a software issue there are some hardware things that could mess you up. For example if you have too much loading on your phone line. Each device has a REN (ring equivalent number) indicating the loading, the maximum loading for a line is four and some modems have a REN of two.

That means two phones and a modem is your limit, so connecting all that in parallel is not a goer. Even so, some modems are not happy working at the limit so you could try removing a phone or two. Another thing that messes up faxes is the call waiting system, this can also disrupt Internet connections.

There is always going to be some combination of modem and software that prevents faxes being 100% compatible. Even commercial fax machines occasionally come up with an incompatible combination. For example my Motorola modem running on my Mac won't connect to the fax machine in the *Acorn User* office. Why? No one knows. Sorry but it's an area where there are no guarantees.

boot up, shut down and opening windows?"

A I am not sure if you are trying to access the disc files from an application. To see if the disc is okay copy the files onto your harddisc.

If that works try to use them from the application. If that fails then your application might need upgrading to cope with the StrongARM processor.

If you can't even copy them onto the hard drive it looks like the disc

drive has not been put back correctly, probably the connection leads have not been pushed home. Alternatively you could have put the drive out of alignment, in which case see a dealer.

Video clips are a bit tricky, WSS does have software with various video capabilities that will allow you to play most but not all videos. Finally, there is a sound effects program on P F Johnson's Kosovo CD called *Events* (part of CC's *Audioctrl*).

END

Subscribe to

The world's number 1 RISC OS Magazine

ACORNUSER

You already know what a great magazine *Acorn User* is – it's the only place you can get accurate, rumour-free, detailed RISC OS news, in-depth hardware and software reviews, and without doubt the best cover discs available.

Take out a subscription today and you guarantee never to miss an issue of the biggest and best RISC OS magazine in the world – at a lower price than you can get in the shops.

**Call our
Subscription Hotline**

Tel: 0870 606 0424

Fax: 01625 859808

e-mail: subscrip@acornuser.com

Please quote code 'A9911' when
subscribing by phone or e-mail

Subscribe now!

To receive the December *Acorn User* (issue 214) all subscriptions must be in by Tuesday 19th October. Subscriptions received after this date will start with the Christmas *Acorn User* (issue 215).

78

back ISSUES

Missed out on one of our previous issues? Take this opportunity to bring your collection up to date. But hurry – stocks are limited.

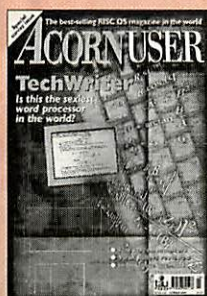

**Issue 212
October 1999**

- Detailed TechWriter review
- Flat screen monitors
- Viruses feature
- TechWriter demo on disc

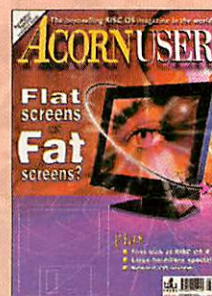

**Issue 211
Sept 1999**

- First look at RISC OS 4
- DataSafe review
- Home Networks Part II
- Eurofighter Typhoon reviewed



**Issue 208
June 1999**

- Film Trailer CDII
- RISCOS Ltd interview
- APDL games CD's
- DigSigGen review

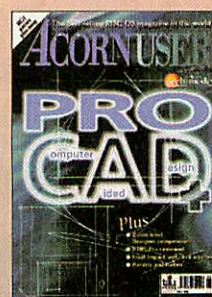

**Issue 207
May 1999**

- !ProCAD+
- Heretic & Hexen
- Acorn Confidence Part II
- Fishy Disk

OS '99
-wguide
The best-selling RISC OS magazine in the world

ACORNUSER

Power Modelling

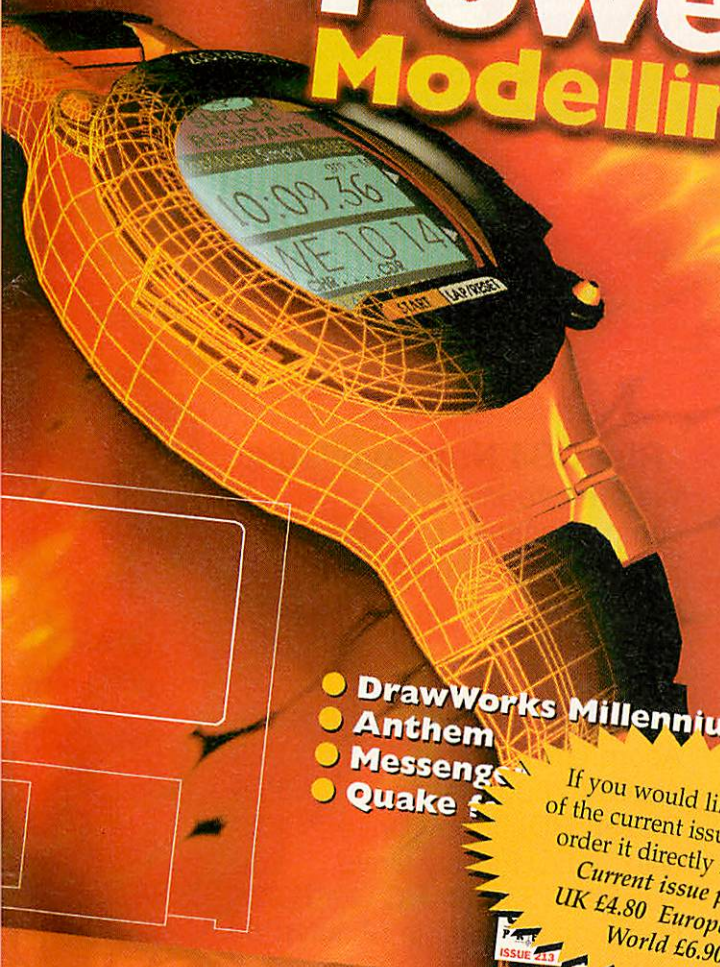

- DrawWorks Millennium
- Anthem
- Messenger
- Quake

If you would like a copy of the current issue you can order it directly from us:
Current issue prices
 UK £4.80 Europe £5.30
 World £6.90

Please send me the following subscription/back issues:

Please subscribe me for:

4-issue subscription			
	<i>New</i>	<i>Renewal</i>	
UK	<input type="checkbox"/> AUN99114	<input type="checkbox"/> AUR99114	£15.99
EU	<input type="checkbox"/> AEN99114	<input type="checkbox"/> AER99114	£17.99
World	<input type="checkbox"/> AWN99114	<input type="checkbox"/> AWR99114	£20.99
8-issue subscription			
	<i>New</i>	<i>Renewal</i>	
UK	<input type="checkbox"/> AUN99118	<input type="checkbox"/> AUR99118	£29.99
EU	<input type="checkbox"/> AEN99118	<input type="checkbox"/> AER99118	£34.99
World	<input type="checkbox"/> AWN99118	<input type="checkbox"/> AWR99118	£40.99
Annual subscription (13 issues)			
	<i>New</i>	<i>Renewal</i>	
UK	<input type="checkbox"/> AUN9911Y	<input type="checkbox"/> AUR9911Y	£45.99
EU	<input type="checkbox"/> AEN9911Y	<input type="checkbox"/> AER9911Y	£51.99
World	<input type="checkbox"/> AWN9911Y	<input type="checkbox"/> AWR9911Y	£63.99

Please send me the following back issues:

	UK	Europe	World
<input type="checkbox"/> Issue 212, Oct 1999	£4.20	£4.70	£6.30
<input type="checkbox"/> Issue 211, Sept 1999	£4.20	£4.70	£6.30
<input type="checkbox"/> Issue 210, Aug 1999	£4.20	£4.70	£6.30
<input type="checkbox"/> Issue 209, July 1999	£4.20	£4.70	£6.30
<input type="checkbox"/> Issue 208, June 1999	£4.20	£4.70	£6.30
<input type="checkbox"/> Issue 207, May 1999	£3.95	£4.45	£6.00
<input type="checkbox"/> Issue 206, April 1999	£3.95	£4.45	£6.00

Any 2 back issues: UK £7.40 Europe £8.05 World £11.15
 Any 3 back issues: UK £9.60 Europe £10.55 World £15.20

I wish to pay by:

Cheque/postal order (payable to Tau Press Ltd)

Credit Card (Visa/Mastercard)

Credit Card No:

Expiry Date: Prices include postage & packing

Name on card:

Signature:

All credit card transactions will be under the name Powertrack International

Name.....

Address

.....Country

Postcode.....Tel.....

E-mail.....

Send your completed Acorn User subscription/back issues form to:
Acorn User, Tau Press, Media House, Adlington Park, Macclesfield, SK10 4NP, England.

Telephone **0870 606 0424*** or fax your completed Acorn User subscription/back issues form with credit card details to **01625 859808**

*calls charged at National Rate
 Have a query? E-mail subscrip@acornuser.com
 Please note e-mail is not secure, we do not recommend sending your order details as plain text.

Please tick here if you do not wish to receive promotional information from other companies



- Issue 210 August 1999**
- Netpilot Internet server reviewed
 - AAUG update
 - RiscStation report
 - Home Networking Series



- Issue 209 July 1999**
- New Photodesk series
 - Y2K compliance for your PC card
 - New programming series
 - Caves game on disc



- Issue 206 April 1999**
- !OHP uncovered
 - Acorn Confidence Part 1
 - !Sleuth 3 Review
 - Java and !Impact-3 continued



- Issue 205 March 1999**
- Web Wizard
 - Using Impact-3
 - Ovation Pro Tutorial
 - Java Programming

Thin Clients

- Low cost per unit
- Low maintenance
- Reliable
- Compact
- Very flexible
- Centralises maintenance at the Server
- Can be used as RiscOS or Windows Terminals or Both!

Acorn Network computers when used in conjunction with a LinServer or NT Server can be used as economic RiscOS terminals which offer performance, security and much reduced maintenance since all services are provided from a central server.

Introducing a WinFrame/MetaFrame Mutli-user Windows server allows NC's, using the Citrix ICA Client from Acorn, to run Windows NT4. Again, all resources are located centrally at the server offering the same level of central management. Why install Windows or RiscOS software on EVERY workstation when you can simply install it once on the Server.

Ring us now to arrange a demonstration.



Robust, Reliable Economic & Flexible

It is possible to have a Server with ALL these attributes!

LinServer - An Internet Gateway & File Server running LINUX (UNIX® for PC's) which supports PC, NC & RiscOS Computers

LinServer is an incredibly robust and dependable File, Print & Internet Gateway server providing virtually every internet resource which doesn't cost the Earth! There are NO licensing issues on the number of users supported. LinServer supports over 10,000 users, the limit being only storage capacity and RAM.

Standard features:
NFS, PC File server with disc quota's
POP3, SMTP, IMAP4
Mail Server
NNTP News Server
Web/Proxy Server
FTP Server
Printer server
Internet dial-on-demand using ISDN or modem
Dial-in modem access
WWW Server Tools
... Plus many more.

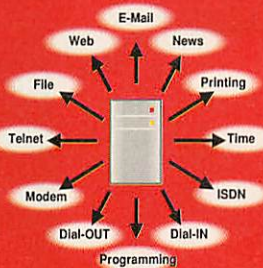

It supports PC's, Network & RiscOS computers. You can literally place this server in a secure room and forget about it, being almost completely self maintaining except for user administration. Contact us now to arrange a demonstration.

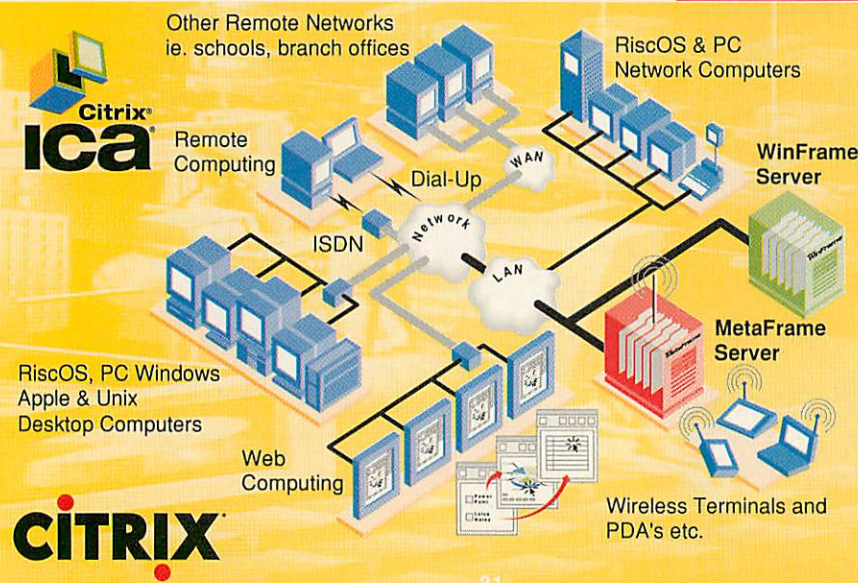

RiscOS4 Now Available

We are offering a comprehensive RiscOS4 Installation service. Ring for further details.



Special Offers

Strictly while stocks last

- | | |
|-----------------------------|-------------|
| Acorn Grey Mouse | £25 |
| Acorn A7000 Mouse | £25 |
| Citizen HD Floppy Drive | £20 |
| Citizen DD Floppy Drive | £30 |
| CJE586-133MHz PC Card | £225 |
| Nintendo 64 Bundle (2 only) | £60 |
| - With SuperMario/Goldeneye | |
| RiscDisc Vol 3 | £5 |
| Wolfenstein 3D (SA compat.) | £5 |
| 4D Games | £5-£10 each |
| Krisalis Games | £10 each |
- Ring for details of other offers.

200W Active Speakers

Mains powered, Magnetically Shielded

**£15
Incl.**



A Citrix® WinFrame or MetaFrame Server provides access to virtually any Windows® application, across any type of network connection to any type of client (including Thin-Clients & RiscOS). It allows multiple, concurrent users to log on and run applications in separate, protected Windows sessions ON the server, resulting in each user consuming as little as one-tenth of their normal network bandwidth.

It gives you centralised management, exceptional performance and improved security for all your education/business critical applications and data.

Ring us now for further information or call into our showroom for a demonstration.

Desktop Projects Ltd



Tel: 0161-474 0778 - Fax: 0161-474 0781

Open 10.00 - 18.00 Monday - Saturday

All prices Include VAT. Carriage not included. E&OE. 110699

www.desktopdemon.co.uk - email: info@desktopdemon.co.uk

Unit 2A Heapriding Business Park, Ford Street, STOCKPORT, Cheshire. SK3 0BT

Do you do voodoo?

In reference to your article on RiscStation's RS7500 PCI-slot capable machine, and announcements on their Website concerning Voodoo graphics cards.

An anonymous developer of drivers for 3DFX has claimed that as far as drivers go, "the Voodoo 3 2000 is the only card feasible for the RS7500 PCI slot system". This is because the Voodoo 1 and 2 are 'loop back cards' which means they run through a separate base graphics card. The Voodoo 3 2000 on the other hand is an 'all in one' base card and 3D Accelerator. The RISC OS drivers are apparently available on the Voodoo developer website.

In a separate conversation an unnamed spokesman for Creative Labs – a company famed in the PC world for sound cards, DVD players, MPEG Cards and Graphic cards – was reported to have said that "the Acorn market's size is far more extensive than I realised. To ignore it would be passing up a great marketing opportunity, although much would depend on how the PCI system development progresses, the further development of the operating system and the potential cost for driver conversion".

This is definitely food for thought as Creative is one of many companies using the NVIDIA graphic chipset – currently the PC markets Open Graphics Language Standard – and support from this area would be a major boost for the Acorn market.

This is especially true when you take into consideration that, as well known a company as 3DFX are, their reluctance to licence the Voodoo 3 chipset to other card manufacturers in the PC market has raised questions about their long term future. This in turn has seen a rise in NVIDIA's profile

Slayer correction

Last month we ran an article on virus killers, and one of them, *Slayer*, had a bit chopped off it's Product box. The correct e-mail address for *Slayer*'s authors is unciscy@eh.org

Dunstan Orchard

and on the 31 January NVIDIA announced a new generation of GPU (graphic processing unit) cards. These are due to be released by most of the major graphic manufactures by the beginning of October 1999.

A.D. Fector, by e-mail

Podules, what fun

I read in one of my game instructions that you can make a set of pedals and a steering wheel to plug into an old (but nice) A3000. One problem. I need an I/O Podule. What is an I/O Podule? Apparently without it the said pedals and steering wheel will not work.

Secondly, is it possible to do some DIY software conversion? Thirdly why won't High Street steering wheels/pedals work on an Acorn (RiscStation R7500 and so on)? Fourthly, won't someone up there at *Acorn User* please create a series with a theme of game design/programming or maybe some Run The Risks for the younger readers of the magazine – just like a certain Mike Cook did in the *Let's Compute!* magazine.

Kevin McMullin (13), by e-mail

An I/O podule is a card that plugs into your computer that gives you some input/output (I/O) ports that are the same as the old model B. Basically this is an 8-bit digital User Port and a 4-channel 12-bit A/D (analogue to digital) converter. These cost about £50.

The reason you can't plug in a High Street steering wheel is that there's nowhere to plug it in. PCs have a joystick which contain a simple bit of electronics that the software knows how to drive.

So any scope for DIY? Well yes, I did an article in June '96 on how to use PC-type joysticks you can get it on the Web from <http://www.doc.mmu.ac.uk/Physics/Acorn/RTR96.html> however remember any software will have to know how to drive it. Another one in October '95 showed the Acorn standard way of connecting joysticks you can find that on <http://www.doc.mmu.ac.uk/Physics/Acorn/RTR95.html>

I do include some 'low tech' construction articles from time to time although I haven't recently, so I will think about a few. Hope that helps.

Mike Cook

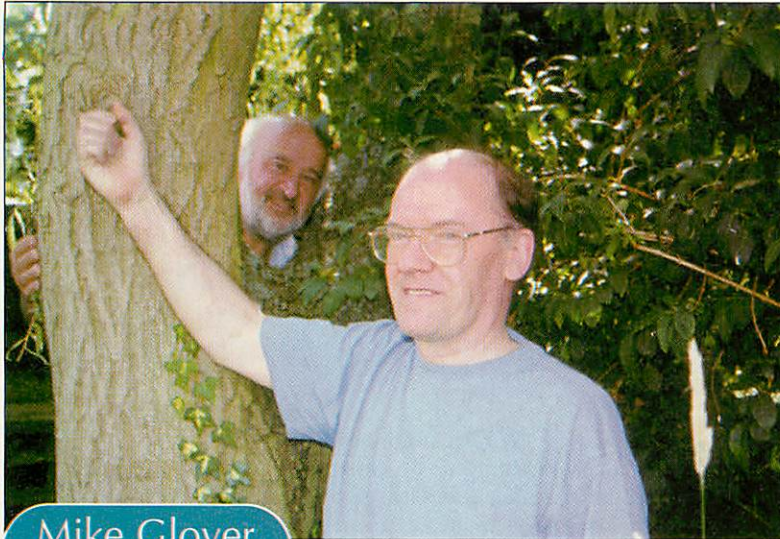

Mike Glover
and
Bob Pollard

‘It’s funny – people think of DTP as making small documents, no one thinks of it on a novel scale.’

A person can fool you into thinking that they’re a nice guy if you meet them at a show, but it’s hard to keep up the pretence when you spend four hours in the same car. I spent four hours driving with Mike Glover and I can confirm he is officially a nice guy. This interview is a tale of two cities, Stamford and Holmes Chapel, and two partners in Icon Technology: Mike Glover and Bob Pollard.

Most people will admit to doing a bit of DIY and many have a few tools or even a small workshop, but what you don’t expect is to find a full tool shop complete with wood-cutting machines capable of making window frames. Mike and his wife Angela are renovating their ‘country cottage’. This not just painting, this is fitting windows, taking down walls and roofs.

The first thing after the tour I am shown is the office, and then *EasiWriter*, which I have been finding out does exactly what it says on the box.

‘We started on the Mac, with *MacAuthor*,’ Mike explains. ‘Douglas Adams used it to write *Dirk Gently’s Holistic Detective Agency*, and was probably the first author to typeset his own novel. It’s funny – people think of DTP as making small documents, no one thinks of it on a novel scale. These days we are just on the Acorn platform but another platform as well would be fun ... perhaps when we’ve made more money. Both *EasiWriter* and *MacAuthor* are different from other programs because they are written from a writer’s viewpoint, not a programmer’s.’

Mike met Bob through a mutual acquaintance when Bob was working for ICL. Bob lives in Holmes Chapel, and Mike gives me a lift over to Bob’s house, telling me what he’s done in previous lives on the way.

‘I have been to the same party as Bill Gates, back in 1979. Gates and Scully were wandering around saying hello to everyone. In those days I was living in Brazil. It was the usual story, I

went for two years and ended up staying for nine. I was a regional manager for Dunlop. I looked after the whole of South America.’

Mike tells me that he will show me what his factories used to make when we pass the next electrical transmission line. Another hour later we eventually see some; the black anti-vibrators which are needed when you conduct high voltage electricity. Without them the vibrations caused by conducting a high voltage alternating current would cause the conductors to fail and fall down.

We eventually arrive at Bob’s house: ‘Bob is the chief programmer and I’m the other one’, jokes Mike.

‘I worked for ICL straight from University,’ says Bob, ‘must have been for about 20 years. In those days computers were room-sized.’

‘It’s your fault we got into the Acorn market,’ Mike reminds him.

‘Acorn has been my hobby since the BBC Micro came out,’ agrees Bob. ‘I was actually working in the factory where they were made. Unfortunately no discount, but it was interesting.’

‘What also happened was that someone at Acorn was using *MacAuthor*. So Acorn came to us and commissioned us to do something with the functionality of *MacAuthor* and *Formulator* – something Bob wrote in a year by himself which just did mathematical formulae. As with all good software developers we were a bit late on delivering so Acorn asked us to drop the maths bit and come out with the word processor part, then get on with *TechWriter*.

‘Then Acorn decided that they really did not want to be in the business of publishing their own software, so they gave it back to us – which was nice. We have done other stuff for Acorn like the word processor in the Network Computer.’

Icon would like to make more money so it could employ some people to program for them. It’s Bob who does it all at the moment.

‘I program in C++, we have been doing C++ from the start...’

‘Now don’t be modest,’ butts in Mike.

‘On the Mac,’ continues Bob, ‘we used *Object Pascal*. We needed something object-oriented on the Acorn so I thought let’s go for C++, but there was no compiler so I had write my own. Five years later Acorn got around to doing it.’

The interview turns to chatting and I find out that Bob the hoarder still has his original Sinclair calculator. Bob and Mike chat a little about business and I get see how well they get on as a team. Then it’s back to Stamford with Mike giving me a classical music lesson on the way.

That ‘nice guy’ image Mike projects at shows? It’s genuine. Trust me.

Jill Regan

New Olympus cameras for the Autumn:

The C920ZOOM £549.99, the C-21 £699.99 and the fantastic SLR, the C-2500L £1199.99

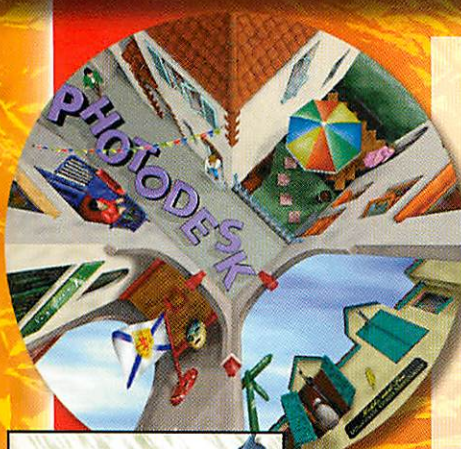

PHOTODESK 3 is the *layers* package which defines studio quality image editing and artwork on RISC OS machines. It is easy to use but has many powerful features, including **LAYERS** and a sophisticated colour management system (CMS) for the full-time graphics professional. **£299.50**

PHOTODESK 2 is still available, retaining the CMS but not layers, **now only £199**

PHOTODESK LIGHT, an economic alternative to PHOTODESK3 retains most of its creative features apart from the Colour Management System, Layers and some features essential to the professional user. **£134.75**

Plug-in Effects Packs are available for all Photodesk packages. Each pack contains 10 special effects: **£19.95**

Purchasers of Photodesk 3 or Photodesk Light will receive a complimentary CD-ROM of useful resources, utilities and Tutorials. This CD is available to existing users for £14.95

A NEW CD-ROM "An Introduction to Digital Art" featuring bitmap and vector graphics tutorials by the well-known artist, David Cowell, is also available for £24.95

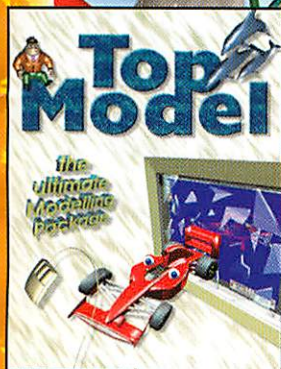

A New Version of TopModel2 V.2.14 is now available for £152.75. Existing users may upgrade for **£29.95** or buy the NEW CD-ROM packed with resources, the new plug-in Top3DFonts! and a free 2.14 upgrade for only **£58.63**

TopBones Skeleton Management System now ready **£39.50** ...as well as TopModel CD-ROM #3! **£49.95**



OHP A presentation package on CD-ROM from Spacetechnology

Makes your slide shows quick and easy to create!

- Start building your presentation 5 minutes before the lesson? – No Problem
 - Use your existing work in a presentation? – No Problem, just drag 'n drop it in!
- Only £29.95**



New Olympus Cameras for the Autumn: Olympus have discontinued the C900Zoom and the C1400XL cameras. The new range from Spacetechnology includes the entry level C830L at **£399.99**, the C900 replacement, the C920ZOOM at **£549.99**, the fantastic 2 Megapixel C2000ZOOM at £749.99 the fantastically compact 2 megapixel C-21 at **£699.99**, and the new SLR, the sensational 2.5 Megapixel C-2500L at **£1199.99**. All Cameras supplied by us have the RISC OS PhotoLink software bundled as well as Mac and PC drivers. We stock the full range of Olympus accessories.

For full specs, please ask us for brochures, or see our website





PhotoReal is the Acorn driver extension for the Canon BJC4300, BJC4650, BJC7000, BJC 7100 BJC2000, Epson Photo, Photo700 and PhotoEX printers with photo-realistic capability. PhotoReal makes use of the same advanced techniques for producing high-quality four colour separations as Photodesk and comes ready calibrated for the special dye-based inks used for photo-realistic printing. A calibration application is also supplied to allow you to tailor the results to your own specification.

Driver only **£69.00** Inc.VAT. or FREE if purchased with printer!

Examples: Stylus Photo700 was £249.50 NOW **£204.45**
Canon BJC2000 **£149.95**
BJC4650 A3 **£299.99**
BJC7000 **£245.00**
BJC7100 **£299.00**
Epson PhotoEX A3 was £454.73 NOW **£363.07**
(all prices include PhotoReal Driver)

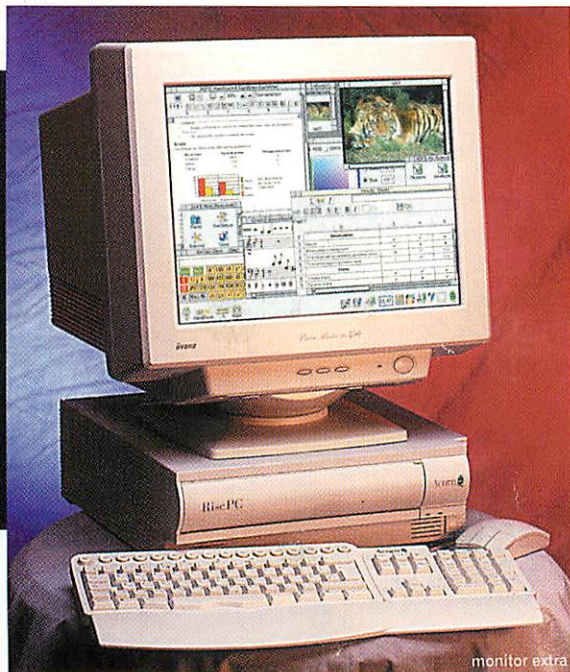
Lightning-fast computing



Acorn ™
RiscPC 233T

Castle's lightning-fast Acorn RiscPC233T sets the standard for robust, trouble-free computing. The 233MHz processor is further enhanced by the exceptionally efficient and robust RISC OS architecture. This puts the RiscPC233T among the leaders for raw computing power.

- **INTEL StrongARM 233MHz (revision T) processor** - ARM designed
- **Modular expansion** - increase the case size quickly and easily
- **2nd processor slot** - eg use with PC card for Windows applications
- **CE marked** - your evidence of top quality and safety
- **100% Acorn** - the original tried and tested Acorn design further enhanced

RiscPC233T

8MB, 2GB, RiscOS 3.7
£749 + vat

RiscPC 233T CD

18MB, 4GB, 40xCD,
RiscOS 4.0
£879 + vat



RiscPC233T WEB WIZARD

Internet Suite, JAVA, 32MB, 2VMB,
8GB, DVD-CD, 56K modem,
17" monitor, RiscOS 4.0
£1149 + vat

Order now!

Call 01728 723200
FreeFAX 0800 783 9638

Delivery £11 (£12.93 inc. VAT) per system.



CASTLE
Computers for Education
Business and Home