

Doom
competition
results

The best-selling RISC OS magazine in the world

ACORN USER

32 x 600MHz =
20GHz
Processing power

Plus

- RiscStation report
- AAUG update
- Home networks
- Kosovo CD appeal

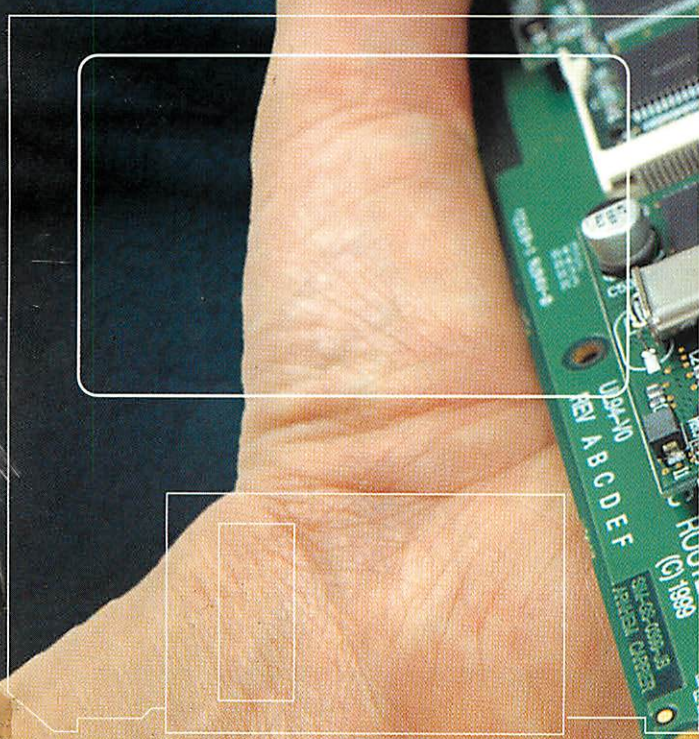

 08 >
P R E S S 9 1 7 7 0 2 6 3 1 7 4 5 1 1 6
ISSUE 210 AUGUST 1999 £4.20

i16 sound sampler

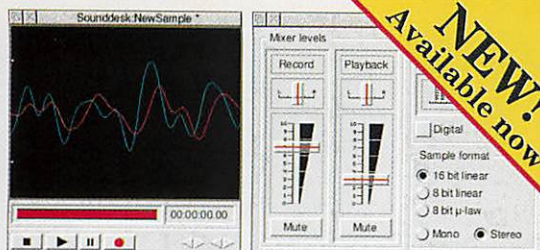

Designed to complement our existing range of video digitisers and multimedia cards, **i16** features high quality direct-to-disc recording from both analogue and digital sources, making it the perfect companion for today's affordable CD writers.

i16 is equipped with S/PDIF input and output for direct digital connection to suitable CD players, DAT and Mini-Disc recorders.

- 8/16-bit linear and 8-bit μ -law formats.
- Sample rates from 4 - 50kHz in 1Hz steps.
- Saves Replay and WAV files.
- Analogue and digital input/output.

Videodesk



Videodesk is a powerful non-linear video editing system. It allows full-size, full-colour and full-motion video to be edited to frame accuracy, and effects and titles added. The finished material can then be output for display or recorded back to tape.

For a limited period only, **Videodesk** is offered with your choice of either:

- a FREE 9.1Gb fast SCSI hard disc, or
- a FREE 32-bit SCSI II interface card, or
- a FREE Risc TV card.

Risc TV

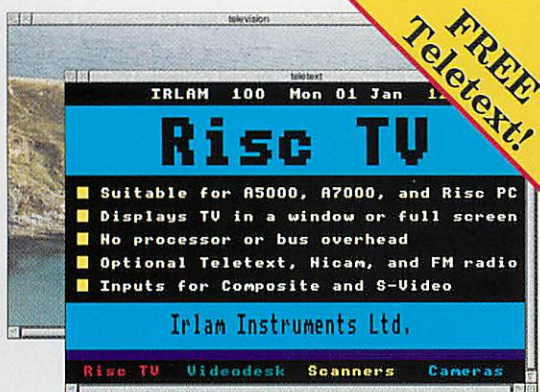

Risc TV is a unique multimedia digitiser complete with built-in television tuner and audio processor, which allows you to watch television on the desktop and digitise high quality still images from the tuner or an external video source.

Unlike other digitisers, **Risc TV** uses special hardware to overlay video directly. So, full motion video can be displayed in 24-bit colour, with no processor or bus overhead. Now you can watch television and use your computer!

Scanners & Cameras



We support Epson's range of high quality colour flat-bed scanners, suitable for home, school and business applications. All scanners are supplied complete with our renowned **ProImage** driver software.



As the leading independent supplier of digital cameras to the Acorn market, we have support for over thirty-five different models from the leading manufacturers - Agfa, Epson, Olympus, Sanyo, and Sony. Contact us for full details of scanners and cameras, and latest pricing information.



For the Complete Picture...

Irlam Instruments Ltd,

Brunel Science Park, Brunel University, Kingston Lane, Uxbridge, Middlesex, UB8 3PQ.
Tel/Fax: 01895 811401 Email: sales@irlam.co.uk
Visit our website: www.irlam-instruments.co.uk



ACORN USER

August 1999

Features

- 24 RiscStation**
Steve Turnbull reports on the development of RiscStation's R7500
- 47 CDs for Kosovo**
Find out about the new charity CD from Paul Johnson and how you can help the orphaned children in Kosovo
- 52 AAUG**
The latest AAUG information

Regulars

- 6 News**
Last month's Mico news (sorry!), Pace update, new Psion hardware, Hotmail horror, and investing in RISC OS
- 13 Comms**
Connecting PCs and Acorns Samba style, also Find it, Name it, Dial it
- 15 Cover disc**
This month's 1.6Mb disc contains a playable demo of Botkiller 2, plus all the usual RTR, MIDI, and OOP files
- 16 Public domain**
Paul Vigay takes up the PD reins - this month; MP3 players, star gazing, thumbnails and sheep
- 19 PC page**
Taking a look at PC tyranny in schools; counteracting secret configuration and at free ISPs
- 42 Game show**
Find out who won the Doom WAD designer competition, and what's on the games horizon
- 65 Free ads**
Lots of wonderful second-hand hardware and software
- 70 Subscriptions page**
Take advantage of our fantastic subscription offers and get yours today
- 72 Letters**
Our lovely readers have their say in the Letters page
- 74 The regan files**
This month Jill makes transatlantic cow-eyes at Ian Molton

Education

- 59 Education news**
Pam Turnbull lets us know what's new in the world of education
- 60 Education reviews**
Pam looks at Turtles and LOGO as well as !Look! Hear Talking Topics

Reviews

- 20 Netpilot**
Mike Buckingham reviews a Linux-based Internet server

Hands on

- 28 Photodesk series**
Part 2 of Walter Briggs's series on 24-bit art packages
- 33 MIDI controllers**
Michael Cowgill introduces us to NPRN MIDI controllers
- 34 Photo retouching**
Simon Anthony continues his series on photo re-touching for free
- 37 OOP**
Greg Scott looks at object-orientated concepts in C++
- 48 Home networks**
The first of Mike Buckingham's short series on creating a multi-platform network in your house
- 63 Run the Risc**
Mike continues his article on a sound exciter - this month it's the software
- 66 Rambles**
More questions for the maestro of micros - from music, to machine networks, to video captioning

Next month

Part one of a Flat Screen Monitor round-up, how effective are our Virus killers, the pitfalls of big hard drives, plus all the ongoing series

On sale 5th August 1999

Published by



Media House, Adlington Park, Macclesfield SK10 4NP
e-mail enquiries@acornuser.com
http://www.acornuser.com/
Tel: (01625) 878888 Fax: (01625) 859808
Printed by Apple Web Offset, Warrington

Editor Steve Turnbull

Deputy Editor Dunstan Orchard
Production Manager Alan Jones
Art Editor Anthony Broughton

Contributors

Simon Anthony, Alasdair Bailey, Walter Briggs, Mike Buckingham, Ian Burley, Mike Cook, Michael Cowgill, David Dade, Jill Regan, Paul F. Johnson, Greg Scott, Neil Spellings, Pam Turnbull, Paul Vigay.

Account Manager John Snowdon
Ad Production Dunstan Orchard
Finance Manager Charlie Moran
Subscription Manager Richard Siggee
Circulation Director Darren Whiteman
Distribution COMAG (01895) 444055
Managing Director Steve Turnbull

Subscriptions:
0870 6060424

E-mail: subscrip@acornuser.com
13 issue subscription rate: £45.99 (UK),
£51.99 (EU), £63.99 (World)

Acorn User is available as speech from the Talking Newspaper Association UK

©1999 Tau Press Ltd.

No material may be reproduced in whole or in part without written permission. While every care is taken, the publishers cannot be held legally responsible for any errors in articles, listings or advertisements and the views of contributors do not necessarily reflect the views of the publishers

Internet Services provided by Argonet, www.argonet.co.uk

- EasyFont Pro special offer Page 56
- Eesox IDE CD-RW special offer Page 62
- Advertisers Index Page 68
- Back issues Page 70

Finance Deals

- * 0% Buy now, pay 6 months later
- * Can convert into standard finance package, no penalty (still get 6 months interest free)
- * Low Cost Finance Option @ 1.5% per month (19.9% APR) up to 5 years to pay
- * No early settlement penalties.
- * Can make additional purchases up to your credit limit without re-application.
- * Ring For full details

Desktop FAX MODEMS

56k x2/V90 3Com USR	£118.30	£129.00
56k Flex/V90 (Rockwell)	£55.32	£65.00
ISDN modem (external)	£99.00	£116.33
High speed serial cards from	£67.23	£79.00

Internet & Modem Software

ANT Internet Suite	£94.05	£110.51
Webster XL	£21.28	£25.00
Java CD	£33.19	£39.00
ArcFax Fax software	£26.38	£31.00

All monitors inc 3 yrs wty unless specified

MONITORS

	Ex VAT	Inc VAT
14" SVGA 0.28 (3yr on-site)	£85.00	£104.58
14" SVGA 0.28 Multi-Media	£99.00	£116.33
15" SVGA 0.28 (3yr on-site)	£110.00	£129.25
15" SVGA 0.28 Multi-Media	£129.00	£151.57
15" liyama Vision Master 350	£129.00	£151.27
17" SVGA 0.28 (1yr RTB)	£149.00	£175.08
17" SVGA 0.28 (3yr on-site)	£170.00	£199.75
17" SVGA 0.28 m-media(3yr)	£190.00	£223.25
17" SVGA 0.25 (3yr on-site)	£275.00	£323.13
17" liyama Vision Master 702	£235.00	£276.13
17" liyama Pro 400	£316.00	£371.30
19" SVGA 0.26 (1yr RTB)	£280.00	£329.00
19" SVGA 0.26 (3yr on-site)	£360.00	£423.00
19" liyama Pro 450	£460.00	£540.50
21" SVGA 0.25 (3yr on-site)	£540.00	£634.50
21" liyama Pro Diamondtron	£665.00	£781.38
38" SVGA (1yr on-site)	£1500.00	£1762.50
AKF18 Multisync (14")	sold out	sold out
AKF53 Multisync 14" 1yrRTB	£160.00	£188.00
AKF50 Multisync 14" 1yrRTB	£195.00	£229.13
AKF12 PAL 14" refurb 90 days	£65.00	£76.38
Multisync A300/A3000 cable	£8.50	£9.99

* 2nd user mon's available with 90 days WTY

THE BEST PRINTER PRICES

(Please ring for latest prices)

	Ex VAT	Inc VAT
Canon BJC 1000 colour A4	£80.00	£94.00
Canon BJC 2000 colour # A4	£100.00	£117.50
Canon BJC 2000 Scan # A4	£169.00	£198.58
Canon BJC 4650 colour # A3	£228.00	£267.90
Canon BJC 4650 Scan # A3	£275.00	£323.13
Canon BJC 7000 colour # A4	£169.00	£198.58
Epson Stylus 440 colour A4	£99.00	£116.33
Epson Stylus 640 colour A4	£116.00	£136.30
Epson Stylus 850 colour A4	£198.00	£232.65
Epson Stylus 1520 colour A3	£350.00	£411.25
Epson Stylus Photo 700 # A3	£135.00	£158.63
Epson Stylus Photo EX # A3	£265.00	£311.38
HP 420C A4	£74.00	£86.95
HP 695C colour A4	£99.00	£116.33
HP 895CXI colour A4	£200.00	£235.00
HP LASERJET 1100	£249.00	£292.58
HP LASERJET 2100	£454.00	£533.45
Photo drivers for #	£58.72	£69.00
Scanner drivers for I	£29.79	£35.00

FREE Acorn driver by request

0% Interest FREE credit (6 months) or LOW cost finance on all new systems, & FREE Internet connection

6 months Interest Free Credit On All Systems inc peripherals, software and 2/3 yr optional warranties

RiscStation

RISC Based Technologies



R7500 50 mip PCI based system with 16M / 4.3G / 40x CD / 14" mon & Stereo Spk for only £649 exc vat (£762.58)
FREE Software Bundle
Due 31st July 1999
See www.riscstation.co.uk for details

233Mhz SA RiscPC Offers



e.g. RPC SA
2M+32Mb/4G/40x CD & 17" monitor for only
£1125 + VAT or £34.00/month via

L.C.F. * RPC SA bases from £850 inc VAT or £22.00/month via L.C.F. * AND we will match or beat your best offer

SA J233 Web Wizard

2M+32Mb/4G/40x CD/15" mon/stereo Spk, inc !Browse, Java and Word 6/7 compatibility & 56K modem for only **£1145 + VAT**

Availability soon

A7000 + Peak Performer

29 Mips 16M / 4G / 40x CD / 15" mon & Stereo Spk free software bundle
£699 + VAT or £21.00 / month on L.C.F.
(£789 + VAT for internet bundle)
8Mb bases from **£499 + VAT**



internet bundle includes 56K modem and Ant internet suite

add £89.00 + vat for network card

Please ask for other combinations

Casio QV100 Digital Camera



PC s/w only £170.00 exc vat (£199.75)
Acorn & PC s/w **£255.00 (£299.63)**
Qv11a/Qv100 s/w kit £96 (£112.80)

HARD DRIVES AND SUB-SYSTEMS WHY PAY MORE???

A3000/A3010			A3020		A4000/A5000/A400			RPC / A7000 / RiscStation		
Ex. VAT	Inc. VAT		Ex. VAT	Inc. VAT	Ex. VAT	Inc. VAT		Ex. VAT	Inc. VAT	
170Mb	£95	£111.63	£55	£64.63	210Mb refurb	£25	£29.38	210Mb refurb	£25	£29.38
340Mb	£112	£131.60	£89	£81.08	420Mb	£49	£57.58	512Mb	£55	£64.63
512Mb	£127	£149.23	£85	£99.88	540Mb	£55	£64.63	1.2Gb	£60	£70.50
810Mb	£139	£163.33	# £119	£139.83	730Mb	* £85	£99.88	2.1Gb	£65	£76.38
1Gb	£149	£175.08	# £124	£145.70	1.2Gb	* £105	£123.38	4.3Gb	£75	£88.13
2Gb	£159	£186.83	# £134	£158.63	2.1Gb	* £110	£129.25	6.4Gb	£85	£99.88
3Gb	£169	£198.58	# £144	£169.20	3.2Gb	* £135	£158.63	8.4Gb	£99	£116.33
4Gb	£189	£222.08	# £164	£192.70	4.0Gb	* £120	£141.00	16.8Gb	£165	£193.88

A3000/A3010 version includes CD ROM i/f which can also be used in A3020 or A4000.
For external A3000 i/f add £20.00 +VAT
includes partitioning software

* inc. internal removable HD & CD ROM i/f.
For partitioning software only deduct £25.00 + vat (£29.38)

Partitioning software for RISCOS 3.5/6/7 only £25.00 + vat (£29.38)



ACORN TRACKBALL & MOUSE
£29.79 + VAT

CD-ROMS

IDE		SCSI	
40x	£39.00 (£45.83)	40x	£65.00 (£76.38)
24x	£35.00 (£41.13)	32x	£55.00 (£64.63)
8x	£30.00 (£35.25)	8x	£30.00 (£35.25)

For external IDE or SCSI I add £50.00 + VAT (inc.cable)
For external SCSI II add £55.00 + Vat. (inc. cable)
IDE driver for RiscOS 3.5 £15 + vat
IDE int. fitting kit £5 inc. Int. SCSI fitting kits from £10 + vat

SCSI HARD DRIVES

540Mb # limited supply	£60.00	(£70.50)
1Gb	£70.00	(£82.25)
2Gb (5400 rpm)	£90.00	(£105.75)
2Gb (7200 rpm) #	£100.00	(£117.50)
4.3Gb (5400 or 7200rpm)	£140.00	(£164.50)
9.1Gb (7200rpm)	£235.00	(£276.13)
18.6Gb (7200 rpm)	£425.00	(£499.38)

For EXT. SCSI I case £50.00 + VAT (inc. cable)
For EXT. SCSI II case £55.00 + VAT (inc. cable)

CD-ROM WRITES



Prices Start from **£170.00 +**

2x2x6x	£170.00	(£199.75)
4x4x16x	£235.00	(£276.13)
CD-BURN	£49.00	(£57.58)
CD-SCRIBE 2	£49.00	(£57.58)



SCSI 8x Autochanger
£85.00 + vat
(£99.88)

IDE Removable Drives

Zip 100 int	£65.00	(£76.38)
Zip 250 int	POA	POA

Parallel Removable Drives

Zip 100	£110.00	(£129.25)
Zip 250	£159.00	(£186.83)
Jaz 1G	£239.00	(£280.83)
Jaz 2G	£299.00	(£351.33)

SCSI Removable Drives

Zip 100 M int	£85.00	(£99.88)
Zip 100 M ext	£85.00	(£99.88)
Zip 250 M int	£135.00	(£158.63)
Zip 250 M ext	£135.00	(£158.63)
PD650/CD	£139.00	(£163.33)
Normal 750	£165.00	(£193.88)
Jaz 1G int	£189.00	(£222.08)
Jaz 1G ext	£199.00	(£233.83)
Syjet 1.5G int	£199.00	(£233.83)
Jaz 2G int	£249.00	(£292.58)
Jaz 2G ext	£249.00	(£292.58)

Removable Drive Media

	Inc VAT	Ex VAT		Inc VAT	Ex VAT
100Mb Zip	£8.00	£9.40	1Gb Jazz	£58.00	£68.15
Zip 5 pack	£35.00	£41.13	2Gb Jazz	£69.00	£68.15
250Mb Zip	£12.76	£14.99	1.5Gb Syquest	£58.00	£68.15
120M LS 120	£7.00	£8.23	CDR CD-ROM	£1.28	£1.50
135M Syquest	£21.00	£24.68	CDR 10 pack	£10.00	£11.75
230M Syquest	£19.90	£23.38	CDR 25 pack	£21.28	£25.00
270M Syquest	£29.75	£34.96	CDRW CD-ROM	£8.51	£10.00
650Mb PD	£19.00	£22.33	CDRW 10 pack	£70.00	£82.25
750Mb Normal	£38.00	£44.65			

6 Drive CD-ROM SCSI Towers
8x £299 exc. 4x 8x £699 exc.
40x £499 exc.

Interface Adapters

Storm SCSI 8-bit (A30x9 int)	£88.00	£103.40
Storm SCSI 16-bit (podule)	£96.00	£112.80
Storm SCSI 32-bit (podule)	£128.00	£150.40
Powertec SCSI32 32-bit (podule)	£170.00	£199.75
Simtec 8-bit (A3000/A3010)	£55.00	£64.63
Simtec 16-bit (AX00/A5000/RPC)	£45.00	£52.88
APDL 16-bit DMA	£45.00	£52.88
APDL Blaze 32-bit DMA	£115.00	£135.13
Rap IDE32	£119.00	£139.83
Removable IDE or SCSI housing unit	£20.00	£23.50

3 yr Warranty on ALL Acorn MEMORY why Pay More??

ACORN MEMORY NEW PRICES

	Ex VAT	Inc VAT
4-8Mb Up. (A310, 440, 3000*)	£99	£116.33
4-8Mb Up. (A5000*)	£119	£139.83
*rework for A3000/5000/25Mhz	£25	£29.38
A3010 1-2Mb Upgrade	£25	£29.38
A3010 2-4Mb Upgrade	£45	£52.88
A3010 1-4Mb Upgrade	£55	£64.63
A3020/4000 2-4Mb Upgrade	£40	£47.00
A5000 2-4Mb Upgrade	£45	£52.88
A3000 1-2Mb Non-Upgrade	£20	£23.50
A3000 2-4Mb Upgrade (exchange)	£45	£52.88
A3000 1-4Mb Upgrade	£55	£64.63
A3000 Serial Port Upgrade	£23	£27.03
A310 4Mb Upgrade	£50	£58.75
A400/1 1Mb Upgrade (per Mb)	£25	£29.38
RISC OS carrier board (A310)	£19	£22.33
MEMC 1A Upgrade (short supply)	£45	£52.88
NEW A540 4Mb	£97	£113.98

RISC PC MEMORY

	Ex VAT	Inc VAT
Also for A7000		
8Mb SIMM	£10.00	£11.75
16Mb SIMM	£20.00	£23.50
32Mb SIMM	£42.00	£49.35
32Mb high clearance	£53.00	£62.28
64Mb SIMM	£85.00	£99.88
128Mb SIMM	£160.00	£188.00
1Mb VRAM	£38.30	£45.00
2Mb VRAM	£76.00	£89.30
1-2Mb (exchange)	£66.00	£77.55

33 Mhz Arm 3 upgrade

with FPA socket	£99.00 inc.
with FPA 10 fitted (25Mhz)	£159.00 inc.

RiscOS 3.11 Rom upgrades
£25.00 exc Vat (£29.38)

NETWORKING

ETHERNET INTERFACES

	Ex. VAT	Inc VAT
A3000 int. 10base2 or T. Access+	£89.00	£104.5
A400/A5000 10base2 or T Access+	£89.00	£104.5
A400/A5000 10base2 & T Access+	£99.00	£116.3
A3020 10base2 Access+/ext. MAU	£99.00	£116.3
A3020 10baseT Access+/ext. MAU	£99.00	£116.3
Risc PC/A7000 10base2 or T Acc+	£89.00	£104.5
Risc PC/A7000 10base2 & T Acc+	£99.00	£116.3
Ant Access+ ROM upgrade	£10.00	£11.75

Cables

2M	£3.00	£3.53
3M	£5.00	£5.88
5M	£6.00	£7.05
10M	£10.00	£11.75
20M	£15.00	£17.63

State 10base2 or 10baseT any size made to order

Network Hubs

	Ex VAT	Inc VAT
10baseT 16+2(18) port	£75.00	£88.13
100/10 Auto 16 Port	£249.00	£299.58

We supply and / or install all network components please ring for your requirements



RISC OS 4 £99.00 +vat

(£116.33) place your order now
Fitting & data transfer, if required, £25 inc vat
(£15 with new HD).

MICE & KEYBOARDS



High Quality Acorn ERGO Mouse £12.00 (£14.10)

	Ex. VAT	Inc. VAT
Acorn Trackerball/Mouse NEW	£29.79	£35.00
Acorn Original Mouse	£25.00	£29.38
Acorn ERGO Mouse NEW	£12.00	£14.10
A7000 replacement Mouse NEW	£12.00	£14.10
Ergo (std) Risc PC Keyboard	£21.28	£25.00
Ergo curved Risc PC Keyboard	£29.78	£35.00
A400/A5000 replacement K/brd	£59.00	£69.33
A400/A5000 Ergo Keyboard	£69.00	£81.08

Replacement Floppys Drives

A3000/400/500 £29.00+vnt (£34.08)
A30X0/4000/5000 floppy allows cross - formatting of HD and DD discs £29.00+vnt (£34.08)

POWERED SPEAKERS

	Ex. VAT	Inc. VAT
60 watts with PSU	£16.98	£19.95
240 watts with PSU	£24.68	£29.00
Subwoofer system	£42.00	£49.35

Character Mouse Mats

Southpark Kenny	£4.99
Southpark Cartman	£4.99
Disney Mickey, Pooh, Donald, etc	£4.99
X-Files (four types)	£4.99
Garfield or novelty	£4.99
Standard matt £1.00 / Econ. £0.65	

Switch Boxes

2-1 with cable	£15.00	£17.63
2-1 Auto with cable	£15.00	£17.63
4-1 with cable	£19.00	£22.33
2-1 Monitor/K'board	£29.79	£35.00

R-Comp CD-ROM Software

ABUSE	£22.00	Quake (due soon)	£33.00
Descent	£27.00	Syndicate	£26.00
Doom+ Trilogy (E32.50 with book)	£30.00	Towers of Darkness (Hexen Triple)	£30.00
Heroes of Might and Magic 2	£32.00		

Consumables

Premier Quality Ink Refills

Single refills (1x22ml)	£6.00 inc
Twin refills (2x22ml)	£10.00 inc
Triple refills (3x22ml)	£14.00 inc
Tri- Colour (C.M.Y.K)	£15.00 inc
Quad-Colour (C.M.Y.K)	£20.00 inc
125 ml	£21.00 inc
250ml	£38.00 inc
500ml	£50.00 inc
1 litre	£70.00 inc

All sizes available in C.M.Y.K

FLOPPY DISKS @ 20p!!

	Ex VAT	Inc VAT
DD Re-label Acorn fmt 10	£2.00	£2.35
DD Re-label Acorn fmt 100	£17.02	£20.00
HD bulk Acorn or PC 10	£2.00	£2.35
HD bulk Acorn or PC 100	£17.02	£20.00
HD Branded 10 pack	£3.50	£4.11
20 cap Disk Box	£1.69	£2.00
40 cap Disk Box	£2.54	£2.98
100 cap Disk Box	£2.98	£3.50
3.5" Floppy head cleaners	£2.50	£2.94
CD-ROM cleaner	£4.25	£4.99

Printer Ribbons, Inkjet

Cartridges,
New/Recycled Laser Toner Carts
Prices available on request

ARCSHARE

Acorn networking for PCs
£29.95 exc Vat £35.19 inc Vat
see network section for Cards etc

StrongARM Special Offer

£259.00 inc VAT
(with any Hard Drive / Memory purchase)

RiscPC PC Cards

DX2-66	£145.00 inc VAT
DX4-100	£195.00 inc VAT
586-100 (Acorn)	£290.00 inc VAT
586-133 (CJE 512)	£300.00 inc VAT

We can repair/upgrade your machine(s) and monitors at competitive prices please ask
All Acorn's, BBC's & PCs

NEW STAFF

CTA Direct are recruiting new sales, technical and Modern Apprentices.
Please send CV to Main Address marked Careers@CTA

COLOUR SCSI SCANNERS

All scanners inc Acorn Software



P'ilel Mustek 600dpi	£99.00	(£116.33)
Mustek A4 600dpi	£119.00	(£139.83)
Mustek A4 1200dpi	£149.00	(£175.08)
Epson GT7000	£199.00	(£233.83)
Epson GT7000P	£249.00	(£292.58)

Imagemaster & Twain also available separately

(All Prices below include VAT)

THE BARGAIN BASEMENT

Acorn Software Bin

A3010 Joystick Controller Software	£15.00
Acorn Pocket Book..Schedule	£10.00
Alone in the Dark	£29.00
Arm Tech Labeller	£9.00
Arm Tech ClipArt (various per pack)	£8.00
Birds of War	£20.00
Boxing Manager	£8.00
ColourSep (Colour Separation Software)	£8.00
Creator 2	£25.00
D'File Font Pack (Academy)	£10.00
D'File Font Pack (Balmoral)	£10.00
D'File Font Pack (FreeStyle Script)	£10.00
D'File Font Pack (Manhattan)	£10.00
D'File Font Pack (Mastercard)	£10.00
D'File Font Pack (Old Towne 536)	£12.00
Diary +	£9.00
Drifter	£30.00
FIRE and ICE	£15.00
Frak (for RPC)	£13.00
Galactic Dan	£10.00
Game ON (for RPC)	£15.00
Global Effect	£25.00
Guile	£10.00
HERO QUEST	£15.00
Imagery Art Package	£25.00
Jahangir Khan Squash	£8.00
KV (Platform Game)	£8.00
My World Support Disc Ancient Egypt	£12.00
My World Support Disc Ancient Greece	£13.00
Nuclides II and Elements II (save £5.00)	£25.00

Quest for GOLD	£5.00
Revelation 2	£29.00
SilverBall	£9.99
StrongGuard	£25.00
TURBO DRIVER - Epson Stylus	£45.00
Visual Backup	£15.00
Wavelenth	£12.00
World Class Leaderboard (GOLF)	£10.00
Zool (on HD)	£10.00

Acorn CD-ROM Software

Crystal Maze	£15.00
D'File PDCD 3 or 4	£5.00
D'File PDCD 5	£10.00
Hutchinson Encyclopedia	£39.00
Robert Duncan Cartoon KIT	£39.00
TopicArt CD	£5.00
Tots TV ABC	£15.00
YITM Electricity and magnetism	£15.00
YITM Elements	£15.00
YITM Materials	£15.00
YITM (all three titles)	£35.00

CD General Resource Titles

35000 Clip Art (WMF)	£20.00
50000 Clipart	£20.00
75000 Clip Art (WMF) & images	£15.00
Internet Clipart (new)	£25.00
COREL ARTSHOW 5	£29.00

Werewolf Software

Shuggy	was £25.95	now £14.95
T.A.N.K.S.	was £25.95	now £16.95
RAMplify	was £19.95	now £17.95
ChildPlay (desktop)		£14.95

1/2 price (or less) Book Bargains

Dabhand Guide "Budget DTP"	£3.00
Dabhand Guide "C" ver 3	£8.50
Dabhand Guide "C" ver 2	£3.00
Dabhand "Graphics on the ARM"	£7.50
Dabhand Guide "Impression"	£7.50
Internet info server	£20.00
SQL	£17.50

Various Hardware bargains

A3000 2Mb bases from	£65	£76.38
A3010 2Mb bases from	£85	£99.88
A3020 2Mb bases from	£125	£146.88
A4000 2Mb bases from	£150	£176.25
A5000 4Mb bases from	£250	£293.75
A4 Portables (6 months wty)	£550	£646.25
RPC bases from	£468	£549.90
SVGA Monitors Various from	£45	£52.88
Pioneer SCSI 4x 6x stack	£139	£163.33

We have a large collection of Budget PC software suitable for RPC Pc Emulators and PC clones inc, Education, Home, games an utilities please ring for list

Alternative PC Bases

i.e. Siemans Nixorf Pentium
200 MMX from ONLY £249.00
+ VAT ring for latest prices.

HOW TO ORDER

BY MAIL or PHONE: Cheques or P.O.s should be made payable to "CTA DIRECT".
CREDIT CARD / SWITCH please give name, address, tel. no, card no, expiry date, issue no.
BY EMAIL: sales@cta.u-net.com
OFFICIAL ORDERS by MAIL or FAX please Carriage charges inc. ins. & packaging charged at cost
Small items (under 2kg).....no more than £6 + vat
One box of items totalling upto 25kg...£6.50 + vat
Computer systems.....£13 + vat
All prices are correct going to press. E&OE
All goods are fully guaranteed but not supplied on approval

£200,000 bargain

Pace Micro Technology plc has completed its £200,000 deal to acquire Acorn's set-top box business and have effectively taken on Acorn's set-top box engineering team. The 40-strong team's expertise in ADSL (asynchronous digital subscriber line), high-speed networking through ordinary telephone wires, fills a gap in Pace's technology armoury.

ADSL is the alternative to broadband digital cable services being rolled out by cable TV companies and digital satellite services. It is expected to be favoured by organisations, mainly large phone companies like BT in the UK, to deliver digital TV and Internet services in the future over existing wires. Malcolm

Miller, Pace's chief executive, explained: 'Our track record in digital broadcasting is second to none.'

'By acquiring Acorn's set-top box division we now have the engineering expertise to develop effective Pace solutions across an even wider range of digital technology'. Miller added: 'ADSL opens up a new market which we believe has real potential for telecommunications companies as they develop their interests in television delivery, both in the UK and overseas.'

As we understand the situation, the ex-Acorn staff will continue to work out of the same Newmarket Road address, sharing the building with Element 14.

Turn of the machine

With the future of RISC OS software secured through the creation of RISCOS Ltd, confidence is beginning to bloom in the Acorn community. That confidence even extends to the point that there is a debate as to whether we should replace 'Acorn' with the 'RISC OS' brand as the platform's point of reference.

At the Wakefield Show in May we saw RISC OS 4 in public officially for the first time and confirmation that the target time for first shipments is July. With the OS secure, the door is wide open to let enthusiastic hardware companies apply their imagination to the task of designing and building a new home for the OS. And we mustn't forget that existing Acorn models are now being manufactured by Castle Technology and being distributed via their CTL sister company, the official Acorn distributor in the UK.

We have already covered one of the newcomers – the Interconnex 'Peanut' portable – although this has been beset by teething problems and was absent from Wakefield, a year after its original public debut. Then there is the Millipede Risc PC motherboard replacement, the German Galileo project and in last month's news we brought the first photos and details of the new family of RISC OS computers from RiscStation Ltd, a sibling of the Acorn dealer company, CTA Direct. RiscStation's new babies were on show at Wakefield, generating a great deal of interest and there is further news from them elsewhere in this month's magazine.

At the other end of the Wakefield show hall was the very latest addition to the rapidly expanding family of RISC OS hardware developers – the Mico from MicroDigital featured on the cover of last month's magazine. Their first attempt was the still-born Medi computer which adorned the August *Acorn User* cover last year. This was basically a re-packaged Acorn A7000+ sporting a

strikingly coloured case. However, the Medi died when Acorn's latest upheavals took place as MicroDigital could not source the A7000+ motherboard from Acorn.

Instead, MicroDigital set out to design their own board and like the RiscStation it is based around the latest 56MHz ARM7500FE integrated processor. A unique feature of the Mico is a proprietary expansion card system called 'MicroBus' – the joke being that this is now the VW CamperVan of a computer.

The Mico will have options including an internal 56K modem, a 100Base Ethernet card, UDMA33 (double-speed bus) IDE harddisc support and even a single PC-standard ISA expansion bus slot.

The IDE interface is apparently a big step forward to what RISC OS users have been used to – even quadrupling performance compared to Acorn's IDE implementation, making it faster than some SCSI cards.

It has since emerged that USB (Universal Serial Bus) connectivity will be a key attraction of the Mico family. Sound capabilities will also be impressive, according to MicroDigital, with a full wavetable synthesizer SoundBlaster-compatible sound system.

Prices will start from just under £500. We were shown a bare board at Wakefield, but hopefully Mico computers will be shipping around the same time as RISC OS 4 appears for the first time in production form.

For more information, contact MicroDigital on tel: 01274 618774, Web: <http://www.microdigital.co.uk>

(The Mico news should have appeared last month, but due to, ahem, problems it was delayed until this issue - Ed).

Multi-processor monster

RiscStation Ltd, the sister company of CTA Direct, which previewed its new range of RISC OS-compatible computers at the Wakefield show in May, has revealed that it is planning to support a multi-processor expansion card which could house as many as eight StrongARMs. Potentially, four cards could be used in parallel, making 32 processors in all.

RiscStation Ltd has also replaced the support for ISA-bus PC

peripheral cards with higher performance PCI-bus support instead. PCI bus cards are slowly but surely replacing ISA in the PC world, so the decision makes a lot of sense.

They are also theoretically easier to configure as they conform to a plug-and-play standard, which most ISA cards don't. See the main feature on RiscStation and the multi-processor monster on page 24 of this issue.

New Psion hardware

Exactly two years and over half a million sales after Psion originally launched its Series 5 pocket computer, an enhanced version, the Series 5mx has been unveiled. At the same time, Psion has announced a Java-based family of compact portable computers called netBook. The netBook introduces colour screen technology to a Psion product for the first time.

The Series 5mx will be available in the UK from the July 1st, priced £429.95 including VAT and a software bundle. Main improvements include a new ARM710T processor doubled in speed to 36MHz, a brighter screen, 16Mb RAM as standard instead of 4Mb or 8Mb, enhanced infra-red communication and improved Web and e-mail software, including SMS messaging support for GSM phones.

A full Java virtual machine (JVM), if required, can be loaded off the bundled CD-ROM to upgrade Web-browsing capabilities. The CD also contains the newest release (2.3) of Psion's *PsiWin*



travellers, if the number of S5s seen in airports and airline cabins is any guide.

With this in mind, an Internet roaming agreement between Psion and GRIC Communications, Inc. means that Psion Series 5mx users can access news, travel and local information through the world's first Internet portal developed specifically for mobile palmtop users at a local phone rate.

Psion users will be able to tap into world-wide access points to log onto the nearest local ISP when travelling, rather than making a long-distance call back to their home service provider for access to the Internet and e-mail.

Arguably more exciting than the new S5mx is Psion's netBook announcement. This is a business/corporate targeted product featuring a VGA colour screen, lithium ion rechargeable batteries and a comprehensive and standard implementation of Java.

The netBook will be the first of a series of related products ranging from quarter, half and full VGA, pen and keyboard-driven tablet and clamshell devices.

The press release doesn't mention Psion's EPOC operating system but we were independently assured that it hides under the netBook's JVM. The netBook

also gets a full-size PCMCIA (PC Card) slot as well as Compact Flash compatibility. An optional disc drive can be added to the unit, if required. A single battery charge cycle, lasting 2.5 hours, should give users at least ten hours of power – enough for a long working day.

Claes Bergstedt, Commercial Director for Psion Enterprise Computing, points out: 'Java offers rapid application deployment, application re-use and compatibility across the enterprise from hand-held to server. Until netBook, the notebook PC has been the only viable solution for mobile Java applications. Now you can have Java combined with the 'instant-on', ease of use, reliability and robustness of a new range of mobile network computers.'

In many ways, the netBook could be seen as Psion's reply to Microsoft's insistence that corporate types should go for Windows CE devices. The Series 5, even in its new 'mx' guise, is not a complete alternative to some of the latest Windows CE machines – some of which are now fitted with StrongARM processors. The netBook's colour screen, PCMCIA slot, standard Java implementation and rechargeable battery, will make it a much more able competitor to Windows CE machines.

Psion's Web site is at: <http://www.pSION.com>. Other related sites include: www.planet.pSION.com and www.mobile.pSION.com

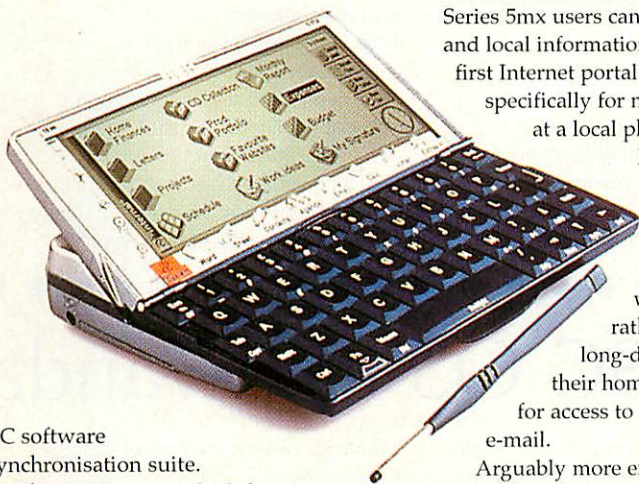

PC software synchronisation suite.

There's also a new look for the Series 5mx, which loses its original grey/green rubberised paint job for a brighter matt aluminium look. The 5mx is not a radical improvement over its predecessor but brings some overdue remedies to the few fundamental failings of the original model – primarily speed, the dim screen and poor Web browser, which now supports frames for the first time.

Psion has gone beyond the product design to enhance the 5mx's usefulness. Many Series 5 owners are frequent



Fresco locked out

Hundreds of users of ANT Ltd's *Fresco* Web browser are discovering that they can't access their Hotmail



Hotmail™

mailboxes on the Internet because their software don't support SSL (Secure Sockets Layer), the E-commerce encryption standard for making online buying secure.

According to ANT Ltd, *Fresco* isn't normally supplied with its SSL module when distributed to desktop computer customers.

This is because the SSL code is not, under UK law, allowed to be exported without a special licence. ANT seems unable to trust the desktop market, so its SSL module is only

supplied for less vulnerable *Fresco* implementations, like NCs. SSL is now almost a standard requirement in a Web browser and ANT acknowledges this.

After the publicity of one school where 650 students have reportedly been unable to use *Fresco* to access their Hotmail e-mail, we hear that ANT has been motivated into seeking a solution, but any announcement isn't expected before this issue of *Acorn User* goes to press.

In the meantime, affected Hotmail users can apparently use a detour around the problem – for the time being at least – by logging into their Hotmail using the Microsoft Network's (MSN) front page links. (<http://www.home.msn>)

Investing in RISCOS

A statement regarding a venture aimed at investing in RISCOS Ltd has been received from Steve Ellacott:

'A group of RISC OS enthusiasts are forming a club to invest in RISCOS Ltd. and, at a later stage, perhaps other RISC OS companies. We have been in contact with RISCOS Ltd and understand that there is opportunity to invest up to about

£50,000 in a mixture of shares and loan stock.

'Membership will be limited to 20 people, and will be on the basis of purchasing one or more units at £500 each. (In the event of there being too many subscribers, preference may be given to those purchasing more than one unit)' Draft constitution

and rules may be found at <http://homepages.enterprise.net/nedabell/rig/>

Anyone seriously interested in subscribing should e-mail Ellacott at s.w.ellacott@brighton.ac.uk

The deadline given was before this issue of *Acorn User* went to press, but it may well be fruitful to contact him anyway.

ExpLAN brings RISC OS to Rwanda

Devon-based ExpLAN will be a bit short-staffed until 9th July as several of the staff will be journeying to the troubled central African state of Rwanda. Part of their task is to set up some RISC OS computers in the capital, Kigali.

ExpLAN's Paul Richardson explained: 'We are most grateful to those RISC OS Developers and others who have kindly given assistance, donated equipment or made it available at very large discounts, for use by the church group in Rwanda who will run the computers. Specifically we would like to thank: Castle Technology Ltd,

David Pilling, IFEL, Computer Concepts, Interconnex, Kyocera Printers UK, The Electronic Font Foundry, Argonet, the Bible Society in Swindon and Archive magazine.'

Richardson adds: 'We will be travelling through the area of southern Uganda where the Interahamway massacred the Western tourists in March, and into Rwanda itself, where there is 70 per cent unemployment and women now outnumber men by four to one.

Our computers will be used not only for the work of the ever-growing Christian church, but also to assist with communications and publicity

material to kick-start small business enterprises.

'We are confident that the inherent reliability of RISC OS, the computers' tolerance of erratic mains power supplies, and the ultra-low running costs, make the Acorn/RISC OS machines well-suited to this environment.'

We have been promised some photos of the computers in action after they are installed and look forward to showing them to you later in the year.

ExpLAN Computers Ltd, tel: 01822 613868, e-mail: info@explan.demon.co.uk
Web: www.explan.demon.co.uk

Thin Clients



- Low cost per unit
- Low maintenance
- Reliable
- Compact
- Very flexible
- Centralises maintenance at the Server
- Can be used as RiscOS or Windows Terminals or Both!

Acorn Network computers when used in conjunction with a LinServer or NT Server can be used as economic RiscOS terminals which offer performance, security and much reduced maintenance since all services are provided from a central server.

Introducing a WinFrame/MetaFrame Mutli-user Windows server allows NC's, using the Citrix ICA Client from Acorn, to run Windows NT4. Again, all resources are located centrally at the server offering the same level of central management. Why install Windows or RiscOS software on EVERY workstation when you can simply install it once on the Server.

Ring us now to arrange a demonstration.

Robust, Reliable Economic & Flexible

It is possible to have a Server with ALL these attributes!

LinServer - An Internet Gateway & File Server running LINUX (UNIX® for PC's) which supports PC, NC & RiscOS Computers

LinServer is an incredibly robust and dependable File, Print & Internet Gateway server providing virtually every internet resource which doesn't cost the Earth! There are NO licensing issues on the number of users supported. LinServer supports over 10,000 users, the limit being only storage capacity and RAM.

Standard features:
NFS, PC File server with disc quota's
POP3, SMTP, IMAP4
Mail Server
NNTP News Server
Web/Proxy Server
FTP Server
Printer server
Internet dial-on-demand using ISDN or modem
Dial-in modem access
WWW Server Tools
... Plus many more.

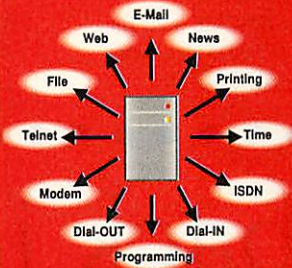

It supports PC's, Network & RiscOS computers. You can literally place this server in a secure room and forget about it, being almost completely self maintaining except for user administration. Contact us now to arrange a demonstration.

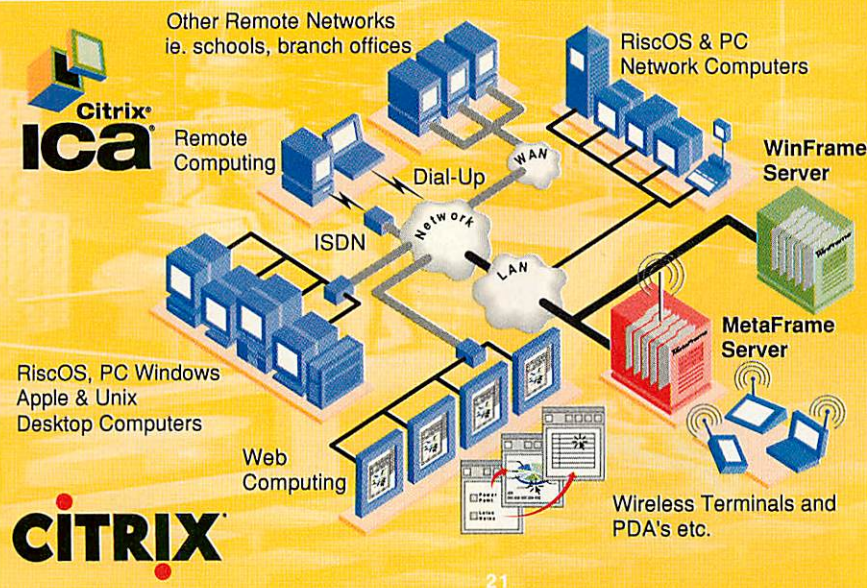

Tektronix®

Superb Colour Lasers



Phaser 740L £1175

A4 16ppm Mono Parallel/10BaseT Network Laser Printer. Colour upgradeable.

Phaser 740N £1645

A4 16ppm 1200dpi Mono, 5ppm 600dpi Colour Parallel/10BaseT Network Laser Printer.

200W Active Speakers

Mains powered, Magnetically Shielded

£15
Incl.



Suitable for ALL RiscOS Computers

£5 Inc VAT

A Citrix® WinFrame or MetaFrame Server provides access to virtually any Windows® application, across any type of network connection to any type of client (including Thin-Clients & RiscOS). It allows multiple, concurrent users to log on and run applications in separate, protected Windows sessions ON the server, resulting in each user consuming as little as one-tenth of their normal network bandwidth.

It gives you centralised management, exceptional performance and improved security for all your education/business critical applications and data.

Ring us now for further information or call into our showroom for a demonstration.

Tel: 0161-474 0778 - Fax: 0161-474 0781

Open 10.00 - 18.00 Monday - Saturday

All prices Include VAT. Carriage not included. E&OE. 110699

www.desktop.demon.co.uk - email: info@desktop.demon.co.uk

Unit 2A Heapriding Business Park, Ford Street, STOCKPORT, Cheshire. SK3 0BT

Projects Ltd
Desktop
Projects Ltd



PEP Associates to close

About the time this issue of *Acorn User* hits the doormat, PEP Associates will be completing the final stages of winding up their business. The CD-ROM software specialists have a proud history in the Acorn market, but trading conditions have proved too tough. A statement from the company read:

'This has not been an easy decision for us: for the past nine or ten years, PEP Associates has delivered a number of leading and innovative products to the Acorn market: the first commercial software speech synthesizer for RISC OS machines, the first product to migrate an existing PC CD-ROM natively to the RISC OS platform and the award-winning CD-Net

product – unbeaten in its ability to share CD-ROMs to Acorn computers.

'However, the last eight months have not been kind to us. Sales of *VirtuaCD* and the optional add-ons for CDFSfiler have been very disappointing and have led to the conclusion that we cannot survive as an Acorn developer any longer.'

Orders are being accepted up to the end of June, but support will not be available after that date. *Acorn User* sincerely wishes the staff of PEP Associates well for the future. PEP Associates: PO Box 62, Fordham, ELY, Cambs, CB7 5ZD, Web: <http://www.pep-assoc.co.uk/>

Risc PC back in production

Castle Technology, whose sister company, CTL, is the officially licensed distributor for Acorn-branded computers, has successfully acquired the manufacturing rights to the Risc PC, the flagship model of the Acorn range. Castle has also announced a new StrongARM upgrade for existing Risc PC users and reduced the price of the A7000+.

For quite a while supplies of Risc PCs on the market have been sourced from manufacturing completed last year. Now, Castle will re-start production, with a gradual ramp-up and general availability is promised for the Autumn.

Castle warns potential customers to place orders as soon as possible as demand will initially outstrip supply. Jack Lillingston, Castle Technology's managing director, said: 'Castle is delighted to be leading the way in the return of the availability of computers running the unbeatable RISC OS software. We are now also delighted to offer our customers the choice of RISC OS 4 with all its speed, usability and visual improvements.'

The Risc PC that Castle will be making is fitted with a 233MHz StrongARM and will be known as a Risc PC233. A choice of specification

will include: RISC OS 4, large/fast hard drives, VRAM, high capacity memory, CD or DVD-ROM and various monitor and communications options.

Risc PC233 prices start from £749 + VAT. The top end, fully featured model is the Web Wizard Risc PC233, priced £1149. The Risc PC233 compliments the existing Acorn A7000+ which remains Castle's top-selling Acorn computer. At the same time Castle has dropped the price of the A7000+ to £499 + VAT.

If you already have a Risc PC, maybe you haven't yet taken the StrongARM plunge? Castle wants to hear from you because they have announced an updated Risc PC StrongARM Upgrade. The new TurboStrongARM upgrade features the latest revision T 233MHz StrongARM.

Notable features include: 268 mips performance, that's ten times faster than the Risc PC's original ARM 610 processor, or eight times faster than subsequent Risc PC's ARM 710 processor. Plus it supports 'lazy task swapping' which benefits RISC OS 4 users even more. TurboStrongARM upgrades are priced £249 + VAT.

Castle Technology can be contacted at tel: 01728 723200, e-mail: jack@castle.org.uk, Web: www.castle.org.uk

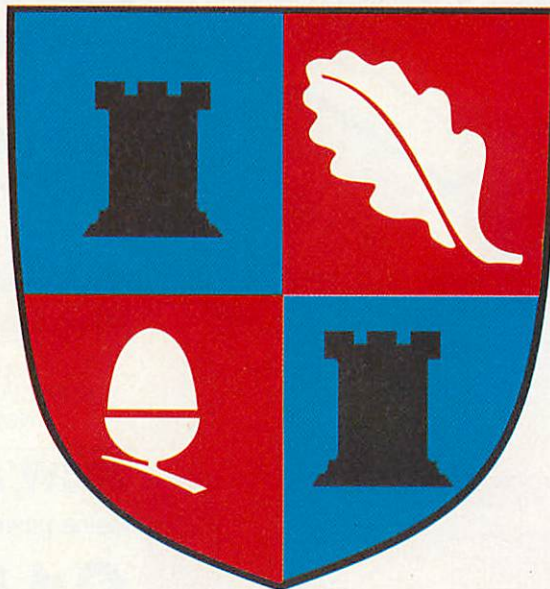

CASTLE

Kosovo appeal CD-ROM

Paul Johnson has been at it again. First there was the great online charity auction and now a charity CD-ROM, with profits going to help all those in need in strife-torn Kosovo. The £6.75 (minimum donation, including UK P&P) CD contains 600Mb of goodies – in Paul's own words: 'It's a cracking CD, contains all the *Archimedes World* cover discs (well, their first and only CD and the second one I did), exclusive demos (inc the first ever of Clare's *Rhapsody 4*) and commercial software galore (*Rhapsody 2* (originally worth £50), *MacFSLite* (£30), *AudioWorks* (£50), *CFS* (£20), *Mad Professor*

Moriarty (£30), non-SA/RPC) and piles of other really good software.'

CDs can be ordered from Clares, *Archive Magazine*, APDL or Paul directly, though if you wish to pay by credit card, you should order from one of the first three. Clares is equipped to deal with foreign orders, for which there will be an additional shipping charge. The aim is to send at least £5 to Kosovo charities for each CD sold. See our article on page 47 for full details.

USB at last for RISC OS

MicroDigital, who are behind the new Mico range of RISC OS compatible computers, have announced they will be making a four-port USB (Universal Serial Bus) hub development board and software available to third party hardware peripheral developers. MicroDigital, whose machines will offer USB compatibility, says it is trying to ensure that compatible USB devices will be available when the Mico goes on sale in September. Development boards will be available by the end of June 1999.

USB is a platform-independent standard designed to replace the old RS232/423 serial interface standard. Instead of 115.2K bits per second (14K bytes), which is the usual maximum speed for serial ports, USB operates at 10 megabits per second (128K),

making it over nine times faster. Its hub-based bus architecture is similar to, but not compatible with, 10BaseT Ethernet, meaning that with a hub you can add several devices to one host computer.

Typically, USB has been embraced by manufacturers of modems, ISDN terminal adapters, Internet video cameras, keyboards and mice. Digital still cameras are now coming out with USB support.

High quality digital microphones will support USB, eventually – it's a very versatile standard. MicroDigital say their board is based on a single-width Acorn podule and plugs into A540/A5000/A7000 or Risc PC computers.

Moxon moves

Former *Acorn User* editor, Mark Moxon, has landed a new job working for cult author Douglas Adams, of *Hitch Hikers' Guide to the Galaxy* fame. Adams' company, The Digital Village, recently launched a new Web-based service loosely based on the ideas which spawned the multimedia book at the centre of the Hitch Hikers story.

The new service is called h2g2 and can be found at <http://www.h2g2.com>. Mark will be in charge of h2g2's editorial content.

Of further interest to *Acorn User* readers; TDV's technical team

is largely composed of former Computer Concepts employees, including Jim Lynn – who headed the *Artworks* development team and Sean Solle – himself an occasional contributor to *Acorn User* and the guy who looked after software driver issues with many of CC's hardware products, like the Eagle A/V sampler.

Meanwhile some of the graphics work for TDV projects is created by former *Acorn User* graphics page editor, 'Doc' Jack Kreindler, with the help of his Risc PC. Needless to say, Mark is in good company!

Hand-coding of HTML

WebChange 2 is a new application from Soft Rock Software designed to help programmers who prefer to write their HTML code by hand, removing some of the more tedious and repetitive tasks. Its author, Vince Hudd, says: "The full version is currently in the final stages of beta testing, and will hopefully be released shortly, but in the meantime the free 'Lite' version is now available for download from the WebChange site at <http://www.softrock.co.uk/webchange/>"

He adds: "While the full version is not quite available as yet a

price of £12 has been settled on, with a special launch offer of only £10 if bought before the 30th June, 1999."

Soft Rock Software will accept orders now, though customers will be asked if they would like to receive a beta before the final version or if they would prefer to have their payment held until the final version is released.

Orders can be made via the Web or cheques can be sent to Soft Rock Software, Freeport (BS 7978), Westbury-on-Trym, Bristol, BS10 7BR

Silliest graphics tablet?

It's not a joke – use your Psion Series 5's touch-sensitive screen as a graphics tablet. Interconnex has published some free software to enable you to do just that.

It can be down-loaded off the Web from: <http://>

www.interconnex.co.uk/~paul/

RISC OS 3.5 and, naturally, a Psion Series 5 are required. Interconnex UK Ltd. paul@interconnex.co.uk, tel/fax: 01934 522880.

Please contact us for free **EFF Font Poster**, **Acorn Price List** and **EFF New Product Guide**.

EFF² Professional Typography Cd - Volume 2 of the best selling font Cd

EFF2 Cd will feature **800** highest quality, **professional** typefaces in the double format: **Acorn** (RiscOS3 and Publisher) and **Windows** (PostScript and TrueType). All the fonts are of **original** EFF quality, fully **hand hinted** and containing full character sets (**including**). EFF2 Cd is unique in offering you the highest quality, **great value** for money and the end to the cross platform font compatibility problems. The Cd will include all fonts from EFF1 Cd plus all the latest releases. Nothing to pay until the Cd is ready for despatch (before RiscOS'99 Show). Upgrade from EFF1 Cd is available.

EFF2 Cd (Private User Licence) costs **£49** (£59.84 UK incl.) upgrade or **£99** (£118.09) new order.



EFF Type1Translator Our latest application for converting PostScript (Windows or Mac) fonts. Produces automatically hinted, fully editable Acorn fonts in seconds.

EFF T1T, single computer licence, costs **£29** (£35.84 UK incl.)



EFF TrueTypeTranslator Convert all the free Windows TrueType® fonts to Acorn format! TTT will allow you to view any TT font and add automatic hinting.

EFF TTT, single computer licence, costs **£39** (£47.59 UK incl.)



EFF Font Table A simple and effective tool for producing font tables in !Draw format. Very useful for cataloguing your fonts, easily customised by a number of options.

EFF FT, single computer licence, costs **£7** (£9.99 UK incl.)

Always available:

- individual fonts from EFF type library of over 1,300 typefaces for over 60 languages.
- good value font packs and font collections
- symbolic, scientific & foreign fonts
- custom fonts made to your specification
- font distribution licences
- free friendly and professional advice on all type related matters

If you would like further information on any of our products, or have any questions please do not hesitate to contact us. You can also visit our website, www.eff.co.uk

APDL

Blitz
ideA

You wanted fast IDE drives - we gave you the APDL Fast IDE interface, twice as fast as the built-in system. You wanted low cost - we made it so cheap no-one could believe it. You wanted to use modern ATAPI CD ROM drives - we added drivers free! Now you've asked for even better performance to match RISC-OS 4 - so we're giving you

at only **£119** inc. VAT and carriage

Blitz

The APDL Blitz IDE interface is simply the quickest interface you can put in your machine. Lightning fast, it has double the speed of our 'normal' fast interface, better than 7 Mb/sec, and that's a 'real' average read/write figure using a standard EIDE drive, not a 'massaged' statistic!

All the features of our standard ideA card, but with a full 32 bit interface so it's twice as fast. Now you can fit low cost EIDE drives and get superior speed to a 'fast' SCSI setup at a much lower cost.

Upgrades from our standard ideA interface and some other third party interfaces are available.

We will be offering upgrade packages consisting of **RISC-OS 4, Blitz interface and a bigger hard drive**

APDL, 39 Knighton Park Road, Sydenham, London SE26 5RN
Phone: 0181 778 2659 Fax: 0181 488 0487 www.apdl.co.uk/
See main advert for drive prices or phone for latest package deals.

- No setting up. It's self-configuring so just plug it in!
- Full 32 bit DMA (Direct Memory Access) on Risc PC.
- Over four times as fast as the built in IDE interface.
- With CDFS and ATAPI drivers for many popular CDs
- Four devices, any combination of CDs and hard drives
- Up to 8 partitions with secure password protection.
- Software in flash EEPROM for easy update
- Connectors available for external drives or CD ROMs
- If your two DMA slots in the backplane are occupied it will still give over 4Mb/sec. in a non-DMA socket
- Direct plug in replacement for our standard ARCIN ideA interface - all the same features but twice as fast!
- Use low cost IDE drives and yet get better performance than a much more expensive SCSI setup

The RISC OS samba

You might call it dancing with the Devil; I'd call it wanting the best of both worlds. It is becoming necessary to combine the most intuitive features of RISC OS with the money-thrown man-years of *Windows* to keep up with Web navigation trends.

However, setting up and successfully networking RISC OS machines with a Windows PC can lead you a merry dance.

OmniClient, recently given away with the *Acorn Browse* and *Java* CDs, on an Ethernet network with Acorns and PCs, allows access to a PC's discs from the RISC OS desktop. Mike Buckingham's home networking article in this issue and Paul Vigay's Networking page at <http://www.matrix.clara.net/Acorn/networking.html> describe how to set this up. Remember to set up sharing on the PC's directories and discs.

An alternative investment is *LanMan98* (£41.13 inc VAT) from Warm Silence Software which gives the same facility and shows the *Windows95/98* long filenames.

David Buxton's new freeware port of the *Samba* Server completes the circle by

making available network shares of RISC OS discs, directories or files to other *Windows* or *Unix/Linux* machines on the network. In my home set-up, *Smbserver* allows RISC OS objects to appear in *Windows98 Explorer*, and be accessed directly as further network drives. This makes passing image files between say, *WebStyle* and *Photodesk* a doddle.

The diagram above shows how my machines are named and numbered to use these network applications. A private Class C network address and unique name are configured in the Internet setup of each machine, and listed in the *Hosts* file that appears in the *Acorn !Internet.Files* directory, and also on the PC in the

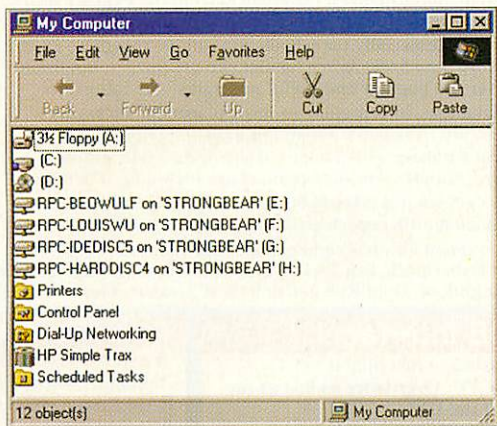

Samba's sockets sharing successfully

Windows\Hosts file. There's an example *Hosts* file in most *Windows98* PCs called *Hosts.sam*.

The *Smbserver* config file specifies the RISC OS discs and directories to be shared with *Windows* and their share names.

David Buxton's HTML help file gives good illustrated set-up details, but note that the application needs at least 4Mb RAM to itself. The RISC OS machines on

my network share discs using *Acorn Access+*. All networked machines use Network Address Translation for Internet access, dialled on demand by the *D-Link* ISDN Router.

Smbserver, a port of *Samba 2.0.2* by David R.H. Buxton, is available in Alpha development version from <http://www.merddin.demon.co.uk/riscos.html>. *LanMan98* is from Warm Silence Software; e-mail info@wss.co.uk and visit <http://www.wss.co.uk> for latest product information.

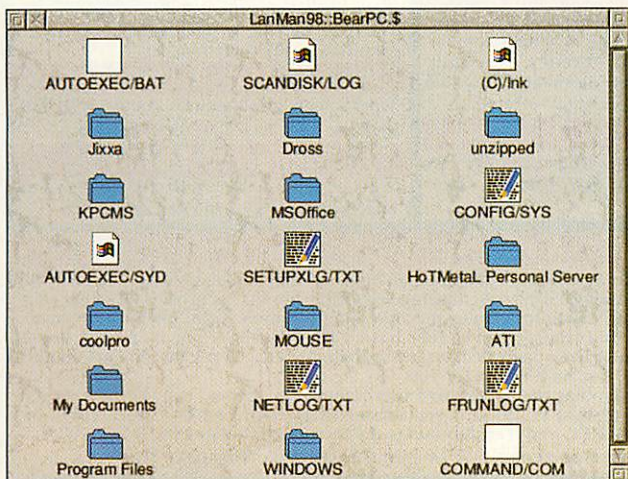

Not a pretty sight, but when the devil drives...

In brief

Find it

It can be difficult to separate out a RISC OS program or Website from the rest of the results when using the popular Web search engines. AcornSearch is an Acorn RISC OS-specific search engine for Websites and files.

It currently indexes 3,500 individual pages over about 70 Acorn related sites. You can submit your own Website and downloadable item URLs to AcornSearch using simple instructions described on the site.

AcornSearch

<http://www.acornsearch.com>

Name it

As AAUG Chairman, Neil Spellings probably won't mention his attractive personal domain name deal introduced at the Wakefield Show: The £70+VAT registration package for yourcompany.co.uk names includes all Internic/Nominet registration fees, DNS hosting, free Web forwarding to an existing ISP and/or domain, and free unlimited e-mail addresses in your new domain forwarded to an existing dial-up account.

Domain names .com, .net and .org are also available at £80+VAT; with .ltd.uk, .net.uk and .org.uk at £75+VAT; and with any of these packages there's nothing else to pay for 2 years.

Spellings Computer Services
E-mail: domains@spellings.net
0385 935497

Dial it

British Telecom has introduced its free Directory Enquiries Web service called PhoneNetUK. The normal 192 service costs 35p inc VAT for two requests from a voice operator, but BT's new Web service is free apart from the cost of the phone call.

PhoneNetUK allows unlimited private and business searches and also shows the address of the found subscriber. It seems to work OK with versions of Fresco© but not Browse.

PhoneNetUK
<http://www.bt.com/phonenetuk/>

3.5" IDE Hard Discs

	Drive	Plus i/face
210 Mb	£39	£81
420 Mb	£49	£87
540 Mb	£57	£105
1.2 Gb	£69	£116
2.1 Gb	£79	£126
2.5 Gb	£82	£129
3.2 Gb	£88	£135
4.2 Gb	£95	£142
6.3 Gb	£105	£152
8.2 Gb	£118	£165
10 Gb	£151	£198
12.7 Gb	£159	£206
18.8 Gb 5 1/4"	£219	£266

'Plus i/face' price includes an APDL fast IDE interface.

Part-exchange available if you need a bigger drive. Please phone for prices.

2.5" IDE Hard Discs

	A3020	3010/3000
30 Mb	£36	£79
80 Mb	£49	£97
120 Mb	£53	£103
170 Mb	£60	£110
210 Mb	£66	£116
250 Mb	£72	£122
330 Mb	£79	£129
420 Mb	£86	£136
512 Mb	£93	£143
1.8 Gb	-	£149

A3010/3000 includes APDL IDE interface, A3020 includes fitting kit Larger sizes and HD+CD available

Blitz

idea

Is here!

The ultimate super fast IDE interface for your Risc PC. Over 7 Mb per second! See separated advert on page 24

SCSI Hard Discs

210 Mb	£29
420 Mb h/h	£49
1 Gb	£74
4.2 Gb h/h	£149
4.2 Gb	£165
8.7 Gb h/h	£279

IDE CD ROM drives

Internal

Drive with all cables and drivers for RO 3.6+ where required

36x	£47
40x	£49

Drive including APDL IDE interface

36x	£94
40x	£96

External

Drive in case with power supply and including an APDL IDE interface. Probably the best way to fit a CD to a pre-RISC-PC machine.

36x	£151
40x	£153

CD ROM driver software

Works with most ATAPI CDs eg.. Pioneer Goldstar, Panasonic, Lite-on, Mitsumi, Sony, Hitachi, NEC, Toshiba, Sanyo, etc. Includes CDFS for use with RO 3.5. Intended for RPC but can be used with an A5000. Only £8 or £7 with a drive

RiscPC and A7000 RAM

8 Mb	£8
16 Mb	£26
32 Mb	£49
32 Mb High Clearance	£56
64 Mb from	£79
128 Mb from	£159
2 Mb VRAM	£69
1 Mb to 2 Mb exchange	£47

Datafile PD CDs

PD CD - 3	£6.50
PD CD - 4	£8.50
PD CD - 5	£6.50

Public Domain, Shareware and other low cost hardware and software for Acorn computers



APDL

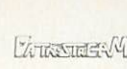

Prices include VAT and UK carriage except hard drives add £5 for internal drives, £8 external This is only a fraction of what we have available. We also have thousands of discs PD and Shareware and around 500 discs of Acorn format clip art. For a full catalogue on 800K or 1.6Mb disc please send 50p or two 1st class stamps or see our web site.



APDL, 39 Knighton Park Road, Sydenham, London SE26 5RN

Phone: 0181 778 2659

Fax: 0181 488 0487

www.apdl.co.uk/



APDL Public Domain, Clip Art and other CDs

- APDL PD-1** The best PD CD from the best PD library. Over 1,800 programs and utilities, more than 100 novels, etc. No games, clip art, music, or other non-serious stuff. **only £12.50**
- APDL PD-2** Around 700 games and novelties, over 250 games cheats and over 200 demos, plus over 2,000 music files and more than 550 digitised sound samples. **Both for just £22 only £12.50**
- DTP-1 and DTP-2** Each have over 500Mb of clip art files, all ready to use in Acorn Draw, Sprite or Artworks format. Ideal for use in education. **only £9.90 each**
- DTP-3** The third highly acclaimed APDL clip art CD. More than 720Mb of material. Great for schools or anyone who needs a huge collection of clip art at a sensible price. **only £17.50**
- DTP-1 plus DTP-2 plus DTP-3, just £34.50**
- DTP-4** Our new clip art CD. Over 12,000 clip art files, plus more than 400 Artworks files and 170 high quality colour pictures. All catalogued and complete with thumbnail images **only £19.50**
- Games CD 1** A collection of twenty of the best PD games of all types. Ready to run direct from the CD on almost any machine. Hours of fun for an unbeatable price. **only £7.90**
- Games CD 2** Our Games Collection No. 1 CD was so popular we've done it again. Another twenty of the best best games at a real budget price. **only £7.90**
- Skullsoft Collection** A great budget priced games CD from APDL. Full versions of three popular games from Skullsoft, !Arya, !Xenocide and !Plig **only £9.90**
- Soft Rock Collection** Six classic games from Soft Rock Software, plus a new version of !Trellis, the adventure game creator/interpreter with two adventures **only £9.90**
- Fantasy Pictures** By request from our customers, the pictures from the Fantasy section of the APDL catalogue. Lots of Sword 'n Sorcery pics and many others **only £7.90**
- Education Resources** A CD from APDL especially for schools. Has all the things we know you want. More than 5,000 Acorn format clip art images, hundreds of e-texts, over 300 popular and useful programs, and lots more. **£16.50**
- Earth in Space** Pictures, databases, information on stars, planets, moons, space missions, etc. A massive amount of data at a realistic price. **Ten for just £79 only £9.90**
- Earth Data** Geographical database with a huge variety of data and statistics on every country. Simple menu-based interface. Including !Earthmap **only £9.90**
- Wizard Apprentice** Have you got what it takes to become a Wizard? 100 levels of this great game with superb graphics and sound. RISC-PC only **£14.95**
- Generation Design collection** New version now has eight games. AlfaXL5, Pharaohs Secret Tombs, Last Cybermoch, Sea Trek, Caves of Confusion, Robocatch, and two new additions, Gold Run and Jewels of Jezabar. Also available on disc. **£16.50**

APDL idea fast IDE interface

- No complicated setting up. It's self-configuring so just plug it in!
- Uses DMA (Direct Memory Access) on Risc PC. Over twice as fast as the built in IDE interface or others which don't use DMA.
- Includes CDFS and ATAPI CD drivers for many popular CD ROMs.
- Four devices, any combination of CDs and hard drives.
- Up to 8 partitions, so you can have large drives on pre RO 3.6 machines
- Software in flash EEPROM for easy update (including VProtect).
- Supports the new range of Syquest SparQ low cost 1Gb removable drives.
- Connectors are available for external drives or CD ROMs
- Fits A310, A400, A5000, A540, A7000 and any RiscPC.

All these features for the incredibly low price of just **£52**

A version for the A3000, A4000, A3010 or A3020 is available with all the above features. Supports two internal and two external devices - **£62**

APDL Paralell Port Syquest drive

The 1Gb SparQ drive is the ideal solution for backing up larger hard drives where old technology like a Zip drive just isn't realistic. Big enough to hold lots of data, and with our software you aren't restricted to just RISC-OS 3.6+ but can use it on any machine with a bi-directional printer port including the A5000, A3010 etc. as well. With Acorn and DOS driver software. just **£199**

Ancestor +

We've promised it before, but it's available at last! The long awaited successor to Graham Crow's highly popular genealogy program Ancestry, previously sold by Minerva. Upgrades from Ancestry 1 and Ancestry 2 available. Can use Ancestry 1 files and we're working on a converter for Ancestry 2. Only **£59**

ACE 586 PC cards

Available with 128K cache from just **£199** or 512K cache from **£299**. We can offer a trade in against your old card, which makes it even cheaper. Good performance for Windows at a sensible APDL price.

General software

Faster PC - £20 The alternative XT PC emulator. Works on any model with 2Mb RAM from A3000 to Strong ARM RPC.

PowerBase - £15 Popular extremely powerful but very easy to use database. With examples, tutorials and printed manuals. Better than most products costing many times the price. Does everything that 99% of database users will ever need.

MenuBar - £15 The very best pull-down menu system. An absolute essential for any hard disc user. You can switch between up to 30 different menu bars. Incredibly easy to set up, add items to menus, move them, etc.

Tiger - £15 Lets you use very long descriptive filenames. Unlike some products this is very robust as it works in parallel with the filer so can't corrupt discs.

WorkTop - £15 Switch between up to 30 different environments with a single mouse click. Stars the tasks you require, opens directories, loads files, changes screen mode. Just like moving to another computer. An essential productivity tool.

Joy Connect joystick podule

Works with most games. Podule with one joystick **£42** Extra joysticks **£6** each.

Connect 32 fast SCSI

We have a limited number of these very fast interfaces (up to 7.5 Mb/sec) at only **£109**

Data Safe - A new concept in backup and data security

A new idea from APDL, Data Safe consists of an external case to hold a 3.5" IDE hard drive, connected to your machine's printer port. This gives a large capacity portable drive, movable between machines and locations. Ideal for backup, secure data storage and transport. The filer has all the features of our ideaA card so you can partition drives, password protect partitions, etc. Great for schools. Supply your own drive or we'll fit one for you.

Data Safe Super has the drive fitted in a removable drawer. You can fit a similar drawer to your Risc PC (best if you use our IDE card) and then just unplug the drive from the RPC and transfer data to another machine using the Data Safe.

Prices start at **£104** or with a 3.2Gb drive from just **£199**



Data SAFE

Botkiller 2 - kapow!

Well now, if you haven't already had a look at the disc you may not realise that this month's offering is on a HD 1.6Mb floppy, which means those of you with older machines may not be able to use it. Don't worry though, if you send your disc to us at the office we'll split it onto two DD discs and post it back.

The reason it's on HD this month is that Artex and Wag Software were good enough to give us a playable demo of *Botkiller 2* – and that alone came to over 1Mb. The demo features 3 of the 25 levels, and true to form (I got stuck on level 1 of last month's cover disc game) I couldn't

get past the first stage of this demo either. I don't know what happened, first I got stuck in a lift, then I couldn't get a door to open – anyway, I'm no Alasdair Bailey, that's clear enough.

The demo features some good little touches, for instance, quiz a SpaceTronic Access Terminal (looks like a cashpoint) for information and you get a nice spinning animation – see below for a simplified view of this.

I've just spoken with Games Boy Alasdair Bailey and he referred me back

to his review of *Botkiller 2* in the April issue. The conclusions there were good graphics and challenging game-play, requiring quite a bit of thought (damn even on the early levels).

Well, I'm a bit stuck for things to write since I can't get past the first level (I must have a duff copy) so I'm going to put some pictures in instead.

But before I go, here's my Big Tip – go and read the Game Controls in the *!Help* file (contained within *!Botkill2*) as it lists key-presses not mentioned within the

Control Configuration section of the game – that's why I got stuck down the lift.

If you want to order a full copy of *Botkiller 2* (requires ARM3 and 4Mb RAM) – which features over 25 'action packed' levels, send a cheque for £15 to Wag Software, 5 Queens Close, East Markham, Nr. Newark, Notts. NG22 0QY. **END**

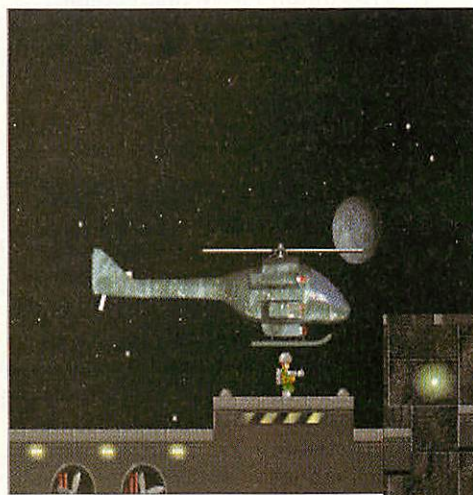

The start of your mission



Don't get stuck down the lift shaft

Disc information

The software on the cover disc has been compressed using *!ArcFS 2* from VTI, and are opened by running a copy of *ArcFS* then double-clicking on the archive to open it. There is a copy of *!ArcFS* on each disc. Most software will run straight from the archive, but some programs may need to be copied out of the archive before being run, uncompressing them in the process. Any program that saves a file to disc, for instance, will be unable to do so into the archives on the disc.

Faulty disc?

If your disc is faulty, test whether it will verify by clicking with Menu on the floppy drive icon and choosing Verify.

If it fails to verify or is physically damaged you should return it to Acorn User, Media House, Adlington Park, Macclesfield SK10 4NP.

The *Acorn User* cover discs have been checked for viruses using *!Killer* version 3.001 from Pineapple Software.

MP3 or not MP3

The RISC OS software scene occasionally reminds me of waiting at a bus stop. You stand around longing for something and then several come along at once. One such 'bus' is MPEG3 and that means music. This is all the rave at the moment, not least because it's helped by loads of controversial publicity – mainly because record companies don't like it, fearing people will realise how expensively inflated the price of music CDs is.

In a nutshell, by encoding your favourite music tracks from CD into MP3 format, you will save vast amounts of space, but not lose any perceptible musical quality. This means that, in theory, you could probably cram as many as 200 individual tracks on a single CD. Compare this with an average of around 15 tracks on a standard CD and you'll soon understand why they are so popular.

An average MP3 track occupies roughly 1Mb per minute of music, which means those people with fast modems can swap tracks without too much of a phone bill – and without going anywhere near a music shop – a serious cause of concern for record companies and their excessive profits, not that I recommend piracy.

The only downside of all this is that you will need a fairly high-powered computer, or one of the new MP3-style walkman devices, in order to play back the samples – so unless you've got a StrongARM-powered Risc PC I'd forget it. In theory the module-based players *should* work on a Risc PC700 but so far I haven't had any success.

Like Real Audio and Shockwave, MP3 is a format made popular by the Internet, but unlike some other sought-after formats MP3 is available to RISC OS users. Indeed, we're pretty spoilt for choice because as I write this there are no less than eight players, with at least two more under development. The reason you need

a StrongARM is because decoding MP3 in real-time (it wouldn't be much use otherwise) is pretty hard work. You may get away using an A7000+ or one of the new machines (which should be available by the time you read this) but I haven't tested them on lower spec machines. In fact, all of them bar Thomas Olsson's *AMPlayer* require 16-bit sound.

AMPlayer will auto detect 8- or 16-bit, but won't run without a StrongARM. Although there seems to be quite a lot of choice, all of the players are based around just two 'core' decoders; Ossi Lindvall's 'dmp' player, or the newer module-based decoder by Peter Teichmann.

The latter generally performs better because there is less likelihood of the music 'jumping' when the machine is doing something else – like moving windows around or the hourglass temporarily appearing.

My personal favourite so far is Thomas Olsson's *AMPlayer* which is pretty stable and has a snazzy LCD look-alike front-end. Another good one (which should be available by the time you read this) is *RiscAMP*. This is Andy Boura's attempt at copying the look and feel of the popular Windows MP3 player *WinAMP* – and very good it is too.

It has more features than *AMPlayer* such as allowing you to change skins – the colour, textures and 'feel' of the control panel to you and I – and to manage play-lists. This latter feature is very handy if you, like me, have a directory full of MP3 tracks and want to play them continuously – which could provide you with around 10 hours of continuous music.

I've compiled a list of all the currently available MP3 players and added them to my Internet RISC OS links page, so hop over to <http://www.matrix.clara.net/Acorn/links.html> if you want to see what's available.



Andy Boura's *RiscAMP*

In brief

Nailed

Here's one which should prove valuable to Web designers, or those of you with digital cameras or directories full of images.

Nail will simply and easily create a Web page of thumbnail images for any directory of images dragged to it. It uses *ChangeFSI* for it's scaling and processing so will cope with any image type you can throw at CFSI.

There are loads of options available to specify; X:Y pixel sizes, or scaling relative to the original, how many images per line, border widths & colours as well as controlling the various CFSI options. It will also support *Speech* if you have it loaded. Download *Nail* from <http://www.cimbrae.co.uk/>

Sheep2

Sheep2 is another desktop silly, which veteran Acorn users will view in the same vein as *Wanda*. On loading, the backdrop changes to a rather fetching shade of green, scattered with an assortment of pretty flowers.

Into this 'field' you can add up to 50 sheep, who will aimlessly wander around munching, skipping, sleeping and all manner of other sheepy things.

Of course, this is quite likely to completely distract you from what else you happened to be using the computer for – but hey! What's the world coming to if you can't turn your backdrop into a peaceful meadow?

<http://www.stubbsll.freeserve.co.uk/david/programs>

Contacting Me

You can contact the PD page by writing to me, Paul Vigey, at Acorn User, Tau Press Ltd, Media House, Adlington Park, Macclesfield, SK10 4NP. Or preferably, by e-mail (but no large files) to pdpage@acornuser.com

IFEL

21 Glenfield Road
Glenholt Plymouth PL6 7LL. Tel (01752) 777106. Fax (01752) 777830

Ordering details. Orders can be placed by phone, fax or email. Official orders welcome. VAT is included. Most cards accepted (eg Access, Visa, Switch). UK postage £3.50 on small items, £4.60 on hard discs. Larger items sent by carrier at cost.



Est. 1984

Hard drives from only £11.75!

Computer systems

RISC PC 233MHz, 4Mb, 1.7Gb	£949	We can build a system to match your requirements (eg extra memory or larger hard disc). Please ask for a quote.
RISC PC 233MHz, 4Mb, 1.2Gb, CD	£979	
RISC PC 233MHz, 10Mb, 1.2Gb, CD	£1249	
RISC PC Web Wizard	£1350	
A7000+ Peak Performer	£880	

Memory Lane

A310 4Mb*	£52.87
A400/1, per Mb	£22.32
A310 4-8Mb	£99.87
(Assumes machine has a MEMC1a)	
400/1 4-8Mb	£99.87
A3000 1-2Mb	£5.87
A3000 1-4Mb	£52.87
A3000 to 8Mb*	£99.87
A5000 2-4Mb	£47.00
A5000 4-8Mb*	£99.87
A3010 1-2Mb	£23.50
A3010 1-4Mb	£45.82
A3020 2-4Mb	£34.07
A4000 2-4Mb	£34.07
RISC OS 3.11	£29.37
MEMC1a	£41.12
*Carriage/fitting	£22.32

RISC OS 4 £116.32
Available soon.

RISC PC, A7000/+

Use FPM for the RISC PC and A7000, and EDO for the A7000+

	FPM	EDO
8Mb	£11.75	£11.75
16Mb	£25.85	£23.50
32Mb	£52.87	£44.06
32Mb HC*	£66.97	--
64Mb	£104.57	£123.37
128Mb	£217.37	£217.37

*=High Clearance.

VRAM (RISC PC)

1Mb	£43.47
2Mb	£78.72
1-2Mb u/g	£47.00
1Mb*	£25.85
2Mb*	£45.82
1-2Mb u/g*	£29.37

*For non-StrongARM machines

Printers

Epson	
Stylus 440 Colour	£116.32
Stylus 640 Colour	£139.82
Stylus 850 Colour	£229.12
Stylus 1520 Colour	£405.37
Stylus Photo EX	£311.37
Stylus Photo 700	£158.62
Stylus Colour 900	£340.75
Canon	
BJC250	£99.87
BJC4400 Photo	£165.67
BJC 4650 A3 Colour	£264.37
BJC5000	£233.82
BJC6000	£222.07
BJC7000	£198.57

Monitors

Iiyama	
15" Vision Master 350	£139.82
17" Vision Master 400	£311.37
17" Vision Master Pro400	£327.82
17" Vision Master Pro410	£363.07
19" Vision Master 450	£487.62
19" Vision Master Pro450	£527.57
21" Vision Master 502	£809.57
21" Vision Master Pro502	£809.57
22" Vision Master Pro510	£920.02

Other types of monitor available from around £100.

Spare & repairs We can repair Acom machines and supply/fit upgrades.

Removable drives

Omega	
SCSI Zip ext	£99.87
Parallel Zip ext	£99.87
Software parallel zip	£29.37
SCSI Jaz 1Gb ext	£222.07
SCSI Jaz 2Gb ext	£304.32
100Mb Zip cartridge 10pk	£88.12
1Gb Jaz cartridge 3pk	£205.62
2Gb Jaz cartridge 3pk	£210.32

25MHz ARM3 £57.57

400 dpi A5 scanner (256 grey scale), suits any machine fitted with a backplane.
Only £34.07

A3000 & A5000

Special offers

A3000: Upgrade to 8Mb and 170Mb hard disc, £180.95
Add £52.87 to have an ARM3 fitted.

A5000: Upgrade to 8Mb and second 500Mb drive, £180.95

Other sizes of drive available. Offer subject to availability. Price includes collection, fitting and delivery. (UK mainland only).

Switch boxes	2-way	£17.62
	3-way	£19.97
	4-way	£22.32

Guarantee

The warranty varies from one product to another, up to three years in some cases. Many items also carry our no-quibble 14-day money back guarantee. Please ask for details. Statutory rights unaffected.

New Product

RISC OS 4
£116.32

Available Soon

Hard discs

NB Check out the Bargain Box below!

2.5" IDE A3000 A3010 and A3020

170Mb	£57.57
210Mb	£76.37
340Mb	£81.07
510Mb	£96.35
810Mb	£135.12
1Gb	£141.00
1.3Gb	£139.82
2.1Gb	£152.75
3.2Gb	£164.50

The A3020 will require partitioning software for drives larger than 510Mb £29.37

Other drive sizes available. Part exchanges considered.

3.5" IDE A4000 A5000, A300, 440/1

420Mb	£49.35
540Mb	£58.75
1Gb	£71.67
2Gb	£92.82

The A4000/A5000 require partitioning software for drives over 510Mb £29.37

RISC PC/A7000

540Mb	£58.75
1Gb	£71.67
2.1Gb	£92.82
4.3Gb	£104.57
6.4Gb	£116.32
8.5Gb	£128.07

In order to use an IDE drive, the A3000, A3010, A300 and 400/1 machines require an IDE interface (i/f). The cost of this varies depending on the features required. Example price: 170Mb for A3000/A3010 inc. i/f £92.82

Not sure what's required to fit a hard disc? Confused by the different options? Just ask for our free data sheet.

£81.07

170Mb hard drive system. Suits any machine fitted with a backplane. Limited stock.

Bargain Box

NB Many of the items in this section are second hand, and the list is constantly changing. Therefore please ring to check availability before placing an order.

3.5" IDE drives (Type, Qty, Price)

40Mb NEC	2	£11.75
50Mb Quantum	2	£12.92
60Mb Conner	1	£14.10
80Mb Western Digital	1	£17.62
110Mb Conner	1	£19.97
130Mb Seagate	2	£23.32
160Mb Seagate	2	£25.85
160Mb Conner	4	£25.85
170Mb Seagate	1	£25.85
200Mb Conner	1	£30.55
200Mb Western Digital	1	£30.55
230Mb Conner	1	£31.72
250Mb Fujitsu	2	£35.25
250Mb IBM	2	£35.25
250Mb Western Digital	1	£35.25
260Mb Seagate	2	£35.25
400Mb Conner	4	£37.60
400Mb Seagate	2	£37.60
450Mb Seagate	1	£38.77

500Mb Fujitsu	1	£41.12
500Mb Quantum	1	£41.12
500Mb Maxtor	1	£41.12
540Mb Quantum	2	£43.47
1.2Gb Seagate		£61.10
1.7Gb Seagate		£66.97
2.5Gb Western Digital	2	£72.85
3.2Gb Fujitsu	2	£84.60
4.3Gb Seagate		£88.12
6.5Gb Seagate	2	£99.87

An IDE interface suitable for most of the above drives can be purchased for only £29.37 when bought with one of the above drives. Larger units (>500Mb) may require partitioning software when used on pre-RISC PC machines. Please phone for details. A mounting bracket is an additional £1.76. Example price: 40Mb Seagate with interface and mounting bracket £42.88.

Various

1Mb A3010 computer	£125.00
Hewlett Packard SVGA monitor	£65.00
Both the above, only	£150.00
170Mb Hard Disc for A310	£81.07
1-2Mb A3010	£17.62
4Mb A3000 ram upgrade	£23.50
A3000 PSU	£17.62
400/1-Risc PC floppy drive	£23.50
Mouse A300-Risc PC	£14.10
Mouse A7000/A7000+	£17.62
RISC OS 3.11	£29.37
RISC OS 3.70	£45.82
RISC OS carrier board A300/400	£11.75
Input/Output (I/O) card	£34.07
A5 Scanner inc interface	£34.07
A5000 2-4Mb ram upgrade	£23.50
Backplane for Risc PC	£34.07

Various Cont.

Backplane for A7000+	£45.82
Risc PC PSU (Second user)	£70.50
Alsystems SCSI 2 card	£175.07
PC Keyboard	£17.62
Keyboard encoder A300-A4000	£45.82
PLCC extraction tool	£2.35
ROM extractor tool	£2.35
56K modem	£69.32
Fan kit (300 series)	£8.22
Fan filters (pack of 5)	£3.52
486 clip-on cooling fan	£7.05
Dongle Dangle	£7.05
VIDC (New)	£34.07
VIDC (Second user)	£8.22
IOC (Second user)	£8.22
ARM3 25Mhz	£57.57

Reader's letter

I have a confession to make: I had a really interesting letter and I've lost it. So my apologies to its author, who was, I think, a technology teacher, but I did read it and my guess is he'll know who he is. So here's the answer. But first things first, what was the question?

Like many a school teacher the writer told me he is facing being networked with an exclusively PC system. Yet his files, including many created for school, such as worksheets for his technology department, are on Acorn. He doesn't want to lose his Acorns. Nor does he want to lose his worksheets. So what can be done? If the worst comes to the worst, can the worksheets be transferred to PC?

Taking the last question first, mostly the answer is no – if you want to modify files there are no conversion programs I know of that will take native RISC OS files and make them readable by say Microsoft *Word* (as I recall the originals are mostly in *Impression*). You cannot

even ask a PC to read RISC OS discs, though an Acorn will write to PC format discs which might suffice for text-only files saved in a pure text form.

But let me suggest another solution. Why give in to PC tyranny at all? In your situation, dear reader, I'd suggest you have a go at your headmaster and plead a special case for having a Risc PC with PC card in your tech room. These can both be networked so that they can benefit from shared printers and so on.

The Risc PC will give you access to your old files. The PC card will run the school admin software being forced upon you.

What you need to ensure the platforms mix is Acorn *Omnicient*. This isn't too difficult to use and takes only a few minutes to set up.

If you're not familiar with Acorn networking, ask your net card supplier for help or see my highly instructive articles (page 48) which will tell you all the answers. Or you can e-mail me.

In easy steps

I remember when *Windows 95* came out and I bought a fairly early upgrade, there were already books on the shelves with titles like *1001 fixes for Win95* and of course, *How to get the best out Win95*. Well little has changed, except perhaps that *Windows* has become even more bloated and learning its intricacies is an ever more obscure art – just where is that setting hidden?

Of course with RISC OS, few programs mess around with your settings, so once you've got them right they tend to stay that way. What I've found with *Windows* is that, increasingly, software simply decides to 'customise' something you didn't even know could be customised. What then? *Windows Help* isn't usually much real help. So what do you do?

One answer is to turn to the *In Easy Steps* books. Normally I don't like such books. My guess is that if one were to be written for RISC OS not only would it

prove unnecessary because the OS is so easy to use, but few users would ever need it because we tend to know what we are up to. However, for RISC OS users having to use *Windows*, which includes the PC card, these books can be just right. They are written for the very beginner and they do tell you how to actually use things – whereas the *Windows* manual tells you something is possible, not what to do.

I've been looking at the *Windows 98* book and the one on networking. Both are useful introductions for the complete rookie and even sometimes help out those of us with a little more experience. If I have a criticism it's that they don't get far enough – but that would simply make them as bloated as the products they describe, so perhaps it's a blessing. So if you need some very basic help in printed form, have a look to see if there is one in the series to help you out.

In brief

Memory

I was reminded the other day that while RISC OS is very memory efficient, *Windows* software is demanding ever greater amounts of RAM. A few months ago I added a 32Mb SIMM to work alongside a 16Mb already fitted. It ensures that when running the PC card (usually configured to use 32Mb of RAM) I never run short of memory under RISC OS, which on a few occasions with just 24Mb fitted, I did.

The extra RAM also speeds up the PC card by a useful amount. Given that memory is supposed to be rising in price again, get it while it's cheap. Make sure though you don't buy just any old new memory SIMM. It has to be the right type and Acorn dealers are the best sources. Cheap new PC memory may not work.

Freeserve et al.

No doubt a great many of you will be tempted by the offer of free Web access and e-mail using the PC card running either Freeserve or BT's ClickFree.

Of the two I have to say Freeserve seems better – at least it works and is decently fast. ClickFree, which now only charges local rate calls where it once charged a small premium, is fine for Net access but has failed time and again when trying to access the e-mail option, and that includes trying to log on with a 'real' PC. So far as I am concerned, life is too short and I shall stick to Argonet which is far quicker than either and far easier to use. And if you must use *Internet Explorer* or *Netscape* which you can do with the PC card, you can set that up to access your regular ISP.

Contacting AU

You can contact me, Mike Buckingham, by dropping me an e-mail at: pccpage@acornuser.com

Netpilot

*Mike
Buckingham
looks at
a Linux-
based
Internet
server*

The NetPilot (yes, it does have two 'i's) is a multi-purpose Internet Server initially designed for small businesses and now being updated to cater for school needs as well. Using the Linux operating system, and currently based on AMD processors, a new StrongARM-powered version is due to appear in September this year.

Since Acorns have been designed with the foresight to be compatible with industry standards in networking, such as ethernet and TCP/IP, they have the potential to be used with alien servers that utilise those

standards. NetPilot is such an 'open standards' device and utilises software such as Apache, which is used by Web servers worldwide.

Essentially the NetPilot is designed to be an Internet server that can be used with a modem and dial-up Internet access, or ISDN, or leased line connection. There are therefore slightly different variants of the Netpilot depending on what type of connection it is to be linked to, one to be attached to a leased line, for instance will have two network cards installed, while others may have a modem or ISDN connection together with one network card.

The Netpilot is a multi-function all-in-one solution and provides a number of applications, including being:

- a router (for ISDN/leased line connections)
- a firewall (to prevent unwanted intrusion from the Internet)
- a filter, with user definable access controls to restrict use of unsuitable sites
- a Web cache/proxy server to store and issue commonly used pages from its own hard disc rather than having to go out over the Internet every time
- a Windows file server
- a Windows printer server
- an intranet server
- a DHCP server which will assign IP addresses to clients automatically (can be turned off if not wanted)
- an e-mail server

Getting going

It comes as a single box with no monitor or keyboard, as all configuring is done from a browser on a client machine. It does have connections for monitor and keyboard but this is only useful for those who wish to use Linux commands. This is likely to be neither useful nor desirable for most users who will utilise the 'point and click' simplicity of the browser interface.

The initial configuration is then done from a client attached on an ethernet network. The Netpilot uses an IP address for its clients that is one of the ones reserved for internal use on networks and not on the

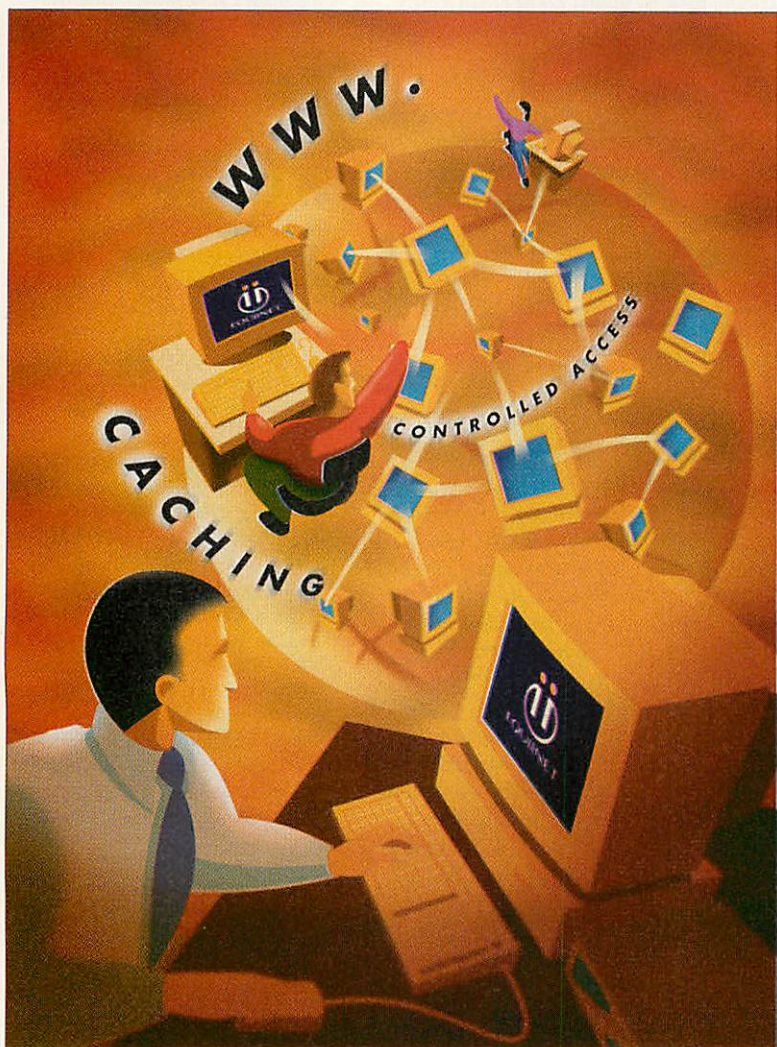

Internet itself. By default that address is 10.0.0.1 so in *Fresco* that setting is entered in the appropriate LAN settings shown in Figure I, the client being given an IP address with a unique last digit but similar first three.

For those not familiar with IP addresses this can seem a bit off-putting, but after it is done on one client it becomes much easier on the others, only the first section of the Host Name and the last digit of the IP address are different on each machine.

Once *Fresco* has been set up for LAN use in this way it is only necessary to type in `http://Netpilot` to access the Netpilot's administration pages, though for security's sake these are password protected. The main administrator page is shown as Figure II.

The next step is to set up the Netpilot as an Internet server. How this is done depends on the type of connection. If you are dialling out via a modem or ISDN, for instance, there are a number of ISPs listed to select from and then enter personal details in much the same way as arranging dial-up from a single machine.

If you are using a leased line you can set the IP address that the Netpilot is to use, this must be one allocated to you and is the one 'seen' by the outside Internet world. In this case the Netpilot has one IP address as far as the outside world is concerned and one (10.0.0.1) for internal use. Because the Netpilot handles its own clients on internal IP addresses this means that for dial-up/ISDN connections only one IP address is needed and can be dynamically allocated by the ISP at time of connection.

Therefore a whole network can be connected via one dynamically allocated IP address. It's not necessary to understand all the principles described here, you can just set up the Netpilot following the instruction booklet and it takes care of the rest itself.

Because the Netpilot has no graphical interface to maintain on the server itself, all its processing power can be focussed on the functions it has to fulfil (unlike an NT server). The use of a browser interface is a clever way to bypass the need to use Linux commands and allow Linux to be used as the operating system.

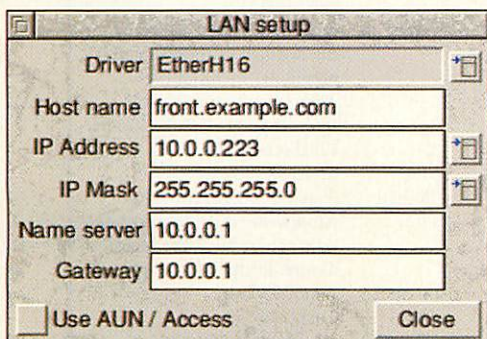

Fig I: Entering the LAN settings

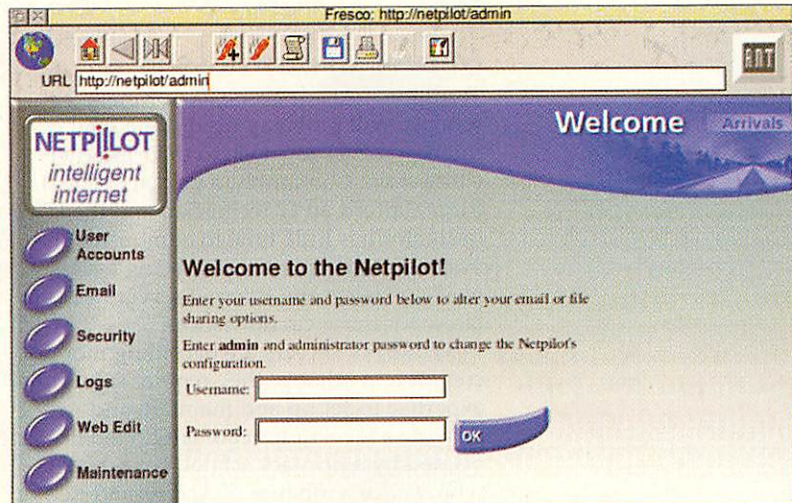

Fig II: Netpilot's protected admin pages

www from an Acorn

The NetPilot is an Internet server and as such is accessed via a network. To access from an Acorn it will be necessary to have an ethernet network card (ANT cards are still available from Atomwide, i-cubed cards are also suitable if you already have one) with DCI 4 protocols.

I have only successfully accessed the NetPilot using the *Ant Internet Suite*, though theoretically *Browse* with the Acorn Internet stack should also be capable of so doing. In order to do this the ANT suite must be set for network use as described earlier. Once this is done Internet access takes place as 'normal' with the NetPilot making the decisions about when to connect, though if it is on a leased line then connection is, of course, continuous.

This then is one of the main advantages of using an Internet server such as this. When a request for a Web page is received then if it is available it is delivered from the cache (store) of Web pages retained (and intelligently updated) on the Netpilot's own hard disc. If it is not available in the cache the Netpilot will get it from the Internet, either making a dial-up or ISDN connection or going out to the Internet over a leased line.

Netpilot drops any dial-up connection after a default time period of non-use. The use of a Web cache therefore helps speed up access which can be delivered at network speeds, typically 10 or 100Mb/sec (megabit); only making connection when necessary saves your phone bills as well.

Users can be created, edited or deleted via the admin pages, though you can have Web access without user-controlled access if you want. Users can also have their own folders on the hard disc but these are Windows compatible, as is the printer serving facility, so is only relevant here if you have a cross-platform network with PCs as well as Acorns using the Netpilot. There are various other utilities also available from the browser interface

including e-mail set-up.

Server usefulness

Traditional Acorn users, like primary schools, will probably need some kind of Internet server to attach to their Internet connection. Commonly, a primary school cannot afford an IT technician and the IT coordinator has little time to administer IT systems in school on top of being a class teacher. Hence any Internet server needs to allow for those circumstances.

While NT servers are becoming more common in schools, they require substantial expertise to set up and maintain and provide a level of functionality often not needed by a primary school. For schools which have a mixture of Acorns and PCs or Macs this kind of server allows all three platforms to access the Internet over the same standard network. For similar reasons, some small businesses may prefer a solution such as this to the complexities of NT.

Because the Netpilot has multiple functions including offering firewall and filtering ability it provides an 'all-in' solution in one box.

It allows multi-user access, via a network, to a single connection which, as it requires only a single dynamic IP address, may mean you can connect a network for the price of a single user (depending on the terms of the ISP), or free if you can find a suitable free ISP.

Since it will make and drop the connection as needed it can save bills on systems which have on-line charges such as dial-up and ISDN. Schools do have 'all in' unlimited phone use or ISDN billing systems available but if one of these is not used telephone bills can escalate very quickly.

Since it can speed Web access by virtue of its Web caching/proxy function it can improve the performance of networked Internet access. If you have a mixed platform network with PCs it may provide a useful Windows server facility that may be preferable to Windows 95/98 sharing. It can save on the need for a PC computer to act as a printer sharer for PCs on the network, queuing print jobs from the clients.

It can be your e-mail server, downloading mail from your ISP and distributing to clients as appropriate. It is likely to be lower maintenance and easier to maintain than, say, an NT server and since it has no monitor and keyboard it can be less prone to interference and can be located somewhere secure quite easily.

Software upgrades are available over the Internet which allows easy upgrading. These are likely to be free and release users from the continual Windows upgrading treadmill that the PC world is encumbered with. The unit has the facility for dial-in maintenance from a remote source so that, for example, a support unit could maintain

the Netpilot units in schools in an area remotely, reducing the need for site visits.

Conclusion

This is a very well thought-out product which could provide a low maintenance solution to Internet serving. I have found the company that produces them, Equinet, to be very willing to listen to suggestions and develop a product that is suitable for their users' needs. They use 'open standards' and make no attempt to lock people in to their systems (unlike some other major educational suppliers) which facilitates cross-platform use, including Acorns.

The price is all-in (£1495) without the need for ever-increasing client licenses if you add more clients, unlike Windows NT. While the current retail price is more small business orientated, watch out for educational price re-structuring which could make it suitable for primary school use as a general purpose Internet server.

Secondary schools may also be interested in using a solution such as this, for example for their Web caching/proxy facility which takes virtually no setting up, particularly if you do not need individual user controlled access.

This is an interesting example of a potential combination of Linux and StrongARM to provide a practical solution to needs that arise from the development of Internet access and particularly multi-user access from networks.

This is an area developing rapidly in schools as a consequence of the government's National Grid for Learning initiative and the need for a server such as this is becoming more and more apparent. It combines multiple functionality with ease of maintenance.

While this article may sound entirely in favour of the Netpilot I have simply not found any drawbacks to it yet. That does not, of course, mean there are none, I just haven't found any!

END

Product details

Contacts: **Equinet**, Unit B1, Acre Business Park, Reading, Berks RG2 0SA,
 Tel: 0870 6081530
 Web: <http://www.equinet.com> (note the double i in equinet and netpilot)
Argo (distributors of ANT Internet Suite), 7 Dukes Court, Chichester PO19 2FY
 Tel: 01625 585 586
 E-mail: enquiries@argonet.co.uk
Atomwide (distributors of ANT ethernet cards), 7 The Metro Centre, Bridge Rd, Orpington, Kent BR5 2BE
 Tel: 01689 814 500
 E-mail: sales@atomwide.co.uk

7 reasons why ArgoNet are the best:-

1st Packs for New Subscribers

Starter Packs come with three months unlimited online time and free phone support - there are no 'hidden' costs. Packs include everything, except the computer, needed to get online and stay online with ArgoNet.

2nd Get Online Starter Pack

This pack gets you online for the first three months to the full ArgoNet and ArgoSphere services. At £24.95 the pack also includes, if required, access software for Acorn, Mac or Windows.

4th Laptop Online Starter Pack

For Laptop users, this pack comes with a PCMCIA 56K fax/data card and access software for Windows. With three months online to the full ArgoNet 56K service, this pack represents incredible value at £129.95.

5th SuperSurfer Starter Pack

An ISDN pack with everything needed to get started for only £169.95. Includes a 128K external ISDN terminal adaptor, access software for Windows, Acorn or Mac and three months online to ArgoNet's ISDN service.

3rd Surf at Speed Starter Pack

Complete with external 56K voice/fax/data modem, access software for Windows, Acorn or Mac and stereo headset. Includes three months online to ArgoNet's full 56K (V.90) service. Only £99.95.

6th Domain Name & Web Services

ArgoNet deals direct with the naming authorities and provides full registration and Web site hosting services. Subject to availability, ArgoNet can register any name - let ArgoNet secure it before someone else does!

7th ArgoSphere for Children

ArgoSphere is ArgoNet's award-winning Website for children aged 3 and older. Can be used offline by children in complete safety in school or at home. Explore the latest educational activities on ArgoSphere free at www.argosphere.net.

ArgoNet's Internet Services

ArgoNet's Premier Service for **home** and **business** users includes 20Mb Web space and 5 e-mail addresses. For **schools**, the Education Online Service includes a free school domain, unlimited Web space for your school's use and unlimited e-mail addresses.

A subscription to ArgoNet includes full use of ArgoSphere the award-winning Web site for children, unlimited access with 100% local call coverage and free phone support. Subscriptions for dial-up modem or ISDN access are available monthly, 6-monthly or annually from only £10 (exc. VAT) per month.



Call FREE PHONE
0500 585 586
for information
and to order



Brave new

*Steve Turnbull reports
on the exciting
development of the
RiscStation R7500*

world

The last few months have been a scary time in the RISC OS market – with desperate swings from hope to despair. But it looks like the final swing is going to be up, and up, then up some more.

The RiscStation R7500 should be with us by the end of July, and it looks to be a very nice machine indeed – despite being based on the slower ARM7500FE chip rather than the StrongARM. But before getting into the details of the machine itself I spoke to Roy Heslop of CTA and asked him why he had created the R7500:

“Without a new machine right now the market is dead and with it goes a lot of businesses and goodwill. We had been working on ideas for a machine for a long time – its time has come.

“So we did it because we could, the current machines are five years old and, while they may be very easy to use, they are old kit and Acorn let the operating system stagnate. RISCOS Ltd have got that problem in hand but there was still the hardware

“We needed to break the

hardware/software spiral: When it's running upwards the spiral creates better hardware and better software. But with RISC OS it was running down, no hardware development meant little software development, meaning no drive to make more and better hardware. The worst sort of downward spiral.

“With the R7500 we are breaking that spiral and producing a machine with excellent hardware specifications and expandability which provides a basis for further hardware development. This will really give the software writers something to get their teeth into.

“We are launching an entry level machine with a specification that beats anything else in the RISC OS market, it's the new minimum.

“Acorn suffered very badly from NIH – Not Invented Here – it prevented developers from helping them produce better machines, they were killing goodwill in the market as well as cutting their own throats. The R7500 is the product of seven developers. We're not scared to let others in, we're grateful for the opportunity to use the skills that exist.”

What did you go for when designing the hardware?

“One of the best features of the Acorn machines were their longevity – it's a powerful selling point – we are following that lead but the R7500 is even tougher, electrically, than Acorn's designs.

“Another important feature was expandability. If you go back to the BBC Micro it had fantastic expansion capabilities, Acorn lost that with some intermediate machines but regained it with the Risc PC. The disadvantage was that the expandability was only available through Acorn-only hardware.

“In our original R7500 design we wanted a PCI bus, but it wasn't feasible – there was no way to make PCI work properly which is why our original announcements didn't have it. However the designers eventually found a way to have fully capable PCI running and that really opened



The RiscStation R7500 in tower mode

the door to the future we're envisaging.

"By the way, those people on the comp.sys.acorn newsgroups who think that they 'persuaded' us to go to PCI should understand that that was where we wanted to be all the time, it was only design constraints that stopped us at first.

"We didn't even consider compatibility with the old Acorn podules - they're a dead-end and our research shows that most people won't be disadvantaged. The only real concern has been with those people who still use the LaserDirect printing system. Well they've certainly had their money's worth out of the LD system and with this machine modern laser printers will run ten times faster."

Why is PCI so much better?

"What PCI means is that the dealers (who are mostly also developers) don't have to develop hardware anymore, they can buy PC hardware off the shelf, write the drivers and sell them on, it allows them to add value to the machines and tailor them to the needs of the buyer. It's not going to happen overnight but it puts the opportunity there.

"Although CTA is a dealer, RiscStation isn't and we will be referring people to their nearest dealer as a first step - not to CTA Direct. It's the market as a whole that concerns us, we can't survive

without a new machine and we can't survive alone.

"PCI gives to the RISC OS market the revitalisation it needs, getting the money and products flowing again, giving the magazines products to talk about - it puts the life back."

The R7500 is based on Sintec's CATS board shown here with the 5-module PCI card plugged in

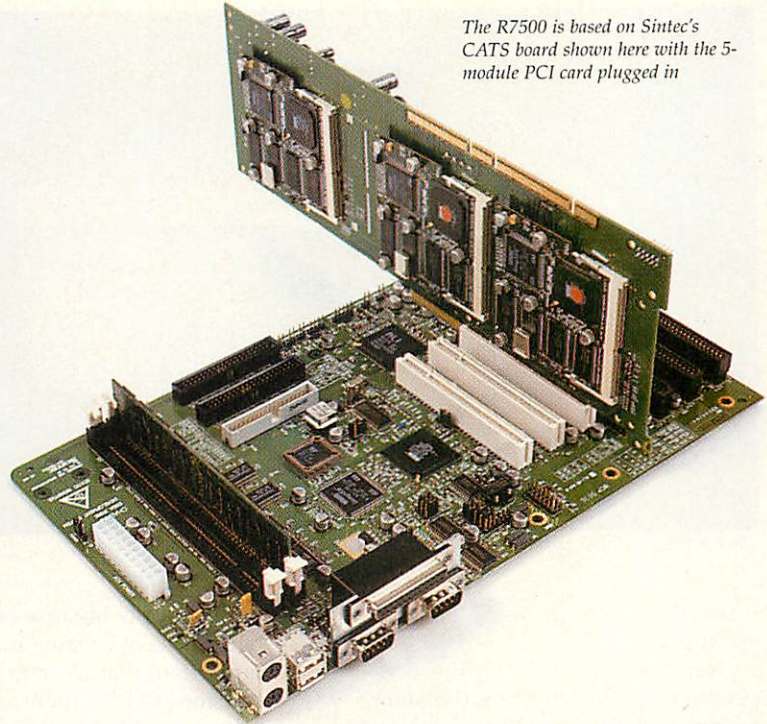

3x SA-DIMM cards

RS232 diagnostic serial port

Control logic

64 bit-64 bit PCI bridge

64 bit-32 bit PCI bridge

2x SA-DIMM cards

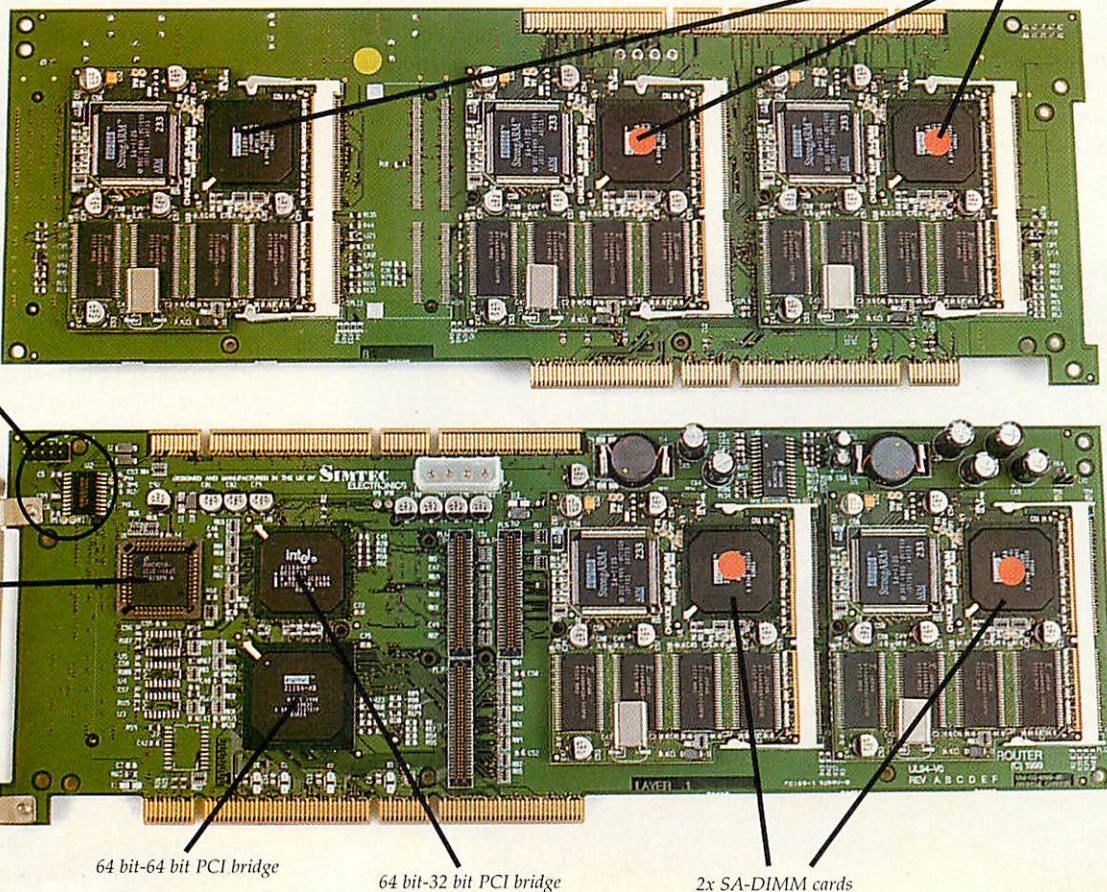

The Sintec PCI card that holds five SA-DIMM cards



The RiscStation R7500 desktop unit

Who are you going to sell this machine to?

"The time has come for those people who are still using the older machines limited to 4Mb to upgrade and join the rest of us, because we do have a future now. More than we did when Acorn were running the show – it's a shame they didn't leave the market five years ago.

"But, surprisingly, we've also had a lot of interest from people with Risc PC StrongARM machines, though of course most of them want it for the ability to plug-in the PCI cards. Having said that the R7500 is about as fast as the Risc PC 600 – and it can do floating-point as well.

"Apart from individuals, the education market is a crucial one for

RISC OS, simply because of the huge installed base of existing machines. It's important that we stop the rot of conversions to PCs, there are several steps that need to be taken. We've also identified several other key markets that we can sell into plus we have actually found the bigger PC magazines to be quite sympathetic and willing to review the new R7500.

"What we have is the Bill Gates-free OS."

As a final note, a crucial comment expressed by Roy during our chat involved money. He had been talking about adding a particular hardware feature and said "well, it only added £1 to the cost, so why not?", not an attitude you would

have found in a certain other defunct, business of our acquaintance.

RiscStation R7500

The design of the new computer is based on the Simtec CATS board but with a ARM7500FE processor running at 56MHz. There are two SIMM slots for memory with 16Mb RAM as standard, unlike Acorn's design, Simtec's will accept variable speed DRAM – if you put in faster RAM the machine will go faster. You get 16Mb of 60ns EDO RAM but you can go down to 25ns. The resultant access speed will probably be about 30ns, twice as fast.

As it runs at 56MHz it's about 50 per cent faster than an A7000+, but with the addition of RISC OS 4 and its speed improvements the overall speed-up means it runs about twice as fast as an A7000+. A problem when you start comparing these speeds with the Risc PC is that there are two distinct Risc PC benchmarks: one with and one without VRAM. The A7000+ was faster than a Risc PC 700 without VRAM – so the R7500 is getting up into the realms of equivalent to, say, a Risc PC 600 with VRAM.

RISC OS is, of course, in ROM but now it's flash ROM so that major operating system updates can be supplied in software (via disc or even the Internet) and then written into the ROMs. As always new modules can be loaded onto the !Boot sequence to provide incremental improvements.

In case anyone starts worrying about viruses being programmed into their operating system, sitting in ROM in their machine: First of all, the ROMs are link-protected, in other words you have to move a physical link inside the computer before the ROMs can be re-programmed. Also it's actually not that simple to re-program Flash ROMs, it's a very complex system that requires a special program writing to two different memory locations simultaneously, and six specific bytes sent prior to the actual byte to be written, plus there are time-out limits as well. So have no fear, RISC OS will remain as protected as ever.

Storage is in the form of a 4.3Gb IDE harddisc with a lot of extras; there's a 40x CD-ROM drive; 10BaseT network port; two serial ports; parallel port; a sound sampler; two MIDI ports; PC-style joystick port; and four PCI

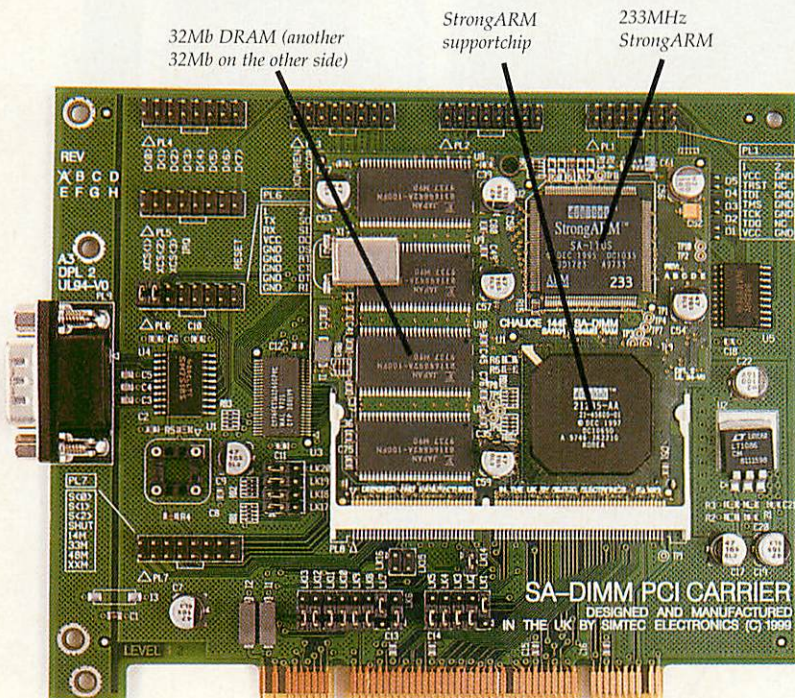

Simtec PCI carrier for a single SA-DIMM

100baseT network card

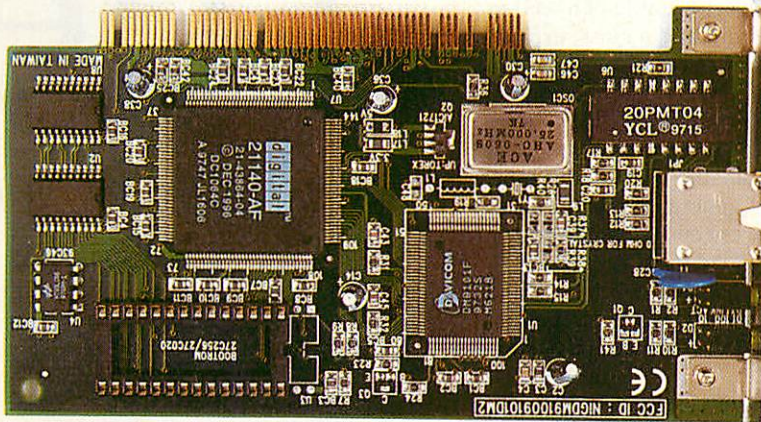

expansion slots. All standard.

The internal IDE system will take four devices and there will be additions for the new USB protocols and for IrDA infra-red networks.

Additional features include the ability for the machine to wake up from sleep mode on various external events such as when the local network it's connected to

PCI and the R7500?

PCI stands for *Peripheral Component Interconnect* and is the current standard for plug-in expansion cards in PCs, transferring either 32- or 64-bits at a time to or from the cards. This standard has superseded the pretentiously named ISA (*Industry Standard Architecture*) which could only transfer 16-bits at a time.

The PCI 2.0 standard, which is what the R7500 has, is designed to be independent of machine design and the computer's processor and memory are connected to it in along with all the cards on the PCI bus.

Any card can become the bus master and be in charge of transferring data directly to or from memory at up to 64Mb/sec (theoretically 132Mb/sec) – this compares with the very pedestrian 6Mb/sec of Acorn's bus for podules.

Owners of older Acorn machines may recall the screen blanking that occurs when memory intensive operations (copying big files to/from disc) stopped the screen access from working. RiscStation have assured us that this won't happen on the R7500.

becomes active; based on an alarm time; when its modem receives a call and so on. The off switch is placed to avoid accidentally switching it off. All the I/O is static-protected to new CE standards and the machine has self-resetting semiconductor fuses. Making it even more robust than the Acorn machines it replaces.

All the software needed to use the standard inputs and outputs are provided such as Internet connectivity software, MIDI software and so on. You also get *EasiWriter* for *Word* compatibility. RiscStation have promised at least 1Gb of software on the harddisc.

This is a superb machine with excellent specifications and a great future at an affordable price: £576 plus VAT.

StrongARM power

So that's all about the 56MHz R7500 – but where does the totally unbelievable 20GHz of processing power come in?

A few years ago the RISC OS electronics design company, Simtec, released the Hydra board which took five ARM610s or ARM710s, the idea was that these additional processors could work alongside the main processor and increase the throughput.

Due to Acorn's lack of support and enthusiasm Hydra was never released – but that didn't stop Simtec.

They are about to release a PCI card that can take up to eight plug-in cards, each plug-in could have a 600MHz StrongARM 2 (to be released next year) and 64Mb RAM on-board – and you can put four of these PCI cards into the

RiscStation.

This could provide the equivalent of about 20GHz of processing power. Now Simtec wanted me to emphasise that this is all speculation, so what about the realities?

The PCI card with five plug-in spaces already exists for another customer – producing the eight space version is no problem. All it needs is to be constructed and inserted into the R7500.

The design of the plug-in cards and the PCI bus itself means that the memory of each card can be made visible to the main processor and any of the other cards. In case anyone is concerned about power consumption of eight StrongARMS with 64Mb RAM each – one plug-in card takes just 2W, that's a total of 16W and a single PCI board is rated to a maximum of 25W.

As the R7500 will take PCI cards – and is already running ARM code – extensions to allow the additional processors to run code won't be far behind. Support software to allow this to be done automatically has been started but is not yet ready.

Having said that there is known to be a RISC OS game designed to take advantage of any additional processors already being written. A version of Java could be written to use them, plus it would be very effective to throw the RISC OS font manager onto a separate processor and let it keep its font cache in the 64Mb of onboard RAM. It would even be feasible to write a module to handle 3D graphics to be loaded into a co-processor in the same way – like a software graphics accelerator, definitely in keeping with the RISC OS design philosophy.

Going away from RISC OS, Linux and Unix are designed to be multiprocessor operating systems, so they could be run in one or more processor cards – and appear in a window on the RISC OS desktop. It's even feasible to run multiple versions of RISC OS, one on each processor.

The possibilities are endless and realistic: These are not vapourware, the R7500 exists, so does a PCI card with plug-in StrongARMS. RiscStation, with Simtec, are breaking that hardware/software spiral and giving us a RISC OS machine that has incredible potential and opportunities for the most amazing software.

The tools are being provided, it's up to everyone else to put them to good use.

END

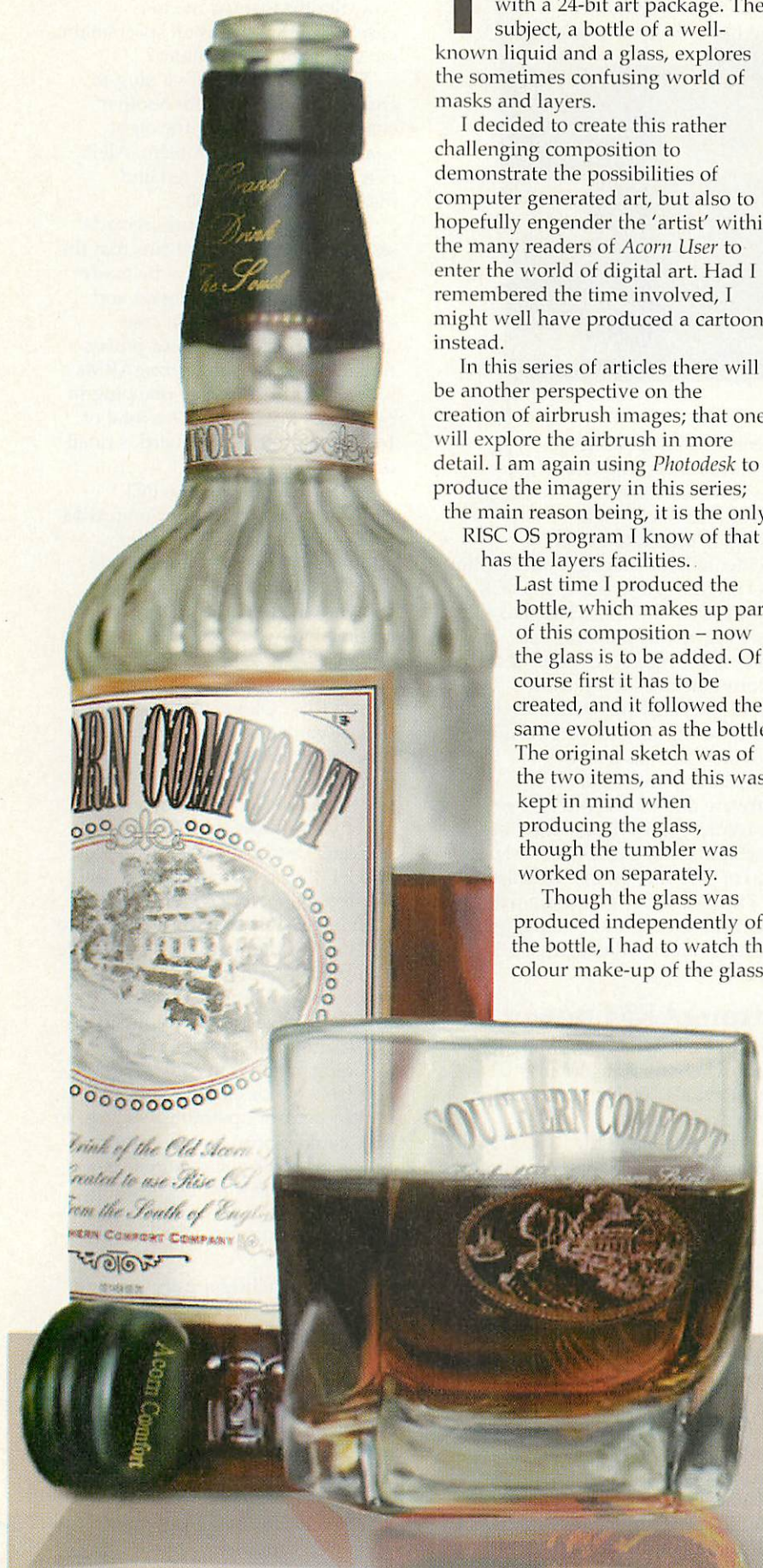

This is the second article on this topic of creating illustrations with a 24-bit art package. The subject, a bottle of a well-known liquid and a glass, explores the sometimes confusing world of masks and layers.

I decided to create this rather challenging composition to demonstrate the possibilities of computer generated art, but also to hopefully engender the 'artist' within the many readers of *Acorn User* to enter the world of digital art. Had I remembered the time involved, I might well have produced a cartoon instead.

In this series of articles there will be another perspective on the creation of airbrush images; that one will explore the airbrush in more detail. I am again using *Photodesk* to produce the imagery in this series; the main reason being, it is the only RISC OS program I know of that has the layers facilities.

Last time I produced the bottle, which makes up part of this composition – now the glass is to be added. Of course first it has to be created, and it followed the same evolution as the bottle. The original sketch was of the two items, and this was kept in mind when producing the glass, though the tumbler was worked on separately.

Though the glass was produced independently of the bottle, I had to watch the colour make-up of the glass,

The

Part 2 of Walter Briggs's series on 24-bit art packages

so that it was still in keeping with the rest of the image.

An empty glass

The first stage was to produce another sketch, of just the glass. (Figure 1) This was a rather rough drawing, that was cleaned up with the drawing tools in *Photodesk*. This also straightened the lines up a bit, and using the ellipse tool, I also tidied up the label. But no doubt you will see that the picture is still rather grubby, and the lines a little less than steady – still 'a man on a galloping horse' would hardly notice.

In the sketch there is only the suggestion of text and structural lines, but enough to be able to fill with masks, and allow the airbrushing to begin.

I employed my usual method of working, and began to 'paint' the top of the glass – finishing each area before gradually moving on to the next.

Figure 2 shows the text that was created in *Artworks* and dropped onto my working page. This really is the simplest way to produce curved text. Once created, *Photodesk* gives you the option of either pasting the Vector (*Draw*) object as a mask, as in

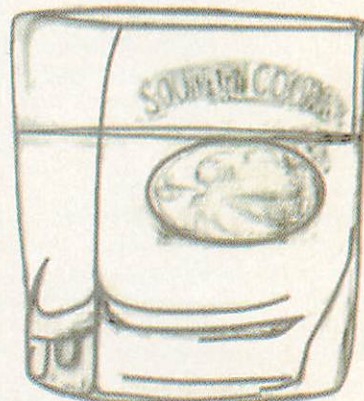

Fig 1: Rough sketch of the glass

hard stuff

this case, or as a coloured image, painted onto the main canvas. If it's pasted as a coloured RGB image it then becomes part of the main picture.

Of course at any stage, if the text begins to suffer from over enthusiasm, and starts to fade, I can re-paste the text back again. Though usually, if the text has become indistinct, I would drop the vector image back onto a mask layer, and gradually spray the finer details back in.

The whole image is made up of a number of 8-bit channels, Red, Green and Blue (or 4-bit CMYK) and you can add a number of new channels, which can contain masks. So when you paste your image as part of the existing picture, it is pasted onto the RGB channels; but as a mask it is pasted on to a new 8-bit channel.

The fact that it is 8-bits, means it has 256 shades of colour or depth of mask, so it can have soft, anti-aliased lines or graduations, which make for smooth edges and variable masks.

The top left side of the glass is now finished. A gentle grey/green tint has been sprayed over this area, a simple shadow being the only real



Fig II: Text from Artworks added



Fig III: Lefthand side finished

detail. For glass – 'less is more'.

There is a temptation to over-work your masterpiece, but resist. You can always alter it later if you are not happy, but it's easier to add details than to subtract unwanted work at a later date.

Amber nectar

Figure III shows this section of the glass finished, and the highlight and shadow almost eliminating the text, but that's just as it should be. The white highlight was airbrushed over the text, and as the light got stronger, the text was covered, almost as it is in reality.

The glass has a distinct shape, and the angle which is seen as a line on the top of the glass, is in fact the corner of the tumbler. This line in the top section is very important, and should join up with the corner on the bottom.

Distinct features such as this make painting a little less complicated, since the perspective is easier to get right. There is little colour variation to the 'liquid' in the side of the glass, but the shadow dictates that this is enough. I have worked the base as well, and here there is a splash of

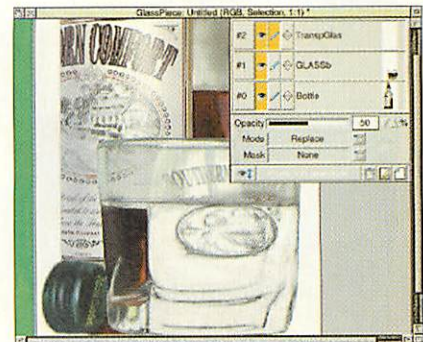

Fig IV: Photodesk's menus

colour in the glassware. This is one region of the glass that holds some brighter colours. The bottom corner reflects some golden/yellow tones from the contents. This really lifted the rather sombre liquid to a more 'tasteful' hue.

It was at this point that I thought it would be a good idea to place the glass in front of the bottle just to make sure the transparent part of the glass would work.

Figure IV shows a screen shot of the *Photodesk* window along with the menus in all their glory. There are three layers – the bottle, the glass, and the piece of glass cut from the tumbler side. This is one way to create a transparent section of an illustration; as you'll see later there are other ways.

The section of glass that allows the bottle to show through, is the top left section above the liquid. What I did was cut out this fragment of glass and paste it onto a different layer. This layer then had its opacity reduced to 50% to allow the bottle to show through this small area of glass. This is one very useful facility with layers – the ability to alter the opacity of the layer – or a masked object on that layer.

Bottoms up

Once the glass transparency was achieved, the bottle layer was



Fig V: Working the base of the glass



Fig VI: Colouring the liquid

switched off and work continued with the glass. Though I would later decide that there was another way to achieve this transparency that would work better.

The colours that make up the front of the glass base, are a lot more subdued. The rich reds inside the glass are not reflected in this section, so it remains only shades of greys.

Now that the base and right side are beginning to emerge, the tumbler is taking on a three dimensional form. An illustration like this shows that masks within packages like *Photodesk* and *Studio 24* can hide all kinds of information. But only *Photodesk* allows this feature to be applied to whole layers.

Now that the most important feature is finished – the contents of the glass – the blush of colour becomes very rich. The contents of the glass have the same colour as the side – but now, due to reflection, the drink is much brighter at the bottom, and the whole glass appears more tasteful.

You may also notice that the base of the glass appears a little more luminous, this is because this portion of the tumbler had the contrast increased. All this does is increase the difference between the colours making it appear more vibrant.

You have to be careful in doing this, since the edges where two colours meet can become too distinct, losing the blend of hues; but in this case it was enough to bring out the base. The contrast was only just



Fig VIIa: The vector label

applied to the base section.

This can be done in a number of ways, including the use of masks to protect unwanted areas. All I did was choose the airbrush, the contrast option, and 'sprayed' 30% contrast over the base area.

Sticky label

All that was left for the glass was to add the label. It must have been a particularly inspiring day, when I realised how easy it would be to create this dark red embossed label.

Using the vector label that had been stuck on the bottle (Figure VIIa), I simply applied the 'detect edges' (or you could use an emboss option) with the 'magic wand' to the whole image. This raised the features of the label that needed to be emphasised, and created the embossed label in Figure VIIb.

Now the tricky part. The label had to be coloured in such a way that the high points would still stand out



Fig VIIb: The embossed label

once it had been painted dark red. First I applied a red tint to the whole image by using the 'colour balance', so it retained its various features – this only created a pink imitation. I now had to protect the high points to be able to retain the features, and still be able to paint the dark red needed to match the glass contents.

Figure VIIc shows the mask applied to the high points of the embossed label, allowing the dark pigment to be applied to the 'low regions'. The new mask was created in 'blue', which meant I could easily see the masked areas on the red background.

Using the magic wand set to global colour, and with the mask tool chosen, I 'clicked' on all the light sections of the image, which then became masked. Once the label was close to the colour I wanted, I needed to

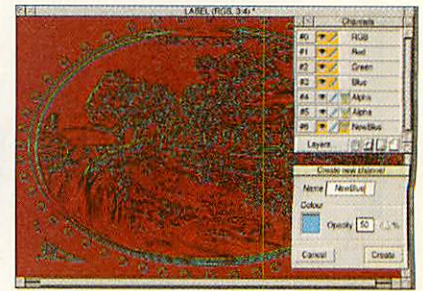

Fig VIIc: The masked label

stick it onto the glass. It was easy to cut out the embossed label and drop it onto the glass canvas – you are then given the option to paste in onto a new layer, which I did (Figure VIII).

With the label on a different layer, I could experiment until the colour matched the contents, and not affect the layer beneath. Any stray edges, were masked so they would be then hidden from view when the mask was switched on.

Drinks channel

This subject of masks (or Alpha channels) can be quite confusing, but it is really straightforward. The analogy has been drawn with a mask and a piece of acetate or similar stencil material, this comparison is good in that the mask can protect certain areas of an image, and can be transparent. It's good to remember the two options for the mask – active (protecting your image) and visible.

The visibility of the mask doesn't affect its ability to protect, it just means you know where it is. This means you can protect a section of your picture, and have the mask colour switched off so you can compare the region you are working on, with the adjoining, protected section. The concept is the similar when using masks and layers, only this option really controls what is

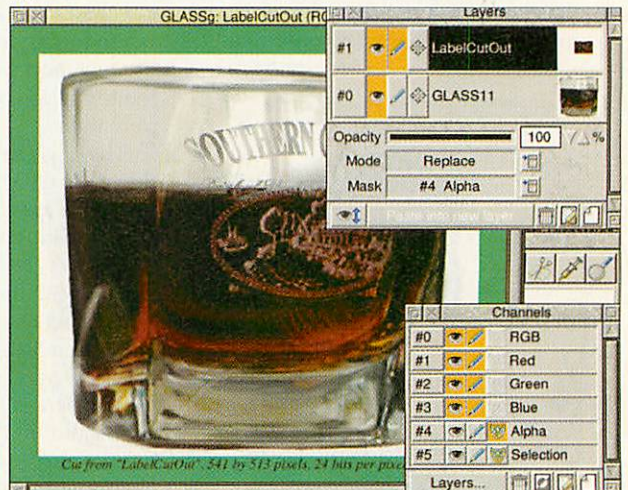

Fig VIII: Pasting the label



Fig IX: The masked glass

finally seen.

It's possible to switch the mask on and off in the mask channel, as well as selecting this mask in the layer menu.

Making the mask active in the channels menu doesn't affect how your picture appears. But activating the mask on the layer option will make the area beneath the mask invisible.

The glass and bottle in Figure IX shows a screen shot of the masked glass, with the mask invisible on the channel menu but not selected in the layers menu, so the surrounding white page is still visible.

Switching the mask on and off in the mask channel does not affect how this mask works on the layer menu, and so on your overall picture. This shot shows white areas and a solid glass, the bottle is not visible. This is because the mask is no longer hiding these areas on the 'layer' menu.

It's possible to have a mask on one of your mask channels protecting an area of your picture, but unless you select this mask on the layer menu, then it will not hide your masked area. You must get the combination right! The masked section of your layer (and remember this applies to each layer) must have

a mask on your channel menu – then select this mask, on your layer menu as well. So when you save this image out in a format for other programs, such as a TIFF, it's a case of 'Layers' – WYSIWYG.

Since you can have more than one mask, you must select the appropriate mask channel on the right layer – you

are given a drop down menu of all masks (Alpha channels). It helps to have appropriate names for your mask channels.

If you find that your top layer still shows your mask, even though it is selected in the layer menu, just click the 'eye' icon off on your mask channel.

Hidden drinks

In Figure X, the working mask is visible. This is the same section as Figure IX, but the mask's eye icon switched is on, so the mask is visible. In this shot you can see there is now a mask over the top left section of the glass – which earlier had been cut out and placed on another layer. I changed my mind about the best way to make this piece of glass transparent.

Rather than have this fragment on another layer, I decided to simply spray a mask over this section, allowing for a more subtle transparency for the bottle behind.

The next image (Figure XI) also shows how the masks channels work, and why they are such a boon to artists who are forever changing their minds – and their pictures.

The slogan which accompanies the name of the drink on the front of the glass, had become lost – so

dropping the vector text file back onto a mask channel, allowed me to re-spray the embossed text again.

This screen shot of all the layers shows the text visible on the top layer, the glass on the next and the bottle on the bottom, or back layer.

The mask is active (mask icon down) but still visible (eye icon up) on the mask channel. However, the mask



Fig XI: The mask channels

is not active on the layer menu (there is no mask selection – the box says 'none') so the mask is seen.

So, I could spray the glass with this selection, and the mask would protect the area of glass beneath the magenta mask. But since it's on the top layer, I would need to switch the mask off, making it invisible, and then select it in the layers menu, to mask and hide all the unwanted areas in the illustration.

Applying all that I have just said the finished illustration appears in its final form below.

A little reflection on the surface it's sitting on adds just a finishing touch.

Hopefully this article has proved helpful, and though the actual painting was rather glossed over; with any luck the next article will enlighten you a little more.

END

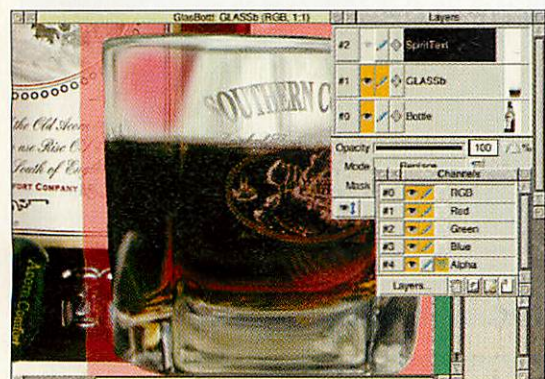

Fig X: Visible working mask



Century House, Market Street, Swavesey, Cambs. CB4 5QG
Tel/Fax: 01954 208208, e-mail sales@eesox.com, www.eesox.com

EESOX

4-Piece Multi-Media Sound System



Graphic Equaliser and 3D 600W Subwoofer Speaker System
For Acorn SE Show & July ONLY Special offer price
£79.00 Incl. VAT

Internal Graphic Equaliser **£43.00**
600W Subwoofer Speakers **£39.00**



All prices less carriage (£11.75 incl)



40x SCSI CD-ROM Drive External

£125.00 Incl. VAT

External Drive & Eesox

SCSI Card Bundle **£249**
With Cables

Summer (8) Special Offer **£115.00**

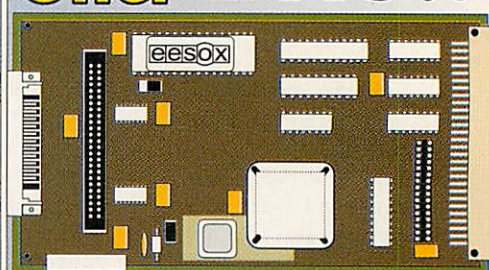

EESOX SCSI CARD

Liquid Silicon

32-bit MIDI Sequencer



Powerful
Flexible
Easy to use drag & drop
Controller maps (e.g. tempo and velocity) easily alterable by drawing with the mouse
Patterns can be linked to reflect changes made to other patterns
Handles System Exclusives
Multitasking playback
Supports any MIDI interface, including parallel and serial
Up to 192 MIDI channels and no track limit
Free demo disc available
Now available - £129.00

Recent/New Releases

- Abuse - £23.00
- Descent CDs - £28.00
- Heroes of Might and Magic 2 - £32.00
- Heretic & Hexen CD - £32.00
- OHP CD (Spacetechn) - £28.95
- Photodesk 3 - £279.95
- Sunburst - £12.50
- Syndicate Plus CD - £26.50



Discs (example 10x white discs - £4.60, 50x black discs - £15.10, 5x HD red/blue/green/white discs - £2.49)
Batteries (e.g. 4x AA Xtra alkaline - £2.18, 1x 9V alkaline - £1.84)
Audio & Video Tapes - £Various

FREEPOST EH2725
Kirkcaldy, Fife, KY2 5BR
United Kingdom

Tel: 01592 592265 Fax: 01592 596102

email: Liquid@cableinet.co.uk
http://www.cybervillage.co.uk/acorn/liquid/

We supply a range of CCD and laser bar code scanners and include with these our iBarReader driver software which allows bar codes to control most desktop software.



Further information is available. Complete systems from £158.63



Our bar coding software produces Draw files of the following formats: EAN 8, EAN 13, UPC A, ISBN, ISSN, Code 39 (Normal and Full ASCII), Telex and Binary.

Further information is available. iBarCoder - £89.33

Computer Systems

These prices do not include monitors, unless specified.
Risc PC 4+0Mb 1.7Gb HD - £911.00
"Web Wizard" - as J233, speakers, EasWriter Pro, 33.6K modem, ANT Suite - £1265.00
"Peak Performer" - A7000+, 8Mb, 32x CD, 14" monitor & software pack - £841.00
"Peak Performer Internet" - A7000+, 24Mb, 32x CD, 14" monitor, modem, ANT Suite - £947.00
"Sprinter" NC system - 10baseT, 16Mb, 14" monitor, keyboard & mouse - £444.00
MicroDigital Mico - From £588.00
RiscStation R7500+ - From £675.00

Monitors

(Either bought with computer or separately):
Iiyama 350 (15") - £159.00
Iiyama S702GT (17") - £289.00
Iiyama 400 (17") - £323.00
Iiyama Pro 400 (17") - £334.00
Iiyama Pro 410 (17") - £375.00
Iiyama 450 (19") - £499.00
Iiyama Pro 450 (19") - £539.00
Iiyama 502 (21") - £770.00
Iiyama Pro 502 (21") - £770.00
Iiyama Pro 510 (22") - £875.00
Iiyama Pro-Lite 36a 14.1" LCD - £587.00
Iiyama Pro-Lite 38a 15" LCD - £594.00
Iiyama Pro-Lite 38c 15" LCD - £1032.00
Iiyama Pro-Lite 39a 15" LCD - £1599.00
Iiyama Pro-Lite 46a 18" LCD - £2469.00
Touchscreens - £Call

PC cards

5x86-100 with PC Pro 3 - £285.00
PC Pro 2 - £98.95
PC Pro 3 - £70.50
PC Sound Pro 2 - £39.95
Win95FS - £39.95
Windows 98 CD - £100.00

Psion Series 5

8Mb, with PC connection kit - £369.95
Parallel link - £34.95
PsiRisc link - £Call

Memory Upgrades

Please call to check current prices. Other upgrades are available.

A3000 1-4 Mb - £64.60
A3010 1-4 Mb - £69.30
A3020/A4000 2-4 Mb - £62.80
A5000 2-4 Mb - £69.30
A300, 400, 5000 4-8 Mb - £128.00
Risc PC/A7000 SIMMs:
Call for EDO SIMM prices
16Mb - £27.75
32Mb (not original RPCs) - £54.40
32Mb (high clearance) - £73.50
64Mb - £104.00
128Mb - £204.75
1Mb VRAM - £49.00
1-2Mb VRAM swap - £55.00
2Mb VRAM - £92.00

Music & Sound Section

Please call for other musical items
MIDI interfaces:
DMI 50 dual MIDI card (2x2) - £119.95
DMI 50XG - £259.95
XG upgrade for DMI 50 - £151.95
16-bit sampler for DMI 50 - £87.95
MIDI Max II Internal 1x1x1 - £92.75
Parallel Port 1x1x1 - £89.20
Synth 8 or Basic Synth - £46.95
Synth Plus - £58.65
Music & Sound Prog. Guide - £16.95
Other hardware:
Fatar SL 760 - £450.00
Fatar SL 880 - £600.00
Fatar SL 1100 - £800.00
Fatar SL 2001 - £1050.00
Irlam sound sampler - £118.00
Digital-upgraded Irlam sampler - £177.00
MIDI upgrade for Irlam sampler - £Call
Sound Byte Recorder - £57.50
Yamaha YST-M8 speakers - £45.50
YST-M20 DSP speakers - £65.75

YST-MS28 speakers & subw. - £70.95
YST-M100 speakers - £117.00
YST-MSW5 subwoofer - £59.00
YST-MSW10 subwoofer - £71.20
Yamaha MU10 sound module - £169.00

Other software:
MediaPack - £23.95
MIDI Support - £18.50
Prosound - £116.95
Rhapsody 4 - £94.95
Junior Sibelius - £49.00
Sibelius 6 - £99.95
Sibelius 7 Student - £319.95
Sibelius 7 - £625.00
Sibelius for Windows is also available
Optical Manuscript - £259.00
Sound module serial driver - £37.95
Studiosound - £116.95

Other Hardware

Dual fast serial card - £104.50
Ethernet card (Combi NIC slot) - £104.50
Hard drives & kits - £Call
Risc PC second slice - £140.00
RPC second slice (no PSU) - £90.00
StrongARM upgrade - £275.00

Other Software

Ankh - £23.00
ANT Internet Suite 2 - £112.00
Brutal Horse Power - £26.00
DataPower 2 - £165.00
Doom+ CDs - £30.00
EasiWriter Pro - £129.00
Empire Soccer 94 - £22.00
Exodus - £21.00
Impression Style - £88.00
Impression Publisher - £135.00
Inferno - £9.50
IXRC - £14.99
Ovation Pro - £150.50
Personal Accounts 3 - £43.00
Photodesk Light - £125.00
Prophet 3 - £160.00
Schema 2 - £116.00
Steuth 3 - £110.50
Telexase - £54.50
TopModel 2 - £145.00

Books & Manuals

RISC OS 3 PRIM - £104.00
The Tekkie CD - £45.00

Catalogue

Our free catalogue contains over 2000 items. Please ask for a copy.

We will attempt to match or beat any advertised price - even special offers.

All prices INCLUDE VAT & UK carriage
Official orders and callers welcome. Finance available.



Keeping

Michael Cowgill
introduces NRPN
MIDI controllers

control

Greetings again for the fifth part of this series on MIDI controllers. This time I'm going to talk about Non Registered Parameter Numbers or NRPNs. Unfortunately if you have a sound module which merely conforms to the GM standard (or earlier) you will not be able to use these messages. Owners of Sound Canvas or other GS compatible modules, and those of you with XG compatible sound generation gear, such as the DB50 card supplied with the DMI card, will be able to reap the benefits of these controllers.

NRPNs are about controlling extensions to the GM system first added by Roland in its GS system, and further extended by Yamaha with XG. In XG the most commonly used NRPNs are duplicated by ordinary controller messages. Details about how Filters work can be found in my first article on controllers in Volume 15, Issue 8 of *Archimedes World*, and you can read my comments about Envelopes in last month's *Acorn User*.

GS sound module owners have to access these with NRPNs, and although most of the latest PC sequencer versions allow direct editing of NRPNs with a graphical interface, with Acorn sequencers you are probably going to have to resort to the event list. If this is not the case with one or more of the Acorn sequencers, please let me know.

NRPN messages

This is achieved by first of all sending an NRPN MSB (controller 99), followed by an NRPN LSB (controller 98), and then a Data Entry MSB (controller 6). The procedure is concluded by sending an NRPN Null

message (MSB and LSB both 127).

The example below is taken directly from Yamaha's PDF documentation for XG (see their Website at www.yamaha.co.uk for further information) and shows how to set Vibrato rate with an NRPN message. All values are in hexadecimal:

Example: Changing The Vibrato Rate

```
Bnh 63h 01h NRPN MSB
Bnh 62h 08h NRPN LSB (selects
Vibrato Rate parameter)
Bnh 06h dd Data Entry MSB
Bnh 26h 00h Data Entry LSB
(ignored) (sets the relative
Vibrato Rate value)
Bnh 63h 7Fh NRPN MSB
Bnh 62h 7Fh NRPN LSB (sets NRPN
to null)
Note: dd = Data Entry value (00h
- 7Fh, with 40h the centre
value, corresponding to a
decimal range of -64 to +63).
```

Drumming up support

Where NRPNs really come into their own is for drum parameter editing. This enables the fine tuning of every sound in the drum kit, particularly if you have an XG module, although the most important controls are present in GS.

A good drummer can play a surprising number of sounds, just given a snare drum, a cymbal and a hi-hat, and the level of control provided by the XG NRPN drum parameters enables the programmer to emulate this, thus adding further realism to percussion parts.

Some of the things you might like to experiment with are filter cut-off, which will enable the emulation of striking the kit with different kinds

of sticks; envelope attack which allows you to program realistic sounding cymbal rolls; and envelope decay and release which allow you to add realism into the length of time it takes for a cymbal crash to die away, and also to create some really funky special effects by using filter cut-off and resonance to change the tonal characteristics of the decaying cymbal crash.

The other really useful parameter in XG NRPNs is the drum variation send. This enables you to apply delay or echo to the snare or other percussion voice without affecting anything else, thus providing scope for some really exciting drum effects.

You may ask why the XG NRPNs duplicate some of the normal XG controllers. To understand this you have to bear in mind that XG is an extension of GS, and therefore as part of its specification is backwardly compatible with GS. This is so it will handle SMFs (Standard MIDI Files) containing GS NRPNs properly.

Well that's just about all that there's space for this month. Should you want to explore this subject further, have a look at some of the Websites included on the cover disc. Just drop the text files into the URL window of your Web browser.

Should you have difficulty in obtaining my previous ramblings on the subject, e-mail me, and I will send you the relevant article in *Impression* format. If you're not connected to the Internet, make sure you enclose a stamped, self-addressed envelope for me to send you a printout of the article, or you won't receive anything.

Next month I shall be looking at RPNs or Registered Parameter Numbers. Until then: happy music-making.

END

Very Re-touching

Part two of Simon Anthony's photo re-touching series

Last month I began an explanation of how to use RISC OS kit to rescue valued images from the past. I left off by saying that as *Paint* doesn't have an undo facility any error can be a disaster, but then hinted at a way in which undo in *Draw* can be used instead.

By its nature *Draw* can only create vector graphics, fortunately it can also display and manipulate images which already exist as sprites or JPEGs. *Paint* can therefore easily drop its images into *Draw* and all three formats can be mixed to our advantage.

In this example I have started from a scanned image of a photograph, and readers from last month will have their own tarted-up sprites all ready for the next steps, so the first

thing this month is to display that image.

At all stages from now it is essential that we use the highest possible screen mode, though there is little point in using a mode higher than that of the original image.

Small defective areas – like damage to a negative – can be removed by just the use of *Paint* and its internal snapshot facility, but if there is more than one blemish you need another technique, or one error on your part will lose all your work.

Small problems

Dealing first with the damaged area to the top right of Figure I, use *Paint* or *Draw* to show the part of the image you wish to sort out, it is only that part we need to bother about

at the moment.

Now, using *Paint*'s snapshot facility, grab the irritating flaw within the section. Figure I is a composite of the stages required to make the little snippet shown at the top right.

The original sprite is shown in a *Draw* window. You won't ever be able to see all these windows open at once, I show them open here only to illustrate all the stages. The figure itself was created in *Draw* using the methods described later in this article.

Figure I shows the snipped out bit in two places. One has a standard *Draw* bounding box around it to prove it is in *Draw*, the other has been saved back into *Paint*. (One way to do this is to drop *Paint*'s 'Save As' icon either on to the *Paint* icon bar icon or into an open *Draw* window).

Figure II is another composite faked screen shot. It shows a close-up of the snippet as the working area at the top and the tools and menus used in this stage under it. At the bottom right is the same blemish on its way out, the small view shows what it looks like as it goes. The trick here is to use the 'Select colour' option. Move the pointer over a pixel which is as close to the blemish as you can get, but which is a fitting colour to use for the patch – for a few times at least. Then press the Menu button

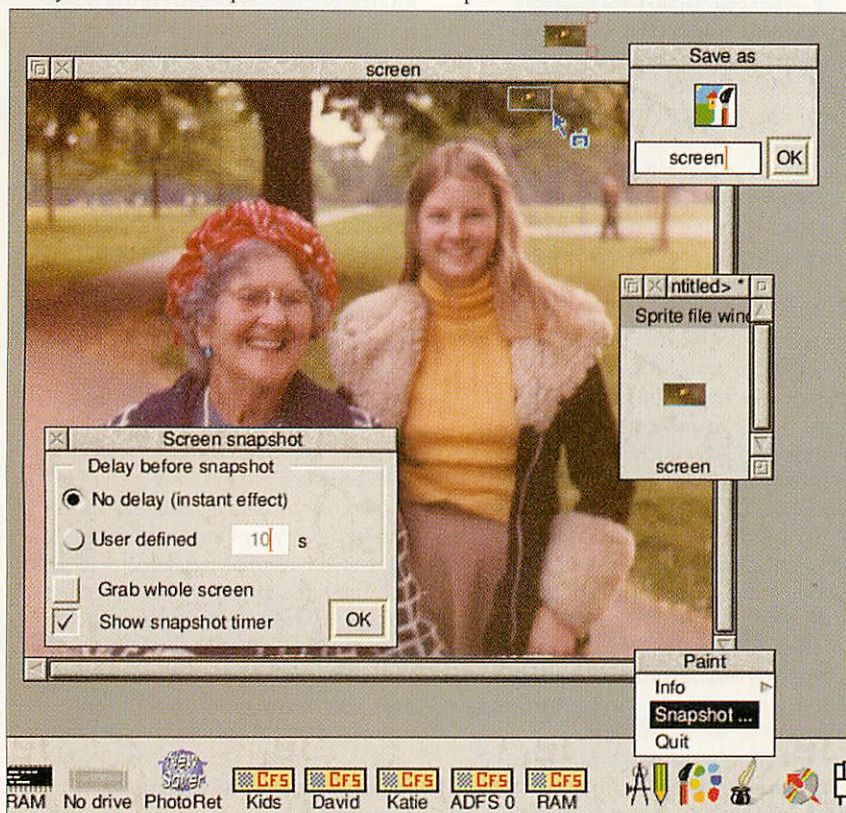

Fig I: Composite image

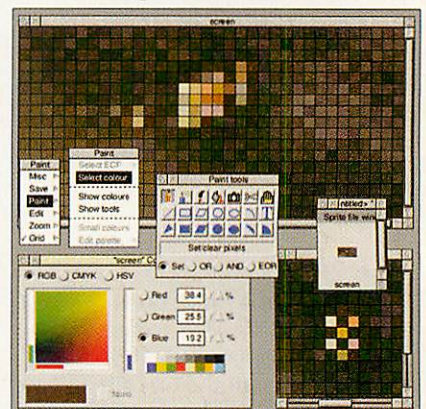

Fig II: Close-up composite of snippet

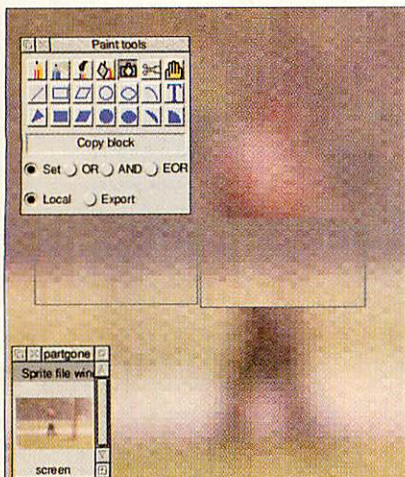

Fig III: Using the internal snap-shot tool

while the pointer is still.

Now if you go to the 'Select colour' option the colour you will see in the main colour picker window's selection box will be the same as the pixel you were over when you pressed Menu. Not an obvious method – but it works. Now ensure that the tool you have selected is the pencil one, as shown in Figure II, then peck away at the wrong-coloured pixels.

Change your source pixel colour from time to time so as not to make blotches and dab out the blemish bit by bit. Keep a look at the real scale version as you go to make sure it's working. Job one done.

Larger problems

That's all very well for negligible damage like that, but what about that man in the background? I don't want him in my picture. You could use the



Fig IV: Tunic-tug montage

above pick and dab method to get rid of him but it would take ages. Another method would be quicker and Figure III shows it.

Take a snapshot of the area you want to improve on as before and zoom in as far as you feel fit. Turn off the grid which will pop on after a few zooms as this confuses the eye. By using the internal snapshot camera tool, as shown in Figure III (rather than the external tool we used last time) a chunk of related pixels can be used as a rectangular dabbing brush and thus do more in one go.

The edges have a nasty habit of showing up with this method and so pixel dabbing may also be required round the joins which I didn't do. As the Figure VI shows doing the whole

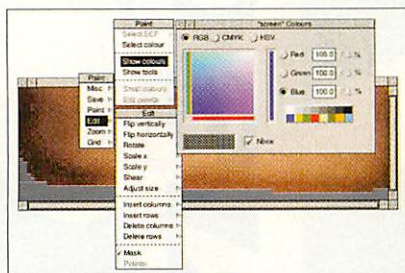

Fig V: Close-up colour selection

area this way does not work perfectly, but then I did it that way to show that problem – always use a mix of techniques.

General problems

When searching for areas of the screen to use as a patch don't restrict yourself to exactly what is there. Remember that *Draw* can stretch, squash, skew, rotate and otherwise

creatively muck-up sprites and bits of sprites very effectively. Take your small section of flawed image and drop it in to a *Draw* window to work on it.

Then take the section of source image which you hope to use as a patch and add that to the *Draw* window too. Now ensure that you don't alter the size of the first flawed sample but alter the second one – just by dragging the righthand control boxes ('ears' as my students used to call them) until it fits over the flaw and corrects



Fig VI: Final image

the image perfectly... Well, that won't often happen in just one pass but it could do. Assume this time that it did.

The final step is to drop the entire original image into the same *Draw* window, group the fixed parts you have just created, and slowly nudge the altered area to sit exactly over the same patch on the original image – and there you are. Figure IV is a montage of the stages I used in the Star Trek-style tunic-tug which I performed on my sister's jumper. The last step in Figure IV is one of using the dabbing method on the bits that don't quite match, with pixels from nearby bits that do.

If you keep a drawfile and sprite file copy of each section and each stage as you go along then mistakes can be recovered and alterations can be made much more easily (and you have a history of mistakes for reference).

Handy hints

Don't worry about oversampling the picture, as we are working with digital images this constant re-snapping will not degrade the picture. However, if you need to make a stretched patch smaller again you must go back to the original bit and try again rather than alter it, as re-scaling for a second time will make things worse very fast.

Obviously there is likely to be a lot more to it than just that. Remember you are not always going to get a perfect result but we will get something better for our efforts. If you go through the above steps multiple times correcting smaller and smaller faults at each stage you can do rather well. **END**

Contacting me

You can contact me, Simon Anthony by e-mail at: sranthony@innotts.co.uk or by writing to me at Acorn User, Tau Press Ltd, Media House, Adlington Park, Macclesfield, SK10 4NP

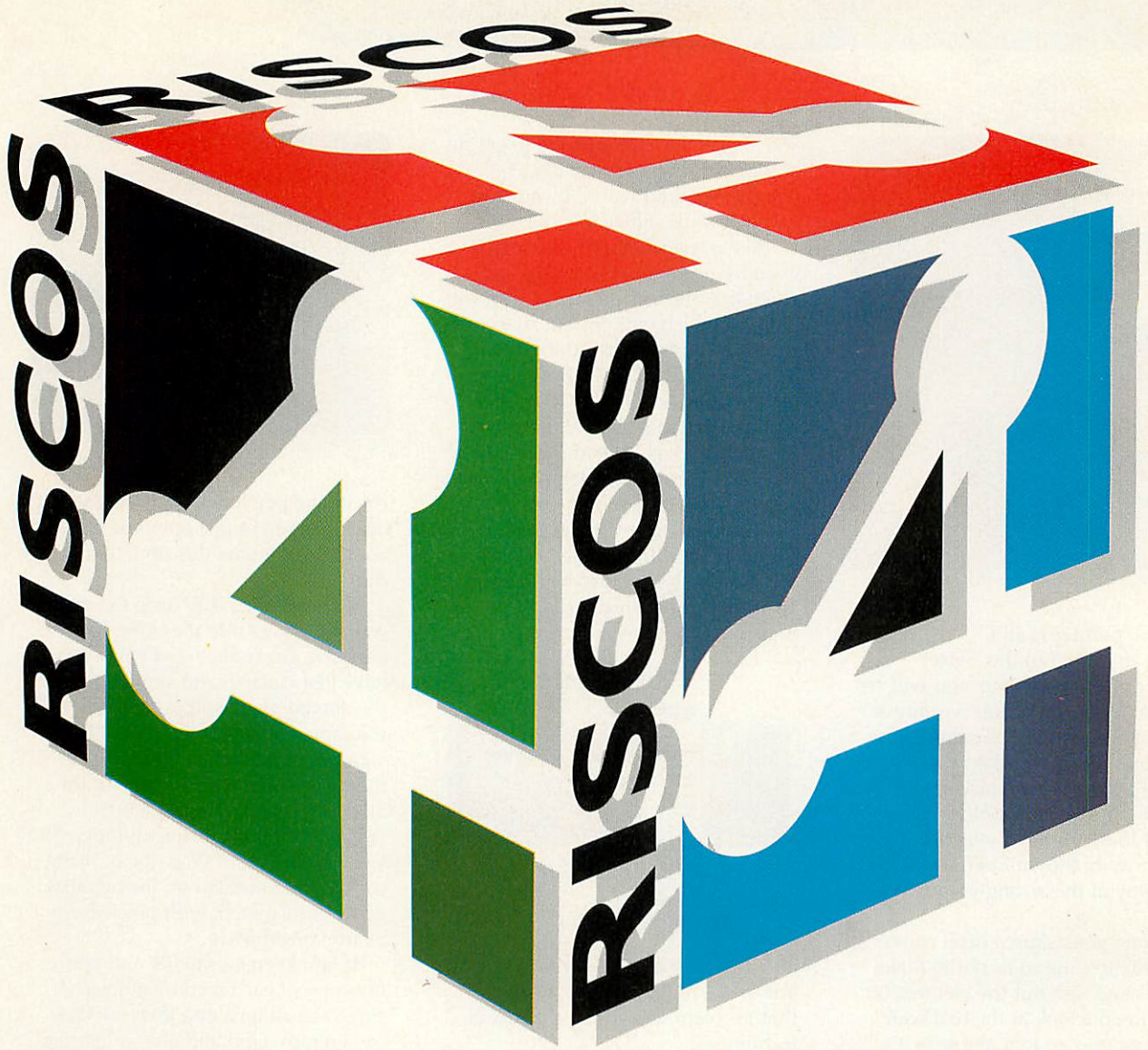

£120

incl VAT & delivery

See <http://www.riscos.com>
for ordering details

Objects of desire

Greg Scott looks at object-orientated concepts in C++

A class is the entity which we use to define an object. It contains both data and functions (or *methods*) which operate on that data. We have seen how encapsulation can be used to limit access to properties of each class and how this can facilitate easier maintenance of a system.

Let's focus on a working example implementing an integer Last-In First-Out stack, illustrated in Figure 1. A LIFO stack is used to store and pass data, analogous to a pile of plates. Put one on top of the pile and it will be the first taken off.

Like many of the examples to appear in these articles, the source code can be found on the cover disc.

Firstly, the stack class definition is shown below:

```
class stack
{
private: // this line could be
omitted, it is default
int end_position, size, current_size;
int *stack_pointer;
moveon(int *);

public:
stack(int); // constructor
~stack() { delete stack_pointer;
} // destructor
remove_item();
insert_item(int);
show();
}; // we could declare instances
of this class here
```

Five properties of the stack class have been declared as private: the integer *end_position* holds the index position of the top of the stack, *size*

holds the maximum size of the stack, and *current_size* the number of items occupying the stack. The variable *stack_pointer* points to the beginning of the stack memory itself. The only private function to be declared is *moveon()*, which will take an integer pointer as a parameter. Notice that when declaring functions at this stage, parameter names need not be specified, only their types. The *void* keyword can be omitted for functions of this type which do not return values.

Constructors/destructors

The first two public functions to be defined (which must have the same name as the class) are the constructor and destructor functions. C++ contains the powerful facility for constructing instances of an object by allowing the constructor function to be called (if defined) as the class is created. Destructor functions (preceded by a ~ symbol) are called when a class is deleted, or when the end of the program is reached.

Other than the time of execution, constructors and destructors behave just like any other function. Constructors can even be passed

arguments (mentioned in a moment). The destructor function has been defined inline, within the class definition.

This is common for small functions (typically one or two lines – large functions tend to make the class definition unreadable). The *delete* operator (found in the *~stack()* function) is new to C++:

```
delete stack_pointer;
```

Recalling that the destructor is called automatically when the program has come to an end, the *delete* command deletes the contents of and releases the memory pointed to by *stack_pointer* (occupied by the stack). The C programming equivalent would be:

```
free(stack_pointer);
```

Three other public functions are declared, to add, remove and display items in the stack. Any functions not defined inline are done so outside of the class template. We use the '::' symbol, called the 'scope resolution operator', with the following syntax:

```
function_type
class_type::function(parameters)
{ ... }
```

The code for the stack constructor function is defined as follows:

```
stack::stack(int s)
{
end_position=current_size=0;
size=s;
stack_pointer=new int[size];
}
```

This function takes the integer

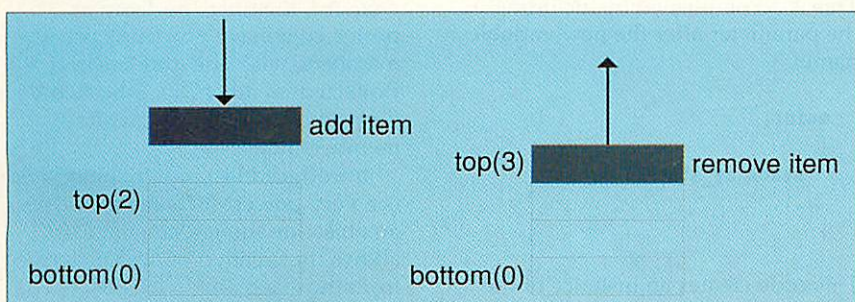

Figure 1: What a LIFO stack looks like

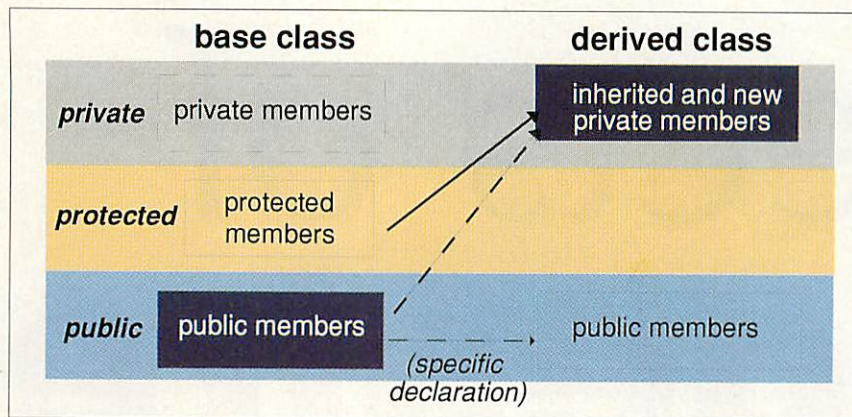

Figure II: Default (private) inheritance in C++

argument *s*, which sets the maximum size of the stack array. To dynamically reserve memory for this array we use the new operator. The basic syntax is as follows:

```
pointer=new type[number of
objects of type];
```

In C we could have used the `stdlib.h` function `malloc()`:

```
pointer=malloc(sizeof(int) * size);
```

The code for placing an item on the top of the stack first checks that there is memory space available.

If there is room on the stack, the data is stored at the current stack position, and the index incremented. The variable `current_size` is also incremented to represent the new increase in stack size.

```
stack::insert_item(int item)
{
    if(current_size==size)printf("Ca
nnot add new value\n");
    else
    {
        *(stack_pointer+end_position)=item;
        end_position++;
        current_size++;
    }
}
```

To remove an item from the top of the stack we decrement the stack index and the `current_size` variable. The actual value from the stack is not deleted, though this could easily be done.

It would also be worthwhile to return the value of the integer removed (this has been left as a simple exercise for the reader – the solution is also on the coverdisc).

```
stack::remove_item()
```

```
{
    if(current_size==0)printf("No
value to remove\n");
    else
    {
        end_position--;
        current_size--;
    }
}
```

The last member function displays the entire stack by listing each value in the array. We have used the `C printf()` function for simplicity's sake:

```
stack::show()
{
    for(int
start=0;start<current_size;start++)
    {
        printf("%d\n",*(stack_pointer+st
art));
    }
}
```

The `show()` function accesses members of the class which have been declared as private. This is perfectly legal because the function also belongs to the class.

Constructors and variables

To successfully create an object of type `stack` we have to pass an argument to the constructor function. This is accomplished by including the parameter after the new variable name:

```
main()
{
    stack my_stack(10);
    ...
}
```

This code creates an instance of the class type `stack`, called `my_stack`. The constructor of `my_stack` is called, and

a ten-element integer stack initialised in memory. The stack itself cannot be altered by any external code except through the functions provided because of the encapsulation involved.

To summarise how constructors are used, we pass the constructor function its parameters after the expression which declares the class. In the above example, we are passing the constructor function the value 10, which meets its function definition.

stack(int)

Sometimes there might be a common size of stack required by the programmer, so it would make sense to have a default value to pass to the constructor instead of having to re-specify it each time. In C++ we can assign default values to arguments for when parameters are omitted:

```
stack::stack(int s=10)
{
    ...
}
```

Using this definition of the constructor function the following code would generate an object with a ten element stack:

```
stack usual;
```

Only the last (right-most) arguments in a function definition may be given default values.

Protected and inheritance

To control the level of encapsulation within a class, we have used the private: (default) and public: operators. Private properties of a class are only accessible by members of that class. Public members are accessible from both inside and outside the class.

There is a third access keyword: `protected`. Members declared as protected behave exactly as private members, with one difference. Protected members are inherited by a derived class, whereas private members not.

Introduced last month, inheritance is a very powerful characteristic of an object-orientated language. It allows the creation of objects derived from those already in existence. The new object inherits properties of the base class as well as having its own,

individual members. The syntax to create a derived class from a base class is as follows:

```
class derived_name:access_specifier
base_name
{ ... }
```

The access specifier can be public, protected or private (default). This defines not which members of the base class are inherited, but rather what access status they are given.

In a private situation (see Figure II), the public and protected properties of a base class are both inherited by the new class as private members. If we were to use the public access specifier, all public members of the base class would be inherited as public, and all protected members as protected (see Figure III).

Consider the following class:

```
class rectangle
{
    int is_square;
protected:
    int side_a,side_b;
public:
    int perimeter;
    float angle,hypotenuse;
    rectangle(int a=10,int b=10)
    {side_a=a; side_b=b;}
    calculate_edge() {
        perimeter=(2 * side_a +
        2 * side_b);
    }
    printf("perimeter is
    %d\n",perimeter);
};
```

We shall now create a derived triangle class which inherits the properties of the rectangle class. We use the default private access specifier, making all inherited

properties private to the new class.

```
class triangle:rectangle
{
    // side c is a
    new variable, but
    int side_c; // side_a, side_b,
    perimeter, angle and
    // hypotenuse are
    inherited here, as
    // are rectangle
    and calculate_edge funcs
public:
    rectangle::perimeter;
    // specifically declaring
    inherited variable as public

    triangle(int a,int b,int c){
    side_a=a; side_b=b;side_c=c;}
    calculate_edge(){
        perimeter=(side_a+side_b+side_c);

    printf("perimeter is
    %d\n",perimeter);
    }
};
```

There are several points to make about this definition: Private members of a class are not accessible by a derived class, so the variable *is_square* is not available to triangle unless there was a public or protected function that could access it.

A specific notation is used to set the inherited property perimeter as public. Without this mechanism, the variable would automatically be inherited as a private member (because of the inheritance access specifier), and unemployable by external code. To control a certain member we use the syntax:

```
base_class::member;
```

This access declaration is put under the appropriate access heading in the

derived class' declaration. The only point to remember is that one cannot raise or lower a member's access status. This would destroy the entire encapsulation system.

The triangle class also inherits the rectangle constructor and *calculate_edge()* functions. The compiler allows us to define new constructor and *calculate_edge()* functions for the derived class. This isn't to say that either of the old functions are replaced – in fact the base constructor function is still called when an instance of the new class is created.

The new *calculate_edge()* function has to use a different equation to compute the perimeter of the triangle. If we need to access the old *calculate_edge()* function, the '::' (scope resolution) operator must be used again:

```
calculate_edge()
{
    perimeter=(side_a+side_b+side_c)
    ; // new equation
    printf("perimeter is
    %d\n",perimeter); // output result

    rectangle::calculate_edge();
    // this displays the perimeter
    according to
    // the old calculate_edge()
    function.
}
```

Although largely redundant in this example, the ability to distinguish between old and new versions of a class member is very beneficial. On account of the encapsulation involved, the new version of *calculate_edge()* is always the one called from outside the function, so no ambiguities arise.

A final point here, before the OOP programmers write in to complain, deriving a triangle from a rectangle is a poor example. A better way would be to define a class *shape* and then derive each *triangle* and *rectangle* from that – this is where the planning aspects of programming are crucially important: isolating which objects are needed and what classes should be defined and derived for the best efficiency.

Inheritance is an essential property of any object-orientated language. In C++, there are strict rules and notations which the programmer must follow to avoid pitfalls.

We shall touch on inheritance again next month, so don't worry if it hasn't sunk in.

END

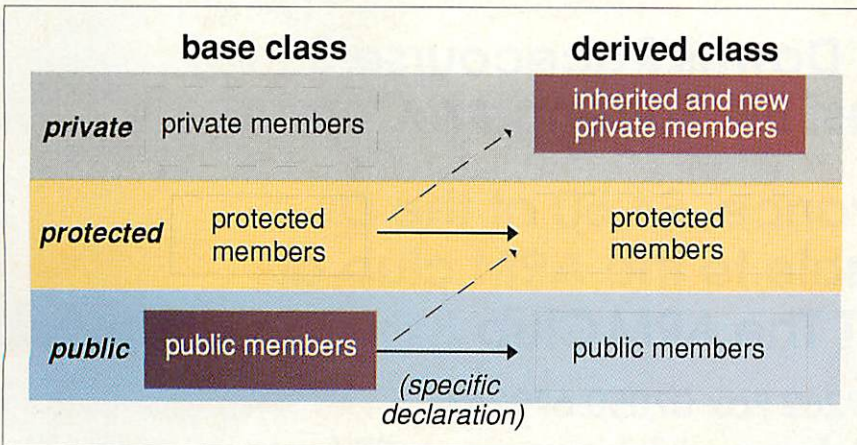
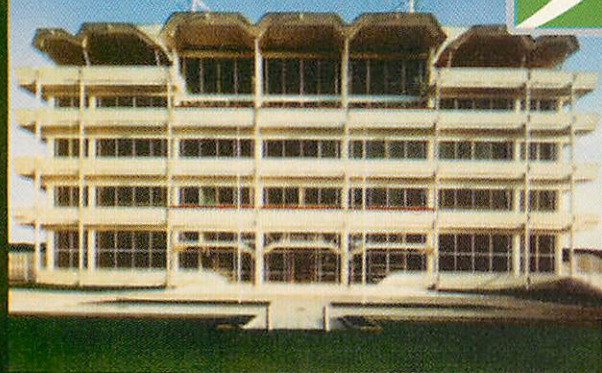

Figure III: Public inheritance in C++

RISC OS 99 *SHOW*



Sponsored by

ACORNUSER

spacetech
imaging technology

Organised by **The ARM Club**

Supported
by



Sat 30th October 10.00 to 17.00
Sun 31st October 10.00 to 16.00

Queen's Stand, Epsom Downs Racecourse Surrey
(Close to M25, Nearest BR: Tattenham Corner)

Entrance £3.50 Advance, £4.50 at the Door
Send cheque payable to the ARM club at
FREEPOST The ARM Club

Tel 07050 679262 Fax 07050 679263

<http://www.armclub.org.uk/shows/riscos99/>

Show Highlights

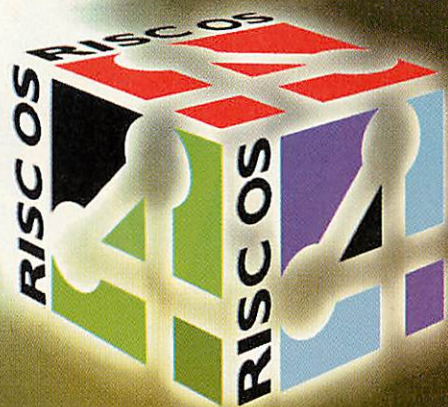

Cerilica
vantage

New Hardware?

Organised by

**ARM
Club**

Supported
by



Sponsored by

ACORNUSER

spacetech
imaging technology

The
RISC OS



SHOW

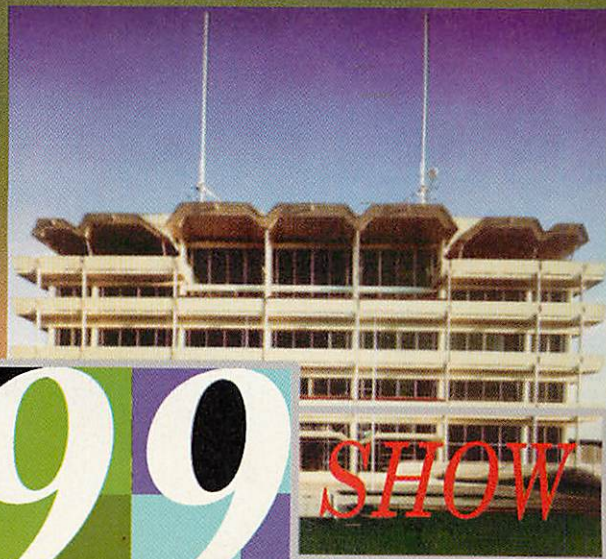

Who's a winner?

*Alasdair Bailey
presents the results
of the Doom
competition*

Welcome to yet another fine edition of Game Show. It may not look like we're very busy this month but I have lots of information to pass on to you, including the results of the *Doom* level design competition from the May issue. I'll also be taking a look at two new compilation CDs from APDL and bringing news of what was on offer for gamers at the Wakefield show.

Unfortunately, many of the products we were expecting to be released at Wakefield did not make it out in time. Sadly, neither the *Heroes of Might and Magic II* expansion pack nor *BotKiller 2* were on sale at the show. The latter should be available by mail order well before you read this and the former may be a couple of months in the coming because of a delay in getting the CD-ROMs shipped from the US.

Final Doom, which I reviewed last issue, did make it, as did the R-Comp's *Doom+*



Prepare to take on the enemy base in Cyrius

and *Heretic and Hexen* upgrades. The *Doom+* upgrade adds bi-linear filtering to the game as seen in the original release of *Heretic and Hexen*. However, this feature is only really of benefit to StrongARM users. The *Heretic and Hexen* upgrade on the other hand picks up on a bug which meant the game would always crash at a certain point on a particular level.

Both upgrades are available free of charge from R-Comp Interactive, who may be contacted by phone on 01925 755043 or via e-mail at rcomp@rcomp.co.uk.

Just as new releases were getting a little thin on the ground, R-Comp have announced that they are working on yet another PC to Acorn conversion. This time it comes in the form of the PC flight sim, *F16 - Fighting Falcon*. As the name suggests, this is a simulation of the highly-versatile American F16 fighter jet.

This could be our first big flight sim since the days of *Chocks Away* so I'll bring you a full preview as soon as I can. In the meantime, feast your eyes upon the screenshot of the PC version which accompanys this text.

There's also news of another flight sim in the making. Just like busses these things, we wait ten years then two come along at the same time. This one aims to simulate the Eurofighter, the European fighter project which has



Xenocide, just six months old and already on a compilation CD

encountered so much bureaucracy that it's now over five years out of date and only just starting production.

Dave Watts, author of the game, tells me that *Eurofighter Typhoon* is to be more of a simulation than a flying game of the likes of *Chocks Away* and *Star Fighter 3000*. The game is priced at £24.95 and a review will follow next issue.

Skullsoft and Softrock

The latest pair of budget CDs from APDL have just reached my desk. Both are compilations of the work of particular coding groups. They are now available from APDL at the rather modest price of £7.90. See their advertisement elsewhere in this issue for contact details.

The Skullsoft CD contains all three games previously released by the group on one CD. They are (in no particular order): *Arya*, *Plig* and *Xenocide*. *Arya* is a text adventure game with some graphics included to brighten things up a little. I don't have space to give a full review here but the guys at Acorn Arcade were pleased with the product, they summed up their review with 'Overall, *Arya* is definitely more than "just another text adventure game"'.

Plig was the group's first production, it is a nice puzzle-solving game with simple but well-drawn graphics. Look out for the sequel in coming months.

Xenocide was reviewed in the March issue and is well worth getting hold of. The game is a simple vertically scrolling shoot 'em up but does feature nice graphics and addictive gameplay.

At a price of £7.90, this CD is definitely worth getting hold of. The two shareware titles, *Arya* and *Xenocide* would cost £8 a piece to register normally, so it's a bargain whichever way you look at it. If you're still not convinced, demos of all three titles may be obtained from <http://www.eganc.demon.co.uk/>.

The Soft Rock game compilation CD is a bit of a mixed bag really. It contains



Whoosh - I can fly!

eight games in all, many of which are puzzle games of a very similar nature. However, they are still a joy to play and although some look a little dated now, *DropRock2* and *Exeria2* are both very nicely presented using high resolution screenmodes and well-drawn graphics.

A copy of *Trellis*, the adventure game interpreter, is also included along with two games. If you're into puzzle games or text-adventures in a big way, this CD is definitely for you. Otherwise, your £7.90 might be better spent on the Skullsoft offering.

Doom Results

The May issue contained a *Doom* level design tutorial and a competition to see who could come up the best *Doom* level. It is now time to announce the winners of this competition to end all competitions.

Many thanks to Richard Goodwin, James Stevens, Tim Fountain, Dave Sloan and Justin (*Doom+*) Fletcher for judging the levels.

The final rankings are shown below along with a very brief description of each level. All being well, the levels should appear on this month's cover disc, if not they'll be on the September issue or a future cover CD.

- 1st Place: *Hell Meets Earth* by Jeffrey Lee
A huge level which is at the same time very well constructed and a joy to play. The author tells me this level is based upon a dream - we worry about your mind, Mr Lee.
- 2nd Place: *Exodus* by Alex Macfarlane Smith
You start off with a huge monster behind you, what more can we say but

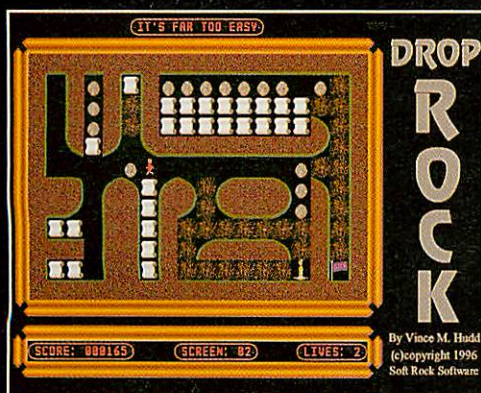

Drop Rock 2 from the Soft Rock CD

run like hell! An excellent WAD, well designed but perhaps a little difficult for first timers.

- **3rd Place: *Cyrius*** by Nick Wright
The design and overall feel to this level challenges some of *Doom's* own offerings. The level is slightly let down though by the positioning of the monsters. A double barrellled shotgun would have been nice from the start on harder difficulty settings.
- **4th Place: *The Physics Department*** by Andrew Buckingham
The author was planning on re-creating his whole college as a *Doom* level but

this is as far as he got before the 'A' levels got the better of him. Primarily a deathmatch level for more than one human player, but still jolly good fun in single player mode.

- **5th Place: *Remorse*** by Ben Holmes
A simple level, some judges weren't too keen on this one but it does deserve a copy of *Destiny*.
- **6th Place: *The Pain Element*** by Jeffrey Lee
A very playable level by the same author as *Hell Meets Earth* earlier on. The start is a little tricky but after that, it's great fun.
- **7th Place: *Truly Nightmarish*** by Alex Macfarlane Smith
A nicely designed level, just a bit too linear at times. This level has previously been available on the Internet and it's also the author's second entry so doesn't get any prizes I'm afraid.
- **8th Place: *Redemption Denied*** by Alex Macfarlane Smith
Not wanting to rest on their laurels, the Macfarlane clan have come up with yet another entry. This one is quite hard to start with but then a little more interesting once the numbers are thinned out and it becomes a fight for life.
- **9th Place: *Exit to Heaven*** by Maarten Bezemer
Though original and nicely designed, this level is a little short and some corridors are a bit thin leading to some sticky situations.

Stats for Hell Meets Earth

MAP 01 Difficulty:	S1	S2	S3	S45	M1	M2	M3	M45
Play modes:								
Single player								
Cooperative (4 player)								
Deathmatch (37 starts)								
Bosses:								
Baron	1	1	2	4	1	1	2	4
Final Boss	1	1	1	1	1	1	1	1
Monsters:								
Trooper	8	8	12	19	8	8	12	19
Sergeant	10	10	15	23	10	10	15	23
Chaingun guy	5	5	7	7	5	5	7	7
Imp	15	15	21	29	15	15	21	29
Demon	6	6	11	4	6	6	11	14
Lost soul	9	9	9	9	9	9	9	9
Cacodemon	0	0	2	3	0	0	2	3
Mancubis	1	1	1	2	1	1	1	2
Arachnotron	0	0	0	2	0	0	0	2
Weapons:								
Shotgun	1	1	1	1	1	1	1	1
Super shotgun	2	2	2	2	2	2	2	2
Chaingun	1	1	1	1	1	1	1	1
Rocket launcher	1	1	1	1	1	1	1	1
Plasma gun	1	1	1	1	1	1	1	1
BFG-9000	1	1	1	1	1	1	1	1
Chainsaw	1	1	1	1	1	1	1	1
Equipment:								
Backpack	1	1	1	1	1	1	1	1
Invulnerability	5	5	4	3	5	5	4	3
Berserk	1	1	1	1	1	1	1	1
Invisibility	1	1	1	1	1	1	1	1
Radiation suit	2	2	2	2	2	2	2	2
Expendibles:								
Bullets	440	220	240	275	440	220	240	275
Shells	288	144	164	196	288	144	164	196
Rockets	46	23	23	23	46	23	23	23
Cells	480	240	240	240	480	240	240	240
Armor points	1400	700	700	700	1400	700	700	700
Health points	1590	795	795	795	1590	795	795	795
Difficulty:								
Total monster hp	516	516	844	1355	516	516	844	1355
Max ammo damage	4336	2168	2328	2587	4336	2168	2328	2587
RATIO	0.119	0.238	0.363	0.524	0.119	0.238	0.363	0.524
Other info:								
Average brightness	189 (0=dark, 255=bright)							
Secrets	0							
Nukeage/sectors	12/254							
Triggers/linedefs	109/1331							
Reject resource	YE							

Compiled by Justin Fletcher

Statistics

Justin Fletcher, one of the judges, was good enough to run the *Doom* levels through some nifty little program of his and it compiled some nice statistics (Justin's like that you see).

The stats of all the entries can be found on the cover disc, but I've put the stats for the winning entry, here (see left).

And finally...

Well done to all those who entered, especially those who go home with copies of *Destiny* or the R-Comp voucher. You may have noticed that we allowed multiple entries by the same author, not to worry though, nobody was good enough to deserve two copies of *Destiny*!

Have a good summer and remember to go and watch the new *Star Wars* movie. I must apologise about talking about *Doom* so much these past few months, I promise not to mention the game again for the rest of my days. As usual, if you have any comments or complaints, e-mail me at games@acornuser.com

END

Rcomp

Pushing forward the frontiers in RISC OS internet & web authoring software

New Release



Messenger

An E-mail and News Client for RISC OS Professional Edition

£30

The only RISC OS Internet software with the GOOD NET-KEEPING seal of approval

SiteSeer

£25
Web grabbing software for offline viewing

HTMLEdit Studio

Next generation WWW authoring for RISC OS

£105
All the tools you need

Our RISC OS web authoring solutions set new standards in power and ease of use

The Studio edition provides

- | | | |
|----------------------|--|------------|
| HTMLEdit 4+ | Java support, sound and music, link and image checking, syntax colouring and OLE | £53 |
| Enhanced Web Toolkit | Visual frames, tables, animations, maps, palette control, Draw file conversion | £30 |
| WebSpell | Full HTML-aware spelling checker | £15 |
| Webster XL | Browser with frames, tables, forms, sound and JavaScript | £25 |

SiteMaster

The Web Site Management System for RISC OS Computers **£30**
Now with automatic up-loader for getting changes online fast

Rcomp

Interactive

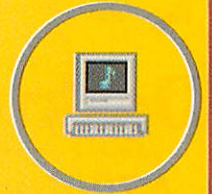

anthem* £70

inc. VAT

The RISC OS MIDI Sequencer

Anthem is a feature packed, easy to use MIDI sequencing package for RISC OS computers. It employs a powerful and acclaimed new object-oriented (phrases of music) song structure that allows the musician flexibility in arrangement, and ease of editing unparalleled by any other RISC OS sequencer.

We believe our prices are simply unbeatable

Existing Sound & Music Products include PC SoundPro 2 £35, MIDI Synthesizers, Sound Cards, MIDI Cards, Parallel/Serial Port MIDI, MIDI Support....

DOOM FINAL

New!

Extra Levels Pack £15 inc.
Requires Doom or Doom+

Other Games Titles

Heretic & Hexen (Towers of Darkness Pack)	£32.50
Heroes of Might & Magic 2	£35.00
Descent	£30.00
Doom+	£32.50
Syndicate+	£29.00
Abuse	£25.00

Distributors for ARTEX: Ankh, Exodus
PRO ACTION: Various titles

ALL PRICES INCLUDE VAT

Desktop system prices include delivery!

Mouse mat & !Printers setup included

(UK mainland)

A7000+ Computer Systems

RiscPC Computer Systems

A7000+ 8Mb HD 4Gb
32 Speed '**CUMANA**' CD, 14" Monitor &
200Watt speakers or headphones
£793.13 inc vat

SA RPC 233MHz 10Mb HD 2Gb, 32x
'CUMANA' CD, 14" Monitor &
200Watt speakers / headphones
£1150.33 inc vat

'Peak Performer' A7000+ as above
(80watt speakers) plus either
'Foundation' or 'Extreme'
software pack
£821.33 inc vat

SA RPC 233MHz, 42Mb RAM, HD 2Gb
5x86/100MHz PC Card & PCPro 2,
'CUMANA' DVD ROM drive
(24 speed CD read & dual speed DVD read)
14" monitor, Windows '98 installed,
HP610c printer & either 200Watt
speakers or headphones
£1820.08 inc vat

[These bundles are aimed at the private user or small primary as the
titles are single user.]



Place your orders now for RISCOS 4 with us.

£99.00 + vat
(£116.33 inc vat)

Fitting and installation service available, call for details.

RISCOS 4 option available
with new machines for an extra
£59.00 + VAT (£69.33 inc vat)

THIN CLIENT TECHNOLOGY

Thin Client Technology - and Independent Computing Architecture (ICA)

This is a new system to provide cross-platform software compatibility with low client station capital and running costs, whilst providing higher levels of reliability. To explain, you need a network infrastructure, an NT server and any number of Thin Client computers, or Network Computers (NCs). All the Thin Clients are controlled from a central NT server (or servers), which hold user configurations that are centrally administered and thus client systems cannot be re-configured locally; this minimises client station problems. As NCs have no floppy disc drive it is impossible to introduce viruses or indeed pirate software from these client stations. Other standard desktop computers can also be added to the system if required and these can comprise a mix of Acorns, AppleMacs and PCs. ICA is a cost effective way of extending the useful life of your existing older Acorn (or PC) computers, many of which will probably be mechanically sound for a good few years yet. Any schools or individuals who are interested in receiving our "ICT Planning Document" please contact us on the below numbers and we will post a copy to you.



The Acorn NC (Network Computer)

'Sprinter' - NC (Network Computer), client station
with 16Mb RAM, QWERTY Keyboard, Mouse & 14" monitor
(suitable for Acorn RiscOS, Windows, Internet & Web browsing applications)

£379.00 + VAT (£445.33 inc.)

[Please note : NCs require connection and configuration to host server, locally or remotely]

CD-R/W and CD-ROM Drives

CD-R SCSI, (Panasonic 7503 8x24) Internal drive	£314.31
CD-R SCSI, (Panasonic 7503 8x24) External drive	£417.13
CD-RW SCSI, (Yamaha 4416) Internal drive	£299.99
CD-RW SCSI, (Yamaha 4416) External drive	£370.00
CD-R - Blank Writable CD's (Dysan 1 off).....	£1.41
CD-RW - Blank Re-Writable disc (Dysan).....	£20.00
ICDBlaze CD-R/W Software for Acorn.....	£82.24
Oscar Encore - Parallel port External CD-ROM drive.....	£198.58
Panasonic 32 speed internal atapi CD.....	£81.08

All
CDR/W
Drive
prices
include
a copy
of
!CDBlaze

Monitors & Printers - Call for other makes & models

14" Viewsonic	£116.33
15" Viewsonic Stereo.....	£189.00
17" Viewsonic	£247.53
Hewlett Packard Deskjet 610c.....	£92.83
Hewlett Packard 2000c.....	£438.28
Canon BJC2000	£133.95
Epson Stylus Colour 440	£129.25
Epson Stylus Colour 740	£196.23
HP LaserJet 1100, 8 ppm, 600 dpi.....	£284.35

CDs for Kosovo

Paul F. Johnson
and his latest
charity push

The Great Acorn Auction in aid of Comic Relief had finished, the Acorn world stood with baited breath for the final total and gasped, cheered and generally went 'hurrah' when the final amount of £4716.46 was announced.

Meanwhile, in a small republic of Serbia...

All hell was being let loose by the Serbian army on the people of Kosovo. I'm not going to get involved with the arguments on air strikes or the war in general, but one thing was certain, people were being displaced.

Okay, this happens all the time around the world, so what?

The final total for the Comic Relief auction was released a couple of days early to a bunch of people who had (in some way) been instrumental in either setting up the auction, running the auction or helping out. One of these, Dave Clare, suggested that my next project would be something for the Kosovo Albanians. 'Urgh!' was my initial reaction, but thanks to the BBC News, my mind was changed.

Dave has a young daughter and most of my nieces and nephews are below 10 with my own son being around 8 months old. The news highlighted the Kosovo orphans: kids, the same age, dressed in the same clothes with the same labels and the same childish smiles and tears. I was brought to tears. A quick phone call to Dave and we were set: A compilation CD and, with Wakefield just around the corner, charity tombolas.

At the start of this year, the good ship *Archimedes World* sank beneath the waves. Around September 1994

The CD will be available at the following shows:

Acorn South East Show, 3rd July 1999 (CTA, Archive, APDL and AU stands)

RISC OS Show, 30th/31st October 1999 (CTA, Archive, APDL and AU stands)

they bought out their first (and only) CD, though at last year's Wakefield show, they did promise one for the end of 1998. Tau Press had bought up the rights to AW's past issues and cover discs. A quick e-mail to Steve Turnbull and permission was granted for me to make the second CD. Discs were obtained and the image put together. It was only 160Mb, so I lumped on the first CD as well which took it to 300Mb.

Something I always found nice on cover CDs were the exclusive demos and the exclusive versions of programs: Clares were very helpful here and produced a demo of their newest version of the *Rhapsody* family. Icon Technology rushed me brand new demos of both *TechWriter* and *EasiWriter*, Warm Silence Software passed over *Win95FS* and *LanMan98* demos and Abacus Training produced a demo version of the ever-popular *PipeDream4* application.

The commercial apps were harder to get hold of – who wants to part with software which brings in the money – I approached Computer Concepts as on the first CD they allowed *Impression Junior* to be used and thought they may like to do the same with *Impression 2*. This would cause problems for them, though they did say I could include *MacFSlite*, *CFS* and *AudioWorks*. Clares gave over *Rhapsody2* and SoftRock Software allowed an elderly version of *Trellis* to be included.

That was nice, but a game would be fun. So Krisalis Software (remember them) gave us their *Mad Professor Moriarty*. This won't work on an A7000+, Risc PC or the new RiscStation R7500 – but then it will work on anything less, so copy it off and play away.

Where possible the PD programs have been updated to their latest incarnation and there's a text file describing StrongARM compatibility. In the end, the final image was about 580Mb. The isoimage was made and burned onto a CDRW using *CDBurn*

from WSS for testing. Duplication became a nightmare and there were so many delays that we missed Wakefield and then the Big Ben club show in Holland. But we have them now.

How do you get one?

Simple. If you're overseas or would like to pay by credit card, then contact either:

Paul Beverley, Archive Magazine
(paul@archivemag.co.uk)

Dave Holden, APDL (info@apdl.co.uk)

Dave Clare, Clares Micro Supplies
(DClare@claresmicro.com – 01606 833999)

Roy Heslop, CTA Direct (roy@cta.u-net.com – 01942 797777)

Cheques should be payable to me Paul Johnson and sent to: 77 Station Road, Haydock, St. Helens WA11 0JL (paul@physchem.freereserve.co.uk – 01744 600733).

How much will this gem cost? An amazingly small £6.75 (minimum you can give more) – which includes p&p. About £5.20 from each CD goes to the orphan appeal. The appeal itself is being handled through the TEAR foundation.

Never mind the rights and wrongs of the Kosovo situation, there are children who need our help. Even if you don't normally buy this sort of thing, dig into your pockets and buy this CD.

END

Thanks to

I would like to thank all the companies involved with this CD, but most notably....

Paul Beverley (Archive), Dave Clare (Clares Micro Supplies), Roy Heslop (CTA Direct), Dave Holden (APDL), Warm Silence Software, Kate Moir (Computer Concepts), Steve Turnbull (Tau Press), Janice Gallagher (Acorn / E14), Adrian Roberts (MRK – CD Duplication), Richard Atterer (raFS) and Bev & Richard Johnson.

Small networks

Mike Buckingham starts a short series on creating a home network

If you run a big company with a computer on every desk, you'd certainly be thought of as somewhat out of date and inefficient if these machines languish as solitary beasts without the support of a network. Likewise a great many schools benefit from networks.

Whether it be for educational or business users, the ability to share resources between machines, particularly such things as Net access and printers, plus the option to keep important documents in one place on one backed up system – a network offers considerable advantages.

But where does that leave the small business or home enthusiast? To network or not to network? That is certainly a big question. Perhaps the biggest part of that question being whether the expense is worth it. And for some, another question is highly pertinent – can you actually do it yourself?

The final element in the jigsaw is the vexed question of mixing hardware – it has to be said that networking a variety of platforms together adds to the difficulties and limits the options. It also limits, to some extent, the rewards, but that's what I will look at here as it's what I've just done. It took me a while to sort out what is possible, what isn't, and how to do it. So this is my idiot's guide. It's the article I wish I'd had in front of me prior to starting out as, I freely admit, a network ignoramus.

So why network?

I remember many years ago visiting John Coll at Acorn. All around were BBC micros –

every one connected to the office EcoNet. Its value was amply demonstrated when he wanted to find a colleague who wasn't at his desk to answer his phone. John went to a machine, found where the colleague was logged on, sent a message and said colleague appeared. Magic.

That was my first exposure to networks. Since then, I've avoided this apparently arcane artform, having suffered as a user at the hands of numerous unreliable PC – based systems at offices where I have worked.

The idea of a network – to be able to share resources like printing and file servers, Internet connections, programs and so on, as well as being able to pass files from machine to machine with relative ease, is an attractive one. The downside is the expense of installation, along with the work involved, plus the need to maintain the hardware and keep the whole thing working.

I may be wrong but my impression is that all the downsides have diminished over the years. Networking has evolved and is now cheaper, easier to set up and far easier to maintain than it once was. And as we shall see, even mixing platforms isn't too hard either.

What is a network?

Any assembly of computers linked up somehow probably qualifies, but what we're looking at is machines linked via Ethernet. That bit is easy – aside from the old, comparatively slow and outdated Acorn Econet, it's the only network system available for this kind of use. Exactly what form your network takes depends upon need. Bear in mind the Ethernet standard defines the hardware, the cabling and the way the packages of data are passed around. It does not define what use is made

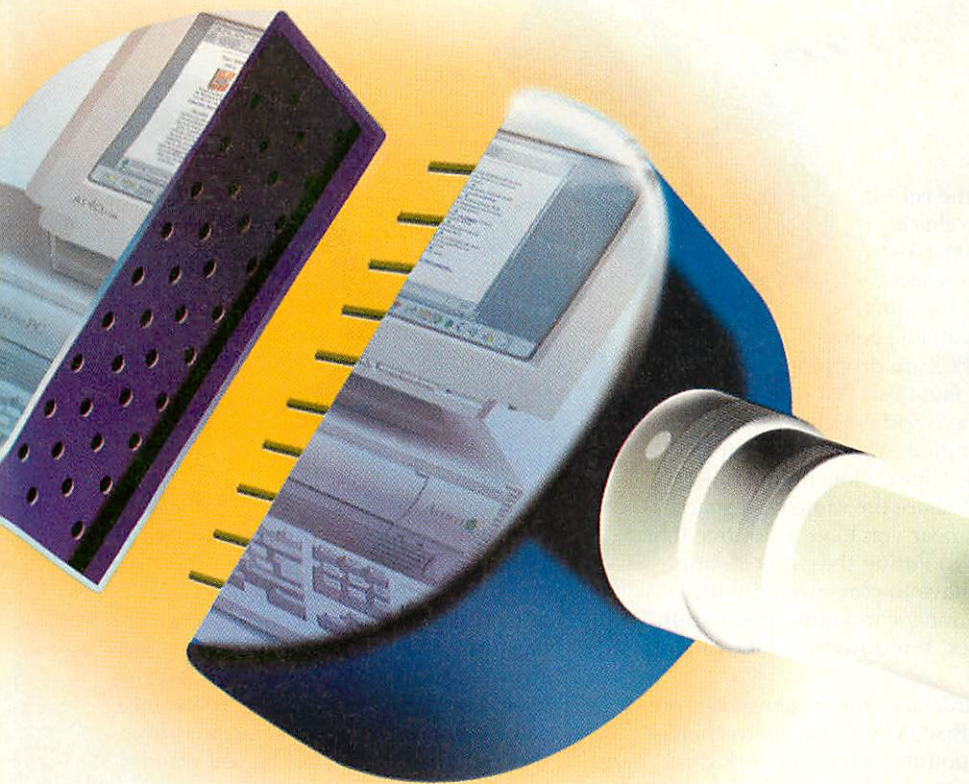

of those packets, so you can have different network protocols on the same hardware.

Mention networks to profit-hungry computer salesmen, as I did at one stage to a selection of suits at a few major computer stores, and suddenly I needed an extra room, a few thousand pounds and a heart stimulator. 'Real' networks use *servers* – machines (usually very powerful ones) dedicated to providing services to the network.

Those servers need juicy software packages running on them and if you want to use them to supply software to networked machines you need the network versions of your packages. That's fine if you want to connect a great many computers together but it's over-egging the pudding if you just want to hook a few machines, not to mention prohibitively expensive.

The alternative is what is known as *peer to peer* – in this environment the machines are hooked up together and each is able to ask for, or send data to, any other on the network and some resources can be shared too. It's a much simpler, cheaper, option. Acorn *Access* will link RISC OS machines together, Win95/98 supports PC *peer to peer* networking. Sadly the incompatibilities between the two mean you can't just hook them together and expect them to talk –

but there is a solution.

Hardware

Every machine connected to any network needs a network card. Acorn Ethernet cards are available to support the most common connection standards: 10base2 and 10baseT. In both cases the 10 is the speed: 10MHz. The vast majority of systems are 10MHz, though newer PC cards sometimes support 100MHz. The base2 tag denotes the cable – in this case a co-axial almost (but not quite) identical to TV co-ax, terminated using BNC connectors. BaseT uses a different cable – a six-core cable comprising three twisted pairs, terminated in six-pin plugs (called RJ45) that closely resemble US phone connectors.

These can be mixed on a network but usually you have one or the other. So what's the difference in practice? 10base2 is essentially a single co-ax cable that runs from machine to machine and which must be terminated at each end with special 50ohm plugs. It's quick and easy to build but does suffer some disadvantages, for instance, if you don't have all your machines powered up or one goes down, the network won't function. There are fancy plug systems that claim to get around this problem by ensuring that the network remains viable even with a machine unplugged, but these

add to the cost and complexity.

The downside of 10baseT is you need one extra piece of hardware – a hub. The simplest hubs are tiny boxes featuring usually four RJ45 sockets and a few LEDs. At £50 or so they are no longer expensive items so this option is more attractive than it once was. The hub manages the information packets that the computers send across the network. This has several benefits.

First off, if a computer isn't connected or is turned off, the hub doesn't care; Secondly, it slightly speeds up the process as the individual machines are not bothered by packets they don't need to see, the hub sorts it out – in 10base2 every computer checks every packet for its own 'mail'. And finally, during set-up, the LEDs show the status of the ports and flash when traffic passes through – so diagnostics is made simpler.

I mentioned earlier that you can mix the two types. Some hubs have their complement of RJ45s plus one BNC 10base2 connector. This can be very useful when mixing new with old. My home network is mixed: simply because I buried a crucial 10base2 cable under the floor long ago with a view to setting up the network eventually. At that stage I hadn't done my homework and assumed I'd be using 10base2, so having done that and rebuilt the room over it, I couldn't face sticking a new cable on the surface of newly decorated domestic walls. Hence one section of 10base2 and the rest 10baseT.

For most purposes, the cost of a hub is a small price to pay for an ultimately more reliable, robust and versatile network. There are so many different hubs around I'm not going to review them. I'm using a CentreCom unit that is almost unique in being built of steel and very strong – could be useful for some. But that's on loan and is shortly to be replaced by a marginally cheaper unit from 3Com. Bear in mind that if ISDN/Home Highway is of interest, you can get hubs with ISDN capability, called routers, which may save some cash and hassles.

Buying the bits

PC network cards are plentiful and cheap – about £20. Obviously you need one that supports your chosen cable type, though most now do both and autosense which connector is in

use. As for standards, the code you need to check for is NE2000. (Also remember to check what expansion slots you have available before ordering – PCs are dropping ISA slots in favour of PCI so check what you have and which ones are already occupied. Also be aware that some boards 'share' slots in that one PCI and one ISA share the same card space, so it may appear you have a slot free that actually isn't.) Fitting the cards is simple unless you have to play around with interrupt numbers and other nasty stuff. But with luck, Windows will take care of that for you.

Acorn cards are more expensive, around £100. For a Risc PC you have two choices though – a podule – style network card, or one that fits into the network connector on the main board. The former is probably easier to fit, just like a normal podule. Getting the other net card into position requires substantial dismantling and some fiddling. But it's not too hard and if you have split a Risc PC apart before it shouldn't hold too many terrors.

I bought mine from Atomwide who sell ANT network cards. The company i-cubed has left the Acorn market but its cards are being sold by DesignIT. The ANT cards are well built and capable, and Atomwide certainly offer good advice and backup. Cards are also available for older machines and aside from the possibility that you might need to update parts of the OS, the principles of network set-up are the same. I'm hoping my old A310 (one of the very first but upgraded a few times) will rejoin the fray and be logging on again in due course.

So what have we landed up with? A peer-to-peer network using a hub and 10baseT with the addition of a segment of 10base2 – at least my cock-up with the co-ax means I ended up installing some of it so I can tell you about it. Windows 95/98 will handle the PC side, *Omnicient* will be needed to link the Acorn hardware onto the network. The rest of the Acorn network software is loaded from the network card.

Omnicient

PCs and Acorns do not mix happily. *Omnicient* is the bridge, though in a sense it's a bridge that goes only one way. *Omnicient* installs only on the Acorn hardware and

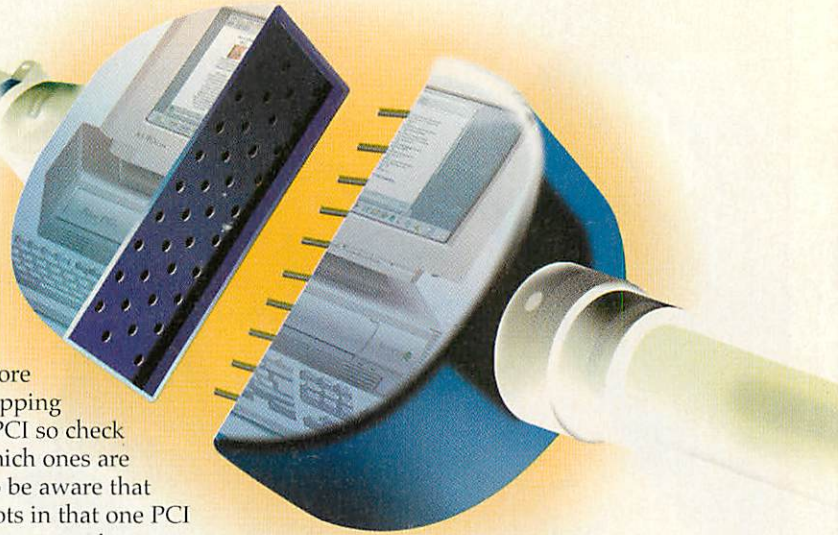

enables the Acorns to communicate with Windows machines.

What you cannot do is sit at a PC and access Acorn drives or connected hardware, such as printers tied to an Acorn machine. Like many other Acorn users I sit at my Acorn out of preference, so being able to access PC facilities from the Acorn is fine. [In fact, if you wander back to page 13, Comms addresses this problem with a quick look at *Smbserver* – Ed].

The downside is that much of my peripheral hardware is connected to the Acorn and unavailable to the PCs. In time I can alter things to make that less of a problem, but right now it's a limitation that you should be aware of.

Omnicient is, however, essential. It's available on its own for about £70 but is also to be found on the *Browse* and *RiscCafe* CDs for about half that.

Getting it together

Assembly is pretty straightforward. Having installed the cards and found somewhere to site the hub, the rest is a simple matter of plugging up the cables.

10baseT cables can be bought in a variety of lengths (and colours) from computer stores. Maplins sell complete cables as well as all the bits and tools you might need to construct your own.

The components are reasonably priced but the tools (co-ax crimping and RJ45 connector tool) are around £20 each, though you will

probably only need one of them. Buying ready-made RJ45 leads is easiest option.

The next step is to configure everything. Networks do not start themselves – not yet at least. Without a decent crib sheet, setting up the network is nearly impossible for the novice as you must get all the steps right for it to work.

END



It doesn't have to be this complicated

DrawWORKS Millennium

the complete graphic design studio on one CD-ROM



PURPOSE :
graphic design & illustration



DrawWorks Vector/Bitmap graphics package
Over 2100 superb outline fonts
Over 1000 pieces of high quality clip art
Mr Clippy clip art manager
Dr Fonty font editor with PC export
Over 420Mb of applications & resources

"...a whole range of new functionality...easy to pick up...a vital feature of only the best software...excellent...really makes a complete package...this is the right purchase."

Acorn User

"...undoubtedly the best new CD-ROM for RISC OS that I've seen for a very long time...it's 423Mb of extremely useful resources...there's no doubting that this is the company's best value product to date. Buy it without hesitation."

Risc User

Some of DrawWorks features:

- DrawWorks vector/bitmap graphics package
- Over 2100 superb outline fonts
- Complete copy of Typography 2100 Expert
- Over 1000 pieces of clip art
- Over 630 vector clips & 394 bitmap clips
- NEW Mr Clippy clip art manager
- Nested clip art groups and WMF file support
- Dr Fonty font editor
- Import & Export of EPS PostScript™ files
- Export Acorn fonts as PostScript™ Type 1
- Import WMF (Windows MetaFiles) drawings
- Can be run from CD or hard disk
- Complete integrated package
- All clips already referenced by Mr Clippy
- Colour print preview paper simulator system
- CMYK and Spot colour separations
- Tint objects shades of any colour

- Alter CMYK/RGB colour levels
- Contrast & Brightness tools
- User defined multi-document text styles
- Comprehensive illustrated on-line manual
- Realtime interactive help
- PureTint and Named spot colour pickers
- ViVID enhancers for Pre-RiscPC computers
- Automatic drop shadow tool
- Print tiling across multiple sheets
- All files fully compatible with Draw files
- OLE sprite editing using IPaint
- Configurable user levels
- Example effect worksheets
- Auto convert text to paths when required
- Custom line width / pt size tools
- Export EPS, JPEG, GIFF files
- EuroSymbol support using special fonts
- Automatic colour filling/tinting tools

- Map making tool
- Lining style tool with custom styles
- Access clips directly from DrawWorks
- Full font editing facilities
- Tint bitmap images for use as backgrounds
- View font examples without installing
- iDesigner application to choose fonts for you
- Anti-aliased file export (Sprite & GIFF)
- Turn font groups on or off from DrawWorks
- CMYK grey component compensation
- Font catalogue printing
- Spiral text tool & kerning of outline fonts
- PostScript™ font names database
- On-line font dictionary
- Easy to use installer application
- Quick and easy access to Draws features
- Auto-grouping of objects
- Hierarchical toolbar with grouped tools

- Tear off object tool bar
- DrawTrix image effects processor
- Produce Isometric 3D projections easily
- Bend objects and text round circles
- Fit objects and text into pre-defined moulds
- Make and keep your own mould designs
- Save custom effects for different tools
- Configurable undo buffer
- Set default font for new documents
- Full control over Draws preferences
- Spot colour separate sprite files
- Easy to use and quick to master
- The professional choice for graphic design
- Tested on Risc OS 4 (pre release version)
- Over 420Mb of applications, fonts & clips
- Requires OS 3.1+, 4Mb Ram, CD-ROM

DrawWorks Millennium Pricing

Single user copy £61.50

Site licence copy £121.50

Upgrade* from DrawWorks Designer £31.50

Upgrade* from DrawWorks2 £41.50

Upgrade* from Mr Clippy £31.50

Upgrade* from Dr Fonty £31.50

Upgrade* from Typography 2100 £31.50

Site licence upgrade* from DrawWorks Designer £61.50

*upgrade requires the return of the original products master disk and original products site licence if upgrading from site copy of DrawWorks Designer

All quoted prices (unless stated) are for single users versions only.

Special offers relate to single user versions only.

Offers valid till end Sept 1999

Overseas orders please add £2.00 carriage

All details correct at the time of going to press E&OE
NDT & Typography are trademarks of iSV Products. All other trademarks are acknowledged
This advert was produced using NDT fonts from
Typography 2100 & DrawWorks Millennium

**iSV
products**

iSV Products
86 Turnberry • Home Farm
Bracknell • Berks • RG12 8ZH
Tel 01344 455769

<http://members.aol.com/isvproduct/>

Members only...

*Neil Spellings brings us up to date
with his latest AAUG report*

Well, it's been a fair few months since my last article and in that time quite a lot has been going on. The highlight of the year is without doubt the signing of the deal to continue development of our beloved OS by RISCOS Ltd.

With any luck, RISC OS 4 upgrades should be landing on doormats any day now. We've had details of no less than six new RISC OS machines in the pipeline, Acorn

changing its name to Element 14, then being split up and sold to Pace.

At the other end of the scale, you've had yours truly appearing on Sky's [.TV] *Blue Chip* program alongside Stan Boland and then 'starring' in *Acorn User's* very own *Regan Files*. What a start to the year!

The user group scene has been equally active, with several new groups making an appearance during the first half of the year. The AAUG has also launched its new Internet domain – more details below.

July 1999

- 3rd AAUG exhibiting at the Acorn Southeast show in St.Albans
- 7th Suffolk Acorn Risc Club meeting
- 7th Wakefield Acorn Computer Group meeting
- 8th North Kent Computer Club meeting
- 9th Welwyn Hatfield meeting
- 12th Southampton meeting
- 12th Surrey & Sussex Acorn User Group meeting
- 12th Derbyshire Acorn Risc Club meeting
- 13th Bottisham Acorn User group meeting
- 13th Liverpool Acorn User group meeting
- 13th Essex Acorn User group meeting
- 27th Acorn Club North East meeting
- 27th Blackpool meeting
- 28th Bristol Acorn User Group meeting

August 1999

- 4th Suffolk Acorn Risc Club meeting
- 4th Wakefield Acorn Computer Group meeting
- 9th Southampton meeting
- 9th Surrey & Sussex Acorn User Group meeting
- 9th Derbyshire Acorn Risc Club meeting
- 10th Bottisham Acorn User group meeting
- 10th Liverpool Acorn User group meeting
- 10th Essex Acorn User group meeting
- 12th North Kent Computer Club meeting
- 13th Welwyn Hatfield meeting
- 24th Blackpool meeting
- 25th Bristol Acorn User Group meeting
- 31st Acorn Club North East meeting

AAUG.net

At this year's Wakefield show, the AAUG launched AAUG.net – a new way of contacting both the AAUG and the user groups who are members.

Every user group now has an e-mail address of the form *clubname@aaug.net* and their Website can be accessed through: <http://www.aaug.net/clubname/>

All these new contact details can be found in the updated user group directory on the following pages and this information is also kept up-to-date on the main AAUG Website: <http://www.aaug.net/>

RISC OS 4 installation

Along with dealers, many user groups will also be authorised to install the RISC OS 4 upgrade. At the time of going to press it is not yet known which user groups will have



<i>Company</i>	<i>Discount</i>	<i>Products</i>
Acorn User Magazine	Bulk purchase available for groups – save up to £1 per copy	
Mijas Software	17.5%	All products
Apricote Studios	20%	All products
Anglia Multimedia	25%	All products plus other special offers
Learning Through Computing	10%	All products
Fabis Computing	25%	Any single purchase
	40%	Any 10 mixed items
	50%	Any 10 identical items (bulk buy)
NCS (Archive)	£10	off new subscriptions plus a free CD
Yellowstone Electronic Solutions	10%	All catalogue products
Tower Electronics	Free connection to Enterprise Internet	
Quantum Software	10%	All products
Clares Micro Supplies	10%	All software products
Topologika	10%	Any single purchase
	20%	Two purchases
	Buy three get one free!	
H S Software	15%	All products
The Event Horizon	10%	All products
Werewolf Software	10%	All products
Longman Logotron	10%	Single purchase
	15%	5 to 10 items
	25%	10 or more items
Computer Concepts	10%	All software
	20%	All hardware (exc. printers)
Alternative Publishing	17.5%	All products
SpaceTech	10%	All products
Creative Curriculum Software	20%	All products
Sherston	20%	All products
Argonet	£10 off	Surf at speed pack
Quadworks	10%	All products
TBA Software	10%	All products
4Mation	15%	All products
The Datafile	10%	All products
The ARM Club	10%	All products
R-Comp/R-Comp Interactive	Various special offers – ring for details	

been authorised to perform this service but these details should be available by the time you read this from both the AAUG and RISCOS Ltd.

As the RISC OS 4 installation will involve replacing the ROMs in your computer, and also an optional reformat of the harddisc for long filename support, RISCOS Ltd are recommending that only people trained and authorised by them perform the upgrade. Many groups are also offering the service to non-members – contact your nearest club for details.

Discount scheme

The user group discount scheme continues to grow and now offers all user group members discounts on the products and services of 28 companies. To order products from any of the companies listed above at the discounted price, you must

be a member of one of the groups listed in the club directory, and you must use the official AAUG order form – available from your club committee.

Events diary

The meeting dates for some of the UK clubs over the next two months are shown opposite. For details of guest speakers, topics covered, location of, and directions to meeting places, contact the club concerned directly.

RISC OS '99 Show – volunteers wanted

The ARM Club is organising a 2-day Southern-based show to replace the traditional Acorn World in the autumn. The show will be held at a new venue for Acorn shows – Epsom Downs Racecourse

in Surrey on Saturday 30th and Sunday 31st October 1999. The AAUG have various positions available for volunteers to help out, in and around the venue, over the two days.

Obviously all volunteers will get free admission to the show, plus those clubs who provide volunteers will be entitled to a share of the proceeds from the entrance fees. This is a great way for any user group member to get free admission to the show, and help your club in the process. If you can spare anything from a few hours to the entire two days, please drop me an e-mail.



Association of Acorn Usergroups

Name

Address & Phone

Global Groups

The ARM Club	FREEPOST, The ARM Club (07010 709849)
Acorn Enthusiasts Group	Internet only group
ARM-Acorn Developers Artists	39 bd Louis SCHMIDT, 1040 Brussels, BELGIUM (+32 273 399 93)

UK Groups

Acorn Club North East (ACNE)	4 Penshaw View, Wardley, Gateshead. NE10 8BJ (0191 4697200)
Blackpool Computer Club	11 Cedar Avenue, Thornton Cleveleys, Lancs. FY5 2HZ (01253 864028)
Bottisham Acorn User Group (BAUG)	9 Chestnut Close, St Ives, Huntingdon, Cambs. PE17 4UQ (01480 381996)
Bristol Acorn Risc User Group (BARUG)	3 Thorndale Court, Bristol. BS8 2JA (0117 973 6237)
Derbyshire Acorn Risc Club (DARC)	4 Beacon Drive, Rolleston-on-Dove, Burton-on-Trent, Staffs. DE13 9EL (01283 815349)
Essex Acorn User Group (EAUG)	43 Spalding Way, Great Baddow, Chelmsford, Essex. CM2 7NZ (01245 471463)
Lincolnshire Acorn User Group	High Fen, Gosberton Clough, Spaldin, Lincs. PE11 4JU (01775 750535)
Liverpool Acorn Users Group (LAUG)	26 Roe Lane, Southport.PR9 9DX (01704 530741)
Loughborough (student) Acorn Users	5 Far Lane, Coleby, Lincoln. LN5 0AH
Manchester Acorn User Group (MAUG)	65 Victoria Road, Salford, Manchester. M6 8FZ (0161 787 7985)
Norfolk Acorn User Group (NAUG)	20 Rye Close, North Walsham, Norfolk. NR28 9EY
North Kent Amateur Computer Club (NKACC)	(01959 701435)
Nottingham Microcomputer Club (NMC)	NMC, Woodthorpe House, Mansfield Road, Sherwood, Nottingham (0115 944 7504)
Milton Keynes Acorn User Group (MKAUG)	11 Cavenham, Two Mile Ash, Milton Keynes. MK8 8JP (01908 265112)
Southampton Acorn Users Group (SAUG)	50 Cornwall Road, Midanbury, Southampton. SO18 2QZ (023 80325560)
Suffolk Acorn Risc Club (SARC)	50 Ash Road, Onehouse, Stowmarket, Suffolk.IP14 3HB (01473 728943)
Surrey & Sussex Acorn Users Group (SASAUG)	White Cottage, Shirley Drive, Worthing, West Sussex. BN14 9AX (01903 260666)
Wakefield Acorn Computer User Group (WACG)	95 Cumbrian Way, Lupset Park, Wakefield, West Yorks (01924 379778)
Welwyn Hatfield Computer Club (WHCC)	1 Common Lane, Batford, Nr Harpenden Herts (01582 767540)

Non-UK Groups

Acorn Users Auckland	35 Laurie Avenue, Parnell, Auckland 1 (+64 9 3790278)
ACorner	Bellomontedomein 48, 6229 GL, Maastricht (+31 (0)43 3616301)
Acorn User Group Sydney	417 Hawkesbury Road, Winmalee, 2777, Australia (+61 (0)2 4754 1796)
Acorn User Group Austria	A-3240 Kritzendorf, Hauptstrasse 101, Austria (+43 (0)2243 36786)
Arche Acorn User Club	Schubertstraße 7, D-51427 Bergisch Gladbach, Germany
Beebnet	8 Anzac Strret, Salisbury Heights, 5109, South Australia (+61 8 8250 4472)
Big Ben Club	Postbus, 1189, 6801 BD, Netherlands (+31 (0)71 4080339)
German Archimedes Group	Alte Landstrae 21, 22962 Siek, Germany (+49 (41 07) 99 00)
Canberra BBC User Group (CanBUG)	16 Cruikshank Street, Wanniasa, ACT 2903 (02 6231 4345)
Victoria BBC Users Group	31 Curtis Avenue, West Brunswick, Victoria 3055 (+61 03-9386 1402)
French Acorn User Group	4 Rue Marius Jacotot, 92800, Puteaux, France (01 47 789967)
Wairarapa Acorn User Group	39 College Street, Masterton 5901, New Zealand
Wellington Acorn Computer Club (WACC)	PO Box, 45-106, Epuni, Lower Hutt, New Zealand (04 938-2097)

Specialist Groups

Christian Acorn User Group	The Rectory, Swan Lane, Long Hanborough, Witney. OX8 8BT (01993 881270)
C/C++/Java Acorn User Group	13 Priory Close, Hoddesdon, Herts EN11 8DB (01992 469004)
Fortran Friends	PO Box 64, Didcot, Oxon. OX11 0TH (01235 834357)

E-mail	Website	Subs	Coverage
info@armclub.org.uk	www.armclub.org.uk/	£12	Worldwide
aeg@aaug.net	www.aaug.net/aeg/	Free	Worldwide
armada@aaug.net	www.aaug.net/armada/	250FF for mag and disc	Worldwide
acne@aaug.net	www.aaug.net/acne/	Free at present	North East England
blackpool@aaug.net	www.aaug.net/blackpool/	Free	Blackpool and Fylde area
baug@aaug.net	www.aaug.net/baug/	£12	Cambridgeshire, North Essex, Bedfordshire and Suffolk
barug@aaug.net	www.aaug.net/barug/	£7	Bristol, Gloucestershire, South Wales, Wilts, Somerset
darc@aaug.net	www.aaug.net/darc/	£15	Derbyshire, Staffordshire, Nottinghamshire
essex@aaug.net	www.aaug.net/essex/	£12	Essex
lincs@aaug.net	www.aaug.net/lincs/	Free	Lincolnshire
laug@aaug.net	www.aaug.net/laug/	£2 joining, £10 annual	Merseyside, Cheshire.
lau@aaug.net	www.aaug.net/lau/	£5	Loughborough
maug@aaug.net	www.aaug.net/maug/	Free	Greater Manchester, Cheshire, Lancashire, Yorkshire, Merseyside and Cumbria
naug@aaug.net	www.aaug.net/naug/	Free	North Norfolk
nkacc@aaug.net	www.aaug.net/nkacc/	£15, £10 concs.	Kent, Croydon and SE London
nmcc@aaug.net	www.aaug.net/nmcc/	£18 (concs £11.50)	Members from Nottinghamshire, Derbyshire and Leicestershire
mkaug@aaug.net	www.aaug.net/mkaug/	?	Milton Keynes, Buckingham, Bletchley
southampton@aaug.net	www.aaug.net/southampton/	Free	South Hampshire
sarc@aaug.net	www.aaug.net/sarc/	£15	Suffolk, Cambridgeshire, Norfolk, Essex
sasaug@aaug.net	www.aaug.net/sasaug/	£12	Surrey and Sussex
wacg@aaug.net	www.aaug.net/wacg/	£10	Yorkshire
whcc@aaug.net	www.aaug.net/whcc/	£4	Welwyn Hatfield
auckland@aaug.net	www.aaug.net/auckland/	\$30NZ	New Zealand
acorner@aaug.net	www.aaug.net/acorner/	Dfl 55	Netherlands
sydney@aaug.net	www.aaug.net/sydney/	\$30A	New South Wales, Australia
austria@aaug.net	www.aaug.net/austria/	Free	Vienna, Austria
arche@aaug.net	www.aaug.net/arche/	25DM	Germany
beebnet@aaug.net	www.aaug.net/beebnet/	Free	Metropolitan Adelaide, South Australia
bigben@aaug.net	www.aaug.net/bigben/		Netherlands, Belgium
gag@aaug.net	www.aaug.net/gag/	DEM52.20 for mag	Germany, Austria, Switzerland, Netherlands
canbug@aaug.net	www.aaug.net/canbug/	Free	Canberra ACT
vicbug@aaug.net	www.aaug.net/vicbug/	A\$45	Victoria, Australia
fraug@aaug.net	www.aaug.net/fraug/	250FF	Paris and France
wairarapa@aaug.net	www.aaug.net/wairarapa/	Free	Wairarapa province, New Zealand
wacc@aaug.net	www.aaug.net/wacc/	NZ\$25	Wellington, New Zealand
xaug@aaug.net	www.aaug.net/xaug/	£4	Worldwide
caug@aaug.net	www.aaug.net/caug/	£20	Worldwide
ff@aaug.net	www.aaug.net/ff/	Unknown	Worldwide

Easy Font

Professional

Easy Font Professional is probably the best Font management software on Acorn machines. This superb piece of software provides an easy to-use, yet powerful interface.

Easy Font Pro allows you to add fonts easily and quickly, as well as allowing the fonts to be viewed for simple selection.

Other features of Easy Font Professional include:

- The ability to allow you to group fonts.
- Up to 40% compression
- Fonts which load only when a particular application is loaded
- Fonts can be accessed on other media, eg. CDs

Easy Font Professional comes on two DD floppy discs. One contains the application, while the other contains several styles of font. It also comes with a printed manual which contains instructions on how to use Easy Font Professional to its full ability. As well as this a quick reference guide is included which shows each button and its function, plus the keyboard shortcuts.

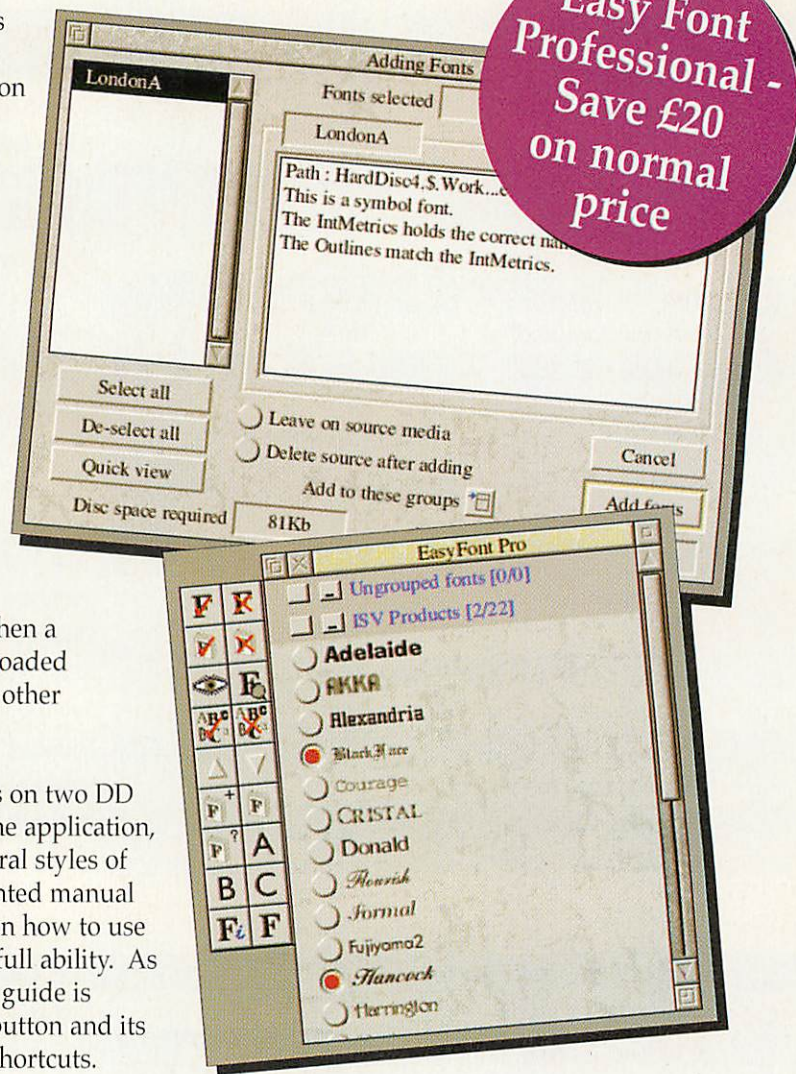

56

ORDER FORM

Please send me:

<input type="checkbox"/> Easy Font Pro	<input type="checkbox"/> Font Pack
<input type="checkbox"/> UK - £40	<input type="checkbox"/> UK - £10
<input type="checkbox"/> Europe - £43	<input type="checkbox"/> Europe - £12
<input type="checkbox"/> World - £45	<input type="checkbox"/> World - £14
	<input type="checkbox"/> HD or <input type="checkbox"/> DD

Prices include postage and packaging and VAT

I wish to pay by:

Cheque/postal order (payable to Tau Press Ltd)

Credit Card (Visa/Barclaycard/Mastercard/Access)

Credit Card No:

Expiry Date: / Name on card:.....

Signature:.....

Please tick here if you do not wish to receive promotional information from other companies AU9908

Send your order to: Easy font pro, Tau Press, Media House, Adlington Park, Macclesfield SK10 4NP.

Name

Address

.....Postcode.....

E-mail

Font Pack

Want some more fonts to use with Easy Font professional? Or maybe you just want to increase your range of fonts? If so, then the Font Pack is for you. It features over 50 different styles of font giving you a wide choice of type-faces to choose from.

For Easy Font Professional you will need a minimum of RISC OS 3.1 or greater with 2Mb of RAM and a harddrive

PC Cards Again Cheaper than ever!



We have in stock Acorn ACA 57 PC Cards with Cyrix/IBM 5x86 processors at 100 MHz. With this Card you can run Windows and DOS applications under Windows 3.1, 95 or 98. You can use PC CD ROMs and, with an Ethernet Card and our Network Links software, a Risc PC can act like any other PC on a PC network. The PC Pro software now supports VESA2 and DirectX standards.

NEW LOWER Prices include VAT & P&P:

ACA57 PC Card with no software	£225
ACA57 Card with PCPro3 Software for new user	£285
ACA57 Card+PCPro3 if you return PCPro2 disc	£260
The following prices apply if ordered at the same time:	
Windows 95 on CD ROM	£75
PCSound Professional (sound support by RCI)	£35
IBM PC DOS v7 (not required for Windows)	£10
Network Links Software for one user	£20

Our Web page on Benchmarks shows the tiny effect of a larger cache or a 133MHz processor; the processor we offer here has a heat sink fitted and does not need a fan. DirectX/VESA support does not generally benefit from more than 128KB cache anyway.

Aleph One Ltd The Old Courthouse Bottisham
CAMBRIDGE CB5 9BA Tel: 01223 811679 Fax: 223
812713 E-mail: sales@aleph1.co.uk
www.aleph1.co.uk/AcornProd/Software/PCPro3Demo/index.html

NEW! from STD

Stuart Tyrrell Developments

NEW!



Switch Boxes

Share keyboard, mouse etc between RiscPC and PC

Complete with all cables, adaptors etc. Add PS2Mouse to use a switched PS/2 mouse with an Acorn machine
Keyboard (AT or PS2), PS/2 mouse and Serial £39.95 (ideal if your monitor has 2 inputs available)
Keyboard + Monitor (twisted pair VDU cables) £39.95
Keyboard, Monitor, Serial (eg serial mouse) £49.95
Keyboard, Monitor, PS/2 mouse £49.95
15HD to 5X86C cable for 2-input monitors £19.95
15HD m-m tw pair (as supplied with switches) £14.95
Many other switches, cables and adaptors available!

NEW!



Touchpad

"A pleasure to use"
Neal Philips, AU, Xmas 1998

Use directly on A7000, or via PS2Mouse/PS2Mouse+ on other machines £34.95 or purchased with PS2Mouse/+ £29.95

PS2Mouse

... allows you to use any PS/2 device with your Acorn only £24.95
PS2Mouse+ with a port for Acorn mouse ideal for touchpad or trackballs £39.95

NEW!



Trackball

An ergonomic trackball which plugs directly into your Acorn!

Features ergonomic shape with 3 buttons. Heavy ball may be easily removed for cleaning. Switch allows reconfiguration of Select / Menu position.

Trackball £34.95

OLD...

Not quite everything we do is new!

These are just some examples of our wide range of Game, Interface and SEN Access products.

If you would like further information, please see our website, telephone or write to ask for our full product information flyer.

Please note our **NEW!** telephone number!



PO Box 183, OLDHAM OL2 8FB
Email: info@STDevel.demon.co.uk
www: http://www.stdevel.demon.co.uk
Tel: 01706 848 600 (9am - 9pm)
Orange: 0976 255 256 dFAX 0870 164 1604
All prices include P&P. All trademarks acknowledged. E&OE.
Access/Visa/Delta/Mastercard accepted.

Monitors

Iiyama 15" 350	£145.00
Iiyama 17" (S702GT) .28dot	£279.00
Iiyama 17" 400 Pro .25 dot	£359.00
CTX 14" Digital Scan	£125.00
CTX 15" Digital Scan	£145.00
CTX 17" .28 70Khz Digital	£259.00
CTX mons have (3 year on-site warranty)	
Many other models available	

Switch Boxes

Parallel 2 way (25w 'D' skts)	£16.99
Parallel 4 way (25w 'D' skts)	£19.99
Serial 2 way (9w 'D' skts)	£19.99
Monitor+Keyboard 2 way	£19.99
Suitable cables and other boxes available, please ask	

VGA to PAL TV Converter

The VGA Converter allows the output of any Acorn running in a VGA or SVGA mode (or PC comp) to be displayed on a TV or recorded onto a video recorder. Please ask for more information.

Price £159.00 inc vat

Colour Printers



Epson Stylus Colour 440	£125.00
Epson Stylus Colour 640	£159.00
Epson Stylus Colour 850	£279.00
HP Laserjet 1100 (laser mono)	£289.00

Virus Protection

Pineapples Virus Protection Scheme has been running for over six years and is still being updated with new viruses on a regular basis. New software versions are sent out to members every four months and the total number of viruses which can be removed is well over 200. The latest version is now scanning at up to four times faster than previous versions despite coping with many more viruses.



Joining fee just £28.20

If you're interested in virus protection, join the Pineapple Virus Protection scheme and buy Killer. Accept no alternative - 'Acorn User Feb 96
Inexpensive multi-user licences

Parallel to SCSI adapter



A brand new product from Pineapple providing an inexpensive alternative to a SCSI card when using SCSI scanners. The SCSI adapter plugs into the parallel port (with a 'through' printer connector), and can be used directly with SCSI scanners. Works with A3010/3020/4000/5000/A7000/RiscPC (inc StrongARM).

Price just £59.00 inc vat

Colour Scanners



The new Epson GT7000 is great value and the Photo version with transparency adapter gives excellent quality on both transparencies and negatives. Our new SCSI parallel port adapter cable makes this excellent scanner very affordable. The Plustek 12000P parallel port scanner also gives excellent quality at the cheapest possible price. All scanner prices include Imagemaster and Twain software.

Epson GT7000 - SCSI	£259.00
Epson GT7000 Photo - SCSI	£299.00
Epson FilmScan 200 - SCSI	£435.00
Canon Canoscan 2700F - SCSI	£557.00
Plustek 12000P - Parallel Port	£149.00

Pineapple Software

352 Green Lane, ILFORD
Essex IG3 9JS

Tel 0181 599 1476 Fax 0181 598 2343
email:- sales@pineapple.demon.co.uk
www:- http://www.pineapple.demon.co.uk

Terms:- All prices include 17.5% vat. Carriage £5 on most hardware. Small items £3 (or less). Phone for quote outside UK. Official orders, cheques and all major credit cards accepted at no extra charge.

Studio24Pro

Many Acorn User front covers have been created from scratch using this program alone, concrete proof of the power of this creative tool! - Acorn User Mar96

Now just ★ £99.00 ★



Users note FREE update v2.16 is now available.

THE DATA STORE

Dedicated to serving the Acorn community

RISC OS 4
COMING SOON!
E116-33

From Data Store Software...

FONTFX 6

WE'VE AMAZING NEW EFFECTS!

New control panel with many improvements including 'compass' knobs

FONTFX
New border effect

User-definable shadow length and direction

FONTFX
New rainbow fill option

FONTFX
New 3D Shadow effect

FONTFX VERSION 6
New grow and shrink feature

New toolbox controls

PRICE £31.95 inc. VAT and postage
SITE LICENCES AVAILABLE
Upgrades at special prices for owners of earlier versions: phone for details

Our existing customers know the wide range of products we supply, but if you've never purchased from us before, here are just a few of the names...

Canon/Epson/HP Printers • Epson/Plustek Scanners
Olympus Digital Cameras • Yamaha CD Writers
Iiyama and Logix Monitors • Iomega Zip/Jaz Drives
Eesox CD-ROM Drives • Psion Palmtops
Computer Connections 'Swap Drives'
Audio Dynamics and ESP MIDI Cards
Fatar MIDI Keyboards and Accessories
Roland and Yamaha MIDI Modules and Keyboards
plus a full range of hard discs, memory, switch boxes, cables, ink and toner cartridges...

...and if it's not in this list, we can probably still get it!

And don't forget our service department: we repair almost any Acorn computer (and PCs too!), and can fit upgrades or install software for you as well.

EDUCATIONAL SOFTWARE

SALE • SALE • SALE • SALE • SALE

Extended until 31st July 1999 on existing stocks only, so first come, first served!

Adventure Playground <i>Storm</i>	£15.00	Look Hear! <i>Sherston</i>	£40.00
Amazing Maths <i>CSH</i>	£20.00	Maths - Algebra/Geometry/Stats <i>10/10</i> . .	£10.00
ArcVenture 1, 2, 3 or 4 <i>Sherston</i>	£27.00	Mega Maths <i>LCL</i>	£18.00
Astro <i>Topologica</i>	£25.00	Micro English/German/Spanish <i>LCL</i>	£18.00
Being a Scientist (CD) <i>Anglia</i>	£30.00	Money Matters <i>Triple R</i>	£10.00
Catch <i>Lander</i>	£10.00	Music Box <i>Topologica</i>	£25.00
Christmas Adventure <i>Storm</i>	£15.00	Oxford Reading Tree (CD) <i>Sherston</i> . .	£25.00
Craftshop 1 <i>4Mation</i>	£15.00	Polyominoes <i>Topologica</i>	£25.00
Craftshop 2 <i>4Mation</i>	£15.00	Puncman <i>5/6/7 Chalksoft</i>	£12.00
DataWord <i>Triple R</i>	£ 5.00	Rainbow <i>Longman</i>	£20.00
Dinosaur Discovery <i>4Mation</i>	£20.00	Sellardore Tales <i>Sherston</i>	£15.00
Dinosaurs <i>10 out of 10</i>	£10.00	Six French Games <i>AVP</i>	£25.00
Driving Test <i>10 out of 10</i>	£10.00	Talking Clocks <i>Topologica</i>	£25.00
Elf Tales (CD) <i>Sherston</i>	£25.00	The Complete Wordsearch <i>AVP</i>	£15.00
Eternal City <i>Cygnat</i>	£13.00	The Snowball Rent (CD) <i>SIR</i>	£10.00
Five Things to Find (CD) <i>SIR</i>	£10.00	The Three Little Pigs (CD) <i>Dial</i>	£20.00
German <i>10 out of 10</i>	£10.00	Viewpoints <i>Sherston</i>	£30.00
Global English <i>SIR</i>	£25.00		
James Pond Running Water <i>SkillsWare</i> .	£20.00		
Just a Pile of Rice <i>SIR</i>	£10.00		
Kiyeko/Lost Night (CD) <i>UbiSoft</i>	£20.00		
Linkword German <i>Minerva</i>	£27.00		

Other previously advertised titles are now sold out

Contacting us by email? Failed to get a response?

Please take care to address your messages correctly. Our email address is: datstore.demon.co.uk

Note that there is *no* second *a* after the first *t*.

If you send messages to datstore.demon.co.uk, they will be sent to a completely different company who will not reply!

SIBELIUS

THE MUSIC NOTATION SOFTWARE



Sibelius 7	£575
Sibelius 7 Student	£320
Sibelius 6	£105
Optical Manuscript	£275

And new...

Sibelius for Windows	£595
-----------------------------	-------------

Acorn Sibelius users wishing to move to Sibelius for Windows: we can supply specially-priced PC systems that share your existing monitor/printer - please phone for details...

The Data Store is one of the few dealers in the country which offer full, detailed demonstrations of Sibelius software. If you want to find out how the best just got better, ring us **NOW** for an appointment - you'll need at least an hour!

There are **THOUSANDS** of software titles available for Acorn Computers! We stock hundreds of the most popular titles on our shelves for you to browse and try, and can obtain most of the rest within a few days - so there's **NO EXCUSE** not to make full use of your Acorn machine **RIGHT NOW!** Place an order today!

OPENING HOURS

	AM	PM		AM	PM
Monday	9:30	5:30	Thursday	9:30	5:30
Tuesday	9:30	5:30	Friday	9:30	5:30
Wednesday	Closed	Closed	Saturday	9:30	5:30

6 CHATTERTON ROAD BROMLEY KENT BR2 9QN

Tel (020-8)460 8991 • Fax (020-8)313 0400

Web <http://www.datstore.demon.co.uk/>

E-mail info@datstore.demon.co.uk

ALL PRICES IN THIS ADVERTISEMENT INCLUDE VAT @ 17½%

A wide world

SEMERC (0161-827 2927) have launched My World Online which for £15 a year provides a Web-based resource comprising award-winning My World screens covering Art, Design, English, Geography, History, Modern Foreign Languages, Maths, Music, PE and Science.

Each screen contains an explanation as well as useful ideas or instructions which can be customised by teachers (or parents) to suit the activity you're doing. SEMERC have also aligned the language level to the recommended age-range for each screen.

The site is also available on CD-ROM

for schools or Education Authorities to run on their own intranets and will be available in September for £29.



Now you can get into My World on the Web

Moving forwards

SOFTEASE (01335 343421) have added Xemplar's Stuart Payne to their team as Product Development Manager. His brief is to generate further sales of *Textease Multimedia* and to take the product outside education, where it has won a number of awards, to home and overseas users.

Commenting on his recent appointment, Stuart said, 'I have watched *Textease* over many years - in its various forms - develop into an outstanding multimedia package. It has always been a favourite within education, but it has a great deal to offer other people as well as students

and teachers.'

In the meantime *Textease Multimedia* now comes with free clip-art to enable students to create even more amazing designs. There are 1,750 images to choose from which have been selected by teachers and students and categorised into topics: Animals, Architecture, Borders, Cartoons, Clothes, Effects, Around the House, The Internet, Medieval Times, Music, Nature, People, Photos, Religion, Tiles and Effects (especially good for Web page backgrounds), and Vehicles. Watch this space for their next project: the addition of video clip and animation libraries.

ICT for science teachers

THE Science Consortium (01491 414243) is offering training to every science teacher, using the allocation of National Lottery money from the New Opportunities Fund. Training is a mix of tutorial booklets, CD-ROMs and an integrated Website, as well as face-to-face training. In addition there is a portfolio and tried-and-tested lesson plans presented as six themed modules. These have been developed from material used by consortium members over many years.

While the modules address the NOF's aims for teachers' ICT skills, they focus

on ideas and processes that are part of everyday science, covering themes such as collecting, handling and interpreting data for science, models and scientific theories and visualised scientific ideas.

Dick Fletcher is the Consortium's spokesperson and is adamant that teachers' needs are paramount: 'We know our science and we not only know where ICT enhances it, but also where ICT can distract from it. We have all come to ICT, not as computer sales people, but as educators with our feet firmly rooted in science.'

In brief

Countdown to 2000

HANDS up those who won't be covering the Millennium in the Autumn or Winter terms? If you're looking for ICT tools to help then as well as Sherston's *This Week in History* take a look at *Timelines* from SoftTeach (01985 840329). Unsurprisingly, this product allows you to create a colourful and multimedia pictorial timeline. You can use family photographs, letters and even sound and video clips for school, CD-ROM or Internet collections and then print your creations for class displays.

A nice touch is that you can even use AVP's superb PictureBase series of CD-ROMs for your sections on Kings, Queens and Leaders, Buildings, Battles and Wars, Treaties and Laws, Exploration, Science, Literature and the Arts, Ancient monuments or whatever you want. Aimed at Key Stages 2 and 3 it's tied closely to the QCA Scheme of Work for History. The price starts at £49.90 for a Junior/Middle school 5-user licence.

Argo for schools

ARGOSPHERE has a new subscription service for schools. The full site is available for £120 per year which gives school unlimited access and teachers full access from home. A special feature is that activities can be downloaded to use offline on standalone computers or across a network, thus saving on the phone bill (www.argosphere.net).

ArgoSphere are also concerned that their site be seen as a safe port of call for all children, so have instigated a *downloading bureau* for offline use creating a secure environment in which children can learn. If you want to have a taste before committing to the subscription then significant parts of the site are free to access and will continue to be so. ArgoSphere has also launched *ArgoSphere Volume 1* a collection of the most popular activities and resources which is available for £29.

Moving it

Turtles and LOGO can send teachers into cold sweats, Pam Turnbull looks at a new-look old favourite which could make things easier

I was recently asked why we bother with LOGO and turtles at all these days when the 7-year-olds will be using nothing like this when they get to secondary school. Perhaps C++ or Java may be more in line with current technology, but the idea behind LOGO and Turtle Graphics in particular is that it is highly visual, immediate, simple and instills into even the youngest pupil the fact that a computer will only do what you tell it and no more. It also stresses that logical thinking and planning are very important - and not just when it comes to computers.

The major problem is that for non-programmers even turtle graphics programs can be overwhelming. The key is to start simple and build skills just as you would with any other subject. When I opened the new version of Screen Turtle I was struck by the yellow, laminated Quick Start Page which promised results in five minutes. True this did lead to a few questions such as 'Why would I want to load any words in the first place', but it did make the whole concept seem straightforward and induced my more reticent testers to load it up.

What you get are two windows, one for the turtle (though you can change this to a sailing boat, train, feet and so on) to roam around in and the second holds the instructions. You can type instructions in or use the toolbar - whatever button you click the command appears in the window; some, such as movement, require a number. You can move in screen units - in Mode 28 the turtle's screen is about 1000 units high and 1200 units across - go too far and the screen wraps so the turtle appears at

the other side of the screen. You can also move by coordinates and bearings, or even vectors if you're feeling confident. Turns are measured in degrees.

You can LABEL your turtle creations or TYPE anywhere on screen though this can't be undone whereas labels can be. And if you really like something why not loop it again and again!

There are some sample puzzles, worksheets and lots of guidance in the box and the program is very forgiving of novices and accepts a range of language for different operations. Now if you want to build your own procedures (called Words here) it is straightforward and the work children have done in creating these

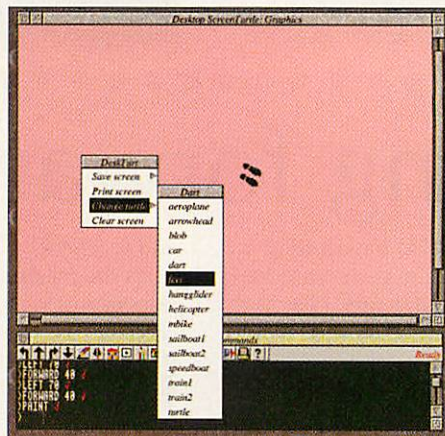

and working with them can be saved to give teachers evidence for recording purposes.

There are excellent examples which come with the program: My favourite is bunnies which

loads and uses the words *circle*, *curve*, *petal*, *head*, *eyes*, *whiskers*, *teeth*, *bunny* and *go* and draws lots of the creatures on the screen for you.

If you need a LOGO or turtling program this is a must, but should you upgrade from an earlier version? As well as now being fully compliant with StrongARM and the A7000+, there are other changes such as the toolbox which has been replaced by a permanent toolbar (with options to remove some or all of the buttons). If you attach numbers to the arrow buttons you can use this as a click/draw program. You can also define a screen with parameters which means that this supports the new IT exemplar scheme from the DfEE and QCA. Children can add and remove variables as they develop their own words/procedures and Screen Turtle will display variables dynamically so children can see how they are changed inside their words. All the normal toolbar functions are now available as you create or edit words which makes life easier for younger users and Screen Turtle 3 highlights each line as the program is stepped through so children can see exactly which line is doing what. Good value for money too as this can be used effectively from Key Stage 1 up to 3. **END**

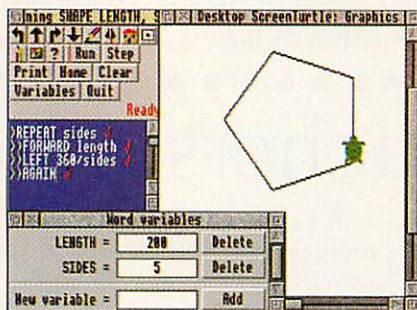

Product details

Product: Screen Turtle 3
 Ages: 7+
 Price: £45 for single user (upgrade free if previously bought 1998/9, otherwise upgrade cost £15 for single user). For information on site licences contact Topologika
 Supplier: Topologika, 1 South Harbour, Harbour Village, Penryn, Cornwall TR10 8LR
 Tel: 01326 377771
 Fax: 01326 376755
 E-mail: sales@topologika.demon.co.uk
 Web: www.topologika.com

Talking

*Pam Turnbull
looks at a new
release of an old
favourite*

topics

Look! Hear! Talking Topics were first released on floppy disc in 1994 and these simple databases proved ideal for Reception and Year 1 classes. Sherston have now put all the books onto one CD-ROM.

There are six altogether: *The Body*, *Land Transport*, *Dinosaurs*, *Homes*, *The Seashore*, and *Pets*. All the text is read aloud - just click on the ear icon to hear it - and the contents screen lists the chapters on each topic.

Each chapter consists of two (though the occasional chapter has three) pages of text and pictures. The first page gives general information, the second more specific facts, figures and comparisons.

Text is large and clear and there is never too much information on screen at once. At any time children can click the ear to hear the text or the eye to see an animation and/or sound effect. Using Sherston's Playbook program shell common to *Naughty Stories*, *Rosie and Jim* among others this will be a familiar format for many schools.









Once the program has been installed on to your hard disc you'll be asked to choose one of the books. Choosing *The Body*, for instance will open a page of nine chapters: seeing, hearing, smelling, tasting, feeling, breathing, eating, moving and growing. The information is not comprehensive but it is interesting, varied and leads to further questions or research. Clicking on the open book icon will return you to the chapter menu, click again to go to the book menu.

The other topics have been well chosen covering areas which are regulars in the classroom. The content is also very much British-based. For instance, *Land Transport* covers bicycles, cars, buses, trains,

motorbikes, tractors, horse-boxes, milk tankers, car transporters and tanks. Information is given in kilometers per hour and would mesh nicely with topic work on the environment.

Also *Homes* covers everything from houseboats to manor houses and places each in a country, town, village or city setting, while *Pets* covers 10 favourites from cats and dogs to tortoises and stick insects. Did you know that goldfish can live up to 25 years?

Dinosaurs covers ten of the beasts: Ankylosaurus, Baryonyx, Coelophysis, Diplodocus, Pachycephalosaurus, Parasaurolophus, Velociraptor, Stegosaurus, Triceratops and

	 Baryonyx 
	The name means heavy claw.
	It was nine metres long.
	It ate fish. 
	A 30cm. long baryonyx claw was found in England. 

Tyrannosaurs. The first page sports an extra icon of a person and clicking on it shows the relative size of a dinosaur, this is expanded further by giving the size in metres but also in people lengths.

There are real gems of information in these books: such as the 30cm Baryonyx claw found in England or that the Prime Minister lives in a terraced house.

These really set my children talking and thinking with some intense discussion about whether Tony Blair should live in a bigger house like the Queen or President

of the USA or whether he lived in the house at all or a flat in a house.

The Seashore was a book I hadn't used before but proved useful for finding out about creatures as diverse as limpets, barnacles, sea anemones, jellyfish, razorshells, lugworms, winkles, shells, starfish, sea urchins, crabs, and seaweed.

As two or more items are shown together the program labels the pictures which I found useful in the Literacy Hour - pages are easily printed, just press Control+P.

I used the same print option to print out the two pages of shells and their names which became the basis of a sorting exercise. Can you tell the difference between a cowrie, cockle and oyster-drill?

Also on the CD you'll find a selection of worksheets supplied as sprite files. Are these a useful resource to spend your money on? Well they're useful in the Literacy Hour for a variety of learning purposes whether differentiating between fact and fiction or building reference skills, the dinosaurs section I found useful when teaching standard, non-standard and comparative measure while the content led to much discussion useful across the curriculum. **END**

Product details

Product: Look! Hear! Talking Topics
Ages: 5+
Price: £29.95
Supplier: Sherston Software, Angel house, Sherston, Malmesbury, Wilts SN16 0LH
Tel: 01666 843200
Fax: 01666 843216
E-mail: info@sherston.co.uk
Web: www.sherston.co.uk

SAVE
OVER £30

IDE CD-RW offer

Always wanted a CD ReWriter? Can't afford the expense of a SCSI drive and a SCSI card? Here's an offer you can't miss!

Bought to you in association with Eesox, this remarkable value-for-money package is an offer you can't ignore. This IDE CD-RW is easy to install and comes with full fitting instructions. It also comes with Eesox's own *CD Scribe* software allowing you to create CDs easily and quickly.

It can read normal and Audio CDs. It will also allow you to write to CDR, but, unlike most CDR writers, will also allow you to use CDRWs. CDRWs have the advantage of being reusable, all you have to do is erase it, then use it again.

Sorry, but this offer is UK only.

Requires an A7000 or Risc PC with at least RO 3.5, a harddisc and one internal IDE slot free



ORDER FORM

Please send me IDE CD rewriter(s)

Name

Address

.....Postcode

E-mail

Prices include postage and packaging and VAT

I wish to pay by:

Cheque/postal order (payable to Tau Press Ltd)

Credit Card (Visa/Barclaycard/Mastercard/Access)

Credit Card No:

Expiry Date: /

Name on card:

Signature:

Please tick here if you do not wish to receive promotional information from other companies

For the amazingly low price of £170 inc P&P and VAT, you will receive:

IDE/ATAPI CD-RW 2x2x24

Eesox *CD Scribe* software (and Win95/98 software)

3xCDR

1xCDRW

CD Marker Pen

Audio and data cables and screws.

Last month we looked at the theory of a sound exciter, basically it added controlled amounts of harmonics to an audio signal. Choose the right harmonics, at the right level, and the sound appears to be more alive and punchy. To do this we need to be able to construct a circuit capable of having any transfer function we want. We looked at a simplified block diagram last month but the full circuit diagram is shown in Figure 1.

At the heart of this is a dual-ported RAM, I used the IDT7130 which is 1K8-bit, however, I am only using a quarter of it so if you come across a 2568-bit dual ported RAM you could use that. This RAM, as its name suggests, has two sets of address and data lines, this means that we can read and write to it with two sets of signals. Here I want to read it with one set, and write to it with the other set.

The computer needs to write to this RAM in order to set-up the look-up table, but

is an ultra-fast one that I just happened to have lying about, but virtually any D/A converter would suffice here. The only other thing is that the A/D converter needs a bit of a kick to get it started, and that is where the transistor comes in.

Writing to the RAM is summarised in Figure II, it shows what bits need to be toggled to latch in the address and then the data. Once the transfer function has been written into the RAM then the circuit will continue working without any further computer intervention, so any controlling software only has to be able to calculate the transfer function and write it to the RAM. However, the word 'only' here hides quite a bit of complexity.

You see, the idea is that we can control the transfer function by use of a foot pedal. Maplins sell a foot pedal with a 100K log potentiometer in it, this is fine as a volume control but not so good for our purposes. I replaced this with a 100K linear

Excite your audio

Mike Cook explains the software that will twist your sounds

63

with 8 data bits and 8 address lines we have to resort to a bit of multiplexing to achieve this from the printer port. I have used two 4-bit latches, 74LS75, to hold the address lines steady while the printer port provides the data inputs to the RAM. The printer control line C2 provides the write pulse to put a byte into the RAM. Once our transfer function is stored in the RAM then the rest of the circuit applies this to an incoming audio waveform.

The audio input is put on the input of the analogue to digital converter, with two clamping diodes in case the input exceeds the power supply rails. The digital output is then fed to the address lines of the RAM, and each time a sample is ready the monostable, 74LS221, is triggered to generate a read pulse. The contents of that address are fed to the input of a digital to analogue converter and the output sample is generated. The D/A converter used here

potentiometer and connected it to the analogue input (A0) of my IIC interface board. The wiper of the pot (centre connection) is wired to A0 and the end connections to +5V and ground. If you want the foot control to work in the opposite direction swap the end connections over, but it really doesn't matter. Use the IIC monitor application to see that it is working smoothly.

Now, on the cover disc is the application *Distort* – the icon is supposed to represent an input sound being minced up to produce an output waveform. Double-click this to produce the control window and with the live update box ticked you should see the pedal number and transfer function change as you move the pedal. You can still experiment with this if you don't have the hardware as all the values can be typed straight into the icons. Along with the transfer function is a drawing of what a sine

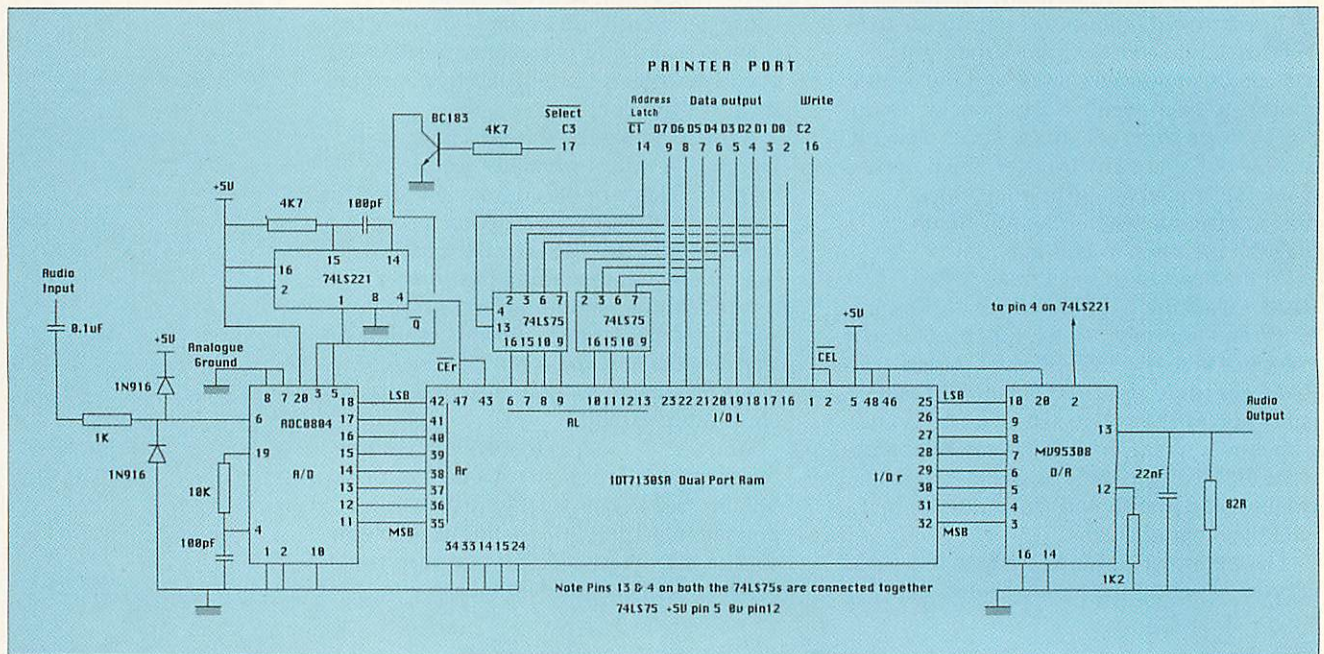

Fig 1: The transfer function circuit

wave will look like when passed through the transfer function.

The pedal allows you to use 256 different transfer functions and it would be quite tedious if you had to put them all in one at a time. Instead the application allows you to define key transfer functions and then generates a series of them that blends from one to the other. At its simplest you only need to define the functions at 0 and 255, here is how to do it.

Make sure that there is 0 in the *From* icon and 255 is in the *To* icon and pull the harmonic sliders up and down so you have the mixture of harmonics you want. Then click the right-pointing *Make* arrow and the transform function and the resulting waveform will be displayed. Then click the up-arrow under *Make* and the *To* and *From* values will swap

places. Adjust the harmonic mix to the one you want and again click the right point *Make* arrow. Now click the *Fill* button and the computer will calculate the transfer functions between the two you have set up.

With a pedal connected and the *Live update* ticked you can now see all the intermediate transfer functions as you move the pedal. If you haven't got round to making the hardware yet click on the *Live Update* icon and an up-arrow will appear above the pedal number. You can type in a pedal value and click on this up-arrow to see the transfer function at that point.

To get really fancy you can morph between several functions, for example no distortion in the middle with second harmonic at one end and third at the other. The left-point

arrow on the pedal icon will transfer the current value to the *From* field to allow you to define your transfer function at that point. In this way you can set break points at pedal movement positions that you feel comfortable with. Finally, when you are satisfied with a transfer function you can save the set from the application's menu. There are several sets I have made on the cover disc. On slower computers,

that is non-StrongARM ones, *Live update* should be turned off to get a good response from the pedal.

There are a few points to note when using this circuit and the first is that it accepts a signal at 5 volts peak to peak. You don't get this value from a guitar or other instrument so there needs to be some amplification before hand. Also the amount of harmonics introduced only applies to a full amplitude signal, for anything less than full amplitude there will be less distortion, this is the nature of the transfer function technique.

One way to elevate this is to feed the signal through a compressor before this circuit. Also you might want to use a pre-distortion filter to remove any very high harmonics, remember this is a digital system and as such any harmonics higher than half the sampling frequency will show up as aliased distortion, which sounds very grating. You can also use output filtering to smooth the sound even more.

There is a phenomenon where the ear quickly gets used to distortions of this type so use them sparingly in a studio mix otherwise you will find yourself putting more and more distortion in. Finally, if you like the idea and the sound you could, at considerably greater expense, adapt this to produce a 16-bit version for even better sound quality. Happy transfer functioning. **END**

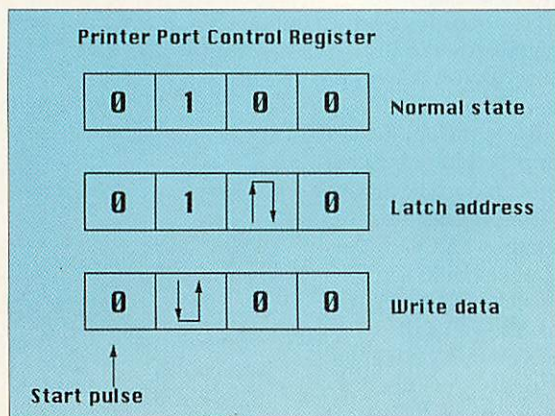

Fig 2: Controlling the memory

- Wanted: SimCity 2000 for A5000. Must work with only 4Mb. Also Scanlight 256 Mk III (greyscale hand-held scanner with software) for A3010 etc. for sale £45 ono. E-mail: James@ingshouse.freereserve.com
- Must go. Two slice StrongARM RPC 600 with new boot software and Doggysoft newlook desktop. 24Mb RAM, 2 H/D's, 500Mb and 1.6Gb HD, 4xCD-ROM. 14" Monitor YellowStone RepIDE card. 486sxl PCcard and a CC hand held 256 grey Scanner. Impression Style, Termite Internet software and PC software eg. Windows 95, Netscape 3. £600 ono. Tel: 01494 565399 Evenings. Kev
- Wanted: Acorn Winchester HD for BBC Micro. Sensible prices paid. Tel: Paul on 0181 202 3309 or e-mail: paul_jagger@uk.ibm.com
- Leading Edge joystick interface V2.40; CC Video 256 card inc hand scanner & SA software; Revelation 2; Junior Pinpoint; CSH multimedia showcase; CSH amazing maths; CSH Cromwell the fire fighter; Vivid 5000; Chatter; Pipedream 3; Pipedream 4; Fabis Font Namer; Oregon DiskCat; Spell; The Big Picture. For BBC enthusiasts Magscan & Fontstyle. Offers to David on 0161 941 1683 or e-mail: marshalls@argonet.co.uk
- RPC 700, 450Mb HD, 20Mb RAM, std. monitor, BJC4100 colour printer, Irlam colour mobile scanner, Impression, ArtWorks etc etc. Looking for a good home, offers welcome. E-mail: charlescol@aol.com
- Laptop & printer. Olivetti Echos 43 Colour laptop. Intel 486 DX2/40MHz, 8Mb DRAM (exp. 24Mb), 1Mb VRAM, 170Mb HDD 2 No. Type II (or 1 No. Type III) PCMCIA Card Slots, built-in mouse, port for ext. monitor, docking port for desktop configuration. No software or manuals. Mannesman Tally T7010 Black Inkjet Printer. Each item complete with Power Supply/Battery Charger units. Plus NEW Targus CN04 Universal Carry-case (holds everything). £300 the lot. Tel: Hill (evenings) on 01574 270184 (Larne, N.Ireland)
- Acorn StrongARM RPC, 1.7 Gb HD, 20Mb RAM, Multimedia. Brand new, unwanted prize. £850.00. Tel: 0181 303 5979 (Bexley) or e-mail: Computer@kmb-pr-travel.co.uk
- RPC 700, 17in colour monitor and PC using dual switch box. Scanlight scanner. Proteus Drive 2 optical Discs. 13Mb RAM 5.4GB HD. Impression. Other software. £850 ono. 01566 774719 (North Cornwall)
- A420/1, 4Mb Memory, 40Mb HD, RGB Monitor, RISC OS 3. Includes all Manuals and software. Good Condition. £130. Buyer Collects. Tel: 0181-551-1839 (Ilford)
- 486 SX-40 PC Card for Risc PC in box with manuals and RISC OS software - £40 ono. 128Mb Risc PC Simms £130 (£250 for 2), 32Mb £30, 16Mb £15, 8Mb £8. E-mail: tim.joseph@cwcom.net or tel: (0118) 947 8480 (Reading) after 5 pm
- RPC 700, 24+2Mb, 850HD, CD-ROM, PC Card, PRM, Acorn C/C++, 100s of Acorn magazines, various software and books. £500. Offers considered. Tel: 01279 402135 (Can leave message) Rob or e-mail rmb@nortelnetworks.com
- Acorn 4000 with monitor, keyboard, mouse, trackerball and powerpad with the game Burnout. £150. Contact Alan Gillespie, Wigton, Cumbria. Tel (016973) 43518.
- 72pin SIMMS for sale! 8Mb, tested in Risc PC, 4 available, £10 each. E-mail: Christopher.McKeown@ncl.ac.uk
- RPC600 with 700 CPU, 48Mb DRAM, 1.2Gb HD, 8x CD-Rom, 586x 133MHz PC card, Windows 95/98. Very good condition £600, also RiscPC600 CPU card £50, plus lots of software. E-mail: k.rolfe@virgin.net or Tel: 01703 868695
- RPC600, AKF60 monitor, 410Mb HD, 48Mb RAM, CD-ROM, manuals, CDs, etc (magazine), loaded with software, excellent condition. Offers over £500 please. E-mail: keith@bronteland.freereserve.co.uk or tel: 01535 643 419 (Yorks) will send if required
- Arcterm7 £10, MacFS Lite £25, DOS 6.2 £10, SCSI I Cable £2, Chocks Away £5, Chopper Force £5, Powerband £5. Tel: (0113) 2421797
- ESP Midi Synth Plus. Play MIDI files via software. Complete package with CD and discs. Cost over £100. Quick sale £50 inc postage. Mobile: 07990 507 524
- RPC 700, Twin Slice, 24+1Mb, CD-ROM Drive, RapIde Card, Audio Dynamics DMI 50S Card, DX4-100 PC Card, 3.8Gb and 420Mb Hard Drives, PC Pro, PC Sound Pro, All boxed, as new, £420 o.n.o. Tel: 01642 711866 or e-mail cojk@knock.freereserve.co.uk (Cleveland / N.Yorks)
- A3000, 4Mb RAM, RISC OS 3.11, 14in monitor, VGC, boxed with manuals and stand. £100. Phone (01786) 822607. (Stirling area)
- Reasonable offers accepted on Birds of War, Virtual Golf and Augusta course, Stunt Racer 2000 and extra tracks, Break 147 and Superpool. Tel: 0958 746440

Acorn User Free Ads Service

Why not take advantage of our free reader ad service? Fill in your details on this coupon (25 words maximum, one word per box below) and send it to Free Ads, Acorn User, Tau Press Ltd, Media House, Adlington Park, Macclesfield SK10 4NP or by e-mail to: freeads@acornuser.com. Only one ad per reader please. Although we try to publish every ad we receive, we can make no guarantees;

publication is entirely dependent on space and time constraints. We may also publish free ads on the cover disc if magazine space is short. Please fill in your name and telephone number below - these will not be published, but they enable us to contact you in case of any queries. Please include your town/county in each ad to help other readers with their purchasing decision.

Your name: Telephone no:

450478	Hand scanner	Canon BJC4100	£25. Solid	£77.95
£10.00	DX4-100	tray	ArtWorks	more
33.6	Games	loads	more	

Rambles though Acorn

Mike Cook
gets another
bumper crop



Another bulging postbag this month, keep those letters coming. To kick off, in case you've not heard elsewhere, Mike Buckingham is looking for those interested in audio projects, he writes:

'An associate is trying to build up a list of Acorn users interested in using sound on the Risc PC, especially those who have some practical bent. This may turn into a group to put good audio support back on the agenda. If you are interested contact me at: mb.renegrad@acornet.co.uk

Next, Jonathan Smith has a word to say on the subject of networking Acorns:

'I have discovered that there is a software package available to network two Acorns. It is available from Desktop Projects for £20 pounds without a cable.'

Thanks for that, I haven't seen it so I can't comment specifically, however, note that networking and file transfer are two very different things, so you have to be sure what you need.

Next, Martin Angove wants to tap signals from his computer:

'I have an old A3010 2Mb, floppy only, and thought, since it has an RF connector, there must be composite video on the motherboard somewhere for feeding into the tin can at least. I'd like to get at this so that I can use the computer for video titling. I'm using MODE 7 on a Beeb at the moment, which is actually rather good, but anti-aliased fonts sound like fun to me, and the 'chroma key' circuit on my video

mixer has some problems with the thin lines so it's not easy to overlay text on pictures.

'So, have you any idea, first where I can tap off the composite, and second whether I'll need to buffer/amplify it so that my video mixer and recorder can see it? I don't need the RF at all since I'm using a monitor with the machine if that helps.'

The best place to get it is on the input of the modulator can itself, there are three inputs; power, earth and composite signal. Run a length of screened cable from the modulator can into your video mixer. If you find there is not enough signal try disconnecting the connection into the modulator first as that will boost the signal. If you have to resort to an amplifier remember it needs to have at least a 6MHz bandwidth.

Aaron Larnder goes on to ask another question:

'I have two machines, an A5000 and an A3010 that I would like to connect using Econet. The A5000 already has an Econet upgrade fitted but the A3010 doesn't, and I know the standard upgrade can't be used with it, so is it possible to get an expansion card that provides Econet capability?'

Yes you can get a card to fit Econet into an A3010, but it's not as simple as just connecting two computers together. You need a network server (another computer dedicated to just controlling the network). So you are always 'throwing away' one computer, therefore there is not much point in networking just two

computers (at least with Econet anyway).

If this were a Mac the file-sharing software would allow you to do this through the serial port and for RISC OS machines with bi-directional printer ports you can get *ParFS* from ST Developments - both your machines have bi-directional ports.

Scott Boham has an idea for a new project he wants me to build:

'I have recently seen that laser diodes are really cheap, around £30, and was wondering how you would go about making a computer-controlled laser show thingy. I think they use servos to control mirrors that move the laser beam about really quickly so it looks as if there is a continuous line on the wall/ceiling/fence. The main problem I can see is that would it be possible to control two servos from the Acorn? I have a few lying around from old radio-controlled cars and thought I could put them to use.'

I have thought about doing something like this since I got a Laser pen in '97. However the problem is the servos. These need to have a very quick response time, the ones you get in model shops will not be fast enough. You need it to run at least at 50Hz. Then there are the mirrors, basically these need to be front-silvered otherwise you get two reflections, one off the glass, the other off the silvering.

There is no problem with the computer speed, you could even get the model B fast enough. It might be possible to modify some loudspeakers with a metalised patch,

but not many people have access to a vacuum-deposition unit. Anyway I will keep it in mind, thanks again.

Scott continues his letter by adding his advice to past problems:

'Reading February '99 *Acorn User*, Graham Brooker says he wants to connect his Acorn to a PC. I connected my PC to my A3010 using the serial ports. I use *GrapeVine* terminal software on the Acorn and *HyperTerminal* on the PC. I send files using the Xmodem protocol and it always works at 19200bps.

'The cable was a bit tricky to set up though, I've got one of those ones with all the switches on each end so you can play about with the connections without having to do any soldering. After random trial and error I came up with the following setup that works. Connect pin 1 at the Acorn end to pin 1 on the PC. Do the same for pin 7. Connect pin 2 on the Acorn to pin 3 on the PC and vice-versa. Also connect pins 4, 5 and 6 together at the Acorn end.

'It may be different for an A7000, but this works fine on my A3010. I hope this can be of some use.'

Next Mark Unstead from Slough wants to bring a new lease of life to some old technology:

'I have currently got an ancient

BBC microcomputer and I wish to use this in assessment of human performance by using an exercise cycle and cycle computer. I need to obtain a digital/analogue interface for the BBC so I can use the data from the bicycle in a program to calculate power output and CO2 max values.

'Would I need to alter the signal form the revs counter on the bicycle computer to comply with the D/A interface? I am also a bit in the dark with regards to including the interface data in a spreadsheet, would I be able to just refer to the input.'

It appears you don't know what sort of signal you are getting from the bicycle. If it is an analogue one then you need an A/D converter not a D/A. You need to know what voltage range it kicks out for how many revs. However, a rev counter is normally digital, that is you get a pulse for each revolution of the wheel.

In that case you don't need any interface, or at the most one that converts your pulses into logic level pulses. Then all you need is a program that counts the pulses and measures the time - it's rather trivial. As to the data what you have to do is to gather and store the results in a text file with the numbers separated by tabs - or some other separator

defined by your spreadsheet - then you load the whole file into your spreadsheet.

On to the vexed problems of Pascal, my thanks to Tony Penton, Aaron Larnder and Ben Carter for this information:

'There is a "free" version of Pascal for the Acorn, the GNU Pascal Compiler (GPC). It is available from HENSA or can be ordered from APDL. There is another called "Norcroft Pascal", which was basically free but requires Acorn C to work, I think it was available from Acorn's Website at some point. This was very good and stable - I did some fairly major programming on it at one point.'

Carsten Bollenbach finishes thing off with a quickie:

'I have one of the very last A5000s and I am looking for a Linux distribution for this machine. My searches weren't as successful as expected so I thought that you can help me. Do you know any sites or sources where to get a copy of Linux for A5000?'

Try <http://www.arm.uk.linux.org/~rmk/armlinux/arch.html> However you might be struggling with only 4Mb. **END**

Simon Lee can only use a decent computer occasionally so his problems can take time to sort out:

'I wonder if you can give me some advice about troubles that I'm having with the family computer (a StrongARM Risc PC) which I can only get access to during the university holidays. Firstly, the CD drive gives a 'drive empty' message whenever you try to access it. A friend said that it might just need cleaning (would an audio CD cleaner work?). However, if that didn't work, then I suppose that it would need mending.

'Unfortunately the supplier (Beebug) has now stopped doing anything useful on the practical side of things, and it would be a great inconvenience to have it sent away - my dad uses it for work, and my sister for projects. Therefore, would it be relatively simple to replace it myself? I'm willing to have a go but I'm scared by the dangers of static electricity

and things damaging the computer.

'Also, would I be able to fit a PC CD drive instead (if it was the drive that wasn't working) - the same friend said that they are available from about £20. Secondly, I have always had my suspicions that the VRAM supplied with the machine isn't working either at all, or properly. Is there any way to test this without resorting to one of your complicated-looking electronics projects? I hope that you're able to help in these matters - independent advice is hard to come by these days.'

With regards to the CD drive it can be either the hardware, that is disc drive or interface, or the software, perhaps something has changed in your boot sequence. It will not be cured by cleaning, because if that were the problem the error message wouldn't be about empty drives but about unreadable discs.

You will have great difficulty damaging anything by static in fitting a CD drive. However, be warned that

not all PC drives will work and I don't know how to tell which will and which won't because it all depends on the sort of interface and driving software you have and how that interacts with the new drive.

Anyway I went to PC World last month for a new drive for my Mac (it uses an IDE type) and the price is nearer £40 than £20. I did try it in my Risc PC and it wouldn't touch it although I have heard of people getting them going by using the *CDFSSoftATAPI* module that's part of the operating system. However I think you are best going to an Acorn outlet then you know it will work.

You can tell if the VRAM is working in two ways. First look at the total memory you have (click on the Acorn) the VRAM is added to the total, so if you have 8Mb RAM and 2Mb VRAM you should see the total of 10. Second try accessing a high resolution mode or one with greater than 8-bit colour.

ADVERTISERS' INDEX

Aleph 1.....	57
APDL.....	12, 14
Argonet.....	23
Arm Club Show.....	40, 41
Cannon.....	46, 69
Castle Technology.....	OBC, 69
CTA.....	4, 5, 68
Davyn.....	68
Desktop Projects.....	9, 69
Eesox.....	32
Electronic Font Foundry.....	12
IFEL.....	18
Irlam Instruments.....	IFC
ITS Consultancies.....	68
Liquid Silicon.....	32
Pineapple Software.....	57, 69
R-Comp.....	45
RISCOS Ltd.....	36
Spacotech.....	IBC
STD.....	57
The Data Store.....	58, 69
Uniqueway.....	69
Wardlaw Surveys.....	69



168 Elliott St.
Tyldesley
Gtr. Manchester
M29 8DS

Acorn Dealer and RiscOS Centre of Excellence

Acorn Spares and Repairs

All Acorn Machines available on 0% finance

Installation, Networking
Repairs on a no-fix
no-fee basis.

See Main Advert on
Pages 4 & 5

Tel. 01942 797777 Fax 01942 797711



We thought we'd tell you something about Frak...

but what can we say?

WEST YORKSHIRE

THE CHOICE OF EXPERIENCE **For the best service in Yorkshire (we think)**



Visit our Showroom

Open 9.30 to 5.30
Mon, Tues, Weds, Sat.
9.30 to 7.30
Thurs & Fri.

Davyn Computer Services
Printers, Ribbons, Ink Cartridges, Refills
Expert Advice & After Sales Service
Mail Order Master Card, Visa, Switch
Ring for Prices
Service & Repair to all Equipment
Full Range of Acorn Hardware & Software
(We operate the Acorn Finance Schemes)
Full Range of Educational Software
Tel. 01924 254800 Fax. 01924 258036
e-mail sales@davyn.demon.co.uk



How to find us

WE ARE HERE
The 'Workshop'
off Princess Street
Sandall
Wakelield
WF1 5NY



WILTSHIRE



ITS consultancies

Your Acorn Approved Specialist
with Teaching Experience

Educational Consultancy Training and Support
Acorn Computer Supply and Installation
Software Upgrades and Repairs

Tel - 01225 764863
Fax - 01225 761437
email itscon@argonet.co.uk

Contacting us

Editor: editor@acornuser.com

Enquiries: enquiries@acornuser.com

Advertising enquiries: johns@ssm1.telme.com

Web master: webmaster@acornuser.com

Subscriptions: subscrip@acornuser.com

Free Ads: freeads@acornuser.com

Letters: letters@acornuser.com

News: news@acornuser.com

Comms page: comms@acornuser.com

PD page: pdpage@acornuser.com

Business page: bizniz@acornuser.com

PC page: pcpage@acornuser.com

Music page: music@acornuser.com

Games page: games@acornuser.com

Education page: educ@acornuser.com

Rambles: rambles@acornuser.com

SOUTH EAST

CANNON COMPUTING AUTHORIZED RESSELLER **CITRIX** 

Acorn Educational Reseller

Key independent Educational suppliers of customised 'switch on and go' Acorn Computer systems, associated peripherals for 15 years. We specialise in the installation, supply & configuration of complete intergrated multi-platform networks.

Please see our main page advert for more details of some of our products.

Incorporating **CUMANA** The best name in memory

Whitegate, Dunmow Road Hatfield Heath, Bishop's Stortford Hertfordshire. CM22 7ED
Tel +44 (0)1279-730800 (Cannon)
Tel +44 (0)1279-730900 (Cumana)
Fax +44 (0)1279-730809
www.cumana.demon.co.uk

LONDON

THE DATA STORE microcomputers 0161-463 2941

FOR SIXTEEN YEARS, PUTTING THE EMPHASIS ON THE VERY BEST SERVICE...

THE DATA STORE

Visit our well-equipped showroom just 30 minutes from Central London. For more information, look for our full-page ad elsewhere in this issue.

6 CHATTERTON ROAD BROMLEY KENT BR2 9QN
Tel (020-8)460 8991 • Fax (020-8)313 0400
Web <http://www.datstore.demon.co.uk/> • E-mail info@datstore.demon.co.uk
CLOSED ALL DAY WEDNESDAY

HIGHLANDS

Wardlaw Surveys

Authorised Acorn Dealer, for all your needs from supply, service, repair & full after sales.

Tel/Fax: 01463 831214

LONDON & ESSEX

 **Pineapple Software** 

Pineapple have been in the Acorn marketplace for over eleven years and we have recently moved into large new premises where you can see a variety of Acorn equipment in action. We specialise in building RiscPCs to your specification and we also supply scanners, printers, harddrives or anything else you may need for your Acorn system. We also undertake repairs and upgrades to Acorn computers. Come and visit us for a chat!

Open 0900 - 1730 Mon - Sat
352 Green Lane, Ilford, Essex IG3 9JS
Phone 0181 599 1476 Fax 0181 598 2343
e-mail: sales@pineapple.demon.co.uk
<http://www.pineapple.demon.co.uk>

CARDIFF

UNIQUEway 

SOUTH WALES' ONLY DEDICATED ACORN DEALER AND ACORN CENTRE OF TECHNOLOGY

Technical Support - Repairs - Hire - Internet Connections
Low cost finance available on all systems.



3 Clarendon Road, Cyncoed, Cardiff CF3 7JD
Tel 01222-464020 Fax 01222-440071
<http://www.uniqueway.co.uk>

SUFFOLK

 **CASTLE TECHNOLOGY** 

Full range of Acorn Computers
Comprehensive back-up service

Call 01728 621222 or
fax us on 01728 621179

Ore Trading Estate Woodbridge Road Framlingham Suffolk IP13 9LL
e-mail: sales@castle-technology.co.uk
Web: <http://www.castle-technology.co.uk>

NORTH WEST

THE 1997 **ACORN USER AWARDS** **'BEST DEALER'**

For all your Acorn needs Visit our Showroom **10am - 6pm Monday - Saturday**



Desktop Projects Ltd
Unit 2A, Heapriding Business Pk Ford Street STOCKPORT Cheshire. SK3 0BT

Authorised Acorn Dealer & Centre of Technology

Desktop Projects Ltd 
Tel: 0161-474 0778 Email: info@desktop.demon.co.uk

To advertise in **ACORN USER** contact **John Snowden on 01625 539494**

Subscribe to

The world's number 1 RISC OS Magazine

ACORNUSER

You already know what a great magazine *Acorn User* is – it's the only place you can get accurate, rumour-free, detailed RISC OS news, in-depth hardware and software reviews, and without doubt the best cover discs available.

Take out a subscription today and you guarantee never to miss an issue of the biggest and best RISC OS magazine in the world – at a lower price than you can get in the shops.

Subscribe now!

**Call our
Subscription Hotline**

Tel: 0870 606 0424

Fax: 01625 859808

e-mail: subscrip@acornuser.com

Please quote code 'A9908' when
subscribing by phone or e-mail

To receive the September *Acorn User* (issue 211) all subscriptions must be in by Friday 23rd July. Subscriptions received after this date will start with the October *Acorn User* (issue 212).

70

**back
ISSUES**

Missed out on one of our previous issues? Take this opportunity to bring your collection up to date. But hurry – stocks are limited

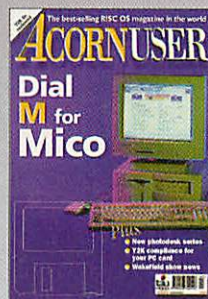

**Issue 209
July 1999**

- New Photodesk series
- Y2K compliance for your PC card
- New programming series
- Caves game on disc



**Issue 208
June 1999**

- Film Trailer CDII
- RISCOS Ltd interview
- APDL games CD's
- DigSigGen review



**Issue 205
March 1999**

- Web Wizard
- Using Impact-3
- Ovation Pro Tutorial
- Java Programming

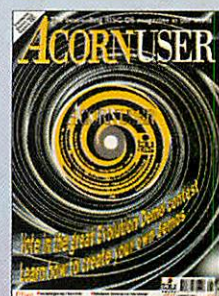

**Issue 204
February 1999**

- Evolution demo CD
- Evolution Competition
- Site Seer review
- Using Ovation Pro macros



The best-selling RISC OS magazine in the world

ACORN USER

Dial
M for
Mico



Plus

- New photodesk series
- Y2K con...
- you...
- W...

If you would like a copy of the current issue you can order it directly from us:
 Current issue prices
 UK £4.80 Europe £5.30
 World £6.90

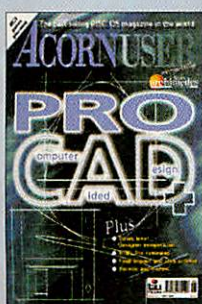

- Issue 207
May 1999**
- !ProCAD+
 - Heretic & Hexen
 - Acorn Confidence Part II
 - Fishy Disk



- Issue 206
April 1999**
- !OHP uncovered
 - Acorn Confidence Part I
 - !Sleuth 3 Review
 - Java and !Impact-3 continued



- Issue 203
January 1999**
- Rhapsody 4
 - AddressII
 - Speakers reviewed
 - Film Trailer CD

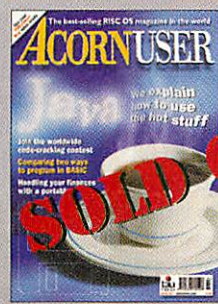

- Issue 202
Xmas 1998**
- Writing Java
 - !AUCD4
 - Code cracking
 - Wimpworks vs Wimpbasic

Please send me the following subscription/back issues:

Please subscribe me for:

4-issue subscription			
	<i>New</i>	<i>Renewal</i>	
UK	<input type="checkbox"/> AUN99084	<input type="checkbox"/> AUR99084	£15.99
EU	<input type="checkbox"/> AEN99084	<input type="checkbox"/> AER99084	£17.99
World	<input type="checkbox"/> AWN99084	<input type="checkbox"/> AWR99084	£20.99
8-issue subscription			
	<i>New</i>	<i>Renewal</i>	
UK	<input type="checkbox"/> AUN99088	<input type="checkbox"/> AUR99088	£29.99
EU	<input type="checkbox"/> AEN99088	<input type="checkbox"/> AER99088	£34.99
World	<input type="checkbox"/> AWN99088	<input type="checkbox"/> AWR99088	£40.99
Annual subscription (13 issues)			
	<i>New</i>	<i>Renewal</i>	
UK	<input type="checkbox"/> AUN9908Y	<input type="checkbox"/> AUR9908Y	£45.99
EU	<input type="checkbox"/> AEN9908Y	<input type="checkbox"/> AER9908Y	£51.99
World	<input type="checkbox"/> AWN9908Y	<input type="checkbox"/> AWR9908Y	£63.99

Please send me the following back issues:

	UK	Europe	World
<input type="checkbox"/> Issue 209, July 1999	£4.20	£4.70	£6.30
<input type="checkbox"/> Issue 208, June 1999	£4.20	£4.70	£6.30
<input type="checkbox"/> Issue 207, May 1999	£3.95	£4.45	£6.00
<input type="checkbox"/> Issue 206, April 1999	£3.95	£4.45	£6.00
<input type="checkbox"/> Issue 205, March 1999	£3.95	£4.45	£6.00
<input type="checkbox"/> Issue 204, Feb 1999	£3.95	£4.45	£6.00
<input type="checkbox"/> Issue 203, Jan 1999	£3.95	£4.45	£6.00

Any 2 back issues: UK £7.40 Europe £8.05 World £11.15
 Any 3 back issues: UK £9.60 Europe £10.55 World £15.20

I wish to pay by:

Cheque/postal order (payable to Tau Press Ltd)

Credit Card (Visa/Barclaycard/Mastercard/Access)

Credit Card No:

Expiry Date: Prices include postage & packing

Name on card:

Signature:

Name.....

Address

.....Country

Postcode.....Tel.....

E-mail.....

Send your completed Acorn User subscription/back issues form to:
Acorn User, Tau Press, Media House, Adlington Park, Macclesfield, SK10 4NP, England.

Telephone **0870 606 0424*** or fax your completed Acorn User subscription/back issues form with credit card details to **01625 859808**

*calls charged at National Rate
Have a query? E-mail subscrip@acornuser.com
 Please note e-mail is not secure, we do not recommend sending your order details as plain text.

Please tick here if you do not wish to receive promotional information from other companies

CAD and RISCOS

I have some information which may help Nick Turner in his quest for CAD on the RISC OS platform. However I can't answer his questions about *WorraCAD* – although I did look at this a few years ago, I chose to buy *ProCAD* and *Apollonius PDT* instead.

Version 1.21 of *Apollonius PDT* works fine on both a Risc PC600 and 700. The publisher, Oak Solutions, seems to have gone out of business. Does anyone know what the legal situation is surrounding this sort of thing?

However I usually use *ProCAD* (and more recently *ProCAD+*) in my daily engineering work. It's a wonderful piece of software and at £225 *ProCAD+* really is a bargain (*ProCAD* used to cost £500). It's very powerful and incredibly easy to use – a demo version can be downloaded from <http://www.zynet.co.uk/dsnell/>.

David Snell, the author of *ProCAD+*, has put hours and hours of work into this software and has listened to users carefully. Complicated lines, curves and arcs join up accurately enough for CNC use, unlike some of the much more expensive 'industry standard' CAD software on the PC platform. And the number of alternate drawing methods which he has built-in allows users to work the way they want to rather than having to work the way the software demands.

Complicated procedures like drawing multiple copies around a circle is fast and amazingly straightforward. A lot of thought has been put into facilitating the input and output of drawings to and from other software and hardware.

If it's of interest, I've written engineering software to work alongside *ProCAD+* and am

considering releasing it more generally. It enables you to convert selected parts of *ProCAD+* drawings into CNC toolpaths and to set-up all the parameters for a CNC milling machine. Oak Solutions once wrote something similar for Denford Machine Tools, but it was always considered to be rather weak. Readers wishing to obtain further details of my engineering software should get in contact with me.

Finally, I used to be a CDT teacher myself but now run my own engineering business, so I think I can claim to understand both sides of life (or work). I understand that £225 is a large chunk of school capitation, but it is quite small compared to the enormous power of *ProCAD+*. If I were still a teacher I would find the funds to buy it – even the most sceptical Head or Advisor can be persuaded if you're enthusiastic and firm enough.

Chris Bell
chrisbell@argonet.co.uk

As far as the legality of WorraCAD goes – copyright almost always reverts to the author if the company goes out of business. If the business is bought out then the copyright will go to the new company. Copyright must be actively relinquished in order to be removed before the 70 years it legally exists for – it never just evaporates.

No ArcFS

I have just received through the post my July issue of *Acorn User* and was pleasantly surprised to find that a copy of *ArcFS* wasn't on the cover disc. This is not a comment on the excellent program but I have thought this should be the case for some time now in order to fit more on the disc. I reckon everyone with a RISC OS computer now has a copy of it and

unless I'm mistaken all new machines have it included on the HD with the rest of the software supplied.

I would be interested to find out if any one contacted you as in the text file on the disc if they didn't have a copy. If this is the case, as I suspect, then is there any chance of it being a regular occurrence?

I would also like to add that the new magazine format looks fresh and professional and I think RISC OS has a very good chance of success in the future. Good luck to all involved.

Mike Hambley, via e-mail

It can be frustrating producing the cover discs with only 800K to work with, but this month we've upgraded to a 1.6Mb disc in order to fit the Botkiller2 demo on. As you rightly say, most people in the Acorn world must surely now own a copy of ArcFS, but in order not to disappoint anyone I'll continue to put it on if there's room.

However, if it's the choice between a useful PD app and ArcFS then I'll relegate the de-archiving program to the bench. Mind you, at only 49K there aren't many programs smaller – Sheep, for instance, was going to replace it this month, but was too large.

Where are the reviews?

I was interested to read D C Hammond's 'Great Ideas' letter and your response in the July issue. I fully agree with his point of view about new users; without fresh blood RISC OS is doomed to a lingering death.

Nick Van Der Walle's comment about the availability of new and up-to-date hardware is also very relevant, but interestingly, the week you published contained two announcements from Castle

Technology, of a new build of Risc PCs with the Revision T StrongARM, and upgrade boards containing the same chip.

By my rough calculation, the combination of the 'T' chip and RISC OS 4 would give about a 70 per cent speed increase over my 200MHz StrongARM/RISC OS 3.7 machine – a useful boost!

We need to actively spread the word. Manufacturers of RISC OS machines should endeavour to get reviews in PC magazines as well as the Acorn press.

No doubt advertisement rates in the likes of *Computer Shopper* and *Personal Computer World* are sky-high, but the audience is enormous, and the placing of ads should not be ruled out either, after all, PC manufacturers with relatively modest turnovers regularly advertise in a range of magazines.

The PC mainstream, as evidenced by the magazines I occasionally read, strikes me as much less 'Wintel-centric' now than a few years ago. Articles on Linux, EPOC and other OSes regularly appear, and the Silicon Graphics 320 workstation got a rave review in the April issue of *Personal Computer World*.

In the same issue a review of alternative platforms appeared; RISC OS is covered (at the same length as Mac OS) and in complimentary terms; it's robustness, graphical user

interface, anti-aliased fonts and extensive use of drag-and-drop are particularly highlighted.

The ARM chip is now a world-class architecture, which also helps to raise the profile of RISC OS outside the Acorn market. If the Millipede StrongARM machine turns out to be as capable as planned, I am sure reviews could be secured in at least one of the PC magazines already mentioned.

George Greenfield, Bucks

I've just called RiscStation and asked them about their plans for advertising the new machines in the PC world. It seems that reviews and product placement are the order of the day, as an advert on it's own may leave people wondering what on earth RISC OS is. Although PC magazines will be targeted, the national newspapers seem to be the main focus for RiscStation.

MicroDigital have also expressed a wish to advertise in the 'foreign press'. Adverts in Acorn publications will inform those wishing to upgrade their machines, but to get new blood into the RISC OS community PC titles will have to be exploited to their fullest.

Some form of agreement with RISCOS Ltd may well be sought on the advertising front, if companies can double up in promoting the RISC OS platform – hardware and OS – then all the better.

Incidentally, the article you refer to in Personal Computer World was co-

written by Ian Burley, who writes the news for Acorn User.

Peacock correction

Some difficulty may have been experienced when trying out my ColourCubeA and B from the June 99 *INFO. Where the hard copies do not match up with their on-screen appearance (missing rows in a block or wrong number of coloured squares). This is possibly due to the TextAreas falling slightly short of the grid points, forcing the last Selwyn character on a line to occupy the next text line, and is easily rectified.

Load the files and ensure that the Grid Lock is on, and the grid setting is Inch at 1"x16". Then alter the Zoom setting to 2"x2". Next, double-click on each of the three colour blocks in turn, and select-slick in their bottom handles so that the select boundary boxes enlarge to the rightmost grid points. They should line up with either the right outside edge of the cube net, or dotted division line. Re-save the files, and they should now print correctly.

Jack Peacock, Glasgow

p.s. I trust that an apology was made to Tom Thorne for suggesting that his ray-tracing programme came under my authorship.

Erm...no. Sorry about that Mr Thorne.

END

All-rounder

Having lived on a student income for the past few years, my software library has been rather sparse, but I recently invested in some new software, namely *Eureka 3*, *Datapower 2* and *EasiWriter professional*, spurred on by discount offers. I'm impressed with the quality and sophistication of these products. Especially good is the rapid development of *Datapower* and *EasiWriter*.

All three packages run well on my A540, and the level of integration between them is better than I had imagined – for example saving as *Impression* OLE format in *Eureka* means that selections can be dragged to *EasiWriter* directly.

Also *Eureka* and *EasiWriter* can read/write data to/from their Microsoft counterparts. This makes owning a Acorn far more flexible, even without a PC card.

What annoys me a bit is that a package like *Eureka* has been overlooked for so long – and yet it's one of the platforms most powerful packages. Surely the most attractive thing about a computer is a range of

powerful packages that can interact with other platforms – *RiscStation*, *MicroDigital* and *CTL* must take this into consideration.

Despite regular complaints that 'there is no software for Acorns', there are excellent applications on the market which could help them sell machines. Yes the graphics packages lead the way, but this should not overshadow the all-round ability of RISC OS computers.

Most businesses use Microsoft *Office*, particularly *Excel*, *Word* and *Powerpoint*. RISC OS packages can already take care of the first two. More has to be made of this, and quickly.

The Acorn Software Network on the Internet may be a great idea, but the lists have started to become a bit meaningless as many of the packages haven't been covered for ages – the market needs reminding about some of the greats – sales might just pick up as a result, and hopefully improve development of relatively neglected packages.

Paul Relf, via e-mail



Ian Molton

‘I couldn’t be “left behind” by my little sister’

About eighteen months ago, when I was spending the night at a friend’s maisonette, he was concerned that his computer might keep me awake at night ‘moo’-ing. My first thought was that he had some new *Cowz* screen saver, but it turned out that he was part of the *distributed.net* project (see *Acorn User* issue 202). My curiosity was piqued, and I felt from that moment I had to interview someone connected to the Acorn RC5 cracking group.

Ian Molton should be familiar to regular *Acorn User* readers through his articles on the RC5 cracking effort. Ian’s a first for the Regan files: the first transatlantic interviewee via e-mail. It was meant to be a face-to-face interview in the UK last December, but I had to cancel because of the dreaded ‘flu. Ian then moved to Montgomery in New York State to marry his fiancée Gina, and although coincidentally I was Stateside for a few weeks we never found the time to meet up.

‘Would it be OK if I stop short of the meaning of life?’ jokes Ian, when I demand to know everything. We compromise on his first encounter with Acorns which was when his father brought one home from work.

‘Being somewhat younger back then,’ explains Ian, ‘most of my time was spent playing *Labyrinth*. A couple of years later my sister and I got an Electron for Christmas, on which I wrote my first program. To be honest my sister actually wrote the first program out for the both of us – under direction from my dad she drew an envelope on the screen with DRAW and MOVE. Of course, I couldn’t be “left behind” by my little sister, so it went from there.’

For those of you who don’t know, *distributed.net* was set up in 1997 to solve immense numerical problems which need lots of processing power. The processing can be done in the background on your computer, in the quiet moments between mouse clicks and writes to the screen. The whole thing is called Project Bovine (hence the ‘moo’-ing

noises), possibly because of the notion of many stomachs ‘chewing of the cud’ through the data fields.

‘The software to do the cracking has been converted for RISC OS, so Acorn users can do it too,’ explains Ian. ‘More importantly, for those people who are proud of their Acorn computers and would like to spread the word, there is a league table of how well each platform is doing. People from all over the world see this table and so it would be good if RISC OS machines were up there with the front runners. It would really get RISC OS noticed.’

Like many Acorn enthusiasts, Ian tinkers not only with programming but also electronics

as well. He does have rather an ambitious project in mind, but sounds as though it could also be commercially viable.

‘Electronics is another strong interest of mine’ enthuses Ian. ‘I have always wanted a portable MP3 player, so I am hoping to build a small SA1100-based machine, which will be about as big as a walkman and will play MP3s. I am going to do it partly as an exercise and partly because I’ve always wanted one.’

So, yet another person who sees a non-Acorn future for the ARM chip, albeit away from the desktop market in this case.

‘I’m really pleased about how well dealers survived the big dump from Acorn, and I’d love to get my hands on RISC OS 4, and maybe that new Millipede motherboard. People always seem to moan about how expensive Acorn kit is, but when you look at how big the market is, how can it be any cheaper? And it lasts forever!’

A love of Acorns lasts forever too, it seems. Time and time again, I come across people who used Acorns when they were kids and simply kept using them. Ian is no exception, and feels that he owes Acorn a lot.

‘Well, I’ve basically learnt all I know about computers with various Acorns – from the BBC, through an Electron, Archimedes A410/1, and now a Risc PC with a StrongARM. I learnt to program BASIC, C, and Assembler, and have written a fair amount of software, including one or two programs I have been paid for. Acorns are great machines to use – although the hardware is looking a little dated right now. I’ll be using my StrongARM Risc PC as my main machine for many years to come, I’m sure.’

So if you want to put your spare processing power where your passion is and get cracking, go to <http://www.alphapro.demon.co.uk/Acorn/rc5des.html>, and your computer can keep people awake by going ‘moo’ too.

Jill Regan

TopBones and new TopModel CD ready.
Fully functional BJC7000 and BJC7100 PhotoReal Driver
and now brand new BJC2000 Driver! Epson Photo Printers
now much cheaper!

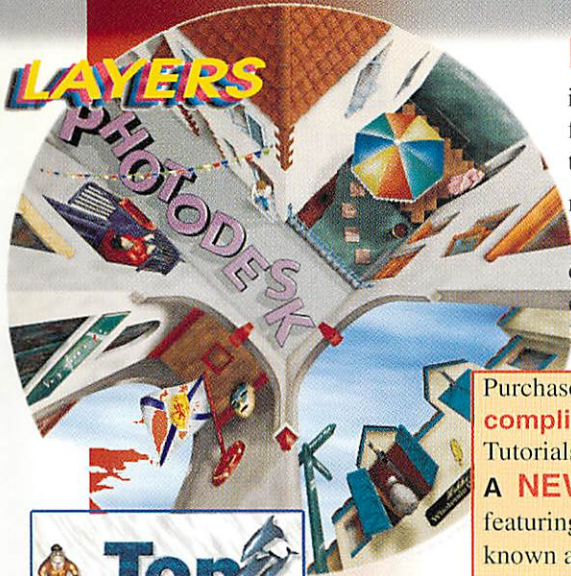

PHOTODESK 3 is the **LAYERS** package which defines studio quality image editing and artwork on RISC OS machines. It is easy to use but has many powerful features, including **LAYERS** and a sophisticated colour management system (CMS) for the full-time graphics professional. **£299.50** **PHOTODESK2** is still available, retaining the CMS but not layers, **now only £199.00**

PHOTODESK LIGHT, an economic alternative to PHOTODESK3 retains most of its creative features apart from the Colour Management System, Layers and some features essential to the professional user. **£134.75** **Plug-in Effects Packs** are available for all Photodesk packages. Each pack contains 10 special effects: **£19.95**

Purchasers of Photodesk 3 or Photodesk Light will receive a **complimentary CD-ROM** of useful resources, utilities and Tutorials. This CD is available to existing users for **£14.95**.

A **NEW CD-ROM "An Introduction to Digital Art"** featuring bitmap and vector graphics tutorials by the well-known artist, David Cowell, is also available for **£24.95**

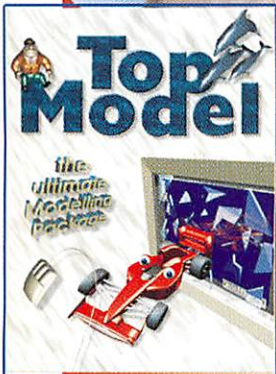

A New Version of **TopModel2 V.2.14** is now available for **£152.75**. Existing users may upgrade for **£29.95**. or buy the **NEW CD-ROM** packed with resources, the new plug-in **Top3DFonts!** and a free 2.14 upgrade for only **£58.63**.

TopBones Skeleton Management System now ready **£39.50** ... as well as **TopModel CD-ROM #3!** **£49.95**



OHP

A presentation package on CD-ROM from Spacetech

Makes your slide shows quick and easy to create!

- Start building your presentation 5 minutes before the lesson? - No Problem
- Use your existing work in a presentation? - No Problem, just drag 'n drop it in!

Only £29.95

digital cameras

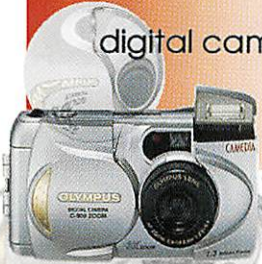

PhotoLink is an Acorn multi-driver for the most popular makes of digital camera. Cameras currently supported include the **new Olympus** range including the fantastic **C900 ZOOM**, the **theC830L** a new replacement for the 840L and the **C1400XL SLR Zoom**. Superb hard copy can be obtained via Epson or Canon **PhotoReal**. PhotoLink is available on its own at £69.00 or bundled FREE with a camera.

New Prices! **C1400XL £749.99** (was £999.99) **C830L £399.99!** (was £549)

C900ZOOM Zoom megapixel compact with Optical AND Digital zoom **£549.99** (was £649.99)



PhotoReal is the Acorn driver extension for the **Canon BJC4300, BJC4650, BJC7000, BJC7100 BJC2000, Epson Photo, Photo700 and PhotoEX** printers with photo-realistic capability. PhotoReal makes use of the same advanced techniques for producing high-quality four colour separations as Photodesk and comes ready calibrated for the special dye-based inks used for photo-realistic printing. A calibration application is also supplied to allow you to tailor the results to your own specification **Driver only £69.00 Inc.VAT. or FREE if purchased with printer!**
examples: Stylus Photo700 was £249.50 NOW £204.45 Canon BJC2000 £149.95 BJC4650 A3 £299.99. BJC7000 £245, BJC7100 £299.00, Epson PhotoEX A3 was £454.73 NOW £363.07 (all prices include PhotoReal Driver)

All Prices Include VAT

Spacetech Ltd

1 The Courtyard, Southwell Business Park, Portland, Dorset, DT5 2NQ, U.K.

Telephone: +44 (0)1305 822753

Fax: +44 (0)1305 860483

Email: sales@spacetech.co.uk

Web : http://www.spacetech.co.uk

Lightning-fast computing



Acorn 
RiscPC 233T

Castle's lightning-fast Acorn RiscPC233T sets the standard for robust, trouble-free computing. The 233MHz processor is further enhanced by the exceptionally efficient and robust RISC OS architecture. This puts the RiscPC233T among the leaders for raw computing power.

- **INTEL StrongARM 233MHz (revision T) processor** - ARM designed
- **Modular expansion** - increase the case size quickly and easily
- **2nd processor slot** - eg use with PC card for Windows applications
- **CE marked** - your evidence of top quality and safety
- **100% Acorn** - the original tried and tested Acorn design further enhanced

RiscPC233T

8MB, 2GB, RiscOS 3.7
£749 + vat

RiscPC 233T CD

18MB, 4GB, 40xCD,
RiscOS 4.0
£879 + vat



RiscPC233T WEB WIZARD

Internet Suite, JAVA, 32MB, 2VMB,
8GB, DVD-CD, 56K modem,
17" monitor, RiscOS 4.0
£1149 + vat

Order now!

Call 01728 723200

FreeFAX 0800 783 9638

Delivery £11 (£12.93 inc. VAT) per system.



CASTLE
Computers for Education
Business and Home