

ACORN USER

BBC micro, Electron and Atom magazine

April 1984 £1

ELECTRON:
user keys

GRAPHICS:
with 6845

BBC TV:
schools

REVIEWS:
15 packs

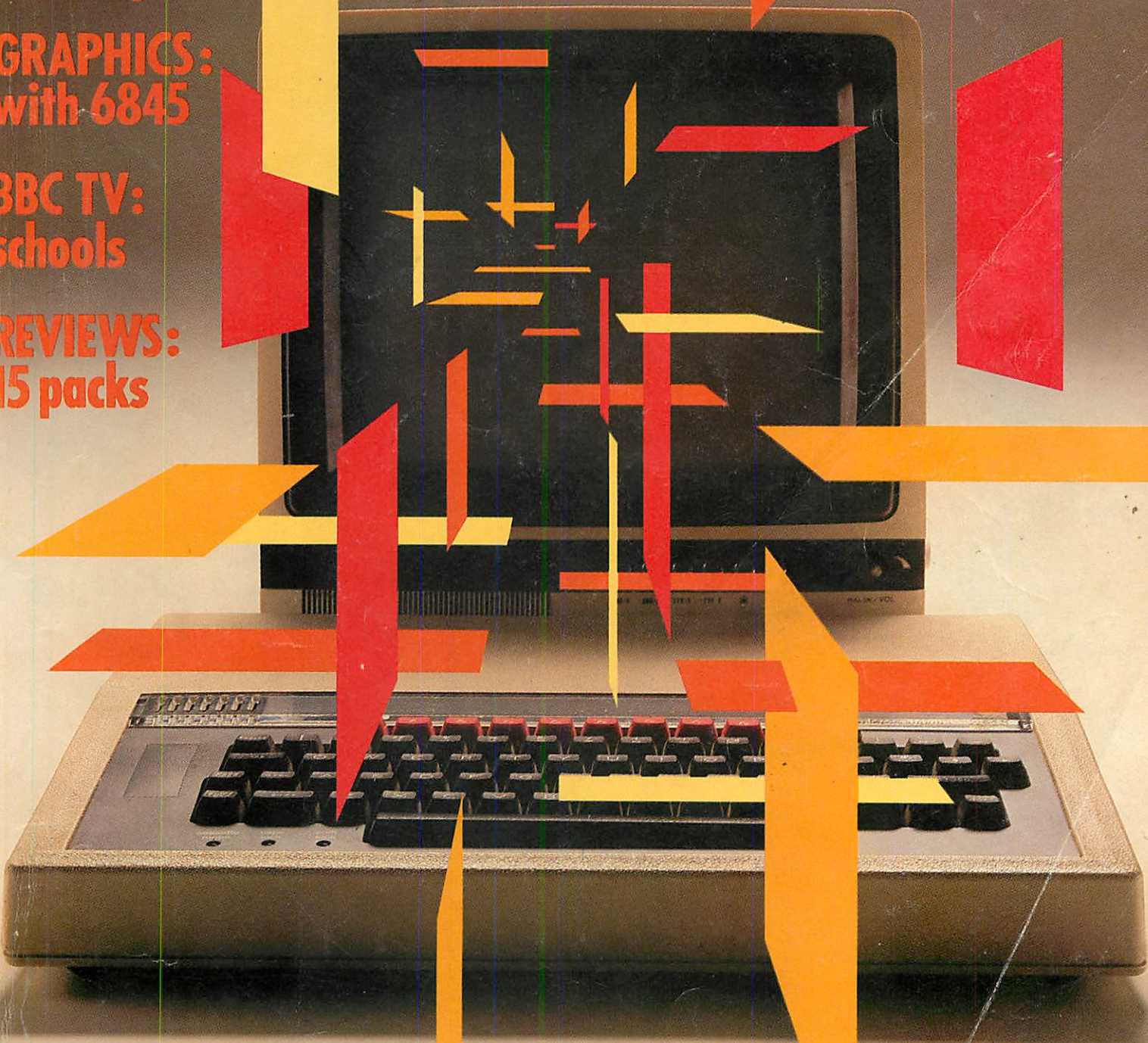

GRAPHICS ROM:
how good is it?

DESIGNED WITH PROGRESS IN MIND



An example of superior technology, total reliability and outstanding performance, combined to produce the LVL Disk Drive Family.

**Truly professional units designed to work with the BBC
Microcomputer.**

- Compatible with the BBC drive units. Disks are interchangeable with those formatted on the BBC Drives.
- Operates either from the BBC DOS the LVL Double Density DOS Kit or from the optional Z80 and CP/M.
- Supplied complete with all necessary connecting leads, utility disk and full operating manual.
- Available from all LVL Dealers.
- Powered from your BBC model B computer. No chance of data corruption from on-board power supply.



Scientific House, Bridge Street, Sandiacre, Nottingham
NG10 5BA Tel: 0602 394000

KEENEST PRICES ★ PROMPT RELIABLE SERVICE ★ That's Twillstar!

BBC MICROCOMPUTER

Model B £399.00
 Model B & Disk Interface £469.00
 Model B & Econet £446.00
 Model B & Econet & Disk Interface £516.00
 Teletext Receiver £225.00
 Official BBC Data Recorder £29.95
 Official Joysticks £13.00

BBC UPGRADES

1.2 O/S £11.50
 Basic 11 £32.00
 Disk Interface Kit £97.00

ECONET ACCESSORIES

Econet Interface £70.00
 Clock Box (Inc. PSU) £45.00
 Terminator Box (Inc. PSU) £35.00
 Printer Server Rom £49.00
 File Server Level 1 £99.00
 File Server Level 2 £249.00
 10 Station Lead Set £29.00
 100M Econet Cable £99.00
 Econet System User Guide £10.00

DOT MATRIX PRINTERS SHINWA CP80

80 column, friction and adjustable tractor feed, bi-directional logic seeking HI-RES graphics and block graphics sub and super scripts, condensed and emphasised print, and underlining vertical and horizontal tabs, self test, italic print, etc.

Shinwa CP80 F/T £230

MANNESMANN MT80

High quality 80 column serial dot matrix printer. Dual density dot addressable graphics, quick tear facility as standard, optional sound reduction kit to give an impressive L55dBa acoustic noise rating. Ability to handle both tractor-fed fanfold and single paper.

Special price of £249

EPSON

Epson FX80 F/T £395
 Epson RX80 F/T £305
 Epson FX100 F/T £499

EWI RITEMAN MATRIX PRINTER

SLEEK DESIGN EXCELLENT FEATURES. SUPERB PRINT QUALITY

80 COLUMN · FRICTION AND PIN FEED · 120 CPS BI-DIRECTIONAL · HI-RES AND BLOCK GRAPHICS · 9 x 9 MATRIX TRUE DESCENDERS · NORMAL, EXPANDED, CONDENSED PRINTING · EMPHASISED AND DOUBLE STRIKE PRINTING · ITALICS PRINTING · AUTO UNDERLINING · SUBSCRIPT AND SUPERSCRIPTS · INTERNATIONAL CHARACTER SETS · EASY ACCESS DIPSWITCHES · 1:1 HIGH RES (TRUE CIRCLES AND SQUARES) · OPTIONAL TRACTOR UNIT · OPTIONAL RS232C INTERFACE

£230

NEW! STAR DELTA - 10 THE ULTIMATE MATRIX PRINTER AT UNBEATABLE PRICE

TRUE 160 CPS, 80 COLUMN UHR PRINTER WITH 100% DUTY CYCLE AND UNBELIEVABLE FEATURES

STAR BUYS

160CPS BI-DIRECTIONAL LOGIC SEEKING · STANDARD SPOOL RIBBON · UP TO 136 COLUMNS · 5, 6, 8, 10, 12 and 17 CHARACTERS PER INCH · DOWNLOADABLE CHARACTER SETS (UP TO 384 CHARACTERS AVAILABLE) · MACRO INSTRUCTION SET · PARALLEL AND SERIAL INTERFACE STANDARD · STANDARD WITH 8K BUFFER · 240 CPS WHITE SPACE SPEED · EMPHASISED AND DOUBLE STRIKE · SUPER AND SUB SCRIPTS · COLUMN SCAN BIT IMAGE GRAPHICS · ITALICS · FRICTION, TRACTOR AND ROLL HOLDER AS STANDARD

DAISYWHEELS £395

JUKI 6100

20 CPS max (13 CPS Shannon text) 10, 12, 16 CPI and proportional spacing up to 220 characters per line, diablo protocols. Bold, shadow printing and underlining.

2K Buffer Standard £395

BROTHER HR15

13 CPS. 10, 12, 15 CPI and proportional spacing up to 165 characters per line, colour printing, shadow printing, super/sub script, auto underlining, text reprinting.

3K Buffer Standard
 Brother HR15 £395
 Keyboard £160
 Sheet Feeder £228
 Tractor Unit £109

MONITORS PHILIPS TP200 Green Monitor

You can use this latest Philips Green Monitor for personal computers, business computers, control systems, automatic test equipment. The picture quality of the TP200 means not only 80 x 24 lines of information but also usage for high resolution graphics.

NOW AVAILABLE BBC Official 12" GREEN MONITOR RECOMMENDED BY DTI FOR SCHOOLS, EDUCATION AUTHORITIES & INDUSTRY. SPECIAL CASING, HIGH RESOLUTION.

AT THE BARGAIN PRICE OF £79

14" TV/MONITOR

NORDMEND 14" TV/MONITOR

This TV Monitor is not a modified television as many TV Monitors are, but a 14" TV/Monitor which has been designed to perform both functions. It has RGB and Composites video and sound. An RGB cable for a BBC is supplied as standard.

With Remote Control £269

MICROVITEC 14" Colour Monitors

Microvitec 1431 14" Std. Res. £245
 Med. Res. £395
 Hi-Res. £495

★ STAR BARGAIN!

WORD PROCESSING PACKAGE

BBC Model B plus Disc/Interface fitted view, V.D.U. Green Monitor, Daisywheel Printer, 200K Dual Disk Drives and manual and formatting disk.

ONLY £1,329 (incl. all cables)

TCL DRIVES AT LOW PRICES! SLIM DISK DRIVES

TEAC 55A S/S 40 TRACK

100K Single £165
 200K Dual £330

TEAC 55E S/S 80 TRACK

200K Single £199
 400K Dual £398

TEAC 55F D/S 80 Track

400K Single £255
 800K Dual £510

Power Supply Unit (Optional) £29
 40/80 Switch £8

MITSUBISHI DRIVES

400K D/S DD Single £245
 Dual £435

ROM EXPANDER

Double your sideways Rom sockets, with the TCL Rom expander. Simple to install and very easy to use! Manufactured using components of the highest quality!

Extremely reliable! £18.95

WORD PROCESSORS

View Word Processor £59
 Word Wise Processor £39

UTILITY SOFTWARE

Screen Dump Rom £17.25

For EPSON, SHINWA, NEC, STAR

NEW TCL MICROGUIDES

The KEYPLATES to make it easy!

Microguide KEYPLATES fit neatly over your computer keys - Gives you an easy to read list of commands - Alphabetically arranged for immediate access - Placed exactly where you require it as part of your computer keyboard - The Keyplates, made of durable plastic, have space for function key notes - Clean-wipe pen for function key identity is supplied + FREE ERROR MESSAGE BOOK. ALL FOR ONLY £5.95

SURE SHOT

BBC Compatible KLIK STIK JOYSTICK - SELF CENTRING Two Fire Buttons

Single - £17.95
 Dual - £34

CABLES - Drive Cables

Single £9.50
 Dual £13.50
 BBC Printer Parallel £13.50
 Serial £25
 BBC Cassette Leads £3

FLOPPY DISKS

Floppy Disks in packs of 10

Single sided 40 Track £20
 Double sided 80 Track £35

TCL VINYL DUS COVERS

BBC £3.50
 Printer £5.50
 Monitor £4.50

NOW AVAILABLE THE ACORN ELECTRON ONLY £199

★ 24hr DELIVERY ★ ON ALL ITEMS ★

(subject to availability.)

STAR BUY GRAFPAD

£143.75

Add new dimensions to your computer enjoyment. Create your own designs. Complete with Utility programmes.

Amazing value. Complete unit - simply plug in -

BOOKS BBC

Micro's for Beginner's £6.95
 Advanced Prog Tech £7.95
 ALP on BBC (A.W.) £7.95
 Ass Lang for BBC (Shiva) £7.95
 ALP (Macmillan) £8.95
 Basic (Arnold) £5.95
 Basic (Mel-House) £6.95
 Basic Progs for BBC £5.95
 Easy Progs for Your BBC £5.95
 Expert Guide £6.95
 Functional Forth £5.95
 Further Progs £5.95
 Games BBC Computers Play £6.95
 Games for Your BBC £2.95
 Graphics & Sound (Granada) £6.95
 In Education £6.50
 Introducing the BBC Micro £5.95
 Let Your BBC Teach You £6.95
 Advanced User Guide £7.95
 Micro Revealed £6.50
 Programming the BBC £4.95
 Putting Your BBC to Work £6.50
 Structured Programming £9.95
 Using Floppy Disks £5.95
 21 Games for BBC £5.95
 30 Hour Basic £4.95
 30 + Progs £6.95
 35 Educational Progs £5.95
 36 Challenging Games for BBC £14.95
 Hobbit BBC (cassette) £5.95
 Hobbit BBC (book) £5.95
 Brainteasers for BBC £5.95
 Best of PCW Software BBC £6.95
 Graphics on the BBC £6.95
 Disk Companion £6.95

★ SERVICE CONTRACTS TO EDUCATION AUTHORITIES AT DISCOUNT

★ OFFICIAL ORDERS FROM DEALERS, GOVERNMENT DEPARTMENTS, COLLEGES AND SCHOOLS WELCOME

★ ALL PRICES INCLUSIVE OF VAT

HOW TO ORDER

You may purchase any of the items listed by cheque made payable to: TWILLSTAR COMPUTERS LTD., Barclaycard or Access. All you have to do is fill your requirements on a separate sheet of paper. Post to us and we will dispatch within 24 hours subject to availability. All prices inclusive of 15% VAT. ADD £2.50 P&P for orders below £150, OVER, ADD, £8 P&P.

TELEPHONE ORDERS (01) 574 5271

CREDIT CARD HOLDERS MAY ORDER BY TELEPHONE. GIVE CARD NO. NAME, ADDRESS & ITEMS REQUIRED.



Twillstar Computers Limited
 17 REGINA ROAD · SOUTHALL · MIDDLESEX · TEL: (01) 574 5271
 (OPEN SIX DAYS A WEEK - 10 a.m. to 8 p.m.)



AA4/8A

7
The News
 Spiderman adventures are coming, disc drive rivalry hots up, parish councils go for micros, TV series on control, Harry Harrison adventures

12
Software Top 20
 Tracing the fortunes of the top sellers

17
Acorn Abuser's Diary
 A new column for bean-spilling and back-biting

18
TV picture show
 The BBC demonstrates what can be done with Beeb graphics on television

26
Hardware graphics
 Ken Worrall shows what the 6845 chip can do



Meet
 Uncle Klunk
 on page 15

31
Advanced filing systems
 Charles Schaeffer gives the low-down on Acorn's latest ideas

39
Lisp part II
 Stan Froco continues his in-depth look at this language

47
Hints & Tips
 Martin Phillips airs some strong views on protection, before tackling readers' problems

53
Beeb Forum
 George Hill kicks off this month's offerings from readers

61
Pick of the disc
 Robin Newman's utility lets you choose which tracks to copy

69
Function key editing
 Electron and BBC micro owners can benefit from Bruce Smith's ideas

77
Teletext dumps
 A follow-up to last month's article by George Hill on printing mode 7 screens

83
Joe's Jottings
 Education specialists CES come under Joe Telford's scrutiny

89
Passing variables
 John Ryding gets around the problem of procedures

92
When in ROM . . .
 . . . graphics utilities can be a boon says Malcolm Banthorpe reviewing Computer Concepts' latest chip

99
School simulations
 From Saqqara to the Spanish Main with Barry Holmes and Steve Fletcher

105
Easter dates
 Paul Caswell establishes once and for all when the Bunny arrives

111
Better programming
 Tidy up your input and output code with Susan Jones

119
Atom Forum
 Barry Pickles presents more cash-winning routines

123
Atom ROM routines
 Useful locations revealed by Mark Plumbley

133
Converting Basics
 Barry Pickles takes the BBC version and converts it into the Atom variety

How to submit articles:

You are welcome to send articles to the Editor of *Acorn User* for publication. *Acorn User* cannot undertake to return them unless an sae is enclosed. Articles should be typed or computer written with double line spacing. Indicate which machine, Basic and OS the programs are suitable for. Black and white photographs or transparencies are also appreciated. If submitting programs a cassette or disc is vital. Please indicate if you have submitted your article elsewhere. Send articles, reviews and information to: The Editor, *Acorn User*, 68 Long Acre, London WC2E 9JH. Tel: 01-836 2441.

Annual subscription rates:

UK	£15
Europe	£18
Middle East	£20
The Americas and Africa	£22
Rest of the World	£24

These prices are inclusive of post and packing (air mail overseas) for 12 issues.

139

Competition

That fiend Dally's at it again with arch accomplice Mad Alex

140

Reviews

- Aries B20 RAM board
- Acacia Diary and RAM system
- Five books for the Atom
- Ecce BBC Toolkit
- Sanyo and JVC monitors
- Music Editor by System Software

Teletext graphics dumps on page 77

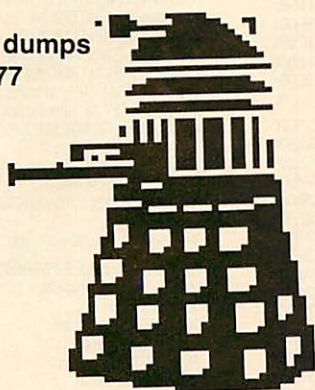

- My Secret File from Mosaic
- Schools: three Acornsoft offerings
- 12 Electron and BBC games: Attack on Alpha Centauri; Mined-Out; Felix in the Factory; Gateway to the Skies; Pengwyn; Escape from Moon Base Alpha; Atom Smasher; Plankwalk; Cylon Attack; Protector; Alien Break-In; Birds of Prey

143

Printers

Three Star printers under £400, the DP8480, Gemini 10X and Delta 10 are compared

169

Readers' letters

Tape protection, smug programmers, troublesome ROMs, problematic printers . . . and the rest

Coming soon in *Acorn User*:

The Bitstik

Hook up a BBC micro to a second processor with Robocom's joystick-based hardware and you've got a versatile CAD tool. We've got our hands on one

Graphics

More loopy ideas to amaze and astound you and your friends

Discs

A program to check the free space on a disc amongst other utilities coming your way

OS calls

The great debate continues, with Beeb Forum making its contribution on 'illegal' calls, especially in relation to Econet

Forth

Competing BBC versions of this language compared and reviewed

Front cover design by Phil Kanssen

Authors please note

We've been inundated with articles for publication – many of an extremely high standard. It takes time to read them, try listings out and edit them – which is the only way to maintain standards. Also remember that magazines work at least two months in advance.

So please bear with us if you hear nothing for weeks (although all submissions are acknowledged).

Thanks for your patience and apologies for any frustration caused.



Actual screen shot of *Swordmaster*

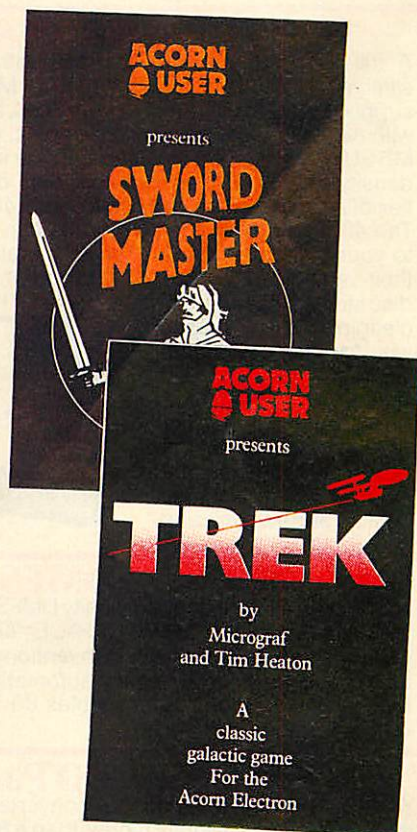

£7.95 each

TWO games are now available from *Acorn User*. They are *Sword Master* (BBC B and Electron) and *Trek* (BBC B and Electron). Both make extensive use of the excellent graphics, speed and sound of the machines. Turn to page 10 for details.

All rights reserved. No part of this publication may be reproduced without prior written permission of the publisher. The publisher cannot accept any responsibility for claims or errors in articles, programs or advertisements published. The opinions expressed on the pages of this magazine are those of the authors and do not necessarily represent those of the publisher, Acorn Computers Ltd, or Acornsoft Ltd. Acorn, Acornsoft, and the Acorn symbol are the registered trademarks of Acorn Computers Ltd and Acornsoft Ltd.

Editor Tony Quinn. **Editorial Assistant** Kitty Milne. **Art Editor** Phil Kanssen. **Publishing Director** Michael Potter. **Editorial Director** Christopher Ward. **Typesetting & Artwork** Camden Typesetters, Camden Rd, London NW1. **Production** Aquarius Print and Design Ltd, Scala St, London W1. **Printed in Great Britain** by Watmoughs Ltd, Bradford. **Advertising Agents** Computer Marketplace Ltd, 20 Orange St, London WC2H 7ED. Tel: 01-930 1612. **Distributors to the News Trade** Comag, Tavistock Rd, West Drayton, Middlesex UB7 7QE. Tel: (0895) 44405. **Subscriptions** Subs. Dept., Redwood Publishing, 68 Long Acre, London WC2E 9JH. Tel: 01-836 2441. **Publishers** Redwood Publishing, 68 Long Acre, London WC2E 9JH. Tel: 01-836 2441
© Redwood Publishing 1984.

PRINTERS:

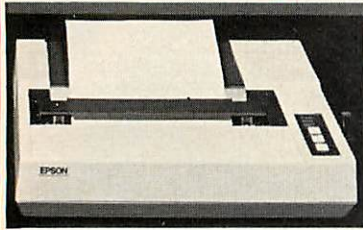

We have a range of printers that will meet most requirements.

EPSON—the high quality dot-matrix printers that set the standard in the industry—versatile printers that provide the optimum in performance & reliability. The RX80/FT provides all standard printing & graphic functions, (single sheets & perforated paper),

with the de-luxe FX80 giving in addition proportional printing, italics, programmable characters etc. The FX100 also allows the use of 15" wide paper. The **JUKI** daisywheel provides a quality normally found in printers costing far more. Printer cables, interfaces, ribbons, paper etc. are all normally available from stock.

SPECIAL OFFER
Epson FX80
only £325

DISC DRIVES:

A full range of disc drives fitted with quality Japanese slimline mechanisms, (such as TEAC, MITSUBISHI etc.) are supplied ready to connect to your BBC, and come complete with necessary cables, formatting disc, manual etc. TEAC & MITSUBISHI mechanisms can operate in single and double density modes. The switchable disc drives give the user flexibility, by allowing access to both 40 & 80 Track discs. The 40/80 Track switching module can be simply attached to your standard 80 track drives thereby vastly increasing their versatility. We have a full range of diskettes, variety of disc storage cases, disc-drive cables. The Floppiclone head cleaning kit, is the ideal way to ensure optimum performance of your drives. The use of disposable cleaning discs eliminate the risk of recontamination and abrasion, and ensure continuous data capture and transmission.

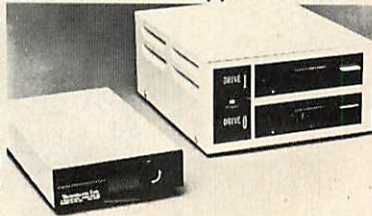

KENDA DMFS

A truly professional double density DMFS with several unique features:- *requires no RAM i.e. PAGE=&EEO *uses standard CP/M filenames & disc drive conventions *no limit to number of files *single/double density automatically selected *runs most 'protected' software *enables 80 Track drives to read 40 Track discs.

TORCH Z-80 Pack:

Your BBC computer can be converted into a business machine at a cost slightly higher than a 800K disc drive. The Torch pack with twin disc drive and a Z80A processor card greatly enhances the data storing and processing capability of the computer (NOTE: In BBC mode the disc pack functions as a normal BBC drive). Z80A card comes with 64K of RAM and a CP/M compatible operating system in ROM. The system is supplied complete with a BBC owner's user guide, a System/Demo disc, a PERFECT software package and COMANEX, a business management game. The PERFECT software package comprises of a DATABASE, CALC, WORD PROCESSOR and SPELLER commercially valued at over £1000. We are now supplying a Utility that enables software on 40 Track discs to be transferred to 80 Track discs **£730.**

NOW AVAILABLE - The TORCH Z80 SECOND PROCESSOR CARD - for those who already have suitable disc drives. The card is supplied with all the free software, as detailed above, presenting a very attractive package. **£375.**

ACORN COMPUTER SYSTEMS

BBC Model B	£348.00a
BBC Model B + Econet	£389.00a
BBC Model B + DFS	£429.00a
BBC Model B + DFS + Econet	£470.00a
Acorn Electron	£175.00a
BBC Teletext Receiver	£195.00a
BBC Dust Cover	£4.00d
Pair of Joysticks	£11.70c

TORCH Z80 SYSTEM

TORCH Z80 Disk Pack	£730.00a
TORCH Z80 2nd Processor Card	£375.00a

UPGRADE KITS

A to B Upgrade Kit	£75.00d
Installation	£15.00
DFS Kit	£95.00d
Installation	£15.00
Econet Kit	£55.00d
Installation	£25.00
Speech Kit	£47.00d
Installation	£10.00

ECONET ACCESSORIES

Printer Server Rom	£41.00c
File Server Level 1	£86.00c
File Server Level 2	£216.00b
Clock + 2 Terminators	£92.00b
Econet User Guide	£10.00d

BBC FIRMWARE

1.2 Operating System	£7.50d
Basic II Rom	£32.00d
View Word Processor Rom	£52.00c
Wordwise W/P Rom	£32.00c
Beepben W/P Rom	£29.00c
BCPL ROM + Disc	£87.00b
Disc Doctor Utility Rom	£30.00c
Termi Emulator Rom	£29.00c
ULTRACALC Rom (BBC Publ.)	£65.00c
Gremlin debug Rom	£28.00c
Computer Concepts Graphics Rom	£28.00c

BBC ANCILLARY HARDWARE

EPR0M Programmer	£89.00b
Smartmouth Speech Synthesiser	£37.00b
RH Light Pen	£39.50b
"Time-Warp" Real-Time	
Clock/Calendar	£29.00b
ACORN IEEE Interface ANK01	£282.00c
EXMON	£20.00d
TOOL KIT	£20.00d

PRINTERS & PLOTTERS

EPSON FX-80	£350.00a
EPSON RX-80 FT	£250.00a
EPSON FX-100	£450.00a
Printer Sharer + Cable Set	£88.00c
SEIKOSHA GP100A	£160.00a
JUKI 6100 Daisy wheel	£350.00a
MCP40 Col. Printer/Plotter	£129.00a

Accessories:

Parallel Printer Lead	£10.00d
Serial Printer Lead	£8.00d
Epson Serial Interface 2K	£60.00c
Epson Serial Interface	£50.00c
NEC Serial Interface	£42.00c
Epson Paper Roll Holder	£17.00c
FX-80 Tractor Attachment	£37.00c
PAPER Fanfold 2000 sheets	£13.50b
Printer Sharer Parallel	
3 computers - 1 printer	£59.00c
Gemini Delta 10	£350.00a
Gratpad Graphics Tablet	£125.00c
GRAPHICS Plotter	£270.00a

COLOUR/GREEN MONITORS (leads incld)

Microvitec 1431 14" RGB Std Res	£215.00a
Microvitec 1431P 14" RGB/PAL Std Res	£249.00a
Microvitec 1431PS 14" RGB/PAL + Sound	£259.00a
Microvitec 1451 14" RGB Med Res	£325.00a
Microvitec 1441 14" RGB Hi Res	£440.00a
Microvitec 2031 20" RGB Std Res	£287.00a
KAGA Vision I 12" RGB Med Res	£230.00a
KAGA Vision II Hi Res	£260.00a
KAGA Vision III 12" RGB Super Hi Res	£370.00a
KAGA 12" Green Hi Res	£106.00a
SANYO DM8112CX 12" Green Hi Res	£99.00a
KAGA RGB Lead	£6.50d
BNC Green Screen Monitor Lead	£3.50d

BBC COMPATIBLE 5.25" DISC DRIVES:

(All include cables, manual + format disc)	
100K (40 Track)	£150.00a
100K (40 Track) with psu	£185.00a
200K (40/80 Track)	£180.00a
200K (80 Track) with psu	£260.00a
400K (80 Track DS)	£195.00a
2x100K (40 Track) with psu	£320.00a
2x200K (40/80 Track) with psu	£400.00a
2x400K (80 Track DS) with psu	£420.00a
Accessories:	
40/80 Track Switching Module	£30.00c
Single Disc Cable	£6.00d

ALL PRICES EXCLUDE VAT. Please add carriage 50p

COLOUR GRAPHICS PLOTTER:

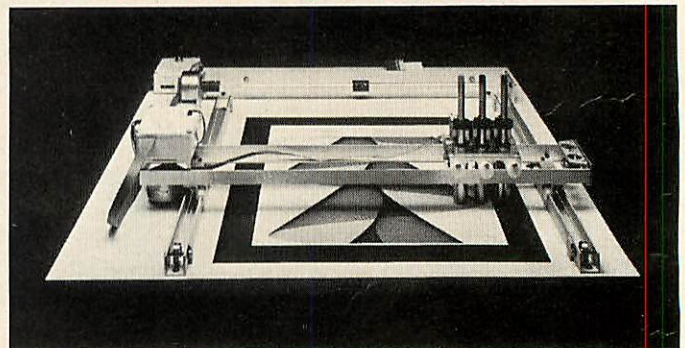

This robustly built 3-colour graphics plotter provides both versatility & precision. The carriage can be moved with an accuracy of 0.025 cm. over an area the size of A4 paper. The plotter bed can accept paper & far thicker materials, at sizes of up to A3. The basic plotter carries three pens each of which is software selectable. Optional accessories that can be fitted include: Scriber, miniature drill, router, and high-resolution optical sensor for scanning. This versatile plotter can provide an endless source of creative ideas.

Everything you need for your BBC Computer

Plus friendly service and professional advice

Double Disc Cable	£8.50d	6809 Assembly Lang Programming	£13.95
DISCS/Pkt of 10	WABASH 3M	Advanced Prog Tech for BBC	£7.95
40T SS/SD	£15.00	Advanced 6502	£10.25
40T DS/DD	£17.50c	Advanced User Guide	£12.95
80T SS/DD	£22.00c	Assembly Lang Pro on the BBC	£7.95
80T DS/DD	£24.00	Assembly Lang for the BBC	£7.95
FLOPPICLENE Drive Head Cleaning Kit	£26.00	Assembly Lang Prog for Electron	£7.95
	£30.00c	Assembly Lang Programming	£8.95
Disc Library Case	£14.50c	Basic Prog on the BBC	£5.95
Disc File Case 30/40	£2.50d	BBC Basic	£5.95
Disc Lockable Case 30/40	£8.00c	BBC Basic for Beginners	£6.95
Disc Lockable Case 60/70	£16.00c	BBC Micro for Beginners	£6.95
	£30.00b	BBC Micro Compendium	£14.95
		BBC Micro Disk Companion	£6.95
		BBC Micro Expert Guide	£6.95
		BBC Micro Graphics & Sound	£6.95
		BBC Micro in Education	£6.50
		BBC Micro Revealed	£5.00
		BCPL User Manual	£15.00
		Beyond Basic	£7.25
		Creating Adventure Progs	£6.95
		Creative Graphics	£7.50
		Discovering BBC M/Code	£6.95
		Forth	£7.50
		Friendly Computer Book	£6.95
		Graphics on the BBC Micro	£6.95
		Graphs & Charts	£7.50
		Interfacing the 6502	£10.95
		Intro BBC Micro	£5.95
		Let YR BBC Teach U 2 Prog	£5.00
		LISP	£7.50
		LISP	£7.50
		Micro Basic Sound Graphics	£7.95
		MOS Memory Data Book	£3.95
		Prog the BBC Micro	£6.50
		Programming the 6502	£9.95
		Programming the 6809	£11.35
		Programming the 8086/8088	£10.95
		Programming the BBC	£6.50
		Programming the Z80	£9.95
		Start Prog with Electron	£6.95
		Structured Programming	£6.50
		The Computer Book	£5.95
		The Electron Book	£7.95
		TTL Data Book Vol-1	£9.00
		TTL Data Book Vol-2	£5.20
		User Guide	£15.00
		Using BBC Basic	£10.00
		Using Floppy Disks	£6.95
		Using the 6502 Assembly Lang	£14.50
		Z80 Applications Book	£10.95

MANY MORE BOOKS IN STOCK

ACORN IEEE INTERFACE

A full implementation of the IEEE488 standard, providing computer control of compatible scientific & technical equipment, at a lower price than other systems. Typical applications are in experimental work in academic and industrial laboratories. Phone for details. **£282.**

TELETEXT

Converts your BBC into a fully fledged Teletext Terminal. In addition to normal reception of Teletext pages, it is able to 'download' software as well as saving standard pages on any of the four TV channels. **£196.**

ULTRACALC

With advanced features, such as: *Handling of labels as well as numbers, as values, allowing the search of a list by a meaningful name, instead of just a number. *Efficient memory usage allowing large spreadsheets to be constructed. *Variable width columns.

It helps you to create and manipulate *Budgets *Cash-Flow forecasts *Price Lists *Balance Sheets *Time Sheets *Order Entry *Small Databases *Scientific Calculations etc. **£65.**

MICROTEXT

Developed by the National Physical Laboratory, is a programming system designed to simplify the production of a wide range of man-computer dialogues. Using MICROTEXT, an expert in any field can construct their own complete courses of computer-based instructional material. Applications include interviewing systems, teaching packages, training courses and interactive demonstrations and simulation. **£43.35p**

RH LIGHTPEN:

The Acorn-approved superior design, with a programmable 'push tip' switch, status indicator LED and an interface box. Supplied complete with manual, full software and basic demo programs. Colour graphics programs will be available separately.

GRAFPAD

A low cost graphic-tablet offering the performance and durability required for the business, industrial and educational user. It is small, accurate & reliable. Working area: 240 x 192mm + Menu area. **£125.**

BUZZBOX

The micro modem, a full feature, Originate/Answer, 300 Baud, CCITT V21 modem - direct connect with BT approval. Uses include inter-office business use, as well as hobbyist use. (not for use on Prestel).

Continued on page 6

INSTITUTIONS & EDUCATIONAL ESTABLISHMENTS

Our bulk purchasing power enables us to provide very competitive quotations, as well as being able to supply in quantity, a very wide range of equipment, accessories and spare parts from stock.

MAIL ORDERS TO: 17 Burnley Road, London NW10 1ED
(Tel: 01-452 1500, 01-450 6597 Telex 922800)

SHOPS AT: NW London: 15 Burnley Road, London NW10 1ED
(Dollis Hill 2 mins walk, ample car parking space)

West London: 305 Edgware Road, London W2. Tel: 01-723 0233
(Near Edgware Road)

TECHNOMATIC LTD.

All prices exclude carriage & VAT. Please add carriage as indicated and add 15% VAT to the total order value. For fast delivery telephone your order quoting VISA or Access card or official order number. (Minimum telephone order £5).

SANYO DR 101

Data Recorder. An advanced data recorder that consistently achieves superior performance.

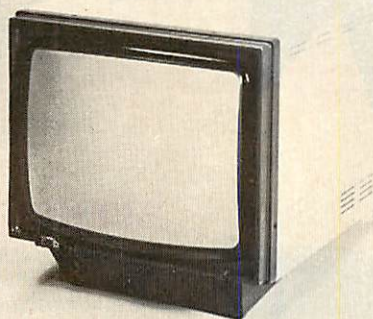

MONITORS:

MICROVITEC—a range of British Made DTI/ACORN approved Std/Med/Hi-resolution RGB colour monitors that have a consistent, reliable performance. Also available in RGB/PAL/SOUND versions. The KAGA range provides a similar performance in 12" screen format. Our Japanese manufactured Hi-Res green screen **SANYO** is an ideal solution for high clarity 80 column text display. The **KAGA** green screen, with its 'chemically etched' anti-glare screen for the discerning user. All monitors are supplied with suitable leads at no extra charge.

EPROM PROGRAMMER:

A fully self-contained mains-powered eprom programmer housed in an attractive finished case. It is able to program 2716, 2732/32A, 2764 & 27128's in a single pass. It is supplied with vastly superior software when compared to any currently available similar programmer. In addition to normal eprom programming, you are now able to load your favourite basic programs onto eprom.

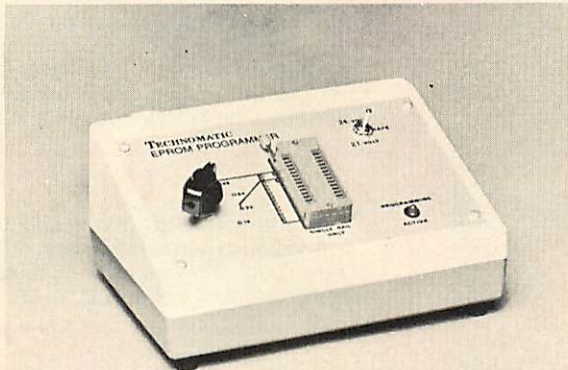

The programmer comes complete with cables, software & operating manual.
£89 + £2.50 carriage. Software on disc £2 extra..

- * Menu Driven Software provides user friendly options for programming the eprom with:
 - a) Basic programs.
 - b) Ram resident programs.
 - c) Any other program.
- * Programmer can read, blank-check, program & verify at any address/addresses on the Eprom.
- * Personality selection is simplified by a single rotary switch.
- * Programming voltage selector switch.
- * Full Editor with ASCII Disassembler, allowing direct modification of memory data in HEX or ASCII.
- * Continuous display of time left for completion of programming.
- * Continuous display of current addresses as they are being programmed.

EPROM ERASERS



UV1T Eraser with built-in timer and mains indicator. Built-in safety interlock to avoid accidental exposure to the harmful UV rays. It can handle up to 5 eproms at a time with an average erasing time of about 20 mins. £59 + £2 p&p.
UV1 as above but without the timer. £47 + £2 p&p.

SMARTMOUTH:

WITH AN INFINITE VOCABULARY—

A ready built self contained speech synthesiser unit, allowing the creation of any English word, with both ease and simplicity, while, at the same time being very economical in memory usage. You can easily add speech to most existing programs. Due to its remarkable infinite vocabulary, its uses spread throughout the whole spectrum of computer applications—these include industrial, commercial—no need to open your computer—educational, scientific, recreational etc. No specialist installation—simply plugs into the user port—and due to the simple software, no ROMS are needed.

SMARTMOUTH is supplied with demo and development programs on cassette, and full software instructions.
£37 + £2.50 carriage.



'TIME-WARP' REAL-TIME-CLOCK/CALENDAR

A low cost unit that opens up the total range of Real-Time applications. With its full battery backup, possibilities include an Electronic Diary, continuous display of 'on-screen' time and date information automatic document dating, precise timing & control in scientific applications, recreational use in games etc—its uses are endless and are simply limited by one's imagination. Simply plugs into the user port—no specialist installation required—No ROMS. Supplied with extensive applications software. Please phone for details. £29.00 + £2.50 carriage.

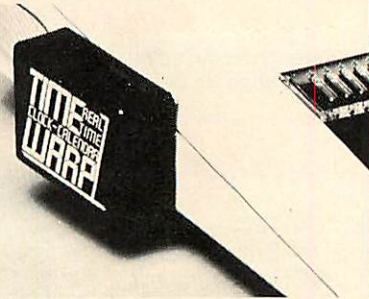

BEEBUGSOFT

A professional range of Firmware/Software to suit both the advanced programmer and the user. From the well known 'EXMON' and 'TOOLKIT' to the WORDWISE SPELLCHECK.

See our double page spread advertisement on pages 4 and 5

MAIL ORDERS TO: 17 Burnley Road, London NW10 1ED
(Tel: 01-452 1500, 01-450 6597 Telex 922800)

SHOPS AT: NW London: 15 Burnley Road, London NW10 1ED
(Dollis Hill 2 mins walk, ample car parking space)

West London: 305 Edgware Road, London W2. Tel: 01-723 0233
(Near Edgware Road)

TECHNOMATIC LTD.

All prices exclude carriage & VAT. Please add carriage as indicated and add 15% VAT to the total order value. For fast delivery telephone your order quoting VISA or Access card or official order number.
(Minimum telephone order £5).

Acorn profits up by 156%

IN ITS first six months' trading as a public company the Acorn Computer Group's taxable profits increased by 156 per cent from £2.04m to £5.21m.

These debut figures were seen as a disappointment by some City commentators, since the half-year's trading profits were a mere 14 per cent ahead of the previous six months, compared with last year's trebling of profits between the two half-years. However, the cost of setting up operations in the US and West Germany was £2.5m and there are other factors, such as the delay in building up production of the Electron, associated with the world-wide chip shortage.

The half-year figures to January 1, 1984 show that turnover increased from £14.39m to £40.4m and operating profits were over £5m, compared with the previous figure of £2.13m. For the year ending July 1, 1983 they were £8.6m.

The group looks well-placed to increase its profitability by a more impressive margin. Production of the Electron is due to come on-

Start-up costs bite, but should pay off

stream at AB Electronics, Gwent, this month, according to Acorn marketing director Tom Hohenberg. Sales are targeted to reach 40,000 a month, compared with the 25,000 BBC micros sold at present.

Moreover, the US operation is likely to start earning its keep in the second half-year. The Boston-based subsidiary Acorn Computer Corporation has already made inroads into the US educational market. Orders taken were worth more than \$50m by the beginning of last month, and the Washington District School Board, Phoenix, Arizona, has put in a \$175,000 order.

More than 1,000 dealers have been appointed in North America to sell the Beeb and the American subsidiary has set up a national educational advisory board to vet software for the Acorn micro.

The Acorn Research Centre got under way last month in Silicon Valley and this division is expected to make a significant contribution within a few months.

In the face of speculation about the renewal or lapse of its contract with the BBC, Acorn Computer has maintained its confidence – some would say smugness – pointing out that the Corporation has earned millions of pounds in royalties from sales and is planning future products.

Nor is the replacement of Aubrey Singer as managing director of BBC Television by Bill Cotton likely to affect the collaboration, even though Singer was known to have a personal interest in microcomputer technology. Cotton, former head of Light Entertainment, must have cut his technological teeth as managing director of the BBC's direct broadcasting by satellite project.

The year 1984, therefore seems to hold few terrors for Acorn. According to the *Financial Times* 'a figure of £15m pre-tax looks possible' for Acorn's first full year.

Enter the 6502 and Bitstik

THE long-awaited 6502 second processor has arrived. It is being launched by Acorn this week (March 14) jointly with the Bitstik, the computer-aided design pack. Both are available now, the 6502 at £199 and the Bitstik at £375.

The second processor links to the BBC micro via the Tube output port, bringing an extra 32k of memory but, more importantly, a significant increase in programming speed. For it effectively shares the processing tasks with the Beeb's main CPU, taking charge, for example, of complicated graphic simulations.

The Bitstik, which represents one of the 6502's applications, is an elaborate joystick that enables graphics to be drawn and manipulated on screen, with zooming at any number of levels, rotation of image and output to a printer/plotter. Its great virtue is its user-friendliness, for it operates on two menus and bypasses any keyboard input.

Acorn is marketing Robocom's Bitstik, which it claims is faster than the Apple version, as a professional package appealing to graphic designers, engineers and architects, and anticipates a lot of response from colleges, where applications might include circuit board design and similar experimental tasks. The Bitstik can hold a number of pictures in memory on a central file for later 'assembly' into a main design.

There is still a wait for other Acorn add-ons, however. The business-orientated Beeb user can pencil in May as the next promised month for the Z80 processor, while the Prestel adaptor looks like arriving 'at the end of April'.

The add-on box for the Electron (printer interface/joystick connector) will probably be available in May, says Tom Hohenberg, Acorn's marketing director.

Software boost for microdrives

VIRTUALLY all the leading disc drive distributors in the UK are now promoting the 3in alternative, and the growing range of software makes their task easier.

Advanced Memory Systems, which markets Hitachi 3in drives at £255 (single-sided, 100k) and £399 (double-sided), is one of the pioneers that will benefit from business software for 3in discs from Gemini; a utility range from Clares; educational software from Bourne; and utilities from Beebugsoft.

At Opus, sales manager John Harris predicts a big move into 3in discs: 'Being enclosed in plastic they are very robust and they can be integrated with 5¼in systems. They can be daisy-chained to provide back-up, and now the software's coming'.

Opus' answer to the AMS's single-sided 3in disc system was a double-sided Sanyo drive at £230, available through W H Smith and other outlets.

Now Viglen is in contention with a TEAC 40-track single 3in disc drive (reversible, 100k per side) at £159, the same price as the comparable 5¼in system. Managing director Vig Boyd explained that his company was late in committing itself to 3in drives because it wasn't happy with the reliability of systems being manufactured. 'We found we had the least comeback with TEAC drives,' he said.

'We've now introduced a dual drive for the educational market for transferring data from 5¼ to 3in discs, and when our 3½in disc drive has been launched in July we'll have a dual case for 3-to-3½in transfer.'

Boyd explained: 'Both standards have a place in the market. The 3in is indestructible and therefore suitable for industrial environments and the rough handling of primary schools, while the more fragile 3½in is replacing the 5¼in discs. This offers greater capacity – 1Mb of storage on 80 tracks.' He estimates its price at about £250.

As yet, he said, he hasn't found a double-density 3in system that operates satisfactorily – 'although we are looking closely at one now.'

A British-made 3in drive for the BBC B has been launched by Northern Computers of Frodsham, Cheshire (0928 35110). Called 'Micro Pulse', this is a double-sided system costing £169 plus VAT.

Meanwhile, back on the 5¼in front, Cumana has reduced prices across the board by about 10 per cent. According to Cliff Musson, the company is passing on the benefits of competitive buying in Japan. He cites the slimline 40 track, single-sided CSX100 drive (100k) at £169 (formerly £185) and the £345 CD200 2×40 track, single-sided 200k drives (formerly £385), and hints that more reductions could be

on the way.

John Harris at Opus, however, believes prices have now bottomed out. 'Prices are hardening,' he says, 'because components are in short supply and the Yen is getting stronger.'

As Vig Boyd points out, the chip shortage has been made even more acute by IBM's purchase of Intel. So the message is buy now – don't wait for further reductions.

● Viglen is to release a ROM socket next month that fits externally on the Beeb, enabling the user to snap in the EPROM required.



Northern Computers drives into the 3in market with Micro Pulse for the BBC B

Gemini's ring of confidence

GEMINI appear to have been doing a lot of work on software protection – and their confidence seems tantamount to a challenge to the pirates.

Managing director Dale Hubbard described the protection on their forthcoming database ROM so: 'Life has been made extremely difficult for software thieves with our design and we expect to set a standard of software protection which, no doubt, other software houses will strive to achieve.'

The company announced its intention to go into ROM last year, and the 24k of machine code which makes up the database is expected by May. The system is disc-based, and is claimed to be a 'true random access, database management system.'

A series of applications 'masks' are planned to allow the database to be set up immediately for tasks such as invoicing, stock control, order entering and broking. It is also being converted for the American version of the BBC micro.

The ROM database will be linked to the HCCS suite of business software which Gemini is marketing. This includes nominal and sales ledgers, stock control, invoicing and payroll facilities. The price per module is £99.95.

Hubbard also hopes to see Gemini quoted on the Unlisted Securities Market alongside the Acorn group next year.

The Hulk tamed

SPIDERMAN, the Incredible Hulk and Captain America will be making their graphic entry on to British-owned micros next month – but not on the BBC micro or Electron.

Adventure International (UK) will be releasing their first graphic adventure in May on several computers, but the problem of memory space had led them to settle for a text-based game for the Beeb and Electron.

The Birmingham company has been licensed by the Marvel Entertainment Group of New York to produce at least a dozen adventures over the next 10 years – and it could be up to 60.

Managing director Mike Woodroffe explained: 'Marvel aren't happy with BBC graphics, so we might have a text-based game with a sealed pack of cards to open as you progress.'

'Marvel have done all the sketches for the screen layouts and the cover – it's all hand-coloured. There will even be a special comic available separately, called *Questprobe*, and the adventures will follow on from that.'

The games plan is being written by Scott Adams, a leading figure in adventures.

Gail Munn, vice-president of international licensing at Marvel, explained that the company has been keen on getting the graphics right as that was its business. 'We've been disappointed with past efforts so we're looking for the best companies from a design standpoint. We licensed a Spiderman video game and that was just OK, nothing special.'

'So we're affiliating with people who really know what they're doing.'

A new Marvel character has been



invented called the Chief Examiner, who sends the heroes out on their quests. Although each title will centre around one super-hero, others will make guest appearances and the Chief Examiner will be introduced into Marvel Comics, said Ms Munn.

The first offering from Adventure International will be based on the Hulk and comes out in April at £9.95.

Tape kit translates any Basic

AN ENCODING kit costing less than £4 enables Basic programs to be run on different models of micro-computer. The kit is Basicode, central to which is a translation program that is loaded into a micro to convert a Basic program into a standard electronic code for recording on a cassette. The 'Basicoded' cassette can then be read by any other micro that itself has

been loaded with the Basicode translation program.

Basicode was created by the Dutch broadcasting corporation NOS and the kit has been available to download software broadcast in the Dutch radio programme *Hobby-scoop* (*Acorn User*, October, page 13). It is now available in the UK from Broadcasting Support Services, who were approached by

BBC Radio to handle distribution of a product that would make it possible to decipher the programs put out after midnight by Radio 4's *Chip Shop*. The listener tapes the electronic 'screech' encoded in Basicode and uses the Basicode kit to load the data into his micro.

The Basicode kit consists of a cassette and a handbook. As well as both BBC models, it can be used with Apple II and IIe, the Commodore 64, Pet and Vic 20, Sharp MZ80A, Sinclair ZX81, Tandy TRS80 and Video Genie.

The kit costs £3.95 from Basicode, Broadcasting Support Services, PO Box 7, London W3 6XJ.

Novel ideas at Mosaic

THE *Stainless Steel Rat* author Harry Harrison is working on a computer version of his book featuring



Galactic hero Jim deGriz is now preparing for computer action...

the slippery galactic hero Jim deGriz.

And Desmond Morris has signed the rights for an adventure game based on his *Inrock* fantasy novel, as revealed in last month's *Acorn User*.

The Harrison adventure is being co-authored by Sean O'Connell and starts off with training and a test to enter the Special Corps, of which deGriz is, of course, a leading member. A copy of the book will accompany the game and, says Harrison: 'Careful study of the book should help you pass!'

Inrock is based around a miniature world under a rock, and the efforts of a young boy to help its inhabitants. The game is being designed and written by Jonathan Griffiths, of *Snapper* fame.

Both projects are being published by Mosaic, who also have the micro rights to Robert Louis Stevenson's *Treasure Island* signed up. Prices for the book and game should be about £15, with the *Rat* coming out in May and the others in the autumn.

THE FEB FOUR

THE February special issue on adventures proved to be a bit more of an adventure than expected.

Among the more unusual tricks that crept in was that the article 'Planning and plotting' was not written by Mike Austin, but his brother Pete. Apologies to Pete (or should it be Mike?).

Next onto 'Cliffhanger' by Peter Killworth. Readers have asked whether he's the one to blame for *Philosopher's Quest*, and yes, we admit it, he is!

Peter is also the (warped) brain behind *Castle of Riddles*, *Countdown to Doom* (his favourite) and *Kingdom of Hamil* (with J Partington). All of these are, of course, marketed by Acornsoft. A fifth game, *Quondam*, written with R Underwood, is nearing completion.

Peter first got interested in adventures when he came across a system for writing them on the IBM 370, written by David Seal and Jon Thackray (whose names you will have seen elsewhere in the February issue).

Key addition

BEEB owners who dabble extensively in data entry or incorporate a lot of mathematical expressions into their programs can break out of the qwerty straitjacket by adding a new keypad from Extron.

At £50, this keypad has 25 keys, including all the numerals and arithmetic operators, together with the nine commonly used shifted characters. They all operate at a single stroke, thus giving the Shift key the elbow.

The keypad comes in a tough metal case matched cosmetically to the Beeb and attaches to the main keyboard via a ribbon cable, requiring no RAM or ROM and leaving the normal operation of the computer unaffected.

It is available, with fitting instructions, from Extron at 16 Priory Park, Bradford-on-Avon, Wilts BA15 1QU.

MATHS TUTORS

Educational Series

VECTORS

A suite of fourteen programs carefully designed to teach the user the skills and techniques associated with the main vector algebra requirements of syllabuses such as G.C.E. examinations in Additional Mathematics and 'A' level Mathematics, as well as many other courses requiring a knowledge of vector algebra. The following topics are covered:-

★ The vector as a directed line segment ★ Scalar multiplication ★ Equivalent vectors ★ Vector

GRAPHS

A suite of five programs for use by students studying G.C.E. at 'O' and 'A' level, or an equivalent syllabus.

1. A versatile curve sketching program which allows the user to plot any curve, including trigonometric functions and curves with asymptotes.
2. A parametric curve sketching program which allows the user to plot any parametric curve written in terms of parameters for X and Y.
3. An interactive multiple-choice program giving practice in the recognition of trigonometric curves.
4. A multiple-choice tester for the recognition of straight line equations.
5. A multiple-choice tester for the recognition of quadratic and cubic curves.

£9.95

French Tutor.

BBC Model B.
Test Vocab, speech idioms and irregular verbs, create your own files; progress assessment and revision list available at any time £9.95

737 Flight Simulator.

For the BBC micro is now available for the Acorn Electron and on disc £9.95

BBC Utilities Package.

Sound Shaper, EDG-Epson Screen Dump, Teletext Screen Editor, Disassembler £9.95

EDG Graphics Package.

A sophisticated technical drawing package. Tape Version £19.95 Disc Version £24.95 Also available, Electron Graphics Package £9.95

summation ★ Vector co-ordinates in 2 dimensions ★ Matrix notation of vectors ★ The modulus of a vector ★ Dot (scalar) product of two vectors ★ Angles between vectors ★ Perpendicular and parallel vectors ★ Internal and external ratios ★ Ratio theorem ★ Parametric equation of a straight line in 2 dimensions ★ Vectors in 3 dimensions ★ The Right-Hand Rule ★ Dot product of 3 dimensional vectors ★ Vector equation of a plane in 3 dimensions ★ The Cartesian equation of a plane ★ Intersection of a vector and a plane **£14.95**

TURBO COMPILER

Turbo is a highly compact machine-coded BASIC compiler for use with both the BBC Microcomputer (Models A and B) and the Acorn Electron microcomputer. Its small size allows Turbo to compile programs instantaneously within the micro, without the need for intermediate use of tape or disc. Supplied with detailed documentation, Turbo is ideal for constructing fast machine code routines for use in BASIC/machine code hybrid programs, or for writing 100% machine code programs.

★ Highly compact machine-coded compiler (2K).
★ Fast compilations in under 1 second. ★ Disc based version also supplied on same cassette
★ Supports sub-set of BASIC commands directly.
★ Comprehensive documentation details how to implement a total of 65 BASIC keywords.
★ Compiled code can be used without the compiler being resident. ★ Provides an ideal intermediate stage for users who wish to move from BASIC programming to the use of machine code and the Acorn Operating System.
★ Turbo requires a Series 1 Operating System on the BBC Micro. **£9.95**

Please add 50p to all orders for P. and P.
Send A5 SAE for full Catalogue.

Cheques and postal orders payable to:

Tape duplication by
DATACLONE

Salamander

SOFTWARE

17 NORFOLK ROAD, BRIGHTON, EAST SUSSEX. BN1 3AA TELEPHONE: BRIGHTON (0273) 771942.

Local heroes

THE Beeb is about to enter parish pump politics.

The National Association of Local Councils will take the opportunity at its annual conference next month to launch two BBC-based software packages that are specially tailored for the needs of small councils.

There are more than 8,000 parish and town councils in England, involved in the administration of local matters ranging from footpath signs to the construction of sports complexes. Electorates can consist of a few hundred inhabitants in a scattering of hamlets to several thousand in ancient market towns. Whatever their size, though, nearly all of them are fairly busy and the paperwork tends to fall on the shoulders of a hard-pressed part-time clerk.

The situation is, the NALC believes, ripe for the introduction of computer power to community politics.

Work on the project started last July when the association's general secretary John Clark and assistant general secretary Martin Harvey began looking for the best way of introducing the chip revolution into the work of parish and town councils.

'We thought it was about time our members came into the 20th century and stopped using the quill pen,' explains Harvey.

'By coincidence, the very next day they were contacted by

Andrew Pickering, clerk to Bicker Parish Council and a computer programmer in Lincoln, who explained his plans to develop software suitable for council work to be carried out on a BBC micro.

NALC decided it would be sensible to develop a standardised system that would cope with the type of workloads common to almost every town and parish council.

'The idea,' says Martin Harvey, 'was to develop a standard form of accounts preparation, something which could be uniform throughout the country.'

This meant getting the approval of the Audit Commission, whose job is to keep an eye on how councils maintain their books.

Other software prepared includes a program to tackle the problems of preparing council and committee minutes, agendas and the like.

The cheaper of the two BBC packages will be a cassette-based system, while the other will be a 400k disc-driven package. Costs have yet to be fixed but could be about £550 for the cassette system and £2000 for the disc package. The NALC is confident that there will be a rush of councils keen to get themselves computerised.

'We have not even announced the scheme yet but we are already being inundated with inquiries from councils that have heard about it,' said Martin Harvey.

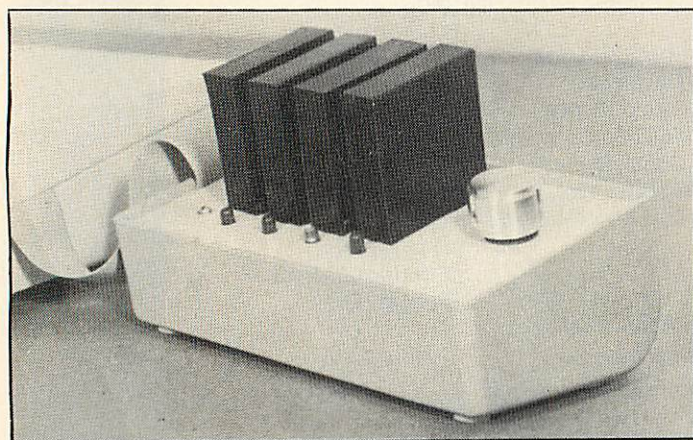

Heat's off for duffers

SO you're a duffer at soldering and you flunked your electronics degree. That won't prevent you from installing your own ROM extension, says Ramamp Computers. The company's new ROM Extension Unit has slots for four plug-in ROM cards and gives an extra 16k of RAM. Each ROM can be switched on-line at any one time, and more cards can be purchased cheaply to slot in more ROMs. It plugs into the Beeb via a ribbon cable. The unit costs £45.80 and the ROM cards £3.80 each. Contact Ramamp Computers at 25 Avon Drive, Whetstone, Leicester, tel: 0533 864966.



£7.95 inclusive
for 32k BBC micro
or Electron
(joystick or keyboard)
Two-player game

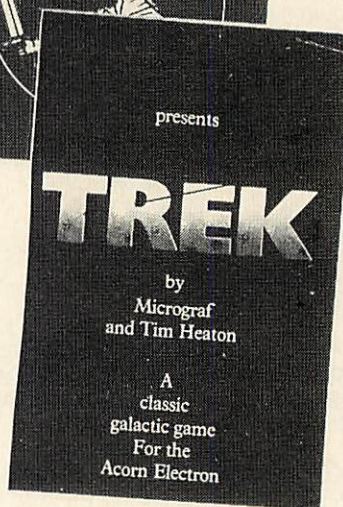

£7.95 inclusive
for Electron
or
32k BBC micro
(joystick or keyboard)
Uses voice synthesis

Acorn User presents two high-quality games on cassette for your micro which put you at opposite ends of time. Developed, produced and tested by Micrograf.

Sword Master by Ken Worrall is based on the fencing rules written in 1190 by Herman von Salza for the Deutscher Ritter Order of Teutonic Knights. It features full colour, machine code animation of a sword duel between the players shown on screen as knights.

Full instructions, music, sound effects, player rankings (from greenhorn to Swordmaster) and a roll of honour (which can be saved) and all included. The game also closely reflects the rules, style and dress of the Deutscher Ritter Order.

Trek puts you in charge of a Starship with the task of wiping out an alien fleet. It's an excellent adaptation of the classic game with 7 screen displays, 3 on-board computers and 2 weapon systems.

Versions have been written for BBC micro and Electron to use both machines to their full. The BBC tape uses voice synthesis (if the chips are fitted).

The game has been extensively developed from Tim Heaton's Trek III. It now barely fits into 32k - and the graphics are in mode 7.

More tapes will soon be released.

To: Acorn User Software, 68 Long Acre, London WC2E 9JH.

Please send me:

- copies of **Sword Master** at £7.95 each for BBC (32k Series 1 OS) £
- for Electron £
- copies of **Trek** at £7.95 each for BBC (32k Series 1 OS) £
- for Electron £

I enclose a cheque for £..... made payable to Redwood Publishing.

Name

Address

Post code

A SUPERB B.B.C. PROGRAM FROM BRITAIN'S LEADING SOFTWARE HOUSE!

ZARM

Weave through the orbiting asteroids to rescue the stranded scout patrol on the inhospitable planet below. Then navigate your shuttle past Zarm's FIVE cunning defence systems using infinite precision to re-dock with the waiting mothership.

Another first-class machine-code game featuring selectable levels, redefinable keys and 'Invisibles' button. ONLY £7.95.

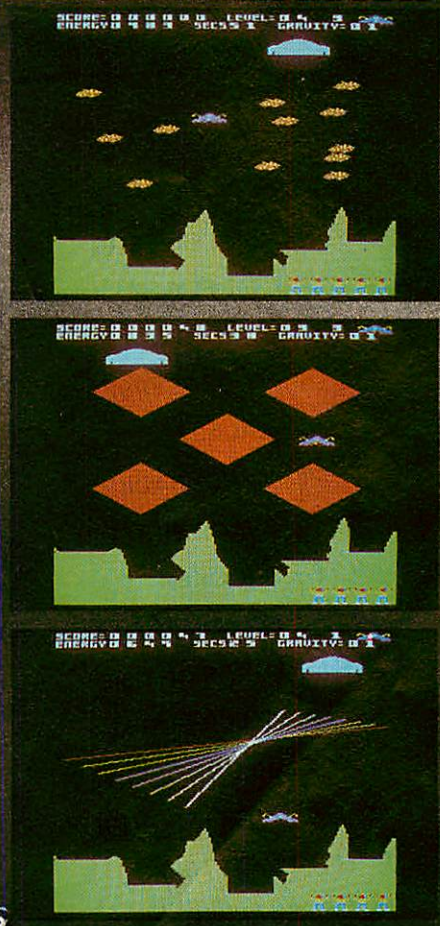

WE STOCK THE BBC MICRO, ELECTRON, DRAGON 32, COMMODORE 64, ORIC AND SPECTRUM.

SPECIAL OFFER
Deduct £1 per cassette when ordering two or more.

All cassettes are fully guaranteed and contain two recordings. All prices inclusive of VAT. Mail Order: Please add 55p per order to cover P & P.

WRITTEN ANY PROGRAMS? WE PAY 20% ROYALTIES



WE'RE EXPANDING!
 Showroom: Northwood House, North Street, Sheepscar, Leeds LS7 2AA, Tel: (0532) 458800
 Mail order: Dept. 8/8a Regent Street, Chapel Allerton, Leeds LS7 4PE, Tel: (0532) 683186/696343

WE Guarantee
THAT ALL OUR ADVERTISED PROGRAMS HAVE BEEN COMPLETED AND ARE READILY AVAILABLE

The following titles are available for both the BBC Micro and Electron: Killer Gorilla £7.95/ Moonraider £7.95/Bandits at 3 o'Clock £6.95/ Croaker £7.95/Felix in the Factory £7.95/ Felix and the Fruit Monsters £7.95/Chess £7.95/ Escape from Moonbase Alpha £7.95/Draw £9.95/ Swoop £7.95/Cybertron Mission £7.95.
 B.B.C. only (at present): Labyrinths of LaCoshe £7.95/ Martian Attack £7.95/Demon Decorator £6.95/ Asteroid Storm £7.95/Laser Command £7.95/ Galactic Commander £7.95/Cowboy Shootout £6.95/ Danger! UXB £7.95/Timetrek £7.95/Filer £9.95/ Adventure £7.95/Beebmon £7.95/Barrage £7.95/ Alien Swirl £6.95/Caveman Adventure £6.95/ Chemistry £6.95/World Geography £6.95/ Where? £6.95/Junior Maths Pack £6.95/ Constellation £6.95/Physics £6.95.

BBC MICRO AND ELECTRON PROGRAMS CAN BE OBTAINED FROM SELECTED BRANCHES OF W H SMITH, JOHN MENZIES, BOOTS, HARRODS. ALL GOOD MICRO DEALERS, OR DIRECT FROM POWER.

TITLE	PUBLISHER	TAPE	DISC
1 (4) TWIN KINGDOM VALLEY	Bug Byte	£ 9.50	
2 (15) CHUKKIE EGG	A&F Software	£ 7.90	
3 (20) 747 FLIGHT SIMULATOR	Doctor Soft	£ 8.95	£11.95
4 (10) THE HOBBIT	Melbourne House	£14.95	
5 (-) APOCALYPSE	Red Shift	£ 9.95	
6 (-) ZALAGA	Aardvark	£ 6.90	
7 (6) HUNCHBACK	Superior	£ 7.95	£11.95
8 (-) SPACE SHUTTLE	Microdealer	£ 8.00	£10.00
9 (-) SNOOKER	Visions	£ 9.95	
10 (-) FELIX IN THE FACTORY*	Program Power	£ 7.95	
11 (-) LORDS OF TIME	Level 9	£ 9.90	
12 (5) KILLER GORILLA*	Program Power	£ 7.95	
13 (-) SALOON SALLY	Psion	£ 7.95	
14 (9) WHITE KNIGHT II	BBC Soft	£10.00	
15 (11) PLANETOID	Acornsoft	£ 9.95	
16 (19) SNAPPER*	Acornsoft	£ 9.95	
17 (3) 3D BOMB ALLEY	Software Invasion	£ 7.95	£11.95
18 (1) DR WHO	BBC Soft	£10.00	
19 (-) TRANSISTOR'S REVENGE	Softspot	£ 7.95	
20 (-) MONSTERS*	Acornsoft	£ 9.95	

BUBBLING UNDER

LOST CITY	Superior	£ 7.95
FAIRGROUND	Superior	£ 7.95
OBLIVION	Bug Byte	£ 7.50
SPACE ADVENTURE	Virgin	£ 7.95

*AVAILABLE ON THE ELECTRON

This chart was compiled from a panel of specialist computer outlets by RAM/C. It is based on returns from mid-January to mid-February.

WHICH will be the biggest software house of 1984? Program Power was laying claim to the title at the end of last year – but other contenders show no sign of lying down.

PP certainly pumps out volume, with at least one new game each month, but Acornsoft wins the numbers game this month with a trio in the best-selling score.

However, they're all the old favourites released in 1982. This seems to shoot down the company's protectionist stance and claims of massive pirating destroying sales. Perhaps the real problem is that the vidiots reckon the new games just aren't as good.

While Acornsoft relies on its backlist, PP is indeed making the running with its *Donkey Kong* derivatives such as *Killer Gorilla* and *Felix in the Factory*.

The Software Invasion range is based on traditional ideas, but the company's interpretation – and the excellent graphics – is all that's needed to set the vidiots going.

Doctor Who is slipping down the charts, to our relief, and *The Hobbit* is holding up well, despite the feeling that the BBC version has lost something in its translation from the Spectrum's 48k.

On the adventure front, Level 9 has jumped in at number 11, hope-

fully part of a trend we craved last month.

Doctor Soft's flight simulator has fought off Salamander's challenge as it zooms back up the charts. That game's been up and down more times than a yo-yo!

We can't really say much about Bug Byte's number one because we haven't seen it, despite requests to do so. Ah well, can't have everything.

So what's going to be tops of the doobriedoos next month? *Chukkie Egg*, *Zalaga* or *Saloon Sally* are the front runners round the office (which probably dooms them all to disappear!).

Lingo learning with Linkword

FOUR tape-based packages due from Acornsoft in a few days will help you brush up on your French, German, Italian and Spanish, or pick up the basic grammar and vocabulary.

The packages, costing £14.95, consist of a cassette with ten programs plus an audio cassette to help keep your ear for the accent acute, and a 20-page booklet. The first offerings are for the Beeb but Acornsoft is preparing versions for the Electron.

The main market is expected to be among home users rather than schools. The teaching method is based on Linkword, a technique devised by Michael Gruneberg of University College, Swansea, that links foreign words with similar-sounding English words with the aid of visual mnemonics. The Linkword programs don't take advantage of the Beeb's graphics capabilities but operate on a prompt-by-bleep system.

The technique has proved effective at Thompson Holidays in training managers.

Cheap talk

IT WILL cost you less than £25 to make your Beeb talk. Cheetah Marketing is following up its successful launch of a speech synthesiser for the Spectrum last year with a 'Sweet Talker' for the BBC micro.

Unlike the cased Sinclair version, though, the new one is a printed circuit board with a 28-pin plug which is installed internally into the Beeb's IC99 socket. Cheetah says the installation is simple and requires no soldering or cutting of tracks.

Sounds are produced on an allophone system, so that words, phrases and sentences can be built up in a Basic program. Cheetah sees its product as an amusing toy that will enable you to pep up your games with appropriate 'comments' and other noises. The sounds are broadcast, of course, through the micro's own speaker.

The board comes with a short machine code driver program (making a simple change to one of its 10 lines will ensure its compatibility with all Beeb operating systems), a demonstration cassette, and installation instructions which list the 64 allophones from which all speech can be built up.

Cheetah is negotiating on retail distribution of the Sweet Talker but meanwhile it is available by mail order at £24.95 (inc VAT and p&p) from Cheetah Marketing, 24 Ray Street, London EC1 3DJ (01-278 6954). Orders, we are assured, will be met ex-stock within 10 days.

Bargains from Cambridge!

The book for every BBC user

Over 500 pages of detailed information on commands, programming, interfaces and hardware, including the complete circuit diagram of the

BBC computer. We sold over 10,000 copies in 6 weeks; buy it and you'll see why! Excellent value at **£12.95**

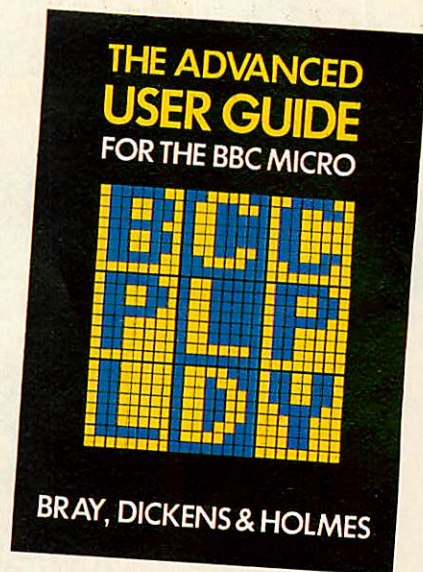

**Word-processing:
a complete
package for £899—
including VAT**



Package comprises: **BBC Model B Microcomputer • TEAC disk drive 100K • SHINWA CP80 printer, complete with cables, ready to use.**

TYPE 'N' TALK SPEECH COMPUTER

Developed and manufactured in Cambridge, the Type 'n' Talk is a very powerful software package, optimised to convert any text into speech faster than it can be spoken. Connected to any computer via an RS232 or RS423 serial link, it allows you to type in words or numbers which are then spoken out loud over a powerful speaker. All in all, an amazing new concept in man/machine communication. **£171.35**

PRINTERS

EPSON FX-80	£395.00
EPSON RX-80FT	£315.00
EPSON RX-80T	£275.00
SEIKOSHA GP 100A	£220.00
SHINWA CP-80	£275.00
JUKI 6100	£395.00
BROTHER	p.o.a.

Delivery charge: £6.00 per item

DISK DRIVES

100K TEAC Slimline, complete with cables, etc.	£155.00
200K TEAC 40/80 switchable, complete with cables, etc.	£175.00
400K TEAC 40/80 switchable, complete with cables, etc	£240.00

Delivery charge: £6.00 per item

MONITORS

SANYO 14" green	£86.31
KAGA 14" yellow	£123.45
KAGA 14" green	£108.00
KAGA 12" colour.	£300.00

Delivery charge: £10.00 per item

MISC. ITEMS

Printer cable for BBC	£16.50
Disk drive signal cable BBC	£7.75
Disk drive power cable BBC	£3.50
Diskettes:	
3M SS/DD set of 10	£20.68
DS/DD set of 10	£28.00
SS-96 TPI set of 10	£32.00
DS-96 TPI set of 10	£44.00

Delivery charge: £1.00 per item

BOOKS

Dragon 32	£5.95
Over the Spectrum	£6.95
Understanding your Spectrum	£7.95
Practical Programming for the BBC	£6.95
Creating Advanced Programming for the BBC	£6.95
...and many other books.	

ALL PRICES INCLUDE VAT

Credit terms available for orders of £500 or over. Access, Barclaycard and American Express welcome.

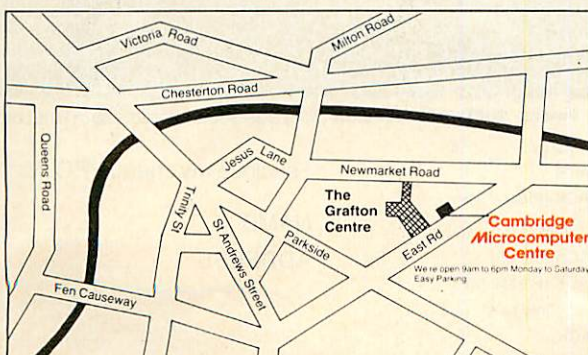

Cambridge Microcomputer Centre is a wholly owned subsidiary of Namal Associates Limited.

Cambridge Microcomputer Centre

Distributors of Computers & Computer Peripherals • Publishers
153-4 East Road, Cambridge CB1 1DD
Telephone (0223) 355404 Telex 817445

The invasion has begun... for BBC Model B

Let excitement invade your home computer!
Travel to Alpha Centauri. Enter the Vortex.
Command the ground missiles, or join the
shoot-out at the O.K. Corral!

ATTACK ON ALPHA CENTAURI

For the BBC Micro Model B



... he punched the key, and the control monitor filled with the picture of bug-eyed wasps attacking from their volcanic nest; decisively he dived to the left and his laser gun burst into action...
3D ACTION, EXPLOSIVE SOUND EFFECTS
BBC MODEL B
£7.95 CASSETTE
£11.95 DISK

VORTEX

For the BBC Micro Model B

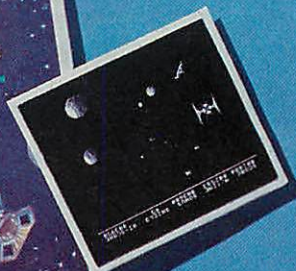

... there was no escape, he had to enter the Vortex and bet on his skills! He grabbed the manual controls and with determination fired both upper deck guns...
KEYBOARD OR JOYSTICK, EXCELLENT SOUND
BBC MODEL B
£7.95 CASSETTE
£11.95 DISK

3D BOMB ALLEY

For the BBC Micro Model B



... the continued thunder of the hissing ground missiles had long now deafened him - unless he had some of those bombers down, the fleet, in the small stretch of water was a sitting duck...
3D ACTION, SOUND EFFECTS, BEAUTIFUL GRAPHICS
BBC MODEL B
£7.95 CASSETTE
£11.95 DISK

GUNSMOKE

For the BBC Model B



...the movement of the saloon-bar door was all the warning he needed! At the speed of light his hand moved toward his holster, while a sixth sense warned him of the upper floor window...
3D ACTION, SOUND EFFECTS, BEAUTIFUL GRAPHICS
BBC MODEL B
£7.95 CASSETTE
£11.95 DISK

SOFTWARE INVASION

50 Elborough St.,
Southfields,
London SW18 5DN.
Tel: (01) 870 1197

● Distributors, Multiple Store and Retailer Group inquiries invited.

● Available from WH Smith, HMV, all Spectrum shops and over 500 retail outlets in the U.K.

Do you write your own programmes? If you have an unusual programme which can meet our standards you could be earning more than £250 p week. Why not take advantage of our sought after reputation. Write no

HOW TO ORDER

You may purchase any of the Games listed from most good BBC Software Stockists, WH Smiths, HMV or your nearest Spectrum Dealer.

To order direct, fill in the coupon below with your requirements, make cheque/P.O. payable to: SOFTWARE INVASION and post to us. Please allow 7 to 14 days for delivery.

Post to: SOFTWARE INVASION 50 ELBOROUGH STREET SOUTHFIELDS LONDON SW18 5DN

(Title) (Qty) £

(TAPE) 40 TRACK

(DISK) 80 TRACK (Please tick)

(Title) (Qty) £

(TAPE) 40 TRACK

(DISK) 80 TRACK (Please tick)

(Title) (Qty) £

(TAPE) 40 TRACK

(DISK) 80 TRACK (Please tick)

Total £

I enclose my cheque/P.O. for £

NAME

ADDRESS

TEL: (Day) TEL: (Eve)

I am a Distributor/Multiple/Retailer/Dealer
Please contact me.

(Please delete whichever not applicable)



Putting the finishing touches to Uncle Klunk. Note the cable running from the chair, and the Apple computer on the left

Klunk clicks with Auntie

THUNDERBIRDS are go as far as the BBC is concerned, with computer-controlled puppets and robot 'spiders' featuring in the new television series *Computers in Control*.

Uncle Klunk (a sports commentator) and the Rock-a-Fire Explosion band are life-sized animated puppets who star in American pizza parlours, while Disney has produced its own versions called 'Animatronics' for Epcot in Florida.

These figures are used as examples of how solenoids, pistons, motors and relays can play out 3D cartoons once under the control of a micro.

The 'spider' is a six-foot, six-legged automaton which pops up in one programme to illustrate a more serious example of robots used for surveillance in places where man might not want to boldly go.

American examples are matched by studio projects using the BBC micro. Binky (who for some unknown reason is called Steve in the series) is a ventriloquist's puppet which is hooked up to a Beeb.

Other BBC examples include a sophisticated, turtle-like graphics plotter from Cheswell Graphics, an 'intelligent' BBC Buggy – and a home security system.

Paul Bond, one of the leading

lights behind the BBC micro's operating system, devised the security system to make use of voice recognition. The micro compares sound envelopes to decide whether the person telling it to switch on the central heating over the phone should be allowed to.

The 'Buggy Brain' is an Economics BBC Buggy with a cut-down BBC micro attached by Control Universal. A board holds the Basic, OS and memory chips with battery support and an RS232 interface. This means it can be programmed down the RS232 port from another BBC micro and left to its own devices – no strings, no cables.

Several interfaces are demonstrated: the Beasty, Interbeeb from RH Electronics, and Unilab's offerings.

Two location sequences show John Coll and Ian McNaught-Davis, who host the five-part series, at Lotus Cars and Southampton University.

Lotus have developed a computer-controlled suspension system for racing which keeps the cars on an even keel – even at 100mph round bends!

Southampton University shows off a new type of wind tunnel which does away with the need to physically support any model under test. The model is fitted with a magnetised metal device and sits in a cylindrical tunnel. This means its position can be altered by magnets surrounding the tunnel, and, of course, computers do all the controlling.

David Allen, the producer, and

Robin Mudge, the director, hunted out the US stories and spent time at the Chicago Robot Show with the likes of Hero, mentioned in last month's news pages.

Mudge was particularly impressed with the Disney animatronics. These puppet-robots are programmed by animators in a similar way to cartoons. The animator chooses the start and end positions, then a computer does the 'in-betweening' to produce realistic movement.

Characters such as Uncle Klunk and the band are controlled by micros, with recorded voices. In our pictures of the Klunk assembly line, an Apple can be seen connected up to the puppet, and bear drummers are visible in the background. Creative Engineering in Florida, who build these puppets, also show off Fatz, their friendly gorilla in the series.

The five episodes include an introduction to robotics and control; ways in which a micro can monitor and react to its environment; motors, solenoids and relays; problem-solving and dedicated computers; and the future: what robots will be capable of as speech and pattern recognition are developed.

Programme times and dates

Computers in Control started on Friday, March 2, with repeats on the following Thursdays and Sundays. The times are Friday at 12.30 on BBC2 (first showing March 2); Thursday at 23.30 on BBC1 (first repeat starts Thursday, March 8); Sunday at 12.35 on BBC1 (second repeat starts March 18). Many of the programs

used in the series will be available from the Telesoftware Service on Ceefax.

Notes on the programmes cost £1.30, plus a large sae, from Computers in Control, Broadcasting Support Services, PO Box 7, London W3 6XJ. The NEC is also preparing a course on control for BBC micro users.

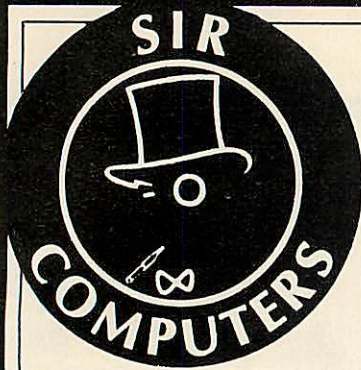

**SIR RESEARCH PRESENTS:
OUR RANGE OF PERIPHERALS FOR THE
NEW ACORN ELECTRON**

SIR ELECTRON 12-ROM BOARD

- ★ Provides for up to 192K of ROM space (16K of this will support either ROM or RAM).
- ★ Fully buffered design.
- ★ Easy to install, just plugs in, no soldering necessary.
- ★ Allows further expansion via rear edge-connector.
- ★ Permits use of most BBC ROM-based software (such as VIEW, PASCAL, FORTH, etc.)
- ★ Price: **£40.00 + VAT.**

SIR ELECTRON PRINTER & JOYSTICKS INTERFACE

- ★ CENTRONICS printer interface.
- ★ Analogue-to-Digital Converter (ADC) allows use of any BBC-compatible joysticks.
- ★ No soldering, plug-in design.
- ★ Full firmware support.
- ★ Built-in, versatile edge-connector provides for further expansion.
- ★ Price: **£45.00 + VAT.**

**AVAILABLE SOON:
INPUT/OUTPUT PORT, RS423 INTERFACE,
and more!**

**THE ULTIMATE ROM/RAM
EXPANSION SYSTEM FOR THE BBC MICRO
NEW IMPROVED FACILITIES!**

- ★ 12 extra ROM sockets complement those already provided by the micro to allow up to 256K ROM space.
- ★ Four of these sockets can support either ROM or Static RAM (up to 16K maximum RAM).
- ★ The Model 2 board allows switching between multiples of 2K, 4K, 8K or 16K ROM/RAM.
- ★ Fully buffered design.

NOW EVEN EASIER TO FIT!

- ★ No soldering, plug-in design.
- ★ Fits easily inside BBC case.
- ★ Plugs into CPU socket via short flexible connector.
- ★ Improved plug design allows the Model 2 board to connect securely to any type of BBC CPU socket with no harm to micro or board.
- ★ Board is held in place by sturdy supports.
- ★ Full instructions provided.
- ★ Additional features include the ability to transfer paged firmware to disc, and then load back into sideways RAM for future use - giving you no limit to the number of effective ROMs accessible!

**SIR BBC MICRO ROM EXPANSION BOARD MODEL 2:
PRICE £40.00 + VAT**

BBC MICROCOMPUTER

BBC Model B	£399.00
BBC Model BD	£469.00

DISC DRIVES

Single 100K	£199.00
Dual 100K	£349.00
Dual 400K	£669.00

PRINTERS

Dot Matrix:	
Shinwa CP-80	£263.35
Epson RX-80	£275.00
RX-F/T	£289.00
Epson FX-80	£399.00
Daisywheel:	
Smith-Corona TPI	£258.75
Juki 6100	£399.00

MONITORS

Sanyo B/G	£85.00
Microvitec RGB	£229.00

SOFTWARE

We have over 200 titles currently in stock including ROM based programs such as **VIEW (£59.80)**, **HCCS PASCAL (£49.50)**, **Computer Concepts GRAPHICS ROM (£39.95)**, **WORDWISE (£39.95)** and **DISC DOCTOR (£29.95)**. Please telephone for full details of software range and current stock.

TORCH UNICORN RANGE

**CP/M compatible extensions
to the BBC Microcomputer System:**

ZEP 100: Z80 2nd processor card; 64K RAM; FREE SOFTWARE **£375 + VAT**

ZDP Z80 Disc Pack: ZEP 100; 2 x 400K floppy disc drive; FREE SOFTWARE **£839.50**

ZHDP-20: 6800 processor; 20 Megabyte hard disc drive; 400K floppy disc drive full System 3 UNIX Operating System **£2895 + VAT**

Also: As **ZHDP-20** but with basic UNIX. **£2400 + VAT**

TORCH C-500: Complete self-contained unit (NO BBC MICRO REQUIRED) comprising BBC Micro system, ZDP, hi-res colour monitor & British Telecom approved communication card **ring us for a competitive quotation.**

FREE 'PERFECT' SOFTWARE: Perfect Writer (word processor); Perfect Calc (spreadsheet); Perfect Filer (database filing system); plus 'COMANEX' business management game. **Complete software package normally worth about £1000!!**

We have a range of alternative Word Processing/Business packages based around the BBC Micro-computer system available at special prices. The following two systems represent our best-value Basic and Executive packages:

Basic Package:

BBC Micro (with disc interface & word processor ROM);

100K single disc drive;

Smith-Corona TP-1 Daisywheel printer;

Black/Green 12" monitor;

ONLY £1066 (incl. VAT)

Executive Package:

BBC Micro (with disc interface);

TORCH Z80 disc pack with 'WORDSTAR'

wordprocessor program;

Juki 6100 Daisywheel printer;

Black/Green 12" monitor;

ONLY £1799 (incl. VAT)

The above packages are also available as expansions for those users already owning a BBC Micro at suitably reduced prices.

Please telephone us for a quotation.

Postage & Packaging: *Small items* (ROM Boards, etc) please add £1.00 *Large items* (Printers, etc) please add £10.00 ACCESS/BARCLAYCARD TELEPHONE ORDERS WELCOME.

ALL PRICES ARE INCLUSIVE OF VAT (UNLESS STATED OTHERWISE)

Address all enquiries to: **SIR COMPUTERS LTD**
(DEPARTMENT C12)

91 WHITCHURCH ROAD, CARDIFF, CF4 3JP
TEL: (0222) 21341/621813



ACORN ABUSER'S

*Diary***Go on
Dan, we
dare you!**

WHEN will British companies wake up to the potential of micros? The Americans are going hell-for-leather to market software in their products while we sit back.

A classic example is the Marvel deal in adventure games – there could be 60 over the next 10 years with the whole Marvel Universe, from the Silver Surfer to the Fantastic Four making an appearance.

Where are the Bash St Kids? Dan Dare? Or for that matter Gollum and Biggles?

The attitude is typified by Allen & Unwin. They licensed Melbourne House to do *The Hobbit* three years ago, but there's no sign of a follow-up.

As Rayner Unwin says: 'We're not sitting upon any gold mines. We cannot sell *The Hobbit* to anyone else, otherwise Melbourne House would spit.'

The American attitude at Marvel: 'We're absolutely aggressive. This is our first software deal, but we're already talking to a British educational publisher.' They're happy to do other deals 'as long as it doesn't overlap with the adventures'.

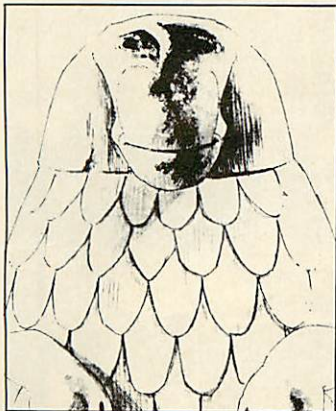

We've been nagged into it, folks. Mad Alex has been really peeved that we haven't shown his picture in our recent Dungeon competitions. So here it is!

**Syntax
error**

IMAGINE should be taken to see a greengrocer. Not because they're a load of cabbages (their software is quite good considering the machines they write for), but because the people who write their advertisements might learn a thing or two about apostrophes.

There's a well-known phenomenon called the greengrocer's apostrophe, whereby traders have a habit of inserting these little gems of punctuation where they're not needed: hence, cabbage's 55p each. Imagine's trick is to leave them all out: hence 'weeks time', 'whats more'.

Now this lapse can be explained, or excused, by a useful get-out called 'style': some magazines and advertising copywriters might spell connection with an 'x', or use, say, 1000 rather than 1,000. (Although forgetting apostrophes might seem an extreme style, it has been done. George Bernard Shaw was apparently anti-apostrophe and had them all left out of some of his books. Adverse public reaction led him to change his mind*.)

However, even allowing for style, this sentence in the Liverpool firm's latest advert is nonsense as a piece of English: 'When such computer wizards as . . . are locked away for

weeks on end, anything can happen, will they maintain their sanity, or whats more to the point can you control your patience?' There's at least a semi-colon and apostrophe missing there.

It reminds me of the remark by one English teacher to a particularly bad pupil: 'I sometimes wonder if English is your native language.'

Here's hoping they improve their grammar before converting *Arcadia* for the Beeb!

Stop press: they're at it again! The latest Imagine ads leave out question marks left, right and centre.

"Keep Taking the Tabloids" by Fritz Spiegl (himself no stranger to Liverpool) gives a good low-down on the greengrocer's apostrophe (page 166).

**Name of
the game**

OUR favourite Editor was a little subdued one Monday a few weeks back. Normally the Ed is just grumpy as he's suffering from the after-effects of playing football on a Sunday, but he's soon giving accounts of his astounding footwork on the left-wing (hence the name Big Ed).

On this day, however, it took several pints of The Black Stuff (Guinness to us) before he finally admitted over breakfast that his team had been thrashed 11-1 the day before (yes, eleven, not two).

But the final ignominy was yet to come. 'What was the name of the team that could defeat The Cavaliers so heavily?'

Ed looked up with contempt in his eyes, made some terrible remarks to his questioner, and replied, while trying not to cry into his beer: 'Acorn ***** Anodysing!'

**JARGON
JUNGLE**

WE'VE read some rubbish in our time (as well as written it) and we reckon you've stumbled over the pretentious, the inept and the gobblegook on your travels through the technological column-inches. So let's see who can snip out the looniest lines, the most turgid turns of phrase, the brightest gems of obfuscating jargon. The cutting printed will win a fiver.

To start you off, we've picked a golden oldie (the *Financial Times*, February 1983). P J Cavill, Inmos technologist, is being quoted on the subject of the transputer: 'An optimum length instruction lookahead maximises store bandwidth utilisation and minor cycle pipelining is used so that all microsteps are fully overlapped with microcode fetches.'



Uncle Klunk and Mac in the puppet factory . . . but what is Mac saying to Klunk? £5 for the best suggestion by April 9

GRAPHIC EXAMPLE

'I CAN'T program well, I might just about write a loop to print out my name ten times in different colours – with a following wind and going downhill.' Now that might sound a strange admission from a man who's producer of a BBC television series which is breaking new ground in the use of BBC micro graphics, but Dr Peter Bratt doesn't think so.

His interest in the Beeb comes from being a 'technology freak' who loves to get hold of the latest gadgets: and the programme he produces for schools – *Science Topics* – gives him access to just about all the hi-tech toys he could wish for. That's why the opening credits to the series are written by a laser, and the programmes make use of everything from pop groups to space shuttles to try to put across the theory of science to teenagers.

But the Beeb isn't used just as a toy, or because his office is below those intrepid men who produced the computer series. The Beeb is there to put across the ideas in graphical form. The pictures on page 19



How one BBC series is using micros to create all its screen graphics

show some of the results; they were all set up on a Beeb, and then animated.

Who writes the graphics software though? Well, as Peter couldn't do it, he went to see the BBC micro experts one floor above: 'They told me to go to Ian Trackman, and he's been doing the job ever since'.

Ian Trackman is a name many readers will be familiar with. He worked as a consultant on The Computer Programme, Making

the Most of the Micro, and the Micro Live Special. He produced many of the programmes used in the series, some of which were released on cassette by BBC Soft. His latest release is the BBC Soft Toolbox.

In the days before the micro came along, Peter would sketch an outline storyboard and hand it over to a graphic artist. Nowadays, he takes the same rough sketches to Ian and they work out between them whether the idea's feasible or if there's a better way of doing it on the micro.

'Ian plays a major part at this stage', says Peter, 'because he's the one who knows what is and isn't possible. I don't know, and that's a good thing because it means my ideas aren't limited, and sometimes we do things you mightn't have thought possible on such an inexpensive computer.'

Once the pictures have been programmed, they are animated and filmed. The film is then edited, and certain sequences are speeded up, slowed down or chopped together.

So far the animations for *Science Topics*



Peter Bratt directs a sequence from 'Waves', one of the programmes in the Science Topics series, in Ealing Studios

have ranged from an explanation of the genetics of plant breeding to the propagation of sound waves. Sequences produced to explain the effect of electronic components in analogue and digital signals have worked particularly well, says Peter.

But the producer of *Science Topics* isn't blind to the major disadvantage of using the BBC micro for television work – the low resolution of the machine, even in the 'high resolution' graphics modes, and hence the crudeness of some of the images. 'We're not completely mad! Not by any stretch of the imagination could the BBC micro-generated graphics be compared to those produced by a mainframe system or a conventional animation artist.'

What lies behind the decision to use the micro is the intention to put out software packages for schools which will use the same graphics as the TV series. And with the Beeb going into so many schools, it was the obvious choice.

'Normally micros only appear on television in specialist computer programmes. And that's a great pity because the micro is no longer a temperamental piece of electronic wizardry reserved for the informed and committed expert.'

'We believe we are at the start of an age when the micro will take its place alongside bunsen burners and microscopes as a normal piece of school science equipment. Not that the TV series ever draws special attention to the computer. Rather than being something different, the computer is treated as another tool, to be used when appropriate.'

Using the BBC for graphics is part of this long-term project. The next step is to discover whether video discs could play a role. Peter is looking into whether edited versions of the television series on video disc could be controlled by a micro. That, however, would require extra filming, and hence extra costs, which his present budgets don't allow. But he's hopeful of convincing the Corporation to part with the cash, or for sponsorship from an outside source.

Software to accompany *Science Topics* is already being written at Chelsea College in London. Work on the packages started last autumn and the first fruits are expected for the new school year. Peter came into contact with the College while doing a course there and went back to them with the idea. But it wasn't all a foregone conclusion. 'When we started filming, we took a bit of a gamble in planning the micro graphics and the idea of the software as financing hadn't been worked out with BBC Publications, but it paid off in the end.'

Ten software packs are planned to accompany the series on subjects such as waves, chemical bonding, ecology and electronics – not to mention 'Newton and the Space Shuttle'. But Peter is particularly excited about this one as it puts pupils at the helm of a Nasa Shuttle to experience Newton's laws of motion for themselves.

page 23 ►

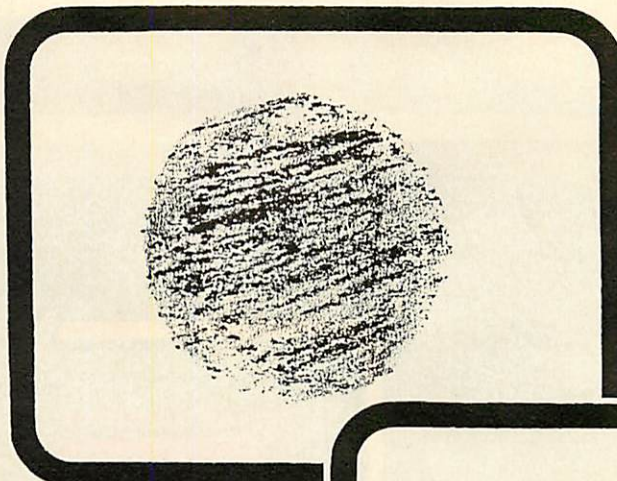

Atom as solid
'ball' of colour

'1/2 tone'
with nucleus
e four electrons
(Current bun
idea!)

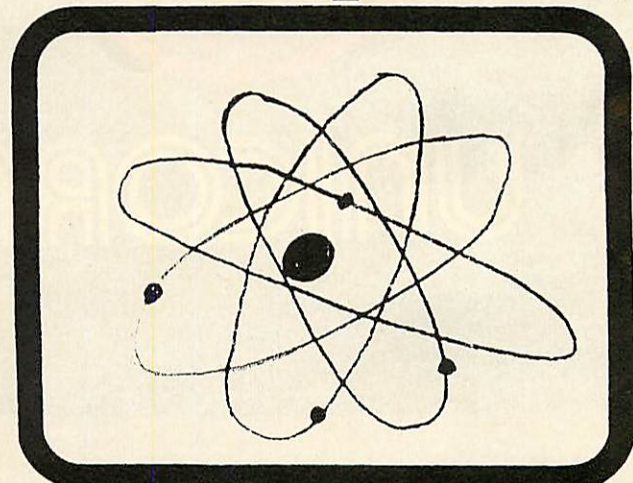
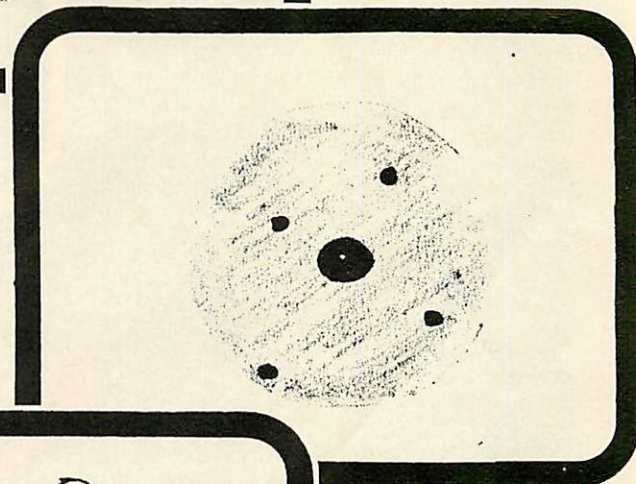

Electrons move
in 'orbits'

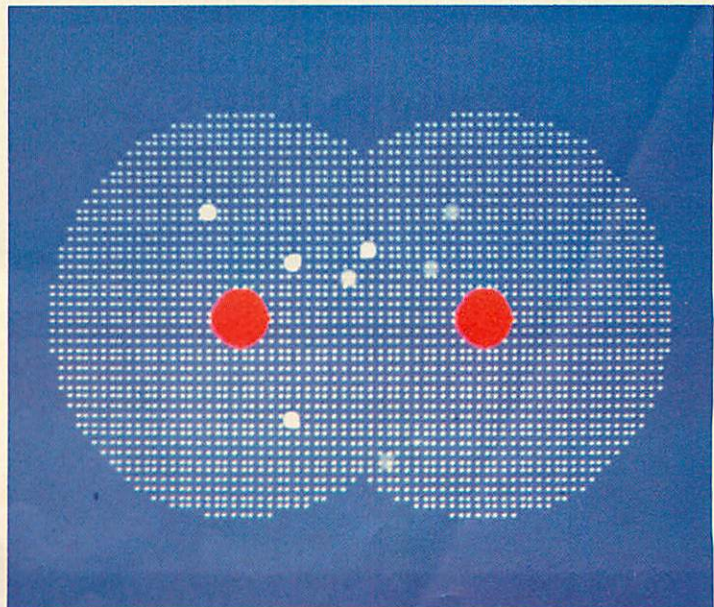

Above: three stages in Peter Bratt's storyboard for an episode of *Science Topics* on atomic bonding, and right, a shot from the finished TV graphics



UNICORN

SONY

TRINITRON

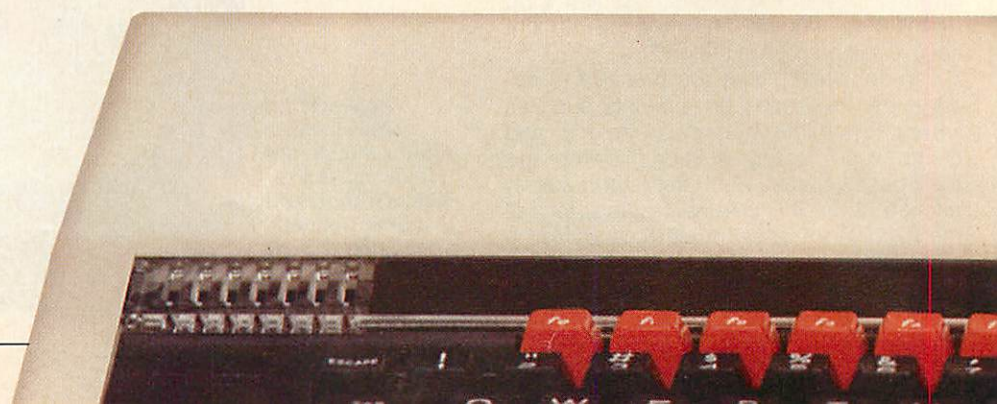

Unicorn opens 5 new channels for the BBC.

The BBC Model B micro packs a lot of potential. As a basic computer, it is reliable, efficient and simple to use – but, more than that, it is the first step on the road to a complete computer system.

TORCH COMPUTERS have chosen the BBC micro as the heart of their open channel system – UNICORN. UNICORN means a wide choice of upgrade channels to transform your BBC into a complete business system, a fully communicating workstation, or a high-powered 32-bit data processor.

At the gateway to the Communications Channel is the UNICORN ZEP100 – a 64K processor board and the software needed to promote your Model B into TORCHNET a local area network station. Further along the channel, the UNICORN FDP240 will provide twin 400K floppy disc drives, which with the addition of the ZEP100 will result in a Z80 disc pack.

The UNICORN Business Channel develops the BBC micro into a flexible professional tool equipped to manage the most complex business requirements. Opening with the HDP240 – a simple but powerful disc drive, the channel provides for any level of upgrade from the well-proven ZDP240

(TORCH Z80 Disc Pack) up to the ultimate addition – the UNICORN – combining the HDP68K – a 32-bit 68000 processor with the UNIX[®] operating system.

And if you get lost in the by-passes and flyovers around your BBC, there is one simple route for you to follow – the straight channel to your nearest TORCH UNICORN dealer. He will assess your requirements, then recommend the ideal solution to cope with your present and future needs.

For full colour product brochure, price list and the name of your nearest TORCH UNICORN dealer, just clip the coupon.

UNICORN

Open channels for the BBC micro.

To: Torch Computers Ltd., Abberley House, Great Shelford, Cambridge CB2 5LQ. Telephone: Cambridge (0223) 841000.

Please channel further details on the Unicorn range to:

Name _____

Address _____

AU 4.84

Text and Graphics provided by BBC Model B.
Keyboard provided by BBC Model B.
Disc interfaces are necessary for use with the Unicorn range.

CP/M is a registered trademark of Digital Research Inc.
Unix is a registered trademark of Bell Telephone Laboratories Inc.

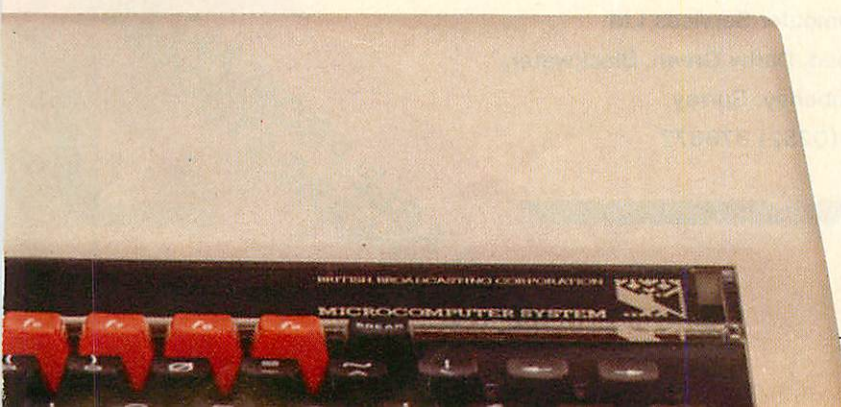

Great News for Electron and Micro Users
Now Available

CHESHIRE CAT

EDUCATIONAL SERIES

from

AMPALSOFT

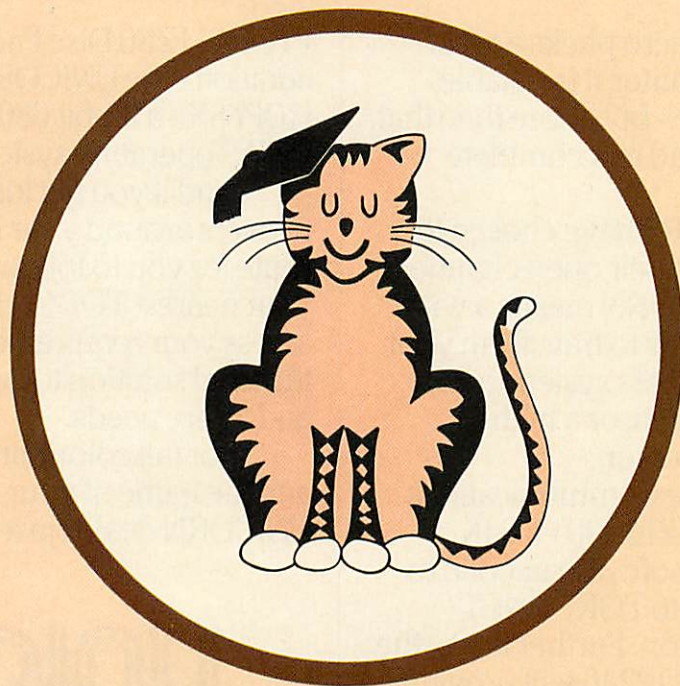

CHESHIRE CAT

The First name in Educational Software.

An exciting range of top quality programs covering all needs from pre-school to 'A' level.

Ampal Computer Services Ltd.
31 Woodbridge Road, Darby Green, Blackwater,
Camberley, Surrey.
Tel: (0252) 876677

**AVAILABLE FROM ALL GOOD
SOFTWARE STOCKISTS**

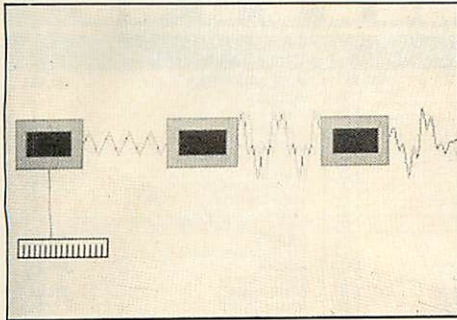

Ripple tank graphics - far less merry than playing around with water, and, below, how an electric organ works by altering the shape of the sound waves

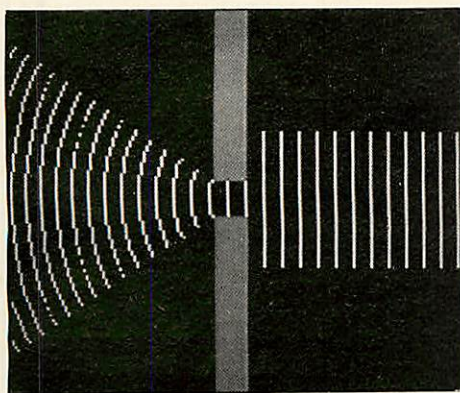

Other packs use World Health Organisation statistics and models, with a few Lisa-type icon screens thrown in, and another is based on a nature conservatory in Devon.

The object of the software is to get pupils to think for themselves, which Peter believes is important. 'Computers in classrooms help to promote genuine problem-solving rather than rote learning of facts. In the long run it might be seen that the development of problem-solving skills is the biggest benefit of the computer revolution.'

And the combined use of television and software could be a big factor in stimulating pupils. Peter explains: 'Pupils watching a television programme about malaria might well feel strongly about the plight of the children in the African village. How much better the learning becomes if afterwards they can go to the computer and take part in a simulation where they become the malaria control officer in that African village.'

As the graphics have become more demanding on *Science Topics*, so the Beeb's, and Ian Trackman's, talents have been stretched. A development version of the 6502 second processor came to the rescue, however, and *Science Topics* hopes other advances, such as the Aries and Solidisk boards, will have a role to play.

Ballerina Nina Falaise is deaf, but is able to sense the music through vibrations



AID at last!

Assembler Interactive Debug for the BBC Micro with DUALSCREEN

STOP PRESS . . . AID receives superb review . . . see below

AID has now established itself as the finest machine code monitor ROM for the BEEB. With its unique DUALSCREEN operation so far in advance of the competition, AID puts unprecedented debugging power into your hands. No other monitor can begin to tackle machine code graphics - something AID takes effortlessly in its stride! Beginner or expert, you cannot afford to be without DUALSCREEN AID.

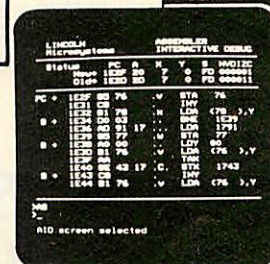

Read what "The Micro User" thinks . . .

"My immediate impression of AID was that it was a very professional product . . . AID offers additional features far in advance of other monitors . . . I found it easy to use, particularly as the user guide is very thorough and accurate . . . I wish I had something like this when I first started dabbling in machine code . . . The last facet I explored was the DUALSCREEN facility, which is perhaps the pearl of the system . . . In conclusion, AID seems a must for the serious machine code programmer and a very useful learning aid for the novice. It is a highly professional product in every way and could prove to be the standard by which others are compared."

"The Micro User" January 1984

The most advanced machine code AID for the BBC Micro

LINCOLN
Microsystems

Dept DP1, 22 Lagan Walk
Peel Hall
Manchester M22 5WG

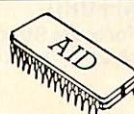

ROM
plus manual
(OS 1.2 required)

£28

p&p add
UK £1.50
Europe £3.00
Outside Europe
£4.50

Computerama

GRUNDIG 14" TV/MONITOR + REMOTE CONTROL

RGB input for a super clear display. The picture must be seen to be believed. We have not seen better colour on any dedicated monitor.

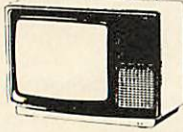

ORDER TODAY, we guarantee that you will not be disappointed. And remember, when you finish computing, just flick the switch and you have a super quality 14" colour TV - what better way to justify the expense to your wife or girlfriend!

Complete with lead for BBC for only

£309 inc VAT

Turn your BBC into a powerful business system with the NEW Torch Z80 2nd Processor Board includes additional 64K RAM PLUS Free Software Valued at over £1,100. - ONLY £429 inc. VAT.

Software includes:

- * Perfect Writer
- * Perfect Speller
- * Perfect Calc
- * Perfect Filer
- * Torch Net.

ORDER NOW. And receive our Enhanced Utilities Disc. Many additional and useful programs included.

HURRY - limited numbers available.



SIDELINE Rom Expansion Board

- * Full sidewise Rom Expansion to 16 Roms
- * 16K Battery backed CMOS Ram option
- * No soldering required to fit sidewise
- * Plug-in-and-go construction - Mounts neatly inside the BBC machine.
- * Full buffering of address and data busses - prevents data bus loading problems associated with unbuffered boards.
- * Pin1 of on board sockets are connected properly - No spurious crashes due to this known fault on BBC
- * Existing sockets on BBC are usable. All eprom sockets are accessible without removing sidewise.

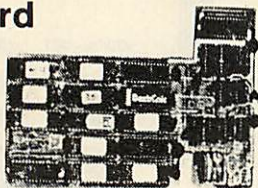

ONLY £43.70
+ £1.00 carriage

TORCH Z80 DISC PACK with over £1,100 of software FREE



NOW ONLY £835 inc. vat
Free carriage UK only

Software includes:
* PERFECT WRITER * PERFECT SPELLER * PERFECT CALC
* PERFECT FILER * TORCH NET * Comanex - The Interactive Management Game. Approved and used by leading management consultants. The TORCH Z80 DISC PACK is the most powerful BBC Disc upgrade available, it provides 800K of storage plus a Z80 Second Processor running Torch's own CP/M compatible operating system - over 200 packages now available - discs can also be used for storage under Acorn D.F.S. system.

Clip this ad to your order to receive free 40/80 T converter program.

BBC	INC VAT
Acorn Electron	199.00
BBC Model B	399.00
BBC Model B+DOS	469.00
BBC Disc Upgrade	P.O.A.
BBC A-B Full Upgrade	95.00
BBC Teletext Receiver	225.00
BBC Z80 2nd Processor	T.B.A.
BBC 6502 2nd Processor	T.B.A.
DISC DRIVES	INC VAT
LVL Single x 100K Drive	265.00
LVL Expansion Drive	149.00
LVL Dual x 100K Drive	389.00
Pace Single 100K	212.25
Pace Single 40/80T D/Sided	349.95
Pace Dual 100K	379.95
Pace Dual 40/80T D/Sided	664.95
Pace 200K 40T D/Sided	270.00
Torch Dual 400K Z80 Disc Pack	835.00
Opus Single 100K	179.95

ORDER A COMPLETE SYSTEM - GET ALL
LEADS FREE

MONITORS	INC VAT
Microvitec 14" Colour	247.00
Sanyo 14" Colour	287.00
Fidelity 14" Colour Monitor	229.00
Grundig 14" Colour TV/Monitor	309.00
Sanyo 12" Green Screen	89.00
Phoenix 12" Hi-Res Amber	129.00
PRINTERS	INC VAT
Epson RX80	269.00
Epson RX80 FT *NEW	299.00
Epson FX80	425.00
Epson FX100 *NEW	569.00
Riteman	286.00
Shinwa CP80	229.00
Juki 6100 Daisywheel	449.00
MISCELLANEOUS	INC VAT
Sanyo DR101 Data Recorder	39.95
Cassette Leads—all types	3.90
Acorn Joysticks	13.00
Quickshot Joystick	19.95
Printer Cable (parallel) 1.2 m	13.00
BBC Deluxe Dustcover	5.95
Light Pen	28.95
The Plug Power Filter	14.95
ATPL Rom Expansion Board	43.70
ROM SOFTWARE	INC VAT
Wordwise	39.00
View	59.00
Disc Doctor	32.95
Termi (terminal emulator)	32.95
Graphics Rom	32.00
Pace DFS	39.95
HCCS Forth	} 57.00
HCCS Logo Forth	
HCCS Pascal	
HCCS Excal	
LVL LDOS Double Density	89.00
BOOKS	NO VAT
30 Hour Basic	5.95
A.L.P. for BBC Micro	8.95
BBC Micro Disc Companion	7.95
Advanced Programming Techniques	7.95
Basic Programming on the BBC Micro	5.95
Creative Graphics	7.50
Graphs & Charts	7.50
Lisp Manual	7.50
Forth Manual	7.50
BCPL Manual	15.00
30 Programmes for BBC	4.95
100 Programmes for the BBC Micro	6.95
Discovering BBC Machine code	6.95
21 Games for the BBC	5.95
The Book of listings	3.75
The BBC Micro An Expert Guide	6.95
Programming the BBC Micro	5.95
Creating Adventure Games on the BBC	6.95
Games BBC Computers Play	6.95

WE ACCEPT INSTITUTIONAL AND
EDUCATION ORDERS

ALLIGATA	INC VAT
Contract Bridge	7.95
Bug Blaster	7.95
Dam Busters	7.95
Eagle Empire	7.95
Neanderthal Man	7.95
Primary Art	7.95

PROGRAM POWER	INC VAT
Killer Gorilla	7.95
Chess B	7.95
Cyberton Mission	7.95
Croaker	7.95
Danger UXB	7.95
Escape Moonbase Alpha	7.95
Felix in the Factory	7.95
Felix and the Fruit Monsters	7.95
Hell Driver	7.95
Swoop	7.95
Chemistry	6.85
Positron	7.95
Physics	6.85
Demon Decorator	6.85
Alien Swirl	7.95
Alien Destroyers	7.95
Martian Attack	7.95
Moon Raider	7.95
Labyrinths of LaCoshe	7.95
Zarrm	7.95
SUPERIOR SOFTWARE	INC VAT
Colditz Adventure	7.95
Galaxians	7.95
Road Runner	7.95
Hunchback	7.95
Pontoon	7.95
2002	7.95
Gideons Gamble	7.95
Lunar Mission	7.95
Lost City	7.95
DYNA-BYTE	INC VAT
Pool	7.95
COMPUTER CONCEPTS	INC VAT
Logo-2	11.50
OPUS	INC VAT
Dogfight	9.95
BUG-BYTE	INC VAT
Twin Kingdom Valley	7.95

RING FOR LATEST PRICES, MANY
REDUCTIONS EXPECTED

BBC/ACORN/ST (A Selection)	INC VAT
Algebraic Manipulation	9.95
Arcadians	9.95
Business Games	9.95
Castle of Riddles	9.95
Creative Graphics	9.95
Countdown to Doom	9.95
Forth	16.85
Graphs and Charts	9.95
Hopper	9.95
Lisp	16.85
BCPL (Rom + Disc)	99.95
Missile Base	9.95
Meteors	9.95
Monsters	9.95
Peeko Computer	9.95
Planetoid	9.95
Rocket Raid	9.95
Snooker	9.95
Sphinx Adventure	9.95
Starship Command	9.95
Tree of Knowledge	9.95
Snapper	9.95
View	59.00
Speech Kit	55.00
Personal Money Management	9.95
Draughts and Reversi	9.95
Wordhunt	9.95
White Knight II	11.50
Vutype	15.00
Tax Calc	20.00
Beyond Basic	10.00
Toolbox	21.00
Canyon	10.00
Record Keeper	15.00
Doctor Who	10.00
SOFTWARE INVASION	INC VAT
3D Bomb Alley	7.95
Gunsplode	7.95
Attack on Alpha Centauri	7.95
Vortex	7.95
VISION	INC VAT
Snooker	7.95
Daredevil Dennis	7.95
PSION	INC VAT
Saloon Sally	7.95
VuCalc	14.95
VuFile	14.95

A SMALL SELECTION FROM
OUR VAST RANGE

MELBOURNE HOUSE	INC VAT
The Hobbit	14.95
CLARES	INC VAT
GraphKey	7.95
Replica (Disc Only)	9.95
Graph Disc	12.95
The Key (Disc Only)	12.95
Single Key Entry	4.95
Shadow/Inspector	7.95
State 40/80T for Discs	
DR SOFT	INC VAT
747 Flight Simulator II	8.95
AMCOM	INC VAT
Space Highway	6.95
GEMINI GAMES	INC VAT
Missile Control	9.95
Liberator	9.95
Caterpillar	9.95
GEMINI	INC VAT
Cash Book Acc	95.00
Commercial Acc	19.95
Data Base	19.95
SOFTWARE FOR ALL	INC VAT
Stock Control C/D	19.95/29.95
Invoicing/Statements C/D	19.95/29.95
Sales/Purchases C/D	19.95/29.95

24 HOUR DESPATCH ON STOCK ITEMS

ADVENTURE INTERNATIONAL	INC VAT
Adventureland	9.95
Voodoo Castle	9.95
Secret Mission	9.95
Pirate Adventure	9.95
SOFTSPOT	INC VAT
Transistors Revenge	6.95
Heist	6.95
AARDVARK	INC VAT
Zalaga	6.90
A&F	INC VAT
Cylon Attack	7.90
Chuckie Egg	7.90
DYNABYTE SOFTWARE	INC VAT
Corporate Climber	7.95
Lemming Syndrome	7.95
MIRROR/ST	INC VAT
First steps with the Mr Men	8.95
ASK ACORN/ST	INC VAT
Hide & Seek	9.95
Lets Count	6.95
Face Maker	6.95
Number Gulpser	9.95
JOE THE LION	INC VAT
Challenger	7.95

24 HOUR DESPATCH ON STOCK ITEMS

MAIL ORDER
Post your order today to
COMPUTERAMA, 1 Sash Street, Stafford
ST16 2PS Or telephone your Access or
Barclaycard number, we will despatch
immediately (0785) 41899.

Call in today. Home Computer Centre for the
BBC enthusiast.
Send large SAE for further details of any
product.



CARRIAGE
Micro's Monitors, Disc Drives,
Printers £8.00, Books £1 each.
Cassette Decks £2.00, Leads and software
50p/item, £1.50 max.

WE EXPORT WORLDWIDE
Telex 36540 Hours G.

QUICKSHOT II BBC JOYSTICK - Now with rapid fire option

Self centring joystick. Works even with keyboard only programs. A sensation at the Micro User Show. More fun - reaches the games other joysticks cannot. Limited supplies of this item.
£19.95 + £1.00 p&p



Computerama

STAFFORD
59 Foregate Street, Stafford,
ST16 2PR. Tel: (0785) 41899

STOKE-ON-TRENT
11 Market Square Arcade,
Hanley, Stoke-on-Trent,
ST1 1PD.
Tel: (0782) 268620

SHREWSBURY
13 Castle Gates, Shrewsbury
SY1 2AB. Tel: (0743) 60528

□ *Acorn User* is not distributed in Canada, except by subscription, but there are a considerable number of Atom enthusiasts out there. To assist them, there is the Atom Users Group of **Canada**. It claims members from the Atlantic to the Pacific and from the frozen North down to the Caribbean.

The group publishes its own quarterly newsletter and is building up a software library. Subscription details are available from John Wood at the address below.

□ We've had a letter from the **Irish** Amateur Computer Club, now in its second year. The club has more than 100 members

and a variety of micros are represented – there's a BBC user group within the club and it would like to hear from other BBC users in Ireland. The club caters for both city and provinces, with monthly meetings in Dublin and regular newsletters to members. New members should contact Austin Vaughan at the address below.

CLUB CONTACTS

● The Secretary
Wakefield BBC Micro User Group
116 Pindersfield Road
Wakefield
West Yorkshire WF1 3PL

● Colin Price
Keighley Computer Club
Red Holt
Hainsworth Wood
Keighley
W. Yorks
Tel: Keighley 603133

● Jennifer Woeller
Sutton Library Computer Club
Sutton Central Library
St Nicholas Way
Sutton, Surrey
Tel: 01-661 5031

● Mr C. Rutter
Medway Atom Users Club
St John Fisher School
Ordnance Street
Chatham
Kent

● Mr J. Ashurst
Acorn Computer Users Group
Abraham Moss Centre
Crescent Road
Manchester 8

● **BBC Adventure Club**
18 Weardale House
Woodberry Down
London N4 1QN

● John Wood
Atom Users' Group of Canada
812 Cabot Trail
Milton
Ontario L9T 3MB
Canada

● Austin Vaughan
Irish Amateur Computer Group
35 Monastery Drive
Clondalkin
Dublin 22
Eire
Tel: (01) 593112 (evenings)

● Miss J. Lines
South East Essex BBC User Group (SEEBUG)
97 Oakhurst Drive
Wickford
Essex SS12 0NW
Tel: 03744 63396

● A. Wood/D. Donaldson/E. Wilson
Bracknell Primary Schools Computer Users' Group
Wildridings County Junior School
Netherton
Bracknell
Berks RG12 4DX
Tel: Bracknell 425483

● Stuart Mallinson
Huddersfield BBC Micro User Group
34 Ryefields
Scholes
Huddersfield
West Yorks HD7 1XF

● Rupert Steele
Amateur Computer Club
St John's College
Oxford OX1 3JP

● **Beebug**
374 Wandsworth Road
London SW8 4TE

● J Smith, Secretary
Brighton, Hove & District Computer Club
30 Leicester Villas
Hove
E. Sussex BN3 5SQ

● Mr Ric Keyworth
North London BBC Micro Users Group
'The Penthouse'
4b Kilburn High Road
London NW6 5UL
Tel: 01-734 9235
(7am-3pm Mon-Fri)

● **West Midlands Computer Group**
12 Apsley Road
Oldbury
West Midlands B68 0QZ

● Mr J. Price
Bedford House
27-28 St George's Road
Brighton
Sussex

● Mr P. Beverley
Norwich Area Acorn User Group
Room 12a, Norwich City
College
Ipswich Road
Norwich NR2 2LJ

● Keith Mitchell
Edinburgh ZX Computer Club
19 Meadowplace Road
Edinburgh
Tel: 031-334 8483

● Steve White
Atom/BBC User Group
c/o Superior Systems Ltd
178 West Street
Sheffield
Tel: (0742) 755005

● Robin Bradbeer
Association of London Computer Clubs
Polytechnic of North London
Holloway
London N7 8DB

● Nik Kelly
Liverpool BBC & Atom Group
56 Queens Drive
Liverpool L4 6SH
Tel: 051-525 2934

● Andy Purkiss
Namebug
12 Palm Close
Witham, Essex.
Tel: 0376 515609

● I. Beng
BBC Micro Club
PO Box 1297
Santa Cruz de Tenerife
Tenerife

● Lindsay Thachuk
Beebnet
PO Box 262
Kingswood
South Australia 5062

● Mr D. L. Evans
23 Hitchin Road
Henlow Camp
Bedfordshire

● N. P. (Bazyle) Butcher
Harrow Computer Group
16 St Peter's Close
Bushey Heath
Watford WD2 3LG

● R. Welch
Harpenden Microcomputer Group
7 Tylers
Harpenden
Herts AL5 5RT

● Mr P. Frost
Atom Users Group
3 Leyland Road
Bulkington
Warcs CV12 9LW

● Oivind Grenness
BBC Norway
O-Inform
PO Box 716
N3191 Horten
Norway

● R. V. Souter
TRS/80 Beeb Users Group
25 Carr Lane
Willerby
Hull HU10 6JP
Tel: 0482 654117

● E. R. Piper
Bognor Computer Group (BUG)
2 Ely Gardens
Aldwick Park
Bognor Regis
Sussex PO21 3RY

● Andrew Pike
Peterborough Personal Computer Club
920 Bourges Boulevard
Peterborough PE1 2AN
Tel: 0733 44342 (after 5pm)

● Simon Sadler
Mid-Cheshire Computer Club
75 Swanlow Lane
Winsford
Cheshire CW7 1JD

● **Liverpool BBC Microgroup**
c/o Fred Shaw
14 Albany Avenue
Eccleston Park
Prescot
Merseyside L34 2QW

● John Harris
Bottisham Acorn User Group
1 Rowan Close
Bottisham
Cambridge CB5 9BN
Tel: (0223) 811487

● Peter Smith
Fareham and Portchester Amateur Computer Club
23 Sandy Close
Petersfield
Hants

● Paul Barbour
Laserbug
10 Dawley Ride
Colnbrook
Slough
Berks SL3 0QH

● Brian Pain
Colour Micro Users Group
40a High Street
Stony Stratford
Milton Keynes
Tel: (0908) 564271

● Mr D. Coulter
Preston BBC User Group
8 Briar Grove
Ingol
Preston PR2 3UR

● **Acorn Users Group of Sweden**
c/o Janne Soderberg
Frihetsvagen 32
S-175 33 Jarfalla
Sweden

● Peter Wilson
Universal Micro Club
26 North Cape Walk
Corby
Northants NN18 9DQ
Tel: Great Oakley 742622

● John Haigh
Iver Computer Society (IC's)
141 Leas Drive
Iver
Bucks SL0 9RP

● John Eary
Kinder Peak Computer Club
36 Parkway
New Mills
Tel: New Mills 43870

● C. Verrier
Wandsworth Computer Club
Earlsfield Library
Magdalen Road
London SW18

● Mr J. Craig
National BBC User Group
40 Mount Pleasant Avenue
Wells
Somerset BA5 2JQ

● Mr R. Luff
Kingbee
54 Arlington Close
Kingwinford
West Midlands

● **Computer Club**
Caterham Leisure Centre
Godstone Road
Caterham
Surrey CR3 6RE
Tel: Caterham 48304/43316

● Ted Ryan
Eastwood Town Microcomputer Club
15 Queens Square
Eastwood
Nottingham NG16 3BJ

● Mr T. A. Kayani
SOBAT Computer Club (East London)
12 Calderon Road
London E11 4EU
Tel: 01-556 5423

● Mr M. G. Forster
Potbug BBC Users Group
8 St George's Avenue
High Lane
Tunstall
Stoke-on-Trent
Tel: 818499

● **Muse** (for teachers)
Freepost
Bromsgrove
Worcs B62 7BR

● Mr B. Carroll
The Cottage
42 Manor Road
Aldershot GU11 3DG

● Steve McLeod
BBC Users Group of Canberra
5 Hatfield Street
Evatt A.C.T. 2617
Australia
Tel: (062) 58 7719

● A. H. Fowler
Tonbridge School Computer Society
44 Birling Road
Tonbridge Wells
Kent TN2 5LY

● J. Assies, Secretary
Big Ben Club
PO Box 177
4670 AD Zevenbergen
The Netherlands

● H. W. H. Fisher
Sunningdale BBC User Group
82 Cedar Drive
Sunningdale
Berks SL5 0UB
Tel: Ascot 25030

● Peter Hughes
Format 40/80 Club
BBC Disc User Group
5 March Street
Bristol BS1 4AA

● Dave Davies
229 Manley Road
Chorlton-cum-Hardy
Manchester M21 1RB
Tel: 061-881 0382

● Tony Latham
Computer Users Club
69 Hadlow Road
Welling, Kent DA16 1AX

● Tony Pickard
Newcastle & Washington BBC User Group (NEWBUG)
c/o Washington Town Centre
Library
The Galleries
Washington, Tyne & Wear
Tel: 091-417 3992 after 7pm

● John Fryer, Treasurer
ABUG
17 Edgedale Road
Sheffield S7 2BQ

● Chris Parry, Secretary
Stratford Computer Club
16 Sackville Close
Stratford-on-Avon
Tel: 0789 68080

● Robert Watt
Inverclyde BBC Micro Users' Club
9 St John's Road
Gourock
Renfrewshire PA19 1PL
Tel: Gourock 39967

● Antony Hurden
West Suffolk BBC Micro Users' Club
14 Plovers Way
Bury St Edmunds
Suffolk IP33 2NJ

CASH IN ON REGISTERS

Screen scrolling, slicing up screens, dissolving graphics – it's all possible and Ken Worrall shows how

THE Motorola MC6845 cathode ray tube controller (CRTC) with the BBC 'micro's video ULA form the system which puts the display on your TV or monitor. The 6845 contains 18 registers, 14 of which are write-only registers, two are read or write registers and two are read-only registers.

There are two main ways to write to one of these registers:

1. VDU23,0,register,value,0,0,0,0,0,0 or VDU23;register,value;0;0;0
2. ?&FE00=register: ?&FE01=value

The second method is more direct, and shows the way the chip is accessed: it is also easier to remember without all those noughts and commas in the VDU command.

There is, however, only one way to read a register:

```
?&FE00=register:PRINT?&FE01
```

Next we have a brief description of the 18 registers and some examples of what can be achieved by altering some of the values.

Register 0: This eight-bit, write-only register contains the total number of displayed and undisplayed character cells in each mode, minus one for horizontal timing purposes:

Mode	0	1	2	3	4	5	6	7
Value	127	127	127	127	63	63	63	63

Program 1 shows how altering the value of register 0 can cause the display to dissolve and reform.

Register 1: This carries eight bits, and can only be written to. It contains the number of displayed character cells per horizontal line, for each screen resolution:

Mode	0	1	2	3	4	5	6	7
Value	80	80	80	80	40	40	40	40

You will notice that the number of displayed character cells is not equal to the number of displayed characters in the four and 16 colour modes. This is because of the memory used by colour; each character is made up of two or four character cells.

Program 2 demonstrates how altering the value of register 1 can be used to slice up and reform the display.

Register 2: Again an eight-bit write-only register, which determines the position of the sync pulse on the horizontal line.

Mode	0	1	2	3	4	5	6	7
Value	98	98	98	98	49	49	49	51

register determines the position of the vertical sync:

Mode	0	1	2	3	4	5	6	7
Value	34	34	34	27	34	34	27	27

Register 8: Interlace and blanking are governed by this write-only register using eight bits. The lower two bits control the interlace:

- 0... No interlace
- 1... Interlaced sync
- 3... No interlace
- 4... Interlaced sync and video

Modes 0-6 are interlaced sync only and mode 7 is interlaced sync and video. The high six bits control the video blanking and are only used in mode 7 when bits 5 and 8 are set.

Mode	0	1	2	3	4	5	6	7
Value	1	1	1	1	1	1	1	147

Register 9: A five-bit, write-only register which determines the number of vertical scan lines, including spaces, minus one per character.

Mode	0	1	2	3	4	5	6	7
Value	7	7	7	9	7	7	9	18

Register 10: Seven bits this time for a write-only register controlling the cursor size and flash rate. The lower five bits (0-4)

Register 3: This determines the width of the horizontal and vertical sync pulse:

Mode	0	1	2	3	4	5	6	7
Value	40	40	40	40	36	36	36	36

Register 4: This one uses seven bits and is also write-only. It holds the integer number of vertical character line times, to determine the vertical sync:

Mode	0	1	2	3	4	5	6	7
Value	38	38	38	30	38	38	30	30

Register 5: A five-bit write-only register containing the fraction to be used with register 4 to provide an exact frequency for the vertical refresh rate:

Mode	0	1	2	3	4	5	6	7
Value	0	0	0	2	0	0	2	2

Register 6: This seven-bit, write-only register stores the number of displayed vertical characters:

Mode	0	1	2	3	4	5	6	7
Value	32	32	32	25	32	32	25	25

Register 7: This seven-bit, write-only

Program 1. Alters register 0

```
10 MODE5:value=63:REM Set value for each
mode.ie. 0-3=127,4-7=63
20 FORX=0TO1279 STEP10
30 MOVE 640,0
40 DRAWX,1027
50 NEXT
70 PRINTTAB(5,15)"ACORN USER"
80 X=1
90 Z=value
100 REPEAT
110 ?&FE00=0: ?&FE01=Z
120 IF Z=0 X=-1
130 IF Z=value X=1:VDU7:FORC=0TO5000:NEXT
140 Z=Z-X
150 UNTIL0
```

Software for the BBC micro

Graphics ROM

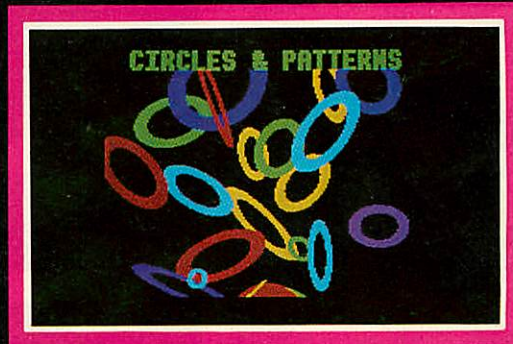
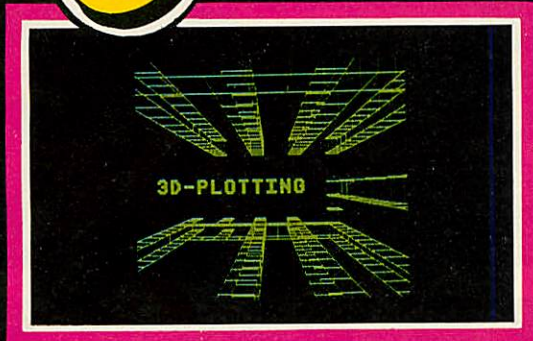

The Graphic Extension ROM for the BBC Micro 32K

Our latest utility ROM includes over 28 new graphics related commands. These can be typed in like any normal commands and can of course, be included in BASIC programs. The commands are split into 3 distinct areas:-

1. **Sprite graphics**
These are multi-coloured shapes up to 24 x 24 pixels in size. Once a sprite has been designed (using in-built routine) it can be plotted at any position on the screen and easily moved around. A sprite can also be part of a 'film' — a sequence of frames allowing animation. Up to 32 sprites or 'films' can be active on the screen at any time. A 'film' can contain up to 47 frames, each frame being any sprite image.
2. **LOGO 'turtle' graphics**
By using simple FORWARD, BACKWARD, LEFT and RIGHT commands a 'turtle' can be moved very quickly around the screen, producing intricate patterns by the most user-friendly means. Including these commands in structured BBC BASIC programs provides a system faster and more powerful than many of the packages currently used to demonstrate the LOGO language.
3. The third section consists of a large number of general purpose commands, such as:-
 - ★FILL which will fill ANY area on screen.
 - Fast circle and arc drawing
 - 3D graphics routines allowing X, Y, Z co-ordinate plotting
 - Large character printing in a range of patterns
 - Scaling — allowing any part of the screen to be expanded or diminished
 - A rotate command that will rotate all plotting by any angle around the originBecause this is a ROM, all the commands are instantly available, and has a built-in help menu showing the syntax of all commands. Supplied with a comprehensive manual and step-by-step fitting instructions, suitable even for the inexperienced. This ROM represents extremely good value for money.

Available directly from us, mail order only, or from all good dealers
£28.00 plus £1.00 p&p plus VAT

**COMPUTER
CONCEPTS**



CASH OR ROYALTIES. We specialise in quality software for the BBC machine and can offer the best rates around. We are always interested in obtaining new programs to add to our range and offer either a cash payment for the outright purchase or alternatively pay a royalty on each one sold.

16 Wayside, Chipperfield, Herts WD4 9JJ. Telephone (09277) 69727

determine on which scan line the cursor starts (scan lines as set by register 9). If bit 6 is set (+64) the cursor will flash. With bit 5 set (+32), the cursor flashes slowly, otherwise it will flash quickly. If bit 5 is set and bit 6 is not, the cursor will be invisible. For example, in mode 7:

Mode 7	18	No flash
	18+32=50	Cursor invisible
	18+64=82	Fast flash
	18+96=114	Slow flash
		(normal setting)

Mode	0	1	2	3	4	5	6	7
Value	103	103	103	103	103	103	103	114

Register 11: This five-bit, write-only register determines on which scan line the cursor ends. For example:

Mode 7	Register 10	96+0=96
	Register 11	9=9

This will give a cursor starting on line 0 and ending at line 9; therefore the cursor will occupy the top half of the character. Its values are:

Mode	0	1	2	3	4	5	6	7
Value	8	8	8	9	8	8	9	19

Registers 12 and 13: These two combined form a 14-bit, write-only register. Register 12 contains the lower eight bits and its partner contains the high six bits. In modes 0-6, this 14-bit combination contains the screen start address divided by eight. In mode 7, register 12 contains the high byte of the screen start address minus &74 and EOR'ed with &20; register 13

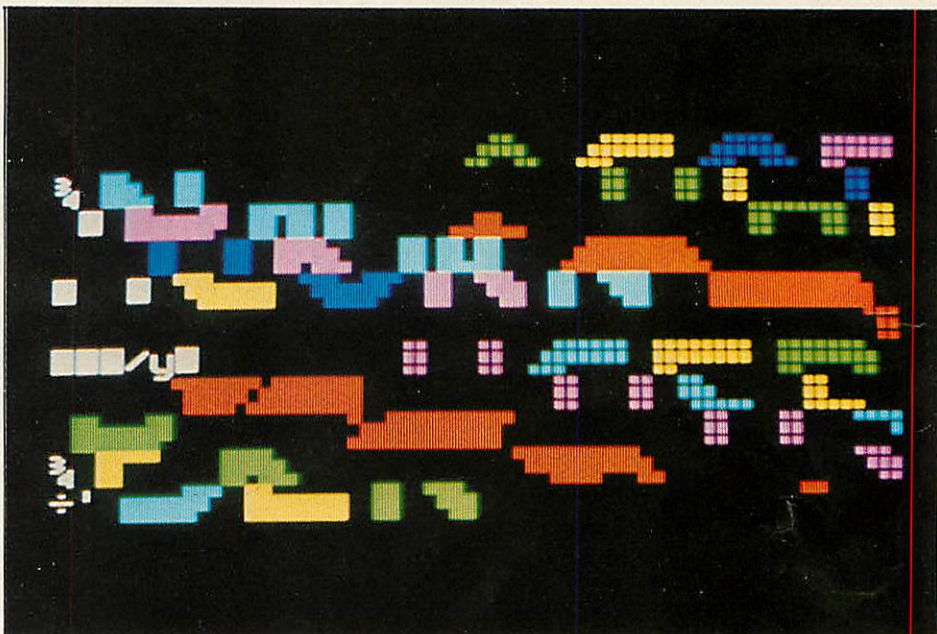
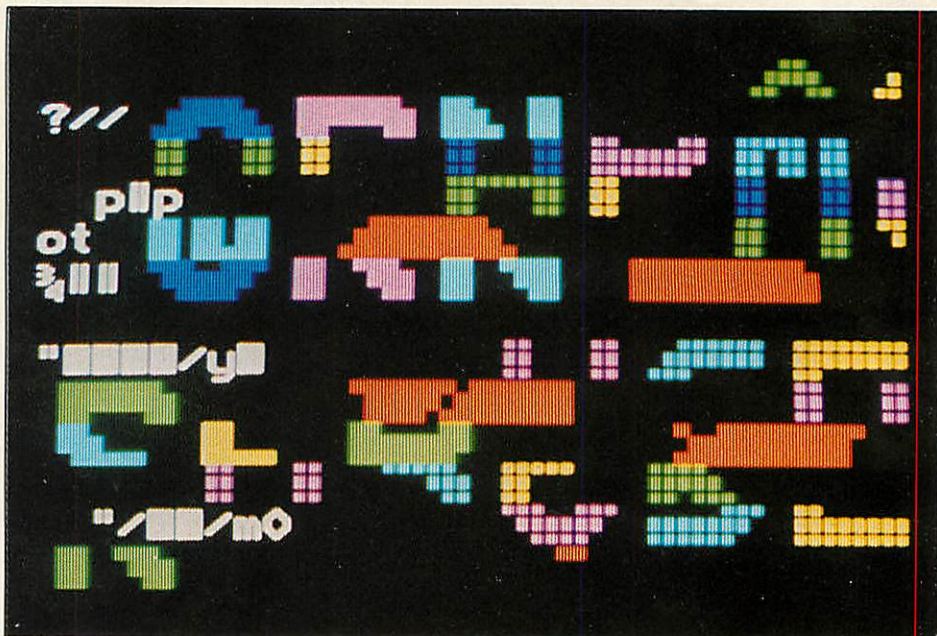

Program 2. Register 1 slices up display

```

10 MODE5:value=40:REM Set value
for each mode.ie. 0-3=80 4-7=40
20 ?&FE00=1: ?&FE01=0
30 MOVE100,100
40 DRAW100,927
50 DRAW1179,927
60 DRAW1179,100
70 DRAW100,100
80 PRINTTAB(5,15)"ACORN USER"
90 FORX=0TO value
100 ?&FE00=1: ?&FE01=X
110 FORZ=0TO100:NEXT
120 SOUND1,-15,X,1
130 NEXT
    
```

Program 3. Cursor keys will scroll screen. Removes lines 170 and 180 to look at zero page or OS

```

10 MODE5:screenstart=&5800:
screenend=&8000:char=40:
REM Change to suit mode
20 size=screenend-screenstart
30 *FX4,1
40 MOVE100,100
50 DRAW100,927
60 DRAW1179,927
70 DRAW1179,100
80 DRAW100,100
90 PRINTTAB(5,15)"ACORN USER"
100 S=screenstart/8
110 REPEAT
120 X=INKEY(0)
130 IFX=136 S=S+1
    
```

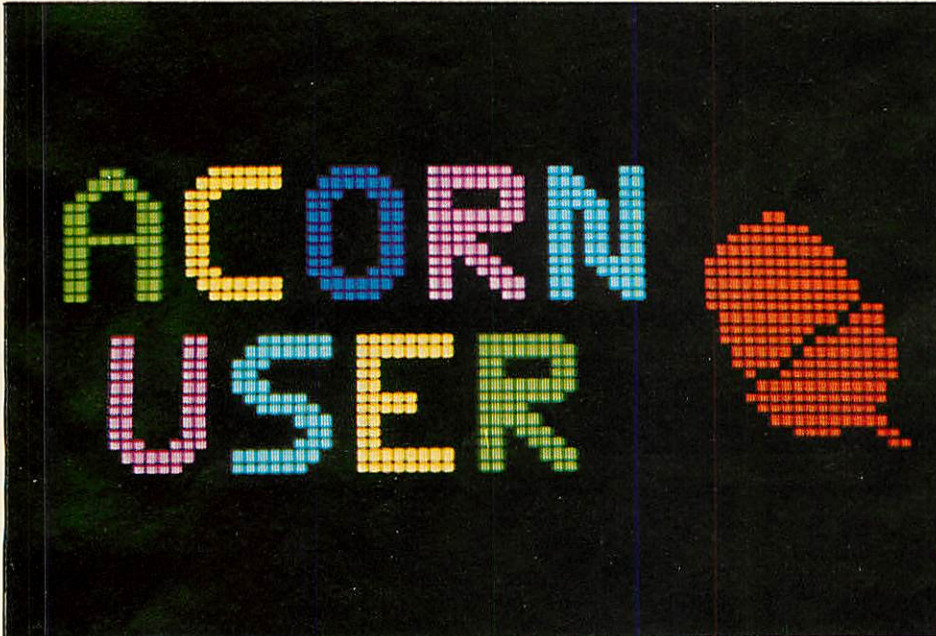
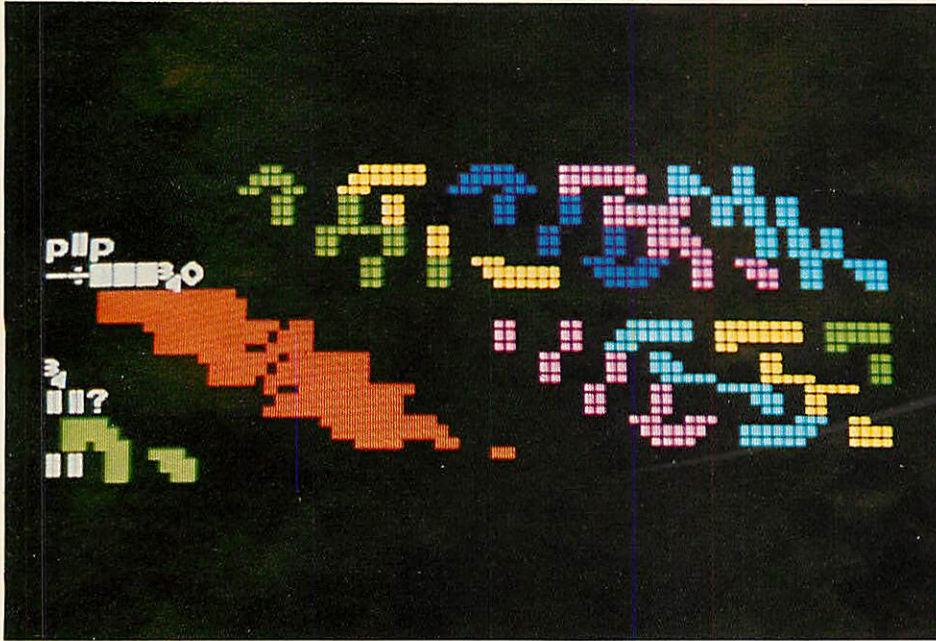

contains the unmodified low byte. These registers can be used to scroll the screen in any direction.

Program 3 demonstrates the use of these registers; by using the cursor keys the screen will scroll in any direction. If lines 170 and 180 are removed the screen will no longer wrap around and the screen can be moved down to look at zero page, or up to look at the operating system.

Program 3a is a mode 7 version of program 3. It is not possible to obtain full screen wrap-around in mode 7 as the screen ends at &7FE7 while the screen memory ends at &7FFF. This gives 24 unwanted bytes which offset the screen when trying to wrap around.

Registers 14 & 15: These two form a 14-bit read or write register. Register 14 contains the lower eight bits, and register 15 the high six bits. In modes 0-6 this 14-bit register contains the cursor address divided by eight. In mode 7 the high byte is stored in the same format as register 12.

Registers 16 & 17: This combination forms a 14-bit, read-only register which is used to read the lightpen input signal. (For further details on using this register, see *Acorn User* March '83.)

The registers 0-11 have preset values, as listed, which are stored in ROM:

Mode	Value
0-2	&C46E - &C479
3	&C47A - &C485
4-5	&C486 - &C491
6	&C492 - &C49D
7	&C49E - &C4A9

Program 4 shows this in the form of a table.

```

140 IFX=137 S=S-1
150 IFX=138 S=S-char
160 IFX=139 S=S+char
170 IFS>=screenend/8 S=S-size/8
180 IFS<screenstart/8 S=S+size/8
190 ?&FE00=12: ?&FE01=(S DIV256)
200 ?&FE00=13: ?&FE01=(S MOD256)
210 UNTILO
    
```

Program 3a. In mode 7, full screen wrap-around is not possible

```

10 MODE7
20 *FX4,1
80 PRINTTAB(11,12)"ACORN USER"
90 S=&7C00
100 REPEAT
110 X=INKEY(0)
120 IFX=136 S=S+1
130 IFX=137 S=S-1
    
```

```

140 IFX=138 S=S-40
150 IFX=139 S=S+40
160 W=((S DIV256)-&74)EOR&20
180 ?&FE00=12: ?&FE01=W
190 ?&FE00=13: ?&FE01=(S MOD256)
200 UNTILO
    
```

Program 4. Gives preset values of registers 0 to 11 as stored in ROM

```

10 MODE7
20 @%=6
30 PRINT "Mode..0-2
3 4-5 6 7"
40 FORX=0TO11
50 PRINTX,X?&C46E,X?&C47A,X?&
C486,X?&C492,X?&C49E
60 NEXT
    
```

ALLIGATA THE SOFTWARE
WITH BITE
BRINGS YOU

DAMBUSTERS

THE
DEVASTATING
NEW GAME
FOR
BBC (Model B)

Alligata presents a superb range of software products that are designed specially for you. Games that cleverly combine full machine code and high resolution, full colour graphics to create hours of fun and excitement. And utilities that have been developed to open new doors and help get the best from your BBC (Model B) micro. If it's to be outstanding quality and amazing value for money then Alligata has to be your choice.

Send a stamped addressed envelope for our full colour catalogue which gives details of the complete range.

WRITE OR PHONE
YOUR ORDER TODAY!

also available from all
good software stockists.

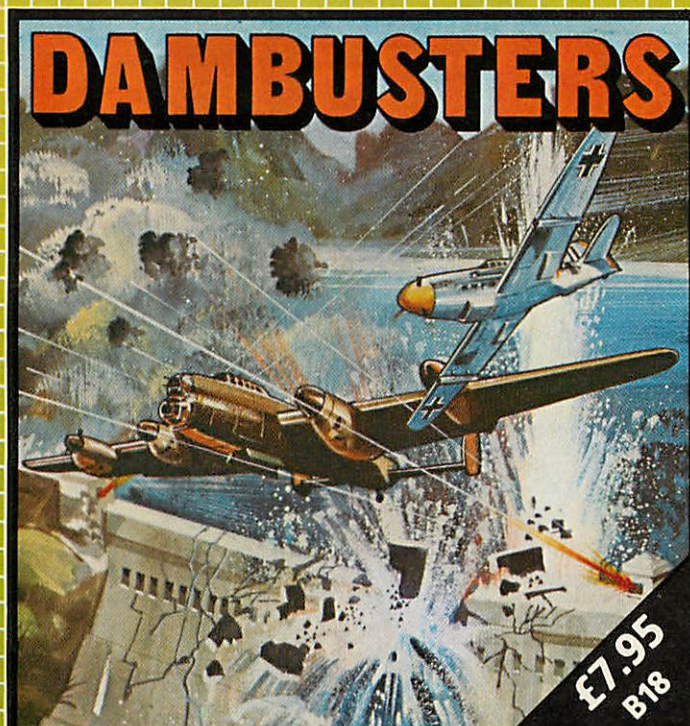

Harried by night-fighters, bombarded by heavy anti-aircraft fire pilot your bomber through the treacherous valley and deliver the revolutionary bouncing bomb on its path of destruction.

£7.95
B18

FREE
COMPETITION
WIN A TRIP
TO GERMANY

The highest scoring player on Dambusters will win a free holiday in Germany accompanied by a friend. Full details and entry form are available with every Dambusters program. So hurry, get your copy today and start practising.

ALSO AVAILABLE

B19 NEANDERTHAL MAN £7.95

Relive the dangers of primitive man - whilst foraging for food for your family you've only a spear to protect your family from the prehistoric monsters.

B07 LUNAR RESCUE £7.95

Land your moon buggy and rescue a precious cargo, destroying all opposition on the way - finding your way back to the mother ship start again against greater odds.

B12 PRIMARY ART £7.95

Create a picture to be proud of - place pre-programmed shapes in any position, any size or any colour. Features free-hand drawing and animation effects.

B03 DMON £7.95

Disk £11.95 ROM £19.95

A superb machine-code monitor and disassembler available on BBC. Features: Full disassembler with ASCII dump, full hex dump with ASCII, reads any ROM, edits any byte of RAM, and many more.

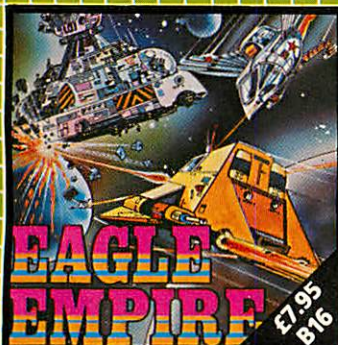

Fight your way through four action packed levels of attack from the menacing phoenix and battle armed eagles, before you can blast to destruction the heavily armoured and strongly defended Eagle Empire.

£7.95
B16

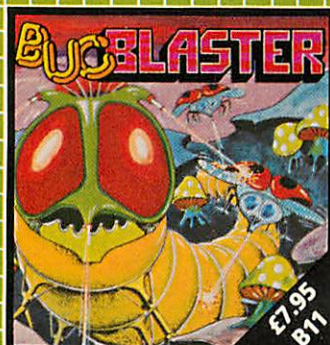

A superb action packed arcade special. A really fast implementation of the splendid 'centipede.' Features include spiders, mushrooms, centipedes and the mushroom poisoning scorpion affectionately known as 'Brian.'

£7.95
B11



Qualify in under 60 seconds for the race of a lifetime - fantastic speeds, death-defying manoeuvres and a narrowing circuit - an exacting challenge for a future world champion.

£7.95
B15

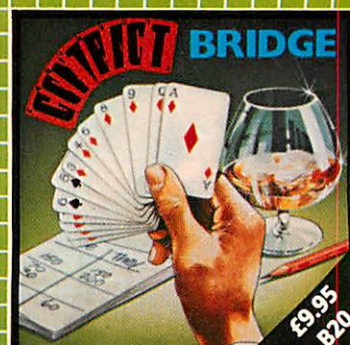

The ideal opportunity to improve your technique in a sophisticated program where the computer bids and plays the other three hands.

£9.95
B20

Despatch is normally made on receipt of order and should reach you within 7 days.

INDICATE PROGRAMS REQUIRED

B18 B16 B11 B15 B20 B19 B07 B12 B03

I enclose cheque/PO* for £: _____ Charge my Access/Visa £: _____

Card No. _____ Signature _____

Name _____

Address _____

*payable to Superior Systems Ltd., 178 West Street, Sheffield S1 4ET.
*allow 75p for post and packaging.

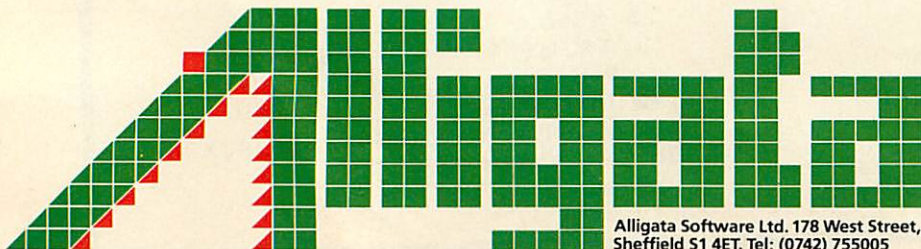

Alligata Software Ltd. 178 West Street,
Sheffield S1 4ET. Tel: (0742) 755005

FUTURE FILING

The existence of a second generation of Acorn filing systems for the BBC micro has just come to light. Charles Schaeffer introduces the concept of hierarchies of information common to all the new filing systems, and later issues will detail their structure and operation

MOST people will agree that the present disc filing systems for the BBC micro cannot exactly be described as sophisticated, and in the long term Acorn will no doubt do something about them. A version two of Econet will be launched with the 6502 second processor that will be the first advanced filing system (AFS). Then there's the long-awaited double density disc drives which will no doubt need an AFS (though it's anybody's guess as to exactly when). This series of articles will describe these developments under the umbrella of 'advanced filing systems', a name chosen because most of these filing systems are radically different and much more powerful than those BBC micro users are used to. It is worth noting that all this information is equally applicable to the Electron, as and when the peripherals become available.

A filing system is designed to control the storage and retrieval of programs and data. To organise this, a central concept in all the AFS's is the idea of hierarchies of data. The idea of a hierarchy exists in a primitive form in the DFS, where the single letter 'qualifier' can be used to subdivide the files on the disc into chunks, each of which is represented by a unique letter. The advanced filing systems extend this concept to provide a file storage system which may be arbitrarily subdivided into named blocks, called 'directories', each of which may be subdivided into further directories. At each level of the hierarchy files may exist along with directories, and the familiar *CAT command will display the catalogue of files and directories at a selected level. These names are provided exclusively by, and for, the user's convenience, and most have no meaning to the computer at all (the exceptions will be examined later).

This sort of file structure can be represented as an upside-down 'tree' (figure 1).

At the top of the tree is a directory known as the 'root' and represented in Acorn filing systems by the symbol '\$' (see Stan Froco's article on trees in the August 1983 issue for details). In figure 1 the root directory contains entries for subdirectories JOHN, JIM and JEREMY. Directory JOHN in turn contains a directory called BASIC (presumably used to store John's Basic files). To specify a directory or file, a string is used known as the 'pathname'. Each item of the pathname is a point on the tree, and the items are separated by a full-stop ('.') which is pronounced 'dot'. Thus the full pathname for the file PROG1 is \$.JOHN.BASIC.PROG1 (pronounced 'dollar dot john dot basic dot prog1'). To catalogue a directory the pathname is placed after the command, ie:

```
*CAT $.JOHN.BASIC <CR>
```

Note that attempting to catalogue a file is not allowed and will produce an error, eg:

```
*CAT $.JIM.LISP.PROG3
```

produces the message 'Not found'.

When the user starts a session using an AFS, the system provides an initial directory in which to work. With disc systems this is the root directory, but with Econet it depends on a number of factors (to be discussed next month). This initial directory becomes the currently selected directory (CSD): a simple *CAT will produce a catalogue of that directory, and when using the

CSD filenames may be specified without the full pathname; eg if the CSD is \$.JOHN.BASIC then CHAIN"PROG1" is all that is required to load and run PROG1. Note, however, that you may still specify a full pathname to bypass the CSD, so CHAIN"\$.JOHN.BASIC.PROG1" has exactly the same effect.

The user may change the CSD by means of the *DIR command. For example

```
*DIR $.JIM.LISP
```

selects \$.JIM.LISP as the new CSD. The command *DIR on its own makes the CSD the 'initial directory', that is the directory which is the CSD when the user starts using the system. There is a disadvantage to this filing system structure, however: if the CSD is \$.JIM then *DIR LISP is valid (because it is a subdirectory of \$.JIM) but *DIR JEREMY is not because it implies movement 'up' the tree (see figure 1). This can be overcome using the full pathname (beginning with '\$') or in some filing systems by using an explicit command to move up the tree.

The limit to how long (and complex) a pathname can get, and therefore how many files can be stored, is set by the amount of space on the medium for directory information, rather than being preset as it is in the original DFS: no 31 files limit in an AFS!

Next month: Econet level one.

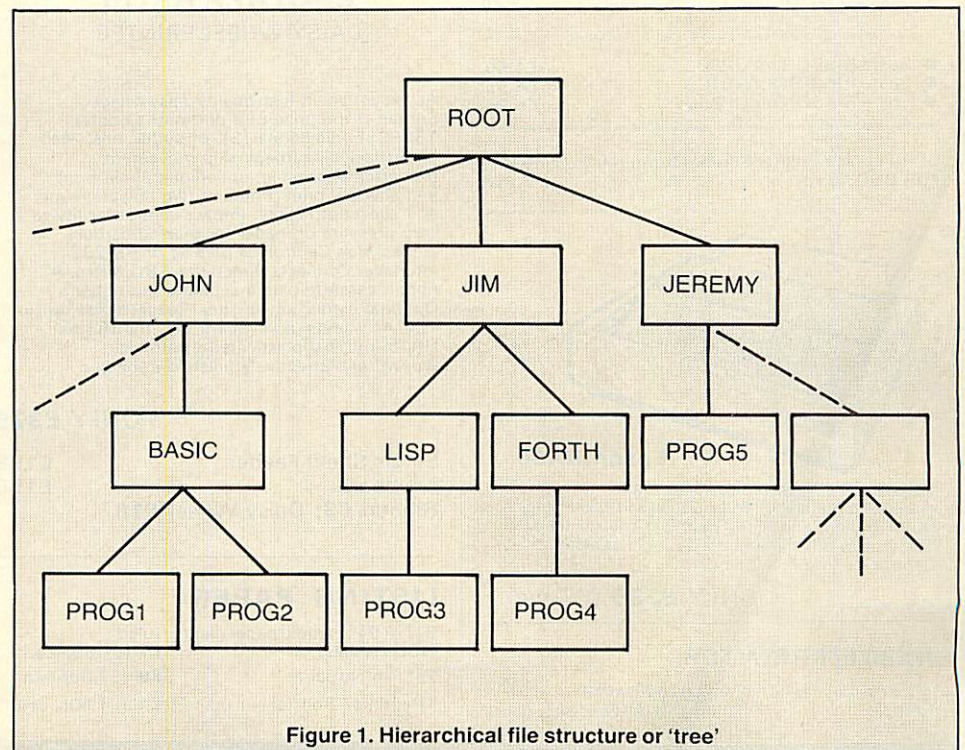

Figure 1. Hierarchical file structure or 'tree'



Watford Electronics

Dept. BBC, CARDIFF ROAD, WATFORD, HERTS. ENGLAND.

Tel: Watford (0923) 40588/37774 Telex: 8956095 WAELEC

Prices subject to change without notice.



BBC MICROCOMPUTER

Model A—£260; Model B—£346

Upgrade your Model A with our Upgrade Kits and save yourself £ s s s

- BBC1 16K Memory (8 x 4816AP-3 100nS) **£24.00**
- BBC2 Printer User I/O Port **£8.10**
- BBC3 Disc Interface Kit **£95.00**
- BBC4 Analogue I/O Kit **£8.25**
- BBC6 Expansion Bus Kit **£7.75**
- Complete Mod. A to B Upgrade Kit **£55.00**

Dust Cover for BBC Micro

Protects your expensive Micro from foreign bodies. **£3.95**

SEIKOSHA GP100A

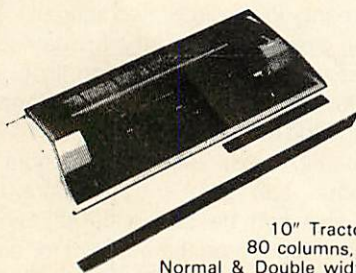

10" Tractor Feed, 80 columns, 50CPS Normal & Double width Char, Dot res graphics. Parallel Interface standard. **ONLY £155 (£7 carr.)**

INTERFACE CABLE

BBC to Seikosha Cable **£8.00**

FRICTION FEED

Attachment for GP100A or 250X Printers **£28**

- Spare RIBBON for GP80 **£4.50**
- Spare RIBBON for GP100 **£4.95**
- Spare RIBBON for GP250 **£5.95**

GP-700 Colour Printer Screen-dump routine in ROM FOR BBC Micro **£12**

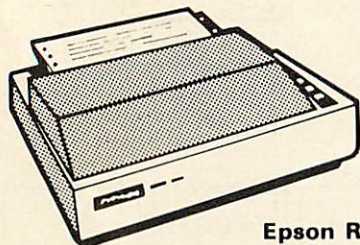

Epson RX80

100 CPS, 9 x 9 matrix, dot addressable graphics, condensed and double width printing. Normal, Italic and Elite Graphics. Tractor feed, 10" max width, bi-directional, logic seeking. Centronics Interface standard.

ONLY £235 (£7 carr.)

RX80 F/T PRINTER

As above but has both Friction and Tractor Feed. **£259 (£7 carr. Securicor)**

Epson FX80 Printer

160 CPS, 11 x 9 matrix, proportional spacing, superscripts, subscripts, dot addressable graphics. Normal, Italic and Elite characters. Up to 256 user definable characters. Down loadable character set. Condensed and double width printing. Full proportional spacing. Four user defined margin positions. Tractor and Friction feed. 10" maximum width Bi-directional, logic seeking Centronics interface standard.

ONLY £345 (£7 carr.)

Epson FX100 Printer

Same as FX80 but has a 15" wide Carriage **£495**

	Ribbons	Dust Covers
MX80FT	£4.75	£4.50
MX100	£10.00	£5.25
FX80	£4.75	£4.95
RX80	£4.75	£4.50
GP80	£4.50	—
GP100	£4.95	£3.95
GP250	£5.95	£3.95

RX & FX PRINTER INTERFACES

RS232	£35
RS232 plus 2K Buffer	£69
IEEE 488	£65
2K Parallel	£58

PRINTER INTERFACE BUFFER

Neatly packaged self contained box, supplied complete with all leads, manual and detachable power supply.

Price: 16K Unit **£99**
Price: 48K Unit **£135**

BROTHER HR-15

DAISY-WHEEL PRINTER

An exceptionally high quality daisy wheel printer at the price of a dot matrix printer. 18CPS; bi-directional, 3K of buffer; has clear buffer facility, carriage skip movement, proportional spacing; underlining; bold print and shadow print. Prints in two colours; super and subscript facility. Impact control facility to vary pressure on paper for making carbon copies. Has Centronics parallel or RS-232 interface. Connects directly to BBC Micro. A ribbon cassette plus a separate red ribbon. Optional extras: single sheet feeder takes up to 150 A4 sheets; a keyboard that transforms HR15 into a sophisticated electronics typewriter. Attractively finished in beige.

ONLY £375

Single Sheet Feeder **£199**
Keyboard **£150**
Ribbon **£3**; Daisy Wheel **£18**

LISTING PAPER

8½" or 9½" Fanfold paper plain or ruled (1000 sheets) **£7 (£1.50p carr.)**
15" Fanfold paper **£9 (£1.50p carr.)**
Teletypewriter Roll (econo paper) **£4 (£1.50p carr.)**

PRINTER LEAD 36"

Ready made printer lead to interface BBC Micro to EPSON, SEIKOSHA, NEC, STAR, JUKI, BROTHER, SHINWA, etc., Printers.

ONLY £8
Special Extra long 5 foot Cable **£12**

BBC Micro WORD-PROCESSING PACKAGE

A complete word processing package consisting of: BBC Model B, Zenith 12" Green or Amber Monitor, Twin 200K highly reliable (1 year warranty) Teac Disc Drives in matching beige colour, the popular WORDWISE word processor, Watford's own highly sophisticated 62 File DFS interface fitted, the world renowned Brother HR15 Daisy Wheel Printer, Gemini's Beebplot & Beebcalc Spreadsheet Analysis Software discs, 10 blank diskettes, 500 sheets of fan-fold paper. Manuals and all the leads. To enable you to carry your Micro around, we shall pack it in our Antique Brown leatherette Attache carrying case.

ONLY £1,275 (carr. £15)

(P.S. We will alter the package to suit your particular requirement. Call in for a demonstration.)

5¼" DISKETTES

- 10 WABASH Diskettes S/S **£15**
- 10 WABASH Diskettes D/S **£25**

(Lifetime warranty)

- 10 Verbatim or 3M Diskettes S/S **£17**
- 10 Verbatim or 3M Diskettes D/S **£27**

DISC ALBUMS

Attractively finished in beige leatherlook vinyl. Stores, protects and displays 20 discs in double-sided clear view pockets. **ONLY £4.95**

PLASTIC LIBRARY CASES for Disc Storage 5¼" (holds 10) £2

LOCKABLE STORAGE UNITS

Attractively finished, strong beige plastic base fitted with dividers. Smoke acrylic top. Supplied with adhesive title strips for ease of filing.

- M-35 Holds upto 35 mini discs **£16**
- M-85 Holds upto 85 mini discs **£20**

FLOPPY HEAD CLEANERS

Unless your office/home is dust free, you should clean heads at least once a week to avoid the risk of cross contamination. Simply apply the cleaner to one of the specially formulated cleaning discs, insert into the drive and initialise. If your system has no initialisation program then insert the disc and open and close the door 5 times. **£16.00**

DISC DRIVES CASED WITH CABLES (less PSU)

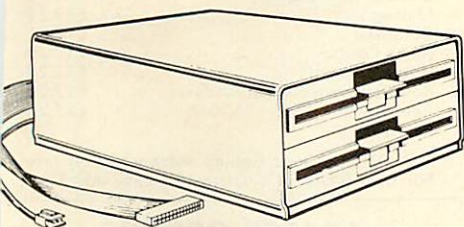

- CLS100 TEC Single sided 40 track 100K, 5 1/4" Disc Drive **£139**
- CLS400 Mitsubishi Double sided 80 track 400K, 5 1/4" Disc Drive **£199**
- CLS400S Mitsubishi Double sided 40/80 track Switchable, 400K, 5 1/4" Disc Drive **£215**
- CLD200 TEC Single sided 40 track 200K, twin 5 1/4" Drives **£259**
- CLD800 Mitsubishi Double sided 80 track 800K, 5 1/4" TWIN Drives **£375**
- CLD800S Mitsubishi Double sided 40/80 track switchable, 800K, Drives **£399**

(CUMANA) DRIVES CASED WITH PSU & CABLES

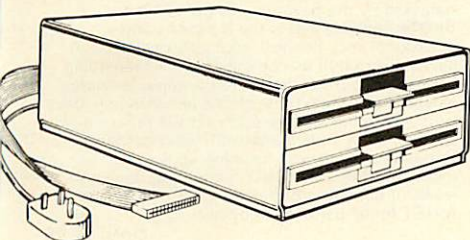

- CS100 TEC Single sided 40 track 100K 5 1/4" Single Disc Drive **£165**
- CS200 TEC Single sided 80 track 200K 5 1/4" Single Disc Drive **£230**
- CS400 Mitsubishi Double sided 80 track 400K 5 1/4" Single Drive **£265**
- CS400S Mitsubishi Double sided 40/80 track 400K 5 1/4" Single Drive **£340**
- CD200 TEC Single sided 40 track 200K 5 1/4" TWIN Disc Drives **£310**
- CD400 TEC Single sided 80 track 400K 5 1/4" TWIN Disc Drives **£430**
- CD800 Mitsubishi Double sided 80 track 800K 5 1/4" TWIN Drives **£440**
- CD800S Mitsubishi Double sided 40/80 track Switchable 800K TWIN Drives **£465**
- SPARE DRIVE CABLES, SINGLE **£6**; DUAL **£9**

MONITORS

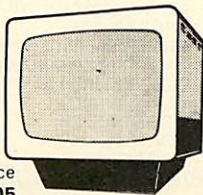

MICROVITEC 1431

14" Colour Monitor, RGB Input. (as used in BBC programmes) FREE Interface Lead. **£205**

- MICROVITEC 1451 Hi-res 14" Monitor incl. lead **£319**
- NEW MICROVITEC 14" Colour Monitor/Composite Video **£249**
- KAGA RGB 12" Medium Resolution Colour **£205**
- KAGA RGB 12" High Resolution Colour **£259**
- KAGA 12" Standard resolution colour MONITOR/COMPOSITE VIDEO **ONLY £209**
- BNC Connecting Lead **£3**
- RGB Connecting Lead **£5**
- ZENITH 12" Green or Amber Monitor Hi-resolution **£75**

Carriage on Monitors £7 (Securicor)

READY-MADE LEADS

CASSETTE LEADS 7 pin DIN Plug to 5 pin DIN Plug + 1 Jack Plug	£2.00
to 3 pin DIN Plug + 1 Jack Plug	£2.00
to 7 pin DIN Plug	£2.50
to 3 Jack Plugs	£2.00
6 pin DIN to 6 pin DIN Plug (RGB)	£2.50
Monitor Lead, BNC to PHONO	£3.00
Disc Drive to BBC Micro Power Lead	
Single: £3.00 Dual £3.75	

NEW

Mk II 13 ROM SOCKET BOARD

Now all lines fully buffered - On board battery back-up facility - will now accept EPROMS 2716, 2732, 2764 & 27128 and ROMs 6116 & 6264.

Simply plugs into one of the four ROM sockets currently available in BBC Micro. There are only 5 solder connections to be made. Full instructions are supplied.

Our 13 ROM SOCKETS BOARD enables the User to increase the Sideways ROM capacity the basic four sockets on the main board up to the full SIXTEEN capable of being supported by current operating systems. In addition the board is designed with the facility to hold up to 16K RAM, which when switched into operation is automatically selected, by any WRITE signal to the Sideways ROM area. This gives the User the ability to write a utility or language and upon pressing break have the utility or language up and running (new ROM software can be developed and tested in situ.)

The Board gives the User, plenty of freedom to explore the possibilities of the new paged ROMs due in the coming months and offers them the chance to develop their own.

All lines are fully buffered and the Board meets or exceeds all timings for operation in the BBC Microcomputer. When fully populated, the ROM Board consumes less than half the recommended maximum current limit.

Supplied ready-built and tested complete with fitting instructions.

ONLY £29.95 (carr. £1)

EPROMs & CMOS RAMs for BBC MICRO

2764-250nS (8K ROM)	£5.95
27128-250nS (16K ROM)	£19.00
6116-150nS (2K RAM)	£6.00
6264-150nS (8K RAM)	£32.00

Z80A 2nd PROCESSOR BOARD for BBC Micro

● Although intended as a BBC add-on, it is totally stand alone (i.e. Can be used with any RS232 Terminal/Computer).

● Z80A Processor running at 4MHZ (No. wait states) 64K Dynamic Memory, 16K ROM space. Disc interface with single/double density, 40/80 track, single/double sided. Two serial channels at independent BAUD rates. Parallel printer interface.

● No additional drives are needed other than those already being used on the BBC as the disk drives can be shared or can be run on the Z80A Processor alone. (This unit can be operated without the disc interface inside the BBC.)

● EXPANSION - OPTIONS

- IEEE-488 GPIB Interface with Control, Talk and Listen
- Ram in 64K and 192K increments
- Hard Disc INTERFACE (to controller)
- Dual Parallel Interface
- 8" Floppy Disc Controller
- Dual Serial Interface
- Real Time Clock
- Prototypeboard

(Also another 64K Ram card can be plugged inside the unit)

● CP/M 2.2 - Not a lookalike, making the CP/M Users Group available to you.

● All BBC screen, sound and OSBYTE facilities available to the CP/M user.

● Uses a full intelligent terminal emulator to enable the user to run 99% of all commercially produced CP/M software with no modifications whatsoever.

● Supplied in a standard half height drive case with integral PSU and finished in the standard BBC colour.

All this and more for **ONLY £350** plus VAT.

EPROM PROGRAMMER for BBC MICRO

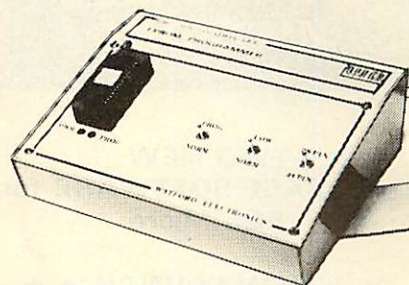

At last! - the EPROM Programmer for BBC Micro Computer from WATFORD ELECTRONICS that will suit both your pocket and all your requirements. Programs all popular types of EPROMS from 2K bytes up to 16K bytes - **2716 - 2516 - 2532 - 2564 - 2764 - 27128**.

This extremely powerful system is designed for your needs of TODAY & TOMORROW! - BBC Basic programs can be copied into EPROM and subsequently re-loaded faster than from a disc! Suitable for both hobbyist and professional users!

Just look at these features:

● **COMPLETELY SELF CONTAINED** - Housed in its own sturdy case - Uses its own power supply - connects directly to the 1MHz Bus - Simple and Safe!

● **FULL SOFTWARE SUPPORT** - Comes complete with simple to use fully machine code ROM based software and easy to understand manual. Facilities include Verification, Reading, Virgin Testing, Writing, Editing, Saving, Loading and more! NOTE!! - This software does not simply comprise hastily prepared routines to get you going, but is a professional, purpose designed applications package.

● **ACORN BUS COMPATIBLE** - Use of the 1MHz connection complies with all Acorn addressing recommendations - That means you can still add-on such things as the TELETEXT, IEEE 488 TUBE and PRESTEL

● Allows more than one program to reside in an EPROM using the ROM Filing System.

ONLY £89 incl. Manual (£3 carr)

BEEB SPEECH SYNTHESISER

VERSATILE SPEECH SYNTHESISER UNIT FOR THE BBC MICROCOMPUTER

Watford Electronic's very own Speech System. Specially designed so that even a novice can make his BBC talk:-

SIMPLY the best! - An unlimited speech synthesis system. Complete with easy-to-follow manual. Controlling software is in ROM so no Cassette Loading problems!

PHONEMES for word synthesis - That means unlimited vocabulary! No extra speech dictionary chips to buy!

BUILT-in Library of approximately 500 words to get you started.

ENGLISH accent - Utilises inflexion techniques to produce highly comprehensible speech.

EASY to use system - Just plug the software ROM into a socket, the Speech unit into the User Port, and away you go! No specialised 'dealer upgrade' required!

COMPACT unit - The whole system is built into a small case - easily tucked behind the computer. Auxillary output socket provided for direct connection to an external amplifier.

HOURS of fun! - Suitable for any application - Games, Educational Programs, Specialised Packages.

We know this all seems to good to be true but **DON'T BE LEFT SPEECHLESS!** Order your Versatile Speech Unit now!

Only £39

Continued



WONDERFUL WATFORD

TWO NEW DATABASE SOFTWARE for BBC Micro

★ ★ NEW LAUNCH ★ ★ DISCDATA

At last for BBC Micro Disc users, Watford Electronics have produced 'DISCDATA' which must be the most versatile general database at the price on the market. The length of your files is restricted only by the space on your disc. You can have upto 20 fields with 'page' length records of upto 254. Characters. The program is completely menu driven obviating reference to a manual although written guidance is given with the program. Add and delete records, amend title, field names and records, sort on any field and search for any record or group of records in any field. You do not need to abandon or rewrite your files if you wish to add additional fields or extend the length of any field, the program will rewrite the files for you. Your files can be in any drive. Output can be in 40, 80 or 132 character width with Printer routines. Two forms of output are provided for, horizontal for label type output and a tabulated output with title and headings. What is more, the selected fields can be placed in any order on the screen. In the horizontal mode you can scan backwards or forwards with wrap around effect. Output can be started or stopped anywhere in the file. There is automatic totalling on decimal fields and an automatic count of the number of records output.

On disc at **Only £15**

It has to be the best value.

★ ★ NEW ★ ★ FILE-PLUS

A 16K ROM containing the most flexible and easy to use disk based Database system on the market. A database may occupy your total on-line storage capacity. You may design any number of data entry forms using a "paint" on screen technique. Forms may be upto 3 screens in size. Any of these forms may be used to Add, Delete, Update, Print and Spool records from your Database. Quick search facility on any text field. A query language provides full maths support (-, +, /, *, +-9999999999.9999) and compare facilities (=, >, <D, <=, >=, &, I) when used with the keywords - Assign, Compare, Display, End, Goto, If, Ift, Print, Read, Search, Spool and Update. Full printed output control via embeded commands. Supplied with 70 page manual and fitting instructions.

Only: £43

★ ★ NEW LAUNCH ★ ★ VERSATILE LIGHT PEN SOFTWARE

- Enjoy, Explore, Educate!
 - Pixil, Line, Character Definition
 - Free hand drawing
 - All Colours - MANY Special Effects
 - Fill, Refill and Stripes
 - User defined "Brushed Strokes" plus Character definer
 - Grid, Scale, Perspective aids
 - 2 TO 200 Points palletable in one Design with Circles and "RUBBER BANDING"
 - Move design/character to any screen position
 - Save and Load screens, User defined Graphics and line drawings for video titles, Own programmes, etc.
 - Many Educational uses
 - Instruction booklet included
 - Full software support for "CUSTOM USE"
 - Works with Watford, Robin, Acorn User, DIY, and many other LIGHT PENS
 - Available on DISC or TAPE
- Price: Tape **£7**; Disc **£8**

★ ★ STAR LAUNCH ★ ★ BUFFER & BACKUP ROM

A very versatile firmware. An ideal ROM for engineers, programmers, teachers, students, etc.
★ Converts your Sideways RAM to a 4K or 16K BUFFER for a parallel printer. (Uses * FX5.3). (You no longer require to purchase expensive (£100+) Printer Buffers.)
★ Dumps selection of Disc files to Tape.
★ Makes backup copies of tapes onto Tape, Disc and Hobbit.
★ Displays contents of a chosen paged ROM on screen.
★ Menu display on 'shift-break' using ROM Filing System.
★ Comprehensive Manual
Simply a give away at **£16**

EDUCATION Software

JUNIOR MATHS PACK (32K) **£6.95**

Makes learning fun for 5-11 year olds. This package consists of 3 programs (menu driven) that increase in difficulty as your child becomes competent. A very good supplement to standard educational methods.

CHEMISTRY **£6.00**

Make learning fun with this graded program which teaches the Atomic table including Atomic Symbols, Atomic Number and normal form using a fruit machine type display. 5 levels.

WORLD GEOGRAPHY (32K) **£7.00**

Beautifully drawn Hi-Res colour map of the world illustrates and aids this graded series of tests on capital cities and populations of the world.

WORDHANG **£7.80**

(Age 7-13). A word guessing program based on the well known Hangman game. Uses full colour graphics. Complete with 260 words and the facility save your own list of words.

WORLDWIDE **£7.80**

(Age 7-15). Two constructive geography programs allowing children to build detailed data bases covering both the UK and the world. Encourages children to refer to atlas and reference books. Save the database anytime.

PHYSICS **£6.00**

Displays measurements of mass, work, temperature, etc., their associated units and formulas for calculating these units. For 4th and 6th formers.

WHICH SALT **£6.00**

Identify a compound from the result of a series of tests. Superb graphical animation shows what would otherwise be observed in a laboratory. For 4th and 6th formers.

HAPPY NUMBERS **£7.80**

(Age 4-6). No reading skills are required to use this colour graphics number recognition and counting program. Children build patterns of flowers corresponding to figures, quickly learning their significance.

INTRO TO ARITHMETIC **£10.45**

4 programs - Additions, subtractions, multiplications and divisions. Help stage, moving graphics and colours. Worksheet produced at the end of program. (5-7 years old).

SPECIAL 'DISC DRIVE OFFER

MITSUBISHI DISC DRIVES

Cased, including Power Cable and Interface Cable. Plugs directly to BBC's Power Supply socket.

- LCS400 Single 400K Drive **£188**
- LCD800 Twin 800K Drives **£369**

LOGO II

This language is very popular in American schools as it is an ideal educational program. It can graphically demonstrate the ideas of defined procedures, sub-routines, loops and even recursive programming. Gives excellent introduction to LOGO language for young and old alike.

£9.95

GEMINI'S BUSINESS SOFTWARE

Cashbook Accounts	£52
Final Accounts	£52
Invoices & Statements	£17.25
Commercial Accounts	£17.25
Mailing List	£17.25
Database	£17.25
Stock Control	£17.25
Home Accounts	£17.25
Beebcalc Spreadsheet Analysis	£17.25
Beebplot	£17.25
Payroll	£39

N.B. All the above Gemini software is on tape. For Disc Based (40/80 track) please add £3.

ACCESS ORDERS

Simply phone your order through
and we will do the rest.

Tel: (0923) 50234

**WATFORD - Always
a step ahead**

★ PENGU ★

One of the most sophisticated full colour, 100% machine code games software. This arcade game will give hours of fun. You (Pengo) are being harassed by the devouring Snobees (Snow Beasies) whose diet is the Ice-cubes and an occasional juicy Pengo!! Your only means of survival is to hurl the ice-cubes at the marauding snobees and crush them into the snow. Beware, as you crush them to death the remaining snobees turn even more vicious. Each act will bring a new species, even more aggressive!!! All is not lost; Bonus points are won by lining up the three indestructible DIAMOND cubes. Progressive levels of difficulty. Bonus Pengo at 30K points. A MUST for all BBC Micro owners.

Only: £7.75

CRAWLER

A new challenge for your reflexes, exercise your fingers. Crawler is the best yet BBC version of the game popularised in the arcades as "CENTIPEDE". Blast the voracious caterpillar before it eats you. Avoid the wandering spiders. Shoot the scorpions before they poison the mushrooms. Kill the descending fleas as they cause massive mushroom growth. This game is a delight to play, the controls are responsive and fast yet precise. All this for **ONLY £6.95**

GAMES SOFTWARE (PROGRAM POWER)

CHESS	£6.95
CROACKER	£6.95
Escape from MOONBASE ALPHA	£6.95
CHUCKIE EGG	£7.90
FELIX in the FACTORY	£6.95
GALACTIC COMMANDER	£6.95
KILLER GORILLA	£6.95
MUNCHYMAN	£5.95
MOONRAIDER	£6.95
PENGO (Watford)	£7.75
SWOOP	£6.95
747 FLIGHT SIMULATOR	£7.75

LEVEL 9 ADVENTURE GAMES

COLOSSAL ADVENTURE. The classical mainframe game "Adventure" with all the original puzzles plus 70 extra rooms. **£8.65**

ADVENTURE QUEST. Through forest, mountains, desert, caves, water, fire, moorland and swamp on an epic quest vs tyranny. **£8.50**

DUNGEON ADVENTURE. Over 100 puzzles in the Demon Lord's dungeons. **£8.50**

SNOWBALL. Save a 7000 location colony starship in 2302 AD. **£8.50**

BEEB PRINTER ROM



Are you fed up with not being able to unravel your printer manual and use all those features you paid for? Need sensible paging for use in the creation of booklets? Then you certainly need our Beeb Printer ROM.

A machine code printer utility in ROM.

★ 'Single' key operations replace control code sequences for underline, front and size selection, paper movement, etc. Up to 30 come pre-defined, without effecting normal fn key usage.

★ Automatic fanfold page margins. Puts gaps in listings. PRINTed text etc to skip the folds. The gap size alternates to minimise paper wastage when using binders.

※ Form feed and related commands, made available on ALL printers. Can also provide a left margin.

★ User defined characters embedded within text are printed as on VDU.

★ ★ Commands select option for GP100, STAR, NEC, MX/FX, LP VII/DMP100, DMP200. Operates with parallel interface printers and is turned on by *FX5,3.

Supplied complete with Manual.

Price: £24

(When ordering, please specify the make of printer you have.)

TWO NEW GRAPHICS SCREEN DUMP ROMS from WATFORD

DUMP OUT 2

A versatile machine code hi-res Screen Dump ROM.

- You can now have small or large 2 tone dumps and multi-tone 'colour' pattern dumps (8 distinct mode 2 shades) on every printer.
- *Commands initiate the required dump optional parameters may be included for colour masking and selecting the part of the screen to be dumped.
- Clever use of the processor stack means that no workspace is required! (Multitone dumps also use 2 zero page locations.)
- For GP80/100/250, STAR, NEC, EPSON MX/RX/FX, LPVII, DMP100/120/200/400.
- Screen modes 0, 1, 2, 4, & 5.
- Instruction Manual

All this for

ONLY £15

EPSON DUMP ROM

Will accurately DUMP all Screen modes including TELETEXT, GRAPHICS and DOUBLE HEIGHT. MULTITONE DUMPS are also supported. Simple single command (*SCDUMP) operation. **Only: £16**

DISC EXECUTOR

Disc Executor is a sophisticated disc utility, designed for the BBC Micro, which allows you to transfer almost all of your tape software to disc. It will handle 'Locked' programs and allows you to load full length adventure type programs (i.e. up to &6E blocks) from disc in seconds rather than minutes. Available in 40 or 80 track, please specify.

Price: £12

WATFORD JOINS THE COMMUNICATION REVOLUTION

MODEM 84



PrestelTM

A British Telecom Service.

With the launch of Watford's MODEM 84 you can now hook into PRESTEL, MICRONET, HOMELINK, TELECOM GOLD, etc., for about the cost of a good tape recorder. Prestel gives you access to an incomparable database covering almost every subject under the Sun. There is Micronet with lots of free programs that you can download and run. Details of Clubs and User groups, a diary of meetings and exhibitions, news and reviews, technical information, etc. There is Homelink with On-line banking. And there is armchair shopping, travel information, Entertainment, World News, Sports News, Business News, Weather information, Electronic mail and lots more. The basic Prestel subscription is only £5 per quarter for domestic user and at off-peak times there is no charge for access time. Can you afford not to be part of this revolution?

Now using the latest techniques and the new generation of Modem chips, Watford have developed a Modem that is newer, better and yet cheaper than any on the market.

Compare the Specifications:

MODEM

- Direct-connect Modem using BT approved isolation components.
- Full Duplex V23 operation for Prestel and TELECOM GOLD operation (1200/75 Baud).
- User-to-User half duplex 1200/1200 Baud operation with AUTOMATIC SEND/RECEIVE switch (BEWARE - most MODEMS switch manually between send and receive, which precludes the use of intelligent user-to-user software).
- Simple single button operation and comprehensive LED status display.
- Attractive Beige case to match your Micro. Sized to sit on the disc drive.

BEEB FORTH TOOLKIT

Adds following facilities to FORTH. 6502 Assembler, providing machine-code within FORTH - Turtle graphics enables easy to use colour graphics - Decompiler routines enables versatile examination of your compiled FORTH programs - Full double number set - An example FORTH program and graphics demonstration - Other useful routines - 64 page manual included FREE. **ONLY £13**

NEW SUPER PRESTEL INTERFACE ROM

Fully compatible with Watford's MODEM 84 as well as with PRISM and most other Modems.

- Supports full Prestel Colour Alpha and Graphic Characters including Double Height, Flashing, Conceal/Reveal.
- Called by simple *PRESTEL command. Disc and Tape configurations fully supported.
- Telesoftware downloader included.
- Comprehensive MAILBOX facilities including offline editor.
- Auto Logon sequence, can be burnt into ROM if desired.
- Unique "TAG" facility allows tagging and recall of interesting pages - avoids the common and annoying 'NOW WHERE WAS THAT PAGE' problem.
- Page load and save to tape or disc. Pages are automatically saved under Page Number reference in a 'FRAME' directory.
- Print page options are ASCII only (i.e. with suppression of Graphics) - fast and works with any printer - as well as a full graphics dump for the popular Epson printer.
- 'USER' function call built into interface with specialist add-on routines (your own as well as ours).
- All the above facilities available from Function Keys. An overlay is provided giving simple yet comprehensive guidance to the key functions.
- Comprehensive instruction manual supplied.

Price: Only £69 (carr. £1.50)

(Please allow up to 28 days for delivery)

Coming soon:

BEEB User-to-User ROM. For automatic user-to-user communication including file/program transfer. (Requires Watford's MODEM 84 or PRISM 2000).

Please write to Watford Electronics for full details, Order and Application Forms. (P.S. BT approval applied for).

FORTH for BEEB on CASSETTE

Follows FORTH-79 standard and has fig-Forth facilities - Provides 260 FORTH words - infinitely extensible - Full screen editor - Allows full use of MOS - Permits use of all graphic modes, even 0-2 (just) - Easy recursion - Runs faster than BBC BASIC. **ONLY £15** FREE 70 page manual and a Summary card.



WATFORD ELECTRONICS

Continued

THE ULTIMATE DFS FOR BBC MICRO

by Watford Electronics

High acclaimed at the Acorn User Show.
What do the independent press say?

Good value for money - *Beebug Aug. '83*
A very worthwhile package - *The Micro User*
You'll be buying a very powerful package -
Personal Computer News
Superior DFS; Excellent disc sector editor -
Computer Answers

Without a doubt, the most sophisticated DFS
Software yet written for BBC Micro Computer.

This powerful new DFS is fully compatible with
ACORN DFS yet has much increased power
due to additions, carefully designed to make
life easier in normal use. It consists of over
14K of efficiently written machine code. It is
entirely self contained and so does not require
a utilities disc to function.

- * The system can either use the ACORN standard 31 files per disc side or DOUBLE THE CAPACITY to 62 files. The size is selected at formatting time. Copying between discs with different catalogue sizes works perfectly normally.

- * A FORMATTING PROGRAM is built in, permitting formatting to 35,40,80 track formats with either 31 or 62 files. Since the formatter is built in to the DFS it can be used without affecting whatever program you are using.

- * A DISC VERIFIER is also built in. This checks the internal checksums on each sector to identify any corrupted data. This is extremely useful when saving valuable data as it shows faulty discs quickly and easily. Again it does not affect the program you are using.

- * A built in DISC SECTOR EDITOR gives a screen window onto the disc enabling detailed editing of any byte on the disc. This is very useful for recovering accidentally deleted files and can save weeks of work.

- * A double step mode allows the user of 80 TRACK DRIVES TO READ 40 TRACK DISCS. This mode is software selected for each drive individually, thus allowing a 40 track disc to be copied onto an 80 track one very easily. THIS ELIMINATES THE NEED FOR EXPENSIVE SWITCHABLE DRIVES.

- * A WORKFILE function sets the name to be used when the null filename is issued. This allows a program to be edited and repeatedly saved having only typed its name once.

- * When using LOAD, CHAIN, etc. it is possible to specify an ambiguous filename. This will result in the first file whose name matches the specification being used. This saves typing the end of a filename that you know is uniquely identified by its first few characters.

- * Two commands exist to simplify the transfer of programs from TAPE TO DISC. These load the file to &1100, switch off the disc system and then move the file to its correct load address; thus saving a lot of complicated programming. This command can be used to load files up to 27K75 long.

- * An advanced COPY command is included which will prompt the user, requesting whether to copy each file.

- * RENAME has been extended to allow the use of ambiguous filenames. This allows you to change BERT1, BERT2, BERT3 to FRED1, FRED2, FRED3 with only one command.

- * OPENOUT has been improved to give you fewer annoying 'Can't extend' errors, as it automatically picks the biggest space on the disc in which to put a file. A SPACE command lets you know how much space *COMPACT could create before you waste time doing it.
- * 2K of RAM can be reclaimed from the DFS by setting "PAGE" to &1100.

Now with extra features:

- * The powerful library system has been extended so that libraries now work on all accesses not only *RUN. This allows you to have a utility directory with all your commonly used programs without muddling in your current workfiles. Very useful for BCPL User.
- * Programs can now reside lower in memory by reclaiming some of the DFS' workspaces, indeed PAGE can be taken as low as £1100 under most circumstances.

- * To make DFS easy to use, wild cards ("*") have been made vastly powerful, e.g. *INFO

Continued:

BEEBFONT ROM

BEEBFONT is a remarkable new concept in BBC software, exclusively available from Watford. Once fitted, the 16K ROM will enable you to produce attractive text displays in following different styles:



★ It works in modes 0, 1, 2, 4, using full colour.

★ Simply use Ctrl-V to select the font and all further screen output will be in a new style.

★ Even the ordinary Beeb character set can be enhanced by doubling height or width and emphasising to give bold print.

★ A comprehensive editor is included which enables the user to design his own characters.

★ A spooling program is provided which enables pre-formatted text files to be displayed on an Epson printer using the full range of character styles.

★ This really must be one of the most original and exciting products of the year.

★ A twenty page manual is provided and the demo/editor software comes on disc or cassette (please specify when ordering). **ONLY £39**

DISC DOCTOR £26

A sophisticated Disc Utility ROM with many useful commands. (For detail description please refer to Computer Concept's advert in this magazine.)

Wordwise

Without doubt a very sophisticated piece of software for the BBC Micro. It has all the features of a professional word processor yet is easy to use.

only £33

DFS continued:

- *A* gives information on all files in the current directory which have an "A" anywhere at all in their filename.

- * Comprehensive and clearly written Manual (available separately) gives the user a complete package deal.

- * Fully compatible with BBC TELETEx and TORCH Systems

DFS ROM **ONLY £29**
Complete Disc Interface Kit including DFS ROM and fitting instructions **ONLY £95**

Comprehensive and clearly written DFS Manual. **£7.50 (No VAT)**

P.S. We will exchange your existing ACORN DFS or PACE (AMCOM) DFS for the highly sophisticated Watford's DFS ROM for

ONLY £25

Watford's DFS is exclusively available from Watford Electronics. We DO NOT retail through any Dealers.

BEEBMON

The most powerful and versatile machine code monitor ROM yet written for BBC Micro. It has all the normal memory editing, moving and relocating facilities, plus all editing is with a full screen editor allowing scrolling up and down memory, entering in Hex, ASCII or standard assembler mnemonics.

In use as a debugging tool, you run code under a total emulation system. Everfelt a desperate urge to set a breakpoint in ROM? No problem - you can even have breakpoint on reading or writing locations in memory and on register contents. The system fully supports debugging of sideways ROMs e.g. BASIC can fully and easily be run from within Beebmon and from there DFS and other sideways ROMs can be used in total emulation mode.

Beebmon can even run itself. In so doing you can nest Beebmon up to a level limited only by the memory size. Beebmon uses 256 bytes of workspace, located anywhere in memory, even on the 1MHz Bus. Beebmon effectively uses no zero page workspace, so your program (e.g. BASIC) can use any or all of the base page. How does it achieve this? By providing a 6502 interpreter all programs running under it exist in a virtual BBC, so special memory locations like the ROM latch are not actually accessed by your programs, instead they alter a location in Beebmon's workspace. Emulation also allows immediate return to Beebmon command level by ctrl-escape no matter what code is being executed at the time. All this exceptional power and flexibility is complemented by a clear and detailed manual included in a value for money price of:

SPECIAL OFFER THIS MONTH
Only: ~~£25~~ £19

★ NEW ★ DISASSEMBLER ROM for BBC Micro

DISASSEMBLER ROM

Discover the hidden secrets of BASIC and the OPERATING SYSTEM with this easy to use programmers tool.

A ROM based machine code Disassembler for the BBC micro. It enables machine code programs to be listed in BASIC/DUMP format and thus is the perfect complement to the built in assembler. It allows Sideways ROMs, files on disk or tape to be listed, and also has a comprehensive editor, allowing mnemonics to be altered directly, as well as HEX, DECIMAL, ASCII and BINARY memory editing. There is also a full set of labelling facilities available (up to 3,200 labels), with the major locations and routines already labelled.

Thus DIS-ASM enables any monitor program, such as BEEBMON to be used to much greater effect as it is not necessary to disassemble memory each time the display is altered. All these and other facilities for **ONLY £16** (Price includes a comprehensive manual and fitting instructions.)

FORTH ROM for BBC

This superb (FIG FORTH) compiling language now available in ROM. Simply plugs into one of the ROM Sockets. Manual included. **£34**

VIEW

Acorn soft's Wordprocessor ROM. **£52**

★ NEW ★ FX80 PRINTER DRIVER for VIEW

Do you want to use Italics or Enlarged Characters with View? French or German Characters? These and other FONTS from FX80 character sets can be accessed using our Printer Driver with VIEW. The disc contains an example as well shows how to use. Available on 40 or 80 track Disc. **ONLY: £7.50**



ACCESS ORDERS BY TELEPHONE
Simply phone your order through. We do the rest

(0923) 50234/40588

ADVANCE USER GUIDE for BBC MICRO

Only: £12.50 (no VAT)

BOOKS (No VAT on Books)

30 Programs—BBC Micro	£3.25
30 Hour BASIC (BBC Micro)	£5.95
35 Educational Programs for BBC	£6.95
36 Challenging Games for BBC	£5.95
40 Educational Progs. for BBC	£5.95
100 Programs for BBC Micro	£6.95
Cassette version of above	£10
6502 Application Book	£11.95
6502 Assembly Lang Prog	£13.95
6502 Assembly Lang. Subroutines	£14.25
6502 Machine Code for Beginners ...	£5.95
6502 Software Design	£10.50
A young persons guide to BBC Basic ..	£4.50
ACORN ATOM Magic Book	£5.50
Advanced User Guide for BBC Micro	£12.50
Advanced 6502 Interfacing	£10.95
Advanced 6502 Programming	£12.45
Assembly Lang. Prog. on BBC Micro	£7.95
Advanced Programming Techniques for the BBC Micro	£7.95
BBC Basic	£7.95
Assembly Lang. Prog. on BBC	£7.40
BBC BASIC	£5.95
BBC Forth	£7.50
BBC Lisp	£7.50
BBC Micro An Expert Guide	£6.95
Easy programming for BBC Micro	£5.95
BBC Micro Graphics and Sound	£6.95
BBC Micro ROM PAGING System Explained	£2.95
BBC Micro Revealed	£7.95
BBC Micro Instant Machine Code including Software Cassette	£34.00
BBC Micro Assembly Lang. Prog.	£7.95
BBC Micro Disc Companion	£7.95
BBC Micro in Education	£6.50
Basic Programming on BBC Micro ...	£5.95
Creating Adventure Programs on BBC Micros	£6.95
Creative Graphics Cassette (Acornsoft). Has 36 graphics programs	£8.95
Creative Graphics on BBC Micro	£7.50
Complete Programmer for BBC	£5.95
DISC FILING SYSTEM Manual for BBC (comprehensive)	£7.50
Discover BBC Machine Code	£6.95
Discover FORTH	£13.95
Easy Prog. for BBC Micro	£6.50
Further Prog. for BBC Micro	£5.95
FORTH Programming	£14.40
Functional Forth for the BBC Micro	£5.95
Games on your BBC Micro	£2.95
Games BBC Computer can Play	£6.95
Getting Acquainted/Acorn ATOM	£7.95
Graphs & Charts on BBC Micro	£7.50
Intro to Micro Beginners Book (3 Ed.)	£9.90
Graphic Art for BBC Computer	£5.95
Graphs and Charts (Cassette)	£8.95
Graphics on BBC Micro	£6.95
Introducing the BBC Micro	£5.95
Let your BBC teach u to program	£6.45
LISP	£9.25
Logo Programming	£8.95
Mastering VISICALC	£12.45
Mastering CP/M	£13.65
Micros in the Classroom	£4.90
Practical Prog. for BBC & ATOM	£5.95
Programming the 6502	£11.95
Programming the BBC Micro	£6.50
PASCAL	£9.25
Programming for Education on BBC	£5.95
Structured Prog. with BBC BASIC	£9.50
The BBC Micro Book, BASIC, SOUND & GRAPHICS	£7.40
Using Floppy Discs with BBC Micro	£5.95
Using BBC Basic	£6.95

DFS MANUAL for BBC

A fully comprehensive disc manual for BBC Micros. All extra commands are included. A bargain at **£7.50** (no VAT).

PLINTH for BBC MICRO

Protect your micro from the weight of the heavy TV/Monitor. This sturdy plinth is attractively finished in BBC colour. Air vent slots have been provided to allow maximum air circulation. It can be used to support a monitor or a printer. The micro slides underneath comfortably. A must for every BBC Micro owner, specially for those who have to move/open their computer frequently.

Price: **£11** (carr. £1.50)

PLINTH for PRINTERS

Keeps your desk tidy. Place the printer on the plinth and the paper underneath. Finished in BBC colour.

£10 (carr. £1.50)

VOLTMACE'S DELTA 14

Hand-set

(Highly acclaimed at the Acorn User Exhibition) Save your BBC Keyboard from a games bashing with our precision, smooth, sprung return 'Delta 14' Joysticks which has a built-in 14 Button Keypad. The hand set is Acorn Soft compatible and will work as a Joystick and two Fire buttons. Adding the ADAPTOR BOX will enable the use of all twelve Buttons (plus two repeated).

A user friendly, Keyboard to Keypad transfer program allows you to assign any Keyboard Key to either Keypad button or Joystick direction. The program also allows you to adjust sensitivity on the Joystick and conversions can be saved in a library which already contains some Acorn-Soft conversions.

Price: 'Delta 14' Hand set **£12.50**
ADAPTOR MODULE **£11.95**
TRANSFER PROGRAM **£5.15**
Tape **£5.15**
Disc **£7.75**

JOYSTICKS for BEEB

Two versions available:

SINGLE: Player type **£7.00** each
TWO Players type **£11.50** per pair

SURGE PROTECTOR Plug

Safely eliminates dangerous voltage surges. During a thunderstorm, a nearby lightning strike can induce high voltage spikes in the voltage supply or fluctuating loads can also result in transient overvoltages which if unchecked, lead to expensive data corruption/loss. Our surge protection plug will provide the necessary surge protection. Simply replace your standard 13Amp mains plug with the surge protection plug (which is almost the same size). Ideal for computers, Hi-Fi systems, precision instruments, fridge freezers, etc. Max. surge current 2KAmp; Max. Voltage 250 Volts. A must for all serious computer users.

Price: **£8.95**

ONLY THE BEST AT
WATFORD

DATA RECORDER & ACCESSORIES

Top quality Slimline, portable Data Recorder for computer use. Mains/Battery, operated with counter **£24.00**

DATA RECORDER CABLE For our Data Recorder to BBC Micro **£2.50**

DATA CASSETTES Top grade C12 Data Cassettes in library cases. **36p**

STAK-PAK

The unique computer program filing and storage system. Made of tough black plastic these compact drawer sections hold two cassettes each and lock together vertically to form miniature cabinets of any height. Each drawer section has two Agfa C12 Cassettes with labels plus external index card. Five twin Paks (10 Cassettes) **£6** (Postage £1.00)

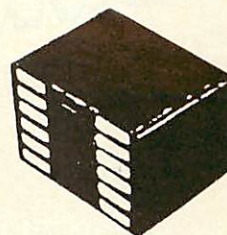

ATTACHE CARRYING CASE for BBC Micro

These Attache Carrying cases are attractively finished in mottled antique brown leatherette. An ideal and very safe way to carry your BBC Microcomputer. Price: **£12** (£2 carr.)

LIGHT PEN for BEEB

A ready-made Light Pen for BBC Micro. Enables you to produce drawings on your own TV/MONITOR screen. Supplied complete with Software Cassette and instructions. Only: **£17**

TEX EPROM ERASERS

* New Broom for EPROMS *

EPROMs need careful treatment to survive their expected lifetime. Rushing it could burn their brains out. So cop-out of this helter-skelter world; take it easy the TEX way and give your chips a well earned break. Cool, gentle and affordable. EPROMPT does it properly.

Two versions available:

- EPROMPT EB – The standard version. Erases up to 16 chips. **£30.00**
- EPROMPT GT – Erases up to 32 chips. Has an incorporated safety switch which automatically switches off the UV lamp when the Eraser is opened. **£35.00.**

We stock a wide selection of games software and peripherals for BBC Micro. Why not call in at our shop for a demonstration. Be satisfied before you buy.

Prices subject to change without notice.

MAIL ORDER AND RETAIL SHOP. TRADE AND EXPORT INQUIRIES WELCOME. GOVERNMENT AND EDUCATIONAL ESTABLISHMENTS OFFICIAL ORDERS ACCEPTED. CARRIAGE: Unless stated otherwise, please add 75p to all cash orders.

VAT: UK customers please add 15% VAT to the total cost incl. Carriage.

SHOP HOURS: 9.00am to 6.00pm. Monday to Saturday. (Ample Free Car Parking Spaces)

ACCESS ORDERS: Simply phone: Watford (0923) 50234. (24 Hours)

Watford Electronics

Dept. BBC, Cardiff Road, Watford, Herts, England.
Telephone: 0923 40588/37774. Telex: 8956095

ACORN USER &
CENTURY COMMUNICATIONS
PRESENT THE GREAT
PUZZLE CHALLENGE

**ACORN
USER**

**CENTURY
COMMUNICATIONS**

**£1000
TO BE WON!**

In the *Century/Acorn User* prize puzzle competition it's your turn to set the puzzles! Here's what you do:

Write your puzzle in a clear and unambiguous way – and then write a Basic program to solve it. The best puzzle submitted in the opinion of the editor of *Acorn User* and Century Communications Ltd will win £500. Each runner up will receive £5.

Your puzzle may be an old chestnut or it may be completely of your own devising but you must include a Basic program to solve it – preferably on cassette or disc. Try to make it as concise as possible.

Send your puzzles to:

Century/Acorn User
Prize Puzzle Competition,
Century Communications Ltd,
12-13 Greek Street, London W1V 5LE.

Rules of entry

1. Any number of entries may be submitted. The closing date of the competition is Tuesday, May 2, 1984.
2. Winners will be informed by post and announced in the pages of *Acorn User*.
3. Copyright in all winning puzzles and Basic programs submitted will belong to Century Communications Ltd and *Acorn User* and may be published both in the magazine and in a book.
4. The decision of the editor of *Acorn User* and Century Communications Ltd is final and no correspondence will be entered into.

LITTLE BOXES

In the second of his three-part series on learning Lisp Stan Froco explains how lists – and thus Lisp programs – are represented in the computer

WE CAN represent lists using simple box diagrams. For example, the list

(A B C)

is drawn as

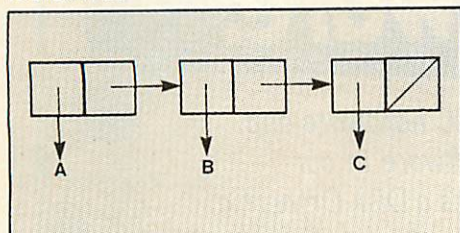

Each box has two halves the first pointing to the item in the list, the second to the rest of the list. The symbol



is used to represent a pointer to nowhere, signifying the end of the list.

These boxes represent the computer's memory, each box representing four bytes in two two-byte halves. Suppose this list were somewhere in the computer's memory, say at address 5000.

5000	5008	5016
5004	5024	0000
5008	'A' 0	0 0
5012	'B' 0	0 0
5016	5012	5004
5020		
5024	'C' 0	0 0

This shows the first box occupying bytes 5000 to 5003. The first two bytes are a pointer to the textual item 'A'. A pointer is just the address in memory of the thing being pointed to (5008 in this case). Byte 5008 holds the character 'A' (ie, its ASCII code 65). Since it is convenient to use memory in blocks of four bytes, the next

three bytes are padded out with zero. Bytes 5002 and 5003 comprise the second half of the first box and hold a pointer to the rest of the list (at byte 5016). The structure is as for the first box.

When we come to the third box (at byte 5004) we see that its second half holds zero, corresponding to a pointer to nowhere (it wouldn't be sensible to put lists in zero page, which is used by the operating system etc). This pointer to nowhere is given the name NIL. We have come across this before as being the same as the empty list

()

and this seems a sensible item to use as end-of-list marker. An important thing to notice is that the order of boxes in memory is irrelevant, and many other combinations are possible. The structure is all given by the values of the pointers.

This is a slightly simplified representation of the mechanism used by most Lisp systems. The subtle differences between this and the actual implementation will be covered in the last article (they're not particularly relevant at this stage). The role of the Lisp system is to provide the necessary facilities for handling these lists in memory. We can build arbitrary lists using our box notation – for example, a list of lists

((THIS IS) (A SENTENCE))

would be drawn as

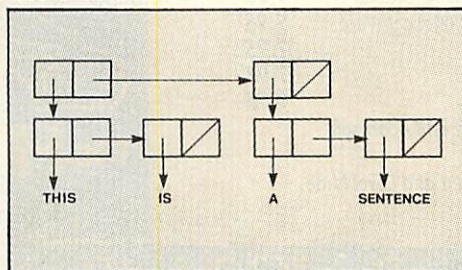

Similarly, function evaluations such as (PLUS 2 3)

are represented as:

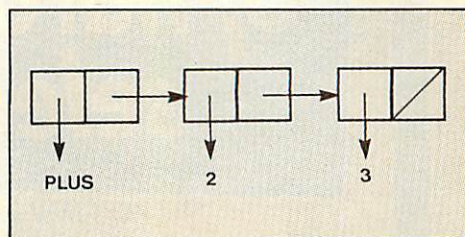

We can examine the action of CAR, CDR and CONS on box structures. If we give CAR a box

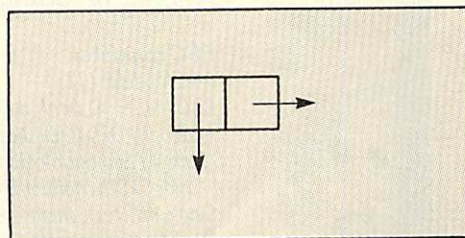

CAR will return the thing pointed to by the left half. For example, CAR applied to

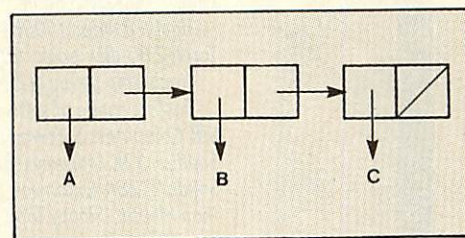

would give us the textual item A.

Similarly CDR gives the item pointed to by the right half, in this case the list

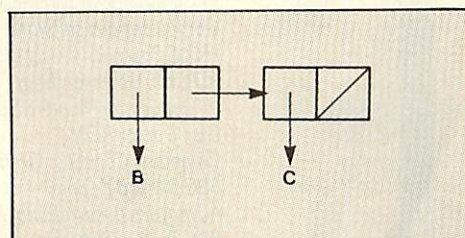

The reason for the strange names of CAR and CDR is related to this. The IBM 709, one of the first machines on which Lisp was implemented, had 36-bit memory words, which it used in two 18-bit halves for Lisp boxes. These words could be loaded into a pair of registers in the machine, the Address and Decrement registers. CAR was short for Contents of Address Register and CDR was short for Contents of Decrement Register. These strange names have stuck.

CONS is the opposite of the above. Every time CONS is called it creates a new four-byte box, or cell, from the remaining memory (I will discuss what happens when

Now there's a selection of hardware to match our selection of software.

At HMV we've just installed the latest ranges of BBC hardware and peripherals alongside the massive selections of BBC software in our Computer department. So whatever you need, whether it's a Disk Drive or a Hobbit, or simply some expert advice, you'll know exactly where to find us.

BBC computer

BBC Model B (32K)	399.00
BBC Model BD (with disk interface)	479.00
Acorn .90 DFS (including fitting)	95.00
Cumana Compatible disk drives. (With switched mode PSU, Manual, Utility Disk and Drive Cable.):	
Single 40 track single sided (100K)	209.00
Dual 40 track single sided (200K)	385.00
Dual 80 track single sided (400K)	449.00
Dual 80 track double sided (800K)	559.00
Dual 40/80 switchable doubled sided (800K)	599.00
Torch Z80 disk pack - 800K Dual Disk (including fitting) (Z80 card, 64K memory and Perfect range of software)	850.00
SIR Computers Sideways ROM Board (Mk2)	45.00
Solidisk 32K Sideways RAM Board	54.95
Solidisk 128K Extension for Solidisk 32K	85.00
Ikon Hobbit 'Floppy Tape' with zero memory option	149.00
Voltmace Delta 14B Joystick Controller	12.95
Ultracalc ROM (BBC Soft Spreadsheet)	74.00
View Wordprocessing ROM	59.00
Word-Wise Wordprocessing ROM	45.00
Gemini serious software	from 19.95
HCCS Pascal-T	67.00
ADE Macro Assembler/Debugging Monitor/Editor	60.00
Disc Doctor ROM	33.95
Computer Concepts Graphics ROM	33.95
BBC Record Keeper	16.10
Adventure International Adventures	9.95
BBC Toolbox Software	21.00
EDG Graphics Package	19.95
The French Mistress educational software	9.95
The German Master educational software	9.95
Hunchback	7.95
Killer Gorilla	7.95
Planetoids	9.95

- Complete range of BBC Soft and Acornsoft programs
- Complete range of Lothlorian and Level Nine software

-Selected Program Power and Superior Software programs

-Most popular Games software

-Complete range of educational software

ACORN ELECTRON computer

Acorn Electron	199.00
SIR Computers joystick/printer interface	45.00

-Complete range of Acornsoft programs

-Selected Program Power software

PRINTERS AND MONITORS

Acorn API00 dot matrix printer	199.00
Epson FX-80 dot matrix printer	410.00
Juki 6100 daisy wheel printer	425.00
Zenith 12" monochrome monitor	89.00
Microvitec med res colour monitor	139.95

ACCESSORIES

Printer cables (all printers)	15.00
Cassette leads (all types)	2.99
VDU screen cleaner	2.99
10 C15 blank computer tapes	5.00

BLANK MEMOREX DISKETTES

(with hub-ring re-inforcements)	
40 track single sided (box of ten)	19.95
40 track double sided (box of ten)	29.95
80 track single sided (box of ten)	29.95
80 track double sided (box of ten)	37.95

Please note that prices may change without notification. Ring 01-629 1240 to check availability.



The Computer Dept., 1st Floor, 363 Oxford Street. (Next to Bond St. Tube)

Lisp runs out of memory in the next article), and points the left half to its first argument and the right half to its second argument. Thus CONS applied to

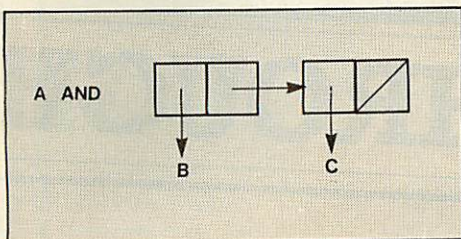

yields a new cell

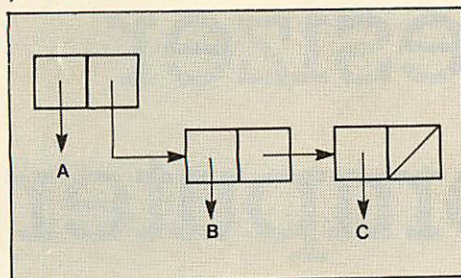

You may wonder what happens when we apply CONS to two textual items such as A and B. Not surprisingly we get:

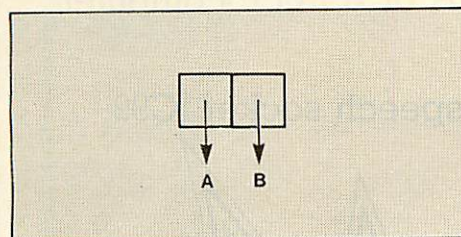

We have a problem here in that we know how to print out structures only where the second half is another list or NIL. The above structure is called a *dotted pair* and is printed out or entered as:

(A . B)

A list is just a special type of dotted pair. We could write

(A B C)

as

(A . (B . (C . NIL)))

If you draw them you will see that the box structures are the same. Lists are so common, however, that the first notation is used, being shorter.

Most Lisp functions that return new list structures (as opposed to functions like CAR and CDR which return bits of existing list structures) call CONS internally to create the new structure. This means that you can get several different copies of something which looks the same. When you use the predicate EQ to test for equality you must beware of this. EQ checks whether structures are the same thing, not whether they look the same. Thus

```
(SETQ A (LIST X Y Z))
(SETQ B (LIST X Y Z))
(EQ A B)
```

will return NIL.

We need to look at what items can be held as values by Lisp variables. There are the following in Acornsoft Lisp:

Numbers
Textual items
Built-in functions not defined in LISP

Lists
Other structures based on dotted pairs

The last two items are special and are grouped together as *S-expressions*. They have the property that they can be split by using CAR and CDR and created by using CONS.

The first three items are grouped together as *atoms*. Atom comes from the Greek *atomos* meaning not divisible, and atoms cannot be split by CAR and CDR (and of course can't be constructed using CONS). Lisp keeps a list of all known atoms, called the *Object list*. The function OBLIST will create a list from this of all character atoms (the correct term for textual items) being used as variable names. This of course includes all functions, built-in functions having as value a function atom which, among other things, gives the execution address of the function.

Every time a function returns a new atom it first looks for it on the object list. If it is already there then the function just returns a pointer to it, otherwise it puts the new atom on the object list, and returns a pointer to it. Thus there is only ever one copy of an atom. This is why

```
(SETQ A 'X)
(SETQ B 'X)
(EQ A B)
```

returns true. Both A and B point to the same character atom X. This is the fundamental difference between S-expressions and atoms.

It should be pointed out that in practice to look up number atoms all the time on the object list would be inefficient. Lisp systems may have several different copies of a number, but the comparison routines know

'Notice that the order of the boxes in memory is not important'

this, and if it is a number they check the value, rather than the place on the object list. Thus the way number atoms differ is not seen by the user.

Two functions modify an existing data structure (as opposed to creating a new one by an internal call to CONS). These are RPLACA and RPLACD (for *replace CAR* and *replace CDR*), which alter the CAR and

CDR parts respectively of their arguments. Thus

```
(SETQ X '(A B))
(RPLACA X 'Z)
```

will leave X with the value (Z B). This can be used to create circular lists:

```
(SETQ X '(A B))
(RPLACD (CDR X) X)
```

X has the box structure

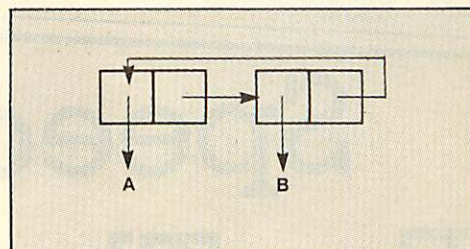

If you give this to the PRINTC routine you will find it prints an infinite list of As and Bs. Like most Lisp functions, it assumes lists are not circular, and keeps on printing until it comes to a NIL.

You may have noticed that the ' mark is the only time something in Lisp is not expressed as a function. This is in fact not the case and ' is short for the function QUOTE.

'A

is shorthand for

(QUOTE A)

QUOTE just returns its argument unevaluated. There are a number of built-in functions which don't evaluate their arguments. We have already seen one, SETQ, which doesn't evaluate its first argument, but uses it as a variable name. There is a function SET which does evaluate its first argument. Thus

```
(SETQ A 10)
```

and

```
(SET 'A 10)
```

are identical. SETQ (an abbreviation of SETQUOTE) is so useful that it is built in.

There are a number of characters which are useful but difficult to print out. These include:

() space . carriage return

We have seen the use of the variable BLANK to incorporate spaces into text, and there are corresponding variables (LPAR, RPAR, PERIOD and CR) for the other characters. There is, however, an easier way. If you want to use a special character in a character atom just precede it by an exclamation mark, and its usual effect will be overridden. For example:

```
(PRINTC 'The! cat! sat! on! the! mat)
(PRINTC '!(brackets!))
```

To get an exclamation mark use !!

The function PRINT (as opposed to PRINTC) will print out items putting exclamation marks before these special charac-

BBC SPEECH

PRICE BREAKTHROUGH

Speech Synthesizer For The BBC Computer

Totally unlimited vocabulary is now possible with the revolutionary "SWEET TALKER" Speech Synthesizer for the B.B.C. A or B Microcomputer, any series.

The CHEETAH "SWEET TALKER" simply plugs into speech socket IC99 within the computer.

No soldering, no cutting of tracks, no headaches.

Based on an allophone system you can easily program any word, sentence or phrase and incorporate speech into your software games.

Fully tested and guaranteed.

Complete with demonstration cassette and full instructions.

Price includes V.A.T., Postage and Packing.

Delivery normally 14 days.

Export orders at no extra cost.

Dealer enquiries welcome.

Send cheque/PO now to:-

CHEETAH MARKETING LIMITED

Dept. AU3, 24 Ray Street, London EC1. Tel: 01 278 6954

Cheetah, products available from

branches of **John Menzies** *Boots* **WHSMITH** and **Rumbelows**



ters. PRINTC is short for *PRINT* Characters, ie, no extra exclamation marks.

PRINT and PRINTC always put a carriage return at the end of each line. If you don't want this use PRIN or PRINC.

There are a number of corresponding routines to write to and read from files on disc, tape and so on. Files are opened for reading by

```
(OPEN filename T)
```

and writing by

```
(OPEN filename NIL)
```

OPEN returns a number as result, which is a file handle. This must be used whenever writing to, reading from or closing the file. To read a Lisp expression from a file use:

```
(READ handle)
```

READ without a handle reads from the keyboard. To write to a file use WRITE or WRITE0, which correspond to PRINTC and PRINC. They take as their first argument a handle, with the rest of the arguments as for PRINTC and PRINC.

These provide a useful way of saving and loading routines back in without destroying the whole image, as happens when LOAD is used.

If you define a function in Lisp and print it out you find it is printed out in the minimum possible space. It would be better if it were neatly displayed, as with the examples I have given. The layout doesn't alter the meaning of the function but makes it easier to understand. The Lisp superprinter SPRINT is supplied as a built-in function defined in Lisp. Every time a new level of bracket nesting is encountered the printing is indented three more spaces. Where possible, everything is printed on one line, otherwise vertically downwards.

A slightly better version is given in Norman and Cattell's *LISP on the BBC Microcomputer* (Acornsoft). A good way to find out how it works is to use

```
(SPRINT SPRINT)
```

to print it out. You will see it uses two functions, XTAB and CHARCOUNT, to print

'Functions defined in Lisp are printed out in the minimum possible space'

out spaces at the beginning of lines and to work out how much space is left on the line. CHARCOUNT uses a variable LINEWIDTH to work out the number of characters allowed per line (it should be one less than the maximum allowed). This is initially 31 (for compatibility with Atom Lisp) but can

be sensibly altered to 19 for modes 2 and 5, 39 for modes 1, 4, 6 and 7, and 79 for modes 0 and 3.

I do not propose to describe SPRINT in detail. When you get to the end of this article you should be able to understand how it works. It is anyway described in the appendix to *LISP on the BBC Microcomputer*.

SPRINT uses three new functions, LOOP, UNTIL and WHILE. Strictly speaking, you do not need the equivalent of FOR...NEXT and REPEAT...UNTIL loops in Lisp. A loop can always be replaced by recursion (put the loop into a separate function; at the end of the function make a recursive call to the function - this is equivalent to jumping to the beginning of the loop).

Early Lisp systems did not have loops, but they were soon added as a convenient and natural way of programming. The loop function has the form

```
(LOOP
  (function-call1)
  (function-call2)
  .
  .
  (function-calln))
```

Every function call is executed in turn until the end of the loop is reached, when execution returns to the first function call and they are all executed again. This is repeated ad infinitum.

The loop function is useful only if you can get out of the loop. For this there are the UNTIL and WHILE functions, which can be used inside a loop. The UNTIL function has the form:

```
(UNTIL condition expression
  expression . . .)
```

There may be any number of expressions for evaluation. If the condition is false nothing happens, NIL is returned as value. If the condition is true, then each expression is evaluated, and the loop containing the UNTIL is terminated. The value of the last expression is returned as the value of the loop function (NIL if there are no expressions).

The WHILE function is identical except that the loop is terminated when the condition is false. The following calculates the squares of numbers from 1 to 20:

```
(SETQ n 1)
(LOOP
  (PRINTC n BLANK (TIMES n n))
  (UNTIL (GREATERP (SETQ n (ADD1
    n)) 20)
  (PRINTC 'All! done)))
```

Last month I rather skated over the problem of how to edit Lisp functions after you've defined them. A good Lisp programmer rarely defines functions that are more than ten lines long, and so retyping is a feasible method of editing. However, Acornsoft Lisp provides a rather more elegant editor, EDIT, defined in Lisp.

EDIT allows you to modify values of variables. In particular I explained last month how functions were variables with values which are lists of the form:

```
(LAMBDA (argument list) body of function)
```

EDIT allows you to modify lists by stepping along them and changing bits. To use it let us consider a variable BILL whose value is the list

```
((A B) (C D))
```

or in box notation

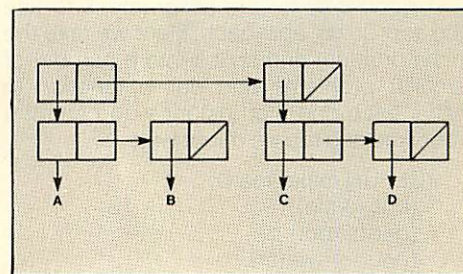

If we now use

```
(EDIT BILL)
```

we get BILL superprinted out and we can use a number of commands to modify it. At any stage we can see where we are by hitting return.

If we want to modify a part of BILL we can use A or D to select the CAR or CDR part. After we have finished editing the part we can use B to go back to where we were before. If we wanted to edit the sublist (A B) of BILL we could enter A followed by return and we would get printed

```
(A B)
```

We have three options for modifying the current sublist. We can use X to chop the first item off a list. In this case we would get:

```
(B)
```

That is, the current list has been replaced by its CDR. We can now use C to CONS an item onto the front of the list. For example if we now use

```
C
(X Y)
```

we would CONS the list (X Y) onto the list (B) and get:

```
((X Y) B)
```

Finally, we can use R to replace the whole item, so if we used DA to get

```
B
```

as the current item, followed by

```
R
Z
```

we would get Z as the current item. Using B to go back to where we were (*undoing the last A*) would give us:

```
(Z)
```

Another B (*undoing the D*) would give us:

```
((X Y) Z)
```

Another B (undoing the first A) would give us:

```
((X Y) Z) (C D)
```

And a final B would take us out of the editor, leaving BILL with the value

```
((X Y) Z) (C D)
```

Try experimenting – it takes some getting used to.

I said earlier that good Lisp programmers don't write functions of more than ten lines (at least, not very often). What is a good way to write Lisp programs?

A good way for big programs is to use the 'top-down' approach. Here we take the main problem and split it into a number of smaller problems and call a function to solve each one. For instance, to control a robot making tea we might write:

```
(DEFUN make-tea ()
  (boil-kettle)
  (get-teapot)
  (pour-on-water)
  (wait-minutes 5))
```

We could then write each of these functions in terms of smaller functions, for example:

```
(DEFUN wait-minutes (n)
  (LOOP
   (wait-one-minute)
   (SETQ n (SUB1 n))
   (UNTIL (ZEROP n))))
```

and so on. We can test the logic at any stage by making any incomplete functions just print out their name and arguments when called. We can then check the main function or any of its sub-functions to see if the right things are printed out.

The alternative approach is 'bottom-up' programming, often appropriate for small programs. Here we write a number of useful small functions and bolt them together into bigger functions. A typical example is in games programming, where you start by writing a set of functions to move shapes round the screen, flash colours and so on.

Almost all programmers use a combination of both styles. My example below does. You have to find the right approach for yourself.

One rule to follow whatever your style is *Keep your functions small*. If it takes more than about ten lines it's probably better split into several functions. You can help keep things clear by giving your functions long names that explain what they do. This helps make up for the absence of a commenting facility in Acornsoft Lisp.

Mainframe Lisp systems rarely worry what size numbers grow to. To put a limit on the size of numbers is an annoying recognition of the limitations of real computers, and inevitably hampers portability. The best solution is to hide the problem inside the Lisp system.

Acornsoft Lisp allows only numbers in the range -32768 to 32767. This package, closely based on the one in *LISP on the BBC Microcomputer*, implements main-

frame style unlimited arithmetic.

One way of representing numbers would be as a list of digits. For example a million would be

```
(1 0 0 0 0 0)
```

The scheme used here is almost the same, with three differences

1. Digits are to base 100, ie, the components of the list are in the range 0 to 99 rather than 0 to 9. This speeds things up.
2. Numbers are stored back-to-front to make carry and borrow operations simpler.
3. Numbers less than 100 are stored without any list structure as ordinary numbers. Numbers up to 9999 are then stored as a dotted pair. For example 1234 is

```
(34 . 12)
```

Larger numbers are stored as lists with a dotted pair at the end. For example, a million is

```
(0 0 0 . 1)
```

'We write a number of small functions and bolt them together'

First a routine to print out big numbers

```
(DEFUN big-print (n)
  (COND
   ((NUMBERP n) (PRINC n))
   (T (big-print (CDR n))
      (print-two-digits (CAR n)))))
```

which uses

```
(DEFUN print-two-digits (n)
  (PRINC (QUOTIENT n 10)
         (REMAINDER n 10)))
```

print-two-digits ensures numbers are always printed with two digits. If we didn't do this then numbers such as a million would be printed out as

```
1000
```

Next, a number to convert ordinary numbers to big number representation:

```
(DEFUN big-number (n)
  (COND
   ((LESSP n 100) n)
   (T (CONS
        (REMAINDER n 100)
        (big-number
         (QUOTIENT n 100))))))
```

Now to add numbers.

```
(DEFUN big-plus (a b)
  (COND
   ((NUMBERP a) (small-plus-big a b))
   ((NUMBERP b) (small-plus-big b a))
```

```
(T (join-digit
    (PLUS (CAR a) (CAR b))
    (big-plus (CDR a) (CDR b))))))
```

and

```
(DEFUN small-plus-big (a b)
  (COND
   ((NUMBERP b) (big-number (PLUS a b)))
   (T (join-digit
        (PLUS a (CAR b))
        (CDR b)))))
```

Notice that small-plus-big also adds two small numbers. Join-digit is used to add a small number to the least significant end of a large number, propagating a carry if the number is greater than 99. Its definition is:

```
(DEFUN join-digit (n a)
  (COND
   ((LESSP n 100) (CONS n a))
   (T (CONS
        (REMAINDER n 100)
        (small-plus-big
         (QUOTIENT n 100)
         a)))))
```

Multiplication requires another group of routines that are very similar:

```
(DEFUN big-times (a b)
  (COND
   ((NUMBERP a) (small-times-big a b))
   ((NUMBERP b) (small-times-big b a))
   (T (big-plus
        (small-times-big (CAR b) a)
        (CONS 0 (big-times a (CDR b)))))))
```

Note the use of (CONS 0 ...) to align digits correctly for the addition.

```
(DEFUN small-times-big (a b)
  (COND
   ((NUMBERP b) (big-number (TIMES a b)))
   (T (join-digit
        (TIMES a (CAR b))
        (small-times-big a (CDR b))))))
```

This completes the multiplication routines. You can extend this set of routines to your heart's content. *LISP on the BBC Microcomputer* shows how to raise one number to the power of another by repeated multiplication.

One routine that is difficult is division. Consult a book on computer arithmetic, such as D E Knuth *The Art of Computer Programming – Volume 2: Semi-numerical Algorithms*, published by Addison-Wesley. If you start building in subtraction you will have to work out a way of representing negative numbers. As it stands the system only handles positive numbers.

Next month in the concluding article I'll cover one or two remaining features of Lisp and take a look at some of the uses to which the language has been put. I'll also consider one or two of the languages that have evolved from Lisp. The last part of the article will present a simple computer-aided design system which takes advantage of the BBC micro's graphics. ●

SPECIAL OFFER FROM VIGLEN

**THE OUTSTANDING
TEAC DISK DRIVE**

Complete Disk System for the BBC Model B

- Package assumes you own a BBC Model B with switched-mode power supply plus 1.2 operating system

Offer includes:

- Disk Interface (call at factory for free fitting)
- 100k TEAC 55 Series Slimline Disk Drive including case and all leads
- User Guide
- Formatting Disk

Viglen
COMPUTER SUPPLIES

Unit 7 Trumpers Way
Hanwell W7 2QA
Telephone: (01) 843 9903

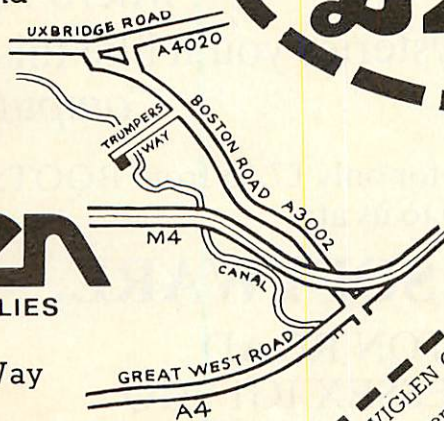

**DISK DRIVE
AND INTERFACE
£229 INC. VAT**

Post to: VIGLEN COMPUTER SUPPLIES UNIT 7, TRUMPERS WAY, HANWELL, W7 2QA

Please send me (state number required)

I enclose Cheque/P.O. for £

I prefer to pay ACCESS/BARCLAYCARD (Delete whichever not applicable) Card No.

Signature _____

Name _____

Address _____

made out to VIGLEN COMPUTER SUPPLIES (please add £8 for carriage)



SHARDS

THE ULTIMATE SECRET?

WHEN you have endured the burning farmhouse and discovered a strange diary, avoided the football hooligans, met the shady lady, Japanese tourists, the pop star and the busker; avoided the gunmen, Eddy the crook and Scarface; visited the waxworks, the natural history museum and the arcade; worked in the street market, the agency or the cafe; travelled through France, Germany, Italy, Turkey and Israel, experiencing Abdul's maze, the labyrinth and meeting a handful of very strange people on the way . . .

ONLY THEN can you be deemed worthy of discovering the ultimate secret. **ALTERNATIVELY** you can play **PETTIGREWS DIARY** on your Dragon, BBC B or Electron, and learn the secret from the safety of your own armchair.

BUT DON'T JUST LISTEN TO US!

"Pride of place in this supplement for the most original and entertaining adventure . . . it's got to be value for money"

Computer & Video Games adventure supplement

"The best adventure game for the Dragon on the market that I've seen" *Personal Computer News*

"I have nothing but praise for this unorthodox adventure" *Micro Adventurer*

"If you like puzzles and mysteries you'll like this package" *Computer Choice*

PETTIGREWS DIARY is available for only £7.95 from BOOTS and all major stockists or by sending a cheque/PO to us at:

SHARDS SOFTWARE,

189 ETON ROAD

ILFORD, ESSEX IG1 2UQ

(Access/Barclaycard orders phone 01-514 4871)

SOFTWARE: DO WE HAVE THE RIGHT OF ACCESS?

THIS month Mr G Smith wins £5 for a problem to which I can give no solution, but is worth airing. His letter concerns tapes which have been 'locked' or otherwise made difficult to copy, and makes the following points:

- Some publishers offer to replace uncopiable tapes which become unreadable, but many do not.
- Several adverts have appeared for software which claim to copy protected tapes and discs.
- The *Advanced User Guide* explains what a 'locked' tape is and therefore enables such tapes to be unlocked by an experienced user.
- Magazines have shown methods for bypassing program protection.

Mr Smith concludes that the purchaser of a locked tape who has limited experience will be unable to take a back-up copy or make his own modifications – but ways round this are readily available at a price. Hence the more inexperienced computer users are at a disadvantage.

Although software piracy costs the publisher a considerable amount of money, I agree with the sentiments expressed by Mr Smith. Some software houses are now going to ridiculous lengths to prevent copying. One notable educational software house now breaks programs up into as many as 20 parts, some only one byte long! Not content with that, they have altered the cassette loading mechanism halfway through the program, making it even more difficult to load.

Before Christmas I gave a lecture to a group of 40 teachers on using the BBC micro in science. I decided to include a demonstration of one of the programs from this software house (produced in conjunction with an education authority). For ease and speed I normally use discs during a lecture, but these programs were available only on cassette, and this particular program could not be transferred to disc. To cut a long story short, when I wanted to show the program it proved exceptionally difficult to load, mostly because the cassette filing system had been altered. Not only did this put 40 teachers off that particular software, but it started me thinking along similar lines to Mr Smith.

As well as the points he raises I would like to raise others on behalf of all those BBC users who have bought, or are planning to buy, programs that will not copy. I will talk in the context of educational pro-

grams, although many of the points have a wider concern.

First, will software houses replace any faulty tape if a back-up copy cannot be made, even if the damage is not their fault? If so, is this clearly stated, or will cassettes be changed only if enough fuss is made?

Second, what happens to those uncopiable cassette programs if a disc drive is later purchased? Will the publisher refund the cost of the tape against a disc version?

Is an establishment expected to purchase both a disc and cassette version if it has a mixture of disc and tape machines and needs the program to be used on either?

How much extra does the purchaser pay for all the programming involved in making the program difficult to copy?

Having bought the software, usually without seeing it first, why should users not be able to alter it to their requirements?

An establishment is forced to either purchase a copy for every machine that wants to use the software simultaneously or load each machine one after the other. If it is expected that a copy is purchased for each machine then doesn't the Econet system break the copyright law?

All the protection devices slow down loading – this can even double the time taken.

The use of many small programs to prevent the whole program being copied makes loading tedious, and any failure to load means the process has to be started all over again.

Many users find programs recorded on their own cassettes will load more reliably. This cannot be done with an uncopiable tape.

And all this fancy protection does not prevent copying by the simplest and quickest method; tape-to-tape. No one has successfully found a method of preventing this method, although the quality of the copy is degraded. I prefer the attitude adopted by publishers such as Longmans, which writes its programs in Basic and advises users to make a back-up, at the same time pointing out why it is detrimental to the user's interests to make illegal copies.

For those software houses who prefer to put their efforts into producing uncopiable programs, might I suggest that if they reduced the price of their wares then the incentive to copy them would be much reduced. Why should a computer tape be so much more expensive than an audio tape?

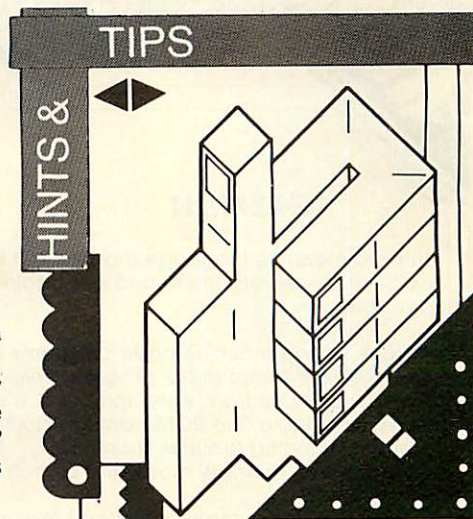

THESE problem pages, presented each month by Martin Phillips, offer simple hints and tips and answer queries from readers concerning the BBC micro and Electron and BBC Basic. If your letter is published you earn £5 for your trouble!

If you have a query on some technical hitch or a worrisome aspect of programming, please supply full details and make your question specific. It is not enough just to say that you are getting the error message 'No room' or 'Dim space' – there are, of course, a number of reasons why a program will run out of memory. A diagnosis can be made only with full information on the program, the style of programming, the techniques employed, whether discs or Econet are being used, and so on. Include a listing where appropriate.

We cannot reply to letters individually, nor can we return listings.

Write to: Hints & Tips, Acorn User, 68 Long Acre, London WC2E 9JH.

HOW TO TACKLE

BLOCKS

NO DOUBT readers will have come across the 'Header?', 'Data?' or 'Block?' messages when trying to load a program from cassette. Unlike most error messages, it is not clear what these are trying to indicate. To understand what they mean you have to know how the computer stores programs on tape.

Imagine a book of short stories. This is equivalent to a tape with several programs stored in it. For convenience the book is split into small parts called pages, each of which is numbered. A program is also split up into small parts called blocks, and each of these is numbered (the computer counts

ROMS

SOFTWARE FOR THE BBC MICRO

GREMLIN

This is a machine language monitor ROM designed for use as an aid to development and debugging of machine code programs.

Anyone writing machine code programs will at some time come across a bug in the program. Trying to track down the bug is usually far from easy and this is where GREMLIN will prove invaluable. The ROM contains a full machine code monitor including features such as a disassembler, memory move and search routines etc.

GREMLIN includes many advanced features like a full expression evaluator, and an assembler. It can single step through programs both in RAM and ROM and allows operation on any sideways ROM. Variables may be declared and used in expressions and with most commands much like BASIC. This makes the system very powerful but simple to use. Other features include —

- WORKS IN ANY SCREEN MODE
- DISASSEMBLER & ASSEMBLER
- FULL STATUS SHOWS REGISTERS, STACK etc.
- UP TO 8 BREAKPOINTS
- SINGLE STEPS THROUGH ANY ROM
- BUILT IN HELP MENU
- SPECIAL MODE FOR DEBUGGING GRAPHICS PROGRAMS

Supplied with simple to understand fitting instructions and spiral bound manual. £28 plus £1 p&p plus VAT

TERMI

TERMI is a general purpose communications ROM for the BBC micro. It will allow communication between the BBC and practically any other machine with an RS 232 interface. This ROM is not dedicated to emulating a particular terminal but has several modes of operation. It can be used as a slave graphics terminal or, in the custom mode, as a DEC VT52 terminal emulator. It will also act as a dumb terminal. The user is free to swap between 40 and 80 column screen modes even while on-line.

The most powerful feature of this package allows the user to send ASCII files from a BBC disc down the line or to receive files from the RS 232 and to save these on disc. It also allows a copy to be kept on the printer.

TERMI is supplied with a "CUSTOM" program on disc that allows the user to set up his own protocols i.e. line speeds, screen modes, start & stop bits etc., and to have these loaded from the disc every time TERMI is used.

TERMI is an 8K ROM supplied with a manual, fitting instructions and a customisation disc. £28.00 plus £1 p&p plus VAT.

new release

Communicator VT100 Terminal emulation

COMMUNICATOR is a single chip that plugs into a normal BBC Micro and turns it into an advanced DEC VT100 terminal emulator. The combined cost of a BBC Micro and this software is considerably less than a new VT100 — and you get all the advantages of one of the best micro computers available. A large range of high quality software is already available for this micro — word processors, spreadsheets etc.

Computer Concepts commissioned Specialist Software Products Ltd. to produce the most advanced emulator possible for the BBC microcomputer, its features include:

- ★ Exceptional XON/XOFF handshaking, even while spooling at speeds of 9600 baud.
- ★ Superb menu driven configuration — a great improvement over the real VT100.
- ★ Double height and double width character lines plus two character enhancements.
- ★ Independent windowing — for split screen operation.
- ★ VT100 character graphics.
- ★ Disc spooling and transmission of ASCII files.
- ★ Application keypad mode — including generation of these escape sequences.
- ★ VT52 mode.

Nearly a full VT100, the most notable omission is the 132 character mode — impossible to implement on the BBC Micro.

While COMMUNICATOR can be used for direct communication to a mini or mainframe, it also allows access to the world of electronic mail. This ROM is already widely used with the DAILCOM electronic mail service. Text may be prepared off-line with the BBC machine and transmitted at full speed via a modem when on-line to the system.

COMMUNICATOR is a 16k ROM supplied with a spiral bound manual and clear fitting instructions. £59.00 plus £1 p&p plus VAT.

Both TERMI and COMMUNICATOR may be used for any of the following

- Mainframe or mini communication.
- DEC VT52 terminal emulation.
- British Telecom Gold. (Electronic Mail)
- Bulletin boards of most types
- DISTEL, REWTEL, MAPTEL etc.
- Almost any async. RS232 communication systems.

available now



COMPUTER CONCEPTS

16 Wayside, Chipperfield, Hertfordshire. WD4 9JJ Telephone: Kings Langley (09277) 69727



in hexadecimal, based on 16 rather than base 10, and starts counting at 0). Play a tape without the computer lead plugged in and listen to the sound. There is a single tone called the 'leader' followed by a series of buzzing noises, each of which lasts about three seconds. Each separate buzzing noise is a block. The computer keeps a note of the block it has just read and will give a 'Block?' message if the next block it reads is not the one it was expecting.

At the top of a page you often find the name of the story printed as well as the page number. The computer always saves the title and block number at the start of each block, together with a check of the number of bits. This information is contained in what is called the 'header'. If the computer is unable to read the header correctly then 'Header?' is printed.

Below the title and page number in a book comes part of the story itself written in words and sentences. This is equivalent to the commands, statements and lines that make up a program and is called data. Once the computer has read a block of data it uses the checksum given in the header to make sure it has read the data correctly. If not, the 'Data?' message appears followed by the message 'Rewind tape'. You need to rewind only to the start of that block and not to the start of the program.

THE EQUALITY TEST

QUITE by chance when working on a number program for the speech synthesiser, I found a way of printing a more accurate result of a computation. In December's Hints & Tips I showed how the BBC micro had a routine to tidy up numbers and print them out with rounding off, which caused problems. By putting the result of a computation directly into a string using the STR\$ statement, the exact number stored can be printed out. Using December's example, we can gain more insight into why the program would not work.

To refresh memories, the program is given again here (listing 3). One would expect it to print out 'Correct', but the computer does not take A+B to be the same as C. To see what the computer has done, try listing 4. On my machine with Basic 1, I get the following printout:

```
RUN
A =.3
B = 6.4
C = 9.4
A+B-C = 3.7252903E-9
```

This method still does not give the complete picture of what is happening as the STR\$ function uses the same binary-to-decimal conversion routines and works to the same precision as the PRINT statement (nine figures on Basic 1 and 10 figures on Basic II). This is why it prints out A, B and C

WHEN ERROR REPORTS START MAKING MISTAKES

ERROR reporting on the BBC micro and Electron is usually very good – so much so that one tends to rely on it too much. It is not always precise, and cannot always be so. One example of this occurs when there are errors in data statements. The line at which the error is reported is the line where the read statement is, and not the data line. This can be confusing because the error is expected to be at the line given. A deliberate error has been induced in the data line of listing 1, and a 'No such variable at line 20' error is reported after correctly printing 1 3 5. The read statement expected to find a number and found a string instead.

Listing 2 shows a common error that can occur in data statements. A comma has been put at the end of line 50, and the computer expects to find another number on that line. The same error as the first example is reported. Similarly, extra commas put in other places in data lines will also cause errors:

```
50 DATA,1,3,5
or
50 DATA 1,3,,5
```

In these examples it is easy to spot the mistake, but when typing in listings with many lines of data it can be difficult. The only solution is to check all data lines carefully before running the program. If you are writing a program with data in it, keep each data line short; that way, listings are easier to check, and mistakes are easier to find. Also use the WIDTH command to set the screen display to the same length as, say, the magazine listing (*Acorn User* normally sets to 40 characters).

If using string variables in DATA statements, take care not to get any extra spaces either before or after the string. It is easy to overlook these and then wonder why the program does not work. If in any doubt, enclose the string in speech marks:

```
DATA "January", "February", "March"
```

```
10 REM listing 1
20 FOR N=1 TO 5
30 READ T
40 PRINT T
50 NEXT N
60 DATA 1,3,5,ERROR,9
```

Listing 1.

```
10 REM listing 2
20 FOR N=1 TO 5
30 READ T
40 PRINT T
50 NEXT N
60 DATA 1,3,5,
70 DATA 7,9
```

Listing 2.

```
10 REM Listing 3
20 A=3
30 B=6.4
40 C=9.4
50 IF A+B=C PRINT "Correct"
60 PRINT "I've finished"
```

Listing 3.

```
10 REM Listing 4
20 A=3
30 B=6.4
40 C=9.4
50 IF A+B=C PRINT "Correct"
60 A#=STR$(A)
70 B#=STR$(B)
80 C#=STR$(C)
90 D#=STR$(A+B-C)
100 PRINT " A = "A#"
110 PRINT " B = "B#"
120 PRINT " C = "C#"
130 PRINT "A+B-C = "D#"
```

Listing 4.

correctly. It does, however, enable the difference between A+B and C to be shown. As can be seen, the difference is very small but is enough to fail the equality test.

COPYING MACHINE CODE PROGRAMS

JUSTIN DODSON of Hull is one of several readers who have asked how it is possible to copy machine code programs on the Electron. The method given here will work for both the Electron and the BBC and will also save data files. (It is assumed the reader is aware that it is illegal to copy programs subject to copyright.)

Instead of the normal loading method, the program to be copied is loaded into a specific memory area, and the contents of that memory area are saved, as opposed to saving an actual program. This is done with the *LOAD and *SAVE commands. To make a copy of a program called MYPROG, the following steps will need to be taken. First type *OPT1,2 and press Return. This switches on the detailed information about cassette loading and saving addresses. Now type *LOAD"MYPROG" 0E00 and press Return.

Insert the program to be copied into the cassette recorder and load in the normal

way. The reason '0E00' is put after the program name is to force the program to be loaded at 0E00, the start of the user's memory. This overrides the address given when the program was saved. Once the program has loaded, the prompt will re-appear, and at the side of the program name four sets of hexadecimal numbers will appear. The first is the two-digit hexadecimal number that normally appears on loading and shows the block currently being loaded. The second number is a four-digit hexadecimal number and is the actual length of the program.

In figure 1, MYPROG has a length of &573 bytes. The third and fourth numbers are eight digit hexadecimal numbers, the first four digits of each are either '0000' or 'FFFF', and can be ignored. The last four digits of the third number is the execution address, and the last four digits of the fourth number is the reload address.

The execution address for MYPROG is &801F and the reload address is &1900.

The third step is to type *SAVE"MYPROG" 0E00 +0573 801F 1900 and press Return.

Insert a blank cassette in the player and save the program in the usual way. The four pieces of information that have been included after the program name are:

- start address of memory where the

- program is stored
- length of memory to be saved
- execution address (optional)
- reload address (optional)

If no reload address is given, it is assumed to be the same as the start-address of memory where the program is stored. Notice that both the *LOAD and *SAVE statements expect to be followed by hexadecimal numbers. The screen dump shows the steps taken to load MYPROG and then resave it. This method for saving areas of memory can be used to save parts of or all the screen memory in the same way and to load it in again. Hence a picture displayed on the screen can be saved, loaded back into the screen memory area and shown again. By using an area of memory that cannot be loaded with a program, such as the memory where the Basic ROM chip resides (&8000), a program can be verified without losing the original from memory. Once a program has been saved, reload it in again using the following command: *LOAD"" 8000. This will then try to load the program into the Basic ROM, and in the process it will check that the program will load correctly. If not, simply resave the program as the original program will not have been overwritten. It works for Basic and machine-code programs.

<pre> BASIC >*OPT1,2 >*LOAD"MYPROG" 0E00 Searching Loading MYPROG 05 0573 00001900 0000801F >*SAVE"MYPROG" 0E00 +0573 801F 1900 RECORD then RETURN MYPROG 05 0573 00001900 0000801F </pre>	<p>Figure 1.</p>
--	-------------------------

THE CASE OF THE COMPULSORY 'THEN'

FOR most purposes the keyword THEN is an optional part of the IF... THEN... ELSE structure and is often left out of listings. However, there are occasions when it must be included, and there is a brief warning to this effect in the *User Guide* on page 363 when used with pseudo-variables such as TIME.

One not very obvious example where THEN must be used is if control passes to the machine operating system after the test condition. A machine operating system (MOS) call always starts with a '*' Examples of MOS calls are *TAPE, *MOTOR, *FX, *CAT etc. A full list is given on page 416 of the *User Guide*.

To demonstrate the point, *MOTOR is used as an MOS call with an immediate and obvious effect: it turns the cassette motor relay and light on and off. Listing 5

will not work as intended, and comes up with a 'No such variable at line 30' error. This is because the asterisk is interpreted in this case as a multiply sign and the unknown variable is MOTOR0. The cure is simple: put the THEN in, as in listing 6.

<pre> 10 REM listing 5 20 INPUT"Enter 0 OR 1 "N 30 IF N=0 *MOTOR0 40 IF N=1 *MOTOR1 50 GOTO 10 </pre> <p>Listing 5.</p> <pre> 10 REM listing 6 20 INPUT"Enter 0 OR 1 "N 30 IF N=0 THEN *MOTOR0 40 IF N=1 THEN *MOTOR1 50 GOTO 10 </pre> <p>Listing 6.</p>	<pre> 10 REM listing 7 20 MODE2 30 VDU5 40 VDU23,240,24,60,90,90, 126,60,36,102 50 VDU23,241,0,0,36,36,0, 0,0,0 60 C#=CHR#18+CHR#0+CHR#1+ CHR#240+CHR#8+CHR#18+CHR #0+CHR#14+CHR#241 70 MOVE 640,512 80 PRINT C# </pre> <p>Listing 7.</p>
---	--

TWO-COLOUR CHARACTERS

NICHOLAS HORNE of Great Missenden has sent in a short routine to program multicoloured user-defined characters. One way to do this is to define a character for each colour and then superimpose them on each other. For example, take a small monster; if the body is coloured in red and the eyes are to be cyan then CHR\$240 can be defined as the red part and CHR\$241 as the cyan part.

Then the two characters can be included in a string, with the appropriate colour

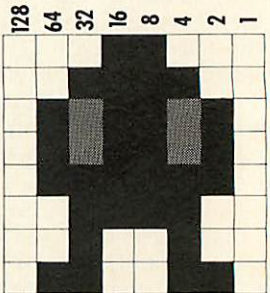

changes included. This is done by using CHR\$18+CHR\$0+CHR\$1 which is the same as GCOL0,1. To give the two coloured character the string will be:

```

C$=CHR$18+CHR$0+CHR$1
+CHR$240+CHR$8+CHR$18
+CHR$0+CHR$6+CHR$241
        
```

CHR\$8 moves back one space to effectively overprint the first character. Normally this would erase the first character before drawing the new one, but if VDU5 is used, it enables one character to overwrite another without erasing the first. Hence the two-coloured character.

To add more life, the monster can be given flashing eyes by using colour 14 instead of colour 6. Listing 7 demonstrates how to program user-defined characters in two colours. By a similar technique it is possible to join several characters together. Also, more than two colours can be used at once. The four control codes which move one pixel in a specified direction are:

- CHR\$8 . . . back one space
- CHR\$9 . . . forward one space
- CHR\$10 . . . cursor down one line
- CHR\$11 . . . cursor up one line

DISC DRIVES

**FOR THE
BBC
MICRO**

CHASE DATA LTD

The exclusive disc drive company,
cut out the middle man to
bring you **BEST PRICES** on
CANON disc drives.



**110/210 DUAL
DRIVE SYSTEM**



**221 DUAL
DRIVE SYSTEM**

**1 YEAR
WARRANTY
ALL PARTS
& LABOUR**

CHASE DATA LTD are pleased to announce the launch of the latest generation of Canon disc drives – the ultra slim model 221 (double sided 80 track) – **TRULY SUPERB VALUE FOR MONEY**

All inclusive means
Disc drive + case + all power and data cables + U.K. carriage + utilities disc & manual + V.A.T.

Quality product
State of the art disc drives. E.g. Model 221 features: unique LED Indication on front panel of mode selected.

Full service support
Our units come with a full 1 year warranty on parts & labour. Disc drive service is via the leading U.K. Independent Drive Service Company.

Send remittance (Cheque only please) with your order to:

CHASE DATA LTD

P.O. Box 6, Woking, Surrey GU21 4PB. (Tel: 0784 38487).

All inclusive price list

MODEL	110	210	221
FORMATTED CAPACITY OF SINGLE DRIVE ON BBC MICRO	100K	200K	400K
SINGLE DRIVE IN CABINET	£170	£198	£236
DUAL DRIVE IN CABINET	£320	£370	£437

All units available with on-board power supply.
Additional cost: £25.

WHAT RESOLUTION FOR ONLY £230. (EX.VAT)



Our RGB high resolution colour monitors (580 × 470 pixels) sell for £229.95 (excluding VAT)—a saving of over £100 compared to other leading monitors of similar specifications.

That's a bargain we guarantee you won't see from any other micro retailer.

We've managed to acquire the sole distribution rights enabling us to offer these superb monitors at this unbeatable price.

And just because you're saving on price doesn't mean you're sacrificing quality. Here's what Personal Computer News had to say about our monitors.

"There is no doubt that the JVC range of ECM colour monitors is excellent value for money... there is no loss in quality of picture after long periods... remember as more and more resolution is available with new micros, the need for a better display will be that much greater."

For those who only require medium resolution we also have a model (370 × 470 pixels) at £149.95 (excluding VAT) which is equally excellent value for money.

Both units have a 14" screen and are suitable for the BBC Micro, Spectrum QL, Lynx, Oric, Apple, IBM and

most other leading micros.

And naturally there's a years full guarantee.

Another one of our commitments is to make certain we deliver your monitor by courier within ten days of receiving your order.

You can order by filling in the coupon below and posting to: Opus Supplies Ltd., 158 Camberwell Road, London SE5 0EE. Or by telephoning 01-701 8668 quoting your credit card number. Or, of course, you can buy at our showroom between 9.00–6.00pm, Monday–Friday 9.00–1.30pm, Saturday.

Now available from John Menzies.

MODEL REFERENCE	1302-2 High Resolution	1302-1 Medium Resolution
RESOLUTION	580 x 470 Pixels	370 x 470 Pixels
C.R.T.	14"	14"
SUPPLY	220/240v. 50/60Hz.	220/240v. 50/60Hz.
E.H.T.	Minimum 19.5kv Maximum 22.5kv	Minimum 19.5kv Maximum 22.5kv
VIDEO BAND WIDTH	10MHz.	6MHz.
DISPLAY	80 characters by 25 lines	80 characters by 25 lines
SLOT PITCH	0.41mm	0.63mm
INPUT: VIDEO	R.G.B. Analogue/ TTL Input	R.G.B. Analogue/ TTL Input
SYNC	Separate Sync on R.G.B. Positive or Negative	Separate Sync on R.G.B. Positive or Negative
EXTERNAL CONTROLS	On/off switch and brightness control	On/off switch and brightness control

To: Opus Supplies Ltd., 158 Camberwell Road, London SE5 0EE.
Please send me:

_____ High Resolution Colour Monitor(s) at
£229.95 each (ex. VAT).

_____ Medium Resolution Colour Monitor(s) at
£149.95 each (ex. VAT).

_____ Connection lead(s) at £6.00 each.

I understand carriage per monitor will cost an extra £7.00.
(N.B. A High Resolution Monitor including VAT, lead, and carriage costs £279.39. A Medium Resolution Monitor including VAT, lead and carriage costs £187.39).

I enclose a cheque for £_____. Or please debit my credit card account with the amount of £_____. My Access/Barclaycard (please tick) no. is_____

Please state the make of your computer:_____

Name:_____

Address:_____

Telephone:_____

Opus.
Opus Supplies Ltd.

(AC11)

AUTO-RUN A PROGRAM AT ANY ADDRESS

SEVERAL suggestions have been made for making Basic programs respond to the *RUN or *<filename> command. The most notable came from A Oliver in the October issue, and from Ben Clarke, who offered a complicated method of protection in the January issue. I have followed up Mr Oliver's suggestion, and I think removed many of its shortcomings.

His method consisted of embedding a piece of machine code in a REM, at the start of the program, which placed the characters RUN<CR> in the input buffer. This was operated by *SAVEing the resulting program with the execution address at &1906, the start of the REM code.

There are a number of drawbacks to this procedure. First, an unsightly and meaningless REM appears, with flashing characters (these result from the use of character 138 in the *FX138 call). Second, renumbering can upset the program. Third, it is restricted to auto-running at address &1900.

For the best use of the auto-run facility it should be possible to cause the program to run at any address, including those below the default setting of PAGE. This is particularly important, for instance, in my tape-to-disc copying program (March issue), which must run at &1100, and it is tedious to have to type PAGE=&1100 before every use and wasteful to have to have a separate loading program. It is also desirable to be able to auto-run 'loading' programs (which load and shift machine code or long Basic programs) at high addresses.

The machine-code add-on that accomplishes this will be more complicated and longer, so it is tacked on invisibly to the end of the Basic program.

Listing 1 works as follows. First the procedure PROCfiling_system uses OSARGS to determine the current filing system. If the tape filing system is in use, then OSARGS returns 1 or 2 in the accumulator, and this is extracted by ?user. If the disc filing system is operative then ?user is 4. (The other filing system numbers are detailed, along with the other OSARGS information, on page 454 of the *User Guide*.) The program is aborted if a system other than tape or disc is in operation.

The user is now asked what value of PAGE is required. The filing system determines the lowest usable value of PAGE. Impossibly low values are forbidden, but if you choose too high a value, hard luck!

Next the filename is obtained, and the required file is *LOADed into memory at the previously determined address. OSFILE is used to do this, as it leaves in the information block the length of the file. This

value, when added to the value of PAGE, will give us the value of TOP for the Basic program. It is at this address that our extra code will be placed.

The characters for

```
PAGE=&<page><CR>OLD
<CR>RUN<CR>
```

are poked in at TOP. PROCassemble now adds, immediately above this, the code which will cause these characters to be inserted into the input buffer. This bit of code is rather complex, as both index registers are required in the OSBYTE call with A=138 and so cannot be used for counting. The OLD is necessary when PAGE is set below the default value. I found the appearance of the 'No room' message irritating. It made me feel like Alice at the Mad Hatter's tea party, saying: 'Don't be silly, there's plenty of room!'

The resulting program is *SAVED, again via OSFILE. The load address is the previous value of PAGE. The length is the original length plus &50 for the extra code. The execution address is the address of the 'start' of the code.

Finally, if successful, a little message is issued and you are returned to Basic. This is done by using *BASIC rather than END. The effect is to restore PAGE to its default value, among other things.

To use the program it needs to be loaded in at a high address, to prevent its being wiped out when the Basic program is

Chaired this month by George Hill, Beeb Forum is a platform for ideas, tips and applications relating to the BBC micro and Electron. It is intended to enable the more experienced programmers to share their thoughts – which should either be original or based on earlier Forum correspondence. The idea should be described clearly and fully, and listings supplied where necessary. Acorn User will pay £5 for each tip published, or more for something special. We are looking for originality and skill in implementing a routine. Your contribution should be typed or printed, with any substantial listings on cassette – but only included to make your point. Write to: Beeb Forum, Acorn User, 68 Long Acree, London WC2E 9JH.

*LOADed. This could be done by typing

```
PAGE=&7000<CR>
CHAIN"STARRUN"<CR>
```

But this is precisely what the program was designed to avoid. So as an example of how to use it, let's use it on itself.

Listing 1. Auto-run add-on for a Basic program

```
10 REM TO AUTO-RUN A BASIC PROGRAM
20 REM G.B.HILL NOVEMBER 1983
30
40 MODE7
50 PRINT"" STARRUN""
   G.B.Hill (c) 1983""
60 PROCsetup
70 PROCfiling_system
80 IF NOT (tape OR disc) THEN CLS:PRINT
  "Unrecognised filing system":VDU7:GOT
  0 240
90 INPUT"Type in the hex address for
PAGE "P#
100 IF LEFT$(P#,1)<>"%" THEN P#="%" + P#
110 page=EVAL(P#)
120 IF tape AND page<&800 THEN PRINT""
  Too low. PAGE must be > &800"":VDU7:GOT
  0 90
130 IF disc AND page<&1100 THEN PRINT""
  "PAGE must be greater than &1100 or ""
  the DFS does not work."":VDU7:GOT090
140 INPUT"Type in filename of the BAS
IC program "filename#
150 IF disc AND MID$(filename#,2,1)<>"
  " THEN filename#="." + filename#
160 IF disc THEN n=9 ELSE n=10
170 filename#=LEFT$(filename#,n)
180 PROCload_file(filename#)
190 top=page+block*10
200 PROCassemble
210 PROCsave_file(filename#)
220 CLS
230 PRINT"Program "filename#:" will
  now auto-run""at address "page
240 PRINT"RETURNED TO "
250 *BASIC
260
270 DEFFPROCsetup
280 osfile=&FFDD
290 osargs=&FFDA
300 DIM block 17
310 DIM user 9
320 DIM user 3
330 block?0=name MOD 256
340 block?1=name DIV 256
350 ENDFPROC
360
370 DEFFPROCload_file(F#)
380 X%=block MOD 256
390 Y%=block DIV 256
400 $name=F#+CHR#13
410 FOR I=2 TO 17
420 block?I=0
430 NEXT
440 block?2=page
450 AX=&FF
460 CALLOsfile
470 ENDFPROC
480
490 DEFFPROCsave_file(F#)
500 $name=F#+CHR#13
```

page 55▶

Microware presents the latest news on BBC.

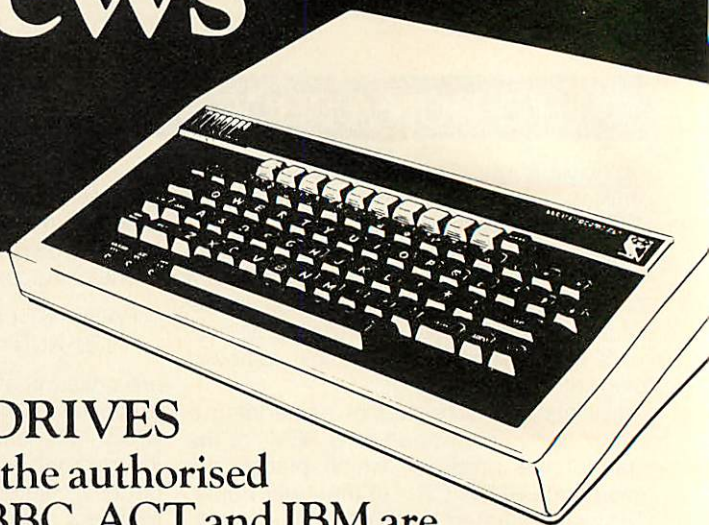

N.B. 40/80 Format Switch – call for information

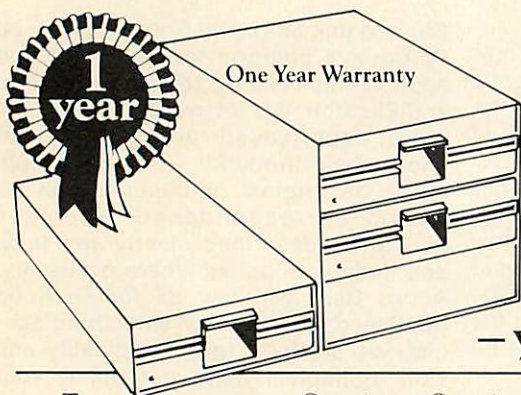

ZL DISK DRIVES

Microware, the authorised dealers for BBC, ACT and IBM are still making news. The new ZL range of disk drive subsystems is the best available – yet compare the prices. The new Double Density

Disk Controller is another first from this company, which continues to write the headlines. Phone today for details.

Type	Dual unit	Capacity Acorn DFS	Capacity with DDFS	Power Supply	No. of Files Acorn DFS	Price
ZL 241 BH		200K	400K		62	£199.00
ZL 242 BH	✓	400K	800K		124	£375.00
ZL 241 H	Expandable	200K	400K	✓	62	£229.00
ZL 242 H	✓	400K	800K	✓	124	£395.00
*ZL 281 BH		400K	800K		62	£250.00
*ZL 282 BH	✓	800K	1.6Mb		124	£445.00
*ZL 281 H	Expandable	400K	800K	✓	62	£290.00
*ZL 282 H	✓	800K	1.6Mb	✓	124	£490.00

All prices quoted exclude VAT. All cables included in price

*40/80 Format switch and Manual available



PRINTERS

Epson FX 80	£375.00	Star 80	£257.25
Epson RX80	£275.00	Star 100	£313.95
Epson RXFT	£320.00	Shinwa CP80	£257.25
Epson FX100	£425.00	Juki 6100	£399.00

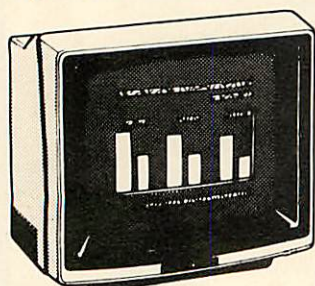
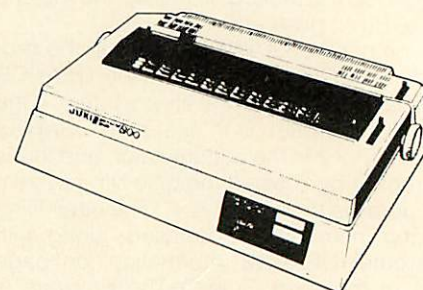

MONITORS

12" Green Screen

Sanyo	£99.00
BMC	£99.00
Amdex	£135.00

14" Colour

Microvitec	£257.00
Luxor	£450.00

High Resolution

Microware

Showroom: 637 Holloway Rd London N.19
Telephone 01-272 6398/6237. Telex 297598

Double density controller available now

● First type in the program, and save it under the name "STARRUN". If you are using discs, then save a backup copy under the name B.STARRUN or similar to avoid disastrous loss if you have made a typing error.

● Now CHAIN it (at the default setting of PAGE).

● Respond to the prompt for PAGE with 7000 (or &7000 – either will do).

● Respond to the prompt for filename with STARRUN.

● Hey presto! It's done.

To use the resulting program from disc, simply type

```
*STARRUN<CR>
```

and respond to the prompts. From tape, use the new version of the program and type

```
*RUN<CR>
```

and again respond to the prompts.

▶ from page 53

```

510 block!2=page
520 block!6=top+19
530 block!10=page
540 block!14=top+&50
550 A%=0
560 CALLOsfile
570 ENDFPROC
580
590 DEFFPROC filing_system
600 X%=%80
610 Y%=0
620 A%=0
630 !user=USPosargs
640 tape=(?user=1 OR ?user=2)
650 disc=(?user=4)
660 ENDFPROC
670
680 DEFFPROC assemble
690 $top="PAGE="+F$+CHR#13+"OLD"+CHR#1
3+"RUN"+CHR#13
700 zerop=%80
710 limit=%83
720 counter=%84
730 FOR opt=0 TO 2 STEP 2
740 P%=top+19
750 LOFT opt
760 .start
770
780
790
800
810
820
830
840 .loop
\to put chars in input buffer
850
860
870
\ready for osbyte
880
890
900
910
920
930
940 .end
950 J
960 NEXT
970 ENDFPROC
lda #top MOD 256
sta zerop
lda #top DIV 256
sta zerop+1
lda #19
sta limit
lda #0
sta counter
ldv counter
\to put chars in input buffer
lda (zerop),Y
tav
lda #138
ldx #0
jsr &FFF4
\osbyte to insert into keyboard buffer
inc counter
lda counter
cmp limit
bne loop
rts

```

£5 ROUTINE RESCUE

by Jamie Stephenson

THE purpose of this RECOVER routine (listing 2) is to recover Basic programs after a 'Bad Program' message has been returned. It must have happened to all BBC programmers at times, resulting in the frustrating and time-consuming job of re-keying or even reinventing your program.

RECOVER has been made deliberately short – less than one page – so that it can be loaded without overwriting the original program. All the user has to do is type in:

```
PAGE=&D00
CHAIN"RECOVER"
```

Once loaded, the program prompts for the start address of the 'Bad Program', this can be keyed in hex (eg, &E00). The routine then reads the Basic lines of the program, attempting to bridge the faulty lines so that the Basic interpreter can once again read the program. This is achieved by checking that a RETURN character is to be found at the start of each line of Basic. If it does not exist, a search is made for the next RETURN character and the line-length adjusted accordingly. The routine stops when either the end of the program is reached or when a RETURN character cannot be found. In the latter case an end-of-program marker is inserted. Finally, the variable PAGE is updated.

Though any corruption of the program cannot be undone, the program can be listed, preferably in mode 7, in case any control codes have been introduced. Corrections can then be made to restore the program to its former glory. Note that the routine uses PAGE &D00 and so is only suitable for cassette machines.

```

10 REM PARAMETERS :
20 REM     A#     PAGE value
30 REM     A%     Pointer to current line
40 REM     ?A%   13 if line found
50 REM     A%?1  line number high byte
60 REM     A%?2  line number low byte
70 REM     A%?3  line length
80 REM     B%     Pointer to next line
90 REM Input PAGE value in hex
100 INPUT A#
110 A% = EVAL(A#)
120 REM Start of Program = 13
130 ?A% = 13
140 VDU14
150 PRINT "PAGE = &"; A%
160 REM End of program found?
170 IF A%?1 > 127 PRINT "End OK" : GOTO420
180 REM Print line number & hex address
190 PRINT A%?1 * 256 + A%?2, "A%"
200 REM Is line length invalid?
210 IF A%?3 < 4 GOTO 280
220 REM Move pointer to start of new line
230 REM and check line present
240 B% = A% + A%?3
250 IF ?B% = 13 THEN A% = B% : GOTO 170
260 REM No line at expected position so
270 REM search for the start of a line
280 PRINT "No line"
290 B% = A% + 4
300 REPEAT B% = B% + 1
310 UNTIL (B% - A% = 255) OR (?B% = 13)
320 REM Line found so update previous
330 REM line length to bridge gap
340 IF ?B% = 13 THEN A%?3 = B% - A% : GOTO 170
350 REM No line found within maximum
360 REM permitted line length so there
370 REM is no alternative but to insert
380 REM an end of program marker
390 A%?1 = 255
400 REM Reset PAGE to LIST/SAVE the
410 REM recovered program
420 PAGE = EVAL(A#)

```

Listing 2. RECOVER routine by Jamie Stephenson

DOT MATRIX PRINTERS



ALL PRINTERS HAVE CENTRONIC PARALLEL INTERFACE UNLESS OTHERWISE STATED. ALL PRINTERS HAVE HI-RES. DOT ADDRESSABLE GRAPHIC MODE. PLEASE SEND SAE FOR FULL DETAILS.

EPSON
FX 80 160 CPS, 10" wide fric. & pin feed £344 + VAT £395
FX 100 160 CPS, 15" wide fric. & tract feed £431 + VAT £495
RX80FT 100 CPS, 10" wide fric. & tract feed £261 + VAT £299
RX80T 100 CPS, 10" wide tractor feed £234 + VAT £269
LQ1500 200 CPS Letter quality printer £29 + VAT £33
8143 RS 23 Interface for FX and RX printers £60 + VAT £69
B148 RS232 Interface with 2K buffer, xon/xoff £7 + VAT £7
Ribbon Cartridge for FX80, FX80 & MX80 £12 + VAT £13
Ribbon Cartridge for FX100 & MX100

STAR
Gemini 10X 120 CPS, 10" wide fric. & tract feed £200 + VAT £229
Gemini 15X 120 CPS, 15" wide fric. & tract feed £295 + VAT £339
Delta 10 160 CPS, 10" wide fric. & tract feed £327 + VAT £375
Delta 15 160 CPS, 15" wide fric. & tract feed £414 + VAT £475
Radix-10 200 CPS, N.L.Q. 16K Buffer Par & serial interface, downloadable characters, incredible value at £431 + VAT £495
Radix-15 15" wide version of Radix-10 £518 + VAT £595

SEIKOSHA
GP100A 50 CPS, 10" wide tractor feed £156 + VAT £179
GP250X 50 CPS, 10" wide tractor feed, ser. & par. £196 + VAT £225
GP100VC 30CPS, 10" wide, VIC 20 & 64 inter £174 + VAT £199
GP500A 50 CPS, 10" wide tractor feed £187 + VAT £215
GP550A 50 CPS, 10" wide friction & tract. correspondence quality £234 + VAT £269
GP100AS: Serial interface, ideal for Spectrum with microdrive £174 + VAT £199

SHINWA
CP80 80 CPS, 10" wide friction & tract feed £187 + VAT £215
Spare ribbon cartridge for CP80 £6 + VAT £6

RITEMAN
Compact 120 CPS, 80 col fric. & tract feed £200 + VAT £229

CANON
PW1080A 160 CPS, 10" wide, 27 CPS N.L.O. 24 x 16 matrix £283 + VAT £325
PW156A 160 CPS, 15" wide, 27 CPS N.L.O. 24 x 16 matrix £347 + VAT £399

COLOUR PRINTERS
Seikosha GP700A 7 colour, 50 CPS printer £347 + VAT £399
Canon PJ1060A 7 colour, 40 CPS ink jet printer £391 + VAT £449
CPP40 40 column 4 colour battery operated £118 + VAT £135

ALL OUR PRINTERS HAVE 1 YEAR WARRANTY

BBC MICROCOMPUTER SYSTEM

WE ARE AN OFFICIAL BBC COMPUTER DISTRIBUTOR
DEALER ENQUIRIES ARE WELCOMED

Acorn Electron £199^{INC} VAT
WE SUPPLY FREE 30 HOUR BASIC BOOK AND A DUST COVER WITH EACH COMPUTER

This is the best microcomputer currently on the market. 32K RAM, 32K ROM, 8 modes of operation, full colour, full-size keyboard, internal expansions such as disc interface, speech synthesizer, Econet interface - in short it is a personal computer capable of expanding into a small business system.

BBC Microcomputer Model B	£348 + VAT	£399
BBC Mod B - disk interface	£409 + VAT	£469
BBC Mod B - Econet interface	£389 + VAT	£447
BBC Mod B - disk and Econet interfaces	£450 + VAT	£517
BBC 100K disk drive	£26 + VAT	£29
BBC dual 800K disk drive	£699 + VAT	£803
Torch 280 disk pack including 280 2nd processor, 64K RAM and CPU operating system - Free Perfect Software	£696 + VAT	£799
BBC Teletext receiver (Aug)	£196 + VAT	£225
BBC cassette recorder and lead	£26 + VAT	£29
Disk interface kit (free fitting)	£84 + VAT	£96
Mod A to Mod B upgrade kit	£70 + VAT	£80
Fitting charge for A to B upgrade kit	£20 + VAT	£23
16K memory upgrade kit	£30 + VAT	£34
Games paddles	£11 + VAT	£12
12" Monochrome monitor incl. cable	£89 + VAT	£102
14" Colour monitor incl. cable	£199 + VAT	£222
User guide	£10 + VAT	£10
Econet interface (free fitting)	£60 + VAT	£69
Speech interface (free fitting)	£47 + VAT	£54
BBC disk manual - formatting disk	£30 + VAT	£34
Parallel printer cable	£10 + VAT	£11
BBC word processor (view)	£52 + VAT	£59
BBC Fourth language cassette	£15 + VAT	£17
BBC Lisp language cassette	£15 + VAT	£17

APPROVED ECONET SERVICE CENTRE
WE STOCK A LARGE RANGE OF SOFTWARE FOR BBC MICRO INCLUDING ACORN/SOFT BBC SOFTWARE LONGMANS SOFTWARE PLEASE SEND LARGE STAMPED ADDRESSED ENVELOPE FOR FULL DETAILS.

TORCH Z80 2nd PROCESSOR For only £347 + VAT

Torch 2nd Processor Z80 is supplied with perfect writer (a powerful Word Processor), perfect speller (spelling checking program - I should have used one for making this advert!), Perfect Filer (A Database Program), Perfect Calc (Spread Sheet). It includes 64K memory (Almost 60K available to user). Fits inside BBC Computer.

Z80 2nd Process - Perfect Software	£347 + VAT	£399
Z80 Processor - Perfect Software - Dual 800K Disk Drives	£695 + VAT	£799

GUARANTEED LOWEST PRICES

100% BBC COMPATIBLE MITSUBISHI AND TEAC SLIMLINE DISK DRIVES

NEW LOWER PRICES!



These drives are supplied ready cased with all the necessary cables, formatting program and User Guide.
There are some very useful utilities included on formatting disc e.g.
• DISASSEMBLER: This is 6502 machine code disassembler.
• DUP: To copy and rename a file on disc.
• FORMAT: Formatting program for 40 & 80 tracks.
• FREE: This utility provides a disk usage analysis.
• MDUMP: Enables you to display and modify any part of BBC memory.
• MERGE: Merge a number of text files into one file.
• RELOCATE: Downloads a basic program to &E00.
• SDUMP: Screen dump for EPSON in all graphic modes.
• VERIFY: Verifies every sector on a disk.
• MENU: A flexible menu program.

Single drive 100K 40 trks, single Sided	£147 + VAT	£169
Dual drive 200K 40 trks, single sided	£286 + VAT	£329
Single drive 200K, 40 trks, double sided	£173 + VAT	£199
Dual drive 400K, 40 trks, double sided	£330 + VAT	£379
Single drive 400K 80 trks, double sided	£199 + VAT	£229
Single drive 400K 40/80 trks, switchable DS	£217 + VAT	£249
Dual drive 800K 80 trks, double sided	£382 + VAT	£439
Dual drive 800K 40/80 trks, switchable DS	£408 + VAT	£469

All above drives are low power slimline. (0.3 A typ. at +12v and 0.4 A at +5v per drive). Normally extra power supply is not required, the BBC Computer power supply is designed to drive two low power drive (IT IS NOT DESIGNED TO DRIVE INTERNAL ROM BOARD).
40 Track SS/DD diskettes (10 Box) £18 + VAT £20
40 Track DS/DD diskettes (10 Box) £23 + VAT £26
80 Track SS/DD diskettes (10 Box) £28 + VAT £32
80 Track DS/DD diskettes (10 Box) £30 + VAT £34
ALL ABOVE DISKETT ARE CERTIFIED EITHER MEMOREX OR DETALIFE

YOUR CONTACTS AT AKHTER ARE

DEALER/BULK ENQUIRIES	HAMAYUN MUGHAL
TELEPHONE ORDERS	PAULA HAYES
DEALER ORDERS	TONY GLOVER
BUSINESS SYSTEMS ENQUIRIES	DENNIS SUTCH
EXPORT ENQUIRIES	MAHAMAD EDIB
ECONET SYSTEM TECHNICAL ENQUIRIES	ALAN LAFOLLEY
ACCOUNTS	CARON ANDREWS
DESPATCH	PAUL SWIFT
REPAIRS	JOHN MAULE

BUSINESS SYSTEMS



APRICOT - SIRIUS - SANYO IBM - TEXAS - TORCH

APRICOT "Portable Executive Computer" 16 Bit Micro, 256K RAM, up to 1.44 megabytes floppy disk storage, 3 1/2" Sony disks. Portable brief case styling. Modem with auto dialler (optional) hard disk optional. Vast software library (compatible with Sirius I).
Apricot with Single Drive and Monitor £1690 + VAT
Apricot with Double Drive and Monitor and Free Printer or 2nd Monitor £1890 + VAT

SANYO PROFESSIONAL COMPUTER
16 Bit Micro 128K RAM expandable to 256K. Single or Double Disk Drive built in full colour graphics (640 x 200 pixels in 8 colours) IBM compatible. Free software. Sanyo MBC 550 128K RAM single drive and free software including Wordstar and Calcstar. £699 + VAT
Sanyo MBC555 128K double drive and free software including Wordstar, Calcstar, Intorstar Datasstar etc. £899 + VAT

SIRIUS 1 Sirius 1 Computer with 128K RAM and 1.2 megabyte Floppy disk storage including CP/M 86, MS DOS and Microsoft Basic £2195 + VAT

Sirius 1 Computer with 256K RAM and 2.4 megabyte Floppy disk storage including C/M 86 MS DOS & Microsoft Basic £2895 + VAT

TORCH
CF500 COMPUTER with colour monitor includes Twin 400K disks, Torchnet Operating System free perfect software (perfect writer, perfect speller, perfect calc, perfect filer), Torchmail Plus (Electronic Mail), Torch Mars (Financial modelling with graphics), Torchtel (Viewdata Access System) Executive Aid (Menu System), Datael 600 (Link to outside mainframe services i.e. Telecom Gold) £2950 + VAT

TEXAS INSTRUMENTS PROFESSIONAL COMPUTER
TI 502 Dual 320KB Drives 256K RAM. Up to 10 megabyte on board storage possible. TI speech command hardware option brings a new level of user friendliness to computing. Allows voice operated keyboard control (Optional). Price £2650 + VAT

MAINTENANCE CONTRACTS ARE AVAILABLE.

DAISYWHEEL PRINTERS

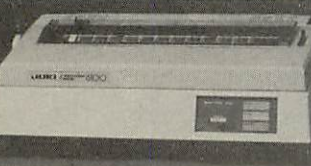

JUKEI 6100
20 CPS Bi-Directional Logic Seeking 10.12.15 CP1 + PS £349 + VAT £395
Spacing, 2K buffer, bus selling Daisywheel £217 + VAT £249
Singer sheet feeder unit £95 + VAT £109
Tractor Unit £52 + VAT £59
RS 232 Interface £17 + VAT £19
Spare Daisywheel

BROTHER HR-15
15 CPS Bi-directional, 10.12.15 CP1 + PS £344 + VAT £395
Keyboard Unit £139 + VAT £159
Single Sheet Feeder Unit £217 + VAT £249
Tractor Unit £95 + VAT £109

DAISY STEP 2000
20 CPS Unidirectional, 10.12.15 CP1 £260 + VAT £299

SMITH CORONA TP1
12 CPS 10.12. CP1 unidirectional £208 + VAT £239

PROFESSIONAL MONITORS



*SANYO
*MICROVITEC
*FIDELITY
*PHOENIX

SANYO DM8112 12" Green screen 18 MHz Hi-Res	£86 + VAT	£99
DM2112 12" Green screen 15 MHz Monitor	£66 + VAT	£75
CD3125 14" RGB Normal Res. Colour Monitor	£173 + VAT	£199
CD3117 14" RGB Medium Res. Colour Monitor	£286 + VAT	£329
CD3115 14" RGB High Res. Colour Monitor	£391 + VAT	£449

MICROVITEC CUB
1431 MS 14" RGB Normal Res. Colour Monitor £173 + VAT £199
1451 MS 14" RGB Medium Res. Colour Monitor £321 + VAT £369
1441 MS 14" RGB High Res. Colour Monitor £417 + VAT £479

FIDELITY Colour Monitor
CM14 14" RGB RGBY Composite sound col £187 + VAT £215

PHOENIX
Phoenix High Res 12" Green Monitor £66 + VAT £75
Phoenix High Res 12" Amber Monitor £69 + VAT £79

AKHTER INSTRUMENTS LTD. T/A



COMPUTER GROUP

28/29 BURNT MILL
HARLOW, ESSEX. CM20 2HU U.K.
Tel. HARLOW (0279) 443521 Telex: 818894 AKHTER G

ORDERING INFORMATION:

We accept official orders from UK Government and Education establishments. Carriage is Free (UK only) for normal delivery. If express delivery is required please add £30.00 + VAT per parcel. We accept telephone orders on Barclay and Access Card please ring (0279) 443521 (10 lines). All cheques made payable to "AKHTER INSTRUMENTS"

N.B. ALL VAT INCLUDED PRICES ARE THE CORRECT PRICES. EXCL. VAT PRICES HAVE BEEN ROUNDED UP TO NEAREST POUND.

OPENING HOURS: MON-FRI 9am-6.30pm, SAT 10am-5pm
We welcome callers, no parking problems.



£5 TELETypING

by David Stonebanks

A TELETYPE should print correctly with carriage return followed by line feed. The carriage return movement will be completed before the next printing character is received unless the Teletype is faulty.

I have been using Teletype with my BBC micro for over a year without difficulty using the circuit in the diagram below.

This produces an output pulse of about 4 milliseconds at 9Hz, allowing the Beeb to send characters at this rate. I found that this pulse had to be less than half a bit time, otherwise the Beeb issued two characters. Modify baud rate as Beebug fix - change over link S28, select serial printer *FX5,2, transmit data rate 75 baud *FX8,1 (=110 baud with fix), width 60.

I have since read in *Acorn User*, September 1983 (page 57) that *FX156,16,227 should provide two stop bits so that my circuit (and the software in your present article) should not be necessary, but I haven't tried this.

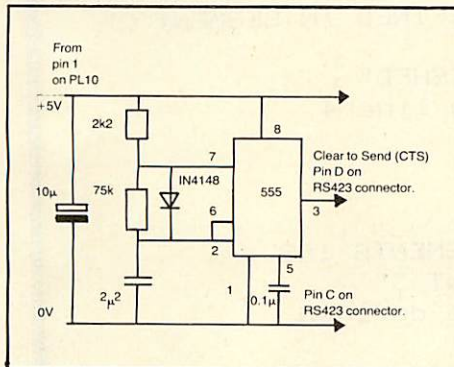

SAVING TEXT FOR VIEW by Susan Jones

£5

SCHOOLS and other educational establishments may have several BBC machines but only one copy of View. Listing 3 allows any BBC machine to create a text file which can later be read by View for editing, formatting and printing. The program works for both tape and disc and makes use of the maximum available memory.

Lines are entered one at a time, the return key being pressed after each one. The delete and copy keys can be used for the current line, but text already entered cannot be changed except by View.

The version of the program given here uses mode 3 so that 80 characters can be shown across the screen, but the mode

statement may be changed to make more memory available. Input lines cannot be longer than 255 characters and the program will end text input automatically when there are fewer than 255 bytes of free memory left. To end text input normally, press return immediately after the '?' symbol (blank lines must contain at least one space).

The program will report how many lines in the text, then request the name of a file in which the whole text is to be saved. The default filename is TEXT.

To read this file in View, just go into command mode and type LOAD "filename" in the usual way.

```

10 REM Program to create VIEW-compatible files
20 MODE3:N%=HIMEM-LOMEM-24:*FX11,0
30 DIM B% N%:P%=B%:L%=0:Q%=5:C%=&C00
40 PRINT "Enter your text line by line"
50 REPEAT:V%=VPOS:L%=L%+1
60 PRINT TAB(0,0);N%; " bytes remaining";SPC59
70 PRINT TAB(0,V%);:INPUT LINE $P%
80 N%=N%-LEN($P%)+1:P%=$P%+LEN($P%)+1
90 UNTIL P%?(-2)=&D OR N%<255
100 PRINT L%; " Lines of text entered"
110 PRINT "Name of text file to be written";
120 INPUT $C%:IF $C%="" THEN $C%="TEXT" ELSE $C%=LEFT$( $C%,6)
130 $C%="SAVE "+$C%+" "+STR$^B%+" "+STR$^P%
140 PRINT $C%:X%=0:Y%=&C:CALL &FFF7
150 MODE7:*FX12,0
160 END

```

Listing 3. Creates a View-readable text file.

£5 HIDDEN PROGRAMS by James Tyler

I THOUGHT you might be interested in the following techniques that I have come up with regarding the security of programs stored on disc. Both involve inserting 'invisible' control characters into the filename when saving programs on disc.

The first technique utilises the DELETE code CHR\$127. If you have a program stored in the Beeb which you wish to save, here's an example of what you would do. Enter:

```
SAVE "PRO"+CHR$127+"G"
```

If you now enter *CAT, the program will appear to have been stored on the disc under the filename "PRG". This is, of course, due to the fact that the letter 'O' has been deleted from the display by CHR\$127.

The program may now only be loaded using:

```
LOAD "PRO"+CHR$127+"G"
```

Attempts to use any other filename will

result in a 'file not found' message.

Several DELETE codes could be inserted in different parts of a filename to increase the program's security.

The other technique is similar and involves putting teletext colour codes at the end of a filename, for example:

```
SAVE "NAME"+CHR$129
```

As before, the control code (red in this case) will not be displayed when the disc is *CATalogued but it is still required when the program is to be loaded:

```
LOAD "NAME"+CHR$129
```

Also, since colour control codes may be obtained directly by pressing function keys, it may be more convenient to load the last program using

```
LOAD "NAME[f2]"
```

By adding different combinations of colour codes onto the end of filenames, the security of programs may again be increased.

BASIC BUG

£5

by R B Pinsker

I HAVE discovered a bug in the BBC Basic assembler, present in both versions of the language. For example:

```
ROL ADDR is interpreted as ROL A
LSR AP2 is interpreted as LSR A
```

and, in fact, if any symbol beginning with 'A' is placed after ASL, LSR, ROL or ROR it will be interpreted as accumulator addressing mode.

This can be overcome by placing the symbol in brackets:

```
ROL (ADDR)
```

The assembler does not attempt to interpret this as some form of indirect addressing.

I THINK this might be described as a peculiarity of the assembler rather than a bug, but thanks for pointing it out - Ed

£5 VERIFY A FILE

by Richard Bhanap

IN RESPONSE to your recent request in *Acorn User* for a verifier program, I offer this VERIFY key definition (listing 4) guaranteed to verify a cassette/disc file on a Beeb model A/B with OS 0.1/1.2 and Basic III - ie, on any Beeb.

It can verify a file of any length on backing store with one in memory and only takes as long as it takes to save the same program. I find it particularly useful when using the cassette filing system, since this is more prone to mishap than disc.

I hope readers will find my VERIFY as useful as I have. To use it, simply press f0.

```
10 *KEY0 CLS:INPUT '
"Filename";F#:PRINT "S
earching";Z=OPENIN(F#)
:FOR J%=PAGE TO TOP-1:
A%=BGET#Z:IF ?J%<>A% T
HEN PRINT "ERROR":CLO
SE #Z:STOP:ELSE NEXT J
%:PRINT "OK":CLOSE#Z:IM
```

Listing 4. VERIFY key definition

£5 SPACE PROBLEM

by J T Hindle

HANDLING two-dimensional arrays does not sound too difficult (if you know the maths). I was dealing with two integer arrays X and Y which pointed to the third value Z, to which the obvious solution was to use an array Z(X,Y). However, the values of X and Y ranged from 1 to 47 so that a 2129 element array would be needed, occupying nearly 9000 bytes of memory. Since Z ranged from 1 to 71 there had to be a better way!

The solution was to turn X and Y into ASCII codes from A to o by adding 64. The corresponding characters can then be put into a string in the appropriate combinations and sequence and located using INSTR. For example:

Z	X	Y	X#	Y#
1	1	1	A	A
2	2	7	B	G
3	12	8	L	H

The string Z# is then "***AA*BG*LH*" The asterisks are to correct the start of the string and to separate data pairs so that the first two pairs in the example cannot be interpreted as AB.

The value of Z can now be obtained from (INSTR(Z#,K#))/3 where K# is X# + Y# + "***. For the original problem Z# occupies only 239 bytes - a useful saving! If necessary, more than one string may be used for Z# and of course more than two initial variables may be used.

£5 SEQUENTIAL TAPES by P H Cowley

I WAS interested to read the article in November's *Acorn User* about disc file overlays. I must point out that the technique can be equally useful for tape users. Listings 5, 6 and 7 demonstrate how a number of programs may be run in sequence.

I have used the technique when carrying out number-crunching on large arrays.

Once the crude number bashing is complete the next segment of program is automatically loaded to plot the results using the data which is still in memory. An advantage of this method is that each segment needs only minimal alteration from a stand-alone program, allowing *debugging* to proceed on each segment individually.

Listing 5. Enter without spaces or extra lines unless the load address is to be changed.

```
1 REM SEGMENT 1
2LOMEM=HIMEM-&1000
4REPEAT
6*LOAD""0E21
```

Program 6.

```
10 REM SEGMENT 2
20 Will not run without SEGMENT 1
30 PRINT "RUNNING SEGMENT 2"
40 X=2
50 Y=3
60 Z=12.97
70 A#="X,Y AND Z WERE DEFINED IN SEGMENT 2"
80 integer%=1234
90 PRINT "SEGMENT 2 FINISHED"
100 REM Return control to line 4
110 REM of SEGMENT 1
120 UNTIL FALSE
```

Program 7.

```
10 REM SEGMENT 3
20 Will only run with SEGMENTS 1&2
30 PRINT "RUNNING SEGMENT 3"
40 REM A#,X,Y, and Z were defined
50 REM in SEGMENT 2
60 PRINT A#
70 PRINT "X=";X
80 PRINT "Y=";Y
90 A=(X+Y)/Z
100 PRINT "(X+Y)/Z=";A
110 PRINT "Integer=";integer%-233
120 PRINT "END OF SEGMENT 3"
130 REM Leave REPEAT loop started
140 REM at line 4 of SEGMENT 1
150 UNTIL TRUE
160 END
```

£5 PROCEDURE I D by B Cope

WHEN developing a structured program, do you have difficulty in locating a procedure so that you can improve it? Do you have even more difficulty after you have renumbered the program?

A neat solution is to identify the procedures and their line-numbers at the start of your program:

```
10 GOTO 200
20 PROCinit:GOTO 600
30 PROCintro: GOTO 900
```

```
40 PROCoption:GOTO 1510
etc
200 REM The program starts
etc
600 DEF PROCinit
etc
```

The purpose of the GOTO in line 10 is to avoid executing the following few lines. The other GOTOs are to ensure that the procedure line-numbers are automatically updated during any future renumbering.

SEE US
ON STAND
111



WORLD STANDARD MODEM

WS 2000
MODEM
£99.95
EXCL.
FOR A LIMITED
PERIOD ONLY



- *BBC connecting lead supplied. Other computers (25-way D etc) extra £7.00 - VAT
- *BT Modular line plug & socket
- *Full BT Spec. Isolation Components
- *Built-in 240VAC power supply
- *Plug-in board AA1 gives you Auto-Answer/Dial-up and number store from your computer (subject to software)
- *CL1 optional control lead for Computer software controlled MODE selection
- *Designed & manufactured in England by Minor Miracles - leaders in high technology at an affordable price.
- *Specify WS2000 for all uses: Timesharing, business links or home computing

- CCITT (UK-Euro) Standards
- *V21 300 Baud Full Duplex Originate & Answer
 - *V23 600 Baud Half Duplex
 - *V23 1200 Baud Half Duplex
 - *V23 1200/75 Baud Prestel etc. BELL (USA) Standards
 - *103 300 Baud Full Duplex Originate & Answer
 - *202 1200 Baud Half Duplex
 - *202 1200/75 Baud
 - *Link to Micronet/Prestel adaptors in "reverse" 75/1200 Mode
 - *RS232 port: DTR, RTS, CTS, DCD, TX Data, RX Data
 - *BBC Terminal listing supplied. Other computer software available, including Micronet and Computer Concepts DEC VT100 emulator on BBC!

PROFESSIONAL DATA COMMUNICATIONS AT AN AFFORDABLE PRICE



PO BOX 48
IPSWICH 3
IP4 2AB
(0473) 50304



WS 2000 MODEM £99.95 + £18.05 VAT/P&P = £118.00
AAI AUTO DIAL/ANS. BOARD £39.00 + £5.85 VAT = £44.85
CLI OPTIONAL CONTROL LEAD £9.50 + £1.42 VAT = £10.92
ORDER NOW OR PLEASE SEND S.A.E. FOR DETAILS

A Full One Year Warranty offered on all the products we sell.
Full Pre/Post Sales Support.

PRINTERLAND



EPSON RX80

- 100 CPS 9 x 9 matrix
- True descenders
- Bit image graphics
- 11 character sets
- 3 character styles
- 6 printing sizes
- Very reliable

RX80T £219.95
RX80F/T £239.95

• FREE Screen dump (Cassette)

STAR GEMINI 10X

- 120 CPS 9 x 9 matrix
- User defined characters
- Friction/Tractor and roll holder
- Macro Instructions
- 3 character styles
- 6 printing sizes
- Value for money

10X £218.95
15X £315.00

• FREE Hi-Res. Cassette

COPY ALL DISK

- Copies ALL protected disks inc. tape to disk utilities
- So good it even copies itself
- Simple to use
- Includes sector editor
- Reads individual sectors
- Re-writes sectors
- Verify & mend

COPY ALL £10.50

WORDWISE

"The" Word Processor £32.00
Printer Cable £10.99
BASF SS S/D Disks (Box 10) £13.95
Paper (2,000 shts.) £12.00 + £3.00 carriage

EPSON FX80

- 160 CPS 9 x 9 matrix
- Proportional spacing
- Downloadable characters
- 3K Ram buffer
- Extra forms handling
- User defined margins
- 3 character styles
- 6 printing sizes

FX80 £329.95
FX100 £434.00

• FREE Hi-Res. Cassette

DAISY WHEEL PRINTERS

BROTHER HR15

- 18 CPS • 3K buffer
- Proportional spacing
- 2 colour print

HR15 £369.00

DAISY STEP 2000

- 20 CPS • 10, 12, 15, CPI
- Proportional spacing
- Japanese reliability

DS2000 £267.00

MONITORS FIDELITY

CM14"

- RGB • RGBY
- Composite video
- Works with all micros & VCR's

CM14 £169.95

PHILIPS 12" Green Screen

- 80 column & graphics
- Fully BBC compatible

TP200 £74.95

ORDERING INFORMATION

- Orders received before 3pm - despatched same day
- Government, Educational orders welcome
- Credit Cards - just ring your order through

CARRIAGE printers/monitors (24 hour delivery) £7.00
Other - 50p (1st Post)
Please add 15% VAT

UNIT 27, ESTATE BUILDINGS, 2 RAILWAY STREET, HUDDERSFIELD HD1 1JP TEL. HUDDERSFIELD (0484) 514105

**BBC
32K**

**AS SEEN
ON TV**

FINANCIAL GAMES

'Three great games, enjoyed by thousands of BBC owners throughout the world'

Join them – don't delay order today.

GREAT BRITAIN LIMITED – £5.95

Ever thought you could run the country better?

Here is your chance!

As Prime Minister and Chancellor (of the party of your choice), you have to guide the country through its social and economic ills for 5 years, then put yourself up for re-election.

"Great Britain Ltd is easily as exciting and certainly more satisfying than any game of space invaders" – Micro User.

"A must for all budding politicians" – Computer Answers.

"Thoroughly enjoyable and worthwhile decision making activity and as such can be thoroughly recommended" – Educational Computing.

"Highly enjoyable" – Acorn User.

"A dream for Megalomaniacs" – Micro Update.

INHERITANCE – £5.95

Have you ever wondered what you'd do if you came into some money? Would you be able to invest it and watch it grow, or maybe start a small business and become a millionaire. With Inheritance you have the chance to find out.

"A great game, really two games for the price of one" – Micro User.

"Well presented and good value for money" – Personal Computer World.

WORLD TRAVEL GAME – £6.95

A game for 1 or 2 players. Rush around the world collecting souvenirs. Keep your head and try to avoid Hijacks, Strikes, Thieves, Cash shortages, Bankruptcies, Bad Weather etc.

"Exciting, competitive and even educational – not to be missed"

**ALL THREE GAMES NOW AVAILABLE IN A SPECIAL PRESENTATION
PACK – AN IDEAL GIFT**

£17.95 complete

Available from your local computer shop or by 24hr despatch from:-

SIMON W. HESSEL SOFTWARE
(Dept. a), 15 Lytham Court, Sunninghill, Berkshire.
Telephone: Ascot 25179

Please add 30p P&P on orders for single games – UNLIMITED GUARANTEE.

Dealers – Reserve your Christmas stocks NOW.

Schools and Education Authorities – special deals on multiple orders.

SELECT COPIER

**Pick your files
and copy them all
to another disc
in one operation –
with this program
by Robin Newman**

ONE of the shortcomings of the Acorn disc filing system is that although there is a selective delete command *DESTROY there is no comprehensive selective copy command. You can use *COPY with the wildcard characters '#' and '*', but in general this restricts you to copying all the files in a given directory or all the files which start with, say, the same letter. If you wish to copy a random selection of the files from one disc to another it is generally only possible to do this one file at a time using *COPY.

This utility enables you to select any combination of files from a disc catalogue and copy the combination in one operation. It will work with either a single or a dual drive, although in the former case you will of course, have to change over the source and destination discs when prompted.

In this version I have deliberately avoided using the EQU commands available with Basic II, although it makes the program slightly messier to read, so that those with Basic I can use it. Also, colour commands have been included explicitly for clarity – eg CHR\$130 – but you can simplify matters by using the shifted function key codes given on page 154 of the *User Guide* and incorporate them in the relevant print statements.

The program incorporates a machine code sort procedure for a string array taken from Ian Birnbaum's book *Assembly Language Programming for the BBC Micro-*

computer. Publication therefore should be only with his consent and with due acknowledgement. However, the program will still work if the sort procedure (lines 6000-7190) is removed, together with lines 190 & 200, although the catalogue will not then be displayed in alphabetical order while the selection is being made.

The program falls into five parts:

1. The source and destination drives are selected (lines 10-110).
2. The source catalogue is read into a buffer (PROCassemble_read_cat and then the filenames are decoded into a string array (PROCdecode_cat).
3. The filenames are sorted into alphabetical order (PROCassemble_sort_code and

line 200) and then displayed on the screen (PROCdisplay_cat).

4. The files to be copied are marked and a record kept in array C (PROCmark_cat) and then a list of the filenames to be copied is assembled at &1200 (PROCsetup_copy).

5. Finally, a short piece of machine code is assembled at &1400 (by PROCassemble_mccopy) which will pass the required copy commands one by one to the command line interpreter: ie, the actual copying is done using the standard disc *COPY command. This code is called in a rather odd manner. The command CALL&1400 is inserted in the keyboard buffer and then the program ends, whereupon the code is called. This is so that the code is called from immediate mode, because by the time the copying has finished the "SELCOPY" program will have been overwritten and it will not be possible for control to be returned to it. This somewhat messy transfer of control is masked by switching the screen off while the command CALL&1400 is processed (using VDU21) and switching it on again within the machine code (effectively using VDU6).

It is important that you save the program *before* trying it out as it is destroyed in the copying process.

In the listing, the '£' sign is the hash key (shifted 3) and the '[' (open square bracket) key is printed as a left-pointing arrow in mode 7, in which the program is run. ●

```

10 REM SELCOPY
20 REM Selective Copier (c) R.Newman
30 REM Oundle School Aug.1983 VER 1.4
40 REM Basic I version
50 MODE7:PRINTTAB(5,2)CHR$129"S e l e c t i v e   C o p i e r"
60 PRINTCHR$130"Source drive (0-3) ";
70 SD%=GET-48:IF SD%<0 OR SD%>3 THEN 70 ELSE PRINTSTR$(SD%);
80 PRINTCHR$130"Destination drive (0-3) ";
90 DD%=GET-48:IF DD%<0 OR DD%>3 THEN 90 ELSE PRINTSTR$(DD%);
100 PRINTCHR$130"Is this OK? (Y/N) ";
110 A$=GET$:IF A$="N" THEN RUN ELSE IF A$<>"Y" THEN 110
120 PRINTA$;
130IF SD%=DD% PRINT"Insert source disk in drive ";SD%'"& push"CHR$131"RETURN
";ELSE PRINT"Insert source and destination disks""& push"CHR$131"RETURN ";
140 REPEAT UNTIL GET=13:PRINT
150 PROCassemble_read_cat
160 CALLreadcat
170 IF blk?10<>0 THEN VDU7:CLS:PTAB(5,5)"Disk Read Error":STOP
180 PROCdecode_cat
190 PROCassemble_sort_code
200 CALLsort,E%,NAME$(0)
210 PROCdisplay_cat
220 PROCmark_cat
230 PROCsetup_copy
240 PROCassemble_mccopy
250 IF N%=0 THEN PRINTTAB(5,2)CHR$129"No Files Selected for Copying":END
260 PRINTTAB(5,2)CHR$129"Commencing Copying..."
270 REM insert CALL&1400 in keybd buffer
280 REM and exit program

```

continued on page 63 ▶

**Expansion
SALE**

WE NOW HAVE A 2,500sq. ft HOME COMPUTER SHOWROOM
& A 3,000sq. ft BUSINESS COMPUTER SHOWROOM MAKING
US THE LARGEST MICRO-COMPUTER DEALER IN THE UK.

TO CELEBRATE OUR MOVE WE HAVE THE
FOLLOWING SPECIAL OFFERS

OFFERS ONLY APPLY ON PRODUCTION
OF THIS ADVERTISEMENT

	Normal Price	NOW
Selected Acornsoft Games	£ 9.95	<u>£ 6.95</u>
Broadway 200K Dual	£391.00	<u>£351.90</u>
Cumana CD400S Dual Drives (1 only)	£573.85	<u>£516.46</u>
Torch Z80 Disc Packs	£839.50	<u>£776.54</u>
Microvitec Colour Monitors	£247.25	<u>£222.52</u>
Epson RX80F/T Dot Matrix Printer	£339.25	<u>£305.32</u>
Epson FX80F/T Dot Matrix Printer	£440.72	<u>£396.65</u>
Juki 6100 Daisy Wheel Printer	£458.85	<u>£412.96</u>
MCP40 Colour Plotter	£129.95	<u>£123.45</u>
BBC Printer Cable	£ 17.25	<u>£ 12.07</u>

All prices include VAT

10% OFF BASF FLOPPY DISCS
10% OFF C12/C15 CASSETTES

ARRIVING SHORTLY THE SENSATIONAL
NEW ELAN HOME COMPUTER

PLEASE NOTE WE NOW STOCK BOOKS &
SOFTWARE FOR THE SINCLAIR
SPECTRUM, VIC20, COMMODORE 64,
DRAGON 32 & 64

Windsor
Computer Centre

Quayside House Thameside
Windsor Berkshire SL4 1QN
Phone Windsor (07535) 58077



```

290 *FX15
300 *FX138,0,67
310 *FX138,0,65
320 *FX138,0,76
330 *FX138,0,76
340 *FX138,0,38
350 *FX138,0,49
360 *FX138,0,52
370 *FX138,0,48
380 *FX138,0,48
390 *FX138,0,13
400 VDU21:REM switch off screen to avoid untidy call command
410 END

1000 DEFPROCassemble_read_cat
1010 DIM BUF% &200,readcat &50,sort &D0
1020 osword=&FFF1
1030 FOR Z%=0 TO 3 STEP 2
1040 P%=readcat
1050 [OPTZ%
1060 LDA f&7F:LDXf blk MOD 256:LDY fblk DIV 256
1070 JMP osword
1080 .blk:]
1090 REM parameter block for read command
1100 ?P%=SD%:P%!=BUF%:P%?5=3:P%?6=&53:P%?7=0:P%?8=0:P%?9=&22:P%?10=0
1110 NEXT
1120 ENDPROC

2000 DEFPROCdecode_cat
2010 E%=(BUF%?&105)/8:REM number of cat.entries
2020 DIM NAME$(E%-1),C(E%-1)
2030 FOR Z%=0 TO E%-1
2040 FOR Y%=0 TO 6
2050 NAME$(Z%)=NAME$(Z%)+CHR$(BUF%?(Y%+8*(Z%+1)))
2060 NEXT
2070 REM Find Directory: allow for files in DIR 0
2080 REM used by the Author for certain protected files!
2090 D%=BUF%?(Y%+8*(Z%+1)):IF D%=0 THEN D%&=32 ELSE IF D%=&80 THEN D%=&80+32
2100 REM work out Locked entries
2110 IF D%<128 THEN NAME$(Z%)=CHR$(D%)+". "+NAME$(Z%):ELSE D%=D%
AND&7F:NAME$(Z%)=CHR$(D%)+". "+NAME$(Z%)+ " L"
2120 NEXT
2130 ENDPROC

3000 DEFPROCdisplay_cat
3010 CLS:PRINTTAB(5,1)CHR$129"File Selection"
3020 PRINTTAB(0,4);
3030 FOR Z%=0 TO E%-1STEP2
3040 PRINTTAB(1)NAME$(Z%)TAB(12)CHR$131" "CHR$135;:IF Z%<=E%-2 THEN
PRINTTAB(20);NAME$(Z%+1)TAB(31)CHR$131" "CHR$135
3050 NEXT
3060 PRINT
3070 ENDPROC

4000 DEFPROCmark_cat
4010 REM Cursor Off
4020 VDU23,1,0;0;0;0;
4030 PRINTTAB(0,21)CHR$130"Select file with"CHR$131"["CHR$130"using cursor
keys"CHR$131"SPACEBAR"CHR$130"marks file for
copying"CHR$130"Use"CHR$131"DELETE"CHR$130"for
corrections"CHR$131"@CHR$130"ends selection and initiates copying";
4040 REM enable cursor key codes
4050 *FX4,1
4060 REM adjust key repeat & delay rates
4070 *FX12,20
4080 *FX11,20
4090 X=13:Y=4
4100 PRINTTAB(X,Y) "["
4110 REM mark entries to be copied

```

continued on page 65 ►

GROW WITH THE BBC MICRO

Harrison Associates specialise in producing a wide range of quality information software packages geared to the specific requirements of businesses of all kinds and sizes.

Using proven accounting and planning software, the resources of big names in hardware and their own expertise and wide experience in systems development, Harrison Associates have developed a range of systems and software packages to meet individual requirements in accounting, office automation, records management and financial planning.

Their ability to meet the needs of businesses today with

answers that are built for the future is reflected in the wide range of information software, including the EASY accounting system, one of the fastest selling integrated accounting packages. And now EASY JUNIOR, enabling you to upgrade your Model B to a full professional, CP/M based business micro giving access to a wide range of business software.

To find out how their full range of accounting systems and financial planning software can benefit your Company, contact Harrison Associates today.

SOFTWARE

BBC ROM Software

WORDWISE	£35.00
DISC DOCTOR	£33.50
TERMI RS423 emulation	£33.50
GRAPHICS extension	£33.50
GREMLIN machine code de-bugger	£33.50

BBC Cassette Software

A wide range of Educational, Games and Small Business Software is available.

For example:

"TRANSISTORS REVENGE"	£7.95
"GORF"	£7.95
"SPRITE MASTER"	£9.95
"HEIST"	£7.95

ACORN - complete range

Call for complete list of available BBC cassette software.

CP/M Based Business Software

EASY Junior	£339.25
A complete accounting system including Sales Ledger, Invoicing, Purchase Ledger, Stock Control and Nominal Ledger. Available for TORCH Z80 Disc Pack.	

PAYROLL	£575.00
WORDSTAR Word Processing	£339.25
SPELLSTAR Spelling Checker	£172.50
MAILMERGE Maillist System	£166.75
CALCSTAR Spreadsheet	£207.00
DATASSTAR Database	£201.25
dBASE II Database System	£517.50
MARS Financial Planning	£454.25
BBC Basic (Z80)	£126.50
A full implementation of BBC Basic for the Z80 processor. The TORCH version includes graphics and sound.	

CIS COBOL	£488.75
LEVEL II COBOL	£1,109.75
FORMS 2	£126.50
PROLOG	£333.50
MS COBOL 80	£593.40
BCPL	£230.00

HARDWARE

BBC Microcomputer

BBC Model B	£399.00
BBC Model B + Disc Interface	£469.00
BBC Model B + Econet	£446.00
BBC Model B + D.Int + Econet	£516.00

BBC Accessories

Cassette Recorder	£29.95
Joysticks	£13.00
Disc Interface Kit	£95.00

BBC Monitors

Zenith 12" Monochrome	£95.00
Microvitec 14" Colour (std res)	£247.00
CABEL 14" Colour (std res)	£240.00
Monitor stand + power leads	£11.00
Monitor & TORCH ZDP stand	£25.00

Printers

Seikosha GP80	£189.00
Seikosha GP100	£215.00
EPSON RX80	£279.00
EPSON RX80 FT	£319.00

BBC Disc Upgrade Package

TORCH Z80 Disc Pack	£839.00
---------------------	---------

Includes Z80 second processor, twin 400kb floppy drives, CP/M compatible operating system and free PERFECT SOFTWARE (WordProcessor, Spelling Checker, Database and Spreadsheet).

Also available - TORCH Disc Pack with 20 Mb Winchester drive, with 68000 processor and UNIX.

Call for details.

inc VAT

TORCH Professional Microcomputers

TORCH Microcomputers include a CP/M compatible operating system, the MARS Financial Planning System, the PERFECT range of software, various Utilities and Prestel/Datel interface software.

TORCH CF500	£3,390
Z80 & BBC processors, twin 400kb floppy drives, high resolution colour monitor, speech processor, Econet interface and integral Prestel/Datel 600 modem.	

TORCH CH520	£6,490
Z80 & BBC processors, 400kb floppy and 20Mb Winchester drives, high resolution colour monitor, speech processor, Econet interface and integral Prestel/Datel 600 modem.	

Other machines available - call to discuss how we can meet your requirements with single user, networked or multi-user systems incorporating the latest techniques in hardware and software.

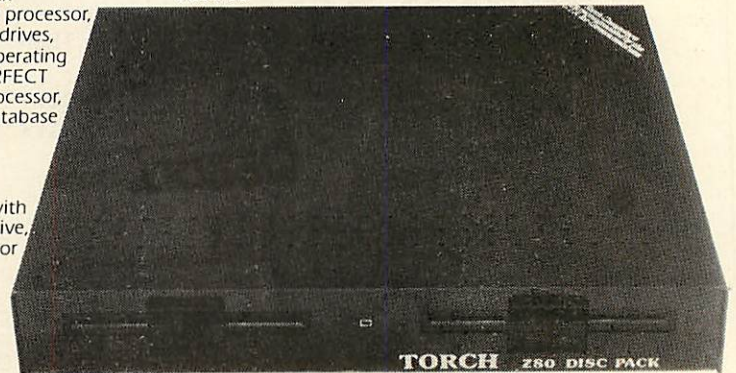

Note All prices are inclusive of VAT at 15%. Delivery will be charged at cost.

AND KEEP IT SIMPLE

My particular interest is _____

Name: _____

Position: _____

Company name: _____

Address: _____

Tel: _____

Harrison Associates
MEETING THE NEEDS OF TOMORROW TODAY

Unit 307, 16 Brune St, London E1 7NJ. Tel: 01-377 1630

► from page 63

```

4120 REPEAT
4130 Z=GET
4140 REM test for cursor keys and move if possible
4150 REM The complicated conditions ensure
4160 REM the [ can only be moved beside a file entry
4170 REM Cursor Down
4180 IF Z=138 AND NOT ((Y=3+(E%+1)DIV2-1)AND(X=32)AND(E%MOD2=1))AND
NOT(Y>2+(E%+1)DIV2) THEN PRINTTAB(X,Y) " ":Y=Y+1:PRINTTAB(X,Y)"["
4190 REM Cursor Up
4200 IF Z=139 AND Y>4 THEN PRINTTAB(X,Y) " ":Y=Y-1:PRINTTAB(X,Y)"["
4210 REM Cursor Right
4220 IF Z=137 AND NOT((Y=3+(E%+1)DIV2)AND E%MOD2=1) THEN PRINTTAB(X,Y) "
":X=32:PRINTTAB(X,Y)"["
4230 REM Cursor Left
4240 IF Z=136 THEN PRINTTAB(X,Y) " ":X=13:PRINTTAB(X,Y)"["
4250 REM test for Spacebar and mark file in array C
4260 IF Z=32 THEN PRINTTAB(X-13,Y)CHR#130:C(2*(Y-4)+1+(X=13))=1
4270 REM test for Delete and remove file marker from array C
4280 IF Z=127 THEN PRINTTAB(X-13,Y) " ":C(2*(Y-4)+1+(X=13))=0
4290 REM exit on @ being pushed
4300 UNTIL Z=64
4310 REM restore repeat & delay rates
4320 *FX12
4330 PRINT
4340 REM restore cursor operation
4350 *FX4
4360 REM Cursor On
4370 VDU23,1,1;0;0;0;
4380 ENDPROC
5000 DEFPROCsetup_copy
5010 REM Set up file names to be copied
5020 REM in a list starting at %1200
5030 CLS
5040 K%=%1200:N%=0
5050 FORZ%=0 TO E%-1
5060 IF C(Z%)=0 THEN 5090
5070 $K%=LEFT$(NAME$(Z%),9)
5080 K%=K%+10:N%=N%+1
5090 NEXT
5100 ENDPROC
6000 DEFPROCassemble_sort_code
6010 REM this proc is written by Ian Birnbaum
6020 REM and is published in his book
6030 REM Assembly Language Programming
6040 REM for the BBC Microcomputer
6050 REM modified to ignore lower case
6060
LOOPCOUNT=%70:FIRST=%71:SECOND=%73:TEMP=%75:
ADDRESS=%76:NUMBER=%78:STORE1=%7A:S
TORE2=%7C:LGTH1=%7E:LGTH2=%7F:OSWRCH=%FFEE
6070 FORI%=0TO2STEP2:P%=sort
6080 IOPTI%
6090 LDA&600
6100 CMP#2
6110 BNE MISTAKE
6120 LDA&603
6130 CMP#4
6140 BNE MISTAKE
6150 LDA&606
6160 CMP#81
6170 BEQ OK
6180 .MISTAKE
6190 LDA#ASC("?")
6200 JSR OSWRCH
6210 RTS
6220 .OK
6230 LDA&601
6240 STA FIRST
6250 LDA&602
6260 STA FIRST+1
6270 LDY#0
6280 LDA(FIRST),Y
6290 SEC
6300 SBC#1
6310 STA NUMBER
6320 INY
6330 LDA(FIRST),Y
6340 SBC#0
6350 STA NUMBER+1
6360 .LOOP3
6370 LDA&604
6380 STA STORE2
6390 LDA&605
6400 STA STORE2+1
6410 LDX#0
6420 STX LOOPCOUNTH
6430 .LOOP4
6440 LDY#0
6450 LDA STORE2+1
6460 STA STORE1+1
6470 LDA STORE2
6480 STA STORE1
6490 CLC
6500 ADC#4
6510 STA STORE2
6520 BCC NOCARRY3
6530 INC STORE2+1
6540 .NOCARRY3
6550 LDA(STORE1),Y
6560 STA FIRST
6570 LDA(STORE2),Y
6580 STA SECOND
6590 INY
6600 LDA(STORE1),Y

```

continued on page 66 ►

► from page 65

```

6610 STA FIRST+1
6620 LDA (STORE2),Y
6630 STA SECOND+1
6640 LDY£3
6650 LDA (STORE1),Y
6660 STA LGTH1
6670 LDA (STORE2),Y
6680 STA LGTH2
6690 LDY£0
6700 .LOOP5 \check for lower case and ignore
6710 LDA (SECOND),Y:CMPE97:BCC normal:SEC:SBC£32:.normal STA TEMP
6720 LDA (FIRST),Y:CMPE97:BCC normal2:SEC:SBC£32
6730 .normal2 CMP TEMP
6740 BCC NEWRECORD
6750 BNE SWAP
6760 INY
6770 CPY LGTH1
6780 BEQ NEWRECORD
6790 CPY LGTH2
6800 BEQ SWAP
6810 BNE LOOP5
6820 .PIVOT1
6830 BPL LOOP3
6840 .PIVOT2
6850 BNE LOOP3
6860 .SWAP
6870 LDY£3
6880 .LOOP6
6890 LDA (STORE1),Y
6900 STA TEMP
6910 LDA (STORE2),Y
6920 STA (STORE1),Y
6930 LDA TEMP
6940 STA (STORE2),Y
6950 DEY
6960 BPL LOOP6
6970 .NEWRECORD
6980 INX
6990 BNE NTZERO
7000 INC LOOPCOUNTH
7010 .NTZERO
7020 CPX NUMBER
7030 BNE LOOP4
7040 LDA LOOPCOUNTH
7050 CMP NUMBER+1
7060 BNE LOOP4
7070 DEC NUMBER
7080 BEQ LOWZERO
7090 LDA NUMBER
7100 CMPE£FF
7110 BNE PIVOT2
7120 DEC NUMBER+1
7130 BPL PIVOT1
7140 .LOWZERO
7150 LDA NUMBER+1
7160 BNE PIVOT2
7170 RTS
7180 JNEXTI%
7190 ENDPROC
8000 DEFPROCassemble_mccopy
8010 oscli=&FFF7
8020 FORZ%=0TO3STEP2
8030 REM This code uses buffer space allocated to the DFS.
8040 REM It should not normally be in use when this
      program is used.
8050 P%=&1400:copylist=&70:numfiles=&72
8060 [OPT Z%
8070 LDA£6:JSR&FFEE \switch on screen
8080 LDA £N%:BNE ok:RTS \double check there are
      files to copy!
8090 .ok STA numfiles:LDA £0:STA copylist:LDA £&12:
      STA copylist+1 \copylist stored at &1200
8100 LDA £SD%+&30:STA dinfo:LDA £DD%+&30:STA dinfo+1
      \store drive numbers in copy string
8110 .nxfile LDY £9
8120 .nxfile2 LDA (copylist),Y:STA buf,Y:DEY:BPL nxfile2
      \move next filename to copy string
8130 LDX fosc MOD256:LDY fosc DIV256:JSR oscli \send to
      Command Line Interpreter
8140 LDA £10:CLC:ADC copylist:STA copylist:LDA £0:ADC
      copylist+1:STA copylist+1
      \move pointers in copylist
8150 DEC numfiles:BNE nxfile \check if more files
8160 RTS \finished!
8170 .osc:]
8180 REM copy string follows. Drives inserted in dinfo
      and dinfo+1
8190 REM filename in buffer 'buf'
8200 $P%="COPY":P%=P%+4:dinfo=P%:?P%=0:P%?1=0:P%?2=32
8210 P%=P%+3:buf=P%
8220 NEXT
8230 ENDPROC

```

Selective disc file copier by Robin Newman.
 Compatible with both versions of BBC
 Basic. Note that £ sign should be #

ARIES-B20

Add 20K to your BBC micro in five minutes

Features

- ★ Adds 20K of useable RAM to your BBC Micro
- ★ Run programs up to 28K long in ANY SCREEN MODE
- ★ Extra memory can be used directly from BASIC I and II, VIEW 1.4, FORTH, LISP, and many other existing programs
- ★ ARIES-B20 is compatible with all correctly written BBC Micro software, on cassette, disc, sideways ROM or cartridge
- ★ Don't be deceived: this product is unique – no other expansion unit has these capabilities
- ★ Complete compatibility – ARIES-B20 uses only documented MOS facilities
- ★ Fitted in 5 minutes using only a screwdriver
- ★ Simply plugs in inside the case
- ★ No soldering or cutting
- ★ (Unlike some add-on products) will cause no damage to your

- BBC Micro – can be removed at any time
- ★ Incredibly simple to use
- ★ Patent applied for
- ★ Designed in Cambridge by BBC Micro experts
- ★ Top quality manufacture
- ★ Unquestionably the most important add-on ever produced for the BBC Micro
- ★ Top software houses are racing to produce the "super-programs" made possible by the extra capacity
- ★ 1 year guarantee.
- ★ Available mail-order only
- ★ Official purchase orders accepted from bona-fide educational establishments, all other trade cash-with-order

- ★ Price £99.95 including post, packing and VAT
- ★ If not completely satisfied with your purchase, we will refund your money in full providing you return the ARIES-B20 in good condition in its original packaging within 14 days

Machine requirements:

- ★ BBC Micro model B
- ★ MOS 1.2 or later
- ★ Plugs into CPU socket and 1 sideways ROM socket

Also available IEEE-488 interface.
Coming soon: Compatible ROM expansion board.

How to Order:

Send cheque or postal order made payable to: Cambridge Computer Consultants Ltd and forward to:
Cambridge Computer Consultants Ltd, FREEPOST, Cambridge CB1 1BR.
Telephone Cambridge 0223- 210677

Please send me (Qty). ARIES-B20(s) at £99.95 (incl. p.p. & VAT).
I enclose a cheque/postal order made payable to

Cambridge Computer Consultants Ltd for £.

Signed

Name (block letters)

Address

. Post Code

AU3-84 Cambridge Computer Consultants Ltd, FREEPOST Cambridge CB1 1BR
Telephone Cambridge 0223-210677

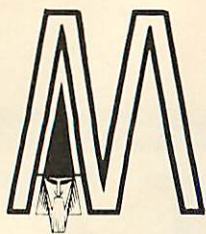

A BBC WORD PROCESSOR TO REALLY TAKE ADVANTAGE OF YOUR DISC DRIVE.

SCRIBE is a word processor which frees the user from the limitations of computer memory. Now it is possible to create a single document with as many pages as the disc will hold. These are automatically swapped between memory and disc at the touch of a key without you even knowing it's happening. This means that your disc is being used in the way it was intended and not just as a fast cassette. Why go to the expense of buying a disc system and then use simple software really only designed for cassette?



The superb features include:

- All functions menu driven - no knowledge of the computer system necessary.
- Edit in 80 column mode (40 optional) see it as it's printed! INCLUDING UNDERLINING.
- Create up to 255 pages, right justify, word wrap, insert, delete, move, copy and centre.
- Edit Basic programs, produce and merge basic and text files.

Plus many, many more professional features.

SCRIBE comes in ROM with five minute fitting instructions, printer utilities on disc and a comprehensive manual. (Currently recommended for Acorn & Watford DFS)

PRICE £59.95 (incl. VAT) (Post and packing 60p)

AVAILABLE SOON - a superb database to integrate with SCRIBE or to stand alone. Create over 2000 records on disc. One record equivalent to a screenful of information. Find any record in 2 seconds. Format printer output using SCRIBE. Link screens etc. etc.

MERLIN DISC DRIVES

ABSOLUTE TOP QUALITY Shinon drives - aluminium chassis, head load light, band stepper motor, silent operation, latest half height dimensions. Guaranteed fully compatible with the BBC.

40 track, double density specification; systems disc containing formatting routine plus ADDBOOK - a superb disc based address book program. Create any size address file up to the maximum capacity of your disc. Also acts as a teaching example on how to write random access files. Comes with a highly comprehensive manual plus all cables and connectors. GUARANTEE ONE YEAR!

PRICE 100K single £182.50 (incl VAT) 200K dual £325.00 (incl VAT)
(Securicor delivery £8.00)

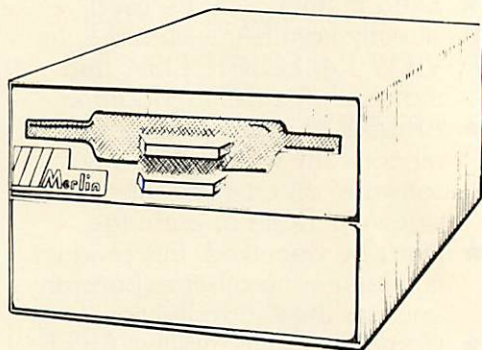

MERLIN REAL TIME CLOCK/CALENDAR

Now - highly accurate time and date continuously available on your BBC - timing not interrupted when computer is switched off.

- Battery backup, connects to user port.
- Resolution 0.1 sec.
- Generates interrupts 1/min, 5 sec, 0.5 sec.
- Handles leap years automatically.
- Day/week calendar, software included for clock display etc.

PRICE £39.95 plus VAT (Post & packing 30p)

S-LOGO

A superbly comprehensive version of this educational asset. This is a graphics version - each instruction controls the movement of a pen on screen. Each program produces a picture.

- Vocabulary of over 50 instructions.
- 20 pre-set shapes (sprites).
- Printer screen dump and Program listing.
- Super editor.
- Colour and scale choice.
- Error diagnosis.
- Use variables.
- Use BASIC expressions.
- Show results of calculations.
- Draw on compass-bearings, colour-fill, draw circles etc.

PRICE £19.95 plus VAT (Post & packing 25p)
Includes full Instruction Manual with Teaching examples.



Merlin Computer Products (Bucon Limited)

35/36 Singleton Street, Swansea, SA1 3QN Tel (0792) 467980 (3lines)



CANNY KEY IDEAS FOR FUNCTIONS

ANYBODY who has used the function keys on the Beeb or Electron knows what a blessing they are. Efficient use of them means that Basic text can be entered in a fraction of the time that would otherwise be needed. Trouble is, though, that editing them means typing in the whole definition again. Here's a routine (program 1) that will take care of just that. The final version (program 2), written in machine code, can sit in a quiet corner of the memory map and be called whenever a listing of key definitions is required. Figure 1 shows the output produced by the program. Editing a key definition can be done in the normal manner, using the cursor control and copy keys.

To understand how the program works requires a little knowledge about how the key definitions are handled and stored in memory.

The soft key buffer is located between &B00 and &BFF. However, the first 17 bytes of this, &B00 to &B10, are allocated to the function keys, each byte relating to a particular function key (see figure 2) rather than directly to the definition contained within the key. This means that the space available for key definitions is reduced to 239 bytes.

To investigate this area of memory further it is useful to produce a hexadecimal and ASCII dump of the region. Program 1 provides such a dump. Before entering it switch your Beeb off at the back to ensure that the operating system resets the entire region. Running the dump program at this stage should produce the result shown in

Electron and BBC users will know the blessing which function keys can be. Bruce Smith makes them even better

figure 3, the entire soft key buffer being filled with &10. Now enter a key definition such as:

```
*KEY0 PRINT "HELLO THERE" !M
```

Re-running the dump program shows the definition within the buffer (figure 4). The dump clearly shows that the 'PRINT "HELLO THERE"' portion of the definition is within the buffer. Note that the 'M' has been replaced by &0D (ASCII RETURN). The key associate bytes now give some indication as to their operation. The first byte we know is associated with key 0. This byte contains &10 (16 in decimal). If we count 16 bytes from this location we arrive at the last byte of the key associate bytes (&B10), which is immediately followed by the key definition; therefore the address of the KEY0 definition is simply:

&B00+(?&B00+1)

The values in the rest of the key-associated bytes have changed from &10 to &23 (or 35 decimal). Counting 35 from &B00 brings us to the last byte of the definition: the carriage return character &0D at &B23. From this it would seem that the address of the

last byte in the definition can be ascertained by PRINT -&B00+(?&B00?1). However, further thought shows that this cannot be true, for if we were to define key 1 we would overwrite this byte. In fact, as you may have noticed from figure 2, the last of the reserved bytes at &B10 has no key associated with it but instead points to the top of the keyboard buffer definitions at any one time. By peeking this value it is possible to calculate the amount of space remaining in the buffer.

Figure 5 shows the effect on memory if a further definition is added, such as:

```
*KEY7 CLS:VDU7 !M
```

This definition is entered on to the buffer directly above the previous one. The key 7 associate byte at &B07 still contains &23, but the undefined key bytes and the pointer byte have been updated to point to the last byte after the newly entered definition.

The reasons for updating the undefined key bytes are twofold. First, by comparing a key byte with the pointer byte, the MOS can immediately tell whether or not a key is defined, thus making the redefinition of keys much easier. Second, it makes entering new key strings simpler, as an index from &B00 is immediately available, allowing the relative bytes to be stored directly into memory.

What happens if a key is redefined? Figure 6 shows the reshuffled buffer after executing:

```
*KEY0OLD !M
```

Here we see that the still-valid definition of

```
*KEY 0 CALL&C00 !M
*KEY 1 RUN !M
*KEY 2 PRINT CHR$(12) !M
*KEY 3
*KEY 4 SAVE "TEMP" !M
*KEY 5
*KEY 6 LOAD "TEMP" !M
*KEY 7
*KEY 8
*KEY 9 LIST !M
*KEY 10 OLD !M
*KEY 11
*KEY 12
*KEY 13
*KEY 14
*KEY 15
```

Figure 1. Typical output of main program

Soft Key Buffer Key Associated Bytes		
&B00	:	Key 0
&B01	:	Key 1
&B02	:	Key 2
&B03	:	Key 3
&B04	:	Key 4
&B05	:	Key 5
&B06	:	Key 6
&B07	:	Key 7
&B08	:	Key 8
&B09	:	Key 9
&B0A	:	Key 10
&B0B	:	Key 11
&B0C	:	Key 12
&B0D	:	Key 13
&B0E	:	Key 14
&B0F	:	Key 15
&B10	:	Key definition 'TOP' pointer

Figure 2. Key-associated bytes of the soft key buffer

The magic world of machine code is at your finger-tips...

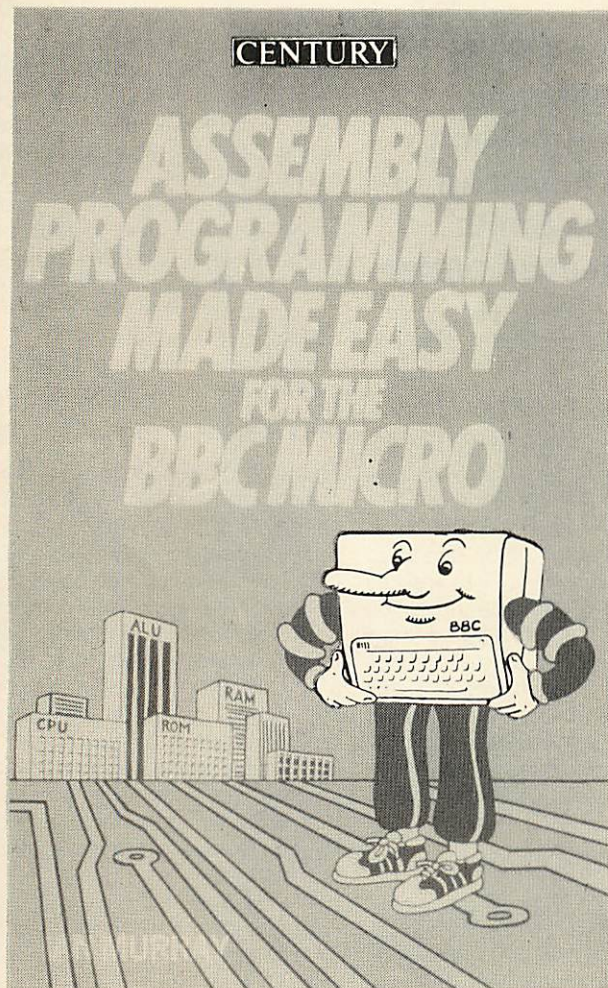

ASSEMBLY PROGRAMMING MADE EASY FOR THE BBC MICRO

IAN MURRAY

Here is a really easy guide for the enthusiastic beginner to assembly language for the BBC Micro. Using easy examples, cartoons and short, very simple programs you will quickly learn how to put graphics on the screen, use the BBC operating system and bring the machine to life.

£5.95 paperback 208pp

*Available through all good bookshops
but if you experience any difficulty
please fill in the form below.*

**Cassette is available at a special
price of £6 each***

**Only available to purchasers of the book.*

ORDER FORM

To: George Philip Services Ltd.
Arndale Road,
Wick, Littlehampton
West Sussex BN17 7EN

BOOK ONLY

Please send me.....copy/copies of
ASSEMBLY PROGRAMMING FOR THE
BBC MICRO by IAN MURRAY at £6.55 per
copy (post paid)

BOOK AND CASSETTE

Please send me.....copy/copies of
ASSEMBLY PROGRAMMING FOR THE
BBC MICRO by IAN MURRAY plus
cassette(s) at £12.95 per pack

I enclose my cheque/postal order for £
(please make cheques/postal orders
payable to George Philip)

Name _____

Address _____

Please allow 28 days for delivery.

CENTURY COMMUNICATIONS

A division of Century Publishing Co Ltd.
12-13 Greek Street London W1

```

800 10 10 10 10 10 10 10 10 .....
805 10 10 10 10 10 10 10 10 .....
810 10 10 10 10 10 10 10 10 .....
815 10 10 10 10 10 10 10 10 .....
820 10 10 10 10 10 10 10 10 .....
825 10 10 10 10 10 10 10 10 .....
830 10 10 10 10 10 10 10 10 .....
835 10 10 10 10 10 10 10 10 .....
840 10 10 10 10 10 10 10 10 .....
845 10 10 10 10 10 10 10 10 .....
850 10 10 10 10 10 10 10 10 .....
855 10 10 10 10 10 10 10 10 .....
860 10 10 10 10 10 10 10 10 .....
    
```

Figure 3. Soft key buffer reset to contain &10 throughout

```

800 10 23 23 23 23 23 23 23 .....#
805 23 23 23 23 23 23 23 23 .....#
810 23 50 52 49 4E 54 22 48 HPPRINT*4
815 45 40 40 47 30 54 48 48 HELLO THE
820 52 45 22 00 10 10 10 10 RE*.....
825 10 10 10 10 10 10 10 10 .....
830 10 10 10 10 10 10 10 10 .....
835 10 10 10 10 10 10 10 10 .....
840 10 10 10 10 10 10 10 10 .....
845 10 10 10 10 10 10 10 10 .....
850 10 10 10 10 10 10 10 10 .....
855 10 10 10 10 10 10 10 10 .....
860 10 10 10 10 10 10 10 10 .....
    
```

Figure 4. The buffer after the entry of *KEY0 PRINT "HELLO THERE" !M

```

800 10 20 20 20 20 20 20 20 .....#
805 20 20 20 20 20 20 20 20 .....#
810 20 50 52 49 4E 54 22 48 /PRINT*4
815 45 40 40 47 30 54 48 48 ELLO THE
820 52 45 22 00 43 40 53 3A RE*.CLS:
825 56 44 55 37 00 10 10 10 VDU7....
830 10 10 10 10 10 10 10 10 .....
835 10 10 10 10 10 10 10 10 .....
840 10 10 10 10 10 10 10 10 .....
845 10 10 10 10 10 10 10 10 .....
850 10 10 10 10 10 10 10 10 .....
855 10 10 10 10 10 10 10 10 .....
860 10 10 10 10 10 10 10 10 .....
    
```

Figure 5. The buffer after *KEY7 CLS:VDU7 !M

key 7 has been moved up to the start of the buffer and the new key 0 definition placed after it. The key-associated bytes and pointer have been adjusted accordingly.

Using the above information, the task of writing a program to print the KEY contents is greatly simplified. Program 2 lists the assembler. The source listing generates 126 bytes of hex code, which makes it small enough to be tucked neatly away. I have chosen to use the user defined character buffer located at &C00. As always, changing the value assigned to P% in line 100 makes the code relocatable.

Figure 6 flowcharts the program's operation, which can be clearly seen as two loops imbedded one inside the other. The program begins by printing out the word "KEY", followed by the key number. The former is handled by 'print_word_key' subroutine held in lines 480 to 550. The ASCII characters have been entered using the pseudo-mnemonic EQU\$. Basic I owners can achieve the same result using the clever routines provided by Jonathan Griffiths in the January issue of *Acorn User*. Note that the key string is back-to-front and includes two spaces before the 'Y' and a single space after the '*'. The key number printing routine uses a look-up table to obtain the ASCII characters to be printed.

Throughout the program the X register is used to hold the number of the key currently being processed. As keys 10 to 15 need two ASCII characters, numbers 0 to 9 are preceded with a space to pad them out. This also aids in justifying the key numbers when they are printed (see figure 1). As each key number consists of two characters, the X register needs to be multiplied by two to obtain the correct index into the table. Line 140 takes care of this, transferring the register's contents into the accumulator before executing an arithmetic shift left. The new value is then returned to the index register. On completion of the number printing, the original value of the X register is restored by dividing it by two with a logical shift right.

The current key-associated byte is loaded into the accumulator and compared to that held in the key top pointer (lines 230, 240). If they are dissimilar a key definition exists and therefore the branch over executed. Otherwise the program is updated and the next key definition searched out.

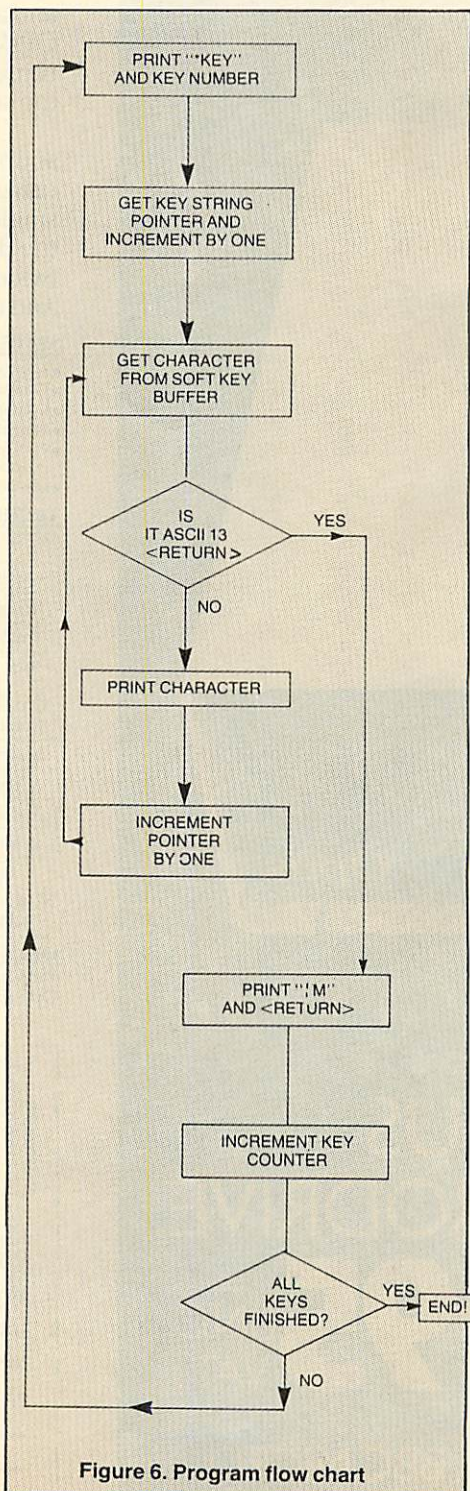

Figure 6. Program flow chart

```

RUN
800 10 10 10 10 10 10 10 10 .....
805 10 10 10 10 10 10 10 10 .....
810 10 43 40 53 3A 58 44 55 .CLS:VDU
815 37 00 4F 40 44 00 48 45 7.OLD.HE
820 52 45 22 00 43 40 53 3A RE*.CLS:
825 56 44 55 37 00 10 10 10 VDU7....
830 10 10 10 10 10 10 10 10 .....
835 10 10 10 10 10 10 10 10 .....
840 10 10 10 10 10 10 10 10 .....
845 10 10 10 10 10 10 10 10 .....
850 10 10 10 10 10 10 10 10 .....
855 10 10 10 10 10 10 10 10 .....
860 10 10 10 10 10 10 10 10 .....
865 10 10 10 10 10 10 10 10 .....
870 10 10 10 10 10 10 10 10 .....
875 10 10 10 10 10 10 10 10 .....
880 10 10 10 10 10 10 10 10 .....
885 10 10 10 10 10 10 10 10 .....
890 10 10 10 10 10 10 10 10 .....
895 10 10 10 10 10 10 10 10 .....
900 10 10 10 10 10 10 10 10 .....
    
```

Figure 7. The buffer after redefining *KEY OLD !M

The character printing routine starts by moving the string byte offset from the accumulator into the Y register (line 280), where it is incremented ready for use. Using Y as an index the first string character is loaded into the accumulator and checked to see if it is a <RETURN> character (line 320), which would mark the end of the key string text. If the test is false the character is printed, the index register incremented and the next character accessed (line 360). When the Return character is located this inner loop is exited and the 'M' characters that are normally used to terminate a function key's definition are printed out (lines 380 to 410).

The update routine outputs a Return, then tests to see if all the keys have been serviced (lines 440 and 450). If not, the main loop is repeated.

There are several ways in which the program could be improved: you might like to undertake these suggestions as a project. First, the routine does not take into account key definitions that contain multiple Return characters. For example, definitions such as:

```
*KEY9 NEW !M LOAD "PROGRAM" !M LIST !M
```

are perfectly legal, but the program as it stands at present would print "KEY 9 NEW M" only as it exits on the first Return character.

Second, the program uses the OSWRCH routine and control characters inserted into

NOW AVAILABLE FROM W.H. SMITH

A DOUBLE-SIDED 3" DISC DRIVE AT A SINGULAR PRICE.

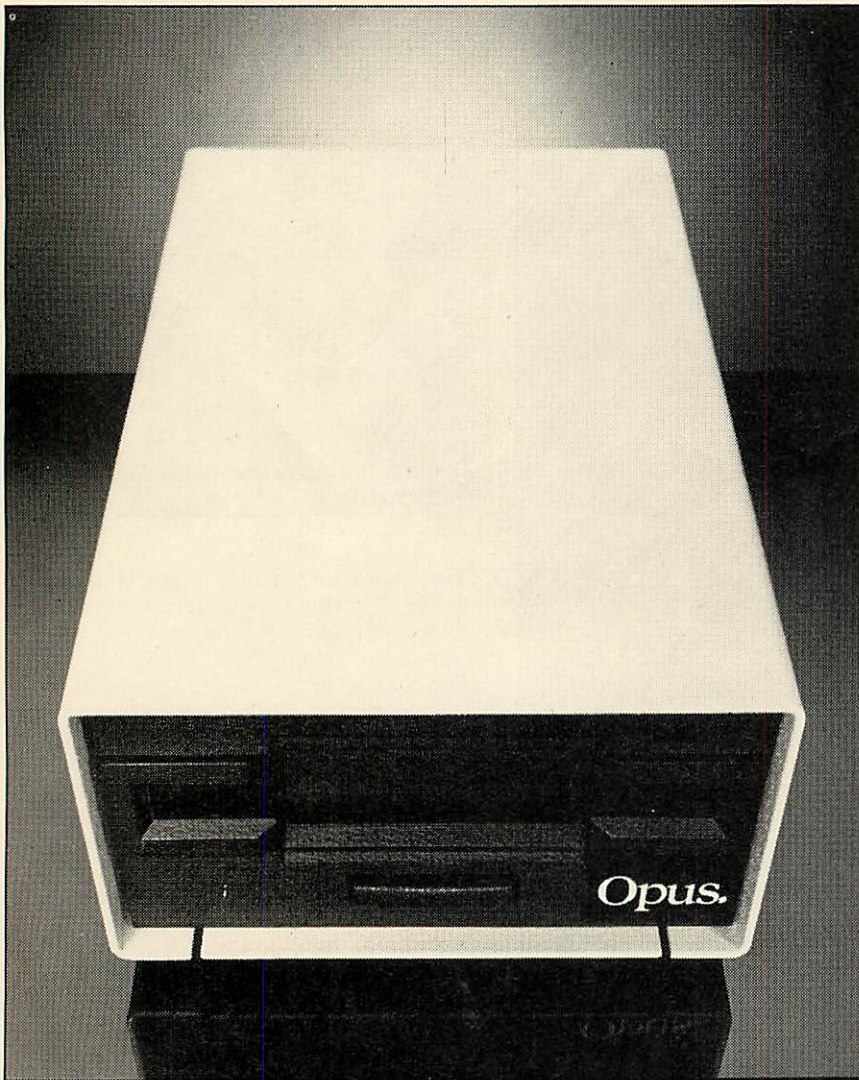

For only £229.95 (and that includes VAT, and all the necessary leads) you can have an OPUS 500k double-sided disc drive. And remember 3" disc drives are fast becoming the standard for home and business use.

This is an even bigger bargain than it sounds. For you're getting a double sided drive at the price that other company's sell single sided drives for. It reads and writes to the disc cartridge from both sides, giving you twice the on-line capability of other 3" drives. And there's no need to flip the disc over!

STATE OF THE ART TECHNOLOGY FEATURING:

- Easy to connect to the BBC Micro
- Compatible with most other makes
- Comprehensive manual
- Free disc cartridge
- Format, verify and other utilities provided
- Direct Drive
- Double sided
- One touch cartridge load
- 3 ms access time
- Portable, compact and reliable
- One year's full guarantee
- Totally compatible with 5¼" drives

TECHNICAL PERFORMANCE.

	Single Density	Double Density
Capacity	250K Bytes	500K Bytes
Recording density	4,915 BP1	9,830 BP1
Track density	100 TP1	100 TP1
Total number of tracks	40 (each side)	40 (each side)
Recording method	FM	MFM
Rotational speed	300 RPM	300 RPM
Transfer rate	125K Bits/Sec	250K Bits/Sec
Access time track to track	3 ms	3 ms
Access time settling	20 ms	20 ms
Motor start time	0.5 sec	0.5 sec

The Opus Super 3 Microdrive is now available from W. H. Smith's and leading specialist shops. Dual disc drives are also available for £460.

OPUS SUPPLIES LTD.

158 Camberwell Road, London SE5 0EE.

Opening hours: 9.00-6.00 Monday-Friday,
9.00-1.30p.m. Saturday.

01-701 8668
01-703 6155

To: Opus Supplies Ltd., 158 Camberwell Road, London SE5 0EE. Please rush me the following: **(ALL PRICES INCLUDE VAT & CARRIAGE.)**

Quantity	Description	Price
	Single drive(s) at £229.95 ea.	
	Dual drive(s) at £459.95 ea.	
TOTAL		

I enclose a cheque for £ _____
Or please debit my credit card account with the amount of £ _____
My Access/Barclaycard (please tick) No. is _____

Name _____
Address _____

Telephone _____

Opus.
Opus Supplies Ltd.

THE OPUS
SUPER 3 MICRODRIVE.

£229.95 (INC. VAT)

FOR USE WITH YOUR BBC MICRO.

definitions would actually be printed as such. Therefore a key definition entered as *KEY7 "IBLISTIM"

would produce a CTRL B when the printing code encounters it, turning the printer on and outputting the rest of the key listing to your printer. This is because the MOS interprets the 'B' as <CTRL> B when the string is entered and therefore places &02 into the appropriate position in the buffer.

Finally, it might be useful to extend the program to print the number of bytes remaining in the soft key buffer so that you know how much room is left.

For those still a little baffled by machine code, program 3 is a Basic listing which produces the same results as those already described and could be extended as described. It could be located away from the normal PAGE setting and called using those lovely function keys.

Program 1. Soft Key buffer hex/ASCII dump

```

10 REM *** MEMORY DUMP ROUTINE ***
20 a%=0.
30 CLS
40 PRINT"SOFT KEY BUFFER"
50 start%=&B00
60 FOR loop=0 TO 160 STEP 8
70 PRINT "(start%+loop):"
80 FOR byte=0 TO 7
90 peek=7(start%+loop+byte)
100 byte?&70=peek
110 IF peek<&10 THEN PRINT "0";
120 PRINT "peek:"
130 NEXT
140 FOR character=0 TO 7
150 ascii=character?&70
160 IF ascii<&20 PRINT "."; ELSE PRINT CHR$(ascii);
170 NEXT
180 PRINT
190 NEXT

```

Program 2. Source code listing

```

10REM *** FUNCTION KEY DEFINITION PRINTER ***
20REM *** (c) Bruce Smith 1984 ***
30REM *** assembles into user defined ***
40REM *** character area, 126 bytes long ***
50key=&B00
60pointer=&B10
70oswrch=&FFEE
80osasci=&FFE3
90FOR pass=0 TO 3 STEP3
100P%=&C00
110COPT pass
120LDX #0 \ set key offset
130.main_loop
140TXA : ASL A : TAX \ multiply offset by 2
150JSR print_word_key \ print "*KEY"
160LDA number_table,X \ get two digit
170JSR oswrch \ key number from
180LDA number_table+1,X \ and print both
190JSR oswrch
200TXA : LSR A : TAX \ divide offset by 2
210LDA #&20 \ print a space
220JSR oswrch
230LDA key,X \ get string pointer
240CMP pointer \ is it to top of buffer
250BNE over \ no, definition present
260JMP update \ yes, no definition
270.over
280TAY
290INY \ move string pointer into Y
\ and add one
300.next_character
310LDA key,Y \ get character
320CMP #13 \ is it a <RETURN> ?
330BEQ carriage_return \ yes, process it

```

UTILITIES

```

340JSR oswrch
350INY
360BNE next_character
370.carrriage_return
380LDA #ASC"! "
390JSR oswrch
400LDA #ASC"M"
410JSR oswrch
420.update
430LDA#13:JSR osasci
440INX
450CPX#16
460BNEmain_loop
470RTS
480.print_word_key
490LDY#6
500.next_letter
510LDA spell_key,Y
520JSR oswrch
530DEY
540BNE next_letter
550RTS
560.number_table
570\ key number table
580 EQU$ " 0 1 2 3 4 5 6 7 8 9101112131415"
590.spell_key
600EQU$ " YEK* "
610]
620NEXT
630END

```

\ no, print character
 \ move to next character
 \ repeat again
 \ print "IM" to
 \ indicate end of string
 \ Print a (RETURN)
 \ increment offset
 \ all 15 keys done?
 \ no, so do all again
 \ yes, back to good 'ole BASIC!
 \ 5 characters to print
 \ get each letter
 \ and print them
 \ until complete

Program 3. The Basic version

```

10 key=&B00
20 pointer=&B10
30 FOR loop=0 TO 15
40 PRINT "*KEY";loop;" ";
50 IF loop<10 THEN PRINT " ";
60 IF key?loop()?pointer THEN PROC_print_key
70 PRINT
80 NEXT
90 END
100 DEF PROC_print_key
110 string=(key+1+(key?loop))
120 counter=LEN($string)
130 FOR print_loop=0 TO counter
140 character=string?print_loop
150 IF character=13 THEN PRINT"IM"; ELSE PRINT CHR$(character);
160 NEXT
170 ENDPROC

```

A SLIMLINE TONIC FOR THE BBC MICRO

Cumana 5¼ inch slimline dual disk drives for the BBC Micro are now available from well known high street outlets, including W. H. Smith, John Lewis and Spectrum UK, as well as from Cumana's national dealer network.

The dual drives are available in two versions, as shown, including a 'switchable'. This version enables either drive to be switched independently between 40 and 80 track modes.

Each unit has an independent power supply, 12 months warranty, and is fully assembled and tested before packaging. A drive connecting cable, user manual, formatting diskette, power supply lead and plug are all supplied complete with the disk drives.

Look out for the distinctive Cumana packaging in your high street, today!

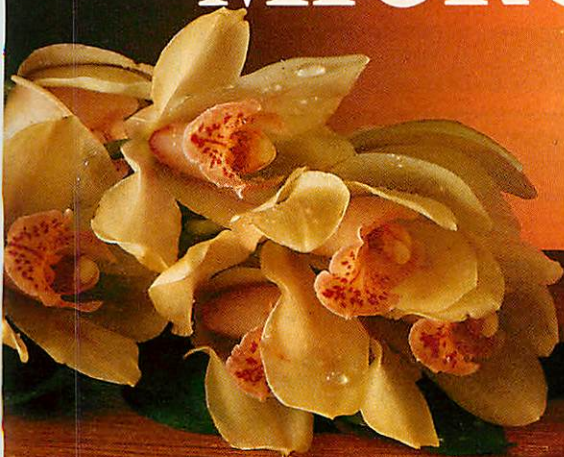

- High quality 5¼ inch Japanese dual disk drive
- Cabinet finished in hard wearing BBC beige
- Track mode



Cumana Limited, Pines Trading Estate,
Broad Street, Guildford, Surrey, GU3 3BH.
Telephone: Guildford (0483) 503121 Telex: 859380

For further information about Cumana dual disk drives for the BBC Micro, please complete and return this coupon.

Name

Address

Interests:

Home Use

Education

Dealer

Business

Tel. No. AU4/84

Note: If dealer, please attach this form to your letterheading.

MACRO SAVINGS FOR MICRO USERS

**14" STANDARD RESOLUTION
MICROVITEC COLOUR
MONITOR £199.95**
NO EXTRAS!

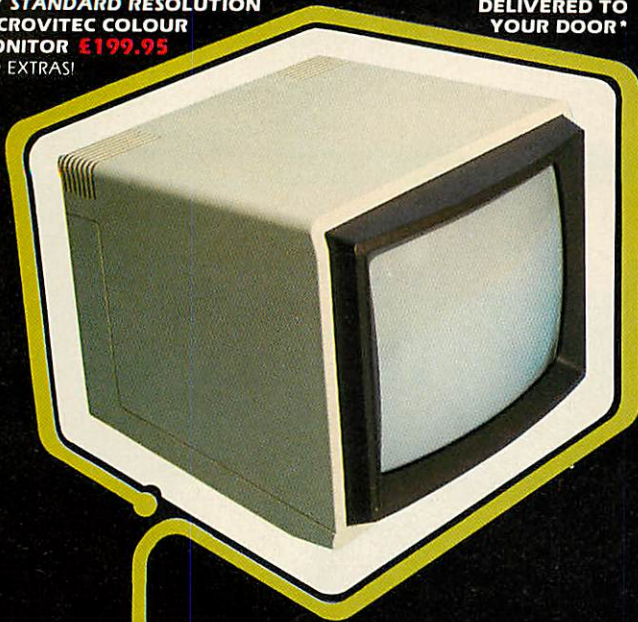

**DELIVERED TO
YOUR DOOR***

**UCL 100 DISK
DRIVE SYSTEM
DELIVERED TO
YOUR DOOR*
£139.95**
NO EXTRAS!



**UCL 100D DUAL
DISK DRIVE SYSTEM
DELIVERED TO
YOUR DOOR*
£269.95**
NO EXTRAS!

14" STANDARD RESOLUTION MICROVITEC COLOUR MONITORS

- Matching BBC COLOURS • RELIABLE 12 MONTHS WARRANTY
- 40-64 CHARACTERS • DOT PITCH 0.63mm
- FULLY COMPATIBLE WITH MOST COMPUTERS
- LOW POWER CONSUMPTION • BRITISH MANUFACTURE

PRICE INCLUDES VAT, DELIVERY* & PACKAGING. **£199.95**

EPSON DOT MATRIX PRINTERS

RX801 80 Column 100 CPS	£259.95
RX80FT 80 Column 100 CPS	£289.95
FX80 80 Column 160 CPS	£399.95
MX100FT3 136 Column 100 CPS	£425.95
FX100FT 136 Column 160 CPS	£525.95

STAR DOT MATRIX PRINTERS

Gemini 10X 80 Column 120 CPS	£229.95
Gemini 15X 136 Column 120 CPS	£339.95
Delta 10 80 Column 160 CPS	£369.95
Delta 15 136 Column 160 CPS	£499.95
Radix 10 80 Column 200 CPS	£525.95
Radix 15 136 Column 200 CPS	£599.95

DAISYWHEEL PRINTER

Juki Model 6100 20 CPS	£395.95
Juki Tractor	£99.00
Juki Cut Sheet Feeder	£239.00
Ricoh RD 1300S	£995.95
Ricoh RD 1600S	£1395.95
Tractor (Bi Di 1600)	£175.00
Mechanical Sheet Feeder	£495.00
BBC Cable	£12.00

PRICES INCLUDE VAT, DELIVERY* & PACKAGING

HALF HEIGHT, BBC COMPATIBLE DISK DRIVE SYSTEMS

UCL 100 Single side double density 40 track 250K Unformatted Formatted 100K BBC single density or formatted 200K BBC double density	£139.95
UCL 200 Double sided double density 40 track 500K unformatted Formatted 200K BBC single density or formatted 400K BBC double density	£175.95
UCL 400 Double sided double density double track 80 track lmb unformatted. Formatted 400K BBC single density or formatted 800K BBC double density	£199.95

DUAL DRIVE DISK SYSTEMS

UCL 100D Dual single sided double density 40 track 250K x 2 unformatted. Formatted 100K x 2 BBC single density or formatted 200K x 2 BBC Double Density	£269.95
UCL 200D Dual double sided double density 40 track 500K x 2 unformatted. Formatted 200K x 2 BBC single density or formatted 400K x 2 BBC double density	£339.95
UCL 400D Dual double sided double density double track 80 track lmb x 2 Unformatted. Formatted 400K x 2 BBC single density or formatted 800K x 2 BBC double density	£389.95

(AVAILABLE ALSO AS STACK MODELS — PLEASE SPECIFY ON ORDER FORM)

ALL DISK DRIVE UNITS COME COMPLETE WITH:

- Professional case • Ribbon cable to connect to BBC Micro
- Power cable to connect to BBC micro • Manual and formatting disk

PRICES INCLUDE VAT, DELIVERY* & PACKAGING

THIS MONTHS SPECIAL OFFER

CONTROL DATA FLOPPY DISCS

SS/DD 48 TPI Per Pack of 10	£12.00	DS/SD 48 TPI Per Pack of 10	£16.50
SS/DD 48 TPI Per Pack of 10	£12.50	SS/DD 96 TPI Per Pack of 10	£19.00
DS/IDD 48 TPI Per Pack of 10 ...	£16.50	DS/IDD 96 TPI Per Pack of 10 ...	£20.50

UNIVERSAL COMMUNICATIONS COMPANY

ROYD NOOK, ROYDSTONE ROAD,
BRADFORD, WEST YORKSHIRE.
TEL: BRADFORD (0274) 390114



ORDER FORM — FILL IN THE ORDER FORM AND SEND IT WITH REMITTANCE TO:—

Universal Communications Company, FREEPOST, Roydnook, Roydstone Road, Bradford, W. Yorkshire BD3 7BR.

PLEASE SUPPLY THE FOLLOWING

ITEM	QTY.	PRICE	TOTAL
TOTAL PAYABLE			

NAME.....

ADDRESS.....

.....POSTCODE

TEL. NO.

I enclose a cheque/PO for a total of £.....
made payable to U.C.C.

Signed

PLEASE ALLOW 28 DAYS FOR DELIVERY
*DELIVERY TO ANY ADDRESS IN U.K.

TELETEXT BY ANOTHER MODE

LAST month I showed how the mode 7 and teletext screens could be dumped to the Epson and Star printers. At the end of that article I said that I did not have time to do the job for any printer. However, inspiration struck!

The inspiration was the thought that the Epson dump, using user-defined ('download') characters, could be mimicked within the Beeb. If user-defined characters could be set up in mode 4 to give a graphics capability similar to the mode 7 and teletext graphics, then it should be possible to 'translate' the teletext screen into mode 4. The mode 4 picture can now be dumped on any dot-matrix printer by conventional means.

The user-defined characters between 128 and 159 are defined as sets of 16 continuous and 16 broken graphics characters. This and other character redefinition is carried out using VDU23. I should point out problems for those with OS 0.1. They will have to be content with the graphics characters only, being unable to redefine the 'special characters' 91 to 95 and 123 to 126. They will also have to remove the *FX20 call, as this is not implemented in the older operating system, and use characters 224 to 255 (with base at

While he's in the mode, George Hill devises a way of translating the teletext screen so that it can be dumped to any dot-matrix printer

224), instead of 128 to 159.

I also need to bring your attention to inaccuracies in the *User Guide*. To use *FX20 to 'explode' the user-defined characters, you must ensure that space is left for the new character definitions in RAM. This requires not only space for your own characters, but space for copies of the ROM codes. The re-definition codes go into the buffer from &C00 to &CFF first. We need the whole of this buffer for the graphics characters. The explosion takes place in stages, using *FX20,n where n is between 0 and 6. Values of n above 1 are not mentioned in the ordinary *User Guide*. The *Advanced User Guide* has it roughly as in table 1.

OSHWB is most easily obtained by typing:

```
CTRL BREAK
PRINT PAGE
```

This will yield a hexadecimal number that will be variously &0E00, &1100, &1900, &1B00 or even higher, depending what sideways ROMs you have fitted. Obviously we have to leave &600 bytes of memory clear if we want to define characters in all ranges. The program uses *FX20,6, and so must be loaded and run at an address &600 above the normal value of PAGE. This is taken care of in the loading program 1, but you must do it yourself if you use the program in any other way. In principle, before using program 2 (the translator), PAGE must be reset by the line:

```
PAGE=PAGE+&600
```

Program 2 reads the teletext screen character by character and builds a screen image in memory. This consists of a block of 1000 ASCII-type codes. Mode 4 is now selected and the codes are read line by line. The codes are adjusted as last month to produce a unified set. If the code represents a text character, then the corresponding mode 4 character is printed, with

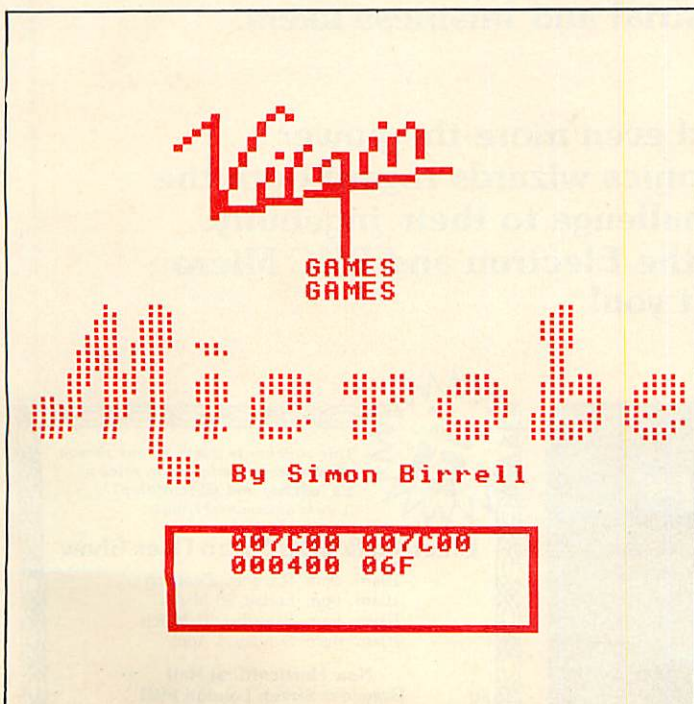

Show sponsored by
The Micro User
and Electron User

ELECTRON & BBC MICRO USER SHOW

Don't miss
the great
Spring show
of all that's
new for the
Electron and
BBC Micro

New Horticultural Hall (*Westminster Exhibition Centre*)
Thursday to Sunday, March 29 to April 1

Here's your big chance to catch up on all that's been happening recently in the fast-developing world of the Electron and BBC Micro. And there's so much new to excite and intrigue you ...

NEW programs from the fertile minds of Britain's leading software writers - games galore, plus a growing number of new packages for teachers and for industrial and business users.

NEW hardware add-ons that expand even more the power and versatility of your micro. Electronics wizards regard both the Electron and the BBC Micro as a challenge to their ingenuity. Their latest creations on display at the Electron and BBC Micro User Show will astound and delight you!

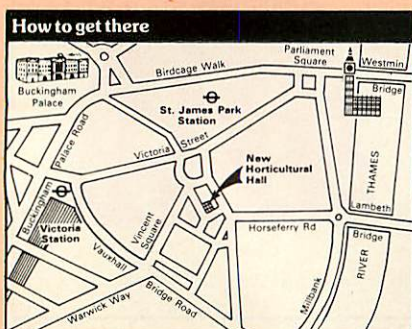

School and College Groups

Entry only £1 per student if bookings are made in advance. Send your cheque (made payable to Database Publications) and SAE to:

Electron & BBC Micro User Show
68 Chester Road, Hazel Grove
Stockport SK7 5NY
Tel: 061-456 8383

Voucher worth
£1

This voucher is worth £1 per person off the normal admission price of £3 (adults) and £2 (children) (Valid for a maximum of 4 people)

Electron & BBC Micro User Show

10am - 6pm, Thursday, 29 March
10am - 6pm, Friday, 30 March
10am - 6pm, Saturday, 31 March
10am - 4pm, Sunday, 1 April

New Horticultural Hall
Greycoat Street, London SW1

AU

Table 1. The redefinition codes

OS call	Action	Codes	Memory used
*FX20,0	allows redefinition of	128 to 159	&C00 to &CFF
*FX20,1	effect of *FX20,0 and	160 to 191	OSHWM TO OSHWM+&FF
*FX20,2	effect of *FX20,1 and	192 to 223	OSHWM+&100 to OSHWM+&1FF
*FX20,3	effect of *FX20,2 and	224 to 255	OSHWM+&200 to OSHWM+&2FF
*FX20,4	effect of *FX20,3 and	32 to 63	OSHWM+&300 to OSHWM+&3FF
*FX20,5	effect of *FX20,4 and	64 to 95	OSHWM+&400 to OSHWM+&4FF
*FX20,6	effect of *FX20,5 and	98 to 127	OSHWM+&500 to OSHWM+&5FF

the exception of characters 91 to 95 and 123 to 126, which have been redefined. If a graphics character is required, it is selected from the user-defined characters from 128 to 159, in the same way as in the Epson dump last month.

The characters are put on the screen via the graphics cursor. The text and graphics cursors are joined (VDU5), and the cursor is positioned by a MOVE statement to calculated x% and y% co-ordinates by PROCprint (). Each line is scanned twice, and text characters are printed as blanks on the second scan, whereas the graphics

Program 1. The loader

```
10 REM LOADER
20 MODE7
30 *LOAD"XXXX"7C00
40 PAGE=PAGE+&600
50 CHAIN"TRANSTT"
```

Program 2. The translator

```
10 REM TELETEXT TRANSLATOR
20 REM G.B.HILL (c) DECEMBER 1983
30 REM VERSION 2
40
50 HIMEM=&4800
60 PROCset_up
70 REM*** Read screen into memory ***
80 A%=135
90 VDU26.15.30
100 FOR I=0 TO 999
110 REM call osbyte with A=135
120 !user=USR&FFF4
130 screen?I=user?1
140 VDU9
150 NEXT
160
170 REM*** Main translating loops ***
180
190 MODE4
200 VDU5
210 FOR Y%=0 TO 24
220 FOR scan%=0 TO 1
230 text=TRUE
240 base=128
250 FOR X%=0 TO 39
260 char=screen?(Y%*40+X%)
270 IF char>128 AND char <136
THEN text=TRUE
280 IF char>144 AND char <151
THEN text=FALSE
290 IF char=153 THEN base=128
300 IF char=154 THEN base=144
310 IF char>127 AND char <160
THEN char=32
320 x%=32*X%:v%=(25-Y%)*36
330 IF scan%=1 THEN v%=v%-12
340 IF text THEN PROCptext ELSE
PROCpgraphics
350 NEXT
360 NEXT
370 NEXT
380 VDU4
390 REM CHAIN or *RUN dumping
program here
400 *RUN E012
410
420 END
```

```
430
440 DEFFPROCset_up
450 DIM user 3.screen 999
460 REM Define special characters and
graphics characters
470 *FX20,6
480 VDU23.128,0,0,0,0,0,0,0,0,0
490 VDU23.129,240,240,240,0,0,0,0,0
500 VDU23.130,15,15,15,0,0,0,0,0
510 VDU23.131,255,255,255,0,0,0,0,0
520 VDU23.132,0,0,0,240,240,240,0,0
530 VDU23.133,240,240,240,240,240,240,0,0
540 VDU23.134,15,15,15,240,240,240,0,0
550 VDU23.135,255,255,255,240,240,240,0,0
560 VDU23.136,0,0,0,15,15,15,0,0
570 VDU23.137,240,240,240,15,15,15,0,0
580 VDU23.138,15,15,15,15,15,15,0,0
590 VDU23.139,255,255,255,15,15,15,0,0
600 VDU23.140,0,0,0,255,255,255,0,0
610 VDU23.141,240,240,240,255,255,255,0,0
620 VDU23.142,15,15,15,255,255,255,0,0
630 VDU23.143,255,255,255,255,255,255,0,0
640 VDU23.144,0,0,0,0,0,0,0,0,0
650 VDU23.145,96,96,0,0,0,0,0,0,0
660 VDU23.146,6,6,0,0,0,0,0,0,0
670 VDU23.147,102,102,0,0,0,0,0,0,0
680 VDU23.148,0,0,0,96,96,0,0,0,0
690 VDU23.149,96,96,0,96,96,0,0,0,0
700 VDU23.150,6,6,0,96,96,0,0,0,0
710 VDU23.151,102,102,0,96,96,0,0,0,0
720 VDU23.152,0,0,0,6,6,0,0,0,0
730 VDU23.153,96,96,0,6,6,0,0,0,0
740 VDU23.154,6,6,0,6,6,0,0,0,0
750 VDU23.155,102,102,0,6,6,0,0,0,0
760 VDU23.156,0,0,0,102,102,0,0,0,0
770 VDU23.157,96,96,0,102,102,0,0,0,0
780 VDU23.158,6,6,0,102,102,0,0,0,0
790 VDU23.159,102,102,0,102,102,0,0,0,0
800 VDU23.91,0,16,32,127,32,16,0,0
810 VDU23.92,32,32,32,38,9,2,4,15
820 VDU23.93,0,4,2,127,2,4,0,0
830 VDU23.94,8,28,42,8,8,8,8,0
840 VDU23.95,0,0,0,127,0,0,0,0
850 VDU23.123,32,32,32,34,6,10,15,2
860 VDU23.124,0,36,36,36,36,36,36,0
870 VDU23.125,240,16,32,146,102,10,15,2
880 VDU23.126,0,8,0,127,0,8,0,0
890 ENDFPROC
900
910 DEFFPROCptext
920 IF scan%=1 THEN PROCprint(32):ENDPROC
930 IF char=163 THEN char=96
940 IF char=223 THEN char=35
950 IF char=224 THEN char=95
960 char=char AND &7F
```

characters are selected by 'index' in the same way as in the Epson dump.

The method is not perfect. I still have not produced either colour or double-height. The latter is now possible for anyone with the patience to define the necessary double-height character set. Colour is also possible if the program can be fitted into mode 1. These refinements are left as an exercise for the reader.

There is also some distortion, principally

a compression in the Y direction, but fortunately this is cured by the dumping process on many printers. The broken graphics gaps are not completely even but seem quite acceptable. The method of use for stored mode 7 or teletext screens is:

1. Load program 1 and alter the "LOAD"XXXX"7C00 line to contain the picture name.
2. Run the program. The rest should be automatic.

Note, however, that the usual precautions should be taken against Searching and Loading messages from tape; and you must include a simple on/off dump. This can be *RUN (if machine code) or CHAINED (if Basic or hybrid), or included as a procedure in the translator program. Mine was the machine code equivalent of Epatall from the December issue.

I hope this will help dot-matrix users not catered for in last month's article.

▶ from page 79

```

970 PROCprint(char)
980 ENDFPROC
990
1000 DEFFPROCgraphics
1010 IF scan%=0 THEN PROCgraphics1 ELSE
PROCgraphics2
1020 ENDFPROC
1030
1040 DEFFPROCgraphics1
1050 IF char=35 OR char=223 THEN
PROCprint(35):ENDPROC
1060 PROCswapem
1070 IF index=4 OR index=5 THEN PROCptext
ELSE PROCprint(base+(char MOD 16))
1080 ENDFPROC
1090
1100 DEFFPROCgraphics2
1110 PROCswapem
    
```

```

1120 IF index=2 OR index=4 OR index=5
THEN PROCprint(32)
1130 IF index=3 THEN PROCprint(base+4)
1140 IF index=6 THEN PROCprint(base+8)
1150 IF index=7 THEN PROCprint(base+12)
1160 ENDFPROC
1170
1180 DEFFPROCswapem
1190 IF char=96 THEN char=35
1200 IF char=95 THEN char=96
1210 char=char AND &7F
1220 index=char DIV 16
1230 ENDFPROC
1240
1250 DEFFPROCprint(c)
1260 MOVE%v%,v%
1270 VDUc
1280 ENDFPROC
    
```

CHARGEN

Acorn User approved and tested software by George Hill

The easy way to define the "DOWNLOAD CHARACTERS" on the EPSON FX80 Features:

- Dot-by-dot definition on an easy-to-use screen grid (see illustration)
- Automatic calculation of codes and proportional attributes
- Automatic transfer of codes to file on disc or tape
- Instant transfer of the defined characters to the printer
- Redefine all or any of the characters in the permissible range (32 to 255)
- Edit the characters in a previously defined file
- Automatic renumbering of the characters in a file

FREE

- Greek character set on file
- Teletext character set on file
- Tape-to-disc transfer program
- Full Instructions

0123456789A

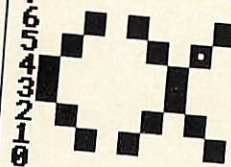

Cursor keys
move pointer

X prints dot
Z erases dot

RETURN to end

Calculating codes, please wait.
Descenders (Y) or not (N)?N
Another character? (Y/N) Y

Also available, subject to demand, version for the Star Gemini 10X and Delta 10 printers.

Versions for tape and disc supplied on the same tape
Facility and instructions for automatic transfer to disc

Send cheque or postal order for £8 to GEOSOFT, 42 Horn Park Lane, Lee, LONDON SE12 8AR

GET ON THE RIGHT TRACK WITH MICRO POWER



Micro Power are an official service and information centre, and we are major suppliers to Government and educational establishments. We stock the complete range of Acornsoft and Program Power software as well as a wide range B.B.C. Micro and general computing books. Our expert staff are always on hand to provide advice and assistance in the relaxed atmosphere of our showroom.

COMPUTERS

BBC Model B 399.00
 Acorn Electron 199.00
 (phone for availability)

MONITORS

Philips TP200 89.95
 Kaga Green Screen 12" .. 123.05
 Ferguson TX Monitor/TV 316.25
 Microvitec 14" Colour (Plastic Case) 286.35
 Microvitec 14" Colour (Metal Case) 247.25
 Plinth for above 5.75

PRINTERS

Epson FX80 453.85
 Epson RX80 F/T 366.85
 Mannesmann Tally Spirit 80
 plus 1000 sheet plus cable 299.99
 Epson MX80 111 F/T 401.35
 Smith Corona TP-1 401.35
 MCP 40 129.95
 Juki 458.88

DISK DRIVES

Pace 40 track 100K 212.75
 Pace 40 track double sided 200K 270.25
 Pace 40/80 track double sided 200/400K 350.75
 Pace 40 track double drive 200K 388.70
 Pace 40 track double sided double drive 400K
 516.35
 Mitsubishi 40/80 track double sided double drive
 400/800K 650.00
 Torch Z80 Disk Pack 80 track double sided
 double drive (including Perfect Soft) 839.50

ACCESSORIES

Datex/Lloytron cassette recorders (inc. leads) 29.90
 Acorn BBC cassette recorders (inc. leads) ... 33.90
 Memorex S/S S/D Disks (Box of 10) 20.00
 Scotch D/S D/D Disks (Box of 10) 32.50
 Disk storage cases 17.95
 Vinyl dust covers for computers, disk drives,
 monitors and printers 4.50
 Sureshot self centering arcade joystick 18.22
 Sureshot self centering double joysticks 34.44
 Acorn joysticks 13.00
 Nuway Master Plug 9.95
 System Sac 19.95
 Computer labels (2000 off) 23.00
 Printer paper (2000 sheets) 18.40
 370mm wide paper (FX100 compatible 2000 sheets)
 23.00
 Printer cables (parallel or serial) 15.50
 Stack light pen 28.75
 Speech synthesiser plus cartridge socket
 (Free 1.2 if required) 55.00
 Acorn Disk interface (Free 1.2 ROM if req.) 97.00
 Pace disk interface kit 95.00
 1.2 ROM upgrade 11.50
 Econet (Free 1.2 ROM if req.) 70.00
 Teletext adaptor (Free 1.2 ROM if req.) 225.00
 View wordprocessor (Free 1.2 ROM if req.) 59.00
 Wordwise wordprocessor 45.42
 Beebcalc spreadsheet 39.25
 Disc Doctor 33.35
 Auto Prommers Eprom Programmer 138.00
 Tutor Mate shelves 10.50

**FOUR FREE
 PROGRAM POWER
 CASSETTES
 WITH EVERY
 MODEL B**

ALL PRICES INCLUSIVE OF V.A.T.

We provide free fitting for all firmware.

ALL ROADS LEAD TO MICRO POWER!



Showroom: Northwood House, North Street, Leeds LS7 2AA, Tel: (0532) 458800
 Mail Order: 8/8a Regent Street, Leeds LS7 4PE, Tel: (0532) 683186/696343

Send an SAE for our complete listing of hardware, software and books.

CARRIAGE FREE for BBC, printers, monitors and disk drives. Carriage £5 for Electron. Books and software only 55p per order.

**SPECIALISTS
 IN ECONET**

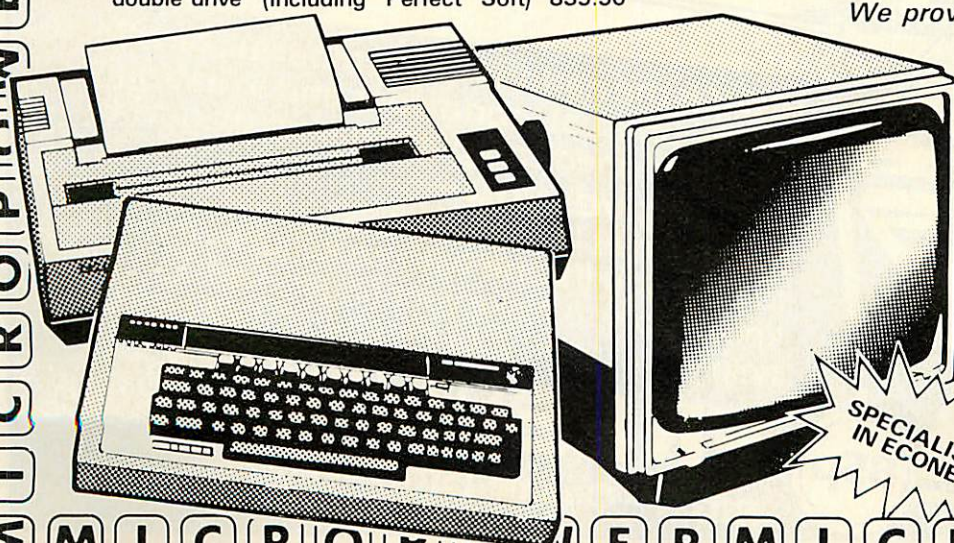

Put the thrill-power back into your programs with **BIG K!**

KEVIN WAS ONCE AN OBSESSIVE, INTROVERTED MIDNIGHT HACKER...

DURN BUG'S GOT TO BE IN HERE SOMEWHERE - YAWN!



...UNTIL ONE DAY HE DISCOVERED **BIG K!**

GOSH! THIS IS A-MAZE-ING!



NOW BUGS ARE A THING OF THE PAST...



...THANKS TO **BIG K!**

BIG K is the nation's most colourful, fact-filled, stylish, unusual, obnoxious and irritatingly well-informed computer games magazine.

BIG K gives you -

Great games listings for the top micros. Reviews to drive you insane with excitement. Technical know-how to make your fingers itch. Facts to help you expand your micro and your brain.

FREE C15 COMPUTER CASSETTE WITH EVERY COPY
BIG K - On sale 15th March

85p

PROBLEM-SOLVERS OF TADDLECOT

Joe Telford reviews the first major education software pack from Acorn CES. Pupil initiative is tested in the performance of simulated civic tasks

SINCE John Coll's departure last year to the MEP (*Acorn User*, October), Acorn's education division has been reorganised under the experienced eye of Maurice Edmundson, who has marshalled the company's appearances at the recent education exhibitions.

The biggest development in the shape-up has been a major new software facility, and the centring of Acorn's education wing at Maidenhead. The group aims to develop full-blown educational software in competition with established publishers, in addition to efforts made by Acornsoft.

This all began in late 1983, when Acorn bought an offshoot of the British mainframe manufacturer ICL (International Computers Ltd) called CES. This company was effectively a team of staff, plus the educational material which they were currently selling and completing. The team was situated at the Hermitage and promptly renamed Acorn CES (Computer Education Services).

The team's first major release under Acorn colours is the pack that was being completed when they were still part of ICL. Rather than being just a collection of software, this offering is a complete package of materials. It is entitled 'Computers, Information and You'.

The Acorn CES package comes in five parts:

1. A student's book
2. A teacher's (or parent's) guide
3. A set of activity sheets
4. A copy of program documentation (on tape)
5. Six programs supporting the texts.

It is aimed at children in the first years of secondary education and is best used as a complete pack, although the cost must be considered if, say, a year group is to be equipped. The complete pack is designed as a 20-hour module which can be used as a complete short course, if time is at a premium.

All the applications described in the student's book centre on the fictional town of Taddlecot and pupils are able to appreciate by illustration both the benefits and problems new technology brings. Among the residents of Taddlecot are the 'problem solvers', known as Ramley, Romley & Promley Ltd, who can be called upon by the townsfolk. Ramley, Romley & Promley may be regarded as systems analysts, although they are not referred to as such. In

lighted throughout the book and examines some of the wider implications of information technology. Other sections of the book describe a variety of applications, including information retrieval and computer-aided design.

The book is well-written and illustrated with many photographs and line drawings, which should encourage children to read through it. As usual with computing texts, the reading age may be a little high for the target audience, but is closer than many similar offerings. It is up-to-date, bright, and makes exciting reading.

The teacher or parent buying the book will, of course, need to discuss many of the terms with the children, although the book gives a simple definition of every jargon word as it is encountered.

I enjoyed reading the book, as have a number of adults and young people who have dog-eared my copy over the last month or so.

The teacher's or parent's notes are collected in an A4 handbook and are of the same high standard as the student's book. The notes are in two sections. The first explains key points in each chapter for the teacher's benefit, and then gives answers

describing their assignments, many chapters adopt a problem-solving approach to computer applications.

In fact, pupils are introduced to problem-solving in the first chapter, while the next two examine the nature of information. The computer itself appears in chapter 4, in which the basic differences between micro and mainframe computers are described. Chapter 5 looks at some applications of robots, and chapter 7 examines the way in which computers are controlled, the concept of a program being introduced by examining instructions that we issue to both people and machines. A simple treatment of the manufacture and application of microprocessors is included in chapter 8, and this leads on to a discussion of control applications in chapter 12. The concluding chapter draws together the points high-

ORDER, ORDER – In the Dairy program pupils have to decide on the delivery order, keep track of accounts and make RUNNING adjustments

Round number 12

Smith
3 Forest Road

	MILK	EGGS	BUTTER	CREAM
Mon	1	1	1	0
Tue	2	1	1	0
Wed	0	1	1	1
Thu	2	0	0	0
Fri	1	1	0	0
Sat	2	1	1	0

Press C to change delivery
Press B to pay the bill

£7.24

Small business can now stop going by the book.

For under £1,000 a small business can now equip itself with a BBC Microcomputer, a disc drive, a word processor and printer.

(All tax deductible by the way.)

Once you've parted with that money, you'll find that business has never been brisker.

Because now, there's a new series of floppy disc software specially for the smaller business.

It has been developed by Acornsoft, the software division of Acorn Computers who are the manufacturers of the BBC Micro.

For only £24.95, each disc can store volumes of vital bookwork which can be updated and amended in a fraction of the conventional time.

And there is a disc to cover most aspects of paperwork and book-keeping.

The Invoicing package.

This program stores details of products, VAT numbers and, of course, the names and addresses of your customers. As orders come in, you simply record them. Then, when it's time to invoice, you just press a few keys and each invoice or credit note is printed automatically in seconds.



Allowing for variable terms of trading, the system calculates and prints discounts. And it should help to improve your cash flow dramatically.

The Order Processing package.

With this program, you can confirm your customers' orders, prepare and print despatch notes and make fast analyses of individual orders or of all the orders stored on disc.



The Accounts Receivable package.

Now, it couldn't be easier to keep your customer accounts under control.

In an instant, you can analyse debtors, produce statements, keep a check on any credit limit and calculate VAT output automatically.

Using this package in conjunction with the invoicing package, you can also keep tabs on payments received against payments outstanding.



The Accounts Payable package.

This package will keep you fully up-to-date on how much you owe and who to. In addition, it calculates

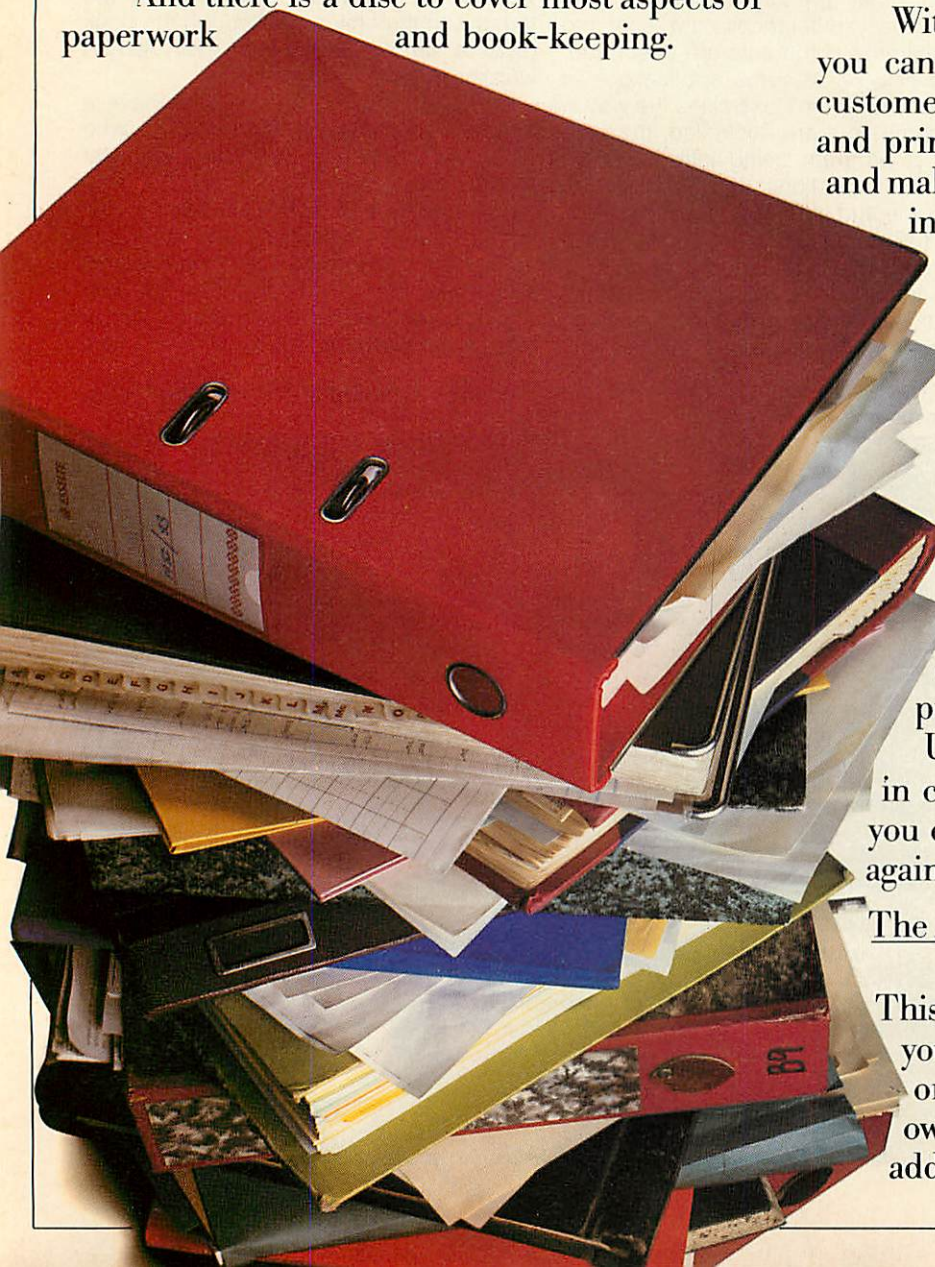

input VAT and, used with the Accounts Receivable package, produces instant VAT returns.

It also highlights settlement discounts, produces remittance advices and provides an immediate analysis of all creditors.

The Stock Control package.

Touch a few keys and you have instant access to stock status and automatic analysis by quantity and value.

Consequently, it's easy for you to maintain correct stocking levels, having an early warning of out-of-stock situations or the likelihood of over-stocking.



Average value of the business they do with you, or whether they are good or bad payers.

Then, when you are doing a mailing, you simply choose the group or groups of customers you want.

At £24.95 each, these packages could be priceless.

Each package comes with clear instructions on how to get the program running so that you can devote much more of your time to more profitable activities.

If you're a credit card holder, you can order any or all of the packages by ringing: 01-200 0200 anytime. Or 0933 79300 during office hours.

(By ringing the same number, you can get the address of your nearest stockist, or full details of the BBC Microcomputer system if you don't already have one.)

Alternatively, you can order the packages by sending the order form below to: Acornsoft, c/o Vector Marketing, Denington Estate, Wellingborough, Northants NN8 2RL. Please allow 28 days for delivery.

 Credit card holders, phone 01-200 0200, anytime. Or 0933 79300, during office hours.

The Purchasing package.

All your suppliers' names and addresses go onto the disc. Then they can be retrieved instantly for preparing and printing orders.

All order data can be recalled in seconds, allowing you to check on orders, and suppliers' invoices and to record all deliveries.



The Mailing package.

Instead of the shotgun method of sending mailshots, this package enables you to refine each mailing down to the customers who are most likely to respond.

It gives you a rapidly accessible mailing file of your customers, according to any criterion you choose. Size of company, for instance, or type of business.



To: Acornsoft, c/o Vector Marketing, Denington Estate, Wellingborough, Northants NN8 2RL.
Please send me the following business software packages at £24.95 each.

PROGRAM	QUANTITY	TOTAL	(Code Acornsoft use only.)
Invoicing			SNB 08
Order Processing			SNB 12
Accounts Receivable			SNB 10
Accounts Payable			SNB 13
Stock Control			SNB 11
Purchasing			SNB 14
Mailing			SNB 09
TOTAL			

I enclose PO/cheque payable to Acornsoft Ltd. Or charge my credit card.

Card Number _____
Amex/Diners/Visa/Access (Delete)

Please send me details of the BBC Microcomputer System

Name _____

Address _____

Postcode _____

Signature _____

Registered No. 1524763

VAT No. 215 8123 85

AC.4.



to each question posed in that chapter. The second part explains in detail how to use the six programs.

The activity sheets are a collection of single-sided A4 sheets which may be copied for class use, to be used with the programs by students at the computer. They serve the dual purpose of focusing the student's attention on the task and recording his progress. My only criticism is that teachers may be tempted to let the activity sheets do all the work and not produce any useful material of their own.

The documentation is supplied on one side of the single tape package. It can be loaded onto a model B BBC micro and displayed on screen or printed out. The tape is positioned in the recorder and rewound. Then the first program is CHAINED. This loads a further program, which performs a number of tests to set up the printer.

The documentation is then loaded and printed out on paper, if a printer is available; otherwise it is displayed on-screen. During this printout each printer is given a type number. My Olivetti ink-jet printer was regarded as type number 1, and although it reproduced two test patterns equally well, it performed line feeds only after I nominated the second pattern as correct. Users may need to experiment here.

The documentation itself is brief and obviously intended as a reference guide, although it is an alternative to the more complete documentation for those who have not bought the teacher's notes.

The program tape consists of six main programs, each prefixed with a loader program. They are not protected against copying, but each loader program must be copied to allow its companion program to run. The loader programs display a company logo (which on my version still says 'ICL'). The main programs are designed to run on model Bs with either cassette or disc filing systems, and level 1 Econet versions are soon to be available. Acorn CES wisely suggest that back-up copies be made. The

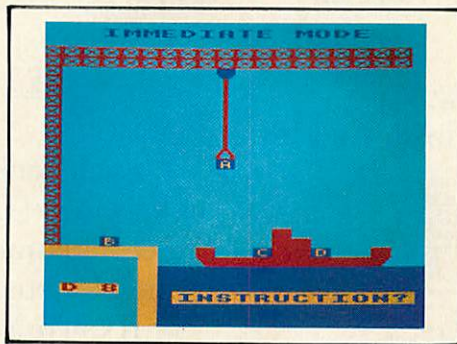

CRANE CONTROL – Cargo lets the children operate a crane

programs on the tape are:

Calling program	Main program
EMERG	IT1
DAIRY	IT2
CARGO	IT3
VEHICLE	IT4
FASHION	IT5
HOUSES	IT6

As well as displaying a logo while the main problem is loaded, each calling program sets a number of system variables. This means it is important to include the calling program (and hence the logo) in any back-up. Some programs allow the use of a printer and users are informed at the beginning of a run at which point they can answer 'no' or select their printer type. Pressing Escape during any program gives the opportunity to end or continue execution, while pressing Break restarts the execution from scratch. In addition a simple Help command is provided in each program by pressing the '@' key.

Emerg (Emergency), the first program on the tape, supports chapter 1 of the student's book and illustrates the computer's ability to solve complex problems rapidly.

Users are presented with three different situations in which they select one of four ambulances and direct it to the scene of an emergency. A map of Taddlecot is shown where streets are measured in time intervals (a topological map). The aim is to

minimise the 'thinking' time for selecting an ambulance and the journey time for that ambulance.

After each journey the computer solves the same problem and users are invited to compare results. After the third journey, students are given the opportunity to create their own emergency situations by moving both the ambulances and the emergency to new locations.

Using the program proves easy, though some teachers will prefer the sound to be turned off, as it is rather powerful. My only complaint centres on the colour scheme for the map, ambulances, emergency and chosen routes. Except for the ambulances, the graphics are all line drawings, so the effect of flashing lines on a black background is startling. I would have preferred a coloured background. However the program achieves what it sets out to do, regularly demonstrating that it can reduce the thinking time for even the fastest pupil by half, and shorten the ambulance journey by several minutes.

Dairy is the second program on the tape. Supporting chapter 3 of the student's book, it illustrates ways in which the computer can process data in order to provide information in a variety of forms.

Users are shown a list of a roundsman's customers in delivery order. Then, using the map provided in the activity sheets, they must decide on an appropriate delivery order for additional customers. They can examine and update customer accounts and verify that the loading information has been altered to correspond.

This program is much larger than EMERG and weighs more heavily on the user. The pupils must drive this program, and the activity sheets are a must, in my opinion. Unlike EMERG, it is possible to get nothing at all from this program, unless previous activities have prepared the children and the teacher has explained what must be done. The program has an essentially menu-driven structure, and the sequence of menu options and the reason

WHEEL BASE – Information retrieval demonstrated in Vehicle.

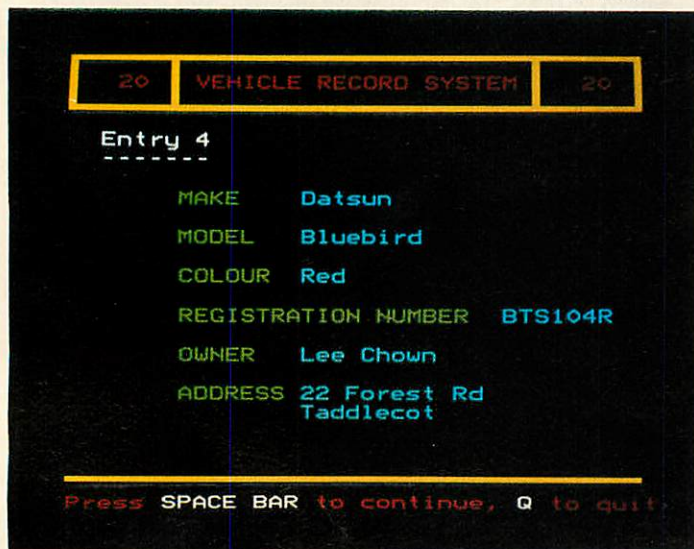

RAG TRADE – Fashion is for five dedicated followers of stock control

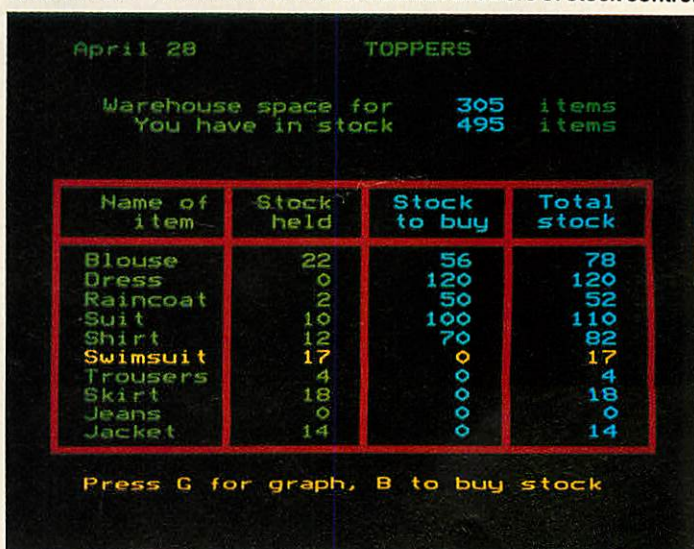

for that sequence must be firmly established by the teacher before less able pupils use the program. The layouts are impressive, and the methods of information input are compatible with commercial practice. Another high-rating program.

The third program on the tape, Cargo, supports chapter 7 of the student's book and introduces the idea of a program as a series of instructions. Users are presented with a dockside scene in which a number of crates are to be loaded onto a waiting ship by means of an overhead crane. The crane is controlled by sequences of simple instructions and care must be taken to distribute the weights evenly on the ship. The program functions in one of four modes:

1. Immediate mode, where instructions are obeyed as they are entered.
2. Program mode, where the instructions are entered and stored.
3. Execute mode, where the stored instructions are executed.
4. Single-step mode, in which stored instructions are executed one at a time.

This is perhaps the program which will appeal to most children. The chance to operate a crane, loading cargo onto a ship, is one not to be missed. The CES team have thoughtfully provided many motivators in the program, apart from the success factor. Sound is well used and the screen display, including the mnemonics for the crane programs, well organised. A human touch has been added by allowing careless operators to sink the ship if they misplace the cargo or the crane's jaws. A good teacher will find many uses for this program and it will provide a springboard for further studies by the children.

Computers, Information and You is the first in a set of two packs in the Acorn CES series 'Living with Computers'. It is available from Acorn CES, c/o Vector Marketing, Denington Estate, Wellingborough, Northants NN8 2RL. Enquiries to Acorn CES on (0628) 71592

Some local education authorities are purchasing a software licence for all schools in their areas, so if you are a teacher it may be best to check prices with your local Advisory staff.

Prices

Pupil's Book	£2.95 (schools) £3.95 (other)
Teacher's guide and activity sheets	£9.50 (schools) £12.50 (others)
Pack of 6 programs	£25.00

Vehicle, the fourth program, supports chapter 9, illustrating one use of a computer in information retrieval.

It contains details of more than 170 vehicles belonging to people in the Taddlecot area. Users may select vehicles according to make, model, colour or registration number, and they can use combinations of these details to select vehicles. A list of selected vehicles may be displayed, printed, and extended or refined by further enquiries.

This is another program that can be 'played with' at a superficial level, without much learning occurring. But if the teacher prepares the material properly and the children use the activity sheets there will be no problem, but simply to let the children loose on it with no pre-knowledge or aim would be wasteful. The displays are clear

and understandable, and the program succeeds in simulating an important application.

The Fashion program, supporting chapter 10, illustrates how the computer may be used to make business decisions.

It is a game played among up to five individuals or groups. The aim is to sell as many items of clothing as possible in each of six fortnightly trading periods. The only constraint is the stock-holding capacity of the warehouse. The computer can present information which the users can interpret to assist in the purchase of stock. This help is in the form of graphs showing sales trends and an updated table containing details of stock held and on order.

This program seems unassuming, even boring, at first glance, yet it covers probably one of the most important applications of computers in commerce. My own experience has been that the program tends to be used as much by the Home Economics and Business Studies departments as by the computing department of a school. Once the element of competition between teams is introduced, the program can form the basis of a range of business-type games, and there is a valuable side-effect involving the interpretation of graphs, which makes the program even more useful. The problem is that some children need a practice run before the competition, as it takes a short time to get accustomed to the key sequences.

Houses, last of the six, supporting chapter 11, illustrates the use of the computer as an aid to visualising the final stages of an as yet incomplete project. Users see a plan of a proposed housing estate in Taddlecot. By moving a pointer on the plan, they can see a variety of three-dimensional views of the estate in its completed form.

This program is easy to use, and acquits itself creditably as an important part of the pack. Like Fashion, it can easily be transferred into other curriculum areas, where it can be used to advantage. Despite a small problem with perspective and the fact that the Taddlecot builders have only one design of house, the program achieves its aim.

Until I saw this pack I thought that most of the exciting software was to be found in the primary age-range. Although I'm tempted to say that fourth-year junior children would get a lot from the package, I feel it is really aimed at the first couple of years of the secondary school, though teachers of older children will have a short honeymoon period of using it with their pupils in 'appreciation' courses. Although the package produces a model short 'awareness' course in information technology, it would be possible, in schools without computing departments, to share the package among departments so that it was covered in different areas of the curriculum. However it is deployed, the package provides a valuable 'gentleman's knowledge' of many of the applications of information technology.

HOME KEYS – The computer as visual aid to planning in the Houses program

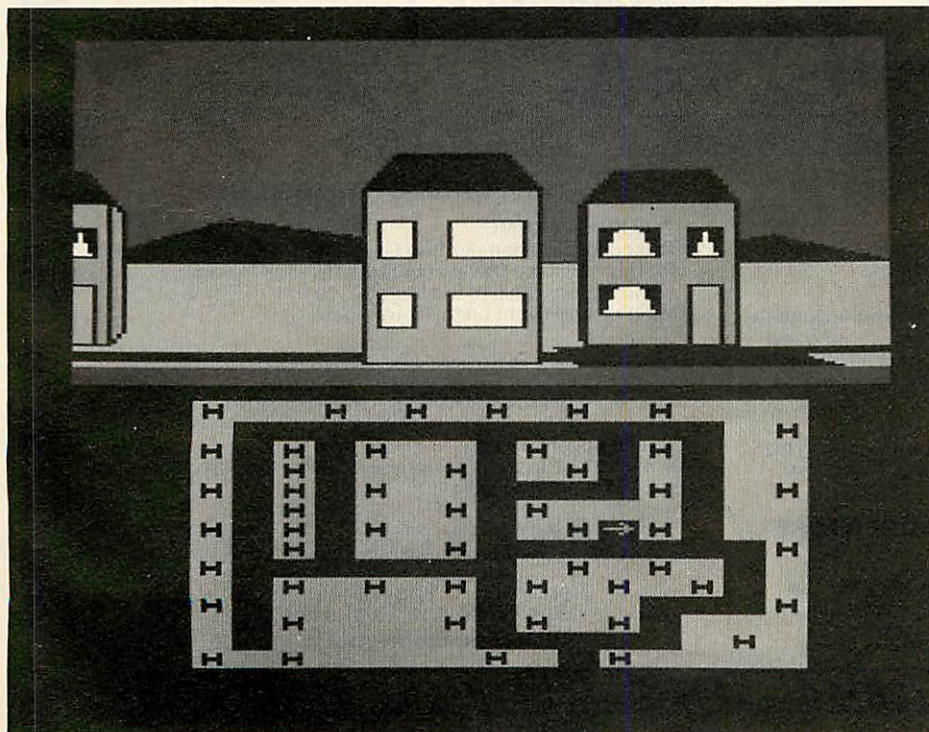

LORDS OF TIME

Joins our range of acclaimed pure-text puzzle-adventures, at £9.90, for:

BBC 32K **COMMODORE 64 SPECTRUM** 48K **LYNX** 48K **NASCOM** 32K **ORIC** 48K **ATARI** 32K

ADVENTURE REVIEWS

"Adventures which have a fast response time, are spectacular in the amount of detail and number of locations, and are available to cassette owners . . . Simply smashing!"

— *Soft, Sept 83*

"Colossal Adventure is included in Practical Computing's top ten games choice for 1983: "Poetic, moving and tough as hell."

— *PC, Dec 83*

"Colossal Adventure . . . For once here's a program that lives up to its name . . . a masterful feat. Thoroughly recommended"

— *Computer Choice, Dec 83*

"Colossal Adventure is one of the best in its class. I would recommend it to any adventurer."

— *Acorn User, Feb 84*

"Adventure Quest . . . This has always been one of the best adventures for me as it seems to contain the lot. In all it took me about eight months to solve."

— *PCW, 18th Jan 84*

"To sum up, Adventure Quest is a wonderful program, fast, exciting and challenging. If you like adventures then this one is for you"

— *NILUG issue 1.3*

"Colossal Adventure is simply superb . . . For those who want to move onto another adventure of similar high quality, Dungeon Adventure is recommended. With more than 200 locations, 700 messages and 100 objects it will tease and delight!"

— *Educational Computing, Nov 83*

ADVENTURE REVIEWS

"Colossal Adventure . . . undoubtedly the best Adventure game around. Level 9 Computing have worked wonders to cram all this into 32K . . . Finally **Dungeon Adventure**, last but by no means least. This is the best of the lot — a truly massive adventure — you'll have to play it yourselves to believe it."

— *CBM 64 Users Club Newsletter*

"The puzzles are logical and the program is enthralling. **Snowball** is well worth the money which, for a computer program, is a high recommendation."

— *Micro Adventurer, Dec 83*

"Snowball . . . As in all Level 9's adventures, the real pleasure comes not from scoring points but in exploring the world in which the game is set and learning about its denizens . . . this program goes to prove that the mental pictures conjured up by a good textual adventure can be far more vivid than the graphics available on home computers."

— *Which Micro?, Feb 84*

"Lords of Time. This program, written by newcomer Sue Gazzard, joins my favourite series and is an extremely good addition to Level 9's consistently good catalogue . . . As we have come to expect from Level 9, the program is executed with wonderful style — none of those boring "You can't do that" messages! Highly recommended."

— *PCW, 1st Feb 84*



MIDDLE EARTH ADVENTURES

1: COLOSSAL ADVENTURE

A complete, full size version of the classic mainframe game "Adventure" with 70 bonus locations added.

2: ADVENTURE QUEST

Centuries have passed since the time of Colossal Adventure and evil armies have invaded The Land. The way is long and dangerous; but with cunning you can overcome all obstacles on the way to the Black Tower, source of their demonic power, and destroy it.

3: DUNGEON ADVENTURE

The trilogy is completed by this superb adventure, set in the Dungeons beneath the shattered Black Tower. A sense of humour is essential!

THE FIRST SILICON DREAM ADVENTURE

1: SNOWBALL

The first of Pete Austin's second trilogy. The giant colony starship, Snowball 9, has been sabotaged and is heading for the sun in this massive game with 7000 locations.

THE LORDS OF TIME SAGA

7: LORDS OF TIME

Our congratulations to Sue Gazzard for her super design for this new time travel adventure through the ages of world history. Chill to the Ice-age, go romin' with Caesar's legions, shed light on the Dark Ages, etc.

Price: £9.90 each (inclusive)

Level 9 adventures are available from good computer shops, or mail-order from us at no extra charge. Please send order, or SAE for catalogue, to:

LEVEL 9 COMPUTING

Dept A, 229 Hughenden Road,
High Wycombe, Bucks HP13 5PG
Please describe your computer

CALLED BY REFERENCE

BBC BASIC is a great improvement on the standard versions of Basic found on other micros. Apart from being very fast, it is designed to promote structured programming. This article demonstrates how the BBC procedure call, already far superior to the GOSUB command from the point of view of readable code and the ability to pass the values of variables into subroutine, can itself be greatly improved.

Several articles and books have discussed the problem of how to pass variables back out of procedures. None so far has suggested very satisfactory answers. The problem arises because procedures in BBC Basic call variables by value rather than by reference. Only the values of variables are passed into the corresponding dummy variables in the subroutine. Since these dummy variables are local to the subroutine, any operations upon them leave the variables outside the subroutine unaffected. If this is unclear, try running listing 1. This program returns the value A equals 2, since A is unaffected by the procedure.

Languages such as Fortran adopt a different method for passing variables into subroutines, known as call by reference. When A is passed into a subroutine, the location in memory of the variable A is assigned to the corresponding variable

John Ryding explains how variables and arrays can be passed into and out of procedures in Basic, effectively changing the procedure call to a call by reference. His technique, he believes, allows you to write more structured programs. Particular tasks, such as sorting arrays and inverting matrices, can be hived off to separate subroutines that can be written in general terms and included in any program without your needing to know details of the array to be passed from the main program

within the subroutine, and thus operations on A inside the subroutine affect the value of A outside. For example, if one compiled and ran listing 2, Fortran would return the value 4.

In this simple illustrative case, the problem could be solved in BBC Basic by using a function call, which returns a single value; however, in more complicated cases, typically those involving arrays, this solution cannot be used. The ability to pass arrays into and out of procedures would be a very useful addition to BBC Basic. A procedure, perhaps a sort routine (or an algorithm for inverting a matrix), could be called from any part of the program, and sort any array (or invert any matrix). Indeed, one could maintain a library of useful procedures and use them in any program (programs can be merged using *SPOOL) without having to alter the procedure for the specific array it has to deal with.

The solution lies in somehow passing the location in memory where the array we wish to operate upon is stored. If this location

could be 'attached' to an array inside the procedure, then operating on this array would also alter the array outside the subroutine.

To see how this can be done, we need to know a little about how variables and arrays are stored inside the BBC micro. Most versions of Basic store the name of each variable and its value as it is created. To find a particular variable, the computer has to search the whole Basic heap. However, BBC Basic maintains a separate list for variables beginning with different letters (upper and lower case being treated as distinct letters). An area of RAM starting from &0482 is used to store the pointers of the first variable beginning with a particular letter, two bytes for each. For example, &0482 and &0483 contain the least significant byte (LSB) and most significant byte (MSB) of the address of the first variable beginning with the letter A. Thus the address of the first variable beginning with A is given by $(? &0483) * 256 + (? &0482)$. The formula to determine the pointer to the LSB of the first variable beginning with any letter, A\$, is:

$$2 * \text{ASC}(A\$) + \&0400$$

At the address given by the pointer is the LSB of the address of the next variable beginning with A\$, with the MSB in the next address. Then follows the name of the variable (excluding the first letter), including % or \$ if relevant, and an open bracket in the case of an array. The end of name is marked by a zero byte. After this follows details about the dimensions of the array (if any) and the data. For example, if an array called ARRAY (...), was located starting at address &6000, then memory from this location would contain the information detailed in table 1.

The routine to pass an array by reference into a subroutine works as follows (listing 3). Pass the array name into the subroutine as a character string (including \$ or % if relevant). The example is a routine which reverses the elements of an array. Inside the procedure, call a function (FN pointer)

```
10  A = 2
20  PROCSQUARE (A)
30  PRINT A
40  END
50  DEF PROCSQUARE (A)
60  A = A*A
70  ENDPROC
```

Listing 1. Variable A remains unaffected

```
A = 2
CALL SQUARE (A)
PRINT A
END
SUBROUTINE SQUARE (A)
A = A*A
RETURN
END
```

Listing 2. The value of A outside the subroutine is changed

Memory location	Contents of location
&6000	LSB of address of next variable beginning with A
&6001	MSB of address of next variable beginning with A
&6002	ASC ("R")
&6003	ASC ("R")
&6004	ASC ("A")
&6005	ASC ("Y")
&6006	ASC ("")
&6007	0 (end of name marker)
&6008 and onwards	Details of dimensions and data

Table 1.

to search for the address of the start of this variable. This function works by starting at the pointer for the address of the first variable starting with the same letter as the array name (line 270) and searches through the variables beginning with this letter until the array is found, or the list is exhausted (lines 280 to 370). If the array exists, the memory location of the array three bytes lower in memory than the end of name marker is returned, or four bytes lower if the array is a string or integer array (lines 360 and 380). The LSB and MSB of this address can be poked into the memory locations for the pointer to the first variable beginning with another letter (in the example x is used, see lines 160 to 180), and the array can now be referred to as x (...) in the procedure.

In this example (suppose that ARRAY (...) was stored from &6000 onwards as in table 1) the x pointer will be set to &6004, so that the memory is in the correct configuration, ie &6004 and &6005 are set aside to contain the address of the next variable beginning with x, and &6006 contains the rest of the array name "(".

If you enter and run listing 3, you will see that the array has been re-ordered, proving that we have passed ARRAY by reference. There are some points to note about this listing.

First, since the pointer to the first variable beginning with x has been altered in PROCreverse, any variables or arrays in the main program beginning with an x have been lost. There are two solutions to this: one could use a modified version of FN pointer to find the last variable beginning with an x, and place the address for ARRAY in here; alternatively, unless we want to pass a variable by reference beginning with x, we could add:

```
165 LSB = ? start: MSB = ? (start + 1)
```

which would store the address of the current x pointer, and

```
235 ? start = LSB: start ? 1 = MSB
```

to replace the original pointers at the end of the procedure.

Second, the routine can be easily modified to pass non-array variables, by including the open bracket when passing arrays. One would have to modify line 370, then exclude + "(" since this is now included in the procedure call, and alter line 380 to place point to the correct location (you might like to try this as an exercise to check your understanding of the article).

Third, any letter can be used to represent the array(s) passed, by altering the parameter in the FN start call.

The techniques presented in this article show how one can greatly improve the BBC PROCedure call. If you use them, you will be able to write many of your programs with greater clarity than previously. It is only a shame that calls by reference were not included in the Basic itself, so that one did not have to resort to such measures as those presented here.

```

10 REM Routine to pass
15 REM variables by reference
20 REM into procedures
25 REM by John Ryding.
30 REM Acorn User (1984)
40 DIM ARRAY(5)
50 FOR I=1 TO 5
60   ARRAY(I)=I
70 NEXT I
80 PROCreverse("ARRAY",5)
90 FOR I=1 TO 5
100  PRINT "ARRAY(";I;")=";
ARRAY(I)
110  NEXT I
120 END
130 DEF PROCreverse (A$,n)
140 LOCAL point,start
150 point=FNpointer(A$)
160 start=FNstart("(")
170 ?start=point MOD 256
180 start?1=point DIV 256
190 FOR I=1 TO (n/2 DIV 1)
200   TEMP=x(n+1-I)
210   x(n+1-I)=x(I)
220   x(I)=TEMP
230 NEXT I
240 ENDPROC
250 DEF FNpointer(X$)
260 LOCAL loc,address,point
270 loc=FNstart(X$)
280 REPEAT
290   address=? (loc+1)*256+?
loc
300   IF address?1=0 THEN PR
INT "Array ";X$;" does not exist":END
310   loc=address : Y$="" :
address=address+2
320 REPEAT
330   Y#=Y#+CHR$(?address)
340   address=address+1
350 UNTIL ?address=0
360 point=address-3
370 UNTIL Y#=#MID$(X$,2)+" ("
380 IF RIGHT$(X$,1)="#" OR R
IGHT$(X$,1)="#" THEN point=poi
nt-1
390 =point
400 DEF FNstart(Z$)+2*ASC(Z$
)+&400

```

Listing 3. The array is passed by reference

THE DRIVE FOR QUALITY



In the rapidly expanding world of computer peripherals there is one company which continually leads the field — Cumana. Whether it is the best Japanese components used in our top quality designs, the rigorous training which all staff receive, or the superb technical service we offer, everything must be of the highest standard.

Cumana disk drives have an independent power supply, 12 months warranty, and are fully assembled and tested before packaging; and they are now available for the BBC and Dragon Micros — at unbeatable value for money prices — from selected branches of W. H. Smith and Spectrum UK in addition to Cumana's nationwide dealer network.

For further information on these and other Cumana products — including dual slimline disk drives for the BBC Microcomputer — contact:

Cumana Limited, Pines Trading Estate,
Broad Street, Guildford, Surrey, GU3 3BH.
Tel: (0483) 503121 Telex: 859380



Dragon is the registered trademark of Dragon Data Ltd.

<p>For further information about Cumana disk drives, please complete and return this coupon.</p>	<p>I am interested in Cumana disk drives for the BBC/Dragon* Microcomputer. *delete as necessary</p>	<p>Interests: Home Use <input type="checkbox"/> Education <input type="checkbox"/> Dealer <input type="checkbox"/> Business <input type="checkbox"/></p>
<p>Name</p>		
<p>Address</p>		
<p>Tel. No. AUA/84</p>		
<p><i>Note: If dealer, please attach this form to your letterheading</i></p>		

SPICE FROM SPRITES

All aboard – sprites, turtles and pixels! But Malcolm Banthorpe finds no bugs in Computer Concepts' Graphics Extension ROM

THE Graphics Extension ROM is the latest piece of firmware from Computer Concepts to follow the Wordwise, Beebcalc and Disc Doctor chips.

Many programmers must have noticed, when consulting the *User Guide* on such topics as the PLOT command, that certain codes have been 'reserved for future expansion' and wondered when some enterprising company would get round to producing a graphics extension ROM. (Acorn's promised version not having been heard of since 1982!), There must be a good reason for those apparently useless extra zeros in the VDU19 command.

The Computer Concepts ROM contains many of the facilities that might have been expected in such a product, although it doesn't make use of the reserved codes.

While the graphics commands in the Beeb's operating system and accessible from Basic are probably more extensive than in any other machine of its class, several features could have been usefully added if there were space. This ROM goes some way to filling the gaps and provides a number of facilities not generally found elsewhere.

Some sort of circle-drawing command is now quite common on other home computers. Although most people who have done graphics programming will know at least one way of writing a suitable procedure, it is undeniably much more convenient to be able to simply type

*CIRCLE 640 512 300

to draw a circle of radius 300 at the centre of the screen. The speed of drawing is probably considerably better than could be achieved with any Basic routine. The price of this convenience is that any programs incorporating these new commands will not be transportable to a machine not equipped with the ROM.

All the commands, with one exception, are preceded by asterisks, as is normal with commands that are directed through the operating system. All are accessible either directly from the keyboard or within a Basic program. As with all operating system calls, there must be no other Basic statements on the same line, with the exception of a 'MODE 8' command, which is used just as the normal Basic MODE statement.

As its name suggests, it gives you an extra graphics mode. The resolution is lower than the existing ones at 80 by 256 but it allows the full 16 colour (eight flashing) to be displayed simultaneously, while the screen uses only 10k of memory. A possible use would be for a game that requires more than four different colours

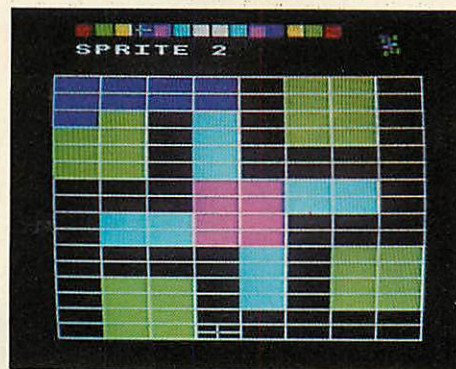

and also occupies more program and data memory than the 8k or so that would be available in mode 2. Text in this mode appears as 32 lines of just 10, rather fat, characters.

Apart from mode 8 the ROM offers 29 new commands and a useful *HELP function which can be called upon as a reminder of the syntax which of any of the commands expects. Abbreviations, ending in a full stop, are permitted and could be useful in saving memory, since these commands will not be stored in a tokenised form, as Basic keywords are. If you make a mistake in using any of the commands, there is a fairly comprehensive list of error messages and, where appropriate, the correct syntax will be pointed out.

Commands can be divided into three groups: sprites, turtle graphics and general-purpose.

Several home computers offer hardware-based sprite graphics that allow small shapes to be moved rapidly around the screen. In this ROM 11 commands allow the creation of sprite characters and use software to move them around the screen. Software sprites cannot be moved as quickly as their hardware counterparts but allow Basic programmers to spice up games that otherwise require machine

code to achieve speed and smooth movement.

Sprites differ from ordinary user-defined characters in that each may contain any selection from the available colours of the graphics mode in use, rather than just a foreground and a background colour. It is theoretically possible for a mode 2 sprite to contain all 16 colours. It may be up to three characters wide by three characters deep (24 by 24 pixels) and there can be up to 32 different sprites. Initially the command *RESERVE sets aside a section of memory, normally just below the screen area, to hold the sprite definitions. The manual gives instructions for estimating how much memory you need to reserve, taking into account the number and size of the sprites and which mode you are using.

The command *DESIGN, which takes a sprite number and its size as arguments, draws a grid of the appropriate dimensions and a palette of the available colours. Sprites are easily created, using the keyboard to move a colour-selecting cursor and to fill the squares that correspond to individual pixels. Figure 1 shows a mode 2 sprite in the process of being defined. The sprite is displayed actual size at the top right-hand corner of the screen.

Up to 32 different sprites can be defined and stored. *IN and *OUT are used to position them on the screen and to remove them. When a sprite is to be moved you don't have to delete it from its existing screen position before re-plotting it. The *IN command will simultaneously erase it from its old location before re-drawing it.

If you need to leave a permanent image of a sprite at a particular screen location the command *IMAGE can be used.

*FILM allows a sequence of up to 47 sprite numbers to be specified. Subsequently, each time that particular film number is called, the next sprite in the sequence is plotted. The sequence will repeat after the last item has been displayed, a convenient way of setting up simple animated sequences. For instance, two or three slightly different space invader sprites displayed in quick succession can give the effect of moving arms, legs, eyes, etc. Once the basic shape of a sprite has been designed, *ALTER allows slight variations of this type to be rapidly incorporated into new definitions without having to enter the whole shape again.

The main use of sprites is in games, but they can be more generally useful for the display of the cursors and symbols (or, to use a fashionable word, 'icons') that need to be moved around the screen. Their main limitation as implemented in this ROM is that their horizontal position can be defined

only to the nearest screen byte. As a result, in mode 1 they move across the screen in four-pixel steps and in mode 2 in two-pixel steps. The effect is that while smooth vertical movement is possible, some slight jerkiness is apparent on horizontal and diagonal movement. This should not detract too much from their effectiveness and is a minor deficiency considering how easy they are to define and move quickly, with a single command, from Basic.

Using a FOR...NEXT loop, I found that four 3x2 sprites could be moved 1,000 times in just under 40 seconds in mode 1. Put another way, four sprites can be moved in 1/25th of a second or one television frame. This, of course, does not allow for any other processing between moves (which a game or any other program would almost certainly require) but gives an idea of the speed possible. Smaller sprites take less time to move.

*DATA will return information about any or all of the sprites and show how much reserved memory is free. It returns such information as the memory location of each sprite definition, the mode in which it was defined, and its size. *RESET deletes any or all definitions. Two more commands allow a set of sprite definitions to be saved and loaded on tape or disc.

A function often found with hardware sprites but conspicuously lacking here is one to detect collisions between one sprite and another or between a sprite and other screen objects. It will be needed in some form for most games but poses no real problem as the exact location of each sprite will be known, and only a little programming will be needed to monitor the hits.

Like the *CIRCLE command mentioned earlier, the luxury of having all the commands available directly from a sideways ROM will have considerable appeal. In this form, the only extra memory required is for the sprite definitions themselves – an important consideration when using modes 0 to 2.

The second and smallest group of commands is concerned with 'turtle' graphics and is probably best considered as a useful alternative to the normal Basic plotting commands. Instead of specifying the end co-ordinates of a line, you merely specify its length and direction. In this way it is easy to generate complex geometric patterns without having to think of the co-ordinate geometry involved.

As the 72-page manual mentions, one of the main reasons for the increasing popularity of Logo in education is its use in turtle graphics. As all the commands can be entered directly from the keyboard, people with no programming knowledge can draw simple shapes on the screen by typing familiar words such as FORWARD, BACKWARD, RIGHT and LEFT. These commands can also be used to advantage within programs to draw more complex shapes. For instance, a procedure to draw a hexagon of side length L%, starting at

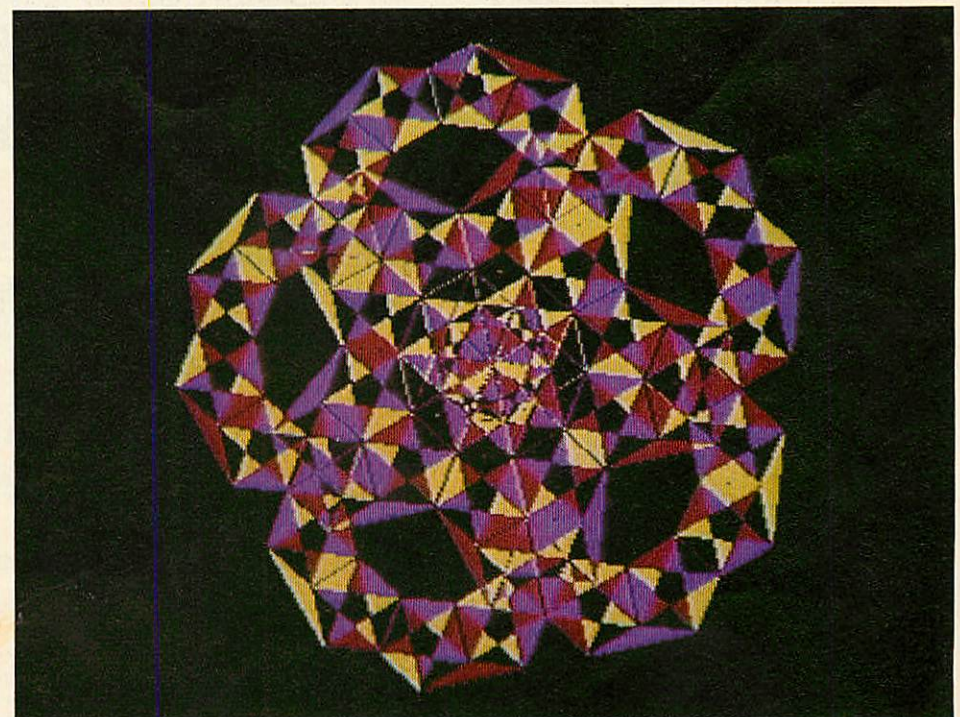
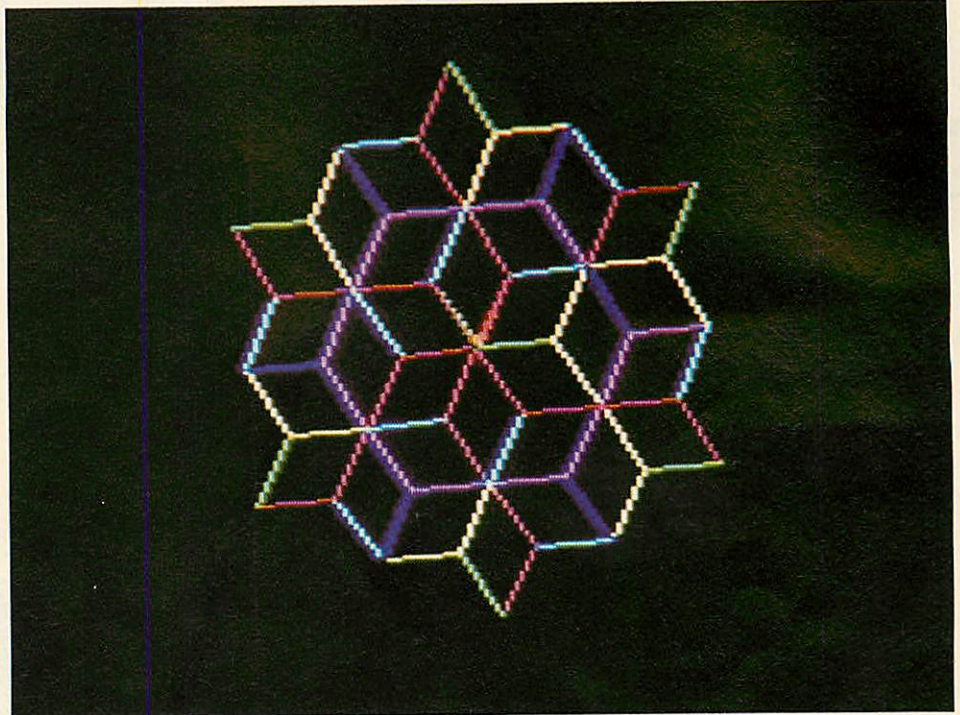

screen co-ordinates X%,Y%, could be:

```
1000 DEFPROC hexagon(X%,Y%,L%)
1010 *POS X% Y%
1020 FOR SIDE = 1 TO 6
1030 *FORWARD L%
1040 *RIGHT 60
1050 NEXT SIDE
1060 ENDPROC
```

*POS moves the turtle to a starting point. Although it is not normally possible to pass variables to operating system commands, this ROM allows the integer variables A% to Z% to be used as arguments. At first I assumed this would mean that only the system variables A% to Z% could be used. In fact, as the above example demon-

strates, local variables with these names are also permitted.

There are also advantages to be gained in using turtle graphics when you're required to rotate a shape. For example, once a hexagon has been defined as above, you need only change the initial angle of the turtle to rotate the whole hexagon around the starting point (the ROM also provides a more general means of rotating the screen display around any point – see later).

The turtle itself is displayed as an arrow shape whose size, proportions and colour may be set using a *TURTLE command, although if maximum plotting speed is required the turtle does not have to be

W THE WAR W

RUN CITIES, COUNTRIES, CONTINENTS— BUT, BE WARNED!

Someone is about to press the button for **Apocalypse**

The leading game (APOCALYPSE) has four different maps, on any one of which you may fight your war (see section A.). An additional tape which contains a further six maps may also be added to expand your atlas (see section B.). Alternatively, you can be NERO in the FALL OF ROME or NAPOLEON'S CAMPAIGN in 1813 (see section C.). Can you survive the War of 1984 or could you lead your marines from island to island in the PACIFIC war? (see section D.).

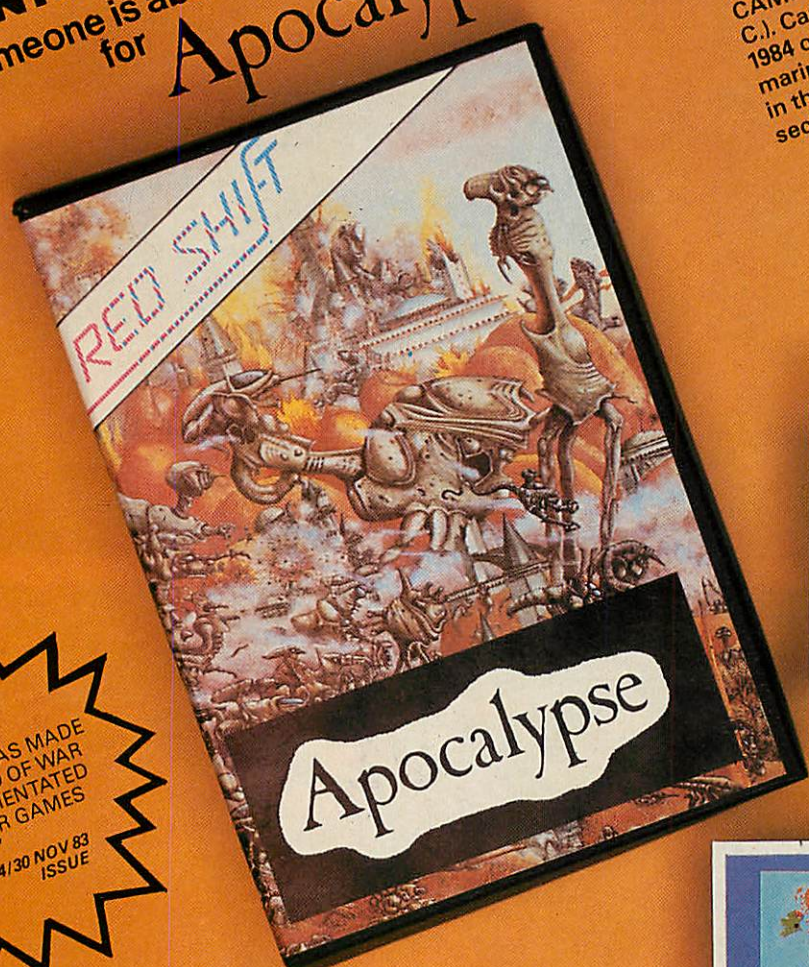

A. APOCALYPSE For: Spectrum 48K & BBC Model B £9.95 inc. VAT and P&P. Available from J. Menzies, Boots & Microdealer UK.	B. Volume 1: NOVAMAPS Six New Maps USA ARCTIC CIRCLE SE ASIA STAR SYSTEMS S AFRICA NETHER EARTH
C. Volume 2: CHAPTER 1 FALL OF ROME NAPOLEON'S CAMPAIGNS 1813	D. Volume 2: CHAPTER 2 THE 1984 PACIFIC WAR

Expansion Kits for Spectrum 48K (B, C & D only) £4.95 each inc. VAT and P&P.
 Microdrive version available by negotiation.

"REDSHIFT HAS MADE THE WORLD OF WAR GAMES ORIENTATED COMPUTER GAMES ITS OWN"
 P.C.W. — 24/30 NOV 83 ISSUE

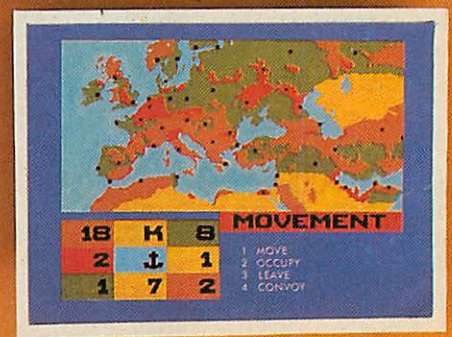

NEW RELEASES!

- NEBULA**
A masterly introduction to a strategy game!
48K Spectrum
£6.95 inc. VAT and P&P
- FIRST EMPIRE** *COMING SOON*
Your introduction to complete "Table top moderated war games"
48K Spectrum & BBC
- REBELSTAR RAIDERS**
Can you survive the Rebel Star Raiders?
48K Spectrum
£9.95 inc. VAT and P&P
- TIME LORDS** *COMING SOON*
Get entangled in the complexities of time travel...

HOW TO ORDER. You may purchase any of the items listed by cheque or postal order. All you have to do is fill in the details in the coupon enclosing your cheque/P.O. made payable to **BINDERMAN Ltd** and your order will be dispatched within 7 to 14 days. All prices inclusive of VAT and P&P.

Post to: REDSHIFT LTD, 12c MANOR RD, STOKE NEWINGTON, N16.

I would like to purchase item(s):
 (Please circle/tick item(s) required)

A B C D (For Apocalypse) Available for BBC/Spectrum (Delete which is not applicable)

Nebula Rebel Star Raiders

I enclose my cheque/P.O. for £.....

Name

Address

Tel (Day) Tel (Eve)

Please allow 7 to 28 days for New Releases



12c MANOR ROAD, STOKE NEWINGTON, LONDON, N16
 TEL: (01) 800 1333

Apocalypse is produced under licence from The Games Workshop Ltd.



displayed. A further parameter of the *TURTLE command determines whether the trail left by the turtle is a solid line or composed of dots or triangles. Figure 2 shows a fairly typical turtle graphics pattern. I haven't come across the ability to leave a trail of triangles in turtle graphics before. It can produce some interesting effects such as in figures 3, 4 and 5, in which I have also used EXCLUSIVE-OR (GCOL3,...) plotting.

The other commands in this section are *PENUP and *PENDOWN, which determine whether or not the turtle leaves a trail when it is moved.

The third and largest group, and the one which I found most useful, is composed of general purpose commands.

*SCALE allows the scale of all of the normal Basic plotting commands to be varied. For example, the statement

```
*SCALE 0 0 100 100
```

would make all subsequent plotting commands behave as if the bottom left-hand corner of the screen were location 0,0 and the top right-hand corner location 100 100. therefore

```
MOVE0,0:DRAW100,100
```

would draw a diagonal across the whole screen. This is not the same as using the co-ordinates of the two corners to define a graphics window, as when using VDU24. Effectively, it uses the whole screen to display what would be contained in a window defined by VDU24,0;0;100;100;. The horizontal and vertical scaling do not have to be the same and so the shapes can be squeezed and stretched. The manual says the screen size should not be defined as smaller than 12x12 or larger than 31000x31000. This gives a potential 'zoom' ratio of over 2,500 to 1. Some possible uses that spring to mind include

the display of maps or diagrams that can be examined in greater detail by zooming in on the area of interest. As long as the screen is redrawn after each *SCALE statement, using standard Basic plotting commands, this should be achievable.

Another possible use is as an aid to drawing detail when a joystick, graphics tablet or other graphics input device is being used. Small areas requiring accurate detail could be temporarily scaled up while the detail is entered and then restored to their intended size. Again, it doesn't seem to involve much additional programming. The manual nicely demonstrates a similar use with a program for a simple graph drawn using various scales.

*ROTATE will rotate anything subsequently plotted on the screen by a given angle around any point. So

```
*ROTATE 30 640 512
```

before plotting would give the effect of the whole screen having been rotated by 30 degrees around its centre point. Together with *SCALE it could be useful in computer-aided design and drawing programs. Neither this nor the previous command affects sprite shapes but will affect the position at which they are plotted. Nor do they affect display of normal text.

*PIXEL allows larger-than-normal pixels to be plotted. Both the width and height of what are effectively solid rectangles, can be varied. If the size parameters are omitted the size will be appropriate to the screen scaling. So

```
*SCALE 0 0 80 64  
*PIXEL 40 32
```

would plot at the centre of the screen a 'pixel' whose width was 1/80th of the screen and whose height was 1/64th. Width and height are also affected by

*ROTATE.

*PRINT allows text to be printed in any defined size on the screen. It is affected by *ROTATE so that sloping or vertical text is possible – useful for labelling graphs and diagrams. Non-standard GCOL parameters can be used to give patterned lettering, though experiment is needed to find out what will give the desired effect.

*CIRCLE, as mentioned, allows circles to be drawn rapidly. *ARC complements it by allowing arcs and parts of circles to be drawn. It can also be used to draw what the manual refers to as ovals but which appear to be true ellipses.

*FILL is a command for filling complex shapes. BBC Basic has the PLOT81 and PLOT85 type commands for filled triangles and these can be adapted for filling some other shapes. *FILL will fill an area of any shape as long as it has an unbroken boundary of a colour other than that of the starting point. Even a small break in the boundary results in the fill colour 'leaking out'. It is slow in action, depending as much on the size of the area to be filled as its complexity, but is faster than equivalent Basic routines.

*PATTERN is described as 'a complex routine allowing a large variety of patterns to be drawn'. It behaves in some ways like a compound turtle command and takes up to six arguments. It has the property of not terminating until the graphics cursor returns to the starting point. I used

```
*PATTERN 5 640 512 500 300 1
```

to draw the ellipse in figure 6. By changing the last argument, an angle step, to 72, a pentagon was drawn that fits inside the ellipse exactly. Substituting 120 produced a triangle, which also fits exactly inside the ellipse. Spirograph-type patterns are also possible by using angle steps that don't divide exactly into 360 degrees so that the pattern goes through several revolutions before it terminates. One of the other variations I found useful was as a rapid method of drawing filled circles and polygons.

*PLOT takes four arguments, consisting of an operator, which determines the type of plotting, and three co-ordinates. It is used to draw projections of three-dimensional lines, points and triangles. The ease with which it can be used encourages experiment with wire-frame representations although, as with all 3D graphics, the initial task of working out all the co-ordinates can be tedious. More solid-looking shapes are possible if 85 is used as the first argument. Figure 7 shows a series of random vertical and horizontal planes drawn with this command. Figure 8 is a less abstract-looking example of how it can be used, involving a longer program. Here I avoided having to estimate any co-ordinates of the main shapes by letting the program calculate them from SIN and COS functions.

*GFX is a multi-purpose graphics effects command used to return various pieces of information about the other commands. Its

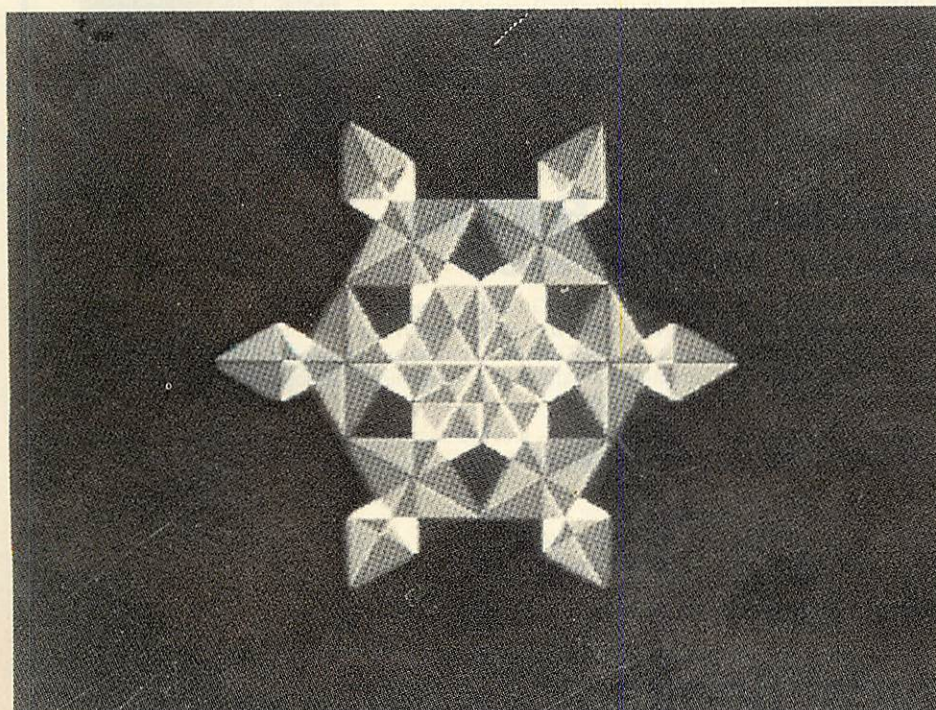

exact function is determined by the arguments used and the information returned in the integer variables A%,B%,C%,D% and E%. For instance, the Basic POINT command cannot be used to read the colour of one of the large pixels but a GFX command will return the value. Included also are fast SIN and COS functions that could be particularly useful in conjunction with the *PLOT command for 3D rotation.

The manual, like earlier examples from Computer Concepts, is well laid out and describes all the commands clearly and fully, giving plenty of programming examples to illustrate the effects. There are also details of what RAM is used by the ROM. Memory from &C00 to &CFF is used as workspace. This would normally be reserved for user-defined characters but there is a GFX command to reserve an

alternative section if these are required at the same time as the ROM facilities. For games or other programs that make use of &C00 to &CFF the ROM can be disabled with a *FX command.

Altogether, despite the minor limitations mentioned, this is an excellent package. With the exception of the sprites, for which machine code would be essential, most of the functions available could be written by a reasonably competent programmer in Basic, although they would run more slowly. More importantly, an attempt to implement more than a few of them in a mode 1 or 2 program could use up a significant chunk of the program memory.

Anyone writing graphics programs on the BBC micro (and still waiting for the second processor) is likely to be restricted by the limited program memory. With such a useful set of commands in a sideways ROM there is less constraint upon what can be included in a program and fewer compromises have to be made. Those with more limited programming experience will find that they have instant access to a host of graphics effects that they would otherwise find difficult to achieve.

In six weeks of use I've been able to discover no bugs and everything worked as described in the manual. The addition of this ROM to the Beeb considerably enhances the graphics facilities of an already exceptional machine.

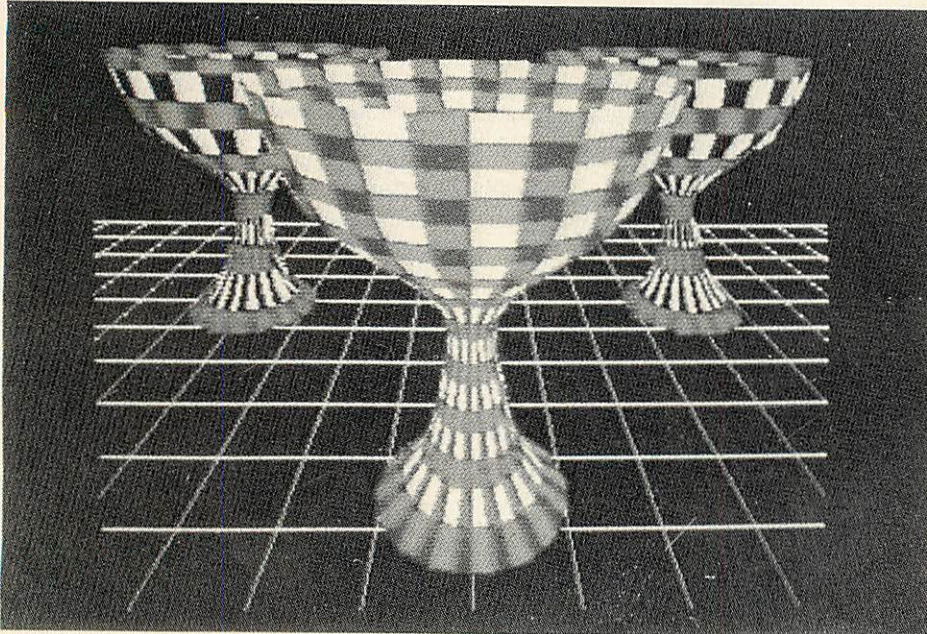

FOR THE BEST VIEWING ON BBC

BBC Micro Programs in BASIC

Derrick Daines

Here is a bumper collection of 27 games programs which utilise the excellent graphics and colour facilities of the BBC Micro. The games will run on the Model B or Model A with upgrade. Derrick Daines presents an absorbing variety of programs – you can run horse races, play word games, shoot torpedoes . . . even take on the role of Moses leading his people to the Promised Land! Each program is introduced with details of how it works, how to play it, the effects produced, and a list of variables used.

Softcover 128 pages 0 408 01415 6 £5.95

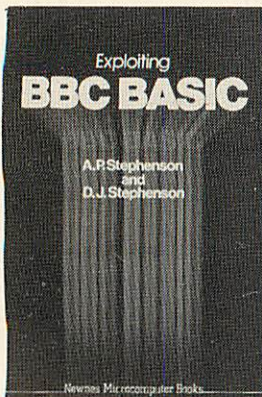
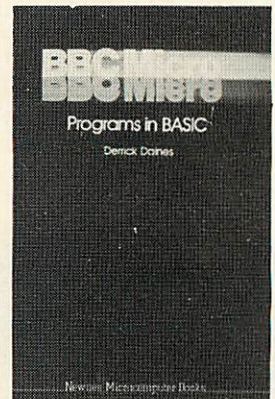

Exploiting BBC BASIC

A P Stephenson and D J Stephenson

This book has been written to complement the User Guide provided with the BBC Micro; its purpose is to emphasise the power of BBC BASIC and to show how the machine can be put to serious use. The book concentrates on the special strengths of BBC BASIC, comparison and explanation of the different modes available with the machine, structured programming, applications, storing and retrieving information, and the sound and animation facilities.

There are also a number of original program listings – and two cassettes are available which contain some of the longer programs! Using the cassettes with the book, you will soon be exploiting BBC BASIC.

Softcover 176 pages 0 408 01437 7 £6.95
 Cassette 1 0 408 00972 1 £6.90 (incl VAT)
 Cassette 2 0 408 00973 X £6.90 (incl VAT)

Available from all good booksellers

Newnes Technical Books Borough Green, Sevenoaks, Kent TN15 8PH

ELBUG FOR THE ACORN ELECTRON

JOIN NOW FOR A FREE CASSETTE

Join the Electron User Group

Members receive 10 copies of the magazine **ELBUG** each year. **ELBUG** is devoted **EXCLUSIVELY** to the **ELECTRON MICRO**. It is packed with News, Reviews, Hints, Tips, Programming ideas, Major articles, plus Regular program features including games and useful utilities.

ELBUG is produced by **BEEBUG** Publications Ltd., publishers of **BEEBUG**, the magazine of the National User Group for the BBC Micro. **BEEBUG** now has some 20,000 members and has achieved a high reputation both in this country and abroad.

The formula which makes **BEEBUG** an invaluable companion for users of the BBC micro, has been applied to **ELBUG**.

By subscribing to **ELBUG** you gain all the advantages of a single-micro magazine, with

no space wasted on programs and articles for other computers.

BENEFITS OF MEMBERSHIP

ELBUG MAGAZINE

Ten copies a year mailed free of charge.

DISCOUNT SCHEME

Extensive discount scheme with major retailers.

SOFTWARE LIBRARY

A growing range of software titles at budget prices for members.

SOFTWARE CLUB

Substantial discounts on software from major software houses.

LOCAL USER GROUPS

Lists of local affiliated user groups.

SPECIAL OFFER 8 FREE PROGRAMS

Subscribe now, and get a free introductory cassette containing 8 tested programs for the Electron.

1. **SPACE CITY**. Defeat the invading Aliens with your laser, and save the city
2. **3D NOUGHTS AND CROSSES**. Pit your wits against the **ELECTRON** on a 4x4x4 board
3. **RACER**. Guide your racing car to victory, avoiding other cars and obstacles on the track
4. **3D MAZE**. In this challenging game, you must escape from the maze - The screen displays a 3D view from inside the maze
5. **PATCHWORK**. A multicoloured display of continuously changing patterns
6. **KEY SET ROUTINE**. A program to set up the user function keys
7. **MEMORY DISPLAY**. An efficiently written utility to display the contents of memory (ROM and RAM)
8. **CHARACTER DEFINER**. Define individual graphics characters with this useful utility for use in your own programs.

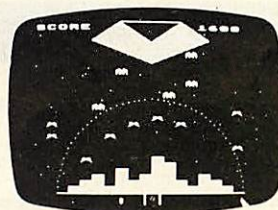

SPACE CITY

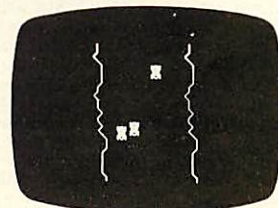

RACER

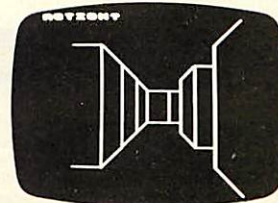

3D MAZE

HOW TO JOIN

To subscribe for one year, and get your FREE CASSETTE send £9.90 (payable to Orbit) plus a strong stamped addressed envelope (for the cassette)

SUBSCRIPTIONS TO: ELBUG, DEPT 13, PO BOX 109, HIGH WYCOMBE, BUCKS

Six months trial subscription (5 issues) UK only £5.90—FREE CASSETTE OFFER STILL STANDS.
Membership outside UK (one year only): Eire and Europe £16.00. Middle East £19.00. Americas and Africa £21.00, other countries £23.00.
Editorial Address: ORBIT, PO BOX 50, St Albans, Herts.

BBC COMES OF AGE..

β-BASE: (Ring for availability)

β-BASE is a very powerful and very flexible database program. Because β-BASE is designed specifically for disks there are none of the limitations found in most database programs, which are usually upgraded cassette programs. β-BASE is not limited by memory and even the disk limit can be overcome easily to provide an unlimited file size. Take a look at the features listed below and compare it with so called professional programs at up to £400, we think that you will be amazed.

Maximum File Size (40 track) - 99k & (80 track) - 199k.
Maximum Record Size - 2k; Maximum Number of Fields - 200;
Maximum Field Length - 254 chrs.

Options Include:

- 1) WRITE - for adding records.
- 2) WORK - for displaying records, editing and deleting.
- 3) CALC - allows you to cope easily with fluctuating prices and VAT rates. (works with whole file or search lists). Uses EVAL function allowing complex calculations to be performed, and the results to be displayed on screen or placed in a nominated field.
- 4) SEARCH - multiple function search on up to 5 fields.
- 5) OPTIONS: a) sort records found in search on 3 fields in ascending/descending order + set number of chrs to sort on (max records sorted is 500).
b) work search list, with edit and delete.
c) save records found in search to disc.
d) load previously saved search for re-search etc.
e) make a search list.
- 6) PRINTER - copes with parallel and serial printers and allows you to set up the printout + all printer codes allowed + allows you to join fields together and allows you to set them into columns etc. A label print routine allows single or double labels to be printed.
- 7) REDEFINE - allows you to transfer all records from old file to new file plus add or amend field or record size. No more re-entering all your data if you wish to add a field.
- 8) TRANSFER - allows you to transfer selected records between files.
- 9) NEW - allows you to define new file.
+ real time clock + many more features.

If you want a professional database for the BBC micro the β-BASE is your only option.

REPLICA II: £12.00

This is the one that everybody has been waiting for. The original REPLICA set a very high standard and many said that it could not be improved. The specification that we set our chief programmer included some supposedly 'impossible' features. In fact ACORN state that some of the things that we have done are impossible, it just took us a little longer that's all. REPLICA II will transfer most of your cassette based programs to disk, even more than REPLICA did. Now when you buy disk drives you do not have to throw away your expensive cassette based programs. REPLICA II will transfer 'LOCKED' programs, programs loading as files, programs that load below &E00, those with up to 6 sections and those up to &6E in length eg adventure programs. No more waiting for 6 minutes whilst your adventure programs load. REPLICA II is very easy to use and the user just enters a name, how many sections and whether CHAIN, *RUN or *LOAD is used to load the first section. Press play and let the program do the rest, even a menu. You cannot afford not to have a REPLICA II, think how much it will cost you to buy just 1 disk version of your favourite program - it is probably more than REPLICA II which will hold up to 16 programs, limited only by the disk capacity.

BEEBSYNTH: disk £11.00 cassette £8.00

A very powerful yet easy to use sound generating program that can be used by expert and novice alike. Up to 16 envelopes can be defined and saved. The envelope definer is very easy to use, control is through the cursor keys, and the effects of your changes can be heard immediately. When you have defined your envelopes press 'K' for Keyboard and the keyboard is transformed into a musical instrument, but you control which instrument. Lets you play chords, not just single notes, change pitch and duration etc etc. A superb program that you can use immediately. Unlimited sounds at your disposal. Recommended by MICRO USER, PCN, HCW etc.

THE KEY: £12.95

A disk utility program that provides the user with the tools to explore the disk environment and use it to its best advantage. The programs are:

- 1) FORM40 - Formats and verifies 40 track disks.
- 2) FORM80 - Formats and verifies 80 track disks.
- 3) BACKUP - Allows backup copies of your valuable disks to be made.
- 4) EDITOR - Enables the user to read the disk sector by sector and to alter programs on the disk, even most protected and unlistable ones. More fun than any adventure game.
- 5) RETRIEVE - Allows the user to recover data or programs that have been accidentally erased or damaged by a head crash.

Every disk owner should have one, you will wonder how you ever managed without it. Recommended by

WHICH MICRO, EDUCATIONAL COMPUTING etc. 'THE KEY' has been imitated by many but bettered by none.

NOTE: All disk software is now available on 3" disks. Just add £3 to the printed prices. Ring for prices of special deals e.g. any 2 programs on same disk.

available at larger

Boots

JOYSTICK UTILITY: £6.00

Converts non joystick programs to work with joysticks. Works with any program using INKEY (-) in Basic or machine code, to detect movement, which applies to most programs. The routine is relocatable and sensitivity of the joystick can be varied. Compatible with most games, including Acornsoft. Very easy to use, just press the keys you want to transfer. The machine code can be saved as a block of just 100 bytes. Supplied on cassette but can be transferred to disk.

available at larger

Boots

SHADOW: £8.00

SHADOW is a tape cloning program that will enable you to make security copies of your own valuable cassette software. SHADOW works with 99% of all known programs including those with sections at 300 BAUD and those that load as files. SHADOW will handle programs with any number of sections and it will work with any of the current operating systems including 0.1, 1.0, & 1.2. SHADOW is the definitive tape backup system and as a bonus you also get 'INSPECTOR' on the same tape. This allows you to view all areas of memory, search and alter bytes, etc. Colour coding helps to simplify memory usage. All this for just £8.00, I don't know how we do it. 'It is a condition of sale that this program is not used for piracy'.

NOTE: All prices are inclusive of VAT and postage - NO EXTRAS!

Clares[®]
MICRO SUPPLIES

**Dept. BMU4, 98 Middlewich Road,
Northwich, Cheshire, CW9 7DS.**

Tel: 0606 48511

All prices inclusive of VAT + Carriage - No Extras.

CHILD'S PLAY

HOW do computers fit into primary education? This question has tested decision-makers for several years, although at least one consensus is appearing – that just practising skills is too narrow an application for such a versatile machine.

One neglected source of opinion is the children themselves, some of whom hold strong views.

'That's pitiful!' exclaimed one of my fourth years, while watching a spelling program demonstrating this aspect of using computers. The program was a poor example of a skills practice program, but typical of many currently available.

Now using the computer to practise tables and spelling is not to be decried as it can provide the motivation and stimulation many children need. However, time spent on these activities can destroy the real potential and benefits of the micro.

As home computer programs become more sophisticated, so will the judgment of children – who often have more experience than adults of sitting at the machine and

It's a waste of the computer's huge potential to use it as a drill sergeant. Barry Holmes and Steve Fletcher prove the point in assessing the various benefits of five simulation packages from Ginn

know more about the range and quality of software. The child does not perceive the micro simply as a tutor, but more as a tool to explore and investigate the world. This has led us to believe that one of the major influences of computers is in the area of simulations.

What is a simulation? It is generally thought of as a model of a 'real' situation,

which can be analysed, the various components examined, and a set of rules devised. The way in which the elements or actions affect the flow and sequence of the activity and the consequences of various inputs must be examined and tested. Devising a simulation requires careful analysis to ensure the model resembles the actual conditions as closely as possible, given the limitations of the computer and the conceptual ability of the children.

When we started examining simulations some four years ago, they appeared to be confined to the higher levels of education. Their use in modelling scientific experiments allowed hypotheses to be tested without a large number of time-consuming experiments. Further examples found in the commercial field are now almost historic: 'Star Trek' and 'Lunar Lander' are classic examples, both modelling space flights, one based on reality, the other on imagination. They contain an element of role-play, and require decision-making and skills which have been or are being learnt,

The large-scale map supplied with the Adventure Island program

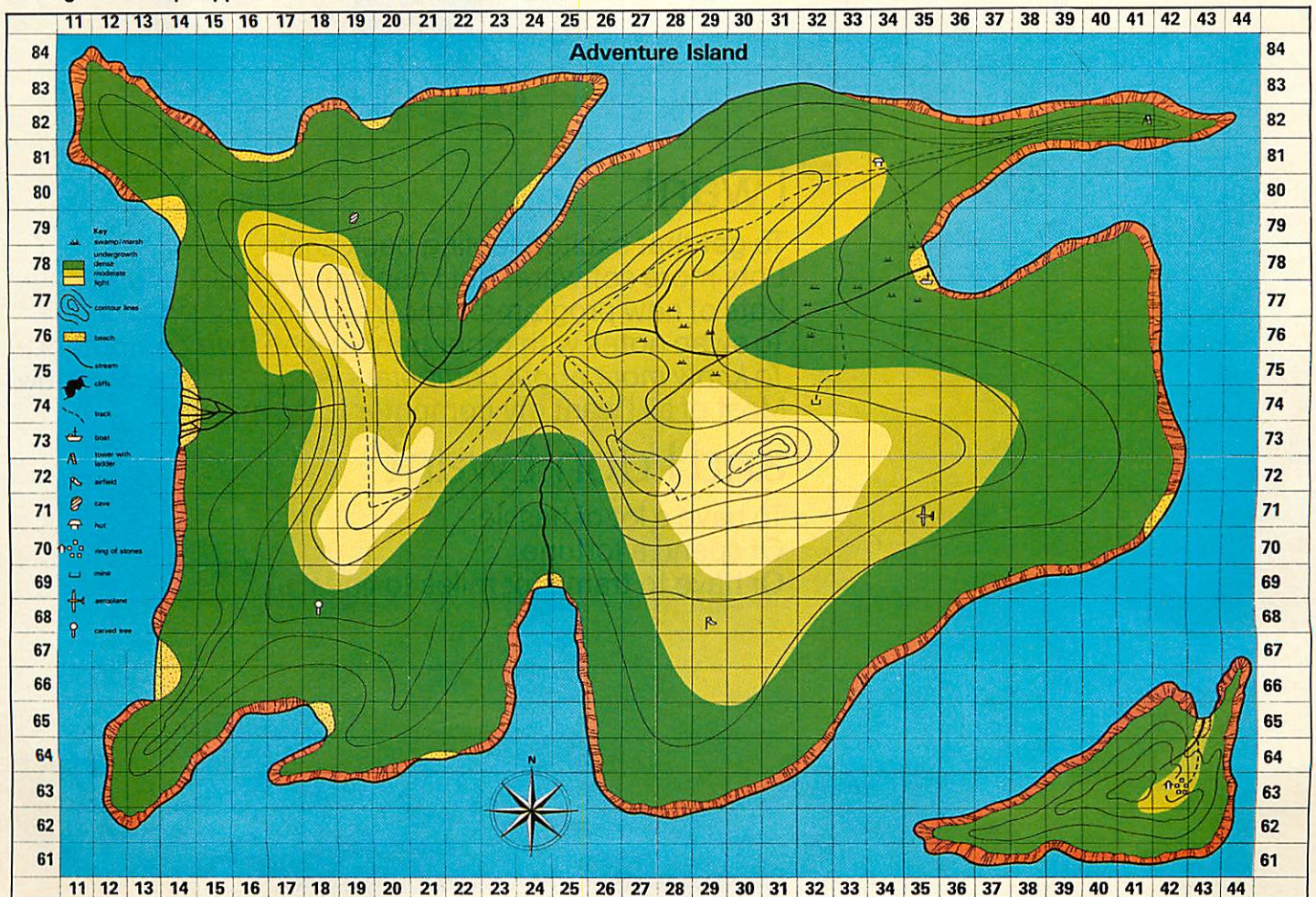

Sometimes even
the best of friends
need something
new to say
to each other..



“I want

To get that excited feeling back again.
Lots more software. But I can't afford it all the time.
Lots of new programs. I know all mine backwards.
To swap notes with other people who love computers.
To know more about computers. And to use what I know.
Most of all I want my computer to do more!

and I don't want

To have a lot of hassle.
Or spend a fortune.
Or have to tramp for miles to find it all.”

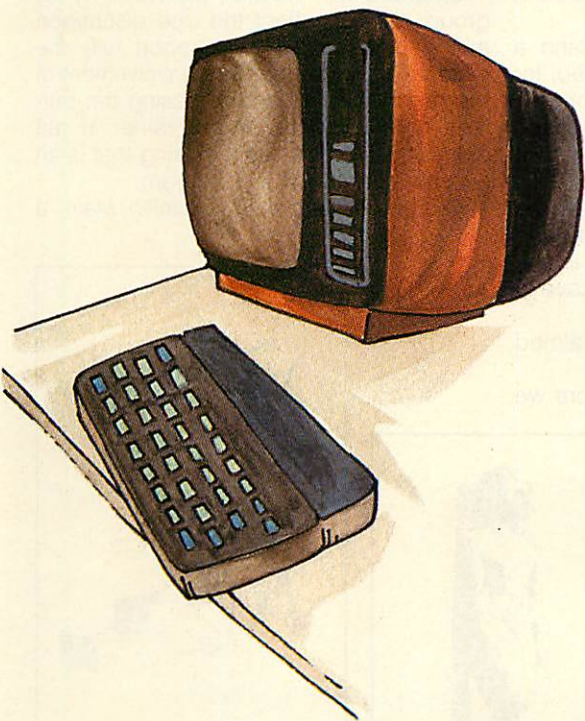

You get

An amazing new world of fun and learning. A system that puts more muscle into many popular makes of micro. Dozens of free computer programs and scores of exclusive software bargains. *Through your own 'phone line.* A whole sophisticated 2-way communication system. Prestel™ – the world's biggest viewdata system, under your control.

and you don't have to spend a fortune to get it all now.

MICRONET 800, Scriptor Court, 155 Farringdon Road, London EC1R 3AD Tel: 01-278 3143.

It's enough to blow the mind of any micro

RITA Recognition of Information Technology Achievement
AWARD

Systems Innovation of the year

I would like full details on Micronet 800.

Name _____

Make/Model of Micro _____

Address _____

Telephone _____

MICRONET 800, Scriptor Court, 155 Farringdon Road, London EC1R 3AD Tel: 01-278 3143.

AU4

micronet
800



One of the many faces on Prestel

independently of the program.

Landing a lunar module may be fun, but the reasoning and mathematics involved put this activity beyond the scope of most primary children's comprehension. Yet they enjoy playing the 'game' and some gain an uncanny proficiency even though they are not working to any mathematical formula, and decisions seem to be based on intuition.

How, or whether, to use a model with young children depends on their appreciation of a situation and must relate to their conceptual understanding. Simulations often demand prolonged activity and 'getting the feel' for an idea, so developing strategies and the motivation to become involved is paramount. A computer is essential for these activities because its speed of reaction means the project does not become too time-consuming and inefficient.

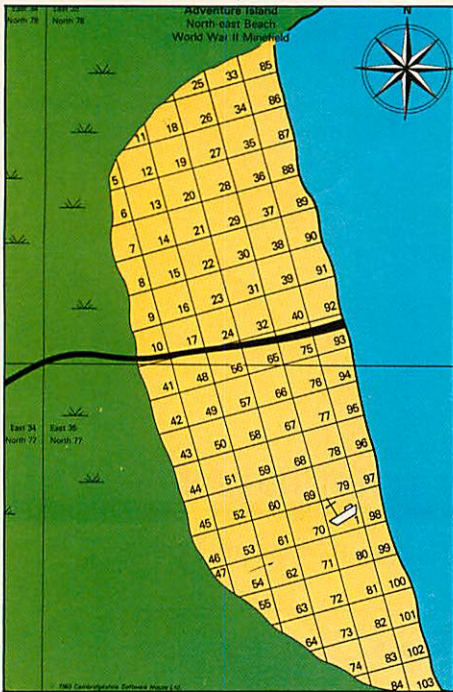

Local map of Adventure Island's mined North-east beach

Let's examine one adventure simulation and the questions that arise.

'You have found some tapioca,' reads the message on the screen. 'What is tapioca? How would you prepare it for eating?'

The answers to these two questions are certainly not: 'It's the "frog-spawn" we have for school dinner. You open the tin . . . etc.'

These two questions are among the many posed in one simulation, devised by Ian Whittington, called *Adventure Island*. The children, in groups of four, have to survive the rigours of this fictitious island, exploring the various features in an attempt to escape or summon help.

First, the children write a short story describing the events which led them to be marooned on the island. Then they must choose five items of equipment from a limited list to aid their survival: first aid kit; nylon cord; knife; mirror; box of matches; magnifying glass; shovel; axe; five-litre wa-

ter container; magnetic compass.

Then, starting from a predetermined position, they begin their exploration of the island, using a large-scale map as a reference of their position and guide to the features on the island. An integral part of the project is keeping a daily diary of the group's experiences on the island, as a part of a creative writing exercise. They also need to research the various 'finds', such as tapioca. They may have to decide, if they have taken a first aid kit, which medicine they need to administer should one of the group suffer from ailments such as heat exhaustion.

As they progress around the island a variety of problems need to be solved; for example, they may need to decipher a mathematical sequence or morse code message. They will also be faced with many dangers and dilemmas.

For instance, a group working on the program was attacked by a wild boar and Claire was injured. The two boys in the group were intent on travelling to a cave to gain shelter for the night.

'But if we carry on I'll die,' exclaimed Claire.

'No, we must reach the cave before we

rest for today,' determined the boys, more concerned for their own safety than Claire's plight.

Amanda, who had been concentrating on the map, joined the conversation: 'Claire will never make it! She has only 48% fitness now, and to go to the cave takes us up a steep climb; look at the contour lines.'

She pointed the route out on the map.

A heated discussion of the route and of Claire's health then took place, with the boys finally agreeing. 'Okay, we'll stop for the day and let her recover.'

Unfortunately, the diary produced by the group did not reflect the true discussion that had taken place or report fully the incident with the boar. The involvement of the group was not with pressing the buttons on the computer but rather in the discussion and decision-making that is an essential element of the program.

Another simulation is *Spanish Main*, a

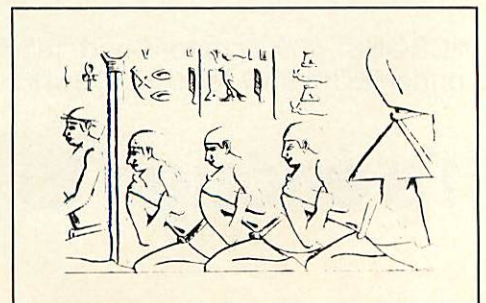
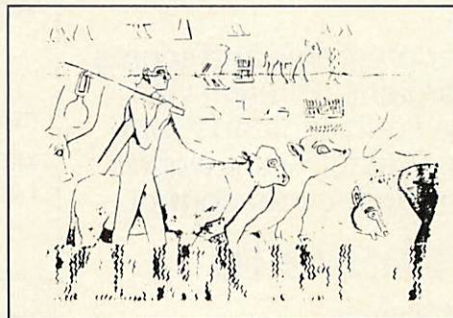
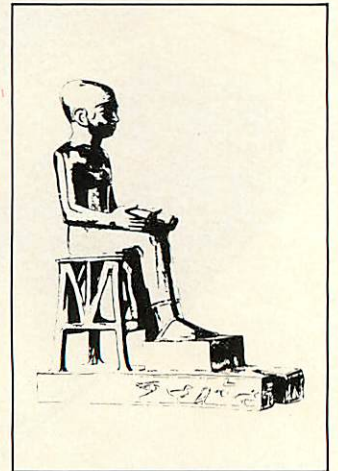

scenario of pirates searching for a treasure galleon. This is designed specifically for primary children. The program involved logical thinking related to planning, strategy and group co-operation, with groups

having tasks independent of, but still affecting, the actions of their opponents.

The simulation caters for two crews of four children each, sailing their galleons around a fictitious area of the Caribbean. The pirates have the task of capturing the treasure ship on the open sea. The other crew, while collecting treasure from various islands, have to avoid capture. The direction of the wind, the amount of booty on each island and on the treasure ship, all affect the decisions and consequences of the children's actions. The main problem for the pirates is to gain information on the whereabouts of the treasure ship, as each group comes to the computer in turn and initially has no information about the other group.

Information is acquired by visiting port and is given in terms of the amount of booty on board the treasure ship and, if it had visited that port, the direction it left in. The treasure is shown as chests of gold and bags of jewels. This pair of numbers enables the pirates to calculate the ports the ship had already visited and thus calculate where it might be heading. Each group is given a map on which to plot moves and to use in their discussion while awaiting their

turn.

Thus the computer is used for information storage, retrieval and processing and acts as an overall judge. Children are expected to take into account several factors, such as the direction of the wind, the direction of travel and thus the likely outcome, in their general strategy.

As with most good simulations, most of the planning and work is done away from the computer. In the above case it takes the form of some fairly heated discussion about tactics, some of which can be extremely devious.

The way children and teachers reacted to all this confirmed my belief not only in the place of the micro in the primary school but also in the potential of simulation. This faith has been further strengthened during the past three years.

In another simulation, *Expedition to Saqqara*, children are sent on an archaeological expedition to Egypt. Before commencing the program, they must write letters to the Department of Antiquities in Cairo for permission to dig at Saqqara and to universities applying for grants. The children work in groups and each child keeps a diary of events on the site.

On arrival the children have to survey their area. Each group's survey is plotted on a master plan of the area and information is shared as it is discovered. The computer will inform them if they find evidence of a possible site. This may be 'pot shards' scattered over the surface, or 'sand dampness' indications, each suggesting something worthy of investigation. They will also meet landmarks such as the Step Pyramid of Zoser or the Causeway of Unas.

Saqqara is a real place and the site has been carefully excavated, so the simulation must be as accurate as possible. The indications of a site are those an archaeologist would look for and they are in the 'right' place. The information has been researched with the help of Professor H. Smith of London University.

Having found a possible site, the children begin their excavation. Each tomb contains a series of passages, chambers and shafts closely modelled on those at Saqqara. As with the surface survey the children must carefully plot their excavation. They must decide on the number of workers to employ to do the digging through the 'sand-filled passages' or 'stone' to enter the tomb. Where they dig and what strategy they adopt must all be recorded or they could find themselves having to dig further tunnels, at extra cost, to re-enter the tomb.

When they are successful in making a find of archaeological significance a message such as 'Archaeological Find 48D' is displayed. The teacher then gives the children a picture and/or details of their discovery. It is at this point that the children search through the reference books for further information and try to attach appropriate significance to their find. One of the major values of this type of historical simu-

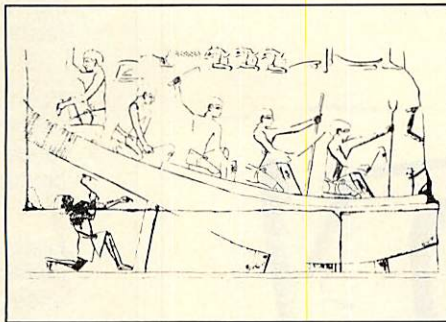
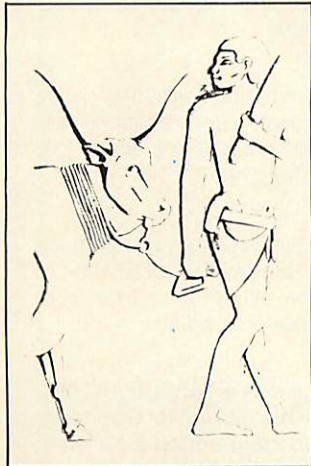
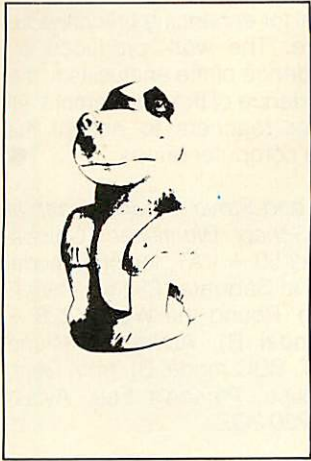

Game cards from the Saqqara pack, illustrating the archaeological discoveries that the pupils make

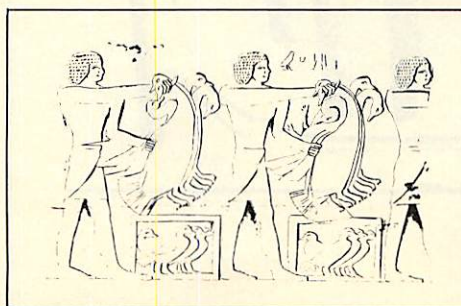
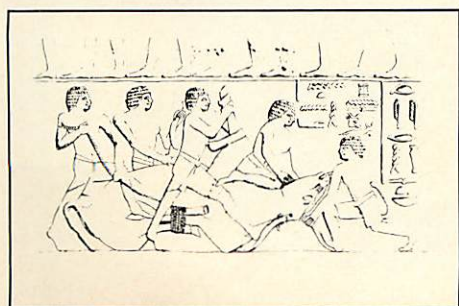

lation is shown at this point. The children are looking for a specific reference, developing a mosaic of historical facts linking each new find to their previously acquired knowledge. As the children discover new facts, they reorganise their thinking because of the new information, which serves to demonstrate that historical knowledge is not finite but is being added to daily.

At the end of their session, each group is given a summary of its finances and is informed of any disasters which have befallen it. These are varied and can include 'the Land-Rover breaking down' or 'offending the workers,' for which extra costs are incurred.

It must be stressed that the bulk of the work is done by the children away from the computer. Also, the learning is not derived from merely responding to the computer's display but is in the interaction of the group, the research and the joy of discovery. This is exemplified by the experience of one teacher who took his class to an Egyptology exhibition at the British Museum after running the program. While walking through one of the galleries a child suddenly exclaimed: "We found that!" It was a stone baboon from the site at Saqqara and had featured in the program. His excitement was real.

There is a series of simulations which are designed to encourage children to work co-operatively. Projects like the *Mary Rose*, which simulates the discovery and excavation of this now famous Tudor warship (see review in the February issue), are designed to give children the chance to speculate, to become involved as far as possible, in the reasoning processes used by the 'real life' experts.

Another simulation, *Round the World*, provides practice in reading simplified timetables, use of the 24-hour system, and

addition and subtraction of time. As the title suggests, the children have to journey to several countries in the world, starting from London. They must decide from a clue their next destination, how they will travel (using the permitted options), and calculate the length of the journey to their next destination. This may be part of a geography project in which the children produce a folder on the countries they visit during their travels. The groups devise a number of approaches to solve the problems. In some they work independently, coming together only to check their results, while others may work together.

One group that had to travel from Tunis to Tashkent, asked if they could go by train to Cairo, from Cairo to Delhi by plane and then drive to Tashkent. Asked why they wanted to take that rather circuitous route they replied: 'We can save 12 hours on the ferry and train option!' Unfortunately the computer program did not allow this combination, but as it already contains 20,000 pieces of information there is a limit to just how 'real' a simulation can be. I did, however, promise to take 12 hours off their total journey time if they recorded the details and could prove them correct. They did.

The examples used here to illustrate the idea of computer simulations with children serve to show the motivation and enthusiasm which can be generated. They give opportunities for groups of children to work together to solve a common problem. The contributions made by individuals in helping the group to succeed will vary during the course of the project. Children may lead, offer suggestions, or be purely supportive to ideas they consider of value. It is within the group that there will be this interplay and exchange of ideas which is one of the fundamental aims of these

simulations. If education is to be concerned with helping and improving the quality of children's thinking, it is essential that they are given opportunities to undertake exercises with this as a basic aim.

The potential for enhancing primary education is there. The work produced by children is evidence of the enthusiasm, the discussion evidence of the involvement. All it needs is for teachers to accept the challenges the computer brings. ●

Barry Holmes and Steve Fletcher teach at St Helens CP School, Bluntisham, Cambs. Mary Rose (£32.50 + VAT, for BBC model B), Expedition to Saqqara (£32.50 + VAT, BBC model B), Round the World (£28 + VAT, BBC model B), Adventure Island (£32.50 + VAT, BBC model B), from Ginn, Prebendal House, Parson's Fee, Aylesbury, Bucks HP20 2QZ.

Acorn User's consultant for the schools series is Paul McGee, of the Microelectronics Centre, Croydon.

POINTS

TO REMEMBER

1. Simulations can be just as effective in the primary classroom as in higher education.
2. Simulations allow pupils to follow the steps of historical figures or the reasoning processes of real life aspects.
3. Good simulations provoke pupils into discussion and decision-making: poor ones leave them just pushing buttons.
4. Young pupils often need much 'playing' time with a simulation to relate the situation to their conceptual understanding.
5. Historical simulations should help develop the ability to use references and to produce a coherent account of what happened.

The children have to research the significance of their find

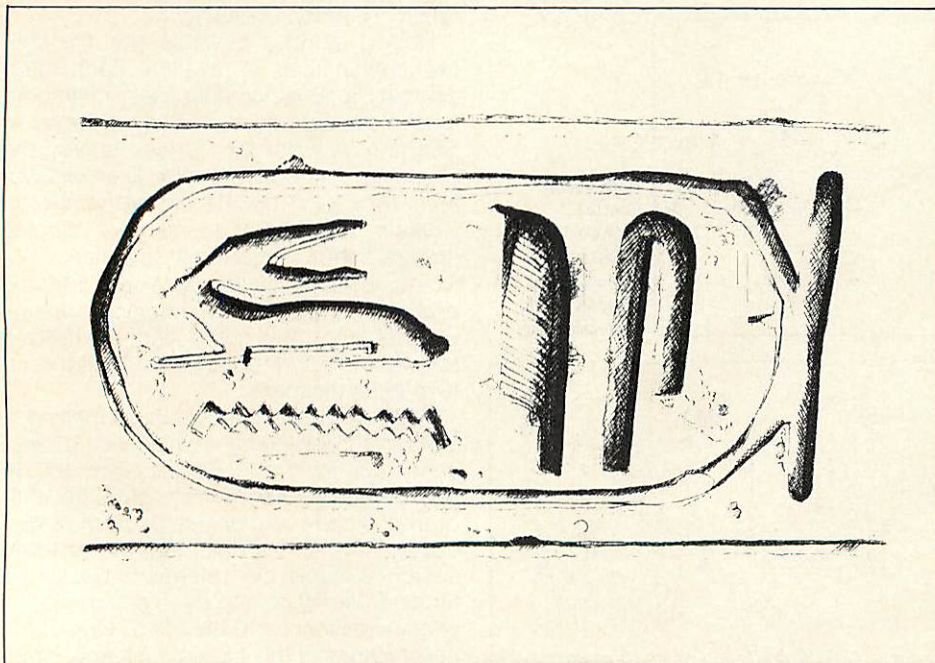

HEAVEN'S DATE

Paul Caswell's challenge was to computerise the formula by which Easter Sunday was fixed. He reached for his prayer book . . .

IT ALL started with a straightforward program to print the Gregorian calendar for any month of any year. 'When's Easter, then?' asked a voice. And so I set off on an analysis of the tables in the Book of Common Prayer that left me with extreme regard for the ancients and the beautiful simplicity of the system they devised.

Easter Sunday, you recall, is the first Sunday after the date of the Paschal Full Moon after the vernal equinox: when the sun returns to the northern hemisphere for our summer. So the first problem is to see how the date of this Paschal Full Moon is decided within the prayer book.

Using modern figures, the length of the (mean solar) year is 365 days 5 hours 48 minutes and 46 seconds; and of the (mean lunar) month 29 days 12 hours 44 minutes and 2.87 seconds. Hence:

19 years = 6939.601782 days
235 months = 6939.688362 days

In other words, the date of the Full Moon repeats in a 19-year cycle with an error of 0.08658 days (about 2 hours). Furthermore, each year equals 13 months *less* 18.65 days: the moon advances 18.65 days each year.

The first step is to construct a simple form of this 19-year cycle. To the nearest integer, each month will have 30 days and the advance from one year to the next will be 19 days – yes, 19 again! This the prayer book does, but there are two snags to be overcome:

1. A span of 30 dates would include two Full Moons, so only 29 dates are available to allocate to the 30 days of the cycle: this is overcome by counting either April 17 or April 18 twice.
2. Since $19 \times 19 \text{ MOD } 30 = 1$ rather than 0, the advance from the end of one cycle to the start of the next has to be 18 days rather than 19. This makes it essential that our program starts each cycle on the same year as the prayer book.

Now we need a way of numbering off the years within each 19-year cycle. This is done by calculating the 'Golden Number' by the formula $n = (\text{year} + 1) \text{ MOD } 19$, except that if this is 0 it is called 19.

So far so good. But remember that error of about 2 hours in each cycle? After 341.08 cycles this aggregates to a whole month. So there is another 'outer' cycle correcting the first simple 19-year effort. In fact, the prayer book gets stuck on the number 19 and uses 19×19 cycles, simplified to 69 centuries, for the period of this outer cycle.

If we ignore the year 1600AD, when the

table started off anyway, the cycle will contain 17 leap-centuries. So instead of cycling through our 30-day month as 0-29, we have to cycle 0 to $(29 + 17 = 46)$ and then knock off a number each time we cross a leap-century. This done, the pattern used in the prayer book is beautifully simple (see figure 1).

You can see that the pattern is almost achieved by a simple +1 +0 +1 +1 +0 +1 system, except that it is necessary to insert an extra 1 after 25 and after 50 centuries to achieve the desired cycle.

It is clear from the prayer book tables that the compilers did not realise that for the calendar to keep step with the sun, the years 4000 and 8000 will have to be non-leap. It is unfortunately difficult to persuade the authorities of Church or State to address this decision with the urgency required of our poor little computer! But this difficulty aside, it is now easy to construct a computer program to add the date of Easter Sunday to our calendar. ●

Figure 1.

Years	Pattern	Leap correction	Prayer book
1600	0 1 1 2	-0	0 1 1 2
2000	3 3 4 5	-1	2 2 3 4
2400	5 6 7 7	-2	3 4 5 5
2800	8 9 9 10	-3	5 6 6 7
...			
4000	16 17* 18 18	-6	10 11 12 12
...			
6400	32 33 34* 35	-12	20 21 22 23
...			
8000	43 44 45 45	-16	27 28 29 29
8400	46 0	-17	29 0

PASCHAL FULL MOON

The moon is not entirely regular in its habits, so may come around as much as two days before or after its 'mean time'. (The sun is also irregular: hence Greenwich mean time). In the interests of simplicity, this and other small discrepancies are accepted and the date of Easter calculated by reference to a 'theoretical' moon defined by the tables and called the Paschal (ie, Church) Full Moon.

JULIAN CALENDAR (Known as 'Old Style')

Established by Julius Caesar as from January 1, 45BC, this had 365 days in a 'common' year and 366 in a 'leap' year. One year in every four was to be a leap year and so the average year has 365.25 days. This is about 11 minutes too long, so after a while the seasons got out of step with the calendar dates – hence the need for a reform.

GREGORIAN CALENDAR (Known as 'New Style')

Pope Gregory XIII directed in 1582 that century years should not be 'leap' unless divisible by 400. Thus 1900 was not 'leap' but 2000, the last year of this century, will be. This 'New Style' calendar, which almost corrects the Julian error, was adopted in Great Britain by Act of Parliament in September 1752, but in some countries not until this century, and in some Eastern churches not yet! On adoption of this calendar, the one we use today, the dates were corrected for the discrepancy accumulated by the Julian error since the Council of Nicea in AD325, when the rules for Easter were decided.



Software News



INNOVATIVE
BBC SOFTWARE

from the professionals

ROM UTILITIES FOR THE BBC !

MOLI-TOOL

Moli-Tool is an essential programming aid/utility for the BBC Basic Programmer. As it is supplied on an EPROM it simply pops into the socket in the BBC and is constantly available for use.

- ★ **CHANGE** — Used to alter one variable name to another, or one string to another string within the program.
- ★ **CHARS** — A quick reference chart which displays normal ASCII characters and user defined characters, with a cross reference to the character number.
- ★ **FIND** — Finds virtually anything, that the user specifies, in the program. PROC, names, single letters, or whatever, FIND will give you the line number.
- ★ **FNKEY** — Displays the definitions or functions allocated to the function keys.
- ★ **MEND** — If you have a bad load, MEND will rescue whatever part of the program was loaded in.
- ★ **MEND+** — Mends programs which have been in memory but have since become corrupted.
- ★ **MOVE** — Moves a Basic program up or down in memory.
- ★ **STRIP** — Takes out all unnecessary spaces or REM statements.
- ★ **PAD** — Puts spaces back in.
- ★ **VAL** — *Extremely* useful. Supplies you with a list of the values of any current variables.
- ★ **VLIST** — Lists all referenced variable names in the program.

£28.00 + £1.00 p & p + V.A.T.

MICROMON

A powerful de-bugging tool and monitor, available on EPROM or tape. Micromon contains 23 commands which are as follows and are self-explanatory.

1. Modify memory in ASCII.
2. Modify memory in hexadecimal.
3. Set a breakpoint.
4. List all breakpoints.
5. Remove a breakpoint.
6. Display memory.
7. Execute a CALL.
8. Find a stipulated string.
9. Find a stipulated byte.
10. Execute a jump to a specified address.
11. Disassemble a stipulated section of memory.
12. Disassemble memory to the printer.
13. Change the contents of a register.
14. Change the contents of the program counter.
15. Trace the execution of a program by single stepping.
16. Skip the next instruction in single stepping.
17. Single step the next instruction.
18. Dump a stipulated section of memory to the printer.
19. Dump the screen to printer.
20. Plug memory, that is to say, load a stipulated byte into a block of memory.
21. Move a block of memory from one part of memory to another.
22. Move the memory display down by 64 bytes.
23. Move the memory display up by 64 bytes.

EPROM £28.00 + £1.00 p & p + V.A.T.
TAPE £14.00 + £1.00 p & p + V.A.T.

TEL: [0424] 220391/223636

MOLIMERX™ LTD
A J HARDING (MOLIMERX)

TELEX 86736 SOTEX G

1 BUCKHURST ROAD, TOWN HALL SQUARE, BEXHILL-ON-SEA, EAST SUSSEX.

SOFTWARE CATALOGUE ——— A4 size stamped addressed envelope for 17p.

◀ from page 105

page 108 ▶

◀ *from page 107*

3D COMPUTERS

THE HOME COMPUTER SPECIALISTS

Easy parking at all branches

TOLWORTH
230 Tolworth Rise South,
Tolworth, Surbiton,
Surrey KT5 9NB.
Tel: 01-337 4317

SUTTON
30 Station Road,
Belmont, Sutton,
Surrey SM2 6BS.
Tel: 01-642 2534

EALING
114 Gunnersbury Avenue,
Ealing, London W5 4HB.
Tel: 01-992 5855

NEWBURY
26, Stanley Road,
Newbury
Berks RG14 7PB.
Tel: (0635) 30047

RICKMANSWORTH
Grey Stone Works,
The Green, Croxley Green,
Rickmansworth,
Herts WO3 3AJ.
Tel: 0923 779250

LUTON
1 Manor Road,
Caddington, Luton,
Beds LU1 4EE
Tel: (0582) 458575

WITH MORE BRANCHES THAN
ANY OTHER ACORN DEALER
WE OFFER

ONE-STOP SHOPPING

FOR YOUR
BBC MICRO
AND
ELECTRON

CALL IN AT YOUR LOCAL
BRANCH FOR FRIENDLY
ADVICE AND SERVICE
SEE A COMPLETE DISPLAY
OF HARDWARE & SOFTWARE
TO BUILD UP YOUR
ACORN MICRO SYSTEM

SOFTWARE

PROGRAM POWER
BUG-BYTE
SUPERIOR SOFTWARE
A & F
SIMON HESSEL
MOLIMERX
ALLIGATA
ACORNSOFT

PERIPHERALS

DISCS SINGLE/DUAL
TORCH Z80 DISCS
CUMANA DISCS
PRINTERS
JOYSTICKS
MONITORS
B & W/COLOUR
LIGHT PENS
BBC BUGGY

*large range of books,
diskettes, cassettes &
printer paper always
in stock*

PRICE BREAKTHROUGH

NEW CASH &
LOW CARRY
PRICE PRICE

COLOUR MONITORS

FIDELITY CM14	189	180
MICROVITEC 1431	209	199
MICROVITEC 1451	313	299

MONOCHROME MONITORS

SANYO DM2112	73	69
SANYO DM8112CX	97	92

TORCH ADD-ONS

ZEP 100 — EXTENSION Z80 PROCESSOR WITH £1,100 OF SOFTWARE UNDER CP/M COMPATIBLE OPERATING SYSTEM	339	322
Z80 DP2 — AS ZEP 100 BUT INCLUDES TWIN 400 K DISK DRIVES, P/S AND CABLES	730	695

MATRIX PRINTERS

SEIKOSHA 80	158	150
SEIKOSHA 100	188	179
KDC FT-5001 (COMPATIBLE TO RX80 F/T)	237	226
EPSON RX80	242	230
EPSON RX80 F/T	279	265
EPSON FX80	382	363

DAISYWHEEL PRINTERS

JUKI 6100	374	356
SILVER REEDEXP 500	307	293

NEW CASH &
LOW CARRY
PRICE PRICE

DISC DRIVES

SINGLE 100K	158	150
SINGLE 200K 3"	200	190
SINGLE 400K	261	248
DOUBLE 200K 3"	393	374
DOUBLE 400K	508	483

FLOPPY DISCS

3"	4.75	4.50
S/S 40T	1.75	1.65
D/S 40T	2.20	2.10
D/S 80T	2.80	2.65
FREE LIBRARY CASE WITH EVERY 10 5 1/4" DISKS.		

NEW CASH &
LOW CARRY
PRICE PRICE

**ALL PRICES SHOWN
INCLUDE V.A.T.**

DELIVERY CHARGES FOR MAIL ORDER:
FLOPPIES (10'S ONLY) — ADD £2
ALL OTHER ITEMS — ADD £10

SOFTWARE/FIRMWARE FROM ACORNSOFT, COMPUTER CONCEPTS, PROGRAM POWER, A & F, LEVEL 9, etc

**BBC Model B microcomputer,
including FREE, NEXT DAY mail
order delivery or 2 FREE cassette
games of your choice, for cash
and carry sales.**

£399

BEAT THOSE PRICES!

microFAST
The Experts

57 HOXTON SQUARE, LONDON N1
OPEN FOR PERSONAL CALLERS FROM
MONDAY TO SATURDAY, 9AM TO 6PM.
MAIL ORDER OR OTHER ENQUIRIES

01-729 1778

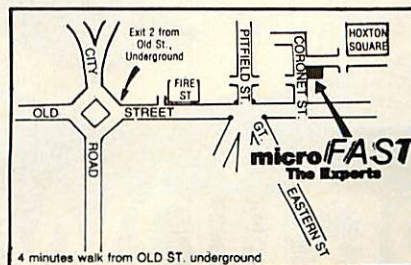

Draw with the BBC micro and show the true potential of your machine

Fill shapes in one of 23 colours (Mode I)
 Draw points, lines, rectangles, ellipses and circles
 Smooth curves
 Wire frame diagrams
 Hidden line removal
 Draw in perspective
 Measure scaled distances
 Ekta sketch lines, Half tone facility
 Mirror images
 Repeat images, SS, enlarged, reduced, stretched
 Actual colour displayed
 Store up to 10 ellipses or circles in memory
 Redraw any one of these at cursor position
 Change any actual colour for one of 8 others
 Clear screen, load screen, save screen
 Print characters or numbers at any pixel point
 Error messages for incorrect input
 Fully comprehensive manual

356 496 * □ ***

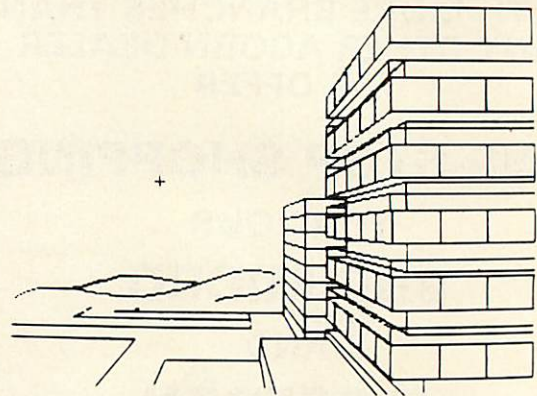

This programme has been purpose designed by professional Graphic Designers for simplicity and ease of use, and is undoubtedly the most versatile drawing programme on the market at this time. There is no need to input any numerical data, as all judgements are made visually. The BBC Micro is the finest drawing machine in its price range. Find out what it can do.

The A.B. Designs drawing programme costs only £35 for over 70 functions (Model B). New AB2 Program, available on disc (price £60.50) and cassette (price £50.50). When ordering send Cheque/PO and include 50p for P&P. Please include phone no. with all correspondence. For further information send SAE and phone no. to A.B. Designs, 81 Sutton Common Road, Sutton, Surrey. 01-644 6643 (closed all day Thursday).

BREAK KEY GUARD

NEW. A simple but effective guard against pressing the BREAK-KEY by mistake – all that work for nothing! We've all done it, but never again with this new break-key cover. At only **£2.50** (including postage, packing and V.A.T.) it's a must. Easily fitted: instructions enclosed.

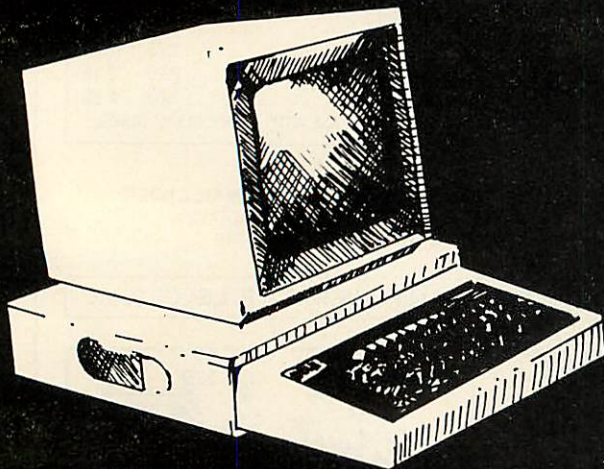

MONITOR STAND

Makes life easier for the BBC micro user. Includes a side opening for easy access to the on/off switch. It slides easily into position, so that your monitor sits just where you want it. Made from heavy duty aluminium and attractively finished. A bargain at **£14.50** (including postage, packing and V.A.T.)

Name _____
 Address _____
 Code _____

I enclose a cheque/postal order for £ _____ p made payable to brainwave. For my order of:

Break Key Guard @ £ 2.50 each
 Monitor Stand @ £14.50 each

On all orders please allow 28 days delivery.

To: Brainwave
 Enterprise House
 2 Glisson Road
 Cambridge
 CB1 2HD

brainwave

– for blue chip products
 Brainwave, Enterprise House,
 2 Glisson Road, Cambridge CB1 2HD

BRUSH UP ON YOUR WRITING

Input and output are vital to many programs, but need thinking about. Susan Jones gives her ideas on improving your programming

THE BBC micro owner is now faced with a plethora of software, but much of it fails to exploit the capabilities of the machine to the full. This article focuses on techniques for producing clear, professional-looking output and providing concise, flexible and secure input facilities. These are illustrated with general-purpose procedures, which assume some familiarity with the *User Guide*, but do not require acquaintance with esoteric ideas such as indirection operators.

Perhaps the first point to discuss is whether software writers should exploit machine-dependent features at all. Portability – the ability to run programs on different machines – is a valuable objective, and a great deal of effort is wasted in converting or rewriting programs originally conceived for a different machine. However, we must be realistic: Basic is a language notorious for its dialects and any attempt to work with a 'standard' subset would mean relinquishing just those features of microprocessor systems which make them attractive, namely the graphics, screen-formatting and special input facilities. Moreover some of the extensions to the language provided on the BBC machine, such as repeat loops and parameterised procedures, allow us to write more concise and powerful programs. So the use of machine-dependent language features may be justified on the grounds that:

- the BBC machine is attracting a large community of 'customers' for specially-written software;
- although extensive rewriting of the *code* of a BBC Basic program will be necessary to transfer it elsewhere, the logical structure should be so much clearer that the conceptual difficulties of rewriting for another Basic machine (or another language) are actually eased.

A common requirement in educational software and games instructions is to print small sections of text which the user can take in at his own speed, moving on when ready. First, how to output text? The obvious answer seems to be by a series of commands to PRINT quoted character strings. However, this sort of text is essentially program *data*, and so the business of

printing it might be best isolated in a self-contained procedure like this:

```
DEFPROCpage: LOCAL N%, I%, Line$
READ N%: FOR I% = 1 TO N%: READ Line$
PRINT Line$: NEXT I%: ENDPROC
```

Every page is treated as a separate block of data, preceded by a count of the number of lines to go on to the screen, for example:

```
DATA 4, "This is a program about...", "In a
minute you will see...", "", "Look carefully
and decide..."
```

Four lines, one of them blank. Data lines like these can be planned, typed and edited independently of the program to print them. Note that the procedure contains local declarations for variables N%, I% and Line\$; the use of these variables here will not affect their value elsewhere, so PROCpage can safely be called from any other part of the program. It can be used with:

```
DEFPROCreturn: PRINT "" "Return"
*FX 15,0
REPEAT: UNTIL GET = 13: CLS:
ENDPROC
```

PROCreturn spaces down three lines from the current print position, and prints "Return" to indicate that the user must press the return key to move on. The *FX command clears the keyboard buffer. The repeat command sets up a loop to read and test any keystroke; since 'return' is a non-printing key, it is the corresponding ASCII code (13) which is tested for. Before exiting, the procedure clears the screen, or at least that part of it defined as the text 'window'. In the main program, pages of text can be output simply by making a series of procedure calls, eg, PROCpage: PROCreturn: PROCpage, etc. If the sequence is sufficiently repetitive these calls can themselves be put into a loop.

Where text and graphics are to be displayed simultaneously it is often wise to define two separate windows which can be cleared and scrolled independently. The following example assumes a division of the screen into a top and bottom half, in mode 4 or mode 1. The relevant commands would be:

```
VDU 24, 0; 512; 1279; 1023;
REM graphics window at the top
VDU 28, 0, 31, 39, 16
REM text window at the bottom
```

Details of these VDU statements are given in the *User Guide*; here simply note that both specify left, bottom, right and top limits, the first in terms of graphics 'points', the second in terms of lines and character positions (note the use of ';' in VDU 24).

```
DEFPROCreplace(CH1$,CH2$,X,Y)
VDU 5: REM go into 'graphics-directed' mode
MOVE X-16, Y+16: GCOL 0,0: PRINT CH1$;
REM erase by over-printing in background colour
MOVE X-16, Y+16: GCOL 0,1: PRINT CH2$;
REM print in foreground colour
VDU 4: REM return to 'text-directed' mode
ENDPROC
```

Listing 1. Erasing characters in graphics modes must be numbered and called (*User Guide*, page 102)

FILE — PLUS

an exciting database package for the B.B.C. micro computer equipped with Acorn compatible D.F.S.

★ General Features

- Easy to use - Full colour - Help information always on screen on bottom 5 lines
- Design any number of data entry forms using a "paint" on screen technique - any of these forms may be used to add, delete, update, print or spool records from your data base.
- Forms may be 3 screens in size - each screen occupies 20 rows by 40 columns.
- Forms may contain any number of text and numeric fields, together with background text.
- Full printed and spooled output formatting via embedded commands !S, !P, !F, !C, !L, !W, !X, !R, !I
- Database may occupy the total online storage capacity of a system - typically up to 800K
- Query Language provides full arithmetic and selection facilities for records plus quick search on text.

★ Query Language Features:

- Operators allowed - Unary minus, -, +, /, *, =, <, >, <=, >=, <>, &, !, ↗
- Precision — $\frac{+}{-}$ 9999999999.9999
- Keywords — Assign, Compare, Display, End, Goto, Iff, Ift, Print, Read, Search, Spool, Update
- Full screen program entry

- ★ Applications include — Budgets, Labels prints, Mail shots, Club memberships, Collectors records, Household accounts, etc.

Supplied on a 16K ROM together with a 70 page manual and full fitting instructions for £49.95 inc. or enclose S.A.E. for fact sheet.

data tap

88 Willowhayne Drive, Walton-on-Thames, Surrey, KT12 2NR

Singles, pairs, three of a kind, six-packs, round dozens — you name it — We'll send it!

Single sided — double density
£1.50 each.

Double sided — double density
£2 each.

Now you can buy high quality media in any quantity you like at really low, low prices. 5¼" disks with labels, read/write protect tabs in a convenient mailing pack.

AND SO GOOD THAT WE GUARANTEE IF YOU CAN FIND A FAULTY ONE WE'LL SEND YOU TWO BY RETURN.

Just clip the coupon and send it with a cheque to the address below.

Disco Technology Ltd., 20 Orange Street
London WC2H 7ED. Tel: 01-930 1612.
Part of the Rushworth Dales Group

Access card holders can ring
01-930 1612 (24 hours)
Dealer enquiries on
01-930 3619



CLS will clear text and CLG will clear graphics. Overlapping windows can be defined, but they may interfere with one another.

Text can be written in the graphics window, but its position and colour is determined by graphics-based rather than text-based commands. For instance, characters can be erased only by, as it were, replotting them in the background colour. The procedure in listing 1 wipes out CH1\$ centred at position X,Y and replaces it by CH2\$.

By default it is the top left corner of the character which appears at the current X,Y position: hence the use of X-16, Y+16 to 'centre' the character correctly.

Next, consider sound output - an area where the BBC machine has sophisticated facilities. We will deal only with its simplest functional use; to give warnings when expected input is not forthcoming or incorrect. This is too often overdone; loud, prolonged or shrill 'beeping' of users' mistakes is in the end counter-productive. I find even the default noise produced by VDU 7 unacceptable, and prefer the procedure:

```
DEFPROCbuzz(V%): SOUND 1,V%,50,1:
  ENDPROC
```

Volume setting, given here by parameter V%, is best adjusted according to the noise level of the room in which the program will be used.

It should go without saying that no incorrect data supplied by the user should cause a program error. In BBC Basic, non-numeric data typed in response to a request to INPUT a numeric value will be treated as zero, for which a check can be made. The procedure in listing 2 accepts three parameters: a message to be printed, and upper and lower bounds for the range of acceptable input values. It exits only when it has received a number within range, otherwise it buzzes and returns the cursor to a point on the screen immediately following the message.

OK is used in listing 2 as a logical variable, saving the result (true or false) as to whether Num is in range or not. The trouble with this procedure is that although values for Mess\$, High and Low can be sent to it as parameters, it is impossible to transmit the value of Num back to the calling program in the same way (although utilities printed in *Acorn User* have helped

```
DEFPROCnumin(Mess$,High,Low): LOCAL OK
REPEAT: PRINT Mess$;: INPUT Num
OK = Num <= High AND Num >= Low
IF NOT OK THEN PROCbuzz(V%)
UNTIL OK: ENDPROC
```

Listing 2. Checks numeric values

do this). An assignment made to a parameter with a procedure has no effect outside it. So Num must be a global variable, seriously detracting from the generality of the procedure. Perhaps the solution is to recast it as a function, which is allowed to return at least one value to the calling program:

```
DEFNnumin(Mess$,High,Low): etc.
as before
UNTIL OK
=Num
```

This function can now be called in quite a general way:

```
P = FNnumin("How many players",1,4)
Q = FNnumin("How many questions",5,10)
```

For a more flexible, but slightly riskier, form of numeric input, the special EVAL function can be used to evaluate expressions typed in by the user. For example:

```
PRINT Mess$;: INPUT Expr$: Num =
  EVAL(Expr$)
```

It may be convenient to allow the user to input 1/3, say, instead of .33; unfortunately the input of an erroneous non-numeric character may cause program failure because EVAL is looking for a non-existent variable. Such an error can be trapped by the ON ERROR statement, but this in itself may have unwanted side-effects, so caution is necessary.

There are a number of possible approaches to non-numeric input and validation, and complete generality is difficult to achieve. If a user is required to input one of, say, a dozen character strings, it is almost always necessary to:

- check the string is valid;
- link it to a number which will be used to select the appropriate part of the program to execute (this is called 'mapping').

```
DEFPROCwordin(Mess$,N%): LOCAL Word$
REPEAT: PRINT Mess$;: INPUT Word$: W% = 0
  REPEAT: W% = W% + 1
  UNTIL W% = Table$(W%) OR W% = N%
UNTIL W% < N%: ENDPROC
```

Listing 3. Searches array for valid word

There are several alternatives, including menu selection, full-word input and single character input.

With menus, the program lists numbered possibilities and a selection is made by typing the appropriate number. Essentially it is the user who does the 'mapping', and validity checking is reduced to a range check similar to the one discussed above.

In cases where it is more natural for the user to type in real words, or names, checking and mapping is best done by scanning an array of valid words. Not only is this method more concise in terms of code than using a series of individual IF statements, it makes it easy to extend the range of possibilities. Nothing betrays the amateur programmer like a failure to exploit arrays for this sort of problem. Listing 3 gives a procedure to search an array of length N% for a valid word, repeating the question until it gets one! On exit the global variable W% holds the appropriate index.

Unfortunately, it is impossible to generalise this procedure without resorting to the use of indirection operators. Arrays in BBC Basic cannot be parameters, so the procedure is limited to searching Table\$, which must have been dimensioned and initialised in the main program:

```
DIM Table$(N%): FOR I% = 1 TO N%
  READ Table$(I%): NEXT I%
DATA BACK, FORWARD, LEFT, RIGHT,
etc., ""
```

Note that for PROCwordin to work properly N% must be one greater than the number of possible words and the last entry in Table\$ must be a dummy. Those familiar with more orthodox Basic may wonder why the inner loop of the procedure was not written using the FOR ... NEXT construction. A search implies a premature exit from the loop when a match is found and unfortunately this is not advisable in BBC Basic; it leaves 'loose ends' on the system stack which may cause overflow and program failure.

If the range of possible inputs can be confined to single characters (by, for instance, arranging that initial letters shall be unique), the GET\$ function can be exploited. Listing 4 is a simple procedure to accept two possible answers, 'Y' for yes and 'N' for no.

One advantage of single-character input is that only correct answers have any effect, since data input via GET\$ is not

StarBASE... a new database

StarBASE



StarBASE... for the BBC

StarBASE is a *fast* disc-based machine code database resident in a 16K ROM. Written by a highly qualified school-teacher to meet a *defined need* it is capable of handling 4096 records in any one file. It is absolutely ideal for use in schools, clubs and small businesses. Normally, the only limitation tends to be the capacity of the disc drives employed (an 80 track double-sided disc drive gives a file length of approximately 400K).

- Up to 69 fields in a record
- Up to 255 characters in a field (subject to a maximum of 920 characters in a record).
- Fields can be placed anywhere using the BBC's editing keys
- A super fast Shell-Metzner sort routine is employed (numeric or alphanumeric);
- Searches possible on any field up to a depth of 5 characters anywhere within the field
- Searches on combinations of fields
- Conditional searches possible using logical operators (=, <>, >, <, or wildcards).
- Display can be arranged to automatically justify
- Security system prevents unauthorised access to data files.
- Printout can be generated for such things as label formats

The need for a system that fulfils these criteria has been around for some time: *StarBASE is the answer.*

Price? Only £69.00 inc VAT (plus £1.50 p & p).



STOCK SUBJECT TO PRIOR SALE

Trade & Local authority enquiries welcome.
Prices correct at time of going to press.



GCC (Cambridge) Limited
66 High Street, Sawston, Cambridge CB2 4BG
Telephone: Cambridge (0223) 835330/834641
Telex: 81594 SAWCOM

automatically displayed on the screen. There is no need to buzz, or repeat the question; the fact that an answer is ignored indicates it is wrong. This could be valuable in educational software, forcing the user to concentrate on the task in hand rather than indulge in irrelevant dialogue.

Where there is a greater range of possibilities than two, the character can be looked up in a string of valid possibilities using INSTR. Alternatively, conversion to numeric form can be made via ASCII. It is a good idea to provide the same mapping for upper and lower case versions of the same letter. This function converts A-Z, a-z to 1-26:

```
DEFNconv(CH$) = (ASC(CH$) - 64)
MOD 32
```

Non-alphabetic characters can be detected by a range check; more complex mapping can be made via an intermediate array, using converted ASCII characters as subscript.

With single character input, it is advisable to turn off the auto-repeat on the keys, otherwise users who are inclined to 'lean' on a key may receive output too fast to read. *FX 11,0 turns off auto repeat. *FX 12,0 turns it on again, and this should always be done before leaving the program so editing works as normal.

Even without auto-repeat, the user may inadvertently build up a 'queue' of input characters by idly tapping the keys while the program is busy, only to have a series of outputs flashing past when it is ready to accept input again. To avoid this, use *FX 15,0 at strategic points in the program to flush the input buffer (this instruction occurred at the beginning of PROCreturn, given above). *FX commands must always be put on to a separate program line.

It is often necessary to be able to move a dot or line around the screen to draw or 'point' at something. The gray arrow keys seem obvious for this purpose, although their positioning is not ideal. Normally, they are ignored by the GET and INPUT functions, but the ability to read in the appropriate ASCII codes when they are pressed can be turned on by *FX 4,1.

It is more useful, however, to sample the current state of the keyboard directly, to detect whether two or more keys are being depressed simultaneously, allowing the

user to move diagonally. The technique is to use INKEY with the appropriate negative argument, as specified on page 275 of the *User Guide*. This returns 'true' or 'false' according to whether a particular key is being pressed, and we can exploit the fact that in BBC Basic 'true' is represented as -1 and 'false' as zero. The procedure in listing 5 (used in modes 5 4, 2, 1 or 0) draws lines on the screen under the direction of the arrow keys, starting at position X,Y.

In detail, consider what happens on the X axis in this procedure. If neither horizontal arrow key is depressed, both INKEY(-26) and INKEY(-122) return zero and X remains unchanged. Otherwise it is incremented by -1 (+ INKEY(-26)) or +1 (-INKEY(-122)) according to whether the left or right arrow is pressed. The same principle applies on the Y axis.

The procedure works correctly until either co-ordinate goes outside the limits of the screen. This can be prevented by changing the assignment statement to:

```
X = ABS((X+INKEY(-26)-INKEY
(-122))MOD 1280)
```

MOD 1280 will convert from 1280 to zero and the ABS function will convert from -1 to +1. Thus we get 'wraparound' on the right edge, 'bouncing off' the left edge. Once again the Y co-ordinate can be treated in a similar way. To move rather than draw, wipe out the dot at the current position before printing a new one. Because this technique is based on sampling directly the current state of the keyboard, it is unaffected by settings of *FX 11, 12, and 15, which are related to the input buffer and queue.

A good general-purpose piece of software should allow a choice of options according to the environment in which it will be used. Obvious examples are: black and white or colour monitor, volume setting for music and sound effects. It is annoying not to be able to alter the volume of sound output from a program; most people confronted by the machine for the first time automatically look for a volume control!

Ideally these options should have built-in defaults; should be selectable before the program begins running, and should remain in force for as long as the machine is turned on. Use of the BBC Basic 'resident

integer variables' A% to Z% as program switches satisfies these requirements. They are already defined when the machine is turned on but can be reset in immediate mode and retain their values between successive program executions (although their values vary between operating systems). In the following sequence of instructions colour and sound switches (as used earlier) are set *before* loading a program:

```
C% = FALSE
V% = -9
CHAIN "LESSON1"
```

A program using this technique should begin by setting any switch out of its available range to a default value. For example:

```
IF V%>0 OR V%<-15 THEN V% = -5
```

Obviously the use of switches can add flexibility to an educational program, but it should not be the lazy programmer's excuse to avoid writing dialogue.

Of the examples presented above, it could be claimed that any resemblance to standard Basic is purely coincidental! But one practical advantage of the constructions used is that they do not refer to line numbers, and are as general as language allows. It is possible to hold a set of such procedures (with line numbers) on tape or disc, and merge them with any program that requires them (as Joe Telford has been doing over the past year in his articles). The Basic user now has something like a subroutine library facility - a convenience enjoyed by programmers in other languages for many years. Some limitations on the generality of BBC Basic procedures have already been pointed out, however; in particular that it is difficult to use array parameters or to return values to the calling program through the parameter list.

In general, however, the programming environment which the BBC machine provides is favourable. While retaining the immediacy, simplicity and unfussiness for which Basic has always been popular it is designed to encourage inexperienced users to construct their programs in a logical way. At the same time, it makes it possible for professional programmers to exploit the hardware to the full and create some very sophisticated software. ●

Listing 5. Draws a line controlled by arrow keys

```
DEFPROCanswer: LOCAL A$
REPEAT: A$ = GET$: UNTIL A$ = 'Y' OR A$ = 'N'
IF A$ = 'Y' THEN PRINT 'YES' ELSE PRINT 'NO'
ENDPROC
```

Listing 4. Checks for 'yes' and 'no'

```
DEFPROCdraw(X,Y): REPEAT
X=X+INKEY(-26)-INKEY(-122)
Y=Y+INKEY(-58)-INKEY(-42)
PLOT .69,X,Y: UNTIL .....
ENDPROC
```

CLEARLY HE HAD ONLY ONE KEYBOARD IN MIND WHEN HE DESIGNED THE HUMAN HAND

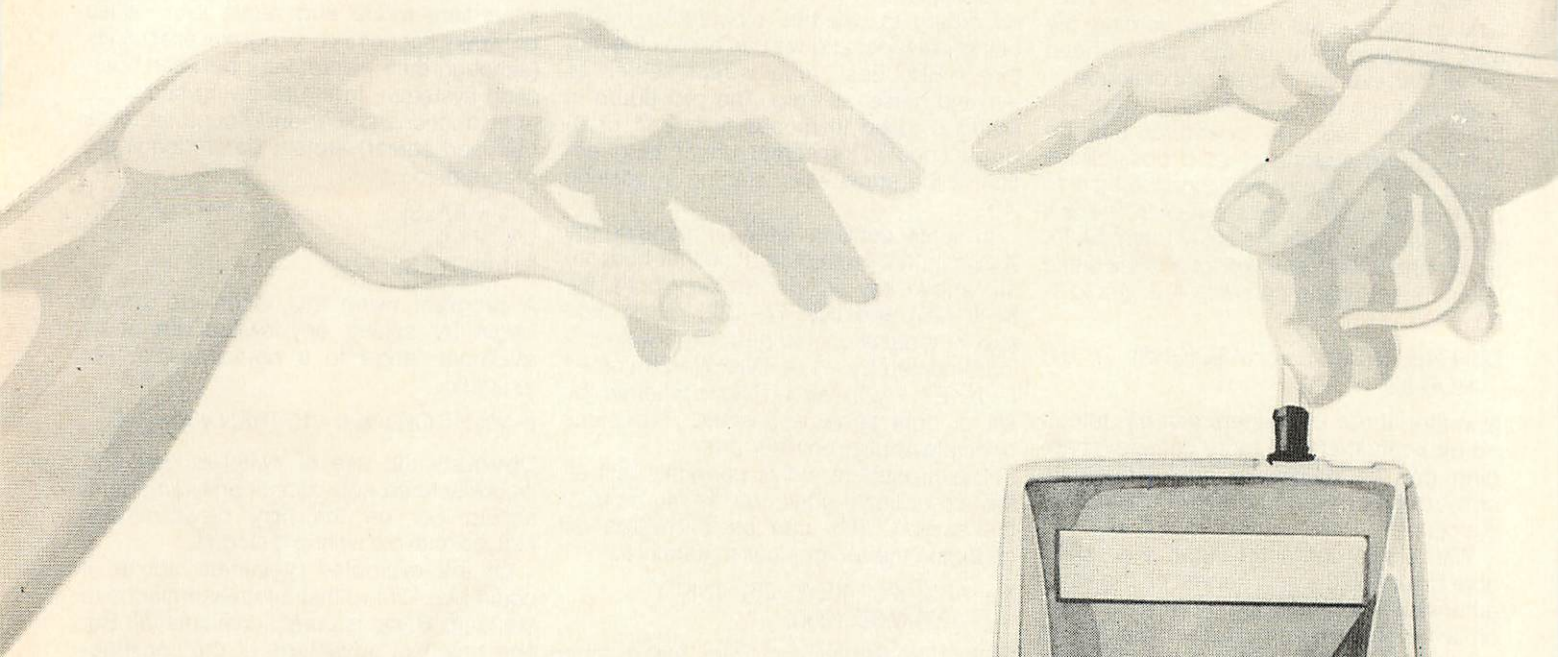

IMAGINE A KEYBOARD

... so simple to use that in under an hour you're touch typing the entire alphabet, numbers and punctuation.

... so effortless it needs only one hand, your eyes never leaving the screen or the document you're copying.

A keyboard you can hold in your palm, and yet, so powerful, it can replace every input, command and function key of your BBC computer ...

Just think how effortless it would be if you could *touch type* your programs, data and text.

How you could lean back and relax; be faster and more accurate; your mind free to think, and your eyes to read.

IT'S CALLED **QUINKEY**

And for **£49.95** you'll get everything you need — hardware and software — to use Quinkey with your BBC computer.

HOW CAN 6 KEYS DO THE WORK OF 72?

You simply press the keys in different combinations. Each combination represents a character.

Quinkey has 5 keys plus a Control key, each finger belonging to its own key — so there's no need to hunt and peck ... BUT ...

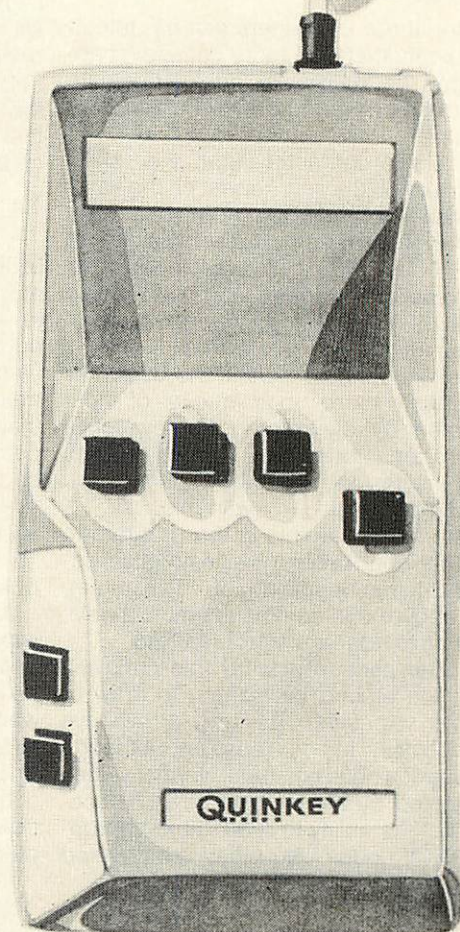

... HERE'S THE MAGIC!

Look at these diagrams:

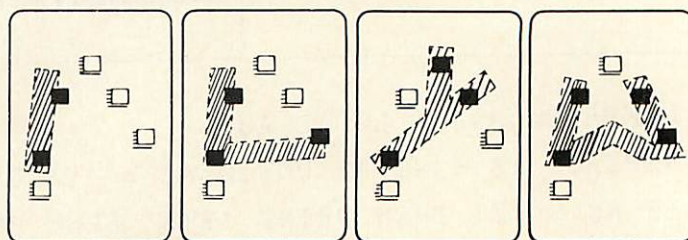

See how the lines joining the key combinations form the characters? For each letter there's an instantly recognised and easily memorised visual clue.

That's the trick — and it works!

YOU CAN TRY IT NOW!

Rest the fingers of your right hand on a table top. Imagine the keys.

To write an "I" you press your Thumb and Index finger down at the same time.

For an "L" you press your Thumb, Index and Little fingers.

To write "Y" you use your Thumb, Middle and Ring fingers . . . and so on.

That's all there is to it.

Here's what users are saying about the keyboard:

— PETER RODWELL (as Editor of 'Personal Computer World') "took me half an hour to learn the alphabet . . . far easier than learning to type. It's an addictive device, and I'm starting to wonder how I ever managed without one."

— PETER WHEELER (in the 'Times Educational Supplement') "a new user can start to touch type after one hour's practice. Handwriting speed is achieved after about 5 hours' usage."

— FRANK DALE (BBC Producer — writing in 'Electronic Times') "no other machine is so easy to use, so easy to learn, so generally useful . . ."

NO RISK, MONEY BACK GUARANTEE

If you're unhappy with your Quinkey just return it within two weeks for a full and courteous refund.

ONLY £49.95 (including VAT and postage & packing). **HERE'S WHAT YOU GET.**

- ★ One Quinkey keyboard.
 - ★ Breakthrough multi-channel interface (plugs into analogue port).
 - ★ Two new powerful software packages, PROG & WP (described below).
 - ★ Comprehensive Quinkey manual.
- "PROG" and "WP" (free with the Quinkey package) are utility programs written specially for the BBC.
- "PROG" enables your BBC to recognise and interpret the signals from the Quinkey keyboard. It combines easily with your application programs enabling you to use Quinkey as a comprehensive alternative keyboard.
- "WP" optimises Quinkey to work with word-processing packages "Wordwise", "View" and "Edword" — a perfect text-writing combination.

TECHNICAL DATA:

Loading length: &605. Running length: &300.
No zero-page locations, all ADC channels.
Interrupt service vector IRQ2V, correctly chained.

TESTED COMPATIBILITY

BBC Model "B"	Acorn
OS 1.2	
BASIC I or BASIC II (unless using	
INKEY with negative argument)	Acorn
DFS 0.90	Acorn
View A1.4	Acornsoft
Wordwise 1.17	Computer Concepts
Edword	Clwyd Technics

KEYBOARD RANGE

All BBC "B" keyboard inputs generate from the Quinkey, except the Hard-wired key. "Break"

AN EXCITING EXTRA SPECIAL OFFER, "SPOOKY MANOR" BY ACORNSOFT

If you order one additional Quinkey keyboard (the plug-in interface supplied enables up to 4 Quinkeys to be used simultaneously) we'll send you Acornsoft's brilliant new multi-player Adventure Game "SPOOKY MANOR" (priced at £9.95), absolutely free of charge.

"SPOOKY MANOR" has been produced especially to run on Quinkey keyboards by ACORNSOFT. It is believed to be the first Adventure Game which can be played SIMULTANEOUSLY by several players, ushering in a new era — computer games which respond to simultaneous inputs, both independently and interactively.

Compete with your friends as you hunt for hidden treasure in a haunted house. Bump into each other in different rooms and see what happens! "SPOOKY MANOR" by ACORNSOFT played on Quinkeys brings a new dimension to adventure games.

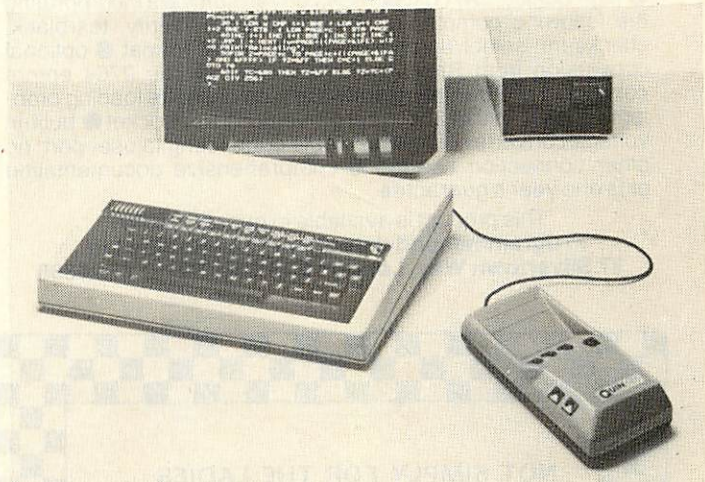

microwriter

An associate company of the Hambro Life Group of Companies

31 Southampton Row, London WC1B 5HJ

To: Vector Marketing Ltd., Dennington Estate, Wellingborough, Northants. NN8 2RL.

PLEASE SEND:

001 _____ Quinkey pack(s) @ £49.95 £ _____

002 _____ Extra keyboard(s) @ £28.75 £ _____
(plus free "Spooky Manor")

003 _____ Educational Pack(s) @ £136.00 £ _____
See next page for Educational pkg. details
(4 Quinkeys plus free "QUAD")

Total cost (price includes p&p and VAT) £ _____

I realise that I can return the pack(s) undamaged within two weeks of receipt of order, if I am not fully satisfied, for a complete refund. Send more information about the Educational Package.

I enclose a cheque made payable to:
Vector Marketing "Microwriter Ltd" for £ _____
Or debit my Visa/Access credit card No. _____

SIGNED: _____

NAME: _____

ADDRESS: _____

AC 484

Please allow up to 28 days for delivery.

Reg. no. 1374069

microwriter
QUINKEY

THE BEST IDEA SINCE THE HUMAN HAND



Eprom Programmer for the BBC Micro

This compact, elegant unit programs 2764 & 27128 eproms and offers the following attractive features.

- high quality, low cost
- menu driven software incorporating the following commands: program, save, verify, testblank, checksum, select eprom, MOS call, ROM format
- optional conversion from Basic to ROM format
- free 2764 eprom containing programming software – no cassette loading problems
- easy to use 28 pin zero insertion force socket
- built-in voltage converter
- integral cable connecting to user port; no other connection needed
- comprehensive documentation plus one year's guarantee.

This product is available in quantity NOW!
Programmer and data sheet from Softlife Ltd.,
 87 Silvertown Way, London E16 4AH Tel: 01 474 0330



Four six year old BBC users at Benton Park Primary School, Newcastle, skilfully operate their Quinkeys to access the class computer simultaneously.

Microwriter Ltd.'s breakthrough multi-user word processing program "QUAD 1" divides the screen into four writing spaces of different colours — one for each keyboard. The BBC's memory is similarly sectored, assigning 75 lines of writing to each pupil, for storing or outputting their work.

A single computer has effectively been multiplied by four at a cost of only £34 per user. Quinkey's Educational Pack, at £136 (incl. VAT & P&P) consists of 4 Quinkey keyboards, 1 Multi-user Interface, operating software (incl. a FREE copy of "QUAD 1").

Educationists, their leading bodies & educational journalists everywhere are hailing this remarkable new development.

For response coupon see Quinkey advertisement on preceding pages.

Education Division, Microwriter Ltd.,
 31 Southampton Row, London WC1B 5HJ.

microwriter
QUINKEY

NOT SIMPLY FOR THE LADIES . . .

We all live to eat — or eat to live!

SHUMWARI ASSOCIATES offers apologies to those who thought we were too sexist in our early advertising for:

"WHAT'S TO EAT?"

Reports received from both genders confirm that the program is a success with families, schools and colleges. Perhaps they are full of bonhomie because they are full of good food and the cooks are happy!

If you haven't tried our recipe for planning your menus on the BBC model B — remember the motto —

Don't Delay — Send Today!

40T disc £13.45 Cassette £10.45

Teacher's Notes now available at £4.50
 Prices inclusive of V.A.T. and post/packing

(O'seas Disc £14 Cassette £11
 excludes VAT includes airmail)

SHUMWARI ASSOCIATES
 (Dept. B)
 12 Marlin Court, Marlow
 SL7 2AJ

SPELLWISE

IS YORE SPELING REELY ATROSHUS?

Or is it just a littel bit off kei?

In either case you need

SPELLWISE.

NOW ON
DISC
 AND TAPE

✿ is a spelling checker for use with your BBC micro and WORDWISE word processor

✿ is a DISC or tape based machine code program with comprehensive user manuals

✿ contains an expandable dictionary of over 6000 words (disc) or 3000 words (tape)

SPELLWISE diligently checks every word in your text against the SPELLWISE dictionary. When it has finished you will be left with a list of words which are incorrectly spelt or not in the base vocabulary.

The program can be interrupted at any stage for inspection of the remaining word list and for the insertion of personal or specialist vocabularies. For this purpose software is included to enable you to create your own data files.

SPELLWISE comprises a set of one disc (or two tapes) plus a complete user manual. The tape version is limited to cassette recorders with motor control.

SPELLWISE costs £12 on tape, £18 on disc and can be obtained from:—

DATAWARE FREEPOST SWINDON SN3 4BR

FLASHING TEXT ROUTINE

WE HAVE previously covered the flashing cursor as a means of prompting for input. The Beeb, in teletext mode, can also flash lines of text, and listing 1 provides the Atom with a similar function.

The routine, once assembled, is enabled by LINK #2800 (or wherever you assemble it to) and uses variables R, C and N to specify, respectively, the start Row (1 to 16), start Column (1 to 32) and Number of succeeding characters to be flashed (1 to 127). Once linked, the routine will flash the specified text until a key is pressed.

The parameters are stored in zero-page locations #90 to #95, and lines 20-60 initialise this block. Line 40 gets the current value of R, line 50 the value of C, and line 60 sets the flash rate (here, 14/30ths second). Lines 70 and 80 get the value of N

and subtract C to get the final column value. Lines 100-150 calculate the absolute address of the row, and lines 160-190 calculate the column offset, thus setting up a vector in #90,91 to the start of the text to be flashed. Lines 200-240 use this vector to store temporarily the old text from #2880 onwards (which is why N must not be larger than 127, or it will overwrite any program at #2900), then wait. Lines 250 and 260 now replace the screen text with spaces. Line 270 checks for a keypress, exiting if found; otherwise, after another delay (line 280), lines 290-320 restore the old text. A further keypress check is made (line 330) before the whole thing repeats itself.

If you want the keypress to be stored for checking, add the following line, which will store it in #96: 335 STY#96

```

5REM: Flash Text      170 TYA;CLC
7REM:R=ROW;C=COL      180 ADC#90;STA#90
8REM:N=NO.OF CHARS    190 LDY@0
10P=#2800;C           200 LDA(#90),Y
20 LDA@#80;STA#91      210 STA#2880,Y;INY
30 LDA@0;STA#90        220 CPY#94;BNE P-8
40 LDA#333;STA#92      230 LDX#95;JSR#FB83
50 LDA#324;STA#93      240 LDY@0
60 LDA@14 ;STA#95      250 LDA@32;STA(#90),Y
70 LDA#32F;CLC         260 INY;CPY#94;BNE P-7
80 SBC#93;STA#94       270 JSR#FE71;BCC P+24
90 INC#94;INC#94       280 LDX#95;JSR#FB83
100 LDX#92             290 LDY@0
110 DEX;BEQ P+16       300 LDA#2880,Y
120 LDA#90;CLC         310 STA(#90),Y;INY
130 ADC@32;STA#90      320 CPY#94;BNE P-8
140 BCC P+4;INC#91     330 JSR#FE71;BCS P-41
150 JMP P-14           340 RTS;J;END
160 LDY#93;DEY

```

Listing 1. Text flasher

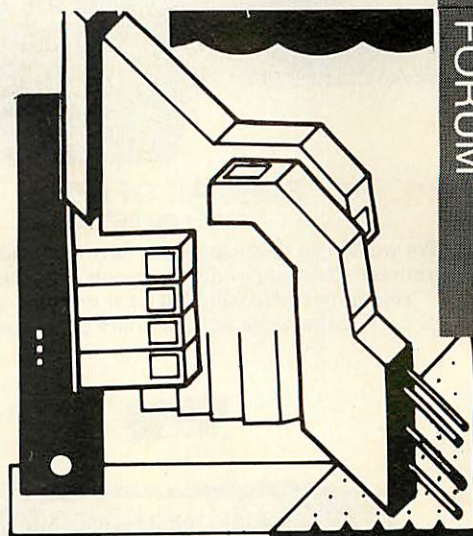

Barry Pickles hosts this cash-for-tips column. Here's a chance to show off your talents – and earn some crinkly green stuff into the bargain.

What we're looking for are those little routines, tips and hardware mods you've discovered. Don't worry if your little wrinkle seems too simple – it's probably just what someone else has been looking for. The same rules apply here as in **Beeb Forum**. Short, sweet and as original as possible is the name of the game.

Send your ideas to Atom Forum, Acorn User, Redwood Publishing 68 Long Acre, London WC2E 9JH. If you want it returned, enclose an SAE. It should be typed or printed and any program should be sent on cassette (with listing if possible).

POPPING

OUT

JUMPING out of loops is not a practice I recommend. It's sloppy programming and can lead to all sorts of problems. However, when converting programs from other machines (like the TRS-80), it's sometimes necessary. Locations 13, 14 and 15 (hex) in page 0 hold a counter which contains, respectively, the current depth of nesting for DO...UNTIL, GOSUB...RETURN and FOR...NEXT loops. Setting these locations to zero will allow you to jump out of such loops. Don't try to use this to increase the depth of nesting – it won't work.

With FOR...NEXT loops another solution is possible. This is to enclose the loop that you wish to jump out of within another loop that will never be jumped out of. When you jump from the inner loop, the program will eventually come across the NEXT of the dummy loop then, as it increments the counter, it resets the data left by the inner loop, avoiding an overflow.

Electronequip

in
Hampshire

SPECIAL OFFERS
PHONE FOR DETAILS

Authorised BBC Dealer &
Service Centre

"We would like to apologise for any confusion that arose from our December advertisements. The BBC B's were sold at full price with £20.00 in discount vouchers redeemable against future purchases."

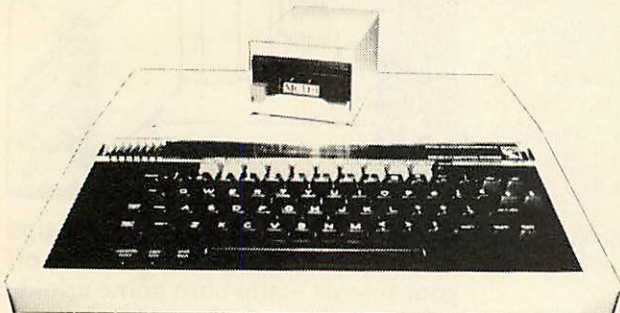

Electronequip is an authorised Acorn service centre and has been an Acorn dealer since the introduction of the Atom. Our demonstration facilities include 20 station Econet and Torchnet systems.

Ref.	BBC Micros	Ex VAT	Inc VAT
ANB01	BBC Model B Micro Computer	348.26	399.00
ANB02	BBC Model B with Econet Interface	389.14	446.00
ANB03	BBC Model B with Disc Interface	409.14	469.00
ANB04	BBC Model B with Disc & Econet Interface	450.01	516.00

3" Micro Disc £129.95
(inc. VAT)

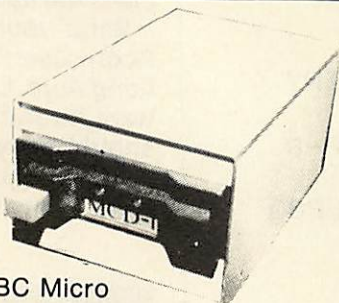

Disc Interface & Drive
£198.95 (inc. VAT)

Micro Disc Drive for the BBC Micro

The Micro disc drive offers a method of low cost quick access to programs. The drive is essentially a small version of a 5¼" disc drive and offers similar features to the larger drive. The data is stored on a 3" disc, this is enclosed in a protective hard plastic cassette which features a write protect switch. The micro drive requires the standard Acorn disc interface, but a new disc filing system rom. Acorn DFS may be exchanged for the micro DFS for £12.00. The new micro disc filing system allows 60 files per disc surface and it can read and write to Acorn DFS discs. Thus if a 5¼ inch and a micro floppy were connected on the same cable files could be transferred between them.

Capacity: 80.64 K bytes **Transfer Rate:** 125kbit/s

TRADE ENQUIRIES WELCOME
Access & Barclaycard Accepted
Large Stocks - 24 Hour Despatch
Carriage 50p to £3.50

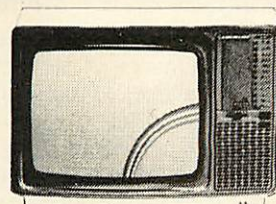

NORDMENDE

14" TV/Monitor £217.00 + VAT

Ref.	Monitors	Ex VAT	Inc VAT
MNB1401	BMC 1401 Colour Monitor	225.00	258.75
MNCE370A	Cable CE 370A Colour RGB Monitor	199.00	228.85
MNKVIS2	Kaga 12" RGB Monitor Vision II (Medium)	285.00	327.75
MNKVIS3	Kaga 12" RGB Monitor Vision III (Hi)	399.00	458.85
MNM1431	Microvitec 1431 14" Colour Monitor (BBC)	215.00	247.25
MNM1441	Microvitec 1441 High Res 14" BBC Monitor	440.00	506.00
MNM1451	Microvitec 1451 Medium Res 14" BBC Monitor	325.00	373.75
MNN1534	Nordmende 14" TV/Monitor	217.00	249.55
MNN3534	Nordmende 14" TV/Monitor with remote control	234.00	269.10
MNN4430	Nordmende 20" Prestige TV/Monitor remote	417.00	479.55
MNN4432	Nordmende 22" Prestige TV/Monitor remote	458.00	526.70
MNN4437	Nordmende 27" Prestige TV/Monitor remote	512.00	588.80

SIDEWISE

SIDEWISE FITTED

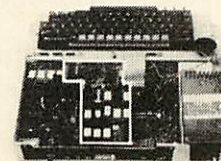
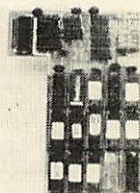

"SIDEWAYS" rom board for BBC Micro.
No soldering required £38.00 + VAT

EPSON

RX-80 F/T £263.12 + VAT

FX-80 £365.09 + VAT

Printer price includes cable for BBC and screen dump rom.

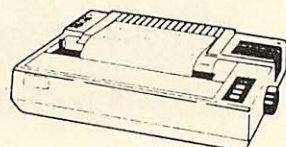

TORCH
COMPUTERS
Perfectly Made in Britain

Ref.	Torch Computers	Ex VAT	Inc VAT
TDZ8DP	Torch Z80 Disc Pack (Dual 800K + Z80)	730.00	839.50
TC301	Torch Work Station (No monitor) (301)	1244.00	1430.60
TC303	Torch Work Station with TOSCA (No monitor)	1449.00	1666.35
TC401	Torch Computer twin 400K (new style)	2250.00	2587.50
TC403	Torch Computer twin 400K & TOSCA (grey)	2455.00	2823.25
TC68000	Torch Computer twin 400K Floppy & 68000	3550.00	4082.50
TC68020	Torch Computer 20Mb Hard Disc & 68000	5900.00	6785.00
TCF500	Torch Computer twin floppies (CF500)	2950.00	3392.50
TCFS500	Torch Computer twin 400K & TOSCA (CH500)	3150.00	3622.50
TCH520	Torch Computer 20Mb Winchester CH520	5650.00	6497.50
TCHS520	Torch Computer 20Mb Hard Disc & TOSCA	5850.00	6727.50
TMC240	Torch Colour Monitor (MC240)	575.00	661.25

Kings Lynn Branch

Tel: 0553 3782



Electronequip

36-38 West Street, Fareham, Hants (0329) 230670



STRETCHING THE LINE-LENGTH

THE Atom's maximum line-length of 64 characters is limited by the length of the input buffer at #100. The input routine, located at #CD0F, uses #52 to check the number of characters input by setting it to zero and subtracting it from the Y register, which is incremented as each character is input. If the result is 64, a routine at #CD4A sets up a loop which can be exited only by pressing the delete key.

Listing 2 allows you to enter program lines of up to 224 characters and has an added bonus in that, although any Atom will execute such long lines, they cannot be edited properly unless this routine is present – so you get program protection as well! LINK #3CA to enable.

Lines 20 and 30 set up the RDCHVEC to point to this routine. Line 60 saves time by checking whether you have input more than 63 characters. If not, it reverts to the normal routines. Line 70 checks the Y register for the new line-length and exits if reached, causing the routine at #CD4A to be called. Line 80 checks the ESC key and line 90 checks for CTRL-X (CAN), resetting #52 to zero if so. Line 110 is the trick. It increments #52 with each character entered, so that the subtraction process always produces a result of 63, thus fooling the computer into thinking that there is always one more space free in the input buffer.

Finally, a word of warning. This routine will also allow you to enter long strings during a program. Don't try it, since it will overwrite the processor stack!

```
5REM: Long Lines
10F=#3CA;Q=F+13;C
20 LDA@(Q%256);STA#20A
30 LDA@(Q/256);STA#20B
40 JMP(#208)
50 JSR#FE94
60 CPY@63;BCC F+20
70 CPY@224;ECS F+16
80 CMP@127;BEQ F+12
90 CMP@24; BNE F+6
100 LDY@255;STY#52
110 INC#52;RTS;J
120END
```

Listing 2. The 64-character question

DISCO FEVER

HERE'S something completely different. Listing 3 monitors the cassette port and displays the pitch of whatever it finds as a continuous graph. Thus, if your tape player's output socket does not disable the speaker, you get something to watch, as well as listen to. Try experimenting with the step value in line 20, for different effects. It's extremely effective on disco music, which has a pronounced beat, and I've had

hours of fun playing with it! Tim Pierse, the author, earns £20 and asks readers to submit any other routines, especially for disco effects. I'll start the ball rolling with listing 4, a multicoloured lightshow. Pressing Shift causes the colour palette to change (it sometimes does this at random, as well) and REPT clears the screen for a new display. Passages of silence cause the screen to gradually white out. Have fun!

Listing 3.

```
5REM: Oscilloscope
10 CLEAR4;MOVE 0,0
20 F,X=0T0255 S.5
30 Y=0;F.N=1T010
40 Y=Y+?#E002&#20
50 N.;Y=(Y/3)+10
60 DRAW X,Y
70 N.;RUN
```

Listing 4

```
5REM: LIGHTSHOW
10 CLEAR0;T=#8000;GOS.b
15 B=#8100;P=#E002
20 DO Y=0;X=A.R.%256
25 A=256-X;F.N=1T010
30 Y=Y+?F&#20;N.
35 Y=(Y/3)+10
40 IFY>100;?P=?P:8
45 G.(50+(Y%3*5))
50 C=#FF;G.a
55 C=#A0;G.a
60 C=#40;G.a
65 C=C&#FF
70a X?T=C;A?T=C
75 X?B=C;A?B=C
78 IFF?-1&#80=0;?P=?P:8
80 U.?P&#40=0;RUN
85bF.N=T TO(T+512) S.4
90 !N=-1;N.;R.
```

MEMORY BANK

WHEN I reviewed the BBC Basic conversion card last year (February and March 1983 issues) I casually mentioned the three 'spare' address lines at IC6. Some of you, apparently, don't know about this so here goes.

Pins 7, 14 and 15 carry addressing for RAM at, respectively, #3C00, #2400 and #2000. RAM chips can be 'piggybacked', as described in the February 1983 *Acorn User*, onto ICs 10-13 (#2000 to #27FF) and ICs 18-19 (#3C00 to #3FFF), to provide a continuous 8k bank. The lines from pin 8 of each 1k pair should be taken to the appropriate pins of IC6. If IC5 is present, these lines should also be ANDed to pin 1 of that IC. Be careful with your soldering since the machine will 'hang up' and some

RAM could be damaged if the lines ever become disconnected. After adding the chips, test the new RAM as described in section 12 of the manual.

If you have the BBC card or the Acorn disc pack, don't bother adding RAM for #2000 to #27FF – it's already there!

TRIPLE

SPACING

HERE'S a quick tip for Wordpack users. You will all know that setting #FE to 255 overrides the linefeed inhibit so that on printers with auto-linefeed you get double-line spacing in normal use. What I've only now realised (I've just done it by accident!) is that with double spacing selected in Wordpack this causes triple linefeeds. Must be of use to someone!

**RING FOR SAMPLE PRINTOUT, FULL SPECIFICATIONS & LATEST PRICES
WE WILL NOT BE BEATEN ON THE PRICE OF STAR OR JUKI PRINTERS**

JUKI 6100 DAISYWHEEL PRINTER

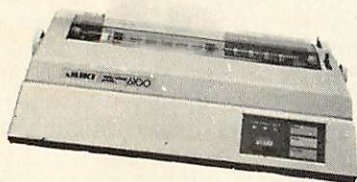

One Year Warranty
18 CPS : BiDirectional & Logic Seeking
10, 12, 15 & Proportional Spacing
Wordstar Compatible
2K Buffer : 13 Inch Platen
Underline : Backspace + Lots more
Centronics Interface Standard
RS 232 Interface £54.00 + VAT Extra
Tractor Feed £99.00 + VAT Extra

JUKI6100 £365.22+£54.78 VAT=£420.00

BBC/ORIC or DRAGON Package

**JUKI 6100 + Cable +
24HR Delivery & VAT £440.00**

NEW

STAR GEMINI 10X

UPDATED
STAR
DP510



One Year Warranty
True Descenders 9 x 9 Matrix
120 CPS Bidirectional & Logic seeking
5,6,8,5,10,12,17 cpi 40,48,68,80,96,136 cpl
Italics, Emphasized, Double strike, Super & Sub Scripts
Hi-Resolution & Block Graphics
Continuous Underline, Backspace
Downloadable Character Set (not 515)
Friction or Tractor Feed
Internal Buffer Expandable to 4K
Centronics Int. Std. RS232 Available

Star Delta 10 160 CPS Centronics and RS 232 Int. Std. 8K Buffer £320 + VAT

**GEMINI 10X (10" CARRIAGE)
£250 including VAT**

PACKAGE FOR BBC/DRAGON/ORIC
GEMINI 10X + CABLE + DELIVERY
BBC SCREEN DUMP SOFTWARE & VAT

£270 including VAT

**STAR DP515 (15" CARRIAGE) £280 Inc VAT.
RING FOR LATEST PRICING**

STAR DP8480

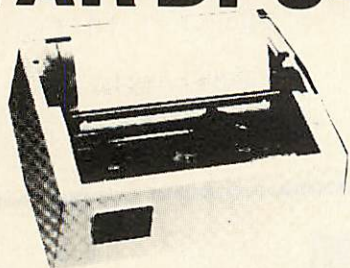

RS232 INTERFACE STANDARD
7x9 Character Matrix (7 Needle Head)
80 CPS Bidirectional & logic seeking
5,6,8,5,10,12,17 cpi
40,48,68,80,96,132 cpl
Friction & Tractor Feed: 10 Inch Platen
Hi-Res option with Software £10.00/15.00

**DP8480 with RS232 Int. £200.00+
£30.00 VAT=£230.00**

Package prices for BBC/Newbrain/Epson HX20

**DP8480 + Cable + Hi-Res + 24Hr Delivery &
VAT = £250.00**

SERIAL PRINTER CABLES

BBC to 25 way D type	£9.50
EPSON HX20 to 25 way D type	£9.50
NEWBRAIN to 25 way D type	£12.00
25 way D type to 25 way D type	£15.00

OFFICIAL ACORN DEALER

ACORN ELECTRON	£199.00
BBC Micro Model B	£399.00
BBC Micro Model B with Disc Int	£469.00

Large range of Accessories including Disc Drives, Printers,
Monitors always in stock

Printer Cables

BBC to 36 Way Centronics Type Connector	£15.00
Dragon to 36 Way Centronics Type Connector	£15.00
Oric to 36 Way Centronics Type Connector	£15.00
Torch to 36 Way Centronics Type Connector	£20.00

Blank C15/C30 Cassettes Ten for £4.50 ANY MIX
Send SAE for Full Price List

VAT INCLUDED WHERE APPLICABLE

PHONE/CREDIT CARD ORDERS WELCOME

Postage 50p per order or as stated
24 HR Securicor Delivery for Printers/Disk Drives £8.00
Shop/Workshop Closed Mondays

**C.J.E.
Microcomputers**

Dept (AU), 78 BRIGHTON RD
WORTHING
W. SUSSEX BN11 2EN
(0903) 213900

BASIC

```

C000 Tables for decode symbol routines
C22C Get <factor> into location 0F, then ...
C231 Skip comma if necessary
C233 Decode keyword/symbol
C279 Test for '=', error if not
C27B Decode single byte symbol
C2AD "NEW"
C2B2 Start up basic, then ...
C2CF Enter immediate mode
C31B <statement>! "THEN" <statement>
C325 "LET"
C334 "PRINT"
C3B2 "LINK" <factor>
C3CB Push <factor>, then ...
C3CB Set Y=@#52, then ...
C3CD Pop number from acc stack into 00,Y .. 03,Y
C3E5 "<variable>=" <expression>
C3EE "! " <factor>= <expression>
C406 "? " <factor>= <expression>
C40F "*" (send rest of line to OSCLI)
C424 Check if FP ROM exists, C set if it does
C434 Get <variable> number (@=0,A=1 etc.),
    C clear if no variable
C465 If next symbol is a <variable>, then
    error, else ...
C46A Get <positive number>, C clear if
    no number
C4DE Test for '=', then ...
C4E1 Get <expression>, then ...
C4E4 Test for <statement delimiter>, then ...
C4F6 Re-point text pointer, then ...
C504 Test ESC key, go to immed mode if pressed,
    return if not
C50C Set up text pointer to following statement
C550 Handle unrecognised <statement>
C55B Go on to next statement
C566 "IF" <testable expression>
C575 "REM"
C589 Print acc no 0 in decimal
C5C8 Print hex single digits from #45,X to #45
C608 Constants for 'print decimal number' (C589)
C62E Find BASIC line given num on stack; pointer
    left in 58,59, C set if found
C661 Set up misc workspace ready for * or /
C689 Do division in misc workspace
C6DA Get <expression>, then ...
C6DD Perform relational tests
C70C <testable expression>
C714 "<relnl expression> AND" <relnl expression>
C722 "<relnl expression> OR" <relnl expression>
C72C <relnl expression>
C731 "$" <expression>= <string right> (test)
C753 <expression> <relation operator> <expression>! <expression>
C75B "<expression> =" <expression> (test)
C764 "<expression> <=" <expression> (test)
C76D "<expression> <>" <expression> (test)
C774 "<expression> <" <expression> (test)
C77B "<expression> >=" <expression> (test)
C782 "<expression> >" <expression> (test)
C78B <expression>
C79A "<term> +" <term>
C7B7 "<term> -" <term>
C7D3 "<term> !" <term>
C7EF "<term> :" <term>
C80B <term>

```

ATOM ROM ROUTINES

by Mark Plumbley

THIS is a disassembled listing of virtually all the routines in Atom Basic and the cassette operating systems.

Here are a few general notes of explanation.

In the Basic and assembler routines, anything which appears in angle brackets, < >, is a syntactic entity, in the same format as in Chapter 26 of *Atomic Theory and Practice*. Anything inside double quotes ("...") has already been recognised, before calling this routine.

All integer arithmetic is done using a 15-deep accumulator stack, in page 0 at #16+X,#24+X,#34+X,#43+X. Page zero location #04 contains the pointer to the next available accumulator, and most of the routines load this into the X register themselves. For example, before routine #C97A is called, a <term> has already been recognised and evaluated, and its value left on the accumulator stack. Also, a + sign has been found. This routine will then evaluate another <term>, add it to the other, and then return, leaving the result on the top of the accumulator stack.

The text pointer is held in locations #05,#06+Y, where Y is held in location #03. Most routines will load location #03 into Y themselves, but a few, like #C4F6 or #C90A, expect this to be in the Y register already.

To keep the information to a manageable level, the complete entry and exit conditions for all the routines have not been specified, but it should not be too difficult to use them, after a little disassembling. Also, the FP ROM or DOS routines are not included. All numbers are in hexadecimal.

continued on page 125 ►



BEEBUG FOR THE BBC MICRO

DEVOTED EXCLUSIVELY TO THE BBC MICRO

MEMBERSHIP NOW EXCEEDS 20,000 MEMBERS BRITAIN'S LARGEST COMPUTER USER GROUP

20,000 members can't be wrong — BEEBUG provides the best support for the BBC Micro. BEEBUG Magazine — NOW 64 PAGES devoted exclusively to the BBC Micro.

Programs — Hints & Tips — Major Articles — News — Reviews — Commentary.
PLUS members discount scheme with National Retailers. PLUS members Software Library.
10 Magazines a year. First issue April 1982. Reprints of all issues available to members.

SCREEN SHOTS FROM PROGRAMS IN BEEBUG

ILLUSIONS
October 1983

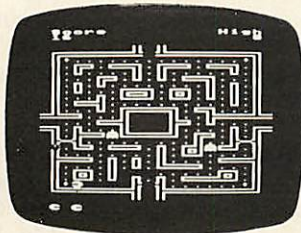
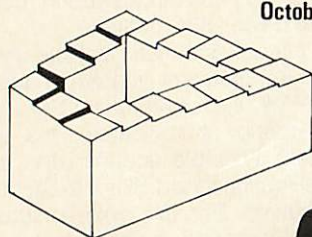

MUNCHMAN
October 1983



3D SURFACES
October 1983



CHEQUERBOARD
Dec 1983

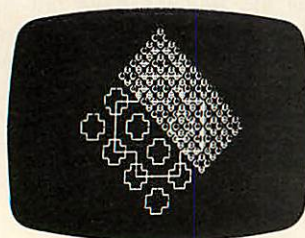

SPIDERS WEB
Aug/Sept 1983

**COMPUTER AIDED DESIGN
PROGRAMME**
Dec 1983

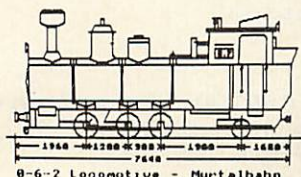

Magazine programs now available on cassette at £3.50 inc: VAT & p&rp — see BEEBUG magazine for details.

November Issue: Program Features: **Reversi**, a challenging board game, **Lunar Escape**, an addictive arcade type game, **SNARFER**, a very useful disc recovery program, **SHAPER** for defining multiple character shapes, **RAPIDS**, another short game, **DEMOLITION**, a sizzling display with matching sound effects. Plus articles on a **Clock Display**, the **Teletext Mode** (part 2 of a series), an Introduction to **Interrupt Programming**, a new **Mode 8** and **The Beeb in Slow Motion**. Plus **Extension ROM Board Reviews**, **Games Reviews**, **Book Reviews**, **M-TEC Torch Basic Review**. Plus News, Hints and a new Competition.

December Issue: Program Features: **Killer Dice** game, **Galactic Invasion**, a fast moving space invasion game, **LINK**, a very useful disc utility for program development, **ASTAAD**, a really excellent program for **Computer Aided Design**, the **Percussion Machine**, moving **Chequer Board** display, **Screen Freezer**, a routine to freeze your favourite game in mid-play, and a musical rendering of the **Twelve Days of Christmas** to add a seasonal flavour. Plus articles on the **Teletext Mode** (part 3) and **Fitting an External Speaker**. Plus **Disc Drive Reviews**, **Book Reviews**, Hints and Tips.

Jan/Feb Issue: Program Features: **Block Blitz**, an excellent arcade style game, **A Disassembler for the BBC micro**, the **Ray Box** game to test your powers of deduction, **Large Digital Displays in Mode 7**, **Dancing Lines**, an interesting visual demonstration of random numbers. Plus articles on **Machine Code Graphics**, the first of an introductory series, **Teletext Mode** (Part 4) with a set of useful procedures, **Protecting your own programs**, and an **Introduction to Forth**. Plus reviews of **Double Density Disk Controllers**, **Graphics Tablets new Software**, **Product news**, **Postbag**, Hints and Tips.

March Issue: Program features: **Krazy Football** game, the **Manhole** game, requiring quick thought and fast reaction, **Extending ASTAAD**, our popular **Computer Aided Design Program**, **The Stonemason**, **Multiple Disc Catalogues**, a program version of **Bach's Cantata No. 147**, a program for **Printing Your Own Function Key Labels**. Plus articles on **Acorn's Latest Developments**, **Testing Out Your Micro** (Sideways ROMs), **Machine Code Graphics** (part 2), **Compact Function Key Definitions**. Plus **Reviews of FORTH** for the BBC micro, **Memory Expansion Board Review**, **Software Reviews**, Hints and Tips.

SPECIAL ANNIVERSARY OFFER

Join by April 15th for your

£1 VOUCHER

Exchangeable for software & hardware.
The voucher will be mailed to all members
with the May issue of Beebug magazine.

Send £1.00 & SAE for Sample

Membership: UK £5.40 for six months, £9.90 for one year.

Overseas one year only: Europe £16.00, Middle East £19.00, Americas & Africa £21.00, Other Countries £23.00

Make cheque to BEEBUG and send to: BEEBUG, Dept 13, PO Box 109, Baker St, High Wycombe, Bucks.

Send editorial material to: The Editor, BEEBUG, PO BOX 50, St. Albans, Herts.

◀ from page 123

C813 "<factor> *"<factor>
 C85E "<factor> /"<factor>
 C870 "<factor> %"<factor>
 C87B "<factor> &"<factor>
 C89C "<factor> ?"<factor>
 C8B3 "<factor> !"<factor>
 C8BC <factor>
 C8C1 "--"<unary plus>
 C8C4 Negate number on acc stack
 C8DC <unary plus>!"+<unary plus>
 C8E1 "<variable>" (extract value)
 C902 "ABS"<factor>
 C90A "#"<hex number>
 C944 (<testable expression>)
 C94C "?"<factor> (extract value)
 C95F "!"<factor> (extract value)
 C973 "TOP"
 C97A "COUNT"
 C986 "RND"
 C99F Push 00,Y .. 03,Y on acc stack
 C9BD "LEN"<factor>
 C9D2 "CH"<string right>
 C9D8 Default BRK handler routine
 C9E7 BASIC error routine string
 CA24 Handle unrecognised <unary plus>
 CA2C Get <expression>, then ..
 CA2F Assign variable
 CA4C Print a character (with COUNT)
 CA51 "LIST"
 CACD "NEXT"
 CB57 "FOR"
 CB81 "TO"
 CBA2 "STEP"
 CBD2 "GOSUB"<go entity>
 CBEC "RETURN"
 CC05 "GOTO"<go entity>
 CC1F <go entity>
 CC81 "INPUT"<input section>
 CC8E Handle <variable> in <input section>
 CCB6 Handle \$<expression> in <input section>
 CCD2 "UNTIL"<testable expression>
 CCF0 "DO"
 CD09 Input a line (for INPUT)
 CD0F Input a line (for immediate mode BASIC)
 CD54 Print a CRLF (with COUNT)
 CD5C "\$"<expression>=<string right> (assignment)
 CD75 "<variable>!"<factor>=<expression> (assignment)
 CD7B "<variable>?"<factor>=<expression> (assignment)
 CD98 "END"
 CDBC Add Y reg to TOP, set Y=1
 CDC9 Deal with BASIC line insertion/removal
 CE83 Do rest of "RUN" (from routine at F141)
 CE93 "?<factor>="<expression> (also used by "!")
 CEA1 Add Y reg to pointer at #58,#59; set Y=1
 CEAE Get =<string right> (ready for assignment)
 CEB6 Set up "\$"<expression> (ready for assignment)
 CEBF Set up string in quotes (ready for assignment)
 CEED "LOAD"<string right>
 CF0A "SAVE"<string right>
 CF2B "EXT"<factor>
 CF29 "PTR"<factor> (extract value)
 CF3E Get <factor> into Y reg
 CF47 "PTR"<factor>=<expression> (assignment)

continued on page 127 ▶

BBC NEWS FROM DPL

- Case to hold one drive
- Ribbon cable to connect one drive to BBC Micro
- Power cable to power one drive from BBC Micro
- Switch on rear of case to select 40 or 80 TPI operation when using FD55E or FD55F.

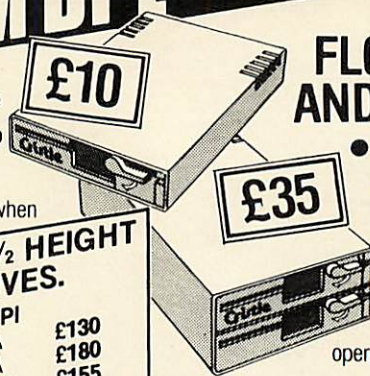

TEAC FD55 SERIES 5.25" 1/2 HEIGHT SLIM-LINE DISC DRIVES.

	Capacity	40TPI	80TPI	Price
FD55A 40 Track, Single Sided.	100K	N/A	N/A	£130
FD55B 40 Track, Double Sided.	200K	N/A	N/A	£180
FD55E 40 or 80 Track, Single Sided.	100K	200K	400K	£155
FD55F 40 to 80 Track, Double Sided.	200K	400K		£218

BBC COMPATIBLE FLOPPY DISC SYSTEMS AND DRIVES

- CASE to hold two drives (complete with blanking panel for use should only one drive be installed).
- Ribbon cable to connect two drives to B.B.C. Micro.
- Integral power supply for two drives.
- Switch on rear of case to select 40 or 80 TPI operation when using FD55E or FD55F.

THIS CASE CONTAINS ALL HARDWARE NECESSARY FOR TWO DRIVES. JUST SELECT ONE OR TWO DRIVES FROM THOSE SHOWN BELOW. IF YOU SELECT JUST ONE NOW, THE SECOND CAN JUST PLUG IN LATER. CASES ONLY SOLD WITH DRIVES.

HANDBOOK AND FORMATTING DISC

£15

DELIVERY: Up to 28 days.
WARRANTY: 90 days.
TERMS: Strictly cheque with order.
 Send to P.O. Box 11, Stroud, Glos. UK GL5 1JN, or phone through your Access or Barclay Card number.

TO ORDER: ADD CARRIAGE/PACKING/INSURANCE AT £10 (COVERS NEXT DAY SECURICOR DELIVERY), THEN V.A.T. AT 15% TO TOTAL. THE ABOVE PRICES ARE VALID UNTIL END OF MARCH 1984.

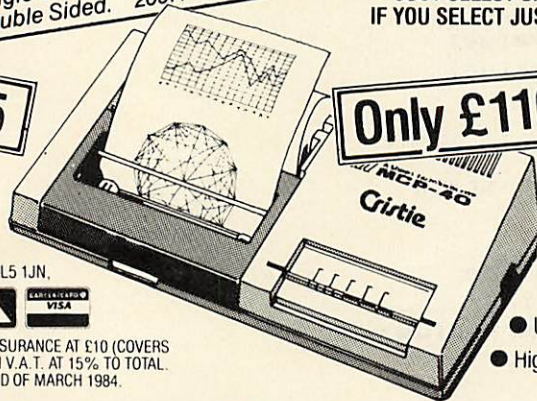

PRINTER AND PLOTTER — MCP 40

- 4 colours
- Selectable 40 or 80 characters per line
- Easy to use—simple software commands
- Standard Centronics interface—cables available for most micros
- Uses 4 1/2" plain paper
- High resolution—over 100 steps/inch

DIGITAL PERIPHERALS LTD. Rodney House, Church Street, Stroud, Glos. U.K. GL5 1JN
 Tel: (04536) 71387. Telex 43551.

A **Cristie** Company

EASIPILOT and SHARE ANALYSER

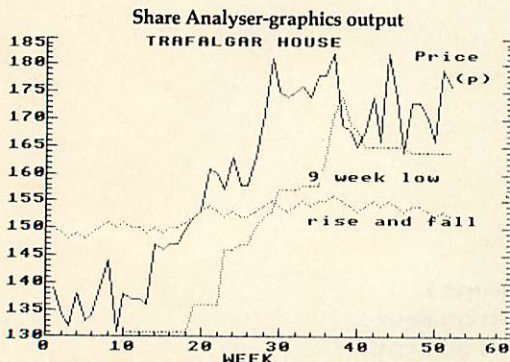

These are some of the comments made to us by users of EASIPILOT over the last few weeks... 'A Masterpiece... Works Beautifully... A joy to use... An excellent package... A remarkable piece of work... I am extremely pleased with the package... thank you for your professional and rapid response' etc... etc (see below for magazine reviews).

NOW we are offering our new IMPROVED range of EASIPILOT and Data Plotter programs and a NEW program SHARE ANALYSER.

Easiplot 1... An upgraded version of the original cassette program which was rated by the leading 'Educational Computing' Magazine among the best 20 Educational Packages (14th) and rated by A&B Computing Magazine Value for money 85%... Overall 92%... A highly Educational and user friendly graph plotting package... lines, bars and pies with many features. NOW AVAILABLE FOR THE ELECTRON.

Easiplot 2... A far more powerful and sophisticated disk based business and administration version, with many additional features and Econet compatible.

Easiplot 3... Easiplot 2 and Data Plotter combined at a bargain price.

Note... ALL EASIPILOT PROGRAMS COME COMPLETE WITH A 50 PAGE OPERATING MANUAL.

Data Plotter... A fast and efficient number charting program with colour/magnification/moving average facilities etc... ideal for share price analysis and Educational use. ALSO AVAILABLE FOR THE ELECTRON.

Share analyser

A share analysis and reporting program capable of analysing or reporting single shares or your entire holding in graphical or report form. Graphical indicators include Lag and Centred Moving Averages, Rise and Fall, Daily or Weekly Low graphs, Comparisons etc. Reports include profit statements, Holding Summaries and movement analyses (with 'flexing' capabilities). Will report to ANY printer and dump graphics to printers compatible with EASIPILOT. Share analyser is a must for the investor at a bargain price!!

All the above programs will produce hard copy on the following printers:—

EPSON (entire range), Shinwa CP80, Star DP510, Seikosha (GP80A & GP100A).

ORDER FORM

	PRICE	STATE CHOICE
Data Plotter (cassette) ... Model B & Electron	£7.00	
Data Plotter (disk) ... Model B	£8.00	
Easiplot 1 (cassette) ... Model B & Electron	£15.95	
Easiplot 2 (disk only) ... Model B	£19.95	
Easiplot 3 (including Data Plotter-disk only)	£22.95	
Share Analyser (cassette) ... Model B & Electron	£14.95	
Share Analyser (disk only) ... Model B	£15.95	

Disk orders... please state 40 or 80 track (add £1 for 80 track and £1.50 for overseas orders). We will upgrade Easiplot 1 to Easiplot 2 for £7 (£10 to Easiplot 3).

Send S.A.E. for full specifications of all our programs or leave your name and address with our 24 hour Answerphone service (Luton 33858).

All programs are normally despatched within 24 hours.

If you are not entirely satisfied with your purchase we will refund your money.

Send cheque/P.O. etc to
 Synergy Software 7, St Andrews Close, Slip End, Luton, LU1 4DE.

◀ from page 125

CF5B "BGET"<factor>
 CF66 "GET"<factor>
 CF7B Get <factor>,<expression> Then PUT LSbyte
 CF8F "BPUT"<factor>,<expression>
 CF95 "PUT"<factor>,<expression>
 CFA6 "FIN"<string right>
 CFA7 "FOUT"<string right>
 CFB6 "SHUT"<factor>
 CFC5 "SPUT"<factor>,<string right>
 CFE3 "SGET"<factor>,<expression>

EXTRA BASIC SECTIONS

F000 Tables for <statement> recogniser
 F02E Unrecognised <unary plus> (from BASIC)
 F03F "<array name>"<factor> (extract value)
 F04B Unrecognised <statement> (from BASIC)
 F085 "<array name>"<factor>=<expression> (assignment)
 F0AE "DIM"<dim section>{,<dim section>}^
 F141 "RUN" (from basic keyword decoder)
 F14C "WAIT"

ASSEMBLER

F155 Table of compressed mnemonic (MSB)
 F195 Table of compressed mnemonic (LSB)
 F1D5 Table of bit mask for addr modes (LSB)
 F1E4 Table of bit mask for addr modes (MSB)
 F1F3 Table of offset from base for addr modes
 F202 Table of no of data bytes for addr modes
 F211 Table of base value for mnemonics
 F251 Table of addr mode group for mnemonics
 F291 Get next non-space character
 F29C "]" (back to basic)
 F2A1 "[" (enter assembler)
 F32E ":"<label name>
 F360 <comment field>
 F36B Put variable P in 52,53
 F376 Print hex byte, followed by a space
 F37E Print hex byte (sets X=FE)
 F38E <assembler statement>
 F3F2 Get addressing mode data and type
 F454 "@"<expression> (immed mode)
 F462 "("<indexX>!"("<expression>),Y!"("<expression>)"
 F482 "<expression>)",Y!"("<expression>)"
 F49B Construct opcode and data
 F4EC Handle relative addressing

MORE BASIC SECTIONS

F531 "OLD"
 F542 "DRAW"<factor>,<factor>
 F546 "MOVE"<factor>,<factor>
 F54E "PLOT"<factor>,<factor>,<factor>
 F585 Plot a line
 F5EB Plot a line, with (X change)<=(Y change)
 F61C Plot a line, with (X change)>(Y change)
 F67B Plot a point (through vector at #3FE)
 F67B "CLEAR"<factor>
 F6C2 Clear mode 0
 F6CF Tables used to CLEAR modes
 F6E2 Mode 0 point plot routine
 F73B Mode 1 point plot routine
 F754 Mode 2 point plot routine
 F76D Mode 3 point plot routine
 F7AA Mode 4 point plot routine
 F7C9 Bit table for graphics

continued on page 128 ▶

◀ from page 127

CASSETTE HANDLING ROUTINES

FD71 Output ascii string after "JSR #F7D1"
 F7EC Set reg X=D4, then ...
 F7EE Print 2 2-byte numbers from 00,X in hex
 F7F1 Print 2-byte number from 00,X in hex, then ...
 F7FD Print a space
 F802 Print A as 2 hex digits
 F80B Print LSnibble of A as 1 hex digit
 F818 Get filename in quotes from command line
 F84F Transfer file control block, and test name
 F876 Get next non-space char from command line
 F87E Convert hex char in A to binary
 F893 Get hex string from command line into 00,X and 01,X (uses 02,X)
 F8BE Tables of OSCLI commands
 F926 Print 'COM?', then error
 F92F Load an un-named file
 F955 "*FLOAD"
 F958 "*LOAD"
 F96E OSLOAD
 F9A2 Check next block's header, and load block if OK
 F9C7 Load block
 FA0B Incr. 2-byte num at 00,X:01,X and test if eq to 02,X:03,X
 FA19 "*NOMON"
 FA1A "*MON"
 FA20 "*RUN"
 FA2A "*CAT"
 FA65 Get a hex number, error if none
 FA6B Get a hex number, and JMP there (not used)
 FA76 Test for end of line, if not then ...
 FA7D Print 'SYN?', then error
 FAB6 Save un-named file
 FABB "*SAVE"
 FAE5 OSSAVE
 FB3B Save a block
 FB78 Wait 2 seconds (tone to tape off)
 FB7A Wait 2 seconds (tone to tape set by X)
 FB81 Wait 0.5 seconds
 FB83 Wait X/60 seconds
 FB8A Wait 0.1 seconds
 FB8E Read header info from tape, and test for un-named file
 FBC9 Read name from tape & compare names
 FBE2 Read rest of header info
 FBEE OSBGET
 FC23 Add A to checksum in #DC
 FC2B Set load addr to be used
 FC38 OSFIND
 FC3E Print 'PLAY TAPE', then wait for key
 FC40 Print message (depends on A), then wait for key
 FC4F Print 'PLAY TAPE', wait for key
 FC58 Print 'RECORD TAPE', wait for key
 FC63 Print 'REWIND TAPE', wait for key
 FCB0 Count duration of tape pulse
 FCCD Test for change in tape i/p level
 FCD8 Wait for 1 falling edge of 2.4kHz signal
 FCDA Wait for (X+1) falling edges of 2.4kHz signal

continued on page 130 ▶

48K
SPECTRUM

BBC
acorn
electron

Regardez!

LANGUAGE LEARNING AIDS FOR FRENCH, GERMAN & SPANISH

Already in use in numerous schools and colleges, these programs provide an immensely powerful aid to foreign language learning. The cassettes include extensive vocabulary lists arranged as a series of lessons, each covering a different subject. A tuition control program enables individual lessons to be loaded and used as required.

Words, phrases etc are presented first in one language, then the other complete with all necessary accents and special

characters. Masculine, feminine and neuter words appear in different colours to encourage gender learning. All lessons can be run in three different ways, i.e. learning only, self-test or speed and accuracy test.

The programs are suitable for pupils of all ages as simple commands enable new lessons in vocabulary or grammar to be entered by the user. These may then be edited as required and stored on cassette for later use. Invaluable for homework and exam revision!

Level A Cassettes: Contain the tuition control program and 16 comprehensive lessons for general vocabulary learning.

Level B Cassettes: Contain the tuition control program and 16 lessons including verb lists, adjectives, adverbs and phrases.

Available from dealers, large stores or mail order.

Also Available "THE SPANISH TUTOR"

KOSMOS Software

1 Pilgrims Close, Harlington, Dunstable, Beds. LU5 6LX Tel: 05255 3942

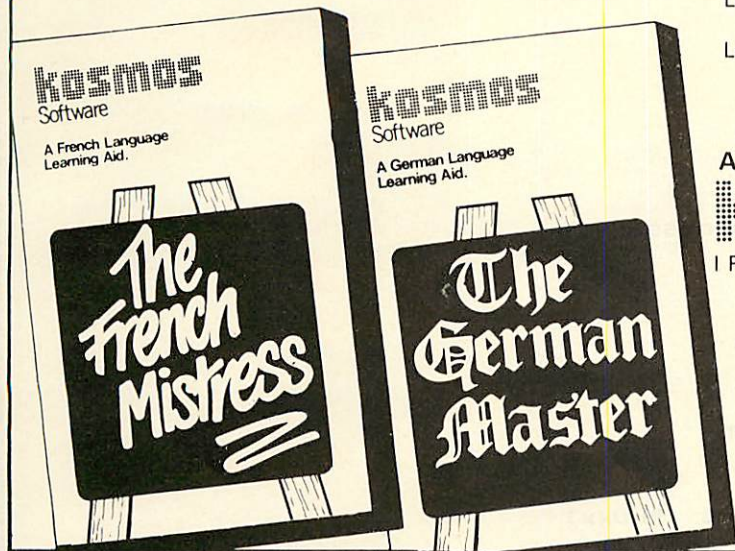

Kosmos Software, 1 Pilgrims Close, Harlington, Dunstable, Beds LU5 6LX.

Please supply the following programs for the computer

(BBC/SPECTRUM/ACORN ELECTRON) (Prices include postage & packing)

The French Mistress Level A @ £9.95 The French Mistress Level B @ £9.95
 The German Master Level A @ £9.95 The German Master Level B @ £9.95
 The Spanish Tutor Level A @ £9.95 The Spanish Tutor Level B @ £9.95

Mr/Mrs/Miss.....

Address.....

Post code.....

I enclose a cheque/postal order value £ payable to Kosmos Software

- * SPY
- * DEBUG
- * CTRLF
- * BRK
- * NOCTRLF
- * NOBRK
- * CLST
- * HLST
- * XLST
- * FTRACE
- * TRACE
- * WHAT
- * AXY
- * AMEND
- * MAKE
- * STAT
- * DEDIT
- * REFORMAT
- * FORMAT
- * VERIFY
- * WHERE
- * MLOAD
- * MRUN

SPY2 is the new comprehensive debugging monitor, dis-assembler and disc utility ROM from SYSTEM.

SPY2 encompasses all the superb easy-to-use facilities of the renowned SPY debugging monitor, additional front panel commands, a new set of powerful disc recovery utilities, a formatter, a relocater, program trace facilities and a versatile dis-assembler.

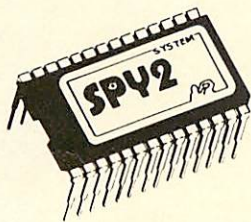

£24.15 inc vat

**powerful
disc recovery
utilities**

- * inspect, single-step through or dis-assemble ANY ROM
- * single-step through subroutines in one go
- * toggle/clear breakpoints
- * colour or black and white front panel display option
- * hex dump, full or intelligent dis-assembly option
- * disc sector editor with hex and ASCII display
- * recover and reformat bad track
- * find string or hex code on disc
- * unstoppable verify disc utility
- * find disc space
- * create and amend disc catalogue entry
- * download (and run) disc file

SYSTEM SOFTWARE Dept. A 12 Collegiate Crescent Sheffield S10 2BA

◀ from page 128

VDU HANDLING ROUTINES

FCEA Write char in A to screen
 FD0B Handle ESC or ACK
 FD1A Handle BEL (do a bleep)
 FD29 Print a non-control character in A
 FD44 Switch cursor
 FD50 Handle DEL
 FD5C Handle BS
 FD62 Handle LF
 FD69 Handle FF
 FD87 Handle VT
 FD8D Handle SO
 FD92 Handle SI
 FD9A 'LOCK' key pressed
 FDA2 Cursor movement keys pressed
 FDAE 'COPY' key pressed
 FDC0 Other key groups pressed
 FDEC Move cursor down, scrolling if necessary
 FE2C Add 1 line to cursor position
 FE52 OSWRCH
 FE66 Wait for start of TV frame sync
 FE6B Wait if not during TV frame sync
 FE71 Scan key matrix
 FE94 OSRDCH
 FEC4 Decode control char or key number
 FECB Table of control characters
 FED7 Table of key-number divisions
 FEE3 Table of control char action adrs (#FDxx)
 FEEE Table of key-number action adrs (#FDxx)
 FEF8 Write char in A to printer (if enabled)

MISCELLANEOUS

FF3F Hardware RESET routine
 FF9A Table of initial OS vectors
 FFB2 IRQ/BRK routine
 FFC7 NMI routine

OS CALLS

FFCB OSSHUT
 FFCE OSFIND
 FFD1 OSBPUT
 FFD4 OSBGET
 FFD7 OSSTAR
 FFDA OSRDAR
 FFDD OSSAVE
 FFE0 OSLOAD
 FFE3 OSRDCH
 FFE6 OSECHO
 FFE9 OSASCI
 FFED OSCRLF
 FFF4 OSWRCH
 FFF7 OSCLI

MACHINE VECTORS

FFFA NMI vector (points to FFC7)

FFFC Reset vector (points to FF3F)
 FFFE IRQ/BRK vector (points to FFB2)

Listing of Atom Basic and
 cassette operating system ROM
 routines

HARDWARE AND SOFTWARE

Micro-Aid

FOR THE BBC MICRO

SOFTWARE - Programs that are guaranteed to run! Save hours of work and worry with these utilities, educational & business programs on cassette or disc.

102	CASHBOOK	Double entry 4 columns with accounts & analysis	£11.95	B	520	BANNER	Print giant text and graphics on paper for displays	£3.95	A/B
102d	CASHBOOK	Full disc version. 1200 items on 100k disc	£19.95	B	521	BIGLETR	Print as above on screen/paper with screen dump	£5.95	A/B
103	LEDGER	Complements CASHBOOK with ageing & analysis	£11.95	B	600	FORTH	'79 FORTH second language ROM	£34.74	B
105	MAILING	Holds 218 addresses. Alpha & post code sorts, searches, any label format, delete, add and amend	£11.95	B	601	LOGO-FORTH	Advanced Turtle Graphics Language ROM with FORTH	£57.50	B
106	PAYROLL (W or M)	In 2 parts to handle weekly or monthly (state which) PAYE & NI for 100 employees. Fully supported	£24.95	B	602	PASCAL-T	Structured language ROM with compiler-interpreter	£57.50	B
107	MEMO-CALC	Database/Calcsheet with up to 255 columns, string or numeric data, sorts, searches, calculations.	£12.95	B	603	XCAL	Computer Assisted Learning ROM for presentations	£65.00	B
201	GAMES 1	5 Card, Minefield, Darts, Pontoon & Mr. Midon	£5.95	B/E	605	WORDWISE	Superb fast & easy to use wordprocessor in ROM	£33.95	B
202	STOCKMARKET	Exciting world of Stocks and shares, 1 - 4 players	£5.95	B/E	606	CDUMP	Screen dump, 8 colours, suitable for GP700A	£12.95	B
301	HANGMAN	Word game in English, French, German, Italian, Spanish	£7.95	B	607	GDUMP	Screen dump ROM, 8 shades, 8 sizes and windows	£17.95	B
302	DISTANCES	Three graphic maps of U.K., EUROPE & the WORLD. Calculate the distance between any 2 places	£4.95	B/E	608	DISKDOC	ROM for disk problems in format, search, files etc.	£27.50	B
303	FLAGS	98 full colour flags of the world with questions	£4.95	B/E	608	GRAPHICS	NEW ROM for Sprites, LOGO, circles, fill etc.	£27.50	B
304	STATPACK	Statistics package giving over 30 results	£9.95	B	700	BOOKS	Various titles for the BBC Micro from	£6.95	
305	GRAPH	Produce varied graphs & charts of functions	£7.95	B	801	CASSETTES	C15 Computer quality tapes packed in 10's	£4.50	
306	FRENCH	New audio visual computer way to learn a language	£7.95	B	810	5.25" DISCS	MEMOREX: SS/SD 40/80T	£19.95	
307	SPELL-CHECK	Add to WORDWISE. 15000 words in 12 dictionaries	£17.95	B			SS/DD 40/80T	£20.95	
504	PROCAID	includes SEARCHBAS to search a BASIC program and alter it, PROCVAR to list variables in a BASIC program & PROCFLUSH to clear resident integers in RAM	£3.45	A/B	900	SEIKOSHA	GP700A 7 COLOUR 30 shade dot matrix printer 50cps	£369.00	
505	UTILITY-A	Our best selling tape includes PROCAID, DEFCHR to design & display graphic characters, SORTM/C a very fast machine code numeric sort, SORTBAS the undisputed fastest BASIC sort routine	£5.95	A/B	901	EPSON RX-80 T/F	Superb. 100cps with Tractor & Friction feed	£275.00	
					902	EPSON FX-80	Magnificent. 160cps, 6 founts, graphics, F/T Roll	£365.00	
					910	DISC DRIVES	Slimline 3" or 5 1/4" 100k - 800k Japanese. Format disc, cable and excellent manual.	£189.00	
					915	DISC UPGRADE	Double & Single Density available in one system	£77.50	
					920	VDU STAND	Stainless Steel Support protects your micro	£19.95	
					930	GREEN VDU	12" Green Monitor, cream sloping front case	£79.95	
					931	COLOUR VDU	JVC 14" Colour Monitor 370 x 470 pixels	£179.95	
					950	SAT-16 MPU	16 bit 68000/68701 stand alone computer from	£570.00	

ADD VAT TO ALL PRICES EXCEPT BOOKS.

ADD £1.75 FOR PROGRAMS ON 40 OR 80 TRACK DISC. NO POST CHARGE IN UK. MOST PROGRAMS AVAILABLE ON MICRONET 800.



Send for our free brochure for more information before parting with your money.

Micro-Aid (AU)

25 Fore Street, Praze, Camborne, Cornwall TR14 0JX.
Tel: 0209-831274

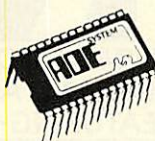

There is nothing else.

Assembler - Debugger - Editor for the BBC microcomputer.

£60 incl. vat. 40 or 80T utilities disc - please specify. SYSTEM SOFTWARE Dept. A 12 Collegiate Crescent Sheffield S10 2BA



Robot Plotter

£59.50
INC. VAT
CARRIAGE
£3.00

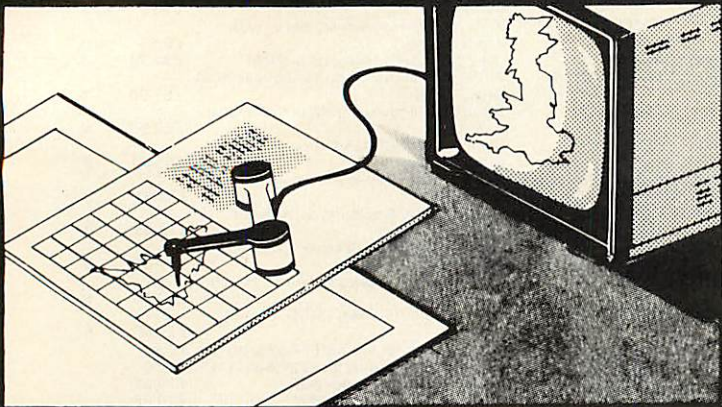

- ★ FOR BBC MICRO MODEL B CASSETTE OR DISC
- ★ ENABLES PICTURES TO BE DRAWN OR TRACED
- ★ WORKS IN ANY GRAPHICS MODE — COLOUR SELECTABLE
- ★ DESIGNED BY A TEACHER FOR EDUCATIONAL USES BY STAFF AND PUPILS
- ★ TRANSPARENT TABLET ALLOWS DIAGRAMS AND MAPS, ETC. TO BE COPIED
- ★ ROUTINE INCLUDED TO SAVE QUICKLY TO DISC OR CASSETTE
- ★ SCREEN DUMPS FOR EPSON AND SEIKOSHA PRINTERS
- ★ TRIED AND TESTED — DIRECT FROM THE MANUFACTURER

COMMANDS FOR:

- LINES
- CIRCLES
- RECTANGLES
- INFILLING
- COPY AND MOVE
- PRINT AT
- AS WELL AS TRACE MODE

Please send me

I enclose Cheque/P.O. for

or please debit my Access/Barclaycard

Name

AddressCode

GOVERNMENT AND EDUCATIONAL ESTABLISHMENT
OFFICIAL ORDERS WELCOME

Robot DEVELOPMENTS LIMITED

**NATIONAL INDUSTRIAL ESTATE
BONTOFT AVENUE, HULL HU5 4HF
TEL: (0482) 448562.**

“DFS UPGRADE”

THE MULTI-FUNCTION ROM BASED UTILITY COMPLETELY
COMPATIBLE WITH ACORN DFS AND ALL ACORN DFS SOFTWARE.
FEATURING—

- BACK UP ALL YOUR SOFTWARE**
A simple method to produce a back up of all your valuable software. No need to format the receiving disc. Simply type MIRROR and watch your exact copy being produced (including protected discs).
- DISC FORMATTER — DOES NOT DESTROY CURRENT MEMORY**
Format a disc directly without need to save your work and load a utilities disc.
- 60 FILES PER DISC**
Create a new catalogue to allow the user up to 60 files. First 30 files are completely compatible with non 'Upgrade' systems.
- FULL SECTOR EDITOR**
Read and display any disc sector in hex and ascii with the option to amend any byte as necessary.

- APPEND FUNCTION**
Speedily join useful routines and programs to form a new working program.
- VERIFY FUNCTIONS**
Checks all contents of disc are readable and reports bad sectors. Also an option to verify that the program just saved corresponds to your current memory contents.
- DISC STATUS FUNCTION**
Check files and free space on a disc without destroying current memory contents.
- RUN CASSETTE BASED SOFTWARE**
Simplifies the running of cassette based software on disc. Both basic and machine code.

£29.95 Order by telephone

I enclose cheque/PO* for £ _____

Charge my Access/Visa £+ _____

Card No. _____

Signature _____

Name _____

Address _____

*payable to Aiiigata Software Ltd. 178 West Street, Sheffield S1 4ET
+ allow 75p for post and packing

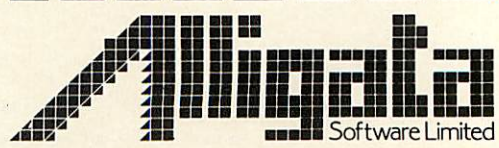

SEND SAE FOR FULL DETAILED SPECIFICATION.

178 West Street, Sheffield S1 4ET. Tel: (0742) 755796

TRANSLATING FROM B TO A

IT IS apparent from your letters that many of you, having been weaned on AtomBasic, find BBC Basic (and other Microsoft-type Basics) difficult to relate to. Microsoft dialects account for about 99 per cent of all published Basic programs and the purpose of this short series is to guide you in the conversion of such dialects, so that you can get more out of *Acorn User* and, indeed, other magazines and books.

Acorn User in particular offers much information on programming techniques which, although written for the Beeb, are adaptable to the Atom. To whet your appetite, take a look at listing 1. This is a program from the excellent Acornsoft book *Creative Graphics on the BBC Microcomputer*. It's called 'Planets' and is often used to demonstrate the Beeb's graphic capabilities. Now take a look at listing 2, which is an Atom version of the same program (in black and white, to retain definition).

To begin at the beginning, table 1 lists those keywords which are syntactically identical in both dialects. However, there are some subtle syntax differences which can cause problems and you should be aware of these. From now on, whenever I refer to BBC Basic you can assume that I also mean Microsoft Basic, unless I specify otherwise.

Almost all Basic dialects run faster if integer variables are used wherever possible. BBC Basic uses the suffix '%' to denote an integer variable, otherwise it assumes a real (f.point) value. AtomBasic is just the opposite, using the '%' prefix to denote real numbers. Similarly, the Beeb refers to A\$, rather than Atom's \$A. You will occasionally see \$A in BBC programs, but this is used when A has been assigned as a pointer to a string not stored in the usual area – in AtomBasic the syntax is identical.

DIM can also cause confusion. On the Beeb, strings are dimensioned using, for example, DIM A\$(32). A statement of the form DIM A%(100) can mean one of two things. It can either be a byte array or it can reserve a specific block of memory for machine code – looking at the rest of the program should elucidate.

Print formatting uses the variable @%, but it is much more complex than the Atom's equivalent. We will shortly be publishing a program to simulate the Beeb version. The Beeb automatically prints a new line, unless you tell it not to, by using a semi-colon – again, Atom does just the opposite. Numbers prefixed by the tilde sign (~) are printed in hex, the hash sign (#) being reserved to denote an immediate operand in assembler. Just to confuse you, the ampersand (&) denotes a hex number in BBC Basic. Line labels are not allowed

Subtle syntax points separate BBC Basic from the Atom dialect. Barry Pickles offers a conversion kit to those fluent in AtomBasic

on the Beeb, so if you see the dreaded GOTO you can speed things up on the Atom. Variable names, functions and procedures may be named using multiple characters, upper or lower case. More of this later.

Now let's look at new keywords that you may encounter, and what to do about them.

ASC Used in the form ASC(A\$), it returns the ASCII value of the first character in A\$. The Atom equivalent is ?A. Some Basics have another form: ASC("A"). This returns the ASCII value of the character in the bracket. AtomBasic uses CH"A" to perform the same task.

BGET#/BPUT# Used only in Acorn Basics. The Atom uses the same function but without the # suffix.

CALL Same as Atom's LINK, except that the Beeb uses C% to specify the state of the carry flag and it also sets up a parameter block showing the type of variable that is to be acted upon and the limits of that variable – you cannot do this from AtomBasic, although a machine-code routine could be constructed.

CHAIN loads and then runs a specified program. This can be done using *RUN "<filename>" in the first program provided you *SAVE the second program so that it autoruns (see Atom Forum, October 1983).

CHRS returns the ASCII character corresponding to its argument. Same as P.\$(x).

CLEAR clears (zeroes) all non-integer vari-

ables and arrays. A two-line subroutine will do this for us:

```
10000REM:Clear
10010 F.N=#2800 TO #288F
S.4;!N=0;N.
10020 F.N=#2EB TO #320
S.4;!N=0;N.;R.
```

CLG Same as CLEARn

CLS Same as P.\$12

READ...DATA...RESTORE See Atom Forum, January 1984.

DEF FN/FN(x) No equivalent Atom routine, so you must either write the function out in full every time you encounter FN(x), or you could implement a function evaluation routine, using Bruce Smith's Extended Basic article in the December 1983 issue.

DEFPROC/PROC(x,y,z) Use a GOSUB, but watch out for local variables.

DIV simply means 'divide by'.

SOUND/ENVELOPE If you have the Atom sound board (see the May 1983 issue), you may translate these; otherwise you'll have to make up your own effects. SOUND parameters are channel/volume/pitch/duration. ENVELOPE parameters conform to the 14 registers of the sound chip.

EOR means 'exclusive OR'.

ERL/ERR—See ON ERROR

EVAL Same as VAL.

EXP means exponent. Atom uses

FALSE/TRUE A logical variable. FALSE has the value 0 and TRUE is -1 (see page 31 of the manual and Atom Forum, January 1984).

GET/GET\$/INKEY/INKEY\$ All perform the function of reading the keyboard. Those with the \$ suffix store the key's ASCII value as a string variable. GET waits for a key-press, while INKEY(n) waits for n/100ths of a second, after which it returns a value of -1 if no key was pressed. INKEY with a negative parameter looks only for a specified key whose ASCII value is the parameter. Atom Forum for June and November 1983 give equivalent routines.

INPUTLINE A keyword peculiar to the Beeb, giving a new line for each item of

ABS	ACS	AND	ASN	ATN	COLOUR	COUNT	
COS	DEG	DRAW	END	EOF	FOR	GOSUB	
GOTO	IF	INPUT	INT	LEN	LET	LN	LOG
MOVE	NEXT	OR	PI	RAD	REM	RETURN	
RND	SGN	SIN	SQR	STEP	TAN	THEN	TO
TOP	VAL	UNTIL					

Table 1. Keywords common to BBC Basic and AtomBasic

input. You can do this, using the character.

INPUT# This gets bytes from tape and returns them in the specified variables. The first argument is the file handle. You will have to use multiple BGETs for this.

LEFT\$/RIGHT\$/MID\$ See page 61 of the manual. We'll shortly be publishing a routine to add these words to AtomBasic.

LOCAL A powerful function, allowing you to declare that the variable(s) used in a function shall be local to that function and retain their original values outside it. Also used in procedures. The way round this is to assign the variable to a specific memory

location, before entering the function/ sub-routine, and recover the value on return.

LOMEM/HIMEM On the Beeb these indicate the lowest and highest addresses that can be used by a Basic program. LOMEM is equivalent to $2^{18} \times 256$. There is no Atom equivalent of HIMEM, which is usually manipulated to protect machine-code above it from being overwritten. You will just have to be careful.

ADVAL This reads a value at the Beeb's A/D port, normally from a games paddle. Most games don't need a true analogue, since control is of the up/down/left/right variety. Convert the program to a keyboard

control or use an Atari-type joystick on the user port.

GCOL This is a colour manipulation command for which there is no Atom equivalent, the graphics chip on the Beeb being very sophisticated and having more colours. You will have to make the best of it you can. If you are using an RGB monitor, you could imitate a kind of GCOL using the circuit in the October '82 issue.

Next month we'll finish off the keywords and look at VDU calls. In the meantime, have a look at some of the Beeb programs in this issue and see what you can make of them. ●

```

10 REM Planets
20 MODE1
30 VDU5
40 REPEAT
50 VDU29,RND(1000)+100;
RND(800)+100;
60 LC%=RND(3)
70 SIZE%=RND(150)
80 SIZES%=SIZE%*SIZE%
90 FOR Y=-SIZE% TO SIZE% STEP 4
100 X%=SQR(SIZES%-Y%*Y%)
110 X2%=2*X%
120 FOR I=-X% TO X% STEP 4
130 IF RND(X2%)-X%<I% THEN
GCOL0,LC% ELSE GCOL 0,0
140 PLOT69,I%,Y%
150 NEXT I%,Y%
160 VDU19,LC%,RND(7);0;
170 UNTIL FALSE
    
```

Listing 1. 'Planets' program in BBC Basic (© Acornsoft 1983)

```

10REM Planets
11REM CONVERTED FROM
12REM BBC BASIC BY
13REM B.PICKLES : 1983
20CLEAR4
40DO
50 M=A,R,%170+20
55 N=A,R,%170+20
70 S=A,R,%25+1
80 Q=S*S
90 F,Y=-S TO S
100 Z=SQR(Q-Y*Y)
105 IF Z=0 Z=1
110 W=2*Z
120 F,I=-Z TO Z
130 IF(A,R,(W)-Z)<I G,b
140 PLOT13,(I+M),(Y+N)
150b N,;N.
160U,0
    
```

Listing 2. AtomBasic version of 'Planets'

SPECIAL OFFER!

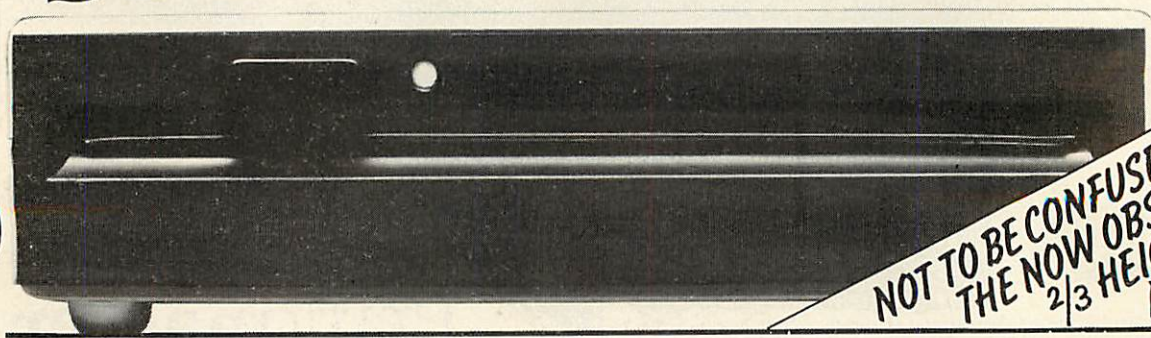

NOT TO BE CONFUSED WITH
THE NOW OBSOLETE
2/3 HEIGHT
MODELS

Latest Model - Slim Disk Drive

FROM VIGLEN

Complete disk system for the BBC Model B

- Package assumes you own a BBC Model B with switched-mode power supply plus 1.20 operating system

Offer includes:

- Disk Interface (call at factory for free fitting)
- User Guide
- Utilities Disk
- 400K double sided 80/40 track switchable with fitted switch. Canon disk drive
- Includes all necessary leads and case

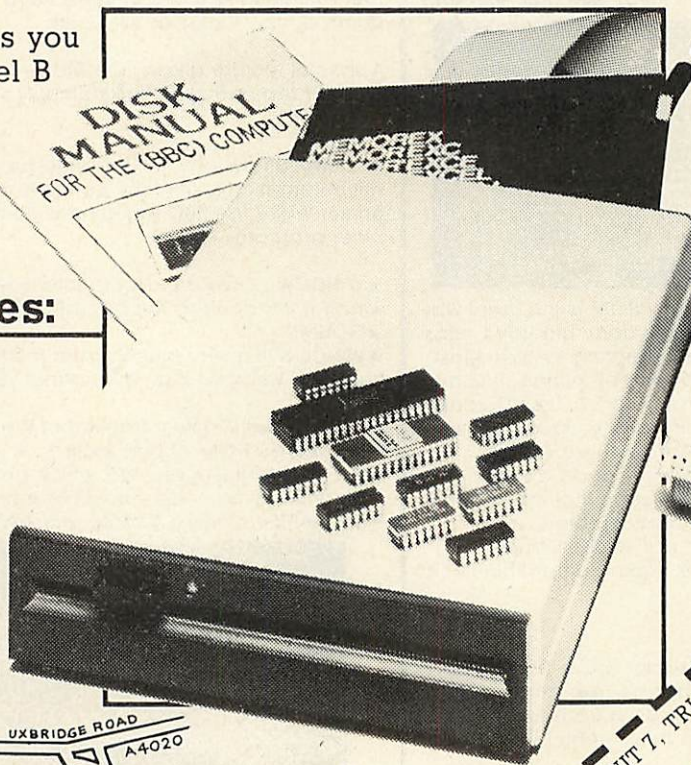
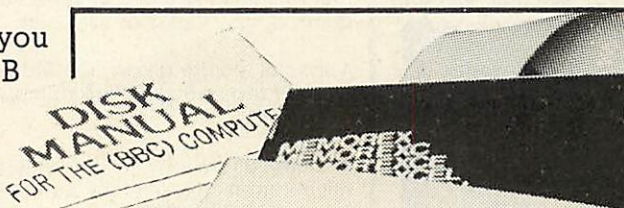

£299
INC. VAT
CANON

Viglen
COMPUTER SUPPLIES

Unit 7 Trumpers Way
Hanwell W7 2QA
Telephone: (01) 843 9903

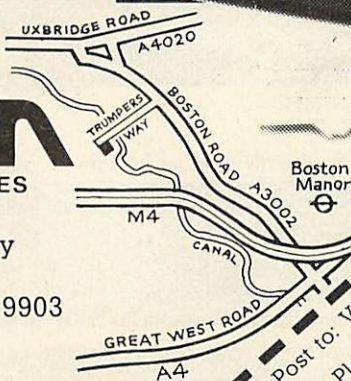

Post to: VIGLEN COMPUTER SUPPLIES UNIT 7, TRUMPERS WAY, HANWELL, W7 2QA

Please send me (state number required)

I enclose Cheque/P.O. for £

I prefer to pay ACCESS/BARCLAYCARD (Delete whichever not applicable)

Card No. _____
Signature _____
Name _____
Address _____

Incl £8 carriage, cheques payable to Viglen Computer Supplies



Put an end to inefficient, slow cassette tape storage



Speed your data access with a TEAC disk drive from Viglen

Please enquire about our latest 3 inch disk drive!

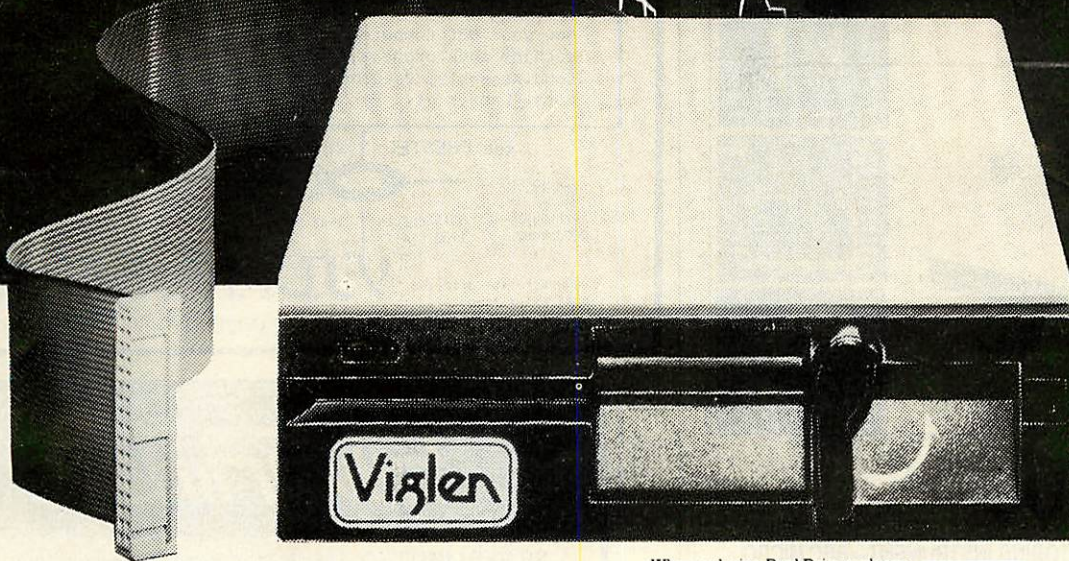

Replacing your cassette with a disk drive means Data Access in less than 5 seconds! If you are looking for a guaranteed disk drive that's fully compatible, at a price that includes VAT, Formatting Disk, User Manual, Case and Leads, then just look at our all-inclusive prices!

When ordering Dual Drives, please state which layout you prefer. A or B.

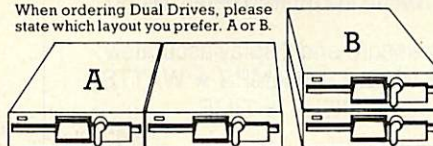

TEAC 55 Slimline Drives		DUAL DRIVES CASED		Incl. VAT	Excl. VAT
SINGLE DRIVES CASED	Incl. VAT	Excl. VAT	40 TRACK 200K	£320	£278.26
40 TRACK 100K	£155	£134.78	40/80 TRACK SWITCHABLE 400K	£402	£349.57
40 TRACK 200K	£230	£200.00	40/80 TRACK SWITCHABLE 800K	£498	£433.04
40/80 TRACK SWITCHABLE 200K	£195	£169.51	DFS KIT	£95	£82.60
40/80 TRACK SWITCHABLE 400K	£249	£216.52	Disc Filing System with integrated Power Supply Unit	£36.80	£32.00

• These drives are fully compatible with other computers and can be still used should you change your computer for another type.
• Orders welcomed from Educational Establishments and Government Departments.

Canon Drives

	Incl. VAT	Excl. VAT
40/80 TRACK SWITCHABLE 400K	£220	£191.30
800K DUAL	£440	£382.60
800K AND POWER SUPPLY	£476.80	£414.60

Full Twelve Months Guarantee

How to order

By post: To purchase any of the items simply fill in the coupon with your requirements. Enclose your Cheque/P.O. or use your Access/Barclaycard. Please make cheques payable to: VIGLEN COMPUTER SUPPLIES and post to above address. Allow seven days for delivery and add £8.00 carriage, package and insurance on all items.

By telephone: Ring (01) 843 9903. Credit Card holders (Access/Barclaycard only) can purchase by telephone. Please give Card No., Name, Address and the items required.

Viglen

COMPUTER SUPPLIES

Unit 7 Trumplers Way
Hanwell W7 2QA
Tel: (01) 843 9903

Post to: VIGLEN COMPUTER SUPPLIES UNIT 7, TRUMPERS WAY, HANWELL, W7 2QA

Please send me the following items:

I enclose Cheque/P.O. for £ _____

I prefer to pay by ACCESS/BARCLAYCARD*. Card No: _____

Signature _____

Name _____

Address _____

Layout A or B* _____

*Delete as necessary



BITS & BYTES

B&B disc drives include utilities, disc, manual and cables all cased in Plastisol steel by BSC which is tough, abrasion resistant, designed to withstand rough handling and is easily wiped clean. Colour near to BBC.

Single Disc Drives

40T	100k	½Height	5¼"	£145.00+vat
40T	100/200k	½Height	5¼"	£150.00+vat
40T	100k	½Height	3"	£150.00+vat
40T	100k	½Height	3½"	£164.35+vat
40T	100/200/400k	½Height	5¼"	£173.04+vat

The new double sided 1 $\frac{3}{16}$ " high, super quiet, linear stepper motor with Epson reliability.

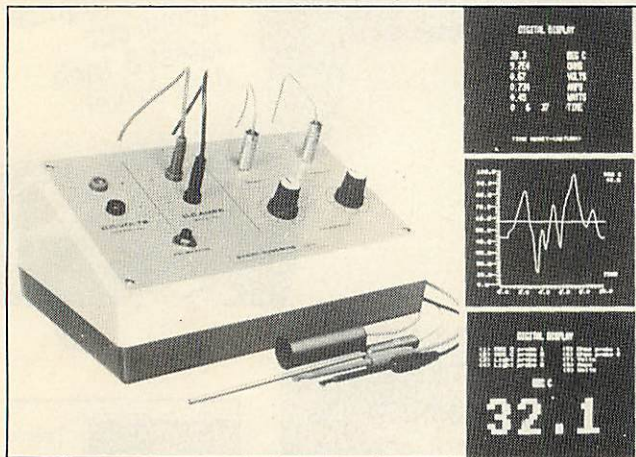

Excet EMU3

SOFTWARE SUPPORTED MONITORING INSTRUMENT—BBC MICRO

Enables the BBC (B) to measure and display accurately:
 POSITIVE & NEGATIVE—VOLTS ★ AMPS ★ WATTS
 ★ OHMS ★ TEMP ★ LIGHT ★ TIME

FEATURES

Up to 6 simultaneous readings
 Graphical or digital display
 Auto scaling and labelling
 Plots any two variables
 Menu driven options
 Full software support
 Unlimited choice of scales
 Event analysis facility
 Teaching display mode
 £99.00 inc. VAT

RANGES

Temp -10 to 110 deg C
 Resistance 0 to 1E6 ohms
 DC volts 40vpd
 DC current 0 to 2000m
 Amps
 Power 0 to 80 watts
 Light 0 to 100 (uncalibrated)
 Time 0 to 1E6 secs (hrs mins secs)
 Accuracy: error generally <1 per cent

Includes instrument, temperature probe, light sensor, electrical probes (three sets), leads, connections, software on cassette, full instructions, application, notes, P&P. Free VHS video demonstration film available on request.

**BITS & BYTES
 (COMPUTERS)
 LTD**

**20/21 SOUTH ST
 S. MOLTON, DEVON
 TEL. 07695 4141**

VASIM

**DISC-BASED
 ASSEMBLER
 in ROM
 for the
 BBC Micro**

The VASM System Vida Rebus 6502 Ass v2.0C Page: 0001

001 *H The VASM System
 002 ;
 ; VASM is a complete DISC-BASED Assembler
 ; and INTEL file Locator System in ROM,
 ; especially designed for use with standard
 ; text editors such as View and Wordwise.
 ; With VASM it becomes possible to develop
 ; professional machine code programs in a
 ; professional way.

009 010
 0011 romv QRY Rom Version
 0012
 0013 cond not romv
 1900 0014 org \$1900
 0015 else
 0016 org \$8000
 0017 endc
 0018 ;
 1900 A200 0019 .start: ldx #0 ;String print routine
 1902 BD0E19 0020 1%: lda msg,x ;Get the character
 1905 F006 0021 beq 2% ;Finished?
 1907 20E3FF 0022 jsr osasci ;No- print it
 190A E8 0023 lnx
 190B D0F5 0024 bne 1% ;and continue.
 190D 60 0025 2%: rts
 0026 ;

**ONLY
 £35
 plus VAT**

ex-stock!

- Professional 6502 Assembler for Disc Systems
- Industry Standard Intel Files
- Compatible with Standard Editors (expands tabs)
- Full Documentation

**ORDER
 YOURS
 TODAY !!**

Now your BBC Computer can be used to develop any size machine code program - in one go! Facilities include Cond. Assembly, Pseudo-Ops., Ext. Libraries, Paged O/p, Local Labels etc. For quality development - use VASM!

see PRESTEL 288 050 49

VAT REG. NO. 403 9099 54

Symbols:



1928 BUF 0015 BUFLN 1922 DATA 190E MESSG FFE3 OSASCI
 0000 ROMV 1900 START

VIDA REBUS

0000 error(s) detected
 628F bytes free

PO Box 256 Watford., HERTS. WD1 8HY Tel: (0923) 53514

Silverlind

SILVERLIND LTD. 156 Newton Road, Burton-on-Trent
 Staffs. DE15 0TR. Tel (0283) 63987

TOWNTST BBC/B £6.50

A very useful aid for teaching Geography in primary schools, this program tests pupils' knowledge of the locations of major towns and cities in England, Scotland and Wales. Well presented, with a high-resolution map.

BIOLOGY BBC/B £12.50

A suite of programs using text, animated diagrams, examples, and questions to assist in the understanding of Biology to CSE, 'O' and 'A' Level standards. Most suited to individual use by students, these programs also contain material teachers can extract for classroom demonstration. Topics covered include the Eye, Ear, Heart, Blood and Circulation, Skeleton, Female reproduction, Genetics, Biochemistry and the Central Nervous System.

ENJOY MATHS 48K Spectrum £8.00

A suite of 4 highly motivating programs for the 8 - 14 age range: tables, simple equations, polygons and areas. The programs combine explanation with tests and make good use of colour and sound.

MASTER DIET PLANNER 48K Spectrum £11.95

The ultimate in diet programs, the MASTER DIET PLANNER contains details of calories, protein, vitamins and other nutrients for 681 foods! The MASTER DIET PLANNER will help you plan a well-balanced diet, including options to restrict fats, cholesterol and salt, or to increase fibre intake - at the same time offering maximum choice of foods. Instructions and Recipe Book included.

ALL PRICES INCLUDE POST & PACKING & VAT

We require good programs to increase our catalogue and pay high royalty rates for published material.

WAGES OF SIN



Simon Dally involves you in the intimate concerns of the dungeon-dwellers – marriage and money

LAST year, as our regulars will recall, we had three popular excursions into the *Acorn User* dungeon. This month we're taking a look at how the occupants are settling in after tunnelling their way from Bedford Square to Covent Garden, and since so many of you have speculated on the absence of females, we thought the married quarters might be of interest.

First, for new readers, a recap of the characteristics of the inhabitants of the *Acorn User* dungeon. All inhabitants are either dwarves or trolls (apart from the odd visitor). Dwarves invariably tell the truth, while trolls are duty-bound to lie on all occasions. This makes life fairly simple for the dungeon dwellers because a dwarf knows that anything a troll says is the opposite of the truth, while anything a dwarf says is true. Unfortunately, humans cannot tell the difference between a dwarf and a troll – except by using logic (and maybe a micro).

The situation is made a wee bit more confusing by the fact that half the inhabitants are completely barmy and believe the truth is the opposite of what they should be saying. Therefore, if we pose a straightforward question such as 'Are there 12 inches in a foot?', the answers will be as follows:

Sensible dwarf: Yes (always tells the truth).

Barmy dwarf: No (believes the opposite of the truth).

Sensible troll: No (lies about the answer).

Barmy troll: Yes (believes 12 inches don't make a foot and then lies about it).

Before being shown the married quarters, you have to solve a puzzle set by the blabbering Mad Alex, newly promoted to guardian of the entire dungeon ('only 12 gold pieces entry money to you, squire').

As you enter the hellish hole, Mad Alex springs out and grips you by the arm to tell you his latest tale. It's all about his own personal RAM which is in something of a state bitwise – in fact, he thinks he needs a sideways ROM to solve his problem. Then, from his left earhole, he produces a listing which reveals the monthly salaries of six dungeon employees. It reads:

	Gold pieces
Squirrel Stuffer and Owl Feeder	... 1,100
Owl Feeder and Electron Eater	... 1,700
Electron Eater and	
Second Processor Hoarder	... 1,100
Second Processor Hoarder	
and QL Quasher	... 3,300
QL Quasher and Gong Hunter	... 5,300
Gong Hunter and Owl Feeder	... 3,200



Mad Alex then stuffs the listing into his mouth, masticates, swallows and burps before explaining that to win the prize money you have to start by working out what each of these six employees earns. And then you have to juggle these figures to produce a winning number (which we'll now go on to explain).

En route to the married quarters Mad Alex explains that the mating habits of dwarves and trolls are fairly similar to those of humans. In the married quarters a strict policy of apartheid rules: no dwarf can cohabit with a troll under any circumstances. On the other hand there is no restriction on the sanity of the various couples – it's fine for a sensible troll to be married to a barmy troll.

Before booting you out of the door Alex announces that if you return to his office and tell him the correct number of gold pieces he owes you after your tour he will give them to you, otherwise you will feel the hot end of his soldering iron for wasting time.

The rules are that you start with a figure equivalent to the number of gold pieces

earned in a month by the QL Quasher. If a dwarf couple gives you a number you should add it to your figure. If a troll couple gives you a number you should subtract it from your figure (you keep a running total as you travel from room to room). The signs tell you what to do.

In addition, if you can determine the sanity – sensible or barmy – of any individual in a room you can award yourself a bonus of 5,000 gold pieces per room where you can make this deduction.

Now that everything's crystal clear you're on your own and here's the state of play.

Room 1

He: My wife is a troll.

She: My husband is a dwarf. One of us is sensible and one of us isn't.

Sign reads: Number of gold pieces = Gong Hunter's salary.

Room 2

He: My wife is barmy.

She: My husband always tells the truth.

Sign reads: Number of gold pieces = Squirrel Stuffer's salary.

Room 3

He: We're both barmy.

She: That's correct!

Sign reads: Number of gold pieces = Owl Feeder's salary.

Room 4

He: We're both trolls.

She: That's correct!

He: We are either both sensible or we're both barmy.

Sign reads: Number of gold pieces = Second Processor Hoarder's salary.

Room 5

He: At least one of us is barmy.

She: That's not true!

He: We're both dwarves.

Sign reads: Number of gold pieces = Electron Eater's salary.



Back you go to Mad Alex and announce how many gold pieces he owes you (having first fused his soldering iron). What's the answer? (By the way, your entry fee is refunded.)

Two pieces of astounding Acornsoft wares await the first three correct entries out of our sack. Answers on a postcard, please, to arrive not later than May 4, 1984, to: April Competition, Acorn User, 68 Long Acre, London WC2E 9JH.

BUG-EYED WASPS WITH THE STING OF DEATH

Attack on Alpha Centauri, Software Invasion, BBC B, £7.95 (disc £11.95)



THIS game is *Galaxian* in its ultimate form. But if you are put off by anything that

resembles a previous game, don't be. *Attack on Alpha Centauri* is excellent in its own right.

As in most games of this type, you have three lives in which to destroy a constant stream of aliens – in this case multi-coloured, bug-eyed wasps that swoop and drop bombs on you. The setting is a mountainous, volcanic planet. This is well drawn in high-resolution graphics, making good use of colour to provide an ideal landscape.

When you start the game the wasps 'explode' from their volcanic hiding place to take up four ranks at the top of the screen, each rank progressively larger the lower down the screen, resembling an invading army. You move from side to side at the bottom of the screen, and of course score more points for destroying the moving targets than the stationary ones.

The most impressive thing about the game is that as the creatures peel off and swoop to attack they loom towards you to

drop their bombs and then fade into the distant landscape. The 3D effect is most appealing and executed very smoothly.

The sound effects are very good but are constant and loud and can become overbearing. Fortunately, you can turn the sound on or off, even during play. The game is fast and furious so it is nice to have a pause facility available during the game, for when your eyes become blurred or your finger starts to ache.

One thing missing is a joystick facility – this may not matter to some, but it annoyed me.

Unfortunately the landscape remains a constant feature, as it is loaded before the main game. This is not unpleasant but means it cannot be removed to provide a league table. Nor is there an option to alter the level of difficulty. Despite these minor points, though, the game is very good, thanks mainly to the graphics. It is good value for money and I'm certain it will appeal to most.

Ian Rowlings

TREAD CAREFULLY

Mined-out, Quicksilva, BBC B, £4.95

MINED-OUT is a refreshing change from the usual 'blast 'em out of the sky' derivatives. The object of the exercise is to get safely across nine minefields to rescue our poor hero Bill the Worm.

The mines are hidden from view but a 'beep' warns you if you move near one or more of them and the screen status line tells you how many (one to three) are in the immediate vicinity. Hitting a mine is fatal, but with a careful blend of backtracking and logical deduction, you can slowly carve a safe passage through the minefields. A couple of damsels (who wave tantalisingly at you) are trapped within each minefield, and extra points are yours if you can rescue them.

To stop you taking too long over each move, a number of additional hazards come into play. Periodically, a mine-laying creature flits across the screen, laying a carpet of extra mines, visible this time. At level four and above a bug chases you along the path you are clearing through the minefield. Although it moves rather slowly, contact is deadly. A further hindrance is an electrified fence which occasionally materialises. It doesn't kill you but you can't get through it.

If all this seems impossible, it's worth remembering that the minelayers not only add extra mines but also remove some of the hidden ones. So paths do not necessarily remain blocked.

One small complaint is that demonstration and instruction files have to be loaded before the main program can be executed. The demonstration is quite entertaining the

first time through but quickly wears thin. It would be helpful if the game could be loaded and run in isolation.

If, like me, you find 'invader' variants a little fast and prefer time to think about your moves, then *Mined-Out* is certainly recommended. Although loading seems unnecessarily long-winded, the game has lasting appeal and is good value.

Vincent Fojut

FACTORY ACTS

Felix in the Factory, Program Power, Electron £7.95

FELIX in the Factory is one of the first batch of Program Power cassettes launched for the Electron, and, after playing *Killer Gorilla*, I was eager to put this one through its paces. I was not disappointed.

It involves climbing up and down ladders, running across conveyor belts and avoiding 'gremlins' in your struggle to retrieve the oil can, which allows you to maintain the level of oil in the generator. To make it more interesting, giant rats run across the screen, which you can kill with rat poison, and to help you past the gremlins you can pick up pitchforks to stab them.

The graphics are smoothly impressive, and to add a little variety the screen layout changes slightly each time.

However, it has its bad points: the controls are a little awkward – A/Z are up/down and P/↑/↓ are Left/Jump/Right. Why did they not stay with the better controls used in *Killer Gorilla*? Sound is also used far too sparingly.

Nevertheless, a good game once you have mastered the controls.

Robert Sassoon

RICH NEW WORLD

Gateway to the Skies, Solarsoft, BBC 32k, £8 (disc £10)

I EMBARKED on my adventure, feet firmly on the ground, in a deserted village square. Searching the village and surrounding areas, I found the equipment and supplies necessary for my perilous journey. The solution to the puzzle of how to leave Earth made me think hard but at last I was away. Finding myself offworld in the Kingdom of Lataeri, standing by the beautiful Fountains of Yorith, I basked in the warm sun under a yellow sky. The time had come to set about exploring this new world, to find its many treasures – if I could avoid death in fiendish traps. Luckily, while back on Earth I had been vigilant and collected clues which were now saving my life. So on I went. . .

Gateway to the Skies is not one but two programs. Part one must be completed before part two can be started. This gives a total playing area of more than 34k, with more than 100 locations full of tricks, traps, monsters and treasure to explore and conquer.

After playing the game for three days, I've come close to completing the first part. I found it entertaining with a good balance between skill and trial and error. It has a load/save facility, which means that the fearless explorer need not restart from the beginning if killed.

There is a minor bug – the game restarts if you are not carrying anything when leaving the furnace room.

The game has no sound or graphics but is a good 'traditional' adventure representing good value for money.

Ken Worrall

A SUPERB NEW PROGRAM FROM BRITAIN'S LEADING SOFTWARE HOUSE!

THE MINE

Tunnel through the strata deep beneath the earth's crust in search of buried treasure. Clear the mine of fire breathing dragons and giant man-eating tomatoes with your neutraliser. But watch out for toppling rocks, poisonous toadstools and ruthless phantoms. An exciting and challenging machine code game for only £7.95.

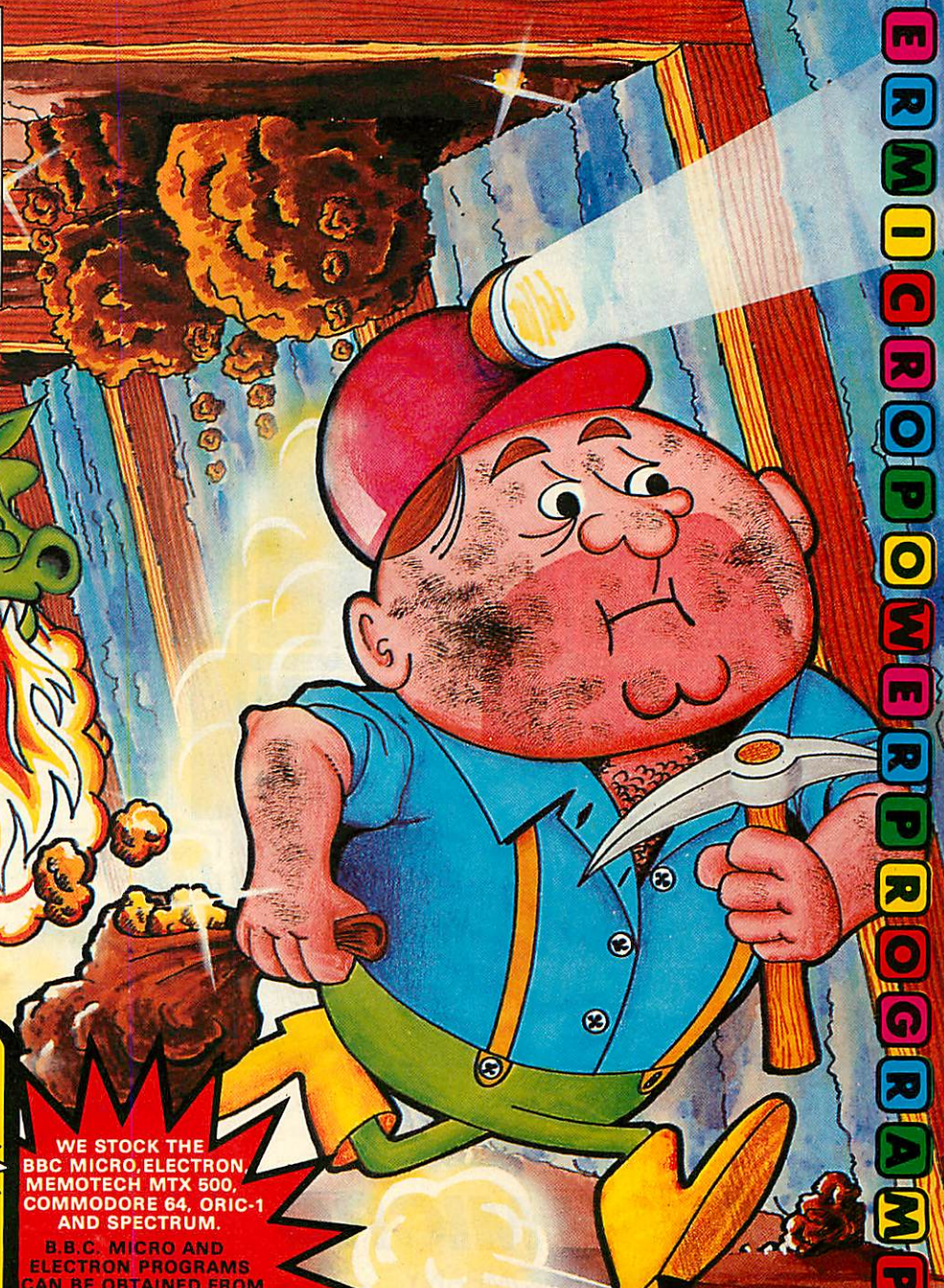
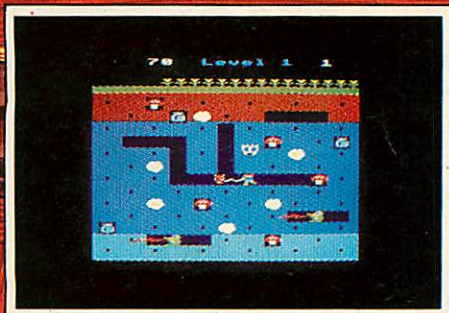

The following top titles are available for both the BBC Micro and Electron:- Killer Gorilla £7.95/ Moonraider £7.95/Bandits at 3 o'Clock £6.95/ Croaker £7.95/Felix in the Factory £7.95/ Felix and the Fruit Monsters £7.95/Chess £7.95/ Escape from Moonbase Alpha £7.95/Draw £9.95/ Swoop £7.95/Intergalactic Trader £8.95/ Positron £6.95/Cybertron Mission £7.95/ Adventure £7.95.

All prices inclusive of V.A.T. Mail Order: Please add 55p per order P. & P.

WE GUARANTEE THAT ALL OUR ADVERTISED PROGRAMS HAVE BEEN COMPLETED AND ARE READILY AVAILABLE.

Showroom: Northwood House North Street LEEDS LS7 2AA Tel: (0532) 458800
 Mail Order: 8/8a Regent Street LEEDS LS7 4PE Tel: (0532) 683186 Or: 696343

WRITTEN ANY PROGRAMS? WE PAY 20% ROYALTIES!

SPECIAL OFFER Deduct £1 per cassette when ordering two or more.



WE STOCK THE BBC MICRO, ELECTRON, MEMOTECH MTX 500, COMMODORE 64, ORIC-1 AND SPECTRUM.

B.B.C. MICRO AND ELECTRON PROGRAMS CAN BE OBTAINED FROM SELECTED BRANCHES OF W. H. SMITH, JOHN MENZIES, BOOTS, HARRODS, ALL GOOD DEALERS, OR DIRECT FROM MICRO POWER.

GRAFPAD

...for as many uses
as YOU
can imagine!



BBC MODEL 2 • SPECTRUM COMMODORE 64

With Grafpad you can now add a new dimension to your computer enjoyment, but most important, it helps you create your own application programmes by the simple use of the Grafpad!

The Grafpad comes complete with a cassette comprising two programmes.

THE FIRST PROGRAMME

displays the co-ordinates of your screen area. The co-ordinates are based on the screen with a grid size of 1023 x 1279 pixel, also in the Grafpad giving you a grid size of 320 x 256 pixels!

THE SECOND PROGRAMME

provides you with the utilities for circles, squares, triangles, free-hand, erasing line-drawing etc, and of course, full "Fill-in" facility in 16 different colours by the simple use of the pen!

Draw from a simple apple to a computer circuit - store in cassette or disk, perhaps transfer direct to a printer - in black and white or full glorious colour!

Purchase unique C.A.D. (Computer Aided Designs) programme and add further enjoyment and professionalism to your computer designs!

The Grafpad comes complete with Operational Manual, Programmes, The Grafpad and Pen and it simply plugs in your computer.

(Size: 25mm height x 55mm width x 260mm depth)
Weight: 1.2 kg (Gross)

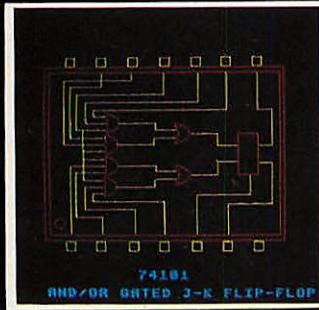
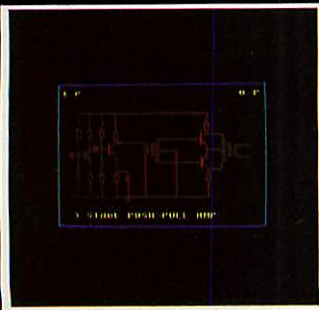
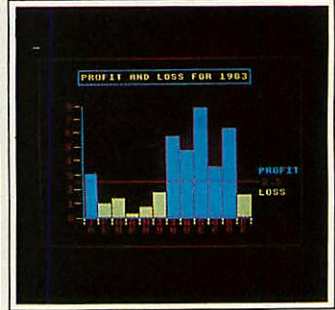
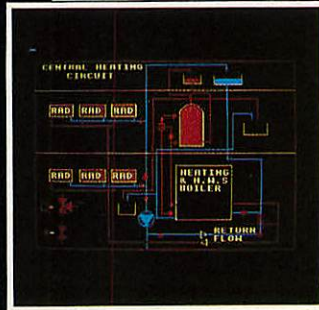
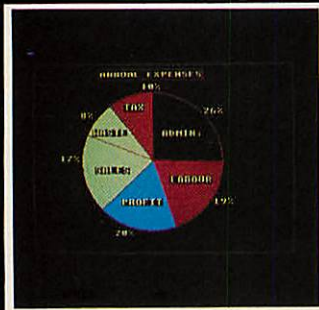
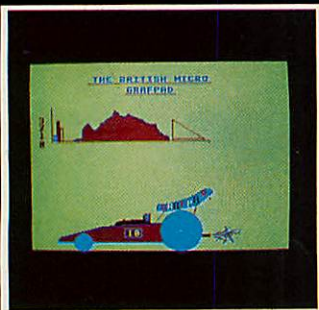

(The above designs were drawn by a 12-year-old at our showrooms!)

HOW TO ORDER:

BY TELEPHONE:
If you are an American Express, Barclaycard, Diners Club or Access Card Holder simply telephone us giving your Card No., Name, Address and item(s) required and your orders will be dispatched within 48 hours!

BY POST:
Simply fill in the coupon, enclosing your cheque/P.O. made payable to: BRITISH MICRO, or use the special section for Credit Card Holders, and post to the address below. Please allow 14 days for delivery.

Post to: BRITISH MICRO, UNIT Q2, PENFOLD WORKS
IMPERIAL WAY, WATFORD, HERTS. WD2 4YY

Please send me Grafpad for:

BBC MODEL 2 SINCLAIR SPECTRUM COMMODORE 64
(Please tick)

Qty.	Item	Ex. VAT	Inc. VAT	Total
	Grafpad Complete	£125.00	£143.75	
	C.A.D. Programme	£18.00	£20.70	
Postage, Packing & Insurance				£5.00
TOTAL				£

I enclose my cheque/P.O. for £.....

I prefer to pay with my American Express, Barclaycard, Diners, Access Card
(Please cross out whichever is not applicable)

CARD NO. _____

SIGNATURE _____

NAME _____

ADDRESS _____

Address above must be the same as card holder.

- DEALER INQUIRIES WELCOMED
- SPECIAL DISCOUNTS FOR EDUCATIONAL AUTHORITIES

BRITISH MICRO

A HEGOTRON GROUP COMPANY

Unit Q2, Penfold Works,
Imperial Way, Watford, HERTS WD2 4YY
TEL: (0923) 48222. TELEX: 946024



THREE STARS FROM THE EAST

**How does a trio
of Japanese printers
shine in the
dot-matrix firmament?
Here are some
observations from
George Hill**

PRINTERS seem to be coming down in price and going up in quality at almost the same rate as micros. Three printers from Star, in the budget price range of £200 to £400, are the DP8480, the Gemini 10X and the Delta 10, and they conveniently lend themselves to comparisons with other models on the market. Star printers in general bear an uncanny resemblance, particularly in their command sets, to members of the Epson range, and these models are no exceptions.

All three are dot-matrix printers of the conventional type. The 8480 has a seven dot-wire head, and the Gemini and Delta a nine dot-wire head.

The DP8480 has been superseded and only end-of-range models are now available. My review machine was from CJE, which supplies it complete with serial interface, graphics character ROM and dumping software.

It has a fairly extensive repertoire of printing styles, and a more attractive character set than the Seikosha, with which it compares in price. It has a rather awkward and slow graphics character set, based on a six-wide, single-dot deep extra character set that curiously brackets some Japanese characters in the ROM. This is inconvenient and slow, even when driven in machine code, and cannot do the one printing wire much good in the long term. However, it is built like a tank, uses ordinary reel-to-reel ribbons (much cheaper than cassettes), and I preferred it to the Seikosha.

The Gemini 10X (review model supplied by Micro-Peripherals) is much more sophisticated. It is an upgrade of the Star 510, which I know only by reputation and from readers' letters. It is neatly packaged and supplied complete with paper separator and roll-holder. Parallel interface is standard, and serial would be a fairly costly extra. No interface cable is included in the basic price.

The variety of printing styles available is much the same as on the Epson FX80, that is, Pica, Elite, Condensed, Expanded and Italic. It can underline and produce ugly (MX80-type) sub- and superscripts. It also has some built-in special characters, including block graphics, of which examples can be found in my article on dumping the Teletext screen (March issue). The text example (Figure 1) illustrates the capabilities.

The pin-addressable graphics capability is almost identical to that of the Epson MX series, so the graphics dumps published so far in *Acorn User* for the MX80 will work on these Stars. Some other graphics

dumps use the ESCape 3 code, and these differ slightly. There is 'quadruple density' graphics, but all the graphics capabilities suffer from the Epson problem – an inability to produce a true circle simply – and are certainly no match for the FX80's.

The way in which the characters have been arranged on the 10X differs radically from Epson's. The normal set consists of 256 characters (if you include controls and blanks), of which the printing set from 32 to 126 are the ordinary ASCII set with nationality options, and 160 to 255 are special characters, including block and 'box' graphics sets of 16 characters. The italics are in an alternate character set which can be switched in and out by ESC 4 or 5. In

this set characters 128 upwards have no extra meaning.

There is a 'download' character set, ie, user definable characters. This would seem to make the Gemini a serious rival to the much higher priced Epson FX80, but in practice the capability is much more limited.

There are only 96 definable characters, as against an apparent 256 on the Epson (though you would be foolish to redefine the control characters), and the download set cannot be mixed with another set on the same line. This really limits the use, as the download characters are frequently needed as *extra* characters, not replacement ones. The characters are defined on a 9 x 7 matrix, using a different system from the Epson. This has the advantage of *not* requiring sequential ASCII values but the disadvantage of being incompatible with Epson and even its own stabimemate, the Delta.

The Gemini 10X is neat, sturdy and quiet and handles the paper efficiently using friction or standard tractor feed. It is fast at 120 cps, with a rapid linefeed and the usual bi-directional, logic-seeking features. It also uses a typewriter ribbon, not a ribbon cartridge – a little messier but much more economical.

Setting the DIP switches reveals a pecu-

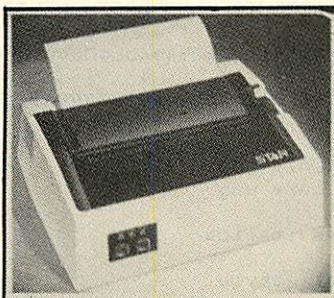

Built like a tank, the DP8480

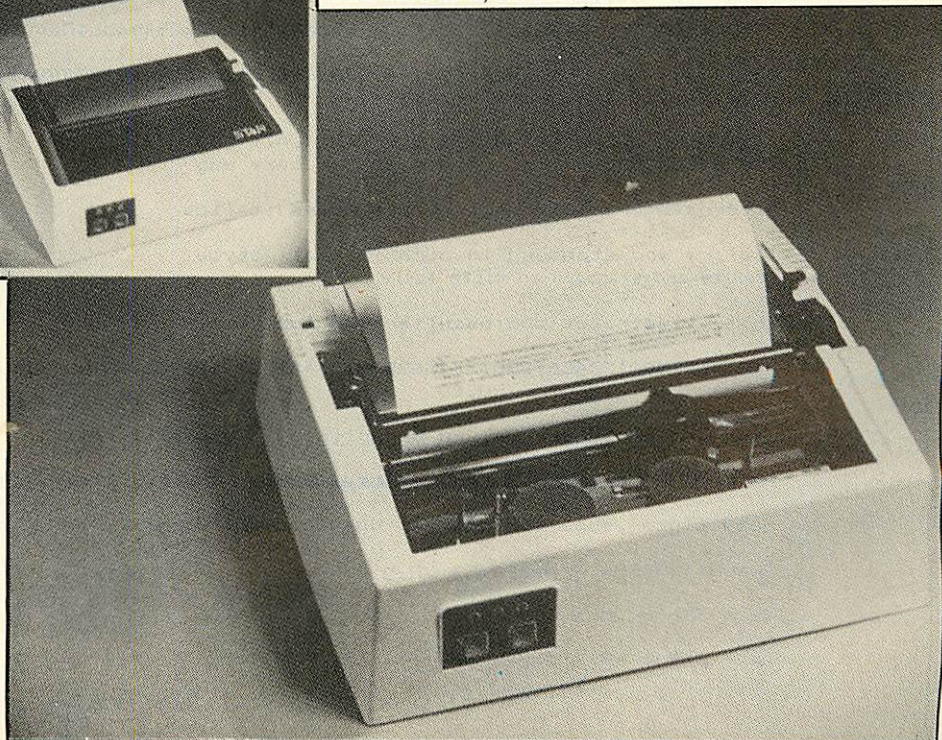

liarity. Why should the Continental character sets be linked to a 12-inch page length, while the UK and US have 11 inches? The DIP switch for setting the paper-end detector, the print buffer, 7/8 bit word length and automatic linefeed is external, which saves taking the lid off.

Two criticisms: when printing block graphics I detected a misalignment of the characters on the forward and backward printing strokes, and the smart smoked-glass effect cover is too opaque to be able to see the printing clearly. I had to take it off to see what was happening, particularly when resetting to the top of a page.

The Delta 10 (also from Micro-Peripherals) is Star's fully upgraded offering. It is almost identical in appearance to the Gemini, but has a number of extras.

First, it is faster (160 cps), and my impression is that, because of the faster linefeed, it is quicker than the Epson FX80, with which it is intended to compete. The increased speed has resulted in different sounds, including a less than pleasant whistle-while-you-print. The speed is further enhanced by the large buffer, so that the micro becomes almost instantly available for other tasks, unless you are printing a very long program or a piece of text of more than 1,000 words.

Second, it has the serial interface board fitted as standard. There is a consequent change in the operation of the DIP switches, and the external switch sets serial/parallel in place of the buffer-full printing.

Third, it has a much more powerful set of download characters, with proportional spacing. A curious feature of the printer is

that there seems to be no way of using the normal characters in proportional mode, although your own defined characters have proportional characteristics. The download characters are on an 11 x 7 matrix, with two-dot descenders available. Characters can be defined in the ranges 32 to 126 and 160 to 254, making it possible to use the full normal set, plus your own defined characters on the same line.

The 'temporary' manuals are tatty affairs giving only bare information and little proper guidance, and a preview copy of the American version was incomplete and verbose.

What do you get extra if you buy the Epson FX80 at a much higher price?

You get much better graphics capabilities, particularly the CRT and plotter graphics, which allow fully accurate screen dumps, with genuinely round circles; you get a more flexible mix of character sets, with proportional spacing available on all characters in most styles; you get slightly more accurate printing, though this is unlikely to be noticeable under most circumstances, and the ability to reverse linefeed. You do not get any block graphics characters, the serial interface as standard, or any better character sets. The Epson and Star sets are virtually indistinguishable, and neither is very beautiful.

Both Gemini and Delta are good value for money.

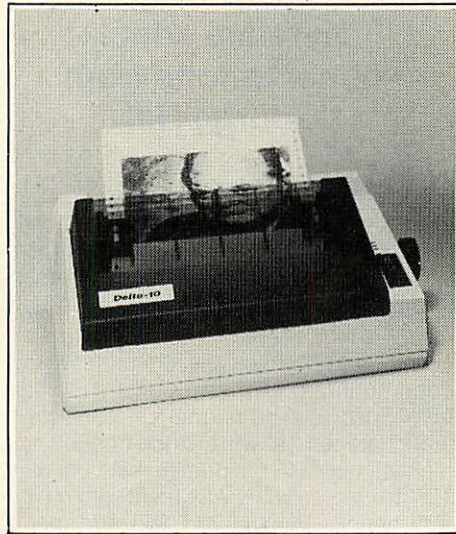

Delta 10 - Star's fully upgraded offering

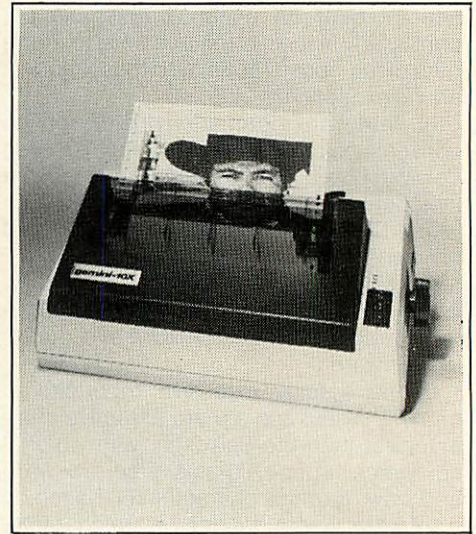

Gemini 10X - neat, sturdy and quiet

STAR DELTA 10 full character set. (GEMINI 10X is identical.)

```
!"#$%&'()*+,-./0123456789:;<=>?@ABCDEFGHIJKLMNPOQRSTUVWXYZ[\]^_`abcdefghijklmnopqrstuvwxyz{|}~
~{|}~"#$%&'()*+,-./0123456789:;<=>?@ABCDEFGHIJKLMNPOQRSTUVWXYZ[\]^_`abcdefghijklmnopqrstuvwxyz{|}~
~{|}~"#$%&'()*+,-./0123456789:;<=>?@ABCDEFGHIJKLMNPOQRSTUVWXYZ[\]^_`abcdefghijklmnopqrstuvwxyz{|}~
```

THE QUICK BROWN FOX JUMPS OVER THE LAZY DOG
The quick brown fox jumps over the lazy dog

Alternate character set - this means italics

Italics and standard in pica (normal) style
Italics and standard in elite style

This illustrates the peculiar TAB function.

```
01234567890123456789012345678901234567890123456789012345678901234567890123456789
^POS1           ^POS20           ^POS50
```

Any word or letter may be underlined in any style

All types of print and graphics **██** can be mixed on one line

Subscripts ,superscripts and download characters

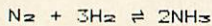
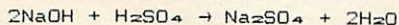

$$(a + b)^2 = a^2 + 2ab + b^2$$

Figure 1.

AN 800K DISC DRIVE SYSTEM. A RECORD £380.

If you're upgrading your BBC Micro to a disc system, you can get unbeatable value from Opus.

For instance, you can buy an Opus 5800 drive with 400K single density, for only £259.95.

And for only £120 extra, we'll give you our new double density disc interface.

Specially developed by us, it effectively

doubles the capacity of your drive, giving you an 800K system for only £379.95. And that includes VAT and carriage.

Our Double Density Interface can be supplied with any of the disc drives listed below. And it is not available anywhere else except Opus.

To place your order, post the coupon or buy direct at our showroom.

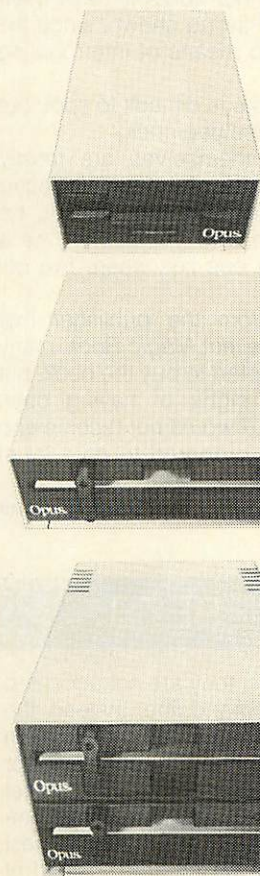

OPUS 3" MICRODRIVE.

Double Sided 40 Track Drive 1/2 Megabyte Unformatted.

- Twice the capacity on line of other available drives
- 200K. Single Density - 400K. Double Density
- Ex-stock delivery
- 3 ms. access time
- Lowest power consumption - direct drive
- Includes case, leads and utilities disc
- Totally compatible with 5 1/4" drives

Single Drive **£229.95.** Dual Drive **£459.95.**

5 1/4" JAPANESE DISC DRIVES.

SINGLE DRIVE.

Opus 5401 Single Sided 40 Track - 250K. Unformatted. Formatted: 100K. Single Density, 200K. Double Density. **£179.95**

Opus 5402 Double Sided 40 Track - 500K. Unformatted. Formatted: 200K. Single Density, 400K. Double Density. **£229.95**

Opus 5800 Double Sided 80 Track - 1 Megabyte Unformatted. Formatted: 400K. Single Density, 800K. Double Density. **£259.95**

Opus 5802 Double Sided 80 Track - 1 Megabyte Unformatted. Formatted: 400K. Single Density, 800K. Double Density. **£299.95**

Switchable 80/40 Track.

- 1/2 Height
- Includes case, leads and utilities disc

DUAL DRIVES.

All Dual Drives are metal cased with separate power supply.

Opus Dual 5401D. Single Sided 40 Track.

200K./400K. on line. **£379.50**

Opus Dual 5402D. Doubled Sided 40 Track.

400K./800K. on line. **£459.95**

Opus Dual 5800 Double Sided 80 Track.

800K./1.6 Megabyte on line. **£499.95**

Opus Dual 5802D. Double Sided 80 Track.

800K./1.6 Megabyte on line. **£599.95**

DOUBLE DENSITY DISC INTERFACE

The ultimate Acorn compatible disc interface for your BBC micro.

- Utilities on ROM including: Format and verify, tape to disc transfer, automatic 40/80 track selection, automatic density selection, unique mass copy routine, powerful machine code operating system giving up to 248 files, 80% faster than single density. Easy to install.

Free user manual supplied. **£120.00**

MONITORS.

12" Green Screen **£89.95**

12" Amber Screen **£99.95**

Lead to connect to BBC Micro **£3.95**

- Ex-stock delivery
- 24 MHz Bandwidth
- Limited quantity

14" JVC Colour Monitor - Med. Res. **£187.39**

14" JVC Colour Monitor - High Res. **£279.39**

THE ORGANISER DESK.

- Top shelf for Monitor/Printer
- Large Desk Top Area
- Lower Shelf for Paper/Book Storage
- Teak Finish
- On Castors
- Self Assembly
- Ample room in front of the shelf for you to sit comfortably.

Only **£59.95**



FLOPPY DISCS.

3" Cartridges **£5.75** each or **£25.95** for 5.

5 1/4" Discs - with full 5 year warranty + free plastic library case.

S/S/S/D **£19.95** for 10

S/S/D/D **£23.95** for 10

D/S/D/D **£26.95** for 10

S/S 80 Track **£29.00** for 10

D/S 80 Track **£31.95** for 10

8" Discs.

S/S/S/D **£21.50.**

S/S/D/D **£28.50.**

D/S/D/D **£29.95.**

GOVERNMENT & EDUCATION DISCOUNTS GIVEN.

QUANTITY DISCOUNTS GIVEN. DEALER ENQUIRIES INVITED.

OPUS SUPPLIES LTD.

158 Camberwell Road, London SE5 0EE.

Opening hours: 9.00-6.00 Monday-Friday.

9.00-1.30 p.m. Saturday.

01-701 8668

01-703 6155

STOP PRESS.

Various Opus products are available from WHSmith, Spectrum and John Menzies.

ALL ITEMS ARE GUARANTEED FOR 12 MONTHS AND ARE SUITABLE FOR USE WITH BBC AND OTHER LEADING MICROS.

To: Opus Supplies Ltd., 158 Camberwell Road, London SE5 0EE. Please rush me the following: **(ALL PRICES INCLUDE VAT & CARRIAGE.)**

Quantity	Description	Price

I enclose a cheque for £_____ TOTAL _____

Or please debit my credit card account with

the amount of £_____

My Access/Barclaycard (please tick) No. is _____

Name _____

Address _____

Telephone _____

Opus.
Opus Supplies Ltd.

AC12)

THE ATOM FROM A VARIETY OF ANGLES

Atom Magic Book, edited by Mike Lord, Time-data (80pp), £5.50.

THIS was the first Atom book to appear. Edited by Mike Lord, it contains 28 programs, from single number guessing games to teletext simulation and speech storage. All the listings are bug-free and with each comes a full description of how the program works, with interesting routines noted, so that you learn as you program. At the end of the book are eight sections of useful notes and program tips.

Atom Magic Book also set the standard when it was first published and was rightly acclaimed. It is mandatory reading for any Atom user.

Atom Business by John Phipps, Acorn/Phipps Associates (110pp) £6.95

WRITTEN by John Phipps, *Atom Business* follows the *Magic Book* formula. It contains 11 programs useful for the small businessman, from a basic addlister, through discounted cash-flow forecasting to complex items like nominal ledgers and queue simulation. Along the way each program is dissected and some useful programming tricks shown. Idiot-proof instructions are given for non-programmers.

The Atom has never really been seen as a small business machine, but it does provide a low-cost entry-level system and this book helps to use it to full advantage. Highly recommended.

Atomic Machine Code, Ecce Productions (111pp), £5.75

AGAIN using the *Magic Book* format, here are 23 programs all in machine code. Again, the idea is 'learn as you program'. Most of the programs are utilities – indeed,

you could build your own toolkit using this book, including character design, data storage and sorting. The programs are often lengthier than they need be, but this is not a bad idea for newcomers to machine code, since it makes it easier to follow the action – when you begin to see short cuts, the book has served its purpose! The programs include a pools predictor (I've tried it, but I'm still not a millionaire) and a pontoon game that cheats. Each listing is fully annotated and a sectional description is also given. Useful ROM routines and a 6502 instruction set are given at the end of the book.

Machine code is noted for its ability to reduce otherwise sane people to gibbering idiots. If you are having trouble with the 'blue pages' in the Atom manual, using this book should provide you with many practical examples to learn from. A cassette of the programs is also available, price £11.50 and buying both together costs £15.50. Well recommended.

Getting Acquainted with your Atom by Tim Hartnell and Trevor Sharples, Interface (184pp), £7.95

THIS is an introductory book for those who find the Atom manual hard-going. It starts from absolute basics, introducing each concept in an easy-going style, illustrated by games programs. Each chapter builds on the previous one, adding new concepts, so that you learn without really being aware of it.

There are more than 80 programs in this book, covering almost every type of game. Authors Hartnell and Sharples are well-known computer journalists. That being so, there is no excuse for the number of errors

found in the listings. Their approach to learning has much to commend it, but it fails miserably when, time after time, the listings given flag an error. A beginner would be too easily put off the subject by incomprehensible 'mistakes'. To be fair, the listings are reproduced at the end of the book, largely without fault, but I cannot recommend this volume, except as an exercise in de-bugging.

Wake Up Your Atom by Brian Lloyd, Timedata (128pp), £4.95

THIS new book for the Atom contains 20 programs and a number of hints and tips. The text is printed on a reasonably clear dot-matrix printer and all the listings have been dumped from running programs. That being so, there is no excuse for the number of errors which I found when typing them in. Indeed, in one case (Directory) the sample run could not possibly have been obtained from the listing shown, since the listing provides no means of interrogating the database!

None of the errors is difficult to spot, but they could confuse a beginner.

The programs themselves are mostly games and make use of the Atom's sound and colour facilities, but they tend to be inelegantly written and the author has a habit of not using one line where five will do.

As it comes from the publisher that produced the excellent *Magic Book*, many users may be tempted to buy the book, but it shows all the signs of having been prepared in haste. I would not recommend it, unless you are prepared to do a lot of work on the listings.

Barry Pickles

IT'S A BARGAIN: FIFTEEN NEW COMMANDS FOR THE BEEB

Toolkit, Ecce Productions, BBC B, £3.95

AT £3.95, Ecce's toolkit must be one of the cheapest ways to add 15 new commands (plus variants) to the Beeb, all accessible via the '*' prefix. The commands cover three major areas – Basic program analysis, machine code analysis and general memory examination.

For Basic, there are commands to list and fix 'Bad Programs' and list all valid programs in memory (*LBP, *FIXP and *LVP respectively). *FBA finds any specified Basic words, optionally followed by a string. An extra formatting facility, *LF, lists multi-statement lines as one statement per line. *SVAR and *VAR permit different variable types (and, optionally, their values) to be examined. For example, *VARAV should display all array variables and their values. Two additional commands are for calling within Basic programs. *BL prints

'Big Letters' at specified screen co-ordinates, while *PD dumps a graphic screen to a printer. Finally, *KR allows function keys definitions to be examined and/or modified – a very useful facility.

For machine code inspection there is *DISS, a fairly standard disassembler, while *BRK provides a novel breakpoint handling or debugging facility. This prints the values of the 6502's internal registers whenever a BRK instruction is encountered. In addition, the values of the user-reserved zero-page locations, from &70 to &8F, are also displayed, so any effects of users' machine code on these locations can more easily be observed.

Lastly, 'general' memory inspection is controlled by three further commands – *FBY and *FS, to find a specified byte or string; and *MEMV, which gives a typical memory dump in both hex and ASCII.

When entering parameters, such as start

and end addresses, they are not accepted as part of the command line. Instead, the new '*' commands are entered in isolation and further sub-menus are displayed for subsequent parameter entry. This can get rather tedious. Most Basic-related commands, for example, persistently request the PAGE value to be entered instead of using the current value by default.

The version under review exhibited a fault in the disassembler program – the branch offset calculation printed an invalid address. One hopes this will be corrected in future releases.

The overall feel of the package is a little rough-and-ready, but, to be fair, many of the programs do just as good a job as similar routines in more expensive ROM-based offerings. And at such a low price, you don't have much to lose. In conclusion, an interesting and inexpensive product.

Vincent Fojut

SERIOUS DECISIONS NEED THE SUPPORT OF OUR 80 COLUMNS



Most serious users of micro computers require the facility to display in 80 columns, especially for word processing. Try this on most monitors and the result will be a frustratingly fuzzy image.

The Microvitec CUB 653 gives the user not only glowing colour, but also pin-sharp-images, thanks to a medium resolution screen 653 pixels wide by 585 high, plus a selective transmission

panel giving super-high contrast. These features make this model from the CUB range of monitors the perfect partner for the high resolutions generated by BBC B, SINCLAIR Q.L., I.B.M.,

MICROVITEC
cub
COLOUR DISPLAYS

ELECTRON, ORIC, APPLE II and Iie, and many others.

So if you wish to sharpen your image, whether in the office or at home, decide Microvitec:

Remember – the highest quality doesn't have to mean the highest cost.

Call at your local dealer or contact us direct and we'll send you full details with a pleasant surprise – our price list.

Microvitec Ltd., Futures Way, Bolling Road, Bradford BD4 7TU. Tel: (0274) 390011. Telex: 517717.

Microvitec Monitors are available from computer dealers, selected branches of W. H. Smith, John Lewis Partnership, Lasky's and other leading retailers.

LVL COMPUTERTOWN

Whether its your first computer or whether you're already an enthusiast, LVL COMPUTERTOWN offers you the quality of service you expect from experts. If you invest money, you go to a bank or a broker - a specialist who can guide and advise you on the best return for your capital. At LVL COMPUTERTOWN we're specialists too. We're there to help guide you through the micro maze, keep you up to date on innovations, help you get the best value for money, whether your computer is for you, your children or your business. Your computer can change your life - make sure you change it for the better: Come and talk to the experts and move into micros with LVL COMPUTERTOWN

PRINTERS

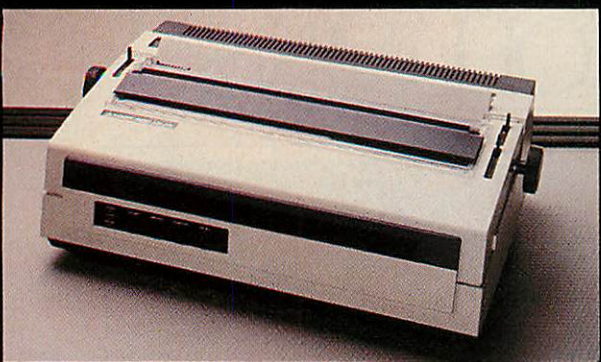

Seikosha GP100A	238.05
Silver Reed EX500	
Parallel	343.85
Silver Reed EX500	
Serial	378.35
Silver Reed EX550	
Parallel	534.75
Silver Reed EX550	
Serial	569.25
Epson RX80	320.85
Epson FX80	503.70
Epson RX80 (F/T)	366.85
Epson MX100 (B2 Col)	546.25
Epson FX100	654.35

COLOUR LIGHTPEN



The lightpen is compact, reliable and comes in a rugged metal case providing physical and electronic protection. Its sensitivity can be adjusted to match any make of TV screen, giving the highest levels of accuracy.

The lightpen package consists of the lightpen, an interface unit, introductory software on cassette and a user guide.

£45.95



MONITORS



SABA 14" COLOUR MONITOR/
COLOUR TV.

£274.45

MICROVITEC 14" Colour Monitor

£247.25

DECCACOLOUR

14" Colour Monitor
£247.25

SANYO

12" Green Screen
£102.35

BBC MICROCOMPUTER

MODEL A	£299
MODEL B	£399
MODEL B with ECONET	£446
MODEL B with DOS	£469
Model B with DOS & ECONET	£516



CASSETTE RECORDERS



£ 39.95

A REFLECTION OF SUPERIORITY

The Bell & Howell/LVL Computer Compatible Data Recorder

- Automatic Level Control
- Automatic Tape Stop
- Tape Counter
- Remote Motor Control

TRI-WRITER

- * IT'S A PORTABLE COMPUTER TERMINAL!
- * IT'S A LETTER QUALITY COMPUTER PRINTER
- * IT'S A FULL FEATURE ELECTRONIC TYPEWRITER

£734.85

SOFTWARE

DESIGNED FOR THE BBC MICROCOMPUTER

LANGUAGES	
LISP	£16.85
FORTH	£16.85
GAMES	
Monsters	£9.95
Snapper	£9.95
Planetoid	£9.95
Arcade Action	£11.90
Rocket Raid	£9.95
Meteors	£9.95
Arcadians	£9.95
Sliding-Block Puzzle	£9.95
Cube Master	£9.95
Starship Command	£9.95
Snooker	£9.95
Super Invaders	£9.95
Hopper	£9.95
Colditz	£9.95
Doctor Who	£10.00
White Knight II	£10.00
Missile Base	£9.95
Draughts & Reversi	£9.95

ADVENTURES	
Philosophers Quest	£9.95
Castle of Riddles	£9.95
Countdown to Doom	£9.95
Sphinx Adventure	£9.95
GENERAL	
Desk Diary	£9.95
Creative Graphics	£9.95
Graphs & Charts	£9.95
Tool Box	£21.00
Record Keeper	£13.80
Magic Garden	£9.95
EDUCATIONAL	
Map References	£7.50
Lasermaths	£7.50
Classmaster	£20.00
Algebraic Manipulation	£9.95
Word Sequencing	£11.90
Missing Signs	£11.90
Number Balance	£11.90
Word Hunt	£11.90
Density Circuit	£11.90
Chemical Analysis	£13.80
Chemical Structures	£13.80
Jars	£11.90
Vu-Type	£16.10

BOOKS

GENERAL	
Programing for the BBC ..	£8.95
Advanced User Guide ..	£12.95

ACORN	
Creative Graphics	£7.50
Graphs and Charts	£7.50
Forth Book	£7.50
Lisp Book	£7.50
View Guide	£2.50
Into View	£2.50
BCPL User Manual	£15.00

BBC	
The Computer Book	£6.75
The Book of Listings	£3.75
30hr. Basic	£5.95
Beyond Basic	£7.25
The Friendly Computer ..	£4.50
Sound & Graphics	£7.95



The items featured represent a very small selection from our vast product range. Further information of both product and services available can be obtained by telephoning or visiting your nearest LVL Computertown Dealer.

CHESHIRE

C-TECH SOFTWARE
184, Market St.
HYDE
Cheshire
061 366 8223
* **COMPUTER CITY**
78, Victoria Rd
WIDNES
Cheshire
051 420 3333
* **OAKLEAF COMPUTERS**
100, Boughton
CHESTER
0244 310099

CUMBRIA

* **THE COMPUTER SHOP**
56/58 Lowther St.
CARLISLE
Cumbria
0228 27710

ESSEX

A.C.L.
1, Northmall
GRAYS, ESSEX
0275 79834
BROADWAY MUSIC
AND VISION
Woodford Green
ESSEX
01 504 7500

GREATER MANCHESTER

* **LOMAX**
8, Exchange St.
St. Annes Square.
MANCHESTER
061 832 6167
WORCS
SPURTREE COMPUTING LTD
Council Buildings,
Teme Street,
TENBURY WELLS,
Worcestershire
0584 811353/811304

MERSEYSIDE

* **THORNGUARD**
46, Pensby Rd.
HESWALL
The Wirral,
Merseyside
051 342 7516

NOTTS'

* **BASIC BUS SYS**
Trent Boulevard
WEST BRIDGFORD
Nottingham
0602 819713
S P ELECTRONICS
48, Linby Rd.
HUCKNALL
Notts.
0602 640377

LEASALINK VIEWDATA Ltd
230, Derby Rd.
STAPLEFORD
Notts.
0602 399484

OXFORD
ABSOLUTE SOUND
AND VIDEO (Oxford) Ltd.
19, Old High St. Headington
OXFORD
0865 65961

AVON
K & K COMPUTERS
32, Alfred Street.
WESTON
SUPERMARE
Avon
0934 419324

COLSTON COMPUTER CENTRE LTD.
The Colston Centre,
11, Colston Ave.
BRISTOL
0272 276619

WARWICKSHIRE

CARVELL
9, Bank St.
RUGBY
Warwickshire
0788 65275

WEST MIDLANDS

RICHARD MORRIS
523, Bearswood Rd.
Smethwick
WARLEY
021 429 1161
JBC MICRO SERVICES
200 Earlsdon Ave.
Nth. Earlsdon
COVENTRY
0203 73813

WILTSHIRE

WILTSHIRE MICRO CENTRE
Unit 6,
Central Trading Estate,
Signal Way,
Old Town.
SWINDON
0793 612299

BUCKS'

HI-VU ELECTRONICS
38, Church St. Wolverton
MILTON KEYNES
Bedford
0908 312808

SUSSEX

C.J.E. MICROS
78, Brighton Rd.
WORTHING
West Sussex
0903 213900

ISLE OF WIGHT

EXCELL
4, Foreland Rd.
BEMBRIDGE
Isle of Wight
098 387 2578

YOUR LOCAL



DEALER

HEREFORD

KEMPSONS
26, St. Owen St.,
HEREFORD
0432 273480

KENT

KENT MICRO
57, Union St.
MAIDSTONE
Kent
0622 52784
GRAVENSEND COMPUTERS
39, The Terrace.
GRAVENSEND
0474 50677

NORTHANTS'

M A ELECTRICAL
7, High St
IRLINGBORO
N'Hants
0933 650133
LEICESTER
PERCY LORD & SON
63, Blaby Rd
WIGSTON
Leicester
0533 785033

LINCOLNSHIRE

* **OAKLEAF COMPUTERS**
121, Dudley Rd.
GRANTHAM
0476 70281

LONDON

CANNONBURY RADIO
185 Upper St.
ISLINGTON N1
London
01 226 9392
PAUL ELECTRICAL
250/2, Grand Drive,
Raynes Park,
LONDON SW20
01 542 6546
WOODS RADIO
257, Lavender Hill,
Battersea,
LONDON
01 228 1768

SALOP

MEDLICOTT BROS
53, Mardol
SHREWSBURY
Shropshire
0743 3060

SUFFOLK

S J EMERY & CO
10, Market Place
BUNGAY,
Suffolk
0986 2141

IRELAND

EVERYMAN COMPUTER SERVICES
BALLYMONEY
Co-Antrim
N Ireland
026 56 62658
NEWBURN ELECTRONICS
BALLYCARRY
Co.-Antrim,
09603 78330

STAFFS

J W BAGNALL
18, Salter St.
STAFFORD
0785 3420
KIRKLANDS
City Rd., Fenton.
STOKE ON TRENT
0782 415787
* **COMPUTERAMA**
59, Foregate St.
STAFFORD
0785 41899.

SURREY

* **HASLEMERE COMPS**
25, Junction Place,
HASLEMERE
Surrey
0428 53850
P & H ELECTRONICS
5, The Parade,
Reading Road,
YATELEY
Surrey.
0252 - 877 222
* Spectrum Members

LANCASHIRE

* **P V MICROS**
38A Water St
ACCRINGTON
Lancs
0254 36521
* **Home & Business Computers Ltd.**
54, Yorkshire Street.
OLDHAM
061 633 1608
Home & Business Computers (RCH) Ltd.
73, Yorkshire Street.
ROCHDALE
0706 344654

WALES

BUCON
18, Mansel St.
SWANSEA
0792 467980

S.I.R.
91, Whitchurch Rd.
Cyncoed
CARDIFF
Wales
0222 621813

THE COMPUTER SHOP

41, The Hayes,
CARDIFF,
Wales.
0222 26666

SCOTLAND

COMMSCOT
30 Gordon St.
GLASGOW
041 226 4878

NORTH LAND

NEWTONS
Main St.,
SEAHOUSES
0865 720307

SLIMLINE PRECISION

These superbly engineered slimline disc drives for the BBC Microcomputer are unsurpassed in quality and accuracy. They feature direct drive brushless D.C. motors and long-life ceramic read/write heads for maximum reliability, and a die cast alloy chassis which gives rigidity and long term stability. Furthermore, advanced chip technology, using large scale integration permits extremely low power consumption to be achieved.

The Pace range includes drives which are switchable between 40 and 80 tracks. Double sided drives give a massive 400K storage per drive in 80 track mode, whilst in 40 track mode they retain compatibility with all commercially available BBC software. All Pace drives will support double density operation.

PACE disc drives are supplied complete and ready to run direct from the BBC's power supply. They are supplied complete with all cables, a utilities disc, and manual. Pace even supply a blank disc so that the drive is ready for immediate use!



Available from your local dealer or direct from:

PACE
Disc Systems

92 NEW CROSS STREET,
BRADFORD BD5 8BS
Tel. (0274) 729306
Telex 51564



Disc drives available:

SINGLE DRIVES

PSD1	Single Sided 40 Track	100k
PSD2	Double Sided 40 Track	200k
PSD3	Double Sided 40/80 Track	400k
PSD4	Double Sided 80 Track Only	400k
PSD5	Single Sided 40/80 Track	200k

DUAL DRIVES

PDD1	Single Sided 40 Track	200k
PDD2	Double Sided 40 Track	400k
PDD3	Double Sided 40/80 Track	800k
PDD4	Double Sided 80 Track Only	800k
PDD5	Single Sided 40/80 Track	400k

Available from good Computer stores everywhere including:
Computer City, Widnes, Cheshire. Tel. 051-420-333. Computarama, Stafford. Tel. 0785-41899. Computarama, Stone-on-Trent. Tel. 0782-268620.
Siron Centre, Edinburgh. Tel. 031-557-4946. G.P.M. Leeds. Tel. 0532-547474. Wilding Computer Centre, Wigan. Tel. 0942-44382.
National Micro Centre, Stockport. Tel. 061-486-4525. Sir Computers, Cardiff. Tel. 0222-21341. Eltec Computers, Bradford. Tel. 0274-722512.

REAL-TIME MINDER

Bruce Smith keeps a date with the Acacia Diary and RAM Filing System

The Acacia Diary and Ram filing system, from Acacia Computers, 5 Coombe Lea, Bickley, Bromley, Kent, £150 inc VAT.

THE Acacia Diary and RAM Filing System enables you to transform your BBC micro into a versatile electronic diary system capable of reminding you of forthcoming appointments at predefined moments in time, whether you are watching the latest edition of M*A*S*H or whiling your evening away playing *Starship Command!*

The Acacia package contains three items: a real time clock complete with 4k RAM, an EPROM containing the system software, and a 35-page manual.

The RTC+RAM is housed in a standard RS-type white and grey box, measuring about 200x140x85mm and comes complete with integral ribbon cable, power lead and power-out connector. Removing the four base screws reveals the printed circuit board, housing the 4k of CMOS RAM (expandable to 30k), a real time clock/calendar chip and a high energy lithium inorganic battery providing a constant supply of volts, thereby making the onboard RAM non-volatile. The PCB is professionally produced, is silkscreen-printed, and has obviously been designed with expansion in mind. Both cables are fully secured, making it almost impossible to disengage them. A further port on the rear of the case is marked 'Alarm'. Internal to this sits an open-ended transistor capable of sinking 20mA – but more on this later.

The EPROM fits neatly into one of the sideways ROM sockets. If placed in the socket next to Basic the *RAM filing system

will be automatically initialised when the computer is switched on. If you have discs, the choice of which one should sit next to Basic is yours, but giving the RTC+RAM priority has advantages, as we shall see.

Connecting the hardware is simple following the procedure described in the first chapter of the manual. The power cable fits readily into the auxiliary power output on the underside of the Beeb's case. If you have discs that normally take their energy from here plug the disc power lead into the power output socket on the rear of the RTC+RAM case. The ribbon signal cable fits into the 1MHz bus connector.

Switching on the Beeb brought up the Acacia copyright message, indicating everything was well. Executing a *HELP revealed the software to be version 1.13.

If a DFS has priority then the RAM filing system can be selected by typing *RAM. The system requires just 256 bytes of the program area for its workspace, thus PAGE is set by the software to &F00. All pointers used by the RTC are stored in 50 bytes of RAM held within the clock chip.

Three programs are supplied with the RTC+RAM, held in the non-volatile RAM. 'RWRAM', 'BUILD' and 'INIT' can be loaded into the user program area and saved on disc or tape by switching between filing systems, as program 1 demonstrates. RWRAM allows a backup copy of the RAM filing system's contents to be made to tape or disc. This may be restored at a later date using the same program. 'BUILD' enables auto-boot files to be created and 'INIT' is used to erase RTC+RAM completely.

The Diary system adds nine new commands to the Beeb's vocabulary. These are implemented as operating system commands, preceded by an asterisk, which makes them available when using other facilities such as Wordwise.

To have a diary you need a calendar and that's where the real time clock comes in. Date and time can be displayed by typing *TIME, which places a data line across the top of the teletext screen:

Thu 10 Nov 10:27:38 PM

The clock, updated every second, is available only in mode 7. *TIMD disables the clock display. Date and time can be set using *TIMS, though this will not often be needed. (The most obvious occasion being in the shift between BST and GMT). The command displays the current time, ie:

10:50:07

and the cursor can be moved to the rele-

```
MODE 7
*BASIC
*RAM
LOAD "RWRAM"
*DISC
SAVE "RWRAM"
```

Program 1. Transferring files between filing systems

```
10 REM ** CALLING THE RTC **
20 REM ** FROM A BASIC PROGRAM **
30 A%=&50
40 X%=&70 : REM low byte of address
50 Y%=&800 : REM zero Page user ram
60 CALL &FFF1
```

Program 2. Obtaining the date and time from the real time clock

```
10 REM ** RTC+RAM SPEED TESTER **
20 REM ** SAVE 04 1K BLOCKS **
30 TIME=0 : *SAVE "123" 2000 2400 : A%=TIME
40 TIME=0 : *SAVE "ABC" 2000 2400 : B%=TIME
50 TIME=0 : *SAVE "FIN" 2000 2400 : C%=TIME
60 TIME=0 : *LOAD "123" 2000 : D%=TIME
70 TIME=0 : *LOAD "ABC" 2000 : E%=TIME
80 TIME=0 : *LOAD "FIN" 2000 : F%=TIME
90 PRINT "SAVE TIMES : ", A%, B%, C%
95 PRINT "LOAD TIMES : ", D%, E%, F%
```

```
>RUN
SAVE TIMES : 2 2 2
LOAD TIMES : 3 3 3
>
```

Program 3. Save and load time under test

EXPANDABLE CONSOLE FOR BBC MICRO

As supplied to Universities, Colleges, Schools,
business & home users

A professional console to house disc drives/2nd processor/Torch dual drives/teletext, etc. All untidy wiring out of sight in the strong aluminium console in a matching textured colour. AVAILABLE NOW a bolt on extra module for extra expansions.

Also available a matching printer stand, yes stack your paper under the printer.

ALSO VDU STANDS AVAILABLE



ELECTRON CONSOLES

The console houses the electron and will safely support the expansion interfaces which plug into the rear of the micro, supports the VDU and tidies up all wiring, allows expansion to disc at a later date.

PRICES

BBC Console £39.99 + £4 p/p
Bolt on expansion £14.99 + £2 p/p
VDU/Printer Stand £14.99 + £2 p/p
Electron Console £34.99 + £3 p/p
£44.99 after 31st March

Please add VAT @ 15% to all prices

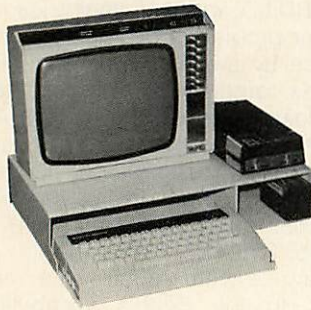

For further information enclose sae or send cheque to,

Mail Order Only **Silent** 01-801 3014 27 Wycombe Rd London N17

Viewing by arrangement **COMPUTERS** 24 hour ansaphone

Please allow 28 days for delivery



**WIMBLEDON
COMPUTER & HI-FI
C·E·N·T·R·E**

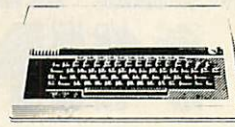

**BBC SERVICE
& INFORMATION
CENTRE**

We have a wide range of printers, disk drives, monitors and other peripherals. Full range of software

WE OFFER

- Full demonstration facilities.
- Finance and leasing.
- Excellent after sales service



WELCOME

Call in for a chat or just come in and browse.



PROGRAM
POWER

Gemini



61 THE HIGH STREET,
WIMBLEDOM VILLAGE, SURREY SW19
TELEPHONE: 01-879 0857

The BBC Microcomputer Specialists

GUILDFORD COMPUTER CENTRE offers a complete range of Computers for Home, Business and Educational applications.

Large stock of additional equipment available includes:- Printers, Hard/Floppy Disc drives, Monitors etc., for most makes.

An extensive range of Business software (Accounts, Stock, Payroll, Word Processing etc.).

Drop in for a frank discussion and expert advice on your requirements or arrange a demonstration. We give a full and expert backup to ALL our sales.

Stockists of:- BBC/Acorn, Torch, Oric, Olivetti, Hitachi, TRS-80, Commodore, Dragon, Sharp, Sirius, Osborne, IBM, Newbrain, Epson, Seikosha, Cumana, etc.

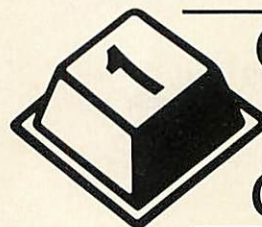

**GUILDFORD
COMPUTER
C·E·N·T·R·E**

1 The Quadrant, Bridge Street,
Guildford, Surrey GU1 4SG
Telephone (0483)578848

commodore

olivetti



HITACHI

BBC

TRS-80®

```
#DIAA : Add a reminder to the Diary
#DIAD : Display and/or delete reminders
#DIAK : Display and/or delete all reminders containing specified
        keyword.
#DIAR : Read and/or delete reminder(s) that have activated the
        diary.
#TIME : Enable the continuous time & date display
#TIMD : Disable the continuous time & date display
#DATD : Display the time and date
#TIMS : Set the time
#DATS : set the date.
```

Figure 1. Diary system commands

```
>*DIAA
Date? 10 Nov 1983
From?
(Power on,Time) Time? 11:15:05 PM
Repetition? None
Entry :
Hello there all you Acorn Users!
*****
*****
>
```

Figure 2. A typical Diary entry

vant digit(s) using the arrow keys, to edit the time as required. A one-off calendar display can be produced with *DATD, and in a similar manner to *TIMS the date can be altered using *DATS.

Entries are made into the Diary with the command *DIAA, upon which you are prompted to enter items. Figure 2 illustrates the procedure. The current date is displayed, and this can be edited to set the date that the reminder is to occur. Hitting return will enter the current date. The next prompt is:

```
From?
(Power on, Time)
```

Hitting 'P' programs the RTC to display the reminder message the instant you turn the Beeb on at the date set. However, this only happens if the RTC+RAM EPROM is fitted as the priority filing system - in other words, if you've plugged it next to Basic. If

```
SHIFT F0 : No effect
SHIFT F1 : Red
SHIFT F2 : Green
SHIFT F3 : Yellow
SHIFT F4 : Blue
SHIFT F5 : Magenta
SHIFT F6 : Cyan
SHIFT F7 : White
SHIFT F8 : Flash on
SHIFT F9 : Flash off
```

Figure 3. Colour control

```
*CAT
*ACCESS
*DELETE
*INFO
*OPT 4,n
*EXEC
*SPOOL
*SAVE
*LOAD
SAVE
LOAD
```

Figure 4. RAM filing system commands

```
>*CAT
Option 0 (Off)

STEP          20 Oct 1983  11:21:00 PM
DESIGN        20 Oct 1983  11:50:00 PM
VIA           21 Oct 1983  11:18:00 PM
EPROM_PROG   21 Oct 1983  11:35:00 PM
ROM_CHECK    22 Oct 1983  12:52:00 AM
ROM_M.CODE   22 Oct 1983  08:02:00 AM

DE bytes free
```

Figure 5. Typical display of an index file

you have a DFS in this position the message won't be displayed at power on.

The alternative, 'T', allows you to preset the time that the message is to be initiated. When this date and time is reached an alarm, in the form of a continuous series of beeps on the internal speaker, is issued. Turning this off is performed by displaying the message that caused it with the command *DIAR. The alarm output could be used to activate other devices connected to it via a relay – in fact you could get it to switch on the Beeb to display its message!

The message can be repeated at predefined intervals ranging from one minute to 31 years(!) by responding appropriately to the 'Repetition?' prompt.

Finally, you can enter the actual message, which may take any format and any number of lines, with up to 200 characters per line, provided enough memory is available. All the normal editing facilities are included and a diary entry is completed by pressing Escape.

If the diary is being used in teletext mode colours may be included in the messages. The function keys are programmed to produce the colours as shown in figure 3. As it is actually the SHIFT-function key buffer that is used the normal function key use is still available.

Deleting diary entries is simple. *DIAD will display one by one any entries in the diary for a particular date; each entry is followed by a 'Delete Y/N' message which acts at your direction. *DIAK acts like *DIAD except that it displays only those messages containing a specified keyword. For example, entering *DIAK KITTY' will display all messages containing references to a certain editorial assistant.

The Diary is provided with a very useful wildcard facility. In fact, two wildcards are provided, '#' and '*'. Wildcards allow words and filenames to be specified with a

certain amount of ambiguity (great if you can't spell correctly). The hash character means 'match any character in this position', thus HOT, HAT, HIT and HUT all fit the bill of H#T. The asterisk can be used to match any number of characters, so that HOOT, HEAT and HALT will all fit H*T, as would the previous examples. It can also save a lot of typing; for example, the command *DIAK ANTIDIS* would be much easier than typing (a deep breath) *DIAK ANTIDISESTABLISHMENTARIANISM.

An OSWORD call is also implemented in the software, enabling the RTC to be read at any time. The call code is &50 and the X and Y registers point to a memory block of seven bytes, where the seconds, minutes, hour, day, date, month and year is returned. Program 2 shows how this call can be used from a Basic program.

The RAM filing system (RFS) is probably the quickest and quietest filing system I've encountered and there are no restrictions to the number of files that may be created. All the standard filing commands are implemented (figure 4). The index file is obtained in the normal manner using *CAT.

A typical display is shown in figure 5. As you can see, the format is a little different from normal. The first line displays the start-up option set by the *OPT 4 command, which is issued to determine the action taken by the !BOOT file. Next follows the file names with the times and dates they were entered. Finally, the number of bytes remaining is displayed in hex (a value that will be altered as entries are made or deleted from the Diary).

LOAD, SAVE and *LOAD, *SAVE, *SPOOL and *EXEC all behave in the usual manner, except they all performed super-fast. Program 3 is the one I used to see how quickly three 1k blocks of memory could be saved and reloaded. The save time for each block was a mere two-hundredths of

a second, and re-loading was a trifle slower at three-hundredths of a second – probably the time the Basic ROM took to interpret the commands! Another nice aspect is that files are continuously updated so that it is impossible to create 'open-ended' files by forgetting to close them. Up to five channels may be open at any one time and files may be opened on more than one channel.

*ACCESS allows files to be locked and unlocked. Wildcards are excepted in the file description so all files could be locked with:

```
*ACCESS *L
```

A locked file has an L postfixed after its catalogue information. Files may be unlocked with *ACCESS FILE – again the wildcard facility is available for use. Similarly, files may be deleted with *DELETE FILENAME; a 'Delete Y/N' prompt is offered to ensure that the file is not erased accidentally. *INFO can be used to determine the length, load and execution address of a file or files.

The instruction manual provides full details of each of the RTC+RAM's facilities and a clear description of each command and its uses. Four appendices are provided that include details on changing the battery. Although its life is expected to be in the order of 5-9 years it is recommended that it be changed every three years. The PCB layout and appendix description provide ample information on what should be a painless procedure.

The RTC+RAM provides a fast and efficient Diary and RAM filing system that is particularly simple to use. The filing system is limited by the small amount of memory provided, but it is much faster than discs. The Diary is its most useful aspect and I can see it being of great appeal to small businesses and the self-employed, though it is perhaps just a little expensive at £150.

RTC+RAM COMPATABILITY

The RTC+RAM has been designed to be compatible with other equipment and software available for the BBC Micro.

```
1MHz BUS : &FCFE is used
Filing System type : &10
Filing system select key : A
Filing system select command : !RAM
Channel number range : &61 to &65
Tube handle : &F
OSWORD code number : &50
```

RTC+RAM has been designed to be compatible with other equipment and software

- The complete AMS disc drive package, tailored to your BBC micro, is compatible with all disc interfaces and includes cables, a comprehensive manual and utilities on disc and EPROM. Housed in a steel case, matching the BBC micro, these reliable and robust Hitachi 3" disc drives are the ultimate for home, office and classroom.
- The 3" disc is totally enclosed in rigid plastic and a unique automatic steel shutter protects the delicate disc surface from dust and finger marks. For the first time discs can be used in industrial, educational and commercial environments without the worry of corrupting precious programs and data.
- The disc is "flippable" like a cassette tape and has a storage capacity of 100K on each side in single density mode (twice as much when used with a double density interface). A neat plastic switch can be flicked back and forth to write-protect valuable discs.
- The AMS disc drives are completely hardware and software compatible with 5¼" drives which can be used in parallel so allowing easy transfer of software. Consequently the 3" drives will operate with all the standard floppy disc interfaces. They take their power from the outlet provided by the BBC micro – there's no onboard power supply to corrupt data.
- The AMS package includes utilities on both a disc and an EPROM for formatting and verifying discs. The EPROM, which is easily fitted, offers a simple to use and permanent alternative to using the utilities disc.
- The impressively engineered Hitachi 3" drives feature an eject button allowing single handed operation, a multi-colour LED indicating the disc side in use, and a brushless direct-drive motor for reliable operation. The super fast track-to-track access time of 3ms is at the forefront of disc drive technology. The longest of programs are loaded in a flash.

Advance with AMS

3" Disc Drives – The Ultimate Choice

Single 100K – £225
 Double 200K – £399
 includes VAT and delivery
 to your door



Reliable delivery

If not available from your local dealer fill in the coupon below and we will send it to you with our full no-quibble money-back guarantee.
 Advanced Memory Systems Ltd, Green Lane, Appleton, Warrington, WA4 5NG.
 RING 0925 62907
 24 HOURS 62682

TO: Advanced Memory Systems, Ltd, Woodside Technology Centre, Green Lane, Appleton, Warrington, Cheshire WA4 5NG.

Please send me by door-to-door courier:

- Qty AMS-3 (S) single disc drive all inclusive package at £225 each
- Qty AMS-3 (T) twin disc drives all inclusive package at £399 each with two free discs.

Prices include EPROM, utility disc, cables, manual, VAT and delivery.

Please send me by post, if not with drives:

- Qty double sided (100K x 2) discs at £4.95 each.
- Qty packs of five at £22.50 per pack.

I enclose a cheque for £ or debit my credit card



No _____

Name _____

Address _____

Post Code _____ Tel No _____

Signature _____ Date _____

Please allow up to 28 days for delivery.

Hitachi - in a word reliability

PENGWYN AND A DASH OF ICE

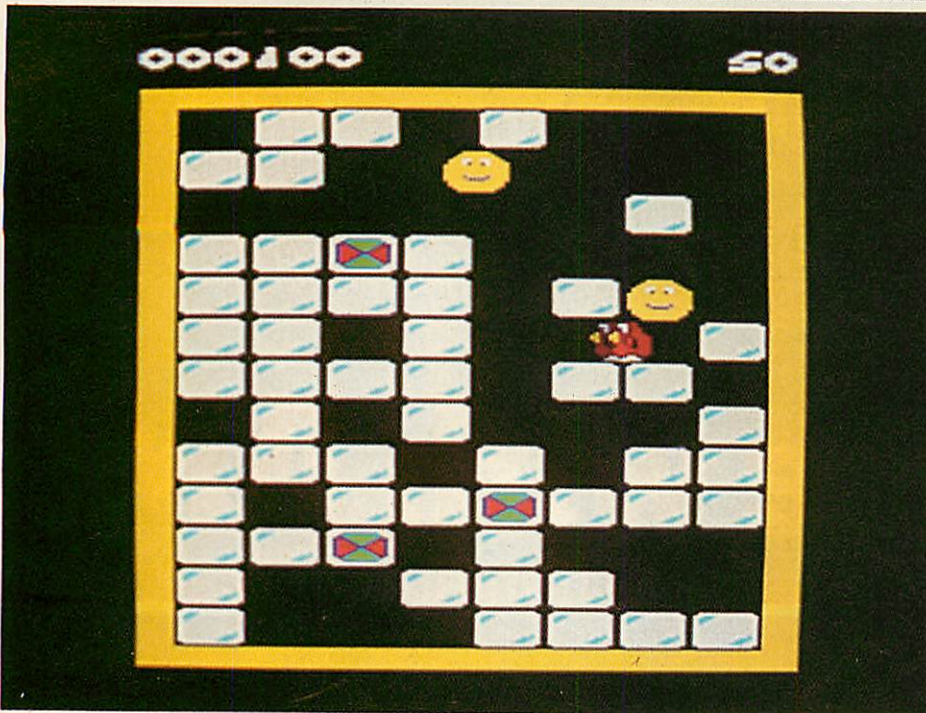

Pengwyn, Postern, BBC B/Electron, £6.95

IS NO animal safe from the hands of that nasty species, the programmer? The range of creatures used in software is beginning to rival the famous Guinness zoo and this time round it's that lovable, funny creature, the penguin... but a Pengwyn!

So, what's *Pengwyn* all about? At first sight, the game appears simple. It loads in three parts, and the challenge is to place three flashing blocks of ice in a straight line. Sounds easy. However, the flashing blocks are positioned randomly, and most of the rest of the screen is filled with ordinary blocks of ice. Pengwyn can move up/down and left/right. He (she) is controlled by four keys, and return enables the bird to move the blocks or melt them. A block of ice is melted if movement forward is obstructed, otherwise the ice cube will move.

Now for the difficult part. There are other animals around called 'Nasties' who also appear quite lovable as moving circles with a happy smile. But they too can melt ice and live up to their name by chasing Pengwyn. The only way our hero can defend himself is by hurling blocks of ice at the Nasties or dodging them. There's a time limit, so you can't afford to hang around.

It takes quite a while to get used to the game and work out a strategy. On the first screen there are two Nasties and three on the second. I haven't got any further to see how many more await!

The Nasties appear from within the ice blocks, so there is no way of knowing where they will come from - and every time one is killed it is replaced with another.

The screen display is very good and I really enjoyed watching the ice cubes melt. Pengwyn really stole the show for me, however, and he is defined so you can see him from the side, back or front, depending on the direction he is moving. You have three lives and if you succeed in lining up the flashing blocks, the screen clears and Pengwyn dances to the tune of 'When the Saints Come Marching In.' Bonus points depend on how much time you have used.

After the praise, the problems. *Pengwyn* is supplied on one tape for the BBC and Electron. However, the small print reveals that there are two versions, to take account of the difference in speed between the two machines. Fine, but finding the correct side for your machine is a game in itself, as the tape label is identical on both sides! I found this out by loading the Electron version on a BBC by mistake and was amazed by the speed - if you want it fast, this must be the ultimate game!

Overall verdict: excellent. It's a pleasure to review a piece of software that is both novel and well written. *Pengwyn* has earned a place on my shelf with the likes of *Snapper*. Praise indeed! **Paul Richard**

JOEY'S PALS

Escape from Moon Base Alpha, Program Power, Electron, BBC B, £7.95

THERE are fast-moving graphic games and slow, absorbing adventure games. *Escape from Moon Base Alpha* successfully combines some of the features of both.

The game has 3D (perspective) colour graphics and makes sensible use of sound. Joey has been abandoned on Moon Base Alpha by his mutinous crew.

His only hope of escape is meeting the Doctor, hidden somewhere on level seven, who for 10 bags of gold will transport him off the base in his Tardis.

The base is arranged on seven levels, nine rooms per level in a three by three arrangement. You control Joey using a sensible arrangement of keys and can actually see him move around the screen and from room to room.

To help Joey in his quest, bags of gold were deposited in certain rooms for him to collect. As well as essential for paying the Doctor, they increase his strength. He has a limited supply of hulk pills, which double his strength momentarily, thus allowing him to fight the more vicious monsters (more about those later) and to walk through walls; however, he pays for these privileges by a large forfeit in his overall strength. There is a wizard who will sell him a hulk pill or turn him back from a frog (mind you, he is never around when he is needed) and there's even a police box which will transport Joey to a random room on the same level.

There are many hazards for Joey to struggle against - Marvin, the manically-depressed robot (from the *Hitch Hiker's Guide to the Galaxy*), who bores him to death; the Metal Mauler (a Dalek), who tries to exterminate him; the Green Grappler, an over-grown frog, who reacts similarly to the Metal Mauler; and Deadly Doris (alias Evil Edna), a crazy TV set which, if she cannot kill Joey, will turn him into a frog.

The hazards make it an interesting game that will take you a while to get bored with; however, the instructions are long and appear as a program in themselves, and so are not available for reference once you've started the game. It would have been better to have them as a printed sheet.

Verdict - highly recommended.

Robert Sassoon

MELTDOWN

Atom Smasher, Romik Software, BBC A or B and Electron, £6.99

AT LAST an original plot to a game! The object of *Atom Smasher* is to stop the meltdown of a nuclear reactor. You control a 'remote controlled super-laser', your job being to shoot a proton, thus cooling the reactor down. But there are problems in the shape of electrons that collide with you, depriving you of one of your three lives.

The program loads in three parts: title screen, instructions and the game itself. There's a joystick option. The program is well presented but the game is a bit of a disappointment, being spoilt by the difficulty in controlling the gun. The sound effects are good and the graphics adequate.

Probably the main buyers of this game would be the model A owners. Model B owners can find much better games - although it's an interesting idea.

Richard Beach and Jason Mallen

Play with a Griffin

So they take school in their stride



Your children are using a computer at school far more often than you think

Computers make learning an absorbing game and retain a child's interest and participation.

Griffin Software have selected and adapted for home use, a series of Griffin educational software titles already used in schools.

The first six titles suitable for 4 to 8 year olds, are available now.

If you have a ZX Spectrum 48K or a BBC Model B microcomputer at home, you can so easily keep up the school's good work. And the beauty of it is, the child sees it as a game!

Wordspell helps with spelling; Tablesums unravels the mysteries of tables;

Fairshare uses Ollie the Octopus to make sense of division; Numberfun makes addition and subtraction easy; Wordgames helps with spelling and expands vocabulary; and with Getset a child is helped with counting.

All good fun!

Griffin Software titles are at WH Smith, Boots, and other computer shops everywhere.

Fisons Plc Scientific Equipment Division



Only £7.99 each to suit the ZX Spectrum 48K Only £9.95 each to suit the BBC Model B

GRIFFIN SOFTWARE
- it's an education.

Free software, only £225.

If you own a BBC Micro, you can now download, store and run programs (transmitted free of charge via Ceefax) with the new Teletext Adaptor, priced £225 inc. VAT.

These programs make up the BBC Telesoftware Service (which is intended to become a computer software broadcasting channel) and although primarily educational, they will soon develop into general interest and business areas.

And, as they will change every two weeks, you'll soon be able to build up a vast bank of top quality software without ever having to put your hand in your pocket.

But that's not all the adaptor has to offer. It also enables you to gain access to the normal teletext store of data. This is different to simply having a teletext TV because it means

this data can now be transferred to memory and manipulated in any way you wish (making graphs or bar charts for instance).

It's yet another development in our programme to help you fully realise your BBC Micro's potential.

If you're a credit card holder you can order the Teletext Adaptor by ringing 01-200 0200 at any time or 0933-79300 during office hours.

(You can also find out the address of your local BBC Micro dealer by calling the same numbers.)

Alternatively, you can order it by sending off the coupon below.



Technical Specifications

Access to Teletext and Telesoftware Services broadcast on U.H.F. channels E21 to E69.

Speed of max. data capture rate approx. 128k baud. (8 lines of Teletext per frame.)

Height 70mm. Width 210mm. Depth 350mm. Weight 2kg.

Colour: BBC Computer cream.

Construction: Moulded top and bottom to match BBC computer profile. ABS injection moulded plastic.

Controls: Four tuning potentiometers on rear panel.

Mains on/off switch on rear panel.

Power in 240v, 50Hz, 15w.

Operating Temperature: 10° to 35°C.

Designed and manufactured to comply with BS415 Class 1 standard.

To: BBC Microcomputers, c/o Vector Marketing, ACA.
Denington Estate, Wellingborough, Northants NN8 2RL.

Please send me _____ BBC Teletext Adaptors at £225 each, inc. VAT and delivery. I enclose PO/cheque payable to Readers A/C, Acorn Computers Ltd, or charge my credit card.

Card Number _____
Amex/Diners/Visa/Access (Delete)

Name _____

Address _____

_____ Postcode _____

Signature _____

Registered No. 140 3810 VAT No. 215 400220

The BBC Microcomputer System.

Designed, produced and distributed by Acorn Computers Limited.

FALL GUY

Plankwalk, Virgin Games, BBC B, £7.95

VIRGIN has unfortunately gained a reputation for stylish presentation of mediocre games. *Plankwalk* may go some way towards rectifying this, but I suspect not far.

Scaffolding Sid, the hero of the game, is set on a screen of planks, blocks, 'power towers' and cherries (?) and it is your job to keep Sid on the screen by moving him left and right and jumping down from one level to the next. The planks scroll smoothly up the screen and, just to keep Sid on his toes, a small black monster chases him. Some of the planks, colour-coded for identification, have a built-in slope or are false (Sid falls straight through). You gain points by dropping Sid through the blocks, picking up the cherries and staying on the screen. Sid can move at two speeds, but uses energy at an appropriate rate.

The main problems with *Plankwalk* concern the use of graphics and the choice of colours. Sid is a simple stick man, like the one on the *User Guide* cover, the planks are single lines and the blocks are just that. The monster looks like a warmed-up space invader and the only attempt at multi-coloured graphics in the entire game are the cherries. Add to this the fact that both Sid and the monster are black on a dark blue background, and it all makes for a fairly uninspired use of the micro's facilities.

Simon Williams

WATCH THIS SPACE

Cylon Attack, A&F Software, BBC, £7.90,

ON THE odd occasion you come across a piece of software that stands head and shoulders above the rest. *Cylon Attack* is such a game in every respect. Let us dispense with the scenario – a game of this class and quality needs little introduction. Devotees of *Battlestar Galactica* will know what it's all about. It is advertised as a 3D real time space battle and that sums it up perfectly. Nearer to reality on the BBC I could not imagine.

You launch from your mother-ship to search for and destroy a wave of enemy ships. Your cockpit provides a long-range scan at the top and readouts at the bottom of the state of your shields, fuel and laser power and the ship's attitude. The simulated view of space ahead of you is extremely well done. In the star-studded blackness you will come across the odd planet or two, and even a Tardis and a signpost (someone's got a sense of humour).

When an enemy ship comes within scanner range it swoops towards you, looming larger all the time, with a relentless and frightening reality. The shape of your sights changes to indicate a good chance of destroying the enemy ship as you lock onto

it. You should aim to do this before it fires back. If you don't, you'll have to out-run its missiles and each hit you suffer reduces your shields – lose them or your fuel and you've no chance.

The object is to destroy the entire wave before running out of fuel. If you run low you may refuel from the mother-ship, but you are open to attack during the process. If you destroy the full wave you must return and dock with the mother-ship to refuel and replenish your shields before the next wave.

Docking – also realistically represented – can be a little tricky. As you attempt to lock on to the mother-ship it veers away from you. You must constantly adjust your position to maintain the mother-ship in your sights, until it looms large enough for docking to take place. This is even more difficult in mid-wave with the enemy ships attacking you at the same time.

Each successive wave involves more enemy ships of various shapes and sizes. Some, like the Cylon Base Ship, move much faster and fire a constant stream of missiles at you. If you find the screen full of enemy ships the best thing to do is run away.

The game is a lot easier to play using joysticks, but you are given two sets of keys as an option and they're not too difficult to get the hang of. *Cylon Attack* is an excellent game and extremely good value for money. The graphics are no less than spectacular and the sounds very realistic. I found no fault with it, and it is one that will fascinate me – and I'm sure many others – for a long time.

Ian Rowlings

POD BOD

'Protector', Quicksilva, BBC B, £7.95,

PROTECTOR from Quicksilva, by Andy Green, is well up to his usual standards. The graphics are stunning. Most startling are the wailing flying saucers or UFOs, whose tops pulsate with colour as they cross the screen laying mines. There are other novel features on the title page, which takes a long time to complete but is worth waiting for.

The game can only be played with joysticks, which is a great pity. All the joystick does is move you (the Protector of the title) about the screen and it is difficult to see why this could not have been done just as well by keystrokes.

The main idea is to protect a set of 'pods' in the centre of the screen from thieves. Other hazards are there to stop you, including monsters, the UFOs and their mines. You ram the thieves and the UFOs, and avoid the mines and monsters.

Scoring and 'high score' are as in most games. You can opt for one or two players from the title screen.

This brings me to a 'bug'. Pressing 1 or 2 (for the number of players) bypasses the

title screen. If you press the escape key, however, the title screen appears at double speed, but the game hangs up and has to be re-loaded.

Excellent value if you like good graphics, and have a joystick.

Miranda Williams

RAPTOR TRAP

Birds of Prey, Romik Software, BBC A or B and Electron, £6.99

ANOTHER clone of the *Galaxians* game, with a few minor variations. For those who suffer from amnesia, *Galaxians* is similar to *Space Invaders* but instead of the aliens plodding rhythmically down the screen they break off and dive at you, screaming as they come.

Birds of Prey is well presented and packaged, loading in two parts: instructions and game itself. It has a joystick option.

The graphics are fast-moving and clear but the sound effects are pretty average. The new twist are death bombs which stroll down the screen. If they hit the bottom you lose a life.

The game is very addictive and a must for all model A owners, although model B users would be better off buying Acornsoft's *Arcadians*.

Richard Beach and Jason Mallen

CRATER CREATURES

Alien Break-In, Romik Software, BBC B and Electron, £6.99

AN interesting game compared to the normal 'smash the alien' type. In *Alien Break-In* you have been left to defend Earth's uranium supply against the might of the Zargon fleet. As well as being shot at by aliens, a mother ship is dropping pods and bombs. If a pod hits the ground it turns into a spider. The only way to destroy it before it kills you is to dig a hole which it falls into and then fill it up.

If a bomb hits the ground it creates a small crater, and when the hole is large enough an alien will land in it and mutate into another indestructible mother ship. When 10 mother ships have been formed the Zargon fleet comes down the screen and invades – in other words, you've lost.

While loading, a tune is played. It is pleasant at first, becomes a nuisance and then a pain after three or four minutes. The instructions give you the option of changing the control keys to suit your preferred layout (or you can use a joystick), of halting the game if the phone rings, and of turning the sound off. Both sound and graphics are good.

The game provides nine skill-levels from 0 (easy) to 8 (horrendous). It's very addictive, though the only thing to aim for is a higher score. A worthy addition to your arcade library.

Richard Beach and Jason Mallen

**NOW AVAILABLE ON THE ELECTRON
D.A.C.C.'s SPRITE - GEN**

Runs in 4 colour Mode 5

PRICE £9.95

Technical specifications as for the highly successful and original BBC version as described below.

Write your own 'Arcade Action' games with D.A.C.C.

Sprite-Gen

This amazing and revolutionary new piece of software, written for the BBC Model B by Dennis Ibbotson, represents the biggest step forward for BASIC programmers since the release of the BBC Micro itself. It allows you to create multi-coloured, fast moving SPRITES, controlled simply from your own BASIC program. Now you can write the kind of "Arcade Action" games you always dreamed of writing before you discovered that BASIC can't achieve the speeds necessary. Until now, only experienced machine-code programmers could produce "Ghost Gobbling Monsters" and "Light Speed" spacecraft. With SPRITE GRAPHICS all the creatures and objects you can imagine are at your command, moving smoothly at any speed and in any direction you choose. Incredibly, SPRITES can be created using ALL SIXTEEN logical colours - eight steady and eight flashing. And as if that were not enough you animate your SPRITES with individual movements such as "a man who walks", "a bird that flaps its wings", "invaders that pulse menacingly", the possibilities are endless! When you own the SPRITE GENERATOR package you have access to every sort of high-speed animation technique you need. Buying expensive machine-code games may become a thing of the past. Look at the following impressive list of features you can access from your own BASIC programs...

- Up to 32 SPRITES on screen at any time.
- Limitless SPRITE design using the SPRITE Generator program included in the package, allows ALL SIXTEEN logical colours "in each SPRITE" if desired. Full operating system capability of logical/actual colour assignment.
- There can be up to EIGHT different SPRITE DESIGNS active at one time, each of which can have up to THREE "CLONES", (copies of the primary SPRITE but each with individual movement control).
- Each SPRITE actually has TWO images which given slight differences will achieve the animation effects when the two are alternated. Or, if you choose, give the two images totally different designs and you have created two SPRITES out of one, usable alternately. This technique can also be applied to the CLONES which means that all 32 SPRITES can be animated, multi-coloured, moving objects!!!
- Once you have completed the design of your SPRITES using the simple grid-based generator utility, they and the high speed machine-code routines that control their movement are secreted into RAM and the BASIC system is ready to accept your own program lines through which you can direct the SPRITES to appear, move, disappear or just remain stationary, with the simplest commands you could imagine.
- SPRITES can be linked together in pairs or groups to produce large scale animation. Of course, if you wish they can be as small as a single pixel.
- Your own creations can move in front of each other with no loss of detail.

SPRITE-GEN is supplied as a package containing:

- *** Sprite-Generator program
 - *** Two 'fast-action' demonstration programs
 - *** Sprite Gen control routines
 - *** Illustrated user manual with examples and listings
- All for only £17.95 (pp and VAT included).
In U.S. \$49.95

**BWARE
OF
IMITATIONS**

DRAGON, ATARI 400/800 (48K), BBC MODEL B, TRS 80 C/C 32K

747 FLIGHT SIMULATOR

Superbly realistic instrumentation and pilot's view in lifelike simulation which includes emergencies such as engine fires and systems failures. This program uses high resolution graphics to the full to produce the most realistic flight-deck display yet seen on a home computer. There are 21 real dials and 25 other indicators (see diagram). Your controls operate throttle, ailerons, elevators, flaps, slats, spoilers, landing gear, reverse thrust, brakes, etc. You see the runway in true perspective. Uses joysticks and includes options to start with take-off or random landing approach. "A real simulation, not just another game." (Your Comp. Apr. 83).

NOW ON THE ELECTRON!

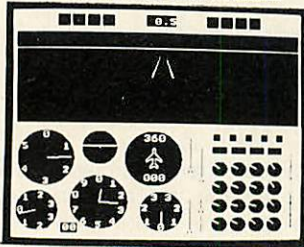

ACTUAL SCREEN PHOTOGRAPH

CASSETTE £9.95 (pp and VAT included).
In U.S. \$27.95 (pp included)

(U.K. orders despatched within 48 hours)

Dealer and foreign distributor enquiries now being taken.
Software writers - sell your programs in the U.S. through DACC.

To DACC Ltd., 23 Waverley Road, Hindley, Wigan, Lancs. WN2 3BN. AU

Please rush me:

_____ qty. SPRITE-GEN at £17.95 each (BBC Model B only)

_____ qty. SPRITE-GEN at £9.95 each (Electron only)

_____ qty. 747 FLIGHT SIMULATOR at £9.95 each (state machine)

I enclose a cheque/P.O. to the value of _____

NAME _____

ADDRESS _____

POST CODE _____

WHICH BBC WORD-PROCESSOR DOES MAIL-MERGING, GIVES YOU AS MANY COPIES AS YOU WANT

PRINTS 50 - PAGE DOCUMENTS
DOES WORD-COUNTING AND EVEN
ADDS UP FIGURES?

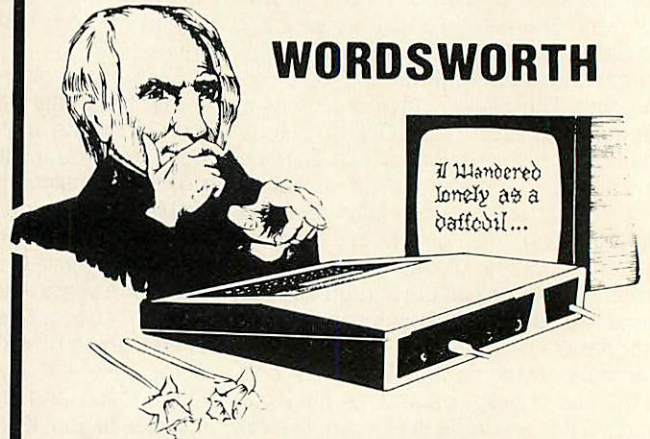

WORDSWORTH

WORDSWORTH

does all these things as well as the usual jobs. No need to buy separate mail-list programs or printer drivers, no need to pay three times the price for word-processors with fewer features! Current versions are compatible with Acorn or Watford DFS, and almost any printer. Interface available with disc version for Microwriter Quinkey.

'The printing option is superb... streets ahead of anything View gives its users. A very powerful word-processing tool with the minimum of fuss.'

— A & B COMPUTING

'A very powerful utility with some very advanced features. Good clear documentation. A clever and complex program which will probably become indispensable for its users.'

— HOME COMPUTING WEEKLY

'I use a printer which has given me hours of trouble with Wordstar, and I had no problem getting it to function with Wordsworth. Clearly laid-out menu structure... logical and easy to use and remember. Very reliable.'

— PERSONAL COMPUTER NEWS

And now... PROPORTIONAL PRINTING

USING WORDSWORTH WITH UTILITY 1
AND AN EPSON FX-80 PRINTER.

Available from selected retailers and distributors or from

IAN COPESTAKE, Dept. W 19

23, Connaught crescent,

Brookwood, WOKING, Surrey GU24 0AN.

Telephone/Mailbox: 048674755

PRICES including MANUALS, VAT, P & P

WORDSWORTH DISC	40-TRACK	80-TRACK
including rigid A5 wallet	£22.71	£23.86

UTILITY 1 DISC

without wallet	£8.62	£9.78
with wallet	£11.78	£12.94

★ £2.00 OFF IF YOU BUY BOTH AT ONCE ★

WORDSWORTH TAPE £17.54 MANUAL ONLY £2.88

DISC WALLET £3.16 PACK OF 10 \$SSDDISCS £19.55

'SEE 10' DISC LIBRARY BOX £3.16
(the best design we have seen)

PROGRAMS AVAILABLE SOON ON 3-INCH DISC

EUROPE:- Prices as above

OUTSIDE EUROPE:- Please add £3.00 per item

DO THESE MONITORS WIN THEIR STRIPES?

Sanyo 3125NB colour monitor, Micro-Peripherals, £199 ex VAT; and JVC 1302-2 colour monitor, Opus, £229.95, ex VAT

BEING in need of a colour monitor for my own purposes, it was a boon to be able to review a couple. I am no TV expert so offer no technical advice, merely the experience of a week's trial on my eyes, and a little advice on what you should look for.

First piece of advice on colour TVs is that if it doesn't have an RGB (red/green/blue) input, forget it. The haze that covers all pictures and the poor colour definition that results from going through the normal TV aerial socket make the resulting eyestrain dangerous. This is true of even the best TVs if you make prolonged use of them.

Second, don't be beguiled by the 'video' input on a TV. The Beeb's output is only black and white from its 'monitor' socket, so you won't get a colour picture from that source (unless you make the hardware changes described on page 171 of the January issue).

The two monitors I tested were the 'normal resolution' monitor from Sanyo, and the 'high resolution' monitor from Electrophome, made by JVC. I have used the Microvitec Cub monitor extensively at college, and as this is the Acorn recommended monitor I'll refer to it as a 'standard'.

The Sanyo is a silver-painted metal-cased monitor similar in size to the Cub. It has far better and more accessible controls, but the picture is disappointingly

small. On a 14-inch (diagonal measurement) screen, there is an unused border at both sides of more than an inch, and one almost as wide at top and bottom. This gave the picture a squashed appearance and caused some distortion, though the top line was always visible, not needing the use of *TV255,1.

The JVC is plastic-cased and looks like an ordinary TV. The picture was not adjustable, except for brightness, and *TV255,1 was required to reveal the top line of the screen. There were left and right margins of about an inch on the 14-inch screen but none at top or bottom, and no distortion.

The criteria I used to determine my preferences were:

1. The visibility and definition of mode 0 and 3 text.
2. The ability to reproduce the horizontal and vertical striped bands in mode 2, generated by programs 1 and 2.
3. The steadiness of the picture.

The Sanyo is claimed to give character definition at only 40 characters per line. Eighty character text, while not actually unreadable, is tiring to decipher. This puts it in the 'not usable with Wordwise' category. You would have to go upmarket to the high resolution monitor to get satisfactory results in mode 0 or 3. The JVC was excellent, giving clear, legible results.

Both performed satisfactorily on the vertical stripe test, where there are only 160 bands across the screen, though the JVC was noticeably sharper. The horizontal

```
10 REM Vertical stripes
20 MODE2
30 FOR I=0 TO 1279 STEP 4
40 GCOL0,(I/4 MOD 8)
50 MOVEI*2,1023
60 DRAW I*2,0
70 NEXT
```

Program 1

```
10 REM Horizontal stripes
20 MODE2
30 FOR I=0 TO 1023 STEP 4
40 GCOL0,(I/4 MOD 8)
50 MOVE0,I
60 DRAW 1279,I
70 NEXT
```

Program 2

stripe test is a stringent one – try it on your own set. The bands are twice as close together as the vertical stripes, and the Sanyo confused them utterly, giving only four colours instead of the intended eight. The JVC colour bands were visible, though a little blurred.

Both gave steadier pictures than the Microvitec Cub, and the colours were rather better.

It seems to me that all 'normal' and 'medium' resolution monitors, including the Sanyo, are simply inadequate to deal with the Beeb's graphics and text output. Was the JVC better than the Microvitec? Would I buy one? Yes to both questions.

George Hill

A FORMULA FOR EXAM REVISION

'Chemical Analysis' and 'Chemical Structures', Acornsoft, BBC B, cassettes £13.80, discs £17.25, inc VAT

THERE are three titles in the Acornsoft 'Chemical' series, although as yet I've been able to get my hands on only two of them, *Chemical Analysis* and *Chemical Structures*. Maybe *Chemical Simulations* is subject to one of Acornsoft's celebrated delays.

The *Analysis* program has three sections. These are, in tape version, curiously and unnecessarily loaded from a menu. Menus are fine on disc but frustrating on tape, particularly when their effect is the same as typing CHAIN"programe".

The three sections are Elements, Inorganic and Organic. All are fairly unadventurous quiz-type programs in which the student guesses the identity of a substance from data provided by the program. In each you can make a guess or ask for more information from a menu of tests. You score points for correct guesses. The programs are in mode 7, without graphics and run without fiddling about on a standard model B with disc interface.

All three can perform a useful backup

function in the study of chemistry for public exams. They are, of course, no substitute for practical work, nor for a skilled teacher, but could well add variety to essentially boring revision. Elements is aimed at 'O' level, while the other two are aimed higher, even at their 'easy' level. I found the misspelling of the plural of 'gas' highly irritating. Talk about illiterate scientists!

Attempts to list the program to discover the answers result in blank data statements so no cheating is allowed.

The *Structures* package contains two programs. Bonding produces semi-animated diagrams of the electron transfers and sharings involved in simple ionic and molecular bonding. (This is commonly known as the 'dot/cross' type of diagram.) 'Shapes' purports to produce 3D diagrams of molecular shapes. More of that later.

In both you are invited to choose by symbol from a periodic table the elements to be investigated, a useful exercise in itself. Certain combinations are impossible and are forbidden by a useful colour-coding.

Bonding is too large to run on disc with the default setting of PAGE, but if PAGE is lowered to &1100 it can be transferred to

disc. I found it admirable, aimed principally at the 'O'-level student but providing useful revision material at 'A' level. Its only drawback is in giving the impression that some compounds are very complex, when the only problem is that data for them is not included in the program.

Shapes is a different kettle of fish. First, it is too large to transfer to disc without shifting. Second, it has an extremely limited repertoire of covalent compounds and tells you that simple ionic examples such as sodium chloride are too complex for it to draw (hardly confidence-boosting!). It purports to draw three-dimensional structures of the covalently bonded atoms, and then rotate the structure to aid understanding.

This can be much more satisfactorily done by 'ball and stick' models. Only three views of the structure are presented, and these are difficult to distinguish, even for tetrahedral molecules. But the clincher is that for linear molecules three identical views are drawn, one after another, with no way of skipping them. I would not show this rubbish to any of my classes, whatever the level.

These programs are provided with adequate documentation, including both pupil and teacher user guides. My overall opinion was that they were high on price, and rather low on ideas. **Miranda Williams**

A 20K RAM BOOST FOR THE 'B' WITH A UNIQUE PAGING SYSTEM

Aries B20 20k RAM expansion board, BBC model B, Cambridge Computer Consultants, £99.95

THE first thing to consider with any board such as this is how easy it is to fit inside a BBC micro. You might have heard horror stories with other boards about soldering to chips and bending pins, but not in this case. As long as you can take the lid off your BBC and remove chips carefully, you'll have no problems with the Aries B20. You first remove the 6502 chip and refit it to the Aries board, then fit the board back into the empty socket. Finally, the special ROM supplied is slotted into one of the spare sideways ROM sockets. Detailed information on fitting and using the hardware is supplied with the kit.

The first thing to notice is the new screen message 'BBC Computer 52k'. This in itself is gratifying and if nothing else will astound your friends, but this is an impressive piece of equipment in its own right and deserves to be taken seriously.

The additional RAM can be switched in or out using *XON or *XOFF, which means you need never remove the board. This is extremely useful in software development to check if a program runs on a standard machine: given, of course, that it was designed to do so. A hard break will always invoke the 52k, but a soft break will maintain the current state of the system.

The burning question is: 'How much memory is *really* available?' And, secondly: 'Is all of the extra available to run large programs?' The short answer is yes. The additional memory is paged as normal, but this is done in a unique way.

With most other add-ons, their paging mechanisms will not allow a large program which resides in both normal and extra memory to be run directly. You would have to store the main program in normal memory and call down other chunks of program from the extra memory to be run as and when required – not an ideal method. The Aries B20, however, pages in an entirely different way. As you may be aware, the normal screen area is between &3000 and &7FFF, and HIMEM is set according to the mode being used. The additional 20k RAM of the Aries board is also positioned from &3000 to &7FFF in parallel with normal memory (figure 1). The Aries ROM intercepts all references to the area above &3000 (excluding the screen) and diverts them to the extra RAM. This is dealt with entirely automatically. Hence HIMEM remains set at &3000 while the Aries is switched on and, even allowing for the little extra required by the operating system software, this provides usable memory slightly in excess of 28k, irrespective of screen mode. This won't sound a great

deal if you are working in mode 7 as it only provides an additional 1k, but in modes 0 to 2 you get the full 20k extra.

You might feel the expansion is not of great value if you use only low resolution, and to a certain extent for programming purposes this is true. However, it can still provide extra memory for data storage. First you set HIMEM to &3000 to ensure the Basic stack and workspace are not in parallel memory. Having done so there are two data areas available – one which is normal memory from &3000 to &7BFF, and a second which is the Aries RAM from &3000 to &7FFF. If you include the area below &3000 this provides an impressive 47k for data.

Acorn have provided a special command for selecting the data area you wish to access – *FX111,0 selects data area 0 and *FX111,1 selects area 1. Data may be stored or loaded from files into either area and all indirection operators can be used to access either set. The Aries manual even provides a simple routine which allows the two areas to be considered as contiguous memory from &3000 to &CBFF.

When programming in machine code, operating system vectors can be modified as required, as long as you follow the rules. The only exception is that interrupt routines must be located below &3000. Another thing to consider is that because the Aries uses 256 bytes of private workspace, when it is activated it increases OSHWM by &100 (I wondered at first why PAGE was automatically reset from &1900 to &1A00).

The special system call is also useful in machine code programming. Calling OS-BYTE with A=&6F (111) and setting X appropriately will allow you not only to select the RAM area to be used, but also to read and write the Aries state and to push or pop this to or from the stack.

The Aries manual also provides some basic information on its use in conjunction with the Torch Z80 Disc Pack using CPN or MCP – for those lucky enough.

An advantage to View users is that without recourse to the EDIT facility a total of 25k of text can be resident at once – a four-fold increase in mode 0. In addition to View, the Aries is claimed to work with both versions of Basic, the second processors, all Acornsoft languages and any software that is written correctly – which of course means it is difficult to estimate what proportion of commercial software will run with the system on. Not that this matters a great deal – you just switch the board off before loading. Wordwise will also run, but because of the way it is written it cannot take advantage of the extra RAM.

Unfortunately, you cannot use most of the ROM boards available (eg Watford, Sir, ATPL) with the Aries board – they just won't

Figure 1.

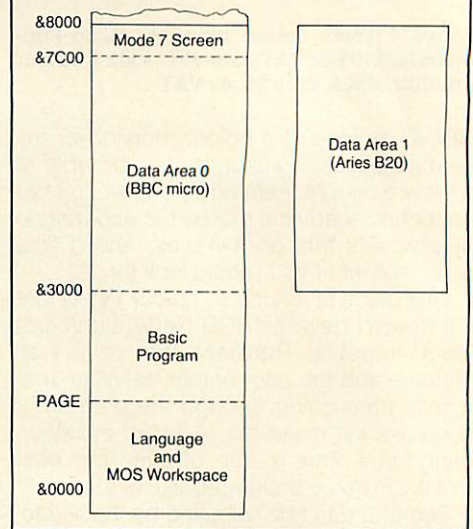

fit. On the question of additional ROMs, it is impossible to say whether the majority that are available will work with the Aries switched on. I found that some of the facilities (ie *MZAP and *MSEARCH) of the Disc Doctor ROM would not work at all with the Aries switched on, which is more than a little annoying. Still, if you do fit a number of add-ons produced by different manufacturers you can't expect them all to be compatible.

With regard to the effect of the Aries system on processor speed, it is claimed that it makes no difference except with some system calls. This is quite true. Tests show that such calls only reduce the speed by between 0.5 and 1.6%.

In conclusion, for those with a serious requirement for 'usable' extra memory this is a good buy, albeit a trifle expensive. Don't be put off if you also need extra ROM – Cambridge Consultants will be producing an expansion ROM board for use with the RAM board. This will support 12 ROMs. The company also intends to produce an external ROM board with its own power supply, which I feel will be of considerable interest. After all, you can't just keep shoving things in – the poor old Beeb can only support so much.

Ian Rowings

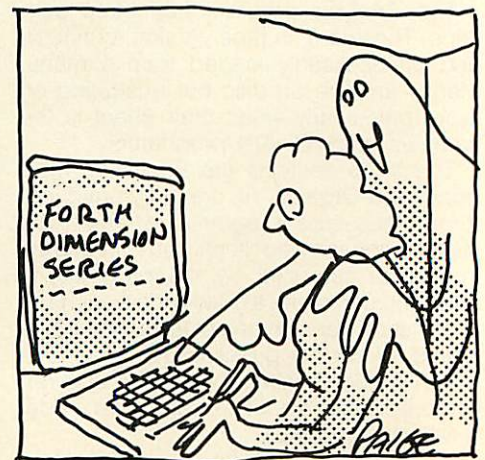

TWO EXCITING NEW PROGRAMMES FOR THE BBC MODEL B MICROCOMPUTER

SHUTTLE PILOT



Shuttle Pilot is the most authentic Space Shuttle simulator available. The screen display is a faithful copy of the instrumentation in Columbia, Discovery, Challenger and Atlantis. As you sit at the controls you have the same view through the head up display (H.U.D) as Schmitt, Evans, Stafford, and other Shuttle Pilots. You have to complete your space mission in the face of enemy satellites and land safely. As Armstrong took a step for mankind, when he walked on the moon, Shuttle Pilot steps out as the flight simulator for space travel.



PAINTBOX

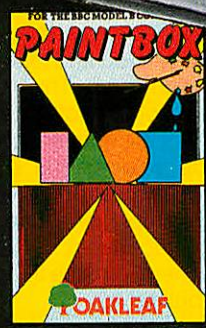

Available at your local computer shop or post the coupon. (DEALERS TELEPHONE 0476 60000).

The superb Graphics programme for the BBC Model B. That turns your screen into an architect's board or an artist's canvas.

OAKLEAF COMPUTERS LIMITED

121, DUDLEY ROAD,
GRANTHAM,
LINCS
0476 76994

100, BOUGHTON
CHESTER
CHESHIRE
0244 310099

To Oakleaf Computers Ltd, Mail Order Dept., Bell's Yard, Dysart Rd, Grantham, Lincs NG31 7EJ.

Please send me _____ (quantity) 'Shuttle Pilot' Software at £9.95 each including VAT and Carriage
 Please send me _____ (quantity) 'Paint Box' Software at £9.95 each including VAT and Carriage

I enclose cheque for £ _____
Please Debit my Access/Barclaycard No. _____

Name: _____
Address: _____

Post code: _____
Day Time Tel No. _____

WHAT'S MISSING IN THE NUMBERS GAME?

ACORN^{SOFT}/ESM EDUCATION

Missing Signs

for the BBC Microcomputer Models A and B

Put in the Missing Signs

27/3 ? 24/3

Missing Signs by Anne and Russel Wills, Acornsoft (for ESM), BBC A and B, £11.90 (disc £15.35)

THIS pack contains three programs that give practice in the four rules of arithmetic with whole numbers, and in the use of equals, less than and greater than. At the start of each program the teacher can choose the level of the questions for the class by setting the layout, content and degree of difficulty (all chosen from menus) and time allowed.

In *Add-Sub* the program presents two sides of an equation or inequality and the pupil fills in the missing signs. It does not matter whether or not the shift key is pressed to get the relevant characters of the keyboard. Incorrect responses produce a bleep and after two incorrect responses the correct answer is given.

The score is stored for each pupil and can be displayed at the end of that pupil's attempt or at the end of the session. The process is repeated for up to 20 children, who use the same specification – any change would lose the stored results. No help is given to suggest how the results are printed and presumably the teacher copies them off the screen.

Mlt-Div is similar except that the teacher can specify which table is to be reinforced. *Signs* presents pupils with incomplete equations into which they put the correct sign or signs, depending on the level of difficulty. The program copes with quite complex equations where there are different possible answers.

As with many programs which rely on random numbers, the questions in *Missing Signs* can vary enormously within a particular difficulty level and questions are sometimes repeated. There is no teacher or

pupil guide and, as the screen is laid out as simple text, the overall effect is of standard but dull drill and practice.

Paul McGee

TUNED UP

Music Editor, System Software, BBC B, £9

WHAT does a music editor do? What can it be used for?

A music editor should let you, the composer, enter music scores quickly and easily and allow the music to be played back in varying ways, particularly where timing and/or speed is critical.

System Software's package is designed for this purpose, and provides some interesting extras. Once the program had loaded, which was difficult, it asked for the key of the music, the tempo and number of voices (maximum three). It divides the number of notes available to each voice so that when three voices have been picked you have just over 300 notes for each. This could be a major drawback if you want to enter long tunes.

After picking these parameters, you are presented with a well laid out editing mode, with which you enter the notes. At the bottom of the screen is a treble and bass clef, complete with the key signature picked earlier on, and at the top are the types of notes available (quavers, crotchets, dotted crotchets etc). These are picked by moving a box over the required note, a particularly nice method. To the right of this are the amplitude levels and a remarkable 16 available envelopes, selected in the same way as the notes. The choice of envelopes allows, together with the 15 levels of amplitude available, 31 variations in the quality of each note. A choice such as this makes possible much more creative use of the Beeb's sound capabilities.

The program provides 16 envelopes to begin with, but any one of these can be changed to those you have designed and these can be saved and loaded back every time you need them. This is probably the nicest feature of this software.

The pitch of the note is picked by moving a cursor up or down the staves, and the note entered by pressing one of a choice of keys – for example, one for a sharp, one for a flat, another for a rest.

Bar lines help to make things clearer and are easily put in.

So once the tune is entered you are presented with the main menu. From this you can edit, play the piece, change envelopes, save the tune, save the envelope parameters or restart the program.

I found editing particularly laborious. For instance, you can't erase a whole phrase and erasing note by note takes a long time. But you can insert and delete notes, which

is very useful. A tracking system allows you to see the amplitude or envelope, duration and pitch of the notes as you move the cursor over them – again very useful.

The *Music Editor* system allows creative use of the Beeb's sound capabilities, but the major drawback is the time and effort needed to enter and edit a complete tune, so this program is not for the easily bored.

Jason Mallen

FAMILY PLOT

My Secret File, Mosaic Publishing, BBC B, £9.95.

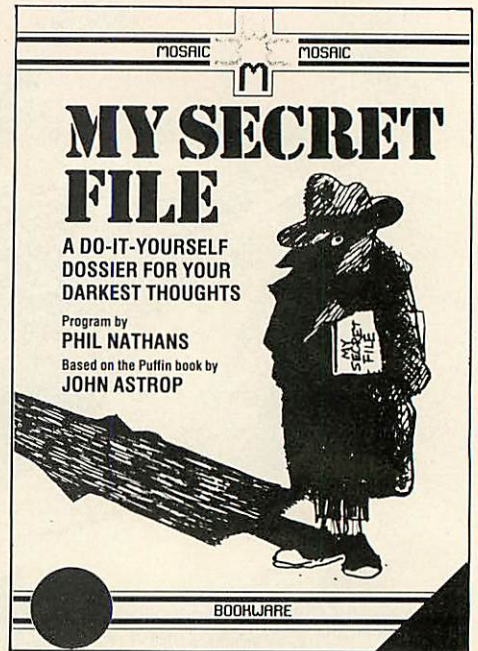

THIS program comes on cassette in a package with a Puffin book of the same name, which has apparently sold 86,000 copies to date. It enables a child (assumed to be in the 7-11 age range) to fill in a lot of slightly tacky-sounding lists – Dad's statistics, Mum as I see her, My Room, My Brothers and Sisters, etc.

The program is more or less a straight crib of the book – indeed, it mirrors faithfully the concept of filling in your own lists and on the computer you even have a secret password which purports to prevent people of a snooping nature from reading your file after you've written it to tape.

It doesn't really work, though. If I were a parent keen to introduce my child to the concept of a database on computer, even though I didn't know much about computers, I'd quickly come to the conclusion that books whose pages you can flip and write in (as in the Puffin) are a much faster and more convenient medium than a computer using a cassette tape as a storage medium. A little more imagination – such as the inclusion of a SORT or SELECT IF function – would have gone a long way towards taking this package from the dreary to the useful.

Simon Dally

SAFETY & SECURITY
WITH THE NEW TIDYBASE MICROCOMPUTER HOUSING

Designed around the BBC model B but suitable for various models.

For School, College, home and business use this compact housing offers special safety and security features. Made up of individual modules—available separately— if you already own the original Tidybase you can upgrade it. With the processor 'locked' in place, plugs and sockets inaccessible there is little opportunity for tampering or pilfering.

- Optional and unique security bar locks equipment in place.
- 3 or 4 way socket accommodates monitor, processor, drive, printer etc. One external lead only for mains input—no multi-plugging, no adaptors.
- Strong metal construction with safety edges, stoved finished Brown or Cream.

- All individual modules interlock to provide complete housing.
- Alternative housings for various disk drives available.
- Optional trolley for ease of movement or unlock and carry the system.



For full details
REMEDIAN INSTRUMENTS LIMITED
 3 Over Links Drive, Poole, Dorset BH14 9QU
 Tel: Canford Cliffs (0202) 708404

remedian

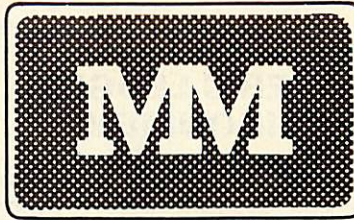

TOP SAVINGS

	EX VAT	INC VAT
PRINTERS		
BROTHER HR 15	349.00	401.35
TRACTOR	68.00	78.20
SHEETFEEDER	195.00	224.25
KEYBOARD	142.00	163.30
EPSON RX80T	215.00	247.25
EPSON RX80F/T	242.00	278.30
EPSON FX80P/T	329.00	378.35
EPSON MX100F/T	375.00	431.25
EPSON FX100F/T	430.00	494.50
FX80 TRACTOR	30.00	34.50
JUKI 6100	345.00	396.75
MANNESMANN TALLY MT 80	199.00	228.85
OKI MICROLINE 80AP	180.00	207.00
OKI MICROLINE 82A	289.00	332.35
OKI MICROLINE 83A	435.00	500.25
OKI MICROLINE 92P	395.00	454.25
SEIKOSHA GP100A	175.00	201.25
SHINWA CP80	175.00	201.25
STAR GEMINI 10X	199.00	228.85
COMPUTERS		
COMMODORE 64	166.51	179.99
COMMODORE 1541 DISK	165.21	189.99
COMMODORE C2N CASSETTE	36.51	41.99
INTFACE 64-PAREL	59.50	68.43
APRICOT 2*D+MON	1575.00	1811.25
SANYO MBC555	799.00	918.85
EPSON QX10	1600.00	1840.00

MAYFAIR MICROS
 362 YORK ROAD, LONDON SW18 1SP
 01-870 3255

There's A Big Plus When You Buy Your BBC Or Acorn Computer From Us

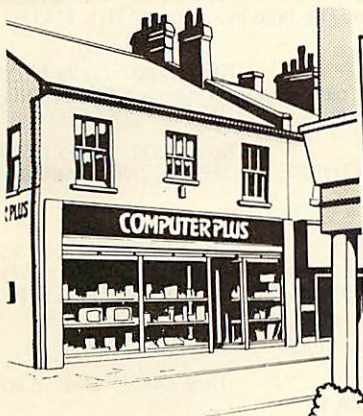

MONITORS	RRP £113	£79.95	DISC DRIVES	£265.00
Sanyo 12" green,	RRP £270	£229.00	BBC 100K	£199.00
Sanyo 14" RGB	RRP £275	£199.00	Midwich 100K/200K/400K, from	
Kaga 14" RGB1			Torch Z80, 800K with	£839.00
PRINTERS	RRP £320	£299.00	Perfect Software	
Epson RX80	RRP £367	£343.00	MISCELLANEOUS	
Epson RX80FT	RRP £504	£424.00	RH light pen for BBC	RRP £44.95 £39.95
Epson FX80	RRP £459	£399.00	Shinecrest BBC computer desk	£59.95
Juki 6100 16 cps daisy	RRP £573	£459.00	Sanyo DR101 cassette data recorder	RRP £49.95 £39.95
Mannismann-Tally MT160	RRP £287	£220.00	including free lead	£4.95
Seikosha 250X matrix			BBC dust cover	

All prices are inclusive of VAT.

PLUS: BBC computers, Electrons, accessories and software from:
 Acorn, BBC, Bugbyte, Computer Concepts, Dr. Soft, Gemini, Logic Systems, Program Power, Quicksilver, Software Invasion, etc., etc. Over 500 titles!

We're an official Acorn Dealer and an approved BBC referral centre. We're approved to carry out upgrades on BBC machines, and we specialise in Econet upgrades for use by schools.

We stock a wide range of BBC accessories, peripherals and software – and we have our own Acorn

trained engineer to make sure it all works. You'll find it hard to beat us for price and service.

Orders by post – cheques accepted. Personal shoppers welcome. Or write for further details.

COMPUTER PLUS

47 Queens Road, Watford, WD1 2LH Tel: (0923) 33927

HARRIS McCUTCHEON SYSTEMS

are pleased to release

HMS HOME ACCOUNTS	£28.75
HMS VAT TRADER'S LEDGER	£21.50
HMS BASIC ENVIRONMENT	£14.50

to BBC Microcomputer users with a minimum configuration of 1 x 40 track single sided disc and an 8" 132-column (condensed mode) printer, to a maximum configuration of 2 x 80 track double sided disc and a 15" printer. The programs allow user allocation of each file between *DRIVE0, 1, 2 or 3, thus making full use of the disc space available.

HMS HOME ACCOUNTS allows all financial transactions within a defined environment to be recorded, printed and analysed. Accounts may be reconciled with statements or passbooks, uncleared entries being highlighted. Depending on the analysis structure you choose, the system can keep track of anything from answering "how much is in the piggybank?" to independent tracking of multiple bank accounts, credit cards, building society accounts and cash in hand. The only reason for keeping home accounts in any form is to have your current financial state apparent on demand and reconcile statements received in order to find out where the money goes. This program is designed expressly for these requirements. You wouldn't keep them if these areas were of no concern, and being of concern you want to keep them thoroughly and effectively. HMS HOME ACCOUNTS allows this.

HMS VAT TRADER'S LEDGER, on the other hand, fulfills a different requirement. Instead of emphasizing analysis, the VAT trader wants to record all his invoices and bills in the least time possible consistent with making out the quarterly VAT return and getting a well-presented ledger listing on demand. Varying and multiple VAT rates are of course catered for. Add the facility to maintain period totals on user-defined bases other than VAT quarters (such as weekly, monthly and to the end of each trading account), and HMS VAT TRADER'S LEDGER should be a boon to you as a sole trader through to the low transaction company.

Both systems allow for 1000 to 10000 records per file depending on configuration and use, and initialise on shift-BREAK without user OS intervention. Fully documented source listings and optional user-modifiable VIEW text operating documentation are included on the master disc, and hard copy manuals are provided.

HMS BASIC ENVIRONMENT is specifically an aid to BASIC program development designed to encourage the creation of well-structured readable code in circumstances where memory becomes a constraint. Procedures to handle screen I/O, cursor switching, CLI invocation, and keyboard validation are provided, with a linking BASIC source-file compressor which includes variable name compression to two bytes. The ability to link as many BASIC source modules as desired into a single condensed running version resolves the coder's conflict between space and intelligibility; 60% compression is effected on our sources for the above accounts packages.

The disc, manual and information contained are sold under license subject to the condition that they are for single user single site application by or on behalf of the purchaser, are not for resale in whole or in part either as originals or copies, and may not be supplied to a third party as part of a package or used as part of a package supplied by a third party to the purchaser, without the written consent of the copyright holders. Damages will be claimed where this occurs, with revocation of license. Purchase indicates acceptance of license terms.

I enclose £..... for the following products (tick and delete where appropriate)

HMS HOME ACCOUNTS	(£28.75).....
HMS VAT TRADER'S LEDGER	(£21.50).....
HMS BASIC ENVIRONMENT	(£14.50).....

VAT, disc, manual, post and packing inclusive.

The credit card companies 4% take precludes our offering their service.

Please supply on 40/80 track disc. I have VIEW/WORDWISE; OS 1.0/1.2; BASIC I/II

Name.....

Address.....

..... Postcode.....

Telephone..... Date.....

Please send with cheque or postal order to: Harris McCutcheon Systems, 40 Huntingdon Street, London N1 1HM (01 609 3207)

BBC/ELECTRON PROFESSIONAL SOFTWARE

Our educational software is used in thousands of schools and homes throughout Great Britain.

EDUCATIONAL 1

BBC/ELECTRON

Tape £8.00 Disc £10.00

Hours of fun and learning for children aged five to nine years. Animated graphics will encourage children to enjoy counting, maths, spelling, and telling the time. The tape includes six programs: MATH1, MATH2, CUBECOUNT, SHAPES, SPELL and CLOCK.

... 'An excellent mixture of games' ... Personal Software - Autumn 1983.

EDUCATIONAL 2

BBC/ELECTRON

Tape £8.00 Disc £10.00

Although similar to Educational 1 this tape is more advanced and aimed at seven to 12 year olds. The tape includes MATH1, MATH2, AREA, MEMORY, CUBECOUNT and SPELL.

FUN WITH NUMBERS

BBC/ELECTRON

Tape £8.00 Disc £10.00

These programs will teach and test basic counting, addition and subtraction to four to seven year olds. The tape includes COUNTING, ADDING and an arcade type game to exercise addition and subtraction. With sound and visual effects.

FUN WITH WORDS

BBC/ELECTRON

Tape £8.00 Disc £10.00

Start your fun with alphabet puzzle, continue your play with VOWELS, learn the difference between THERE and THEIR, have games with SUFFIXES and reward yourself with a game of HANGMAN.

... 'Very good indeed' ... A&B Computing - Jan/Feb 1984.

JIGSAW AND SLIDING PUZZLES

BBC/ELECTRON

Tape £7.95 Disc £9.95

There are two jigsaw and four sliding puzzles on a 3 x 3 and 4 x 4 grid. Each program starts off at an easy level to ensure initial success but gradually becomes harder. It helps children to develop spacial imagination and in solving problems. The tape includes: OBLONG, JIGSAW, HOUSE, NUMBERS, CLOWN and LETTERS.

GAMES & UTILITIES

GAMES OF LOGIC

BBC

Tape £4.95 Disc £6.95

For children and adults alike. The tape includes AUCTION, FLIP, REVERSE, TELEPATHY and HEXA 15.

... 'This package is good value' ... Acorn User - Nov 1983.

SUPERLIFE

BBC/ELECTRON

Tape £4.95 Disc £6.95

Fast (machine code) version of a popular 'GAME OF LIFE' in a large universe.

KATAKOMBS

BBC

Tape £5.95 Disc £7.95

The ultimate adventure game.

UTILITIES

BBC/ELECTRON

Tape £5.95 Disc £7.95

An assortment of useful procedures and functions which can save you hours/days of programming effort: date conversion, input and validation routine, graphic routines, sort, search and many more.

★ ★ ★ SPECIAL OFFER ★ ★ ★ Buy three titles and deduct £4.00

Add 50p p&p per order. Please state BBC or Electron. Cheque/PO.

Golem Ltd, Dept A, 77 Qualitas, Bracknell, Berks RG12 4QG. Tel: 0344 50720.

Animate your Basic programs with Arcade-speed Sprites

SIMONSOFT SPRITES VERSION 2

@ £12.95 each BBC Model B

A devastating new sprites package! FASTEST EVER screen movement seen in Basic programs brought to your own character designs. All routines called from Basic, no knowledge of machine code is required.

Look at these features:

- 1 Pixel-by-pixel movement, resulting in a fluid-smooth motion of sprites. Yet even when moving one pixel at a time, a sprite may cross the screen 40 times in 13.5 seconds.
- 2 Up to 48 SPRITES on screen at any one time.
- 3 All 16 logical colours available in sprite design.
- 4 12 different base sprites each with up to 3 clones. Each sprite has independent screen images and movement control.
- 5 Two images for every sprite to allow ultra-smooth motion (left, righthand pixels). Can be defined separately for animation e.g. jumping frogs, running men, etc.
- 6 COLLISION DETECTOR with hit flags set to the numbers of the sprites overlapping.
- 7 SUPERSPRITES of up to 24 x 24 pixels. Can be moved as a single sprite, uses just two co-ordinate integers.
- 8 Incredible ENLARGEMENT FACILITY allowing up to x5 magnification of any sprites. Let your invaders loom out of the screen in 3-D effects!
- 9 User-defined PRESET FLIGHT PATHS each with 8 directions of 255 steps.
- 10 Both EOR plotting and TRANSFER plotting available. EOR plotting allows sprites to cross background without disrupting it, transfer plotting cuts through background. Transfer plotting + background storage available for no disruption and no colour change as sprites cross background.
- 11 'Old' sprites deleted automatically, screen boundaries crossed automatically.
- 12 TWENTY different sprite routines: optimise on speed and memory space by choosing the routine best suited to your program.
- 13 Routine deposited in RAM, write Basic as normal, then SAVE/LOAD your program and sprites as a whole.
- 14 Two arcade-speed demonstration games (inc. DEVIL SWARM) using sprites.
- 15 Excellent manual accompanies package.
- 16 May be used in programs you wish to market.
- 17 Compatible with DISC/CASSETTE based system, please specify. Add £3 for disc version already on disc, specify 40/80 track.

PLEASE compare with other sprite packages
DON'T OPT FOR ANYTHING LESS

SUPERFRUIT (32K) £5.95

Simply the best. Full colour high resolution graphics. Spinning reels with 'bounce'. Incredible gamble effects, hold, 3 types of gamble, swap reels, two-way nudge, nudge gambles, coin pile that shrinks/grows, great sound effects. Separate instruction program. This implementation is in a class of its own.

"You would be fully justified in claiming that it is better than the real thing"—M. Field, Oxford.

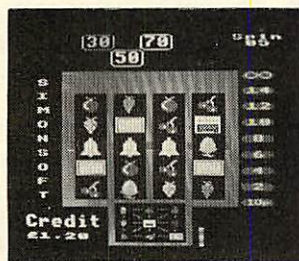

Actual screen photograph

ASTROWARS (32K) £6.95

The up-to-date version of asteroid-style programs. Your ship is trapped in an asteroid swirl and your only hope for survival is to blast a clear path through the asteroid cloud. Two types of alien saucer make your existence perilous. One homes-in on your ship, the other strafes it while dodging your laser bolts. A unique feature allows you to set the speed of the action, the initial screen number, and the frequency of both kamikaze and strafers saucers.

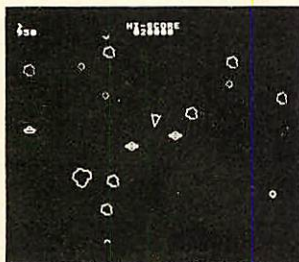

Actual screen photograph

Please order from:

**SIMONSOFT, 25 TATHAM ROAD
ABINGDON, OXON OX14 1QB
TEL: 0235 24146
Dealer inquiries welcome**

THE COMPUTER ROOM

DISC DRIVE OWNERS!!

Get more out of your Disc Systems by using Random Access for rapid storage & retrieval of data. Available NOW is a 114 page book with WORLDWIDE sales...

AN INTRODUCTION TO RANDOM ACCESS FILING ON THE BBC MICRO

Supplied complete with a demonstration disc containing a STOCK CONTROL system and a PERSONNEL system. (40/80 track — please state). A MUST FOR ALL DISC DRIVE OWNERS!!

Features include.

- Overlaid Programs
- Full input validation routines
- Date Check routine
- Menu driven demo-disc
- Genuine high speed Random Access.

PRICE: £12.50 complete

For your TOOLKIT . . .

UTILITIES 1 (40 track)

Two invaluable routines . . .

(A) DISCMAP . . . The only program of its kind for the BBC Micro. Produces a "picture" of your disc surface showing where the files and programs lie. If you were thinking of *COMPACTING a disc then you will find this program extremely useful.

(B) DELETED FILE RECOVERY. In conjunction with the DISCMAP program you can locate and recover ALL or PART of any BASIC or M/CODE program. Also included in this program is a unique SECTOR SEARCH routine that vividly displays sector contents on the screen in a most readable format.

PRICE: £8.95 complete

And for your BUSINESS . . .

A comprehensive suite of RANDOM ACCESS STOCK CONTROL programs.

Here are just some of the features:

- Customised system
- Overlaid Programs
- Add/Amend records etc.
- Goods In/Out
- Stock Valuation
- Low Stock Reporting
- Machine Code Sort
- 256 byte records
- 23 fields
- Complete PRINT menu (Epson)
- Up to 1500 records
- Mode 3 screens
- Comprehensive User Manual

n.b. Minimum configuration TWIN 40track or SINGLE 80track drives plus EPSON printer. Since MODE 3 screens are used, a MONITOR is recommended.

SEND FOR FREE SPECIFICATION, SAMPLE PRINTOUTS and PRICE LISTS

THE COMPUTER ROOM
206 MAIN STREET
NEWTORPE
NOTTINGHAM
Tel: 0773 718578

RESPONSIBILITY OF THE PRESS

Sir, I have recently read Mike Cooke's article, 'Protection Racket' in your February issue. In it he describes how a number of the basic software protection methods work and suggests how these may be circumvented by the average BBC user. I am sorely disappointed that your editorial policy admits the publication of information of this kind, as I have little doubt it will be used for purposes which are less than honourable.

I understand that a recent survey of BBC users indicates that the number of pirate copies of *Snapper* in circulation exceeds the numbers actually sold by a factor of some 20:1. One can only sympathise with Acornsoft who must have committed large resources to developing this program and others like it.

I am aware that software users frequently protest that the copy-protection of software denies them their 'right' to make security back-ups; to transfer programs from tape to disc; and to place several programs on to a single disc or tape. While these activities are all quite respectable, the 'right' to perform them has been so greatly abused, that the publishers now have little option but to withdraw it.

Provided that software publishers deal promptly with returned, corrupted tapes or discs (for, say, a year after purchase), and will transfer returned cassettes to discs for a minimal charge, I see no reason to fault the suppliers, when the software-consuming public is behaving so culpably.

Rather than engaging in such complicit behaviour, may I suggest that *Acorn User* serves its public in a more honourable manner by enquiring of its readers (and publicising) details of retailers who provide a poor service with respect to tape replacement, upgrade, etc.

I am sure many of your readers will be aware that another major UK micro magazine recently published an article which contained information useful to the would-be software pirate. I expect they also know that this magazine subsequently had to part with many tens of thousands of pounds (reports vary) as part of an out-of-court settlement with Acornsoft. It is a great pity that action of this kind is necessary to encourage responsible attitudes on the part of the computer press. **K Pretorius**
London

It is not the policy of *Acorn User* to help people circumvent the copyright protection on any software. However, it is our policy to help writers protect their own software. This was, in fact, the fourth article published on software protection, and describes a technique built into the BBC micro's operating system ROM for anyone to use.

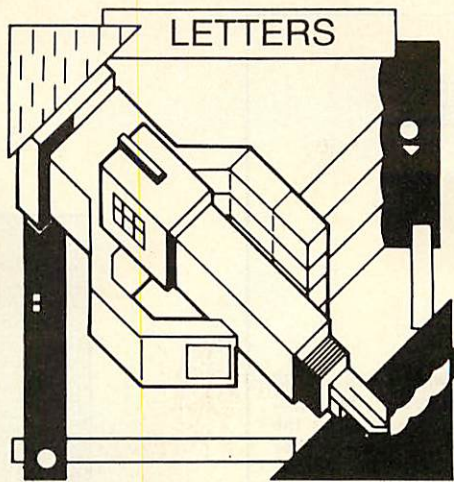

As for software publishers dealing 'promptly' with corrupted tapes or discs at 'a minimal charge' and for 'up to a year', we are not aware of any. Our daily post is full of tales of woe from people whose experience is exactly the opposite, and only behind-the-scenes pressure from *Acorn User* has any result.

Software houses are unwilling to make any public statement on 'bugs' and exchanges, because if they did they would be inundated with requests. The policy is: 'if anyone notices the bug and makes a big enough fuss, then we'll change the software'. An upgrade service often cannot be offered to correct the bugs because of the protection methods used.

WATFORD REPLIES

Sir, I refer to my letter 'Watford DFS compatibility' published on page 164 of your February 1984 issue.

As you know I did *not* give my consent to the publication of the letter sent to your publishers and because of this I believe your readers have been given incorrect information. In the third paragraph of the article it states: 'If he would like to return it, we would gladly exchange (free) for DFS 1.3'.

While our company is very willing to assist your readers in updating their DFS ROMs we are unable to do this free of charge. We do make a charge of £4 for this exchange service including postage.

Would you therefore please bring this alteration of the previous article to the notice of your readers.

Nazir Jessa
Managing Director
Watford Electronics

DISC TROUBLE

Sir, I was most interested to read the correspondence from Mr Jessa of Watford Electronics, from whom I purchased a disc to organise a large church membership roll file.

I was using Watford's 1.1 DFS and a Cumana double-sided, twin 40/80 track drive. I reserved the whole of one disc surface for the file.

When I came to initialise the file by writing blank records I found that records 212 and 213 were unreadable. I tried *SAVEing a dummy file of the requisite length and re-initialising to no avail. I always had trouble at the 64k mark.

Having read the letter I called at Watford to exchange my 1.1 system for the 1.3. I was told I would have to pay a further £3.45. I objected and pointed out that there was a flaw and showed your letter. I was told it was part of some private correspondence and was to placate one customer. The blame was also laid on Acorn for not correctly utilising their own system!

After arguing, I reluctantly paid the money. On trying the filing program again, I successfully initialised the file first time.

I feel that Watford and Mr Bray, the author of the system, should face up to their responsibilities and offer free replacement of faulty software. The current version of this system is 1.3. I know of versions 1.1 and 1.2. How many more attempts has the customer to pay for before they get it right?

M Herbert
Leicestershire

SMUG BRAY

Sir, Mr Nazir Jessa, managing director of Watford Electronics, whose letter you published in your February edition, has done some pretty smart back-peddalling. When I sent him my 1.0 DFS for its free upgrade I got it back unchanged with a circular saying you had printed his letter without his consent or knowledge and that if I wanted the upgrade I'd better send him £4.

I took the line of least resistance and sent along a cheque for the sum demanded. I included a letter to say that I did so under protest, as the 1.0 DFS contains flaws of which the most obvious is that the *EDIT command will not work in Drive 2.

I now have my 1.3 upgrade, along with Watford Electronics' apology 'for the inconvenience caused'. Unfortunately my £4 has been wasted. The new version won't *EDIT in Drive 2 either!

The 1.3 DFS contains the following interesting message at location BC78. 'This DFS comes to you by courtesy of Andrew Bray and Watford Electronics. We consider the WE DFS to have all the features needed so DFS 1.3 is the definitive feature set. Other DFS authors please take note this is the standard you must achieve. . . .'

Stephen Fox
Cheshire

The letter from Watford Electronics which we printed has obviously caused confusion and comment, and we are happy to allow Mr Jessa his statement.

Let us now hope he will be the first to advertise an upgrade service, for those who originally bought the 'fully compatible' early versions.

The DFS message is certainly an example in asking for trouble!

DDT SOFTWARE

presents

MASS

MACRO ASSEMBLER FOR THE BBC

Take the effort out of coding and be professional with MASS. MASS is a powerful new ROM based macro assembler for the BBC. Assembles direct from disc or tape, so there is no limit on the source size. Flexible source code requirements allow any editor to be used, e.g. VIEW or WORDWISE, even the BASIC editor. Supplied with free utility disc including many useful macros and a sort routine.

- * Selective symbol dump
- * Conditional assembly
- * All OS calls supported during assembly
- * Detailed manual
- * Assembles to disc or memory
- * Macro or disc files may be nested
- * Uses same format as BASIC assembler
- * Flexible listing control
- * Binary and string data supported
- * Over 20 powerful pseudo-ops
- * Linking facilities

Dealership and educational establishment enquiries welcome

Price £34.95 (including VAT and carriage)

Order, enclosing full remittance, from:

DDT SOFTWARE
Southfield House, 11 Liverpool Gardens,
Worthing, West Sussex, BN11 1RY.
Tel. (0903) 213174.

adding the finishing touch
to your BBC Computer ...

the OWL PERCH



The 'Owl Perch' Stand is a heavy duty, sand-cast aluminium alloy support designed to enable a monitor or television set to be placed above the B.B.C. Computer. It prevents damage to the plastic case of the computer and allows the VDU screen to be positioned at a comfortable viewing angle. The 'Owl Perch' may be earthed to provide screening for the computer.

The top surface of the stand is recessed to prevent the monitor sliding off the stand and prevent liquids or small objects falling on to the computer. It is finished in an attractive cream coloured epoxy enamel and is fitted with rubber feet to prevent damage to table or desk tops. The 'Owl Perch' VDU Stand provides ample clearance to prevent overheating. The price quoted is for the Standard single tier unit but various extras are available including a second tier kit to provide an additional shelf for mounting disc drive, etc., below the VDU.

£35 incl VAT & p&p (UK)

Leaflet available Please allow 28 days for delivery

WILLIAM BROADY & SON LIMITED (Dept L)
ENGLISH ST., HULL HU3 2DU (est. 1902)

4

Emmanuel St.

**Our new Personal
Computer Centre
specializing in
the BBC Micro
with complete support**

we know computers

**1 Business &
Professional**
Tel 0223 65335 4



**Home &
Educational 4**
Tel 0223 358264

Cambridge Computer Store

1 & 4 Emmanuel Street, Cambridge



ATOMIC MACHINE CODE

A book containing 23 fully explained machine code programmes for the Atom.

DATA SORTS ● MODE 4 CHARACTERS ●

GAMES ● POOLS PREDICTION ● TOOL KIT ●

Over 50K of programmes in 1 book for £5.75 inc.

Book and Cassette (source code) £15.50.

Book and Cassette (ready to run) £15.50.

Cassette only £11.50.



ATOM LOAD

If you now own a BBC don't throw away your tapes, for ATOM LOAD allows you to load Atom tapes directly into the BBC Micro (Model B).

BBC-TYPE BASIC ● ATOM BASIC ● ATOM

TEXT FILES ● ATOM MACHINE CODE ●

ATOM DATA FILES ●

Checks for Syntax differences, checks for direct addressing of memory, disassembles machine code, and in all cases flags possible errors.

On Cassette – All this and more for only £9.75 inc.

ECCE Productions, 3/73 Station Road,

Sidcup, Kent. DA15 7DR.

01 302 1667. (Mail order only)

NO ROOM

Sir, I have been using a BBC micro for about six months and the only slight concern is the lack of memory in the lower modes. I often want to write programs which output a table of results and have to use a lot of DIM statements in mode 3.

Although only 3k long, these programs run out of memory during a run, due to the DIM space required. Invariably I get the message: 'No room' or 'Bad DIM'.

Do you know how the memory can be expanded so I can use larger DIM statements in lower modes? Would another memory chip suffice?

John Luckcock
Middlesex

Adding extra memory chips is no easy matter because the 6502 microprocessor already addresses its maximum of 64k - 32k Basic and operating system, 32k user memory.

If you want more memory in which to run a program, the answer is either to wait for a second processor, or buy something like the Aries board which is reviewed in this issue.

ROM SHIFT

Sir, Terry Holden's comments about ROMs using the same commands in his review of Computer Concepts' Disc Doctor (page 143 February edition), bring to light a problem that could be more serious than he first thought.

I fitted a Beebase-1 database ROM from GCC in Cambridge into a model B which already had Beebcalc from Computer Concepts. Unfortunately, both these ROMs respond to the minimum command *BE.

With Beebase in position 2 (second from left) and Beebcalc in position 3, *BE accessed Beebcalc, but Beebase could not be called at all, *BeeBASE or *BEEBASE giving 'Bad Command'.

Changing the ROMs so Beebcalc was in position 2 and BeeBASE in 3 allowed *BE to access Beebase, but Beebcalc required the full name or a minimum *BEEBC.

D Buckley
Middlesex

DOCTOR CURES

Sir, Having read Terry Holden's excellent review of the Disc Doctor EPROM, I have two suggestions, which I have found from using it.

First, as Terry says towards the end of his review, it is sometimes impossible, seemingly, to use certain commands. However, if one knows which socket the EPROM is in, it can be disabled. Thus, if it was, say, from the given example, the Watford DFS which was causing the problem, and it was in

socket (n), then ?&02An=0 would disable it. It is worth, before doing this, finding out what the value should be, by doing a PRINT ?&02An.

This will enable the ROM which is disabled to be re-used later on, by putting back the value found above with ?&02An=XX.

You can make sure that your actions have worked by using the *HELP command, to see if the operating system knows of the EPROM's existence.

Second, there is a bug in View, such that if fitted together with Disc Doctor, some of the Disc Doctor commands don't work.

This is because of the way View handles a system command, eg *TAPEDISC. This is offered round all the ROMs, until one of them recognises it, and takes control.

However, View, while checking, corrupts some parts of memory which it should be leaving alone! Therefore, to use a command in Disc Doctor which does not seem to be working, it is worth trying first of all moving the ROMs to give Disc Doctor a higher priority, so that it sees commands before View. However, this does not seem to work for all commands, and the above technique, of disabling View by software always works. (Unless you know different!)

My thanks to Acornsoft for explaining all this to me.

R Hallsworth
Oxfordshire

FAST SHUFFLE

Sir, I recently read the two letters in your February issue in reply to J O'Brien's request for a 'non-repetitive' random number generator. Both the solutions published suffer from the same problem, namely it can take a long time to get there!

I have used the procedure below to 'shuffle' a pack of cards.

As you can see, this method takes exactly 'items' steps every time. It may not be obvious that this method is uniformly distributed, but a moment's thought shows that each number has a chance of being picked of 1/items at a particular stage.

Stephen Rogerson
Maidenhead

```

10REM Shuffle
20REM
30items%=10
40DIM list%(items%)
50REM
60REM Initialise the array
70REM
80FOR I%=1 TO 10
90list%(I%)=I%
100NEXT
110REM
120REM Initilise the random
    number
130REM generator.
140REM
150I%=RND(-TIME)
160REM
170PROCshuffle(items%)
180END
1000DEFPROCshuffle(items%)
1010LOCAL I%,J%,S%
1020FOR I%=items% TO 2 STEP -1
1030J%=RND(I%)
1040REM
1050REM Swap the I%th and J%th
1060REM elements
1070REM
1080S%=list%(J%)
1090list%(J%)=list%(I%)
1100list%(I%)=S%
1110NEXT
1120ENDPROC

```

The Rogerson shuffle

WHITE MOVE

Sir, As author of the BBCSoft chess program *White Knight*, I was pleased to see it reviewed in your January '84 issue. There were, however, a few points in the article which I would like you to clarify.

John Vaux stated *White Knight* could not solve the position in figure 6. This is untrue - *White Knight* can solve it in less than 30 seconds if set on a high enough level. I presume the trouble the reviewer had was that *WK* never looks very far ahead when the move number is 1 or 2. This is so that little time is wasted on the opening two moves. The reviewer should try the position with the move number at 3 or more.

Next, the reviewer said the program searches 50,000 positions each minute. It is in fact more than this, at about 72,000 (1200/second).

Finally, Mr Vaux was unable to play the programs against each other. In tests, *WK* beat all the other BBC chess programs by 16 games to nil! It also won the home-computer section of the 1983 European Championships.

M Bryant
Basingstoke

LOUSY CHESS

Sir, I read the article on chess in January's *Acorn User* and I would like to ask a few questions.

I originally came to computers through my interest in chess. Of course, since then I have become 'addicted' to them and spend many happy hours working out mathematical puzzles, programs and so on.

My experiences with chess have not been very satisfactory. I have a program called *Microchess* which I use on my ancient Commodore Pet. This plays in a reasonable time and doesn't play too badly. At the top setting, however, I can always beat it, unless I am drunk or watching the television at the same time! I would like to think this is because I am a Master player, but years of playing mere human beings

Model B
Now available with
joystick or keyboard options

263° ILS DME 110.9 IWW

LONDON, U.K.
GATWICK
ILS Rwy 26

263°
275°

LOM
353.5 GE

Pilot Written.....
BOEING 767
ADVANCED FLIGHT SIMULATOR

Not a game, a realistic
video aid, suitable for
novice and expert. Most
advanced features yet include;
full 3 axis autopilot; position hold; full
instrumentation; navigation computer;
ILS; DME; VOR; ADF; warning computer;
3D landing sequence. Package includes;
comprehensive briefing booklet; selection of real
airport charts; area charts; keyboard overlay.

Fly into the 90's with 767, the new
generation hi tech, computerised
jet liner, great value,
only £7.67 inc. p and p

Chq or PO to
FLIGHTDECK SOFTWARE
Dept. 767, 25 Halsey Road,
Kempston, Beds. MK42 8AP

NEWARK VIDEO CENTRE
PRESENTS
**SUPER CLEAR COMPUTER
DISPLAY - AND A TV!!**
AN RGB MONITOR - WITH TV RECEPTION

14" C2402/RGB £275.00 - 20" C6100/RGB £365.00
16" C3104/RGB £299.00 - 22" C7100/RGB £399.00
16" C3040/RGB with Remote Control (Teletext Extra) £355.00
26" C8400/RGB with Remote Control (Teletext Extra) £465.00

**All prices include VAT, a 12 month
guarantee, a 6 Pin Din lead, a mains plug and
carriage to your door. All are Grundig TV's supplied
with Grundigs consent.**
Educational and quantity discounts are available.

What 'What Micro' said:

'The colours are just unreal like
the 'simulated' pictures in TV
advertisements. The best of all
images came from this set.'

'A very reasonable comparison
could be made with colour
monitors costing several
hundreds of pounds.'

**NEW! 1 Input - 6 output. RGBS Distribution
Amplifier - £250**

For details of the full range contact:
**NEWARK VIDEO
CENTRE LTD**
108 LONDON ROAD, BALDERTON,
NEWARK, NOTTS. NG24 3AQ.
TELEPHONE: 0636 71475
Open 9 am - 6 pm Monday - Saturday
Access and Visa cards accepted

COM-TEC COMPUTER CENTRE LTD

DEALER AND SERVICE CENTRE

DEALER

23 Sheffield Rd
Barnsley
South Yorkshire
Tel: 0226 46972

Educational Orders Welcome
Discounts Available on Bulk Orders

<p>BBC Model B 399.00 BBC Model B + Disk 469.00 Electron 199.00 Disk Interface Kit 101.00</p>	<p>BNC Green Screen 113.85 Mitrovitec 14" Cub 245.00 Phoenix Green Screen 130.00 BBC Monitor 104.54 Amber Screen 135.00</p>	<p>DISCS (Scotch 3m)</p> <p>744 SS40 19.32 745 DS40 27.95 746 SS96 34.50 747 DS96 46.25 7440 Clean kit 19.50</p>	<p>ROMS</p> <p>Wordwise 39.95 Beebcalc 35.00 Disk Doc 33.00 Spy 24.00</p>																														
<p>Seikosha GP100A 189.75 Seikosha GP250A 264.50 Seikosha GP700A 458.50 Epson RX80T 310.50 Epson RX80 431.25 Epson RX80FT 356.50</p>	<p>SD Single Drive DD Dual Drive SS Single Sided DS Double Sided</p> <p>SD SS 40tk 100k 207.00 SD SS 30tk 200k 253.00 SD DS 40tk 200k 228.00 SD DS 80tk 400k 287.00 DD DS 40tk 400k 431.00 DD DS 80tk 800k 511.00 SD DS 40/80 310.00 DD DS 40/80 534.00</p>	<p>SOFTWARE</p> <table border="0"> <tr> <td>Felix in Factory 7.95</td> <td>Swoop 7.95</td> </tr> <tr> <td>Martian Attack 7.95</td> <td>Carm 7.95</td> </tr> <tr> <td>Cybertron Miss 7.95</td> <td>Chess 7.95</td> </tr> <tr> <td>Hell Driver 7.95</td> <td>Physics 6.95</td> </tr> <tr> <td>Moon Raider 7.95</td> <td>Where 6.95</td> </tr> <tr> <td>Alien Swirl 7.95</td> <td>World Geog 6.95</td> </tr> <tr> <td>Laser Cmdn 6.95</td> <td>Adventure 7.95</td> </tr> <tr> <td>Danger UXB 7.95</td> <td>Caveman Ad 6.95</td> </tr> <tr> <td>Escape Mnbs 7.95</td> <td>Fairground 7.95</td> </tr> <tr> <td>Galactic Cmdn 7.95</td> <td>Crazy Paint 7.95</td> </tr> <tr> <td>Labryn Lacush 7.95</td> <td>Lost City 7.95</td> </tr> <tr> <td>Dambusters 7.95</td> <td>Monaco 7.95</td> </tr> <tr> <td>Lunar Rescue 7.95</td> <td>Flexibase 9.95</td> </tr> <tr> <td>Gideons 7.95</td> <td>Alligatacalc 9.95</td> </tr> <tr> <td>Gamble 7.95</td> <td></td> </tr> </table>		Felix in Factory 7.95	Swoop 7.95	Martian Attack 7.95	Carm 7.95	Cybertron Miss 7.95	Chess 7.95	Hell Driver 7.95	Physics 6.95	Moon Raider 7.95	Where 6.95	Alien Swirl 7.95	World Geog 6.95	Laser Cmdn 6.95	Adventure 7.95	Danger UXB 7.95	Caveman Ad 6.95	Escape Mnbs 7.95	Fairground 7.95	Galactic Cmdn 7.95	Crazy Paint 7.95	Labryn Lacush 7.95	Lost City 7.95	Dambusters 7.95	Monaco 7.95	Lunar Rescue 7.95	Flexibase 9.95	Gideons 7.95	Alligatacalc 9.95	Gamble 7.95	
Felix in Factory 7.95	Swoop 7.95																																
Martian Attack 7.95	Carm 7.95																																
Cybertron Miss 7.95	Chess 7.95																																
Hell Driver 7.95	Physics 6.95																																
Moon Raider 7.95	Where 6.95																																
Alien Swirl 7.95	World Geog 6.95																																
Laser Cmdn 6.95	Adventure 7.95																																
Danger UXB 7.95	Caveman Ad 6.95																																
Escape Mnbs 7.95	Fairground 7.95																																
Galactic Cmdn 7.95	Crazy Paint 7.95																																
Labryn Lacush 7.95	Lost City 7.95																																
Dambusters 7.95	Monaco 7.95																																
Lunar Rescue 7.95	Flexibase 9.95																																
Gideons 7.95	Alligatacalc 9.95																																
Gamble 7.95																																	
<p>STAR Gemini 10x 280.00 STAR Gemini 15x 400.00 Riteman 280.00 Juki 6100 458.85</p> <p>STAR BUY ORIC Plotter & BBC lead 129.95</p>	<p>All drives include leads, manual and utility disk</p> <p>Torch Disk Pack 839.00</p>	<p>BUY ANY 3: GET 1 FREE Please state which one when ordering</p>																															
<p>RIBBONS Seikosha Epson IBM82 (Juki)</p>	<p>CARRIAGE FREE ON ALL ITEMS</p> <p>Access and Barclaycards accepted Tel: 0229 46972</p>																																

has demonstrated this is not so!

The various programs I have used on my BBC micro can all be described in one word: 'Lousy' — with one exception. This is *Chess 2.32 Version E* by David Thompson. Like *White Knight*, this also takes its 'intelligence' from the time it takes to move and, when it is set to take six or seven minutes to move, it really does play quite good chess. Unfortunately this means nearly four hours to reach the middlegame!

At one point in the article, the writer comments on the program's 'amazing speed' and then, talks about setting the move time to 59 minutes 59 seconds! To reach the middlegame at this rate would take about 30 hours!

P Arrey
Surrey

It's difficult to say whether White Knight will beat you, but it's the best we've met on a Beeb — although the David Thompson game has never come to our notice.

Perhaps the letter above, especially with its reference to the chess championships, will make up your mind. Let us know how you get on.

STRING REPLY

Sir, With regard to Ian Tresman's letter (December p161) commenting on my hint

(August p51), it is not quite correct to say the same effect can be achieved using *FX 141, because my routine can quickly insert a whole string of characters at once, not simply one at a time. A similar program for the 1.2 OS would be:

```
10 P%=&900:[OPT2:INSERT:LXD#0:
L%:LDA&930,X:CMF#13:BNEP%+3:
RTS:CMF#124:BNEP%+8:INX:
LDA&930,X:AND#31:STX&92F:
LXD#0:
JSR&E4B3:LXD&92F:INX:JMPL%:]
20 $&930="GOTO300 IM"
30 CALL INSERT
```

Perhaps it should be emphasised that, as can be seen from this routine, once the string has been set for the first time, all that is needed to insert it subsequently is the CALL INSERT command.

Alex Selby
London

250X DUMP

Sir, I own a Seikosha 250X printer and was particularly interested in September's issue featuring SKASS, the hybrid graphics program for Seikoshas.

On the assumption, probably wrongly, that the 100A and 250X were similar, I changed the control codes in SKASS to

those for the graphics mode on my machine. This was partially successful as a neat straight line followed.

Unfortunately, this line bears no relation to what appears on the screen and perhaps most interestingly always ends with the word 'pape' accompanied by what appear to be authentic French accents!

Can you help, or should I assume my BBC and Seikosha have the correct answer and drown my sorrows in a bottle of Chateaufeuf du Pape?

A Moreton
London

George Hill replies: I'm afraid the 'pape' phenomenon is only too easy to explain. Pape, and pate, possibly to go with the wine, appear as the result of a series of commands sending ASCII codes greater than 128 to the printer. In this region the printer keeps its 'extra' characters for international character sets. If you read the text of the article you will find that the Seikosha 100 must have its graphics bytes greater than 128, and these are having odd results on the 250.

The graphics commands, and facilities of the Seikosha 250 series of printer are not the same as for the 100 series. It resembles much more closely the Epson system. It prints eight-dot wide bands, not seven, and has escape se-

New
Release

GOLDEN CHALLENGE SOFTWARE [®]

Present

CALIGULA I [©]

'If you had ultimate power
what would you do?'

He made his horse a General, he ridiculed the Senate, smashed his enemies and worse! He was ruler of the greatest, most decadent empire the world had seen, the glory that was Rome. "What would you have done . . . ?" Well now you can find out. Deploy your Centurions to build and maintain an empire; conquer (among others) the Greeks, the Judeans and the (unbeatable?) tribes of England. Decide when to attack? When to seek peace? How outrageous a Palace? How strong a Praetorian Guard? Levy provincial taxes, see the Chariot Races, and to hell with the consequences. . .

There is also the SEER; consult him and you will see that Caligula I[©] is more than you think.

BUY IT—AND LET YOUR COMPUTER TURN YOU ON FOR A CHANGE

Cassette: **£7.95**

Disc: **£10.00**

Price includes **manual** and function key **card**. 32K (Series 1.0 & 1.2)

Credit cards accepted

Tel: **01-404 5737**

24 hr Ans: **01-405 8582**

Cheques/POs to:

**Golden Challenge Software, 2-4 Chichester Rents, Chancery Lane,
London WC2A 1EG**

Copyright

[®] A Division of Nigel Ward A-V Productions (Europe)

BEN BETTERED

```

1000DEFFPROC DUMP
1010REM SEIKOSHA GF250 DUMP
1020REM G.B.HILL (c) 1983
1030VDU2,1,10
1040VDU1,27,1,76,1,2
1050FOR Y%=1023 TO 0 STEP-32
1060VDU1,27,1,71,1,1,1,64
1070FOR X%=0 TO 1279 STEP 4
1080byte=0
1090FOR y%=31 TO 0 STEP -4
1100byte=byte*2
1110IF POINT(X%,Y%-y%)>0THEN
    byte=byte+1
1120NEXT
1130VDU1,byte
1140NEXT
1150VDU1,10
1160NEXT
1170VDU1,10,3,7
1180ENDPROC

```

quences to determine the number of dots per line printed, and the line spacing.

The Basic program above will dump the screen on the 250. To prepare a printer byte for it in machine code requires a process not unlike the Seikosha 100 method, but it must be an eight-dot wide byte not seven, hence count.7 is initialised to 8. (It would be sensible to rename it count.8, but this will have no effect other than to increase legibility). Also, byte should either not be initialised at all, with some slight increase in speed, or initialised to 0. Again this will have no noticeable effect, as the first bit in will be rotated right out anyway, and so is irrelevant.

Sir, Reading some of the letters in the January issue of *Acorn User* it seems that there is some interest in making Basic programs run using *RUN. Ben Clarke's idea outlined in his article on program protection was neat but left room for improvement (Beeb Forum, page 69).

The problem seems to be to have a system which relies only on operating system calls which sets the value of PAGE, initialises all the pointers correctly and runs the program. Also although putting the code in a REM statement is a nice idea it does tend to make the program listing ugly.

Putting the relevant commands to the Basic interpreter into the keyboard buffer, each followed by a carriage return, works. One of the things I find useful though is to have a soft key set up to set PAGE, obey OLD and run a program.

Simply, then, the method for auto-running is to put some machine code directly above the Basic program in memory. This code sets up a soft key definition and puts the soft key value in the keyboard buffer.

The Basic program below achieves this. The user should input the program to be auto run, and then print out the Basic pseudo-variable TOP. Setting PAGE well clear of this (leaving at least 50 bytes free), load and run this small program. When both the value which TOP had, and the value to which PAGE is to be set on auto-running have been typed in, the program assembles some code above the old value of TOP. It then prints out the form of the *SAVE command the user must use to save the auto-running Basic program.

The program uses soft key 10, the break

key, so the program will re-run itself whenever break is pressed. Others may not find this useful, but it is a simple matter to change the number of the soft key used!

Paul Towers
Cambridge

```

10 INPUT "What value did TOP have ";T$
20 INPUT "What value does PAGE need to be ";PA$
25 T%=EVAL(T$):PA%=EVAL(PA$)
30 $T%="K.10PA.="+STR (PA%)+":MOLD 'MRUN 'M"
40 P%=T%+LEN($T%)+1
50 E%=P%
60 [LDX#T% AND &FF
70 LDY#T% DIV      \address of
    &100             \command line
80 JSR &FFF7       \call OSCLI
90 LDA#138         \insert char in
                    \buffer
100 LDX#0          \keyboard buffer
110 TAY            \138 = soft key 10
120 JMP &FFF4     \OSBYTE
130 ]
140 PRINT "NOW TYPE: -"
150 PRINT "**SAVE ?????? "; PA%;"
    "; P%;" "; E%"
160 END

```

PEN PAL

Sir, Before I start, I would like to thank you for an excellent magazine. However, I would like to ask if you know a fast print routine - I've tried Basic, but it's too slow.

Also, here in Belgium, there isn't much to do with a Beeb, so I'm looking for a pen pal in England to exchange ideas and routines.

My address is: Heideloom 13, 8200 Bruges, Belgium.

Sys Johan
Belgium

TAPES: HOW TO GET A RUN FOR YOUR MONEY

WE still receive a lot of complaints from people who haven't been able to load some commercial software, so here we'll run through some things to try (in addition to March's Hints and Tips article by Martin Phillips). Most of the tips have come from Micrograf, and their experience of problems.

First, let's look at the cassette tape itself. Often, the program is recorded on both sides of the tape with slightly different parameters, so if one side won't load, try the other. Listen to the tape playing to check it has been recorded.

Sometimes, new tapes can be a little tight at first. This can cause a fluctuation in the loading speed, giving error messages on loading. To overcome this, run the tape through your recorder on fast-forward and then fast-rewind. This should loosen the tape and prevent sticking.

A game may consist of more than one program loaded consecutively. If your tape recorder does not have an auto-stop facility, ensure you stop the recorder after each

program has loaded, otherwise the tape may run beyond the start of the next program and the computer will not pick it up.

Now on to the cassette recorder. Some of these are more compatible with a particular computer than others. If they don't match, error messages can occur on loading (refer to the *User Guide* for these). Under such circumstances, volume and tone control settings are likely to be more critical and both should be adjusted. Normally, ideal conditions will occur with the volume high and the tone at one of either extremes, but it may take some time to obtain the desired result.

One other point to consider is that the type of connector used can affect compatibility. If you have the option of using DIN or jack socket connections you may find one type more suitable than the other (see February Hints & Tips).

Many people forget to clean the cassette recorder heads regularly and this too can prevent loading. Refer to your cassette

recorder manual and use a proprietary cleaner to prevent this.

Finally, the BBC machine itself. Don't pull the cassette lead in and out with a jerk, or while the micro is on. In the first case you will strain the socket's links to the main board, and the second can damage chips because of static.

Always check before you buy whether a game will run on your machine. Is it model A, model B, 0.1 or 1.0 series operating system? If upgraded from model A to model B, has the 6845 chip been fitted? This controls 'hardware scrolling' on games like *Rocket Raid* and *Defender* (see Ken Worrall's article, page 36). Certain ROMs or hardware additions will also affect some software (see other letters in this issue).

If everything here fails, try other commercial programs, and consider getting your micro checked out. If you return the tape, there should be no problem getting an exchange or your money back from reputable stores and manufacturers.

PLANE SAILING

ALL PROGRAMS AVAILABLE FOR THE ELECTRON



Airline Hijacks, strikes, crashes and spiralling fuel costs must all be overcome if you are to turn your £3 million to £30 million in the time allowed, but your financial wizardry will enable you to take over British Airways, or will it?

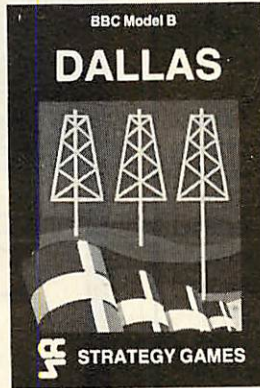

Dallas Can you amass enough petro dollars to take over the Ewing empire. Cut throat business and an eye for the main chance may get you there but you'll need nerves of steel to overcome the oil king of Dallas.



Corn Cropper Limited cash and droughts are two of the problems facing the farmer. Planting, fertilizing and harvesting must all be done economically if you are to reap the rewards offered in Corn Cropper. You choose the methods that will bring you success.



BUSINESS STRATEGY GAMES — £6.95

Selected titles available from Greens, Boots, Rumbelows and all good computer shops or Cases Computer Simulations Ltd., 14 Langton Way, London SE3 7TL.

Increase your fire power!

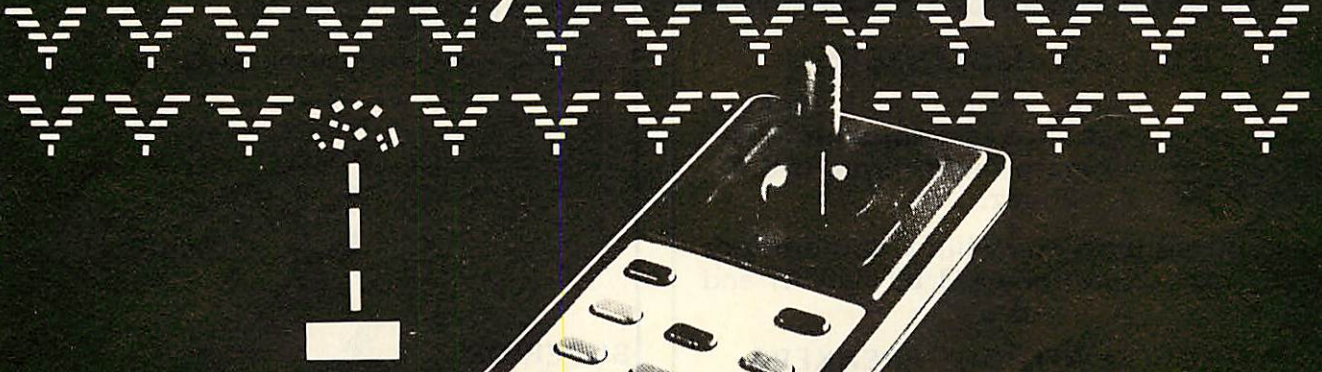

More than just a joystick.

A superb joystick and a keypad for the price of either. Plus the software to integrate it into the computer's systems.

- ★ 12 Months Guarantee.
- ★ 7 day Money back Guarantee (on Hardware)

DELTA DRIVER on cassette or disc: Two programs on each cassette or disc. One diverts machine code programs from the keyboard to the joystick or keypad, with adjustable sensitivity on the joystick and will run on any O.S. The second program (needs O.S. 1.0 or later and an adaptor box) duplicates any keyboard keys on the keypads, in the operating system, so that it can become a numeric keypad or will take on the function keys.

DELTA 14b HANDSET £12.95 DELTA 14 b/I ADAPTOR BOX £13.95
DELTA DRIVER CASSETTE £5.95 or DISC £8.95 Prices include VAT and P & P.

Voltmace Ltd

PARK DRIVE, BALDOCK, HERTS. SG7 6EZ.
 Tel: (0462) 894410

Callers welcome at the factory — Monday to Friday



Complete control at your fingertips.

- Nylon encased — Steel shafted joysticks with ball and socket joint
- Fast spring return to centre
- Graphite wiper linear potentiometers

One handset will work on it's own in the A/D port as a joystick and two fire buttons. Joystick is immediately compatible with ACORNSOFT and similar software.

The adaptor box joins together the analogue and the user ports to use the full keypad giving a total of 24 user definable keys. The adaptor box can also be used as a splitter for the A/d port to take two items at the same time, e.g. joystick and lightpen.

Voltmace delta 14b

DIAL SOFTWARE

Presents:

EDUCATIONAL GAMES FOR THE BBC MICRO

Adventure Quiz	---	Base 10	£4.95
32K	---	Bertie Bear	£4.95
Bells	---	Curve Stitch Planner	£4.95
Childs Play Pack	---	File Handler	£6.50
Fantasy Adventure	---	Cesil	£4.95
Finance Pack	---	Four-in-a-Row	£4.95
Get the Message	---	Golforama	£4.95
Maths Pack	---	Numberhang	£4.95
Odds-On Monarchs	---	Odds-On Writers	£4.95
Odds-On Musicians	---	Odds-On Countries	£4.95
Odds-On Britain	---	Odds-On Inventors	£4.95
Plotter	---	Word Processor	£6.50
Tripote	---	Wordsquare	£4.95
Unimo	---	Science Pack	£4.95
BBC Kaleidoscope	---	BBC Octuplet	£9.50
French Vocabulary	---		£9.50

Add £1.50 for programs on Disc & 50p p & p.

These can be obtained from:

DIALSOFT,

72 Downend Road, Downend, Bristol BS16 5UE

or send an SAE to obtain our latest Brochure. You can also enter our Free Monthly Competition with a prize of £50 of our software. All you have to do is select the four best selling programs of the month.

An independant review of our software has been carried out by "The Format 40/80 Club (BBC Disc User Group) 5 March Street, Bristol BS1 4AA in their Xmas Edition. "The programs represent extremely good value for money"

Write to Peter Hughes at the above address to obtain details of his club and Monthly Magazine on disc, and this independent review of our software.

THE BBC MICRO SOUND SYSTEM MICROVOC

As supplied to Schools & Colleges

SYSTEM INCLUDES:

Speakers, Volume control, jack sockets and all connections (assembled) plus Buzzgo to eliminate the infernal B.B.C. buzz.

Easily fitted with no drilling, soldering or cabinet modifications £23.00 inc VAT and p & p

MICROVOC WITHOUT SPEAKERS £15 inclusive

Now in stock—The Synth. This program allows the mixing and saving of all four channels, including Channel O for cymbals and drums. Complex melodies can now be entered in minutes by even a complete novice.

MICROVOC IS IDEAL FOR SPEECH SYNTHESIS OR COMPUTER PRODUCED MUSIC

MICRO-ADVENT

Ashlyn House, 113 Writtle Road, Chelmsford, Essex.
Tel: 0245 59708

VICTOR MORRIS Glasgow

Authorised

acorn  dealer

**B.B.C. B & acorn
electron**

Disk Drives, Printers, Joysticks,
Acornsoft, Data Recorders, Monitors,
Adds ons by Pace, Torch etc.

spectrum Group Dealer

Access, Visa, Amex, Diners

340 Argyle Street

Between Central Station and Anderston Bus Station

Glasgow G2

Tel: 041-221 8958

A QUALITY LIGHT PEN

SUPERIOR PERFORMANCE

- ★ Absolutely insensitive to ambient lighting.
- ★ Responds to different colours and screen intensities without any adjustment of TV or monitor.
- ★ Red LED readout showing that data is available.

- ★ Switch for program control (allows pen to approach the screen without erroneous data capture)

★ All features are program accessible.

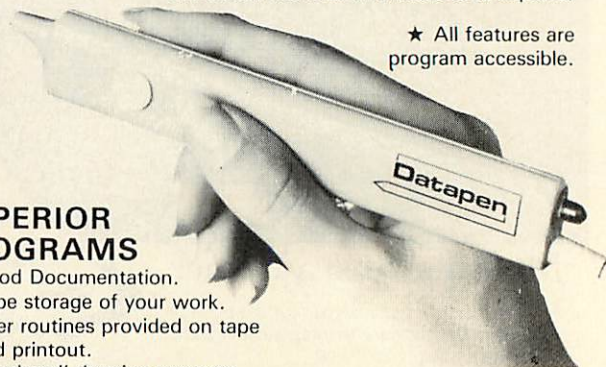

SUPERIOR PROGRAMS

- ★ Good Documentation.
- ★ Tape storage of your work.
- ★ User routines provided on tape and printout.
- ★ 'Freehand' drawing program.
- ★ 'Library menu' drawing program (define your own library of shapes).
- ★ Example programs illustrating uses of the pen and its features.

£25

inclusive of P&P.

Please state Dragon, BBC or Vic20 when ordering. send cheque or P.O. to: Dept AU1 Datapen Microtechnology Ltd, Kingsclere Road, Overton, Hants.

Please enclose SAE if requesting technical literature.

We welcome enquiries from dealers willing to demonstrate our product

Datapen Microtechnology Limited

VT100 Intelligent Workstation

Plug the 'Emuterm' ROM into a BBC Microcomputer (Model B) to give the benefits of both a personal computer and a DEC VT100 terminal.

- ★ line speeds to 9600 baud, 3 or 5 wire operation
- ★ almost all VT100 features supported including VT52 mode
- ★ switch between terminal mode and native microcomputer by simple command
- ★ fitted in a few minutes by following the simple instructions
- ★ optional intelligent file transfer mode
- ★ optional numeric keypad (automatically used if fitted)

VT100 Emuterm £35 inc p&p and VAT

Other terminal emulators (inc Newbury 7000 and 8000 series) and communication software available. Please send sae for details.



All orders and enquiries to:

**Applied Real Time Systems Ltd.,
Dept AU, PO Box 32, Sunderland, SR2 7SN.**

DEC, VT100 and VT52 are registered trademarks of Digital Equipment Corp., Maynard.

Electron Printer Interface

AT LAST ... a complete parallel (Centronics) printer interface for the Acorn Electron with software built in.

★ FX Calls ★

VDU 1, VDU 2, VDU 3 and control characters provide full printer control as on the BBC micro computer.

The interface also provides an 8 bit parallel I/O port, in addition to the printer port giving a total of 16 I/O lines and 4 control lines for user port applications, supplied with full instructions at **£25**.

- ★ Interface grey cable open ended (for different types of printers) **£7**.
- ★ Interface/Centronics connector **£11**.
All Prices include p&p
- ★ BBC paged ROM **EXTERNAL/internal EXPANDABLE** system.

Details on request.

MICRO-Z LTD.

**P.O. Box 83, Exeter, Devon EX4 7AF.
S.A.E. for full details**

**Authorised Dealer & Service Centre
IN**

MID-SUSSEX



BBC
MICRO COMPUTER



- **HARDWARE**
*BBC B's & wide range of Monitors,
Printers, Disc Drives*
- **SERVICING/UPGRADING**
On site Engineering
- **SOFTWARE** *Variety of Educational/
Games/Business Packages*
- **COURSES** *Beginners
& upwards on BBC
Micro from £15.00.
Day/Evening.
Children/Adults*

PHONE
BURGESS HILL
(04446)

45636

Visit our New Computer Store



michael
Business Systems Ltd

195 LONDON ROAD BURGESS HILL SUSSEX

CROYDON COMPUTER CENTRE

OFFICIAL ACORN SERVICE CENTRE

29 Brigstock Road, Thornton Heath, Surrey.



01-689 1280



MODEL A	£299.00
MODEL B	£399.00
ACORN ELECTRON	£199.00

+ Full range of spares always in stock.



TORCH Z80 DISK PACK	£830.00
------------------------	---------

Includes £1,000 free software.

MICROVITEK COLOUR MONITOR	£244.00
ZENITH 12" GREEN OR AMBER	£99.00
CUMANA SLIMLINE DRIVES from	£216.00
EPSON RX80	£333.00
JUKI DAISYWHEEL	£458.85

Full range of books, software, paper and spares for every popular micro and printer. Our four years in the micro business and investment in trained engineers and test equipment is your guarantee of peace of mind.

EXPORT ENQUIRIES WELCOME
Happy customers in twelve countries

ALL PRICES
INCLUDE VAT

01-689 1280

FOR SPARES AND REPAIRS



TIPSTER

This is a suite of programs designed to let your BBC Model B help you to predict the results of National Hunt and flat races.

There are programs to enable race results to be stored on disk; to specify details of a forthcoming race and to find and display records that match your requirements.

The package comes complete with a 5¼" disk containing over 1000 records relating to 5 trainers in the (1982/83) National Hunt season. A full documentation pack is also included.

Send now requesting further information or place an order specifying 40 or 80 track disks

Price £20 (including post/packing).
Despatch by return of post. Money back guarantee and if not satisfied return within 30 days for a full refund.

DP Computer Services, PO Box 57,
Gloucester.
Phone Gloucester (0452) 418922.

SUPER SOUND

- Make full use of the potential sound capabilities of your BBC Micro.
- Add a high quality, full range, external loudspeaker and volume control.
- Give more sound power and realism to your games, music and speech synthesis.
- No soldering required, easily fitted.

Kit includes:

Free standing loudspeaker, volume control, jack plug and socket, circuit board connectors. All pre-wired and ready to fit. Full instructions.

Only **£16.50** Inclusive

Mail order only. Send cheque/P.O. to

CAPITAL CITY ELECTRIC
Dept A, 124 Arthur Rd,
London SW19 8AA

diamondsoft
A better way of computing

SUPPLIED ON CASSETTE
RUNS ON DISC OR TAPE

HOME ACCOUNTS BBC 32K £13.95 (INC)

Complete home finance system packed with sensible facilities to help you maintain up to date records of your BANK, CREDIT CARD, LOAN and SAVINGS ACCOUNTS. Keep track of CHEQUES, RECEIPTS, AUTOMATIC BANKERS ORDERS, BILLS WAITING PAYMENT and much more.

An essential asset for home or club.

BUSINESS ACCOUNTS BBC 32K £17.95 (INC)

Easy to use with small businesses in mind. Facilities include – PURCHASES, SALES, CASH, LEDGER and DAY BOOK LISTINGS, VAT ANALYSIS, CONTROL TOTALS and BANK RECONCILIATION. A simple but effective aid to efficiency.

FLEXIFILE BBC 32K £13.95 (INC)

A powerful, general purpose, file handling system. Quickly create, maintain, sort, select, save and print your own data. Develop complex systems with ease. Invaluable for Home, Club, Schools or Business Records. Offers the use of advanced software techniques to beginner and expert alike.

Cheques or P.O. to Diamondsoft Ltd., FREEPOST,
Cheadle Hulme, Cheshire, SK8 5YB. Tel: 061-485 8705

JUST RELEASED

Counter Attack

as demonstrated at the BBC Micro User Show, December 1983.

A game of strategy incorporating unique rotational movement. Simple in concept, stimulating in practice. A game to be equally enjoyed by infants and serious game players alike. Many similar games already exist, however, this game differs from the norm in one distinct area — rotational movement. Includes customisation routine that allows you to tailor the game to your own requirements.

£6.50 for the 32k BBC/Electron

DODGY DEALER

"You'll be hard pressed to find a better business game for the BBC Micro than this grand effort." (TV Choice, Nov. 1983.) "Best of the lot is a new one called Dodgy Dealer; a cracking Christmas present for the bored business exec." (Office of the Future — Nov/Dec 1983.)



now available from selected branches of
W. H. Smiths and Lightning

A captivating game emulating the real business world. As boss of a small manufacturing company, you are required to make executive decisions to enable your company to survive and even prosper in the face of strong competition. The game is dynamic; the more your skills improve, the greater the competition becomes.

£6.50 for the BBC B 1.2 o/s

One of the biggest attributes that a computer has is the capability to sort vast amounts of information. But have you ever wondered how a computer carries out the sorting process?

SORT ANIMATOR

is the first in the Computer Tutorial series by OIC, explaining visually and in detail how a selected variety of sorts work. Also includes routines that can be used in your own programs.

£6.50 for the 32k BBC

All products supplied on cassette and can be easily downloaded onto disc.

All prices include VAT and P&P.

Latest reviews of both Dodgy Dealer and Sort Animator can be found on page 600121463 of the Micronet 800 database.

Products available from your local dealer or by mail order direct from OIC at our FREEPOST address.

Barclaycard telephone orders welcome (0344) 773229. Ask your local dealer for a demo of our products and details of our cream label products or alternatively write to OIC direct at:

OIC Ltd., Dept. OPD/AU3, FREEPOST, Camberley, Surrey GU15 4BR

Dealers/distributors
contact Richard Edwards on (0344) 773229

Programmers/games designers . . .

send your programs/ideas to us for free evaluation, or send for details of our product development pack. Generous royalties paid on all ideas/games published.

A WORD PROCESSOR FOR YOUR BBC MICRO FOR £4.95.

PUTTING YOUR BBC MICRO TO WORK

□ Chris Callender £4.95.

Yes, it's true. A complete word processor program is just one of 15 major programs in this new, 120-page book. You can keep your accounts in order with the HOME ACCOUNTS program, organise your life with planner and keep your numbers under control with TELEPHONE DIRECTORY. You can even gain experience with spreadsheet calculations with SPREADCALC.



THE BBC MICRO COMPENDIUM

□ Jeremy Ruston £14.95.

More than 500 pages in this massive work, the most important ever published for serious BBC Micro programmers. Major topics covered include: assembly language programming; floating point algorithms; recursive programming; increasing the vertical screen resolution to 512 with software; and an intelligent disassembler. From the author of THE BBC MICRO REVEALED.



36 CHALLENGING

GAMES FOR THE BBC MICRO

□ Tim D Rogers and Chris Callender £5.95

From graphic adventure programs, to fast-moving arcade action, this 270-page book gives you a whole library of software-standard games. The book comes complete with detailed program notes, and screen printouts. Games include 3D INVADERS, RAT ATTACK, DOWNHILL SKIING and SHARK.



LET YOUR BBC MICRO TEACH YOU TO PROGRAM

□ Tim Hartnell £6.45

This book, by best-selling author Tim Hartnell, is the ideal companion for you if the BBC Micro is your first computer. It takes you, step by simple step, through programming in BBC BASIC, with a number of worthwhile programs (including a complete REVERSI/OTHELLO game, and another to play CHECKERS). Computer and Video games said: "... takes you further into the cloudy areas of the BBC Microcomputer than anything else I've yet seen..."



CREATING ADVENTURE PROGRAMS ON YOUR COMPUTER

□ Andrew Nelson £4.95

A major work (complete with three complete ADVENTURE programs) to show you how to devise, program and solve Adventures on your BBC Micro.

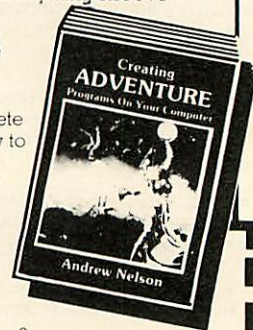

Interface Publications, Dept. AU,
9-11 Kensington High Street,
London W8 5NP.

Please send me the books indicated. I enclose £.....

Name:

Address:

INTERFACE PUBLICATIONS

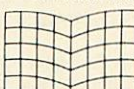

All Interface books are available from computer and book stores, including W H Smiths, Menzies, and Dixons. Trade supplied by: The Computer Bookshop, 30 Lincoln Road, Olton, Birmingham B27 6PA (021 707 7544, telex 334361).

BBC B with Acorn DFS plus new Teac 100k slimline disc drive, joysticks, and masses of software, £525. Tandy CGP115 colour graphics printer with BBC cable, £120. Tel: 06633 3907.

ACORN Atom 12k + 12k floating point ROM, PSU and leads plus Chess and Adventure, £60 ono. Tel: Rainham 56058 (Essex).

WANTED: Atomcalc ROM and manual. Tel: 0203-416653.

GAMES for sale/swap. Many Acornsoft including Missile Base, Super Invaders, Starship Command. Also Q*Bert, Hunchback, Zalaga, Frogger, Danger UXB, Colossal Adventure, Pengo, Bumblebee, Painter, etc. Rod. Tel: 0273 565282 after 6pm.

OVER 100 software titles to swap including Zarm, Cylon Attack, Chuckie Egg, Firehawks, Hunchback, Zalaga, 737, 3D Bomb-Alley, Dogfight, Music Processor, for any really good new software. Most programs on disc, too. Tom. Tel: 0524 68100 4-9pm.

WANTED for Atom: BBC Basic board, four-way ROM board (or circuit). Beresford. Tel: Albrighton 090722-2850 evenings.

BBC desktop console for sale, £20. Tel: Soton (0703) 32729.

BBC model B, OS 1.2, Basic II, leads, etc. Fitted with Wordwise ROM. Condition as new, together with many games and utilities, £400. Willing to deliver around Maidstone area. Tel: West Mall -ing (0732) 848436 after 6pm.

MICROVITEC 14in 'Cub' colour monitor, RGB input, only a few months old, still under guarantee, immaculate condition, including all leads. Need TV so only £200. Tel: 021-351 1730.

SPECTRUM games for sale: Zzoom, Jetmen, Hunchy, Orbiter, Manic-Miner, Kong, Valhalla, Football Manager, etc. 20 in all, £2.50 each. C. Heyman. Tel: Fontwell Magna 811828 or write to Clayesmore, Iwerne Minster, Dorset.

SHARP PC1251 pocket computer with printer and cassette recorder. Unused Dec 83, cost £180, sell for £100 ono. V. Bryant. Tel: Wrington 862451 (Avon).

BBC software half-price. All originals: Killer Gorilla, Moonraider, Timetrek, Atom Smasher, Birds of Prey, Bunfun, Supergold, 3D Bomb-Alley, Bug Blaster, Starship Command, Snapper, Rocket Raid (Space Hi-Way on disc). Tel: Bourne End 23544.

LISP Acornsoft cassette plus glossary for sale, £10. Tel: 0707-53433 after 6pm.

WANTED: View or Wordwise, RH Electronics colour light pen, and Cumana, Amcom or Pace single disc drive. Simon Ward. Tel: 01-398 2523 evenings.

SEIKOSHA GP100A printer for sale. Takes standard 9in paper. As new (still boxed). BBC screen dump software. Bargain at £140. Pete Philips. Tel: 0734 78658.

WANTED! Atom software, particularly Bug-Byte. Anything considered. Write with details and price to Philip Arkley, 384 Whalley Road, Clayton-le-Moors, Accrington, Lancashire BB5 5XQ.

VIDEO Genie, expansion interface, green screen monitor, tons of software, £390. Pascal compiler V5.3, £55. Texas TMS2564 8k EPROMS, £4. Write for details: Mike Tubby, PO Box 119, Leicester LE2 7EP.

WANTED. Atom software, especially Acornsoft's Synthesiser, Games Packs 1, 5, 8, 9, 11 and Program Power's Chess, Cowboy Shootout and Invaders. Tel: 061-439 3193 after 5pm weekdays and weekends.

BBC model B OS 1.2 with audio output for external amplifier, manual, welcome tape, etc. £325. Tel: 0727 74168 evenings.

ELECTRON, less than one month old. Still under guarantee. Must sell to purchase BBC micro. £200 including free Meteors, Moonraider and Killer Gorilla programs. Christopher. Tel: Leics (0535) 392860.

COLOUR Atom 12k RAM, 12k ROM incl FPoint, VIA, printer interface to Centronics 150CPS dot matrix printer. Top quality. Single, double width print. Full service manual. £120 each ono. Tel: 01-778 1944.

SPACE Pirates, Alien Dropout, Attack on Alpha Centauri, Galactic Commander, Galactic Firebirds, Laser Command, Heist, Space Fighter. All originals. Any offers or exchanges. Clarke. Tel: Norwich (0603) 57325 after 6pm.

SWAP your BBC software with me. Lots of titles including Snooker, Zalaga, Flight 737, Vortex, Hobbit and many others. Tel: 01-921 8627 day, 01-445 8793 evenings.

BBC B with disc interface and 13 ROM board, £375. Beebmon ROM, £17. Exmon ROM, £12. View ROM, £45. 1200/75 modem with disc software, £40. EPROM programmer, £25. Tel: 01-958 6228 (Edgware, Middx).

AN unwanted Wordwise with manual, £25. Plus BBC software cassettes: Chess, Snooker, Wall, £5 each. Tim. Tel: 01-727 2126.

ACORN USER magazines. Feb '83 and Apr '83 - mint condition. Will exchange both for issue No 1 (July '82) in good condition. Dawson. Tel: 0274-671619 (Bradford).

BBC hardware Micro Man light pen, £15. Spectravision Quickshot user port joystick, £10. Big Ears speech recognition system, £35. All with software on tape. £55 the lot. Tel: 0698 791940.

BBC model B OS1.2; Wordwise, Beebcalc chips; manuals; tapes including Music Processor, Microtax; all Acorn User, Beebug magazines; CCR800 tape recorder; £350. Tel: Orpington 25052.

BBC B 1.2OS, disc interface, 400k disc drive (uncased), leads, etc. Over £100 of software: Acornsoft, Program Power, etc. Manuals, books and magazines. Worth £900, sell for £650. Tel: Poole (0202) 675550 after 6pm.

ORIGINAL Planetoid and Snapper for sale. Hardly used because of upgrade to disc. £5 each. G. H. Loh, Holbein House, 61-63 Evelyn Gardens, London SW7.

BBC - games and other programs to swap (very large range). Also excellent

chemistry program to sell, £4. Sean. Tel: Welwyn 4053 (weekends or after 5.15) for details.

ATOM Games Pack 4 and Program Power Adventure wanted. Tel: 0942 53537 (Wigan).

DISC drive: Microware slimline double sided 200k. All leads. One month old. Still 11-month guarantee. I am upgrading to two drives. New £230; from me £175. Michael. Tel: 01-670 2745 evenings.

BBC model B 1.2OS, with joysticks. Hardly used, £350 ono. Tel: Oxford 56519 weekends.

BASIC programmers utility. Provides nine utilities via function keys including formatted listing, bad program fix, verify file, compress Basic, single key entry, etc. 1.2OS required, £3. Cassette system only. Tel: Cardiff 0222 691864.

ACORNSOFT cassettes. Defender and Snapper (early versions), £5 each. The Dating Game (two cassettes), £6. All original copies in original packages. Tel: 040 24 51423 (Hornchurch, Essex).

SOFTWARE for sale. Romik's Alien Break/In, £3, Transistors Revenge, Heist, Croaker, Cybertron Mission, £3.50 each. Graphics ROM, £15, Spy, £12, Beebcalc, £15, Wordwise, £15 or all for £50. Tel: Harpenden 69152.

QUICKSHOT joystick with joystick driver program. Connects to the BBC user port. Would cost you £20, sell for £15 (one month old). Tel: 041-946 9110 any time after 6pm.

WANTED. BBC micro DFS. Must be Acorn release 0.90. Will accept DFS chip or entire interface. Will pay well. Mark Leslie. Tel: Welwyn Garden City 35949 after 4pm.

SWAP BBC software with me. Over 300 programs on disc including the very latest. Best makes: Acornsoft, Superior, Program Power, IJK, etc. Jamie. Tel: 0438 723488 after 6pm.

WORDWISE/typing tutor. Complete and in excellent condition, hardly used, as unsuitable for user's needs. £30. Raymond. Tel: 0482 497867 before 5pm.

WANTED. Acornsoft Graphs and Charts, Algebraic Manipulation, Database. Will consider sale or swap for numerous games. Robert. Tel: Gravesend (0474) 22393.

ELECTRONIC building kit. Learn electronics easily. 150 different circuits to build. 8-13 age group. As new, £15. Tel: Theydon Bois 3274 (Essex).

BRAND new! RH colour lightpen, one month old, never used - unwanted gift. Includes software, £39 ono. Adrian. Tel: Bournemouth 291285 after 6pm.

BUSINESS program for sale. The Gemini Cashbook Accounting program, includes VAT, information, receipts and payments analysed, etc. Complete with full documentation. Cost £95, will accept £35. Tel: Tamworth (0827) 893886 (Staffs) evenings.

ORIGINAL BBC and Electron software for sale or swaps urgently wanted. BBC Acorn disc interface for cash and/or software. Also wanted S/D twin 40 track disc drive. Tel: 051-420 3462.

MICRONET: Prism Acoustic Modem for model B, still in original packing with all relevant software, £50 ono. K. M. Earl, 28 Wellington Crescent, Shipley, West Yorkshire. Tel: 0274-587240.

SOFTWARE originals for swap or sale! The very latest. Over 300. 80 column printer wanted. Greg King. Tel: 041-639 7850. Or write: 15 Falkland Avenue, Newton Mearns, Glasgow G77.

MODEL B with DFS. C/w books, magazines and both games and serious tape programs, £250. Tel: 01-670 0592 after 6pm.

P8000 EPROM programmer up to 8x27128, RS232C interface, handles all EPROMs including EEPROM. Verify, blank check, checksum, self test, misplaced and faulty device check, £450 ono. Adrian Loening. Tel: 0203 21633.

BBC software, all original, boxed. Acornsoft: Snapper, Creative Graphics, Castle of Riddles, Rocket Raid, Arcadians, Starship Command. Beebug: Astro-Tracker, The Valley. All £5. Acorn DFS plus manual, £20. Tel: Basingstoke 22863.

MICROSTYLE Quickshot joystick with £100 BBC software (disc), £20. Clares Replica, £8; Key, £8; Hunchback disc, £7, Snapper disc, £7. Fun games: Starship Command (tapes), £5 each. Tel: Harpenden 69152 for details.

BBC software to swap or sell. I have a large collection. Why not give me a ring. Also swap Pace DFS ROM, new, for ROM board. Martin. Tel: Grimsby 74584.

BBC B, £350. Compatible CP80 printer, £250. Teletype, £25. Desk, £50. Games, £5 each. Lots of books, magazines and blank tapes. Offers. For these amazing offers tel: St Helens (0744) 812608 after 7pm weekdays, all day weekend.

BBC disc upgrade kit by Kenda Professional. It also has double density. Easy to fit. Cost £138, bargain at £78, unused, complete with manual. Over 100 new games to swap. Tel: 01-243 0820.

ATOM 12 x 12, FP ROM, BBC Basic board, Ross ROM, printer VIA, ROM selector board, Atomcalc, teletype printer and TTY interface, separate regulated power unit, manuals and software, etc. £150 collect. Tel: 0843 582719.

BBC originals for sale: Vortex, Space Adventure, Killer Gorilla, Nemesis, Lunar Rescue. £4 each (excellent condition). Tel: Guildford 893275 after 5pm. Or Mailbox 483893275.

BBC micro software by Acornsoft, Program Power, Bug-Byte, Kansas, Gemini, BBCsoft, DACC, IJK, Beebugsoft, Pro, Database software, Salamander. Including Rocket Raid and 747. For more details tel: Bristol (0272) 561237.

MICROTAN 65 with Tanex Basic toolkit, Exbug(2), Tanbug, full size keyboard, key pad, Verocase. Offers around £190. Selling for financial reasons. Tel: 01-263 5481 after 6pm.

BBC games for sale. Planetoids, Snapper, Arcadians, Starship Command, Danger UXB, Meteors, Frogger, etc. £2 each. Write to Charles Heyman, Clayesmore, Iwerne Minster, nr Blandford, Dorset. Stop Press! Also Killer Gorilla, Rocket Raid, Monsters.

BASIC COMPILER

Turns your basic programs into really fast machine code. The compiler is very easy to use, and comes complete with full instructions.

For the BBC model B, or Model A with 32k.

Cassette	£14.95
Disk	£19.95
(40 TRACK)	

Cheque/P.O. or SAE for details to

ACK Data

21 Salcombe Drive, Redhill,
Nottingham, NG5 8JF
Tel. (0602) 262498 (outside office hours.)

The Data Store

6 CHATTERTON ROAD
BROMLEY
KENT

for the BBC MICRO

OFFICIAL ACORN DEALERS

WIDE SELECTION OF SOFTWARE
AND PERIPHERAL EQUIPMENT
INCLUDING

EPSON, NEC, SEIKOSHA
PRINTERS

ZENITH, CABEL
MONITORS

CUMANA
DISC-DRIVES

BOOKS AND CABLES AVAILABLE
plus our personal advice service

MACHINES DELIVERED & SET UP
IN YOUR HOME

PHONE 01 460 8991 (9.30 - 5.30)
ORPINGTON 26698 (Evenings)
(CLOSED WEDNESDAY)

ROM EXTENSION SOCKET

only ~
£19.99

Installed in
minutes • no
soldering • no
over-heating •
allows EPROMs
to be dropped
into socket and
removed when
required • easily
removed for any
later up-grades •
ZIF socket for easy
insertion included •

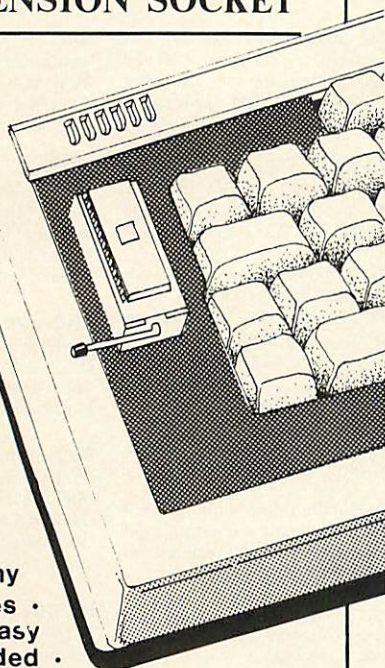

Toad Educational Computing; (AU),
8 Westbourne Grove, Sale, Ches.
M33 1RP. Tel.. 061.969.4740

Disc Drive Multiplexer

Enables the connection of 2, 3 or 4 BBC Computers to the same disc drives. This means that you can save on buying new disc drives for your second BBC.

The unit is completely automatic and there are no hardware modifications or software required. The unit is complete with its own power supply and 2 metres of cable for each computer.

Ideal for wordprocessing, schools, office, etc.

Prices: £ 75.00 + VAT for dual unit.
£135.00 + VAT for quad unit.

Industrial BBC Computer

BBC Computer mounted in industry standard 19" 3U racking case. This unit is complete with:- * 5" green screen VDU * Single or double 5¼" disc drives * Detachable keyboard * Integral 24 column printer * Space for 3 standard Eurocards * IEEE interface as optional extra * Rugged with only one power connector.

This unit is ideal for use as an industrial data logger or controller.

Prices: £1390 for unit with VDU, Printer, and one disc drive.

Contact: Benwick Electronics, 9 Doddington Road,
Benwick, Nr. March, Cambs. PE15 0UX.
Tel: Benwick (0354 77) 471

■ **Beeb-Planner** activity on node project planning program. Will analyse up to 100 activities. Model B only. Instructions and cassette, £35, cwo. Mrs E J Sheffield, 8 Langdon Close, Camberley, Surrey GU15 1AQ. Sae for details.

■ **Sale** of surplus development kit. Two Atoms, full store, Centronics, Econet, one with disc. Many 8k RAM Eurocards, Hundreds 2114s. Call or phone for details. N. Johnston, Stadia Systems, Unit 3B, 25 Gwydir Street, Cambridge. Tel: 0223 60750.

■ **AC** Linear Circuit Analysis program for BBC model B. Analyses circuits with up to 16 nodes and 60 components. Cassette, £35. Disc, £45. Tel: Number One Systems, St Ives (0480) 61778. Access welcome.

■ **Grangefont** (BBC and Epson FX80). Now you can design and download your own character sets on-screen. Very simple to use. Only £6.95. Sae for details. Grange Software, 88 Grange Road, Wigston, Leicester LE8 1JJ.

■ **Sharewise** for your investment portfolio valuations runs on BBC (B) with disc. Cost is £15 or send for details from Catalyste Software, 22 Tabley Close, Knutsford, Cheshire WA16 0NP.

■ **Expand** your Acorn speech unit's vocabulary with our plug-in cartridge. Just fits into keyboard socket. Special price £17.85. PROMIT, 456 Clayhall Avenue, Barkingside, Ilford, Essex IG5 0SH.

■ **Technical** holidays for teenagers. Summer holidays? Learn the basics of Computer Programming, Electronics, Radio Production, Photography or Go-Karting. Practical instruction from qualified staff, combined with the fun and games of a holiday under canvas. Write for details of this and other holidays for

■ **Tape** to disc problems? Send us your programs on cassette and we'll return them ready to be put on disc by typing "TAPE CHAIN". £1 per program. 234 Penns Lane, Sutton Coldfield B76 8LQ.

■ **Screen dump:** BBC model B to Epson FX80. Modes 0/1/2/3, print up to sixteen textures, approx. 9x7in within three minutes. Other modes smaller. Cassette £10. NewWave (Software), 123 Lyndale Avenue, Eastham, Wirral L62 8DQ.

■ **Preschool/Infant** educational software (BBC 32k). Two programs, teacher written to develop early number skills. Graded difficulty. Nursery rhyme themes. Delightful graphics and sound, £5.95 complete. M. Brand, 3 Grove Cottages, Swaffham Bulbeck, Cambridge CB5 0LZ.

■ **Quick-Shot** joystick BBC. Have your fire buttons firing independently of each other. For all those multi-key games, new improved control program supplied. Send joystick plus £3.75 to Ankersoft, 116 Weddington Road, Nuneaton CV10 7LJ.

■ **EPROMs.** New, immediate despatch. 2764 8k byte £6.50, 27128, 16k byte, £18. BBC Compatible. Prices all inclusive, write for quote on quantity. Uff, 1 & 2 The Corner, Horsey, Gt. Yarmouth, Norfolk NR29 4EH.

■ **Sideways** ROM module for BBC. Each plug-in module supports 4 switch selectable ROMs (may include 2x8k EPROMs, ie, 16k). Sae for details to SR Electronics, 9 Haddon Drive, Balderton, Newark, Notts.

A service for enterprising readers and small companies. For £10, you get up to 32 words, one insertion only. Appearance in a particular issue cannot be guaranteed. To advertise, simply complete the form below in capitals with one word per square. Remember your name and address or phone number! £10 is the standard fee up to 32 words (no more!).

■ **BBC 32k** Pools Prediction program. Probably the most sophisticated pools program available for the BBC. Complete with full documentation and up-to-date database. £7.50. E. Crosby, 10 Lodge Avenue, Urmston, Manchester M31 1LL.

■ **Teac** disc drives. 40 track, double sided. Only 40 left for clearance at £110 each plus VAT. Tel: Omega Systems, 0628 29929 (Stevan Lackovic) or 051 647 6448 (Ian Perrin).

■ **Manndisc** BBC educational (disc). "Tables Tester" complete testing routine. "Wordpower" vocabulary, recall, spelling, denotation. Automatic testing, timing, marking, promotion, recording. 4,000 dated records £10 each. 63 Lezayre Park, Ramsey, Isle of Man.

■ **Pattern** generator. Eight months in the making. An aesthetic experience in serial modes 0-1-2-7 for designers, teachers, students and the family. Cassette £5. J. Davis, 16 Mitton Gardens, Stourport on Severn DY13 9AB.

■ **BBC model B - Draw Poker.** Play against your computer in this classic gambling game of skill and bluff. Full colour, high resolution graphics, £5.95 tape or disc version (disc version supplied on tape). G. Carpenter, 164 Whytecliffe Road, Purley, Surrey CR2 2AS.

■ **DataCrunch**, suite of programs for Basic parametric, nonparametric and regression statistics. £12 each or £30 for three. Send sae for further details. OUS Software, Wayside House, Letchworth Lane, Letchworth, Herts. (BBC 32k).

■ **Keypad** for BBC. Add 25 keys for easy entry of numeric and mathematical data. Single key entry of normally shifted keys. Sae for details. Extron, 16 Priory Park, Bradford on Avon BA15 1QU.

■ **Have your own** Basic program in EPROM. <7.5k, £10. <15.5k, £24.00. Loads instantly. Send tape, specify title, "Call (10chrs), copyright info (15chrs). Complies fully with OS requirements. (Tape returned.) Details, Tel: 0203 310893.

boys and girls. Inter Schools Christian Fellowship, Stanford in the Vale Camp, c/o 26 Mays Road, Wokingham, Berkshire.

■ **Image** - ultimate BBC tape copier. Copies practically anything. Copes with locks, files, 300+1200 baud, any length etc. Can unlock and lock programs. 100% M/C. £3.80. P. Donn, 33 Little Gaynes Lane, Upminster, Essex RM14 2JR.

■ **Telist** Versatile program, stores names, addresses, telephone numbers on disc. Features Search (with wildcards), Edit, Private records etc. Supplied on cassette, £5.75. Model B OS 1.2. S. J. Crane, 1 Taurus Close, Steeple Claydon, Buckingham MK18 2NR.

■ **Colour TVs.** ideal for use with computer as well as second TV. Selected for high definition tube, fully refurbished and tested with BBC computer. £79 plus £8 p&p. Tel: 0249 814272 evenings.

■ **French** grammar/tenses - five programs covering some common difficulties which test and explain errors in context. Order series 2, tape £12.95, disc £15.50. Educa, 16 Naish Road, New Milton, Hants BH25 7PU.

■ **Deluxe** computer covers in beige for BBC or Electron, only £2.25 each +50p p&p. Specify type required. Money back if not satisfied. Dept AU1, Covers & Co, 54 Acolfold Road, Birmingham B20 1HG. Send sae for details of alternative colours/models available.

■ **Copying?** Mastercopy converts BBC into copying machine £3. Unlimited copies produced without reloading. Musical mastercopy plays music whilst copying: £3.50. Your choice. Same day despatch. Monkhouse, 33 Willowtree Avenue, Durham City DH1 1EA.

■ **BBC** primary, middle, remedial, secondary, software. 6 discs/cassettes available. Number; language; problems; design; games; shape. Average 20 programs on each. £10 + VAT. Documentation included. Details, Nova, 12 Borrow Road, Lowestoft, Suffolk.

■ **Supergolf**, Trafalgar and Bunfun are well established top quality games for BBC B and Electron. Available at the reduced price of £6 each direct from Squirrel Software, 4 Bindloss Avenue, Eccles, Manchester M30 0DU.

■ **Disc** drive for BBC. £95. Limited number of ex-equipment bare drives with warranty, formatter and two Fuji discs at £95 including VAT. Cable kit £17. Tel: Lynda, Aylesbury (0296) 630364, 631446, 631424.

■ **EPROM** your favourite programs. With just a *Command have your Basic, machine code program running. 7.5k £8, 15.5k £22. Send tape or sae for further details to Romsoft, 37 Powicke Drive, Bredbury Green, Romiley SK6 3EG.

■ **EPROMs** 2764/27128, programmed, copied, erased, BBC Basic + M/Code programs ROMmed. Also BBC/Atom program listing service. Sae for full details: M. Kemp, Unit 2, Nelson Trading Estate, Morden Road, Merton SW19 3BL. Tel: 0732 848436 evenings.

■ **'Superior-Mover'** moves automatically programs like Hunchback, Roadrunner, etc to disc. £5. Tape2tape+ tape2disc+ disc2tape+ disc2disc Nutcracker programs (will handle locked files), £5. Disc menu, £5. R-Soft, 22 Marriotts Close, Felmersham, Beds. Tel: 0234 781730.

■ **Joysticks** at a sensible price. Fully variable stick with zap button. Play games and fly your 747 with your discount price sticks. Just £12.95 for two. Peritron, 21 Woodhouse Road, London N12 9EN.

■ **BBC** single key entry. Optional use of 62 keywords in all 8 modes (OS 1.2), 100% M/C. Diagram provided. Cassette £7, disc £9.50, ROM £15.50. S&L Software, 24 Rosedale Gardens, Belton, Gt. Yarmouth, Norfolk.

■ **Timetabling** for schools. Friendly but sophisticated formatting and analysis for BBC disc - only £25. Details from Yorke House Software, 33 West Street, Oundle, Peterborough PE8 4EJ. Tel: 0832 72362.

■ **The** spelling checker for Wordwise/View. 6000 words. Expandable dictionary. Special file allowed. Unrecognised words corrected, ignored or added. Disc £20. Specify tracks, sides. 50 Guildford Park Avenue, Guildford, Surrey. George, 576754.

£10 SMALL AD SERVICE

Please include your cheque for £10 made payable to Addison-Wesley Publishers Ltd. This is the standard fee. Don't forget your name, address or phone number. Send cheque plus form to Acorn User Small Ads, 53 Bedford Square, London WC1B 3DZ.

THE MICRO PULSE 3 INCH 100K DISK DRIVE + MIRROR



- ✦ Assembled in Britain ✦ Robust metal case, BBC beige colour
 - ✦ Complete with BBC cable ✦ Fully compatible with Acorn /BBC DFS ✦ Can be linked in tandem with 5 1/4" disc drive for easy transfer of software ✦ Red/Green LED indicates which side of the disc is in use ✦ Includes 38 page disc operating system manual ✦ Includes 40/80 track formatter utility disc ✦ Uses standard Hitachi hard-cased 3" discs (automatic steel shutter protects exposed part of disc surface)
 - ✦ Additional double-sided 3" discs available ex-stock
- ✦ DUAL 3 INCH (2 x 100K) DISC DRIVE **£299.95 + VAT**
- ✦ MIRROR 3" CASSETTE-to-DISC utility program Discette
Up-loads approx 20 cassette-based programs ...
(10 on each side of the disc) ... **£9.00 + VAT**

Trade enquiries welcome
please contact: Gareth Littler
Mark Howard or
Judith Allen at
Micro Pulse
Division

northern computers
Churchfield Road,
FRODSHAM
Cheshire WA6 6RD
Tel: 0928 35110

NORTHERN COMPUTERS LTD

THE MICRO PULSE EXTERNAL ROM BOARDS

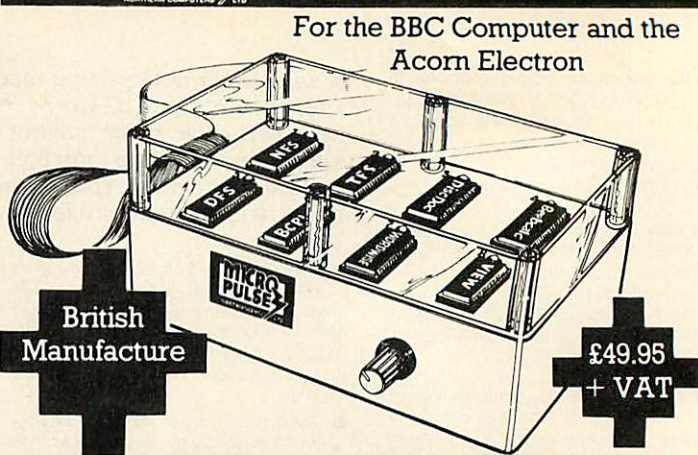

- ✦ BRITISH MANUFACTURE ✦ ALLOWS 8 ROMS ON LINE
- ✦ HARDWARE-BASED ROM SELECTION AVOIDS SOFTWARE INTERACTION BETWEEN UTILITY ROMS
- ✦ SWITCH TO REQUIRED ROM USING MANUAL SWITCH OUTSIDE THE UNIT
- ✦ RED LIGHTS INDICATE THE SELECTED ROM
- ✦ HIT "BREAK" TO ACCESS ROM, NO NEED TO USE SOFTWARE COMMAND
- ✦ INCLUDES ZIF SOCKET, FOR INSTANT CHANGING OF A SELECTED ROM
- ✦ INCLUDES BBC CABLE AND ROM SOCKET CONNECTOR
- ✦ INCLUDES SIMPLE FITTING INSTRUCTIONS, JUST PLUG IN AND GO!

please contact: Gareth Littler
Mark Howard or
Judith Allen at
Micro Pulse
Division

northern computers
Churchfield Road,
FRODSHAM
Cheshire WA6 6RD
Tel: 0928 35110

NORTHERN COMPUTERS LTD

INDEX TO ADVERTISERS

A B Designs	110	Datatap	112	Newark Video	172
Ack Data	182	Dataware	118	Newnes Technical Books	96
Acorn	84/85/158	3D Computers	109	Northern Computer	184
Advent	176	DDT	170		
A J Vision	168	Dial	176	Oakleaf	163
Akhter	56	Diamondsoft	178	OIC	180
Alligata Soft	30	Digital Peripherals	126	Opus	52/72
Ampalsoft	22	Disco-Tek	112		
AMS	155	DP Computer Services	178	PACE	150
Applied Real Time Systems	177			Printerland	59
		ECCE	170		
		Elbug	97	Red Shift	94
Baddleby Assoc.	110	Electronequip	120	Remedian Instruments	165
Beebug	124	Flightdeck	172	Robot	132
Benwick Electronics	182				
Bits & Bytes	138	GCC	114	Salamander	9
British Micro	142	Golden Challenge Software	173	Shard Software	45
		Golem	166	Shumwari	118
		Griffin	157	Silent Computers	152
		Guildford Computer Centre	152	Silverlind	138
Cambridge Computer Consultants	67			Simonsoft	167
Cambridge Computer Store	170	Harris McCutcheon	166	SIR	16
Cambridge Micro Centre	13	Simon Hessel	60	Softlife	118
Cambridge Processor Services	168	HMV	40	Software Invasion	14
Capital City	178			Superior Software	IBC
CCS	175	Interface	180	Superior Systems	132
Century Publishing	70	IPC	82	Synergy Software	126
Chase Data	51	Kosmos	129	System Software	129
Cheetah	42				
CJE	122	Level 9	88	Talbot Assoc.	64
Clares	98	Lincoln Micros	23	Technomatics	4/5/6
Computerama	24	LVL	IFC	Toad Educational Computing	182
Computer Concepts	27/48/135			Torch	20/21
Computer Plus	165	Mayfair Micros	165	Twillstar	1
Computer Room	167	Merlin	68		
Computer Town	148/149	Michaels Business Systems	177	UCC	76
Comtec	172	Micro-Aid	131		
Croydon Computer Centre	178	Micro-Fast	109	Victor Morris	176
Cumana	75/91	Micronet	100/101	Vida-Rebus	138
		Micropower	11/81/141/OBC	Viglen	46/136
		Micro-Vitec	147	Voltmace	175
		Microwave	54		
DACC	160	Micro-Writer	116/117/118	Watford Electronics	32/33/34/35/36/37
Database	78	Micro-Z	177	WCC	62
Datapen	176	Minor Miracles	59	William Broady	170
Datastore	182	Molimerx	106	Wordworth	160

SPECIAL OFFER!
Deduct £1 per
cassette or disc
when ordering
2 or more.

THE BEST BBC MICRO SOFTWARE PRODUCED BY AN INDEPENDENT SOFTWARE HOUSE ★ TOP QUALITY MACHINE-CODE PROGRAMS ★

BBC

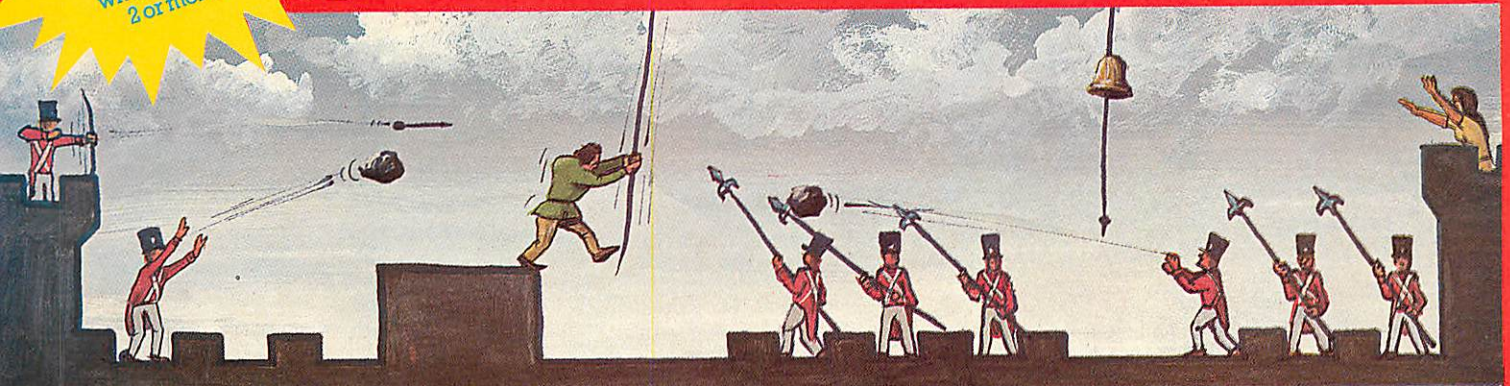

HUNCHBACK (32K) £7.95
Beautifully detailed animation (the best we've yet seen!) as Quasimodo leaps over the ramparts dodging rocks and arrows, swinging on ropes, and avoiding the guards' spears as he attempts to rescue Esmeralda. Twelve different screens of action! This program is sold under licence from Century Electronics Ltd; we have exclusive rights to its sale for use on the BBC micro.
(For use with **KEYBOARD** or **JOYSTICKS**).
"It is an extremely good version of the arcade game ... thoroughly recommended." ... **BEEBUG MAGAZINE**

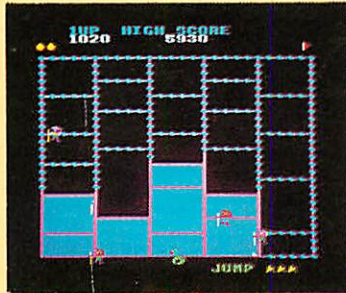

CRAZY PAINTER (32K) £7.95
The only full-feature version available for the BBC micro. On the first screen, you take the part of a monkey being chased by African tribesmen. If you manage to survive by painting-in all the squares, the bonus screen features the monkey trying to reach his bunch of bananas. After that, you take control of a paint-roller and each square painted-in adds to your score. But beware ... the teddy-bears are now in hot pursuit. Superb animation and sound-effects.
(For use with **KEYBOARD** or **JOYSTICKS**).
●●● **NEW RELEASE** ●●●

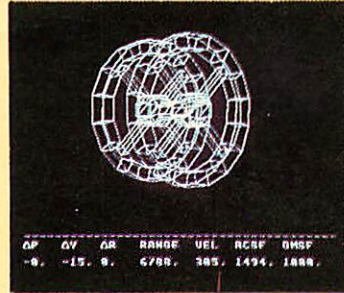

2002 (32K) £7.95
A space docking simulator using 3D graphics to model the motions and responses of the ORION 4 spacecraft. Your mission is to pilot the shuttle to a "soft dock" with the space station. **PITCH, YAW, ROLL, FORWARD, LATERAL** and **VERTICAL** engines are provided together with orbit manoeuvring booster engines. 6 skill levels provide for the completely inexperienced pilot as well as the fully-fledged commander.
●●● **NEW RELEASE** ●●●



ALIEN DROPOUT (32K) £7.95
A novel and unusual program. Arcade-action with this enthralling multi-stage shooting game. You have to shoot the aliens out of their "boxes" before the "boxes" fill up. Once full, the aliens fly down relentlessly, exploding as they hit the ground. Hi-score, rankings, and sound effects.
(For use with **KEYBOARD** or **JOYSTICKS**).
"... this game is as good as any on the market." ... **HOME COMPUTING WEEKLY**.



FAIRGROUND (32K) £7.95
An exciting target-shooting game! Bonuses are scored for spelling out the word **FAIRGROUND** by hitting the appropriate target letters, and for shooting all the targets. Extra bullets are obtained by shooting the numerical targets, but watch out for the "smileys" who are intent on stealing your bullets. Music, sound effects, hi-score, and rankings.
●●● **NEW RELEASE** ●●●



CENTIPEDE (32K) £7.95
Incredible arcade-style game featuring mushrooms, snails, flies, spiders, and the centipedes of course. Excellent graphics and sound. 6 skill levels, hi-score, rankings, bonuses, and increasing difficulty as the spiders become more lively and the number of mushrooms increases.
(For use with **KEYBOARD** or **JOYSTICKS**).
"Visually this game compares well with the arcade version, being colourful and clear."
... **YOUR COMPUTER**

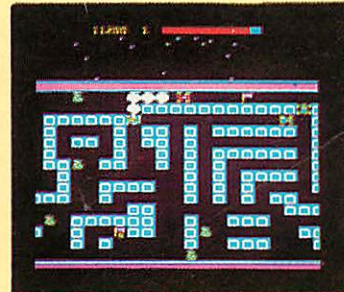

ROAD RUNNER (32K) £7.95
The only full feature machine-code version available for the BBC micro. Features include: scrolling screen, radar display, 3 pursuing cars, checkpoint flags, fuel gauge, smoke screens, 6 skill levels, rankings, increasing difficulty, and sound effects.
(For use with **KEYBOARD** or **JOYSTICKS**).
"I enjoyed the game very much ... the graphics are excellent ... movement is smooth and fast as only machine code can produce." ... **HOME COMPUTING WEEKLY**



FROGGER (32K) £7.95
Not just another version of Frogger ... this is the arcade-action version that you've been waiting to see. Graphically brilliant with gaping-mouthed crocodiles, diving turtles, flies, and frogs that flex their legs as they jump along. Increasing difficulty, and responsive controls.
(For use with **KEYBOARD** or **JOYSTICKS**).
"... very good indeed ... fast flicker-free graphics and a frog that really hops!" ... **BEEBUG MAGAZINE**

ALSO AVAILABLE

- SPACE FIGHTER (32K) £7.95
- GALAXIANS (32K) £7.95
- INVADERS (32K) £7.95
- FRUIT MACHINE (32K) £7.95
- CRIBBAGE (32K) £6.95
- PONTOON (32K) £6.95

DEALERS... DEALERS... DEALERS...

Our software is now available at all good dealers including:
W.H. SMITH - Selected branches.
JOHN MENZIES - Selected branches.
BOOTS - Selected branches.
ELTEC COMPUTERS, 29 Ivetgate, Bradford
MICRO MANAGEMENT, 32 Princes Street, Ipswich
WEST COAST PERSONAL COMPUTERS, 47 Kyle Street, Ayr.
MICROSTYLE, 29 Belvedere, Lansdown Road, Bath.
ELECTRONEQUIP, 36-38 West Street, Fareham, Hants.
3D COMPUTERS, 230 Tolworth Rise South, Tolworth, Surrey.
GTM COMPUTERS, 864 York Road, Leeds.
+ MORE THAN 300 OTHER DEALERS THROUGHOUT THE U.K. AND OVERSEAS.

ADVENTURE GAMES

- COLDITZ ADVENTURE (32K)**
..... £7.95
- STAR TREK ADVENTURE (32K)**
..... £7.95
- LOST CITY (32K)** £7.95
- GIDEON'S GAMBLE (32K)** . £7.95

WE PAY UP TO 20% ROYALTIES FOR HIGH QUALITY BBC MICRO, ELECTRON AND ORIC-1 PROGRAMS

SUPERIOR SOFTWARE LTD.

Dept. AU1,
69 Leeds Road, Bramhope, Leeds
Tel: 0532 842385

ALL OUR PRICES ARE INCLUSIVE OF V.A.T. AND P. & P.

DISC SOFTWARE AVAILABLE NOW

All our programs are ready for despatch on 5 1/4" discs at £11.95 each.

OUR GUARANTEE

- (1) All our software is available before we advertise.
- (2) All our software is despatched within 48 hours by first-class post.
- (3) In the unlikely event that any of our software fails to load, return your cassette or disc to us and we will immediately send a replacement.

PROGRAMPOWERMICROPOWER

KILLER GORILLA

A SUPERB
B.B.C. MICRO
AND ELECTRON
PROGRAM FROM
BRITAIN'S LEADING
SOFTWARE HOUSE!

Scale the ironwork tower to answer the maiden's cries for help. Race along girders, career along conveyors, climb ladders and jump onto moving elevators. Leap the barrels and fireballs or smash them with the hammer. A sensational machine code game for the BBC micro and the Electron

Only **£7.95** (inc.VAT)

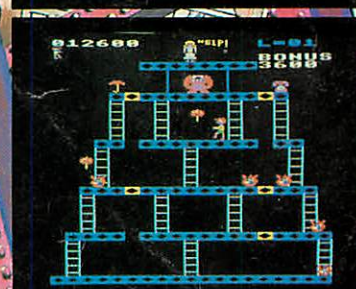
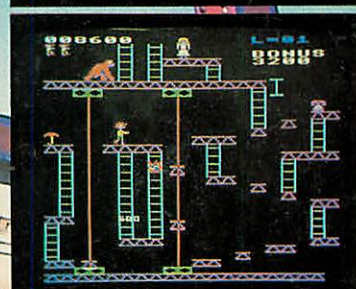

AVAILABLE FROM ALL GOOD RETAILERS INCLUDING SELECTED BRANCHES OF W. H. SMITH. [WRITTEN ANY PROGRAMS? JOHN MENZIES AND BOOTS. [WE PAY 20% ROYALTIES!]

The following top titles are available for both the BBC Micro and Electron:- Positron £6.95 / Bandits at 3 o'Clock £6.95 / Moonraider £7.95/Croaker £7.95/Felix in the Factory £7.95/ Felix and the Fruit Monsters £7.95/Chess £7.95/Draw £9.95/ Escape from Moonbase Alpha £7.95/Cybertron Mission £7.95/ Swoop £7.95/Intergalactic Trader £8.95/



SHOWROOM: NORTHWOOD HOUSE, NORTH STREET, LEEDS LS7 2AA Tel: (0532) 458800

MAIL ORDER: 8/8a REGENT STREET, LEEDS LS7 4PE, Tel: (0532) 683186/696343 P & P: 55p per order

SPECIAL OFFER: Deduct £1 per cassette when ordering two or more

PROGRAMPOWERMICROPOWER