

Y2K fix reviewed

The best-selling RISC OS magazine in the world

ACORN USER

Dial M for Mico



Plus

- New photodesk series
- Y2K compliance for your PC card
- Wakefield show news

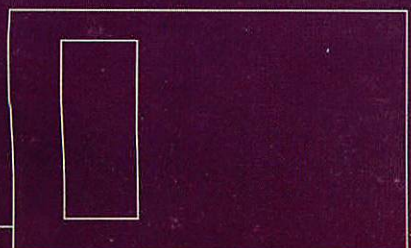

tau 07 >
 P R E S S 9 770263 745116
 ISSUE 209 JULY 1999 £4.20



CASTLE

Computers for Education
Business and Home

FOR ALL YOUR
ACORN
HARDWARE &
PERIPHERALS

INTERFACES

25% off when bought with drive or scanner etc

CT's Storm SCSI interface offers unbeatable performance. Using ISMB/S SCSI components and our ultra-reliable SCSI FS, Storm's a guaranteed winner.



	Ex VAT	Inc VAT
A30x0 IDE interface kit - 2.5" hard drive	£52	£61.10
A3020 fixing kit - 2.5" hard drive	£8	£9.40
A3/400 IDE interface for 2.5" & 3.5" h.d.	£60	£70.50
Storm8 SCSI2 interface - A30x0 A4000	£88	£103.40
Storm16 SCSI2 i/f - A300/A400 AS/7000	£96	£112.80
StormDMA32 SCSI2 i/f RPC	£128	£150.40
Storm16/10BaseT SCSI2 & Ethernet i/f	£148	£173.90
Storm16/Combo SCSI2 & Ethernet i/f	£196	£230.30

HARD DRIVES (BARE)

170MB A3000/A3010 interface included	£95	£111.63
170MB A3020 fitting kit included	£59	£69.33
170MB A300/A400 interface included	£100	£117.50
500MB A3000/A3010 interface included	£120	£141.00
500MB A3020 fitting kit included	£85	£99.88
500MB A300/A400 interface included	£134	£157.45
210MB 3.5" IDE for A4000 & A5000	£45	£52.88
500MB 3.5" IDE for A4000 & A5000	£59	£69.33
1.2GB 3.5" IDE for RiscPC & A7000/+	£69	£81.08
2GB 3.5" IDE for RiscPC & A7000/+	£80	£94.00
4GB 3.5" IDE for RiscPC & A7000/+	£90	£105.75
100MB 3.5" SCSI	£39	£45.83
500MB 3.5" SCSI	£60	£70.50
2GB 3.5" SCSI	£110	£129.25
4GB 3.5" SCSI	£140	£164.50
9GB 3.5" SCSI	£239	£280.83

EXTERNAL SCSI CASES

for hard drives CD drives & removable drives
FREE headphones and data cable worth over £20

The unique Combo Case - takes any two SCSI devices & gets rid of all those cables, mains leads etc. Accepts any 5.25 unit.



Acorn M E U 2x Cd + free 5.25" slot	£69	£81.08
Case for single SCSI device	£40	£47.00
Combo case for 2 SCSI devices	£60	£70.50

SCANNERS

inc FREE software worth £49

The new ultra-slim ScanExpress 36-bit colour scanner has a compact footprint, fast scanning speeds and quiet operation. Free ImageMaster software and TWAIN driver. Free PC interface/software kit (SCSI only). Optional transparency adaptor available.



ScanExpress 6000 parallel	£99	£116.33
ScanExpress 6000 SCSI	£119	£139.83
ScanExpress 12000 SCSI	£169	£198.58
Scanflat 1200 pro SCSI	£399	£468.83
ImageMaster & Twain	£49	£57.58
Scanflat transparency kit - slides etc	£49	£115.08
ScanExpress transparency kit-slides etc	£175	£88.13
CanoScan 2700F film scanner	£499	£586.33

FIXING KITS, CABLES etc

Podule case for A3000	£16	£18.80
Fixing kits for hard drives	£8	£9.40
A4 IDE hard drive fixing kit	£12	£14.10
A300 series backplane (4 way 4 layer)	£48	£56.40
A7000/+ 1 slot backplane (not with CD)	£34	£39.95
Risc PC 2 slot backplane	£30	£35.25
2nd slice for Risc PC inc 105watt PSU	£99	£116.33
2nd slice for Risc PC	£76	£89.30
SCSI I & II cables choice from	£10	£11.75
SCSI/IDE ribbon cables from	£5	£5.88
SCSI terminator/adaptors (selection)	£10	£11.75
Monitor cable for all Acorn (selection)	£10	£11.75

XTRA HARD DRIVES

For exceptional performance a guaranteed 4MB+/sec read transfer rate with Castle Storm 32-bit SCSI card

4GB Xtra SCSI internal	£169	£198.58
8GB Xtra SCSI internal	£299	£351.33

VIDEO HARD DRIVES

Fastest on market - externally boxed and ideal for video use - Storm DMA32 card recommended

9GB Video SCSI external	£599	£703.83
18GB Video SCSI external	£899	£1056.33

CD ROM DRIVES

inc FREE driver software & fixing kit worth £29

Castle Technology's range of CD ROM drives are chosen for their reliability, ease of use and robustness. They have fast access times, and include driver software. They are particularly suitable for multimedia applications.



4x speed SCSI CD ROM drive	£29	£34.08
8x speed SCSI CD ROM drive	£30	£35.25
32x speed SCSI CD ROM drive	£69	£81.08
24x speed IDE CD ROM drive	£35	£41.13
40x speed IDE CD ROM drive	£45	£52.88
IDE CD driver for Risc PC & A7000	£25	£29.38
16x4x4 CD int ReWriter inc iCDBurn	£284	£333.70
16x4x4 Ext CD ReWriter inc iCDBurn	£334	£392.45
CD ROM fixing kit (data & audio cable)	£4	£4.70

COMBOS (HD & CD)

Full range available - free fitting in combo case when all purchased at the same time

8x CD & 100MB HD - external SCSI	£99	£116.33
8x CD & 500MB HD - external SCSI	£129	£151.58

CD TOWERS

7 SCSI CD towers with lockable doors

Add the Castle Technology CD Tower to your network and have simultaneous access to between 7 & 28 CD-ROMs. Enables CD resource discs to remain locked and untouched but accessible from all over the network. Up to 4 towers can be connected to one computer. Fully compatible with Access CD network software.



8x CD 7 drive Tower	£379	£445.33
32x CD 7 drive Tower	£549	£645.08

SPECIAL OFFER! 128k ISDN MODEMS

Join the digital revolution at lightning fast speeds! Using a Castle Technology ISDN modem (connected to an Integrated Services Digital Network pair of lines from BT), you can take advantage of fast Web browsing, fast data transfer, fast faxing, and a hi-performance phone line - all from one hi-tech box!

Choose from four network/stand-alone models at great prices!

Special offer

from **£99**
£116.33 inc VAT

KEYBOARDS MICE ETC

Ergo keyboard for pre Risc PC	£69	£81.08
Ergo keyboard for Risc PC A7000/+ N/C	£39	£45.83
Keyboard for Risc PC A7000/+ N/C	£19	£22.33
Keyboard cable (6 way)	£10	£11.75
Mouse for all Acorns (not A7000 etc)	£12	£14.10
Mouse for A7000/+ N/C	£12	£14.10
Mouse balls heavy (pack of 10)	£15	£17.63
Floppy drive any Acorn except A300 A4	£29	£34.08
Replacement floppy drive for A4	£79	£92.83

REMOVABLE DRIVES

For flexible, expandable storage, the infinite capacity of a removable drive is perfect. All drives are the latest spec, and internal versions can be fitted into the CT Combo case. Data transfer rate up to 8.8MB/sec (Nomai).



100MB ZIP drive external SCSI	£99	£116.33
100MB ZIP drive parallel not A300 etc	£109	£128.08
250MB ZIP drive external SCSI	£139	£163.33
Omega Parallel ZIP driver (100MB)	£25	£29.38
MaxIT internal 500MB SCSI drive	£129	£151.58
JAZ 1GB external SCSI drive	£199	£233.83
Syjet internal 1.5GB SCSI drive	£219	£257.33
Syjet external 1.5GB SCSI drive	£255	£299.63
JAZ 2GB internal SCSI drive	£259	£304.33
JAZ 2GB external SCSI drive	£279	£327.83
PD 24x CD & 630MB optical SCSI drive	£249	£292.58

MEMORY

A300 & A400 1-4MB	£75	£88.13
A300 & A400 4-8MB	£99	£116.33
A3000 1-4MB	£55	£64.63
A3000 4-8MB	£124	£145.70
A3000 serial port upgrade	£23	£27.03
A3010 1-2MB	£25	£29.38
A3010 1-4MB	£55	£64.63
A3020 & A4000 2-4MB	£35	£41.13
A5000 2-4MB	£45	£52.88
A5000 4-8MB	£119	£139.83
16MB SIMM - Risc PC A7000/+	CALL	CALL
32MB SIMM - Risc PC A7000/+	CALL	CALL
64MB SIMM - Risc PC A7000/+	CALL	CALL
128MB SIMM - Risc PC A7000/+	CALL	CALL
Risc PC 2MB VRAM	£75	£88.13

SPECIAL OFFER

BJC 7000 - THE ULTIMATE COLOUR BUBBLE-JET PRINTER FROM CANON

This 4-colour bi-directional printer has a resolution of 1200x600dpi, and can print up to 4.5 ppm on paper up to A4+ size (so you can print right to the edge of A4) Choose from Canon's special hi-resolution papers & optional Photo Cartridge for Super PhotoReal quality prints. For sheer quality and durability, this has to be the one!



Special price only **£189** inc VAT

PROCESSORS & RISC OS

Risc OS 3.11 chip set	£25	£29.38
Risc OS 3.11 manual set	£20	£23.50
Risc OS 3.11 hardware upgrade - A300	£20	£23.50
Risc OS 3.70 (Risc PC Only)	£55	£64.63
Risc OS 4 (RiscPC/A7000 when avail)	£99	£116.33
ARM 610 processor (2nd user)	£69	£81.08
ARM 3 processor for A3000 A300 A400	£115	£135.13

MODEMS

All modems are external and come with FREE on-line time

56k modem	£59	£69.33
128k ISDN modem	£99	£116.33
128k ISDN + 2 analogue phone ports	£109	£128.08
128k ISDN hub router with 10BaseT	£249	£292.58
128k ISDN modem router (managed)	£385	£452.38

DELIVERY CHARGES - Next day insured		
Orders over £200 paid by debit card	FREE	FREE
Small items	£6	£7.05
All other orders	£11	£12.93
Fitting charge (inc collection)	£18	£21.15

We welcome payment by cheque (allow 5 days to clear), Credit and Debit cards.

EDUCATIONAL ORDERS WELCOMED.

CASTLE TECHNOLOGY Ltd, Ore Trading Estate
Woodbridge Road, Framlingham, Suffolk IP13 9LL
TEL: 01728 621222 FAX: 0800 783 9638

REMOVABLE MEDIA

Zip 100MB media	£8	£9.40
Zip 100MB media (6 pack)	£45	£52.88
Zip 250MB media	£14	£16.45
Syquest 105MB media	£45	£52.88
Syquest 135MB media	£45	£52.88
Syquest 230MB media	£45	£52.88
Syquest 270MB media	£45	£52.88
MaxIT 500MB media	£29	£34.08
Nomai 750MB media	£38	£44.65
JAZ 1GB media	£58	£68.15
Syjet 1.5GB media	£75	£88.13
JAZ 2GB media	£79	£92.83
PD 630MB media	£18	£21.15
CD 630MB write once media (Pk of 10)	£12	£14.10
CD 630MB re-write media	£10	£11.75

COLOUR MONITORS

3 year warranty on all monitors (1 year on AKF18)

The latest developments in TFT screen technology bring the ProLite 36 space-saving flat screens from Iiyama. The 14.1" screen has a viewable area almost 17" and a maximum resolution 1024x768.

It is ecologically advanced with low power consumption and reduced eye strain. Suitable for schools or business.



only **£599**
£703.83 inc VAT

AKF53 14" med res pre RiscPC	£149	£175.08
14" SVGA	£89	£104.58
15" digital SVGA	£110	£129.25
17" digital SVGA	£159	£186.83
15" digital SVGA Iiyama	£129	£151.58
17" digital SVGA Pro 0.25 Iiyama	£316	£371.30
21" digital SVGA Iiyama	£665	£818.38
14" colour LCD display (TFT Analogue)	£599	£703.83

INKJET PRINTERS

inc FREE data cable & Acorn driver worth £20

Advanced inkjet technology for bright colour images & fast printing times. Up to 1200dpi resolution (virtual photographic quality). Supplied with Acorn drivers & data cables.



CANON BJC-250	£84	£98.70
CANON BJC-2000	£100	£117.50
CANON BJC-4650 (A3)	£228	£267.90
CANON BJC-5000 (A3)	£189	£222.08
CANON BJC-7100	£229	£269.08
CANON BJC-6000	£199	£233.83
EPSON Stylus colour 440	£99	£116.33
EPSON Stylus colour 640	£124	£145.70
EPSON Stylus colour 850	£213	£250.28
Parallel printer cable	£10	£11.75
Acorn printer driver for any listed printer	£10	£11.75
TCP/IP (LPR) postscript printer driver	£175	£205.63

SPECIALS

DOA warranty only

JP150 sheet feeder	£10	£11.75
Master 128 motherboard	£10	£11.75
German keyboards RiscPC/A7000 etc	£10	£11.75
A5000 Power Supply Unit	£15	£17.63
SJ Econet Bridge	£20	£23.50
Acorn Econet interface - all except RPC	£5	£5.88
SJ Econet starter kit	£20	£23.50
PC card for A3000 A3010 A3020 A4000	£99	£116.33
A-link for pocket book (AHA30)	£25	£29.38
Risc PC sound card (ACD05)	£20	£23.50

Sales lines open Monday to Friday 9.00am till 5.00pm
Saturday 9.00am till 1.00pm

Contact us by e-mail: sales@castle-technology.co.uk
Visit our web site! http://www.castle-technology.co.uk

All trademarks acknowledged.
E&OE.

All products carry a full 1 year warranty unless otherwise stated.



ACORN USER

JULY 1999

Features

29 ECS

Are Acorns ever used in industry? Simon Anthony outlines the roles of Acorns in a textile dyeing plant in Wales

.....
 Play your own "Destiny" special offer Page 48
 EasyFont Pro special offer Page 28
 Advertisers Index Page 68
 Back issues Page 56

Published by



Media House, Adlington Park, Macclesfield SK10 4NP
 e-mail enquiries@acornuser.com
 http://www.acornuser.com/
 Tel: (01625) 878888 Fax: (01625) 859808
 Printed by Apple Web Offset, Warrington

Editor Steve Turnbull
 Assistant Editor Dunstan Orchard
 Production Manager Alan Jones
 Art Editor Anthony Broughton

Contributors

Dave Acton, Simon Anthony, Ian Burley,
 Alasdair Bailey, Walter Briggs, Mike Cook,
 Mike Cowgill, David Dade, Dave Lawrence,
 Jill Regan, Greg Scott, Pam Turnbull,
 Mike Tomkinson, Paul Wheatley.

Account Manager John Snowden
 Ad Production Dunstan Orchard
 Finance Manager Charlie Moran
 Subscription Manager Richard Siggee
 Circulation Director Darren Whiteman
 Distribution COMAG (01895) 444055
 Managing Director Steve Turnbull

Subscriptions:
 0870 6060424

E-mail: subscript@acornuser.com
 13 issue subscription rate: £45.99 (UK),
 £51.99 (EU), £63.99 (World)

Acorn User is available as speech from the
 Talking Newspaper Association UK

©1999 Tau Press Ltd.
 No material may be reproduced in whole or in part without
 written permission. While every care is taken,
 the publishers cannot be held legally responsible for
 any errors in articles, listings or advertisements and
 the views of contributors do not necessarily reflect
 the views of the publishers

Internet Services provided by Argonet, www.argonet.co.uk

Regulars

6 News

RiscStation update, clarification on the Acorn situation, the future of StongARM, and a Kosovo appeal

13 Graphics

DrawWorks Millennium, TopModel and a bit of Digital knowledge

15 Comms

Keep those bookmarks safe, make a good first impression on the Internet, and hasta luego Arctic BBS

17 Public Domain

Evolution demo results out at last, the latest on the Codecraft competition, and a Utilities update

21 PC page

Mike Tomkinson continues his series on becoming a computercontractor

23 Cover disc

A quick look at what's on this month's cover disc - fun game and utility

43 Game show

Games guru Alasdair Bailey pauses long enough to look at Final Doom and Shovy 3D

47 Games Competiton

Five copies of Shovy 3D are up for grabs if you can unscramble the screen shots in this competition

58 Free Ads

Lots of lovely second-hand hardware and software

70 Subscriptions page

Take advantage of our fantastic subscription offers and get yours today

72 Letters

Some interesting suggestions surface in this month's letters page

74 The Regan Files

Jill interviews a rather interesting Aussie, Mal McClenaghan of The Image Factory and RiscStation Australia Ltd

Education

59 Education News

Pam Turnbull lets us know what's new in the world of education

60 Education Reviews

Got problems with spelling and maths? Pam Turnbull to the rescue...

Reviews

30 Millenium Toolkit

Mike Tomkinson pulls on his big boots and goes bug killing with the MBTK

Hands on

24 Photodesk Series

Walter Briggs starts off his new series on Photodesk layers and masks

33 MIDI Controllers

Michael Cowgill continues his MIDI series with a look at controllers 72 and 73

34 Photo Retouching

Simon Anthony demonstrates photo-retouching for free, using Paint, Draw and ChangeFSI

37 OOP

Greg Scott starts his new series on Object-Orientated Programming

49 *Info

In its last appearance, Dave and Dave look back over the years at some of the most interesting submissions

63 Run the Risc

Mike starts a short series on harmonic control

66 Rambles

Wonder-boy Mike Cook offers more technical advice in this month's Rambles

Next month

Exclusive news of what's happening at RiscStation Ltd, an AAUG report, creating a home network plus all our ongoing series'

On sale 8th July 1999

Finance Deals

- * 0% Buy now, pay 6 months later
- * Can convert into standard finance package, no penalty (still get 6 months interest free)
- * Low Cost Finance Option @ 1.5% per month (19.9% APR) up to 5 years to pay
- * No early settlement penalties.
- * Can make additional purchases up to your credit limit without re-application.
- * Ring For full details

Desktop FAX MODEMS

56k x2/V90 3Com USR	£118.30	£129.00
56k Flex/V90 (Rockwell)	£55.32	£65.00
ISDN modem (external)	£99.00	£116.33
High speed serial cards from	£67.23	£79.00

Internet & Modem Software

ANT Internet Suite	£94.05	£110.51
Webster XL	£21.28	£25.00
IBrowse CD	£33.19	£39.00
Ijava CD	£33.19	£39.00
ArcFax Fax software	£26.38	£31.00

All monitors inc 3 yrs wty unless specified

MONITORS

	Ex VAT	Inc VAT
14" SVGA 0.28 (3yr on-site)	£85.00	£104.58
14" SVGA 0.28 Multi-Media	£99.00	£116.33
15" SVGA 0.28 (3yr on-site)	£110.00	£129.25
15" SVGA 0.28 Multi-Media	£129.00	£151.57
15" Iiyama Vision Master 350	£129.00	£151.27
17" SVGA 0.28 (1yr RTB)	£149.00	£175.08
17" SVGA 0.28 (3yr on-site)	£170.00	£199.75
17" SVGA 0.28 m-media(3yr)	£190.00	£223.25
17" SVGA 0.25 (3yr on-site)	£275.00	£323.13
17" Iiyama Vision Master 702	£235.00	£276.13
17" Iiyama Pro 400	£316.00	£371.30
19" SVGA 0.26 (1yr RTB)	£280.00	£329.00
19" SVGA 0.26 (3yr on-site)	£360.00	£423.00
19" Iiyama Pro 450	£460.00	£540.50
21" SVGA 0.25 (3yr on-site)	£540.00	£634.50
21" Iiyama Pro Diamondtron	£665.00	£781.38
38" SVGA (1yr on-site)	£1500.00	£1762.50
AKF18 Multisync (14")	sold out	sold out
AKF53 Multisync 14" 1yrRTB	£160.00	£188.00
AKF50 Multisync 14" 1yrRTB	£195.00	£229.13
AKF12 PAL 14" refurb 90 days	£65.00	£76.38
Multisync A300/A3000 cable	£8.50	£9.99

* 2nd user mon's available with 90 days WTY

THE BEST PRINTER PRICES

(Please ring for latest prices)

	Ex VAT	Inc VAT
Canon BJC 1000 colour	A4 £80.00	£94.00
Canon BJC 2000 colour #	A4 £100.00	£117.50
Canon BJC 2000 Scan #1	A4 £169.00	£198.58
Canon BJC 4650 colour #	A3 £228.00	£267.90
Canon BJC 4650 Scan #1	A3 £275.00	£323.13
Canon BJC 7000 colour #	A4 £169.00	£198.58
Epson Stylus 440 colour	A4 £99.00	£116.33
Epson Stylus 640 colour	A4 £116.00	£136.30
Epson Stylus 850 colour	A4 £198.00	£232.65
Epson Stylus 1520 colour	A3 £350.00	£411.25
Epson Stylus Photo 700 #	A4 £135.00	£158.63
Epson Stylus Photo EX #	A3 £265.00	£311.38
HP 420C	A4 £74.00	£86.95
HP 695C colour	A4 £99.00	£116.33
HP B95CX1 colour	A4 £200.00	£235.00
HP LASERJET 1100	£249.00	£292.58
HP LASERJET 2100	£454.00	£533.45
Photo drivers for #	£58.72	£69.00
Scanner drivers for #	£29.79	£35.00

FREE Acorn driver by request

0% Interest FREE credit (6 months) or LOW cost finance on all new systems, & FREE Internet connection

6 months Interest Free Credit On All Systems inc peripherals, software and 2/3 yr optional warranties

RiscStation R7500



R7500 50 mip processor +16M / 4.3G / 40x CD /14" mon & Stereo Spk for only £649 exc vat (£762.58)

FREE Software Bundle

Due in July 1999

See www.riscstation.co.uk for details

233Mhz SA RiscPC Offers



e.g. RPC SA
2M+32Mb/4G/40x CD & 17" monitor for only £1125 + VAT or £34.00/month via

L.C.F. * RPC SA bases from £850 inc VAT or £22.00/month via L.C.F. * AND we will match or beat your best offer

SA J233 Web Wizard

2M+32Mb/4G/40x CD/15" mon/stereo Spk, inc Browse, Jarva and Word 6/7 compatibility & 56K modem for only £1145 + VAT

Availability soon

A7000 + Peak Performer

29 Mips 16M / 4G / 40x CD / 15" mon & Stereo Spk free software bundle £699 + VAT or £21.00 / month on L.C.F.



(£789 + VAT for internet bundle) 8Mb bases from £499 + VAT

internet bundle includes 56K modem and Ant internet suite

Please ask for other combinations

Casio QV100 Digital Camera



PC s/w only £170.00 exc vat (£199.75)
Acorn & PC s/w £255.00 (£299.63)
Qv11a/Qv100 s/w kit £96 (£112.80)

HARD DRIVES AND SUB-SYSTEMS WHY PAY MORE???

A3000/A3010		A3020		A4000/A5000/A400		RPC/A7000	
Ex. VAT	Inc. VAT	Ex. VAT	Inc. VAT	Ex. VAT	Inc. VAT	Ex. VAT	Inc. VAT
170Mb	£95	£111.63	£55	£64.63	210Mb refurb	£30	£35.25
340Mb	£112	£131.60	£69	£81.08	420Mb	£49	£57.58
512Mb	£127	£149.23	£85	£99.88	540Mb	£85	£99.88
810Mb	£139	£163.33	# £119	£139.83	730Mb	£93	£108.28
1Gb	£149	£175.08	# £124	£145.70	1.2Gb	£115	£135.13
2Gb	£159	£186.83	# £134	£158.63	2.1Gb	£125	£146.88
3Gb	£169	£198.58	# £144	£169.20	3.2Gb	£135	£158.63
4Gb	£189	£222.08	# £164	£192.70	4.0Gb	£145	£170.38

A3000/A3010 version includes CD ROM i/f which can also be used in A3020 or A4000. For external A3000 i/f add £20.00 + VAT # includes partitioning software

* inc. internal removable HD & CD ROM i/f. For partitioning software only deduct £25.00 + vat (£29.38)



ACORN TRACKBALL & MOUSE £29.79 + VAT

CD-ROMS

IDE		SCSI	
40x	£45.00 (£52.88)	40x	£75.00 (£88.13)
32x	£39.00 (£45.83)	32x	£65.00 (£76.38)
24x	£35.00 (£41.13)	12x	£35.00 (£41.13)
8x	£30.00 (£35.25)	8x	£30.00 (£35.25)

For external IDE or SCSI I add £50.00 + VAT (inc. cable)
For external SCSI II add £55.00 + VAT. (inc. cable)
IDE driver for RiscOS 3.5 £15 + vat
IDE int. fitting kit £5 inc. Int. SCSI fitting kits from £10 + vat

SCSI HARD DRIVES

540Mb # limited supply	£60.00	(£70.50)
1Gb	£70.00	(£82.25)
2Gb (5400 rpm)	£100.00	(£117.50)
2Gb (7200 rpm) #	£110.00	(£129.25)
4.3Gb (5400 or 7200rpm)	£140.00	(£164.50)
9.1Gb (7200rpm)	£235.00	(£276.13)
18.6Gb (7200 rpm)	£425.00	(£499.38)

For EXT. SCSI I case £50.00 + VAT (inc. cable)
For EXT. SCSI II case £55.00 + VAT (inc. cable)

CD-ROM WRITES



Prices Start from £170.00 +

2x2x6x	£170.00	(£199.75)
4x4x16x	£235.00	(£276.13)
CD-BURN	£49.00	(£57.58)
CD-SCRIBE 2	£49.00	(£57.58)



SCSI 8x Autochanger £85.00 + vat (£99.88)

IDE Removable Drives

Zip 100 int	£65.00	(£76.38)
Zip 250 int	POA	POA

Parallel Removable Drives

Zip 100	£110.00	(£129.25)
Zip 250	£159.00	(£186.83)
Jaz 1G	£239.00	(£280.83)
Jaz 2G	£299.00	(£351.33)

SCSI Removable Drives

Zip 100 M int	£85.00	(£99.88)
Zip 100 M ext	£85.00	(£99.88)
Zip 250 M int	£135.00	(£158.63)
Zip 250 M ext	£135.00	(£158.63)
PD650/CD	£139.00	(£163.33)
Nomai 750	£165.00	(£193.88)
Jaz 1G int	£189.00	(£222.08)
Jaz 1G ext	£199.00	(£233.83)
Syjet 1.5G int	£199.00	(£233.83)
Jaz 2G int	£249.00	(£292.58)
Jaz 2G ext	£249.00	(£292.58)

Removable Drive Media

	Inc VAT	Ex VAT	1Gb Jazz	Inc VAT	Ex VAT
100Mb Zip	£8.45	£9.93	2Gb Jazz	£58.00	£68.15
Zip 5 pack	£38.30	£45.00	1.5Gb Syquest	£69.00	£81.15
120M LS 120	£7.50	£8.81			
135M Syquest	£21.00	£24.68	CDR CD-ROM	£1.28	£1.50
230M Syquest	£19.90	£23.38	CDR 10 pack	£10.00	£11.75
270M Syquest	£29.75	£34.96	CDR 25 pack	£21.28	£25.00
650Mb PD	£19.00	£22.33	CDRW CD-ROM	£8.51	£10.00
750Mb Nomai	£38.00	£44.65	CDRW 10 pack	£70.00	£82.25

6 Drive CD-ROM SCSI Towers
8x £299 exc. 4x 8x £699 exc.
32x £499 exc.

Interface Adapters

Storm SCSI 8-bit (A30x9 int)	£88.00	£103.40
Storm SCSI 16-bit (podule)	£96.00	£112.80
Storm SCSI 32-bit (podule)	£128.00	£150.40
Powertec SCSI3 32-bit (podule)	£170.00	£199.75
Simtec 8-bit (A3000/A3010)	£55.00	£64.63
Simtec 16-bit (AX00/A5000/RPC)	£45.00	£52.88
APDL 16-bit DMA	£45.00	£52.88
APDL Blaze 32-bit DMA	£115.00	£135.13
Rap IDE32	£119.00	£139.83
Removable IDE or SCSI housing unit	£20.00	£23.50

3 yr Warranty on ALL Acorn MEMORY why Pay More??

ACORN MEMORY NEW PRICES

	Ex VAT	Inc VAT
4-8Mb Up. (A310, 440, 3000*)	£85	£99.88
4-8Mb Up. (A5000*)	£109	£128.08
*rework for A3000/5000/25Mhz	£25	£29.38
A3010 1-2Mb Upgrade	£20	£23.50
A3010 2-4Mb Upgrade (exch.)	£45	£52.88
A3010 1-4Mb Upgrade	£55	£64.63
A3020/4000 2-4Mb Upgrade	£40	£47.00
A5000 2-4Mb Upgrade	£45	£52.88
A3000 1-2Mb Non-Upgrade	£20	£23.50
A3000 2-4Mb Upgrade (exch.)	£45	£52.88
A3000 1-4Mb Upgrade	£55	£64.63
A3000 Serial Port Upgrade	£23	£27.03
A310 4Mb Upgrade	£45	£52.88
A400/1 1Mb Upgrade (per Mb)	£25	£29.38
RISC OS carrier board (A310)	£19	£22.33
MEMC 1A Upgrade	£45	£52.88
NEW A540 4Mb	£79	£92.83

RISC PC MEMORY

	Ex VAT	Inc VAT
Also for A7000		
8Mb SIMM	£10.00	£11.75
16Mb SIMM	£22.00	£25.85
32Mb SIMM	£48.00	£56.40
32Mb high clearance	£53.00	£62.28
64Mb SIMM	£85.00	£99.88
128Mb SIMM	£170.00	£199.75
1Mb VRAM	£38.30	£45.00
2Mb VRAM	£76.00	£89.30
1-2Mb (exchange)	£66.00	£77.55

33 Mhz Arm 3 upgrade

with FPA socket	£115.00 inc.
with FPA 10 fitted (25Mhz)	£165.00 inc.

RiscOS 3.11 Rom upgrades
£25.00 exc Vat (£29.38)

NETWORKING

ETHERNET INTERFACES

	Ex. VAT	Inc. VAT
A3000 int. 10base2 or T. Access+	£89.00	£104.58
A400/A5000 10base2 or T. Access+	£89.00	£104.58
A400/A5000 10base2 & T. Access+	£99.00	£116.33
A3020 10base2 Access+/ext. MAU	£99.00	£116.33
A3020 10baseT Access+/ext. MAU	£99.00	£116.33
Risc PC/A7000 10base2 or T. Acc+	£89.00	£104.58
Risc PC/A7000 10base2 & T. Acc+	£99.00	£116.33
Ant Access+ ROM upgrade	£10.00	£11.75

Cables

2M	£4.00	£5.29
3M	£6.00	£7.05
5M	£7.00	£8.23
10M	£11.00	£12.93
20M	£15.00	£17.63

State 10base2 or 10baseT
any size made to order

Network Hubs

	Ex. VAT	Inc. VAT
10baseT 16+2(18) port	£75.00	£88.13
100/10 Auto 16 Port	£249.00	£299.58

We supply and / or install all
network components please
ring for your requirements



RISC OS 4 £99.00 +vat

(£116.33) place your order now
Fitting & data transfer, if required, £25 inc vat
(£15 with new HD).

MICE & KEYBOARDS



High Quality
Acorn ERGO
Mouse £12.00
(£14.10)

	Ex. VAT	Inc. VAT
Acorn Trackerball/Mouse NEW	£29.79	£35.00
Acorn Original Mouse	£25.00	£29.38
Acorn ERGO Mouse NEW	£12.00	£14.10
A7000 replacement Mouse NEW	£12.00	£14.10
Ergo (std) Risc PC Keyboard	£21.28	£25.00
Ergo curved Risc PC Keyboard	£29.78	£35.00
A400/A5000 replacement K'brd	£59.00	£69.33
A400/A5000 Ergo Keyboard	£69.00	£81.08

Replacement Floppys Drives

A3000/400/500 £29.00+vnt (£34.08)
A30X0/4000/5000 floppy allows
cross - formatting of HD and DD
discs £29.00+vnt (£34.08)

POWERED SPEAKERS

	Ex. VAT	Inc. VAT
60 watts with PSU	£16.98	£19.95
240 watts with PSU	£24.68	£29.00
Subwoofer system	£42.00	£49.35

Character Mouse Mats

Southpark Kenny	£5.99
Southpark Cartman	£5.99
Disney Mickey, Pooh, Donald, etc	£5.99
X-Files (four types)	£5.99
Garfield or novelty	£4.99
Standard matt £1.00 / Econ. £0.65	

Switch Boxes

2-1 with cable	£15.00	£17.63
2-1 Auto with cable	£15.00	£17.63
4-1 with cable	£19.00	£22.33
2-1 Monitor/K'board	£29.79	£35.00

R-Comp CD-ROM Software

ABUSE	£22.00	Quake (due soon)	£33.00
Descent	£27.00	Syndicate	£26.00
Doom+ Trilogy (£32.50 with book)	£30.00	Towers of Darkness (Hexen Triple)	£30.00
Heroes of Might and Magic 2	£32.00		

Consumables

Premier Quality Ink Refills

Single refills (1x22ml)	£6.00 in
Twin refills (2x22ml)	£10.00 in
Triple refills (3x22ml)	£14.00 in
Tri- Colour (C.M.Y.K)	£15.00 in
Quad-Colour (C.M.Y.K)	£20.00 in
125 ml	£21.00 in
250ml	£38.00 in
500ml	£50.00 in
1 litre	£70.00 in

All sizes available in C.M.Y.K

FLOPPY DISKS @ 20p!!

	Ex VAT	Inc VAT
DD Re-label Acorn fmt 10	£2.00	£2.35
DD Re-label Acorn fmt 100	£17.02	£20.00
HD bulk Acorn or PC 10	£2.00	£2.35
HD bulk Acorn or PC 100	£17.02	£20.00
HD Branded 10 pack	£3.50	£4.11
20 cap Disk Box	£1.69	£2.00
40 cap Disk Box	£2.54	£2.98
100 cap Disk Box	£2.98	£3.50
3.5" Floppy head cleaners	£2.50	£2.94
CD-ROM cleaner	£4.25	£4.99

Printer Ribbons, Inkjet

Cartridges,
New/Recycled Laser Toner Carts
Prices available on request

ARC SHARE

Acorn networking for PCs
£29.95 exc Vat £35.19 inc Vat
see network section for Cards etc

StrongARM Special Offer

£259.00 inc VAT
(with any Hard Drive /
Memory purchase)

RiscPC PC Cards

DX2-66	£145.00 inc VAT
DX4-100	£195.00 inc VAT
586-100 (Acorn)	£290.00 inc VAT
586-133 (CJE 512)	£300.00 inc VAT

We can repair/upgrade your
machine(s) and monitors at
competitive prices please ask
All Acorn's, BBCs & PCs

NEW STAFF

CTA Direct are recruiting new sales,
technical and Modern Apprentices.
Please send CV to Main Address marked
Careers@CTA

COLOUR SCSI SCANNERS

All scanners inc Acorn Software



P'illel Mustek 600dpi	£99.00	(£116.33)
Mustek A4 600dpi	£119.00	(£139.83)
Mustek A4 1200dpi	£149.00	(£175.08)
Epson GT7000	£199.00	(£233.83)
Epson GT7000P	£249.00	(£292.58)

Imagemaster & Twain also available
separately

(All Prices below include VAT)

THE BARGAIN BASEMENT

Acorn Software Bin

A3010 Joystick Controller Software	£15.00
Acorn Pocket Book...Schedule	£10.00
Alone in the Dark	£29.00
Arm Tech Labeller	£9.00
Arm Tech ClipArt (various per pack)	£8.00
Birds of War	£20.00
Boxing Manager	£8.00
ColourSep (Colour Separation Software)	£8.00
Creator 2	£25.00
D'File Font Pack (Academy)	£10.00
D'File Font Pack (Balmoral)	£10.00
D'File Font Pack (FreeStyle Script)	£10.00
D'File Font Pack (Manhattan)	£10.00
D'File Font Pack (Mastercard)	£10.00
D'File Font Pack (Old Towne 536)	£12.00
Diary +	£9.00
Drifter	£30.00
FIRE and ICE	£15.00
Frak (for RPC)	£13.00
Galactic Dan	£10.00
Game ON (for RPC)	£15.00
Global Effect	£25.00
Guile	£10.00
HERO QUEST	£15.00
Imagery Art Package	£25.00
Jahangir Khan Squash	£8.00
KV (Platform Game)	£8.00
My World Support Disc Ancient Egypt	£12.00
My World Support Disc Ancient Greece	£13.00
Nuclides II and Elements II (save £5.00)	£25.00

Quest for GOLD	£5.00
Revelation 2	£29.00
SilverBall	£9.99
StrongGuard	£25.00
TURBO DRIVER - Epson Stylus	£45.00
Visual Backup	£15.00
Wavelength	£12.00
World Class Leaderboard (GOLF)	£10.00
Zool (on HD)	£10.00

Acorn CD-ROM Software

Crystal Maze	£15.00
D'File PDCD 3 or 4	£5.00
D'File PDCD 5	£10.00
Hutchinson Encyclopedia	£39.00
Robert Duncan Cartoon KIT	£39.00
TopicArt CD	£5.00
Tots TV ABC	£15.00
YITM Electricity and magnetism	£15.00
YITM Elements	£15.00
YITM Materials	£15.00
YITM (all three titles)	£35.00

CD General Resource Titles

35000 Clip Art (WMF)	£20.00
50000 Clipart	£20.00
75000 Clip Art (WMF) & images	£15.00
Internet Clipart (new)	£25.00
COREL ARTSHOW 5	£29.00

Werewolf Software

Shuggy	was £25.95	now £14.95
T.A.N.K.S.	was £25.95	now £16.95
RAMplify	was £19.95	now £17.95
ChildPlay (desktop)		£14.95

1/2 price (or less) Book Bargains

Dabhand Guide "Budget DTP"	£3.00
Dabhand Guide "C" ver 3	£8.50
Dabhand Guide "C" ver 2	£3.00
Dabhand "Graphics on the ARM	£7.50
Dabhand Guide "Impression"	£7.50
Internet info server	£20.00
SQL	£17.50

Various Hardware bargains

A3000 2Mb bases from	£65	£76.38
A3010 2Mb bases from	£85	£99.88
A3020 2Mb bases from	£125	£146.88
A4000 2Mb bases from	£150	£176.25
A5000 4Mb bases from	£250	£293.75
A4 Portables (6 months wty)	£550	£646.25
RPC bases from	£468	£549.90
SVGA Monitors Various from	£45	£52.88
Pioneer SCSI 4x 6x stack	£139	£163.33

We have a large collection of
Budget PC software suitable for
RPC Pc Emulators and PC clones
inc, Education, Home, games an
utilities please ring for list

Alternative PC Bases

i.e. Siemens Nixorf Pentium
C 266 from ONLY £299.00 +
ring for latest prices.

HOW TO ORDER

BY MAIL or PHONE: Cheques or P.O.s should be
made payable to 'CTA DIRECT'.
CREDIT CARD / SWITCH please give name,
address, tel. no, card no, expiry date, issue no.
BY EMAIL: sales@cta.u-net.com
OFFICIAL ORDERS by MAIL or FAX please
Carriage charges inc. ins. & packaging charged at cost
Small items (under 2Kg).....no more than £6 + vat
One box of items totalling upto 25kg.....£6.50 + vat
Computer systems.....£13 + vat
All prices are correct going to press. E&OE
All goods are fully guaranteed but not supplied on
approval

StrongARM differences

The good news is that Intel, which now owns the rights to the StrongARM family of RISC processors, has announced details of StrongARM version 2 – or SA-2. It will run at up to 600MHz, deliver 750 mips of processing power and still consume less than half a watt of power.

The bad news is that Intel could effectively divorce itself from the collective ARM family by introducing its own extensions to the ARM instruction set. At a recent semiconductor technology event a senior member of Intel's StrongARM design team refused to deny the rumours of new proprietary instructions in SA-2.

ARM Ltd usually makes a cast-iron condition of any licensing of the ARM platform that licensees don't tamper with the instruction set. Digital Semiconductor, who originally licensed ARM's architecture to produce SA-1, extensively modified the ancillaries within the core to enable it to be reliably clocked at higher rates than had been previously possible, however, they dutifully stuck to the basic ARM instruction set in order to ensure it remained software compatible.

Intel is not averse to adding new instructions to its products. After all, the current Pentium family of PC processors is still religiously based on the very first Intel 8088 PC processor first developed nearly twenty years ago. Pentiums now cater for hundreds of additional instructions compared with the original 8088, yet retain almost total backwards compatibility with the old chip.

If Intel remains true to form and manages to add new StrongARM instructions without compromising the original ones, any damage may be limited to relations with ARM Ltd. The

concern is that any Intel-inspired instruction set changes could unavoidably affect software compatibility, and StrongARM could be headed further away from its origins should ARM choose to add its own instruction set enhancements at some time in the future.

Peering through the spectacles of rash speculation, RISC OS might one day be faced with a stark choice to either go down the StrongARM route or the ARM Ltd path.

Nevertheless, the promise of a 600MHz StrongARM is accentuated by news that the chip's internals are getting the once-over as well. A new 7-stage integer pipeline and 8-stage memory pipeline, combined with smarter dynamic branch prediction promise to hurry data throughputs along, which could translate into an overall performance improvement greater than the clock speed multiplication implies.

The fastest current releases of Intel's Pentium II processor family for desktop PCs are clocked at 550MHz, so a 600MHz StrongARM sounds great. However, SA-2 won't start shipping until around this time next year.

Nevertheless, if SA-2 lives up to the hype and can be successfully introduced to the RISC OS platform, it should more than triple the CPU power currently enjoyed by Risc PC users and still not require a heat sink on the chip.

Power consumption, or the lack of it, looks like being excellent as usual and the prospect of PDAs, mobile phones and other portable battery-powered devices equipped with SA-2 using up to 600MHz of StrongARM power could be very impressive.

RiscStation News

Following their successful launch at the Wakefield show RiscStation have decided to increase the initial production run of their R7500 to cope with demand. Full production is still on target for late July with developers machines shipping slightly earlier.

The company will be visiting foreign shores and displaying multiple hardware products at the Big Ben Show in Holland, including currently unannounced hardware and software – exclusive news on that next month.

RiscStation have also announced that as of May RiscStation Australia Ltd will be assembling and distributing their equipment to customers down-under. Mal McClenaghan of The Image Factory

will head this new venture (see The Regan Files, page 74, for more info).

Their press release states 'We anticipate that this will enable us to satisfy market demand and to develop our RISC technology even further, allowing us to expand the RISC OS market.'

'This will allow software developers to expand their projects, and consequently benefit users, with the best software and technology combined.' Resellers and software developers who wish to know more should contact Kathy Cartmell on +44 (0)1942 79 77 77 RiscStation Ltd, or Mal McClenaghan on +61(0)3 9458 3599 RiscStation Australia Ltd.

RiscStation: e-mail: info@riscstation.co.uk or Web: www.riscstation.co.uk

S-Base Returns

S-Base, the programmable database package for RISC OS has returned from obscurity. Originally marketed and supported by Longman Logotron, the package has been without a patron for several years. Now new Acorn developer, Bluewater Systems Ltd based in Christchurch, New Zealand, is re-releasing *S-Base* in a revised form.

A new *S-Base* Personal Online Edition is now available for £29, though it seems that if you want to try it out you have to pay the price and re-claim it, if you decide not to keep using it after the month is up. A new *S-Base* Web site has been set up, and there is also a discussion group for keeping up with events and swapping ideas with other users.

Several bug-fix releases have already been made and upgrades are available for download from the *S-Base* Web site. Online documentation and example applications are also available.

The *S-Base* Web site is www.bluewaternz.com/s-base, e-mail: s-base@bluewaternz.com, Bluewater Systems Ltd, 10 Royalist Ave, Christchurch, New Zealand



Acorn PLC

As these words are written in the middle of May, Acorn PLC still exists, and its shares continue to be traded in the stock market. In fact the price is 255p, near to its high for the year, but in truth we are witnessing the end of Acorn as we know it. Almost a month ago just after June's *Acorn User* had been finished, news came through that the Acorn Computer Group was finally being broken up

Acorn will, with some justification, be regarded in the history books as the last British desktop computer company to both design and manufacture its own hardware and operating system. Only Psion can now claim to be the UK's remaining combined operating system and computer maker, its products, of course, being of the pocket computer variety.

What has happened to Acorn is quite complicated, but it goes like this: Acorn has been bought by an off-shore subsidiary of the US investment bank, Morgan Stanley. The aim is break up the company in order to release Acorn's £300 million shareholding in ARM Ltd. Acorn has been stuck with the shares, unable to cash them in without incurring a massive tax bill.

Some creative accounting courtesy of Morgan Stanley appears to have provided the solution, with Morgan Stanley using the purchase as a tax loss and swapping Acorn investors' shares for ARM shares. The deal also leaves Morgan Stanley ultimately sitting pretty with a large chunk of ARM shares worth around £40 million.

While the huge majority of Acorn's paper worth was its historical quarter share in ARM Ltd, there were two remaining parts of Acorn which needed to find new owners. Pace Micro Technology, who are best known for making satellite TV decoder boxes, have acquired Acorn's thin client computing and traditional personal computer products business, including around 30 staff.

The deal was worth just £200,000 – for Pace, almost a nominal amount. It's this part of the Acorn business which retains the rights to RISC OS and, hence, the licensing deal with RISCOS Ltd which guarantees the future of RISC OS, post-Acorn.

According to Paul Middleton, managing director of RISCOS Ltd, the

corporate drama of Acorn's final dismemberment should, in reality, affect RISCOS Ltd minimally, and business is continuing as usual. It's a similar message with regard to CTL, which has licences to distribute and manufacture Acorn-branded computers.

Elsewhere, Acorn's CEO, Stan Boland, is leading a management buy-out which will see the newly formed Element 14 division hived off as an independent company with the undistracted aim of becoming established as a developer of programmable StrongARM-based chip-sets for digital TV hardware.

E14 has no future interest in RISC OS or any of the more traditional Acorn products and technologies which relate to desktop computing. Acorn's former HQ at Newmarket Road will not be vacated, and although E14 has a design team based near Bristol, it looks like they will share the Newmarket Road site with the staff who have transferred to Pace.

As both Pace and Acorn are listed in the stock market, procedures to approve the proposed arrangements between the two companies will not be completed until after this issue of *Acorn User* goes to press.

Ironically, as Acorn effectively disappears, the 'Acorn' computer market is showing determined signs of survival. Up to five independent companies are either already manufacturing RISC OS-compatible computers, or are making plans to do so.

RISCOS Ltd should, by the time this is printed, be on the verge

of releasing its first product, RISC OS 4.0. However, nobody should be lulled into a false sense of security.



Parallel port networking

Stuart Tyrrell Developments (STD) officially launched *ParaFS*, a disc sharing software package, at the recent Wakefield show. *ParaFS*, which functions as a very simple network was developed by Soft Option and is distributed and supported by STD.

It offers transparent sharing of filing systems between RISC OS machines fitted

with bi-directional parallel ports (including Acorn A5000, A30x0, A4000, A7000/+ and Risc PC machines). According to STD, tests show file transfer speeds in excess of 100K/sec with a variety of machines, sharing hard and floppy discs, RAM discs, CD drives and others.

As STD point out, this is approximately ten times faster than the

highest speed of the Risc PC serial port, and over 50 times faster than the highest serial speed supported by RISC OS on A5000/A30x0 machines.

ParaFS is priced £22.95, or with a 'Red Hot' parallel port cable, £29.95, inc. P&P. Stuart Tyrrell Developments, on the Web: <http://www.stdevel.demon.co.uk>, tel: 01706 848 600.

Novel wireless Internet service for schools

For just £65 per month, schools are being offered a service which provides a permanent, or always on, 128 kilobit link to the Internet, unlimited usage and 5Mb of personal Web space for every student and teacher in that school. The package comes from Tele2, which launched its service to ordinary customers earlier this year.

The main difference is that schools are exempted from a data volume tariff during school hours, which would

otherwise see heavy users having to pay extra should they exceed their monthly quota. Tele2 can undercut their more conventional rivals who offer ISDN and leased line services because they operate a wireless network.

Your site is fitted with a radio data receiver which communicates with a base



station in your vicinity. A 384 kilobit service is also offered and faster connections will be available in the not too distant future.

Tele2 is based in Reading and their service is currently limited to the Thames Valley region, but they are rolling their network out with the target of covering 60 percent of the UK population by 2003. For more information, check out Tele2's Web site at <http://www.tele2.co.uk>

Practice makes perfect

Granada Learning, which owns the SEMERC education company, has released a new set of CD-ROMs for Acorn users which aim to help pupils improve their maths and science skills. The three CDs are called Practice Maths at 7, Practice Maths at 11 and Practice Science for National Tests at 11. Three different types of questions can be set, including multiple choice.

Results can be used to pinpoint areas of weakness requiring remedial tuition. More confident pupils can also use a self-test mode, with an option to beat the clock if required. There is plenty of multimedia content and the packages are designed to be fun to use.

The CDs themselves are backed up with teacher support materials. Practice

Science for National Tests at 11 comes with a free copy of Odyssey Scrapbook, which allows teachers to customise and add their own content to a program.

Each CD is priced £45 + VAT for a 5-user licence, but individual students can obtain their own personal copies for the reduced price of £19.99 inc. VAT. Granada

Learning, tel: 0161 827 2927, fax: 0161 827 2966, Web: <http://www.granada-learning.com>

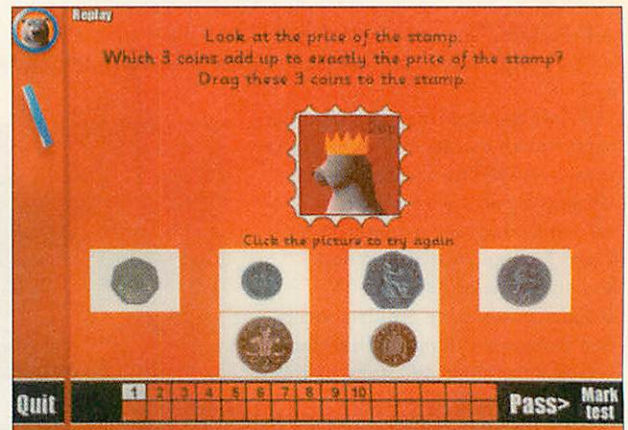

New product from Granada Learning

ISDN Internet solution from Clares

If you aren't keen on getting your hands too dirty messing around with server addresses, Internet protocol settings and dial-up configurations, but would like to get your Acorn connected to the Internet, Clares Micro Supplies have had some interesting comms packages based around the subscription free Dixons FreeServe Internet service.

FreeServe don't offer Acorn support for their service, but Clares provide a FreeServe-ready software package with their modems, including a £99 (Inc.VAT) internal modem and a £149 external v.90

voice/fax 3Com/USR modem.

Now Clares has added an ISDN terminal adapter (TA) to their range. Based on a Zyxel-manufactured external TA, this £199 package includes all the software you need to get connected to FreeServe. The TA has two analogue phone ports, so you can plug in at least two ordinary phones or fax machines. Also included is a voucher for free installation of an ISDN or BT Home Highway ISDN-compatible service.

Choosing the best option is a bit of a nightmare as BT offers several different ISDN packages. Clares' free installation

offer comes from a third party company which charges more for the standing charge than BT, but slightly less for calls.

Plus there is a £49 special offer from BT on converting your existing phone line to Home Highway which could expire at the end of June, though BT has extended similar offers in the past. If in doubt, Clares say they will be happy to help customers choose the best package.

Alternatively, the Internet suite software and FreeServe support is available on its own, priced £49. Clares Micro Supplies, tel: 01606 833999, e-mail: sales@claresmicro.com

Icon Technology

New Pro+ version of Easiwriter and Techwriter now available



EasiWriter professional

- Powerful, fully featured, multi-column word processor.
- Reads and writes MS Word 6, 7 & 8 (Office 97/98).
- IMPRESSION text files with styles are imported complete with formatting.
- Reads and writes HTML. Splits large documents with automatic generation of forward/backward links and contents.
- Reads RTF (Rich Text Format).
- Creates Hypertext documents.
- Built in Table Editor.
- Automatic bulleted and numbered lists.
- Mail merge.
- Automatic numbering of Lists, Sections etc.
- Powerful spell checker.
- Style editor.

EasiWriter professional
£119.84
Easiwriter Pro+
£139.00 (offer)

$$A = \frac{1}{n} \left\{ \sum_{k=1}^n Z_k - B \sum_{k=1}^n X_k \right\}$$

TechWriter professional

"Its great! At the risk of writing advertising copy for Icon Technology, no piece of software on any platform has made me grin with delight as I discover new features as much as TechWriter has." Archive

- All the features of EasiWriter professional plus a powerful easy to use equation editor.
- Writes TeX.
- Saves equations as GIF's (using InterGif) when writing HTML.
- Used by the Mathematical Association to produce the Mathematical Gazette.

TechWriter professional
£178.59
Techwriter Pro+
£199.00 (offer)

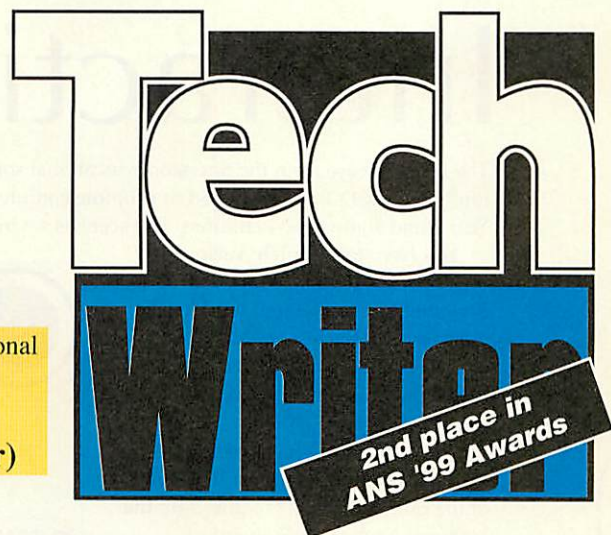

**Reads and writes
Microsoft® Word**

New! Pro+

Text flow over graphics

Paragraphs can contain multiple graphics which can be left and right aligned with text flowing over them. Allows drop caps.

Java enabled

Run Java Applets inside an Easi/Techwriter window

Plus...

Over 100 new user definable keyboard shortcuts, runs animated GIFs and Animator files, 300/360 dpi equation resolution when saving as Word.



Upgrade your StartWrite or
TalkWrite to EasiWriter professional
for just £60.00 inclusive.

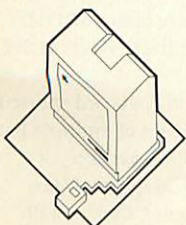

Icon Technology Limited

Church House • Carlby • Stamford • Lincs • PE9 4NB

Phone and Fax 01778 590563

<http://www.icontechnology.net>
email: sales@IconTechnology.net

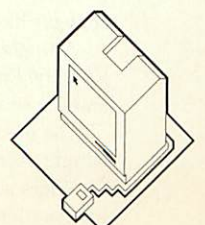

New EFF Typography CD

The Electronic Font Foundry (EFF) has announced Volume 2 of its Professional Typography CD. This will contain all the fonts contained in Volume 1, plus new fonts and, in particular, fonts aimed at users in educational circles.

Formats supported include: RISC OS, Acorn Publisher, Windows PostScript and Windows TrueType. EFF says it is taking orders for the new CD now and early

birds will benefit from a discount. The offer, which closes at the Acorn South East Show on 3rd July, reduces the existing user upgrade price from £49 to £39 and the full price from £99 to £89.

Discounts are also available on school and business licences. For more information, tel: 01344 875 201, e-mail: sales@eff.co.uk or see the Web at <http://www.eff.co.uk>



Kosavo appeal

No sooner has Paul Johnson recovered from raising thousands of pounds from the Acorn community for the Comic Relief appeal, but now the Kosovo crisis has stirred him back in to action, this time in partnership with Dave Clare of Clares Micro Supplies.

For this effort Paul has produced a CD-ROM stuffed with the contents of all previous *Archimedes World* magazine

cover discs, by kind permission of Tau Press.

The CD is priced £6.25 inc. P&P or £5.60 if you manage to pick one up from a show. Credit card orders are being taken by Clares. Of the purchase price, Paul is promising a full £5 will go to Kosovo charities. More information is available on the Web at: <http://www.acornusers.org/comicrelief/Kosovo.html>

Irlam updates i16 sound card

A while back we brought news of Irlam Instruments' new high quality sound sampler card, the i16. Since then, the specification has changed and the final product has been completed – it was shipping just before the recent Wakefield show.

The main addition to the card's specification is the addition of an option for pure digital input and output. This allows direct digital connection to any

device sporting a digital port, like some CD players, DAT and MiniDisc recorders.

Other key features include sampling rates up to 50KHz, auxiliary input for mixing in the host computer's own audio output, audio waveform display with peak meters plus the ability to save Acorn Replay and PC Wave format files. Irlam Instruments, tel/fax: 01895 811401, e-mail: sales@irlam.co.uk, Web: <http://www.irlam-instruments.co.uk>

In brief

A Wheely great mouse driver

Student, John Scott, promised to make a basic Microsoft wheel mouse driver he wrote a couple of months ago available for RISC OS, free of charge. Exams delayed him a bit, but the software is now available from his Web site at www.york.ac.uk/~jjrs101/. You will need RISC OS 3.6 or later to use the driver. John can be contacted via e-mail at: jjrs101@cs.york.ac.uk

TopModel news

Sincronia, the Italian company which develops and produces the remarkable *TopModel* 3-D modelling package for RISC OS, was present at the recent Wakefield show as the guest of Spacetech, who distribute the package in the UK.

A new module, called *TopBones*, was demonstrated at the show by Sincronia. This adds several functions to the main *TopModel* application, including the ability to insert and manage bones and skeletons into models. It is transparent to other tools, including the forthcoming *TopMotion* feature. There is also a 3rd release of the *TopModel* resource CD-ROM.

CDFSfiler

PEP Associates has announced CDFSfiler, an enhanced drop-in replacement for Acorn's CDFSfiler. It boasts a much improved and extended, music CD disc player with a CD database, track title editor and playlist editor. Cache technology has been introduced to enhance the data retrieval performance of the CD-ROM drive.

Acorn's ShareFS is supported, as are PEP's own VirtuaCD and CD-Net products. Last but not least, it's mostly available free of charge from the PEP Web site (<http://www.pep-assoc.co.uk/Products/CDFSfiler/>). Only the CD-ROM cache technology and the CD database are available as optional extras to the basic product, costing £9.95 each.

ISDN Follow Up

Last month we brought news of a new ISDN terminal adapter from PMC Electronics which includes modem-style features like fax and voice messaging capabilities normally absent from such devices. The claims are perfectly true, but we have since discovered that the additional features are *Windows* software-based and so unlikely to be compatible with RISC OS. For more information, PMC can be contacted at tel: 0990 561001 or check the Web at: <http://www.pacem.co.uk>

DrawWORKS Millennium

the complete graphic design studio on one CD-ROM



PURPOSE:
graphic design & illustration

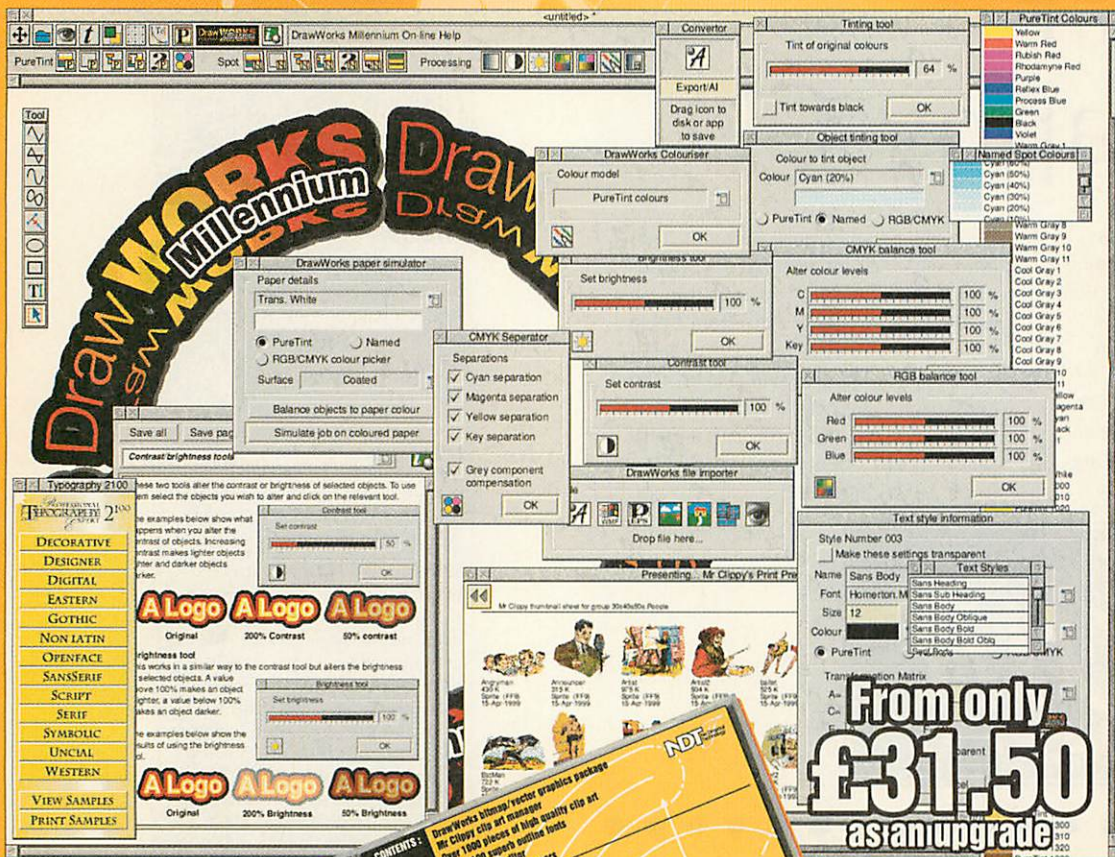

From only
£31.50
as an upgrade

Review Comments on DrawWorks & Typography Fonts

- "...excellent...I thoroughly recommend DrawWorks Designer..."
Acorn Publisher
- "Does for Draw what Cosworth did for the Escort."
Acorn User
- "...it may hardly be worth buying and other vector graphics program...Order it now - I guarantee you won't be disappointed!"
Archive
- "I think I will be ditching ArtWorks!"
Mr T. Leicester
- "THE program I have been looking for...excellent!"
Mr B. Warrington
- "...the best value fonts collection...the package oozes quality, and the standard of Typographical design is very high...an absolute must...truly excellent value for money."
Acorn User
- "...NDT as used by iSV produces superior results."
Acorn Publisher
- "...very comprehensive...this CD-Rom can be recommended to anyone..."
Eureka



NDT No Drop-out Technology
Includes NDT fonts exclusive to iSV Products



Some of DrawWorks features:

- DrawWorks vector/bitmap graphics package
- Over 2100 superb outline fonts
- Complete copy of Typography 2100 Expert
- Over 1000 pieces of clip art
- Over 630 vector clips & 394 bitmap clips
- NEW Mr Clippy clip art manager
- Nested clip art groups and WMF file support
- Dr Fonty font editor
- Import & Export of EPS PostScript™ files
- Export Acorn fonts as PostScript™ Type 1
- Import WMF (Windows MetaFiles) drawings
- Can be run from CD or hard disk
- Complete integrated package
- All clips already referenced by Mr Clippy
- Colour print preview paper simulator system
- CMYK and Spot colour separations
- Tint objects/shades of any colour
- Alter CMYK/RGB colour levels
- Contrast & Brightness tools
- User defined multi-document text styles
- Comprehensive illustrated on-line manual
- Realtime interactive help
- PureTint and Named spot colour pickers
- VIVID enhancers for Pre-RiscPC computers
- Automatic drop shadow tool
- Print tiling across multiple sheets
- All files fully compatible with Draw files
- OLE sprite editing using !Paint
- Configurable user levels
- Example effect worksheets
- Auto convert text to paths when required
- Custom line width / pt size tools
- Export EPS, JPEG, GIFF files
- EuroSymbol support using special fonts
- Automatic colour filling/tinting tools
- Map making tool
- Lining style tool with custom styles
- Access clips directly from DrawWorks
- Full font editing facilities
- Tint bitmap images for use as backgrounds
- View font examples without installing
- iDesigner application to choose fonts for you
- Anti-aliased file export (Sprite & GIFF)
- Turn font groups on or off from DrawWorks
- CMYK grey component compensation
- Font catalogue printing
- Spiral text tool & kerning of outline fonts
- PostScript™ font names database
- On-line font dictionary
- Easy to use installer application
- Quick and easy access to Draws features
- Auto-grouping of objects
- Hierarchical toolbar with grouped tools
- Tear off object tool bar
- DrawTrix image effects processor
- Produce Isometric 3D projections easily
- Bend objects and text round circles
- Fit objects and text into pre-defined moulds
- Make and keep your own mould designs
- Save custom effects for different tools
- Configurable undo buffer
- Set default font for new documents
- Full control over Draws preferences
- Spot colour separate sprite files
- Easy to use and quick to master
- The professional choice for graphic design
- Tested on Risc OS 4 (pre release version)
- Over 440Mb of applications, fonts & clips
- Requires OS 3.1+, 4Mb Ram, CD-ROM

DrawWorks Millennium Pricing

Single user copy £61.50
Site licence copy £121.50
Upgrade* from DrawWorks Designer £31.50
Upgrade* from DrawWorks2 £41.50

Upgrade* from Mr Clippy £31.50
Upgrade* from Dr Fonty £31.50
Upgrade from Typography 2100 £31.50
Site licence upgrade* from DrawWorks Designer £61.50

*upgrade requires the return of the original products master disk and original products site licence if upgrading from site copy of DrawWorks Designer

All quoted prices (unless stated) are for single users versions only. Special offers relate to single user versions only. Offers valid till end Aug 1999

Overseas orders please add £2.00 carriage

All details correct at the time of going to press E&OE
NDT & Typography are trademarks of iSV Products. All other trademarks are acknowledged
This advert was produced using NDT fonts from
Typography 2100 & DrawWorks Designer

iSV Products

iSV Products
86 Turnberry • Home Farm
Bracknell • Berks • RG12 8ZH
Tel 01344 455769

<http://members.aol.com/isvproduct/>

DrawWorks Millennium

As I described last month, iSV are upping the vector design stakes with a new version of their *DrawWorks* software. *Millennium* combines a whole range of new functionality with the rather dated *Draw* application, and seeks to bring it all up-to-date for the modern RISC OS user. iSV's app tags itself onto *Draw* in an effort to patch up its many interface inadequacies, while providing an extended range of features.

This difficult task is fulfilled rather well by *Millennium*, and it's certainly easy to pick up for a new user – a vital feature of only the best software. The basic system of offering toolbar icons for all those hard-to-reach menu features hidden away by *Draw* works well, but you have the distinct impression this is just a patch for *Draw*. You still have to use the select tool to highlight an object before you change its style, a far cry from the excellent drag and drop of the forthcoming *Cerilica Vantage*.

Similarly *DrawWorks* goes only part of the way in dealing with the more complex print abilities of *Vantage*. However there's still a good range of features with fairly

comprehensive import and export, and an attractive number of special effects.

On top of the basic application you also get a whole range of extra goodies bundled onto the *DrawWorks* CD. The excellent font editor, *Dr Fonty*, is accompanied by the usable, but rather silly, *Dr Clippy*.

There's also a good stock of fonts and PD sourced clip-art to get you going. This really makes a complete package and is a great way for beginners to get started with just one purchase.

DrawWorks Millennium is a very usable package and if you liked the original *DrawWorks Designer*, or would like to keep your vector editing simple with an extended version of *Draw*, then this is the right purchase for you. At the end of the day however, *Millennium* is still only a patch for *Draw*. Full functionality (and hopefully ease of use) for a vector package can only be found in *Cerilica Vantage*.

DrawWorks Millennium is available from iSV for £60 or via upgrade from *Designer*, *Mr Clippy* or *Dr Fonty* for only £30. Contact iSV on 01344 455769.



In brief

Digital knowledge

Cadmium Systems have launched an interesting introduction into the use of digital images. Despite being aimed broadly at the Mac market, 'Understanding Digital Images' provides a useful guide to digital source imagery that's still very applicable to RISC OS users.

It'd be nice to see a Web page, or more comprehensive guide, taking this introductory pamphlet further, but whether you're interested in royalty free images for DTP or digital artwork I'd recommend getting hold of this free guide. Simply call Cadmium on 0800 436867.

TopModel news

The Wakefield show was one of the biggest events in the Acorn graphics calendar in recent years. On top of the several major packages which were launched by companies like Cerilica and iSV, Spacetech released the third TopModel CD-ROM.

Featuring the same combination of 3D objects, textures and 3D fonts for use with TopFont, this is another handy resource for users of the premium RISC OS 3D modeller.

Even better is Sincronia's latest addition to the TopModel suite; TopBones. The plug-in is a skeleton management system, and according to Spacetech '...allows you to insert skeletons into models and move the whole structure by moving the single bones. It greatly enhances the positioning of models and can be automatically used by the (forthcoming) animation suite, TopMotion'. I'll be looking at TopBones in more detail next month.

Contacting me

Keep those Picture of the Month entries coming in for a chance to win a copy of Cerilica's Phantasm application and have your artwork in print. You can contact the Graphics page by writing to me, Paul Wheatley, at Acorn User, Tau Press Ltd, Media House, Adlington Park, Macclesfield, SK10 4NP. Or preferably, by e-mail to graphics@acornuser.com

The Acorn Software Network

BUSINESS AND UTILITIES

Ant Internet Suite II	110.51
ArcFax	35.00
ArcFS2	29.37
ARCshare	49.95
Artworks	104.69
CD Burn	58.75
Complete Animator	94.05
DataPower 1	110.00
DataPower 2	166.32
DaVinci 90	81.08
Digital Symphony	56.95
Disc Doctor	28.45
Disc Rescue	45.00
Draw Works Designer	31.50
Easy C++	116.32
EasyFont Pro	59.95
Eureka 3	110.51
FastSpool+	17.62
Fireworkz Pro	166.31
Font Directory Pro	65.00
FontFX6	29.95
Game On! 2	15.00
Holy Bible (Illus.) BP(KJV)	82.25
HTML Edit 4	53.00
ImageFS 2	44.59
IMaster & TWIN Driver	35.00
Impact Pro	139.53
Impression Publisher	136.41
Impression Style	83.54
LanMan98	41.12
MelIDI	129.00
MIDI Synthesizer	46.94
Midi Works	151.95
OHP (Presentation)	29.95
Ovation Pro	158.62
P'rille port Zip driver (Argo)	34.08
PC Pro2	39.00
Personal Accounts V4	49.00
Photo Link	65.55
Photo Real (Canon/Epson)	65.86
Photodesk 3	299.50
ProArtisan 24 (RPC Only)	89.95
Prophet 3	179.77
Rhapsody 4	94.95
Schema 2	121.50
Sibelius 6	116.00
Sibelius 7	599.00
Sibelius 7 Student	345.00
Sleuth 3	116.32
SparkFS	25.00
StrongGuard	25.00
Studio Sound	113.95
Tablemate Designer	60.00
TopModel 2	145.11
TurboDrivers (Can/HP/Eps)	54.69
WebSpider	40.00
WebTool for ANT Suite 2	29.38
WIMP Basic	44.99
Win95FS	41.12
XStitch 2	35.00

EDUCATION

Animated Alphabet, Talk	33.43
Arc Venture (various)	39.01
Aztecs, Age 7-11	50.17
Calabash Pirates	25.98
Crystal Rain Forest	50.17
DataSweet 3	69.33
Dazzle +	83.71
Dinosaurs (10/10)	13.49
Doodle	32.37
English (10/10)	13.49
Essential Maths (10/10)	13.49
Essential Science	13.49
Expl with Flossy the Frog	28.79
First Logo	38.95
Freddy Teddy's Adventure	23.50
French (10/10)	13.49
Fun School 3/4 (various)	24.99
Geography (10/10)	13.49
German (10/10)	13.49

Granny's Garden	28.79
James Pond Run. Water	27.00
Maths (Geometry) (10/10)	13.49
Maths (Number) (10/10)	13.49
Mega Maths	24.99
Micro Maths	24.99
My World 2 + 2	54.70
Naughty Stories Vols 1-6	44.65
New Teddy Bear's Picnic	36.78
Nursery Rhyme Time	33.43
Oxford Reading Tree 3	44.65
Pendown DTP	65.85
Playdays age 3-8	23.40
Playground (Freddy teddy)	23.50
Smudge the Spaniel	25.98
Spelling & Punctuation	13.49
Splosh+ (1-5 users)	51.70
Table Aliens	27.85
TinyDraw/TinyLogo	29.37
Tizzy's Toybox	47.94
Watch Magic Grandad	30.13

GAMES

Alone in the Dark	34.99
Anagram Genius	20.00
BHP Brutal Horse Power	28.49
Birds of War †	30.00
Black Angel	30.00
Carnage Inc.	22.50
Chocks Away Compend.	25.00
Cobalt Seed	23.74
Crystal Maze, age 7+	28.45
Cyber Chess	31.50
Darkwood	20.70
Demon's Lair	20.00
Drifter (DD/HD)	31.50
Dune II (CD - £31.50)	26.60
Dungeon †	27.00
E-Type 2 †	30.00
Eclipse Collection	22.49
Enter the Realm	25.00
Exodus	25.00
Fire and Ice	23.39
Global Effect	27.00
Groundhog	12.00
Haunted House	25.00
Holed Out Compendium	20.00
James Pond 2+	16.20
Logic Mania	27.00
Morph	25.00
Pandora's Box	25.00
Patience Addict	19.95
Play It Again Sam 3	24.95
Play It Again Sam 4	35.00
Real McCoy 2/3/4 (each)	35.00
Real McCoy 5	31.50
Rick Dangerous	15.26
Saloon Cars Deluxe	31.50
Scrabble	26.59
Shuggy	25.95
Shovy 3D	20.00
Silver Ball	12.00
Simon the Sorcerer	27.00
Small †	21.20
Spobbleoid Fantasy	30.00
Stereoworld	22.50
Stuntracer 2000 †	35.00
Supersnail	25.00
The Time Machine	25.00
Virtual Golf	31.50

CD BUSINESS & UTILS

Arm Club PD CD 1	19.00
Arm Club PD CD 2	15.00
Artworks ClipArt 1 or 2	20.08
Bitfolio 7	42.74
Font Emporium	29.95
PDCD4 (Datafile)	15.00
PDCD5 (Datafile)	15.00
ProArtisan 2	98.93
Risc Disc Vol.1	15.00
Risc Disc Vol.2	20.00

Risc Disc Vol.3	25.00
Rob Duncan Cartoon Kit	42.74
Task Force Clip Art	33.20
Tekkie Disc (PRM's etc)	47.50

CDROM EDUCATION

Ancient Egyptians	42.30
Ancient Lands	50.53
Anim Talking Alphabe	33.43
British Isles from the Air	42.30
Castles	42.30
Crystal Rain Forest 2	50.17
Dangerous Creatures	50.53
Dinosaurs	50.53
Era of the 2nd WW	81.08
Garden Wildlife	42.30
Guardians of Greenwood	58.16
Hutchinson's Encyclopedia	52.82
Illustrated Shakespeare	29.32
John Cabot & Merchant V.	42.30
Kingfisher Micropedia	76.38
King Arthur	58.69
Kiyeko with Acorn reader	36.43
Map Detectives	50.17
Musical Instruments	50.53
My 1st Incred. Amaz. Dict.	41.13
Number Time 2	28.99
Oxf. Talking Infant Atlas	22.32
PB Bears Birthday Party	41.13
Perspectives Francais	81.08
Romans	42.30
Science Explorer	66.96
Seashore Life	42.30
Science In Action	13.73
Settlements	81.08
Space Exploration	13.73
Survival: Mysteries of Nat.	42.30
The Way Things Work	50.53
The World's Weather	52.87
Tizzy's Toolbox	44.65
TOTS TV	19.95
Ultimate Human Body	50.00
Understanding the Body	42.30
Vikings	42.30
World of Robert Burns	93.94

CDROM GAMES

Abuse	25.00
Ankh	25.00
Crystal Maze	28.45
Doom Trilogy	35.00
Dune II	31.50
Heroes of Might & Magic II	35.00
Simon the Sorcerer	32.40
Syndicate	29.00
Wizards Apprentice	24.95

1500 titles Available!!

Some dealers may not stock all titles

Minimum delivery £ 2

Credit Cards and Official Orders welcome. E&OE

All Prices Include VAT @ 17.5%

Special Offers on Longman software Up to 50% off!

Eureka 3

Powerful yet easy to use spreadsheet package

RRP £116

Offer Price £55

Notate

Exciting and interactive music notation for children.

MIDI compatible.

RRP £73

Offer Price £35

Pendown

The easy to use word processor. Talking, DTP & French versions available

RRP £45 - Offer £35

The Big Picture

RRP £85

Offer price £35

Advantage, FirstLogo, Magpie & Rainbow also on offer

Key :

NRPC Not for RPC

† Separate RPC version

Many titles abbreviated for advert

Order from a participating dealer

Davyn Computer Services

Tel 01924 254800 Fax 01924 254036

email sales@davyn.demon.co.uk

The Data Store

Tel 0181 460 8991 Fax 0181 313 0400

email sales@datstore.demon.co.uk

CTA Direct

Tel 01942 797777 Fax 01942 797711

email sales@cta.u-net.com

Uniqueway

Tel 01222 464020 Fax 01222 440071

email sales@uniqueway.co.uk

Liquid Silicon

Tel 01592 592265 Fax 01592 596102

email liquid@cableinet.co.uk

CJE Micro's / NCS

Tel 01903 523666 Fax 01903 523679

email sales@cje.co.uk

Top marks for MyBookmarks

MyBookmarks is a free Web-based store for your personal hotlist or bookmark list. By keeping your online list up-to-date, you can access your favourite sites when you're at home, round at a friend's house, in the office or at school.

When you've registered with MyBookMarks.com, by giving your name, location, country and e-mail address, you choose a user name and password. You can then start entering your bookmarks.

Fortunately, although the default screens use Javascript to select functions, there is a no-frames option that works quite well with standard versions of *Fresco* and *Browse*.

URLs and their titles are entered into form fields and their locations chosen within folders by setting buttons on a graphical

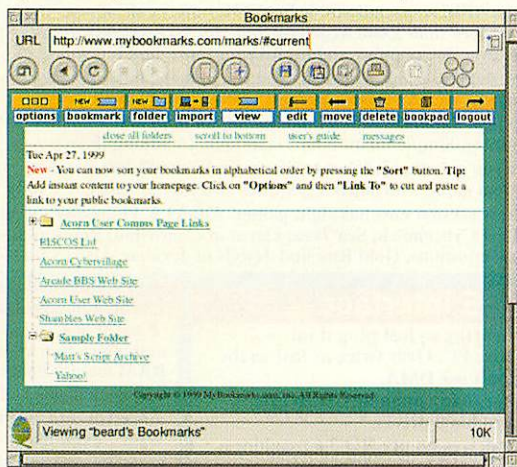

directory display. You can perform all the usual create, move and copy functions within the MyBookmarks Web file.

import-list-from-browser function does not appear to work with *Fresco* or *Browse* though.

MyBookmarks provides a very useful facility for teachers who can create bookmarks for specific teaching topics, these can then be accessed by their students from any machine in

school. The system is ideal for users who do not always sit at the same machine, or use machines with differing browsers.

MyBookmarks

<http://www.mybookmarks.com>

In brief

HTMLTidy sorted!

Since I reported that W3C guru Dave Raggett's HTMLTidy tool, for checking and correcting HTML source code, was ripe for an Acorn conversion, two versions have been ported to RISC OS. Justin Fletcher and Iain Truskett have each produced RISC OS desktop versions that correct and tidy up sloppy HTML coding, and produce neatly laid-out source listings.

Iain Truskett

<http://koschei.shada.com/software/tidy-15apr99.zip>

Justin Fletcher

<http://www.thevillage.ndirect.co.uk/justin/tidy.html>

History of Lenny

Cyber Druidery is the unexplained sub-title of the Somascape and MIDIways Website of Lenny. The MIDI index leads to useful specifications of general MIDI, instrument mapping, the RISC OS-specific MIDI interface, and MIDI file Websites. Other downloads include Historian, a utility for ANT *Fresco* Web browser users. By viewing and editing the *Fresco* history file, the program allows you to retrace your steps online where you forgot to bookmark.

Somascape

<http://www.argonet.co.uk/users/lenny/index.html>

Goodbye Arctic

Steve Pursey finally closed his West London Arctic BBS at the end of April. Arctic has contributed much to the Acorn BBS scene in the last six years. Steve started in May 1988 with a Viewdata BBS system on a BBC Micro, and graduated to an Archimedes A410/1 in 1993 when Arctic BBS was born.

Due to users' increasing interest in the Internet, Steve has decided that it's time to move on. We wish Rose and Steve good luck and good surfing.

It's important

It's easy to forget that there's a potential readership of millions for the words that we casually toss onto our Web pages. First impressions *do* count, and the way words are written say as much about the writer as do the words themselves.

In the old days of movable type, compositors and printing presses, spelling and grammatical errors in published works were quite rare – everything was proof-read several times by different readers before finally going to press. Web publishing is now done instantly, and such errors are easily missed when we alone check our own work.

One famous grammatical hobby horse of mine is the correct use of "it's" and "its". It's

easy to get right when you realise that "it's" is only ever used as a contraction of "it is", (or possibly "it was" or "it has"). It should never be used as the possessive form of "it" which is always "its".

Use "its" to refer to a property of a grammatically neuter object, as in the statement "My computer has lost its settings". "Its" belongs to the same set of possessive pronouns as "his" and "hers". Don't be confused by the use of the possessive noun in a phrase such as "David's computer has lost its settings". Also note there are no plurals that can ever take an apostrophed "s", so a sentence containing "the greengrocer's cabbage's" is quite wrong.

Contacting AU

Keep sending me interesting URLs for the next yoUR List by e-mail to david@arcade.demon.co.uk, or mail #2 on Arcade BBS 0181 654 2212.

3.5" IDE Hard Discs

Drive	Plus	i/face
210 Mb	£39	£81
420 Mb	£49	£87
540 Mb	£59	£107
1.2 Gb	£72	£119
2.1 Gb	£93	£140
2.5 Gb	£97	£144
3.2 Gb	£99	£146
4.2 Gb	£107	£154
5.1 Gb	£116	£162
6.3 Gb	£117	£164
8.2 Gb	£127	£174
10 Gb	£151	£198
12.7 Gb	£169	£216
18.8 Gb 5¼"	£229	£276

'Plus i/face' price includes an APDL fast IDE interface.

Part-exchange available if you need a bigger drive. Please phone for prices.

2.5" IDE Hard Discs

	A3020	3010/3000
30 Mb	£36	£79
60 Mb	£45	£93
80 Mb	£49	£97
120 Mb	£58	£106
170 Mb	£67	£115
210 Mb	£74	£122
250 Mb	£81	£129
330 Mb	£87	£137
420 Mb	£96	£144
512 Mb	£109	£157
1.4 Gb	-	£168
2.1 Gb	-	£187

A3010/3000 includes APDL IDE interface, A3020 includes fitting kit. Larger sizes and HD+CD available.

SCSI Hard Discs

210 Mb		£29
420 Mb h/h		£49
1 Gb		£74
4.2 Gb h/h		£149
4.2 Gb		£165
8.7 Gb h/h		£279

'h/h' indicates half-height approx 1½ inches high, others are 1" high.

IDE CD ROM drives

Internal

Drive with all cables and drivers for RO 3.6+ where required

36x	£47
40x	£49

Drive including APDL IDE interface

36x	£94
40x	£96

External

Drive in case with power supply and including an APDL IDE interface. Probably the best way to fit a CD to a pre-RISC-PC machine.

36x	£151
40x	£153

CD ROM driver software

Works with most ATAPI CDs eg. Pioneer Goldstar, Panasonic, Lite-on, Mitsumi, Sony, Hitachi, NEC, Toshiba, Sanyo, etc. Includes CDFS for use with RO 3.5. Intended for RPC but can be used with an A5000. Only £8 or £7 with a drive

RiscPC and A7000 RAM

8 Mb	£8
16 Mb	£27
32 Mb	£52
32 Mb High Clearance	£59
64 Mb from	£84
128 Mb from	£177
2 Mb VRAM	£69
1 Mb to 2 Mb exchange	£47

Datafile PD CDs

PD CD - 3	£6.50
PD CD - 4	£8.50
PD CD - 5	£6.50

Various games

Emotions (RPC only)	£14.95
Flying High (RPC only)	£14.95
Fire and Ice (not S/Arm)	£8.50
Hero Quest (not S/Arm)	£7.50
Quest for Gold	£6.00
Starfighter 3000	£10.00
Revelation (not RPC)	£3.50

Public Domain, Shareware and other low cost hardware and software for Acorn computers



APDL

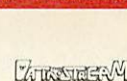

Prices include VAT and UK carriage except hard drives add £5 for internal drives, £8 external. This is only a fraction of what we have available. We also have thousands of discs PD and Shareware and around 500 discs of Acorn format clip art. For a full catalogue on 800K or 1.6Mb disc please send 50p or two 1st class stamps or see our web site.



APDL, 39 Knighton Park Road, Sydenham, London SE26 5RN

Phone: 0181 778 2659

Fax: 0181 488 0487

www.apdl.co.uk/



APDL Public Domain, Clip Art and other CDs

- APDL PD-1** The best PD CD from the best PD library. Over 1,800 programs and utilities, more than 100 novels, etc. No games, clip art, music, or other non-serious stuff. **only £12.50**
- APDL PD-2** Around 700 games and novelties, over 250 games cheats and over 200 demos, plus over 2,000 music files and more than 550 digitised sound samples. **Both for just £22 only £12.50**
- DTP-1 and DTP-2** Each have over 500Mb of clip art files, all ready to use in Acorn Draw, Sprite or Artworks format. Ideal for use in education. **only £9.90 each**
- DTP-3** The third highly acclaimed APDL clip art CD. More than 720Mb of material. Great for schools or anyone who needs a huge collection of clip art at a sensible price. **only £17.50**
- DTP-1 plus DTP-2 plus DTP-3, just £34.50**
- DTP-4** Our new clip art CD. Over 12,000 clip art files, plus more than 400 Artworks files and 170 high quality colour pictures. All catalogued and complete with thumbnail images. **only £19.50**
- Games CD 1** A collection of twenty of the best PD games of all types. Ready to run direct from the CD on almost any machine. Hours of fun for an unbeatable price. **only £7.90**
- Games CD 2** Our Games Collection No. 1 CD was so popular we've done it again. Another twenty of the best best games at a real budget price. **only £7.90**
- Skullsoft Collection** A great budget priced games CD from APDL. Full versions of three popular games from Skullsoft, !Arya, !Xenocide and !Plig **only £9.90**
- Soft Rock Collection** Six classic games from Soft Rock Software, plus a new version of !Trellis, the adventure game creator/interpreter with two adventures **only £9.90**
- Fantasy Pictures** By request from our customers, the pictures from the Fantasy section of the APDL catalogue. Lots of Sword 'n Sorcery pics and many others **only £7.90**
- Education Resources** A CD from APDL especially for schools. Has all the things we know you want. More than 5,000 Acorn format clip art images, hundreds of e-texts, over 300 popular and useful programs, and lots more. **£16.50**
- Earth in Space** Pictures, databases, information on stars, planets, moons, space missions, etc. etc. A massive amount of data at a realistic price. **Ten for just £79**
- Earth Data** Geographical database with a huge variety of data and statistics on every country. Simple menu-based interface. Including !Earthmap **only £9.90**
- Wizard Apprentice** Have you got what it takes to become a Wizard? 100 levels of this great game with superb graphics and sound. RISC-PC only **£14.95**
- Generation Design collection** New version now has eight games. AlfaXL5, Pharaohs Secret Tombs, Last Cybermoch, Sea Trek, Caves of Confusion, Robocatch, and two new additions, Gold Run and Jewels of Jezabar. Also available on disc. **£16.50**

APDL ideA fast IDE interface

- No complicated setting up. It's self-configuring so just plug it in!
- Uses DMA (Direct Memory Access) on Risc PC. Over twice as fast as the built in IDE interface or others which don't use DMA.
- Includes CDFS and ATAPI CD drivers for many popular CD ROMs.
- Four devices, any combination of CDs and hard drives.
- Up to 8 partitions, so you can have large drives on pre RO 3.6 machines
- Software in flash EEPROM for easy update (including VProtect).
- Supports the new range of Syquest SparQ low cost 1Gb removable drives.
- Connectors are available for external drives or CD ROMs
- Fits A310, A400, A5000, A540, A7000 and any RiscPC.

All these features for the incredibly low price of just £52

A version for the A3000, A4000, A3010 or A3020 is available with all the above features. Supports two internal and two external devices - **£62**

APDL Paralell Port Syquest drive

The 1Gb SparQ drive is the ideal solution for backing up larger hard drives where old technology like a Zip drive just isn't realistic. Big enough to hold lots of data, and with our software you aren't restricted to just RISC-OS 3.6+ but can use it on any machine with a bi-directional printer port including the A5000, A3010 etc. as well. With Acorn and DOS driver software. just **£199**

Ancestor +

We've promised it before, but it's available at last! The long awaited successor to Graham Crow's highly popular genealogy program Ancestry, previously sold by Minerva. Upgrades from Ancestry 1 and Ancestry 2 available. Can use Ancestry 1 files and we're working on a converter for Ancestry 2. Only **£59**

ACE 586 PC cards

Available with 128K cache from just **£199** or 512K cache from **£299**. We can offer a trade in against your old card, which makes it even cheaper. Good performance for Windows at a sensible APDL price.

General software

Faster PC - £20 The alternative XT PC emulator. Works on any model with 2Mb RAM from A3000 to Strong ARM RPC.

PowerBase - £15 Popular extremely powerful but very easy to use database. With examples, tutorials and printed manuals. Better than most products costing many times the price. Does everything that 99% of database users will ever need.

MenuBar - £15 The very best pull-down menu system. An absolute essential for any hard disc user. You can switch between up to 30 different menu bars. Incredibly easy to set up, add items to menus, move them, etc.

Tiger - £15 Lets you use very long descriptive filenames. Unlike some products this is very robust as it works in parallel with the filer so can't corrupt discs.

WorkTop - £15 Switch between up to 30 different environments with a single mouse click. Stars the tasks you require, opens directories, loads files, changes screen mode. Just like moving to another computer. An essential productivity tool.

Joy Connect joystick podule

Works with most games. Podule with one joystick **£42** Extra joysticks **£6** each.

Connect 32 fast SCSI

We have a limited number of these very fast interfaces (up to 7.5 Mb/sec) at only **£109**

Data Safe - A new concept in backup and data security

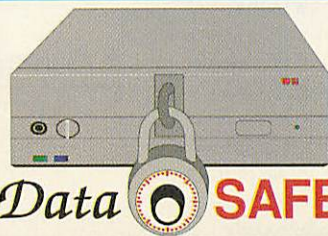

A new idea from APDL, Data Safe consists of an external case to hold a 3.5" IDE hard drive, connected to your machine's printer port. This gives a large capacity portable drive, movable between machines and locations. Ideal for backup, secure data storage and transport. The filer has all the features of our ideA card so you can partition drives, password protect partitions, etc. Great for schools. Supply your own drive or we'll fit one for you.

Data Safe Super has the drive fitted in a removable drawer. You can fit a similar drawer to your Risc PC (best if you use our IDE card) and then just unplug the drive from the RPC and transfer data to another machine using the Data Safe.

Prices start at **£104** or with a 3.2Gb drive from just **£199**

PD direction

Bob Ardler continues our discussion of the future of PD on our platform with a withering but balanced attack on overly complex programs.

There is a rich vein of PD not accessible to ordinary users. I mean those apps which are way harder to use than their help files or manuals allow for. Zap in its latest incarnations suddenly became inscrutable until James Aylett produced a superb help file, making a complex program immediately usable, and giving non-techies hope of learning some of the clever stuff. There are commercial programs with a PD fringe to them – things like applets and vixen, written by clever enthusiasts. This fringe should help to keep RISC OS alive; but not if ordinary users can't make sense of the docs.

The biggest no-go area contains those tantalising ports of enticing PD apps from alien platforms. Many of them, like GNU and Unix ports, come from a command-line environment. To use them you need to know more about file, directory and path layout and the command-line, than a RISC OS user should have to.

RISC OS people expect a very simple drag-and-drop installation process, not a morning spent threading a labyrinth of files; thereafter we want a simple life with mouse and keyboard in the happy Acorn

way. Something is badly wrong if you have to *Dir SkuBedu or take the app by its little hand and show it where to find the library.

Some of these ports have been done by Unix-dwelling students and teachers, still sentimental about their Acorns, still sentimental about their Acorns. In a good mood they may write a 'Wimp front-end'. Then they distribute it to like minds, and move on to another world. You want documentation? Use the original GNU docs. Er, Acorn documentation? Why, sure. Download the source any time you like.'

There was a plaintive letter in Archive from Bill Richardson, asking how to make *TeX* work. He's the man who uses *TechWriterPro* to produce the *Mathematical Gazette*:

'A while ago if you got an article in *TeX* you could drag it to the *TeX Wimp* front end (Datex), convert it to DVI form and view it with Paul Field's superb *DVIview*. But you can't do this with the new version of *TeX*. It's reverted to command-line or task window use, and I haven't got it to work yet.

'Suppose you're not a programmer, but still need to write simple programs. Well, Griswold's excellent *Icon* is flourishing in version 9, but the Acorn port is by Giovanni Lo Conti, whose English doesn't stretch to a help file. So

you have to choose between v8 with a memory fault and v9 without Wimp access. Suppose you're doing a computer science course and you want to do your homework on your Risc PC.

You've got Acorn ports of Bison, Flex, Gawk, XLisp, Scheme, Perl, GNU C++, GNU SmallTalk. Riches indeed, were they not hopelessly documented and a nightmare to get going. I don't know the answer to this problem of PD documentation. Kidnap James Aylett and set him to work? Persuade Acorn mags to do articles on PD packages?

'Add in the commercial apps (no names) whose upgrades have left their docs prohibitively out of date and you have a waste of great software.'

I really have to agree with a lot of what Bob has to say. The reason we use RISC OS is because it's easy, fast and efficient to use. If we're to keep the advantage that our platform offers us, we have to match the usability of the OS with the quality of the apps and utils we run on it. But for me, reams of documentation is a weak solution. The way forward is good interface design in programs which you can pick up and put into use straight away. I'd love to hear your views on the future of Public Domain software within the changing RISC OS market of today, so please get in touch at the usual address.

Utilities update

FishMPEG is a simple desktop front end for playing audio MPEGs with Peter Teichmann's audio MPEG code. Straight forward and with plenty of potential for development, keep checking the web site for updates. Browse to <http://www.fish.zetnet.co.uk/>

FreeMem the essential clock and free memory display program by Liquid Silicon has been updated with a minor bug fix. There's a lot of these programs around, but Liquid Silicon's still remains the best supported and most tastefully designed. Download

it from <http://www.cybervillage.co.uk/acorn/liquid/download/>

WinDragFix patches a problem with RISC OS that stops multi tasking when you drag a window with panes. The patch can be found on author Matthew Bullock's Web site at <http://dialspace.dial.pipex.com/matthew.bullock/>

VideoPlus performs the somewhat unusual task of decoding Video Plus numbers to reveal the actual times and recording details. Why you'd want to do this on your computer I'm not quite sure, but author James MacDonald is planning

to have an encode version on his Web site very soon. Check out <http://www.netbook.demon.co.uk/vp100-pr.zip>

HTMLTidy is a ported application that parses HTML files and, perhaps not surprisingly, tidies them up. The idea is to sort out sloppy handwritten code or to make that ridiculously over-complicated editor-sourced HTML into something a bit easier for the average human to understand. Bit temperamental, but worth experimenting with if you have to edit other people's HTML. The Tidy Web site is at <http://eh.org/~koschei/software/tidy.html>

Codecraft

At the time of writing the Codecraft, 1 and 4K coding contest is still going strong. The 1k contest has seen quite a few entries already, which are well worth checking out. Among the chunks of code entered are a couple of interesting sound modules from David Gamble including a rather nifty echobox effect.

The graphical entries seem to be coming out on top so far however, with Paul Thompson of DFI entering a psychedelic zooming effect, David Gamble with a fading letter zoom and an ingenious maze game from Tony Haines. My favourite so far is Alain's *WimpLife*, providing an excellent version of *Conway's Life* game, complete with several interesting starting

points. But for some reason, I just can't wait for Paul Thompson's 4k web browser...

Of course, the entries are great to try out and enjoy, but the real value is the supplied source code. This is a great way to learn from the best coders on the scene and to encourage new coders to start off. Full information on the contest at

<http://www.cybercable.tm.fr/~brooby/code.htm>

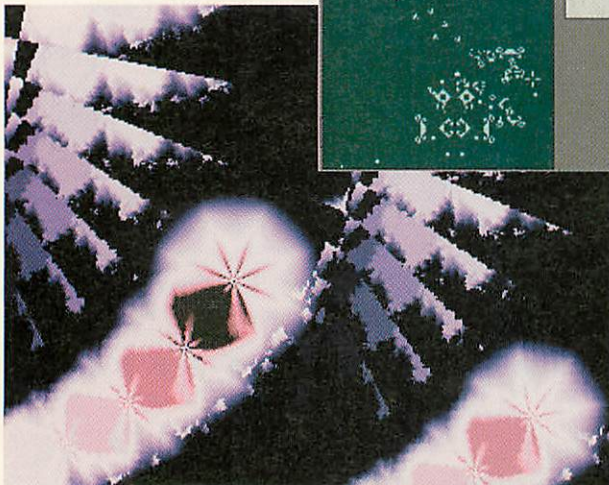
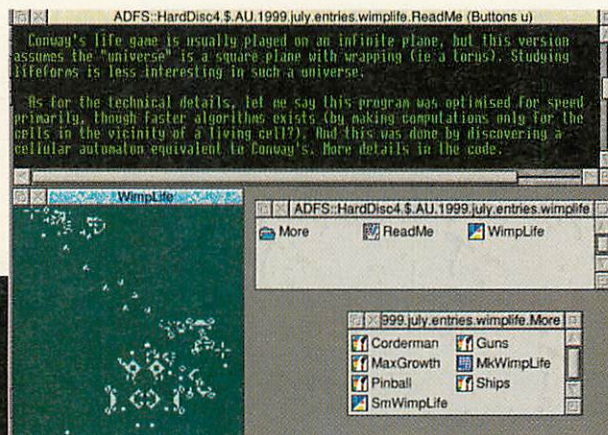

In brief

Evolution ending

The closely fought Evolution demo contest has finally come to an end with the official announcement of the Nutters as the overall winners for their entry: *Zero*.

Congratulations to the team for a fantastic production that narrowly pipped DFI's *K2* to the top spot. Both of the top entries have really taken RISC OS demos to a new level of both programming quality and amazing design.

I think the element that really pushed the Nutters into the lead was the stylish design and production (the award for which they also took) demonstrating the importance of a central theme. The best coder award unsurprisingly went to Paul Thompson of DFI who again demonstrated a fantastic technical knowledge but applied it with a good design sense.

The Best Musician was voted in as *Knackered Amp* of Divine Nature and the Best Artist category was won by your very own PD editor, for the bitmap-laden *Mobius*. The winner of the reader's and voter's prize was Mr Andrew Conroy, who bags a copy of the amazing new *Cerilica Vantage* vector design software worth £200.

Many thanks to Cerilica for the competition sponsorship and thanks also to all the readers who got involved and voted in the competition. The biggest shout however, goes out to all the teams that entered for their hard work and devotion to the scene.

Attacher

John Allen's *UUCoder* has been one of the best of a collection of UU encoding tools available on the Web for some time, but John has now replaced it with a fully comprehensive application by the name of *Attacher*. This new app does just about everything conceivable for a UU tool, including multiple file attachments and application to application dragging. Very handy. Point your browser to <http://www.bramber.demon.co.uk/john/soft.html>

Contacting AU

You can contact the PD page by e-mailing me (but no large files) at pdpage@acornuser.com

7 reasons why ArgoNet are the best:-

1st Packs for New Subscribers

Starter Packs come with three months unlimited online time and free phone support - there are no 'hidden' costs. Packs include everything, except the computer, needed to get online and stay online with ArgoNet.

2nd Get Online Starter Pack

This pack gets you online for the first three months to the full ArgoNet and ArgoSphere services. At £24.95 the pack also includes, if required, access software for Acorn, Mac or Windows.

3rd Surf at Speed Starter Pack

Complete with external 56K voice/fax/data modem, access software for Windows, Acorn or Mac and stereo headset. Includes three months online to ArgoNet's full 56K (V.90) service. Only £99.95.

4th Laptop Online Starter Pack

For Laptop users, this pack comes with a PCMCIA 56K fax/data card and access software for Windows. With three months online to the full ArgoNet 56K service, this pack represents incredible value at £129.95.

5th SuperSurfer Starter Pack

An ISDN pack with everything needed to get started for only £169.95. Includes a 128K external ISDN terminal adaptor, access software for Windows, Acorn or Mac and three months online to ArgoNet's ISDN service.

6th Domain Name & Web Services

ArgoNet deals direct with the naming authorities and provides full registration and Web site hosting services. Subject to availability, ArgoNet can register any name - let ArgoNet secure it before someone else does!

7th ArgoSphere for Children

ArgoSphere is ArgoNet's award-winning Website for children aged 3 and older. Can be used offline by children in complete safety in school or at home. Explore the latest educational activities on ArgoSphere free at www.argosphere.net.

ArgoNet's Internet Services

ArgoNet's Premier Service for home and business users includes 20Mb Web space and 5 e-mail addresses. For schools, the Education Online Service includes a free school domain, unlimited Web space for your school's use and unlimited e-mail addresses.

A subscription to ArgoNet includes full use of ArgoSphere the award-winning Web site for children, unlimited access with 100% local call coverage and free phone support. Subscriptions for dial-up modem or ISDN access are available monthly, 6-monthly or annually from only £10 (exc. VAT) per month.



Call FREE PHONE
0500 585 586
for information
and to order



New Computers

Acorn

Used Computers

£586
INC VAT

Acorn A7000+

Available
Now!

- k RISC OS 3.7i in ROM
- k 8MB RAM (max 136MB)
- k 1 year on site warranty
- 32x CD
- 8mb Upgrade
- k Floating Point Accelerator
- k 4GB hard drive
- k Easy Writer Pro software
- 14" Monitor
- 15" Monitor



A3010	2MB	1.6 Floppy	ARM250	£149.00d
A2020	2MB	1.6 Floppy	ARM250	£199.00d
A4000	2MB	80MB HD	ARM250	£229.00d
A5000	2MB	210MB HD	ARM3	£299.00d
RiscPC	8MB	425MB HD	ARM610 CD	£475.00d

All computers include Keyboard Mouse & 3months Warranty

New Monitors

Acorn AKF60	£159.00d
14" Digital SVGA .28dot	£99.00d
15" Digital SVGA .28dot	£119.00d
17" Digital SVGA .28dot	£199.00d
17" Digital SVGA .26dot	£219.00d
19" Digital SVGA .26dot	£349.00e

3 Years On Site Warranty

Tel: 01924 254800 Fax: 01924 258036

E.Mail: sales@davyn.demon.co.uk

For a full catalogue visit our web site

WEB: <http://www.davyn.demon.co.uk>

Used Monitors

Acorn AKF11/12	£99.00d
Acorn AKF17	£119.00d
Acorn AKF30/40 (swivel stand)	£129.00d
Acorn AKF18 M/S (swivel stand)	£99.00d
Acorn AKF60 SVGA (swivel stand)	£89.00d

monitor cables from £10.00
Other refurbished hardware available ie: interfaces, drives, PSUs, PCBs Etc: ring for details or visit our web site
All Used/Refurbished Hardware comes with a 3 Months RTB Warranty

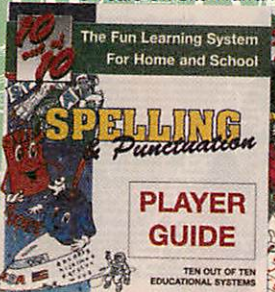

10 out of 10 Special Offer

Each £9.00a
Any 3 for £24.00a
All 18 for £69.00c

Dinosaurs, Spelling & Punctuation, Driving Test, English English a foreign language, Essential IT, Words, Ess. Maths Ess. Science, Early Essentials, Structured Spelling, French Geography, German, Jr.Essentials, Tables, Maths Algebra Maths Geometry, Maths Number, Maths Statistics

All are StrongARM Compatible



ALL PRICES INCLUDE VAT @ 17.5%

RPC Upgrades

A7000+ 16Mb EDO RAM	£29.00b
A7000+ 32Mb EDO RAM	£45.00b
RiscPC 16Mb RAM	£35.00b
RiscPC 32Mb RAM	£65.00b
RiscPC 64Mb RAM	£129.00c
RiscPC 2Mb VRAM simtec	£95.00c
A7000 Backplane	£29.00b
RiscPC 2 Podule Backplane	£34.00b
Access+ Card	£139.00c
Audio Mixer	£39.00b
Movie Magic	£279.00c
Risc OS 3.7 Chips + Software	£64.00b
Second Slice no PSU	£88.00d
Second Slice with PSU	£139.00d
Sound Card	£34.00b

Memorabilia

Acorn China Mug	£4.75a
Acorn Parker Pen	£4.50a
Acorn HTML Mouse Mat	£5.50a

Hardware Upgrades

3.2gb IDE 3.5" HD	£99.00c
4.3gb IDE 3.5" HD	£109.00c
6.4gb IDE 3.5" HD	£129.00c
8.4gb IDE 3.5" HD	£149.00c
32X CD Atapi	£39.00c
IDE DVD + Driver (Cumana)	£99.00c
Risc OS 3.1 Upgrade Chips	£30.00a
Oscar Parallel CD (Cumana)	£189.00c
RiscTV (Irlam)	£295.00c
Teletext module for above	£45.00a
SCSI 1 16bit (Cumana)	£99.00c
SCSI 2 32bit (Cumana)	£175.00c
TV Tuner + Teletext	£159.00c

All Upgrades fitted free if ordered with Computer else £18.00

CD Writer/Rewriter

Yamaha CDRW4416s SCSI	£299.00c
CD Blaze (Cumana)	£69.00c
CD Burn (WSS)	£58.00b
CD Gold writable x10 (Verb)	£15.00b
CD Disc rewritable each	£7.00a
External SCSI PSU Cases	From £90.00

Scanners

SPECIAL OFFER

Plustec OpticPro 9636p

A4 Colour Flatbed Scanner 600x1200 DPI	£99.00d
Scanner + PC Software	£99.00d
Above + Imagmaster/Twain	£129.00d
Epson GTX5500 scsi	£239.00d
Epson GT9500 para/scsi	£539.00d
Image Master/Twain Driver	£35.00a

THE CHOICE OF EXPERIENCE

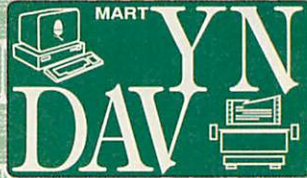

Davyn Computer Services

Printers

Canon		
BJC-250	(colour)	£109.00d
BJC-4300	(colour)	£139.00d
BJC-4650	(A3 colour)	£299.00d
Epson		
Stylus 440	(colour)	£129.00d
Stylus 640	(colour)	£179.00d
Stylus 850	(colour)	£289.00d
Stylus 1520	(A3 colour)	£639.00d
Hewlett Packard		
DeskJet 420C	(colour)	£99.00d
DeskJet 690C	(colour)	£149.00d
LaserJet 1100	(Black)	£329.00d

Spares & Repairs

A3010/A3020/A4000/A5000/A7000/RPC
1.6 Floppy Drive New Only £29.00
A300/A400/A4000/A5000/A7000/RPC
Power Supply Refurb/Exch £40.00c
We carry an extensive stock of new and used spares for all Acorn computers

PCs Built to Your Specifications

Why spend on a PC card when you can have a genuine PC for less money.
Using a Dual Data Switch Box share your monitor & keyboard.

Example PC:Q2	Example PC:Q1
ATX Mini Tower	ATX Mini Tower
AT 100MHz PCB	TX Pro II PCB
64 MB PC 100 RAM	32 MB EDO RAM
AMD K6-2 350 Processor	Cyrix 300 MII Processor
Heat Sink & Fan	Heat Sink & Fan
6.4 GB Hard Disc	3.2 GB Hard Disc
2nd IDE HD Rack	32x CD ROM
32x CD ROM	On Board Graphics
On Board 8mb Graphics	On Board Sound Card
On Board Sound Card	Monitor/Keyboard
160w PMPO Speakers	& Printer Data Switch
Monitor/Keyboard	Sony 1.44 Floppy
& Printer Data Switch	Mouse
Sony 1.44 Floppy	
Mouse	

£399.00

£499.00

No more Compatibility Problems !!



How To Order

Cheques: should be made payable to Davyn Computers
Credit Cards: you may also pay by Visa, Delta, Euro, Switch, Electron, or Master Card. We normally make no charge for this, and take no payment until goods are ready for dispatch. We need the card holders name, address and telephone number, card number an, issue number if any and the expiry date.
Carriage: charges are as follows
a Small Recorded £2.00
b Medium Recorded £3.50
c Med/Large Recorded £5.00
d Courier £10.00
e Courier Large £15.00

Official Orders: are welcome from UK education and government institutions (invoices are due for payment within 14 days and are subject to carriage and late payment charges).

VAT is included:

Order Address: please send your orders to:
Davyn Computer Services
'The Workshop'
off Princess Street, Sandal,
Wakefield, West Yorks. WF1 5NY
Opening Hours:

Monday	9.30 - 5.30
Tuesday	9.30 - 5.30
Wednesday	9.30 - 5.30
Thursday	9.30 - 7.30
Friday	9.30 - 7.30
Saturday	9.30 - 5.30

Terms: All products, prices and specifications are offered in good faith and are subject to change without notice. We Process all orders immediately, but suppliers do sometimes keep us waiting. Goods are guaranteed but are not supplied on approval. Returns and cancellations can only be accepted by prior agreement and there may be a restocking and administration charge. A full copy of our terms are available upon request. E.&O.E 26th March 1999

Contracting

Welcome to this, the third part of my series, on the joys of being a freelance computer contractor. In the previous articles I have outlined the advantages, and how to go about getting that all important first contract. So, an agency has made you an offer, you have met the client and got a start date – what do you do next?

At this point you have some serious decisions to make. I strongly recommend that you consider contracting as a Limited Company. If you do you will need to set that company up. The most cost-effective method of doing this is to use the services of an accountancy firm who specialise in computer contractors.

In this way you kill two birds with one stone; your accounting will be taken care of by specialists in the area, and you will probably get your company set up for free. A good accountant will easily save you their fees if they know what they are doing. It hurts to say

it, but a good accountant *will* save you money.

So, you have accountants and a limited company, registered with Companies House in your name. Strictly speaking you need a Company Secretary and this is where a *significant other* comes in useful. It also means that they can be paid either a wage or dividend, depending on their shareholding.

Now you need to change your mind set: You are *not* self-employed, you are a Company Director working for a company. You may *be* the company, but you need to start thinking about the business as separate from yourself. For example, you will be paid quite a small salary, probably up to your Personal Tax Allowance. The rest you will take as dividends for which you will pay Corporation Tax (20% in this tax year).

You will also pay Directors National Insurance contributions although these are quite low. Be careful here as the benefits are equally low. You will need to consider a Personal Pension Plan, Sickness

Insurance and a Health Plan. If you are in hospital, or incapable of working through illness or accident, who pays the bills?

Then there's VAT. Unless you are expecting a very high income for the company, you probably will not need to register for VAT compulsorily. But there are quite major benefits of registering, even if you are below the threshold. For a start you can charge VAT on your invoices, this will be paid and sits in your account earning interest for three months until the quarterly VAT return. You will be able to claim back VAT on goods and services paid for in connection with the running of your business. This can mount up to quite a sizeable amount on your monthly expenses.

For example, a major concession to contractors is that because they are considered to be mobile, they can claim a mileage allowance on journeys to and from a client's site. There is a two year rule, but even if the contract last, longer than two years there is no claw back. You cannot claim back VAT on the whole amount, but you can claim on that part which is deemed to be for petrol or diesel. Take my advice and register for VAT.

By the way, do not consider buying a car via the company or selling the car you own to the company or any other scheme in which you run a car via the company. It's not worth the effort and quite frankly company cars are now so heavily taxed that the disadvantages outweigh almost any advantage.

Although you have an accountant you will need to do a little simple book-keeping to provide the accountants with the figures on which to base VAT Returns, Tax Forms, Year end accounts, tax certificates, salary slips and so on. This is where your RISC OS machine comes in handy. A simple linked spreadsheet on which you record mileage on one sheet and transfer this to an expenses sheet with all your other expenses is all you need. Any spreadsheet package on the Acorn, for example, *Pipedream*, *Eureka* or *Schema* can cope with this undemanding yet vital part of running a successful business.

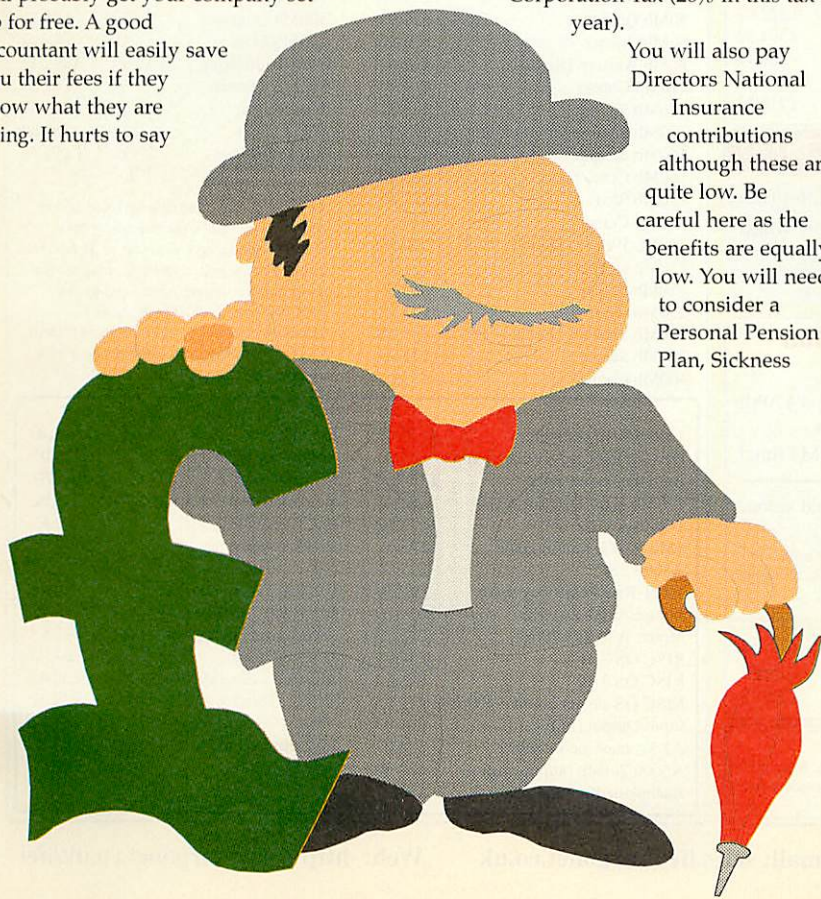



Est. 1984

**Hard drives from
only £11.75!**

Computer systems

RISC PC 233MHz, 4Mb, 1.7Gb	£949	We can build a system to match your requirements (eg extra memory or larger hard disc). Please ask for a quote.
RISC PC 233MHz, 4Mb, 1.2Gb, CD	£979	
RISC PC 233MHz, 10Mb, 1.2Gb, CD	£1249	
RISC PC Web Wizard	£1350	
A7000+ Peak Performer	£880	

Memory Lane

A310 4Mb*	£52.87
A400/1, per Mb	£23.00
A310 4-8Mb	£111.62
(Assumes machine has a MEMC1a)	
400/1 4-8Mb	£111.62
A3000 1-2Mb	£5.87
A3000 1-4Mb	£52.87
A3000 to 8Mb*	£116.32
A5000 2-4Mb	£47.00
A5000 4-8Mb*	£116.32
A3010 1-2Mb	£29.37
A3010 1-4Mb	£45.82
A3020 2-4Mb	£34.07
A4000 2-4Mb	£34.07
RISC OS 3.11	£29.37
MEMC1a	£41.12
*Carriage/fitting	£22.32

RISC OS 4	£116.32
Available soon.	

RISC PC, A7000/+

Use FPM for the RISC PC and A7000, and EDO for the A7000+

	FPM	EDO
8Mb	£13.51	£11.75
16Mb	£27.02	£23.50
32Mb	£52.87	£44.06
32Mb HC*	£66.97	--
64Mb	£116.32	£123.37
128Mb	£217.37	£217.37

*=High Clearance.

VRAM (RISC PC)

1Mb	£43.47
2Mb	£78.72
1-2Mb u/g	£47.00
1Mb*	£25.85
2Mb*	£45.82
1-2Mb u/g*	£29.37

*For non-StrongARM machines



RISC OS 3.70 only
£45.82

limited stocks

Hard discs

NB Check out the Bargain Box below!

2.5" IDE A3000 A3010 and A3020

170Mb	£57.57
210Mb	£76.37
340Mb	£81.07
510Mb	£96.35
810Mb	£135.12
1Gb	£141.00
1.3Gb	£139.82
2.1Gb	£152.75
3.2Gb	£164.50
The A3020 will require partitioning software for drives larger than 510Mb	£29.37

Other drive sizes available. Part exchanges considered.

3.5" IDE A4000 A5000, A300, 440/1

420Mb	£49.35
540Mb	£58.75
1Gb	£71.67
2Gb	£92.82
The A4000/A5000 require partitioning software for drives over 510Mb	£29.37

RISC PC/A7000

540Mb	£69.32
1Gb	£81.07
2.1Gb	£99.87
4.3Gb	£104.57
6.4Gb	£116.32
8.5Gb	£128.07

In order to use an IDE drive, the A3000, A3010, A300 and 400/1 machines require an IDE interface (i/f). The cost of this varies depending on the features required. Example price:
170Mb for A3000/A3010 inc. i/f **£92.82**

Not sure what's required to fit a hard disc? Confused by the different options? Just ask for our **free data sheet**.

£81.07

170Mb hard drive system. Suits any machine fitted with a backplane. Limited stock.

Printers

Epson	
Stylus 440 Colour	£128.07
Stylus 640 Colour	£151.57
Stylus 850 Colour	£245.57
Stylus 1520 Colour	£411.25
Stylus Photo EX	£351.32
Stylus Photo 700	£233.82
Stylus Colour 900	£351.32
Canon	
BJC250	£99.87
BJC4400 Photo	£175.07
BJC 4650 A3 Colour	£264.37
BJC5000	£233.82
BJC6000	£222.07
BJC7000	£205.62

Removable drives

Imega	
SCSI Zip ext	£99.87
Parallel Zip ext	£99.87
Software parallel zip	£29.37
SCSI Jaz 1Gb ext	£222.07
SCSI Jaz 2Gb ext	£304.32
100Mb Zip cartridge 10pk	£88.12
1Gb Jaz cartridge 3pk	£205.62
2Gb Jaz cartridge 3pk	£210.32

25MHz ARM3 £57.57

400 dpi A5 scanner (256 grey scale), suits any machine fitted with a backplane.
Only £34.07

A3000 & A5000

Special offers

A3000: Upgrade to 8Mb and 170Mb hard disc, £180.95
Add £52.87 to have an ARM3 fitted.

A5000: Upgrade to 8Mb and second 500Mb drive. £180.95

Other sizes of drive available. Offer subject to availability. Price includes collection, fitting and delivery. (UK mainland only).

Monitors

Iiyama	
15" Vision Master 350	£139.82
17" Vision Master 400	£311.37
17" Vision Master Pro400	£327.82
17" Vision Master Pro410	£363.07
19" Vision Master 450	£487.62
19" Vision Master Pro450	£527.57
21" Vision Master 502	£809.57
21" Vision Master Pro502	£809.57
22" Vision Master Pro510	£920.02

Other types of monitor available from around £100.

Spares & repairs

We can repair Acorn machines and supply/fit upgrades.

Switch boxes

2-way	£17.62
3-way	£19.97
4-way	£22.32

Guarantee

The warranty varies from one product to another, up to three years in some cases. Many items also carry our no-quibble 14-day money back guarantee. Please ask for details. Statutory rights unaffected.

Bargain Box

NB Many of the items in this section are second hand, and the list is constantly changing. Therefore please ring to check availability before placing an order.

3.5" IDE drives (Type, Qty, Price)			400Mb Seagate		
40Mb Seagate	3	£11.75	400Mb Seagate	2	£37.60
40Mb NEC	2	£11.75	450Mb Seagate	1	£38.77
50Mb Quantum	2	£12.92	500Mb Fujitsu	1	£41.12
60Mb Conner	1	£14.10	500Mb Quantum	1	£41.12
80Mb Western Digital	1	£17.62	500Mb Maxtor	1	£41.12
110Mb Conner	1	£19.97	540Mb Quantum	2	£43.47
120Mb Seagate	1	£23.32	850Mb Conner	1	£47.00
130Mb Seagate	2	£23.32	1Gb Seagate	1	£52.87
160Mb Seagate	2	£25.85	1Gb Fujitsu	2	£52.87
160Mb Conner	4	£25.85	3.2Gb Fujitsu	1	£84.60
170Mb Seagate	1	£25.85			
200Mb Conner	1	£30.55			
200Mb Western Digital	1	£30.55			
230Mb Conner	1	£31.72			
250Mb Fujitsu	2	£35.25			
250Mb IBM	2	£35.25			
250Mb Western Digital	1	£35.25			
260Mb Seagate	2	£35.25			
400Mb Conner	4	£37.60			

An IDE interface suitable for most of the above drives can be purchased for only **£29.37** when bought with one of the above drives. Larger units (>500Mb) may require partitioning software when used on pre-RISC PC machines. Please phone for details. A mounting bracket is an additional **£1.76**. Example price: 40Mb Seagate with interface and mounting bracket **£42.88**.

Various

1Mb A3010 computer	£125.00
Hewlett Packard SVGA monitor	£65.00
Both the above, only	£150.00
170Mb Hard Disc for A310	£81.07
1-2Mb A3010	£17.62
4Mb A3000 ram upgrade	£23.50
A3000 PSU	£17.62
400/1-Risc PC floppy drive	£23.50
Mouse A300-Risc PC	£14.10
Mouse A7000/A7000+	£17.62
RISC OS 3.11	£34.07
RISC OS 3.70	£45.82
RISC OS carrier board A300/400	£11.75
Input/Output (I/O) card	£34.07
A5 Scanner inc interface	£34.07
A5000 2-4Mb ram upgrade	£23.50
Backplane for Risc PC	£34.07

Various Cont.

Risc PC PSU (Second user)	£70.50
Alsystems SCSI 2 card	£175.07
PC Keyboard	£17.62
Keyboard encoder A300-A4000	£45.82
PLCC extraction tool	£2.35
ROM extractor tool	£2.35
56K modem	£69.32
Fan kit (300 series)	£8.22
Fan filters (pack of 5)	£3.52
486 clip-on cooling fan	£7.05
Dongle Dangle	£7.05
MEMC1a (Second user)	£16.45
VIDC (New)	£34.07
VIDC (Second user)	£8.22
IOC (Second user)	£8.22
ARM3 25Mhz	£57.57

Cover Disk

Caves

This nice little game is by Matthew Willson and is the second PD version. To quote from the Help file 'The game is a platform/space flight/obstacle course/shoot-the-aliens type game. There is no implausible plot line.

'You have to navigate over 40 levels of space caves in your ship, shooting aliens, robots, tanks, boomerangs, generators, bases, guns, and crumbly blocks'.

It's good fun and it also makes you think a bit, which is probably why I didn't complete level 1 this morning at the first time of asking. You'll wonder how I failed when you have a go yourself, but I was tired and had a rough weekend...leave me alone.

For help on the game see Matthew's online guide at: <http://www.willson68.freemove.co.uk/guide.html>

Matthew has also included a list of passwords hidden away in the game to help sleepy editors on a monday morning. Change the file type to text (it's currently a data file) to view it properly.



ECS-Utils

ECS-Utils started out as the shareware application *Mytils* and, like its predecessor, is a nested collection of utilities. As has been recognised since the early days, the fundamental user-interface aspects of the Acorn GUI are hard to match, let alone beat. However, some additions are always helpful. Hence *ECS-Utils*.

Filer additions

ECS-Utils has grown as-and-when new facilities were needed. At the moment it will (with key presses):

- Change the display mode used in individual Filer windows (full info, small icons, large icons) or change the sort order;
- Provide a quick and easy dumping ground for random files.
- Put windows to the front or back of the stack;
- Shut any window (Filer or otherwise);

- Centre any window within the current screen display;
- Toggle any window almost to maximum size and position at the top left of the screen;
- Close current directory and open parent Filer directory;
- Close all open windows on a filing system (IDE, ADFS, CD-ROM, IZIP - which will also eject a Zip disc) with Adjust-click on the filing system's iconbar icon;
- Eject a Zip disc from an ArgoFS drive;
- Maximise or minimise any window - even if it has no normal toggle size or adjust size icons.

Version manager

The Version manager is a utility entirely new to any platform I have heard of. Drag a filer object (file, application or directory) with the Alt key pressed and a new directory will be created with a name derived from the first five letters of the name of the filer object followed by the letters 'Vrsns'.

The point of this? If you are developing an application, program, or any other work which requires continual updates this facility will automatically create a directory tree of the versions, date-stamped and everything. As you create a new one, Alt-drag the last version to *ECS-Utils* then save the new version - no need to use a new name.

So, all in all a very comprehensive program - I'm unable to list everything it does here, but see the manual for more in depth information. It's currently Shareware, so if you use it send £10 to ECS Ltd, 2nd Floor, 107 Carlton Road, Nottingham NG3 2FB.

END

Disc information

The software on the cover disc has been compressed using !ArcFS 2 from VTi, and are opened by running a copy of ArcFS then double-clicking on the archive to open it. There is a copy of !ArcFS on each disc. Most software will run straight from the archive, but some programs may need to be copied out of the archive before being run, uncompressing them in the process. Any program that saves a file to disc, for instance, will be unable to do so into the archives on the disc.

Faulty disc?

If your disc is faulty, test whether it will verify by clicking with Menu on the floppy drive icon and choosing Verify.

If it fails to verify or is physically damaged you should return it to Acorn User, Media House, Adlington Park, Macclesfield SK10 4NP.

The *Acorn User* cover discs have been checked for viruses using !Killer version 3.001 from Pineapple Software.

Art of

Walter Briggs
explains the use
of masks in Part I
of his new series

booze

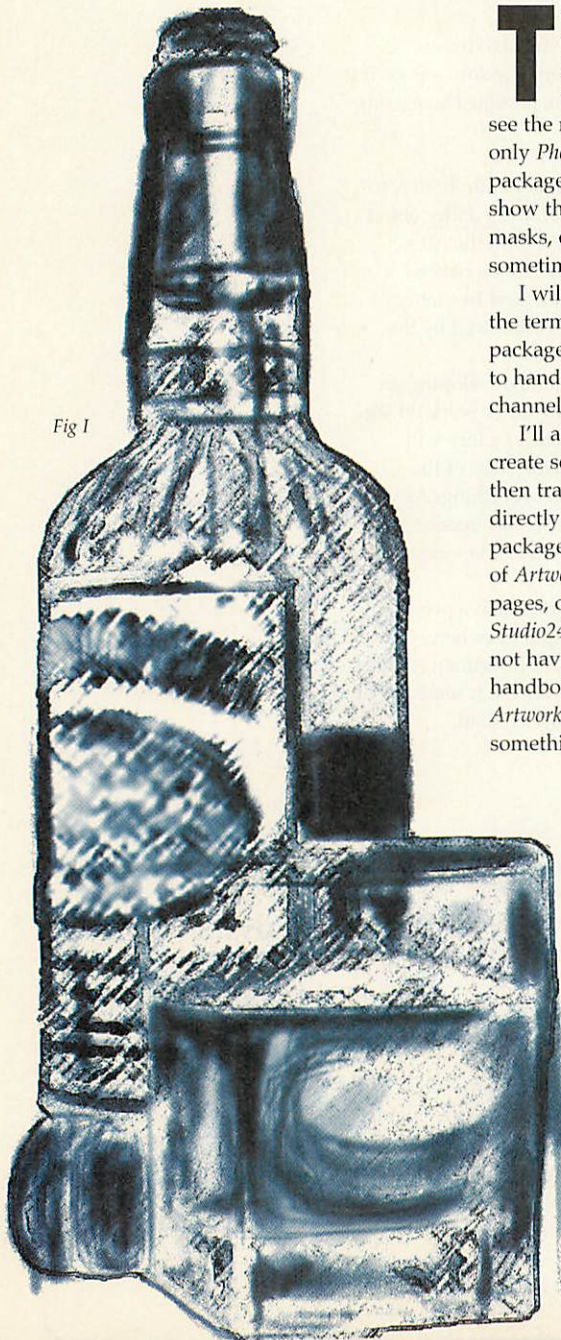

Fig 1

The brief from *Acorn User* was to create a series of articles using *Photodesk*. The criteria – produce work that will help the reader to see the numerous possibilities within not only *Photodesk*, but other 24-bit art packages as well. Especially I hoped to show the potential of software that uses masks, or Alpha Channels, as they are sometimes known.

I will be using *Photodesk*, but most of the terms will apply to other 24-bit packages, although some may not be able to handle, or create more than one mask channel.

I'll also be using *Artworks* to create some line and text work, and then transport the resulting imagery directly into *Photodesk*. Again not all packages will allow the direct transfer of *Artworks*, or drawfiles into their pages, or mask channels. I know *Studio24* does, but other programs may not have this facility – check your handbook. Another reason for using *Artworks*, was the ease of distorting text, something vector packages excel at.

Since I was to demonstrate the use of mask channels and layers, I chose to paint a bottle and glass – such a transparent medium would enable me to test, in particular, the usefulness of the 'layer' option in *Photodesk*. Had I but known the work involved – with the difficult fluted-shaped shoulder to the bottle, and the dreaded deadline, hanging like 'the sword of Damocles', I may have thought again. Still, I was able to evaluate the usefulness of the masks, and hopefully the next feature will test 'layers' to the same degree.

Drop of the hard stuff

The first stage in the operation was to produce a layout of the design. So out came the 'virtual' sketch pad, and I quickly produced some electronic working sketches.

ACORN COMFORT

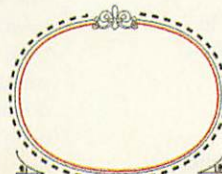

Old Drink of the Acorn Spirit
Created to use Rise of 4
From the South of England
By SOUTHERN COMFORT COMPANY
40% Vol



Fig II



Fig III

In this wonderful computer age there is no longer a need to work-up numerous drafts on paper, though it is sometimes a good thing to rough out a few ideas. This gives you a basis for your digital composition.

If you are working with a traditional sketch pad, then you can scan your ideas into your machine, or simply tape your drawing onto your monitor, and the trace the outline into your favourite program.

My sketch included the glass, (Figure I) though in this article I will only work on the bottle – I will keep a ‘wee dram’ for the next issue. The sketch was created with a small airbrush in *Photodesk* and is a bit rudimentary, but was enough to help me see the overall composition.

Labelled in ArtWorks

The file was saved as a sprite, which *ArtWorks* accepts with aplomb. It was then a reasonably simple task to create the text for the bottle, including the neck label and the main label, which described the delights that lay within.

Figure II shows the newly traced bottle outline and the text – an inducement to imbibe of Acorn technology.

The various fonts I had were close enough to the original ones to work as substitutes; only the main name would need a little extra work.

To make the subject matter a little more interesting, I turned the bottle until only half the label was visible.

Unfortunately the name of this famous liquor had a very distinctive font that had a dotted line down the left edge of each letter, and I possessed no comparative style. The only solution I could come up with was to choose the closest font to the original, copy and alter it, then combine the two fonts.

I filled the original font with the required brown, then ‘cloned’ it. The reason for producing a clone

(shortcut Control+K) of the text, is that a clone is created exactly on top of the source text. It is then a simple operation to move the text very precisely to one side using the arrow keys. Once the new text was moved a fraction to the left, I removed the fill, and made the outline dotted to match the style on the bottle.

There was only one problem – bits of the cloned text staggered out from behind the new text at inappropriate intervals, so a few white shapes were created to cover them.

Eventually the text was complete, and the ‘envelope’ tool used to bend the text to suit the actual design, and shape of the bottle.

Here is where a little foresight would have been helpful. At the next sitting, the bottle (my model), was set at a different position to the first, so the perspective of the subject had changed!

You can see in the outline, the bottom of the label is quite rounded, meaning the base of the bottle was below eye level. This later changed, and the text needed to be straightened in keeping with my blurred vision.

Up to the neck

Once the line-work was finished, the whole *Artworks* file was dropped into *Photodesk* and pasted down as a 24-bit image. This would give me a visual representation to work with (the right hand image in Figure II).

I then went back to *ArtWorks* and changed all the lines and fills to black, this was because the next time I dropped this file into *Photodesk* it would be pasted down as a ‘mask’.

Masks are used to safeguard various parts of your work while you spray contentedly over the ‘open’ areas. They work like a stencil or a sheet of acetate, and appropriately can be made invisible. It’s also possible to vary the opacity, and hence the measure of protection they provide.

These masks, used by *Photodesk*, *Studio24* and other programs, are 8-bit masks; that is 256 shades of grey, appropriately called greyscale images.

This means if you drop a coloured file from *ArtWorks*, or *Draw* onto a mask (Alpha) channel, the various colours will be translated into shades of grey. In this way, the depth of the mask, and hence its measure of

protection, depends on the colour of your file and the various greys it now contains.

A black mask will give complete protection, mid-grey, a measure of protection, and white none at all.

It’s possible in some programs, including the two I have mentioned, to have a number of mask channels. This meant I could drop separate outlines from *ArtWorks* onto different channels.

The outline of the bottle on one, the text on another, and so on.

Feeling green

Now that I had an outline and a number of masks to work with, I began airbrushing the top of the bottle. Even

though the glass appears clear, in reality, if you look closely, there is a definite tinge of green to the proceedings (Figure III).

Highlights prove crucial in giving the image a 3D effect, and they continue down the bottle varying in intensity depending on the reflective material.

The next objective was to spray the neck label (Figure IV) and a shade of dark grey/green was used as the base. The gold writing from the *ArtWorks* file was fine, and so a sample was taken with the ‘syringe’ and a drop put on the page in case I lost the colour while airbrushing the label.

Then a very dark green was used to airbrush the sides of the bottle neck and label. You need to be very patient and use a very low opacity, building up the colour slowly, this will give you the required control. In *Photodesk* I would use about 10%; in *Studio24* (which I still believe has the best airbrush) about 3% (Figure V).

The fluted shoulders have been worked just enough to show you how the airbrush gradually builds up the colour within the teardrop shape of the mask. Figure VI shows the result of the ‘magic wand’ having been used to fill the mask. Once protected with a mask I could airbrush the raised shapes of the bottle shoulders.

Eventually the masks have to be turned off and the work continued freehand, otherwise the lines will be too hard.

You can see in Figure V that I had switched off all the masks, and that some over-spray has got onto the white background. This is easily removed, just invert the mask and paint the backdrop in again.

Due to the freehand work, the writing on the neck was almost sprayed to oblivion – it was strengthened

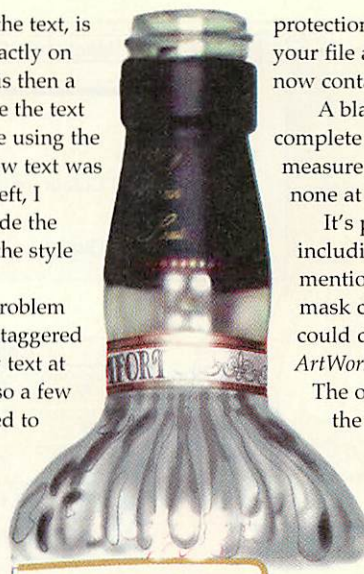

Fig V

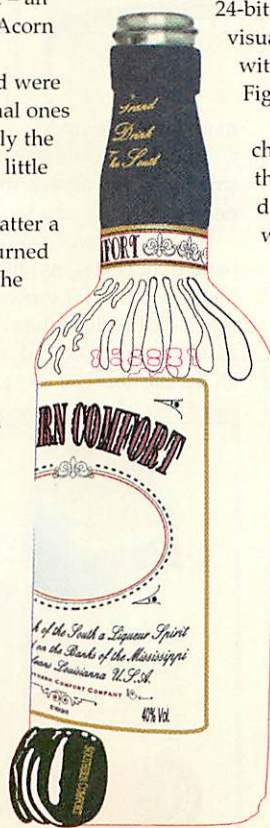

Fig IV

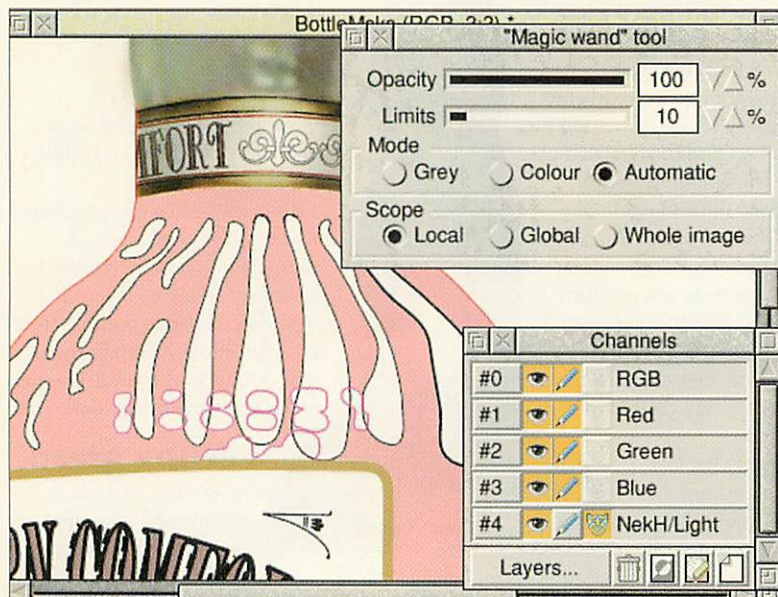

Fig VI

later, by dropping on this section of the *ArtWorks* file.

Neck text

The lower neck-band looks good, but most of the work was done within – you guessed it, hic! – *ArtWorks* (Figure VII). A series of rectangles was created – white on a radial filled brown, and the pattern and text on the top of that. All the objects were grouped, and the envelope tool employed to create the right perspective. Because the edges disappear round the bottle neck the easiest solution was to place two white rectangles either side of the label – just to hide the untidy edges.



Fig VII

This label was dropped onto the *Photodesk* image then pasted as an object (not as a mask), and the various colours kept as part of the bottle. A little darkening of the sides, and brightening the highlights complete the slogan.

Drop of the real stuff

Once the top half of the bottle was finished, my attention turned to the contents of the bottle itself. Since the basic liquid has a red tint, this was where I started.

The grey/green colour of the glass was roughly sprayed onto the rest of the clear glass, and the lower half filled with a bright pink. A similar 'fluted' effect adorned the bottom of the bottle, so a few shades were added with the airbrush. The colour was rather vivid, but surprisingly the moulded shapes on the bottom of the bottle had come out rather well.

Because of this I decided that the density and colour of the liquor would have to be enhanced by a little 'image processing'.

The colour balance was modified and the contrast and intensity altered until the image was near the right colour, while still retaining

the grooved effect on the base (Figure VIII).

Though the label was now in place I wanted to complete the glass section first. This is the way I like to work – finish one section, and progressively move on to the adjoining area, in a sort of creeping natural progression.

Strong spirits

Figure IX shows the highlights created in *ArtWorks* and dropped onto the page of *Photodesk* – the white 'blobs' were used as a mask, and were actually black – they are shown in the shot as white, just so you, the reader, can see them.

The toolbar, which appears when an image is dropped onto the page, allows you to paste the objects either to a mask channel or as a RGB or CMYK full colour image. The tools allow you to accurately size and position the new objects. These ones would be the bright highlights on the raised glass section, so they were painted white, gradually, with the airbrush.

I also took the opportunity to enhance all the highlights and shadows on the complete bottle, though I would do this again before I was completely satisfied – which is never.

Paper work

Now that the glass section is finished, I can move on to the label. Even at this stage the shape of the bottle and label didn't match the shape of the text. And since I had been working for some time

on the bottle in an elevated position, I had to re-work the text.

This was the easier option, since the text still existed in *ArtWorks*. It would also allow me to complete the illustration and text

on the central part of the

main label (Figure X).

The picture in the centre of the label was quite simplistic, and at an acute angle, so it wasn't necessary to spend a lot of time on it. (Figure XI)

The border was a series of lines with an outer band of of circles, not the easiest to emulate. But I had a great idea. I turned the outer line into a dashed line, then created a small circle and cloned and copied it until it covered all the dashes. The text and central image also



Fig VIII

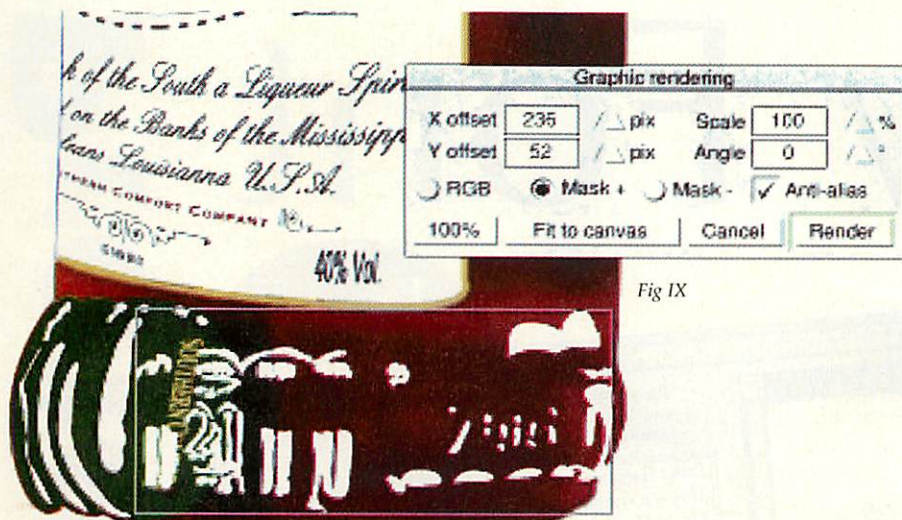

Fig IX

had to be warped into the necessary shape for the side of the bottle. Since *ArtWorks* cannot manipulate sprites, the actual picture is not set at the right perspective – but since the text and border has been distorted the eye is easily fooled into thinking all is in order.

The outside edges of the illustration were easily hidden within *ArtWorks*. A white circle was drawn in with no fill, the line width increased to cover the edges of the scene, and everything grouped and dropped into *Photodesk* (Figure XI).

Intoxicating finale

The illustration is coming on well, and I'm quite pleased. A bit more fine-tuning – the highlights intensified on the glass, the text on the neck strengthened, then on to the final section.

It's fairly simple to generate a three-dimensional look to the label. I just masked off the whole label, and used the largest brush I could manage – at least one third the width of the label. I set the opacity as low as possible, and

didn't see any effect until the third pass of the airbrush. Then I halved the size of the brush and darkened the outer edges. With the same brush I painted a straight white line over the whole label, again and again, until the text began to disappear, and the outer edge became very discernible.

Because the reflections are very bright on the glass just above the label, I felt the need to increase the intensity of the white on the label itself, though it's a much softer light than on the glass. (Figure XII)

That only left the cap to be created. Because of the acute angle it was lying at, and with the addition of the glass (next month) there seemed no need to spend an inordinate amount of time on it.

Hopefully this will have given you an insight into the use of masks, and the implementation of vector images within this bit-map world.

Next time we'll look at masks in more detail, especially in connection with layers, and I should finish the composition. In the mean time have a wee shot yourself.

END



Fig X

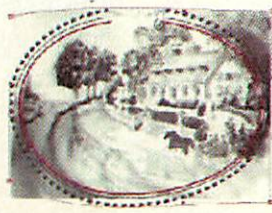
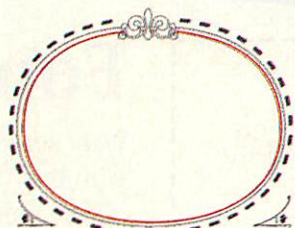

Fig XI

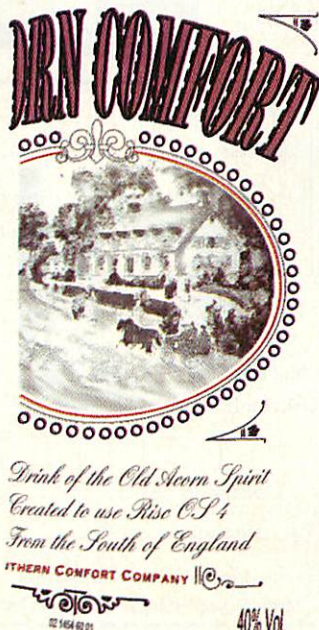

Fig XII

Easy Font

Professional

Easy Font Professional is probably the best Font management software on Acorn machines. This superb piece of software provides an easy to-use, yet powerful interface.

Easy Font Pro allows you to add fonts easily and quickly, as well as allowing the fonts to be viewed for simple selection.

Other features of Easy Font Professional include:

- The ability to allow you to group fonts.
- Up to 40% compression
- Fonts which load only when a particular application is loaded
- Fonts can be accessed on other media, eg. CDs

Easy Font Professional comes on two DD floppy discs. One contains the application, while the other contains several styles of font. It also comes with a printed manual which contains instructions on how to use Easy Font Professional to its full ability. As well as this a quick reference guide is included which shows each button and its function, plus the keyboard shortcuts.

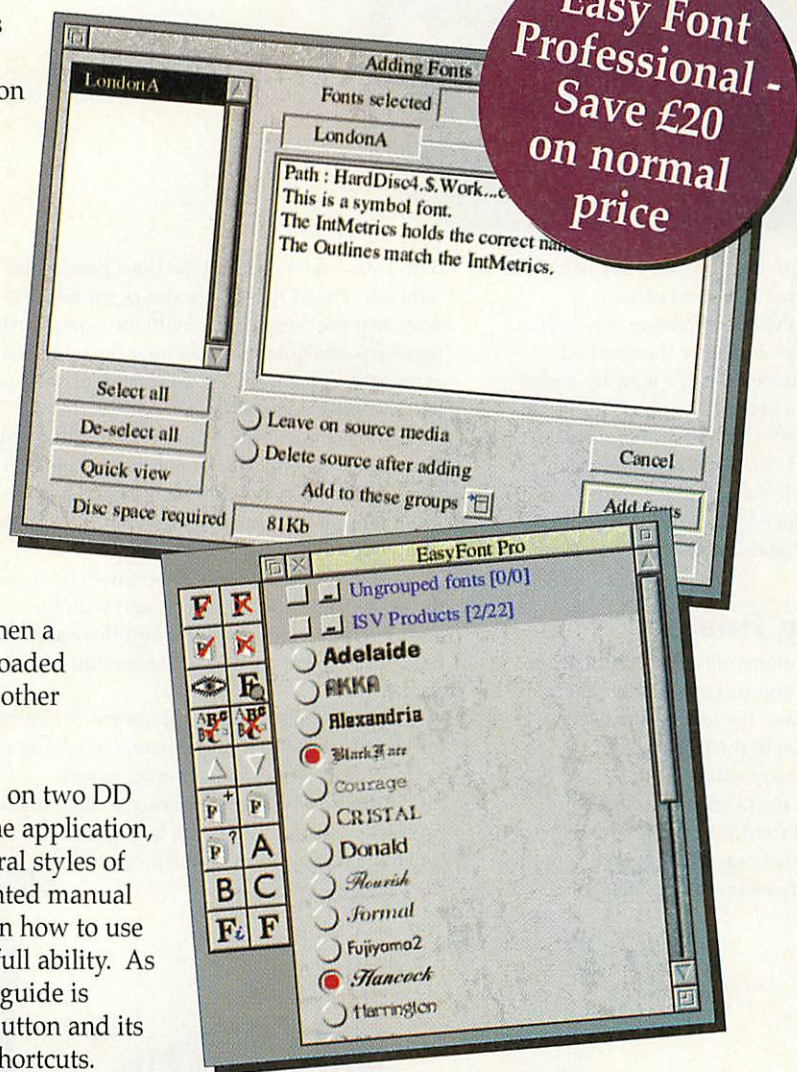

Easy Font Professional - Save £20 on normal price

ORDER FORM

Please send me:

Easy Font Pro

UK - £40

Europe - £43

World - £45

Font Pack

UK - £10

Europe - £12

World - £14

HD or DD

Name

Address

.....Postcode

E-mail

Prices include postage and packaging and VAT

I wish to pay by:

Cheque/postal order (payable to Tau Press Ltd)

Credit Card (Visa/Barclaycard/Mastercard/Access)

Credit Card No:

Expiry Date: /

Name on card:

Signature:

Please tick here if you do not wish to receive promotional information from other companies

AU99K7

Send your order to: Easy font pro, Tau Press, Media House, Adlington Park, Macclesfield SK10 4NP.

Font Pack

Want some more fonts to use with Easy Font professional? Or maybe you just want to increase your range of fonts? If so, then the Font Pack is for you. It features over 50 different styles of font giving you a wide choice of type-faces to choose from.

For Easy Font Professional you will need a minimum of RISC OS 3.1 or greater with 2Mb of RAM and a harddrive

15 glorious years

*Simon Anthony's
dyeing to tell of
Acorns in industry*

It is often said that Acorn computers are not, and never have been used in industry. This is simply not the case. Irritating as this is to hear this, it is difficult to prove otherwise, as the turnover of Acorn related products in industry is quite low. There is a good reason for this – Acorns seldom go wrong, and even more seldom do they need replacing.

Electronic Control Services (Nottingham) Ltd have been keeping the Acorn flag flying in industry for a decade and a half. Currently they provide computer control by means of software running on Risc PCs. These monitor signals sent by smaller computers which themselves do the data collecting.

An example of an ECS installation is the Singlam textile dyeing plant in Wales. Fifteen years ago they were looking for the latest in computerised automation systems for use in the textile dyeing

process. Their dyeing plant is not small and nor is the energy required to run it, so complex and fine control and monitoring of every stage in the dyeing process is required so that efficient use can be made of resources.

The first stage in monitoring what's going on is to get some sensors and hook them up to something cheap, solid, reliable and simple. Something which can cope with being left alone for years without maintenance or any sort of care or even attention. Fifteen years ago the perfect equipment for the data logging, storage and transmission systems were BBC Micro computers, that was when they were installed. They are still running perfectly today.

The data is sent to a central computer system from the BBC machines via a current loop circuit. At the same time an Econet system sends and receives signals to and from the control machinery (Econet is the Acorn proprietary data signalling system, now dropped in favour of the faster Ethernet).

The process of dyeing a fabric is very detailed and complex. A recipe of chemicals has to be mixed and added at the right stage in the dyeing process and in exactly the correct quantities. This information is entered in to an industrial application specifically written by ECS – running on an Acorn RISC OS machine. There the complex and daily varying details of the current recipes are typed in and sent via the Econet system to the file server computer on the factory floor.

Another terminal RISC OS computer, running monitoring software, is used next to the server to keep track of the state of play over fifteen or so massive pressurised dyeing vats. Each machine runs its own program and sends real-time updates of the progress of the job

to the monitoring software.

The dyehouse application scans the output from the machines and updates the monitor display, while at the same time allowing programs to be altered, sent to, or removed from any of the controllers in the factory. The chemical recipes can also be entered and sent to the controllers without disturbing the rest of the system – that is multi-tasking for you in the real world.

Before the RISC OS computer came out, all the recipes and processes had to be controlled by hand and eye. As soon as it was possible RISC OS machines were added to the, by then, five year old existing BBC system. When the Risc PC was introduced the control software was updated to take advantage of the new machines – but the main code did not have to be changed at all.

This idyllic setup looked as if it had had its day when Acorn pulled the plug on Econet. The fear was that the code would have to be totally re-created in order to cope with new communication protocols.

However this turned out not to be the case. Replacement Ethernet cards used the same software calls as the old Econet system. Once the new cards were put in place the software, originally written over ten years earlier, worked perfectly. Hands up for any 'Industry standard' systems that can say anything like that. Obviously requirements in the dyeing industry have changed a great deal over the years, and so a rewrite is finally called for. But that will be another story. **END**

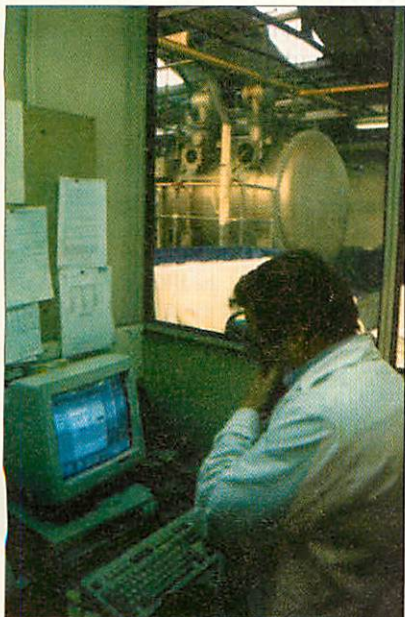

Contacting ECS

Simon Anthony
ecsltd@ecsltd.co.uk
<http://www.innotts.co.uk/~ecsltd/>

Millennium

Mike Tomkinson tests out one of the best ways to defeat the Millennium Bug

Toolkit

Like most Acorn users I react to the Millennium Bug with the same 'Permission to turn on smug mode, Sir' as a certain character in Red Dwarf. The bug won't affect my computer system, and I've had the urine extracted often enough by PC owners for sticking with Acorn, so I'm not too sympathetic.

However, there are Acorn users who must be somewhat worried, either because they have to use PCs at work, or they have PC cards in their Acorns. It is also worth understanding what the problem is for PC owners so, as well as being smug, we can speak with authority.

The problem, as I write this, is that no-one can say to what extent the Millennium Bug will affect us. We currently have a spectrum of reactions from 'No problem' at one end to 'The End of the World is Nigh' at the other. While I think that selling up and heading for a croft in Scotland to become self-sufficient is a little extreme, it does pay to be cautious. A little prudent planning might not go amiss before The Big Day.

The right tools

There are now a number of software products available to help you combat the effects of the Millennium Bug for PCs.

One of the best is *The Millennium Bug Toolkit* from Computer Experts Ltd, and this is the product under review in the rest of this article.

For the purpose of testing the kit, which is software based, I am going to use a recently purchased PC with a 400MHz Pentium II chip.

This is hardly a fair test as the system was sold as fully Millennium compliant, so I would expect no problems with it. But this particular system was misrepresented to me by the advertising in another area, and if they lied about that

then they may have done the same about the Millennium compliance.

The Millennium Bug Toolkit comes with a refreshingly slim manual and single floppy disc. The accompanying Press Release promises to identify and fix all problems with a 'No fix, No Fee' guarantee.

I was using the Single User version, but a version exists for various networks including the two most common: Novell and Windows NT. I know many schools use Novell for their administration systems and NT for their education and/or administration systems, so this has some relevance to education users.

The CD-based Software Scanner, according to the press release and the manual, scans all the software executables on the harddisc and compares the version against the manufacturer's compliance statements to see if it's already been fixed. This also means that if a bug-fix is applied in the form of an update you can re-check the software for compliance at a later date. Unfortunately the Single User, Hardware-only kit does not contain the Software Scanner, so I cannot comment further on it.

Hardware

Here a little background is in order. The first IBM manufactured PC, produced in 1980, required that you enter the date and time whenever you turned the computer on. This was the the old XT PC. In 1984 IBM produced the AT PC which handled the time/date problem by having a Real Time Clock (RTC) chip embedded on the motherboard.

This stored the time/date, and every time the computer was switched on the BIOS (Basic Input/Output System) read the RTC to obtain the correct time/date. I have simplified the process but you should get the idea.

The problem we are faced with today is that the RTC stored the date in the format DD/MM/YY and not DD/MM/YYYY, thus using only two digits for the year. This is fine until the Millennium roll-over when 00 becomes 1900 and not 2000.

What really complicates the issue, if it were not complicated enough, is that the Operating System, DOS, keeps its own time and is informed

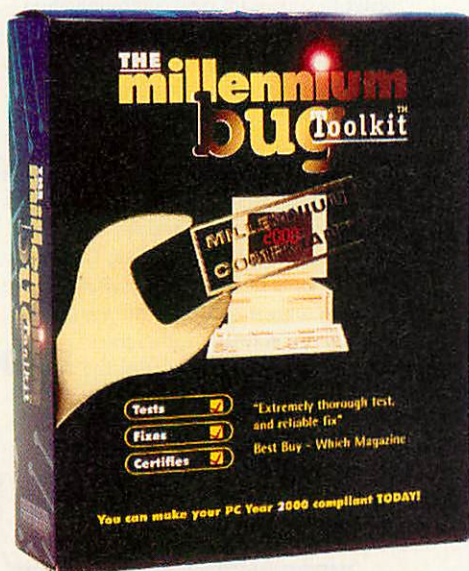

by the RTC that the date is 1/1/1900. The problem here is that this date is invalid to DOS, and so it interprets it as the number of days which have passed since 1/1/80 – returning an incorrect date. The most common date returned is 1/4/80. All in all a complete mess.

If you have been following all this so far you will realise that any bug fixer must deal with one of two problems with the hardware.

The first is if the system is switched on during the roll-over from 31/12/99 to 1/1/2000, in which case it must monitor and correct for any inaccurate date change in real-time.

The second is where a system is switched on any time *after* the roll-over, and the fixer has to cut in when the system is re-started and fix the problem. Complicated, eh?

It gets worse as the Year 2000 is a leap year, I know by the usual rule it should not be, but this is an exception that happens every 400 years.

Getting started

Anyway, enough of the background stuff. The manual, for all its slimness, provides comprehensive information on how the bug fixer works to tackle both the software and the hardware problems.

Computer Experts Ltd have certainly done their research, and you go into the testing phase with a great deal of faith in the product.

This is important, as any mistakes could seriously affect your computer system. Any product claiming to remove a major potential problem *has* to be one in which you have faith. You must be sure that it will remove the fault, but not cause another at the same time.

The software performs a number of tests on your system which, if it passes them, should ensure a high degree of confidence of Millennium compliance.

The system you are testing should be in MS DOS mode, so from *Windows 95/98*, Start->Shut Down->Re-Start in MS DOS Mode. Enter *The Millennium Bug Toolkit* disc and at the A: prompt type 'test'.

Well, it seems easy enough so far. The first thing the software does is to transfer your System files onto the floppy thus creating a bootable floppy. The second thing it does is to make a backup of your CMOS settings – better safe than sorry.

When you re-start the computer with the floppy in the drive it takes you through the various tests. Each test reports a *Pass* or *Fail*. As I would expect, my computer passed all but the *Windows Short Date* setting test. This was deliberate on my part as I wanted the computer to fail at least one test to see how the software would adjust it.

What happens next is that the fix is applied in the form of a small Terminate and Stay Resident Program (TSR). You are then offered the opportunity of re-taking the tests. This I did, and sure enough this time the computer passed the

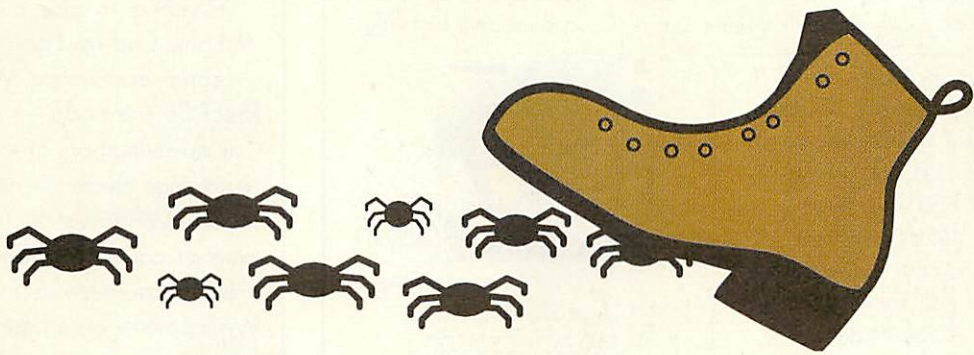

Windows Short Date setting test with flying colours.

So far, so good. The hardware checks out. Obviously the older the machine, the less chance of passing some, or all of the tests, so 386/486's and P75/100's are more likely to require the fix than newer PII's or PIII's. It is also recommended that you use the program again in the run up to the Millennium, and in particular if you change any settings on the system.

The only problem I had with the hardware testing phase was that the date/time were wrong on the system when I re-booted. At least the date was beyond 2000 and the system was still working, so it was easily adjusted to the correct time/date.

In a commercial environment suppliers are often required by customers to certify that they are compliant, or are working towards Year 2000 (Y2K) compliance. To that end a Testing Certificate is supplied with the *Millennium Bug Toolkit*, stating that your system has undergone compliance testing. It does not guarantee full Y2K compliance but should satisfy anyone that such testing has been done.

Is it worth it?

In conclusion I found the *Millennium Bug Toolkit* to be an excellent product. Obviously it has a somewhat limited sell-by date, but if it helps your PC over the Y2K problem it will be money well spent. As for the software on the computer, all I can suggest is that you have the latest versions with any bug fixes and patches applied.

END

Product details

Product: Millennium Bug Toolkit
 Price: Single user – £38 (plus VAT)
 Hardware only
 Network – £58 (plus VAT)
 Hardware and Software
 Scanner
 Network and multi-user
 licences available upon
 request. The usual discounts
 apply to schools, charities,
 and so on.
 Supplier: Computer Experts (UK) Ltd,
 Level 5, New England House,
 New England Street, Brighton,
 BN1 4GH
 Tel: 01273 696975
 Fax: 01273 696976
 E-mail: sales@computerexperts.co.uk
 Web: www.computerexperts.co.uk

AJS Pentium II or Pentium III

Part exchange your Acorn RiscPC for a new AJS Pentium II or Pentium III. A sample system and price is given below, but please give us a call and we can supply a firm quote, usually instantly.

Typical AJS System

- * Intel Pentium II 350MHz
- * Intel 440BX Chipset
- * 64MB PCI00 RAM
- * 8GB Hard Drive
- * 4MB Video card
- * Sound card and speakers
- * 15" monitor
- * 56k Modem
- * Windows95 or Windows 98

£650.00



Typical allowance on a RiscPC - £300.00

**Balance to pay
£350.00 + vat**

Because we build our own systems, we can be sure that the quality of the components and manufacture are among the best. We know that happy customers are tomorrows customers!

NGFL Schools

If you are proposing to change from Acorn RiscPCs to PCs, perhaps as part of the National Grid for Learning, then we may be of some assistance. We can take your old RiscPCs from you - it doesn't matter the age or specification, or even if they work - and exchange them for new Pentium computers running Windows95. The allowance we would give of course depends on the specification, but it could be as much as £350.00 each. We operate on a National basis, so it doesn't matter where you are in the country - and we can accept your official schools order! Give us call



AJS Computers Ltd
Unit 28
East Hanningfield Estate
East Hanningfield
Essex CM3 8AB

sales 01245 400066
technical 01245 400034
fax 01245 400014
sales@ajscomps.demon.co.uk
http://www.ajscomps.demon.co.uk



Liquid Silicon

32-bit MIDI Sequencer



Powerful
Flexible
Easy to use drag & drop
Controller maps (e.g. tempo and velocity) easily alterable by drawing with the mouse
Patterns can be linked to reflect changes made to other patterns
Handles System Exclusives
Multitasking playback
Supports any MIDI interface, including parallel and serial
Up to 192 MIDI channels and no track limit
Free demo disc available
Now available - £129.00

Recent/New Releases

- Abuse - £23.00
- Descent CDs - £28.00
- Heroes of Might and Magic 2 - £32.00
- Heretic & Hexen CD - £32.00
- OHP CD (Spaceteck) - £28.95
- Photodesk 3 - £279.95
- Sunburst - £12.50
- Syndicate Plus CD - £26.50



Discs (example 10x white discs - £4.60, 50x black discs - £15.10, 5x HD red/blue/green/white discs - £2.49)
Batteries (e.g. 4x AA Xtra alkaline - £2.18, 1x 9V alkaline - £1.84)
Audio & Video Tapes - £Various

FREEPOST EH2725
Kirkcaldy, Fife, KY2 5BR
United Kingdom

Tel: 01592 592265 Fax: 01592 596102

email: Liquid@cableinet.co.uk
http://www.cybervillage.co.uk/acorn/liquid/

We supply a range of CCD and laser bar code scanners and include with these our IBarReader driver software which allows bar codes to control most desktop software.



Further information is available. Complete systems from £158.63

Our bar coding software produces Draw files of the following formats: EAN 8, EAN 13, UPC A, ISBN, ISSN, Code 39 (Normal and Full ASCII), Telepen and Binary.

Further information is available. IBarCoder - £69.33

Computer Systems

- These prices do not include monitors, unless specified.
- Rise PC 4+0Mb 1.7Gb HD - £911.00
 - "Web Wizard" - as J233, speakers, Easiwriter Pro, 33.6K modem, ANT Suite - £1265.00
 - "Peak Performer" - A7000+, 8Mb, 32x CD, 14" monitor & software pack - £875.00
 - "Peak Performer Internet" - A7000+, 24Mb, 32x CD, 14" monitor, modem, ANT Suite - £979.00
 - "Sprinter" NC system - 10baseT, 16Mb, 14" monitor, keyboard & mouse - £445.30
 - RiscStation R7500 - From £675.00

Monitors

- (Either bought with computer or separately):
- Iiyama 350 (15") - £159.00
 - Iiyama S702GT (17") - £289.00
 - Iiyama 400 (17") - £323.00
 - Iiyama Pro 400 (17") - £334.00
 - Iiyama Pro 410 (17") - £375.00
 - Iiyama 450 (19") - £499.00
 - Iiyama Pro 450 (19") - £539.00
 - Iiyama 502 (21") - £770.00
 - Iiyama Pro 502 (21") - £770.00
 - Iiyama Pro 510 (22") - £875.00
 - Iiyama Pro-Lite 36a 14.1" LCD - £687.00
 - Iiyama Pro-Lite 38a 15" LCD - £910.00
 - Iiyama Pro-Lite 38b 15" LCD - £945.00
 - Iiyama Pro-Lite 38c 15" LCD - £1032.00
 - Iiyama Pro-Lite 39a 15" LCD - £1599.00
 - Iiyama Pro-Lite 46a 18" LCD - £2469.00
 - Touchscreens - £Call

PC cards

- 5x86-133, 512K cache, PC Pro2 - £360.00
- PC Pro 2 - £38.95
- PC Pro 3 - £70.50
- PC Sound Pro 2 - £39.95
- Win95FS - £39.95
- Windows 98 CD - £100.00

Psion Series 5

- 8Mb, with PC connection kit - £395.00
- 8Mb, SPECIAL EDITION - £445.00
- Parallel link - £34.95
- PsiiRisc link - £Call

Memory Upgrades

Please call to check current prices.

- Other upgrades are available.
- A3000 1-4 Mb - £64.60
 - A3010 1-4 Mb - £69.30
 - A3020/A4000 2-4 Mb - £52.80
 - A5000 2-4 Mb - £69.30
 - A300, 400, 5000 4-8 Mb - £128.00
- Risc PC/A7000 SIMMs:
Call for EDO SIMM prices
- 16Mb - £33.95
 - 32Mb (not original RPCs) - £73.50
 - 32Mb (high clearance) - £73.50
 - 64Mb - £122.00
 - 128Mb - £Call
 - 1Mb VRAM - £49.00
 - 1-2Mb VRAM swap - £55.00
 - 2Mb VRAM - £92.80

Music & Sound Section

- Please call for other musical items
- MIDI interfaces:
- DMI 50 dual MIDI card (2x2) - £149.95
 - XG upgrade for DMI 50 - £151.95
 - 16-bit sampler for DMI 50 - £87.95
 - MIDI Max II internal 1x1x1 - £92.75
 - Parallel Port 1x1x1 - £89.20
 - Synth 8 or Basic Synth - £46.95
 - Synth Plus - £58.65
 - Music & Sound Prog. Guide - £16.95
- Other hardware:
- Fatar SL 760 - £450.00
 - Fatar SL 880 - £600.00
 - Fatar SL 1100 - £800.00
 - Fatar SL 2001 - £1050.00
 - Irlam sound sampler - £118.00
 - Digital-upgraded Irlam sampler - £177.00
 - MIDI upgrade for Irlam sampler - £Call
 - Sound Byte Recorder - £57.50
 - Yamaha YST-M8 speakers - £45.50
 - YST-M20 DSP speakers - £65.75

- YST-MS28 speakers & subw. - £79.95
 - YST-M100 speakers - £117.00
 - YST-MSW5 subwoofer - £59.00
 - YST-MSW10 subwoofer - £71.20
 - Yamaha MU10 sound module - £169.00
- Other software:
- MediaPack - £23.95
 - MIDI Support - £18.50
 - Prosound - £116.95
 - Rhapsody 4 - £94.95
 - Junior Sibelius - £49.00
 - Sibelius 6 - £99.95
 - Sibelius 7 Student - £319.95
 - Sibelius 7 - £625.00
- Sibelius for Windows is also available
- Optical Manuscript - £259.00
 - Sound module serial driver - £37.95
 - Studiosound - £116.95

Other Hardware

- Dual fast serial card - £104.50
- Ethernet card (Combi NIC slot) - £104.50
- Hard drives & kits - £Call
- Risc PC second slice - £140.00
- RPC second slice (no PSU) - £90.00
- StrongARM upgrade - £275.00

Other Software

- Ankh - £23.00
- ANT Internet Suite 2 - £112.00
- Brutal Horse Power - £26.00
- DataPower 2 - £165.00
- Doom+ CDs - £30.00
- EasiWriter Pro - £129.00
- Empire Soccer 94 - £22.00
- Exodus - £21.00
- Impression Style - £88.00
- Impression Publisher - £135.00
- Inferno - £9.50
- iXRC - £14.99
- Ovation Pro - £150.50
- Personal Accounts 3 - £43.00
- Photodesk Light - £125.00
- Prophet 3 - £160.00
- Schema 2 - £116.00
- Steuth 3 - £110.50
- Textease - £54.50
- TopModel 2 - £145.00

Books & Manuals

- RISC OS 3 PRM - £104.00
- The Tekkie CD - £45.00

Catalogue

Our free catalogue contains over 2000 items. Please ask for a copy.

We will attempt to match or beat any advertised price - even special offers.

All prices INCLUDE VAT & UK carriage
Official orders and callers welcome. Finance available.



Keeping

Michael Cowgill continues his series on MIDI controllers

Control

Greetings again for the fourth part of this series on MIDI controllers. This time I'm going to talk about controllers 72 and 73 which control Envelope Generator Release and Envelope Generator Attack respectively, together with an explanation of Envelope Generators in general.

These are XG specific controllers, so only those of you with DB50 daughterboards, external Yamaha XG modules (such as the MU10), or XG compatibles like the Korg N5RS will be able to experiment this month.

GS modules do provide access to this control via NRPNs, so much of this article will be relevant to Sound Canvas owners or other GS compatibles (such as the Korg O5R). I shall be covering NRPNs next month anyway so you won't miss out for long.



sound by taking bits away from the original wave form. An Envelope Generator in this process usually controlled four aspects of the sound:

- The rate at which the sound started, or **Attack**
- The rate at which the sound settled down to a continuous sound, or **Decay**
- The rate at which the sound died away while the key was held down, or **Sustain**.
- The rate at which the sound died away when the key was no longer depressed, or **Release**.

This form of Envelope Generation is consequently known as an ADSR envelope (see Figure 1). It is possible to increase the complexity of

this by adding successive stages to the Decay and Sustain phases of the envelope.

The post GM context

In a modern AWM device, such as the DB50XG, where the sound sources themselves are not editable, the Decay phase as I have outlined it is redundant. The Attack, Sustain and Release phases can be increased or decreased within the limits of the existing sample however.

On the attack

The EG Attack controller (73) is very useful for things such as making a piano sound crisper, for making string sounds mellow by slowing down the attack, or for tightening the attack up to give them more 'edge' or 'bite'.

The one thing to remember about EG Attack in this context is that the effect will vary depending upon the sound that you are editing, and you will only be able to make subtle changes, unlike those in

synthesis where the sound is being created.

This controller uses 64 as 0 (no effect on the sound), thus enabling the attack to be slowed as well as accelerated. One final word: this controller doesn't work as you expect. Slowing the attack is achieved with values 65 to 127, while accelerating it is achieved with values 63 to 0.

The EG Release controller (72) is used when you wish to edit the length of time the sound continues when the key is no longer depressed. This *does* work as you would expect it to, with values 65 to 127 increasing the length of time a note continues after receiving a note off, and 63 to 0 decreasing it.

At first sight this would seem only to be useful for strange effects, but in practice sounds such as guitars and other percussive string instruments, such as dulcimers and sitars, can sound more real after tweaking the EG Release value. Pianos too can benefit from a slight increase in release time. I'm sure you will soon find out what's appropriate.

Tools for realism

I've often wondered why Yamaha didn't assign a controller to EG Decay, but during the writing of this article it occurred to me that stringed and wind instrument players can vary the attack of their instruments, and that string players can also control the release. The decay, however, is irrelevant as it is beyond the control of the player.

I must, therefore, assume that it is an attempt by Yamaha to give XG programmers the power to add more realism to their music than is possible with standard GM devices.

END

Contacting me

You can e-mail me at:
mcowgill@scoremac.
demon.co.uk

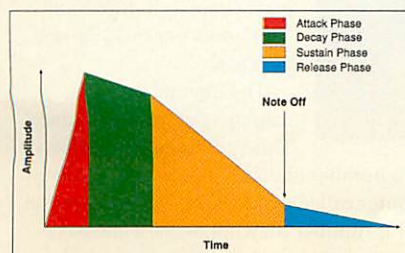

Fig 1: An ADSR envelope

Native retouching

Simon Anthony kicks off his short series on photo-retouching for free

A very long time ago I had a chance to take a photograph of my sister and my great grandmother, as it turned out this was the last photo taken of the two of them together. It has always been one of my favourites.

Unfortunately there is a fault with it that, had it not been the last one, would not matter all that much. My sister's jumper needed a good Star Trek-like tunic-tug, but it didn't get in time. So now, twenty or more years later, I have put the power of an un-augmented Acorn to the task.

Figures I and II show my efforts in the traditional before and after format, although not a perfect job, it's good enough for me. This is all done with just *Paint*, *Draw* and *ChangeFSI* – so it's effectively free.

The first task of getting the image from a snap on to the desktop was done using a £99 scanner from a highstreet box shifter – plugged in to my home-brew PC. A real Acorn-style one would have done as well or better, but any digitising method will do.

Good quality digital cameras are still very expensive, but I find that Photo CDs are now a good way to get from camera to computer – if you have a CD drive that is. Once you have your image any RISC OS 3.1 or better machine can perform the following tug trick.

What I did

The original scan was a little too dark, that's what you get for £99. It was also a JPEG file. This is a

Fig I: The offending article of clothing



Fig II: The retouched image

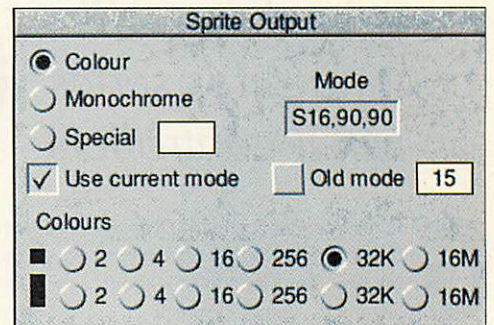

Fig III: The *Sprite Output* option window

compressed image file format which *Draw* can load, but that is not much use here as only *Paint* can really alter the pixels. So, I converted it to a sprite and lightened it up using *ChangeFSI*. This much under-used and under-rated *free* program can do a great deal for your photos

To load a file and convert it from a JPEG (if it is one) just drop it onto the *ChangeFSI* iconbar icon. The output sprite mode will be set by default to that of the current screen. To get the best quality you will have to work in a high mode anyway, so this default setting will be fine if the original picture looks good in it.

To alter the output mode use the options on the 'Sprite Output' item on the menu. Figure III shows the 'Sprite Output' option window. 'Use current mode' is ticked and the other settings of the window, in this case, reflect the current screen mode values.

The computer is therefore in a 32,000 colour mode with square pixels.

The mode display icon in this RISC OS 3.7 version of *ChangeFSI* is a bit odd. It's a hangover from earlier versions of the OS. Frankly I don't know exactly what S16,90,90 means but it changes to S32,90,45 when you select 16 million colours in this window. A rectangular pixel shape is indicated by 90x45 dots per inch; square by 90x90.

The manual says the display is of 'no significance'. This is definitely true when it

displays a number like 29376836 which is what my computer called a 32K, 1024x768 square pixel screen. This number may not be the same next time you use the same mode settings. In 'Old

modes' it shows the correct old mode number though.

The *ChangeFSI* menu as shown in Fig IV shows that the main menu leads off to the Processing options window. Here I have ticked only one box, that of Gamma Correction. This tilts the shape of the black to white contrast gradient, bending it according to the figures shown in its box. The effect is that of making the mid ranges of a picture lighter – with a value above 1, or darker between 1 and 0 – without altering the darkest or lightest areas.

In the real world there are a massive range of brightness levels between these two extremes, but once reduced to film or video – and then on to computer – we have far fewer steps to play with. In the end altering the Gamma can make the most of what brightness levels we have.

Contrast, by the way, is the absolute value of full white with respect to black. As full white can't get bigger than 'all on' and black can't get less than 'all off' there is no real contrast control, but Gamma comes close.

If the range of levels available in your picture does not cover all the possible steps from full white down to full black then you are not making full use of the available contrast range – although the picture may, and probably will, look better that way. To use every step to its full potential the 'Extend dynamic range' option can be used in *ChangeFSI*. This puts the darkest parts of the picture at full black and sets the lightest at full white, the steps inbetween will be set according to the current value of the Gamma contrast gradient, but now there will be more of them to play with.

Don't expect anything to happen when you use Black Correction or Brighten Picture as they are only for black and white pictures being prepared for a laser print out.

Warnings

The above, like just about all that comes next, is a matter of taste, and the final settings are entirely dependant on the type of picture you are using. Try it and see. It is always sensible to spend a lot of effort in getting the best possible starting material as, apart from simply being better, it can be a real pain finding the superior version once you've almost finished the retouching job.

That said, each job is a law unto itself and doing the same thing twice, or more often, can make for a splendid end product. So it's no real disaster if you do have to start again from scratch. Beware though – spending ages removing Red Eye from a photo late in to the night *can* transfer it to yourself in the morning. The optimum time to stop fiddling with your masterwork need not be when you have the 'perfect' result on screen.

Choices

The machine I used for this example was a Risc PC with enough VRAM to allow 32,000 colours in a large screen mode. Had the original photo been of better quality I would have used 16,000,000 colours. This number includes shades of brightness of every

colour as well by the way.

If your machine can't properly display a photo – as many PC created Web sites show – then no amount of care taken when retouching is going to make it look any good.

That means Mode 12 is out, at least for colour, 256

colour modes can look surprisingly good though, but only on an Acorn. *ChangeFSI* does a splendid job down-converting from a higher mode, but even we can't make a low mode image look better by up-converting.

Starting painting

To be able to use *Paint* the picture must be saved as a sprite (an electronic photograph where the grain of the picture is determined by the number of dots (pixels) per square inch making it up). When *ChangeFSI* has done with your work save it as a sprite by putting a tick by the 'Sprite Output' item on the menu. Then use the menu you get by clicking the Menu button over the output picture (Figure V) to do the normal drag and save thing.

It would obviously be daft to drop anything other than a Sprite on to the *Paint* iconbar icon, that is why I have never done it deliberately, but I did it once by accident and it loaded perfectly. Experiments showed that this works fine with RISC OS 3.6 or 3.7. It will also work with earlier OS versions, but only if *ChangeFSI* has been 'seen' by the computer. It just has to have been booted, not even run. It won't even load itself on to the iconbar, but it will do a full mode conversion to get the JPEG to be loaded and displayed in the current screen mode as a sprite in *Paint* – a handy shortcut sometimes.

The next step is the hard one. Here you need a steady hand and a clean mouse. This is because *Paint* does not have an Undo facility. This must be a hangover from earlier machines where memory was at a premium. Even today you can run out remarkably fast when moving sprites around.

Decompressing a JPEG scan from a friend's PC for example can make a 500k file fill 20Mb of memory. But the Risc PC can manage easily. If you don't have that sort of space then stick to lower screen modes which are far smaller in terms of memory and file size but are not of photo quality.

So, how do we get round this lack of undo-ability? The trick is to take snapshots of the parts of the picture you want to tweak and work on them one by one. Then put them back on top of the original (but best) image and there you are. Just how to do that must wait for next month. Hint, we use *Draw* a lot.

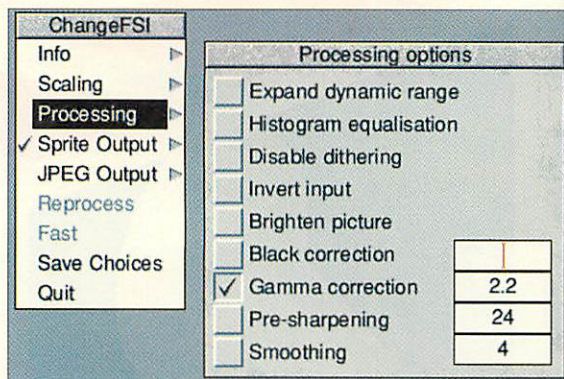

Fig IV: Some of the processing options in *ChangeFSI*

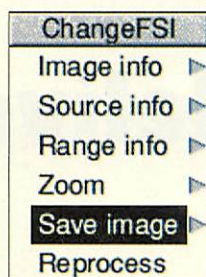
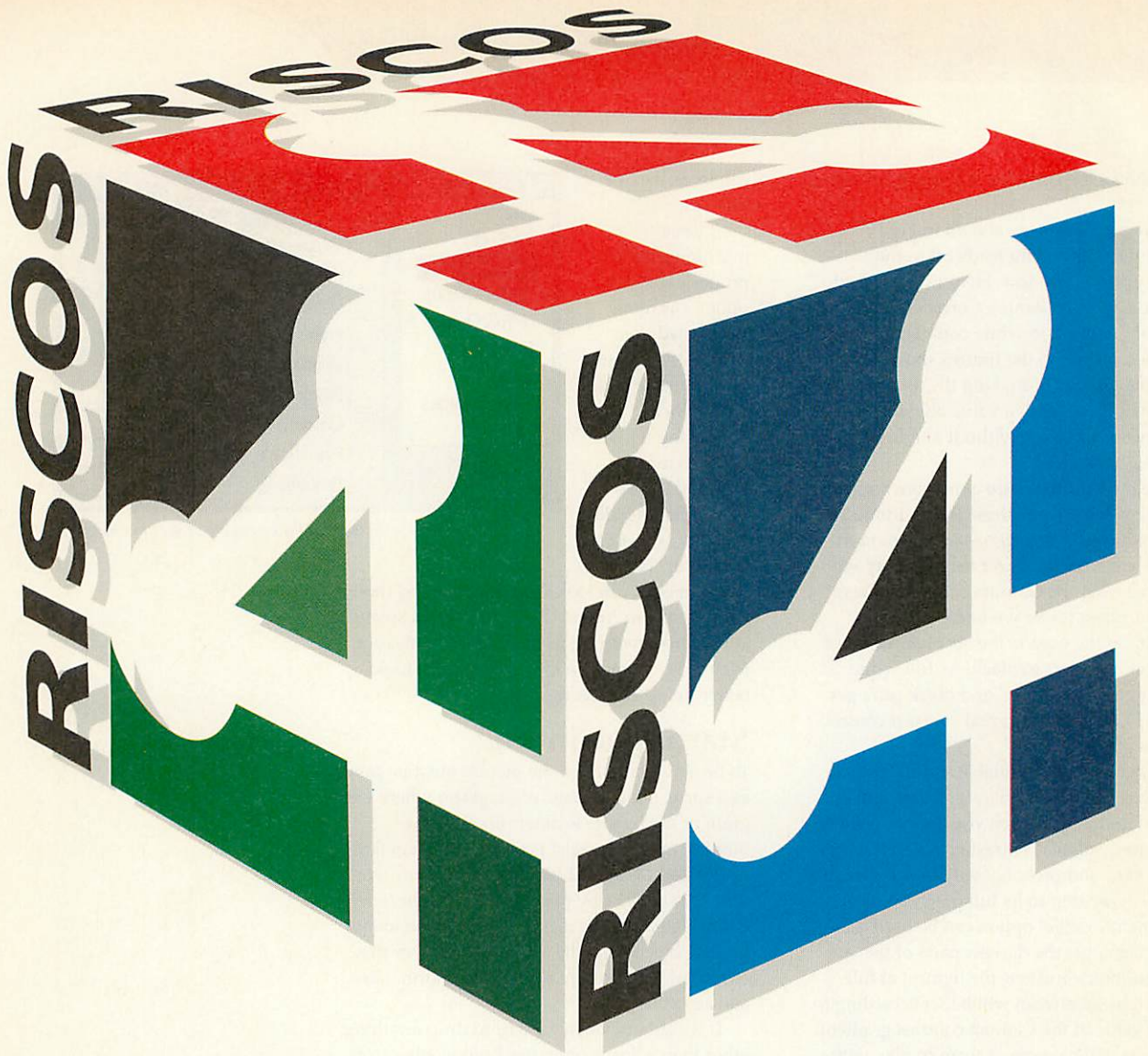

Fig V: *ChangeFSI*'s main menu

END



€120

incl VAT & delivery

See <http://www.riscos.com>
for ordering details

Objects of desire?

In a new series, Greg Scott looks at the most fashionable of the industry's programming accessories

Since the early 90's, Object-Oriented Programming has become a universal term in the software industry, from academic curricula through to corporate consultancy firms. It describes a revolutionary change in the entire software engineering process, from initial specification through to programming and maintenance. By applying its philosophy to modern, quality programming languages such as C++, Eiffel, Smalltalk and Ada, all involved are beginning to reap the productive and financial rewards of OOP.

These articles are about applying professional object-orientated techniques to any software development, large or small, and about increasing the productivity and efficiency of all Acorn

programmers. A knowledge of programming is not required to grasp the methodology of either the software development process or OOP. In fact the majority of industrial software development lies not in programming, but in the analysis and design stages, and these will be covered shortly.

We are mostly concerned with the programming stage, and the object-orientated language C++ will be used in this respect. It is widely available on most platforms (see Figure I), and often used to teach OOP principles at universities. These articles are also ideal for existing C programmers wishing to make the 'increment' to the C++ language. If this is the case, the first thing to appreciate about C++ is that anything you could do in C, you can also do in C++.

C++ Compilers available for Acorn Computers:

Acorn C/C++
Easy C++ (Beebug)
GNU C/C++

Figure I

The advantages of OOP

So what makes OOP such an attractive and popular school of programming? There are two main advantages in using an object-orientated language. The first is that the properties of such a language allow development of systems that, when altered, only require modifications to relatively small parts of the program. This means that maintenance and improvement of a program become more straightforward tasks, as does writing the

program itself.

The second is that because of the encapsulative and polymorphic properties of OOP (described later), parts of a program can easily be used within a completely different project.

Current software development

Before we uncover the roots of OOP, let us begin with the software development process. Just as with other industries, there are well-documented methods for successful software engineering, on any scale. Bearing in mind that theory and reality are two very different situations, consider the system illustrated in Figure II.

Each stage of the process feeds into the next by the creation of a document, or collection of documents. Typically, a client will first supply a software developer with what is known as a Statement of Requirements. This document describes the customer's needs for what the end software system will actually do. Somewhat bizarrely, often the customer does not actually have a complete picture of their aspirations for the project, but rather a short and abstract idea of its specifications. If you are programming your own application, this initial stage may seem irrelevant, but in an industrial situation it is often a good indication of the immediate success of the rest of the project.

Requirements analysis

Requirements Analysis is the technical examination of the statement of requirements. In an ideal world, the statement of requirements would be so specific and comprehensive that this stage becomes redundant. However, in reality, staff in the development team often have

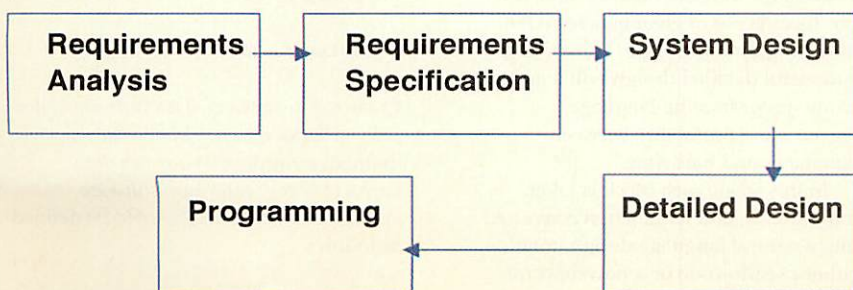

Fig II: The Software development pipeline

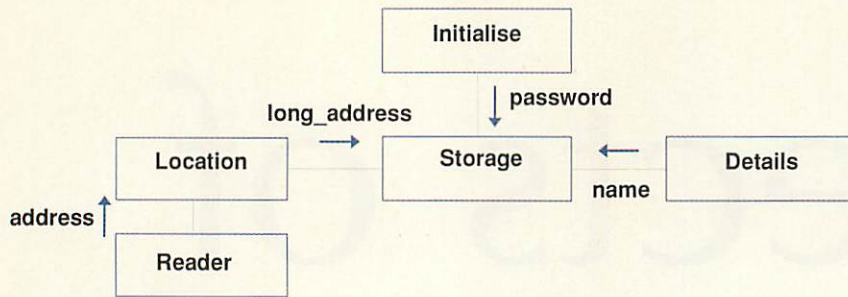

Fig III: System design

to delve deeper into the meaning of the statement of requirements, ask many more questions and clarify ambiguities. The customer may always be right but unfortunately they often don't have a clue about what they really need.

Requirements specification

The Requirement Specification is the technical description produced as a result of the previous analysis. Also known as the System Specification, it is a very detailed document covering not only the functional aspirations of the system, but also factors such as the estimated amount of maintenance required on the completed system and the level of staff training required.

At a functional level, the document will contain specific descriptions of the system's tasks, any constraints (such as hardware resources, memory, response and operating times) and any agreed formats or protocols which the system

must comply to – for example, if a client wishes to expand on an existing computer system, the same filing system must be used.

The importance of the requirements specification cannot be overstated. It is the document from which the rest of the system is solely based, and it is a major reference during later testing and maintenance of the system. It also proves useful when producing documentation for the completed application. Any errors left in the specification will undoubtedly lead to serious problems later in the development stage. Again, if you are writing a program for yourself, it is still important to get down on paper the exact functions and requirements of your idea, in as much detail as possible.

System design

System Design produces a detailed map, an architecture of the system, by taking into account every relevant detail from the requirements specification, including the constraints. It is typically represented in graphical form (see Figure III) as a web of blocks, just as one might first picture OOP itself. Each block is considered an individual function. Each line represents a call between functions, and arrows and variable names (next to the arrows) indicate parameters between the functions. For example, in Figure III, the function 'details' passes name into 'storage'. A function that calls more than one function would be represented by more lines from the function block.

Detailed design

Detailed Design could be omitted altogether in many situations, often because the documentation which it produces is not of great benefit to the final programming stage. However, a successful detailed design will lend itself to any programming language, encouraging portability between languages and hardware.

In this stage, each block is taken individually, and its function converted into a natural language design notation, either pseudo-code or a flowchart for example (see Figure IV). Once all of these stages have been completed, we use the

documentation to implement, test and maintain the final program. It is this programming stage which we shall focus on for rest of this series.

Object-oriented programming

At the heart of OOP is what is known as the abstract data type. This is a collection of both data and the functions that operate on that data. The key to good OOP is to focus more on the structure of these abstract data types, and not on the general functionality of the system.

The mechanism which defines an abstract data type is known as a class. A class is a skeleton, a template for describing the components of an abstract data type (the data and functions within it). Each implementation of a class is called an object.

A class groups together associated data structures and functions into a single object. For example, in a software system designed for a gymnasium, we could define a 'customer' class to hold customer details and have functions to change and add details. We could define a separate class called 'booking' which holds a record of daily bookings and has operations to alter them.

For C programmers, a class is most easily thought of as a *struct* with functions. The basic syntax for defining a class is as follows:

```

class class_type
{
  variables
  ...
  function definitions
  ...
};
  
```

Note that this code does not actually create an instance of a class at all, rather a definition of a class of type `class_type`. This is an important point to remember. To actually allocate memory and create an object, we use the syntax (noticing the use of the standard C++ comments - `// ...` as opposed to `/* ... */`):

```
class_type class_name;
```

For example:

```
customer jane;
```

Creates a instance of class *customer* called *jane* – assumed to have been previously defined. Returning to our previous scenario of a gymnasium software system, a customer class could be defined as follows:

```
class customer
{
```

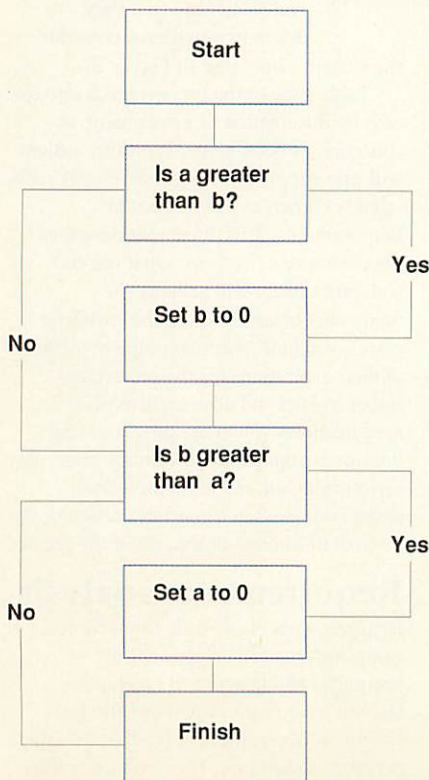

Fig IV: Detailed design flowchart

```
char *name,*address;    // name
of customer, address
int age;                // age
of customer
float height,weight;   //
details of customer
public:
void customer(void);
void alter_statistics(void);
void alter_address(char
*new_address);
}
```

This is a standard class declaration. After the name, 'customer', lies the variables which are local to the class. This means that any attempt to access the variables (*name, *address, and so on) will generate a compile time error. This is why we include the 'public:' keyword. Any data or functions declared after this keyword are accessible from both within and outside the class.

We directly index the components of a class using the '.' operator after the class name (not type) followed by the item we are addressing. For example:

```
customer jane;
jane.alter_statistics();
```

Calls the function *alter_statistics()* for object *jane*.

```
jane.age=20;
```

This is illegal because *age* is private to the class *customer*.

An important function, declared within our previous customer definition above, is that called *customer()*, sharing the name of the class. This function is known as the *constructor*, and it is called every time an instance of a class is created. So in the previous example, when the object 'jane' was created, the *customer()* function within the class was executed. Constructor functions are optional, and often omitted in class definitions. Destructors (the opposite of constructors) will make an appearance at a later stage in the series.

To actually define a function belonging to a class we use a very similar syntax to a usual function definition. The difference is that we have to include

which class the function belongs to:

```
class letter
// define class letter
{
char
letter_of_alphabet;
int
number_in_alphabet;
// public components
follow...
public:
void letter(char
letter,int number);
void next(void);
};
// end class definition
letter::letter(char letter,int
number)
// note the :: operator
{
letter_of_alphabet=letter;
number_in_alphabet=number;
}
letter::next(void)
{
letter_of_alphabet++;
if(++number_in_alphabet>26)number_
in_alphabet=26;
}
```

To define a function belonging to a class, we use the class name followed by '::' followed by the function name. This technique is used whether the function is declared as public or private. Functions can (as in C) be defined within the class if that's what you want.

Even after this brief introduction, a very powerful aspect of C++ has been illustrated. This is known as Encapsulation, and along with Polymorphism, Inheritance and Dynamic Binding makes up the four fundamental characteristics of an OOP language.

Initially undeveloped in early OOP languages, encapsulation is a wonderful entity which extends throughout the entire philosophy of OOP. Also known as Information Hiding, it describes how the contents of an object are protected from outside access and influence, unless declared by the programmer. Components of an object can be made private (as we have seen), only accessible from within the class. Data access between objects becomes more orderly, and far easier to change (see Figures Va/Vb).

The remaining characteristics of an object-orientated language are briefly mentioned below, and covered in far greater detail in next month's issue.

Polymorphism

Sometimes known as genericity, this feature of OOP allows the use of the same class to serve different data types. A

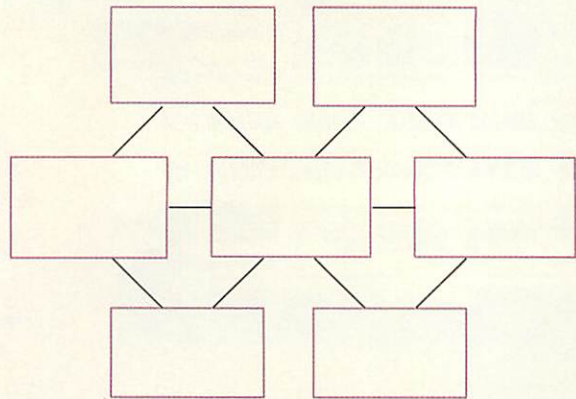

Fig Vb: Distinct data access

typical example is that of a summation function, which receives an array of values and is required to add the entire array to produce a final total. Polymorphism would allow the same class definition, which added integer values, to also handle floating point values, as well as any other data types as long as provisions has been made.

Inheritance and more

This is a fundamental property of any OOP language. It is the passing down of information from a base class definition to a new class definition. For example, suppose we were designing a system to handle different clothing in a factory line. We could create a base class, called 'garment'. This class would hold basic properties such as price, materials and size.

However, if we wanted to add more individual elements to the data, for a specific type of clothing such as a t-shirt, then to add them to this base class would mean including long description strings and data types irrelevant to other forms of clothing. A better alternative would be to create a derived class called 't-shirt', which would inherit all the properties of the base class, but also create its very own fields, such as collar type and button type. This passing down of characteristics and specialisation of a class is called Inheritance.

A feature which is hard to implement in a C++ compiler, Dynamic Binding is the ability of a compiler to sense the type of object being accessed or called, and act accordingly. A very powerful and time-saving property of OOP, it is most useful at avoiding potential pitfalls when two or more different types of class are interacting.

Next month

Next month we shall see how these fundamental properties of OOP are implemented in C++. We shall also begin an on-going project which will closely follow the design philosophy described in these articles.

END

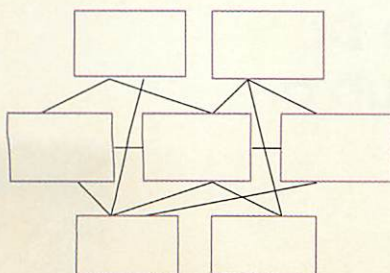

Fig Va: Confusing data access

RISC OS

99

SHOW



Sponsored by

ACORN USER

spacetechnology
imaging technology

Organised by **The ARM Club**

Supported
by



Sat 30th October 10.00 to 17.00
Sun 31st October 10.00 to 16.00

Queen's Stand, Epsom Downs Racecourse Surrey
(Close to M25, Nearest BR: Tattenham Corner)

Entrance £3.50 Advance, £4.50 at the Door
Send cheque payable to the ARM club at
FREEPOST The Arm Club

Tel 07050 679262 Fax 07050 679263
<http://www.armclub.org.uk/riscos99>

Show Highlights



New Hardware?

Organised by *The* **ARM Club**

Supported by



Sponsored by

ACORN USER

spacetechnology
imaging technology



The **RISC OS**



SHOW

Pushing forward the frontiers in RISC OS
internet & web authoring software

Rcomp

New Release



Messenger

**An E-mail and News
Client for RISC OS
Professional Edition**

£30

The only RISC OS Internet software with the
GOOD NET-KEEPING seal of approval

SiteSeer £25

Web grabbing software for offline viewing

HTMLEdit Studio

Next generation WWW
authoring for RISC OS

£105

All the tools you need

Our RISC OS web authoring solutions set new
standards in power and ease of use

The Studio edition provides

HTMLEdit 4+	Java support, sound and music, link and image checking, syntax colouring and OLE	£53
Enhanced Web Toolkit	Visual frames, tables, animations, maps, palette control, Draw file conversion	£30
WebSpell	Full HTML-aware spelling checker	£15
Webster XL	Browser with frames, tables, forms, sound and JavaScript	£25

SiteMaster Price now

The Web Site Management
System for RISC OS Computers **£30**

Now with automatic up-loader for
getting changes online fast

Interactive
Rcomp

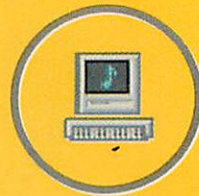

anthem* £70

inc. VAT

The RISC OS MIDI Sequencer

Anthem is a feature packed, easy to use MIDI
sequencing package for RISC OS computers
It employs a powerful and acclaimed new object-
oriented (phrases of music) song structure that
allows the musician flexibility in arrangement, and
ease of editing unparalleled by any other RISC OS
sequencer.

*We believe our prices
are simply unbeatable*

Existing Sound & Music Products include
PC SoundPro 2 £35, MIDI Synthesizers,
Sound Cards, MIDI Cards, Parallel/Serial
Port MIDI, MIDI Support....

DOOM FINAL

New!

Extra Levels Pack £15 inc.
Requires Doom or Doom+

Other Games Titles

Heretic & Hexan (Towers of Darkness Pack)	£32.50
Heroes of Might & Magic 2	£35.00
Descent	£30.00
Doom+	£32.50
Syndicate+	£29.00
Abuse	£25.00

Distributors for ARTEX: Ankh, Exodus
PRO ACTION: Various titles

22 Robert Moffat, High Legh, Knutsford, Cheshire WA16 6PS
Tel: 01925 755043 Fax: 01925 757377 Email: rcomp@rcomp.co.uk rci@rcomp.co.uk

Post wakefield

Alasdair Bailey takes
a look at two new
games releases

The Wakefield show has now passed and it's time to take a look at some of the offerings which have been released into my gaming fold – *Final Doom* and *Shovvy 3D*. A review of RCI's new *Heroes of Might and Magic II* add-on pack will follow next issue, along with whatever information I can glean from the suppliers present at the show.

Feel free to contact me with information on your games, no matter how big or small, at games@acornuser.com or via the usual editorial address if you prefer snail mail.

Unfortunately, Artex Software were unable to attend the Wakefield show due to commitments with their on-going *Iron Dignity* project. We understand that a number of PC publishers are interested in the project, Psygnosis and

Software 2000 included. More details will follow next month.

Final Doom

The *Doom* series goes like this: *Doom* (later re-named *Ultimate Doom*), *Doom II* and then *Final Doom*. *Final Doom* is essentially an extra missions pack for *Doom II*. It contains two additional level files, these are used in place of the main *Doom* level file that was initially supplied with the game. Each level file, or episode, contains 32 individual levels, giving a total of 64 brand new missions in all.

Having been released late in 1995, PlayStation *Doom* was an instant hit on the fledgling console format. id Software followed on from this with *Final Doom*, a collection of levels set to be the final chapter of the *Doom* series.

Final Doom was released on the PC shortly afterwards and now, as the game makes its Acorn debut, it's time to see what's hot and what's not in the world of *Final Doom*.

The Acorn release of *Final Doom* consists of the original PC CD-ROM containing the level files, along with all the usual Acorn-specific documentation and an installer. You will need a copy of R-Comp's *Doom(+)* or the freeware *DIY Doom* player before you can use these levels, the commercial offering is still available from R-Comp at the address in the box-out below.

Two episodes are included in the *Final Doom* pack, *TNT: Evilution* (sic) and *The Plutonia Experiment*. The episodes are intended to be played in that order so that's the order in which I'll consider them here.

The plot behind *Evilution* tells us that after the monsters were expelled from the world of *Doom II*, another invasion of a military plant was led by Hell's minions. This resulted in the plant's staff being turned into zombies once more by the forces of evil (not again! – Ed) and a population of downright evil monsters being stationed there to keep an eye on them. You, the base commander, happened to be strolling in the desert at the time of the invasion, so when you return you set about ridding the base of its new alien inhabitants.

The levels are very well designed, extra wall and floor textures provide a subtle difference to the earlier official *Doom* episodes. Other than that the graphics are just the same as those found in previous incarnations of this game. The behaviour of weapons and monsters also remain the same, emphasising the point that these are just new levels, the game engine itself remains unchanged.

Unlike many home-made levels available on the Internet and from other sources, these are very playable, and much thought and testing has obviously



Nice hand action

gone into their production. It could even be said that these levels are somewhat better than the original *Doom/Doom II* levels. Firstly, they are a lot more challenging, and secondly, a good mix of monsters are thrown at you right from the very beginning.

Evolution's missions also include more puzzle-solving than seen previously in the *Doom* fold. However, the puzzles only really consist of subtly hidden switches, which must be activated to allow progression to the next part of the level, and are still not up to the standard of the mega-puzzles seen in the recently released *Hexen*.

When it comes to playability, *Final Doom* still far surpasses many other titles of its genre. The difficulty level is such that the experienced player will not have to waste time cruising through the initial easy levels intended for those new to the game. With these levels, you can get straight down to work, with some rather challenging monster slaying even taking place in the first five levels.

However, the increased difficulty level does have its downside. From about level 15 onwards, *Evolution* becomes rather tricky, and after about level 20 it's just evil. That aside, the first 14 levels are, for the most part, a joy to play and will be a challenge even if you are already a master at *Doom II*.

The second episode, *Plutonia*, is harder than anything I've ever seen this side of hard-town. If the last few levels of *Evolution* were evil, the task of completing *Plutonia* could be equated to the chances of donning Ripley's shoes and surviving all three *Aliens* sequels. It really is that hard, even your flame-retardant games writer had to resort to low-life cheats to get very far past level five.

The last level is absolutely packed full of the biggest and best baddies

around. That, I would say, is this episode's major failing point. It is insanely difficult and unless you're a pro, it's not worth even trying to complete *Plutonia*.

As with *Evolution*, *Plutonia* includes a few new graphics, but there's nothing really stunning in there. If you're looking for excellent graphics in a game of this kind, you'll need to buy a PC and play *Half-Life* or *Quake II*. However, if good, solid gameplay is more your scene, you can't go far wrong with the *Final Doom* pack.

Pricewise, at £15, the pack is well worth the cash given the amount of time you're likely to spend playing it. However, the price has yet to be confirmed, so although the final price will not be higher than £15, it could well be lower. It is worth pointing out that *Final Doom* may be obtained on GT's *Replay* label for the price of £9.99 from many High Street retailers, including the Electronics Boutique. The

game will still function in the same way, but you won't benefit from Acorn-specific technical support or gain peace of mind from knowing you've supported the Acorn market.

To summarise, if you enjoyed *Doom (II)* and haven't played it in a while, go out and buy *Final Doom* now. However, if you're looking for something more technically complex from this genre, grab a copy of the *Heretic* and *Hexen* double pack or wait for *Quake*.

END

Product details

Product: Final Doom
 Price: £15.00
 Supplier: R-Comp Interactive, 22 Robert Moffat, High Legh, Knutsford, Cheshire WA16 6PS
 Tel: 01925 755 043
 Fax: 01925 757 377
 E-mail: rci@rcomp.co.uk
 WWW: <http://www.rcomp.co.uk/>



Oh, Mr Editor, what have I done to you?



Nice doggy...

Century House, Market Street, Swavesey, Cambs. CB4 5QG
Tel/Fax: 01954 208208, e-mail sales@eesox.com, www.eesox.com



NEW!!

**4-Piece Multi-Media
Sound System**

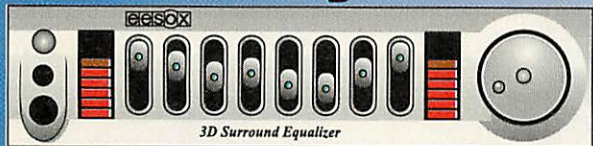

**Graphic Equaliser
and
3D 600W Subwoofer Speaker System**
£99.00 (incl. VAT)



CD Fast3
£29 (incl. VAT)



**Graphics
Tablets**

A5 Tablet only £217
(Including VAT. Carriage £11.75 extra)

DVD Drives
From **£440**
incl.VAT

**40 Speed
IDE and SCSI**

All prices less carriage (£11.75 incl)

Monitors
Iiyama 15" 350 £145.00
Iiyama 17" (S702GT) .28dot £279.00
Iiyama 17" 400 Pro .25 dot £359.00
CTX 14" Digital Scan £125.00
CTX 15" Digital Scan £145.00
CTX 17" .28 70Khz Digital £259.00
CTX mons have (3 year on-site warranty)
Many other models available

Switch Boxes
Parallel 2 way (25w 'D' skts) £16.99
Parallel 4 way (25w 'D' skts) £19.99
Serial 2 way (9w 'D' skts) £19.99
Monitor+Keyboard 2 way £19.99
Suitable cables and other boxes available, please ask

**VGA to PAL
TV Converter**
The VGA Converter allows the output of any Acorn running in a VGA or SVGA mode (or PC comp) to be displayed on a TV or recorded onto a video recorder. Please ask for more information.
Price £159.00 inc vat

Colour Printers
Epson Stylus Colour 440 £125.00
Epson Stylus Colour 640 £159.00
Epson Stylus Colour 850 £279.00
HP Laserjet 1100 (laser mono) £289.00

Virus Protection
Pineapples Virus Protection Scheme has been running for over six years and is still being updated with new viruses on a regular basis. New software versions are sent out to members every four months and the total number of viruses which can be removed is well over 200. The latest version is now scanning at up to four times faster than previous versions despite coping with many more viruses.
Joining fee just £28.20
'If you're interested in virus protection, join the Pineapple Virus Protection scheme and buy Killer. Accept no alternative - 'Acorn User Feb 96
Inexpensive multi-user licences

Parallel to SCSI adapter
A brand new product from Pineapple providing an inexpensive alternative to a SCSI card when using SCSI scanners. The SCSI adapter plugs into the parallel port (with a 'through' printer connector), and can be used directly with SCSI scanners. Works with A3010/3020/4000/5000/ A7000/RiscPC (inc StrongARM).
Price just £59.00 inc vat

Colour Scanners
The new Epson GT7000 is great value and the Photo version with transparency adapter gives excellent quality on both transparencies and negatives. Our new SCSI parallel port adapter cable makes this excellent scanner very affordable. The Plustek 12000P parallel port scanner also gives excellent quality at the cheapest possible price. All scanner prices include Imagemaster and Twain software.
Epson GT7000 - SCSI £259.00
Epson GT7000 Photo - SCSI £299.00
Epson FilmScan 200 - SCSI £435.00
Canon Canoscan 2700F - SCSI £557.00
Plustek 12000P - Parallel Port £149.00

Pineapple Software
352 Green Lane, ILFORD
Essex IG3 9JS
Tel 0181 599 1476 Fax 0181 598 2343
email:- sales@pineapple.demon.co.uk
www:- http://www.pineapple.demon.co.uk

Terms:- All prices include 17.5% vat. Carriage £5 on most hardware. Small items £3 (or less). Phone for quote outside UK. Official orders, cheques and all major credit cards accepted at no extra charge.

Studio24Pro
Many Acorn User front covers have been created from scratch using this program alone, concrete proof of the power of this creative tool! - *Acorn User Mar96*
Now just ★ £99.00 ★
Users note FREE update v2.16 is now available.

Showy 3D

Under their new management at CJE Micros, The Fourth Dimension have released a handful of new titles. Up to now none have really been worth the trouble of buying, but *Showy 3D* is billed as the first of a new run of high-quality releases.

Showy 3D is a puzzle-solving game where you must guide your character around a large playing area and sort coloured blocks into groups of three in order to make them disappear. The game does have the term 3D in its title but that must be an attempt to make it sound good since the game is not truly 3D, it features a flat playing area which is viewed at an angle.

A variety of different blocks are scattered around each level and these must be pushed around the playing area to form groups of three by type which are promptly removed in a tetris-like fashion. The aim is of course to clear the playing area of blocks in order to progress to the next level.

Your character, named Pushy, but not related to the small blobby character in Fred William's *Pushy* and *Pushy II*, wanders about the board and is able to carry out a number of vital tasks.

First and foremost is his ability to push blocks around, without this skill, he would be pretty useless. Secondly, he is able to throw a large blue ball at the opposition, knocking them to the ground. Finally, he is able to dance in the fashion of Mr Bean. This skill may be observed once the player becomes so bored he/she hammers the push key and watches pushy move back and forth without any block to shift.

Showy's main failing point is that the pace of the gameplay is lethargic to say the least. The motion of the character

from square to square is rather sudden and disjointed. Add to that the fact that the game lacks any real moments of excitement and you have a pretty dull game on your hands.

The brain-teasing element of *Showy* does deserve some praise though. Once style and first impressions are put aside, the actual gameplay is fairly good. There are three main types of block available; the ordinary ones which will move one square when pushed, the green ones which will continue to move until they hit an obstacle and then the blue variety which will bounce off walls to come back and hit you unless you keep your wits about you.

Blocks must be sorted by colour, and the specific properties of each block mean that the basic blocks must be used to guide the more awkward types into position. This adds a strong puzzle-solving element and this alone will keep many people who take up the challenge playing for hours, just trying different ways of getting the blocks to meet.

The nasties which bar your way may be killed in two ways. Pushy may launch his big ball at them or he can flatten them with a block. The ball must be retrieved after it has been used since Pushy only has one ball and must look after it carefully. This twist does add something to the game, and perhaps offers something over and above endlessly collecting ammunition.

A time limit is included in each level, but this doesn't really alter the gameplay in any major way because the limits are generous, so you're more likely to have fouled up in some other way before your time expires. However, it is sometimes fun to wait for the time to run out because a nasty creature appears and chases you around the level until you're dead.

When it comes to graphics, *Showy* hardly excels in any area. The title screen is well drawn and the menu is pleasing to look at, but the in-game graphics lack a certain something. Even in the high-resolution mode, the character is rather pixellated, although

the blocks and playing area textures are acceptable.

In these days of high-powered Risc PCs and StrongARM processors, even puzzle games should feature nicely drawn graphics. The freeware *Pushy II* from FishNet is a spookily similar game, it offers very well drawn 24-bit graphics for machines which can handle them and fewer colours for those that can't.

The sound effects aren't much to write home about either. Only a limited number are provided, and although

there are some amusing voice samples, they just don't go far enough.

The main music track sounds similar to the tracker module music which accompanied oh-so-many pre-Risc PC graphical demos.

Perhaps this sort of music will appeal to some, but it's sure to annoy the pants off others.

When launched, the game provides an iconbar icon which serves no further purpose than to get you into the actual game. Upon clicking on this icon, you are presented with a choice of screen modes to run the game in. The low resolution option allows the game to function on machines as lowly as a 4MB ARM3, with the 'Mode 28' option only being suited to Risc PCs with VRAM. There is a minor apostrophe error in this dialogue box, my Risc PC does not own VRAM, I do, and I'm sure that's the case with most other users.

Overall, *Showy 3D* is a playable game which lacks style. Ardent puzzle solvers should buy this game but be warned, you'll need to force yourself to play through the first few levels before really getting into the swing of things.

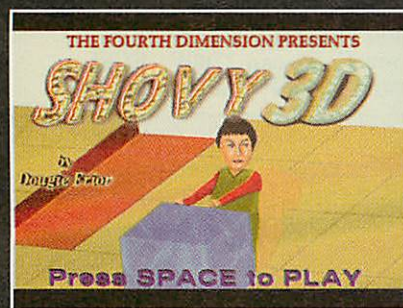

Product details

Product:	Showy 3D
Price:	£20.00
Supplier:	The Fourth Dimension, 78 Brighton Road, Worthing, West Sussex. BN11 2EN
Tel:	01903 213361
Fax:	01903 523679
E-mail:	4d@cje.co.uk
WWW:	http://www.cje.co.uk/4d/

Guess the Game

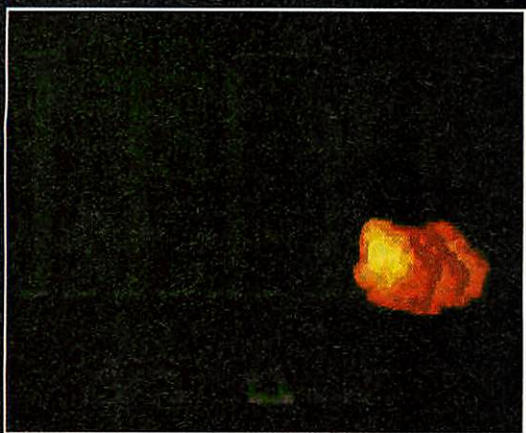

Screenshot 1

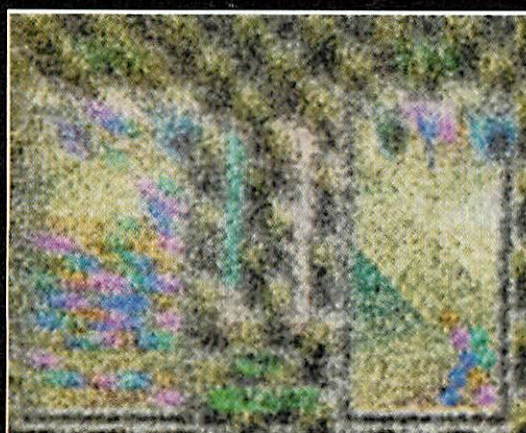

Screenshot 2

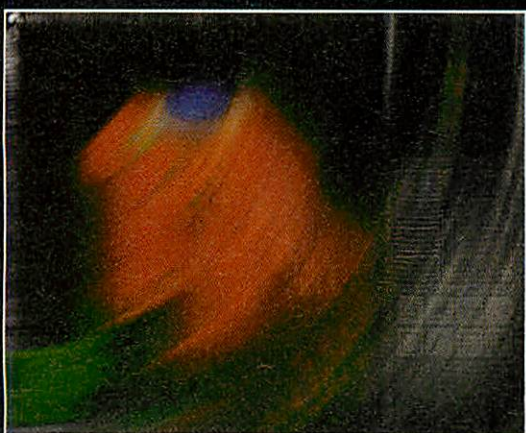

Screenshot 3



Screenshot 4

Oh dear, that darned PC has mangled all my lovely Acorn screenshots again! So, boys and girls, take a long, hard look at them and let me know which game corresponds to which bodged screenshot. But hurry, there's five copies of *Shovy 3D* from The Fourth Dimension up for grabs for the first five correct entries out of the hat.

Once you've made your selections, complete the entry coupon below and mail it to the usual editorial address marked 'Guess The Game' to arrive not later than 19th of July.

Alternatively you can e-mail entries to me at games@acornuser.com giving all the information asked for in the coupon including your full postal address. Thanks go out to David Bradforth, *Shovy's* manager for donating the prizes.

To make life a little easier, here's a list of games to choose the four correct answers from:

1. Heroes of Might and Magic II
2. Syndicate
3. Dune II
4. Sim City 2000
5. Bubble Impact
6. BotKiller II
7. TEK
8. Abuse
9. Xenocide
10. Super Foul Egg

ENTRY FORM

Complete this form and return it to *Guess the Game*, Tau Press Ltd, Media House, Adlington Park, Macclesfield, SK10 4NP. E-mail entries should be sent to games@acornuser.com

Name

Address

.....Postcode.....

E-mail

Screenshot 1 is.....

Screenshot 2 is.....

Screenshot 3 is.....

Screenshot 4 is.....

*Star info

Dave and Dave
reflect on 101 *Infos

FOR i = 108 TO 209

This being the last ever *INFO, we thought we'd take our usual space to revisit some classics of the last nine years and pay respect to the real stars of this column – our readers and contributors. We've spent the morning delving through our drawers and then had a quick look through the stack of back issues in a dim and distant, dank and dusty corner of the *INFO orifice.

From the grand total of 321,946 words and 2,133 programs we've teased out a final selection of a couple of thousand words and our 60 or so

favourite doodly doodles. As this is the final column we thought it would be appropriate if I (DL) use the left hand side of the keyboard and DA takes the right. He's also in charge of the punctuation and I've been lumbered with the numbers and the function keys. Presses of the space bar will be decided by the roll of the official *INFO dice.

Most of the programs mentioned here can be found on the cover disc and also on Ceefax page 812.

1991 – Star-t info

July, and the first *INFO. Michael Attenborough kicked us off with a 3D lissajoux generator – SINS, COSs and a healthy blob of machine code. We also covered sorting techniques and the first obscure game. A fine demonstration of what we wanted in our new column.

August brought us random landscapes (see *Coast*), wavy scrolls (scrolly waves didn't appear for another four years) and star commands. 80MB hard disc? £399!

On to October and Michael A became one of our first regulars with *Pendulum*, starting a trend

for simulating the behaviour of physical objects: magnets on strings, balls on strings, strings on strings. In fact an amazing assortment of stringy things have appeared over the years. The rumours of A New Operating System – RISC OS 3 promised us a healthy future.

The A5000 first appeared in November and we responded with James Wilkinson's stream of *Bubbles* and Michael Fairbank's Jet Set Willy-esque *Rope*. Neither of which required the sheer brute force of a 25MHz ARM3.

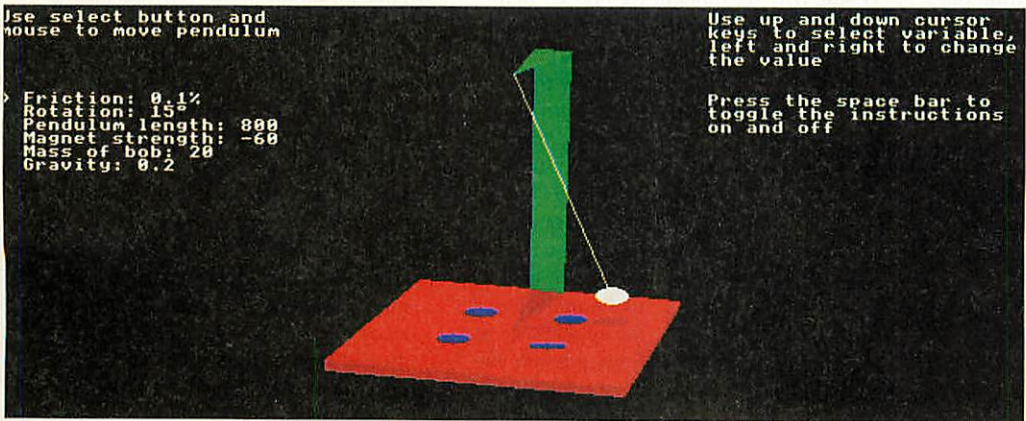

1992 – On a ROL

Our naturist theme continued with the seminal work *BlindFlies* by **Barry Wickett** – a mainstay of our early years. This classic program was subsequently lambasted for being 'too silly!'. Can you believe that? In the same issue **Daniel Tray** gave us *ArmTree*. Even on one of those new fangled A5000s this was sluggish. However coming back to it now with the benefit of 9.32 times as many megahertz and it positively rockets along – as much as a tree can rocket.

The inspiration for a later challenge came from the February issue in the nebulous shape of a cloud generator. The original idea by **Andrew Jones** triggered a gentle trickle of weathery items. Sun, rain, sleet and snow have all fallen on our pages. Except sleet.

'Animated hedgehog land' proclaimed the caption under our next choice, although 'aerial view of Madonna's lingerie production line' would have been

far clearer. *Spikes* fit nicely into our bizarrely popular category of eye/brain discomfort, but what could you expect from our resident Dane, **Jan Vibe**. Jan has stuck with us from the beginning despite the many occasions we've accidentally told everyone he's Dutch.

From April to September the pace really began to pick up – Jan provided us with a psychedelic eiderdown and, incidentally, a program to generate a coloured grid of squares called *Toner27*. We were back to trigonometry in May with a one-liner *TrigProg* from **David** and **Andrew Jefferies** (whose names are actually longer the program). One-liners were a wonderful challenge back then, their point having been somewhat lost in these days of Javascript and Megabytes.

Jan continued to reveal his obsession with Madonna's, err,

unmentionables somehow bridging the gap between the bizarre and the mildly obscene with an unpleasantly pink offering called *Weirdo*. **Michel Grimminck** made *Waves* as did the appearance of the A4 portable. More physical shenanigans were demonstrated by **Bryan Creer** (who definitely did not have a mouth like an ear). His *WaterWheel* showed us all just how unpredictable a wheel full of buckets could be when placed under a dripping tap. Having settled this once and for all we able to close the year with 'The most disgusting picture you've ever seen on a computer screen'. Seven years on, and Jan's tentacles are still quite a sight to behold.

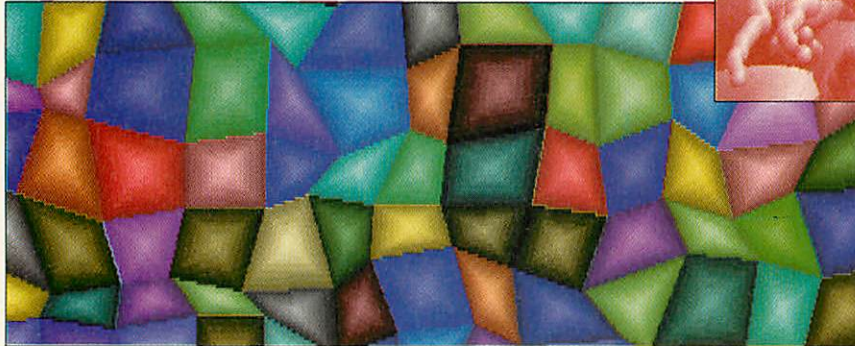

Jan Vibe's
bedspread

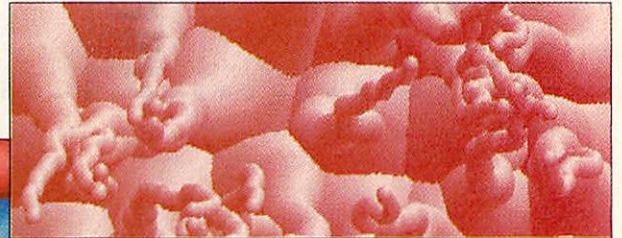

Weirdo

1993 – One liners and three dimensions

Guess who? Jan's *Stars* burst onto our screens in February with a cunning use of the draw module to simplify the plotting. May brought the first Tesco Computers for Schools offer (Does anyone remember the rolling demos running in the shops? I wonder who wrote them then...) and for some reason the news pages showed Sarah Green in a glass box. On the *INFO pages you could find programs from our second most famous Jan V – **Jan**

Vlietinck (but possibly our most famous – inck) – *Snake* plotted recursive hexagons in a three dimensional lissajoux shaped snake. *Top* drew a top, albeit one with 2400 polygons.

June marked the peak of one-line-mania – *Bell7/1* showed it was possible to squeeze **Nigel Thomas'** 380-line campanology simulator into 255 bytes. Quite why we thought we needed to do this is a different matter entirely! How

Robbie Davies fitted the three voice *Tune/1* into the same space was a mystery back in '93 and six years later we're none the wiser! We had to wait two months for the appearance of *Fruit*, possibly the most cunning one line game ever. It

used the RAM disc to create three files of different types representing a fruit machine. It then saved itself with a different name indicating how much money you had left! Marvellous.

Allister Jenks added a well-needed breath of New Age topicality to the one-liner genre with *CropCircle*. So convincing even Patrick Moore might have been impressed if he had been a farmer. More Jan in November with *Shatter2*. The 3D fad of the year was Magic Eye pictures, there are certain parties among the *INFO office who are convinced that these are just another hoax perpetrated by rustic farm hands. Unbowed by the shrieks of 'Oo look – an owl!' said parties remain forever sceptical. **Bryan Creer** proved that these images could be just as elusive, illusive (and quite probably allusive as well) on screen as on paper. The year ended just as disgustingly as the last with an eyeful of the Dutch, sorry, Danish intestinal tract in the shape of *GutsVGA*.

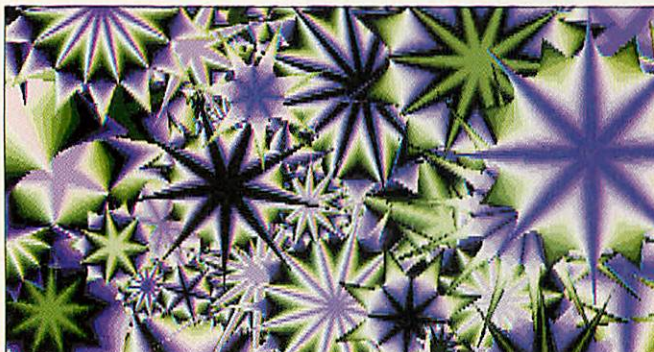

Stars

1994 – birth of the Risc PC

Acorn's speediest creation yet appeared in May '94 but it took a little while for people to start making full use of it's potential. Jan Vibe's tentacles started sprouting a good deal faster, but that may have just been due to a particularly warm spell in June.

Another long-running *INFO tradition was born in the shape of the MUSC (Most

Useless System Call) of the month, where readers nominated contenders for the most pointless SWI ever created, only for other readers to write in the next month with examples of how gloriously useful it was after all.

Another name that was to feature prominently over the years to come was **Jean Van Mourik** – who had clearly tried

hard to distinguish himself from our other regulars by taking an 'e' (into his forename). Clearly on a mission to brighten the screens of Dyfed, he flooded our screens in August with the psychedelic *Whirl* and followed through with the eerie, rocky globe of *Spheragate*. The mineral theme was picked up by **Andy Jefferies** in September with the cryptically entitled *Rock*. Jean brought the year to a graphical crescendo with *Candied*, a curious doodle that produced obscure candy-like mountains.

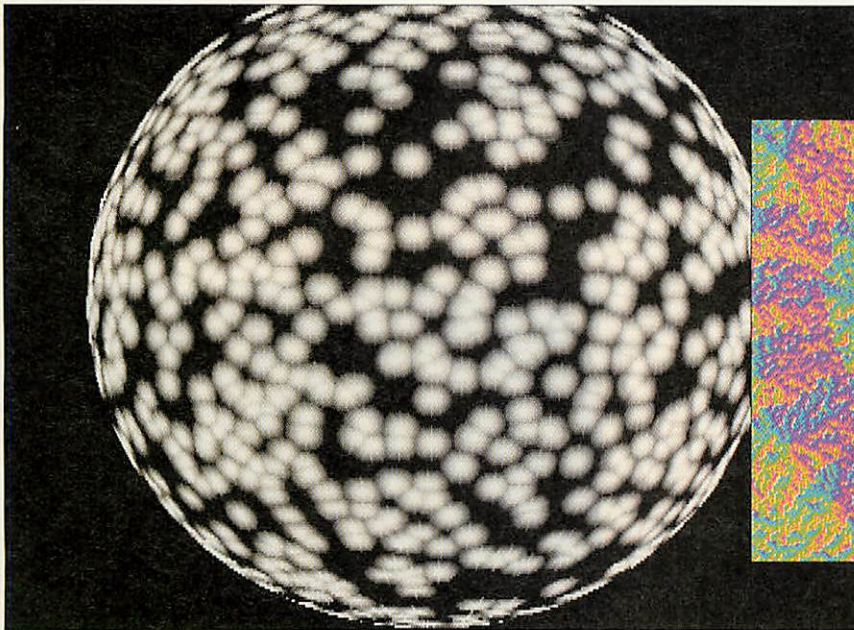

Spheragate

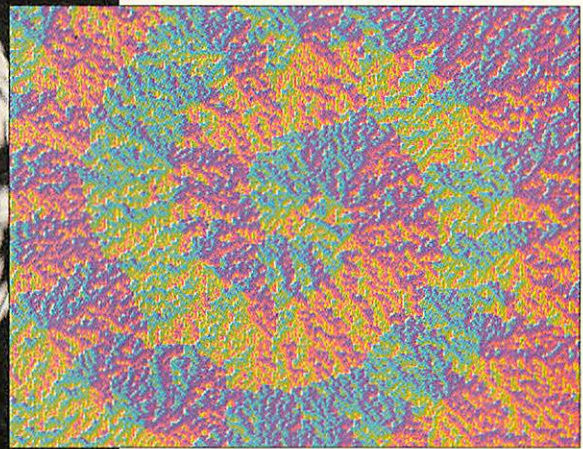

Whirl

1995 – Pearls and Pasta

Your £399 would now buy you 540Mb of hard disc, compared to the feeble 80 when *INFO first opened its doors.

February saw the first issue of *Acorn User* completely produced on Acorn hardware and in it, the writers were asked to make their predictions for the future. We predicted that Jan Vibe

would become president of Denmark and replace the single Danish flag with 256 flags of slightly differing hues to be raised and lowered at 1/50 second intervals.

We continued to supercharge past masterpieces for the Risc PC, providing a 256 colour version of Jan Vibe's *Pearls* in

the March issue. It was joined by a remarkable (well, for early '95) real-time fractal landscape from **Alistair Turnbull**, showing the shape of things to come. (If there were a lot of fractally, fjord-shaped things expected that is.)

April's issue sported a CD-Rom for the first time on which, among many other delights, all your past *INFO classics could be found. And in July, the first murmurings of the superchip known as StrongARM could be heard. Would we ever be able to control Jan's tentacles again we wondered?

Inspired by the Jan's, October saw the technicolour pasta-based demo known as *Taglia*. And then, just when I (DA) had thought we'd seen the last of those stupid 3D pictures (you know, the ones where there isn't anything there, but some people just pretend they can see an owl or something and go on about how great it is) Mr V himself chimes in with *Wood* – a deceptive program that at first glance looked like a "BBC Welcome Tape reject", but which cunningly held "magic-eye" secrets. Well, so he says anyway.



Taglia

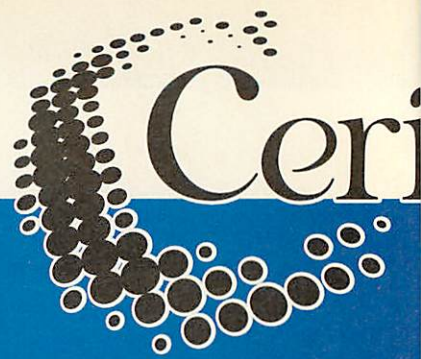

vantage

...the ultimate RISC OS design and publishing tool

You want to design. You want to publish. You want results.

Now there is a new way to get what you want in a fast, powerful manner. From the moment you first double-click on the !Vantage icon you know that you are in for a treat. No clutter. No fuss. Just a direct link to your design and publish abilities with no hindrance along the way.

Cerilica Vantage was created by designers and publishers for designers and publishers — and it shows. When you are presented with a Cerilica Vantage document, you have a clear view of the page that you know will remain true to the eventual printed result. With the aid of Cerilica's powerful TRUISM II and rendering technology, "WYSIWYG" design has now appeared in its most complete form in a package of this kind exclusively on the RISC OS platform. This gives you, the decision maker, the feeling of confidence, enabling you to be creative and efficient in all forms of design work.

However, the power of Cerilica Vantage is not just skin-deep. From the outset the package was designed with both amateurs and professionals in mind. This translates into both initial ease of use as well as the chance to become swifter in every operation as your familiarity grows. Even from the outset you will be aware of the inner strength the application is capable of delivering; from the ease of creating complex profiles, incorporating sprites of any type, manipulating everything before you and through to ultimate control over printing, in whatever form that may take.



www.cerilica.com

Supplied on

Available soon from Cerilica direct in the UK for £29.95 plus postage. Also available from overseas dealers. Ring Cerilica for availability details.

ilica

Vantage

and publishing package



cerilica.com

1 CD-ROM with comprehensive fully printed manual, tutorials and example files. RISC OS 3.5, StrongARM Risc PC, 8Mb of RAM or higher recommended.

Cerilica Vantage highlights

Optimised user interface giving maximum design area • Highly advanced rendering system giving over 200,000 levels of anti-aliasing (including sprites) and random dithering on-the-fly • Multi-page document control • Flexible path and shape creation and manipulation • Text abilities include text areas, text along paths as well as full



typographical control • Transparencies • Special fills, including radial, linear (with inbetween-colours along user-defined paths) and sprite • TRUISM II ink-based colour technology • Import and export to alternative platforms • Use Vantage drawfiles in virtually *all* existing RISC OS packages capable of handling standard drawfiles • Families (advanced layers) • Comprehensive grids and alignment tools • Interactive tool allowing documents to "point" to web pages • Two *professional* EFF font families • Free support

£35.00 (inc. VAT, exc. p+p), or from one of the select
Is on (01989) 567350, or e.mail cerilica@cerilica.com

1996 – In the blink of an Acorn

Just when we thought the days of the home-programmer, doodling away, were finally coming to an end as everyone switched to Windoze and forgot about one-line games and lissajous figures, our readers rallied and provided a yearful of gems. In April, Jan Vibe produced the rather frogspawnesque *V_Tile+* and the,

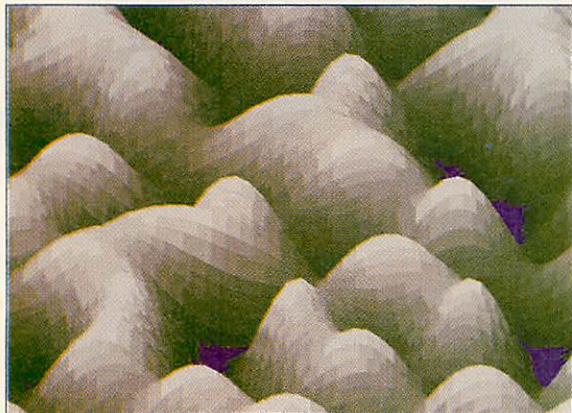

Mountains

erm, mountaineous, *Mountains*. In the same issue, perhaps the cutest and most understated of desktop sillies arrived in the shape of *Blink* by Andrew Ayre. Updated with a few more expressions some months later, the catnapping Acorn still brings a smile to our wizened, timeworn phizzogs.

The recurring theme of the bizarre game, well, kind of recurred I suppose, as May provided the world's first computer version of the Viking game of *Hneftafl*. (We suspect that the inventor of this game wasn't a Viking but simply sneezed just as he was about to answer his friend's question "what do you call this 'ere game then Eric?".

The *INFO pin-up, a relatively scantily clad

young vixen who had come to be known as Jenny, came in for one last round of abuse. Having previously been spun, zoomed, shrunk and generally knocked about, she was finally squished beyond recognition by Alistair Turnbull. Alistair returned to the less brutal world of fractals in the November issue with *CX(1-X)*, and David Llewellyn-Jones accompanied him with *Lights*. At the time we said "if Monet had ever gone into the fireworks business..." November was a cracking issue all round, not least because it featured our favourite Digital Symphony track of all time – Graeme Jefferis' *60sSciFi*. A mere 30K or so, this was one of the most original compositions we ever received.

That old chestnut, the Sierpinski Gasket, took one last trip round the block, with the customary bit of *INFO wibbling by Alistair Turnbull. We wonder if Mr Sierpinski ever guessed what people might end up doing to his lovely gasket?

1997 – World Wide Wodgamacallit

The year everything seemed to go "global". The NetStation was unveiled and it seemed nearly every *Acorn User* cover was about webby things in general. And of course, in line with the Internet explosion, our loyal band of contributors radically changed direction. For example, in January we carried Nigel Stoner's *Rain* and *Snow* doodles. And a cloud generator from Daniel Mossop. Hmm. Well, if it ain't broke, why fix it?

Daniel also came up with a prog called *ATractor* which you would be forgiven for thinking was a revamp of our earlier crop-circle simulators. Not so – it was one of those unusual and attractive fractal numbers for which we are famed. Not one of the gaudy, multi-coloured bouncing ones, but one of the ones that looks like it's been drawn by someone with a Spirograph extra-deluxe and a bucket of sharp pencils.

Our almost-regular challenges have provided much entertainment over the years. The basic premise is you pick an unusually difficult programming task, impose a whole set of largely random and generally quite unreasonable restrictions and wait and see what people come up with.

The Circle challenge was particular rewarding and *Pulse* by Rob Jeffs won a well-deserved first prize with it's endless and rather unpleasant throbbing, all done

with circles of course. The other great thing about our challenges was their never-endingness. Most months we would receive a "late-arrival" in the cloud or tunnel category.

March saw the arrival of perhaps the most frighteningly realistic simulator of all – *Journey* by Nigel Stoner depicted so accurately the view from a speeding train's window that you could almost taste the watery coffee and limp danish pastry from the virtual buffet car. It was accompanied by the home-grown *Writhe* – perhaps the last in the long series of tentacle-like demos first started by Jan.

Writing 3D games was the theme of the April cover, but in *INFO our policy towards such frivolous pastimes has always been "make 'em small, or make 'em strange". Nigel Stoner went for small with a complete Golf game in just 1K. This seemed to be the logical successor to the one-line game of old. How refreshing that while commercial game producers were wondering how to fit their creations onto a CD, our readers could fit 1600 on a single floppy.

The Vibe effect continued to be evident in June, with Philip Mellor's *Craters*. The shaded ball seems to be a stock cupboard essential of the graphical doodler and it's amazing what you can do with a couple of spheres at a push.

Pushing the boundaries of the StrongARM was Jan Vlietinck, with the

fastest Mandelbrot plotter we had ever seen. Making use of the brand new 64-bit multiplication instruction (which was probably added to the chip just for Mandelbrot calculation).

August would probably have been the month we'd have finally kicked our habit for 1K Basic versions of obscure old games that everyone had forgotten about anyway. Well, we would have done had Andrew Clover not provided a splendid 1K Basic version of that classic *DeathChase*. If you've ever been trapped in a spacious meadow at dusk in which there are an inordinately large number of postboxes... Well, you know the patter by now.

Two long-running themes – the tunnel and the utterly revolting were neatly combined in December by David Llewellyn-Jones in the anatomical shape of *Oesophagus*. This was an all-too-real emulator of one of those cameras that goes down (or indeed up) the parts where other emulators fear to get their toes brown. On a slightly more savoury note, we offered *Twine* – another demo from the Spirograph college of sharp pencilship.

And the year was brought to a seasonal close with Jan Vibe's *Sand* (well, seasonal if you're Australian and spend Christmas on the beach). This classic vibism allowed you to write message in virtual sand without risking your toes to the hazards of passing crustaceans.

1998 – Phoebe or not Phoebe

Rumours of The Next Machine raged backwards and forwards throughout the year. Now, of course, we know that the poor old Phoebe was never to see the light of day, but during 1998 the promise of another hike in machine spec kept us poised. In the middle of a particularly pretty January column, **Brian Cooke** impressed us with a colourful spiky-leafed plant, *HSVpetals*. A nice demonstration of colour selection using that trusty *INFO SWI *ColourTrans_ConvertHSVToRGB*.

With hindsight, last August's speculative 'last 1K game' was clearly premature at this point as we featured a magnificent version of the all-time classic *Space Invaders*. **Martin Allcorn** performed the conversion from the original 8K of Z80 code to 1K of BBC Basic. In ten years time are magazines going to be astounded by 1 DVD games?

There wasn't any smoke on the water in the March issue, but there was fire in

the sky. An awful pun on warp speed (we'll leave you to dig out the issue) led us into **Dennis Ranke's** *FireMC*. A truly tiny piece of graphical doodlery that simulates a wall of fire in a mere 256 bytes, less is definitely more! April escaped without an april fool for once, so on to May and (oh no surely not) another lissajoux. We liked **Nigel Stoner's** contribution to the genre because his 3D render of the classic triggy wiggle looked genuinely 3D without the need for glasses, crossed eyes or major surgery.

Regular **Mark Adcock** adorned our monitors with some fading routines in August. A bunch of circles could be made to fade out fast, slow, or in our choice here 'slower'. What they were faster or slower than was never revealed, but *SlowerFade*

gave the nicest effect. C-programmers will be well aware of the 'static void'. It is quite possible that **Stu Smith's** *URHere* was a representation of it, but that's obviously not the case as there's a small green arrow pointing to Where U R!

November

brought us the 200th issue and a crude but convincing roller coaster simulator from **Thomas Madams**. It didn't conjure up the terror of the creepy Don't Look Down man at Alton Towers – possibly more like driving in a Morris Minor down the B4590. But then driving a Morris Minor down the B4590 at 120mph can be quite scary.

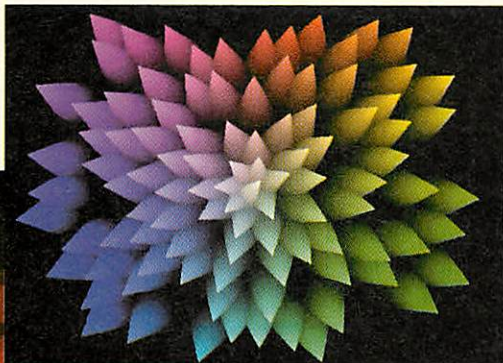

HSVpetals



FireMC

1999 – We've come a long way baby

To round things off, we've chosen **Graham Brooker's** *Dorian* and **David Gamble's** *Blobby*. These seem to sum up very nicely many of the 'strands' running through *INFO over the years. *Blobby* was a colourful, blobby, doodle making use of colour cycling, fading, circles and organic properties and *Dorian* took an idea from a couple of years back (*Expound* – the recursive sentence expander) and used it to produce an entirely unexpected result – a Dorian chant!



Blobby

*Bye

We'd like to thank everyone who has contributed to making *INFO the success that it was. In this potted history we've only managed to cover a tiny proportion of the 2000+ programs we've carried over the last 100 issues. In addition to those here we'd also like to add our special thanks to a few more of our most prolific authors: old crochet-face himself Mr. Adamson, his huge repertoire of MIDI files has kept us entertained for many an issue; Alain Broecker for an eclectic range of bells and whistles and the utility wizard himself Justin Fletcher – it's no surprise he's now deeply embedded in RISC OS Ltd.

We have one final task – to present the *INFO award for Outstanding Contributions to the World of Doodles and Other Useless Graphical Nonsense. There can be no doubt that this most prestigious of honours must surely go to Mr Doodle himself, Jan Vibe, who will receive a certificate and a free lifetime subscription to *Acorn User*. Thanks Jan, thanks everyone, it's been our pleasure. Keep doodling!

back ISSUES

Missed out on one of our previous issues?
Now's your opportunity to bring your collection
up to date. But hurry – stocks are limited



Issue 207 – May 1999

- !ProCAD+
- Heretic & Hexen
- Acorn Confidence Part II
- Fishy Disk

Issue 204 – February 1999

- Evolution demo CD
- Evolution Competition
- Site Seer review
- Using Ovation Pro macros

Issue 206 – April 1999

- !OHP uncovered
- Acorn Confidence Part I
- !Sleuth 3 Review
- Java and !Impact-3 continued

Issue 203 – January 1999

- Rhapsody 4
- AddressIT
- Speakers reviewed
- Film Trailer CD

Issue 208 – June 1999

- Film Trailer CDII
- RISCOS Ltd interview
- APDL games CD's
- DigSigGen review

Issue 205 – March 1999

- Web Wizard
- Using Impact-3
- Ovation Pro Tutorial
- Java Programming

Issue 202 – Christmas 1998

- Writing Java
- Creating AHCD's
- ICN tracking
- Wimpworks vs Wimpbasic

SOLD OUT

Order form

- Issue 208, June 1999
- Issue 207, May 1999
- Issue 206, April 1999
- Issue 205, March 1999
- Issue 204, February 1999
- Issue 203, January 1999
- Issue 202, Christmas 1998 SOLD OUT
- Issue 201, December 1998 SOLD OUT
- Issue 200, November 1998
- Issue 199, October 1998
- Issue 198, September 1998

UK: £3.95 per issue
Europe: £4.95 per issue
Rest of World: £6.95 per issue

- Archimedes World Back Issues
- Vol 15 No 5, 1 May 1998 SOLD OUT
 - Vol 15 No 6, 28 May 1998
 - Vol 15 No 7, 26 June 1998
 - Vol 15 No 8, 24 July 1998
 - Vol 15 No 9, 21 August 1998 SOLD OUT
 - Vol 15 No 10, 18 September 1998
 - Vol 15 No 11, 16 October 1998
 - Vol 15 No 12, 13 November 1998
 - Vol 15 No 13, 11 December 1998
 - Vol 16 No 1, 8 January 1998

Name

Address

Postcode

Tel No

Send cheques payable to Tau Press Ltd to:
Acorn User Back Issues, Media House, Adlington Park, Macclesfield SK10 4NP

Please tick if you do NOT wish to receive mailings from other companies

All prices include P&P
Please allow 14 days for delivery in the UK

56

Acorn User Free Ads Service

Why not take advantage of our free reader ad service? Fill in your details on this coupon (25 words maximum, one word per box below) and send it to Free Ads, Acorn User, Tau Press Ltd, Media House, Adlington Park, Macclesfield SK10 4NP or by e-mail to: freeads@acornuser.com. Only one ad per reader please. Although we try to publish every ad we receive, we can make no guarantees; publication is entirely

dependent on space and time constraints. We may also publish free ads on the cover disc if magazine space is short. Please fill in your name and telephone number below – these will not be published, but they enable us to contact you in case of any queries. Please include your town/county in each ad to help other readers with their purchasing decision.

Free ads are on pages 58

Your name: Telephone no:

.....
.....
.....
.....

NoticeBoard *Professional*

The most sophisticated presentation program yet designed for use with RISC OS computers *NoticeBoard Professional* provides an array of options for the creation of stand-alone rolling displays and slide show-type presentations that can be run forwards or backwards under the users complete control.

Display slides can be created using Cerilica Vantage, Drawfile, Artworks or Spritefiles. JPEG files within a Drawfile can also be displayed.

Sound If you can create sound samples you can add sounds or a commentary to liven up a presentation.

NoticeBoard Professional will work with any version of RISC OS from 3.10 to 4.0.

See NoticeBoard Professional in action at the Acorn South East Show

Special Introductory Offers

NoticeBoard Professional - a completely new program, not an upgrade, and listed at £37.00 will be available at an introductory price of £20 at the South East Acorn Show.

Current users of the original Notice Board program who present a labelled copy of the old Notice Board disc at the Show will pay just £15 for the new program. Users of Notice Board unable to attend the Show should send the disk and a cheque for £16.50 direct to RGSC. Old discs will be returned with the new program.

A program supplied with NoticeBoard Professional converts old Notice Board slides to the NB Pro format.

The Really Good Software Company

39 Carisbroke Road, Harpenden, Herts UK AL5 5QS
Tel/Fax: 01582 761 395 E-mail: sales.rgsc@argonet.co.uk
No VAT. Post & packing for UK and Europe add £1.50
Other countries £5.00

Elvis Lives!

But does he read Archive Magazine?!

Archive contains...

- Hints & tips
- Articles for learners
- Information for the more technical
- Readers' comments
- Averages over 45,000 words per issue
- Over 70 pages of articles

Send no money – just send your address.

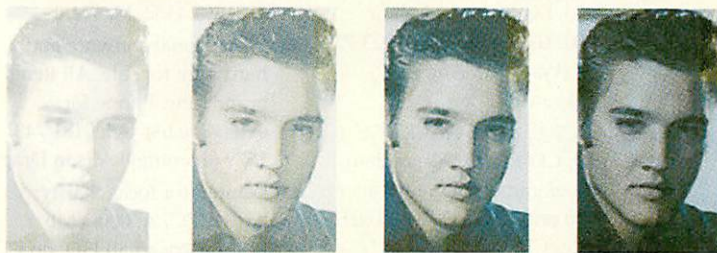

To: **Archive Publications**, 18 Mile End Road, Norwich, NR4 7QY.
Phone: 01603-441777 Fax: 460736 Email: info@archivemag.co.uk

Please send me the next two issues of Archive FREE OF CHARGE on the understanding that (a) I have not subscribed to Archive before, (b) I have not taken advantage of any other such free trial offer, and (c) if I do decide to take out a subscription (£25 in UK, £30 Europe, £38 elsewhere), these two magazines will be the first of the twelve issues for which I will be paying.

Name: _____

Address: _____

Or email your address to: Paul Beverley, paul@archivemag.co.uk

Free Ads

- Iota image overhead 3D colour scanner (A4) – not a flatbed scanner, takes 3D ‘photos’ of objects from above. Includes lights, fast parallel card, animation software. Ideal for school/family/budding 3D animators, £60. Tel: 0181 864 0309 (London)
- Acorn 3010, 2Mb RAM, loads of software, eg. Ovation, Pendown + including Quick Lync serial network and software £125 ono. Tel: 07899 035229. Lee
- A5000 and A7000 CD systems for sale, with software, HDs, etc. Any reasonable offer for either set-up considered. Tel: 01782 252 354. Steve Palmer
- RPC600, 20+2Mb, 540Mb HD, CD-ROM, scanlight 256, speakers, lots of software and games including OvationPro, ArtWorks, Personal Accounts, SimCity 2000, Exodus, Starfighter 3000. £600 ono. Tel: 01923 779 141 (Watford). Andrew Dickson
- RPC700, 32Mb RAM, 4Gb HD, CD-ROM, 56k modem, lots of games and software. £600 ono. Tel: 01376 320 601 (essex) Tim Smith
- A7000, 8Mb RAM, RISC OS 3.6, CD-ROM, 500Mb HD, AKF60, £250. PSU for RPC, £30. 2nd slice, 4 slot b/ plane for RPC, £50. Tel: 01268 478 347. Y McCall
- A5000, 4Mb, HD, etc, AKF 18 colour monitor, £175 or £130 without monitor. Loaded with interesting software and in good condition. Tel: 01268 734 215. Max Scheibl
- A3010, 4Mb, 60Mb HD, 14in AKF monitor, BJ200 printer, software, games, joystick, boxed, £125. Re-advertised due to time wasters. Tel: 01993 776 853
- RPC 600, 8Mb RAM, 420Mb HDD, PC card, CR-ROM. Software includes Impression Style and Ultima. £250. Tel: 01926 641 702 (Leamington Spa)
- Ultimate SA RPC, 17in monitor, 66Mb RAM, 2Gb SCSI HD, P100 PC card, CD-ROM, includes all software and documentation, Impression, Fireworks, Windows 95, £450. Tel: 0114 274 0008 (Sheffield) Simon Hill
- A5000, 8Mb RAM, and Mitsubishi Scan Light+ 2. Excellent condition, £275. Tel: 0171 722 0602 (London) Dr Kane
- A5000 8Mb RAM, 14in monitor, 2 x 420Mb HD, alternate 105 Syquest, Teletext, 2 printers, Integrex32 and Epson LX800. Also 100Mb Zip, software, digitiser, valiant turtle. Tel: 0181894 4132. Mr Dent
- Educational software and hardware for sale. All items brand new. Phone for extensive list. Tel: 0181 743 1579 (evenings) Alison Drage
- Wanted for local charity; Basic RPC/ A7000, 8Mb RAM, very small HD, no CD, no monitor. Any offers. Tel: 01827 280 054 evenings (Tamworth) Jonathon
- A3010 with Acorn monitor, many extras, all manuals, £250. Ovation, £50. Dotmatrix LC24-200 colour printer, £35. All excellent condition. Tel: 01753 893 152 (South Bucks) Anna
- Wanted: Repton4 and a 2nd hand working 8Mb upgrade for A310. Tel: 0161 292 7195 (manchester) Ian Kennedy
- A3010, 4Mb RAM, CD-ROM, HD, software and manuals included, £250. Tel: 0161 626 3028 (oldham, manchester)
- A5000, 14in monitor, 80Mb+350Mb HD, some software and clip art. Superb condition, possibly deliver, £325 ono. Tel: 01296 426 684 (aylesbury) R G Cole
- A3000, monitor and star LC200 colour printer. Excellent condition, user manuals, Learning Curve software and many other applications. Bargain at £85 ono. Tel: 01722 322 504 (Wiltshire) Jo Walker
- A5000, 540Mb+120Mb HD, monitor, hand scanner, software, £250. Tel: 0151 474 6202 (Merseyside) Mr P R Barry
- Monitor cub Microvitec for BBC, £20. Monitor AKF18, £30. Keyboard with mouse, IBM 172Mb HD, £20. Floppy drive/cradle. Tel: 01235 834 544 (Oxford) V J Horgan
- A4000, 4Mb RAM, 410Mb HD, cumana CD-ROM, speakers, full manuals and quality software; educational and general, £200. Tel: 01353 699 637 (cambridgeshire) Bruce Hobbs
- Incomm external modem and firestorm 80W twin speakers, both still in packing as unwanted part of Web Wizard deal, £50. Tel: 01877 384 664 (scotland) John Stewart
- A3010 with monitor, various software, as new with HD upgrade. £95. Tel: 01428 722 084 (evenings)
- A5000 with monitor and educational software. Excellent condition. £250 ono. Tel: 01925 764 174 (Warrington)
- SA RPC, 540Mb HD, 20Mb RAM, 1Mb VRAM, CD-ROM, AKF60, Impression Publisher, £650. Melidi, £90. Sibelius, £65. 30+ mags, £15. Lots more. Tel: 01709 816 268. James Trigg
- RPC700 For Sale: 2Mb VRAM, 24Mb RAM, 1.6Gb HD, DX2/66 PC Card, 4xCD-ROM, TechWriter Pro. Also Iiyama Vision Master Pro 17" (9017E). All offers considered, tel: 07970 219523
- Reasonable offers accepted on Birds of War, Virtual Golf and Augusta course, Stunt Racer 2000 and extra tracks, Break 147 and Superpool. Tel: 0958 746440.
- SA (200MHz) RPC 700: two-slice, 32 + 2 Mb RAM, 3.6 Mb IBM HD, 4xCD-ROM. Two years old. £600. Tel: 0131 447 8624
- A5000 for Sale. 14" Acorn colour monitor, 4Mb RAM 40Mb HD with extra hard drive fitting kit inside. Lots of games and tons of other software. Also Panasonic matrix printer included. Offers between £200-300 please. E-mail: laura@duffy1.demon.co.uk
- Bits for sale: DX4-100 PC-Card with DOS, as supplied with Risc PCs, and in original packages. Artworks CD(v1.7) with complete set of manuals and also the Tekkie-Disc. Tel: Karl on 01703 676317 or e-mail ksharman@soton.ac.uk with any reasonable offer.
- A4000, 4Mb, 80Mb, monitor, manuals, cables, original boxes and discs. Can be shipped, currently in north Wiltshire. £250 E-mail: artlute@argonet.co.uk
- 4Mb RAM kits for A3020 for sale £15 each. Also other A3020 parts, including keyboards, cases, etc. Tel: 01953 681 684 for more details
- Epson stylus 600 with s/ware and Funpack, plus new black refill. £100. Tel: 01304 614 557 or e-mail: stevetaylor70@hotmail.com

The great protector

Cambridge Software House (01487 741223) followed their superb *Frontier 2000* with CD-ROMs on *Burns* and *King Arthur*, their new historical excursion gives us the life and times



of *Oliver Cromwell*. Produced in conjunction with the Cromwell Museum, it follows the familiar *quests* route with over twenty adventures to play. Following probably the most turbulent years of British history, 1599 to 1658, the CD-ROM ranges across the British Isles and features cameos on over 100 people.

You also get a fascinating insight into life in the 16th century, supported by original source material such as Cromwell's letters and speeches, over 800 annotated pictures, and information on over 300 places.

Produced to coincide with the 400th anniversary of Cromwell's birth, CSH promise an interactive journey for schools looking for History or Literary Hour resources all for £49.95.

In brief

Wet and webby

PUPILS from Bignold Middle School in Norwich took part in a field trip to Wicken Fen Nature Reserve in Cambridgeshire in May and linked up – via the Internet and AngliaCampus – with over 20 schools across the UK.

Britain's oldest nature reserve, Wicken Fen is celebrating its centenary this year. The pupils took part in a range of investigations and experiments and reported their findings in history, geology and wildlife habitats to other classes as well as providing information for an online version of the visitor's guide.

For more information contact AngliaCampus on 01603 284104 or visit the free trial site on: www.angliacampus.com

Honey monsters

NEW research from the Economic and Social Research Council suggests that boys are not inherently better at using computers than girls but rather 'male' qualities of the software negatively influences girl's performance.

The research was undertaken by a team from the Open University, Bournemouth University and the University of Hertfordshire and led to a series of tasks being set for 120 school pupils aged between 11 and 12-years old. All were used to working with problem-solving software but this time one of the tasks involved the children being given two computer-based adventure games. One featured kings, pirates, ships and planes and the boys performed better. Yet when the heroes become teddy bears the girls did slightly better than boys. When actual responses were tested it seemed that the boys reacted the same whatever the character.

Further tests showed that girls did better when not working alongside the boys. Commenting on the results, Dr Karen Littleton of the Open University said: 'We think that performance is a by-product of gendered expectations about computer-related abilities. If girls expect boys are going to be better with computers, or if boys think they should perform better than girls, in the absence of any interaction, the expectations may become self-fulfilling prophecies.'

Biology knowhow

If you're looking for inspiration for your own web pages then take a look at <http://websites.ntl.com/~webwise/spinneret/>

All produced on a Risc PC this provides teachers, students and parents with a series of worksheets and teaching notes, supporting

SPEED OF DIFFUSION
Diffusion is faster in gases than in liquids, and at higher temperatures, because heat speeds up the process by making particles move faster.

Look at this picture of a cell alongside a blood vessel.

cell membrane
nucleus
cytoplasm
blood vessel

GCSE Biology at Dual Award and Separate Science levels.

At the moment they constitute nearly a full set of learning/teaching resources, together with 'ideal' answers. They are mostly aimed at candidates for the Edexcel syllabuses and are especially informative in the area of extension material, but they will probably be useful with most GCSE Dual Award syllabuses.

Creator, Dr Richard Steane, has the content in place and is now working on putting some polish to the pages. If you enjoyed the children's exam quotes in last issue then look at the *howlers* section.

More news on NumberWorks

More news from Sherston (01666 843200) on *Number Works*. Featured in the March issue of *Acorn User* the final touches have now all been put in place.

Aimed at Years 3 and 4 it is set in an old factory. A wide variety of activities are provided to complement as much of the maths curriculum as possible. You can jump straight to these or enter specific ones via the menu.

The adventure asks children to mend the cranky old machines found on three different floors of this neglected factory. These machines have been designed to teach,

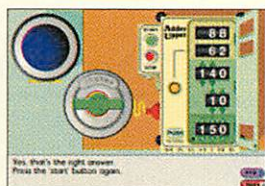

practice and consolidate many of the numeracy skills required by the National Numeracy Framework.

On the ground floor all the machines deal with the number system and place value. One floor up and you're looking at relationships between numbers and computation, while in the attic, machines deal with solving numerical problems. All activities have three levels of difficulty so that children can work at a level relevant to their individual needs and can progress through the levels as their knowledge and understanding develops. The CD-ROM is priced at £49.95.

Contacting Me

You can contact the Education page by e-mailing me, Pam Turnbull at educ@acornuser.com

Maths is multiplying

*Pam
Turnbull
sees how a
new
package
can help
make
learning
tables less
of a chore
for
everyone*

60

Built around the BBC TV broadcasts, you don't have to watch them to use this CD-ROM successfully. As well as great graphics it provides reinforcement and extension ideas to help children learn multiplication facts up to 10×10 . But this is all wrapped up in an adventure format with activities in each room complete with support, advice and suggested learning strategies.

Your adventure starts in the courtyard with nine numbered and padlocked doors. These are numbered 2 to 10 and you start by being given the choice of golden keys to 2, 5 and 10. Choose these in any order and you'll find yourself in the Wizard's Room, Orchard or Treasury working with multiples of 2, 5 and 10 respectively.

Enter room 2 and the Wizard asks you to match the correct creature who (when multiplied by 2) will give the same answer as one of the shuttered windows. Release all the creatures and a dungeon grid appears. Click here and you're taken to a *speed test* of randomly selected questions taken from the rooms you've visited so far. Success rewards you with a password to allow you deeper into the castle.

Teachers can use these passwords (helpfully supplied in the manual) to select appropriate tables for children. So, if on the start up screen you entered *wall* you'd find that the game would assume that you have completed the 2 and 10 times tables at the first level and were going to play with the x5 tables next.

Each game comes with the Jester. Click on him and a screen of written instructions will appear on how to play the game. Sitting next to the Jester is Digit the cat who'll provide help, advice and information on the maths being used. This is very useful, but more speech and investigations rather than plain telling would have been better. Indeed this is the major sticking point of this program, more speech and less text please.

At the next level you're working on the 3 and 4 times tables which takes you to the dining room where the king and friends are seated at a round

table. Your task is to find the total amount of food needed so that each person has a plate with three pieces of food. This is done by clicking on the monarch to reveal a $x3$ table fact, complete the ? and a number grid, from where you must drag the correct answer, arrives. Meanwhile, in the kitchen, no food will be forthcoming unless you match the $x4$ table fact to a range of numbered bottles and cartons on the kitchen shelf.

Moving on again and you're looking at the 6 and 9 times tables in the Beehive and Ballroom. In particular, you must click the bees to wake the correct number to fill the honeycombs, or manoeuvre the King and Queen to the squares which are multiples of 9.

The final level reveals the 7 and 8 times tables at the Pond where you must tread only on

multiples of 7 which have been muddled up. Or how about freeing the queen from the maze with your knowledge of $x8$ table facts. At the bottom of each page in the manual are teaching pointers such as one on commutative law.

This is a nicely put together package but it doesn't have the appeal of Sherston's *Table Aliens* for my class of testers. The graphics are lovely, the sound effects minimal, while speech is even worse. However the content and learning strategies are excellent. There is good control over the mouse options and over the level children are working at, for teachers (or parents), but the repetitive nature of the activities will appeal to some children more than others. **END**



Product details

Product: MegaMaths Tables
Ages: 5+
Price: £39
Supplier: Logotron, 124 Cambridge
Science Park, Milton Road,
Cambridge CB4 0ZS, UK
Tel: (+44/0) 1223 425558
Fax: (+44/0) 1223 425349
Web: www.logo.com
E-mail: info@logo.com

i before e

except after c

This collection of six educational games uses the excellent graphics Resource has adopted since the launch of *Rainbow's Edge* and they really appeal to this age range.

Starting with *Balloons*, you must match a beginning to an ending to make a word.

A simple activity which is useful whether you're working on onsets and rime or suffixes. The teacher can use the provided lists or very easily set up her own. You need to choose three lists to use in the game via the options screen along with setting the number of tries a child can have – from 3 to 25. The game displays a consonant cluster or single letter at the top of the screen with various word endings floating around on balloons.

Children must then click on the balloon which makes a word. This is then spoken and then they're off looking for a new word. If they choose an incorrect ending, the word is spoken but that balloon then bursts progressively cutting down on the options as they go. However, a list of correct words is also spoken and displayed. You can add words to the built-in dictionary with a simple key combination but I think this information is best left with the teacher! Check out the options and set-up before you let the children loose.

The Race is an animated version of Look Say Cover Write Check which took a little getting used to, but you can have words presented as letters (dislike) or word parts (dis-like) and if your chosen list is using words of less than four letters it will be spelled out letter by letter using letter names or sounds – you choose.

Alternatively, *Ladders* has real game feel to it as you must manoeuvre your character up and down ladder and along platforms to collect letters in the correct order avoiding a rather interesting pig-like creature on a skateboard who'll steal your letters.

In *Scramble* all the letters are mixed up leaving the children to work out just what the original word is. *Corrections* I found particularly useful with some Year 2 children who need work on doubling ss and ll. Here they must look for incorrect spellings, find them and the Fing

leaps into action to put it right, but watch out as Pog's on his skateboard again and to many bumps means your Fing will be taken off on a stretcher.

Finally *Magnets* asks you to find words hidden within words. All set on a railway track with you using the Fings to isolate words within words, magnetise them out of the way and then watch as one Fing parachutes away and another whistles up another train of words.

You could just jump straight into this program and used the prepared lists. However, you'll get even more from it if you create your own lists using words being used in class. It may take a little time, but it's worth it.

The separate Editor allows you to change any of the 21 lists provided as well as compile your own. I found it useful to alter one of lists for Corrections so that it contained the common spelling mistakes for a specific group. You have access

to a dictionary with search features which allows you to search for text strings at the beginning, end and within words.

I liked *I Can Spell* as it was so easy to set up (it comes with the nice Primary font too) and the children enjoyed working with the animated Fings. Some of the controls are not that intuitive but the manual is good and my only real concern is the sound. This is not quite as clear as I'd like. Using synthesised rather than sampled speech does mean that every word can be said but sometimes – especially in *Scramble* what you're looking for can be hard to make out.

END

Improve
your
spelling
with a new
fun range of
activities.

Pam
Turnbull
reports

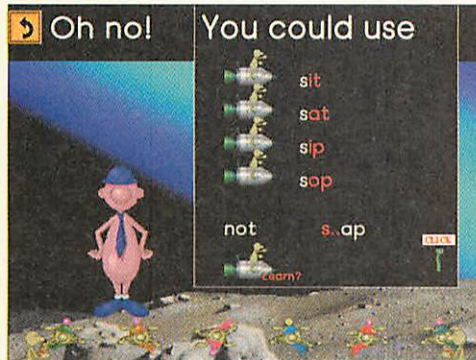

Product details

Product: I Can Spell
 Supplier: RESOURCE
 Address: 51 High Street, Kegworth,
 Derby DE74 2DA
 Tel: 01509 672222
 Fax: 01509 672267
 Ages: 5+
 Price: £30
 Web: www.resourcekt.co.uk
 E-mail: info@resource.co.uk

NEW Plustek OpticPro A4 1200x600 optically with Acorn S/W & **Slide unit £ 190**

Plustek OpticPro 1200x600 optically with Acorn S/W **£ 140**

Epson Scanner GT7000 SCSI 1200x600 with S/W £ 260 inc Film adaptor £ 325

PC Card 5x86 133MHz 512k Cache **£ 250 Special June Price**

Trackerball 60mm Heavy ball, Acorn or PC versions, **half price! £ 75**

56K (V90) Modem £ 80

32 Speed IDE CD ROM Drive £ 60

CD ReWriter IDE with S/W from £ 275

CD ReWriter SCSI Yamaha 4416 with S/W (needs SCSI interface) £ 345

Acorn C++ **HALF PRICE £ 125**

RiscOS PRMs Vol 1-4 **HALF PRICE £ 55**

Second Hand RiscPCs

600s from £ 520, StrongARM from £ 870

A7000+s Now From Stock £ 780

'Foundation' or 'Extreme' £ 895

**StrongARM
Upgrades**

Now available again.

£ 290

RiscOS 4 £ 120

Fitting Service

£ 25 or £ 15 with New Hard Drive

Courier collection & return also available.

Acorn SCSI Interface for A310, A5000 etc Ideal for CD or Scanner **£ 60**

Olympus 420L 2Mb, 640x480 & Acorn software £ 305

Olympus 1400XL 4Mb, 1280x1024, power zoom & Acorn software £ 850

NEW Product 250MB Zip Drive SCSI Ext. £ 185, Printer Port version with S/W £ 215

RiscPC backplane £ 30 / A7000 Backplane £ 30

10.2GB IDE IBM/Quantum Fireball Hard Disc £ 200

Acorn Access+ Interfaces RiscPC NIC 10b2&T £ 100, 10b2 only £ 80

Access+ Podule units S/H 10b2 £ 70, 10bT £ 70

S/H StrongARM RiscPCs from £ 870

DRAM simms for RiscPCs 32Mb £ 60, 64Mb £ 100 & 128Mb £ 220

Acorn Advance Wordprocessor, Spreadsheet, Database & Graphs **£ 58**



All prices **INCLUDE** VAT @ 17.5%

& Delivery. Official Orders Welcome E&OE

Prices subject to change & stock.

CJE Micro's
78 Brighton Road
Worthing
West Sussex
BN11 2EN

CJE4DV30 Tel 01903 523222 Fax 01903 523679 sales@cje.co.uk <http://www.cje.co.uk>

StrongARM Compatible Game Compendiums

Saloon Cars Deluxe £25 Holed Out Comp. £25 Chocks Away Comp. £25

Upgrades available from £ 6

Other StrongARM Compatible titles

Anagram Genius £20, Cataclysm £20, Chopper Force £30, Cyber Chess £30,

Demon's Lair £20, Drifter £30, Groundhog £12, Logic Mania £20,

Pandora's Box £20, StuntRacer 2000 £25, WimpGame £20.

The Fourth Dimension,
78 Brighton Road,
Worthing, West Sussex
BN11 2EN

Tel: 01903 213361

Fax: 01903 523679

Email: 4d@cje.co.uk

Web: www.cje.co.uk/4d/

Prices and specifications are correct at the time of going to press. All prices are fully inclusive. E&OE.



Harmonic Control

Part 1 of Mike Cook's 'aural exciter' project

Sound modifying circuits, or effects units, come in many shapes and sizes, this month's project looks at a unique design that can certainly add that extra something to the sound of an instrument or voice.

Perhaps one of the first guitar effects was the 'fuzz box', it was staggeringly simple and consisted of a pair of diodes that clipped or suppressed the top and bottom of a waveform. This made the sound 'dirty', a much desired effect among the heavy metal rocking fraternity. However, what you really do when you alter or distort a waveform is to add in harmonics.

Any shape of waveform can be made from a number of simple sine waves, each waveform or harmonic an integer multiple of the fundamental or lowest frequency. The quantity and number of harmonics determines the type or timbre of the sound you hear. For example a flute is almost a pure sine wave, whereas a Church organ has lots of harmonics in its waveform.

In real instruments the harmonic content usually varies throughout the

duration of the note, giving a sound it's unique quality. Some instruments vary more than others, that's why a Church organ, who's harmonic content doesn't change over the duration of the note, can never sound like a plucked guitar string, but *can* sound like a bright trumpet.

The simple fuzz box adds odd-harmonics, that is extra notes of a fundamental frequency multiplied by an odd number. In general odd-harmonics in a note make it sound hard and metallic. In contrast, even-harmonics sound warm and mellow.

Incidentally that's why some people profess to prefer valve amplifiers over transistor ones. The design of these mean that valve amplifiers are prone to even harmonic distortion whereas transistor amplifiers are prone to odd-harmonic distortion. Another point to note is that adding odd-harmonics give the waveform symmetrical distortion whereas even-harmonics make the waveform asymmetric.

Now wouldn't it be great if we could control the amount of harmonics in a waveform? In effect that's what the draw

bars of an organ allow you to do, but how can you apply this to other instruments? To a certain extent you can do this with filters, but the harmonic has to be in the waveform to begin with. What is needed is a system of adding harmonics, in controlled quantities, to a waveform that might not contain them.

Such systems go under trade names

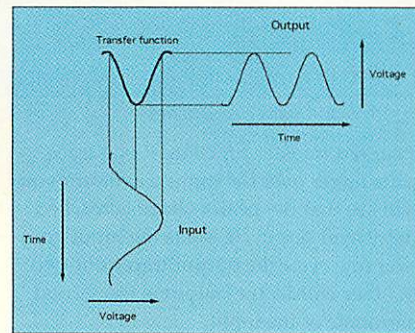

Fig II: Curved transfer function produces only second harmonic

like 'aural exciter' and their operation is subject to great secrecy, however I have discovered how to do the same thing by using your computer and a handful of components.

The secret lies in what is called a transfer function. Any signal processing circuit has a transfer function. Take an amplifier, put a voltage on the input and a voltage appears on the output, if you draw a graph of the different output voltages for a series of input voltages you have drawn the amplifier's transfer function.

If you are designing a Hi-Fi amplifier you want this transfer function to look like a straight line, so that whatever signal shape you put in, you get the same shape out, see Figure I. It might be a bigger signal coming out but it is the same shape as the input. If your amplifier does this it is known as a linear amplifier.

So far so good, but what if the transfer function is not a straight line, in most practical circuits it is not quite straight but curves slightly. What happens then is that the output waveform distorts slightly at high levels, or in other words harmonics are added.

Now, this is the clever bit, if you can exactly specify the shape of the transfer function you can make it such that you get the system to produce any mix of harmonics you want. In Figure II we have

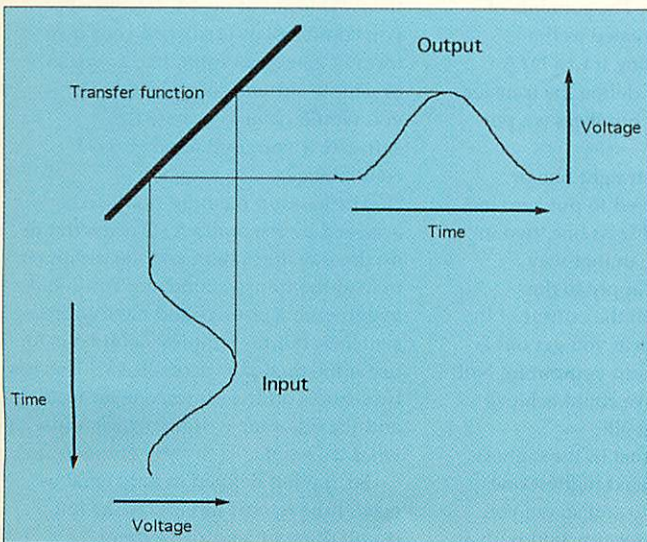

Fig I: Straight line transfer function reproduces the input on the output

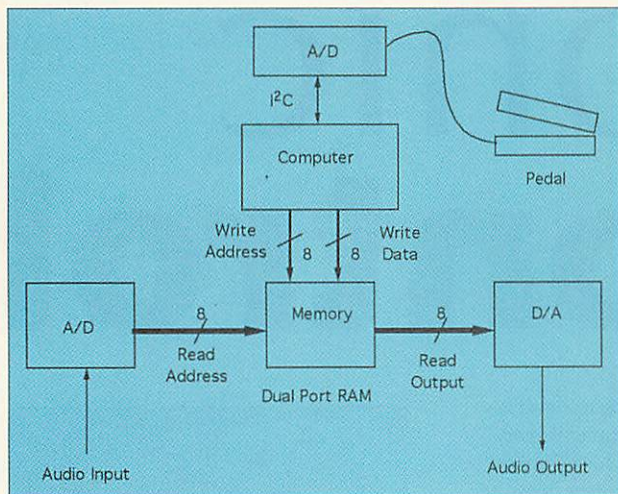

Fig III: Exciter pedal block diagram

a curved transfer function, if you trace your finger over the input waveform you will see that the peak voltage is reached twice over one cycle, so as the input goes over one cycle the output traces out two. In other words, the output is the second harmonic of the input.

In general you can have any mix of harmonics, if you want a waveform that consists of equal parts of the fundamental and say, the fourth harmonic, you can calculate a transfer function to do this. This is a lot easier than it might sound if we break the task up into parts. A mathematical function can be defined for the transfer function that produces any one harmonic, given a fundamental frequency.

As the harmonics get higher so the function has more terms in it, these are called Chebyshev functions and are shown in Table I. You will see the T_1 , or transform for the first harmonic or fundamental, is a straight line graph and

Chebyshev Polynomial

When the transfer function is $T_k(X)$ and a cosine wave with amplitude 1 is applied to the input then the output contains only the k th harmonic.

$$T_{k+1}(X) = 2XT_k(X) - T_{k-1}(X)$$

$$T_0(X) = 1$$

$$T_1(X) = X$$

$$T_2(X) = 2X^2 - 1$$

$$T_3(X) = 4X^3 - 3X$$

$$T_4(X) = 8X^4 - 8X^2 + 1$$

$$T_5(X) = 16X^5 - 20X^3 + 5X$$

$$T_6(X) = 32X^6 - 48X^4 + 18X^2 - 1$$

$$T_7(X) = 64X^7 - 112X^5 + 56X^3 - 7X$$

$$T_8(X) = 128X^8 - 256X^6 + 160X^4 - 32X^2 + 1$$

Table I: Chebyshev functions

T_2 is a cubic equation. The X refers to the second harmonic, so the left hand side of these expressions is the amplitude or Y value of the output. To make matters simpler you can normalise this, that is make it range between +1 and -1.

To produce a mix of harmonics you simply multiply each function by the fraction of the harmonic you want. For example, to produce a transform function that produces

a mix with three quarters of the second harmonic and one quarter of the third, multiply T_2 by 0.75 and T_3 by 0.25 and add the two together.

It's one thing defining a transfer function and another implementing it, what we need is a circuit where we can define what voltage comes out for every possible voltage input. Well, there has been one of these built into every Acorn computer, even the original Model B (or should that be Model A?).

However, this was not used for sound but for video, it was a palette or look-up table, and we can make a sound version in the same way. First of all we need to digitise the sound with an A/D converter and turn it into a stream of numbers, each number represents an instantaneous voltage.

Then apply these numbers to the address lines of some memory so that each number or input value has it's own address in the memory. The contents of that address are then treated as the output voltage by passing it to a D/A converter. We can then define the transfer function simply by the numbers we put in the memory.

For example, for a straight line or linear transform you need to put zero in address zero, one in address one, two in address two and so on, in that way whatever number you apply to the address lines you get on the output of the memory, so the waveform you get out is the same as the waveform you put in. Not very exciting because we could achieve this with no circuitry at all!

However, imagine that in the highest address you put zero, next highest one, second next highest two and so on, you will have a linear transfer function with a negative slope, so any waveform you put

in will produce an inverted waveform on the output, another way of saying this is having a phase shift of 180°.

Because the ear is not sensitive to the phase of a waveform (despite what hi-fi buffs will try to tell you) this again is not very exciting. So let's try to imagine something we can hear, fill the memory so that addresses zero and one contain zero, addresses two and three contain one, addresses four and five contain two and so on.

Now when you apply a signal you will get an output signal that is the same shape, but half the amplitude of the one you put in. You can see that the transfer function is a straight line with a 22.5° slope, in fact the slope of this function defines how much attenuation we have.

By programming different slopes of transfer function we can set the output volume to anything we want, we have created a programmable volume control.

This is interesting but not unique and there are better ways of achieving the same result. However, remembering the first part of the article we could program the memory to contain a curved transfer function, then the output waveform would be a distorted function of the input waveform and that distortion would contain the harmonics we require. As a further refinement this transfer function can be changed, using some user input like a foot pedal, so the harmonic content at any time can be instantly varied.

Figure III shows the block diagram of the circuit we need to use to achieve this. A foot peddle is used to control which one of a number of pre-calculated transform functions are loaded into the look-up memory. This is connected to the A/D input of my I²C interface board, you could just as easily use your own form of analogue input, like a joystick or simple volume control knob, but you would have to change the software if you used another A/D converter.

The look-up memory needs to be accessed by the audio A/D converter to do the transformation and the computer to load the transfer function. You could assign each a priority and have address switches, but the simplest solution is to use some dual port access RAM. This has two sets of address lines, one for reading and the other for writing, which is just what we want.

So, having defined exactly what we need, tune in next month for the full circuit diagram and software to drive this project.

END

THE DATA STORE

Dedicated to serving the Acorn community

RISC OS 4
COMING SOON!
E116-33

From Data Store Software... **FONTFX 6**

THE AMAZING NEW EFFECTS!

New control panel with many improvements including 'compass' knobs

FONTFX
New border effect

FONTFX
User-definable shadow length and direction

FONTFX
New rainbow fill option

FONTFX
New 3D Shadow effect

FONTFX VERSION 4
New grow and shrink feature

New toolbox controls

PRICE £31.95 inc. VAT and postage
SITE LICENCES AVAILABLE
Upgrades at special prices for owners of earlier versions: phone for details

Our existing customers know the wide range of products we supply, but if you've never purchased from us before, here are just a few of the names...

Canon/Epson/HP Printers • Epson/Plustek Scanners
Olympus Digital Cameras • Yamaha CD Writers
Iiyama and Shinho Monitors • Iomega Zip/Jaz Drives
Eesox CD-ROM Drives • Psion Palmtops
Computer Connections 'Swap Drives'
Audio Dynamics and ESP MIDI Cards
Fatar MIDI Keyboards and Accessories
Roland and Yamaha MIDI Modules and Keyboards
plus a full range of hard discs, memory, switch boxes, cables, ink and toner cartridges...

...and if it's not in this list, we can probably still get it!
And don't forget our service department: we repair almost any Acorn computer (and PCs too!), and can fit upgrades or install software for you as well.

EDUCATIONAL SOFTWARE

SALE • SALE • SALE • SALE • SALE

Prices valid until 30th June 1999 on existing stocks only, so first come, first served!

Adventure Playground Storm £15.00	Kiyeko/Lost Night (CD) UbiSoft £20.00
Amazing Maths CSH £20.00	Linkword German Minerva £27.00
ArcVenture 1, 2, 3 or 4 Sherston £27.00	Look Hear! Sherston £40.00
Astro Topologica £25.00	Maths - Algebra/Geometry/Stats 10/10 . . . £10.00
Being a Scientist (CD) Anglia £30.00	Mega Maths LCL £18.00
Catch Lander £10.00	Micro English/French/German/Spanish LCL £18.00
Christmas Adventure Storm £15.00	Money Matters Triple R £10.00
Craftshop 1 4Mation £15.00	Music Box Topologica £25.00
Craftshop 2 4Mation £15.00	Oxford Reading Tree (CD) Sherston . . £25.00
Crystal Rainforest 2 Sherston £35.00	Polyminos Topologica £25.00
DataWord Triple R £ 5.00	Puncman 5/6/7 Chalksoft £12.00
Dinosaur Discovery 4Mation £20.00	Rainbow Longman £20.00
Dinosaurs 10 out of 10 £10.00	Rusty Dreamer (CD) Sherston £39.00
Driving Test 10 out of 10 £10.00	Sellardore Tales Sherston £15.00
Elf Tales (CD) Sherston £25.00	Six French Games AVP £25.00
Eternal City Cygnet £13.00	Talking Clocks Topologica £25.00
Five Things to Find (CD) SIR £10.00	The Complete Wordsearch AVP £15.00
German 10 out of 10 £10.00	The Snowball Rent (CD) SIR £10.00
Global English SIR £25.00	The Three Little Pigs (CD) Dial £20.00
Granny's Garden (CD) 4Mation £27.00	Time Detectives: Victorians Sherston . £35.00
James Pond Running Water SkillsWare . £20.00	Tizzy's Toybox Sherston £30.00
Just a Pile of Rice SIR £10.00	Viewpoints Sherston £30.00

Contacting us by email? Failed to get a response?

Please take care to address your messages correctly. Our email address is: datstore.demon.co.uk

Note that there is *no* second a after the first t.

If you send messages to datstore.demon.co.uk, they will be sent to a completely different company who will not reply!

SIBELIUS

THE MUSIC NOTATION SOFTWARE



Sibelius 7	£620
Sibelius 7 Student	£320
Sibelius 6	£105
Optical Manuscript	£275

And new...

Sibelius for Windows	£695
-----------------------------	-------------

Acorn Sibelius users wishing to move to Sibelius for Windows: we can supply specially-priced PC systems that share your existing monitor/printer - please phone for details...

The Data Store is one of the few dealers in the country which offer full, detailed demonstrations of Sibelius software. If you want to find out how the best just got better, ring us NOW for an appointment - you'll need at least an hour!

There are **THOUSANDS** of software titles available for Acorn Computers! We stock hundreds of the most popular titles on our shelves for you to browse and try, and can obtain most of the rest within a few days - so there's **NO EXCUSE** not to make full use of your Acorn machine **RIGHT NOW!** Place an order today!

OPENING HOURS

	AM	PM		AM	PM
Monday	9:30	5:30	Thursday	9:30	5:30
Tuesday	9:30	5:30	Friday	9:30	5:30
Wednesday	Closed	Closed	Saturday	9:30	5:30

6 CHATTERTON ROAD BROMLEY KENT BR2 9QN

Tel 0181-460 8991 • Fax 0181-313 0400

(The Big Number: 020 8460 8991 / 020 8313 0400 can be used from 1st June)

Web <http://www.datstore.demon.co.uk/>

Email info@datstore.demon.co.uk

ALL PRICES IN THIS ADVERTISEMENT INCLUDE VAT @ 17½%

Rambles through Acorn

*Mike Cook
digs up some
more fungi*



Another bulging post bag, so no time to pontificate this month, on with finding the wood among the trees. First off Tim from Ringwood School, Hants wants to extend his network computer (NC):

'Like many schools we have a number of Acorn NCs, we have just ordered a digital camera which will connect to a standard RISC OS machine via the serial port. Do you know if it's possible or would it make a good magazine project to construct a 'black box' which has IR bits and serial port. Connect a standard serial device to the box and point it at the NC.

'Presumably it would need software at the NC end, ideally to fake the IR connection as standard serial data (whatever user software is used it believes it's using the standard serial port). I assume the NC has IR output as there are a couple of LEDs on the front panel with no other obvious function.

'Obviously this needs access to an NC and documentation? What do you think? Too

tricky, too few NC users? I feel not, with all the Matrix stuff / Sprinter and so on – actually it sounds like the basis of a possible commercial product?'

Yes it sounds like that to me, the problem is that I don't have a network computer nor a digital camera to develop it on, if I had to buy one just for the project I couldn't even begin to recoup the money from the article fees.

If the Network Computer does have an IR interface it is likely to be an IrDA standard. This is very close to a standard serial port in terms of signals, the only difference is that the space signal consists of the LED being on for only the central third of the data period.

The default rate is 9600 baud and it is relatively easy to make a converter to and from the standard serial signal. However, if the camera won't play at that speed, and I think it is a bit slow for transferring images, then you could be struggling.

The IrDA standard does allow for faster speed by negotiation but you would have to

66

Noisy Risc PC

S.I.Evans from Bangor University is full of praise for our favourite computer:

'I have now invested in a StrongARM Risc PC. It is such a wonderful machine, that it makes me cringe every time I have to use the College network of PC's. However, I am having a few problems, very simple ones I do add.

'My Risc PC is making quite a bit of noise as it is running. I have tried to inspect what it is, but couldn't work out what the problem is (I don't think it's the fan). It does sound quite similar to a fridge, and even though I am starting to get used to it, it would be nice to be able to type my essays in peace.

'I am also having problems with *Quake*. I have *ArcQuake6* and have tried to get the PAK files of a *Quake Demo*, to

make sure that it works before going to by the full game. But I haven't been able to locate the PAK files from the game. I was wondering if the problem was caused by the fact that it was from a PC version of a CD, or could it be because it had been compressed? I was wondering therefore if the same problem would occur on the full game?

'Finally, I was wondering, since I am in college and have to move backwards and forwards quite a while, if you could give me some advice about how best to look after the computer while on my journey?'

If it's noisy then it can only be from something moving. The only things that move are the fan and the hard disc. You can check this by specifying a spindown time for the hard drive in the *!Boot*

settings. Then you can see if it goes away. Some drives are noisy, I know my extra SCSI drive is much noisier than the original drive.

You could even try disconnecting the hard drive (when powered off) as unlike a PC it will work without it. If it is the drive I am not sure of a cure, you could try fixing some felt underneath the fixings or propping up the computer box on something sound absorbing. There are no air vents under the box so that should be OK. If you have the original yellow plastic things that go in the floppy drive then use those when transporting your computer, also make sure that you shut down the computer before turning it off as this will park the drive. As to the game sorry I don't know, you could try a call to games@acornuser.com they might know.

handle that externally, possibly with a PIC system. Sounds interesting though, anyone want to pick up this one?

Rob Ward from a land down-under is having just a spot of bother with my oscilloscope:

'I have finally got my Real Time oscilloscope (*Acorn User* July 1998) built after hanging onto the chips for a couple of months. It appears to have a problem in that it only registers the positive half of the waveform. I have added a graphic of the screen below.

'The input was the just the 50Hz hum produced by hanging onto the positive input lead. The negative input lead was clipped to the earth side of the circuit. Later I biased the negative input lead to about .85 volts using a 47k/10k divider and it appeared to make no difference. Isolating the input lead with a 0.1uF capacitor to reduce any chance of leakage pulling the input down also had no effect. Could it be a software problem?

'I have checked the hardware over and over. Could I have blown the ADC chip? I am a teacher and I am looking forward to be able to incorporate diagnostic CRO screen dumps in my Electronics notes for my middle school classes. Many thanks, and believe me, your work is the main reason that I have kept buying *Acorn User*.

'Your articles are so far ahead of any PC magazine where the technical challenges are about at the level of plugging a printer cable. They inspired my Robotics page, at <http://www.mtclearsc.vic.edu.au/Robotics/Robots.htm>

OK flattery will get you most places, I did take a sneaky peek at your Web site and I was most impressed, well laid-out with excellent quality pictures. It details projects suitable for secondary school students and is well worth a look.

Anyway down to your problem, in order to display some pickup you must earth the -ve input. Then you want to bias the +ve input to halfway with a couple of high value resistor to +5 and earth. I would start off by using 1M. Then the displayed waveform should sit at halfway and an AC signal will pull it up and down.

If you are using a signal generator you might have to have a capacitor coupled input if the earth is the same as 0 volts. The thing to remember is that the A/D converts the input

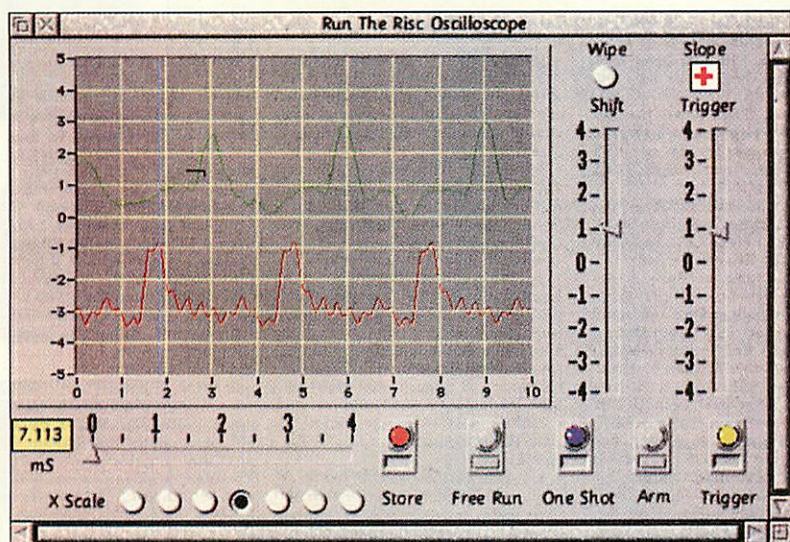

Real Time oscilloscope -
Acorn User July 1998

voltage into a number, however that is only a number for positive voltages, it will not give you anything for negative voltages.

Therefore to display a waveform that goes negative you need to put some positive bias onto the input so the waveform can take it off.

By the magic of the Internet feedback was swift:

'Thanks for the advice below. I put the -ve to earth and used a pair of 1 Meg ohm resistors to provide a central bias towards the 2.5v range for the +ve input of the ADC. The hum waveform now has upper and lower symmetry. Very nice.

'I am going to let my brother know straightaway that I can now analyse circuits and get the graphics for it very quickly. He should be impressed (he is a Mac owner, but a tolerant one) I have tried it on an astable multivibrator and it looks really good. The signal is clean and appears to render the waveform excellently. I am impressed.

'Our Web site should go ahead in leaps and bounds. Would it be easy (relatively?) to add a sprite capture routine to grab 'screen scope' sprite images?'

It shouldn't be two difficult to add a screen grab but why bother when Paint can do it for you, that way you can decide if you want just the waveforms or all the controls as well.

END

ADVERTISERS' INDEX

AJS	32
APDL	16
Archive	57
Argonet	19
Arm Club Show	40, 41
Castle Technology	IFC, OBC, 69
Cerilica	52, 53
CJE	14, 62, 69
CTA	4, 5, 68
Datastore	65, 69
Davyn	20, 68
Desktop Projects	69
Eesox	45
Icon Technology	9
IFEL	22
ISV	12
ITS Consultants	68
Liquid Silicon	32
Pinapple Software	45, 69
ProAction	68
R-Comp	42
RGS	57
RISCOS Ltd	36
Spacotech	IBC
Uniqueway	69
Wardlaw Services	69

Contacting us

Editor:	editor@acornuser.com
Enquiries:	enquiries@acornuser.com
Advertising enquiries:	johns@ssm1.telme.com
Web master:	webmaster@acornuser.com
Subscriptions:	subscrip@acornuser.com
Free Ads:	freeads@acornuser.com
Letters:	letters@acornuser.com
News:	news@acornuser.com
Graphics page:	graphics@acornuser.com
Comms page:	comms@acornuser.com
PD page:	pdpage@acornuser.com
Business page:	bizniz@acornuser.com
PC page:	pcpage@acornuser.com
Music page:	music@acornuser.com
Games page:	games@acornuser.com
Education page:	educ@acornuser.com
Rambles:	rambles@acornuser.com
*Info:	starinfo@acornuser.com

NORTH WEST



168 Elliott St.
Tyldesley
Gtr. Manchester
M29 8DS

Acorn Dealer and RiscOS Centre of Excellence

Acorn Spares and Repairs

All Acorn Machines available on 0% finance

Installation, Networking

Repairs on a no-fix
no-fee basis.

See Main Advert on
Pages 4 & 5

Tel. 01942 797777

Fax 01942 797711

ProAction



We thought we'd
tell you something
about Frak...

but what can we say?

WEST YORKSHIRE

THE CHOICE OF EXPERIENCE



Davyn Computer Services

Printers, Ribbons, Ink Cartridges,
Refills

Expert Advice & After Sales Service
Mail Order Master Card, Visa, Switch
Ring for Prices

Service & Repair to all Equipment
Full Range of Acorn Hardware & Software
(We operate the Acorn Finance Schemes)

Full Range of Educational Software

Tel. 01924 254800 Fax. 01924 258036

e-mail sales@davyn.demon.co.uk



For the best service in Yorkshire
(we think)

CALL US! for A7000, RiscPC & Pocket Book II
Visit our Showroom

Open 9.30 to 5.30
Mon, Tues, Weds, Sat.
9.30 to 7.30
Thurs & Fri.



How to find us

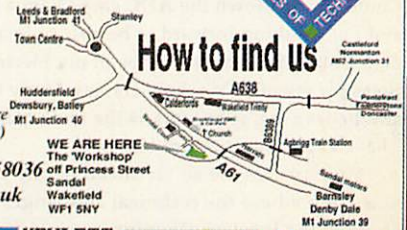

WILTSHIRE



Your Acorn Approved Specialist
with Teaching Experience

Educational Consultancy Training and Support
Acorn Computer Supply and Installation
Software Upgrades and Repairs

Tel - 01225 764863

Fax - 01225 761437

email itscon@argonet.co.uk

SOUTH COAST

- Hardware
- Software
- Installation
- Repairs



78 Brighton Road
Worthing
West Sussex
BN11 2EN

Tel : 01903 523222
Fax : 01903 523679

sales@cje.co.uk

http://www.cje.co.uk/

Open 6 days a week
With demonstrations available

LONDON

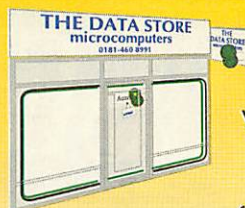

OLD OR NEW, IF IT'S
BY ACORN OR FOR ACORN,
COME TO US!

Visit our well-equipped showroom
for the best service around.

For more information, see our
full-page ad elsewhere in this issue.

THE DATA STORE



1983-1998
15th Year

6 CHATTERTON ROAD BROMLEY KENT BR2 9QN

Tel 0181-460 8991 • Fax 0181-313 0400

Web <http://www.datstore.demon.co.uk/>

Email info@datstore.demon.co.uk

CLOSED ALL DAY WEDNESDAY

HIGHLANDS

Wardlaw Surveys

Authorised Acorn Dealer,
for all your needs from
supply, service, repair
& full after sales.

Tel/Fax: 01463 831214

LONDON & ESSEX



Pineapple Software



Pineapple have been in the Acorn marketplace for over eleven years and we have recently moved into large new premises where you can see a variety of Acorn equipment in action. We specialise in building RiscPCs to your specification and we also supply scanners, printers, harddrives or anything else you may need for your Acorn system. We also undertake repairs and upgrades to Acorn computers. Come and visit us for a chat!

Open 0900 - 1730 Mon - Sat

352 Green Lane, Ilford, Essex IG3 9JS
Phone 0181 599 1476 Fax 0181 598 2343

email: sales@pineapple.demon.co.uk
<http://www.pineapple.demon.co.uk>

CARDIFF

UNIQUEway



SOUTH WALES' ONLY DEDICATED ACORN
DEALER AND ACORN CENTRE OF TECHNOLOGY

Technical Support - Repairs - Hire - Internet Connections

Low cost finance available on all systems.



3 Clarendon Road, Cyncoed, Cardiff CF3 7JD

Tel 01222-464020 Fax 01222-440071

<http://www.uniqueway.co.uk>

SUFFOLK



CASTLE TECHNOLOGY



Full range of Acorn Computers
Comprehensive back-up service

Call 01728 621222 or
fax us on 01728 621179

Ore Trading Estate Woodbridge Road Framlingham Suffolk IP13 9LL

e-mail: sales@castle-technology.co.uk

Web: <http://www.castle-technology.co.uk>

NORTH WEST

THE 1997
ACORN USER
AWARDS
'BEST DEALER'

For all your Acorn needs

Visit our Showroom

10am - 6pm

Monday - Saturday



Desktop Projects Ltd
Unit 2A, Heapriding Business Pk
Ford Street
STOCKPORT
Cheshire. SK3 0BT

Authorised Acorn Dealer & Centre of Technology

Desktop Projects Ltd

Tel: 0161-474 0778 Email: info@desktop.demon.co.uk

To advertise in

ACORN USER

contact

John Snowden on
01625 539494

Film
Trailer CD

The best-selling RISC OS magazine in the world

ACORN USER

Exclusive Movie Previews

ADMIT ONE

Plus

- Inside RISCOS Ltd
- PD games return en masse
- The best of Acorn clip-art

Trailers



Subscr

The world's number

ACORN

You already know what a great magazine *Acorn User* is. It is the only Acorn magazine with up-to-the-minute Acorn news, in-depth hardware and software reviews, and without doubt the best cover discs available.

What you might not know is that by taking out a subscription today, not only are you guaranteed never to miss an issue of the biggest and best Acorn magazine in the world, but you can also claim an excellent free gift or special offer, available exclusively to all new *Acorn User* subscribers.

Textease

The most flexible, straightforward and comprehensive word-processor and desktop publisher ever. Use it to make letters, invitations, cards, banners, notices, posters, overhead foils, in fact any kind of text and graphics. It is designed to be ideal for children and is invaluable for older children and adults.

ONLY £20
RRP £49

Destiny

Your chance to experience one of the most talked about games on the Acorn platform for an even lower price! Experience the 3D world of *Destiny*, where you must battle your way through intelligent monsters and solve puzzles, seeking the power cells you need to return. You could save up to £5 when you order with your subscription.

ONLY £25
RRP £30

Anagram Genius

Prepare to be astounded! Seven years of development have produced the world's most sophisticated anagram generator. Give the software a name or piece of text and it will use powerful artificial intelligence techniques to rearrange the letters to say wierd and wonderful things about it.

FREE

On the brink

The Crash of the Bank of England? Collapse of the Government? Just what difficulties will the Year 2000 cause you?

The "On the brink..." video is a non-technical explanation of the potential

impact of the Millennium Bug in the world's computers and what you need to do about it. Nearly £5 off when you order with your subscription.

ONLY £15
RRP £19.99

Subscribe to

1 RISC OS Magazine

USER

CURRENT SUBSCRIBERS
- you can take advantage of these offers by renewing your subscription at any time

Call our Subscription Hotline

Tel: 0870 606 0424

Fax: 01625 859808

Email: subscrip@acornuser.com

Please quote code 'A9907' when subscribing by phone



DIRECT Debit

Why not make your subscription even easier and subscribe by Direct Debit, spreading the cost of your subscription over quarterly hassle-free payments. Over a year you will receive 13 copies of *Acorn User*. What's more, you need never worry about missing an issue again, as the subscription continues until you decide to cancel. Direct Debit subscriptions cannot be taken over the phone or by fax.

Binder and 2 free magazines

Exclusive to Acorn User this binder will hold up to 13 issues of your favourite magazine. PLUS receive an extra two magazines absolutely FREE!

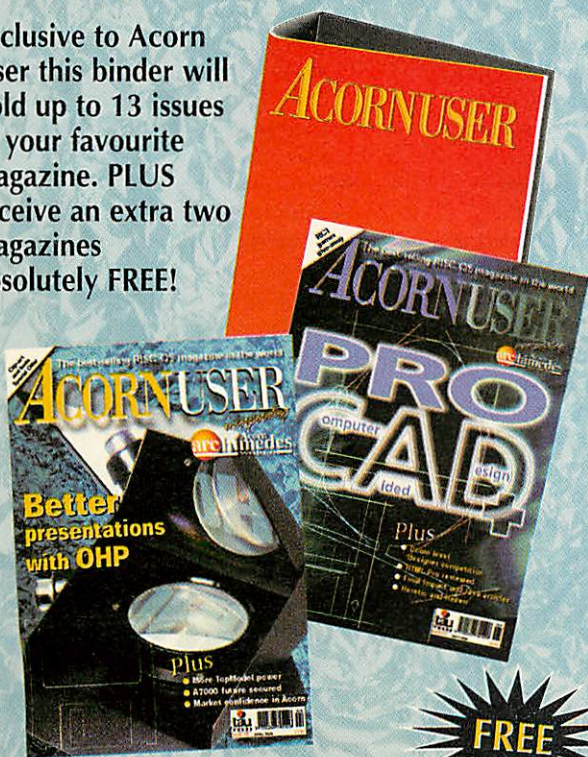

FREE

Yes! I will subscribe...

1

Name.....

Address

.....Country

Postcode.....Tel.....

E-mail.....

2

Please subscribe me for:

4-issue subscription

	New	Renewal	
UK	<input type="checkbox"/> AUN99074	<input type="checkbox"/> AUR99074	£15.99
EU	<input type="checkbox"/> AEN99074	<input type="checkbox"/> AER99074	£17.99
World	<input type="checkbox"/> AWN99074	<input type="checkbox"/> AWR99074	£20.99

8-issue subscription

	New	Renewal	
UK	<input type="checkbox"/> AUN99078	<input type="checkbox"/> AUR99078	£29.99
EU	<input type="checkbox"/> AEN99078	<input type="checkbox"/> AER99078	£34.99
World	<input type="checkbox"/> AWN99078	<input type="checkbox"/> AWR99078	£40.99

Annual subscription (13 issues)

	New	Renewal	
UK	<input type="checkbox"/> AUN9907Y	<input type="checkbox"/> AUR9907Y	£45.99
EU	<input type="checkbox"/> AEN9907Y	<input type="checkbox"/> AER9907Y	£51.99
World	<input type="checkbox"/> AWN9907Y*	<input type="checkbox"/> AWR9907Y*	£63.99

Prices include postage & packing

3

I have taken an annual subscription (13 issues), please send me one of:

- 4773 - Destiny - £25
- 4248 - Textease - £20
- 4705 - Binder & 2 mags - FREE
- 4258 - Anagram Genius - FREE
- 4772 - Y2K Video - £15

*Unfortunately World subscribers are not eligible to receive the free gift/special offer

4

I wish to pay by:

- Cheque / postal order (payable to Tau Press Ltd)
- Credit Card (Visa / Barclaycard / Mastercard / Access)

Credit Card No:

Expiry Date:

Name on card:

Signature:

Send your completed Acorn User subscription form to:
**Acorn User, Subscription Dept, Tau Press,
Media House, Adlington Park,
Macclesfield, SK10 4NP, England.**

Telephone **0870 606 0424** or fax your completed Acorn User subscription form with credit card details to **01625 859808**

Have a query? E-mail subscrip@acornuser.com

Please note e-mail is not secure, we do not recommend sending your subscription details as plain text.

Please tick here if you do not wish to receive promotional information from other companies

Is all as it seems?

Having spoken to many prominent figures at the Wakefield show, I have unearthed some rather unsavoury facts about our knights in shining armour, RISCOS Ltd. According to my sources, all registered dealers/developers must sign a rather draconian contract before being allowed to have a sneak preview of the upgrade, or sell it on to end users.

Two particular examples which I would like to draw readers' attention to read as follows:

- 1) We agree not to disagree with RISCOS Ltd in public.
- 2) If we are to sell products for other platforms, we agree to allow the RISC OS version precedence in advertising and other marketing material.

I assume this refers to situations such as *Sibelius* and possibly *Cerilica Vantage*. It is worth pointing out that those not agreeing to this contract are not allowed to distribute/develop for the new OS. It's quite simple: no contract, no upgrade.

I for one cannot understand why the powers that be at RISCOS Ltd feel so insecure that they must bully developers into not criticising their product, or way of doing things. Okay, so they might be wanting to promote unity in the Acorn platform, but surely big brother tactics such as these will only promote bad feeling and anguish?

Perhaps someone at RISCOS Ltd would care to issue a statement on these matters, because they should be of grave concern to every user who is thinking about purchasing the upgrade. I hope RISCOS Ltd won't want us end-users to sign a similar contract to make us all into pro-RISC OS drones!

Don't get me wrong, RISCOS Ltd are doing a great job and I really enjoyed the article by Alastair Bailey in your June

issue, but perhaps the ethos of the company itself needs to come under some independent media scrutiny too.

Brendan Bowler by e-mail

Paul Middleton, RISCOS Ltd MD replies: *I suppose it is a problem with the English language that anything written can be interpreted in many different ways, and discussing anything with secondhand knowledge can either make an interesting parlour game or lead to panic in the streets.*

In this instance I believe that some deliberate slanting of the facts has been applied by some who would like to see RISCOS Ltd fail in order to further their own ambitions.

Mr Bowler has clearly been seduced by the Dark Side and if he had contacted me directly at the show, as a number of people did concerning this same matter, I could have set the record straight there and then.

Firstly Registered Developers are requested to sign two documents.

- 1) *A Non-Disclosure Agreement, which is absolutely standard and is legally binding, and without which the company or individual cannot become a Registered Developer.*
- 2) *A Code of Conduct, which is not a legal document, but expresses the standard of behaviour that we hope that Developers will want to agree to, in the general operation of their businesses. It is not mandatory to sign the Code of Conduct as we cannot legally dictate terms of employment for a company.*

We are also not forcing people to sign a draconian contract before allowing them to become a Developer, or a retailer of RISC OS upgrades to end users.

As regards the two particular examples quoted:

- 1) *The Code of Conduct actually requests that: 'The Developer agrees not to publicly criticise the actions or inactions of RISCOS Ltd in public forums...' This is*

only normal courtesy. If you have a problem with a company or their service you take it up with the company concerned. You don't complain to a magazine first, before contacting the company concerned, to check that you are not complaining about something that is untrue.

- 2) *The Code of Conduct requests that: 'The Developer agrees not to indulge in any form of anti-competitive actions which might jeopardise the growth/development of the RISC OS marketplace. In particular the Developer agrees not to misrepresent to a customer, or potential customer, the consequences of using their products in preference to those of another Developer. The Developer also agrees not to actively promote software which runs under any Operating System other than RISC OS when suitable software is available for RISC OS.'*

Mr Bowler then goes on to state that 'those not agreeing to the contract are not allowed to distribute/develop for the new OS. It's quite simple: no contract, no upgrade.'

This is definitely not the case.

*Firstly we have different contracts for Developers, Dealers and Installers. Developers **must** sign the NDA, otherwise we will not be able to provide them with any Technical Support – this is completely normal in any business of this sort. The Code of Conduct is, however, just that, a Code of which we hope people will want to adhere but it is optional.*

*However, I must point out that it is **not** a pre-requisite to become a Registered Developer in order to develop and sell RISC OS-based software. We have no wish to stop people developing software but we can only actively support those that want the work with us, rather than those that want to work against us.*

We have no intention of making end users become pro-RISC OS drones by making them

sign contracts, or any other means. The policy of RISCOS Ltd is to enable all types of operating systems to co-exist, by working to provide direct connectivity with Windows, Linux, Macintosh and other systems, rather than having the closed system that is Windows, for example.

Perhaps, however, it is the motives of some of those 'prominent figures', Mr Bowler spoke to at Wakefield that need to come under media scrutiny – or perhaps they should stop dealing in hearsay too.

RISCOS Ltd was set up solely to allow the 200 plus companies that formed the 'Acorn Community' to carry on with their businesses once Acorn had decided to leave the market. There are however, signs that some companies would prefer it if they were left in a monopoly situation, with regards to supply of particular products.

Mr Bowler, based on hearsay evidence, appears to be advocating that people think very hard before considering purchasing RISC OS upgrades in case we are trying to become 'Big Brother'. This is very much falling in line with those who want to see monopoly suppliers, rather than encouraging everyone to go out and upgrade to RISC OS 4. Why not get behind RISCOS Ltd, whose avowed aim is to support the entire RISC OS community?

Goatly wisdom

In reply to Simon Morgan's letter in the June issue of *Acorn User*, I'm not sure I can be much help with your problems, but I thought you might be consoled to learn that you're not alone with the 'disc not formatted' error. I've been getting this on and off now for a few months; sometimes a reset cures it and sometimes not. I replaced the floppy drive (luckily not very expensive) but without benefit other than quieter track-seeking.

I recently had a 1.6Mb floppy (quite old, that had been down the back of a radiator for a couple of years!) that my Risc PC simply would not access, yet my A5000 catalogued it quite happily. Again fortunately, there was nothing of value on it (and the contents would have been rescuable if necessary via the A5000), but I'm not at all sure what was going on.

My only theory is that there might have been a slight misalignment of the drive head(s) on the old drive, but that doesn't explain why some of the problems can be cured by a reset. Personally I blame the scapegoat.

Bruce Goatly, Wimbledon, London

Great ideas

RISC OS might be surviving as a very small collection of niche markets (the Wakefield show was evidence of that), but obviously the Holy Grail is new users. Seeing as the popular complaint against Acorn was its complete lack of marketing ideas, now is the chance to offer realistic solutions. These are a few I came up with:

- An exhibition fund. If possible, a fund should be set up allowing developers a chance to be part of a stylish RISC OS village which could

be present at relevant non-Acorn Computer shows (or even non-computer shows!). There should be stylish stand graphics, and plenty of machines demonstrating clearly the differences between RISC OS machines and the standard fare.

- The return of open days. There always used to be periodic 'open days' in my home town of Taunton. These seemed to attract plenty of non-Acorn people. I'm sure Gordon Taylor was responsible for shifting many, many Acorn machines with his demonstrations of Computer Concepts products at the Taunton open-days. Perhaps Cerilica could do the same in 1999 and onwards. Maybe MicroDigital's efforts to sell Mico as the ultimate home-computer would benefit from the creation of a series of locally advertised Open Days.
- The voucher scheme. Over the nine or so years I've used RISC OS machines at least five people have bought them as a direct result of seeing mine in action. I'm sure many people came to RISC OS machines by seeing a friend's or family member's machine. To encourage people to become RISC OS evangelists, a voucher scheme could help to promote this process, offering those ordinary users responsible for creating new RISC OS users cash-back.

What do other people think could realistically sell RISC OS machines and expand the market?

David Charles Hammonds

I first saw this line of thought on the Acorn newsgroups and asked David to put his ideas into a letter for the magazine. All three sound like excellent suggestions, and personally I'd love to see a stand of the top RISC OS products at a PC show. What better way to directly influence PC users and show the world the benefits of RISC OS and it's associated software.

With RISCOS Ltd now on the scene and pushing a 'let's all work together' message, and with the release of so many excellent products it would seem a prudent time to go on the attack. The ideal time would probably be when RISC OS goes hardware independent, but why wait that long, it can't hurt to let people see what we all use at this moment.

Or can it?

After a chat with Cerilica about their thoughts on the matter, Nick van der Walle made a rather good point. If we were to go to a large PC event to show off our wares, and people where to say 'hey, that's some kind of program you got there buddy. I'll take it. Now where can I buy one of those machines?'

What are we going to say?

'I'm sorry, but you can't buy a StrongARM machine at the moment?' – we can't market software without a machine to run it on.

So, it would seem we have to wait for suitable hardware to become available before we take that step into the very different world of PC marketing. I'd love to hear your comments and ideas on the matter, and not just from end users, if developers and dealers want to comment then feel free.

END

Contacting us

Write to us at:
Acorn User, Media House, Adlington
Park, Macclesfield SK10 4NP
or e-mail: letters@acornuser.com

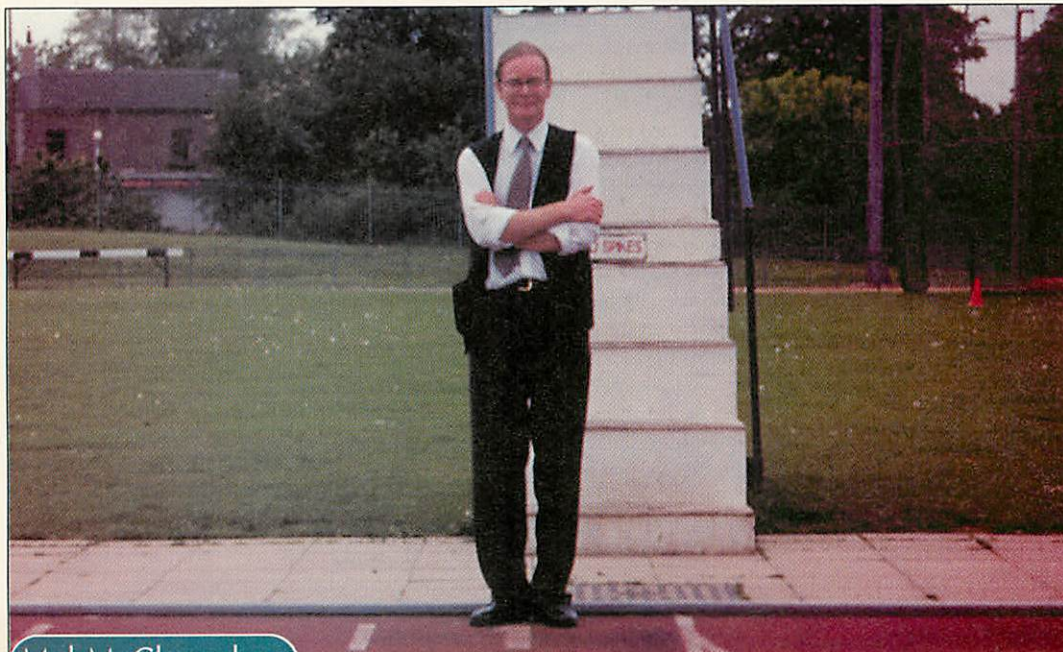

Mal McClenaghan

Roy has drawn a line in the sand... everything has to be this good

Some Regan Files are more pre-planned than others. This month's came about when I was chatting to Graham Simpson on the Simtec stand at the Wakefield show, and he asked me if I'd like to 'meet an Australian'. Always up for new experiences, I agreed, and the Australian in question turned out to be Mal McClenaghan, product manager for The Image Factory, Victoria, Australia.

'I'm here on a working holiday,' Mal claims. 'I haven't had a holiday for five years. It doesn't sound right for an Australian to be coming to England for a holiday. I came on a buying trip, because I wanted to be able to bring in products to the Australian market.'

'Currently, when people walk in the door and decide to buy a Risc PC because we have just demonstrated one, we can't actually sell them one there and then, because it will take me several days to get one. But we want to have the whole shop stocked, we want to be able to say to people: "Here is the machine you want to buy, take it out the door." This has always been a problem for Australian dealers. We can get stock quicker from England than from Western Australia.'

So far he's doing well. Mal had only been at the show for a few hours and had already picked up three new suppliers. His major coup was getting the Australia and New Zealand rights for the RiscStation, the new machine developed by Roy Heslop of CTA.

'One of the problems about being an Australian dealer is that it is very difficult to pick up any gossip,' jokes Mal. 'Gavin from Simtec told me it would be good if I could come to Wakefield but he could not tell me why. I have now met Roy, and know why. The RiscStation has an excellent chance of succeeding in Australia. It is beautifully designed, the pricing is right and

the specs are right too.

'We will be doing the manufacturing. We will import motherboards and make them ourselves, although we have to make sure our AMC regs for our testing is going to cover us for assembly. This means if Roy sells it at a certain price, our price will be the same.'

'There will be none of the familiar: "I see this in *Acorn User* at a certain price and it is much more expensive in Australia." This is going to even things out a lot regarding supply and support; it is these matters which

have worried people a lot in Australia.

'I guess the important thing for the market as a whole is to have room for multiple machine manufacturers. No one is going to be sole provider, so it encourages competition and it is going to bring prices down. The people who benefit are the people who are going to buy. Roy has essentially drawn a line in the sand and has said: "This is the new entry level and everything has to be at least this good."'

One very important person to Mal is his wife Marisa: 'She has been supportive right from the start,' says Mal. 'When we first got married she knew very little about computers and was only answering the telephone; now she gives diagnostics.'

'She is very spirited: if I moan about a supplier she tells me not to moan and do something about it, if I am down in the dumps she says "Yes, yes, yes," and pats me on the head, if I am down in the dumps for a second day she tells me to pull myself out of it and do something about it. When I suggested to her I should come to the show, Marisa said that I had better or someone else would seize the moment and they would mess it up.'

Mal has just won Australian achiever award for excellence in customer service in the area of Internet services and computer buyer. The award is run by an independent group who take nominations for the award. They are given a list of three of the company's customers and one supplier for them to contact and rate the company.

'I am passionate about the RISC operating system' enthuses Mal. 'People have to realise that the Acorn market is not a cash cow to be bled extremely dry. In Australia it is my mission to expose the RiscStation to a much larger community than the Acorn ever was.'

Jill Regan

TopBones and new TopModel CD ready.
Fully functional BJC7000 and BJC7100 PhotoReal Driver
and now brand new BJC2000 Driver! Epson Photo Printers
now much cheaper!

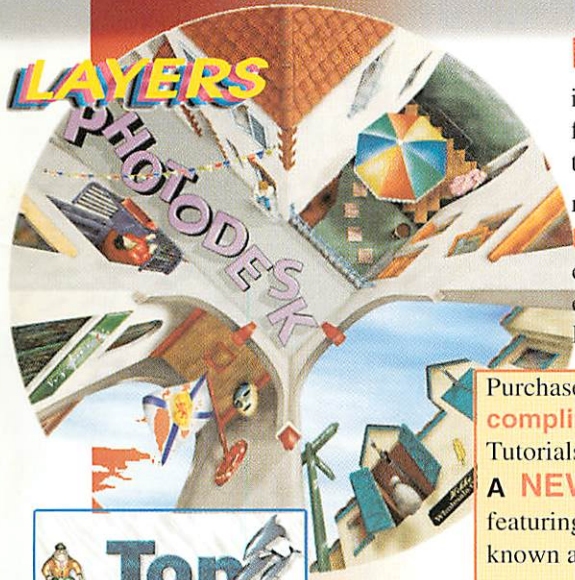

PHOTODESK 3 is the **LAYERS** package which defines studio quality image editing and artwork on RISC OS machines. It is easy to use but has many powerful features, including **LAYERS** and a sophisticated colour management system (CMS) for the full-time graphics professional. **£299.50** **PHOTODESK2** is still available, retaining the CMS but not layers, **now only £199.00**
PHOTODESK LIGHT, an economic alternative to PHOTODESK3 retains most of its creative features apart from the Colour Management System, Layers and some features essential to the professional user. **£134.75** **Plug-in Effects Packs** are available for all Photodesk packages. Each pack contains 10 special effects: **£19.95**

Purchasers of Photodesk 3 or Photodesk Light will receive a complimentary CD-ROM of useful resources, utilities and Tutorials. This CD is available to existing users for **£14.95**.
A **NEW CD-ROM "An Introduction to Digital Art"** featuring bitmap and vector graphics tutorials by the well-known artist, David Cowell, is also available for **£24.95**

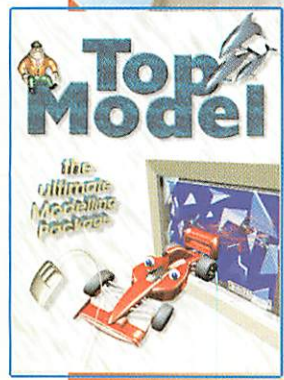

A New Version of **TopModel2** V.2.14 is now available for **£152.75**. Existing users may upgrade for **£29.95**. or buy the **NEW CD-ROM** packed with resources, the new plug-in **Top3DFonts!** and a free 2.14 upgrade for only **£58.63**.

TopBones Skeleton Management System now ready **£39.50** ... as well as **TopModel CD-ROM #3!** **£49.95**

OHP

A presentation package on CD-ROM from Spacetechn

Makes your slide shows quick and easy to create!

- Start building your presentation 5 minutes before the lesson? - No Problem
- Use your existing work in a presentation? - No Problem, just drag 'n drop it in!

Only £29.95



digital cameras

PhotoLink is an Acorn multi-driver for the most popular makes of digital camera. Cameras currently supported include the new **Olympus** range including the fantastic **C900 ZOOM**, the **theC830L** a new replacement for the 840L and the **C1400XL SLR Zoom**. Superb hard copy can be obtained via Epson or Canon **PhotoReal**. PhotoLink is available on its own at **£69.00** or bundled FREE with a camera.

New Prices! **C1400XL** **£749.99** (was **£999.99**) **C830L** **£399.99!** (was **£549**)
C900ZOOM Zoom megapixel compact with Optical AND Digital zoom **£549.99** (was **£649.99**)

PhotoReal is the Acorn driver extension for the **Canon BJC4300, BJC4650, BJC7000, BJC7100 BJC2000, Epson Photo, Photo700 and PhotoEX** printers with photo-realistic capability. PhotoReal makes use of the same advanced techniques for producing high-quality four colour separations as Photodesk and comes ready calibrated for the special dye-based inks used for photo-realistic printing. A calibration application is also supplied to allow you to tailor the results to your own specification **Driver only £69.00 Inc.VAT. or FREE if purchased with printer!**
examples: **Stylus Photo700** was **£249.50** NOW **£204.45** **Canon BJC2000** **£149.95** **BJC4650 A3** **£299.99**. **BJC7000** **£245**, **BJC7100** **£299.00**, **Epson PhotoEX A3** was **£454.73** NOW **£363.07** (all prices include PhotoReal Driver)



All Prices Include VAT

Spacetechn Ltd

1 The Courtyard, Southwell Business Park, Portland, Dorset, DT5 2NQ, U.K.
Telephone: +44 (0)1305 822753 Fax: +44 (0)1305 860483
Email: sales@spacetechn.co.uk Web : http://www.spacetechn.co.uk

from
£499
+ VAT

The
A7000+
Peak Performer

from **£499** + VAT



The
exceptional
Acorn
A7000+ Peak Performer

The Acorn A7000+ Peak Performer is a special offer system which combines legendary build quality, low cost of ownership and high performance to provide the ultimate choice for modern computing (ICT) in Education, Home and Business.

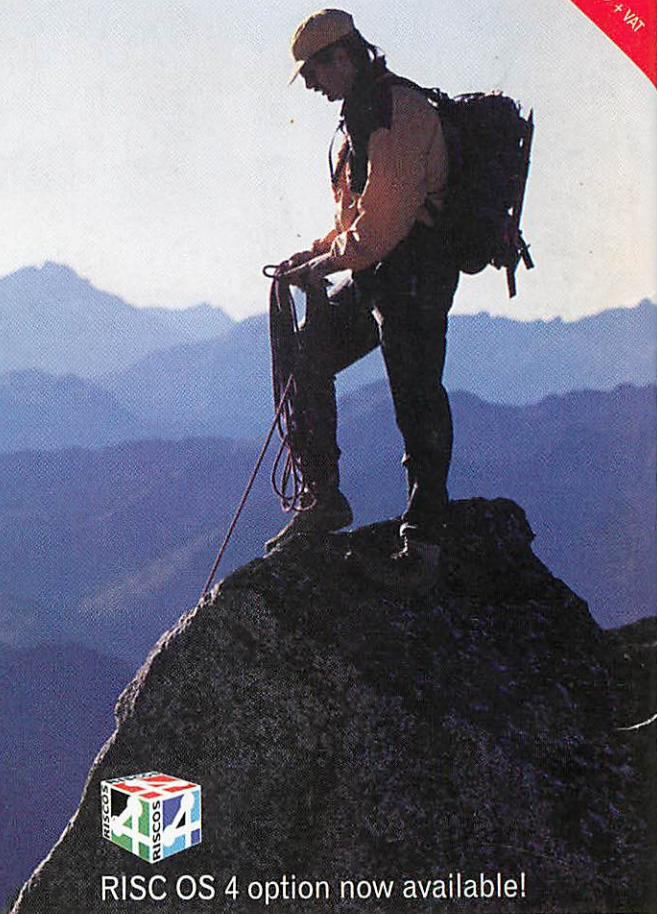

RISC OS 4 option now available!

RISC OS 3.71 in ROM

32-bit ARM 7500 FE processor

Floating Point Accelerator

4GB hard drive

8MB RAM (max 136MB)

Optional 40x CD-ROM drive

Optional monitor & speakers

1 year on-site warranty*



CASTLE
Computers for Education
Business and Home

NOW AVAILABLE in five exciting versions

Order now! Call **01728 723200**

*Advance swap-out
Acorn & the acorn nut device are trademarks of Element 14 Ltd