

The best-selling Acorn magazine in the world

# ACORN USER

Essential for all users of 32-bit RISC OS computers

## Unlocking the Internet

How to find what  
you want in  
30 million pages



**AUGUST 1996**  
**ACORN USER** **Cover Disc**  
**Ridiculous Rhymes**

**EXCLUSIVE**  
**demo from**  
**Sherston Software**

**Plus**

- Run the Risc
- HTML example pages
- \*INFO

**CHECKED ● VIRUS CHECKED ● VIRUS CHECKED ● VIRUS CHECKED ● VIRUS CHECKED**

- All about set-top boxes
- The magic (Lindis) school bus
- Writing HTML, part two
- Plus hands on, programming, education, graphics and all the regulars

**IDG MEDIA**

August 1996 Issue 171 £3.25

9 770263 745086

0 8 >

It's time to  
get *sensitive*  
about the way  
you *create*  
your graphics

.....

Many computer users feel that a graphics tablet is more natural to use than a mouse and without doubt it gives a much faster, smoother and higher resolution response. The mouse remains functional and can be used at the same time as the pen — however the pen has such a natural and precise feel, you will probably prefer it for many operations such as moving windows, drag and drop, region selection etc.

The new (approximately A6) ArtPad tablet offers a superb specification, even by Wacom standards; resolution exceeding 2000 dpi, 200 samples per second and 256 levels of pressure. All Wacom tablets include a cordless pen for added ease of use and flexibility.

The tablets are pressure sensitive, so in combination with suitable applications they can produce realistic effects such as variable width (the Eesox ArtWorks pressure sensitive tool) or variable density airbrush painting (PhotoDesk). The Computer Concept's drivers will be compatible with these and other software that can take advantage of the pressure information, such as Studio 24 and DA Picture.

Computer Concepts can supply the tablets with either Photodesk or the Eesox Pressure Tool at special prices. **PHOTODESK** is a photo retouching package from Spacetech, which offers a wide range of advanced image manipulation features; for example an airbrush, paintbrush and magic wand, full 24 bit colour support, the use of virtual memory, OLE with Impression, complete undo, effects such as colouring, toning and masking, motion blurring, cloning and smudge and smear.

The package contains the Wacom tablet (A6 ArtPad, A5 or A4) and manual, a cordless pen, Computer Concepts driver software suitable for all models of Acorn RISC computer (A3000 must have serial port upgrade) and PC drivers. Requires 1Mbyte or more.

**Price: A6 ArtPad & drivers: £169 + VAT (£198.57 incl.) A5 tablet & drivers: £299 + VAT £351.32 incl.)  
A4 tablet & drivers: £549 + VAT (£645.07 incl.)**

**ArtWorks Pressure Tool with tablet: add £10 + VAT (£11.75 incl.)**

**PhotoDesk with tablet: add £125 + VAT (£146.87 incl.)**

**ArtWorks Pressure Tool: £39 + VAT (£45.82 incl.) PhotoDesk: £169 + VAT (£198.57 incl.)**



Computer Concepts Ltd

WILD AND WACKY STORIES FOR CHILDREN AND ADULTS

# Ridiculous RHYMES

Written & illustrated by  
**Tony De Saulles**

Narrated by TV's  
**Tony Robinson**

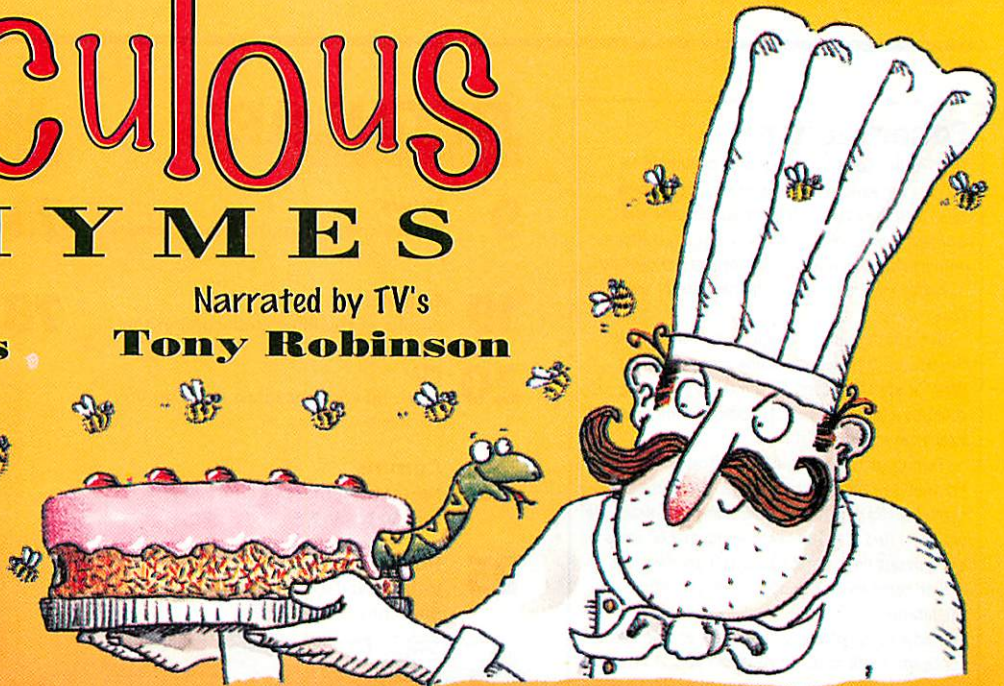

Age 7+ years

COMING SOON - Floppy version (May) & CD ROM version (September)  
For WINDOWS, APPLE MAC or ACORN RISC OS

£47-00 inc VAT

AND FOR THE YOUNGER CHILDREN

NOW AVAILABLE  
on  
WINDOWS  
APPLE MAC  
and ACORN



Volume One

Billy the Bothersome Bully



Doris the Dotty Dog

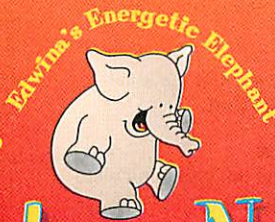

Edwina's Energetic Elephant



Terry's Tricky Trainers



Tina's Terrible Trumpet



Toby the Troublesome Tractor

## The Sherston Naughty Stories



Bobby the Boastful Bird



Clarence the Clumsy Cat



Derek's Dopey Dinosaur



Gordon's Groovy Granny



Lucy the Little Liar



Tessie's Terrible Tantrums

Volume Two

The results of recent research have shown that '... children using the (Sherston) electronic books showed significantly greater increases in word accuracy than those who did not have access to the computer.'

Age 5 - 7 years

Volume 1 or Volume 2 (six talking stories including books)

Each volume £64-33 inc VAT

CONTACT US NOW FOR A FREE COPY OF OUR 24 PAGE COLOUR CATALOGUE AND DEMO VERSIONS OF THE ABOVE PRODUCTS



Sherston Software Limited,  
Angel House, Sherston, Malmesbury,  
Wiltshire, SN16 0LH.  
Tel: 01666 840433 Fax: 01666 840048  
e-mail: sales@sherston.co.uk



# CONTENTS

## Editor's letter

The STB/Net Computer impetus is beginning to build as the various PR companies start to come alive with their task of hyping up this new and wonderful product. And in the vanguard is Acorn with its machine, now named the *NetStation*, with its highly innovative and extremely useful Smart Card concept.

But what's going to happen when the NC hits the streets? Whether it's Acorn or anyone else? Well, Oracle's CEO Larry Ellison could be wrong – it could be a complete flop. This time it won't hurt Acorn too much even if it is.

Perhaps worse, it could be a success. The Internet is not as fast as the hype makes it and the overall speed depends on how many Americans are online – I find that Sunday morning at 7:00 am is the quietest time. What happens if another few million come online? Netlock – that's gridlock on the Internet.

And a bunch of cheap computers end up in the cupboard. Familiar scenario? It was just 14 years ago...

Steve Turnbull

**Managing Editor** Pam Turnbull

**Editor** Steve Turnbull

**Production Editor** Judith Chapman

**Art Editor** Alan Capper

**Assistant Editor** Karen Peach

**Contributing Editors**

Ian Burley (News) Steve Mumford (Games)

Jack Kreindler (Graphics) David Dade

(Comms) Paul Wheatley (Public Domain)

Geoff Preston (Education) Mark Taylor

(Portables) Graham Nelson (Games)

Mike Tomkinson (Business)

**Advertisement Manager** Lisa-Jo Oliver

**Ad Production** Helen Weaver

**Ad Typesetting** Eddie Burke

**Marketing Manager** Steve Tagger

**Production Manager** Sandra Childs

**Commercial Director** Denise Wright

**Circulation Director** David Wren

**Distribution** COMAG (01895) 444055

**Subscriptions & Back Issues**

Database Direct 0151-357 1275

Email: [database@dbdirect.demon.co.uk](mailto:database@dbdirect.demon.co.uk)

**Managing Director** Ian Bloomfield

**Cover** Alan Capper

Member of the Audit Bureau of Circulation *Acorn User* is an independent publication and Acorn is not responsible for any of the articles in this issue or for any of the opinions expressed.



Published by IDG Media Ltd, Media House, Adlington Park, Macclesfield SK10 4NP  
e-mail [auditor@idg.co.uk](mailto:auditor@idg.co.uk)

<http://www.idg.co.uk/acornuser/>  
Tel: (01625) 878888 Fax: (01625) 850652  
Printed by Duncan Web Offset, Maidstone

13 issue subscription rate: £39.99 (UK),  
£53.99 (EU), £68.99 (World)

©1996 IDG Media Ltd.

No material may be reproduced in whole or in part without written permission. While every care is taken, the publishers cannot be held legally responsible for any errors in articles, listings or advertisements

## REGULARS

- 9 News**  
What's going on in the Acorn world – now five pages
- 19 Graphics**  
Results of the Photodesk competition
- 20 PD**  
Catch up with the latest news on the PD scene
- 23 Comms**  
Northern ARM BBS & more WWW sites to browse
- 25 Portables**  
What's available for portable machines on the Net



- 27 Business page**  
Getting the best from your Acorn in the business world
- 51 Cover disc**  
Ridiculous Rhymes plus the usual goodies and fun stuff
- 59 Game Show**  
News, hints and tips plus using maps in adventure games
- 72 Free Ads**  
You may find just what you've always wanted
- 85 Back issues**  
Get up to date – while stocks last
- 86 Subscribers' page**  
Get AU delivered to your door
- 88 Letters**  
A chance to voice your opinions
- 90 The Regan Files**  
John Crick from Crick Computing



## HANDS ON

- 73 \*INFO**  
Blobs, Frogs and lots more to have hours of fun with
- 78 Last of the 3-legged heroes**  
Building an intelligent transistor tester

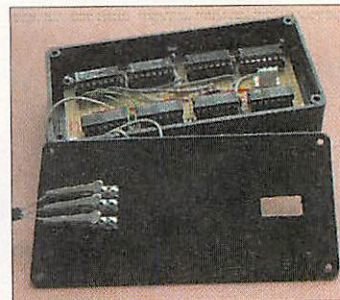

- 81 C Tutorial**  
More about the WIMP C library
- 82 Rambles through Acorn Wood**  
Question-time with Mike Cook

## EDUCATION

- 65 Editorial**  
New educational software releases

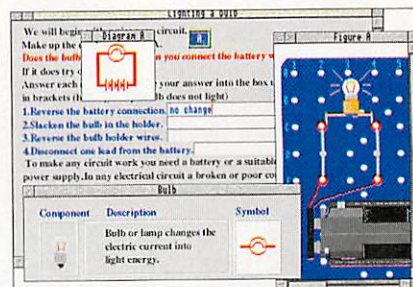

- 67 Early reading**  
Book Project review
- 68 Measuring up**  
Using computers for measurement



- 70 Seizing the blame**  
A look at the controversy surrounding epilepsy and computers

## REVIEWS

- 29** **Searching the Internet**  
How to find what you want using search engines
- 35** **Genial genealogy**  
Ancestry 2, the family tree package reviewed
- 42** **The Magic School Bus**  
Lessons on board the Lindis Technology bus
- 49** **In Brief**  
VT100 Emulator & Paint, Composer, Paper Out, QuickLynk and more

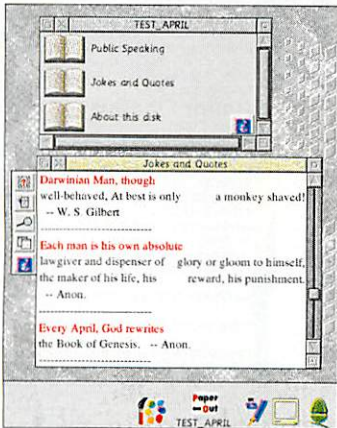

## FEATURES

- 38** **Anchors aweigh**  
Linking documents in HTML

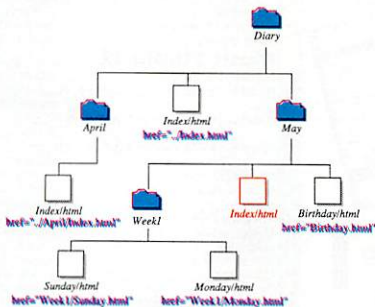

- 45** **Set-top Boxes**  
The Acorn offering, the opposition and the prospects
- 55** **How the West was drawn**  
Creating a picture using ProArtisan 240



## 29

Where do you begin to look for the information you want on the Internet? Paul Skirrow shows how to use search engines to make finding the pages that much easier

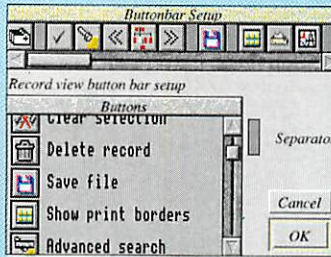

## 35

Steve Turnbull takes a look at Ancestry 2 from Minerva, the genealogy program to help lay out your family-tree

## 42

Karen Peach joins a lesson on board the Lindis Technology Bus



## 51

A complete sample of the new Ridiculous Rhymes from Sherston Software, Mike Cook's Transistor Test software plus \*INFO programs

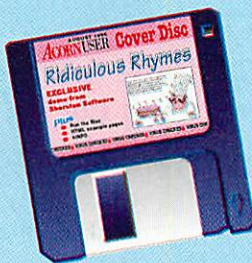

## Next month in Acorn User

- Ovation Pro, almost as long-awaited as the original Impression, is finally here and we get a selection of experts to give it a real going over.
- More MIDI music reviews from Rob Miller

**NEXT  
ISSUE  
ON SALE  
8 AUGUST**





# Risc TV

Risc TV is a new breed of multimedia digitiser. No processing power or bus bandwidth is required, because it uses special hardware to update the screen directly. So now you can watch full-size, full-motion and true-colour TV (or any other video source) in the desktop. An audio processor and TV tuner are fitted as standard, which are digitally controlled by the application software.

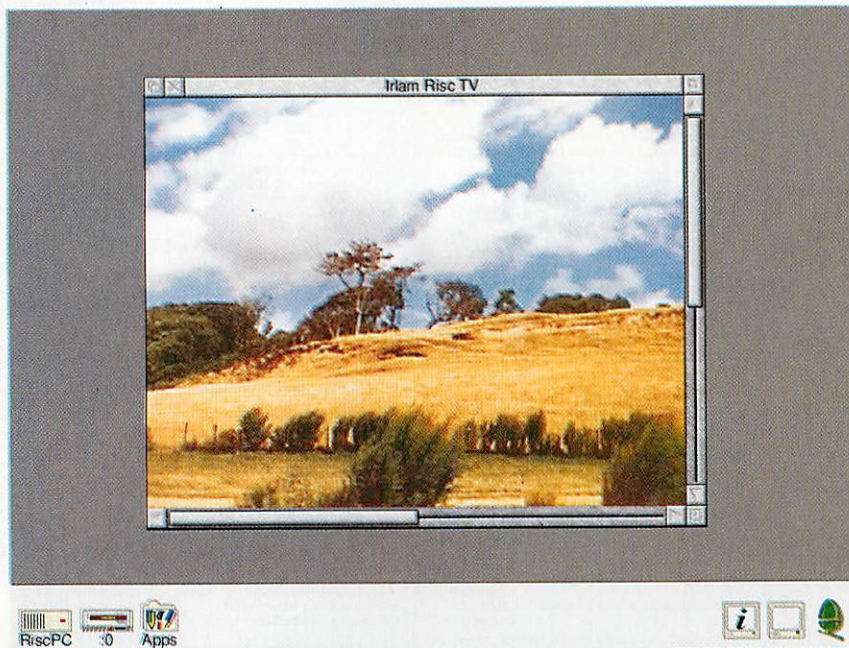

## Real-Time 24 bit Desktop Video System £298.45!\*

\*Price of the complete package including expansion card, software, postage and VAT.

Because it does not rely on processing power or true colour modes, Risc TV works just as well on A5000 machines. And you will always see millions of colours in the video window irrespective of screen mode! Naturally you can use Risc TV to grab high quality still images for DTP etc.

Audio can be selected from either the TV tuner, or from an internal audio source (e.g CD-ROM drive). This can be mixed into the computer's internal sound system, or output to a pair of external speakers or headphones.

Risc TV has been designed to be expandable with special feature connectors. A low-cost Teletext option will be the first available add-on.

- 24 bit framestore (16.7 million colours) updated at 50Hz.
- On-screen display sizes of over 1024 x 768.
- No DMA slot required.
- Real-time control of scaling, filtering, brightness, contrast, and saturation.
- On-board TV Tuner covers Cable and off-air channels.
- Auxiliary inputs for composite video and S-VHS sources.
- Audio support including control of volume, balance, bass and treble.

For the Complete Picture...



**Irlam Instruments Ltd**, Brunel Institute for Bioengineering, Brunel University, Uxbridge, Middlesex, UB8 3PH. Tel/Fax 01895 811401. Email: sales@irlam.co.uk

Please note: **Risc TV** works on A5000 & RISC PC machines (requires one free expansion slot). You must have RISC OS 3.1 or later, a hard disc and 2Mb RAM minimum. All hardware products come with full 1 years guarantee. E & OE.







## Ovation Pro ships at last

BEEBUG'S challenge to the Acorn DTP dominance of Impression Publisher has arrived at last. Beebug says *Ovation Pro* has an impressive range of features, many of which are apparently new to the Acorn platform. These include multi-step undo/redo, and text flow inside and around irregular frames – including Bezier curves, rotated frames, automatic drop capitals, auto-flow around irregular graphics, info palette and user-definable button bar. *Ovation Pro* loads *Ovation 1* documents directly and is supplied with import filters for DDF and RTF files. Another facility allows *Ovation Pro* to be easily configured for beginners and educational users, providing fewer features from a simpler menu structure and button bar.

Later in the year, a free update will be shipped to all registered users, offering more advanced features like full-colour and spot-colour separations, image processing, auto paragraph numbering and local OPI for handling large graphics bigger than the memory size.

Beebug has also announced the expansion capabilities of *Ovation Pro* using extension modules called Applets. These allow Beebug and other developers to write plug-in extensions which add major new features without the need to upgrade the main application. Users with some programming knowledge can also write their own simple extensions using an integrated script language. Beebug aims to build a library of such scripts for free distribution. *Ovation*

*Pro*, including a thesaurus and 50 fonts, is priced at £165 + VAT. Upgrades from *Ovation 1* and other DTP/word processor packages are available from £79 + VAT. The original version of *Ovation DTP* package continues to sell as a budget-priced alternative at £69 + VAT. Beebug, tel: (01727) 840303, fax: (01727) 860263.



## Kodak's affordable digital photography

KODAK has introduced what it claims is the world's most inexpensive, lightest and smallest digital camera. In the past, similar claims have been associated with professional equipment costing thousands of pounds, but Kodak's new baby, the DC20, costs £349 – at the upper end of the amateur price range – and the camera has been designed with simplicity and ease of use as a priority.

The DC20 is also small and light enough to fit into a shirt pocket. A product of the new Kodak Digital Science brand, the DC20 is being touted as the first of a new breed of *fun* digital computer peripherals aimed at the home computer user.

Like its professional siblings, the DC20 is a digital memory device using a digital imaging chip, similar to those found in video cameras but higher in resolution. Images are temporarily stored in on-camera memory and, when you're ready, can be downloaded to a home computer via the serial port, digitally processed as required and then printed using your standard computer printer – see other story on Kodak Snapshot ink-jet paper. However, Kodak thinks a popular use of the DC20 won't involve paper at all – sending snaps to your mates down the Internet.

The DC20 has automatic exposure and

a fixed-focus lens. Shutter speed and ISO 'film' speed values are automatically adjusted to suit the lighting condition, so you're not saddled with a single film speed as with conventional film cameras. Like video cameras, the DC20's imaging system works very well in low light conditions without flash, though a built-in flash is featured. The DC20 incorporates 1Mb of built-in memory, which is enough to store either 8 or 16 24-bit colour images, depending on the resolution selected.

Software for Microsoft Windows 95 and Apple Macs has been developed by Kodak to complement the DC20. At press time it wasn't clear if the image files produced by the DC20 could be natively captured by a RISC OS computer, but at the very least a Risc PC with a PC co-processor running Windows 95 would theoretically be able to run the DC20's Picture Postcard software.

The software manages image transfer from the camera and enables images to be edited, including adding text labels and, if required, sent to the host PC's e-mail program. Images can also be exported in standard file formats. Picture Postcard software is available for free download from Kodak's Web site at: <http://www.kodak.com>. Kodak can be contacted on: (01442) 61122.

## Zip up your A3020/4000

If you intend to increase the amount of memory in your Acorn A3020 or A4000, the message is that you should think about doing it as soon as possible. According to Acorn memory upgrade specialists, Simtec, the availability of the necessary 512x8 Zig-zag Inline Pin (ZIP) DRAM chip components is becoming critical as they are now no longer being manufactured.

Meanwhile, users of the more recently designed Risc PC are enjoying the lowest-ever price per megabyte in system RAM. Independent dealers are selling compatible 70ns 72-pin SIMMs (single inline memory modules), at almost a third of the cost of the same product a year or so ago. For example, 8Mb SIMMs have been spotted for just £49 + VAT and there are reports of even better deals. Remember, don't make the mistake of buying more costly 'parity' memory, which can double the cost of the more common non-parity type of product. Parity memory will work in a Risc PC, but the parity feature is not implemented in the Risc PC's memory architecture.

Unless your supplier has tested the memory being sold in a Risc PC, ensure you have the option of getting a refund if you're unlucky enough to find it doesn't work. EDO (extended data out) and 4K bank switching memory will not work in current Acorn designs, although they are compatible with many PCs. Beware that even if a supplier will refund you, a re-stocking charge may apply.



## CC StrongARM products?

As we reported last month, Acorn has demonstrated *Impression* and *ArtWorks* running on a prototype Strong ARM Risc PC. However, these applications will need substantial modification to run acceptably under a shipping version of RISC OS for a Strong ARM Risc PC.

Acorn had hinted to *Acorn User* that it was in negotiation with Computer Concepts regarding the development of truly StrongARM compatible versions of *Impression* and *ArtWorks*. As two of the most important third-party applications to the RISC OS platform, it's not surprising that there has been behind the scenes work to deliver new versions of the two CC packages, and we now believe that a deal has been struck which will include StrongARM versions of CC's TurboDrivers for printers. At press time a joint press release from CC and Acorn was still being approved - hopefully everything will be confirmed by next month's issue.

## Acorn goes online in Canada

Manitoba Telephone System (MTS) in Winnipeg, Canada, has announced an agreement with ViewCall America to provide customers with Internet services through standard telephone lines and home televisions using ViewCall's Acorn Online Media designed WEBSter(tm) Internet set top box (STB).

The \$300 STB enables an ordinary TV to access the Internet without the need of a separate computer. The \$300 (£200) WEBSter(tm) design is based on the Acorn Online Media interactive video STB, incorporating an ARM 7500 chip, but substitutes an ATM networking adapter for a conventional modem, making it cheaper and more immediately usable via existing telephone services. Approximately 100 Manitoban families are now part of an initial trial. ViewCall's Internet site is at <http://www.viewcall.com>.

# Kodak ink-jet paper

COLOUR ink-jet printers are better than ever, with some managing 720 dots per inch resolution output. Although even the best water-based conventional ink-jet printers can't claim to deliver photographic reproduction comparable to the tradition film and photo-chemical print process, ink-jet is getting close to being acceptable for some non-critical applications. You probably know that ink-jet printers deliver different print qualities according to the type of paper used. For the sharpest and most contrasting results you need to use specially-coated paper.

Now, Kodak has spotted a market opportunity for ink-jet printer paper which is both coated for best-quality reproduction and which has a finish and weight comparable to photographic paper. The new paper is called Snapshot inkjet paper and is supplied in a 10x15cm format, not far off the 6x4 inch standard sized photographic print available from most

photo-finishers, so prints will fit in standard photo albums. Sample prints we have seen look good from a distance, though close examination shows up the characteristic dot pattern of an ink-jet image. At press time, Kodak had not yet decided on pricing and availability. Kodak can be contacted on: (01442) 61122



Image Source: Photo CD  
Printed On Kodak Inkjet Snapshot Paper  
Photo: Thomas Gross, KINSA WINNER

## Multi-threading RISC OS under development

SIMTEC has ambitious plans for its recently-launched Hydra multi-processor expansion board for Risc PCs. Neil Carson (of Risc-BSD fame), who wrote the Hydra FPE support code, is writing a utility to bring multi-threading to RISC-OS applications. Simtec says that by providing a generic interface, this will simplify the writing of multi-threading programs and allow them to be run Hydra multi-processor systems without modification.

This will hopefully endow applications with considerable performance benefits. The specification for interface is still in its early stages and external input to its design is welcomed by Simtec.

The current specification is stored on the Web at: <http://www.rmcs.cranfield.ac.uk/~carson/thread/thread.html> and any comments and suggestions are invited.

Meanwhile, Simtec is looking forward to novel applications for the Hydra board. The suggestion is that you need not be restricted to multiples of just ARM processors. Instead you could have other bus-mastering processors to accelerate all manner of functions, including graphics, for example. Simtec is hinting that a task-specific processor card for the Hydra is currently on the drawing board. A symmetric multi-processing (SMP) system is also a possibility. Simtec can be contacted on (01772) 812863.

## PCs set to unify their memories

THE PC industry is getting excited over the prospect of a new unified memory architecture which, gasp, will enable application programs to use the same memory space as, say, the video subsystem. Acorn computers, including the Risc PC - which has the option of VRAM for the display system - have always allowed sharing of a the memory map in the way proposed by the PC industry.

Separating the video RAM from system RAM is comparatively wasteful, though it does have some advantages. Using VRAM instead of DRAM for video enables faster memory re-refresh which enables bigger, more colourful and less flickery graphics screen modes. However, the price of DRAM has fallen so much in recent months (some memory chips are just a third of the cost compared with this time last year), that the prospect of using cheap DRAM for video RAM is much more attractive. Modern DRAM is also quite fast, with 60ns parts and EDO (extended data out) types becoming the standard for PCs. What we don't need is another RAM chip shortage, though!

# First Choice for Quality Software

## SLEUTH 2

### Optical Character Recognition

Sleuth 2 is a truly professional OCR system with superb features like auto page zoning, style recognition, fully integrated spelling checker and guided editing. Sleuth converts scanned images of printed material into ASCII files and can handle virtually all popular fonts in a wide range of styles achieving over 99% accuracy on good quality images. You will need 4Mb Ram and an Acorn-compatible scanner with a minimum resolution of 300 dpi. Sleuth can scan images directly using Twain drivers, which are available separately.

**SLEUTH 2 Price £116.33** + £2.00 Carriage

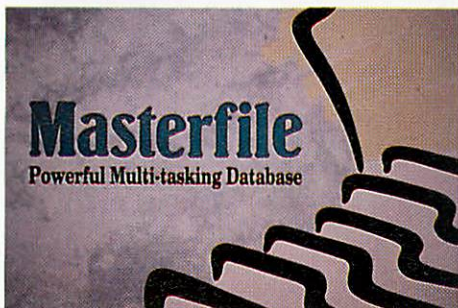

## MASTERFILE

### General Purpose Database

Masterfile is a fast and flexible general purpose database providing powerful data management facilities suitable for business, education and home.

Masterfile is probably the easiest Acorn database package to setup and use!

Its many features include a comprehensive indexing system, subsets which limit access to just those records which match search criteria, and a report generator which allows databases to be printed in a variety of card, spreadsheet or label formats.

**MASTERFILE Price £57.58** + £2.00 Carriage

## EASY C++

### C++ Development System

Easy C++ is an excellent implementation of the in-vogue object oriented programming language C++. This implementation conforms to the latest Stroustrup text and supports both Templates and Exceptions. Unlike some other implementations, Easy C++ is not a C++ to C translator but compiles C++ source directly to ARM code making it quick and easy to use.

Easy C++ uses the much praised Easy C WIMP interface which allows programs to be compiled, linked and run at the click of a button. The package includes ANSI C and IOStream libraries, Make facility, integrated ARM assembler, source level debugger and also supports Throwback. The original highly acclaimed Easy C package is also still available.

**EASY C++ Price £116.33** + £3.20 Carriage

**EASY C Price £69.33** + £3.20 Carriage



## TYPESTUDIO

### Flexible Font Effects

TypeStudio is the best selling font effects package that allows outline fonts to be manipulated to produce professional quality posters, banners, logos, letterheads etc. — the possibilities are endless.

Text may be flowed along straight or curved paths, or moulded into almost any shape. A wide range of interesting effects may then be applied to enhance the design further. These include: wall, floor and graduated shadow, 3D text, mirror, plinth, slant. You can use all of these effects on Draw files too! TypeStudio is intuitive to use, and unlike some other packages, paths and moulds may be created and edited using the drawing tools provided, so you can do all your design work using just the one package.

**TYPESTUDIO Price £34.08** + £2.00 Carriage

## HEARSAY

### Advanced Communications

Hearsay is the definitive general purpose communications package for Acorn systems, designed for easy communications for the first time user, but with advanced features making it also the professionals choice.

Hearsay provides high quality VT terminal emulations, and is ideal for use with Prestel, Campus 2000, Compuserve and virtually all bulletin board systems. Other features include: background file transfer, number directory, script language and support for popular modems.

**HEARSAY Price £88.13** + £3.20 Carriage



## HARD DISC COMPANION

### Reliable Hard Disc Backup

Hard Disc Companion is the acclaimed package that provides a structured system for backing up hard drives to floppy discs and other devices.

It supports Full and Incremental backups with data compression. Files to be backed-up or ignored are chosen using simple drag operations. The backup specification may be saved in a script file for use at a later date.

In the event of disc failure or accidental file deletion, files may be retrieved using simple drag operations.

**COMPANION Price £52.88** + £2.00 Carriage

# BEEBUG

Beebug Ltd. 117 Hatfield Road, St. Albans, Herts. AL1 4JS. Tel. 01727 840303. Fax. 01727 860263

All prices include VAT. Telephone order hotline 01727 840305

## HeartBeat

- Real-time measurement of calories burnt and heart rate
- Audible rhythm selection
- Essential for all exercise workouts and weight control

HeartBeat is a real-time ECG accurate Heart Rate Monitor, incorporating a special program for the "step".

Displayed on-screen as you exercise are such vital fitness indicators as :

- kCalories burnt
- Heart rate / time plot
- Heart rate training zone with high and low alarm settings
- Elapsed time
- Memory files of past sessions
- Recording and other symbols display status at all times
- Metronome

This product is an ideal tool for use in education, as it can be used in a classroom environment with interaction from the pupils. Its features cover many sections in the National Curriculum.

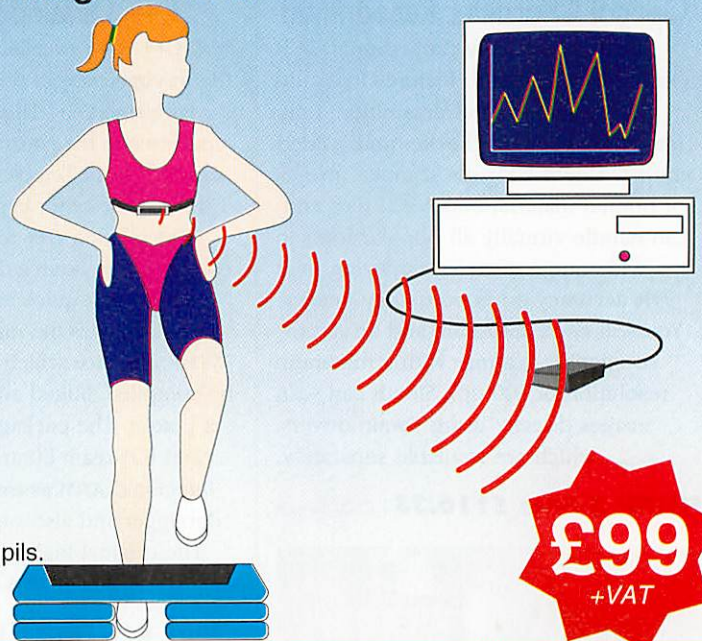

**£99**  
+VAT

## Sound Byte Recorder

- Advanced sound recording at an affordable price
- Powerful, easy to use software
- Ideal for multimedia creations on the Acorn

The Sound Byte Recorder allows you to capture sound using the Recorder's microphone, or from any other source, such as hi-fi or tape recorder. You can record from both sources simultaneously!

Record voice commentary, sound effects, or music to add to your multimedia creations in Genesis, Magpie, Ultima, Animator and other similar packages.

The Recorder is also supplied with the advanced sound editing package, Sonor, which allows sounds to be speeded up or slowed down, merged, digitally filtered, faded, moved, repeated, amplified - in fact, edited in every imaginable way. It is able to import and export sound samples in a wide variety of formats, including PC formats. You also get the simple to use multimedia creation application, Talking Canvas Junior.



**£49**  
+VAT

*"The VTi sampler is really the better package..." - Acorn User, April 95*  
*"...Sonor is a far more useful tool." - Archimedes World, March 95*

Formerly known as the Printer Port Sampler

These products, as well as ArcFS 2 and Voyager/Argo, are available from



VTi, 1, The Shopwhyke Centre,  
Chichester, West Sussex, PO20 6GD

Tel:01243 531194 Fax: 01243 531196 email: vti@argonet.co.uk



# Concepts' turbo upgrades

COMPUTER Concepts has finally started to ship its latest Canon printer, TurboDrivers, which now supports the new 720dpi



resolution BJC-210 and BJC-4100 Canon models. The latest version number is 4.05 and !Printers 1.45 or later is required. !Printers 1.52 and 1.53 have been successfully tested with TurboDriver 4.05. Owners of TurboDrivers version 4.04 can apply for a free upgrade, while owners of older versions can upgrade for £10 + VAT.

Debuted at the recent Wakefield show was Computer Concept's latest version of *Formulix* and a new tool for *ArtWorks*, called Precision. Version 2.10 of the *Formulix* mathematical formula publishing tool for *Impression* now supports horizontal and vertical kerning, plus better control over the quality and size of brackets and braces, as well as some font handling improvements. Existing owners of *Formulix* can upgrade to version 2.10 for £12.77 + VAT.

Precision is an *ArtWorks* tool which offers very accurate graphics object positioning and provides the option of absolute

co-ordinates. Precision can also be used to position group objects. Precision is priced £12 + VAT. Finally, Computer Concepts says it has spruced up its Web site - it can be found at <http://www.cconcepts.co.uk>. To contact Computer Concepts phone (01442) 351000, fax: (01442) 351010, e-mail: [info@cconcepts.co.uk](mailto:info@cconcepts.co.uk).



## Pocket-sized science Lab

Xemplar Education, the new joint venture between Acorn and Apple in the education market, has announced Pocket Lab, a practical bundling of an Acorn Pocket Book with a selection of laboratory add-ons which together

make up a handy and very portable science stool.

The Pocket Lab outfit includes a Pocket Book II 256K plus A-Link serial connector to enable the linking of the Pocket Book to a data logging unit and

two temperature sensors and a light sensor. Pocket Lab costs £429, or £1999 for a pack of five. For more details, contact Xemplar at (01223) 724200, fax: (01223) 724300, Web: <http://www.xemplar.co.uk/>

## Mobile Internet in your pocket

AS reviewed last month, Acorn Pocket Books can run Psion/Vodafone's useful *Telenote Plus* e-mail program to send and receive short messages via GSM digital phone. But you're not restricted to exchanging messages with other phone users - it is now possible to send and receive any on the Internet e-mail using your GSM digital mobile phone and, if you have one, your Pocket Book. This is courtesy of Dynamical Systems Research Limited (DSR), who has announced *Airmail*, a service allowing users of digital mobile telephones to send and receive e-mail directly from their handset via the Internet.

*Airmail* uses an e-mail gateway called SMSgate to link SMS (short message service) services on digital mobile phone networks and the Internet. *Airmail* is simple to use - you don't need to worry about setting up an Internet connection, there are no Internet host addresses to set up, etc.

Messages sent to you simply arrive in your phone's SMS or telenote in-box when the phone is switched on. You can send messages too. Your GSM phone enables you to send and

receive Internet e-mail in any country in the world which has an SMS-enabled GSM network - with the necessary roaming agreement with your service provider.

You can use your phone on its own to view received messages and to send messages, but it's much easier to use your Pocket Book and the *Telenote* mail software. There are limits to *Airmail's* capabilities - messages sent to you which are over 160 characters long have to be split into several shorter messages and you can only reply in 160 character maximum messages.

Attaching files using UUencoding, etc., is out of the question - it's strictly text only. Cost is another consideration. Businesses may be able to justify the £25 registration fee plus monthly subscription of £10, but that may be too much for personal users. Dynamical Systems Research Limited can be contacted by e-mail: [mal@DSR.com](mailto:mal@DSR.com), Web: <http://www.airmail.co.uk/>

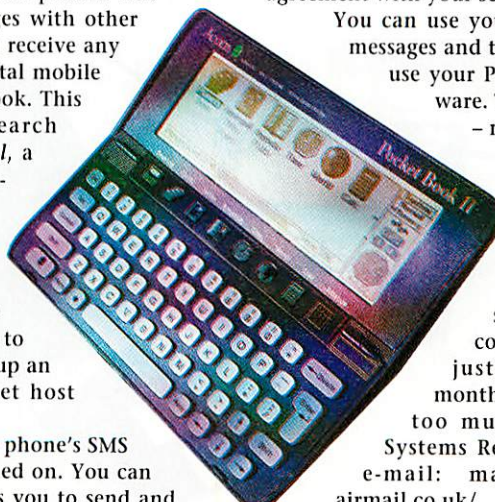



# Acorn invests in NC distribution

ACORN Computers Limited (ACL), has agreed a distribution deal with a newly formed company, NChannel International Limited, to market and distribute Acorn-designed and produced Network Computers (NCs). The official announcement to the stock exchange explained: "The agreement is intended to enable Acorn, without bearing significant financial risk, to exploit its technology lead and to access under the Acorn brand name the potential global consumer market for Network Computing products."

NChannel has been set up with Acorn owning 44.5 per cent of the company. David Lee, Acorn's managing director, will be a non-executive director of the company. Thirty-five per cent of the company has been set aside in trust for its employees and the rest of the company is owned by Titan Computers Limited, which is owned by Acorn co-founder and current non-executive director at Acorn, Hermann Hauser.

On NChannel's board, Hauser will sit as chairman. Titan Computers paid 10 million times 8p a share for its slice of NChannel - that's £800,000. Co-incidentally, it's interesting to note that just a few months earlier, Hauser sold a significant

**NCHANNEL**

Get on to the web from your TV set and join the burgeoning revolution!

The Acorn NetStation, the world's first Internet box, launches this autumn in the UK and it will mean cheap, easy access to the Web for everyone.

The book-sized NetStation is custom-made to make getting around the internet as easy as possible.

It sits on top of your TV set and is operated by a remote control which features an alpha-numeric keyboard for e-mail.

At under \$500 it is the cheapest way to get online. The NetStation features:

- a built-in word processor
- a smart card - which records your favourite places, identifies who you are and will be able to act as a secure credit card

quantity of Acorn shares, and in doing so missed out on the recent Acorn share price rocket impression. Meanwhile, other potential investors in NChannel are expected to help fund the company's formation.

The NChannel deal is the first sign that Acorn's work for Oracle in developing NC reference designs goes far beyond the relatively simple role of third-party contract developer. Acorn intends to compete actively in its own right in the fledgling NC market and looks like being one of the first players to ship a commercial product. NChannel's end of the deal is a worldwide non-exclusive distribution contract valid for ten years, though the contract is limited to the end of 1997 in America. Now all we need is for NCs to be the boom product Oracle's Larry Ellison says it will be.

## Pocket Book floppy drive ships

PURPLE SOFTWARE enters the hardware business this month with Cyclone, a compact portable battery-powered 3.5 in floppy disc drive for the Psion Series 3 family, which includes the Acorn Pocket Book. The drive can take either 720K or 1.44Mb PC floppy discs, though not Acorn format 800K or 1.6Mb floppies. This isn't a problem in practice as the more recent versions of RISC OS can format, read and write PC floppies. The Cyclone drive will appear as drive C to the file manager within the Pocket Book or Series 3.

Enhanced *File Manager* software, originally sold separately by Purple Software, is supplied as standard with the Cyclone drive. Cyclone drives connect to the host machine via the serial connector. It will be interesting to see just how well the Cyclone drive performs because older Series 3s and Pocket Books are limited to 9600 bps (just over 1K per second) while more recent models can go at 19,200 bps.

That means it would theoretically take 10 minutes or so to transfer a 1.4Mb file to the Cyclone drive. SSD (Solid State Disc) cartridges are much faster, but if you need copious storage, the Cyclone solution comes into its own and makes transferring files to a PC or your Acorn much more convenient. The drive is powered either via a mains adapter or 5 AA batteries.

At £169.95 inc. VAT, Cyclone is actually more expensive than a bare 1.2Gb hard disc drive, but when you consider the size of the market Purple Software is entering, the price isn't surprising. Cyclones will be available via most Psion outlets. For more information, contact Purple Software on tel: 0171-387 7777, fax: 0171-387 1188, e-mail: purplesoft@cix.compulink.co.uk



## Check out the Data Protection Act

IF you have a customer database on your PC, you should register your business with the Data Protection Registrar (DPR). Failure to do so could mean a fine. Some organisations holding computerised details about people are exempt, but it would be best to check with the Registrar whether or not you are covered by the exemption. It's now easier than ever to find out about the Data Protection Act and the Registrar as the DPR has its own site on the World Wide Web (<http://www.open.gov.uk/dpr/dprhome.htm>). To contact the DPR directly, phone (01625) 545700 or fax (01625) 524510.



**2Mb A3010 computer**  
plus  
**£200 worth of 1st class**  
**Acorn software for only**  
**£185** (£217.38 inc VAT)

**SOFTWARE:**

**StartWrite** (Wordprocessor),  
**Application Suite**, Mouse Mat, software  
brochures and **discount vouchers**,  
**PLUS** choice of Options 1 or 2 below  
(£39 extra for both together)

**OPTION 1 - EARLY TIMES BUNDLE.**

**Artisan 2.** Art package from Clares.  
**Doris the Dotty Dog.** Naughty story from  
Sherston.  
**Daryl the Dragon.** Adventure story from  
4Mation.  
**Amazing Maths.** Mental arithmetic from  
Cambridgeshire Software House.  
**Gemini.** Matching pair game from  
Cambridgeshire Software House.  
**Maths Gen.** Maths worksheet creator from  
Cambridgeshire Software House.

**OPTION 2 - HOME BUNDLE.**

**Resultz.** Spreadsheet from Colton Software.  
**Desktop Database.** Database from Iota.  
**Revelation.** Art package from Longman  
Logotron.  
**Zool.** Fantasy arcade game from Gremlin.

**THE CASTLE TECHNOLOGY PRODUCT RANGE**

**Scanflats** • from £349

- ◆ Flatbed SCSI scanner
- ◆ Fits all Acorn computers with SCSI interface
- ◆ ImageMaster software included
- ◆ Fast scanning speed - 3.6ms per line
- ◆ Twain compliant

**CD-ROM** • from £65

- ◆ Supplied with Acorn Driver
- ◆ Choice of SCSI or IDE interface
- ◆ Free headphones, Photoview & Audioplayer
- ◆ Compatible with Kodak Photo CD
- ◆ Internally or externally housed

**Hard Discs** • from £89

- ◆ 2.5" or 3.5" sizes
- ◆ Fast access of up to 8ms
- ◆ 20Mb to 2Gb capacity
- ◆ Formatted and soak-tested
- ◆ Interface may be required

**Light Pen** • £199

- ◆ Suitable for all Acorn computers
- ◆ Menu & select buttons on pen
- ◆ Instant response time
- ◆ Three colour aluminium or plastic casing
- ◆ National Curriculum "input device"

**Ergo Keyboard** • £99

- ◆ Built in wrist support
- ◆ Tested to 30 million operations
- ◆ Quiet, tactile and curved low profile keys
- ◆ Full two year guarantee
- ◆ International versions available

**SyQuest Removable Drive** • £199

- ◆ 3.5" 105/270 Mb capacity
- ◆ 5.25" 200Mb capacity
- ◆ SCSI or IDE interfaces
- ◆ Programmable power saving modes
- ◆ Internal or externally housed

**SCSI Disc Share** • from £199

- ◆ Suitable for all Acorn computers
- ◆ Easy to use and manage
- ◆ Share CD ROMs, scanners and printers
- ◆ The fastest disk sharing system
- ◆ Plug-in and go installation

**IDE and SCSI Interfaces** • from £65

- ◆ Designers of interfaces since 1988
- ◆ Connect your computer to hard drives etc
- ◆ Up to seven devices per interface (SCSI)
- ◆ Available for all Acorn computers
- ◆ Transfer rates of up to 4.5Mb/sec



IDE Interface



Ergo Keyboard

**A Special Offer from**



**CASTLE TECHNOLOGY**

Acorn User Best Dealer Award 1995 - Runner-up

**Available now while stocks last!**

**Call 01728 621222**

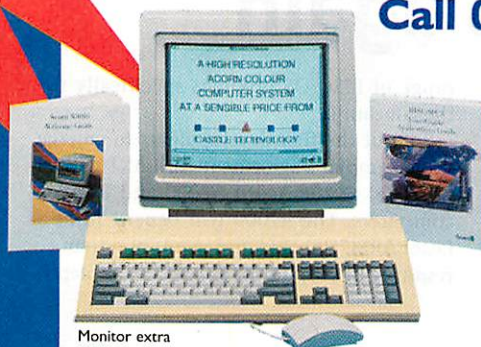

Monitor extra

**ORDER 10 - GET 1 FREE!**

Order 10 computer systems with  
hard drives and monitors and we  
will supply one of our Special  
Offer 2Mb A3010 computers  
**FREE!**

**ORDER NOW!**

Order by telephone on 01728 621222  
or Fax on 01728 621179.

Delivery £9 per computer (£10.58 inc VAT).  
Cheques\*, debit cards (Switch & Delta),  
credit cards (2% charge may apply), and  
educational orders accepted.

All trademarks acknowledged.

\*Cheques: allow 5 working days to clear.

Connect our amazing offer to your TV, or  
use any of the options below to create a  
high specification computer system:

**HARDWARE OPTIONS:**

- 2-4Mb RAM
- High resolution colour 14" monitor
- Hard Drive (120Mb, 200Mb, 500Mb)
- SCSI Interface
- CD-Rom Drive
- MIDI Interface
- Printer

Etc., etc.

**THE A3010 COMPUTER**

The A3010 is ideal for schools, small businesses  
and, of course, in the home. The A3010 shares  
the same processor and main electronics as the  
A3020 & A4000 computers. It has one internal  
expansion slot, a serial port, two joystick ports  
and a parallel printer port.

**SPECIAL SUMMER OFFER!**

**SCANNER**  
plus SCSI Interface

**SAVE**  
**OVER £175!**

**SAVE £100 ON A SCANFLAT SCANNER**

**SAVE £120 WHEN YOU BUY A**  
**SCANFLAT + SCSI INTERFACE!**

**SCSI II INTERFACES**

(when bought with scanner):

**A30x0 / A4000 £69** (£81.08 inc VAT)

**Other Acorns (inc RiscPC) £79** (£92.83 inc VAT)

Buy one of our top quality  
Scanflat A4 flatbed scanners  
and start to realise the true  
power of your Acorn. Save  
time: scan in photos,  
drawings or logos etc;  
create your own full colour  
pictorial greetings cards, newsletters  
or reports; or use it to enhance your  
multimedia programmes.



Scanflat 600

Use the Scanflat range to  
reproduce beautiful photos  
like this:



Framlingham Castle, once one of  
the strongest fortresses in Britain

- ◆ **Special Offer SCSI interface from £69** (£81.08 inc VAT) makes installation easy
- ◆ **Line art, grey or 24-bit colour modes**
- ◆ **Pre-scan colour/brightness control**
- ◆ **Free ImageMaster Software & TWAIN driver**
- ◆ **Full 1 year guarantee**

**Watch out for**  
**more price-beating offers!**  
**For a full price list and colour**  
**brochure call 01728 621222**

	Brochure Price	Offer Price
Scanflat 600 (600dpi)	£449 £527.58 inc VAT	£299 £351.33 inc VAT
Scanflat 800 (800dpi)	£549 £645.08 inc VAT	£399 £468.82 inc VAT
Scanflat 1200 (1200dpi)	£699 £821.33 inc VAT	£549 £645.08 inc VAT

Delivery £9 per scanner. 2% credit card charge may apply



# Acorn leads again

ACORN RISC TECHNOLOGIES (ART) will have its own stand at the Acorn World exhibition at Olympia 2, November 1st-3rd 1996 and will be demonstrating the revolutionary new StrongARM card which makes the Risc PC the fastest and most powerful personal computer available for general use — just as the original ARM-based A310 was when it was launched almost exactly ten years ago.

The StrongARM card, economically priced at £250, will be available for public sale for the first time at the Acorn World Show and ART director Peter Bondar hopes it will form the standard for development of future RISC OS-based computing solutions.

Other Acorn developments on show will be the new NetStation and the sub-laptop portable computer which is still under development.

## Xemplar at Acorn World

Xemplar Education and Acorn Risc Technologies (ART) will be demonstrating significant innovations arising from the recent £1 million in the ongoing development of RISC OS computer products at the

Xemplar has released details of a two-year development plan from ART for a

range of RISC OS products specifically for the education.

Two of the first developments to emerge from Xemplar's agreement with ART will be upgrades to the Acorn A7000 and Risc PC computers. The A7000 will benefit from a faster ARM7500 chip and memory system — resulting in support for greater colour depth



and screen size. The Risc PC 800 and StrongARM versions are also due for release through Xemplar to Education.

"Our aim is to provide high-quality learning solutions to any teacher. The Acorn World exhibition in November gives us the chance to demonstrate the concepts, products and introduce the people who deliver that promise," said John O'Neill, Xemplar's communications marketing manager.

Xemplar's 'Toolbox' series of curriculum solutions, to be launched in September, will also be demonstrated at Acorn World. The 'Toolbox' is a comprehensive range of classroom resources covering secondary curriculum subjects including English, Maths, Science, Geography and Design & Technology.

## At the show

The first day of the show, 1 November, has been designated as the specialist day for education professionals — taking place in term time, unlike previous shows, it will enable serious and committed professionals from education to participate fully in the seminar program.

Saturday and Sunday will feature topics such as publishing, the Internet and ways in which parents can support their children's IT learning.

Acorn hardware and compatible software products will be available for sale at the show at attractive promotional prices and advance bookings for tickets can be taken now on: 0701 0709 090 at £5 for adults; £4 under 16; and £16 for family tickets (2 adult, 2 children). Tickets on the door will be £7 for adults; £5 under 16; and £20 for family tickets.

# Cinematic success for Sibelius 7

THE latest news from Acorn computer music celebrities, the Finn brothers of Sibelius Software, is that their Risc PC-based music authoring package has been used to produce the music for the film *Richard III* and for the Channel 4 documentary series *Astronauts*. *Sibelius 7* was also used in the production of *Loch Ness*, starring Ted Danson and the comedy star's other reason movie, *Gulliver's Travels*.

The music for *Astronauts*, composed by Naomi Shead, was played by *Sibelius 7* running computers rather than real instrumentalists. A live soprano singer, whose music sheets were printed using *Sibelius 7*, was mixed in for added realism.

In Richard Loncraine's film *Richard III*, *Sibelius 7* was used by British company Contemporary Media Music Productions to create the final orchestration of the film, producing the sheet music print-outs for all the performers. *Sibelius 7*'s time-saving instant

automatic part extraction feature proved very useful. Instead of separating each performer's music separately from the full conductor's score, *Sibelius 7* can instantly create and print all the parts. Assistant orchestrator, Julian Kershaw, commented: "The beauty of using *Sibelius 7* is that it makes it so quick and easy to change the music later. This is crucial because films are often being re-cut right up to the last minute."

The latest task being put to Sibelius Software is to emulate the work of turn-of-the-century silent film piano accompanists. An Acorn Risc PC running *Sibelius 7* was wired up so it could actually 'play' a grand piano during the performance of silent movies at the British and American Film Music Festival in June.

Sibelius Software, tel: 01223 302765, e-mail [ben@sibelius.demon.co.uk](mailto:ben@sibelius.demon.co.uk)

# SyQuest removables down by 40 per cent

SYQUEST Technology, who produces the popular EZ135 family of removable cartridge hard disc drives, has announced a price reduction on the suggested retail price to £89 for all versions of the drive. Previously, EZ135 suggested retail prices were £139 for the parallel port version, £165 for the SCSI configuration and £199 for the parallel port configuration.

Syquest says its strategy is to widen its market share and make Syquest drives the ubiquitous removable storage solution.

Syquest already has a near-monopoly of the removable storage market where publishing and print is concerned. Because it is a hard drive, Syquest can claim the EZ135 has the fastest access time of any removable cartridge storage product compared with competing technologies like high-density floppy discs or magneto-optical storage. A number of Acorn resellers stock Syquest products. Syquest is on the Web at <http://www.syquest.com> and Syquest can be contacted at 0800 526599.









# Graphics



## Photodesk competition

WHEN it was announced that Spacetechn was running a competition to win *Photodesk 2* and a FotoFUN dyesub printer, I was half expecting not to have any Pic of the Month entries for months. Thankfully, despite the rather less exciting grand prize of £20, the standard has remained quite superb. The Photodesk competition expectedly attracted a plethora of brilliant bitmap artwork from all over the world. Not a plethora enough to fill a CD-ROM, however, but the graphics were of the very highest standard. Indeed, the invigilators had to ask that there be more than the original number of runners-up prizes, and even official announcements for Highly Commended artwork because the standard was so high.

The Highly Commended artwork went to Tim Bromhead, Dave Cowell, Stephen Jolly and Ross Cooper; Runners-up, who each receive a free upgrade to *Photodesk 2*, were Mrs M Heald, Bruce Hill from South Africa and Pete Clements. Bill Mutter from the Kyle Academy, Ayr was the outright winner with an almost disturbing image, but nevertheless excellent example of what you can do with *Photodesk*. Now, I'm not a bona-fide art critique so there shall be no attempt at deciphering the meaning of the piece, but I will say that it is clearly one of the finest illustrations of how *Photodesk* can be used to incorporate photographic imagery with original artwork.

The winning and the commended images all showed just how well equipped Acorn graphic artists are with packages such as *Photodesk*. There are few sub-£600

applications on any other platform that enable distinctly real-world imagery to be created with all the advantages and qualities of digital artwork.

Congratulations to everyone.

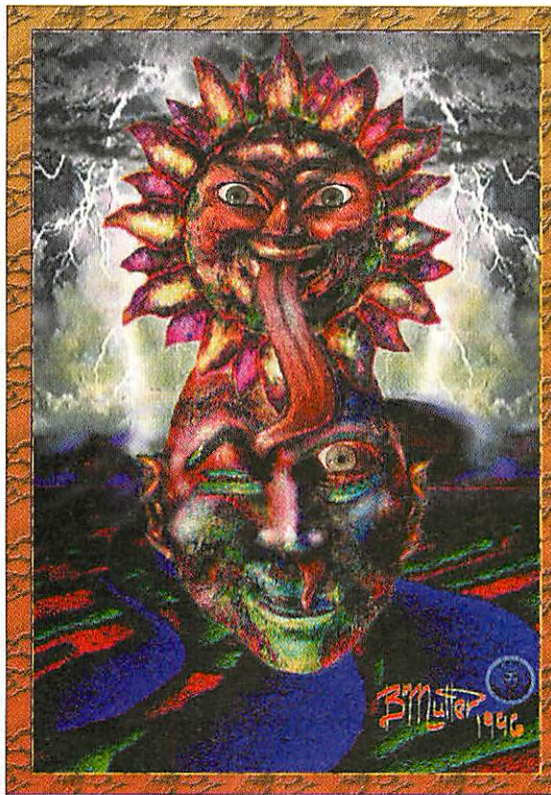

Heaven and Earth  
by Bill Mutter, Ayr

## Pic of the Month

LAST month there was no winning Pic, not for lack of entries but because of the coverage of the StrongARM.

Thanks to everyone for all your entries. This month's winner is Mr Clive S Fisher of Walsall who entered two marvelously detailed *Artworks* graphics, one entitled Train and the other, Ship (pictured). Both had painstaking attention to detail but apart from Mr Fisher mentioning that



he finds his favourite package, *Artworks*, difficult to create textures with, there was no further information as to how he created the pieces, or what machine was used.

Just think - the grand bonanza £20 jackpot first prize could be yours, but please remember to tell me how and on what you you created your artwork as credit is given for originality and minimal resources.

### Printer problems

Since I wrote about the troubles I was having with my Epson Stylus colour printer and, later, the joy I had once I started using Printers 1.52, I have received a huge amount of regular and electronic mail. It is great to hear such positive news from Acorn users pleased with their Epsoms.

For those having problems getting the results they expected, please feel free to write in, and thanks to the number of hints and tips that you have sent I have been able to solve most people's problems so far. I am grateful for your help and questions as they have prompted me to compile a small document of problems and solutions which I would be happy to send to anyone by e-mail or via SAE.

### RISC TV

Thinking about buying a TV tuner card which gives you as close as dammit to broadcast quality video in any desktop screen mode with the added facilities of digitisation and Replay recording? So am I! This is, of course, with reference to Irlam's superbly priced RISC TV product which will be reviewed as soon as a card becomes available.

'It doesn't all happen in England you know' thought I, as a barrage of e-mail from Italy, Denmark, Sweden and, for the first time, France arrived this month. Acorn in graphics and DTP could well be growing faster in Europe than here on Acorn's home turf. Perhaps our neighbours have heard more about the recent advances and less of last year's pessimism concerning Acorns and Risc PC technology?

Perhaps they are not as mad as us as far as our Microsoft obsession goes. Or could it be the beef they eat? The French design and television company RUSH sent in a visually stunning leaflet with information of its impressive local television projects and news of more, professional Acorn usage in other regions of France for graphics and TV. Promising.

### Contacting me

You can contact the graphics and DTP page by writing to me, Jack Kreindler at *Acorn User*, Media House, Adlington Park, Macclesfield SK10 4NP, or by email to [augrafix@idg.co.uk](mailto:augrafix@idg.co.uk).

# Public Domain

## Software Requests

Only one new request this month. B. Malcolm is in need of a graphics conversion program for converting 24-bit sprites to 256 colour sprites with RPC-style defined palettes.

Options to control the output palette and the ability to let the program select an optimum palette would also be useful. There seems to be very little development in this area, and it's a shame when the RPC has the graphics capability to use definable 256 palettes, but we don't have any software to take advantage of it. Keep those software requests coming in.

## Acorn developments

With the advent of the StrongARM, the range of processors and variations of operating systems that our PD needs to run on is getting bigger and bigger. This can be seen as a major difficulty for PD software, where testing on a wide range of machines is simply not possible until release.

But it's important to follow the advances that Acorn is making and to try and take advantage of them. The Risc PC took quite a while to filter through to PD authors when it was first released, and I presume the same will happen with the StrongARM. Having said that, I'm looking forward to seeing the first PD written for the Hydra or StrongARM, and any programs that use the new hardware will certainly get a mention in this column.

## CharGen

Players of the AD&D role-playing game may be interested in a character generation program by Darren Winsper. Darren's code automatically generates all the statistics for a new character, saving you the bother of doing it by hand. The full version of the program costs £5 and is available from: Darren Winsper, Bradmoor Farm, Aylsham Road, North Walsham, Norfolk NR28 0JH.

## Contacting me

You can contact the PD page by writing to me, Paul Wheatley, at Acorn User, IDG Media, Media House, Adlington Park, Macclesfield SK10 4NP. Or preferably, by e-mail to [aupdp@idg.co.uk](mailto:aupdp@idg.co.uk).

## CyberWar

DARREN Windsor's latest multi-player game is an arcade shoot-'em-up that certainly deserves a look for PD games fans. Although somewhat out-presented by *Pushy II* in terms of the graphics in this month's column, *CyberWar* offers one- or two-player fast action combat. Set in 2056, the aim of the game is to prove the abilities of your android attack machine by surviving all ten levels of *CyberWar*.

The single-player mode isn't bad, and offers a whole range of weapons that attempt to take out your ship as you progress through the levels, but the best fun is in the two-player mode. Regular PD column readers will already know I'm a

devout supporter of multi-player games and *CyberWar* is no exception.

The only problem is the key clashes encountered on my RPC keyboard. This does seem to be one of the only drawbacks in owning a RPC and one that really needs to be dealt with as more and more people move to the newer technology. I recently heard a rumour about someone attempting to get round clashes with some rather clever direct access coding, and I'd certainly like to hear from anyone who's managed this.

*CyberWar* is available from the Datafile disc Games 94.

## ReMidi

I'D been intending to review *Timidity*, the first software MIDI file player, for some time, then along came a much improved version in the form of Michael-Dennis Biemans' *ReMidi*.

The program takes a MIDI file – a set of sequencer data that you'd normally use to control a music keyboard or synth – and plays back the music described by the MIDI file. It's all done in software – all you need is *ReMidi* and a full set of GM sound samples. *ReMidi* interprets the sequencer data and decides when to play each of the sound samples that the song uses.

Unfortunately, there are a few problems encountered in playing back demanding MIDI files. To begin with, a song may use a large number of instruments, which means you need a lot of memory to hold all the data. I had to quit practically everything from the desktop before I could get most files to play on my 5Mb machine.

On top of that, there's the computer's limit of 8 sound channels. This

means that only 8 sounds can be played at the same time (and most MIDI files were created on keyboards where 16 track, 32 note polyphony is commonplace). The outcome is that at certain points throughout playback, *ReMidi* struggles to play everything at once and drops out for a short time.

Unlike the single tasking *Timidity*, *ReMidi* runs in a desktop window, but does seriously slow down any other operations on the desktop (and that's on a RPC700). Pre-RPC machines do struggle. Full music controls are included, with the usual pause, fast forward and rewind. There's also support for a playlist which

automatically plays back a sequence of predefined songs.

*ReMidi* isn't a perfect solution to software MIDI file playback and I think it could still be optimised quite a bit more. But with the alternative being a £200 to £300 power-wave card that plays back MIDI files in hardware, *ReMidi* could well be useful stop-gap.

To use *ReMidi* you need the full set of samples which can be found on the net at: [ftp://archive.cs.umbc.edu/pub/midia/instruments.tar.gz](http://archive.cs.umbc.edu/pub/midia/instruments.tar.gz). You also need the *ReMidi* program itself, which can be found at most of recommended download sites listed on the *Acorn User PD Web pages*.

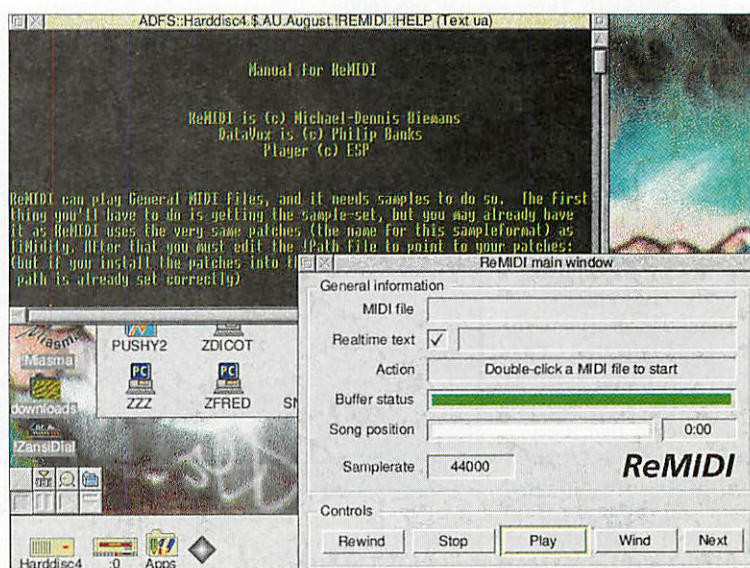



# Pushy II

WAY back in 1994, I made it a priority to review a puzzle game called *Pushy*. A little demonstration of the game, by author, Fred Williams, on the *Acorn User* stand at Acorn World was enough to convince me that a substantial review was warranted. Now, with the release of the sequel, *Pushy*

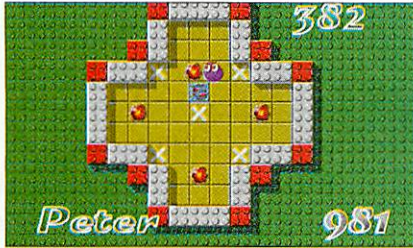

*II*, a quick go at a couple of levels and I'm hooked again.

A lot of puzzle games do seem to be fairly similar, so it's really refreshing to see an addictive puzzler with a character all of its own. The idea is to save purple blobby creatures from fiendish poison traps (or boxes and spheres) by quickly moving all the traps onto safety pads. As Fred is quick to point out, the game story is neither here nor there, and what really counts is the actual gameplay.

Converting the storyline into reality produces the task of pushing the boxes and spheres that are present in a little maze, over the target crosses. Players of

the original *Pushy* game will have noticed the addition of spheres. These add a whole new perspective to the game because once they are pushed they don't stop. You really have to think ahead fast for the trickiest of the sphere levels.

It's very addictive and although possibly a bit on the easy side, there are plenty of levels to keep you going. What is really impressive about the game is the standard of the graphics. The blobby character is animated very nicely and adopts a cute but determined expression when you tell him to push the blocks around the screen. The new translucent sphere objects are also very well drawn, and pulsate gently, while producing little light highlights.

The standard of the graphics work is very important in a scene where attention to detail isn't always the first consideration. Fred's graphics aren't amazingly inventive, but they are pixel perfect. On top of all this, support is given to Hi-Res graphics and 24-bit modes on the RPC, as well as supporting standard modes for older machines. Full marks to Fred for spending the considerable amount of extra effort to get the game running in an array of different modes and colours.

Having just been very complementary about the rest of the game, it's a shame that I have to mention the sound, which was so grating that I turned off my

speakers after 10 seconds of play. A better solution to the repetitive bouncing sounds would be a mod or two of music.

As with the original *Pushy*, this is a great game that comes highly recommended, especially given its freeware status. As well as the actual game itself, have a read of the Diary text file in the game directory. This charts Fred's progress while coding games over the last couple of years, and offers an insight into the man behind the purple blobby character. The *personalised !Changes* file is an interesting idea, that more coders should take up.

Fred is currently finishing *Tyridium*, the *Pushy* level editor, which should be available soon. *Pushy II* is available direct from Fred's Web site at: <http://www.argonet.co.uk/users/rfredw/> or from the Datafile PD library, on disc Games 59.

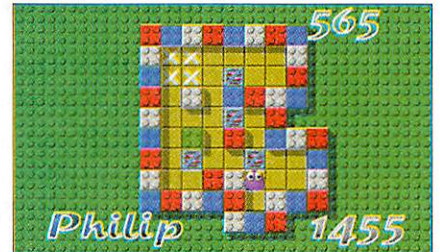

## Phonology



THE Experience demo group has a new release on the way, in the form of the Phonology music discs. The pack will contain about 1.8Mbs of 8-track music. Check the full review here when it hits the streets.

## Backlcon

A NEW module by Sam Kington offers increased usability in the desktop by adding to the operations you can perform with the backlcon of any window. Adjust clicks on the icon now move the window to the front, and shift-select or shift-adjust clicks move the window by one step in the window stack.

If you're regularly using a lot of open windows, this utility could be very handy, but personally I prefer Darren Green's *Iconizer*. This iconizes a window who's back icon is clicked on with adjust. Both programs are on Five Star's U44 disc.

### Recommended PD Libraries

- The Datafile, 71 Anson Road, Locking, Weston-Super-Mare BS24 7DQ
- Naked PD, 'Fayence', Fulford Road, Stoke-on-Trent, Staffs ST11 9QT
- Arch Angel PD, PO Box 41, Exeter EX4 3EN
- APDL, 39 Knighton Park Road, Sydenham, London SE26 5RN
- Five Star Marketing, 4 Shepherds Walk, Bushey, Hertfordshire WD2 1LZ
- Beebware PD, 83 Forrest Road, Huncote, Leicester LE9 3BH
- ARM Club PD Library, Freeport ND6573, London N12 0BR

## Two from Ting

RENOWNED for his skill with desktop enhancement programs, Ting Zwei Kuei seems to be continuously churning out more and more utilities. My favourite of his recent releases is *AppBanner* which displays a loading banner for any application launched in the desktop. As well as looking quite stylish (except when the launched application has its own banner!), it's quite handy for keeping track of any programs launching themselves into your memory.

Another of Ting's releases is the simple button bar program, *Buttons*. It's certainly not as good as Quantum Software's range of Desktop enhancers but it does the job at only 16K of memory, and may come in useful. These utilities are on disc U44 from Five Star Marketing.

# Power Up

## .... a low cost Tape Streamer

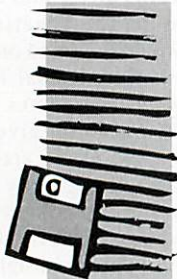

**£175**  
exc VAT

Complete with a 350MB tape for starting a sensible backup program for your important data, this internal Power-tec drive is a compact and attractive alternative to over 200 floppy discs. It is multi-tasking, network compatible, and comes with software for timed and selective backups.

## .... the Fast SCSI II

32-bit DMA Transfers  
Direct DOS Formatting  
Create 4GB partitions with RISC OS 3.6.  
Fully compatible with:

- All branded SCSI Hard Drives
- New SyQuest EZ135 and Iomega ZIP Drives
- SyQuest 5.25" and 3.5" Drives
- Mag-Optical Drives
- 'Proteus' Panasonic PD Drives
- Scanners

**£175**  
exc VAT



## .... Enhanced ADFS

**\*NEW**



**£40**  
exc VAT

- EADFS Software Module  
Add a bigger IDE Hard Disc (ie 1GB or larger) to RISC OS 3.5 Risc PC
- Multiple 512MB partitions possible
  - Read/Write Access Parameters
  - Passwording

**power-tec**  
the power to perform

Check out our Web Site  
on the Internet!  
<http://www.alsystems.co.uk>  
or email  
[sales@alsys.demon.co.uk](mailto:sales@alsys.demon.co.uk)

# Power Up a Power-tec

Please call Alsystems on 01420 561111 for further information on any product in the Power-tec Range  
Alsystems. 47 Winchester Road, Four Marks, Alton, Hampshire. GU34 5HG. England. Tel: +44 (0) 1420 561111. Trade Enquiries Welcome.



## At the Hub with Northern ARM BBS

CHRIS Jackson's Northern ARM BBS is situated in Shipley, West Yorkshire and the BBS has become quite a hub of activity in more ways than one for Acorn users in the north of England. Chris started Northern ARM in December 1994 and the number of calls received since then will have passed 10,000 by the time you read this.

Chris's system now consists of a Risc PC 600 running *ArmBBS* with 1Gb of hard disc storage, as well as a full selection of over £250-worth of CD-ROMs to choose from, using his much admired *CD-Door*. This 'Door' program written by Chris allows BBS users to go 'outside' the main filebase and download files from whichever CD-ROM is in the drive, and if the Sysop is present it will request him to change the disc if the user requires a different one. Now that quite cheap CD-changer drives are available, this could easily become an automatic function.

On its first birthday, Northern ARM BBS was given another phone line and a Pace Linnet V34 (28k8bps) modem to complement the existing USR Sportster V32bis (14k4bps) modem. Some users with US Robotics modems have experienced difficulty connecting with the Pace Linnet V34, and a simple extra AT command seems to help. If you have a V34 USR modem, such as a SportsterVi, try calling Northern ARM after typing AT\$54=96. Around 20 callers a day successfully connect to the two numbers.

Both lines are available for the exchange of FidoNet Technology Network mail, and Northern

ARM BBS is the UK NetHost for the exclusively-Acorn network RiscNet, supplying feeds to all the UK hubs, Iceland and the Trinity BBS Midnight-line Echomail distribution service. The latter is a subscription service for BBS sysops that dials up their systems during the night to deliver and collect Echomail and Netmail in one easy operation.

Northern ARM BBS has a varied filebase, containing the usual Acorn PD, comms, desktop and utility applications, and some special sections like the Paranormal area, dealing with UFOs, alien abduction and how to make yourself invisible. You can get visible evidence of Chris Jackson's BBS by calling either of the 24 hour numbers below.

Northern ARM BBS  
(01274) 530831 (up to 28k8bps)  
(01274) 530841 (up to 14k4bps)



A perfectly normal view of Northern ARM BBS

### Best gets better

Ant Ltd announced details of its *Internet Suite Release II* at Wakefield, and it now has a host of improvements. The *Fresco WWW* browser now supports various *Netscape* and HTML 3.0 extensions such as tables, client-side image maps and improved image rendering. *Marcel*, Nick Smith's e-mail and news client, now features multiple users, improved address book, and the *Suite's* new mail transport agent allows easier newsgroup and extended mail management. The new *Release II* should be available from dealers about now for £99 + VAT, and as an upgrade for existing registered users for £10 incl. VAT and P&P.

E-mail: [sales@ant.co.uk](mailto:sales@ant.co.uk)  
Tel: (01223) 567808

WWW: <http://www.ant.co.uk/>

### URL of the month

Tower Electronics is an Acorn dealership run by Tom Waller in rural North-east Scotland at Fyvie near Aberdeen. Tom is a staunch and vocal Acorn supporter who can sell you anything from a 16Mb SIMM to a complete Risc PC system.

Tower Electronics also offers V34 (28,800 baud) local call access to the Internet throughout the UK for a fixed fee of only £8 + VAT per month, with ISP enterprise.net on the Isle of Man. Tower Electronics offers this service with 2Mb (yes!) of free Web space and personal telephone help too. Check out Tom's chatty and crusading home pages for more details.

Tower Electronics Ltd  
Tel: (01651) 891653

<http://www.enterprise.net/tower-risc/>

### Contact

Send me any Acorn-interest URLs you find, and I'll publish a selection. You can contact me by writing to David Dade, Acorn User, IDG Media, Media House, Adlington Park, Macclesfield SK10 4NP, or by e-mail to: [DavidD@arcade.demon.co.uk](mailto:DavidD@arcade.demon.co.uk), or mail #2 on Arcade BBS 0181-654 2212.

## More World Wide Web sites to visit

HERE are some more URLs that you have sent me:

<http://www.mirage.co.uk/image/others/toby/>  
Thunderbolt BBS Home page. This is an Acorn interest Bulletin Board run by Toby Mackenzie in Orpington, Kent

<http://www.brunel.ac.uk:8080/~cs92adf/ArmClub.html>  
The ARM Club WWW Site. Large set of pages containing much club information and links to other Acorn-related sites.

<ftp://quantum:quantum@ftp.cybervillage.co.uk>  
The Acorn Cybervillage ftp site. Their own FTP site where you can find interesting Acorn-related software free of charge.

<HTTP://www.geocities.com/TimesSquare/3304>  
The Acorn-related pages of Chris Smith and David Hughes. News and reviews of acorn hardware, software and games.

<http://inferno.bell-labs.com/inferno/>  
Site of AT&T networking operating system:

Inferno. It has been suggested that this may be licensed for ARM processors.

<http://www.unitedmedia.com/comics/dilbert/>  
The thinking businessman's cartoon strip and home of the character's marketing area - The Dilbert Zone.

[http://allmovie.com/amg/movie\\_Root.html](http://allmovie.com/amg/movie_Root.html)  
Movie and Movie Star search engine. Reference information on all movies and movie actors. Also contains links to music reference sites.

<http://www.letraset.com/letraset/>  
Quiz prize is a free PS font! (needs !T1toFont to convert).

<http://www.csd.uwo.ca/~tzoq/Goons>  
Goons scripts to download and a very big graphic cartoon on the front page.

<http://www.ucs.de/MainE.html>  
Homepages of German Acorn Dealership Uffenkamp Computer Systeme, with Demo of the month to download and lot of links to sites of Acorn interest.

# Composition

*drag and drop ArtWorks files*

*butterfly mask used as template for Vegas image*

*flower masked, smoothed and tinted. Opacity set to 50%*

*plane masked with wand and then anti-aliased*

*sky 'repaired' with ProArt 24 clone tool via OLE protocols*

*horse masked and blended*

*simple masking with ghost effect*

*drop shadow applied*

*edge and anti-alias filters used to tidy edges  
drop shadow added for emphasis*

*ArtWorks import masked in Compo*

*mask created in Compo and finished in ProArtisan 2*

*circular blend mask used*

*frog attacks Ayers Rock*

**£169.95 inc VAT (P&P free)**

**Special offer price of £85 for ProArtisan 24 owners**

*Introductory offer - £99.95 for users of other art packages*

**CLARES**  
MICRO SUPPLIES

98 MIDDLEWICH ROAD, RUDHEATH, NORTHWICH, CHESHIRE CW9 7DA  
TEL: 01606 48511 FAX: 01606 48512 email: sales@clares.demon.co.uk





# Portables



## AcoPass

A FEW issues ago I asked if there was a password program available for the Pocket Book. Many thanks to all those who wrote and told me about *AcoPass* from Firecrest Software, especially Mr R Sillett and Brian Hickling who were kind enough to send me

a copy of the software – thank you.

*AcoPass* allows you to password your Pocket Book, thus preventing unauthorised people using your machine. I've been using the program for about three months now and have not been able to get past

it. The program is freeware and is available from most Psion PD sources. Acorn originally removed the password option from the Pocket Book because in a school situation it could cause havoc, but in other situations, in my opinion, it is a vital feature.

## What's on the Net?

HAVING recently got online I decided to check out what resources are available for Psion and Pocket Book users – I was pleasantly surprised. There is a wide range of WWW pages from both commercial and shareware authors, a large number of FTP sites and an excellent FAQ list. Printed below are some of my favourite Psion links. Most are reasonably fast but I find that the CompuServe ones, at times, can be intolerably slow.

Probably the best starting points if you are after PD and shareware packages is one of the ftp sites. The original Psion FTP site is located at Imperial College and can be found at: <http://src.doc.ic.ac.uk/packages/psion/icdoc/>. There is also a new FTP site which contains a copy of the Imperial site plus some other files, including the entire 3-Lib library of shareware packages collected by Steve Litchfield. This site is located at: <ftp://ftp.frontiernet.net/pub/psion/>. Finally there is also a site which contains details of all the Psion archive mirrors which highlights other PD and shareware sites. The site's address is: <http://www.apocalypse.org/pub/psion/>

A large number of the more established software authors and user groups have pages on the World Wide Web. Listed below are some of these but there are many more – a Yahoo search brought up about 50 Web and ftp sites! One of my favourite sites is Steve Litchfield's, which contains details of his own software packages, the Psion 3a, a top ten software list and details of 3-Lib (his excellent shareware library). The site is well designed and can be found at: <http://ourworld.compuserve.com/homepages/slitchfield/>.

Widget Software, a company which features in these pages more than most, has recently set up a Web site which is located at: <http://www.widget.co.uk/>.

Steve Godfrey, author of my favourite game on the Pocket Book, *Tetrums*, has his own Web site which contains details of all his software packages and also links, enabling you to download the latest versions. You'll find his site at: <http://www.users.dircon.co.uk/~steveg/>

Another site worth looking at is Pelican Software. It contains details of all its software packages, both PD and commercial, including screen shots and there is the opportunity to download its PD programs and demo versions of

its commercial software. The address is <http://ourworld.compuserve.com/homepages/pelican/>

If you use your Pocket Book/Psion for business purposes, Alan Richey's site is worth looking at. It contains details of his shareware programs which include financial, investment and inventory packages. Go to <http://ourworld.compuserve.com/homepages/alanrichey/> for more information.

If you're looking for packages that will enhance your Pocket Book, point your browser at John Boyce's site. John has written numerous packages including *JBData* (a database enhancer), *JBTree* (a file management system), and *JBLaunch* (a new application management system). You'll find his site at <http://www.compulink.co.uk/~jbsoft/>.

Interested in joining a Psion user group? Take a look at The Psion Series 3 User Groups' Web page at <http://www.nicolas.com/psion/index.htm>. The site has details on the Psion 3/3a, training courses and on how to join.

If you have newsgroup access you may wish to subscribe to the Psion newsgroup: *comp.sys.pSION*. As well as general discussions it also features the excellent Psion 3a FAQ.

Listed above are only a selection of the links available. If you have details of any other sites which you think are worth a mention or, indeed, if you run a Web site yourself which would be of interest to Pocket Book users, then please contact me at the usual address and I'll feature them in a future column.



A selection of Psion/Pocket Book-related Web sites

## Purple Software

Purple Software is one of the biggest developers of software for the Psion. It has just released its new catalogue, which is available free of charge, containing full details of all its software products including *Toolbox 1* and *DataView Pro*.

The review of *DataView Pro* in the June issue may have given the impression that the original *DataView* is no longer available. This is not the case and if you don't require any of the advanced features of *DVP*, for example groups, then you can save yourself some money and plump for the original version. *DataView* costs £39.95 on SSD and £34.95 on floppy disc, and *DataView Pro* costs £69.95 on SSD and £59.95 on floppy.

Purple Software  
Tel: 0171-387 7777

## Letters

I'd just like to say thank you to all the people that have written to me with hints, questions and comments. I appreciate all your letters and read them all, even if I don't have chance to reply – usually due to inconvenient things such as exams!

If it is at all possible please communicate with me via e-mail as this is quicker than snail mail, and you are also more likely to receive a reply (it's cheaper!).

## Bonjour Berlitz

If you are going abroad this year then the Psion Phrase Book from Berlitz could be just what you need. It contains over 2000 useful phrases in nine different languages including Japanese, German, French and Italian.

The program works on both the Pocket Book I and II and is supplied on a 1Mb SSD. It costs 39.95, is available from all Psion dealers and I'll be taking a more detailed look at it next time. Until then *Au Revoir*.

## Contacting me

You can contact the Portables page by writing to me, Mark Taylor at *Acorn User*, Media House, Adlington Park, Macclesfield SK10 4NP, or by email to [auptort@idg.co.uk](mailto:auptort@idg.co.uk).



Krisalis, founded in 1987 has an enviable reputation as one of the leading independent video game developers in Europe. Our clients include Electronic Arts, Acclaim Entertainments, Telstar Interactive, Philips Media, The 3DO Company, Eidos, Imagineer (Japan) and Microprose.

We currently require the following Skilled Professionals to join one of our in-house development teams, working on Sony Playstation, Sega Saturn, Mac and PC platforms.

Included in our staff are a number of programmers from the Acorn world who have successfully made the transition to other platforms.

## **PROGRAMMERS**

A proven ability in C coding is essential. Experience in assembler language will be an advantage.

## **TRAINEE PROGRAMMERS**

We have a track record of bringing new talent to the industry. Most successful candidates will have completed a relevant degree course but we will consider candidates educated to A-level who can prove their ability to program.

Benefits include a good salary and bonus structure and after a qualifying period BUPA membership and pension.

*Applications should be made by CV to*

**Tony Kavanagh,  
Krisalis Software Limited,  
47 Moorgate Street,  
Rotherham,  
S60 2HD**

## Counting costs

Following my last page, where I mentioned the lack of Presentation software for the Acorn compared with the power and sophistication of that available for the PC, I received an e-mail.

This e-mail rightly pointed out that other presentation software does exist and that the apparent lack of sophistication is probably due to the better operating system we enjoy on the Acorn. I agree to a large extent with this – we certainly can claim to have a much better operating system/graphical user interface than exists in the world of WINTEL.

However, the correspondent then went on to talk about the comparative price of software and made the assertion – often heard in Acorn circles – that PC software is expensive when compared to Acorn software. This is a myth. PC software used to be very expensive when compared with equivalent Acorn software, which was especially true if one looked at the Recommended Retail Price or RRP.

Of course no one ever paid the RRP. There was also what was known as the street price, that is, the price which could be paid by shopping around. Acorn users generally do not have recourse to a street price. What You See is What You Pay or WYSIWYP pronounced Whizzwhypt in the Acorn world.

What has happened is that as the price of PCs has fallen, so has the price of software – no one was prepared to pay £700 for software to run on a machine only costing

£700. Thus a bundle like Lotus *Smartsuite* now only costs around £200. That includes a word processor/DTP, relational database, (something else which does not exist for the Acorn), a spreadsheet, presentation package and an organiser.

We have no package of similar power that could be bought for that price – please do not make me laugh by mentioning *Advance*. I know *Impression Style* is good but for how long, now that Computer Concepts is leaving the Acorn area for what it believes to be pastures greener.

Support for Acorn and its associated products must be based on facts not the perpetuation of myths. I know the platform is good, as is much of the software, but we are in danger of being left behind, as the Atari and the Amiga, if we are not vociferous in demanding better software to run on the powerful hardware now becoming available.

Perhaps we, too, need a killer application like the early PCs and Macs had. A killer application is a software application so good that it justified the purchase of the machine. For the PC it was *Visicalc*, the first spreadsheet, for the Mac it was *Adobe* allowing WYSIWYG printing. For most of us I suspect it was almost *Impression*, but what now?

What is the point of 710, 810, ARM7500, StrongARM and Hydra Multiprocessor systems unless we have software able to exploit their processing power?

## Looking good

LAST time I mentioned the value of good presentation software to any business, and the jury still seems to be out on what constitutes good in this area.

I have previously talked about *NoticeBoard* from The Really Good Software Company and while I admit it is fairly basic, it works and can provide excellent results. However, I have also had unsolicited testimony as to the power of a package called *Portfolio* from a user who found *NoticeBoard* lacking in its ability to offer what was required.

*Portfolio* is available from Kudlian Soft. Gary Atkinson of Kudlian says that although the software was originally produced for the education sector and was therefore designed to be user-friendly, many businesses in need of such software have seen *Portfolio* and said 'Wow, that's just what I was looking for – and it's simple to use.'

That is just one advantage to any business of using Acorns – software should be

easy to use. It should also be reasonably priced (see my comments above) and at £29 plus VAT is unlikely to break any bank. Kudlian can be contacted on (01926) 851147 or e-mail support@kudlian.demon.co.uk.

I have only just got my hands on a copy of *Portfolio* but maybe next time I will do a comparative review between *NoticeBoard*, *Portfolio* and *CableNews II* from Lindis.

Choices	
<input checked="" type="radio"/> Carousel	Fade type
<input type="radio"/> Single pass	Smooth
<input checked="" type="radio"/> Auto display	Time (secs) 5
<input type="radio"/> Manual display	<input type="checkbox"/> Control buttons
<input type="checkbox"/> Show file name	<input type="checkbox"/> Disable menu button
<input type="checkbox"/> Play sounds	<input type="checkbox"/> Exact file matching
Save Cancel Apply	

## Out soon

We will all have to wait just a little longer before a relational database becomes available from Iota Software. The relational version of *DataPower* called *DataPower 2* will be released in August/September.

Iota Software is on (01223) 566789 and has a Web site at [iota.co.uk](http://iota.co.uk).

## Real life

Continuing to prove that Acorns are used in real businesses, I have two mentions this month.

The first is for Contessa Furnishings (London) Ltd who won Display Excellence Award at the Lightshow 96 Show at Earls Court. It used *NoticeBoard* to produce a very impressive rolling display of its products. Contact Declan Sharpe on 0181-778 9166.

The second mention goes to Geoffrey Booth FBHI, whose business specialises in cutting wheels and pinions for clocks and small mechanisms and the restoration of old clocks.

Geoffrey uses an A4000 with a wide variety of programs and an old BBC Master to actually drive a wheel cutting machine. Has there ever been a machine as capable as the old Beeb when it comes to plugging things in its back?

Contact Geoffrey Booth on (01929) 471586.

## The NetSurfer

The new box developed by Acorn Network Computing for Oracle allows cheap Web surfing and is almost available – hopefully in time for the Christmas market. Looking uncannily like a modern satellite receiver, it has an ARM7500 chip at its heart.

The price is hoped to be less than \$500 which will probably convert to £500. If these boxes do sell in large numbers it will be a great incentive for more businesses to advertise their products and services on the Net.

## Contact

You can contact me, Mike Tomkinson, by post at the usual *Acorn User* address or by dropping me an e-mail at: [aubizniz@idg.co.uk](mailto:aubizniz@idg.co.uk)

## Memory Solutions for the A3000.....

At Simtec we continue to support all 32-bit Acorn machines. Although A3000 machines have not been in production for some years, that does not mean we have not continued to refine the design of our memory upgrades! Originally 4Mb boards used 24 chips, but developing technology soon rendered this design obsolete, enabling the chip count to be reduced to 8 and now only to 6. The lower chip count lessens the risk of overloading elderly power supplies, especially if hard drives or network cards are fitted.

Designed and manufactured using state-of-the-art assembly techniques, our plug-in boards are engineered with two screw fixing brackets to anchor the board into place to ensure long term, wobble-free reliability. The use of top quality sockets to match the computer's tin-plated memory expansion pins eliminates any corrosion problems caused by sockets of dissimilar metal.

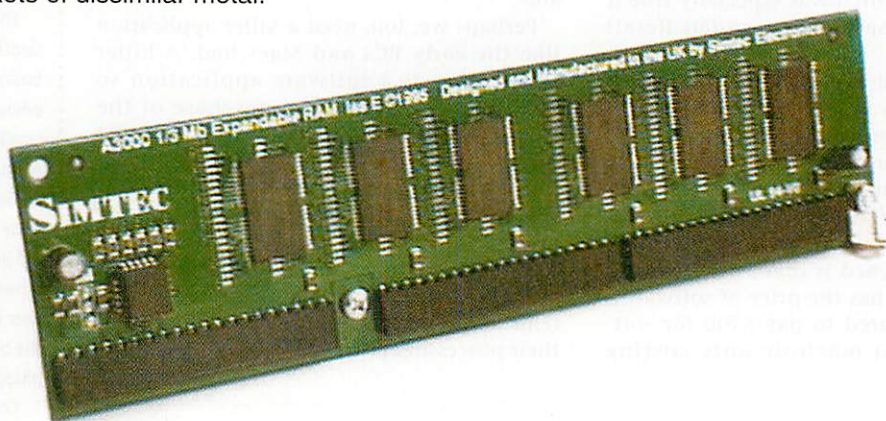

We believe our upgrades are the neatest, most compact around and are available also as a 1 to 2Mb version with empty sockets for easy upgrading to 4Mb if required. For those who need even more memory, we offer a 4 to 8Mb upgrade, although this requires specialist fitting.

Every upgrade is fully tested before despatch and so confident are we of the quality of our boards, that we offer a full two-year warranty against manufacturing defects.

Whatever your machine, if you need more memory choose Simtec, the quality upgrade. A full range always in stock.

Memory sizes available:

1 to 2Mb (expandable)  
1 to 4Mb      4 to 8Mb

**SIMTEC**  
ELECTRONICS

Paul Skirrow shows you how to use search engines to their best advantage

# Searching the

# Internet

REVIEW

The Internet is huge – much larger than most of us can comfortably comprehend. It can be an invaluable resource in the right hands but can also be frightening for new users who feel overwhelmed by the sheer mass of material available.

The concept of *data mining* – searching for useful nuggets of information – is now big business and many large database companies are spending millions developing technology that can cope with it. Fortunately, many search systems are available for you to use, free of charge, and this means you can use the Internet productively rather than aimlessly skipping from one site to another (surfing). The search systems are enormously powerful computers connected to the Internet and available for anybody to use.

They are often referred to as *search engines* to emphasise the automatic, ongoing work that the engine does, and also to convey a sense of the power behind it. The most popular search engines for indexing the World Wide Web (WWW) include Lycos, Yahoo, Web Crawler and, my own favourite, Alta Vista.

## Search Engines

The idea is simple: you give the search engine a word or phrase and it tells you which World Wide Web pages contain it. To be able to do this it must maintain its own enormous index to Web pages and update it regularly. It does this by looking through its list of Web pages and fetching each page in turn. Every page is scanned and the words are indexed in the database.

How does the system know where the pages are? Well, firstly you can tell it when you create a new Web page using the ADD button that most of the systems provide, although it may take a few days for the system to get round to your page. Secondly, when it does search your page it notes any references to other pages and searches them too.

When I submitted my home page to

Alta Vista it immediately included all my other Web pages, and also all the pages they referred to, so all my friends, colleagues and related businesses also benefited. This means that the search engines will eventually find your pages even if you don't tell them, provided they are referred to from some other page.

A system that traverses the Web in this way is called a spider, robot or Web crawler. The Alta Vista spider is the fastest one around and it can search three

million pages every day. When it has finished it starts its task all over again (a bit like painting the Forth bridge). With over 30 million pages in its index you would expect each page to be searched roughly every 10 days. Some Web providers can log page accesses and it is interesting to watch how often your pages are visited by a spider.

If you really want to keep a page private, and stop other people finding it, you either need to make sure there are no

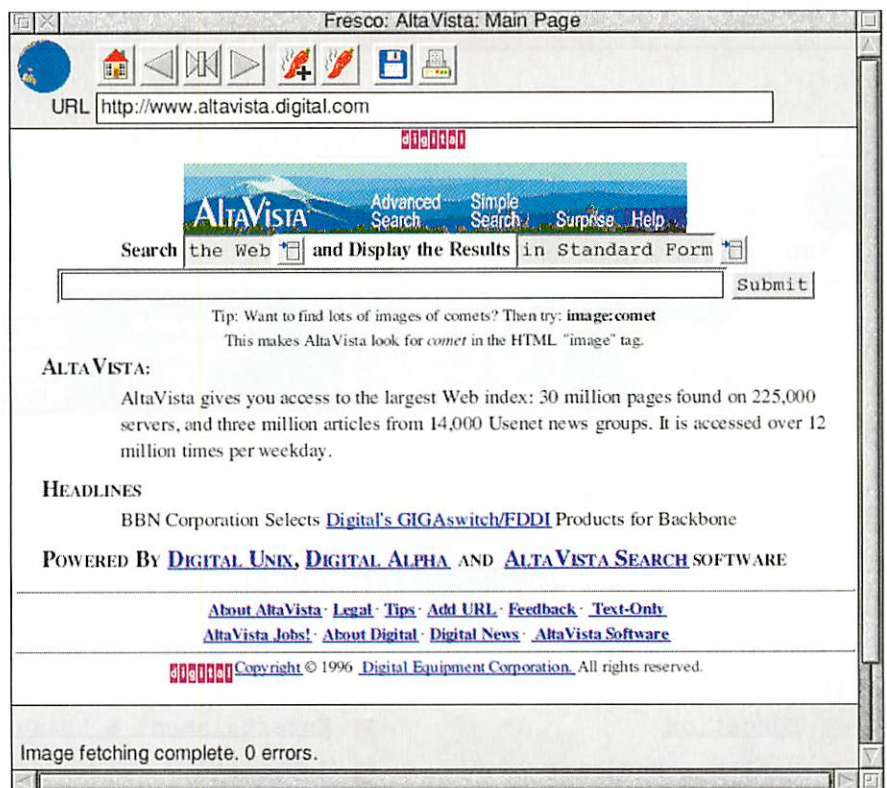

Fig 1: The powerful Alta Vista search engine

## Behind Alta Vista

Alta Vista began as a research project inside Digital Equipment Corporation (DEC) in summer 1995 and went live just before Christmas. Alta Vista is run by Digital and is the most comprehensive search system on the Internet – it now indexes over 30 million Web pages containing 10 billion words in a 33 Gigabyte index, although it is likely that this still only covers half of the Web pages in existence today.

The hardware is really quite awe-inspiring. The front-end system that handles all external traffic has a mere 256Mb memory and a 4 Gigabyte (Gb) disc. The Web indexer behind this is the most powerful computer ever built by Digital, with ten Alpha processors, 6Gb of main memory and 210Gb disc. This is probably 1000 times more than most Acorn users have at home, but something we can all look forward to having on our desk in 10 years time if computer technology continues to improve at the rate it has over the last decade...

The DEC Alpha microprocessors are the fastest in the world, and some of the Alpha technology has since been used by Digital in the StrongARM. The dhrystone benchmark shows the StrongARM to be second only to the Alpha microprocessor family.

Who pays for Alta Vista? Well, at present, Digital does. It handles 12 million queries every day or around 140 every second from around the world, but the publicity and free advertising that it gains out of the project easily outweighs the costs in running it, especially since it aims to be one of the leaders in supplying large search systems. Many of the other search systems rely on advertising – millions of people look at Lycos and Yahoo every day and advertisers pay up to £15,000 for a single advert.

links to it from anywhere else, or put a robot exclusion message in the HTML telling the robot to go away and not search the page.

Some of the more primitive search engines, such as Lycos, only store the fact that a word has occurred on a page – they don't actually store every word. This makes the storage requirements far less demanding, but it does have serious drawbacks. It means that the order of the words has been lost and it is therefore impossible to search for phrases. For example, if you were to search for my company 'Octopus Systems' you would find every single page that contains the word 'octopus' and the word 'systems', although not necessarily together. It is surprising how many underwater systems there are involving octopuses, and is not at all useful for finding 'Octopus Systems'...

Alta Vista is far more sophisticated, in that it can search for phrases as well as individual words, and this makes it much more useful.

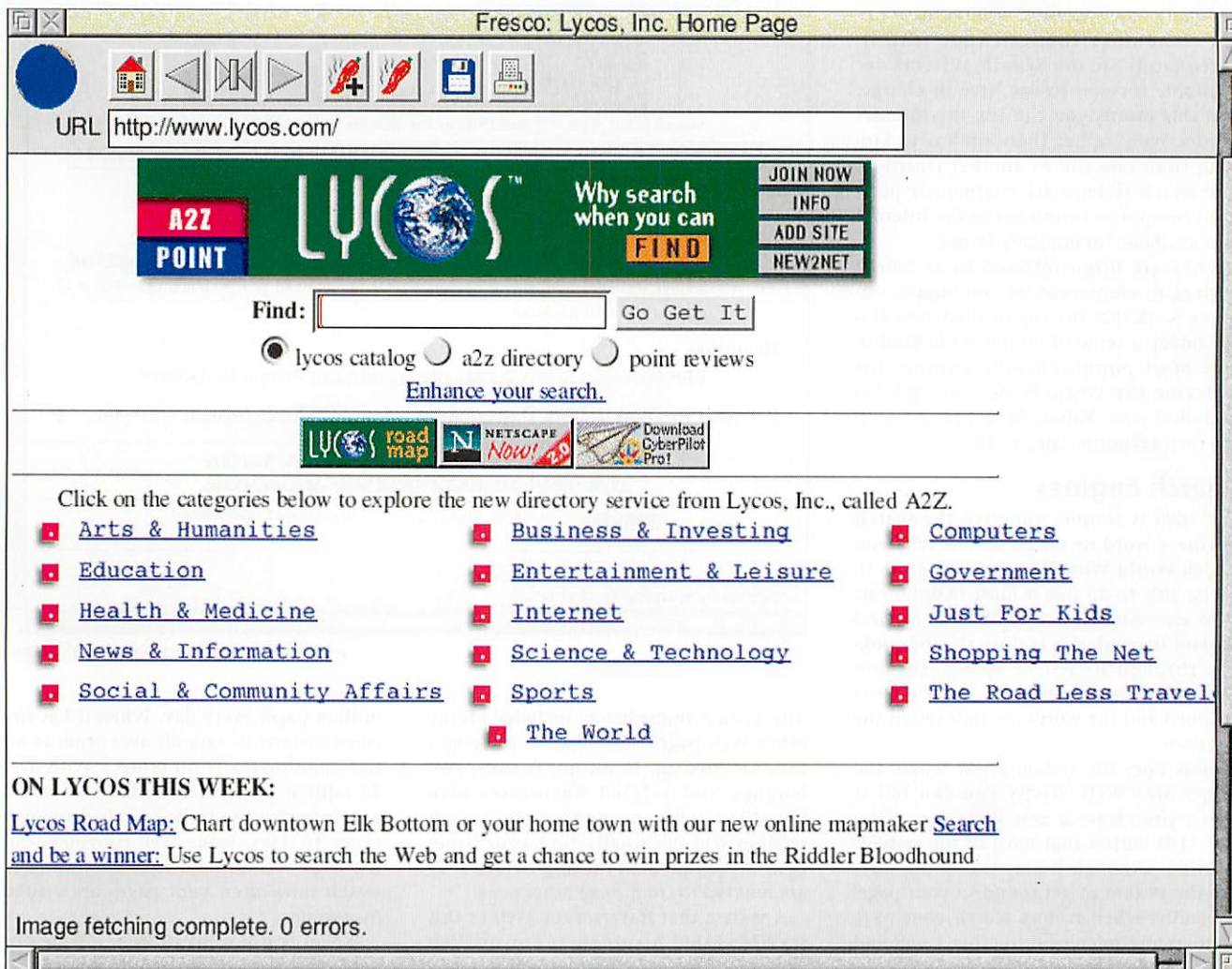
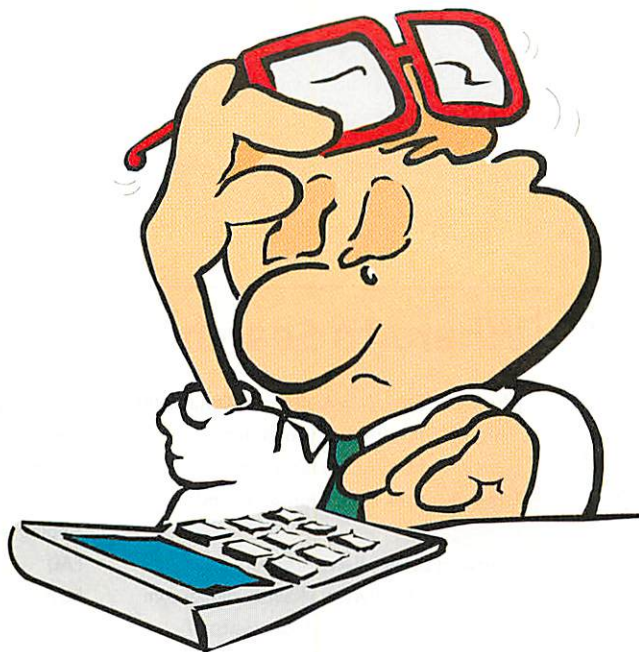

Fig II: Lycos with its new directory service A2Z



# Forget calculators or paper – there are easier ways of doing your home and business finances.

## Personal Accounts v3

Running your personal finances on a computer might seem like overkill, but until you try you will never know the benefits.

Keeping track of direct debits and standing orders is, at best, fiddly and, at worst, expensive when you consider the charges most banks levy if you become overdrawn.

Personal Accounts takes the guesswork out of it. You will know exactly how much you have in each account and when it needs topping up. This, however, is only one of Personal Accounts many features.

Contact us today to see what Personal Accounts can do for you.

## Prophet Accounts v2

If a computer program could replace a manual business accounting system and not only give you more information but also save you time, it would be a worthwhile investment.

If it could also produce invoices, purchase orders, send overdue statements to your customers, automatically enter standing orders on time, produce VAT returns, calculate Profit & Loss and balance sheets it would be hard to ignore.

Prophet does *all* this and a lot more too. It's no wonder that it was voted Best Business Software by Acorn User magazine.

## Shares v5

Simple, easy to use personal stocks and shares portfolio software. Accepts information from most teletext cards.

Varied selection of graphs which include moving averages, historical low, interest rate comparisons, log & linear formats. comparative graphs and overall portfolio graphs.

Other features include detailed summaries, capital gains tax calculations, data import & export and growth functions for comparing different financial products.

**Please telephone, write or fax for a brochure and demonstration disc on any of the above.**

## Apricote Studios

2 Purlis Bridge Farm • Manea • Cambs • PE15 0ND



**01354 680432**

### Using Alta Vista

To use Alta Vista you need to enter the URL (Universal Resource Locator) into your Web browser (see Figure 1).

At the simplest level you can now enter the words you are looking for and it will return a list of the first 10 matches. You can view more matching matches by clicking on a page number or the Next button at the bottom of the page.

Sometimes searches produce hundreds or even thousands of matches and you need to refine the search by adding extra criteria. However, Alta Vista does try to prioritise pages as best it can, so even if a search produces hundreds of matches it is likely that the top ten will have just what you want.

Phrases must be placed inside double quotation marks, and you can enter as many words or phrases as you like, with each one separated by a space. By default Alta Vista will search for pages that contain any of the words or phrases, but you can insist that one *must* appear in a page by preceding it with a + symbol. Similarly, you can tell it to ignore pages that contain particular words by preceding the word with a - symbol.

Words are best entered in lower case as they will then match any word, whether it uses upper case or not. If you use any upper case letters anywhere in the word then Alta Vista will only look for exact matches, so 'risc' would find 'risc', 'Risc' and 'RISC', but 'ART' would only find 'ART' (useful if you are searching for Advanced Risc Technologies rather than works of art).

You can also search for words that appear in various parts of the page or a message, including the page title, the host name of the Web server or the URL by using one of the special constraining words. For example:

- url:uk Constrain search to the United Kingdom
- link:acorn.co.uk Find all pages that have a link to acorn.co.uk

### Where to Search

Alta Vista	<a href="http://www.altavista.digital.com/">http://www.altavista.digital.com/</a>	Searching for files and programs stored on FTP sites:
Yahoo	<a href="http://www.yahoo.com/">http://www.yahoo.com/</a>	FTP search <a href="http://ftpsearch.unit.no/ftpsearch">http://ftpsearch.unit.no/ftpsearch</a>
Lycos	<a href="http://www.lycos.com/">http://www.lycos.com/</a>	Finding e-mail addresses
Infoseek	<a href="http://guide.infoseek.com/">http://guide.infoseek.com/</a>	FAQ
Searching Usenet News Articles:		<a href="http://www.qucis.queensu.ca/FAQs/email/finding.html">http://www.qucis.queensu.ca/FAQs/email/finding.html</a>
Alta Vista	<a href="http://www.altavista.digital.com/">http://www.altavista.digital.com</a>	Four11 <a href="http://www.Four11.com/">http://www.Four11.com/</a>
Deja News	<a href="http://www.dejanews.com/">http://www.dejanews.com/</a>	

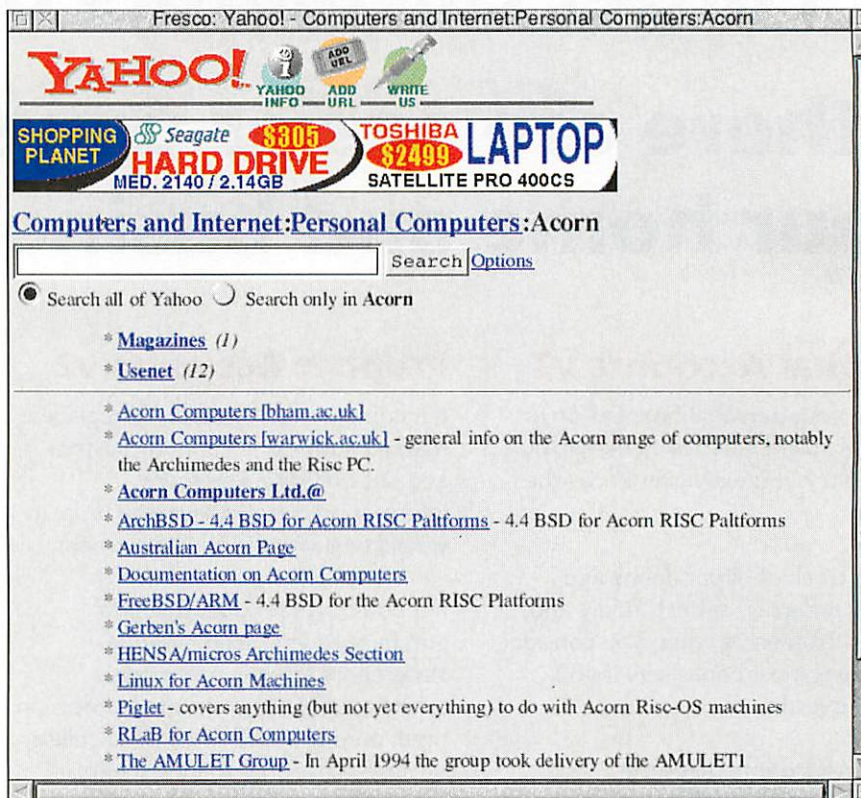

Fig III: Yahoo's rather short list of Acorn sites

### Intranets

Although the Internet is big and becoming widely accepted, we are about to see an enormous surge in the use of intranets which could potentially offer an even bigger market. Intranets are internal networks within organisations, but similar in structure to the Internet.

Many large companies now have their own internal networks which are protected from the rest of the Internet by security systems known as firewalls. Electronic mail can be transferred between their intranet and the Internet as a whole, but access to sensitive data is prohibited.

As an example, the Ford Motor Company's intranet now has 550 sites in 30 countries and is rapidly expanding. These intranets all need

powerful search systems to index the intranet for the company and Digital hope to play a big part in this.

These companies also need low-cost computers to access their intranet data without the complexity of a desktop computer and this is where Oracle fits in with its Network Computer.

Acorn is again at the forefront of technology, having been chosen to produce the Network Computer reference model using the ARM7500FE processor and an operating system based on RISC OS. Nobody will make much money on a single Network Computer, but the potential worldwide market is huge.



- title:SARC Find pages with SARC in the title

By default Alta Vista will search Web pages, but you can also search recent Usenet news articles by clicking on the menu button and choosing Usenet. You can then use similar constraining words:

- subject:"for sale" Search for articles with "for sale" in the subject line
- from:pskirrow@octosys Search for articles from Paul Skirrow
- newsgroups:acorn Search Acorn newsgroups

Alta Vista has some extremely good help available (just click on its help button), as well as hints and tips and a full description of the hardware behind it. It also has an advanced search facility allowing you to search for words near other words and combine searches using logical operators.

Unfortunately Fresco (v0.89), and some of the other Acorn browsers don't yet support the type of Web form that it uses, so stick to simple searches for now and you should find them quite adequate for most purposes.

## The Power of the Internet

To illustrate the power of the Internet I shall use some real examples. Many Web pages use transparent GIF files and I wanted a program to generate them. I tried:

```
+ "transparent gif" +sprite
```

but it didn't produce anything suitable. After a few experiments I tried separating the first phrase into separate words and adding a few more for good measure:

```
+transparent +gif +sprite +acorn  
+convert +software
```

Within seconds Alta Vista found the excellent WebGif2 program and a couple of minutes later I was using it.

Somebody in Canada recently searched the Internet looking for references to her father, and she found me as I have the same name. I told her that I'd never been to Canada, but we've now established that we share some common ancestors who lived in a small Yorkshire village. Everybody who has the ability to create WWW pages tends to produce a small page about themselves. Not only is this ideal for genealogists, it also makes it easy to find friends that you have lost contact with.

I recently received some e-mail in French from a client in Switzerland. My French isn't too good so I decided I should get it translated. I could have mailed it to a friend, but instead I used Alta Vista to find translation services. It

responded with an enormous list, so I narrowed the search down and tried 'automatic translation services' as well as adding the word 'free' (remember this - it can save a lot of money). I tried one that Alta Vista suggested and mailed my French text off to it. Within seconds the reply was mailed back to me automatically. Some caution is needed when using it to translate the other way round: I only just stopped short of recommending 'Impersonation lingerie' instead of 'Impression software'...

## Other search systems

There are many other search systems around and some are more suited for particular types of searches.

If Alta Vista doesn't find what you are looking for you can always use Lycos

(figure 2), Yahoo or Infoseek, but do note that they use a different syntax, and can't search for phrases.

Some of these other search systems try to impose some structure and order to the database, so you could easily find a list of Acorn computer pages by looking in the Acorn section of the personal computer area (figure 3). This relies on people notifying Yahoo when they create a Web page, so I find it less useful than Alta Vista, but it still has its uses.

There are also several similar systems for finding files and programs on FTP sites and for finding e-mail addresses, but there isn't space to cover all of them here. If you want to explore further, I have put a useful list of Internet resources on: <http://www.octosys.co.uk/links.html>

AU

## More Examples

To find all references to RISC OS (there will be lots):  
"risc os"

To find companies that supply Acorn teletext adapters:  
+"teletext adapters" +acorn

To find every page that has a link pointing to <http://www.idg.co.uk>  
link:www.idg.co.uk

To find every reference to a particular person, e.g. Paul Skirrow:  
"paul skirrow"

What are the lyrics for the latest M-People album, Bizarre Fruit?  
+lyrics +"m-people" +"bizarre fruit"

Where can you play Badminton in Ipswich? (note that we want the Ipswich in the UK, not the Ipswich in Australia):  
+badminton +ipswich +url:uk

When was Shakespeare born?  
"shakespeare was born"

When will Datapower 2 be released? Note that we search for Iota in the URL since they are the publishers, and look for synonyms of 'released' to try and cover all possibilities.  
+url:iota +"datapower 2" released ship shipped available

Search Usenet to find all of the people in Ipswich who have posted an article in an Acorn newsgroup (note that this will only find people who include Ipswich in their signature):  
+newsgroups:acorn +ipswich

Is there an Acorn club in Bristol? Insist on Bristol and Acorn, but accept group or club.  
+bristol +acorn group club

Find a review of the book 'Downbelow Station'. This would be best done using the advanced search facility to find "downbelow station" near "review", but we can still use the simple search:  
+"downbelow station" +review

# AFTER READING THE @adult SECTION OF WEB CENTRAL

Barbara found some  
more interesting ways  
to exite her husband



<http://www.wcentral.co.uk/>

**Web Central** is Britain's biggest and best Web site, with up-to-the-minute coverage of news, over 1000 reviewed and recommended links, dozens of articles and the very best in Internet content. If you can't find it on Web Central, it probably doesn't exist.

**webCentral**   
YOUR HUB TO THE INTERNET

# Genial genealogy

**F**inding out about your family is a bug and people who get bitten by it will go to great lengths to find out who their long-lost relatives are, as well as trace back into history to find out about their forebears.

Minerva's first *Ancestry* program was quite popular but suffered from many deficiencies. The replacement program has been very well received in the Acorn market though as it's the only one it doesn't have a great deal of competition.

## What's it all about?

The point of a genealogy program is to allow someone to input details regarding a family of people — names, births, deaths, notes and so on — as individual records and then link them together to show relationships such as marriage, parentage, children and so on.

What a good program of this type ought to do as well, is show these relationships graphically in the typical *family tree* format, so it has to be a database plus the extra display facilities. *Ancestry II* does this easily, and it does more.

However what it doesn't do is in some ways more important: *Ancestry II* is not a program that you can just sit down and start, well you can *if* you are able to remember the names, birthdays (and deaths perhaps) of all your immediate family.

But *Ancestry II* isn't really about your immediate family — it's about your more distant cousins, your further ancestors, it's about what these people did, what they looked like, who they married and what children they had.

When you start to look at family trees, whether your own or someone else's, you find little tragedies — the child that died three days after it was born — and greater joys — the fruitful marriage that lasts 50 years. If you are the sort of person who wants to know and loves to inquire then you could get hooked.

But research is the key: interviewing relatives; acquiring pictures from them; rambling through graveyards; poring through church records; checking the

Steve Turnbull tries out the family tree package from Minerva

The screenshot shows a software window titled 'RECORD VIEW: PERSON (FORM: FOR RECORD VIEWS)'. The form contains the following fields:

- Surname at birth: MOUNTBATTEN
- Forenames: PHILIP
- Bynames:
- Title: PRINCE
- Occupation:
- Born: 10 June 1921 at CORFU
- Died:
- Sex: M
- Record No: Person 85
- Status: M

Below the form is a 'Notes' section with the text: 'Son of Prince Andrew of Greece and Princess Alice of Battenberg. (In 1917 members of the Battenberg family in England changed their name to "Mountbatten".) Served actively in the Royal Navy from 1939 until his marriage in 1947.' To the right of the notes is a small portrait photograph of a man in a military-style uniform.

The standard Record form covers most eventualities

registers of births, deaths and marriages; trawling the Internet for more information, perhaps even finding someone on the other side of the world willing to help and expand your search; finding clues of hitherto unknown relatives then tracking them down.

The software is not the starting point of genealogy, it's the end point, the place where you gather your evidence together. But even then it's not an end in itself because perhaps you'll find anomalies in the family tree that lead to something new.

## Data input

Once you've gathered your data together you can start to build your database of people, it's a simple case of data entry — plus dragging in the pictures if you can get them scanned. There is a data entry form provided but if you want to store different data then you can do so by defining new forms, which I'll cover later.

During data entry you don't create any

of the relationships, it is purely creating the database of people using the *Record* form — putting together the relationships is done on a separate display.

On the standard form you can enter the usual names, dates of birth and death as well as location of birth or death, sex, plus various bits of information such as marital status. The main problem with status is that a family tree refers to a person's entire life whether completed or not, and status changes as time goes on, but you can always ignore or even remove the status if you wish. In fact there's no field which is compulsory.

One excellent feature is the variable-length text field for notes, you can write a mini-biography of the person — or perhaps even a complete biography. Naturally you can add to it as time goes on, building up the description of the person. You can also add an actual image if one is available.

## Relationships

To build the relationships between people in the database you have to shift to the *Tree* view. When you've added new people these poor orphans wait on the right to be connected up with those already linked on the left.

One niggle I have with the program has to do with the way that data is displayed when you change the display being used. For instance, when you are entering data you, naturally enough, use the *Record* form. However, switching to the *Tree* display shows each person's information still using the *Record* form, though no longer editable.

It's then necessary to change the form to a more suitable one, perhaps showing the picture (if any) plus name. To edit a person's details, just double-click, and the display uses the picture plus name form. Now you have to go through the menus to switch back. It's not difficult but it is irritating — hopefully that will be fixed in

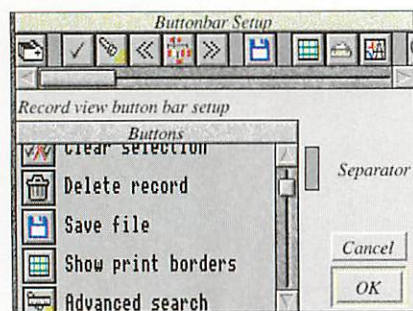

All the button bars are configurable

the newer version. To create a *union* (which can be any form you choose, legal, common law or merely incidental) all you need to do is drag one person's record on top of another, a dialogue pops up asking if you really meant it and, proceeding if you did, the display rearranges to show the new relationship.

Children are allocated to parents in a similar way, dragging the child's record on to the union, a quick check with the dialogue and bob's your uncle — or father, or whatever.

Where parentage is dubious, creation of an unknown person is required, but this concept works far better than miraculous conception, and it gives you something further to research into.

The program places no limitations on numbers of spouses or children, nor does it check for viability of pregnancy and so forth.

## Tutorial

The manual is okay. There's no data missing though the whole thing is a bit terse, but the main problem lies with the contents and index, neither of which is full enough.

On a couple of occasions I had to work through the manual page by page to find the information I wanted, and in both cases they weren't minor items — in fact *Importing GEDCOM 5 files* is a subheading that could easily have been included in the contents.

All the major operations needed for creating a family tree are covered in the tutorial and involve the use of the prepared Royal Family file. This is a fairly comprehensive set of data in its own right with plenty of pictures and the tree stretching right back to Henry VII, and

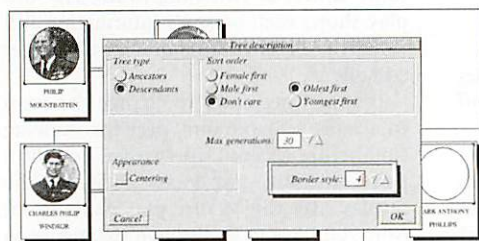

You can adjust the style of the family tree to your preference

illustrating the multiple marriages of Henry VIII. There are also opportunities for updating the file in relation to recent Royal revelations.

## Caught in the Web

That Internet gets everywhere doesn't it? No less so than in the search for genealogical information. It has to be said that there is probably no easier resource to access than the Internet for this type of information.

Genealogists were quick to catch on and there is now a central resource of GEDCOM5 files created by individuals of their own family trees. Most were created on PCs but the common file format makes that unimportant.

A quick search on Alta Vista for **+GEDCOM +file** revealed a selection of 1000 sites but the first items proved all that were needed to yield some samples of GEDCOM files — you may want to take a look at:

<http://genealogy.org/~ajmorris/geddex/ged1.htm>

Alternatively, you could add another limitation to the Alta Vista query of, say, **+url:uk** or your appropriate country domain.

The American site allows you to FTP a huge range of files, some of which are enormous, I downloaded a 700K file to try out. It took *Ancestry II* nearly 45 minutes to sort it out, but it's not the kind of thing you'd do on a regular basis so there's no real problem there.

One caveat though is that the first time you save an *Ancestry II* file derived from a GEDCOM file, the program spends a long time thinking about it — garbage collecting so I'm informed — don't worry, it will save it in the end.

Once you've created your family tree you might want to tell everyone about it on the Web, to this end there's a program called, imaginatively, GED2HTML, which will convert GEDCOM files to HTML pages, you'll find information about it at: <http://www.usit.net/public/mdehart/genealogy/doc/Welcome.html>

## Configuration

One area where *Ancestry II* really stands out is in its configurability. Every display can have a button bar across the top — and you can specify exactly which buttons appear and in what order, tailoring the features to your way of working. You can also insert separators which allow you to drag the bar left and right when it's displayed on screen to give you access to any buttons you can't see.

In fact the only missing feature here is the ability to tie forms to buttons, which would tend to offset the problem I mentioned before about forms not being associated with

certain types of display.

There is a Resources window that allows you to create new forms, add decorations, fields, in fact design the system precisely to your requirements.

To complement the database nature of the program there is an expression language that can be used to create powerful advanced searches as well as design fields whose contents are determined by other parts of the database. For example, you could set up a field which displays the names of a person's parents in the Record form.

## Output

While only covering this briefly, I have to say that the report facilities of *Ancestry II* are quite excellent. Using the same design method as for other forms, you simply set up the way you want the printed reports to appear, they can be graphical or textual and the variable text fields will be printed in full no matter how long they are.

You can also save the files as GEDCOM5 files, and save each screen display as a drawfile for inclusion in other documents. All-in-all I don't think the author missed a trick.

## Conclusion

*Ancestry II* is not flawless, but dedicated users have flooded Minerva with a list of changes and additional features they'd like to see which the company is doing its best to implement for the next version.

Curiously, when I was speaking to Merlyn Klyne at Minerva about the program and its improvements, he commented on how it isn't used in education. This seems quite amazing to me as the research needed to put a decent family tree together covers many points of the National Curriculum, with database use being one of the minor points.

It is feasible to create family trees in other ways, you can draw them in an art package, use text files or, even more flexibly, use HTML. However, *Ancestry II* provides all the facilities you need, the database *and* the graphical display without compromise. And this program in particular is very flexible with its form designer and the ability to add or remove fields on the fly. **AU**

## Product details

Product: Ancestry II  
 Price: £80 ex VAT  
 Supplier: Minerva Software, Baring  
 Crescent, Exeter EX1 1TL  
 Tel: (01392) 437756  
 Fax: (01392) 421762  
 E-mail: [minerva@zynet.co.uk](mailto:minerva@zynet.co.uk)

## A3000 upgrades

### Memory

1-4Mb	£104.50
1-2Mb	£46
(See also the "2nd user" section)	
1-2Mb (upgradable to 4Mb)	£56
2-4Mb upgrade pack	£84.50
4-8Mb	£229

The above upgrades are all constructed on four-layer boards, as recommended by Acorn. Gold plated connectors are used for reliable contact with the A3000 main board. There are no clips or wires, and no soldering is required (except 8Mb upgrade). Some older types of 2Mb board cannot be upgraded to 4Mb, but we offer a trade-in allowance. Please phone for details.

### Hard drives

A range of internal hard disc upgrades is available. The upgrades simply plug into the internal expansion slot. Also suitable for the A3010.

80Mb	£175
120Mb	£217.50
170Mb	£241
240Mb	£270

RISC OS 3	£46
ARM3 (25MHz)	£151.50

(Dealer fitting recommended for the ARM3)

**A3010 2-4Mb RAM upgrade  
Price £92.50**

**A3000 4Mb RAM £104.50**

### A5000

#### Memory

2-4Mb	£81
4-8Mb	£229

Dealer fitting for the 8Mb upgrade is recommended for the 25MHz A5000.

### A3020/A4000

#### Memory

2-4Mb	£87
-------	-----

#### Hard drives

80Mb	£113
120Mb	£155
140Mb	£173

### A400/1

#### Memory

Per Mb (up to 4Mb)	£44.50
4-8Mb	£229
RISC OS 3	£46
ARM3 (25MHz)	£154.50

**Hard drives.** For prices, refer to the A310 section.

### Various

Alsystems SCSI 2	£199.50
ARM3	£151.50
RISC OS 3	£46
MEMC1a	£46
Hard disc cradle	£7
Fan filters (pack of 5)	£3.50
RISC OS manuals, no vat	£22
Dongle dangle	£7
Chip extractor tool	£4.50
(for eg MEMC, ARM2)	
CDFS upgrade for Oak SCSI card	£29.50

**The following items are reduced to clear. Please phone to check availability.**

1 Meg V Ram	£58.50
Wordworks	£29.56

**Prices include VAT @ 17.5%**

**How to order:** Cheques made payable to IFEL. Most Credit cards accepted, and Switch. Official orders welcome.

**Educational and quantity discount available.  
Dealer enquiries welcome.**

## A3010 upgrades

### Memory

1-4Mb	£116.50
1-2Mb	£44.50
2-4Mb	£93

The 4Mb upgrade is constructed on a compact four-layer board. No soldering is required.

### Hard drives

A range of internal hard disc upgrades is available. The upgrades simply plug into the internal expansion slot. For prices, refer to the A3000 section.

## A310 upgrades

### Memory

1-2Mb	£81
1-4Mb	£116.50

All our A310 memory upgrades are constructed using four-layer circuit boards. There is no other 300 series RAM upgrade which has been available for as long as this one, and which has the same reputation for quality and reliability. A fitting service is available.

4-8Mb	£229
-------	------

### Hard drives

A range of internal hard disc upgrades is available. Prices below are for complete systems, including metalwork, controller card and cables as appropriate. No specialist knowledge is required either for installation or use. A backplane is normally required in order to fit a hard drive.

#### IDE

850Mb	£252.50
1Gb	£282

#### SCSI

540Mb	£252.50
1Gb	£333.50

Backplane (4-slot, four-layer)	£57.50
Fan for above	£9.50
RISC OS 3	£46
RISC OS carrier board	£20
ARM3 25MHz	£151.50
MEMC1a	£46

### RISC PC

#### Extra RAM (SIMM)

4Mb	£53
8Mb	£93
16Mb	£175.00
32Mb	£292.50

SIMMs taken in part exchange (4Mb or larger).

2Mb VRAM	£163.50
16-32Mb upgrade	£198.50

#### RAM PACKS For upgradeable SIMMS

4-8Mb upgrade	£70.50
16-32Mb upgrade	£200

### 2nd User

Please phone to check availability.

A3000 1-2Mb	£23.50
A3000 RAM board	£6
(ie bare board, no chips)	
A5000 2-4Mb	£68
4Mb SIMM (Risc PC)	£45

### Spares/Repairs

We carry stocks of most replacement chips for the Acorn range. (MEMC, VIDC, IOC and most memory devices). We can also fit any upgrades and offer a computer repair service.

All products (except some from the "2nd User" section) are fully guaranteed for 12 months. All items normally carried in stock have a 14-day money-back guarantee.

**IFEL**

34 Culver Road, Saltash, Cornwall PL12 4DR. Tel (01752) 847286. Fax (01752) 840029

**PRICES INCLUDE VAT**



# Anchors

## aweigh

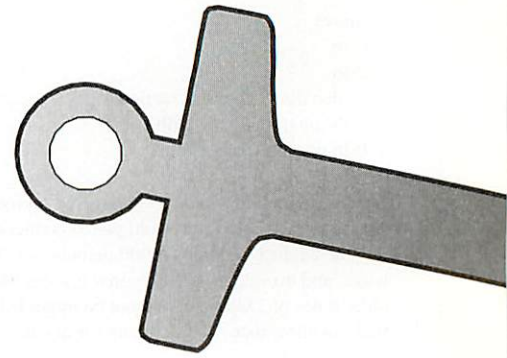

Linking your documents together with the anchor tag is the subject of this issue's HTML tutorial, by David Matthewman

In the first of these series, I likened writing hypertext to the process of writing a diary. You may want to refer back to an incident that you've already written about, and the simplest, most efficient way to do this is to write a note in the text saying (*See entry for last Sunday*).

How do you do this in HTML? Remember that in HTML, what you are doing is marking up certain sections of text with tags to give them some extra meaning. In this case, the extra meaning is 'Jump to the entry for last Sunday', and the tag pair

used is the *anchor* tag pair, `<a>` and `</a>`. So our diary at the moment looks like this:

```
Went to feed the swans with Gerald
who I met at the club <a>last
Sunday</a>.
```

There's a problem with this. We've told the browser that the words 'last Sunday' are an anchor – a link to somewhere else – but we haven't told the browser where to link to – the browser is the program that reads and interprets the HTML, such as *ArcWeb*.

### Internet addresses

In the text, I've talked exclusively about linking to 'local' addresses on your hard drive. This was deliberate, because it reminds everyone that there's nothing to stop you writing HTML even if you're not connected to the Internet.

Even if you're going to put your pages 'online', your links between the pages will be relative links and will look exactly the same whether the pages are sitting on your hard drive or on the server of some ISP at the other side of the country.

However, sooner or later, many of you are going to want to connect to Internet addresses outside your own. You may want the traditional page of links to friends and relations, for instance, so to do this you include the Internet address (actually a URL or Uniform Resource Locator) in the href attribute of the anchor tag.

A URL in HTML usually looks something like this:

```
protocol://site:port/filepath/filename
```

although that does depend a little on the protocol. Now that might look scary, but it's a lot less intimidating than it pretends.

'Protocol' just means how you want to transfer the data – it's a little like saying 'Phone, fax or post?' The protocol used for HTML is HTTP (Hyper Text Transfer Protocol), which is why most addresses on the Web start 'http:'.

The 'site' is the domain name of the site holding the pages: 'www.demon.co.uk', for instance, 'www.arm.com' or 'www.idg.co.uk'. Although most Web sites start with 'www', there's no need for them to, so don't be fazed if you come across a Web site that doesn't start this

way. The 'port' is a little more complicated; each Internet protocol is provided on a particular port by the site. If the port is not the default one for the protocol then you must specify the port number. You don't usually have to do this, but it's worth mentioning in case you come across a case where you do and wonder what this number's doing in the URL.

The filepath and filename are given in Unix notation just as they are for local files. If there's no filepath, the file is assumed to be in the root directory. If there's no filename, the file *index.htm* or *index.html* is (usually) looked for. Hence, the anchor tag:

```
<a href="http://www.idg.co.uk/acornuser/"> ... </a>
```

will link to the HTML file *acornuser/index.html* on IDG's UK Web site.

Why lower case? Many Web pages end up on Unix systems, which are case-sensitive when dealing with filenames. To avoid complete nightmares, therefore, most HTML pages are stored using lower-case file names throughout, and most addresses given entirely in lower case. It's just simpler that way; besides, it takes up less space.

Other protocols you may use include 'ftp' for file transfer and 'mailto' for e-mail. After 'mailto', rather than all the gubbins above, you put the e-mail address of the person to be e-mailed (often yourself). For example, you'll frequently see:

```
<a href="mailto:fred@foobar.co.uk">E-mail us</a>
```

at the bottom of Web pages using the 'mailto' protocol.

There's more to URLs than this, of course, but that's probably all you need to know at the moment.

### Tag attributes

In order to tell the browser where to link to, we need to add some extra information to the tag. This is done by using a tag *attribute*, a variable and value pair. There's nothing to stop a tag having more than one attribute, and the format is like this:

```
<tag variable1="value1"
variable2="value2"... >
```

Only the opening tag has attributes; they're never needed in the closing tag. With some variables in some tags the inverted commas are optional, but it's best to include them unless you're sure they're not needed.

Attributes are named after the variable they use. The attribute that tells a browser where an anchor tag links to is called the

'href' (hypertext reference) attribute. Assuming that all you want to link to is an html file called *Sunday* in the same directory as your original document, your section of the diary now looks like:

```
Went to feed the swans with Gerald
who I met at the club <a href="Sun-
day">last Sunday</a>.
```

Obviously this is no use if the browser doesn't give any indication that the text is an anchor, so most browsers will highlight the text in some way. 'Traditional' *ArcWeb* and *Fresco*-style browsers do this by colouring the text blue and underlining it, although this behaviour can be changed and, once again, you should never assume a browser is going to display text in a particular way.

That's the basis of the whole Web; you link to other documents using the anchor tag. And, as you've just seen, for such a big idea it really is very simple.

### Files in other directories

Unless you're actually going to organise your diary into one single directory, you'll want to allow your anchors to refer to files

in other directories. At this point you have to forget that you're working on RISC OS for a moment and switch to Unix — it's not too hard.

The main differences are:

- directories are separated by a slash / character, not a dot
- the parent directory is reached by two dots .. rather than by a circumflex ^ character
- filenames are case-sensitive
- filenames can have any length that the particular operating system allows; on Unix this is almost unlimited
- rather than having file types, files are identified by an 'extension', a suffix of the form .xxx (HTML files have a suffix of either .htm or .html)

If you're only ever going to view your HTML on your Acorn machine, then the last three points needn't bother you. However, you will still need to refer to files using the syntax described in the first two points, because it's what browsers expect. Therefore, if you want to refer to a file in a directory deeper in the tree than the current file, you would write:

```
<a href="directory/filename"> ...
```

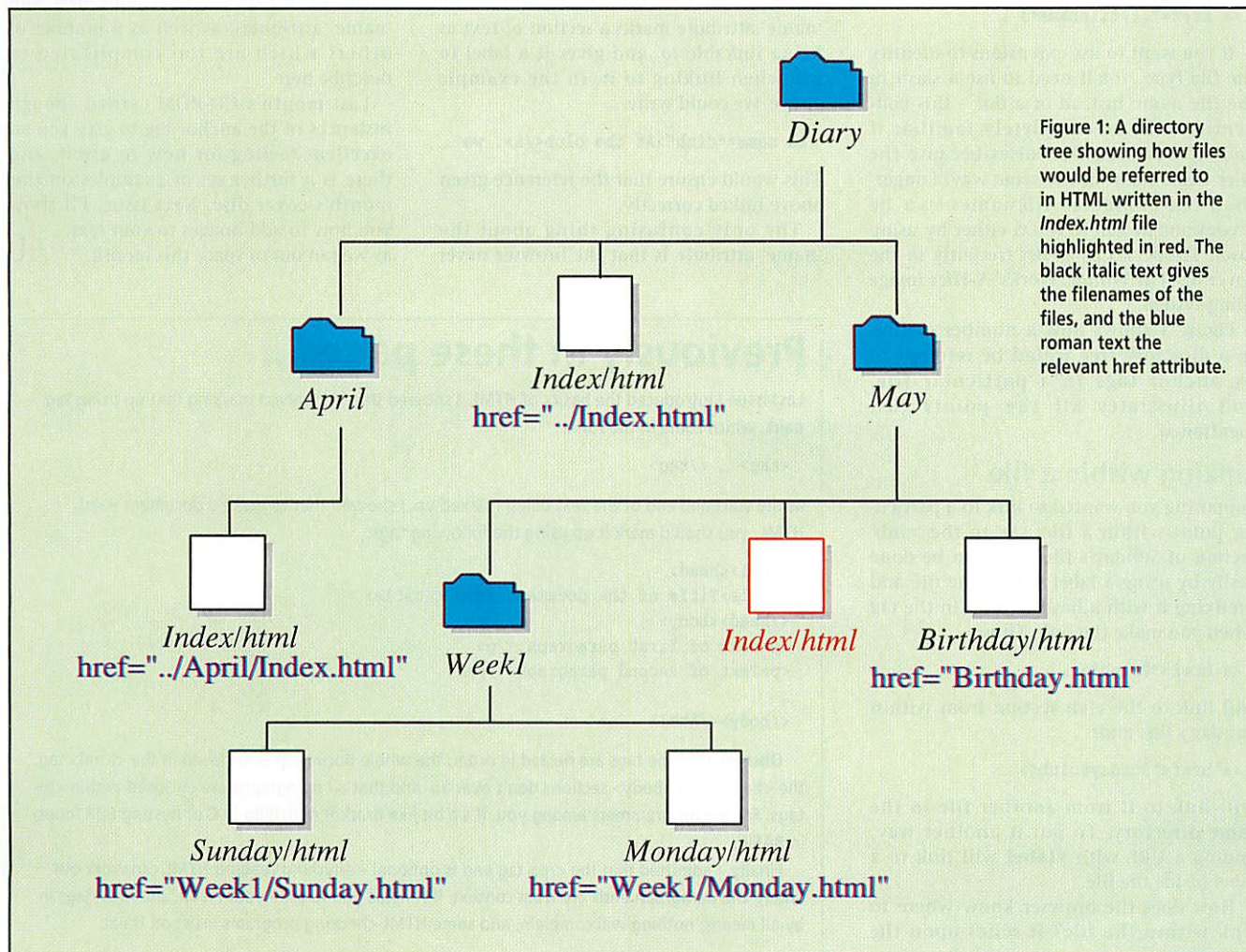

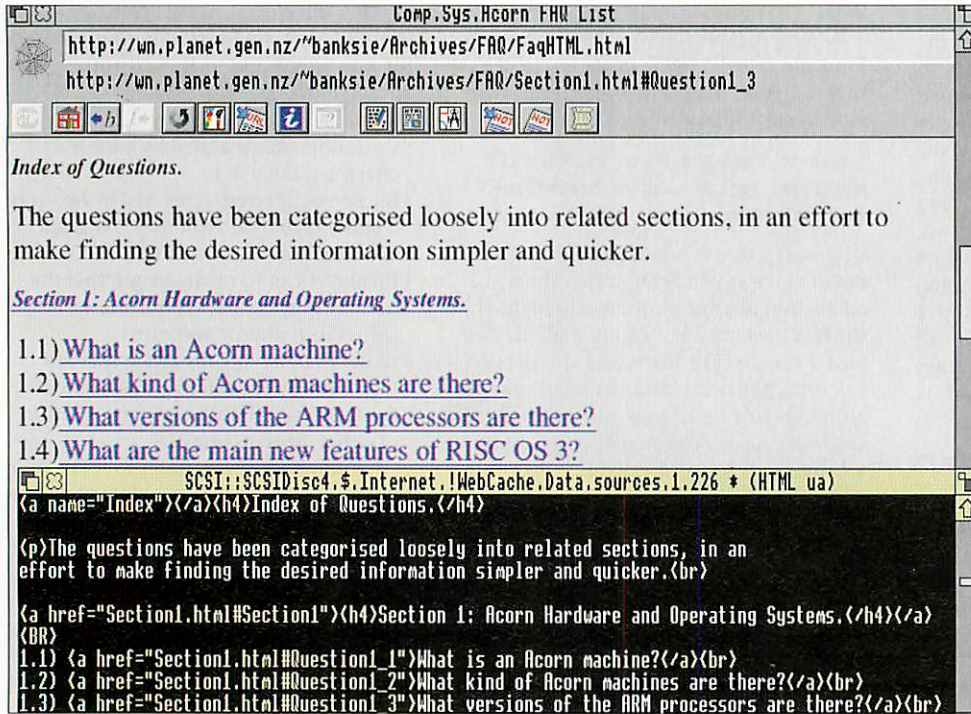

Figure 2: Classic use of a list of anchors to create an HTML-style menu. The source is in the bottom half of the screen, with what the browser displays in the top half. Note that the top line in both is an anchor with a 'name' attribute, which is not marked as anything special by the browser.

and to refer to a file in a directory closer to the root, you write:

```
<a href="../filename"> ...
```

If you want to use extensions to identify the file type, you'll need to use a slash in the file name instead of a dot - this convention will be completely familiar if you've ever used DOS discs because the Filer treats them in the same way. Longer-than-ten-character filenames can be accommodated in RISC OS either by using Jason Tribbeck's *LongFiles* (recently in the cover disc) or WonderWorks' *X-Files* image filing system.

Figure 1 shows how a number of files in a directory tree would be referred to by anchor tags in a particular file, and illustrates all the points just mentioned.

### Linking within a file

Supposing you wanted to link to a particular point within a file; say to the 'club' section of Sunday's file. This can be done easily by using a label within the file and prefixing it with a hash sign (#) in the tag when you make the link. Thus:

```
<a href="#club"> ...
```

will link to the club section from within Sunday's file, and:

```
<a href="Sunday#club"> ...
```

will link to it from another file in the same directory. To put it another way, ending a URL with #label will link to a label inside the file.

How does the browser know where to link within the file? It relies upon the

secret double life of the anchor tag, that's how. As well as the 'href' attribute, the tag can also have a 'name' attribute. The 'name' attribute marks a section of text as being linkable to, and gives it a label to use when linking to it. In the example above, we could write:

```
<a name="club">At the club</a>, we ...
```

This would ensure that the reference given above linked correctly.

The only confusing thing about the 'name' attribute is that the browser never

gives any indication that the text is marked at all when it is displaying it. A single anchor tag can have both 'href' and 'name' attributes, as well as a number of others which are too complicated to describe here.

Last month's CD-ROM carried enough instances of the anchor tag to give you an excellent feeling for how to use it, and there is a further set of examples on this month's cover disc. Next issue, I'll show you how to add images to your text, as we ran out of space this month. **AU**

## Previously in these pages...

Last issue I introduced the basics of HTML. I showed that it involved marking text up using tag pairs, which come in the form:

```
<tag> ... </tag>
```

at the start and end of the text being marked up. I showed that to make a document valid HTML, you should mark it up using the following tags:

```
<html><head>
<title>Title of the document here.</title>
</head><body>
<p>Text of first paragraph.</p>
<p>Text of second paragraph.</p>
...
</body></html>
```

Observe that the tags are nested in order; the whole document is enclosed in the <html> tag, the <head> and <body> sections don't overlap, and that all paragraphs are enclosed within <p> tags. For the programmers among you, it's a bit like bracket matching in C or nesting FOR loops in BASIC.

Finally, I admitted that the </p> tag end is optional - anything reading HTML can work out where the paragraph ends are from context. If it helps you to read your HTML, put </p> tags in by all means; nothing will complain, and some HTML-checking programs insist on them.



Late Night Opening  
Wednesday & Thursday  
till 7.30pm

Open Sunday  
11am to 4pm

**All prices quoted  
Include VAT**

**FIRST  
COMPUTER CENTRE**

### HOWTO ORDER

Order by telephone quoting your credit card number. If paying by cheque please make payable to: "FIRST COMPUTER CENTRE". In any correspondence please quote a Phone Number, Post Code & Dept. Allow 5 working days for cheque clearance.

**SHOWROOM ADDRESS:**  
DEPT. ACU, UNIT 3, ARMLEY  
PARK COURT, STANNINGLEY  
RD, LEEDS, LS12 2AE.

### LOW COST DELIVERY

- 2-4 Week Days £3.50
- Next Week Day £5.95
- Saturday delivery £10.00

Delivery subject to stock availability  
All prices include VAT @ 17.5%  
● Large showroom with parking  
● Multi-million pound company  
● Overseas orders welcome  
● Educational purchase orders welcome

**OPEN 7 DAYS A WEEK**  
Lombard Finance available

Prices are correct at the time of going to press. Please check our latest prices before ordering. All items are subject to our standard terms & conditions (copy available upon request). E&OE.

### Telephone 0113 2319444

24 HR MAIL ORDER SERVICE FAX: 0113 231-9191  
NEW BBS Sales & Technical line TEL: 0113 231-1422  
E-Mail sales@firstcom.demon.co.uk  
www.demon.com.uk/firstcom

#### AUTHORISED REPAIR CENTRE

We offer a FREE quotation on your Acorn or any peripheral (monitors, printers etc.). A delivery tariff of just £5.00 is charged alternatively you can visit our showroom. We can also arrange a courier pickup at an additional cost of £11.00.

EASY ACCESS FROM M62, M1 and the A1

## Hardware

### Acorn Risc PC's

**PC700**

- 5Mb HD540 & AKF60 £1591.95
- 5Mb HD540CD & AKF60 £1720.95
- 5Mb HD540 & AKF90 £1980.95
- 5Mb HD540CD & AKF90 £2110.95
- 10Mb HD850 & AKF60 £1979.95
- 10Mb HD850CD & AKF60 £2108.95
- 10Mb HD850 & AKF90 £2371.95
- 10Mb HD850CD & AKF90 £2500.95

**PC600**

- 4Mb HD540 & AKF60 £1339.95
- 4Mb HD540CD & AKF60 £1469.95
- 4Mb HD540 & AKF90 £1739.95
- 4Mb HD540CD & AKF90 £1860.95

Quad Speed CD drives from £39.95  
Six Speed CD drives from £64.95  
16 Bit Sound Card £68.95  
Extra Slice Case £115.95

**0% Finance Acorn 20/20**  
Interest Free Credit  
20% Deposit 20 Monthly Payments

**PC Cards With Risc PC Separately**

- SX-33 £115.95 £233.95
- DX2-66 £174.95 £292.95
- DX4-100 £233.95 £350.95
- 5x86 £468.95 £585.95

### Acorn A7000 Systems

- A7000 2Mb HD425 & AKF60 £933.95
- A7000 4Mb HD425 & AKF60 £1021.95
- A7000 4Mb HD425CD & AKF60 £1139.95

**Microvitec 1438 Monitor**  
.28 dp, Multi-Sync  
Only £264.95

## Software

Entertainment Software

- Alone in the Dark £25.95
- Black Angel £26.95
- Cannon Fodder £22.95
- Cobalt Seed £22.95
- Cyber Chess £26.95
- Darkwood £26.95
- Fire & Ice £21.95
- Fist Lore £21.95
- FTT Formula 2000 £23.95
- Global Effect £29.95
- High Rise Racing £21.95
- Lemmings/More RiscPC £23.50
- Rick Dangerous £14.95
- Saloon Cars Deluxe £24.95
- SimCity 2000 (A5000) £32.95
- SimCity 2000 (RiscPC) £32.95
- Simon the Sorcerer £34.95
- Star Fighter 2000 £26.95
- The Real McCoy 2,3 or 4 £16.95
- Time Machine £19.95
- Virtual Golf £19.95
- Wavelength £25.95
- Wolfenstein 3D £25.95

Application Software

- Arc Game 7 £53.95
- Arc Fax 1.12 £37.95
- Arcterm 7 £65.95
- Artworks 1.54 £115.95
- Hearsay II £75.95
- Home Accounts £31.95
- Copernicus Astronomy £29.95
- Impression Style £17.95
- Impression Publisher £117.95
- Sibelius 6 Version 3 £174.95
- Sibelius 7 Student ver3 £544.95
- Sibelius 7 Version 3 £999.95

10/10 Education series  
Any 2 for £25.95

PC CD ROM Software

- Schubert £37.95
- Strauss £26.95
- Stravinsky £37.95
- Ancient Lands £26.95

Bookshelf 96 £40.95  
Dinosaurus £26.95  
Encarta 96 £39.95  
Golf £26.95  
MSDOS 6.22 & Windows Works V3 for Windows £67.95  
Reference £26.95  
Chambers Dictionary £35.95  
Groulier Encyclopedia £15.95  
Red Shift Astronomy II £37.95  
Dorling Kindersley Titles  
Encyclopedia of Science £27.95  
Encyclopedia of Nature £27.95  
History of the World £27.95  
My 1st Incred. Dictionary £21.95  
PB Birthday Party £23.95  
Stowaway £24.95  
The Way Things Work £27.95  
The Ultimate Sex Guide £27.95  
Virtual Reality Bird £23.95  
Virtual Reality Cat £23.95  
Top sellers on CD-ROM  
Mortal Combat £31.95  
Will, Shatters TEK Wars £26.95  
Monopoly £27.95  
Command & Conquer £32.95  
Panic in the Park £29.95  
FIFA 96 £33.95  
Encarta 96 £39.95  
Actua Soccer £28.95  
Destruction Derby £32.95  
Hexen £20.95  
Rebel Assault £32.95  
PGA Golf 96 £33.95  
Worms £27.95

### Tabby

only £64.95

The amazing new graphics tablet for the Acorn range of Computers, software developed by First Computers. 94% rated in Amiga Shopper. Requires Riscos 3.1

### Acorn Spares

Acorn Mouse (Original) £29.95  
A5000/A4000 Disk Drive £81.95  
A3020 Disk Drive £100.95  
A3010 Disk Drive £100.95  
A3000 Disk Drive £81.95  
RiscOS 3.11 Full Upgrade £86.95  
RiscOS 3.11 No Manuals £43.95  
MIDI Max (Risc PC & A5000) £80.95  
MIDI User (A30x0 & A4000) £56.95  
MIDI Cables (2x3m) £9.95

Repair & Fitting Service Available

### 2.5" H/Drives

CONNER FUJITSU Seagate

- 80Mb 2.5" IDE £89.95
- 130Mb 2.5" IDE £109.95
- 170Mb 2.5" IDE £114.95
- 250Mb 2.5" IDE £139.95
- 340Mb 2.5" IDE £149.95
- 540Mb 2.5" IDE £188.95
- A3010/3000 IDE Card\* £69.95

\*When Bought With Drive

### 3.5" H/Drives

Quantum TOSHIBA Seagate

- 540Mb 3.5" IDE £150.95
- 1.0Gig 3.5" IDE £194.95
- 540Mb 3.5" SCSI £163.95
- 1.0Gig 3.5" SCSI £222.95
- 2.0Gig 3.5" SCSI £629.95
- A3/A400 IDE Card £80.95
- A5000 2nd H/Drive Kit £119.95

### Memory Modules

- RiscPC/A7000 4Mb £31.95
- RiscPC/A7000 8Mb £64.95
- RiscPC/A7000 16Mb £136.95
- RiscPC/A7000 32Mb £279.95
- RiscPC VRAM 2Mb £169.95
- With 1Mb Trade In £122.95
- A3000 1Mb to 2Mb £65.95
- A3010 1Mb to 2Mb £46.95
- A3010 2Mb to 4Mb £103.95
- A3020/A4000 to 4Mb £96.95
- A5000 2Mb to 4Mb £96.95

Part X. your other Memory Call...

## Printers

### Canon

- Canon BJ30 £169.95
- Compact Portable mono printer, 30 page ASF built in.
- Canon BJC70 Colour £235.95
- High quality Portable colour printer, 30 page ASF.
- Canon BJ200ex £183.95
- High speed, high quality mono printer, virtual 720 dpi.
- Canon BJ210 £190.95
- Mono Printer, 720x360dpi, colour upgradeable.
- Canon BJC4100 Colour £264.95
- High quality colour, super fast mono printing 720 dpi.
- Canon BJC610 Colour £410.95
- New Enhanced, dedicated colour printer, 720x720 dpi.

### CITIZEN

ABC Colour printer £135.95  
simple (as easy as ABC) to use 24 pin printer. Comes as standard with 50 sheet Auto sheet feeder. Tractor feed optional at £38.00

### OKI

OL600ex £374.95  
LED laser printer, p/p/m, 1Mb of Ram.

OL610ex £476.95  
LED laser printer, p/p/m, 2Mb of Ram.

### star

Star LC1009 pin colour £119.95  
9 pin colour printer, 8 NLQ fonts, 180 cps draft.

Star LC909 pin mono £105.95  
9 pin mono printer, ASF built in, push tractor optional.

Star LC240 24 pin mono £117.95  
24 pin mono printer, 192 cps draft, with ASF built in.

Star LC240c 24 pin Colour £132.95  
24 pin colour printer ASF built in, 4 LQ fonts.

Star SJ144 Colour £229.95  
Stunning affordable colour thermal transfer printer, low running costs, 3 p/p/m mono, 1.4 p/p/m colour.

## Accessories

Printer Switch Box 2 way £12.95  
Printer Switch Box 3 way £17.95  
Printer Stands (Universal) £4.95  
1.8 Metre printer cable £4.95  
3 Metre printer cable £6.95  
5 Metre printer cable £8.95  
10 Metre printer cable £12.95  
SCSI Internal Cable £8.95  
SCSI Cable 25D-50Cent £9.95

MULTI COLOUR Disk labels  
500 £6.95  
1000 £9.95

Re-Mark-It disk labels x10 £2.45  
10 Capacity box £0.95  
50 Capacity lockable box £3.95  
100 Capacity lockable box £5.95  
\*90 Capacity Box box £11.95  
\*150 Capacity Posso box £20.95  
100 Capacity CD holder £4.95

\*add £3.00 delivery if purchasing just one Posso or Box box. Normal delivery when purchased with other product or when buying 2 or more.

## Multi Media/CD ROM

Delivery £1.18 per title or £3.95 for 4+

RISCPC's (RISCOS 3.6 only) RISCPC's (RISCOS 3.5 only)

- 8x Goldstar R580B £119.95
- 8x Optics Stingray £119.95
- 6x Goldstar R560B £64.95
- 6x Commodore £64.95
- 4x Goldstar S542B £39.95
- Dual IDE cable £9.95
- Dual IDE cable £9.95

CUMANA

- Indigo CAA340i Quad Speed CD Drive £223.95
- Indigo CAA340ia Quad Speed CD Drive £280.95
- Indigo CAA300i Quad Speed CD Drive £146.95
- Indigo CAA300ia Dual Speed CD Drive £233.95
- Oscar (Parallel) CD Drive £222.95

### Acorn CD Software

- APDL Clipart DTP 1 £18.95
- APDL Clipart DTP 2 £18.95
- Artworks £129.00
- Artworks Clipart 1/2 £20.95
- Cars-Maths in Motion £58.95
- Childrens Micropedia £87.95
- Creepy Crawlies £55.95
- Dune II £41.95
- Goldlocks £45.95
- Grannys Garden £34.95
- Hutchinsons Encyc. £39.95
- OXford Reading Tree £39.00
- PDCD 1 (Datafile) £24.95
- PDCD 2 (Datafile) £24.95
- PDCD 3 (Datafile) £24.95
- PDCD 1 (APDL) £14.95
- PDCD 2 (APDL) £14.95
- Simon the Sorcerer £14.95
- Photobase Landscapes £55.95
- Understanding the Body £50.50

## Modems

### SupraFAX Modem

Class 1 Fax  
Personal Voice Mail  
Fax on Demand  
Call Discrimination

● 14,000 Data/14,400 Fax £98.95  
● 33,600 Data/14,400 Fax £166.95

BABT Approved

### SupraExpress 288

Only £153.95

● Up to 115,200bps (+42bis)  
● LED Display  
● V34 Standard  
● NComm Software

● Class 1 Fax  
● 3 Year Warranty

### Courier V34+

If you thought V34bis was fast try V34+  
£246.95

BABT Approved  
33,600 bps.

## Consumables

### Ribbons

- Citizen Swift/ABC mono £3.95
- Citizen Swift/ABC colour £12.95
- Star LC90 mono ribbon £4.95
- Star LC10/100 mono £3.65
- Star LC10/100 colour £7.95
- Star LC240c colour £13.95
- Star LC240c mono £8.95
- Star LC240 mono £5.95
- Star LC240/300 Colour £13.95
- Star LC240/300 Colour £11.95

### Ink Cartridges

- Canon BJ10/Star S148 £17.95
- Canon BJ200/230 £18.95
- Canon BJ30 (3 pack) £12.95
- Canon BJC 70 mono (3 pack) £10.95
- Canon BJC 70 colour (3 pack) £17.95
- Canon BJC 4000 colour (single) £16.95
- Canon BJC 4000 mono (single) £6.95
- Canon BJC 4000 mono high cap. £28.95
- Canon BJC 4000 mono high cap. £7.95
- Citizen Printiva Std. colours £6.45
- Citizen Printiva Metallic colours £16.45
- HP.Deskjet 500/550 Mono £24.95
- HP.Deskjet 500/550 Colour £24.95
- HP.Deskjet 660 double mono £23.95
- HP.Deskjet 660 colour £25.95
- Epson Stylus mono £13.95
- Epson Stylus colour £27.95
- Epson Stylus Col. II/S/820 Mono £17.95
- Epson Stylus Col. II/S/820 Colour £24.95
- Star SJ144 mono (single) £8.95

### Disks

Bulk DSDD  
10 x £3.45 100 x £26.95  
30 x £9.95 200 x £49.95  
50 x £14.95 500 x £114.95

Branded DSDD  
10 x £4.95 100 x £41.95  
30 x £13.95 200 x £76.95  
50 x £21.95 500 x £175.95

Bulk DSHD  
10 x £3.95 100 x £29.95  
30 x £10.95 200 x £55.95  
50 x £16.95 500 x £129.95

Paper  
Fanfold (tractor feed) 500 sheets £6.95  
Fanfold (tractor feed) 1000 sheets £12.49  
Fanfold (tractor feed) 2000 sheets £21.49  
Single sheet 500 sheets £6.95  
Single sheet 1000 sheets £12.49  
Single sheet 2000 sheets £21.49

Printer repair specialists call for quote

Keeping up with the latest technology is tough at the best of times, but for schools in East Anglia there's a novel way of doing this with the added advantage that they can stay at school and let the technology come to them.

The Lindis Technology Bus is a 36-year old, pink double-decker bus that visits schools in the area giving demonstrations and training. Jonathon Thompson of Lindis explains how it all began. 'We bought the bus in 1991. It's been an idea I've had for some time, and it started for two main reasons really. The obvious one was to raise our own profile and get people to remember us in some way - I think the bus is fairly memorable!

'The problem we perceived specifically in trying to target schools in a rural area is that most teachers, and certainly parents, don't want to spend their free time or weekends trying to find a computer dealer who probably won't understand what they're talking about when they get there.

'We decided if we went to the teachers in their time rather than them having to make time to come to us we would get a much higher hit ratio of teachers per visit.' The teachers then have the opportunity of popping on to the bus in their break or at lunchtime, and it gives them the chance to see and compare different packages, with somebody from Lindis to fire their questions at.

The bus can be driven to the school and the classes can be run in there. If the playground isn't big enough or there isn't access for the double-decker, then the lesson can be held on the bus at the Lindis premises.

### The latest technology

The bus is equipped with the latest Acorn computers. Before a visit the subject areas that the teacher wants to cover with the children are discussed so that the equipment and peripherals can be set up in advance - this would include the software (packages used are from leading software houses as well as Lindis' own product division - *Lingenuity*), scanners, videos etc. When the bus arrives at the school they

can then simply plug it in and begin.

'We try to offer a wide range of equipment for the children to get exposure to, bits and pieces that they wouldn't normally get at school or have limited access to. So we've got things such as PocketLab, scanners and digitisers' Jonathon says.

### The Norfolk/Suffolk divide

Schools in Norfolk are very strongly Acorn based, but those in Suffolk mainly use RM and this is reflected in the fact that Lindis has had far fewer bus visits to Suffolk schools up to now.

The bus is equipped according to the type of school being visited and Jonathon hopes that Xemplar will break down what he describes as 'the age old RM/Acorn competition'. He feels that there are already some rumblings of change.

'We're finding that when we go along to a school we can show them a whole range of things including Macintoshes and Acorns, and they're beginning to take notice. On the bus it's a lot easier to start showing them good RISC OS software. We're finding that especially in the primary schools, the argument is beginning to get through - that there is really good stuff about and that it isn't crucial for the family of the child to have compatible hardware because children learn so fast.'

# The Magic School

### All aboard

Jonathon drives the bus himself and there are other staff from Lindis there to give technical advice and assist with the training or demonstrations.

The bus is available for all age ranges, from pre-school right through. It is set up usually with five computers upstairs and one down, although there can be three downstairs depending on the size of the group. Usually the children work in pairs at the workstations upstairs while the others contribute to a group exercise on the lower deck.

Everything is networked together so, for instance, the clip-art and sound database can be accessed from every machine. Another advantage of this, as Jonathon explains, is that 'if a teacher wants to see how a network works then it's really easy to demonstrate because physically it's all there. You can see very easily how a network is set up and how the data is moving around, and how easy it is to network a printer or share hard drives.'

### Lesson time

The day I visited the Lindis bus there were pupils from a local school on board in the middle of a lesson. They were being introduced to multimedia by putting together a book about themselves using templates

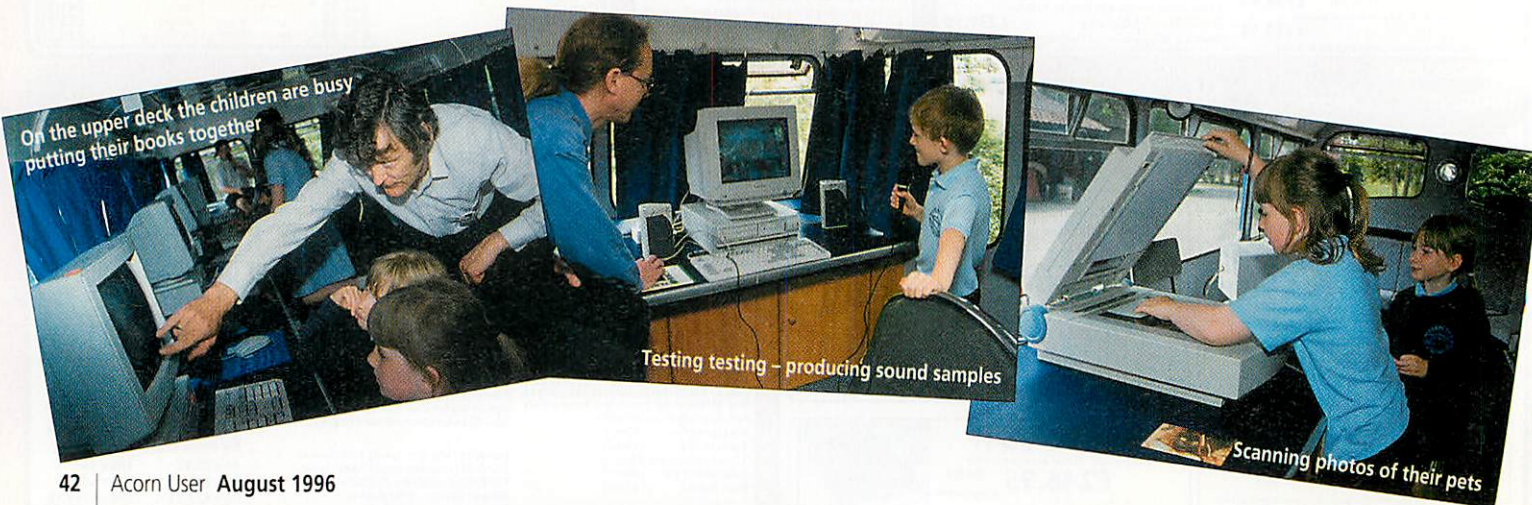

Karen Peach samples the service aboard the Lindis Technology Bus

# Bus



REVIEW

supplied. Paul from Lindis was on the lower deck with some of the pupils scanning in photographs of their pets that they had brought with them. He was also supervising the children using a video digitiser to take pictures of themselves for use in the book later.

From upstairs the cry of 'We hate boys' could be heard. The girls were shouting into the microphone to produce their own sound samples – well, at least it shows that some things never change when you're at primary school. If not involved with one of these activities, the children were busy at their workstations writing the text for their personal book. They had to decide which pictures and sounds they wanted to appear with each page and combine all their work to how they wanted it. Mark Hickson from Lindis was busy helping out and showing the children what to do.

At the end of the lesson the children took their work away on disc so that they could continue with follow up work at school.

## Didn't we have a lovely time...

On this sunny June afternoon on the top deck of the bus with the windows open and the warm breeze blowing through, the children all happily working away on their projects, I almost felt like I wanted to be back at school myself. Jonathon agrees: 'The kids really enjoy themselves. The whole thing is made into a pleasant experience, for the teachers too – they get rejuvenated. Sometimes there are four kids all squashed onto one seat, all trying to get to the keyboard.'

The weather was perfect when I was there, but because of exams and the summer break, the Lindis bus is in demand more from September on through the winter. It goes out a maximum of twice a

week due to all the preparation and organisation that is involved and, obviously, because it means a significant number of the Lindis workforce being out of the office on these days. But there's no need to worry about those cold winter months – the bus is centrally heated!

As well as lessons such as this, the bus is also invited to school open days so that parents can have a look around. Originally, Lindis provided the service for free but as its popularity grew and the demand became greater, a charge was



Say cheese

brought in for training sessions and open days. Obviously, demonstrations remain free and the bus can also be seen at shows in the area.

## No hurry

Although Jonathon has no plans for a fleet of pink double deckers touring the schools around the country, if he had to do it all again he says he would probably use a different type of bus. He appreciates that the old classic look of the double decker is attractive and it certainly gets noticed, but feels that the internal layout could be better.

He would prefer two entrances or staircases so that the flow of people around the bus would improve, and he'd possibly even use a single decker. Jonathon has

already built a bus for another company and is quite willing to build another if anyone fancies giving it a go – enquiries to the address below.

Planning the route to school is important to avoid any low bridges. Being in a hurry is also out of the question so if you happen to be stuck behind a pink double decker bus in Suffolk, control your road rage – you'll probably come off worse.

## Not in service?

The bus has achieved what it set out to do, as Jonathon explains. 'The bus has served its purpose of raising our profile, we're very well known for it now.' He adds that 'apart from actually going on the bus, the serious side is that the children have hopefully had a chance to use technology they might not have had the opportunity to use at school.'

And how about the future? Jonathon expects that 'we'll just carry on trundling along. I can see that it may not be invited out as much because everyone knows it and wants to get on with other things in IT.' I imagine that the bus would be greatly missed if it stopped running. It is providing the schools in the area with the latest technology at their own premises. Until schools can afford to buy all the latest products themselves or IT becomes a thing of the past – both pretty unlikely – then I'm sure the Lindis bus will remain popular. I can't see Jonathon hanging up his driver's cap for some time yet. **AU**

## For more details contact:

Lindis International  
Wood Farm  
Linstead Magna  
Halesworth  
Suffolk  
IP19 0BR

Tel: (01986) 785476  
Fax: (01986) 785460

(Acorn MK2 Cards upgraded by us) **133MHz 586 Cards £ 350** incVAT when trading in an SX33

£ 469 inc VAT with Computer / £ 490 inc VAT Outright purchase / 100MHz 586 from £ 320 inc VAT

Acorn PC Cards (£ 117 off when bought with a RiscPC)

**DX2/66** £ 292 (£ 175 with PartX) **DX4/100** £ 350 (£ 234 with PartX) **5x86** £ 586 (£ 350 with PartX)

## IDE CD Systems Quad speed £ 75 SIX speed £ 100

Two Job Vacancies  
Sales/Support  
Send CV to Mr Evans

Double Speed SCSI CD Rom Drive £ 140

Quad Speed SCSI CD Rom Drive tray loading £ 175

Quad Speed SCSI CD Rom Drive caddy loading £ 235

SIX Speed SCSI CD Rom Drive caddy loading £ 350

6.7 SPEED SCSI CD Rom Drive tray loading £ 350

Prices NOW

**Include**

VAT

## Combined Quad speed CD ROM and 650MB Optical Read/Write Drive £ 520\*

All drives include CDFS driver. Prices are for internal RiscPC versions. Please phone for details of other versions.



SCSI Interfaces A30x0/A4000 £ 115

SCSI Interface for RiscPC/300/400/5000 from £ 95

SCSI II Interface for RiscPC (Cumana or Powertec) £ 195

CD Rom systems for A3/4/5000 from £ 230

Cases for CD ROM drives from £ 47 Caddies from £ 5

\*Optical drive is SCSI interfaced, no media provided. Optical discs £ 46

0%

RiscPC's

from £ 54 p.m.

20% deposit

20 Months to pay

Phone for further details

## RiscPC Ram

Price	4MB	£ 40	Prices
DOWN	8MB	£ 90	NOW
Again!	16MB	£ 169	<b>Include</b>
	32MB	£ 350	VAT

Guaranteed Acorn compatible

15" FST 1280 x 1024 0.28 MPCtrl	£ 300
Microvitec 14" M/S (as AKF50)	£ 300
Idek 8617e 17" 0.26mm Monitor	£ 620
Idek 9017e 17" 0.25mm Monitor	£ 680
210 MB IDE Conner Drive	£ 95
1.6 GB IDE Conner Drive	£ 220
1GB SCSI Drive 8.5ms	£ 290
Hard Disc Kits for A3020 from	£ 110
Hard Disc Kits for A3000 from	£ 175
Syquest 135MB EZ Drives from	£ 205
ARM3 (not for A3000)	£ 150
RiscPC Technical Ref.Man. noVat	£ 49.95

## 15" Monitor at 14" Price

with ACB75 RiscPC systems

(£20 ACB70/£35 ACB60)

or

## £25 Quad Speed CD Drive

with ACB75 RiscPC systems

(£35 ACB70/£45 ACB60)

Prices above are for Quad Speed. £25 extra for SIX Speed

RiscPC's built to your specification

Prices **Include** VAT

Post from £ 2.50 Courier from £8.00  
Credit Card & Official orders accepted.

# CJE micro's

78 Brighton Road, Worthing, West Sussex. BN11 2EN. Telephone 01903 523666 Fax 523679

email: [cjemicro@pavilion.co.uk](mailto:cjemicro@pavilion.co.uk) Web: <http://www.art.acorn.co.uk/coft/CJE/>

# Heading for

# unchartered territories

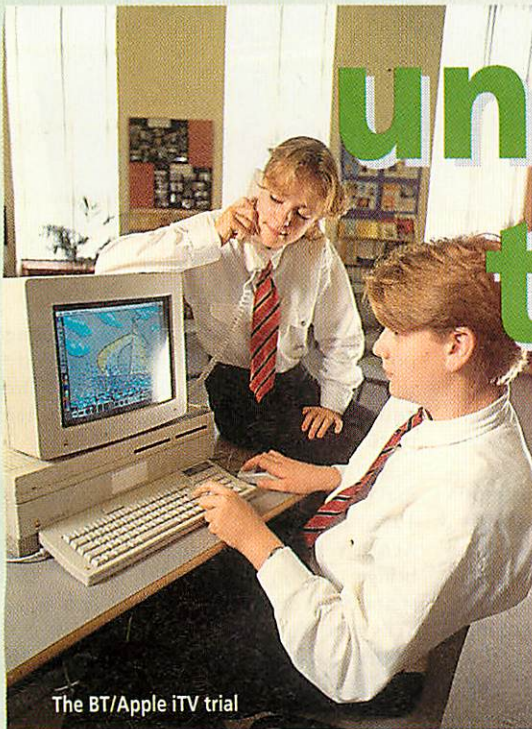

Ian Burley sits patiently as the Acorn world awaits the arrival of interactive TV

non-interactive digital broadcasting is blurring the picture with advanced features which can be implemented much more cheaply than an iTV network.

Deregulation in Europe is another problem for iTV – even

though here in the UK we enjoy the most de-regulated telecomms market in Europe, BT is not allowed to implement an iTV service, despite it being the only company with the financial muscle, network infrastructure and the will to introduce such a service now. The hurdles are even worse in the rest of Europe. Over in the US, early eagerness to get iTV off the launch pad has largely subsided. It all comes down to confidence that the consumer is ready for digital interactive TB services. Only then can the considerable resources required to build media servers and networks be released. The technology, along with AOM, is actually ready and waiting.

The emergence of the NC phenomenon and the underlying boom in the Internet has served to pour more cold water on the immediate prospects for iTV. On the face of it, much of the technology at the user's end is similar to both kinds of service. Basically, you need a cheap but powerful computer to drive a TV display and access information stored on a network of servers. For NCs, that network is the Internet, while the primary network for iTV STBs will be the local cable TV or telephone service provider.

It's ironic that Acorn's current lead in the NC stakes is entirely due to its readiness for the iTV market. The stuff of legend has it that Oracle boss, Larry Ellison – who is personally driving through the NC project – came across AOM's STB

by accident during his search for a truly low-cost Internet surfing device. IBM was talking of sub-\$1,000 stripped-down PCs, but Ellison knew the public needed a device which would cost no more than a cheap video recorder. Until the AOM STB turned up, all the options were too expensive and couldn't be connected to a domestic TV satisfactorily. Of course, Acorn had defeated the problems of cost and TV display compatibility years earlier and these attributes were key selling points of the AOM STB.

Acorn quickly realised a re-engineered AOM STB might just be what Oracle was looking for. In the finest Acorn tradition, a lashed up NC prototype built from STB parts was demonstrated to Oracle in the summer of 1995. Shades of Acorn demonstrating a very wobbly prototype to the BBC some 15 years earlier. What Oracle saw was an AOM STB with a modem instead of an ATM networking interface and an integral Internet browser. However, just like the STB, lurking underneath the Internet facade was good old RISC OS and a motherboard with direct lineage to the A7000s and Risc PCs, which still make up Acorn's bread and butter market.

Acorn is not the only company to have changed direction because of the slow down in prospect for iTV. Apple, a partner of Acorn in several businesses, developed a device called the Pippin, originally as a multimedia player with iTV pretensions. Today, the Pippin is heading down the NC route and in Japan it could become a best-seller multimedia games console. Oracle has close links with Apple – indeed there were industry rumours last year that Oracle was interested in acquiring Apple. However, clearly the Pippin did not fit

The spotlight is tightly focused on Network Computers, or NCs; Oracle's vision of a world where these low-cost, intelligent Internet terminals are at everyone's fingertips. Acorn, as Oracle's choice of reference platform designer for the NC, is perfectly poised to be a leader in the emerging NC market and expects to have a product ready to sell by the autumn.

This time last year the Acorn press headlines were singing another song – that of the brave new world of interactive TV (iTV), and how Acorn's price-leading, feature-rich Online Media iTV set top box (STB), based so closely on Acorn's desktop computer architecture, was poised to lead Acorn into a global iTV market worth billions. Fate, however, can be very fickle and now the facts are that Malcolm Bird, who headed up Acorn Online Media (AOM), has diverted himself and other key resources to the new Acorn Network Computer (ANC) division. So what has happened to AOM and how will AOM relate to ANC?

Answered simply, AOM continues to develop its products in readiness for the patiently awaited iTV boom. Those inside the industry are confident it will happen sooner or later, but later is more realistic than sooner. The problem is that in Europe, existing cable TV services, which are the most likely hosts to iTV services in the future, are not yet ready for the digital revolution. Satellite TV has a strong grip in Europe as well and the advent of

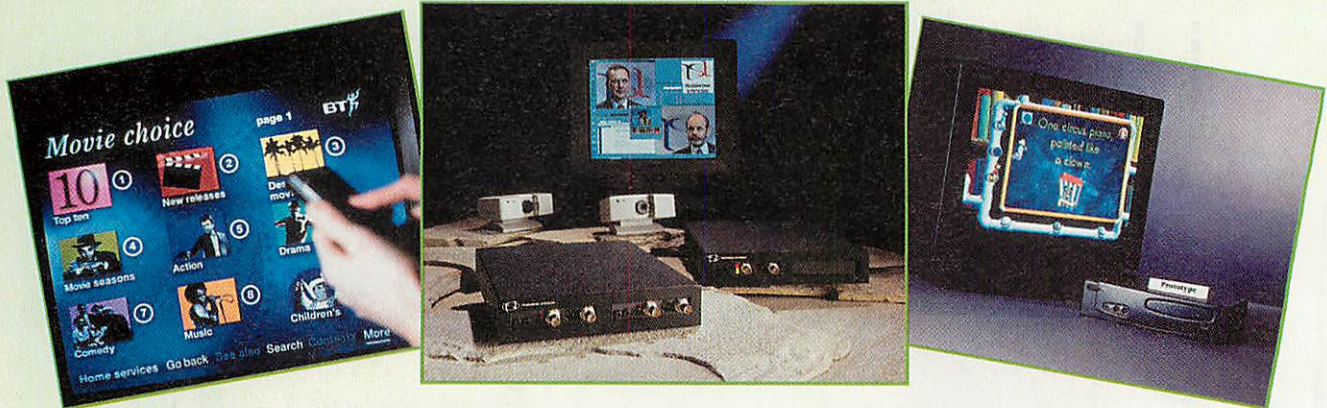

Some of the iTV options

Oracle's NC bill. Fortunately, Oracle was impressed enough with the modified AOM STB to give Acorn the job of developing the definitive reference platform NC.

Larry Ellison, himself, the number two IT business celebrity to Microsoft's Bill Gates, even flew in by private jet (non stop from San Francisco to Cambridge) to see Acorn's set up for himself.

The NC has many commercial advantages over STBs for iTV services. For a start, the Internet already has 50 million users and the network is growing at an

astonishing rate. The NC has a ready-made market which is growing exponentially. NCs can be made more cheaply than STBs because the technology is less demanding. There are no regulatory or heavy investment issues against NCs.

Nevertheless, Acorn and its family of companies had to make some serious engineering commitments before landing the Oracle deal. Sun Microsystems' all-important Java Internet programming language would have to be ported to the underlying RISC OS operating system and ARM

Limited would have to add a floating point maths co-processor to the already tightly integrated 7500 RISC chip. By the end of 1996, work on the NC reference platform within Acorn was at full tilt.

Acorn will be concentrating hard on making the most of the NC launch during 1996, but the iTV dream is still alive. Acorn remains committed to the Cambridge Trial, in which 100 homes plus ten schools are using iTV services and AOM STBs every day.

Just a little way down the road in

## iTV in action – the Cambridge trial

Alistair Wells, head of IT at Netherhall School in Cambridge, is in the thick of it concerning iTV. The Wells family was one of the first to have an AOM STB installed in their home and now Netherhall school is participating in the trial – indeed as a content provider with its own mini video server.

Surprisingly, and rather ironically, the first point Wells made to us about using his school's STBs was Internet-related. "The key element of it is being able to use the World Wide Web using a large screen TV with groups of students who actively discuss where they are going and why." Clearly, Wells can make good use of an NC terminal. Web surfing is also very quick over the iTV network's fast ATM link, making a conventional modem link look very pedestrian.

The school has also linked its conventional ethernet network to the iTV network to improve Internet access. However, Wells also acknowledged the importance of the video resource available instantly over the network, though because of the trial nature of the service, he wishes the programme selection could be updated more regularly.

Of the ten schools linked up as part of the Cambridge Trial, there are two secondary schools and eight feeder primary schools. Netherhall has acted as an authoring centre for other schools which don't have the necessary resources. "We've actually authored for one of the feeder primary schools, creating some pages for them on a classroom project about Egyptians. So they can now look at the pages on their own STB."

At home, each member of Wells' family has a use for the iTV system. Alistair brings work home with him and accesses teaching resources on the system, often building up multimedia presentations which combine video sequences, Web pages and teletext information. Wells was surprised to find that the family took to the radio on demand feature, while a favourite with the kids is Anglia TV's series on local geography.

"They often explore villages in and around the area and the kids are often keen to explore and visit these places as a result." Wells' five-year old is particularly fond of Sherston Software's Naughty Stories, which are also available on the Trial. Teletext is another feature the kids like to play with – being far more responsive on a locally cached server than the usual broadcast version.

The quality of MPEG video playback can be quite variable, depending on the quality of the compression engine originally used. Wells notices the difference, but you soon get used to it: "I can actually show people some of the Anglia TV programmes, which look very good, and ask them if they can tell any difference. They often say, 'well, no, not really'."

Other programmes which are automatically recorded off-air regularly, like the news, for example, do look affected by the compression process, reports Wells. Netherhall school 'broadcasts' its own footage across the network to other schools. Wells explains: "One thing we have been trying is our own hand-held video camera films from field work and putting those onto the system. I don't know whether it's because of Jeremy Beadle's programmes, but when they see video which has been produced by video camera, they are quite happy to watch it. They don't tend to go on about the quality too much."

Ease of use and reliability were praised by Wells. "Even a four-year old uses it – he does everything, even switching it on. And it hasn't missed a beat in terms of reliability." The Cambridge Trial is not a commercial service – at the BT trial, although participants got their STBs and connections for free, they had to pay for some of the programming. The Cambridge Trial is more about testing the technology. Marketing comes later. However, with those who have used AOM's STBs on the Cambridge Trial, the verdict seems to be a thumbs up.

## What is interactive TV?

The thinking behind interactive TV (iTV) is based on a client/server architecture. Users will need a set top box (STB) to use iTV services. A STB is a low-cost client device able to display multimedia information accessed from a central media server machine across a high speed or broad band network. In fact, there can be any number of media servers, both large and small available to 'viewers' – both locally and, possibly nationally and even globally.

An STB must be able to display broadcast TV quality video and sound delivered from the media server. In most cases, the digital compression used is to the MPEG (motion picture experts group) standard. STBs are expected to be used in a similar fashion to today's television sets, VCRs and conventional satellite and cable TV boxes, so they usually have a remote control instead of a keyboard and mouse, and are designed to connect to a domestic TV. Some STBs have optional CD-ROM drives, keyboard and mouse ports as well as a printer port.

What can you do with an STB? The obvious use for an STB is to watch TV programmes, either live or stored on the media server. It is anticipated that conventionally scheduled broadcast TV will run in parallel with interactive TV services for many years. Advantages of iTV over broadcast TV will mean you will be able, via your STB, to watch programmes after they have been broadcast (and in some instances prior to scheduled broadcast), at a time when it suits you.

Services will offer a library of programmes and movies which you can view almost instantly, from the start of the programme, when you choose. This is called video on demand. Random access media server and real-time packet switching network technology means many viewers will be able to watch the same programme at the same time, but at different programme time segments. There will also be audio, or radio on demand services. Some are even predicting the end of domestic hi-fi as we know it. As the 'content' we will view and listen to will be stored on the network, there will be less need for tape recorders, CD players and radio tuners. There will still be a healthy business in amplifiers and speakers though!

Media servers on an iTV network won't be limited to TV programming. With your STB you will be able to surf the Internet, play on-line interactive games with others as close as the next room or on the other side of the world, download games to play off-line, access electronic commerce services like shopping and banking and view information services like teletext. No consensus has been formed as to

how customers will pay for their iTV service. There could be subscriptions, pay as you view or a mixture of the two. Exactly how advertising will migrate to iTV is another un-answered question. The possibilities include a two tier service, one with advertising breaks for a lower up-front cost and an optional premium service minus the advertising altogether.

Many fascinating features could one day be possible through interactive TV. You can already stop, rewind and fast play or freeze pre-recorded programmes using iTV. Later you will be able to do the same during live broadcasts – handy if the phone rings during the Wimbledon final, for example. A proposed feature is the ability to set the STB to 'catch up' mode, whereby you watch the action you have missed at a slightly faster rate so, within a few minutes you're back to the life feed. Talking of being interrupted by the phone, of course the call could eventually be a video phone call and you could be using your STB to take that very call.

Very futuristic options are already being trialed with paying customers in Switzerland and Germany using digital satellite broadcasting DB. This isn't true interactive TV, but a degree of interactivity is available. DB viewers in those countries can pay a little extra and have access to several channels covering a single event. For example, if you are watching a Grand Prix motor race, by switching channels you can view different camera positions and angles, plus look at the same computer timing screen the commentators and racing team crews have at their disposal at the track side. Suddenly, the power of the TV producer is being marginalised.

Interactive TV can do all this and more. The technology is available today to enable virtual reality tele-presence. Special cameras with fish eye lenses able to see in practically any direction from a fixed or mobile position could be positioned in strategic places, like in the front row of a concert, or on top of a speeding police car, for example. A super-high resolution digital imaging chip would feed its all-seeing view to the interactive TV network where a special real time viewer selection device would filter out the part of the scene you have personally chosen to view. Digital processing would eliminate fish-eye distortions and even let you pan and zoom the picture from the comfort of your arm chair.

Real time commercial tele-presence is a long way off, but it's already possible in the laboratory and pre-recorded tele-presence is already a commercial reality in the form of products like Apple QuickTime VR.

Colchester and Ipswich, 1000 homes have been trying out BT's proposed iTV service, using Apple Mac-based STBs. These are thought to be considerably more expensive to make than AOM's design. The BT trial there will have come to an end by the time this issue of *Acorn User* is published. The Cambridge Trial has no planned end date.

As if to hedge its bets, BT is currently trialing AOM STBs through its subsidiary, Westminster Cable. AOM has successfully built up a solid name for itself in the so-far dormant iTV industry and has won a number of contracts to supply both products and consultancy. It would seem fair to say that if the iTV market does wake up, AOM will be positioned to do well. Indeed, the expected success of the ANC division might even be helpful to AOM in the long run.

AU

## Comparison table:

	Acorn Online Media	Acorn Network Computer
Features	Set Top Box	Net Station
Processor	ARM 7500	ARM 7500FE (with floating point)
Stereo audio	Yes	Yes
MPEG video	Yes	No
Java	Optional	Yes
Smart Card interface	No	Yes
ATM network interface	Yes	No (available if required)
Modem	No	Yes
Internet capability	Yes	Yes
Distribution	By cable network	Retail
Projected Market size in 2 years	Small	Medium
Projected Market size in 5 years	Medium-large	Very large
Projected mass production price	c.\$500	c.\$300

# The Internet - whatever your interests, there is something for you - on-line with Argo

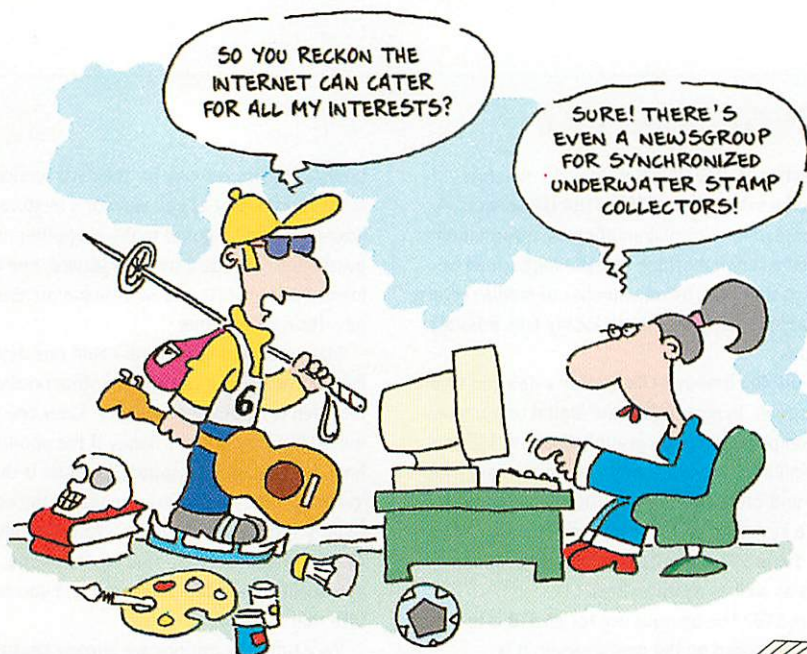

For information on the full range of Acorn Internet packs available, contact **Argo**

Argo, 1, The Shopwhyke Centre, Chichester, West Sussex. PO20 6GD  
 Tel: 0500 585 586 Fax: 01243 531196 email: sales@argonet.co.uk

2 entirely new "killer" apps for Acorn ...

**PHOTODESK v2** £269.50  
 Professional Studio quality artwork

**TopModel** £116.32  
 3-D Graphics creation

prices include VAT and carriage

...available NOW from

**spacetechnology**  
 21 West Wools, Portland, Dorset DT5 2EA  
 Tel 01305 822753 Fax 01305 860483

email sales@spacetechnology.co.uk  
 WWWeb: <http://digibase.com/spacetechnology>



## Get your e-mail here

Receiving e-mail doesn't necessarily require a desktop computer with a high resolution screen capable of displaying n,000,000 colours. In most cases, a Pocket Book and a portable battery powered modem with connecting cable is all that is required, plus the *VT100 Emulator* from Widget.

This will enable you to send and receive e-mail without being tied to your office desk. A suitable modem is one of the so-called Pocket Modems by Pace which can be purchased very cheaply and is powered either by mains or a 9 volt battery. The two are connected together using the half of a serial lead (the 'A' Link) that plugs into the Pocket Book and a multi-modem lead which costs about £15.

The *VT100 Emulator* is supplied on a PC disc so you'll need the serial link to copy it into the Pocket Book first, after which it is installed in the usual way [Acorn]+[I]. Exactly how it is set up will largely depend on what it is to be used for, but in all cases the remote link must be off. (Enter [Acorn]+[L] to display the remote link dialogue.) To set up the software to access a bul-

letin board such as Arcade, go to the Special - Port menu ([Acorn]+[J]) and set the baud rate to that of the modem. Nothing else needs to be done.

To dial up the Arcade Bulletin Board, (or indeed any terminal which supports VT100), type ATDT01816542212 followed by return. (AT=attention terminal, D=dial and T=tone dialling.) The screen will shortly display the familiar Arcade screen with logon prompts, after which it is exactly the same as using the desktop.

Text can be prepared 'off-line' in *Word*, saved as ASCII text and sent from within the *VT100 Emulator*. Mail can also be captured (as can any displayed text) by entering [Acorn]+[C] and entering a suitable name in the dialogue box. If the filename is given the extension .WRD, the

captured text will eventually appear under the *Word* icon on the desktop screen. To finish capturing text, enter [Acorn]+[C] again.

The *VT100 Emulator* costs £58.75 (inc VAT) from Widget Software who can be contacted on (01483) 815444. The Multi-modem cable is also available from Widget.

Geoff Preston

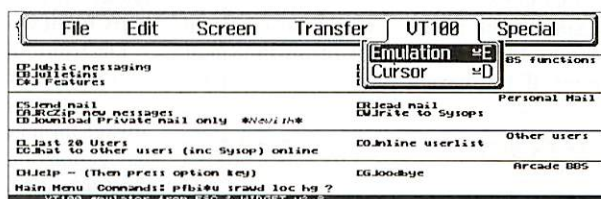

Logged onto Arcade to collect e-mail

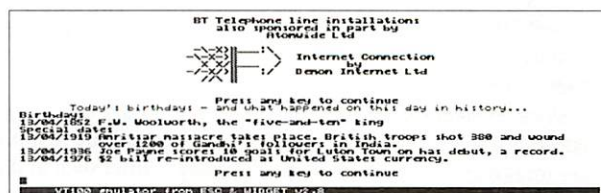

The opening pages of Arcade

## Art, money and song

*Paint* and *Composer* by Widget Software is not one, but two programs on a single SSD which will run on both versions of the Pocket Book.

*Composer* is a simple music editor which will play back the composition through the internal speaker. When using this program, you must forget phrases like MIDI compliant and polyphonic sequencing but instead, consider the program for what it is: a very capable, single part editor which is ideal for initial music scoring before moving on to harmonies and instrumental parts.

Entering music notes from a keyboard designed for entering letters is never easy. *Composer* requires the user to choose the duration of note required from the menu (quaver, crotchet, minim etc.), and select the pitch by pressing a letter between A and G. Repeated pressing of the same letter will move the note up or down one octave.

Attributes like sharps, flats and dots can be added next.

*Composer* can deal with different time signatures and keys and also contains a very comprehensive database of musical terms and meanings.

The *Paint* part of the software is, I feel, less effective. I have used painting programs on desktop computers for many years and the use of a mouse with such software seems to me to be a minimum requirement. This program uses the cursor keys to move around the screen and, as a result, it feels as though it pre-dates drawing on a Sinclair Spectrum by several years. However, it will display drawings in several

formats including GIF and BMP. The program also includes a number of printer drivers so that graphics can be printed.

*Finance Pack 3a*, also by Widget, is a very comprehensive accounting program which would, I'm sure, be welcome in many Business Studies or Accounts lessons, not to mention the home. It can handle several accounts which can inter-react with each other, each of which must be one of six types reflecting the way the account is operated.

Having spent a couple of hours with the program, I've concluded that the author has tried to cover every possible eventuality. The only thing that he hasn't catered

for is ensuring the user religiously enters the details of every transaction.

*Paint* and *Composer* and *Finance Pack 3a* both cost £59.95 inc VAT from Widget Software who may be contacted on (01438) 815444.

Joanne Hinkley

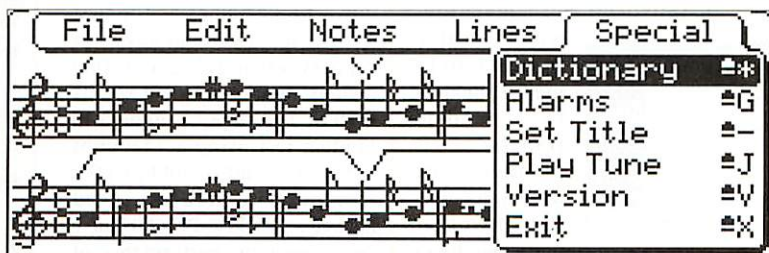

Now you can compose your masterpiece anywhere

## Paper Out

**E**lectronic Books are miniature 3.5in CD-ROMs designed to be played on the Sony hand-held Electronic Books reader. Paper Out is an application that allows you to read them on your Acorn Computer. In order to do this you will need an XA compatible CD drive – those that are photo CD compatible should be OK.

You are best with a tray loading drive because the small CD will fit on the small recess. If you have a caddy system you are

supposed to be able to get a ring to put round the drive, but I failed to find one – most people who had heard of them hadn't seen them for years. Not to worry, you can still use a caddy system if you use a pencil to outline the hole in a normal CD and very carefully place the hole in the Electronic Books CD over this and insert it. It sounds hairy but it works.

Electronic Books are basically just long files with indexed tabs, allowing you to skip to the part you want. As such, it's not always formatted neatly on the screen, but navigation should not be a problem. There are supposed to be hundreds of titles but I could only track a few down, and they cost about £30.

The one I bought to try out was the Electronic Speech writers kit. Unfortunately, I was very unimpressed with the tired and totally un-witty quotes and jokes it contained, along with the advice on making a public speech. There are other titles such as dictionaries, scrabble and even adventure games, and I believe there are simple graphics enlivening some books. If

you do see a title you want, then Paper Out will allow you to read it, but I have yet to be convinced that they are worth the money.

Mike Cook

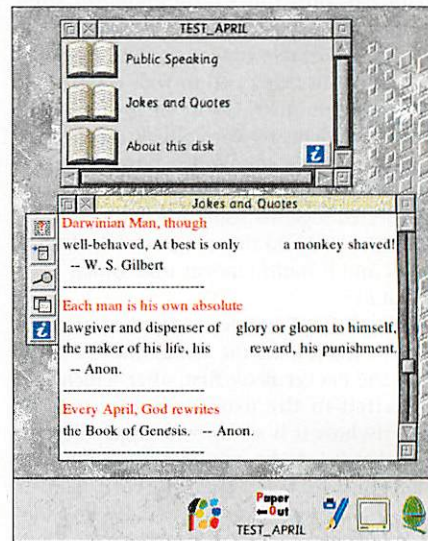

### Product details

Product: Paper Out

Use: Reading Electronic books

Requirements: CD Drive, RISC OS 3.1, 2Mb RAM CDFS 2.2

Distributors: Cumana

Address: Boundary House, The Pines, Broad Street, Guildford, Surrey GU3 3BH

Tel: (01483) 503121

Fax: (01483) 451371

E-mail: sales@cumana.co.uk

## QuickLynk

**Q**uickLynk is an easy solution to the problem of how to transfer a lot of files from one Acorn RISC OS computer to another. It's a serial port file transfer utility from Desktop Projects that can copy files between machines in both directions, either by modem or using a serial link cable which can be supplied as an optional extra. A 'chat' mode allows simple messages to be passed between the machine operators even while files are being transferred.

QuickLynk offers a directory display similar to the RISC OS Filer showing the contents of a drive on the other machine. You

can drag files or applications from the QuickLynk window into your own directories or running applications, or even double-click on a remote file icon to transfer and load it into an application that knows its filetype on your machine. Double-clicking on any remote application or directory opens it to show what's inside.

The software comes on a single floppy with a release note and useful utility programs. The 30-page, laser-printed manual is well-illustrated and contains the single user licence and full operating instructions. QuickLynk is installed on both machines when cable transfer is to be used. If modem transfer is planned, the licence requires that the other party purchases another copy of

QuickLynk, unless the machines to be linked are owned by the same person.

QuickLynk installs on the 'filer' side of the iconbar, and the Config menu option allows setting the disc drives to be made accessible to the other machine, serial port settings and Modem control. Passwords can also be set for named users for security when modem connection is used and, most usefully, a 'RingBack' system allows QuickLynk to share a line with other services and answer the next call after a previous single ring.

Cable tests between a Risc PC 600 and A4 portable at 115200bps produced sparkling performance not unlike hard disc access speed, but settled down to 38,400bps as the best transfer speed without any error reports, although pre-A5000 owners should get good results even at 19200bps. A modem to modem test using a 14400bps CONNECT and 57600bps DTE (computer-to-modem) speed between two Risc PC 600s gave very acceptable performance of up to 2672bytes/sec with

bi-directional file transfers taking place.

QuickLynk is easy to set up, works well and has few flaws. You can only drag one icon at a time from the remote machine, and the Filer display doesn't have the 'full info' option except from a menu-button click on each icon. Desktop Projects plan improvements to the Filer display and to add a two-way window to the Chat function.

QuickLynk is so effective and easy to use that it deserves to be included with any Acorn computer upgrade deal.

David Dade

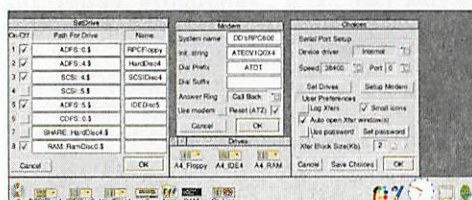

QuickLynk setup for file exchange between Risc PC and A4

### Product details

Program: QuickLynk

Supplier: Desktop Projects Ltd.

Tel: 0161-474 0778

Price: £28+VAT (software only),  
£34+VAT (+5m local cable),  
£39+VAT (+10m local cable),  
£45+VAT (+20m local cable)

Pros: Simple setup, operation,  
can share phone line

Cons: No receive queuing

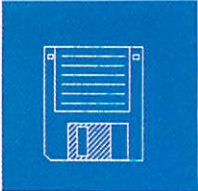

## Ridiculous rhymes

Sherston Software

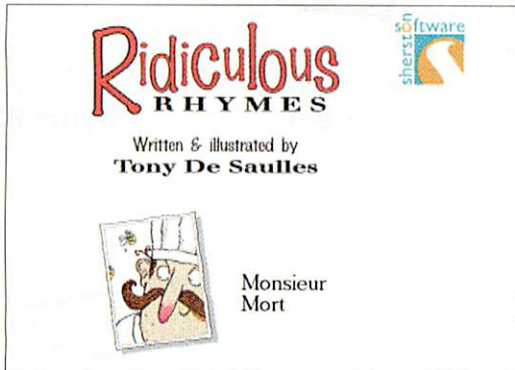

The various Talking Books and Reading schemes by Sherston Software have now been supplemented by the *Ridiculous Rhymes* series.

On this month's cover disc we have a complete sample of just one ridiculous rhyme – as read by TV personality Tony Robinson.

Please note that this demo will work on RISC OS 3 only. However, the full product is fully functional on RISC OS 2.

If you have any queries you can contact Sherston Software at Angel House, Sherston, Malmesbury, Wiltshire SN16 0LH. Tel: (01666) 840433. Further contact details available on the disc.

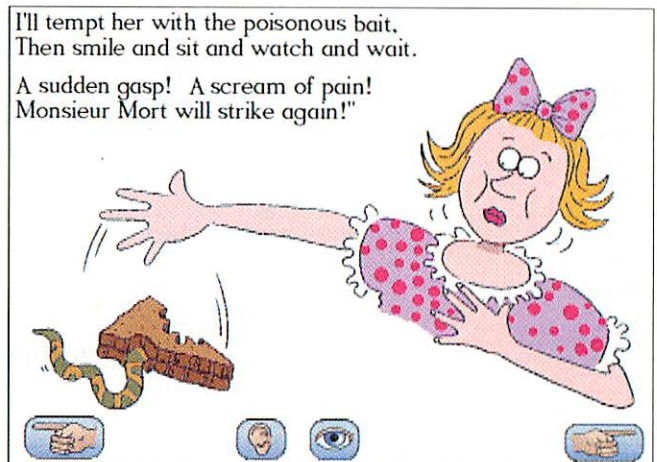
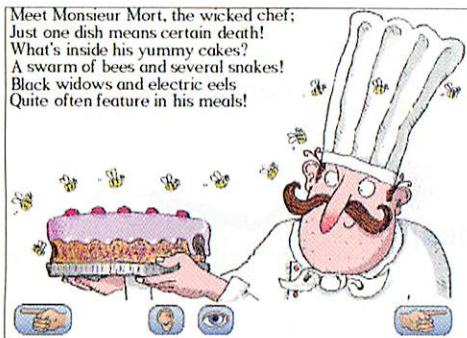

## Disc information

The software on this disc has been compressed using *ArcFS 2* from VTi, and is opened by running a copy of *ArcFS* then double-clicking on the archive to open it. There is a copy of *ArcFS* on the disc.

Most software will run straight from the archive, but some programs may need to be copied out of the archive before being run, uncompressing them in the process. Any program that saves a file to disc, for instance, will be unable to do so into the archives on the disc.

### Faulty disc?

If your disc is faulty, test whether it will verify by clicking with Menu on the floppy drive icon and choosing Verify.

If it fails to verify or is physically damaged you should return it to *TIB, TIB House, 11 Edward Street, Bradford, Yorkshire BD4 7BH*. If it verifies successfully return it to the *Acorn User* editorial office at the usual address.

The *Acorn User* cover disc has been checked for viruses using *Killer* version 2.204 from Pineapple Software.

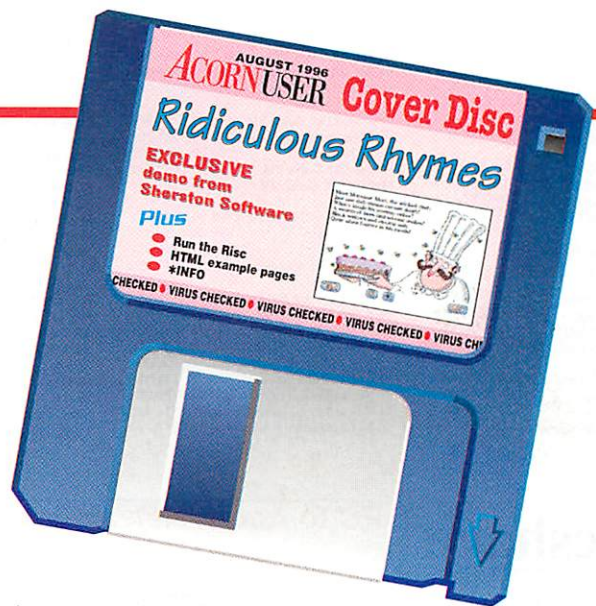

## Regular items

- Run the Risc with the Transistor test software to go with the excellent hardware, which had the rare Mike Cook honour of receiving *Boxed* status.
- \*INFO contains a plethora of demos, utilities and applications to keep you busy – unfortunately, due to space considerations, we have not been able to include all the \*INFO programs this

month, so those that have been missed will be included next month.

For those with Internet access you will find the missing programs on the *Acorn User* Web site: <http://www.idg.co.uk/acornuser/>

- Wimp C continues building the special library of routines to make creating applications much easier.





# Yellowstone

## Educational Solutions



# ALL PRICES INCLUDE VAT

Bramingham Park Business Centre, Enterprise Way,  
Bramingham Park, Luton, Bedfordshire LU3 4BU.  
Telephone 01582 584828 Fax 01582 562255

Enhanced Performance ATA-2 Interface

## RapIDE32 £139.83

A very fast 32 bit Risc PC Interface for hard drives and ATAPI CD-ROMs. Plug your existing drive to RapIDE and typically double its speed. Up to 400% improvement on the Risc PC motherboard controller. Firmware in FLASHROM. Up to 4 devices of any mix. Sustained data rates of up to 8MB/s. Peak data rates of 16MB/s on ATA bus. Ideal for multimedia sound and video.

## RISC PC MEMORY

4 MB	£ 55	Please call for our latest prices!
8 MB	£ 90	
16 MB	£149	
32 MB	£339	

## RAPIDE/IDE DRIVE BUNDLES

Enhanced Performance ATA-2 Interface  
RapIDE32 & ...

- (1) Quantum Trailblazer 850MB **£281**
- (2) Quantum Fireball 1.28GB **£319**
- (3) Quantum Sirocco 1.7GB **£345**
- (4) Quantum Sirocco 2.5GB **£419**

## IDE DISC DRIVES

Quantum Trailblazer 850MB	<b>£170</b>
Quantum Fireball 1.28GB	<b>£217</b>
Quantum Sirocco 1.7GB	<b>£234</b>
Quantum Sirocco 2.5GB	<b>£329</b>

## ATAPI CD-ROM DRIVES

Quad Speed (600KB/s)	<b>£ 65</b>
Six Speed (900KB/s)	<b>£ 92</b>
Eight Speed (1200KB/s)	<b>£139</b>
Price includes free driver with CDFS	

## Mozart

DIGITAL AUDIO

**£70.44**

Improved 16 bit Digital Audio Card and mixer for the Risc PC with superb reproduction and dynamics. Incorporates an oversampling tracking digital filter for the best sound quality independent of sample rate. The four channel mixer section combines CD-ROM and multimedia audio.

## Risc PC Audio Mixer

**£35.19**

Four channel mixer for combining existing sound with CD-ROMs or multimedia audio.

Prices INCLUDE VAT but exclude p&p. Please add £2.35 for orders under £100 and £5.85 for orders £100 and over.

One Stop Storage

One Stop Storage



### Hard Drives

	Exc.	Inc.
	VAT	VAT
A3000 120Mb IDE + User Port. Internal	£145	£163
A3000 170Mb IDE + User Port. Internal	£159	£187
A3000 250Mb IDE + User Port. Internal	£179	£210
A3000 410Mb IDE + User Port. Internal	£259	£304
A3010 120Mb IDE. Internal	£135	£159
A3010 170Mb IDE. Internal	£149	£175
A3010 250Mb IDE. Internal	£169	£199
A3010 410Mb IDE. Internal	£249	£293
A3020 120Mb IDE. Internal	£85	£100
A3020 170Mb IDE. Internal	£99	£116
A3020 250Mb IDE. Internal	£119	£140
A3020 410Mb IDE. Internal	£199	£234
A3000/4000/5000/A7000/RISC PC		
512Mb IDE Drive. Internal	£112	£132
850Mb IDE Drive. Internal	£129	£152
1.2 Gb IDE Drive. Internal	£139	£163
1.6 Gb IDE Drive. Internal	£189	£222
2.5 Gb IDE Drive. Internal	£209	£246
SCSI DRIVES (INTERNAL)		
540Mb SCSI Drive. Internal	£125	£147
850Mb SCSI Drive. Internal	£139	£163
1.2 Gb SCSI Drive. Internal	£199	£234
2.0 Gb SCSI Drive. Internal	£329	£387
4.0 Gb SCSI Drive. Internal	£call	£call
SCSI DRIVES (EXTERNAL)		
540Mb SCSI Drive. External	£165	£194
850Mb SCSI Drive. External	£179	£210
1.2 Gb SCSI Drive. External	£239	£281
2.0 Gb SCSI Drive. External	£369	£434
4.0 Gb SCSI Drive. External	£call	£call

### Optical Drives

	Exc.	Inc.
	VAT	VAT
230Mb SCSI Drive. Internal	£325	£382
230Mb SCSI Drive. External	£365	£429
640Mb SCSI Drive. Internal	£call	£call
640Mb SCSI Drive. External	£call	£call
230Mb Optical Cartridge	£12	£14
640Mb Optical Cartridge	£call	£call

### Memory

	Exc.	Inc.
	VAT	VAT
A3000 1-2Mb	£39	£46
A3000 1-4Mb	£99	£116
A3010 1-2Mb	£38	£45
A3010 1-4Mb	£99	£116
A3020 2-4Mb	£74	£87
A4000 2-4Mb	£74	£87
A5000 2-4Mb	£69	£81
A5000 4-8Mb	£199	£234
RISC PC 4Mb	£35	£41
RISC PC 8Mb	£53	£62
RISC PC 16Mb	£93	£109
RISC PC 32Mb	£235	£276

### Scanners

	Exc.	Inc.
	VAT	VAT
Epson GT-5000 300x300 dpi	£365	£429
Epson GT-9000 600x600 dpi	£599	£704
UMAX S6E 300 x 600 dpi	£299	£351

### Upgrades

	Exc.	Inc.
	VAT	VAT
A3000/4000 IDE Card + User Port	£69	£81
A3000 IDE Card + User Port	£69	£81

A3010 IDE Card	£57	£67
SCSI Card (All Acorn Computers)	£85	£85
RISC OS 3 (Chips Only)	£32	£38
RISC OS 3 (Chips, Software & Manual)	£59	£69
SCSI 25 to 50 Way 1 Metre	£10	£12
SCSI Terminator	£10	£12
SCSI 3 Connector Ribbon Cable 1 Metre	£10	£12
SCSI 4 Connector Ribbon Cable 1 Metre	£12	£14
IDE 3 Connector Ribbon Cable 1 Metre	£8	£9

Multiple SCSI Storage Solutions by DATA CHASER  
Any combination of 2 to 8 SCSI Devices in one Professional SCSI Enclosure



Payment Cards Welcome



### CD-ROM Drives

QUAD SPEED CD SPECIAL £45.00

	Exc.	Inc.
	VAT	VAT
BARE INTERNAL CD-ROM DRIVES FOR RISC PC & A7000		
RISC PC/A7000 x4 Speed Internal IDE	£45	£53
RISC PC/A7000 x8 Speed Internal IDE	£call	£call
RISC PC/A7000 x4 Speed Internal SCSI	£105	£124
RISC PC/A7000 x8 Speed Internal SCSI	£call	£call
INTERNAL SCSI CD-ROM KITS FOR RISC PC & A7000		
RISC PC/A7000 x4 Speed Internal with SCSI Card	£189	£222
RISC PC/A7000 x8 Speed Internal with SCSI Card	£call	£call
EXTERNAL SCSI CD-ROM KITS SUITABLE FOR ALL ACORN COMPUTERS INCLUDING SCSI CARD		
x4 Speed External (Complete Kit)	£249	£293
x8 Speed External (Complete Kit)	£call	£call
CD-ROM TOWERS (SCSI)		
x4 Speed SCSI 2 Drive Tower System	£289	£340
x8 Speed SCSI 2 Drive Tower System	£call	£call
x4 Speed SCSI 4 Drive Tower System	£540	£635
x8 Speed SCSI 4 Drive Tower System	£call	£call
x4 Speed SCSI 6 Drive Tower System	£799	£939
x8 Speed SCSI 6 Drive Tower System	£call	£call

### i-Cubed Network Cards

Etherlan 102 for A3000/3010/3020/4000 (Podule Slot Combo)	£119	£140
Etherlan 210 for A3020/A4000 (Network Slot 10Base 2)	£125	£147
Etherlan 211 for A3020/A4000 (Network Slot 10Base T)	£126	£148
Etherlan 512 for A5000 & A4000/3000 (Podule Slot Combo)	£119	£140
Etherlan 513 Fibre Optic Adaptor for A5000 & A4000/3000	£389	£457
Etherlan 522 for RISC PC with DMA for improved Performance	£145	£170
Etherlan 523 Fibre Optic Adaptor for RISC PC 600/700 & A7000	£269	£316
Etherlan 602 for RISC PC & A7000 (Podule Slot Combo)	£99	£116
Etherlan 102/A+ for A3000 with FLASH ROM (Acorn Access +)	£139	£163
Etherlan 210/A+ TenBase2 A3020/4000 FLASH ROM (Acorn Access +)	£145	£170
Etherlan 211/A+ TenBaseT A3020/4000 FLASH ROM (Acorn Access +)	£145	£170
Etherlan 512/A+ Combo for A5000 FLASH ROM (Acorn Access +)	£139	£163
Etherlan 602/A+ for RISC PC FLASH ROM (Acorn Access +)	£115	£135
AVIGNON ETHERNET BRIDGE PRODUCTS		
E102B A3000 Avignon Bridge Card	£169	£199
E200B TenBase2 A3020 Avignon Bridge Card	£179	£210
E201B TenBaseT A3020 Avignon Bridge Card	£179	£210
E512B A5000 Avignon Bridge Card	£169	£199
E602B RISC PC & A7000 Avignon Bridge Card	£149	£175
Etherlan/B Avignon Software Upgrade for any above Etherlan Card	£49	£58

Technology Matrix supply a full range of i-Cubed Network products. Please call for prices

Equipment, prices and backup that make Technology Matrix the preferred supplier



Technology Matrix Hot Line 0161 320 0000

89a, Stockport Road, Denton, Manchester M34 6DD. Fax: 0161 320 3210

# The art of the WEST

**T**he mystique and magic of the Old West – is it in the eye of the beholder? The real continent of wonders has a very chequered past, and such a romantic portrayal of this era is because of artistic licence. In the last two issues we have seen that it's possible to create some interesting illustrations with just a few tools in the new 24-bit art packages.

Enter *ProArtisan 24* from Clares, not usually mentioned alongside the previous packages of *Studio 24 Pro* and *Photodesk*. Would it be possible to create a reasonable facsimile of the Wild West?

Because I love the airbrush and it's one of the more difficult tools to duplicate on a computer, I thought I would start immediately with that gadget, so metaphorically speaking I just picked it up and started painting. What a surprise: it was great – gentle, smooth and the opacity control enabled a soft blend of colour. I was also amazed how swiftly it was able to keep up with the quick strokes I use with my airbrush technique.



Figure 1



Figure 2



Figure 3

In the last in this series looking at 24-bit painting packages, Walter Briggs gets 'Grizzly' with *Pro Artisan 24*

## First impressions

As the saying goes, 'things don't always prove reliable', and this was the case with *ProArtisan*. It wasn't that the airbrush did not live up to its potential, but that the manipulation of the device was hampered by the rest of the features.

To keep the comparisons of the different packages impartial I wanted to use the same approach with all of them. This was not possible with *ProArtisan* because you can use any brush shape as long as it's round. This meant the various brush shapes used in the other packages would not be usable in *ProArtisan*.

I contacted Clares and asked if it was possible to alter the brush shape and use an irregular one. The reply was apparently not, other than using a sprite as a brush, but this would only

reproduce the same colours of the sprite and not a workable solution. So I began work on the backdrop to the illustration with the round airbrush (Fig.1). As you will see from the composition, it's very blurred because the airbrush produces over spray, and it's not possible to use a mask with this type of freehand work.

At first it was fine because the sky and clouds lent themselves to the soft effect of the airbrush. I had decided that the sky would be a warm, glowing surge of billowing clouds, so the colours, based on a traditional painter's palette, were *yellow ochre* and *burnt sienna*.

Using the Hue, Saturation and Value colour picker, these pigments translate into H:29%, S:640%, V:98%, representing the lighter colour, and H:26%, S:76%,

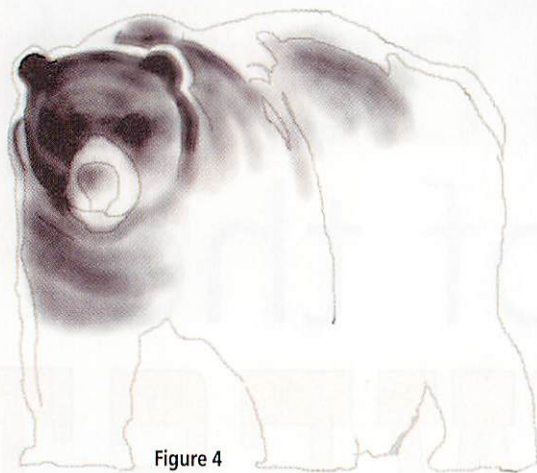

Figure 4

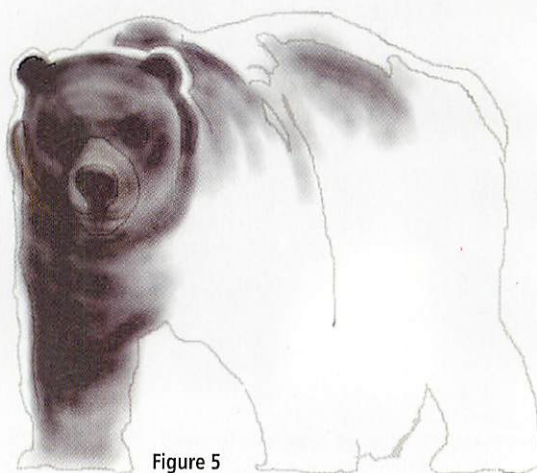

Figure 5

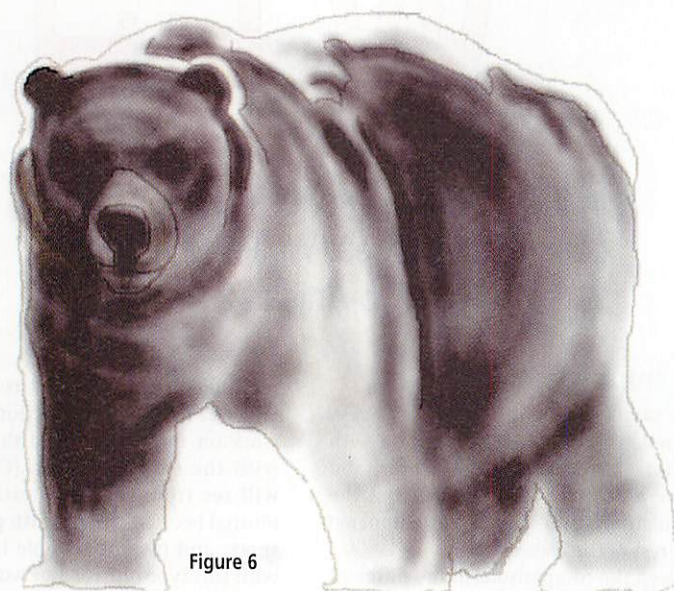

Figure 6

soft edge to any painting along a masked boundary. This great airbrush, and the progress of the Grizzly, meant that I never got round to creating a mask for the protection of the background, but that was not a problem, I could always add a mask later because the background to the bear was a single colour. I then produced a simple outline and began work (Figs 4 - 7).

I used a single colour, a sort of green/brown which

V:98%. The paint was applied in a circular motion, both clockwise and anti-clockwise, at a very low opacity – about 5 per cent – so producing the swirls I desired.

As the canvas began to take form I could distinguish areas that, when enhanced, could be made to represent clouds. Therefore, by adding darker shadows to these sections the sky was born. Painting the forest in subdued tones of purple and brown generated the right mood, but the trees and bushes were very blurred and indistinct (Fig 2).

At this point I had to revise my concept. The mountains I had wanted to include to provide the canvas for the 'Mountain Man' theme that I had imagined had to be abandoned. I was now forced to produce a landscape that would be compiled of shapes and forms that would be viable with the airbrush – the *snowscape* was then conceived.

Having decided that the tools were limiting my artistic expression, and leaving me feeling a little dissatisfied, I discovered that the *blend tool* was once again a superb instrument! This utensil proved to be as

good as most and produced the effect I wanted. It is able to blend – smudge or smear – the pixels of colour into a smooth coalescence of hues, and can stretch them across the picture. This is particularly visible in the snow banks of Figure 3.

### Swings and roundabouts

Though I was disappointed with *ProArtisan's* inability to cope with various brush shapes, the snowscape was acceptable. Now I was going to add a Bear and hopefully the portrait of a 'Mountain Man'. I had wanted to have the Grizzly as a guest in the *Photodesk* session, but time ran out so he was invited to pose in this picture!

As with the other packages, the Grizzly would be worked on separately and then cloned onto the main canvas. However, this became impossible. The great airbrush and smudge tools were let down further by some problems with the clone option.

### Applying a top coat

The bear was started without a mask. *ProArtisan* supports an 8-bit mask (this allows a graduated density), allowing a



Figure 7



may appear black on occasion because it is so dark. I thought I may have to resort to the smudge tool to get the fur effect, but the airbrush proved more than able in rendering this wonderful coat. I wasn't too concerned about the lack of a definitive outline because the Grizzly was to be superimposed onto the main canvas as a ghost image. At least that was my intention.

### To paste or not to paste

What I didn't know was that *ProArtisan* does not allow cloning from one canvas to another. I was sure that I was mistaken, but could find no reference to this option in the manual. This proved to be another bugbear – the manual! Since I could not find any information about cloning from one canvas to another I called Clares. And the answer? 'No this was not possible – why would anyone want to do that?'

'Anyway, if you want to do this you can cut and paste'.

I needed the bear without the background, so I coloured the background 'blue' to make masking easier – the single colour would mean the mask only had to recognise one pigment (Fig 8). I created the mask around the bear and cut it, hoping that the cut and paste would recognise the mask and allow me to grab just the bear. When this did not work I tried to look up 'cut and/or paste' in the index – they weren't



Figure 9



Figure 8

the manual I found that the so-called cloning of a sprite meant it would be in a tile pattern, and there seemed to be no way round it. So it was back to the cut and paste, and while it worked on the principle that Clares said, I could not get rid of all the blue background.

Back to cloning. The bear would have to go where one of the tiled sprites started, so that is why the Grizzly appears where he does, as

shown in Figure 9. there. I finally found these references under the section on Sprites, but there was no reference to cutting in connection with masks.

Another call to Clares provided the information that I *could* 'clone' from a sprite in the sprite pool, and that the mask would then be recognised, but my optimism was a little premature. The bear, if turned into a sprite and given a mask, would be recognised, but only with a 1-bit mask which meant no gradation on the edges.

Perhaps I could just clone the Grizzly very carefully from the sprite pool, and therefore manage without a mask – too easy!

### Bear with me

At first I could not work out why I kept getting the image in a place other than the one I wanted, but after checking this in

shown in Figure 9.

It's a shame that a fine 'boat was spoilt for a happeth' of tar' – a fine set of tools without the support they need. This seems to be an art package too obsessed with 'image processing', so falling short in the painting department – and, I think, **AU** unnecessarily so.

### Product details

Product: ProArtisan 24  
 Supplier: Clares Micro Supplies  
 Address: 98 Middlewich Road, Rudheath,  
 Northwich, Cheshire CW9 7DA  
 Tel: (01606) 48511  
 Fax: (01606) 48512  
 E-mail: sales@clares.demon.co.uk  
 Price: £99.95 incl VAT, ring for upgrade prices

# You can buy the next issue of Parents & Computers for only £1

r.r.p. £2.25



## A guide to education for 3-11 year olds

# Parents & Computers

**The right software**  
 ABC and 123 - choosing the best for your child

Class size what does the future hold?

Essential for all parents with or about to buy a PC, Mac or Acorn



## Parents & Computers £1 Offer

Please send me the next issue of Parents & Computers. I enclose £1 (coin or cheque/postal order made payable to IDG Media)

Name .....

Address .....

.....

Tel .....



Affix coin here



I don't wish to receive any additional promotional materials.

Send to: Parents & Computers, £1 Offer, Media House, Adlington Park, Macclesfield SK10 4NP.

## A guide to education for 3-11 year olds

Parents & Computers is essential reading for anyone with children concerned about how computers are used in school, standards of education and how you, the parent, can make a real difference.

All you have to do is send off this coupon and we will send you the next issue of this outstanding magazine for just £1.



# GAME SHOW

Steve Mumford brings you more news, hints and tips from the Acorn games scene

A special welcome this month to the *Fantasia Software Production* group, all the way from Thessaloniki in Greece. The two main developers of this brand new team are Billy Kotsias and Spiros Vergos, and the bold aim is to provide games of outstanding graphical quality to the deserving members of the Acorn illuminati.

There are two games in the pipeline. The first is *Wizard Apprentice*, and it's a puzzle game with about 70 levels of demanding action. Two versions will be available, allowing those without Risc PCs to enjoy the game in 256 colours at medium resolution. Those lucky enough to own a Risc PC with at least 1Mb of VRAM will be treated to sumptuous VGA-quality visuals.

The *Fantasia* gang has provided me with a couple of backgrounds taken from the game - I've said it before and no doubt I'll say it again, but if the gameplay matches the standard of the graphics, *Fantasia* will make a sizeable crater in the Acorn games world.

The second game promises to combine features from such titles as *Rise of the Robots* and *Killer Instinct* to create a spectacular beat-'em-up for the Acorn. With pre-raytraced characters and backgrounds, the game will be shipped as four distinct versions, catering for users with anything between 2 and 16Mbs of memory.

Due to the huge amount of graphics present in the game, *Fantasia* has plans to release all four versions on one CD. Both games should be ready for the autumn, and I'm eager to get my hands on a working version - good graphics can't rescue bad gameplay, but slap superb visuals on a game with outstanding playability and you've got yourself a masterpiece. The *Fantasia* team is already half way there - let's hope it can make it all the way.

## Going retro

A few months ago, I heard rumours that the Acorn might receive a conversion of *Exile*, that arcade classic from the days of 32K and sideways RAM.

Unfortunately, I've not heard a lot since and pending any startling revelations, it looks like we're going to have to do without. But if there's a game to be played there's a way of playing it, and Warm Silence Software has leapt valiantly to the rescue with its all-singing, all-dancing, almost-foolproof BBC emulator.

To complement this, it also provides a Spectrum emulator for even more gaming nostalgia. Come back with me, then, to a time when the BBC had more memory than you could ever possibly need, and experience the simple pleasures of games gone by. In between rediscovering the delights of the likes of *Exile* and *Castle Quest*, I've been talking to Robin Watts and Mike Borchers about their remarkable products.

*How did the emulator spring into being, and how long did it take to develop?*

Robin - Mike Borchers had the idea, about two years ago. It was developed in his spare time, so it went through periods of inactivity. The past six months, since its initial release, have seen a major degree of polishing to the finished product, and it now looks very nice indeed.

Mike - I started work on the Spectrum emulator during the Easter of 1993, after seeing *JPP* on a 386 PC. It took about a year to get '(c) 1982 Sinclair' on screen! I started the BBC emulator in August 1994, and it was better than *65Host* after only two weeks - I learned a lot about emulators while I was writing *Z80Em*.



*Fantasia's graphics are good ...*

*What's the success rate? Are there any games which fail?*

Robin - *Firetrack* and *Skirmish* fail to play. One or two others have minor problems, but we're not sure whether this is due to the emulator or the copies of the games we have. Our eventual aim is to support all the games we possibly can.

*Do you use the BBC emulator frequently? If so, what for?*

Robin - Games! I mainly play *Zalaga*, *Imogen*, *Galaforce*, *Frak*, *Fortress* and *Repton*.

Mike - I mainly play games in the course of testing the emulator.

*Repton gets used a lot!*

The emulators can be purchased for £15 each, or £25 for the pair. A separate device is available to allow you to load tape games via the parallel port, and they're working on a DFS disc reader which should be available by the time you read this.

I must admit that *Exile* is one of my all-time favourite titles, and *6502Em* runs the game flawlessly. If you'd like to get in touch with Warm Silence Software, you can write to them at St. Catherine's College, Oxford OX1 3UJ, phone them on (0585) 487642 or e-mail Robin at Robin.Watts@comlab.ox.ac.uk.



*... let's hope the gameplay matches up*

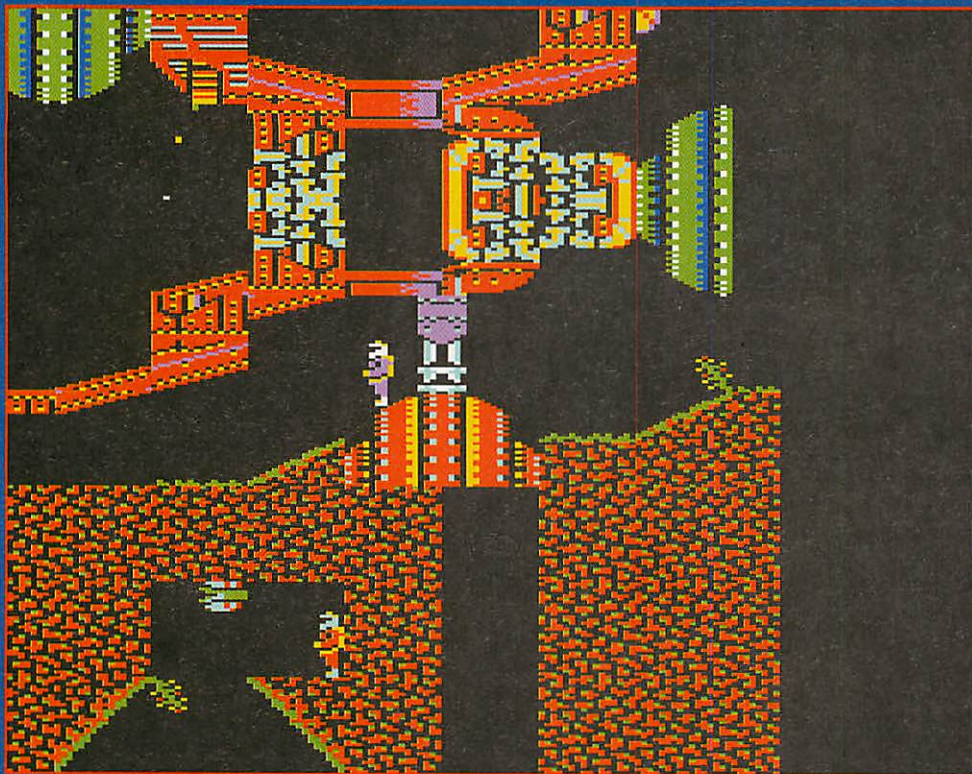

Play *Exile* on your RISC PC?

### Bees do it

Following on from the publication of *Swarm* on a recent *Acorn User* cover disc, I've been talking to its author, Matthew Bloch, about its creation.

*What gave you the idea to write Swarm?*

I've always wanted to write arcade games, and I remembered *Crystal Quest* from a few years back. I dug up a copy and had a go, and it appeared that, yes, the game was still playable.

It could perhaps use a few refinements here and there – you know the sort of thing. Basically, I thought that *Crystal Quest* was flawed in places and I knew I could do better.

Sadly, although I might have been able to improve on *Crystal Quest* in terms of gameplay, I discovered that I couldn't draw, and Robin Jubber offered to help me out when I appealed on the Internet. 'Helping out' is a bit of an understatement; he redrew the entire game in about a month – it took me that long to design one sprite! Robin also

suggested the name, supplied some sound effects and received far less credit than he deserves.

*Since Swarm is a conversion of a classic game, are there any other titles that you consider to be 'classic'?*

If I had to mention one which stood out, it would have to be *Lemmings* – all games up until then were based around the player controlling a central character or vehicle; the idea of having to control hundreds of objects at once was a huge innovation.

On the Acorn platform, the one classic that BBC owners can be proud of is *Elite*. The game had 'classic' written right through it; the authors took a completely original game concept, dared to implement it in three dimensions, combined strategy, simulation and action and managed it all in a memory space of 32K, loading off a tape spool a few metres long! A real masterpiece.

*What are you working on at the moment?*

I've got a spark of an idea – it involves several ostriches, men in armour, a school network, a StrongARM, a 21-inch monitor and a serial link or two.

Essentially, I'm aiming for multi-player *Joust* with a few bells and whistles, but I'd better not give too much away in case I never get it finished. I've done some preliminary work but there's still a long way to go. Again, Robin is providing the graphics for the whole game, but I really don't know when we'll finish it. Maybe by the end of the year?

*Have you any words of advice for Acorn coders?*

If you're going to do something, do it well, or don't bother! There's only so much that small development teams can do – Acorn games programmers need to know their own limitations.

*Finally, are there any cheat modes in Swarm?*

Of course! What sort of person do you think I am? There are a few clues buried in the program code for hackers to look at – as a starter, try holding down *Alt* as you click to start the game. Once you've done that, typing a number between 1 and 50 and pressing *Enter* will jump you to that level. That's one cheat; there are six others, and I promise to give a prize to the first person who can work out all six of them.

### And finally

That's all space will allow this time, but tune in next month for more news, hints and reviews. If you have any burning questions you'd like answered or information you want to spread around, drop me a line at the Game Show, *Acorn User*, IDG Media, Media House, Adlington Park, Macclesfield SK10 4NP or by e-mail at [augames@idg.co.uk](mailto:augames@idg.co.uk). See you next month.



Those old games had their moments

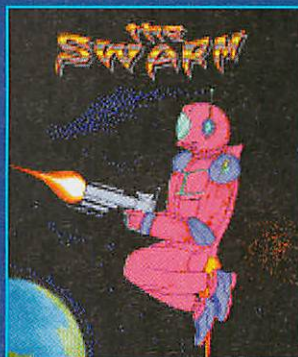

# Invisible cities

Pot plants and tube trains – Graham Nelson examines the significance of the map in an adventure game

Everyone agrees – the London Underground map is a classic. The Paris Metro has better trains, and the Berlin U-Bahn has kitsch wooden seats from the old East; but the London Tube has by far the best map. The lines are smooth and clean, in acrylic-paint colours. From any point, there are only a few ways to go. The gaps between stations are all about equal on the map, though in real life they vary from 100 yards to five miles. It's simple and clean, and it makes a satisfying tangle.

If a computer game had to represent London, the Tube map is how it would do it. Back in the days of Mrs Thatcher, there were several games that did just that – the object, move up in the world; the method, get rich and head for Docklands. Typing *EAST* from Oxford Circus took you to Tottenham Court Road; it

wasn't possible to travel half-way between, or rather, the game could not simulate all the different positions.

Adventure games are like cities which can only be crossed by the Underground, so there is no gradual way in which one place becomes another. You type *EAST* and you're instantly moved one unit to the east; almost as if you have boarded a train, travelled one stop and disembarked somewhere entirely new.

But does that make a good game? Doesn't it seem rather like a computerised version of that other famous coloured map

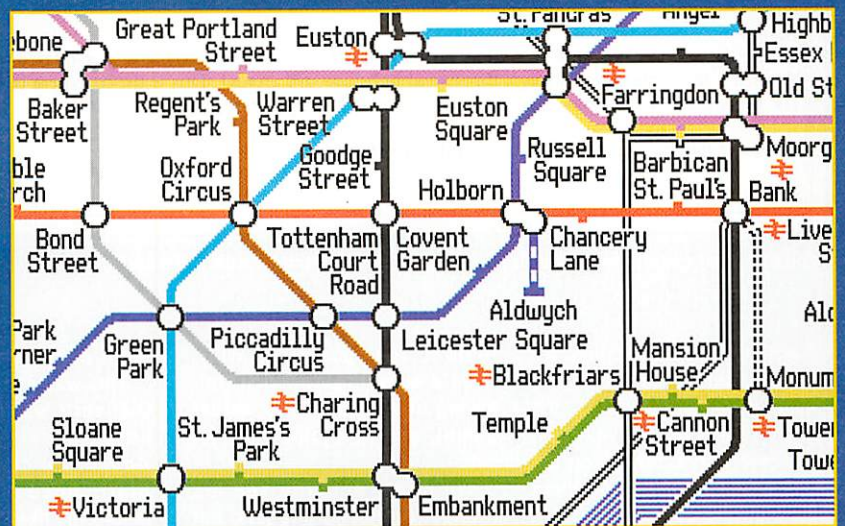

From Alex Hopkin's *UnderGrnd* application, which scrolls through the map – not quite a game

of London, the Monopoly board? During play, the counters are pushed around a board which, on the whole, seems rather empty – the fun of Monopoly is in confronting the other players, not exploring London.

## Game vs. Simulation

The other extreme is a flight simulator where exact positioning is all. No question of a board of squares here: the plane can

hang anywhere in the air, and even when it lands it can career sideways onto the runway.

Perhaps the difference is that simulations are about movement, not about places. So far, 'virtual reality' games can't decide which they want to be: the great idea is 'reality', that it should be convincingly like walking about. When it works the technology is amazing, but the thrill only lasts five minutes



Roaming a mansion of sixty rooms

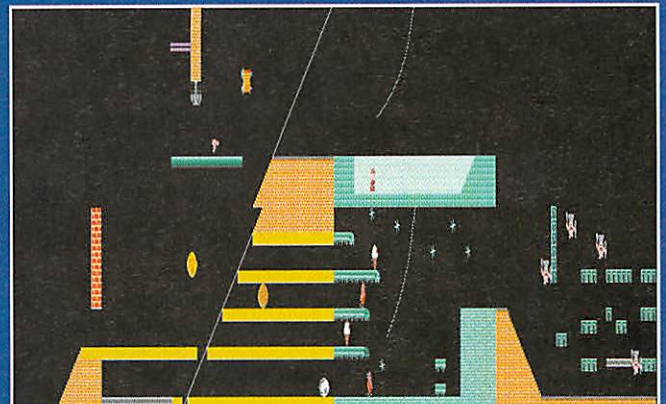

A portion of a typical game map: this is from *Jet Set Willy*

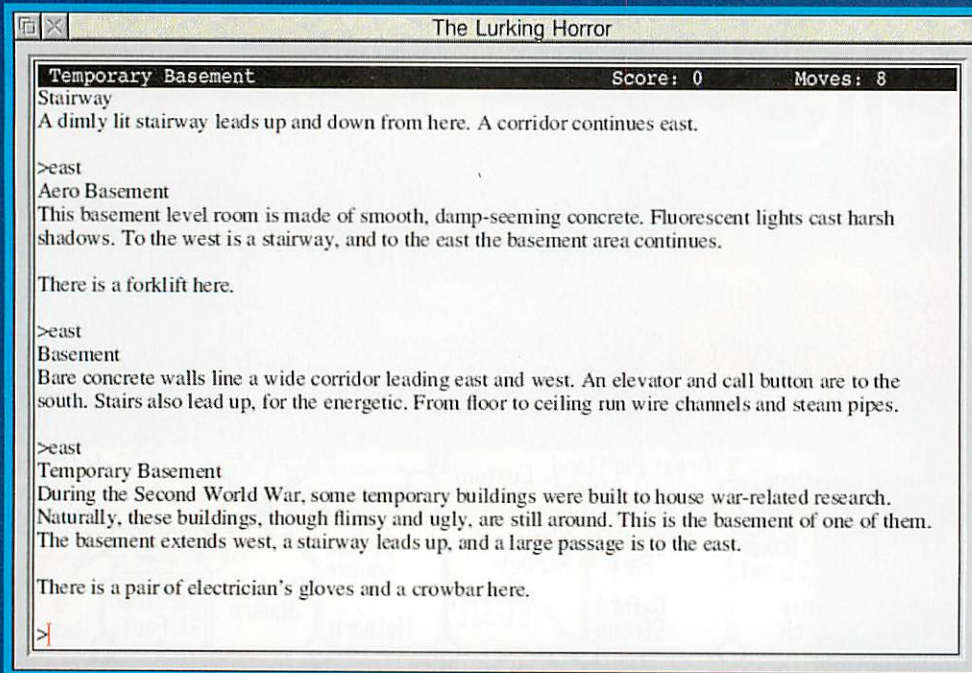

A dull east-west corridor in the hands of an expert – this is from Infocom's *The Lurking Horror*

– if walking was so exciting, we wouldn't need games at all.

The only successful VR games I've seen have been cyber-café affairs, relying on the player knowing that somewhere in the midst of the cuboidal buildings and curve-free pyramids, another human player lies in wait. The actual landscape is dull because everywhere looks like everywhere else – like the prairie of middle America. There's no real sense of exploration if nothing comes as much surprise.

Platforms-and-ladders games reached this stage in the early 1980s. Running and jumping around ledges, picking up diamonds, backpedalling along conveyor belts: and everywhere just like everywhere else.

What saved them was *Jet Set Willy*. Out of all the thousands of Sinclair Spectrum games, this is the one that people still play, if they have to emulate a Spectrum

to do it. The eponymous Willy, once a miner, is now rich (following his exploits in an earlier game), and has joined the jet set.

We never actually see his friends, or indeed any jets, but we do see his new house. *Jet Set Willy* had an entire mansion of different platform-and-ladder 'levels', and what made it original was that they connected together as rooms, each with a style of its own. Who can forget the *Cold Store*, the *Orangery*, the *Wine Cellar*, or the rather more surreal *We Must Perform a Quirkafleeg*?

### Rooms and pictures

Since then, every game designer has doubled as an architect. Games are played out on grids of rooms, and the rooms are all places in their own right, each a little different from the others. The great reward for the player is always to find another new

room, and another.

This was even true of one of the very earliest graphical adventure games, the *Adventure* cartridge for the Atari video console. Long before the likes of the Nintendo or the Sony Playstation, Atari made the first plug-into-your-TV console which didn't just play ping-pong.

*Adventure* was one of the few cartridges which wasn't an arcade game: a character could be steered through (rather annoying) mazes to find a dragon. It was a fairly open secret that one of the walls was false and could be walked through to reach a Secret Room – I once saw this done. But there was a rumour of a second, even more Secret Room. I suppose I'll never know if this was true, but somehow I wanted to believe it.

So how are the non-secret rooms put together? In a lively map, every room should be a different picture, and this is as true of a text game as a graphical one. The great games are like books of poems, or galleries of paintings. What they are *not* is repetitive, and they have sometimes had to work very hard not to be. Real landscapes do repeat themselves: in an average office block, each floor has the same plan. The

obvious way to write a building like this into a game would be to have different rooms for *First Floor Corridor*, *Second Floor Corridor* and so on. But boredom is laid into these like carpet. Making them tolerably interesting is a matter of finding something different to put in each, even if it's only a window or a pot plant.

### Diagonals, curves and junctions

Better still is not to have the same floor plan on each floor anyway. A map which is too regular lacks charm somehow, like the street plan of a modern American city: nothing but horizontals and verticals, blocks of houses and cross-roads. No diagonal connections, and no curves.

The best game maps, like that of the London Underground, have unexpected turns. The paths are mostly north, south, east or west, but some cut across in the diagonal directions: and there are loops. You can go all the way round the Circle Line and get back to where you start: there are two or three different routes between any two stations.

Locations need not be regularly spaced, either. Just because the *Pagoda* is intended to be half a mile from the *Great Wall*, there's no need to have a string of five or six locations for the player to trek through. One move can represent the whole walk if need be, even though elsewhere in the game one move is only from a kitchen to a walk-in cupboard, a distance of ten feet.

These are all virtues, but are they what make the Tube map a classic? I think a great map is one that makes you feel that the city was built from the map, not the other way round. Which brings me back to the title: in Italo Calvino's book *Invisible Cities*, Marco Polo tells the mighty Kublai Khan of all the cities he has travelled through. But Marco begins to confuse them together, until the emperor grows exasperated and sends for a great illustrated Atlas. All becomes clear to Marco again. Ah, says Khan, I think you recognise these cities much better from the map than you did when you were actually there.

### Competition

Time's running short, but if you hurry there's still chance to enter the *Acorn User Interactive Fiction Competition*. Write a short adventure game on any theme, without infringing anybody's copyright, and send it to me (with a file containing the solution) at *Acorn User* by 1 August. We hope to be publishing the best entries.

# Liquid Silicon

FREEPOST EH2725, Kirkcaldy, Fife, KY2 5BR

Tel/Fax: (01592) 592265

## Bar Coding Systems

We supply a range of high quality bar code readers from various manufacturers, integrated into the RISC OS 2 or 3 desktop.

Software processing of the bar codes allows input into any multitasking application. Uses include book checking in libraries, product labelling and POS facilities.

We also produce software to create numerous formats of bar codes yourself, enabling all kinds of information to be stored and read back by a reader.

**We will attempt to match or beat any advertised price.**

## Memory Upgrades

Please call to check prices. Others available

- A3010 1-2 Mb - £44.85
- A3010 1-4 Mb - £94.00
- Risc PC/A7000 SIMM2:
- 4Mb - £38.95
- 8Mb - £65.75
- 16Mb - £139.50
- 32Mb - £288.00
- 1Mb VRAM - from £80.00
- 2Mb VRAM - £175.00

## Music & Sound

This is a small example of our music section

- DMI 50 - £122.50
- Acorn MIDI card - £57.50
- MIDI Max - £79.00
- Music Studio 32 - £90.95
- PowerWAVE 30XG - £265.50
- PowerWAVE 50XG - £283.95
- Rhapsody 3 - £86.95
- Serenade - £87.95
- Junior Sibellus - £55.95
- Sibellus 6 - £187.00
- Sibellus 7 Student - £523.00
- Sibellus 7 - £825.00
- Yamaha YST-M5 speakers - £49.00
- Yamaha YST-M15 speakers - £66.00
- Yamaha YST-M20 DSP speakers - £75.00

## Hardware & Software

- Connect 32 SCSI II Risc PC card - £193.80
- Hard drives & kits - £Call
- Omega Zip drive - £198.50
- Omega Jaz drive - £588.00
- Pocket Book A-Link - £49.90
- Scart leads - £10.95
- Alone in the Dark - £30.00
- The Cobalt Seed - £22.00
- DarkWood - £22.00
- Dune II - £31.00
- Dune II CD - £45.00
- Empire Soccer - £22.00
- Game On! 2 - £15.00
- High Risc Racing - £22.50
- Global Effect - £31.00
- Personal Accounts 3 - £43.00
- Prophet 2 - £160.00
- Revolver - £14.50
- Rick Dangerous - £16.10

## Master Keyboards

- Fatar Studio 49 (49 keys) - £122.95
- Fatar Studio 610+ (61 keys) - £293.95
- Fatar Studio 900 (88 keys) - £593.95
- Fatar Studio 1176 (76 keys) - £683.95
- Fatar Studio 1100 (88 keys) - £818.95
- Fatar Studio 2001 (88 keys) - £1133.95
- Roland PC-200 MikII - £185.00

## Sound Modules

- Akai GM, Piano or Vintage modules - £299.00
- Korg X5DR module - £659.00
- Roland M-DC1 Dance module - £499.00

## InterLink

An easy to use file transfer and "talk" utility, linking any two RISC OS 3 computers via serial and/or parallel cables.

- Serial: 2m - £29.95, 5m - £31.95, 10m - £35.95
- Parallel: 2m - £31.95, 5m - £35.95, 10m - £42.95
- Both: 2m - £43.90, 5m - £49.90, 10m - £60.90

Longer serial cables are available to order. Please call for prices.

## Computer Systems

These computer prices are not for credit cards  
**StrongARM upgrades for £116.33 to end August**  
 Risc PC600 4Mb+0Mb HD425, AKF60 - £1308.53  
 Risc PC700 4Mb+1Mb HD425, AKF60 - £1551.03  
 Risc PC700 8Mb+2Mb HD850, AKF60 - £1929.33  
**Example options when buying a Risc PC:**  
 AKF60 (14") to AKF90 (17") - add £369.57  
 1Mb VRAM to 2Mb VRAM - add £100.00  
 Quad speed CD ROM drives - from £59.00

This is a very small selection of our range - free catalogues are available. 20/20 finance available.

**All prices INCLUDE VAT & carriage**

Official orders and callers welcome



# CD-ROM Solutions

CD-Recorders with software

CD Towers for networks or stand-alone

CD-ROM drives Parallel Port IDE / ATAPI SCSI

CDBrick Fast CD-ROM sharing

Backup 650MB PD

**eesoX**

01954 212263

Eesox, Suite 8c, Newton House, 147 St. Neots Rd  
 Hardwick, Cambs CB3 7QJ

# MICRO LASER DESIGNS



IMAGESETTING • PRINTING • SCANNING • COLOUR LASER COPYING • ACORN HARDWARE / SOFTWARE

Telephone : (01225) 833266

Facsimile : (01225) 833266

email : sales@microlas.demon.co.uk

105 Midford Road, Combe Down, Bath BA2 5RX

Micro Laser Designs is an Authorised Acorn Publishing and Consumer Dealer. **ALL PRICES SHOWN INCLUDE VAT - CARRIAGE IS FREE !**  
 Prices shown are for CASH / CHEQUE / DEBIT CARD / SWITCH only.  
 CREDIT CARDS MAY BE SUBJECT TO A SURCHARGE. E&OE.

**PRINTING!** Don't forget we offer a complete range of printing services at very competitive prices. Letterheads, Business Cards, Booklets, Leaflets, FULL COLOUR BROCHURES etc.  
**ATTENTION SOFTWARE HOUSES :** Why not ask us to quote for your next brochure, leaflet or manual. You are assured of the best prices, prompt service and no hassle!

**! STOP PRESS ! - PLEASE PHONE TO CHECK SIMM PRICES - THEY VARY ALMOST DAILY!**

**20/20 Finance - INTEREST FREE CREDIT OVER 20 MONTHS, 20% Deposit. (Max loan £1484.95)** Please call for details. Businesses / schools can use our leasing schemes. Subject to Status. ACORN ASSIST AVAILABLE.  
**PLEASE TELEPHONE (01225) 833266 for info!**  
**SCHEME NOW EXTENDED**

## ACORN RISC PC 600

- 4M HD425 + AKF60 ..... £1315
- 4M HD425 + AKF90 ..... £1685
- 4M HD425 + QUAD CD ROM + AKF60 ..... £1390
- 4M HD425 + QUAD CD ROM + AKF90 ..... £1760

## ACORN RISC PC 700

- 5M HD425 + AKF60 ..... £1559
- 5M HD425 + AKF90 ..... £1930
- 5M HD425 + QUAD CD ROM + AKF60 ..... £1635
- 5M HD425 + QUAD CD ROM + AKF90 ..... £2010
- 10M HD850 + AKF60 ..... £1939
- 10M HD850 + AKF90 ..... £2310
- 10M HD850 + QUAD CD ROM + AKF60 ..... £2015
- 10M HD850 + QUAD CD ROM + AKF90 ..... £2385

## PC CARDS FOR RISC PC

	Price when ordered alone	Price when ordered with RISC PC
<b>SXL-33</b> .....	<b>£225</b>	<b>£115</b>
<b>DX2-66</b> .....	<b>£285</b>	<b>£165</b>
<b>DX4-100</b> .....	<b>£345</b>	<b>£220</b>
<b>5x86-100</b> .....	<b>£570</b>	<b>£445</b>

## ACORN A7000

- 2M HD425 + AKF60 ..... £ POA
- 2M HD425 + CD ROM + AKF60 ..... £ POA
- 4M HD425 + AKF60 ..... £ POA
- 4M HD425 + CD ROM + AKF60 ..... £ POA
- 4M HD425 + Quad CD + AKF60 ... .. £ POA**

## ACORN A4

- A4 4M HD80 ..... £1310

## ACORN POCKET BOOK

- Pocket Book II 256k ..... £234
- Pocket Book II 1Mb ..... £326
- A Link ..... £49

## SPECIAL OFFERS

while stocks last

**WE HAVE REDUCED THE PRICES OF RISC PC'S WITH QUAD CD - SEE MAIN PANELS FOR DETAILS!**

**1Gb Connor SCSI II Hard Disc ... £270**

**Epson GT9000 Scanner ... £695 (incl. TWAIN / ImageMaster)**

- Impression Style ..... £90
- Impression Publisher ..... £145
- Impression Publisher + ..... £275
- ArtWorks ..... £145
- PhotoDesk ..... £180
- AudioWorks ..... £48
- Advantage ..... £48
- ProArtisan 2 CD ..... £75
- Turbo Drivers ..... £50
- PublicArt 2 ..... £30
- ArtWorks ClipArt CD 1/2 ..... £20
- Haunted House ..... £12
- Sylvia Lane ..... £12
- Crystal Maze ..... £25
- Magnetoids ..... £15
- Cannon Fodder ..... £20

**SIMM MEMORY (RISC PC / A7000)**  
 4Mb SIMM ..... £70  
 8Mb SIMM ..... £110  
 16Mb SIMM ..... £195  
 32Mb SIMM ..... £ POA

1Mb VRAM ..... £99  
 2Mb VRAM ..... £139  
 1 - 2Mb VRAM Upgrade ..... £110

**QUAD SPEED ATAPI IDE CD DRIVE FOR RISC PC / A7000 ... .. £ POA**

**IMAGESETTING** - Check our FILM prices! (P & P may apply). Prices are per page.  
**Don't forget prices INCLUDE VAT.**

Pages	A4	A3
1	11.75	14.10
2-9	6.45	11.10
10-24	5.85	9.40
25-49	5.00	8.20
50 +	4.10	7.00

Bromide prices on request.

Further discounts available - please call.  
 Email: bureau@microlas.demon.co.uk



THE **Datafile**

Tel/fax 01205 354203  
fonts@Datafile.demon.co.uk

**URW<sup>®</sup> 75 font pack.**

**£40**  
Inclusive

**Letraset<sup>®</sup>**  
30 font pack

All fonts fully hinted to Acorn specifications

**£25**  
Inclusive

*Copperplate*

*The new superb fonts package that contains*

*Engravers style fonts and our*

*Frameworks fonts in eight styles.*

**£40**  
Inclusive

Design by Tony Nash

Willoughby House, 89 Woodville Rd, BOSTON, PE21 8BB

### Part Exchange to RiscPC

Risc PC600	£ 1148.00
Risc PC700 5M	£1360.00
Risc PC700 10M	£1692.00
Quad CDRom add	£ 65.00
17" Monitor add	£300.00

### Typical Trade in Allowances

A3000	£ 125
A440/1	£ 225
A4000	£300
A5000	£450

Acorns 0% Finance Scheme available on exchanges



### SIMMs for RiscPC

exchange 4Mb to 16Mb	- £100.00
exchange 8Mb to 16Mb	- £75.00
exchange 8Mb to 32Mb	- £225.00
exchange 16Mb to 32Mb	- £175.00
additional 8Mb	- £65.00
additional 16Mb	- £125.00
additional 32Mb	- £275.00

### A3010 Learning Curve pack

- 2Mb RAM
- 12 months warranty
- AKF52 M/S monitor
- Acorn Advance Pack

**£365.00**

options:  
2-4MB upgrade - £75.00  
120Mb Hard drive - £145.00

### A7000 Special Package

- 6Mb RAM
- 540Mb Hard drive
- Quad Speed CDRom
- Microvitec SVGA Monitor

**£845.00**

### AJS Computers

Millstone House  
51 Heath Drive  
Chelmsford Essex CM2 9HE  
tel 01245 345263  
fax 01245 345233  
email sales@ajscomps.demon.co.uk  
all prices plus vat and carriage

**Hewlett Packard**  
**Deskjet 660C**  
Gobsmacking price  
**£225.00**

### Hard Disk Exchanges

For A3020  
60 or 80Mb to 250Mb - £95.00  
For A5000 and A4000  
40 or 80Mb to 210 Mb - £89.00  
40 or 80Mb to 425 Mb - £119.00  
for RiscPC600  
210Mb to 540Mb - £99.00  
for RiscPC700  
425Mb to 850Mb - £79.00  
425Mb to 1.3Gb - £159.00  
850Mb to 1.6Gb - £129.00  
Software transferred free.

# They say a picture is worth a thousand words...



**AWARD WINNING SOFTWARE**

# ...To us these words are worth a thousand pictures

### Press

"ImageFS is an excellent idea extremely well implemented; it works a treat, and is very good value for money."  
(Risc User Magazine)

"For any serious image processing work, ImageFS is a must."  
"Buy this program as soon as you can."  
(Acorn Archimedes World)

"This program appears to be the exception that proves the rule - for once you can believe the hype."  
"...this program is without peer."  
(Illusions Disc Magazine)

### Customers

"I'd like to say that I'm delighted with ImageFS and gobsmacked at it's speed compared with rival packages such as Acorn's ChangeFSI and CC's transgraphics loader."

"I have found it far better for import than either of Translator or ChangeFSI. It is effectively transparent in use yet easy to control: it is one of the best pieces of software I have ever used."

"The package is very powerful and professional."

"ImageFS is one of those essential products that anyone who is remotely interested in DTP or Graphics should own."

IF YOU USE GRAPHICS, YOU USE IMAGEFS



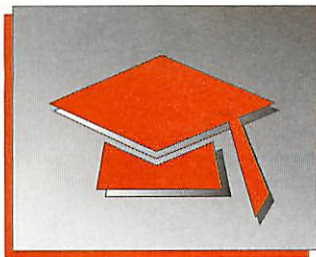

# Camboard's revised circuits

I've never been one who looks for something to criticise, but when something jumps out of the screen and smacks me between the eyes, I feel compelled to point it out.

The most noticeable negative feature of Camboard's *Simple Circuits* (reviewed November 1995) was the eye-smarting blood-red text over lime-green background. I was therefore very pleased to receive the latest version of *Circuits* which takes on board that criticism, and a couple of other suggestions and minor annoyances.

*Simple Circuits* is a computer-aided learning package designed to help children understand electricity and simple electric circuits. Aimed at Key Stage Two Science, it offers a practical approach to making circuits and is suitable for both the classroom and the home.

It covers lighting a bulb, switches – series and parallel – and controlling a motor and a buzzer. Also included is *ExtCir* (*Extension Circuits*) which follows the same theme but introduces resistors

and two-way switches in a further 16 circuits. This extension program could certainly be used in secondary schools.

Each circuit is explained in text form and is accompanied by a picture of the circuit on the board, and a schematic diagram. As the child works through the program, various questions are posed which can be answered immediately, or returned to later. The idea is that the child should go away from the computer to build and test the circuit before returning to answer the questions. Each answer is graded with a mark, and a printout showing the pupil's name with the questions and answers is available.

There is no increase in the £29.95 + VAT price which includes all the hardware

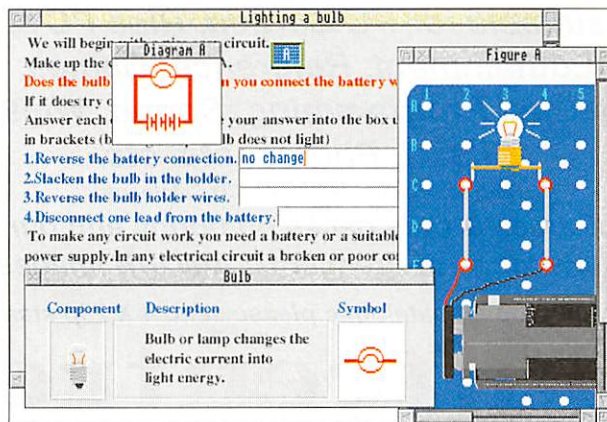

There's a great deal of information within this program. An excellent example of quality and purposeful multimedia presentation

required to make all the circuits used in both programs. A site licence may be purchased for £49.95 + VAT and single users may upgrade for the difference.

Camboard may be contacted on (01223) 264512 (phone/fax) or e-mail 101320,447@compuserve.com

## Xavier's latest word

Xavier, the company which specialises in software to help with reading and writing, has just released two new programs. *Chatback* is a suite of programs described as 'digital recording and audible comparison of the spoken word'.

It allows the teacher to present the pupil with recorded examples of words they can listen to and repeat. A useful feature is the visual display of phonemes which will 'mouth' the sequence of sounds making up a word.

To use this software effectively you must have a sound

sampler such as the Oak Recorder. *WordMaze* has been developed from the original BBC program and is intended to help pupils master single word-recognition and spelling. This is an open-ended program with possibilities for promoting word-reading and spelling skills across the curriculum and at all levels.

The programs are £32.50 + VAT each and a full review will follow shortly.

Xavier can be contacted on (01248) 382616, fax (01248) 382599 or e-mail pss005@bangor.ac.uk

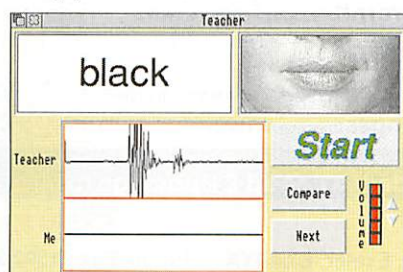

Visual comparison of teacher and pupil sounds

## Video help

Instructional video is more and more commonplace. Not wishing to be left behind, Pineapple has produced *The Artworks Video Guide* by Walter Briggs. The program begins with a general introduction to *ArtWorks*, covering the basic concepts of the program and showing the main tools for drawing and controlling the display.



Watch and learn from the experts

Walter then goes on to show in some detail how he used the program to create the tiger's head feature in several *ArtWorks'* adverts, and which uses most of the tools previously discussed. Although aimed at the beginner, it shows several advanced features of *ArtWorks*. I consider myself reasonably competent with the program, but even I learned a few tricks. This is a very well thought-out video which I sincerely hope will be the first of a series. It costs £19.99 inc VAT.

Pineapple can be contacted on 0181-598 1476 or fax 0181-599 2343.

### Contacting me

You can contact the Education page by writing to me, Geoff Preston at Acorn User, IDG Media, Media House, Adlington Park, Macclesfield SK10 4NP or by e-mail to: aueduc@idg.co.uk

# RISC PC MEMORY

## 72 PIN 70NS NON PARITY

THESE PRICES  
INCLUDE VAT  
Subject to availability

**8MB.....85:00**

**16MB.....175:00**

We now stock nearly 200 CD titles suitable for PC Carded, Risc PC's. Edutainment, Reference, Games, Internet, Programming, Sound, Win95, Clipart, Photos, etc. etc.  
Ring or write for new FREE CD Catalogue.

Games & Utils packs on floppy and our new range of Premier GLAMOUR images

For full product catalogue please send 4 X 25p stamps



**Softcentre**  
20116616  
01924 272511  
25, TOWNGATE OSSETT WEST YORKSHIRE WF5 9BL

CHEQUES (PAYABLE TO TOWNGATE TOYS), P.O., VISA, SWITCH ETC. UNDER £10 PLEASE ADD £1 TO COVER BANK CHARGES. P & P JUST £1.50 FOR ANY ORDER (NOT 50+ BLANK DISCS)

## Archimedes Public Domain Library

P. D., Shareware, and low cost software for Acorn computers. 

### New lower prices for APDL CDs

**APDL Clip Art CD-1 only £19.95**  
**APDL Clip Art CD-2 only £19.95**  
Each contains around 500Mb, all in Acorn format (Sprite, Drawfile and Artworks). Ideal for schools.  
**Buy both Clip Art CDs for just £37.50**

**APDL PD CD-1 only £14.95**  
**APDL PD CD-2 only £14.95**  
A huge collection of P.D. and Shareware at a realistic price.  
**Buy both PD CDs for just £27.50**

### Hard discs

Low cost IDE and SCSI drives and interfaces for all models

**A310/A400 IDE**  
210Mb - £160, 340Mb - £180, 512Mb - £210, 850Mb - £230, 1Gb - £245

**A3010/A3000 IDE**  
80Mb - £135, 120Mb - £165, 330Mb - £235, 512Mb - £265, 810Mb - £359

**A310/A400/A5000/Risc PC SCSI**  
Bare drives - 240Mb - £95, 1Gb - £239, Complete - 240Mb £199, 1Gb - £349  
Prices include cables, brackets and fittings. Lots of others available.

**Syquest EZ 135Mb removable, SCSI or IDE, internal or external Discs only £17. Solve your backup and security problems - from £169**

**Plus** Risc PC RAM upgrades and the famous APDL part-exchange scheme if you need a bigger hard disc (eg. 210Mb to 512Mb for only £125).

For a catalogue please send £1 or four 1st class stamps to  
APDL, 39 Knighton Park Road, Sydenham, London SE26 5RN  
Phone: 0181 778 2659 Fax: 0181 488 0487  
Prices include VAT and carriage - Nothing more to pay!



SSS = ?

The answer....

## Sibelius Software SPECIALISTS!

The best music processing software in the world, bar none! And the best place for a demonstration?  
**DON'T DEAL IN THE DARK! COME AND SEE THE LIGHT AT**

## THE DATA STORE

6 CHATTERTON ROAD, BROMLEY, KENT, BR2 9QN  
Tel: 0181-460 8991 Fax: 0181-313 0400  
Email: sales@datstore.demon.co.uk

If you're fed up with warehouse stores that don't know anything about what they sell, or shops that let you look but not touch, try us for a change! Come in and take advantage of our expertise and considered advice before you buy, and after you've made your purchase, we won't leave you in the lurch if you hit problems - our service is renowned around the world!

## ACORN CENTRE OF TECHNOLOGY

P.S. If you want a full demonstration of Sibelius, ring us first for an appointment - you'll need to reserve at least an hour!

DEC-DATA

### Resource Discs - help files, borders, backgrounds & more...

TextEase & SEMERC'S Pages Resource Disc	£12.95
Impression Publisher Resource Disc	£12.95
Impression Style Resource Disc	£12.95
Ovation Resource Disc	£10.52
Avery Label Templates for Publisher/Style and Ovation	£9.34
Artworks Resource Disc	£10.52

### Draw Clip Art Collections *Drawn in the UK*

Party, Wedding & Anniversary 2 discs	£16.45
Parish Magazine Set 4 discs	£19.95
Primary Teachers Clip Art Set 2 discs	£16.45
Map Set UK - Europe - World 3 discs	<b>LOW PRICE</b> £18.00
Greeks & Romans with ClearView guide	£11.75
Anglo-Saxons & Vikings with ClearView guide	£11.75
Egyptians with ClearView guide	<b>NEW</b> £11.75
19th Century Britain with ClearView guide	<b>NEW</b> £11.75
Earth & the Solar System with ClearView guide	<b>NEW</b> £11.75
The Normans with ClearView guide - 2 discs	£18.80
World War One with ClearView guide - 3 discs	£23.50
Rockets & Space Travel	£9.34
Story of Flight	£9.34
Military Aircraft includes WW1 and WW2	£9.34

### Applications

ClearView 2 hypertext/multi-media authoring system	£39.00
DRAW Changer Draw special effects	<b>LOW PRICE</b> £19.00



Send for the Free brochure of clip art and multi-media resources  
**All prices include VAT. Add £1 postage to all orders**



**Sales Hotline**  
Dep AU8, PO Box 97, Exeter, EX4 4YA Phone/Fax 01392 221702

# Early reading

**T**he Book Project by Longman Logotron is the most recent reading scheme which provides material for Key Stages 1 and 2, with some additional material for early Key Stage 3. Based on three interlinking strands – Fiction, Non-fiction and Language – each strand has up to four levels relating to the National Curriculum programmes of Study and Attainment Targets in English. Interestingly, this scheme can also contribute to pupils' Information Technology capability up to and including Level 3.

The books have been especially written and illustrated for the scheme and you are immediately struck by the clear presentation and lively content. As well as the books there is a range of support materials including cassettes, videos and computer software.

## What you get

Each software pack contains an A4 software resource book and a huge collection of floppy discs, ranging from five to 15. The discs contain the main program, some clip art and a number of activities, each one specifically related to a particular book. At £75 this seems an expensive product, but it does include a full site licence.

## In use

I gave one of the program discs to my seven-year old twins, with no instructions other than to call me when they had something they thought I'd like to see. After about half-an-hour they had more or less worked it out for themselves, and both had produced very creditable pieces of work, having clearly understood the words associated with the activity. But this is not really what this software is about, although it does seem to demonstrate that the teacher would not have to spend a

Geoff Preston looks at some software to help develop reading skills for the very young

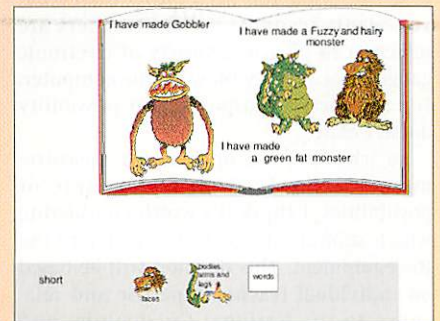
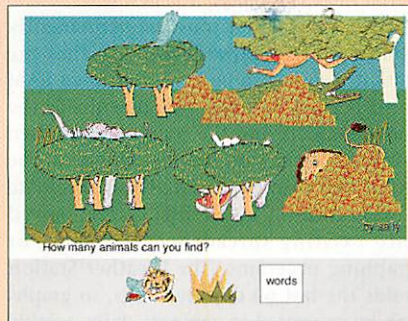

great deal of time showing the pupils how to use the program.

The books, the software and the other resources are intended to compliment one another and although they can be used separately, you really need both to get the most from the material. The software activities are mainly based on building a picture using drag and drop to locate some pre-drawn clips taken from the book. Parts of the picture can then be labelled by dragging on some words or phrases taken from the book.

Simple sentences can also be built in this way, but there is the facility of adding your own text which is entered from the keyboard. Typical of this is *Let's Go Into the Jungle* from Fiction 1. Having read the book, the child can build a picture using pre-drawn animals which are dragged onto a background. The picture can then be labelled using the words provided which are also dragged onto the screen, or by writing short sentences to describe something in the picture.

## Conclusion

I can't help feeling the software needs just a little more time spent on it. If you run it from the supplied floppies, you're occasionally asked to change discs. One prompt asked for Disc 1b to be inserted, yet the six discs currently in use were labelled 1, 2, 3, 4, 5 and 6. That is just sheer carelessness and not something I expect from Longman.

The other concern is with the work disc

which, as far as I can see, must be titled 'workdisc' and placed in drive 0. There is no apparent way of mounting the disc from within the software and if the disc does not contain enough space to save a piece of work, it saves as much as it can before telling you the disc is full. Consequently, there will be an irretrievable drawfile on the disc. To me, these all look like pitfalls waiting for someone to stumble in to!

That aside, this is a very competent scheme. The software costs £75 per pack which is quite pricey, even though you get a great deal of material for your money, and the books range from less than £1 to about £5. On the face of it that sounds cheap, but some books are part of a series meaning the whole series works out quite expensive. However, the quality is excellent and has been thoughtfully written.

Contact Longman Logotron on (01223) 425558, fax (01223) 425349. **AU**

## Footnote

If you're choosing a reading scheme for use at home, either to supplement the work done at school or for pre-school children, which do you choose? The answer is simple. If your child is at school, use the one which matches the one used at school. If your child is pre-school, use the one in use by the school s/he is going to attend.

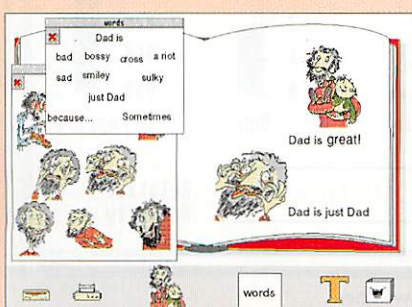

The Information Technology National Curriculum includes some attainment targets which come under the general heading of Measurement and Control. According to several reports, of all the Information Technology areas of study, Measurement and Control is the least well addressed in schools, and of the two, Measurement is frequently not addressed in any serious way.

There are two reasons for this, I feel. Firstly, schools perceive measurement equipment as being expensive. Well, some kits are, especially if you try getting class sets, but some are quite affordable. I think it's unlikely you'll be able to do very much without some additional hardware, but this need not be very expensive – you have to decide what you need rather than what you want. Secondly, many teachers are reluctant to plug in a variety of electronic gadgets in case they blow up the computer. For all practical purposes, that possibility doesn't exist.

So what are the options for measurement? Before looking at a couple of possibilities, I think it's worth considering which subjects are going to be able to use the equipment. This decision will be based on individual teacher expertise and relevance to the National Curriculum, and remember, measurement is required by subjects other than IT.

Here, then, are four options for several subjects, ranging in price from next to nothing to quite a lot. With all of these kits, massive quantities of student (and teacher) motivation are included at no extra charge.

### Voltmeter

In the February 1996 issue of *Acorn User*, Mike Cook described how to make a digital voltmeter. This is something Key Stage 3 or Key Stage 4 students could do very well. Even if you are not actually making the kit Mike describes, the finished item could be used in an experiment to obtain some real measurements.

Keeping a look out for small articles like this can often lead to a cheap IT solution which fully satisfies the National Curriculum requirements. Of course, it may require a little extra work and imagination from the teacher, but where there's a will...

### Weather Station

Finding out about the weather is fascinating for children and The Advisory Unit's *Weather Reporter* enables children to record the wind speed and direction, temperature, rainfall and, optionally, humidity.

If you want to install *Weather Reporter* in your school you'll need to budget for up to £600. The software and hardware kit costs £395 with a further £150 for the optional humidity reader. (If the two are purchased together there is a £50 saving.)

# Measuring up

Geoff Preston looks at some options for using computers for measurement

On top of that you'll need to add about £20 - £30 for fitting because the weather station needs to go on the roof and you'll probably have to pay someone to put it there: a TV aerial fitter is probably the best bet.

Once in place, it must be permanently connected to a power supply so that the data it records can be held in its own RAM until needed. The software downloads the measurements into the computer and then converts them into graphs which can be saved and printed. Alternatively, the data (in the form of a CSV file) can be moved into existing spreadsheet, database or graphing programs. The Weather Station holds the last 60 days readings, so graphs can be generated to compare daily, weekly or monthly weather.

This could be even more useful if more people could access the data. At present, only the computer actually connected to the Weather Station can make use of the data. If you want anyone else to be able to use it, you'll need to export the CSV file to a place others can access. At the time of writing, the software was about to undergo a major update.

The Geography department will, of course, be the leading users of this product,

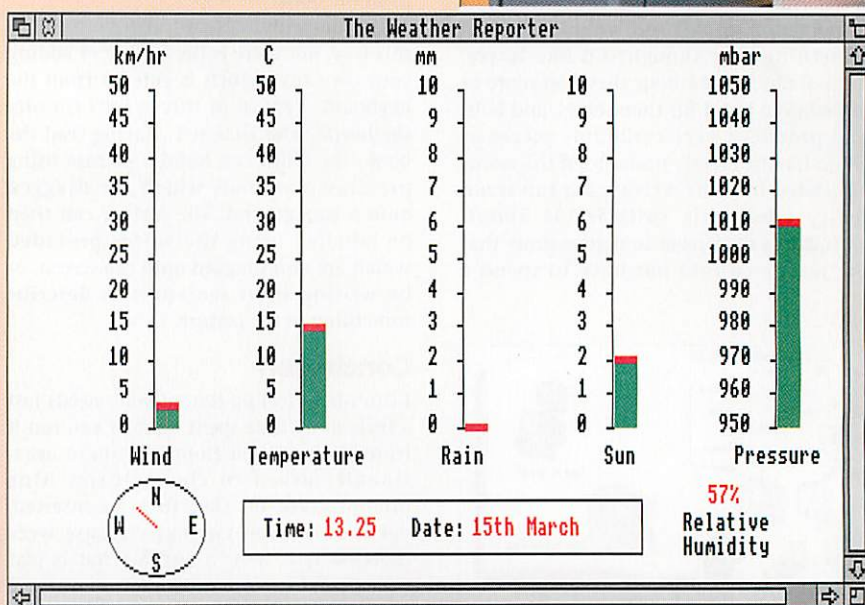

The graph can show hourly, daily, weekly or monthly weather

although the Science department may well find it useful for certain areas of the course.

## Heartbeat

"Information Technology should be used....." appears in the National Curriculum Orders for all subjects, except PE. We have frequently had students measuring their heartbeat with the aid of a stop watch and a pencil and paper. Firstly, take your pulse while at rest. Then go for a lengthy run. At the end of the run, record your pulse rate every half minute or so, then

using the recorded data, plot a graph to show your recovery rate.

For £99, VTI can supply *HeartBeat* which will make the whole process a little more sophisticated, not to mention accurate. *Heartbeat* is a real-time ECG monitor which is very accurate, although it should be noted that this is clearly not a life-monitoring device.

The kit includes a receiver with serial port connection, a 'Cardiosport' transmitter with an adjustable chestband, software and manual. The transmitter is powered by a 3V battery and clips to the chest band. Because it uses high frequency radio, there is no wire connecting the user to the computer, thus allowing easier movement.

Of all the products here, this, I feel, has the best software (even though it was developed by a company with the lip-curling name of Drastic Measures). It feels as though it was written by someone who is a RISC OS programmer, not someone who programs on a PC and has read the manual to produce an Acorn version.

There are two programs on the disc. *HeartMon* merely displays your varying heart rate as a number, whereas *HeartBeat* displays a real-time graph so that you can see your heart rate increase during exercise and decrease during rest. The graph can be saved as a *Drawfile*.

The manual, on the other hand, leaves something to be desired as it could be a little clearer in places.

If you're planning to use this with a class, you'll need to give them a small amount of homework the week before. They'll need their height in cms and their weight in kilograms, which is then entered into a table and used to calculate what the maximum heartbeat should be.

*Heartbeat* is likely to be used mainly by

the PE department, but also by Food Technology and Science.

## Data logging

Of the data logging kits available, the Philip Harris data logging system is, in my opinion, about the best. If ever there was an indestructible piece of kit, this is it. Of course, a system as well built as this is quite expensive, especially if you're thinking of buying class sets, or even half class sets, but you'll have a very versatile resource that will last a long time.

At the heart of the system is the DL Plus (of which there are two versions - 32K and 128K), which is, effectively, a small computer with input via a small keypad and output via a liquid crystal display. There are also four input ports into which you may attach a variety of sensors, and output ports to which you may connect a variety of computers.

There are currently over 20 sensors ranging from temperature to pH value and they cost from £33 to £155. Up to four sensors can be used at any one time, with the values recorded over a wide variety of time spans. The data is held in the DL Plus and can be downloaded into the computer in either native format or as CSV files which can be imported into a spreadsheet or database. Alternatively, if the experiment and the Acorn computer are in the same place, the data from the experiment can be fed straight into the Acorn to give a display which updates in real-time.

My only grumble with the software is that it must be loaded from a writable source. Therefore, if you run a network and usually load software from a read-only source such as an application accelerator, you'll have problems. One way around this is to copy the software from the read only area into a RAM disc: not ideal, but it does work.

Although the Technology department might find some limited use for this product, it is in the Science department that this kit will prove invaluable for recording data from experiments. This system is almost a minimum requirement for KS3 and KS4 Science and Information Technology. **AU**

Virtually indestructible and totally versatile, but at a price



The program monitors the heart rate and plots a very accurate real-time graph

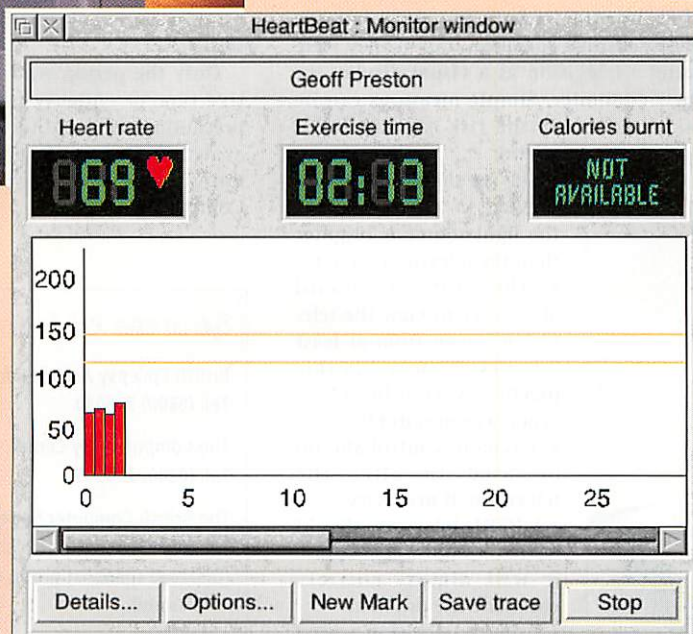

## Contact details

Supplier: Philip Harris  
Tel: (01543) 480077  
Fax: (01543) 480068

Supplier: The Advisory Unit  
Tel: (01707) 266714  
Fax: (01707) 273684

Supplier: VTI  
Tel: (01243) 531194  
Fax: (01243) 531196

# Seizing the blame



**E**pilepsy is defined by the British Epilepsy Association as "..... a tendency to have recurrent seizures (also known as fits.) Seizures may take many forms, differing from one person to another, but the reason is always the same. Seizures are due to bursts of electrical activity within the brain. The type of seizure depends on the part of the brain in which these bursts start and spread."

Around one in thirty children in the United Kingdom has epilepsy. Childhood epilepsy varies in type, degree of severity and links with other problems. Most children with 'straightforward' epilepsy have a normal, active childhood and with a few sensible safety precautions are able to enjoy doing all the things their friends do like swimming, sports and games.

We recently found out that my daughter, Sarah, had been having epileptic fits, and she was diagnosed as having a form of epilepsy which provokes absence seizures, once known as *petit mal epilepsy*.

Having read much in the press over recent years about the effects of computer games and the fact that they were blamed for causing epileptic fits, I felt I needed to know more about this whole issue as Sarah is a frequent computer user and I needed to be sure that this didn't put her unduly at risk.

## Photosensitive epilepsy

It would appear that there is no evidence to suggest that computer games (and by inference computers themselves), can

## Colin Rouse looks at the controversy involved with epilepsy and computers

cause a child to become epileptic unless there is already an underlying tendency for epilepsy. There is also no evidence that I can find to suggest that these can cause an epileptic attack unless the child is suffering from a form of epilepsy called *photosensitive epilepsy*.

This type of epilepsy is where seizures are provoked by flickering light encountered in everyday life. Both natural and artificial light sources can precipitate seizures, but the most common appears to be the television. It is often assumed that everybody with epilepsy is photosensitive, but current figures suggest that between only three and five per cent of people with epilepsy suffer from photosensitive epilepsy. It occurs before the age of 20 and is most common between the ages of nine and 15. Females are more affected and there is some evidence of a genetic factor in this condition.

## Factors to consider

There would seem to be a problem for photosensitive epileptics only if they were using a television as a visual display for their computer. Simple measures can be taken to reduce the risk of inducing a seizure.

- The set should always be viewed in a room where the light source is brighter than the television screen.
- The sufferer should always try to view the television screen from at least 2.5 metres away. (Is this practical when using a television as a monitor?)
- A remote control should be used to alter the television, if necessary.
- A 100Hz television should be used, if possible, because it will almost entirely eliminate the problem.
- Using a television screen

of less than 14 inches will help.

Contrary to public belief, the use of VDUs rarely presents any risk to a person with epilepsy.

## Using computer monitors

There is no evidence to suggest that dedicated computer monitors present any risks to health. Older monitors, refreshing at less than 60Hz, may contribute to seizures in people who have photosensitive epilepsy, but most modern monitors refresh at a much higher rate which presents a very minimal risk, even to those who are susceptible to this condition.

The only real solution for a photosensitive epileptic person who wants to use a computer but is sensitive to the refresh rates used in current technology is to use a flat panel screen such as an LCD matrix used in most laptop and palmtop computers which has no flicker.

## Conclusion

I have come across no evidence to suggest that the person who does not suffer from epilepsy (or is susceptible to it) runs any additional risk whatsoever from using a computer or computer game. Indeed, the vast majority of epileptic sufferers also needn't worry about the use of such things as they are very unlikely to induce a seizure.

Only the person who has a photosensitive type of epilepsy has to take certain precautions to avoid the onset of a seizure as detailed above. So the message to my daughter is 'Carry on **AU** Computing!'



## Sources of Information:

British Epilepsy Association  
Tel: (0800) 309030

The Computability Centre  
Tel: (0800) 269545

The British Computer Society  
Tel: (01793) 417417  
(Disabled specialist group - Mr Colin O'Keefe)

**iSV Products**

"...an essential purchase for any A5000 owner."  
Risc User

# VIVID5000

The graphics enhancer on a disk

The latest version of iSV Products ViVID screen mode enhancer designed for the Acorn A5000, A4000, A3010 & A3020 with 14" multisync monitor

- Most work areas now available in 256 colours including 1024x768 and 2112x1664
- Refresh rates up to 64hz
- Easier access to utilities/information windows
- 1600x1200 work area in 256 colours at 60hz\*
- Almost 100 new screen modes
- Greyscale versions of all modes
- Easy to use RiscPC style mode picker
- Now compatible with Computer Concepts ColourCard
- Save default work area and number of colours
- Almost no slow down even in big 256 colour modes
- Extended 4 colour greyscale dithering
- Compatible with all correctly written multi-tasking apps
- Requires NO extra hardware (But needs Risc OS 3.1)

"...a great package."  
Archive

Only **£16.50**  
inc UK p&p

\*Not all ViVID chips are capable of running at this resolution/number of colours

To upgrade from ViVID20 simply return your master disk with a cheque for £5.50

# Draw Works2



- DrawWorks2 integrates fully with Draw.
- All the new buttons appear to be part of Draw
- Draw Menus can be accessed from button bar
- Click on the justify tool and the justify menu opens
- Open colour pickers with just one mouse click
- Quickly open line width, join and pattern menus
- Select Fonts and pt size from the button bar
- Tear off version of Draws normal toolbox
- Button bar can be vertical or horizontal & torn off
- Our new AutoOLE system

DrawWorks2 adds the following new features

- |                                   |                                     |
|-----------------------------------|-------------------------------------|
| Kerning of Outline Fonts          | Path bending & warping              |
| Path Merging                      | Convert thin lines to 0.25pt        |
| Path splitting                    | Wrap path objects around 3D objects |
| Colour filters                    | Auto-grouping of objects            |
| Full file information window      | Full control over preferences       |
| Decode fonts used in a file       | Isometric transformations           |
| Set Outline colour to fill colour | Define your own transformations     |

"Whenever I load Draw I always have (it) loaded."  
Arc World review of DrawWorks1

"...just what you need...highly useful."  
Acorn User review of DrawWorks1

**Version 2.1 Also offers**  
Contrast & Brightness Filters  
CMYK separations

Advert Produced with DrawWorks2

# XStitch for Risc OS

"...ridiculously low price...cons: none."  
Acorn User November 1995

"...particularly useful... Value 5/5."  
Archimedes World June 1995

Save £5  
**£16.50**  
inc UK p&p

Anchor Approved

Why not visit our Web site on the cover CD

**iSV Products**  
86 Turnberry, Home Farm  
Bracknell, Berks, RG12 8ZH  
Tel 01344 55769

All prices include UK carriage  
Overseas orders please add £2.00

All details are correct at the time of going to press E&OE. All Trademarks are acknowledged  
Discounts are based upon prices exc p&p

## HOW GOOD IS YOUR GRAPH DRAWING PACKAGE?



- Does it support OLE for the latest DTP packages?
- Is it simple to mix different graph types?
- Has it got extensive presentation controls?
- Can you put text anywhere you want?
- Are key areas fully under your control?

We could go on for much, much longer, nag about shadow effects, backdrops, automatic table generation etc...  
Why not contact us for full details of...

# GraphMate

Presentation graphics without tears.

Now with even more control!!!

Furthermore, TRADE IN your old graph drawing software - GraphBox, Presenter, Chartwell etc - to GraphMate before 31st August, and get a £15 discount (Phone for details).

GraphMate costs £45 for a Single User pack, p&p included.

GraphMate also links with the leading Acorn table editor:

# TableMate3

The table editor for RISC-OS

"I would recommend this package to anyone" Archive Feb. 96  
Single User £34-50; Upgrade from Style/Publisher £19-50

Dalriada Data Technology, 74 Greville Road, Warwick, CV34 5PJ.  
Phone/Fax 01926 492459

<h3>PDCD-1</h3> <ul style="list-style-type: none"> <li>• This CD contains a total of 493 Mbs</li> </ul> <p><b>£25</b> Inclusive</p>	<h3>PDCD-2</h3> <ul style="list-style-type: none"> <li>• This CD contains a total of 404 Mbs</li> </ul> <p><b>£25</b> Inclusive</p>	<h3>PDCD-3</h3> <ul style="list-style-type: none"> <li>• This CD contains a total of 648 Mbs</li> </ul> <p><b>£25</b> Inclusive</p>
---	---	---

Buy 2 and get the 3rd FREE

The Datafile Catalogue and Ordering System

We can offer you a truly massive range of Freeware and Shareware.

Why pay for other libraries  
Cats' ours is FREE

Catalogue  
**32**  
Out Now



# Merlin

**£94**  
inclusive

THE Datafile Sales@Datafile.demon.co.uk  
Tel/fax 01205 354203  
Willoughby House, 89 Woodville Road, BOSTON, PE21 8BB

# Free Ads

- Scanlight 256 scanner, £60. EasiWriter Pro, £65. Advance, £40. A-Link for Pocket Book, £35. Tel: 0131-447 8624.
- A3000, ARM 3, RISC OS 3.1, 4Mb RAM, 210Mb HD, DFS interface, provision for internal CD-ROM drive/5.25in drive plus two expansion cards, serial port, software. £350. Tel: 0115-960 5718.
- Software: Eureka v3 (unused), £80, Touch Type, £20, 10/10 Maths, £10, English £10. RISC OS 3 fonts, £10, Pipedream £10. Tel: Reading (01734) 426843.
- A420/1 RISC OS 3, SVGA monitor, 4Mb, software, Inkjet printer, £350 ono. Tel: (01223) 363545.
- Philips 8833 VDU. Master128, double d/sided 40/80 powered drive, quad cartridge with Beebug C, Adv Disc Toolkit, Brom+, Overview etc. Excellent condition. Offers all or part. Tel: (01785) 242294 (Stafford).
- Acorn A3000, 2Mb, Video Enhanced High Resolution Graphics, 14in NEC Multiscan colour monitor. Perfectly working. £250. Tel: 0181-967 3048 (Middlesex).
- A5000, 4Mb RAM, 120Mb HD, Multiscan monitor, FPA10 floating point accelerator, MEMC 1a. Excellent condition, £550 ono. Tel: (01934) 852540 (eve) e-mail: wts@vsi.co.uk
- Risc PC 600, 8Mb RAM, 2Mb VRAM, 420Mb HD, 17in AKF85 monitor, 16-bit sound, CD-ROM drive, audio-mixer, PC 486-33 processor. £1650. Telephone after 5pm (01752) 840027.
- A3010, 4Mb RAM, 81Mb Hard disc, Acorn monitor, games, word processor. all leads and manuals. Excellent condition. £400 ono. Tel: Tim (01952) 814110.
- For sale: CD full of emulators for the PC and Amiga. £20. Tel: Matthew on 0181-523 8058 or 0973 301882.
- Wanted: Omar Sharif's Bridge (A5000). Tel: Peter on (01387) 256657.
- 60MHD IDE A3000int for RISC OS 2V, £40, 1Meg RAM upgrade A3000, £30. LC10, £50 ono. Tel: (01494) 872918.
- A5000, 2-4Mb Simtex memory upgrade, £30. Cumana double speed parallel port CD-ROM drive, £40. Tel: (01248) 852163.
- Archimedes computer software for sale: Eureka 3, Impression Publisher 4.08, Prophet 2.13 (Business Accounting), also Scanlight 256, all £70 each. Tel: 0116-266 3721.
- Archimedes 400 plus upgrade, unused, offers. Microvite CUB colour monitor, model number 1431 DS, unused, offers. Tel: Mike on 0181-850 4047.
- Risc PC 600, 9Mb, 425Mb, AKF60, warranty, 14k4 modem, 486 card, Inkjet printer, serious software, games, £1470. proTeus CD/cartridge drive + SCSI interface, £490. Call (01509) 264934 evenings.
- Cumana 300i dual speed complete package for Risc PC, £50. 4Meg SIMM, £40. Tel: (01386) 49732 evenings. Poss deliver.
- Games: Sim City, Fervour, Virt Golf, Birds of War, Prem Man 3, Crystal Rainforest, Interdictor, £10 each £50 the lot. Tel: Simon (01628) 526144 or 101603.3670@compuserve.com
- Pipedream 4, £10, Pendown, £10, Sylvia Layne, £5, Twinworld, £4. Tel: (01227) 265802.
- A4000, 4Mb RAM, 80Mb HD, AKF40 monitor. Oak sound sampler, Star LC24-200 colour dot matrix printer. Impression Junior, Schema, Spex + various games and clipart, £700. Tel: (01392) 468430.
- A5000, 4Mb, 40 + 170Mb HDs, RISC OS 3.1, AKF18 monitor, PC Emulator, LC + PD software, excellent condition, boxed with manuals, £525 ono. Tel: (01246) 237037 (Chesterfield) or e-mail: rayharris@argonet.co.uk
- Wanted: good quality MIDI compatible keyboard, any makes considered (for deaf daughter). For sale: Impression II fully complete with manuals & hardware key (can be fully upgradeable), £50. Please contact: A J Fox, 10 Hornsby Avenue, The Harleys, Worcester, WR4 0PN.
- Acorn A3000, 2Mb RAM, Learning Curve, colour monitor, printer, PC Emulator, lots of games/software, all manuals, £300. Tel: (01704) 560255.
- HYBRID Music 5000/4000 system for the BBC Master, including keyboards, all manuals, and about 20 discs of music software, £160. Or will split. Tel: (01935) 623506.
- Risc PC 600, 2 slice, 8Mb + 2 VRAM, Power-Tec SCSI II, 420HD + 360HD, Quad CD-drive, Publisher, ArtWorks, Compo, ProArt 24, Personal Accounts + others (no monitor), 18 months on site, £950. Tel: (01233) 632034.
- A5000, 4Mb RAM, 210Mb HD, RISC OS 3.11, Sony Trinitron TV/monitor, Cumana double speed CD-ROM drive, books, software, excellent condition, only £500 ono. Tel: (01248) 852163.
- For sale: Impression Publisher, complete, £70, Eureka v3, £50. Tel: (01223) 892891.
- Canon BJ10ex Bubblejet printer inc sheet-feeder + Turbo-driver cable and software, £150. Tel: 0161-962 7117.
- Games swap: CMaze, Dune II, Cannon Fodder, Stunt Racer, Xenon 2, James Pond, Pacmania, Speedball, Sim City, Chuck Rock, Hero Quest, Cyber Chess. Tel: James (01245) 268834.
- Wanted: Populous, Cannon Fodder and Speedball 2 for swap. Ring Michael for list of games on (01923) 243658 evenings (Hertfordshire).
- Archimedes A3000, 1Mb, RGB colour monitor, RISC OS manuals, application discs, 10 games including Lemmings, Hero Quest, Break 147, Holed out. £200 ono. Tel: 0117-987 1150.
- BBC Master 128K, 40/80 5.25 Viglen drive, some software, VGC. £100 with CUB colour monitor. £60 with mono monitor. Tel: (01242) 233484 (Cheltenham).
- Integrex Colourjet 132 printer, £60. Tel: (01922) 57814.
- 486 SX card with software, boxed, mint. Trade it in for DX? £75. Tel: (01248) 370996 evenings.
- Risc PC 600, 9Mb RAM, 420Mb HD, 1Mb VRAM, 14in SVGA monitor, 486 PC card, CD-ROM, Inkjet printer, £1100. A4000, 2Mb RAM, 80Mb HD, 14in monitor, Easiwriter 2, Desktop DB, PC emulator, £400. Games for sale. Tel: (01438) 787069 (day), (01763) 231059 (eve).
- A310 4Mb RAM, 40Mb HD, BJ200 printer, software includes Impression Style, Tracker, Artelier, loads of 600D games. £550. Tel: (01845) 232208 eves, ask for Neil in Room 5.
- Risc PC 600, 10Mb (8Mb DRAM, 2Mb VRAM), 420Meg HD, dual speed CD-ROM plus Canon BJC 600 colour printer with Turbo driver software and cables, £1400. Tel: (01705) 588311.
- A3000, 4Mb, colour monitor, LQ400 printer, 3.5 disc drive, computer desk, games, Peipedream 3, discs, VGC, £500 ono. Contact Nick on (01707) 874673 Herts.
- Euclid v2.17, hardly used, £14 ono. PC emulator, perfect condition, version 1.82, DOS 3.3 only £24. Phone before 5.30pm on (01329) 285367 ask for Richard.
- A3000, 2Mb OS 3.1, 120Mb HD, Watford MkII Hand Held Scanner, A-Link, joystick. Ovation, 1st Word Plus, other games and applications. £300 ono. Tel: 0131-346 1219.
- A5000, 8Mb RAM, 170Mb HD, ARM3, RISC OS 3.1, Taxan 770 Multiscan monitor, various software, £800 ono. Tel: (01733) 230767 (w/eends only).
- Pocket Book 1 with Schedule, IGC, £90. Tel: (01243) 780334.
- Very cheap! - used 3.5in DSDD discs for sale. Mostly Amiga games, suitable for older Arcs. 25p each. Wanted: HP 4L printer. Tel: (01922) 38483.
- For sale! CD full of c64 emulators and 100's of snapshots for use with emulators, £10. Tel: Matthew on 0181-523 8058.
- For sale: A3000, 4Mb RAM, RISC OS 3.1, ARM3, Taxan 775 14' in Multisync, HCCS Vision digitiser, Serial upgrade, Wild Vision expansion box, Risc high density floppy disc controller, PC emulator 1.8, lots of software, £375. Phone (01734) 571883 (Reading area) or e-mail: p.darnell@ecmwf.int
- For sale: USR modem 14.4, 3 months old and ArceFax Fax and Ans phone utility, £150. Tel: (01244) 548882.
- Games: High Rise Racing, £12, Burn Out, £12, Birds of War, £12, Haunted House, £10, James Pond 2, £10. Tel: (01794) 514613 after 5pm.
- Wanted: Dreadnought by Turcan and Tushima Scenario. Tel: S. Warne on (01203) 471350 (evenings).
- A5000 Learning Curve package and Panasonic KX-P1124i Pin printer, £600 ono. Tel: (01494) 675040 after 6pm and weekends (South Bucks).
- Acorn A3000, 2Mb, Video Enhanced High Resolution Graphics system, 14in Multiscan colour monitor, perfect order, £250. Tel: 0181-967 3048 Middx.
- Cumana 'Oscar' parallel port dual speed CD-ROM drive with utilities disc and speedy CD. No box or instruction manual hence only £55. Tel: (01704) 547167.
- Wanted: Art/graphics programmes and manuals, Revelation Image Pro, Pro-Artisan, Poster, Image Animator. Pay up to £20. Tel: Duddlely (01384) 830675.
- Connor 80Mb IDE Hard disc, ideal for A3010, £40. Tel: Charlie 0116-266 0123.
- Acorn A3000 RISC OS 3.1, 2Mb, 210Mb Hard disc, colour monitor, printer, Games, WP, spreadsheet. Other software. £600 ono. Tel: (01354) 692121 ask for James.
- A400/1, 4Mb RAM, RISC OS 3.1, ARM3, 47Mb HD, VIDC enhancer, Eizo 9060s monitor, £450. Acorn mouse, £10, RISC OS 3.1 full upgrade, £35. Tel: 0181-751 2120.
- Wanted: Mr EE! and Crazy Painter on disc for BBC model B. Will pay good money. Tel: (01952) 814110.
- Impression II/Publisher, £60. English 10/10, £12. Linkword French, £18. Gods, £10. Bloodsport, £6. RISC User magazines Vol 6 - Vol 8, £20. JVC monitor, £30. Tel: (01286) 880997.
- A3000, 1Mb RAM, RGB monitor, Star LC10 printer (colour), 3.5in FDD (lo-density) some discs, wp etc. £200 ono. Contact Mike or Sue (01904) 410881 (York).
- A3000, ARM3, RISC OS 3.1, 4Mb RAM, 210Mb HD, DFS interface, provision for internal CD-ROM drive/5.25 inch drive plus two expansion cards, serial port, software, £350. Tel: 0115-960 5718.
- Hard up pensioner needs hard disc. A3010. No cash but will swap AU CD-ROM, Carnegie Inc, Warlocks, Lotus TC2, Quest for Gold, Chuck Rock. Boxed + manuals + Star LC10 colour printer + lead. Tel: (01204) 571836 Bolton, Lancs. Ask for John.
- A3000, RISC OS 3.1, 4Mb RAM, 30Mb HD, colour monitor, some software. Vgc. £250. Tel: Dave (01372) 815184 (Surrey).
- A410/1 RISC OS 3, 4Mb RAM, ARM3, Acorn AKF II monitor, IDE podule. Various PD programs, £400 ono. Tel: 0181-230 3705.
- Aleph One PC card for A5000. 486/50MHz with 4Mb RAM, software included, £200. Tel: (01248) 600184.
- A4000, 4Mb RAM, 210Mb HD, RISC OS 3.1, £400. As above, with AKF18 monitor, £480. Alternatively above with AKF60, £600. Call Richard on (01603) 455726.
- Impression Publisher v4.08, Eureka spreadsheet v3, Prophet Accounts package v2.13 & Scanlight 256 mono hand scanner (Risc PC version), All £50 each. Tel: 0116-266 3721 (Leicester).
- Acorn Learning Curve software packs including Advance, £50. Also A3000, 1Mb RAM, RISC OS2, £100, including colour monitor. Tel: (01252) 27386 evenings.
- Acorn User back issues for sale. October 1993 to January 1996, £1.25 each or £30 the lot. Tel: Paul on (01246) 551948.
- Quad speed Atapi CD-ROM drive for Risc PC (internal), £60. Original Risc PC 700, 8Mb SIMM DRAM, £100. Tel: James (01703) 760936 (eve).
- A5000, RISC OS 3.1, 4Mb RAM, 40Mb HD, Taxan 770 + LR monitor, programmers manuals, software, Archive magazines. All excellent condition, £490. Tel: Rob on Cheltenham (01242) 231540 evenings.
- For sale: Acorn C/C++ compiler and RISC OS 3, Style guide, brand new unopened, £180 ono. Tel: (01454) 886023 after 5pm.
- For sale: 100 5.25 high density discs, £7.50. Tel: Matthew on 0181-523 8058 (office hours) or 0973 301882 (evenings).

## Acorn User Free Ads Service

Why not take advantage of our free reader ad service? Fill in your details on this coupon (25 words maximum, one word per box below) and send it to Free Ads, Acorn User, IDG Media Ltd, Media House, Adlington Park, Macclesfield SK10 4NP. Only one ad per reader, please. Although we try to publish every ad we receive, we can make no guarantees; publication is entirely dependent on space and time constraints. We may also publish free ads on the cover disc if magazine space is short. Please fill in your name and telephone number below: these will not be published, but they enable us to contact you in case of any queries.

Your name: ..... Telephone no: .....



Dave Lawrence and Dave Acton reveal the hidden gems of programming

# info

## Right hand-y drive

Author: Malcolm Boura

Malcolm Boura was very impressed with our man Nick's *Director* but felt that the 'drives' menu could do with a little enhancement. This menu is meant to produce a set of options that lead to the root directory of each drive on each filing system currently available. As Malcolm points out though, the original code could only handle drives known to FileCore, for example those with a direct ADFS-like filing system, in other words RAM. To help rectify this, he has coded up a replacement menu that can cope with FileSwitch based filing systems and can therefore handle CDFS, networks and so on.

As an added extra, the new drives menu will attempt to load and run *!CDPlayer* to handle audio CDs instead of trying to display a file catalog.

Full installation instructions can be found in the *Manuals* directory on the cover disc, but if you're dying to get started straight away, simply copy the new *FindDrives* into *Director's Menus.System* directory along with *CDPanel*, copy *AppEnsure* and *Click* into

the *Utils* directory and finally insert the lines in *CDPlay* into the default menu.

The programs *AppEnsure* and *Click* are general purpose utilities and you may find them useful in other applications. *AppEnsure* behaves in a similar way to the OS command *\*RMEnsure*, but instead of checking for the presence of a module, it checks for a running application. If the given application is *not* found, then the given command is executed. As it happens, one of our other submissions this month comes from Andrew Kemp who has written the same thing in ARM code and called it *TaskEnsure*.

The *Click* utility is used to simulate mouse clicks on the icon-bar. Malcolm uses this to open the control panel of *!CDPlayer* by using:

```
*Click "CD Player" -select -wait
```

The *-wait* is given to wait until the application has started if it hasn't already.

## Step into the frogger

Author: Mike Goatly

How could we possibly *not* publish a program called *NeonFrog*, with which Mike Goatly wins this month's silliest name award. *NeonFrog* doesn't actually do anything except draw a frog (in neon, of course). Mike said it developed after he wrote a

procedure to draw circles with a neon effect.

A slight alteration was needed to deal with rotated ellipses and all of a sudden the aforementioned frog was spawned. Two versions of the program are supplied. The vanilla *NeonFrog*, uses Mode 28

and *ColourTrans* to select colours and will therefore work on pre-RPC machines. *NeonFrog32* uses a 16-bit 800x600 mode and the Basic command *GCOL r,g,b* to select colours, and thus will only work on Risc PCs.

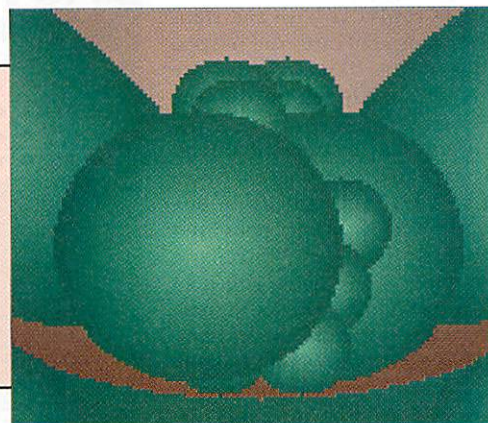

## Clump up the volume

Author: Alan Trewartha

Here's one of those little desktop games that will probably keep you mousing away long into the night instead of writing your column for *Acorn User*...

The game is called *Clumps* and the idea behind it is deceptively simple (as all such puzzle games are) – just clear the board. Tiles can be removed by clicking on them, but only if they are in a group of identical tiles. Once a block of tiles has been removed, any tiles above the block will fall to take their place. If a complete column is emptied, the tiles to the right will move left one space. If there are no 'clumps' of tiles left, you can not make a move and the game ends. Ideally, you must also maximise your score. Points are awarded according to the equation  $(n-2)$ , where  $n$  is the number of tiles removed. Consequently, removing a pair of tiles won't score you anything!

As you might expect, the game installs on the icon bar and a new game can be started from the menu or via the *New Game* icon within the main playing area. The game can be configured via the preferences window, which can be displayed from the icon bar menu or by Adjust clicking on the game icon. From here you can adjust the size of the play area or, more interestingly, change the sprites used for the various clumps in the game.

Click on the large sprite icon to view the game's internal *Tiles* directory. From here you can drag a sprite file into the preference window. You can also drag a file from any other file window, in which case *Clumps* will first copy the file into the *Tiles* directory.

A number of sample files are provided, but if you're feeling artistic why not try designing some of your own. The sprite file should contain 11 sprites labelled 1a to 5a, 1b to 5b (these are used for the five clumps), and 00 which is used as the background. Alan provided all the sprites except for *Girls* and *Girls16*, which were extracted from the original PC version of the game (see notes below), and are included so you can experience the full clumps effect.

At the moment the 'Options' section of the preference window is still under construction, so the difficulty level is not as yet

alterable. Alan hopes to include these facilities at a later date.

*Clumps* is actually a port of a game called *MaciGame* on the Mac and was originally written by Takeshi Takahashi. You can read about this game on his Web Page at <http://www.asahinet.or.jp/~yh2t-tkhs>. It is apparently a 'cult' game in Japan. Takeshi also created the nifty 'bunnies'. Among the pages of Japanese on this Web site we found the following: (reproduced verbatim!)

**Original history of MaciGame:** The game idea of 'MaciGame' is not my original. In 1985, Kuniaki Moribe first made the game named 'Chain Shot!', in which the same color pieces were to be coupled. Some clone games were made after 'Chain Shot!'. In 1992, 'SameGame' was made by Eiji Fukumoto for UNIX under the influence of 'Chain Shot!'. Wataru Yoshioka changed the game for PC-9801(NEC) in late 1992. After Yoshioka's 'SameGame' was uploaded to FGALAM LIB 5 of Nifty-JAPAN, the game became very popular. Adding and expanding the playing rule, many clone games, such as 'TumeGame', 'KomeGame', 'MameGame', 'DebaGame', were made for the PC-9801. Now you can play the game both on Windows 3.1 and on the Macintosh. I know two versions for Windows and two for Macintosh. 'MaciGame' is one of them. Another Mac version by Mr Sumiya is here. One of the Windows version by Mr aby is here.

We particularly like the idea of *MameGame* – Mortal Kombat with lettuces anybody?

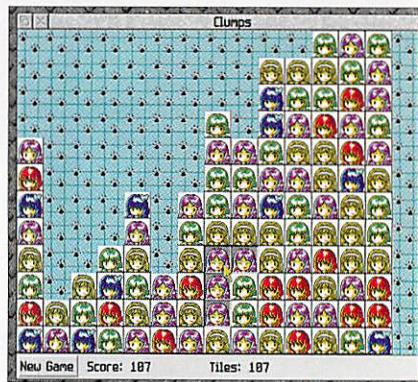

## Have more patience

Author: Paul Irwin

If patience is a virtue, then readers of this humble column can now be doubly virtuous. Following on from his classic implementation of the solo card game last month, Paul Irwin now presents *FreeCell*.

*FreeCell* differs from regular patience in that all the cards are dealt face up. There are also four 'free' cells which may be used as temporary storage locations for single cards. As with the standard game, red cards can only be placed on black cards one higher, and black on red one higher.

Cards may be dragged around as expected and you may also drag a stack of cards from one column to another, provided you have sufficient free cells. If there are  $x$  free cells, you may drag  $x+1$  cards. This is logical, since this is the maximum number of cards you would be able to move singularly if you use the free cells to store the cards one

by one temporarily. (This is all a bit 'towers of Hanoi' don't you think?)

The implementation also features automatic detection of surplus cards. That is, any cards that can be put onto the

finished stacks will be moved there automatically as soon as they are freed. This avoids a lot of tiresome card shifting at the end of a game when you know that you have won.

As with last month's implementation, there is a small menu offering Undo, Resign and other self-explanatory options. The Restart option allows you to restart the game, even if you have 'won' it, but you cannot restart a resigned game.

*FreeCell* currently requires a Risc PC to run on and at least 140k. Paul has told us of improvements he'd like to make to the current version, including making the stack dragging more intelligent and rewriting the game in ARM code. Apparently, he is well on the way to doing this for *Patience* which requires 60K less to run as a result. If you can do better (a one-line version perhaps?) we would like to see it.

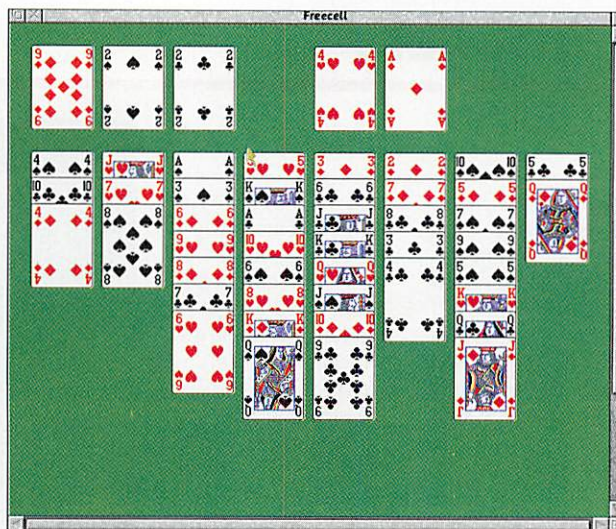

## Rhythm section

Author: Mark Hammond

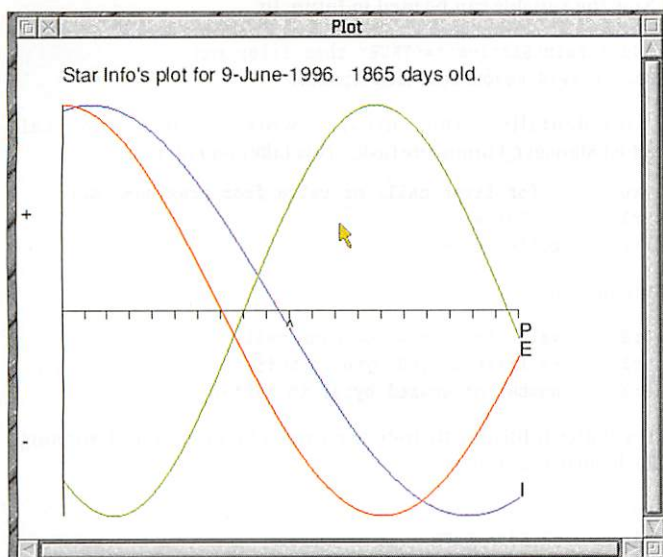

Hands up who remembers *Yellow River Kingdom*? Wasn't that little raider just the most spooky looking Mode 7 graphic you'd ever seen? You could cope with the river flooding, but when that dubious looking character sidled across to your village. Ooh! One shudders to think about the safety of the cattle.

What has this got to do with Mark Hammond's submission? Well, nothing as it happens, but Mark's *Biorhythm* program is based on the original version which came on the BBC and Electron Welcome tape.

Mark's revamp of *Biorhythm* includes the ability to save out the resulting graph as a draw file, a CSV file or even an *Advance* file. Direct printer support is also available.

Click on the icon and select the desired 'birth' day and 'target' days, click on Plot and the Physical, Emotional and Intellectual cycles will be displayed. The most critical days are those when the cycle crosses the horizontal line, denoting a transition between energy being discharged and recharged. Watch out especially when more than one line crosses in close proximity!

Mark also brings up an interesting question – is it possible to represent a sinusoidal wave using a bezier curve? The Biorhythms plotted use a number of short straight lines which is quite sufficient for most uses, but it would be neater if true curves could be used.

## Justin time...

Author: Justin Fletcher

Time, in fact, for another splendid little module from PatchMeister, Justin Fletcher. This one deals with the tricky little problem of the ellipsis.

No, not those squidgy, not quite circular circle things you get if you use the wrong PLOT code by mistake but the three little dots that are often scattered liberally throughout these wild and whacky words of wisdom (hmm...) Yes, there goes one now.

In case you didn't know, rather than just using three dots, there is in fact an ellipsis character (ASCII &8C I do believe), but if you can't be bothered to enter the appropriate code on your keypad,

why not install Justin's module, appropriately entitled *DotDotDot*. This watches for three dots in a row and, if they come along, replaces them with the correct ... character. This is all done at a low level by intercepting the 'insert into buffer' vector and keeping a count of consecutive full stops typed. If this count reaches three, a routine is called back (using OS\_AddCallback, since we are operating at a low level, and have to be careful what OS calls we make) to insert two ASCII 127s and a ... This may be a little 'dirty' perhaps, but it works very well on everything so who cares... (Ooh, there goes another one.)

## Invasion of the 3D blobs

Author: Darren Northcott

Our back-to-basics campaign continues with this doodle cum B-movie simulation. Throw away your 3D specs because you will not need them to witness the horror of Darren Northcott's *3Dblobs*. In fact, Darren has gone straight for the sequel, and the horror or otherwise comes courtesy of *3Dblobs2*.

The blobs, or 'circles' to give them their technical name, spin around some imagined axis in 3D space, simply growing and shrinking accordingly. Simple stuff you might think, and indeed so, but we thought it would be nice to include it to illustrate just how effective a simple trick such as 'making distant things smaller' can

be. The bottom line is that you don't need to be a whizz-bang ARM programmer to produce a convincing feeling of depth in your graphical ditties.

Darren's second demo also comes under the heading of 'pseudo 3D doodles' and is, in fact, an enhanced version of an old one-liner we carried way back when *Acorn User* was delivered once a month on a vellum scroll to the one person in the village who could read. Ah,

those were the days. Anyway, some tables of 3D co-ordinates are built up and then the figures are simply plotted from the tables, swapping screens merrily for that extra smooth effect.

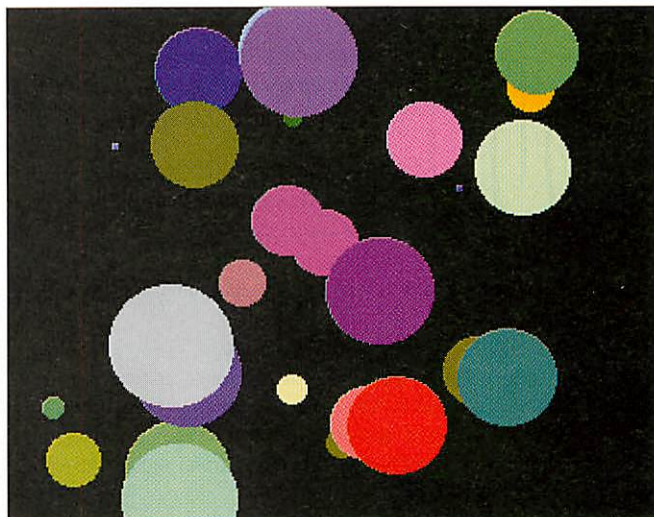
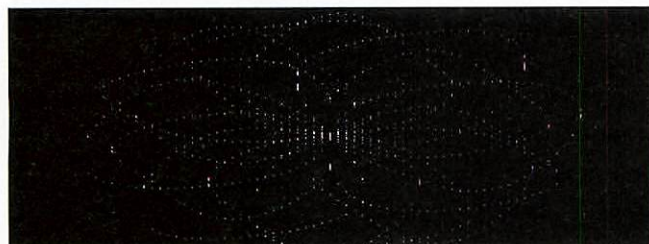

## Task Master

Author: Andrew Kemp

Confirming the theory that great minds think alike, Andrew Kemp had the same idea as Malcolm Boura and came up with the equivalent of *\*RMEnsure* for tasks. As the idea is a good one, and because Andrew's version is in ARM code, we are happy to include both.

The reason the utility is required is simple. During your boot sequence, it is often useful to know whether a particular task is running. Also, there is the perpetual problem of knowing whether a copy of your application is already running, and preventing another being installed in case they clash unpleasantly. This simple *\* command* provides an easy way to make such a check.

The syntax is:

```
*TaskEnsure <task name> <command>
```

where *task name* is the name of a task as it appears in the Task Manager window (this is case sensitive, so be careful), and *command* is simply a *\* command* to be executed if the named task is not running. If the task name consists of more than one word, enclose it in quotes, viz:

```
*TaskEnsure "ADFS Filer"...
```

The command does not need to be in quotes, even if it contains spaces, since the rest of the line after the task name is simply passed to *OS\_CLI*.

If you need to do more complicated things depending on whether a task is up and running or not, you can use *TaskEnsure* to set a system variable appropriately, like this:

```
Set Paint$Active TRUE
TaskEnsure Paint Set Paint$Active FALSE
```

Now the variable can be used in future *ifs*...

```
If "<Paint$Active>"="TRUE" then filer_run
Resources:$.Resources.Wimp.Sprites
```

Incidentally, the utility works using the call *XTaskManager\_EnumerateTasks*. This takes on entry:

```
r0    0 for first call, or value from previous call
r1    -> buffer
r2    buffer size
```

and on exit:

```
r0    value to pass on to next call
r1    -> first unused byte in buffer
r2    number of unused bytes in buffer
```

The buffer is filled with 16-byte entries, one for each task running. Each entry is as follows:

```
0    task handle
4    -> task name
8    memory used by task (in K)
12   flags (bit 0 set if module task, bit 1 set if slot
bar can be dragged, other bits reserved and zero)
```

*TaskEnsure* simply examines each task name in turn and sees if it matches that supplied. By the way, you should copy the task name somewhere else before messing about with it – the copy supplied is for the purposes of reading only.

## Map-happy

Author: Alan Lowe

It's sometimes nice to get back to basics, or back to Basic in this case. We've all seen those real-time, sprite-mapping demos in action, but they are of little use to novice programmers attempting to grasp the rudiments of sprite manipulation. In this spirit we preset *Map* by Alan Lowe – a simple but effective sprite mapping program.

Just run the demo and enter the name of a sprite file and sprite (press Return to use the sample provided). Then choose if you want a random

element included in the tinting of the mapped sprite. Finally, specify the quadrilateral to which the sprite is to be mapped, using the mouse. When ready, click a button and hey presto – not particularly speedy, but the principle is sound. The final image can be saved – the current directory is used and the image is saved as *Texture*. And, since the program is in Basic and quite easy to follow, interested parties should have no trouble in working out what is going on.

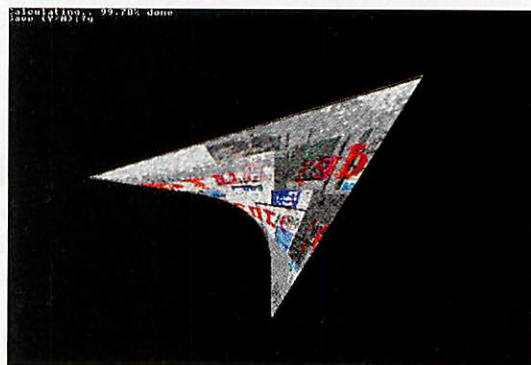

# \*QUIT

All programs, hints, tips, music and anything else you please to the usual address:

\*INFO, *Acorn User*, IDG Media, Media House, Adlington Park, Macclesfield SK10 4NP

or, if your submission is 100K or less, e-mail us (including your real address please) at:

austarinfo@idg.co.uk

You needn't include a letter but please put your name, address and program title on every disc and include a text file containing your name, address, disc contents and program details. Saved screens, drawfiles, background information and the like are always useful and an SAE will ensure your discs are returned.

### Compatibility table

Program	RISC OS 2	RISC OS 3.1	RISC OS 3.5+
Dot Dot Dot	Yes	Yes	Yes
Biorhythms	No	Yes	Yes
Freecell	No	No	Yes
TaskEnsure	No	Yes	Yes
Map	No	Yes	Yes
3D Blobs 2	No	Yes	Yes
Quad 4	No	Yes	Yes
Clumps	No	Yes	Yes
Neon Frog	No	Yes	Yes
Neon Frog 32	No	No	Yes



Programs available for all ages and abilities.

- For school and home use •
  - PC and Acorn formats •
- Send for our free catalogue.

**4Mation**  
Publishers of  
quality educational  
software since  
1983.

**4Mation Educational Resources**  
14 Castle Park Road  
Barnstaple  
Devon  
EX32 8PA  
☎ (01271) 25353

## 16Mb Risc PC Simm (72 pin 70ns Non Parity) Memory

**Call for other memory prices  
2Mb FREE Web Space? Call for details**

- Terms Cash with Order
- No surcharge for credit card sales
- Call the hotline today

**Tower Electronics Ltd 01 651 891 653**  
<http://www.enterprise.net/tower-risc>



Our \*NEW\* demo/catalogue disc for just £1 or buy any pack and get our demo disc free. Sorry, no credit card facilities available.

OUTSTANDING HIGH QUALITY PUBLIC DOMAIN SOFTWARE

### EXCELLENT PACK OFFERS

- Games 1 • Games 2 • Games 3 • \*NEW\* Games 4
  - Draw Clipart 1 • Draw Clipart 2 • Draw Clipart 3
  - \*NEW\* Draw Clipart 4 • Educational 1 • Utils 1
  - Utils 2 • Utils 3 • Sound Sample 1 • Sound Sample 2
- Each pack has three fully archived discs. One pack for £3.75 - Two packs for £7.20 - Three packs or more at £3.50 for each pack.

We are distributors of educational software from Sherston, Semerc and 10 out of 10. We offer at least 10% saving on their recommended prices. Official orders are welcome. For free catalogues and further information write to the address below or call 0181 950 4973.

Five Star Marketing, 4 Shepherds Walk  
Bushey, Herts. WD2 1LZ.

Obtain the StrongARM card for £1 (with a Risc PC ordered from us Order your StrongARM card now for £299 includes Risc OS upgrade.

**Offers on Computers and Peripherals**

Risc PC600 4Mb HD540 14" monitor (AC354/AF50)	£1349
With quad Speed Atapi CD ROM drive add	£55
Risc PC700 5Mb HD540 14" monitor (AC277/AF50)	£1589
With quad Speed Atapi CD ROM drive add	£45
Risc PC700 10Mb HD850 14" monitor (AC375/AF50)	£1989
With quad speed Atapi CD ROM drive	FREE
Upgrade the 4 speed CD ROM drive to Six speed for	£35
Upgrade the 4 speed CD ROM drive to Eight speed for	£69

**Alternative Monitors**

Acorn AKF90 17" £703 or £383 added to 14" prices	
Iiyama MF8515 15" £300 or £40 added to 14" prices	
Iiyama MF8617E 17" £603 or £339 added to 14" prices	
Iiyama MT9017E 17" £678 or £415 added to 14" prices	

**CD ROM Drives suitable for Risc PC and A7000**

Quad speed Atapi drive	£91
Six speed Atapi drive	£126
Eight speed Atapi drive	£161
Panasonic PD CD ROM drive/650Mb optical disc internal	£500
Panasonic PD CD ROM drive/650Mb optical disc external	£572

The Panasonic drives require a SCSI interface from £116.

**Syquest Removable Cartridge Systems**

The SyJet is a 3 1/2" device and will be available July/Aug 1996

SyJet 1.3Gb Ext SCSI cased with PSU inc cartridge	£448
SyJet 1.3Gb Int SCSI inc cartridge	£403
SyJet 1.3Gb Int IDE inc cartridge	£403

**Syquest EZ135**

EZ 135 135Mb Ext SCSI, cased with inc cartridge	£218
EZ 135 135Mb Int SCSI inc cartridge	£175
EZ 135 135Mb Int IDE inc cartridge	£175
EZ 135 cartridge	£18

**Conner IDE Drives**

Capacity 540Mb	£148
Capacity 1275Mb	£180
Capacity 1620Mb	£205

**Conner SCSI Drives**

Capacity 540Mb	£270
Capacity 1060Mb	£324
Capacity 2105Mb	£534
Capacity 2107Mb	£509
Capacity 4207Mb	£864

**Memory**

Pricing on Memory for Risc PC and A7000 at 18th June 1996

4Mb SIMM	£46	8Mb SIMM	£77
16Mb SIMM	£135	32Mb SIMM	£290
1Mb VRAM	£117	2Mb VRAM	£212

1 to 2Mb VRAM upgrade £106

**Memory for other computers available**

All prices include VAT  
We operate Acorn's 20/20 interest free purchase scheme.

WWW: <http://www.art.acorn.com/soft/selective/kmo.html>

**SELECTIVE COMPUTER SERVICES** Telephone/Fax 01332 690691  
8 Old Gate Avenue - Weston on Trent - Derby - DE72 2BZ  
Prices are subject to change, we reserve the right to modify our prices accordingly. (E&O)

## CARE QUALITY & SERVICE

### QUALITY INK JET & BUBBLE JET REFILLS

Our refills use only top quality inks. You buy direct from us hence our superb quality at sensible prices.

Black refills for HP Deskjet 500, 510, 550, 500C, 550C, 560C, 660C, 850C  
CANON BC-01, BJ10E/EX/SX, BC-02, BJ200, BJ130, BJ300, BJ330  
EPSON STYLUS 800, 1000, CITIZEN PROJET, OLIVETTI JPI150, 250, 350,  
6 refill (3 on high capacity cartridges) kit 120ml pure black. £16.99  
CANON BJC600, BJC4000/4100 20 refills pure black 120ml. £16.99  
EPSON STYLUS 4 refills 120ml pure black. £16.99

#### TRICOLOUR REFILL KITS:

HP Deskjet range 10 refills of Yellow, Magenta & Cyan 180ml £24.99  
CANON BJC600, 4000/4100 10 refills of Yellow, Magenta & Cyan 180ml £24.99  
EPSON STYLUS Colour/III/IIIs of Yellow, Magenta & Cyan 180ml £24.99  
"Print Head Recovery Fluid" for unblocking nozzles £6.99 new larger size, new lower price all kits come with full instructions. Other refills available.  
Important: Please state type when ordering

#### Colour Printer Ribbons & Reloads

To Reload a ribbon is easy, just remove the top, take out the old ribbon and reload it with a new one.	Complete One	Five reloads
Citizen Swift/ABC/240 etc.	£11.95	£6.99 £29.95
Panasonic KXP2123/2124/2180	£9.99	£6.99 £29.95
Panasonic KXP2135	£9.99	£6.99 £29.95
Star LC200 9 pin	£9.64	£5.99 £29.95
Star LC24-10/20/200	£9.64	£6.99 £29.95
Star LC24-30/LC240	£8.99	£4.95 £19.99
Seikosha SL95	£14.95	£6.99 £29.95

#### Special Re-Ink

For Panasonic 1080/81, 1123/24, 2123/80, 2135, Star LC200 9 Pin, Epson LQ100/150, Oki 182 to 390 range. Black bottle will re-ink 100 + ribbons £9.95

#### Black Printer Ribbon Reloads

Citizen Swift/ABC/120D 5 black reloads..	£9.99
Star LC10/20/100 5 black reloads.....	£4.99
Star LC24 range 5 black reloads.....	£9.99
Seikosha 1900/2400/SL95 5 black reloads	£9.99
Epson FX80 to LQ800 range 5 black reloads	£11.99
Star LC24-30/LC240 5 black reloads .....	£14.99

#### T-Shirt printing ribbons

4 col Citizen Swift/ABC/240.....	£19.99
4 col Panasonic KXP2123/35.....	£19.99
4 colour Star LC200 24 Pin.....	£19.99
reload for above	£9.99
4 colour Star LC10 .....	£10.99
4 colour Star LC200 9 Pin .....	£12.99
reload for above	£7.99
Black Citizen Swift/ABC/120D .....	£9.99
Black Star LC10 .....	£9.99
Black Star LC200 9pin .....	£9.99
Black Panasonic KXP1080/81, 1123/24 .....	£9.99

Prices include VAT & postage. To order send cheques/PO payable to:

### CARE PRODUCTS

Dept ACU, 15 Holland Gardens, Watford, WD2 6JN  
or use Visa/Mastercard or Education order  
Fax order line 01923 672102



Tel ORDER LINE 01923 894064

# texttease

Simply the Best  
Word Processor and  
Desktop Publisher  
Just click anywhere  
and start to type

**Version 2** £49 + VAT ( £57.58 )

This highly praised word processor and DTP is ideal for home and education use. Use the screen like a sheet of paper, click anywhere and type. Text can be easily sized, moved, coloured or the font changed just by clicking the mouse. Pictures dropped into *texttease* are also easily moved, sized and altered. Children love its simplicity. Adults find it versatile, sophisticated and professional.

**Talking texttease** £65 + VAT ( £76.38 )

This combines excellent speech, integrated thoughtfully into *texttease*. Children delight at hearing their stories read back. The word being spoken is coloured, making it very easy to follow the text on the screen. Also excellent for adults when proof reading work.

Price includes Primary Site Licence for education customers  
Secondary Site £99 + VAT and £130 + VAT

**Softtease Limited, Tel 01332 204911**  
The Old Courthouse,  
St Peters Church Yard, Derby, DE1 1NN

Requires Acorn RISC OS3.1 and 2 MByte RAM  
Produced on *texttease*

# The last of the three-

This month Mike Cook builds an intelligent transistor tester

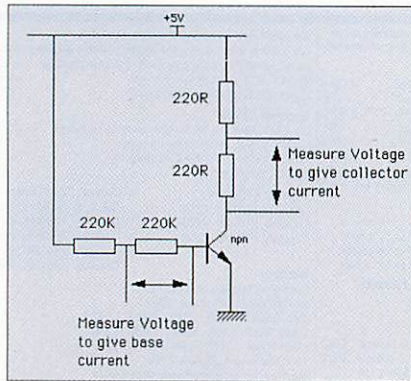

Figure I: Measurement configuration

Last month I introduced you to the background of the intelligent transistor tester, so with that theory behind you it's time to actually build the thing.

What we are interested in is measuring the base and collector currents in a simple common emitter configuration. Once we know this, it is possible to tell if the transistor is working. In order to measure current with a computer it is necessary to turn it into a voltage, and this is very simple here because we have resistors in both the emitter and the base. It turns out that to get the dynamic range I was after, I needed to measure the voltage across half the resistor.

Therefore, both base and collector resistors are split into two and we measure the voltage across one of them, which is shown in figure 1. This is done because the voltage is measured using the differential mode of the A/D converters, which uses the 8-bits in the converter to give a positive or negative 7-bit value. This is necessary because depending on what sort of transistor we are measuring, the current can flow either way, thus giving a voltage that can be either polarity.

Last month we looked at the block diagram of the tester, and figure 2 shows the circuit diagram. This is shown as if you were connecting it to the IIC interface board described in the December 95 issue of *Acorn User*, and if you want to build the whole thing in a single box, like I did, then you will have to add the circuitry shown in figure 3. If you have the back issue to hand you will see it is slightly simpler because you don't have to make provisions for external voltage reference,

crocodile clips to allow easy connection to the transistor.

The circuit uses two 74LS259 programmable latches to generate the 16 control lines we need to control the analogue switches from the 8-bits available from the digital interface. Note that bit 7 is used to supply the data, bits 0 to 2 to supply the address and bits 5 or 6 used to trigger the appropriate latch. So in order to control one of the analogue switches we put the on/off state on bit 7, the three least significant bits of the switch number on bits 0 to 2, bit 5 for the lower 8 or bit 6 for the upper 8 switches. This is summarised in figure 4.

I remember the time when I constantly had to reassure people that they couldn't damage anything inside their computer by running a faulty program - well with this interface you can. If you remember the switching diagram from last month you will see some switches connected to +5 volts and others to earth. If, for example, you turned on S2 and S14 you would short out the power supply through two analogue switches - at best the switches would get very hot but probably they would blow.

This is not a problem when the program is running because we simply avoid those combinations, but on power up it could be. At power up, very little is defined - that is the 74LS259 latches could be at any state - so there is a risk of meltdown. The IIC digital interface powers up as inputs which look like logic ones, so I use that fact to make sure the 74LS259 powers up with a clear signal that turns off all the analogue switches.

As the latches need a logic zero to clear and the interface provides a logic one on power up, we need to invert the signal with a transistor. Therefore, bit 4 acts as a clear line on power up and it's also used when changing the switch combinations.

I built the prototype in a small plastic box with the three test terminals on the top. I used sub-miniature crocodile clips for this, the sort normally fitted with a plastic cover. I removed the cover and drilled two 2mm holes in each and attached them to the lid of the box with miniature 2M bolts. Two screws are required to stop the clips rotating and shorting out, and they should be mounted as close together as possible without touching. In that way you don't have to bend the transistor's leads too much. Also, I cut a rectangular hole in the lid to take the IIC interface connector because this also carries the power, so it makes a very neat unit.

Now we need to work out what combinations of switches we require to turn on to get the desired configurations - remember we need to be

Figure II: Transistor tester circuit to the IIC interface

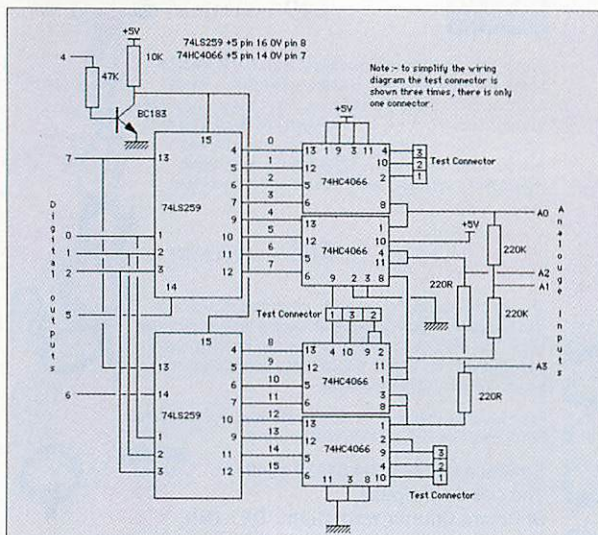

programmable addresses and a buffered analogue output.

Turning your attention back to figure 2, you will see that to simplify the diagram I have shown the test terminals three times. In fact there is only one, and all wires shown going to each box go to the same test terminal.

I made the test terminals from miniature

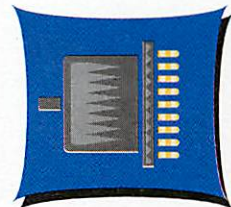

# legged heroes

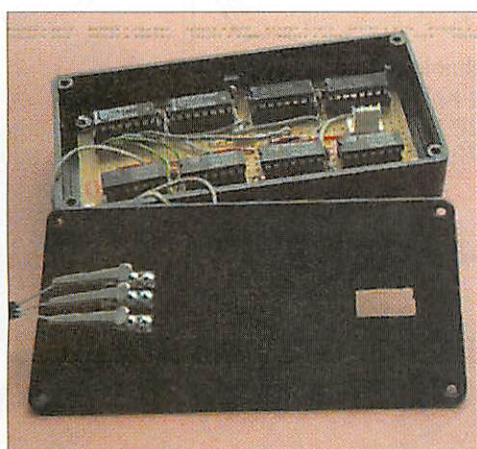

able to treat any terminal as base, collector or emitter in either PNP or NPN configuration. This is only a few of the 65,536 possible combinations and is summarised in table 1. Note here that on the left is the pinout combination we are trying and on the right is the hex value we need to send out to the switches. You can generate this table by looking at figure 3 last month and seeing which switches need to be on.

Having got a transistor into one of our test configurations, we need to work out a strategy for determining if it is working. I tried at first to make measurements of the base and collector currents and work it out from there, but it's not as simple as that. Assume you have a faulty transistor with a collector emitter short. You will get a large collector current and a small base current and this is exactly the situation you would have with a good transistor of very high gain.

Therefore, we must make measurements in two configurations. Firstly, we need to disconnect the base from any source of current by opening S4 and S3, and then we measure the collector current, which should be zero. If it is not then we either have a faulty transistor or a incorrect configuration for the transistor's pinout.

If it is zero then we can now turn on either S4 or S3, depending on the transistor type, and measure the base and collector current. We can then

work out the gain by dividing the collector current by the base current. If we note the gain for all the pinout configurations, the correct pinout will be the one that gives the largest gain.

When converting the voltage readings from the A/D into current we need to simply divide it by the value of the resistor we are measuring across. As these are different in the base and collector circuits, each current measurement has a different resolution. When this is coupled to the fact that any A/D can only give a reading to plus and minus the least significant bit, the gain values can be only trusted to about 10 per cent, but that is more than good enough.

You might find with a high gain transistor that when you measure it the gain is 500 but the next time it is 530. This is all to do with the precision of a 7-bit value plus or minus the least significant bit, but is nothing to worry about.

So finally we need to put all this into the software to drive our transistor tester. There are two programs on the cover disc. The first, IICt, is a simple basic program that goes through each configuration and prints out the results so you can see what is happening at each step. Then it picks the best gain and prints out a report. The second program, !Tr\_Test, is a desktop application that just reports the results when you simply click the Test button.

Well there you have it. One of the most useful projects to date and one that justly deserves box status.

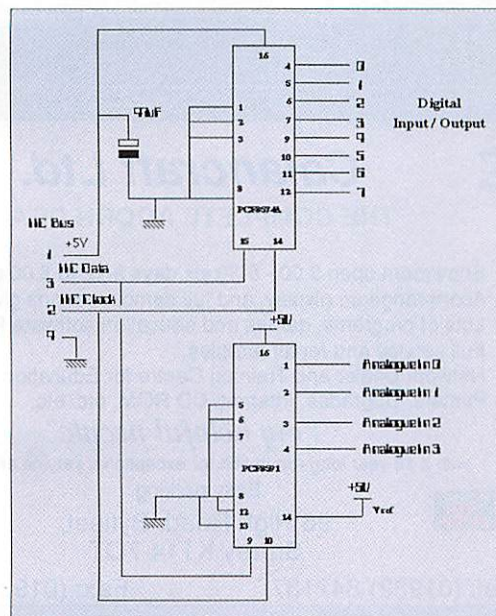

Figure III: A simplified IIC interface for the transistor tester

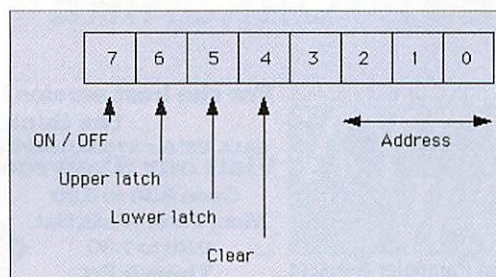

Figure IV: Digital control of multiplexer

## NPN Configuration

1	2	3	S15	S14	S13	S12	S11	S10	S9	S8	S7	S6	S5	S4	S3	S2	S1	S0	HEX
e	b	c	off	off	on	on	off	off	off	on	off	off	on	off	on	off	off	off	3128
c	b	e	on	off	off	off	off	on	off	on	off	off	on	off	on	off	off	off	8528
e	c	b	off	off	on	off	on	off	on	off	off	off	on	off	on	off	off	off	2A28
c	e	b	off	on	off	off	off	on	off	off	off	off	on	off	on	off	off	off	4628
b	c	e	on	off	off	off	on	off	off	off	off	off	on	off	on	off	off	off	88A8
b	e	c	off	on	off	on	off	off	off	off	on	off	on	off	on	off	off	off	50A8

## PNP Configuration

1	2	3	S15	S14	S13	S12	S11	S10	S9	S8	S7	S6	S5	S4	S3	S2	S1	S0	HEX
e	b	c	off	off	off	on	off	off	off	on	off	on	off	on	off	off	off	off	1151
c	b	e	off	off	off	off	off	on	off	on	off	on	off	on	off	on	off	off	0554
e	c	b	off	off	off	off	on	off	on	off	off	on	off	on	off	off	off	on	0A51
c	e	b	off	off	off	off	off	on	on	off	off	on	off	on	off	off	on	off	0652
b	c	e	off	off	off	off	on	off	off	off	on	on	off	on	off	on	off	off	08D4
b	e	c	off	off	off	on	off	off	off	off	on	on	off	on	off	off	on	off	10D2

# ACORN USER guide to local dealers

## SURREY



**Calancraft Ltd.**



**THE COMPLETE ACORN DEALER**

- Showroom open 9.00 - 5.30 six days and to 8.00 on Thursday.
- Acorn range on display, and full demonstrations given.
- Lots of programs, games and education software for you to try.
- Full service and repair facilities.
- Network Dealer and Training Centre for Education and Home.
- Printers, Upgrades, Internet, CD ROM, etc. etc.

*"Very helpful people"*

with a 13 year long reputation for exceptional service and support.

Easy parking.

96 High Road, Byfleet,  
Surrey KT14 7QT



Tel: (01932) 342137

Fax: (01932) 336435

## EAST MIDLANDS

**KEYBOARD TECHNOLOGY**

ACORN Education Dealer  
ACORN Network Dealer  
ACORN Special Needs Centre

**0% finance on Risc PC**

Visit our Showroom just 1/2 mile from  
M1 junction24 (2nd right on A6 south)

Keyboard Technology Ltd  
51 High Street Kegworth  
Derby DE74 2DA  
Tel 01509 672222

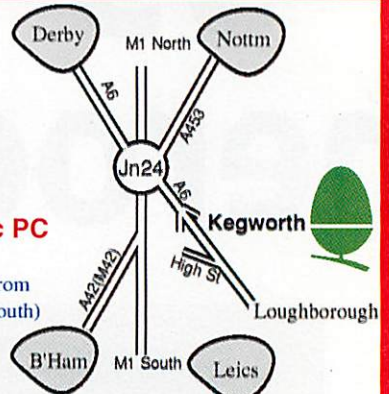

Open Mon to Fri 9.00 - 6.00pm  
Saturday 9.00 - 5.00pm

## WEST YORKSHIRE

THE CHOICE OF EXPERIENCE  
MART **YN**  
**DAV**

**Dayn Computer Services**  
Printers, Ribbons, Ink Cartridges, Refills  
Expert Advice & After Sales Service  
Mail Order Master Card, Visa, Switch  
Ring for Prices  
Service & Repair to all Equipment  
Full Range of Acorn Hardware & Software  
(We operate the Acorn Finance Schemes)  
Full Range of Educational Software  
Tel. 01924 254800 Fax. 01924 258036  
e-mail sales@dayn.demon.co.uk

For the best service in Yorkshire  
(we think)  
CALL US! for A7000, RiscPC & Pocket Book II  
Visit our Showroom  
Open 9.30 to 5.30  
Mon, Tues, Weds, Sat.  
9.30 to 7.30  
Thurs & Fri.

Centres of Technology  
Acorn  
Centres of Technology

How to find us

WE ARE HERE  
The 'Workshop'  
off Princess Street  
Sandal  
Wakelield  
WF1 5NY

Acorn  
RISC PC  
hp  
HEWLETT  
PACKARD  
Canon

A map showing the location of Dayn Computer Services in Sandal, West Yorkshire. The map includes labels for Leeds & Bradford M1 Junction 41, Stanley, Town Centre, Huddersfield, Dewsbury, Bailley, M1 Junction 40, Sandal, Wakelield, WF1 5NY, and M1 Junction 39. It also shows the A67 road.

## SOUTH WALES

**UNIQUEway**

SOUTH WALES' ONLY DEDICATED  
ACORN DEALER AND ACORN CENTRE  
OF TECHNOLOGY

WE'VE MOVED TO BIGGER  
NEW PREMISES

Technical Support - Repairs - Hire - Internet Connections  
Low cost finance available on all systems.

3 Clarendon Road, Cyncoed, Cardiff CF3 7JD  
Tel 01222-464020 Fax 01222-463325  
<http://www.uniqueway.co.uk>

PLEASE NOTE OUR NEW ADDRESS AND PHONE NUMBER FROM 1st MAY 1996

Centres of Technology  
Acorn  
Centres of Technology

A map showing the location of Uniqueway in Cyncoed, Cardiff. The map includes labels for Clarendon Road, Cyncoed, Cardiff, and CF3 7JD.

## MIDLANDS AND OXFORD

**DACO**

459-465 Warwick Road, Tyseley, Birmingham B11 2JP  
**XEMPLAR EDUCATION AGENT**  
Tel: 0121 706 8933 Fax: 0121 706 4306

- Home use
- Business
- Education
- Special Needs
- Software Training
- Acorn approved network installers
- Complete range of Acorn equipment
- Consultancy

For expert advice & friendly service come and see us.  
We are open  
Monday - Friday  
9.00am - 6.00pm

XEMPLAR  
EDUCATION

## CUMBRIA

**Cumbria Software Systems**  
Specialist Acorn Dealer

**XEMPLAR**  
EDUCATION

Risc PC700, A7000  
Sales, Repairs, Software, Peripherals

Network design and installation  
Ethernet, Nexus ATM, Multi-platform networks

Semerc Authorised Dealer

CSS Ltd., Unit 3A, Townfoot Industrial Estate  
Brampton, Cumbria, CA8 1SW  
Tel: 016977 3779



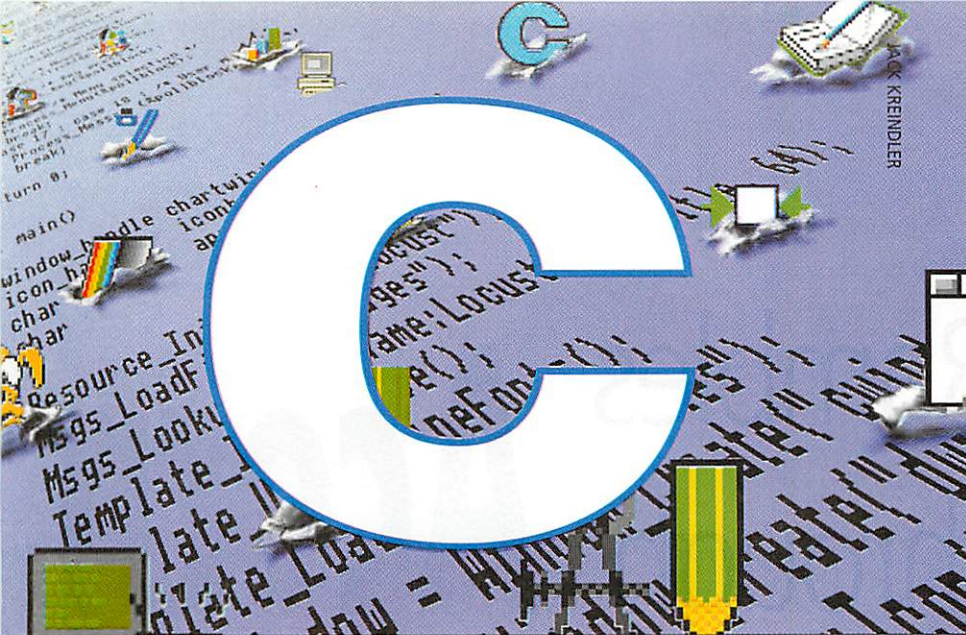

In the original WIMP C example, menus were created with a particularly cumbersome brute-force function that was hardwired for the purpose. All the menu flags were converted into integers and specified as constants within the code – if I'd wanted to place a tick by a menu item, or grey one out, it would have required a great deal of tinkering in the sourcecode with the reference manuals on standby. Obviously, this isn't the sort of situation we should be aiming for, and I've attempted to rectify this in the *Acorn User WIMP C* library.

At present, *AULib* provides four functions for dealing with menu creation and display – **au\_buildmenu**, **au\_addtomenu**, **au\_createmenu** and **au\_openmenu**. Two structure types, **menu\_data** and **menu\_element**, are also defined in the header file – these provide data containers for storing information about the menu header as well as the individual menu elements below it.

If you have access to the Programmer's Reference Manuals, you might like to take a look at the range of flags that the user must specify in order to create a menu. As well as the menu-specific options, including width, colour and entry spacing, each menu element must have a whole host of icon flags too. I spent several hours in a state of bewilderment, trying to discover why my menu options weren't being displayed. Eventually, I realised they were; I'd just neglected to set their text colour to something other than white.

Having kicked myself a couple of times, I decided that the best approach would be to build a shell round the menu creation procedure, allowing the user to specify the basic information and allowing the routines to fill in all the standard options themselves.

The first function, **au\_buildmenu**, takes an array of characters and a pointer to a structure of type **menu\_data** as its arguments – this sets up the appropriate menu header in the structure, using the supplied string as the title, which must be eleven characters or less in length. For instance:

```
menu_data globmen;
au_buildmenu("Test menu", &globmen);
```

# for

Steve Mumford continues to explain the emerging WIMP C library

# yourself

Once this has been done, menu elements can be added; the memory for these is allocated automatically and they're tacked on to the end of the original structure as a linked list. The function that deals with this is **au\_addtomenu** and it takes five arguments:

```
au_addtomenu("Entry 1", MENU_TICK |
MENU_DOTTED, -1, 0, &globmen);
au_addtomenu("Quit", MENU_LASTITEM, -
1, 0, &globmen);
```

The first parameter is the text of the menu entry, again eleven characters or less, followed by three integers and a pointer to a menu structure to hold the information. In order, the integers specify the menu flags to use, a pointer to a menu or window data block to display as a sub-menu (-1 if you don't want a sub-menu), and any extra icon flags you might require.

Various values have been set up using **#define** in *AULib.h*, and **MENU\_TICK** and **MENU\_DOTTED** allow you to tick an item or place a menu separator below one respectively.

In order to inform the WIMP that you've reached the end of your menu, you must tag the last element with the **MENU\_LASTITEM** flag. Finally, if you want to grey out a menu option, you can add the **MENU\_SHADED** flag to the icon

flags parameter. Once you've built up your menu, you have to instruct *AULib* to compile it into a datablock that the WIMP can understand, using the **au\_createmenu** function – this just takes a pointer to the structure that holds the menu details:

```
au_createmenu(&globmen);
```

Once this has been done, you're ready to open the menu using **au\_openmenu** – its three arguments are a pointer to the appropriate menu structure, and two integers giving the x and y coordinates of the top left-hand corner of the menu.

In order to be as useful as possible, a menu creation routine should allow the user to do several things – it should be possible to create menus dynamically, permitting them to be context-sensitive (for instance, the Filer menu displays the filename of the icon the mouse was clicked over).

The user should also be able to edit a defined menu easily so that the items within can be ticked or greyed out without having to rebuild the menu from scratch. Although the current routines in the library go some way to providing this functionality, there's still space for a few improvements – for instance, the data in the menus can't be indirected at the moment, limiting the the length of text strings. We'll tackle this next time – see you then.

AU

It's been another hectic month but this time I have spent it doing other people's biddings rather than my own. The Wakefield Show was busy, and it was good to see a new confidence oozing from the team on the ART stand. The lecture hall was packed for the presentations by Peter Bondar on the future of our beloved machine and as his talk followed mine I had a good audience as well, towards the end at least.

His message was clear – ART could survive and service the enthusiasts' computer market on the back of other commercial contracts. This gives long-term stability, something Apple can't boast at the moment. The down side of this is that things only get done when there is someone to pay for it, not when we want it. This means we might never get to see either of the new portable machines that were showing in prototype unless someone commits to buying a couple of hundred.

At the show, Acorn also revealed the plans for the StrongARM card – Clan members had heard about this a week earlier. In fact, I got my information about it the previous Saturday inviting me to send off £50 to reserve one. I thought about it, listed all the reasons why I shouldn't and then sent off my money before lunch. At the show, ART announced that by Friday it had received over a thousand orders – great for the cash flow. You receive a certificate stating your number in the queue, and I was interested to see that my number is 40, so there are a lot of people waiting after me. When it arrives I'll let you know how it pans out.

On another subject, I was looking at the log files on my Web site, which records every access made, telling me who made it and when it was made. In addition, if the access made is the result of a search, it can tell me what the person was searching for. I was greatly amused to find several accesses to my body build articles when people were searching for 'body build + female' and 'body build + gay'. They must have had quite a surprise when they arrived at my site. I am thinking of putting up a Web page with lots of dodgy words in it but saying 'nothing like this is to be found here'.

*Jeff Car from Huddersfield writes:*

I have recently retired and feel that I have at least one piece of serious writing inside me. I know that publishers now expect material to be delivered on disc. From your knowledge of the trade, would you say that a main-stream publisher would be likely to accept material generated on an Archimedes? I would hate to do a lot of work and then be told to go away and do it again on a PC before anyone would look at it.

# Rambles through Acorn

More words of advice from Mike Cook

Most mainstream publishers would have never heard of an Archimedes let alone be able to cope with the output from one. However, they don't need to. All you need to do is to submit your work on a PC formatted disc as a plain ASCII text file, of the type produced by !Edit. They will then do all the fancy formatting and laying out.

However, it is a good idea if you send a printed copy of your work as this makes it easier for them to evaluate it. You can format PC discs under the latest operating system and simply drag your files into them. Then, advise the publisher in the covering letter that it is in plain text format. Finally, try to avoid using ASCII codes over 128, this means things like curly quotes, curly apostrophes and the symbol for degrees.

*Now for Anthony Park from Lancaster:*

May I enquire about the use of CD-ROM drives. I am confused about the issue of IDE and SCSI – can they work together on the same computer system? I am interested in purchasing a CD-ROM drive for my A5000. Should I buy a SCSI interface and, if so, will it continue to work with my IDE hard disc? I have no plans to expand my computer at present, but in the future I may want to add a hand scanner. Which system should I purchase?

Yes, you can use SCSI and IDE in the same computer. I would advise you to get a SCSI interface because this means you can add things later on, although it is the more expensive option. If you want to go for economy then get an IDE CD drive and then get a printer port scanner later. However, there can be problems if you try to run both an IDE CD and a SCSI CD at the same time.

I have just purchased a quad-speed IDE CD from Yellowstone to replace my single-speed SCSI drive. The problem is that when the CD drivers were installed the computer hung in mid boot sequence. A phone call to Yellowstone produced a puzzled response and a promise to call back which never came.

Therefore I decided to see if that nice

Mike Cook could sort me out! I suggested that I modified the boot file that loaded all the Yellowstone modules in to first kill off all the Morley CDFS modules loaded from the SCSI card. This worked a treat and I now have my internal quad-speed CD working. However, I failed to notice any increase in speed so I did some timing loading in the same 6Mb file. The results were quad-speed IDE 43.57 seconds, single-speed SCSI 43.66 seconds.

*The next question relates to file conversions.*

I am interested in a PC clip art disc, but all the files are stored in .WMF (Windows MetaFile) format. Are there any conversion programs that can handle these type of files and convert them to an Acorn recognised format to be used with Impression Style?

Yes there are a few applications to do this. One I have is !WMF->Draw, which is careware and is available from Norwich Computer Services or the author Keith Sloan, who can be contacted on 0181-654 2212.

*Colin Edmunds from Botley has three posers for me:*

There are a number of points you may be able to assist me with as I am having a few problems with various software packages. I used to use an A3010 with 4Mb RAM and an HCCS hard drive upgrade with a scanner micropodule etc. I have since upgraded to a Risc PC 600 running RISC OS 3.6 and have come across the following problems:

I created some documents on the A3010 with Fireworkz which included two scanned sprites of a signature and a logo. In order to display the logo, without hanging the Risc PC, I have to switch the screen mode to 31 using the Display Manager before loading the document. The signature is displayed without any problem.

The only difference I can find between the two sprites is that the screen colours seem to be inverted (they are two colour sprites) i.e. white is colour 1 and black

# Wood

colour 0 in the logo, and the other way round in the signature. When the program crashes the hourglass appears just before the logo sprite would be loaded and even alt-break will not terminate the task. I have spoken to Colton Software on this issue and the problem had not previously been raised with them, therefore I was offered no solution.

There are so many modes available that it is possible the programmer didn't test that it worked with all of them. I suggest you convert the sprites you have using *ChangeFSI* and save them in a standard mode like 28, 15 or 0.

Another problem I have noticed is that when running the Projector Ace Film Player (version 1.23), the animation fills only the lower half of the window in which it is running, and it appears squashed to fill the space it is confined to. This seems to happen in all but the 1280 x 480 screen sizes and above. I have noticed this on some other PD applications, especially those that display text or sprites in the window. Any ideas?

In order to improve speed, many programmers write directly to the screen memory. This was not too bad as there was a call to inform you where the screen memory was and you could do a little searching and get the format and screen dimensions.

However, with the improved screen resolution and higher scan speeds of the Risc PC, the memory is organised in ways not anticipated by earlier programmers. Even the old modes are emulated by the new machine, and therefore it is not surprising that these sorts of things happen. Your best bet is to get in touch with the original suppliers to see if they have an updated version.

I cannot format a floppy disc unless I unlock the IDE hard drive, yet all other read and write operations are possible with the IDE locked. Is this a security feature or do I have a problem with the Risc PC?

I was puzzled about this one because I couldn't reproduce it on my system. Then I discovered that this is a 'feature' of the

3.6 OS and I am still running 3.5 here. It is possible that this 'feature' may be removed in later versions of the operating system.

*Next we have a response for help in getting sound files to work properly on the Newer machines. Ben Rodgers from Sheffield responds:*

This is the solution for Gary Taylor's problem. \*TUNING is the command used to speed up and slow down the sounds output from *!Configure*, and indeed the rest of the desktop. To use it, enter \*TUNING (+/-)&xxxx. The + or - defines whether a speed up or slow down is required, and the xxxx is relative change to the current speed.

I find that for a lot of samples the value is about -&3000, from 0, which is equivalent to -3 octaves. If this doesn't meet the required speed, \*TUNING 0 will reset the tuning, and then you can try different values of &xxxx until you find one which makes the sample sound alright.

\*TUNING is not a permanent configuration, so if you replace the standard Acorn beep with a sound sample in your *!Boot* sequence, you must also include the correct \*TUNING command to get it to the right speed. Unfortunately, some games and applications which use sound are affected by this, or they change the speed themselves. I do not know how this affect can be avoided.

Also, if re-tuning on the command line, CTRL + 7 will trigger the sample currently selected in *!Configure*, and using this means you don't need to keep entering and exiting the command line. Alternatively, a task window can be used in conjunction with *!Configure* until the correct speed is found.

I hope this has solved some of the problem, although it's not a very elegant solution.

*David Horman sent the same information, plus a little extra:*

With regard to playing Tracker tunes on a Risc PC, the problem may be with the frequency of the screen mode because sample playback is affected by the refresh rate. The older play routines (such as Hugo Fiennes player module, and desktop programs like *Jukebox*) will not account for this, but Digital Symphony does.

*Mr Windley sent me this through the Internet:*

Following your answer to Brian Yewdall in the April edition of *Acorn User*, I decided that a Zip 100 drive was just what I need. So I bought one. The drive is now connected to my Risc PC 600 via an Acorn SCSI card and is recognised by SCSIFS as a direct-access 96 Mbs IOMEGA ZIP 100. Although the drive works

perfectly with Windows 95 and the 486 Card (using the DOS format SCSI option), I can't get SCSIDM to format the discs. Selecting the drive with the SCSIDM command device <n> gives the error: **rdshape: cannot find page 3 of Mode Sense data**

**bad device name 6  
No device selected**

I've a fairly good idea of what SCSIDM is complaining about, but isn't it about time Acorn revised SCSIDM to cope with removable media. Using the Zip 100 as a dedicated SCSI drive in Windows then simply swapping discs to get a RISC OS SCSI drive is a good a way as I know of having your cake and eating it.

*Dave Walker from Acorn sent me some further illumination on the question of IDC specifications:*

There is a short section in Acorn Customer Services Application Note number 223; I know this is strictly about hard discs, but there are a few mentions of CD-ROM drives too. There is a CD-oriented appnote (number 273) as well, but this doesn't cover bus standards. Both these documents are on our ftp site.

The drives we've fitted to the IDE bus are:

- Panasonic CR562B, Sony CD50E and Sony CD56E.

It's a short list, but that's it....

*Next Michael Aves casts some light on another line of discussion:*

Jim Belsey's question (*Acorn User* June page 82), and your answer dug up an interesting corner of musical history. I did not see the television programme, but I guess the instrument referred to is the Theremin, which is named after its inventor (a French-born Russian, Leon Theremin), who demonstrated it from 1927 onwards. There was a short-lived vogue for using it for spooky effects in film scores.

It works by using the performer's right-hand movements to affect, by induction, the rate of oscillation of a valve circuit, thus producing notes of varying pitches. The performer's other hand affects loudness in a similar way.

Apparently, it is extremely difficult to play and is largely supplanted these days by the Ondes Martenot which works on comparable principles but does, at least, have a piano-style keyboard.

I leave to others the question of applying the principle to computer pointing devices - I am happy to have a reliable computer, without redesigning it!

Contact Mike Cook by writing to the usual *Acorn User* address or by e-mail to [auqanda@idg.co.uk](mailto:auqanda@idg.co.uk)



# Back issues

Missed out on one of our previous issues? Now's your opportunity to bring your collection up to date. But hurry: stocks are limited

## Issue 160 – October 1995

- The Acorn User WWW site
- Director ● Fire and Ice
- Compo ● Acorn's education agents scheme

## Issue 161 – November 1995

- Acorn User awards
- CD-ROM roundup ● Graphic design ● Crystal Rainforest 2 demo

## Issue 162 – December 1995

- Cambridge Om trial
- Internet package ● Acorn's new divisions ● Software for dyslexics ● Skillsware

## Issue 163 – Christmas 1995

- Unusual gifts for Christmas ● PD round-up ● Alone in the Dark ● Global Effect demo
- Online Media Technology

## Issue 164 – January 1996

- Hybrid machines ● Travelling with a Pocket book ● Virtual design ● Acorn Educational Products & services Catalogue
- Top Model demo

## Issue 165 – February 1996

- Word processing round-up
- The Clan ● Virus protection
- Sibelius at the Royal Academy ● Resource editor demo

## Issue 166 – March 1996

- Video editing ● Multimedia packages ● Graphics applications
- Colour printers ● Alone in the dark demo ● FSCK



## Issue 167 – April 1996

- Reviews ● Power DTP
- Acorn Australia ● Swarm
- Float ● Glossary

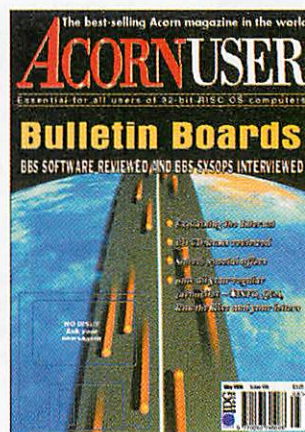

## Issue 168 – May 1996

- Bulletin Boards ● Internet explained ● PD CD-ROMs reviewed
- Demo of Optical

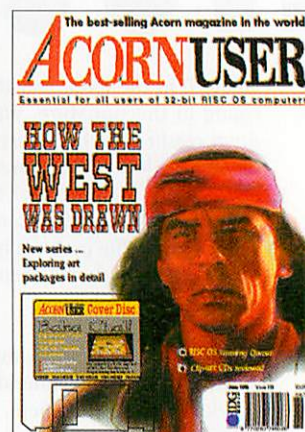

## Issue 169 – June 1996

- Hands-on review of Studio 24 Pro ● RISC OS running Quasar
- Clip-art CDs reviewed
- Baka Chal!

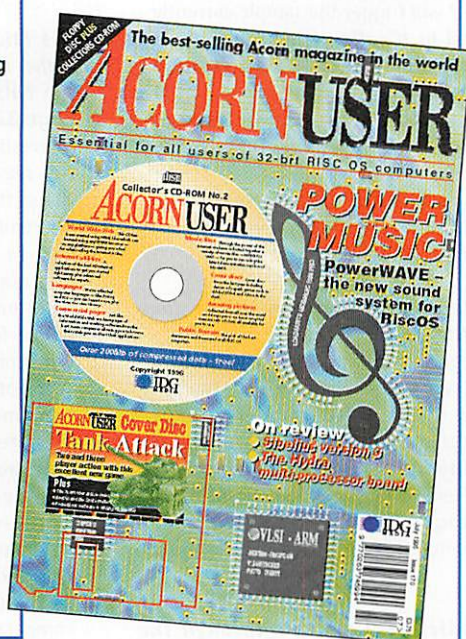

## Issue 170 – July 1996

- PowerWave ● The Hydra multi-processor board
- Sibelius version 3
- Acorn User CD-ROM No. 2
- Tank Attack

## Order form

- |                          |                                |       |
|--------------------------|--------------------------------|-------|
| <input type="checkbox"/> | Issue 160, October 1995.....   | £3.25 |
| <input type="checkbox"/> | Issue 161, November 1995.....  | £3.25 |
| <input type="checkbox"/> | Issue 162, December 1995.....  | £3.25 |
| <input type="checkbox"/> | Issue 163, Christmas 1995..... | £3.75 |
| <input type="checkbox"/> | Issue 164, January 1996.....   | £3.25 |
| <input type="checkbox"/> | Issue 165, February 1996.....  | £3.25 |
| <input type="checkbox"/> | Issue 166, March 1996.....     | £3.75 |
| <input type="checkbox"/> | Issue 167, April 1996.....     | £3.25 |
| <input type="checkbox"/> | Issue 168, May 1996.....       | £3.25 |
| <input type="checkbox"/> | Issue 169, June 1996.....      | £3.25 |
| <input type="checkbox"/> | Issue 170, July 1996.....      | £3.75 |

Name .....

Address .....

.....

Tel No .....

Please allow 14 days for delivery.  
Send cheques payable to IDG Media to:  
Acorn User Back Issues, Database Direct,  
FREEPOST, South Wirral L65 3EB  
or phone 0151 357 1275  
Fax: 0151 357 2813

E-mail: database@dbdirect.demon.co.uk

- Please tick if you do NOT wish to receive further information or special offers

# SOFTWARE SHOWCASE

## MEMORY/HARDWARE

**RISC PC & A7000 & PC Memory.**  
 All prices include VAT & FREE Delivery  
 IBM & Texas Instruments "60ns" SIMM's  
 ☆☆☆☆☆☆☆☆☆☆☆☆☆☆☆☆☆  
 4 MB - £52.00    16 MB - £160.00  
 8 MB - £82.00    32 MB - £350.00  
**NEW!**  
 UNBEATEN QUALITY TO FIT YOUR BUDGET  
 □ ACORN & PC Systems □  
 HARDWARE □ SOFTWARE □ PERIPHERALS  
[http://ourworld.compuserve.com/homepages/RISC\\_Solutions](http://ourworld.compuserve.com/homepages/RISC_Solutions)  
 Mon 0800 - 2300 Hrs    Tues to Fri 2330 - 1400 Hrs  
 Sat 0900 - 2200 Hrs    Sun 1000 - 2000 Hrs  
 Tel: 0121 680 9331 or Fax: 0121 680 9323  
 © RISC Solutions. ©

## BUSINESS SOFTWARE

**DSL SUPPLIES**  
**SPECIAL OFFERS!**

**35% OFF ARMLOCK!**  
 Single User £22.75 Save £12.25!  
 10 User £90.35 Save £48.65!

**35% OFF SQUIRREL!**  
 Single User £90.35 Save £48.65!  
 10 User £361.40 Save £194.60!  
 All prices exclude post & packing

**DSL SUPPLIES**  
 St Margaret's Lane  
 FAREHAM  
 Hants PO14 4BQ  
 Tel/Fax 01329 841600



## EDUCATION

**Xavier Software for  
 Dyslexia / Literacy skills**

Wide range of specialist programs, available on  
 28 day approval. Digitised speech throughout.  
 See review in Acorn User Dec. 95 or CDROM  
 January 96. Illustrated catalogue from :  
**Xavier Educational Software Ltd.**  
 Psychology Dept, University College of Wales, Bangor, Gwynedd  
 LL57 2DG Tel: 01248-382616 Fax: 01248-382599  
<http://www.psych.bangor.ac.uk/deptpsych/xavier/>  
 email: pss005@bangor.ac.uk

## BUREAU

**PRINTMAKER**  
**CUT VINYL BUREAU**  
 LETTERING, LOGOS & DECALS  
 cut in self-adhesive vinyl on our  
 plotter from Acorn DRAW files.  
 Any size, colour and quantity.  
**Ideal for Signs, Van sides, Car Decals  
 & Exhibition graphics.**  
 Tel 01734 567947 Fax 01734 561112  
 14 Eldon Terrace Reading Berks RG1 4DX  
 Contact Chris Mercier Email: mercier@argonet.co.uk  
 see us on the internet...<http://cybervillage.co.uk/folio/printmaker>

## GAMES

**FREE 14 DAY  
 HOME TRIAL**

What we will do is send you our latest  
 five quality budget games for you to try  
 in the comfort of your own home.  
**Any Risc OS with 1 Mb or more**  
**GENERATION DESIGN**  
 2 Whitecliff Gardens, Blandford Forum, Dorset  
 DT11 7BU  
 Tel: 01258 452507  
 Email: genden@argonet.co.uk

# ACORNUSER

## ADVERTISERS INDEX

4 Mation.....	77	First Computer Centre .....	41
5 Star Marketing .....	77	Generation Design .....	85
AJS Computers .....	64	I.C.S. (Ian Copestake Ltd) .....	6, 7
Aleph One.....	OBC	Ifel.....	37
Alternative Publishing .....	64	Irlam Instruments.....	8
APDL.....	66	Kimberley Computer Services.....	52, 53
Beebug .....	11	Krisalis Software .....	26
C.S.S. ....	80	Liquid Silicon .....	63
Calancraft.....	80	Micro Laser Design .....	63
Care Products.....	77	Pineapple Software .....	IBC
Castle Technnology .....	15	Printmaker .....	85
CJE Micros .....	44	Risc Solutions .....	85
Computer Concepts .....	IFC	Selective Computer Services .....	77
Daco Systems .....	80	Softcentre .....	66
Dalriada Data .....	71	Softease.....	77
Davyn Computer Services .....	17, 80	Spacetech .....	48
Dec Data .....	66	Technology Matrix.....	54
Desktop Projects .....	18	The Datafile .....	64, 71
DSL Supplies.....	85	The Datastore.....	66
Eesox .....	63	Tower Electronics .....	77
		Uniqueway .....	80
		VTI.....	12, 48
		Yellowstone .....	54

# Subscribe now to claim your free gift or special offer from

## ACORN USER

the world's number 1 Acorn magazine

You already know what a great magazine ACORN USER is. After all, we've been the main source of information for all Acorn enthusiasts for the past 13 years.

What you might not know is that by taking out a subscription today, not only are you guaranteed never to miss an issue of the biggest and best Acorn magazine in the world, but you can also claim an excellent free gift or special offer, available exclusively to all new ACORN USER subscribers.

*As an Acorn User subscriber you'll benefit from:*

- Protection from any further price increases during your subscription
- Free delivery, every issue, direct to your home
- One of our amazing free gifts or special offers

**FREE**

**BINDER & TWO  
FREE MAGAZINES**



Exclusive to Acorn User this binder will hold up to 13 issues of your favourite magazine. PLUS receive an extra two magazines absolutely FREE!



**EASYFONT 3 SAVE £25.00**

Runner up in the Acorn User Best DTP Software category EasyFont3 is the essential Font Management System. Features include: flexible control over your fonts; WYSIWYG display window; up to 40% space saving on your hard drive; specifically designed Font Filing System giving maximum power and flexibility; the ability to create countless new styles of font quickly and easily; and the elimination of the dreaded 'Font not found' errors.

**SUBSCRIBING HAS NEVER BEEN EASIER**



Why not make your subscription even easier and subscribe by direct debit, spreading the cost of your subscription over quarterly hassle-free payments. What's more, you need never worry about missing an issue again, as the subscription continues until you decide to cancel.

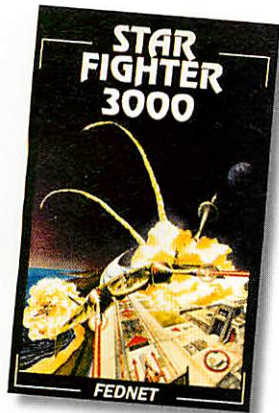

**FREE**  
**STAR**  
**FIGHTER 3000**  
**SAVE £29.95**

Winner of our reader's Best Game award. An original and thrilling space game from Fednet.

**Only £10**  
**PUBLISH ART**  
**SAVE £25.00**

The ultimate DTP resource – 1500 original designs, a massive 13Mb of eye catching resources – for perfect DTP

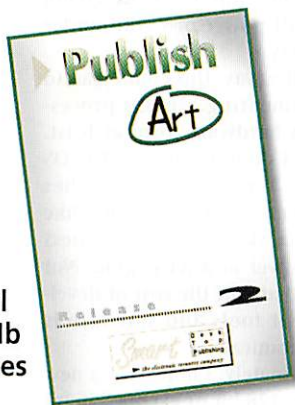

**£50 HOLIDAY VOUCHER**

Acorn User gives you £50 off your next holiday abroad!

**FREE**



Offer entitles recipient to £50 reduction on most ABTA tour operators' brochures when booked with Xpert travel Limited. Valid for minimum two people, seven days holiday overseas. Further information available on request. Only available for UK residents

**4 DISC GIFT PACK**

**FREE**

Four high density discs (low density also available). Including a collection of education resources, a multimedia presentation detailing the top 10 programs released this year and the best PD and Shareware available.



**Subscription Hotline numbers**

Tel: 0151-357 1275

Fax: 0151-357 2813

Email: database@dbdirect.demon.co.uk

**Priority subscriptions form**

**1a**  **YES!**

Please enrol me for the following 13 issue subscription to Acorn User NOW!

See section 2.  
 4234  UK £39.99    4202  EU £53.99    4203  World £68.99\*  
 To renew subscription please tick:  
 4235  UK £39.99    4224  EU £53.99    4225  World £68.99\*  
 \*Unfortunately World subscribers are not eligible to receive the free gift/special offer

I would like to pay by:

- Cheque/postal order made payable to IDG Media
- Credit card (Visa/Access/Barclaycard/Mastercard/Eurocard/Connect)

Expiry date  /

Card No.

**1b** Please enrol me as a subscriber to Acorn User.

4210  with payments of £9.49 by continuous quarterly direct debit  
 See section 2.  
 Your subscription will continue until you cancel. Over a year you will receive 13 issues.

Name of Bank/Building Society .....

Address .....

Name of Account .....

Your Account No. .... Sort Code .....

Date ..... Signature(s) .....

Your instructions to the bank/building society: I instruct you to pay direct debits from my account at the request of IDG Media. The amounts are variable and may be debited on various dates. No acknowledgement required.

any direct debit is paid which breaks the terms of the instruction, the bank/ building society will make a refund. Bank/building society may decline to accept instructions to pay direct debit from some types of accounts.

I understand that IDG Media may change the amounts and dates only after giving me prior notice. I will inform the bank/building society in writing if I wish to cancel this instruction. I understand that if

**FOR OFFICE USE ONLY**  
 Originator's ID No. 851412

Ref No. ....

**2** Please send me the following FREE Gift/Special Offer (tick one):

- 4205  Binder and two magazines **FREE**
- 4206  Starfighter 3000 **FREE**
- 4207  Publish Art **Only £10**
- 4208  Acorn User Gift Pack **FREE**
- 4209  £50 holiday voucher **FREE**
- 4731  EasyFont 3 **Only £10**

For the gift pack please specify whether you require High or Low density discs (delete as appropriate)

● Please remember to either add the appropriate amount when you write your cheque or if paying by direct debit, please send additional payment

All subscriptions will commence with the next available issue. This offer can not be used in conjunction with any other subscription offer. All offers subject to availability.

**3** Name .....

Address .....

Postcode ..... Tel.....

**4** Now send your completed form and payment to Acorn User, Database Direct, FREEPOST, South Wirral L65 3EB. Tel: 0151-357 1275. Please state if credit card billing address is different from the delivery address. Photocopies or handwritten versions of the above information are acceptable.

IDG Media offers you the chance to receive information about other organisations' goods and services, please tick the box if you prefer not to take advantage of this.

# Letters

## A step too far?

The Acorn scene is increasingly becoming home to gloom peddlers. These people are always ready to see the darkside of any announcement by Acorn. I am not one of these people, never have been, but if Acorn ever makes an announcement to confirm the predictions made in *Acorn User* last month I will become one of these people, permanently.

Acorn is really starting to win important strategic battles, the net surfer online media project being the most high profile of these. However, we have rumours from Nintendo that it is about to use the ARM7500 in its next Gameboy machine. Acorns are being used in the television industry with increasing frequency, we also have a multiprocessor board about to come into full action. These are to name but a few of the interesting exciting developments based around the ARM and RISC OS.

Why has the long war suddenly started to turn in our favour? I believe it's because people can see the ARM processor working, they can see that RISC OS offers an excellent environment and that ARM assembler is one of the most efficient assemblers available.

So when Acorn began to announce its cooperation with other platforms there were a few dissenting voices. As far as I was concerned, there is nothing wrong with this, we need the compatibility as this will hopefully entice more people to RISC OS. However, in last month's *Acorn User* Amit Gupta predicted some alarming future developments on the Acorn scene.

The predictions say that the next Acorn machine will be a CHRP-based platform hooked up to the PCI bus. The most alarming prediction is a card for 'backward compatibility'. This is coupled with a prediction that Acorn will no longer

develop major RISC OS or ARM products, therefore indicating a switch, in the long run, from Acorn designing and manufacturing its own computers that run the best OS in the world on some of the most efficient processors, to Acorn manufacturing CHRP computers containing the Mac OS. To me, it appears that this will result in Acorn becoming just another Mac clone manufacturer. Is this what people want?

Do we really want to abandon RISC OS, as 'unlikely to be extensively' developing it further in effect means abandoning it. This seems foolish because a recent survey of RISC OS developers on the Internet (surprisingly perhaps considering the recent doom and gloom), revealed that the overwhelming majority of developers thought they would continue to develop for RISC OS. In light of this will they still want to continue?

If Acorn is considering this move, and I hope for the sake of all the people that use good computers it isn't, then I, for one, will no longer buy Acorn computers. Instead, I will bypass what is apparently an interim step of having an ARM processor and RISC OS carrier board on the PCI bus and upgrade directly to either a CHRP machine or whatever the 'best' machine is available at that time. However, I doubt that I will be able to find another platform that has a community spirit such as the one I found in the Acorn world.

I cannot criticise this prediction without prescribing some sort of alternative. I propose that Acorn, to remain the company that has been at the forefront of computing for more than a decade, must regain its lead. What I think Acorn should do in the short term is plug the ARM's processor bus into a PCI bus, and perhaps work on a card to allow the ARMs to be plugged

into a socket in place of the PowerPC chip, therefore giving the full power of CHRP under RISC OS.

Either way, this could lead to implementing a multi-processor in hardware form at least. What I do not want is RISC OS under Mac OS which crashes frequently and feels to me like using a skateboard to harness the power of a jet engine. Not only that, but the cost of development tools and software is astronomical.

Ultimately, I hope that a new 64-bit, 128-bit or even a 256-bit ARM processor would be developed and a RISC OS to cooperate with it. Such a processor would allow floating point to be stored in a single word, and these could then be plugged into a multiprocessor bus whether it be CHRP or Acorn's bus. To be honest I don't care – the only advantage of using the CHRP board is to keep compatibility with PeeCeeMac and other OSs.

Finally, how hard would it be for a patch on this processor to use an industry-standard floating point unit such as IEEE? This would allow plug in FPU, and it has to be the simplest solution as people are always moaning about RISC OS lack of FPU. Surely this would solve the problem.

In short, moving to the Mac OS, if Acorn is contemplating it, is wrong. The Mac OS is, in my experience, rubbish. If Acorn is moving to the Mac OS then isn't it about time it questioned its existence? Is this what we want – a British Mac OS clone manufacturer? There has to be a way out for Acorn – the innovative British company we know. I hope this is all a misunderstanding, so come on Acorn do something amazing – again.

In hope and expectation,

Jim Belsey  
(jim@jim.zynet.co.uk)

*When I commissioned Amit*



*to write the excellent and informative CHRP article I realised it could be viewed as depressing, in fact I found it rather depressing myself. However, as I've mentioned once or twice, things are moving very fast. And even before the article was printed things had changed.*

*Acorn's new contracts mean that RISC OS will be developed for many years to come and – under various guises – could become the most used OS in the world. So I'm happy to say that things are not as bleak as they may, at first, appear.*

## View from the Mac

I hear and read a lot of opinions about Xemplar, the joint venture between Apple and Acorn. I'm an ex Mac user and that's why I was inspired to





write the following. A lot of people seem to see Xemplar's arrival as the end of RISC OS. I don't think this is true and even if it was, you will probably be able to continue to use your Acorn hardware with a second PowerPC processor card fitted, running all those powerful Mac apps you don't have for RISC OS. You would still be able to use all your existing RISC OS apps.

You have to face a truth many of us don't like - there is much more software development for other non-RISC OS platforms. I'm very glad I bought *Impression Publisher* from CC, although CC seems to be migrating to the Windhoze platform. I will be using it even without any support from CC or whatever because it's good.

*QuarkXpress* is, in many views, better and handier but because of what the Mac OS now is (I worked with it until very recently), working with a DTP package under RISC OS has many advantages.

The excellent drag-and-drop feature is one of these advantages, not to mention the brilliant anti-aliasing which even the Mac lacks! On the other hand, suppose RISC OS eventually dies, then I wouldn't give a damn as long as they give me the possibility to add a PowerPC card to run Copland on the Risc PC too. This would again give me the access to lots of very good Mac CD-ROM titles and apps like: *MacPPP*, *Adobe PageMill*, *HyperCard*, *PlainTalk*, *QuickTime VR*, *QuickDraw 3D*, *Adobe Premiere*, *KPT Bryce*, etc.

You may ask: why didn't you stay with the Mac camp? Well, the truth is, I was fed up with how Apple treated its customers. When I bought my Quadra 660AV, it was very expensive (not so long ago). A few months later the prices dropped dramatically - I got used to that and I was glad I didn't buy the Centris 660AV which had a faulty video circuit and a slower processor. Anyway, I noticed that the Mac OS was quite handy in some ways, but very buggy and slow. Not to mention the amount of RAM it needs. Got used to that too (had to reset a few times every evening). But then came the PowerMac. No upgrade for

my type of computer. Software upgrades came for the PowerMac. The next major system upgrade: PowerMac only. *PlainTalk*: PowerMac only. The same went for *QuickDraw 3D* and other multimedia extensions. It now also has what it calls translucent dragging of icons - instead of only a mere contour - but only on PowerMac. It doesn't require *that* amount of processor power, does it?

Adding a new processor or a second processor? Impossible! Expanding: nearly impossible. Couldn't get used to the idea of getting stuck. That's one of the reasons I bought a Risc PC. Buying a PC I would never do - not to use it as my main computer anyway - and Atari and Amiga didn't feel too comfortable either. An Indy from SGI was far too expensive (other UN\*X machines are too exotic), a BeBox isn't a good idea yet, so actually the Risc PC remained the only logical alternative.

After all I went through with Apple, I must say that I have more faith in Acorn. It won't let us down as simply as that. Maybe one of the Mac clone makers such as Power Computing is more trustworthy, but I don't know that and, by the way, there is too much going on in the PowerPC branch. Meanwhile, I feel quite comfortable with my greatly expandable Risc PC 700 and I enjoy reading *Acorn User*, much more than any other PC magazine because of the fact that there is much more going on in the Acorn world. There are exciting developments like multiprocessing, impressive processors being developed, Internet boxes, and so on.

It gives me more peace of heart than owning any other type of computer - especially a Macintosh: it keeps making all kinds of different types in order to confuse as many people as possible, and the advertisements about so called speedy and user-friendly computers make me sick.

I don't need hundreds of word processors like you do in the PC world. I don't mind having only one package for word processing and perhaps two spreadsheets: as long as they are inexpensive and

good, it's fine with me. On the other hand, we have lots of graphic packages. *PhotoDesk* is comparable to *PhotoShop*, even if it doesn't have all those features: it's not as RAM greedy as *PhotoShop* and much speedier. The price is cheaper and you can always use other packages to compensate for missing features. I don't need buggy *Netscape*, loaded with features I will never use, messing up the RAM...

I could continue for a few hours...

Ronald Schoenmakers,  
Amsterdam

### Bad graphics

Hello, I figure while I'm here at this site I may as well get something off my chest which has been nagging me for ages. I regularly buy your mag as well as countless Sega and Nintendo ones, and in these mags I see excellent games with brilliant graphics and gameplay. But in your mag I see games with badly drawn graphics and poor gameplay (I've bought enough of them and played the demos that come on the free cover discs to make such a sweeping statement). Why? Why is this so?

The Risc PC is so much better than Genesis, SNES and PC, so why are the graphics so bad. To top it off, you guys go and generously reward them with high scores when they wouldn't even get a second look in the real gaming world.

I know this sounds harsh, but it just makes me grind my teeth when I see these low standards. There's no reason why the Risc PC couldn't be better, with the 32-bit consoles that have just entered the gaming arena. No reason at all. I hope this letter kicks up a can of worms because something needs to be done to drastically change the way things are - a fantastic machine with no supporting software.

Phil  
(pat@demitri.unet.com)

### Quality not quantity

Gareth William's letter in the July issue completely misses the point of what should decide a computer purchase. It is true that IBM PC clones have a larger *quantity* of software, but just how *much* of

that is worth having? Despite there being literally *hundreds* of commercial word processors for IBMs, most PC enthusiasts would only describe Microsoft Word as a decent one. It's a pity as it doesn't approach the sophistication of *Ovation Pro*, *Impression Style* or *Textease*.

I wish that producers of Windows-pain-in-the-neck software would realise that functionality for functionality's sake does *not* meet the real needs of a business user, or anyone else for that matter. Microsoft throws money at *Excel*, but the simple fact is that it is inferior to *Fireworkz* on the Acorn platform. Microsoft's bloated offering now contains full programming languages and the ability to fill a whole 640x480 VGA screen with button bars (and that's not an exaggeration). But no-one buys a spreadsheet to program it, they buy it to work out and print quotes etc. So why doesn't *Excel* offer a full page display like *Fireworkz*?

I have considered, on many occasions, moving over to IBM-land. However, there is simply no good software for Windows. Take *Prophet* from Apricote Studios on the Acorn, for example. Name me one Windows accounting package that comes close and I'll eat my hard disc.

Support for IBM-clones and Windows software is non-existent in my experience. Most PC support staff seem to be of the same calibre as PC World's 'technical experts', who could not understand what an IDE interface was, and therefore tried to sell me a serial interface card! Acorn dealers are a good bunch. I recently attempted to buy a modem from Castle Technology but was told it couldn't sell them because it did not have the 'specialist knowledge' required to provide a high enough standard of after-sales support.

So what *should* determine a computer purchase? For me, I would choose the system that has the highest *quality* of software for running a business. So my choice has to be an Acorn for programs like *DataPower*, *Prophet* and *Ovation*.

Alex Singleton, Surrey



Some of my best code is generated on the motorway when I am completely away from the machine

Ask a primary school teacher to name the programs they use in class and one will be mentioned over and over again: *Clicker*. In the 'industry' of teaching, *Clicker* has become a standard; it gives you an on-screen keyboard with speech and pictures, it is easily accessible, and it can be used with pupils of all ages, including special needs. *Clicker* even has switch access, meaning that people who cannot use a mouse or keyboard can still use it. The program, which originated on the Acorn platform and is still developed on it, was written and devised by John Crick.

'I have been going just under three years' explains John. 'Up until then I was working as the IT co-ordinator in a special school for pupils with physical disabilities. My job was connecting kids to computers, so those who were quite severely disabled and could not use a keyboard, a mouse or a pen were given some sort of access so that they could get written work done. I spent a lot of time working out how they were going to work the computer with special switches using whichever part of the body they could.'

John then got the chance to set up on his own, waiting to pick the moment when he could manage without the regular pay cheque at the end of the month. He set up the business at the same time as his partner went back to work because they were used to living on one salary. This made the start up of the business amazingly stress-free.

'Part of the whole thing of running your own business is great because you are learning so much all the time and I find that very stimulating. If I ever have problems coding I get away from the machine, even just a walk in the garden will do, or I deal with other sides of the business. In fact, some of my best code is generated on the motorway when I am completely away from the machine.'

*Clicker* was released in the summer of 1994 and John started going to shows. He was amazed at how much interest *Clicker* generated and also delighted to get feedback from teachers. As John puts it: 'a hell of a lot of learning goes on at shows.'

John now has a version of *Clicker* for the PC and one for the Mac due out in the autumn. For someone dealing with all three platforms, he has an interesting viewpoint.

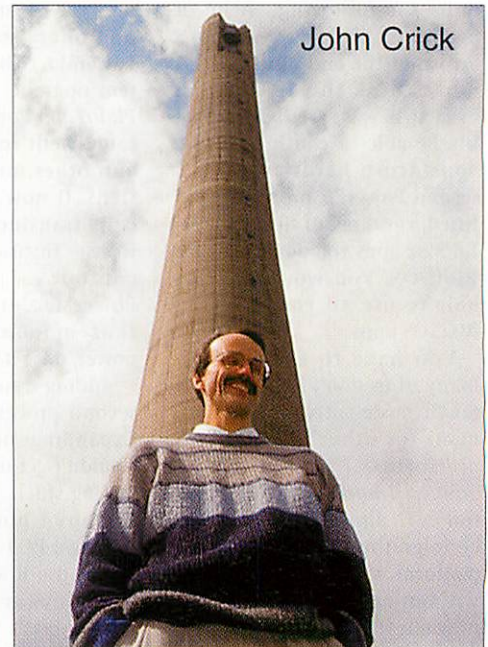

'Acorn is the biggest seller so far, but we have always been ahead on it anyway. We have lots of orders for the PC, and you know as a developer you will have a certain market for Windows software in five-years time. As I work an average of 16 hours a day, I like to know there is some future and pay for the time I invest in my products.'

'Developing for the PC can be tricky. Microsoft's developers software is very good, but there are some problems with some of the component software that I have come across.'

'With an Acorn product you can ship it and say definitely that this will work on your machine if you have (say) RISC OS 3.1. It is not quite as easy on a PC. We had much more difficulty making sure our Windows stuff is 100 per cent reliable on all machines. Our philosophy is: click on install and you want it to install, to work straight away, without messing around installing this or that first. Acorns and Macs are much better for this than PCs.'

'For me it is nice that I can support all three platforms. I strive to produce a really practical program for teachers, and they are not really interested in a particular platform; it is the software that counts. I think the hardware is going to become less and less important, particularly as the Internet grows. If the Internet becomes easy to get onto it will become the main way software is distributed. All schools are going to be connected within 12 months, whoever wins the election, but I do think it should be a computer for every teacher before one for every kid.'

Given how well *Clicker* has started to be received in the US, Crick Computing could well become Northampton's other big success, second only to the Express Lifts Company (it's the Company's testing tower behind John in the photograph). Surely a convincing argument for making programmers have some 'field training' for the software they're writing; John Crick knows his market so well because he's been there.

Jill Regan **AU**

# The Regan files

Studio24 was hailed as one of the best 24 bit painting programs. A completely new program, Studio24Pro is now set to lead the field in painting & photo-retouching

Picture produced by Walter Briggs, Kingfisher Graphics using Studio24Pro

- ### Features
- \* Fast Virtual Memory
  - \* Random mutated texture generation
  - \* Undo brush, Texture and Filter brush
  - \* Over 40 pre-defined filters including Spin blur, Motion blur, Lighting etc, etc.
  - \* PhotoCD and Scanner input
  - \* Merging of Sprites, Jpegs, Tiffs & Draw files.
  - \* Built in Draw file creation
  - \* RGB, CMYK or Indexed channel modes
  - \* Up to 16, 8 bit mask channels
  - \* Filter preview window (shown above left)
- 'Many Acorn User front covers have been created from scratch using this program alone, concrete proof of the power of this creative tool! - Acorn User March 96'

## Studio24Pro

£149.87 inc vat

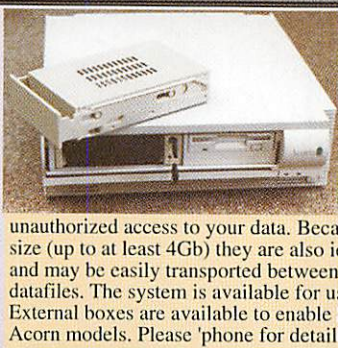

### Removable Harddrive System

**Total Data Security & Harddisc Backup**

The removable harddrive system fits into a 5/4" drive slot in the RiscPC and harddrives are available in many sizes which can simply plug in and out of the slot as required. The drive may be locked in place to prevent unauthorized removal. For total security the drive may be removed and stored in a safe place to prevent unauthorized access to your data. Because the removable drives are available in any size (up to at least 4Gb) they are also ideal for use as backups for existing harddrives, and may be easily transported between different computers for rapid transfer of large datafiles. The system is available for use with both IDE and SCSI filing systems. External boxes are available to enable SCSI removable drives to be used with older Acorn models. Please phone for details. See opposite for prices.

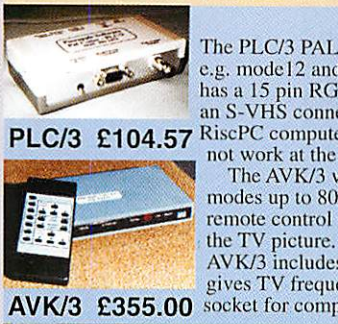

### PAL TV Coders

The PLC/3 PAL TV Coder works in any of the 'Standard' Modes, e.g. mode12 and 15 on all Acorn computer models. The PLC/3 has a 15 pin RGB output for the monitor, a BNC for video and an S-VHS connector for S-Video. The PLC/3 will work with RiscPC computers although the AKF60, AKF85 and AKF90 will not work at the same time.

The AVK/3 will work with all computer models in all screen modes up to 800 x 600 resolution in 16 million colours. It has a remote control with facilities for zooming, freezing & panning the TV picture. Ideal for lectures and demonstrations etc. The AVK/3 includes all connecting cables including a SCART which gives TV frequency RGB O/P for large screen TV's, a phono socket for composite video and an S-VHS socket for S-Video.

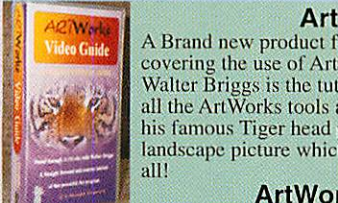

### ArtWorks Video Tutorial

A Brand new product from Pineapple is this VHS Video Tutorial covering the use of ArtWorks.

Walter Briggs is the tutor for this 1 hour video which shows how to use all the ArtWorks tools and then goes on to show how Walter produced his famous Tiger head picture. Walter also draws an impressive landscape picture which can be copied by those with no artistic talent at all!



### 24 Bit Colour Scanners

Pineapple can offer a wide range of Flatbed A4 colour scanners starting from as low as £359 including software and VAT!

The Epson range is currently the most popular although Canon are expected to release a new scanner to replace their IX-4015 shortly. The cheapest in the Epson range is the GT5000 with an optical resolution of 300dpi. This is adequate for virtually all home use. The GT5000 is available with either a parallel or a SCSI interface. The GT8500 has an optical resolution of 400dpi and comes with both parallel and SCSI interfaces. Finally, the GT9000 is the top of the range with an optical resolution of 600dpi and both parallel and SCSI interfaces. Imagemaster and Twain software are included in the price, but we also offer our Studio24Pro Photo retouching software at just £80.00 inc vat with every scanner purchase.

**20 : 20 Finance available on all RiscPC's**  
 Studio24Pro at just £49.00 with any RiscPC purchase  
 Studio24Pro at just £80.00 with any colour scanner  
**FREE membership of the Virus Protection Scheme with any RiscPC**

### Virus Protection

The Pineapple Virus Protection Scheme will allow you to detect and remove over 100 viruses from your Acorn computer.



'If you're interested in virus protection, join the Pineapple virus protection scheme and buy Killer. Accept no alternatives.' - Acorn User Feb 96

### Multimedia Speakers

Yamaha 10 Watt YST-M10 £63.00

### A4 Colour Scanners

Primax Flatbed A4	£359
Epson GT5000 (parallel)	£425
Epson GT5000 (SCSI)	£499
Epson GT8500	£569
Epson GT9000	£699

All scanners include Imagemaster & Twain. Studio24Pro at just £80.00

### A7000 Computers

4Mb HD425 14" Mon	£1019
4Mb HD425CD 14" Mon	£1139

### RiscPC 600 Computers

4Mb HD425 14" Mon	£1325
4Mb HD425CD 14" Mon	£1450
4Mb HD425 17" Mon	£1699
4Mb HD425CD 17" Mon	£1825

### RiscPC 700 Computers

5Mb HD425 14" Mon	£1550
5Mb HD425 17" Mon	£1925
5Mb HD425CD 14" Mon	£1699
5Mb HD425CD 17" Mon	£2049
10Mb HD850 14" Mon	£1949
10Mb HD850 17" Mon	£2299
10Mb HD850CD 14" Mon	£2069
10Mb HD850CD 17" Mon	£2425

### PC Cards

	Separately	with RiscPC
SXL-33 Card	£233.83	£116.32
DX2-66 Card	£289.00	£169.00
DX4-100 Card	£349.00	£229.00
586-100 Card	£579.00	£459.00

### CDRom Drives

x4 Speed CDRom	£120.00
x6 Speed CDRom	£233.82

### Memory Upgrades

1Mb to 2Mb Vram	£116.32
2Mb Vram	£233.83
4Mb SIMM Ram	£ 35.00
8Mb SIMM Ram	£ 65.00
16Mb SIMM Ram	£114.00
32Mb SIMM Ram	£249.00
RiscPC Sound Card	£70.44

Phone for latest SIMM prices !!

All our prices INCLUDE 17.5% vat & delivery!

### Printers

**Citizen Printiva 600C**



Citizen PRINTiva 600C	£399.00
Hewlett Packard Laserjet 5L 4ppm	£458.00
Deskjet 600	£231.00
Deskjet 660 colour	£315.00
Deskjet 850 colour	£415.00
Canon BJC600E colour	£375.00
BJC610 col 720dpi	£415.00
BJC4000 colour	£276.00
BJC4100 col 720dpi	£276.00
BJC200 mono	£205.00
BJC210 (col option)	£222.00
Epson Stylus Colour II	£329.00
Stylus Colour IIS	£244.00
Stylus Pro XL (A3)	£1079.00

### 3.5" Bare Harddrives

540Mb IDE	£149.00
850Mb IDE	£169.00
1.0Gb IDE	£225.75
1.0Gb SCSI	£235.00
2.0Gb SCSI	£459.00
4.0Gb SCSI	£675.00

### Removable Harddrives

IDE Mounting Kit	£ 25.00
540Mb IDE	£168.00
850Mb IDE	£188.00
1.0Gb IDE	£244.00
SCSI Mounting Kit	£ 29.00
1.0Gb SCSI	£255.00
2.0Gb SCSI	£479.00
4.0Gb SCSI	£695.00
External Mounting Box	£ 89.00

### SCSI Systems

SCSI Card	£116.32
SCSI Internal Cable	£ 9.99
SCSI External Cable	£ 19.99
SCSI II Card	£189.00
SCSI II Internal Cable	£ 9.99
SCSI II External Cable	£ 22.32

### Monitors

14" 0.28mm DPMS	£179.00
14" 0.28mm MPRII	£189.00
15" 0.28mm MPRII	£309.00
17" 0.28mm MPRII	£556.00
21" 0.28mm MPRII	£Phone
Ilyama Visionmaster 17" 0.26mm MF8617E	£635.00
17" 0.25mm MF9017E	£699.00

## !! Special RiscPC offer !!

A Quad speed CDRom drive for just £60 with any RiscPC

**Pineapple Software**  
 Suites 13 & 14  
 South Park Business Centre  
 310 Green Lane, Ilford  
 Essex IG1 1XT  
 Tel 0181 599 1476 Fax 0181 598 2343  
 email:- sales@pineapple.demon.co.uk

**Terms:-** All prices include 17.5% vat. Carriage FREE to mainland U.K. Phone for quote outside U.K. Official orders, cheques and all major credit cards accepted. Money back guarantee on all products.

'Pineapple offer some of the finest and friendliest after-sales support you will find' - Acorn User Mar 96

Why not come and visit us (easy parking) where you can see most of the Acorn range of computers and other hardware in action.

Monday - Friday 0900 - 1730



# A flying Start from Aleph One

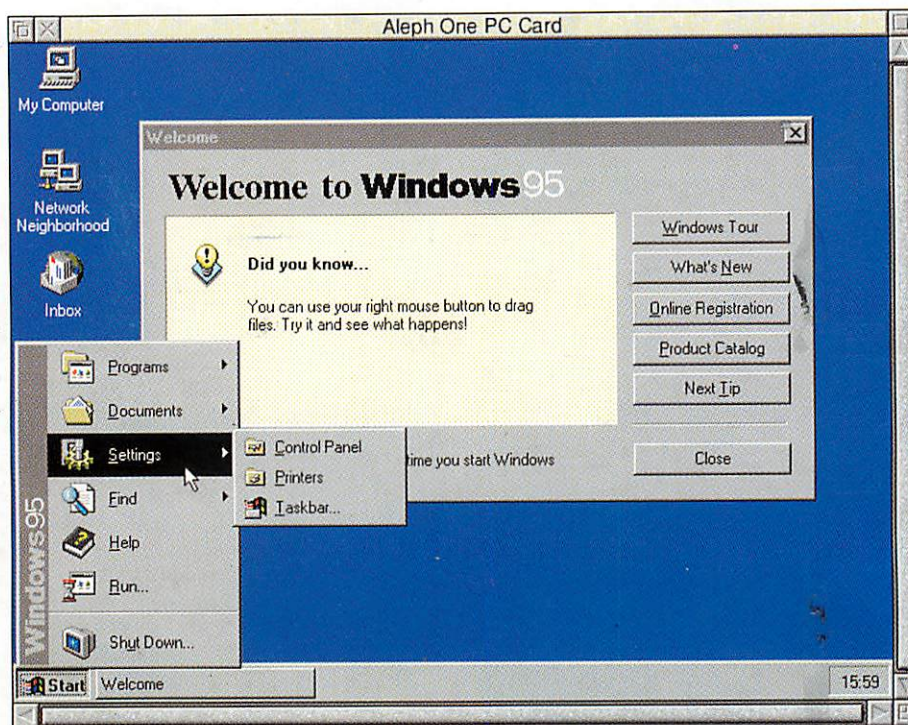

## Pentium-class power inside your Risc PC

If you're planning to run the latest Windows® software on your Acorn Risc PC, an Aleph One second processor card will help you get off to the best possible Start. Our powerful 100MHz 5x86 processor offers unbeaten performance for all applications.

## Top class technical support

Years of development mean that our support software enables you to run the widest range of Windows and DOS software on your RiscPC with confidence. But when you do need help, contact Aleph One and you can speak to the specialists.

## Free software updates for Aleph One customers

Recent enhancements include support for Windows 95 and SoundBlaster™ emulation for the playback of .WAV files. Buyers of Aleph One 5x86 cards will receive a free upgrade to !PC 2.0 and updates throughout 1996. This rewritten version of the support software includes new drivers for even better performance.

## More affordable than ever

The 100MHz 5x86 second processor costs from £399 plus VAT. Quantity and educational discounts are available. Network Links software for connecting the card to Microsoft and Novell networks is also available.



For further information contact Aleph One Limited at:

**Post:** The Old Courthouse, Bottisham, Cambridge CB5 9BA  
**Telephone:** 01223 811679  
**Fax:** 01223 812713  
**Email:** sales@aleph1.co.uk  
**WWW:** <http://www.aleph1.co.uk/~aleph1/>

Windows, the Windows logo and the Windows Start device are trademarks of Microsoft Corporation. All other trademarks acknowledged. E&OE. Prices correct at April 1996.