

SEGA™

**AKkaim**®  
entertainment, inc.

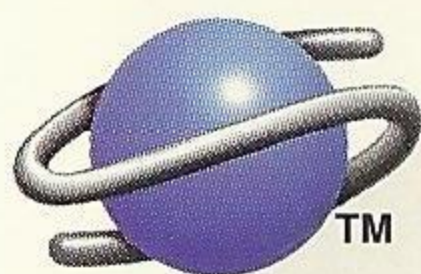

SEGA SATURN™

# Virtual open **Tennis**™

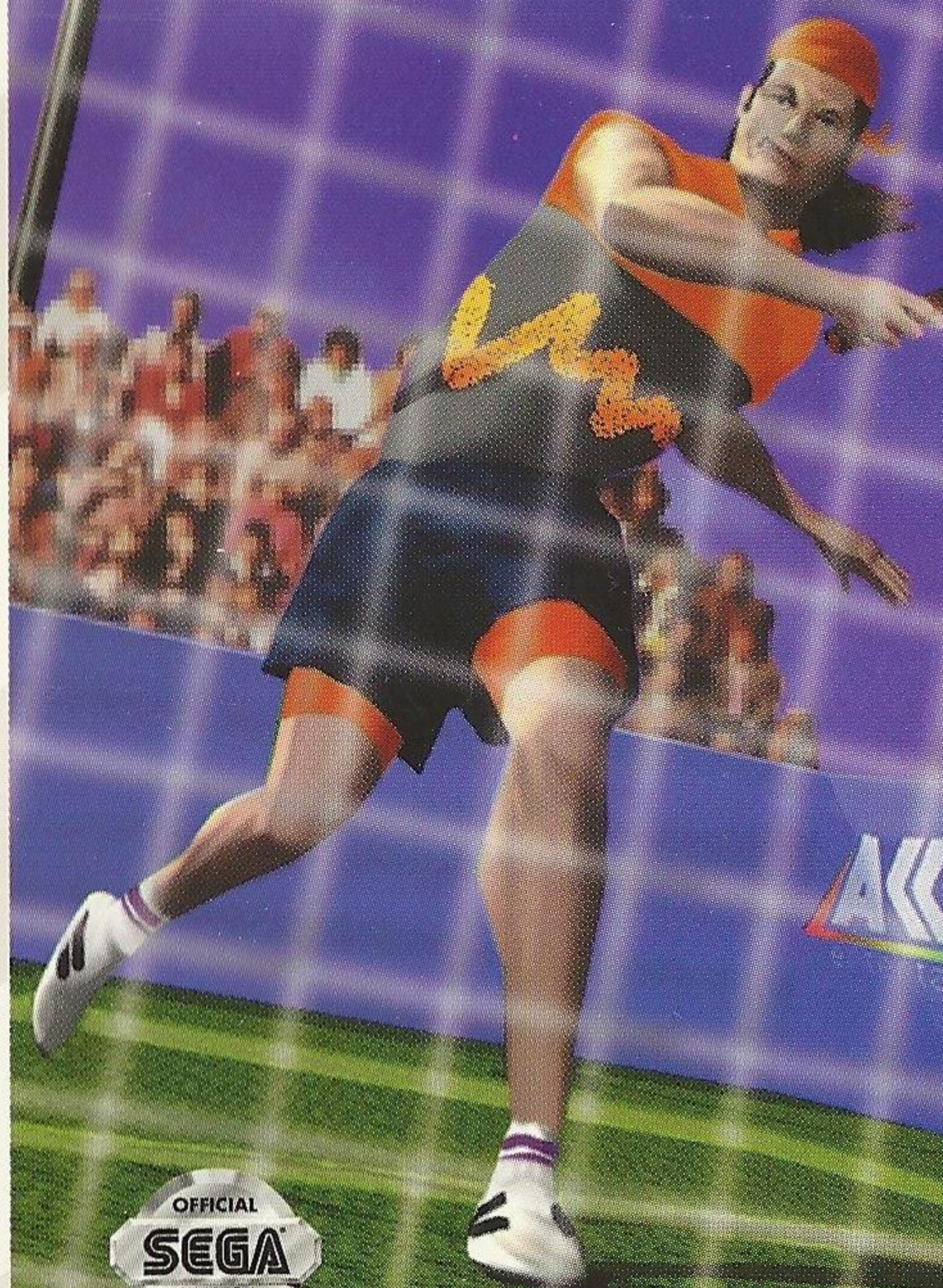

**"A RECOMMENDED  
ADDITION TO  
YOUR SATURN  
SPORTS LIBRARY."**

**-GAME FAN  
MAGAZINE**

**AKkaim**®  
entertainment, inc.



LICENCED BY SEGA ENTERPRISES, LTD.  
FOR PLAY ON THE SEGA SATURN™ SYSTEM.



T-8129H





This official seal is your assurance that this product meets the highest quality standards of SEGA™. Buy games and accessories with this seal to be sure that they are compatible with the SEGA SATURN™ SYSTEM.

### **HANDLING YOUR SATURN DISC**

- The Sega Saturn Disc is intended for use exclusively with the Sega Saturn™ System.
- Do not bend it, crush it, or submerge it in liquids.
- Do not leave it in direct sunlight or near a radiator or other source of heat.
- Be sure to take an occasional recess during extended play, to rest yourself and the Sega Saturn compact disc.
- Keep your Sega Saturn compact disc clean. Always hold by the edges and keep it in its case when not in use. Clean with a lint – free, soft dry cloth – wiping in straight lines from center to edge. Never use solvents or abrasive cleaners.

**WARNING TO OWNERS OF PROJECTION TELEVISIONS: STILL PICTURES OR IMAGES MAY CAUSE PERMANENT PICTURE-TUBE DAMAGE OR MARK THE PHOSPHOR OF THE CRT. AVOID REPEATED OR EXTENDED USE OF VIDEO GAMES ON LARGE-SCREEN PROJECTION TELEVISIONS.**

**THIS PRODUCT HAS BEEN RATED BY THE ENTERTAINMENT SOFTWARE RATING BOARD. FOR INFORMATION ABOUT THE ESRB RATING, OR TO COMMENT ABOUT THE APPROPRIATENESS OF THE RATING, PLEASE CONTACT THE ESRB AT 1-800-771-3772.**

### **WARNING: READ BEFORE USING YOUR SEGA™ VIDEO GAME SYSTEM.**

A very small percentage of individuals may experience epileptic seizures when exposed to certain light patterns or flashing lights. Exposure to certain patterns or backgrounds on a television screen or while playing video games may induce an epileptic seizure in these individuals. Certain conditions may induce previously undetected epileptic symptoms even in persons who have no history of prior seizures or epilepsy. If you, or anyone in your family, has an epileptic condition, consult your physician prior to playing. If you experience any of the following symptoms while playing a video game- dizziness, altered vision, eye or muscle twitches, loss of awareness, disorientation, any involuntary movement, or convulsions- IMMEDIATELY discontinue use and consult your physician before resuming play.



# CONTENTS

Starting Up .....	2-4
Basic Operation .....	4-5
Controls .....	4-5
To Start A Game .....	5-13
To Play A Game (About Modes) .....	6-13
Exhibition Mode .....	7-8
Championship Mode .....	8
Training Mode .....	9-11
Options .....	12-13
Game Screen .....	13
About Players (Profiles) .....	14-19



# STARTING UP

1. Set up your Sega Saturn™ system as described in its instruction manual.
2. Place the Virtual Open Tennis™ disc, label side up, in the well of the CD tray and close the lid.

## Single and Multiple Player set up:

By using the 6Player adapter (sold separately), up to four players can play the game at one time.

## When playing alone

Connect the control pad to Control Port 1.

## When two people are playing

Connect the control pad to the Control Port 1 and Control Port 2, respectively. You can still play when you connect the 6Player adapter to Control Port 2.





## When three or four people are playing

Connect controller to Control Port 1 and connect the 6Player adapter to Control Port 2. Then connect additional control pads into the 6Player adapter.

\* When two or more people are playing at the same time, please purchase separate control pads. For more information on how to connect the 6Player adapter, please refer to the manual that comes with it.

3. Turn on the TV or monitor and the Sega Saturn™. The Sega Saturn™ logo appears on screen. (If nothing happens, turn the system off and make sure it is set up correctly before turning it on again.)
4. If you wish to stop the game in progress or the game ends, press the Reset Button on the Sega Saturn™ console to display the on-screen Control Panel.

**IMPORTANT:** Your Sega Saturn™ CD contains a security code that allows the disc to be read. Be sure to keep the disc clean and handle it carefully. If your Sega Saturn™ system has trouble reading the disc, remove the disc and wipe it carefully, starting from the center of the disc and wiping straight out toward the edge.



# BASIC OPERATION

## In Mode Selection Screen

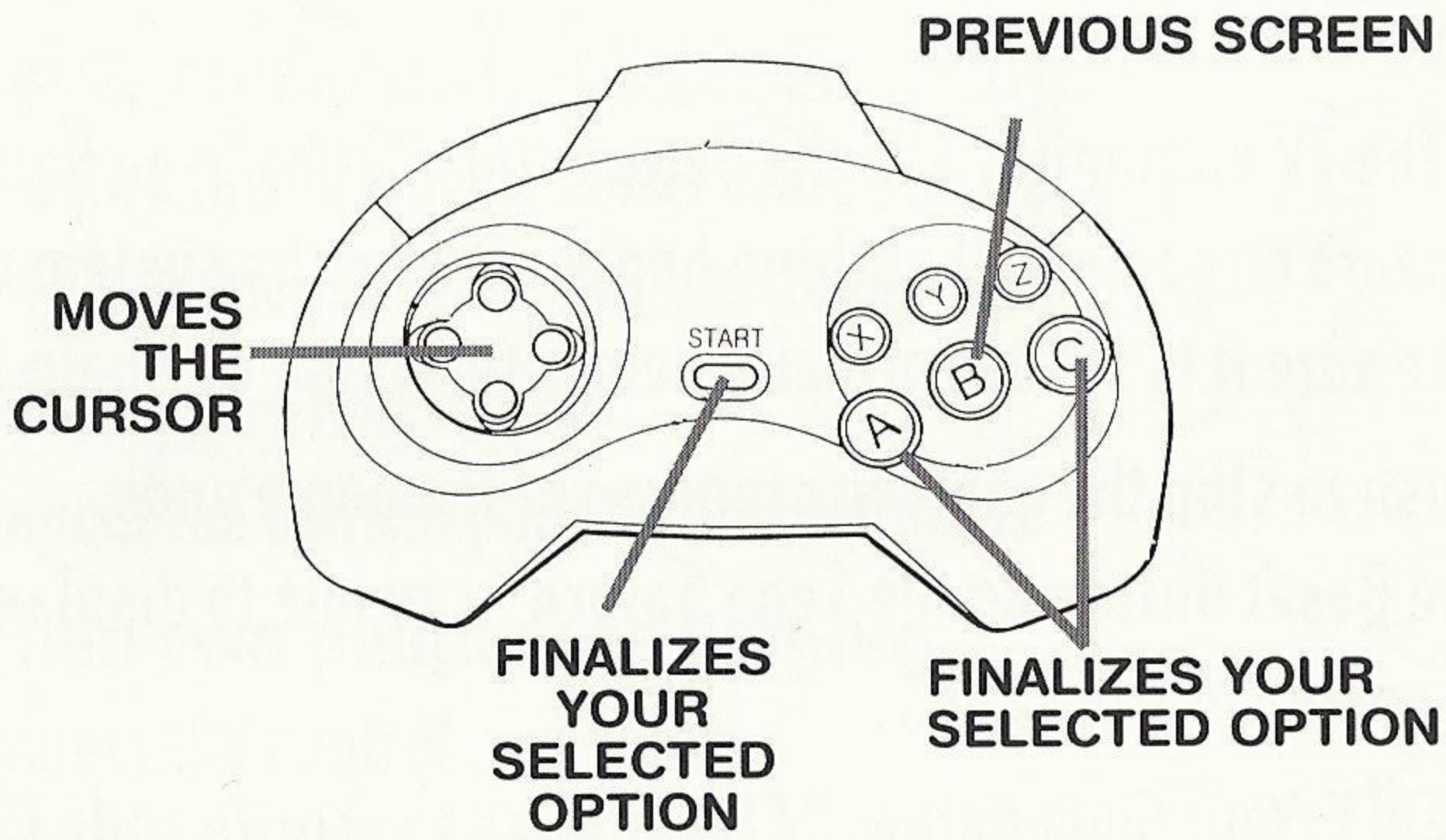



# During the game

COMBINED WITH THE D-PAD, YOU CAN MAKE THE PLAYER DASH IN THAT DIRECTION

HITS FLAT LOBS, SLICE SERVES (AUTO)

HITS TOP-SPIN LOBS, TOP-SPIN SERVES (AUTO)

HITS FLAT LOBS, FLAT SERVES (AUTO)

HITS FLAT STROKES, FLAT SERVES

HITS TOP-SPIN STROKES, TOP-SPIN SERVES

MOVES THE PLAYER AND CHANGES THE DIRECTION OF THE BALL BEING HIT

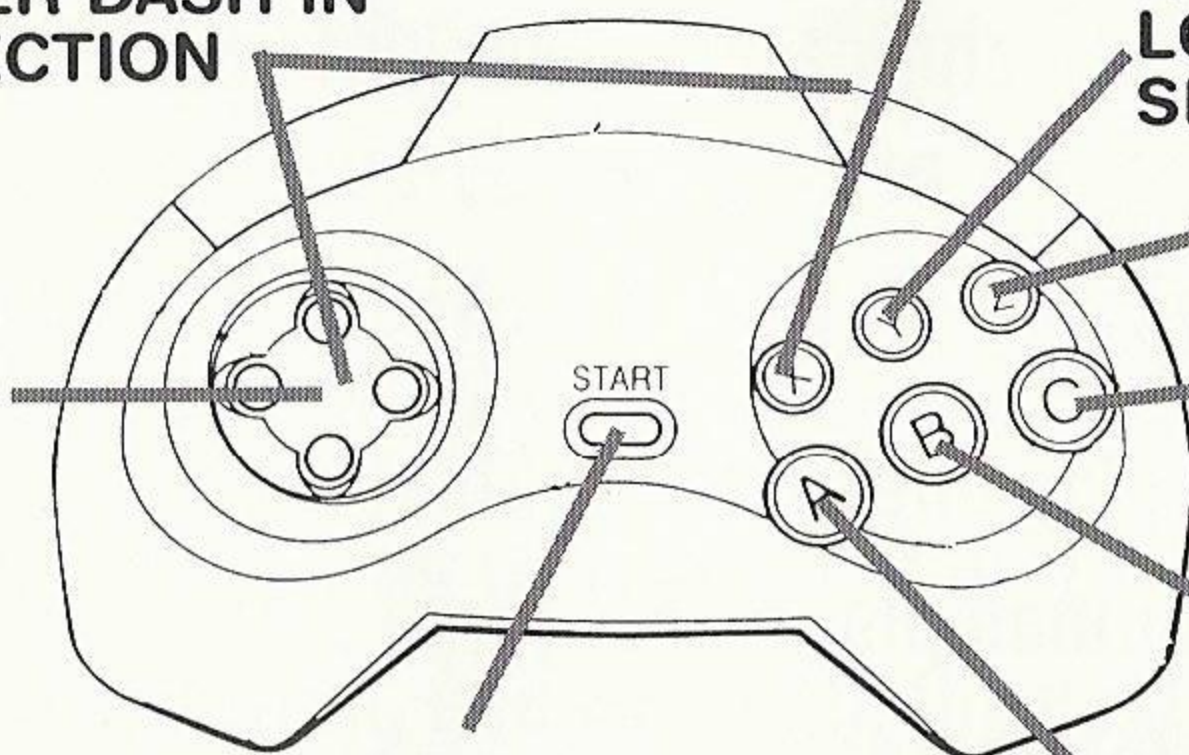

PAUSES THE GAME

HITS SLICE STROKES, SLICED SERVES

## TO START A GAME

At the Title Screen, pressing the START BUTTON will take you to the Mode Selection Screen.

Select your mode, set any options, then begin!

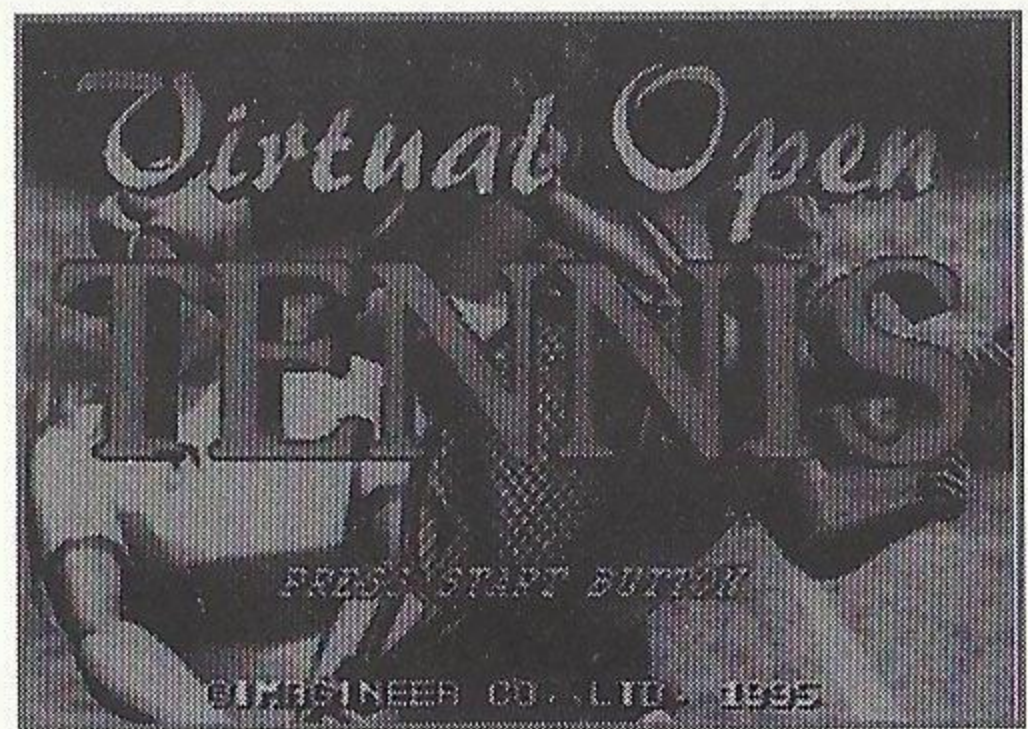



## **MODE SELECTION**

Press UP or DOWN on the D-Pad to select the mode of your choice. Finalize your selection by pressing the A or C Button.

### **EXHIBITION MODE**

In this mode, you can play one match against the computer or another human player. Player(s) can select varying match parameters.

### **CHAMPIONSHIP MODE**

In this mode there is a championship tour in which you will be taken around the world.

### **TRAINING MODE**

Select this mode to practice different tennis techniques.

### **OPTION MODE**

Select this mode to alter various game settings.

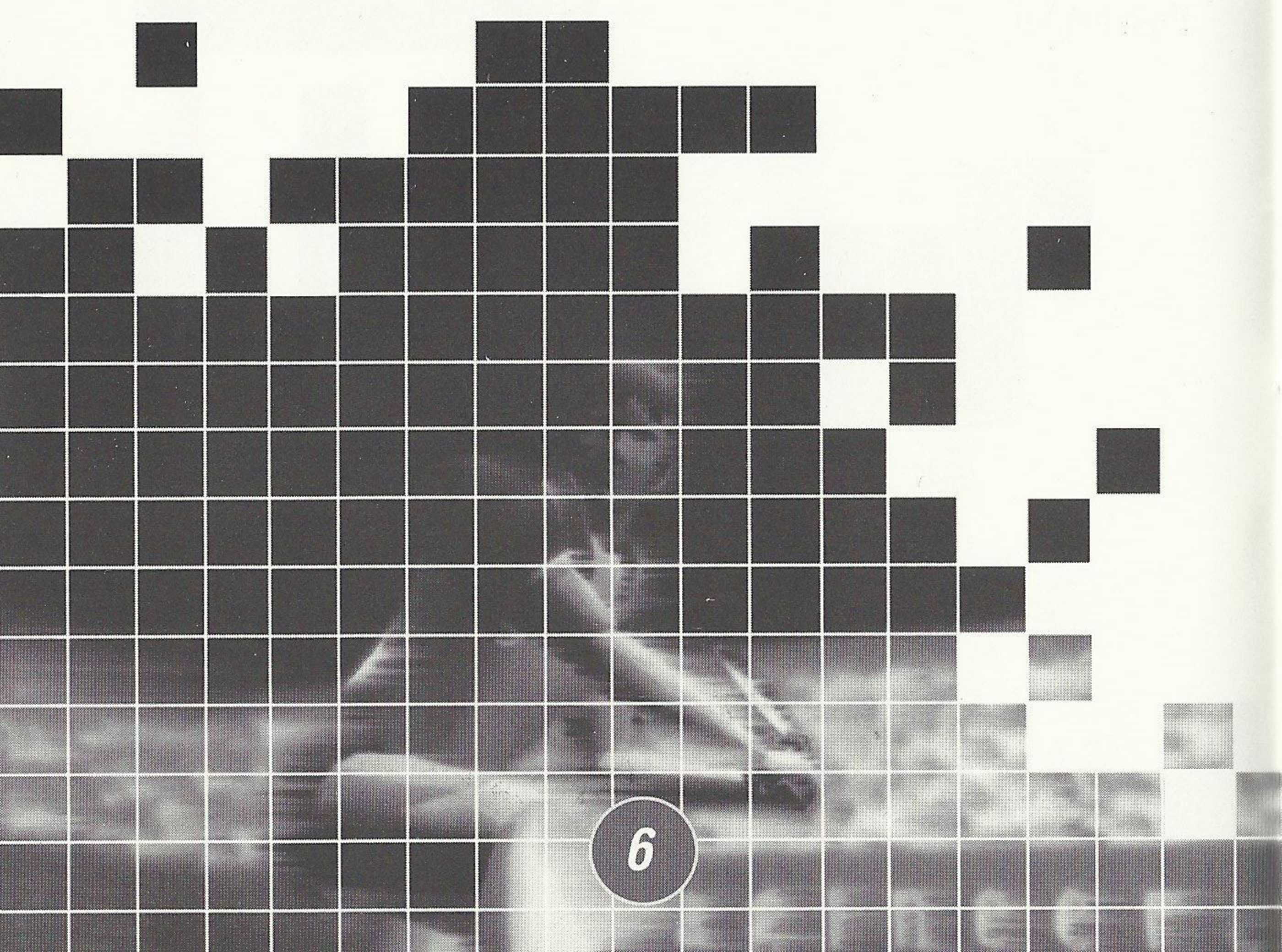



## EXHIBITION Mode

After selecting Exhibition Mode, you will go to the Play Menu, where you can set the type of match you wish to play. Use the UP or DOWN D-PAD to go to STYLE, PLAYER, SET or COURT and change the setting with the LEFT or RIGHT D-PAD. When you press the A/C Button, you will go to the next screen.

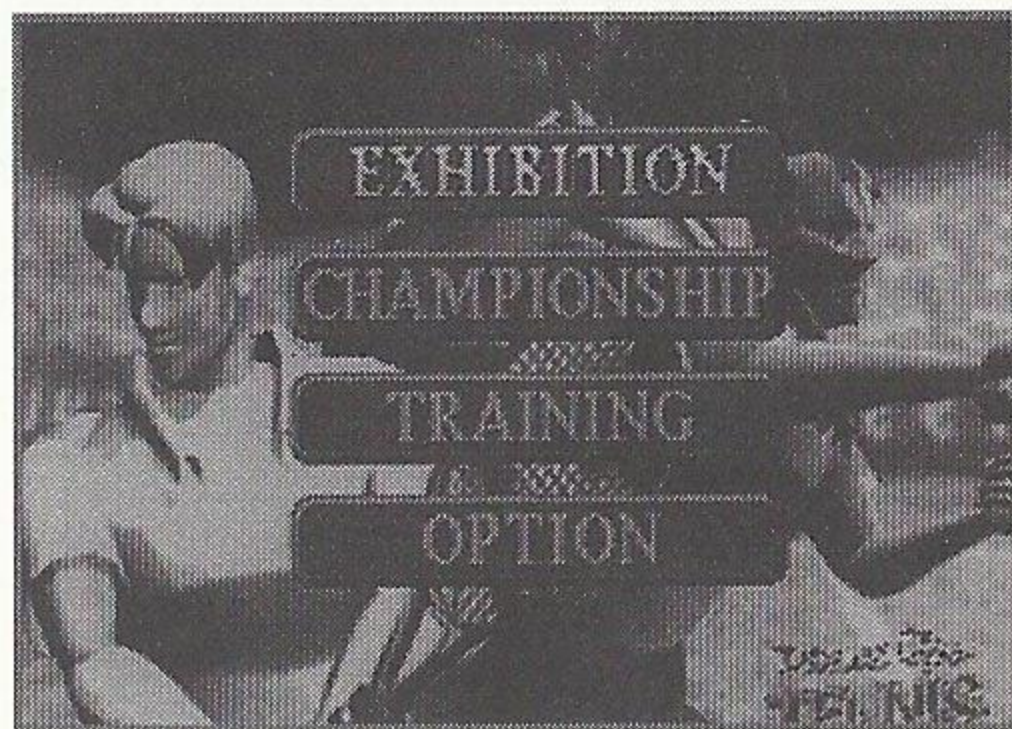

**STYLE:** Choose SINGLES or DOUBLES.

**PLAYER:** Up to four (4) players can be selected. It is also possible to play a mixed doubles match by teaming up with the computer.

**SET:** You can set the number of sets per match at either 1, 3 or 5.

**COURT:** You can select from 3 types of courts:

**LAWN (court):** Ball bounce - low; Ball movement - very fast

**HARD (court):** Ball bounce - high; Ball movement - fast

**CLAY (court):** Ball bounce - medium; Ball movement - slow

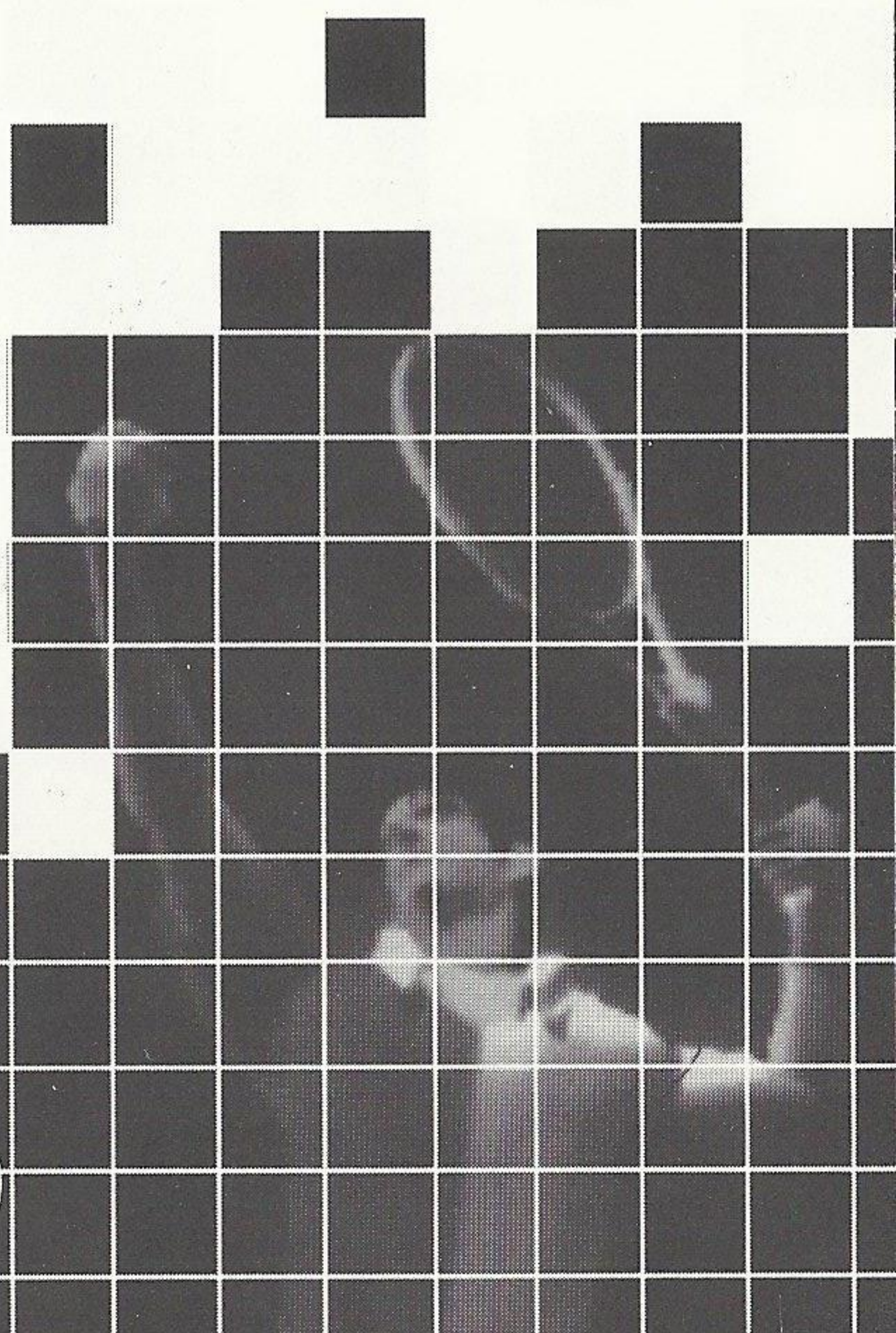
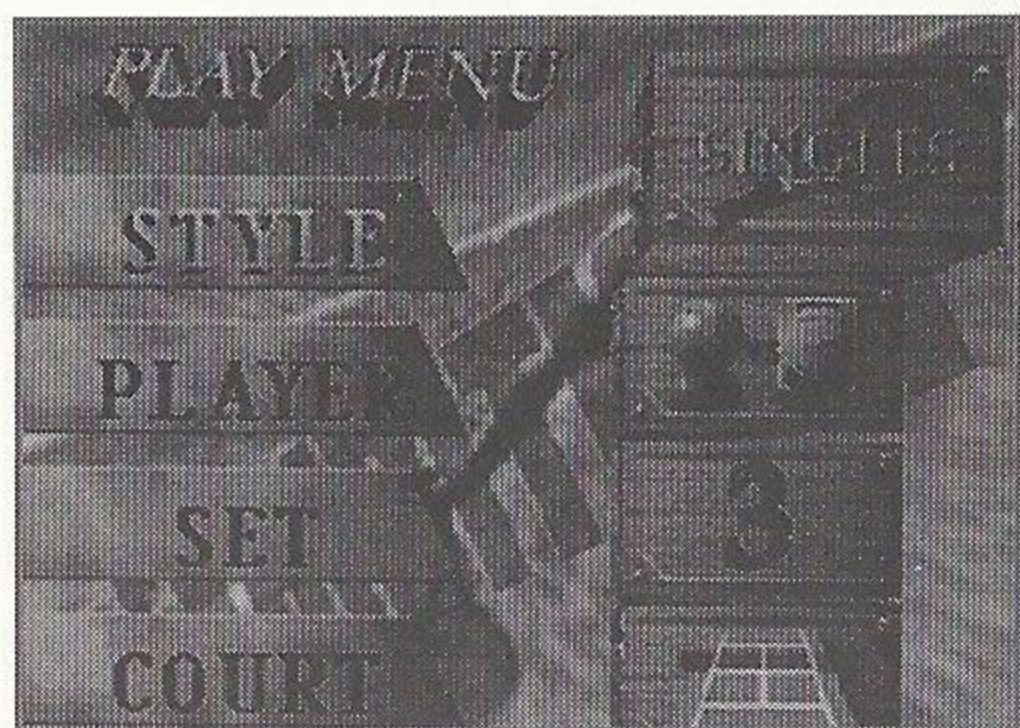



**PLAYER SELECT:** Each human player selects the tennis player of his/her choosing from the ten available players listed in this mode. Finalize your choice with the A/C Button. Now you are ready to play a match.

## **CHAMPIONSHIP Mode**

After selecting Championship Mode, you will go to the Tournament Select screen, where you can select the type of championship game you prefer to compete in. There are two choices:

- "Challenger's Cup Virtual Open" for beginners,
- "Imagineer World Championship" for advanced players.

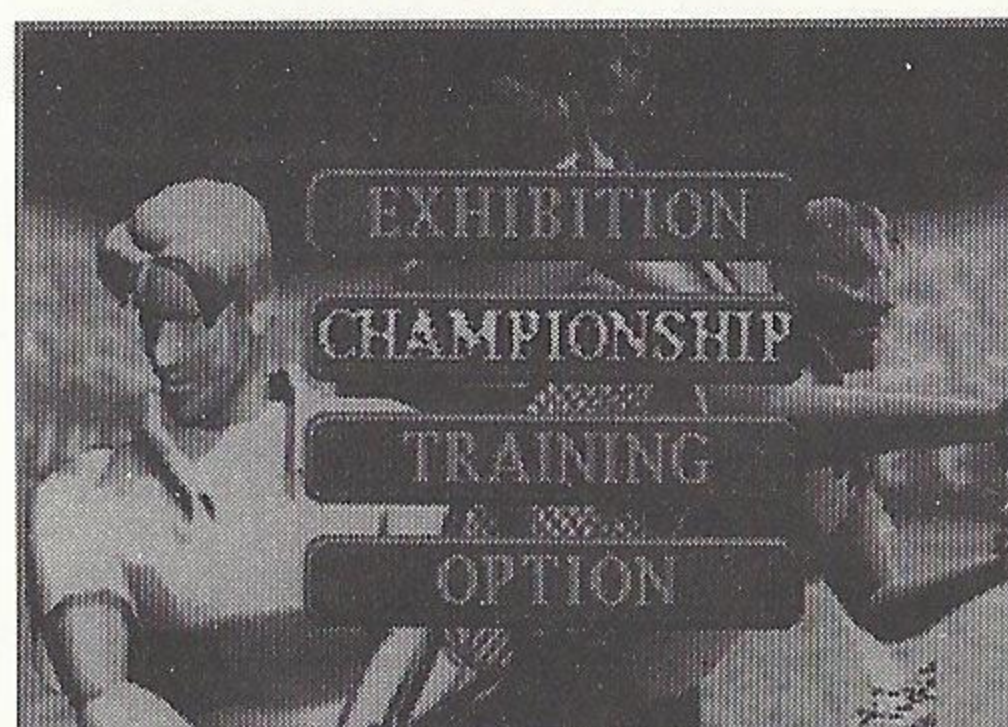
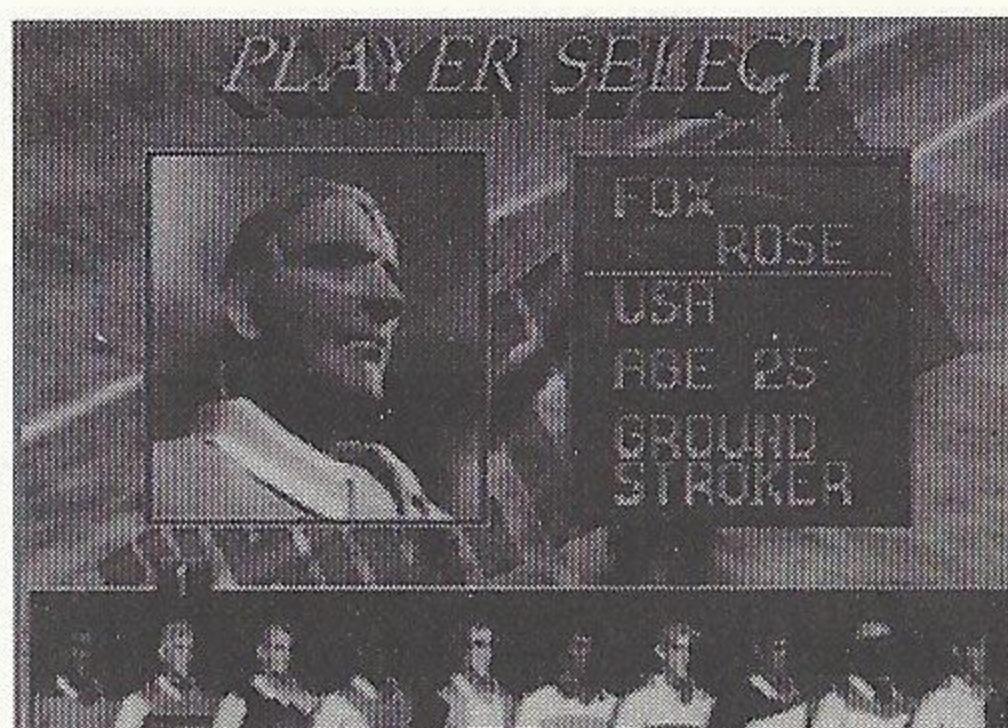



## TRAINING Mode

About the Training OPTION:  
You can select the type of training  
and the can-game shown below:

### Service - train yourself to serve

1. By using the D-PAD, move the tennis player to the service spot on the base-line.
2. Toss up the ball by pressing the A/B/C Button. When you press the X/Y/Z Button, the entire action from tossing the ball up to striking the serve will be done automatically.
3. When striking a serve, use the D-PAD to aim the service.

The longer you press the D-PAD, the more to the outside of the court the ball will be served.

4. Carefully time your pressing of the A/B/C Button when serving the ball into your opponent's court.

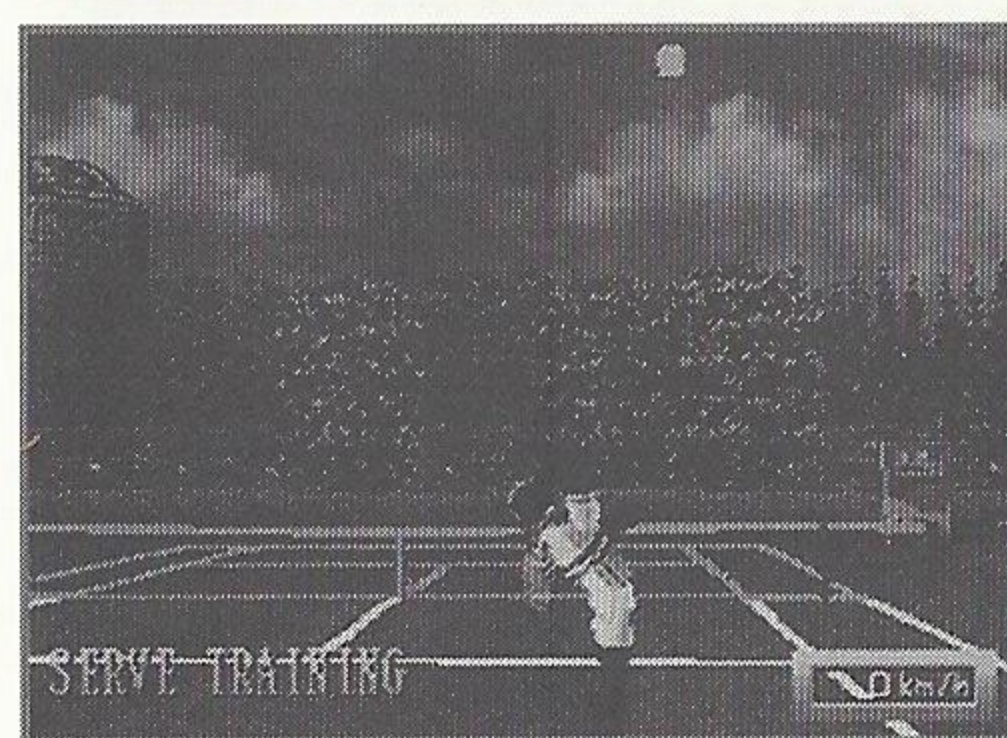
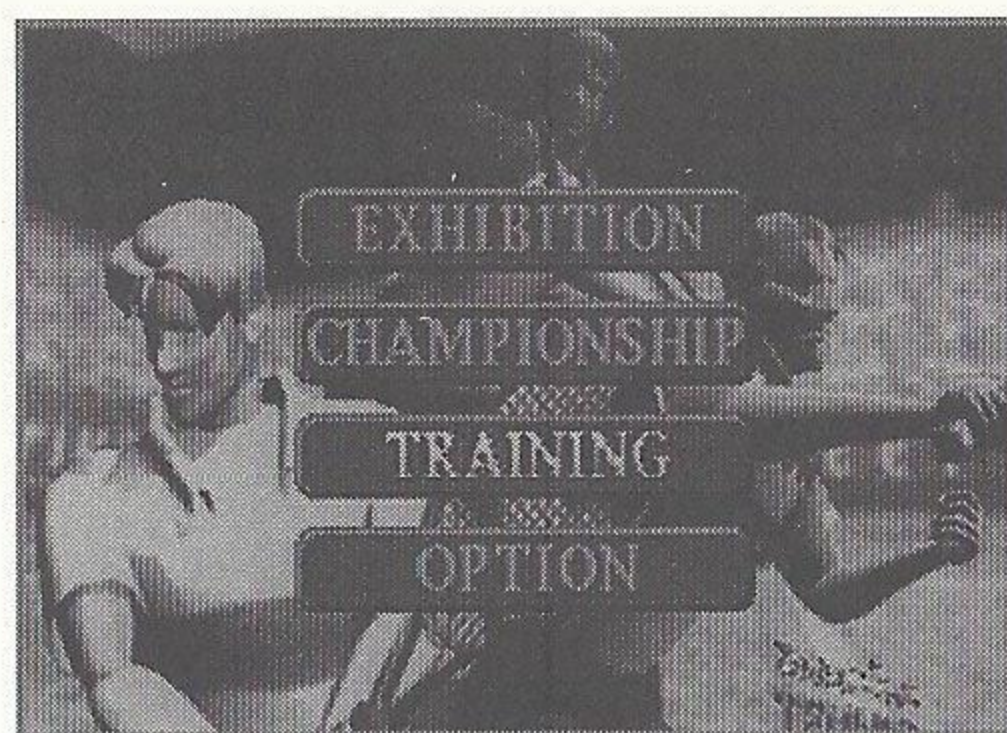



## Return - train yourself to return the ball

1. Once the count-down display in the middle of the screen is over, you will be fed balls by a training machine.
2. Use the D-PAD to move your tennis player closer to the ball, and press either the A, B, C, X, Y or Z Button to return the ball. By using the D-PAD at the time you hit the ball, you can control the direction in which you return the shot.

\* If you choose to use the **MARKER** feature (on the Options Screen), the marker will indicate to you where the next ball will head. If you are having difficulty returning the ball, this marker **SHOULD** help you return the ball better.

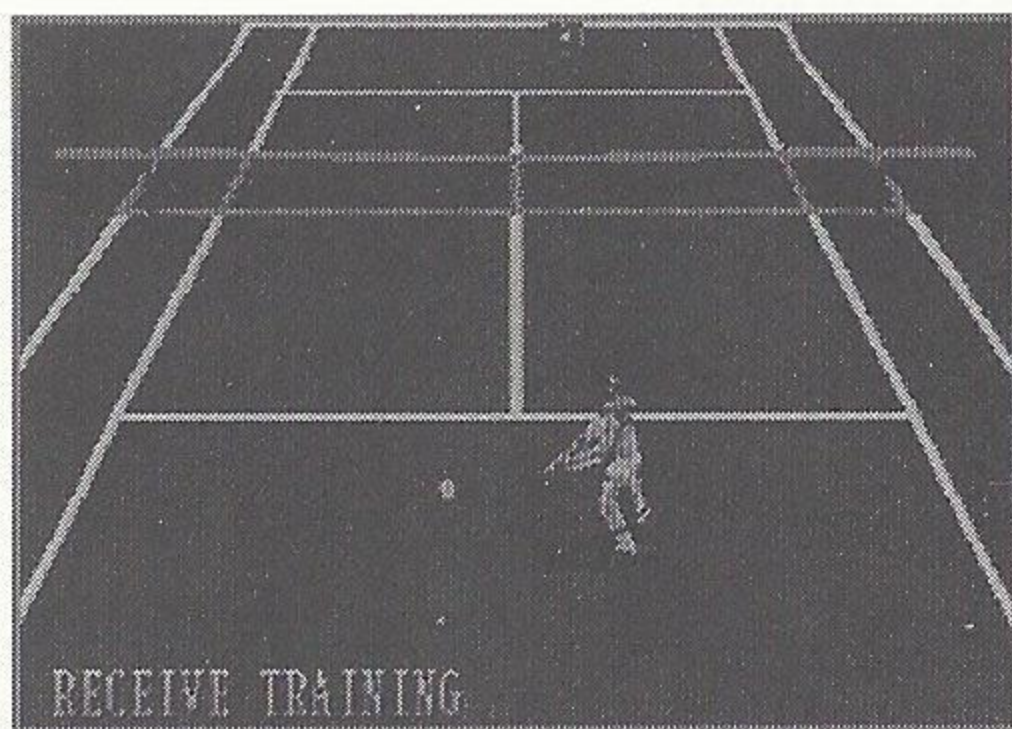



## Smash - train yourself to smash the ball

1. The ball machine serves up high lobs, allowing you to practice your overhand smash.
2. Use the D-PAD to move your tennis player close to the ball, and press either A, B, C, X, Y or Z Button to hit back the ball. By using the D-PAD at the time, you can control where you hit back the ball.

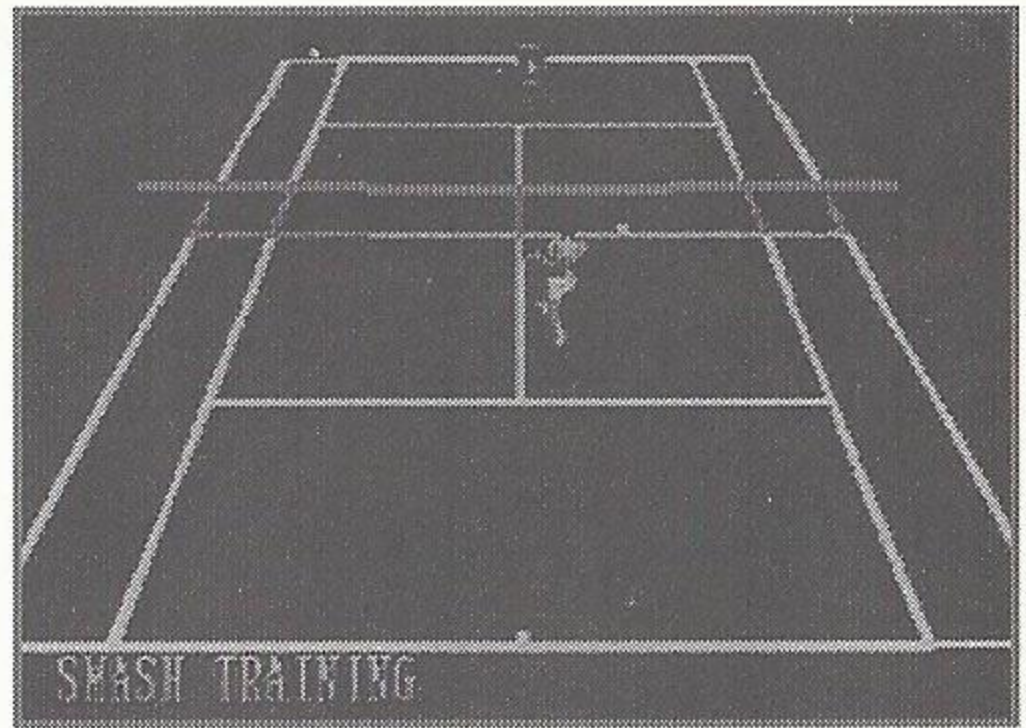

## Can game - "Overhead smash" accuracy competition

The Can Game is the final drill for honing accuracy. The tennis player is controlled in the same way as demonstrated in service training. If/when you hit the can on the court, you will obtain a high score.

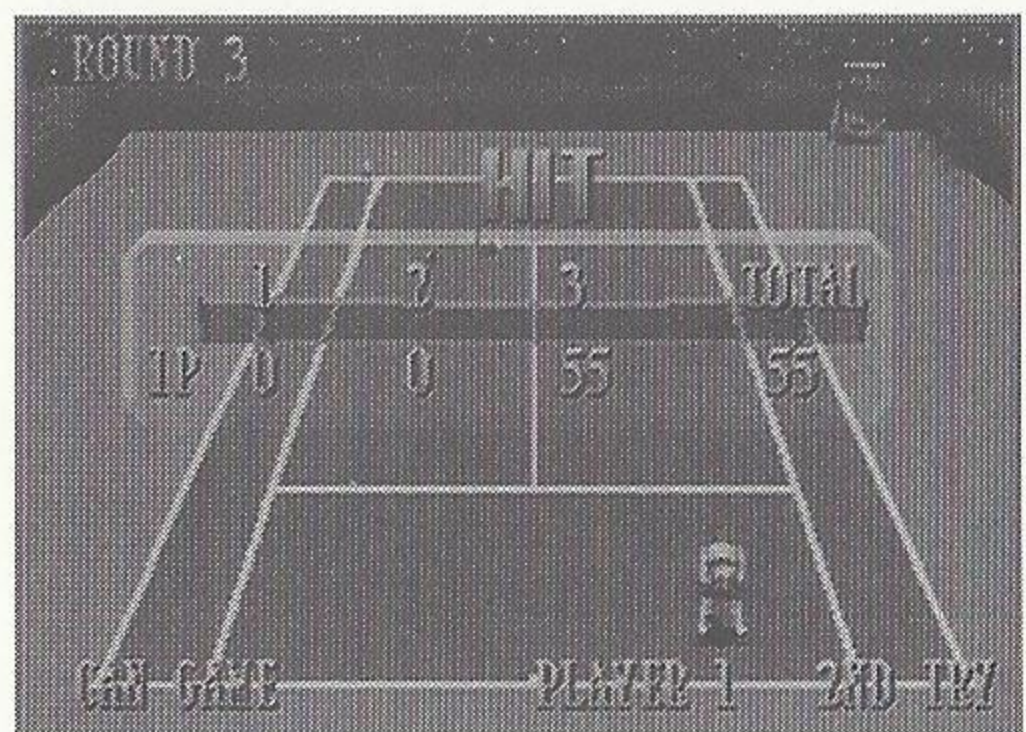

HIT			
1	2	3	TOTAL
10	0	55	55



Before you start, you can set the game's parameters.

**PLAYER:** Decide the number of players in the game

**ROUND:** Decide the number of rounds to be played

**COURT:** Select the type of the court you want to play on

**BONUS:** Select ON or OFF for bonus points such as successive points earned

## OPTION Mode

Press the D-PAD UP or DOWN to go to the setting you desire to change, and select your choice by pressing LEFT or RIGHT on the D-PAD.

**REPLAY: ON/OFF** When ON, Replays occur after each point.

**MARK: A/B/A & B/OFF** Chooses whether you want the place where the ball will land to be indicated, and, if you do, which parts of the court will be marked.

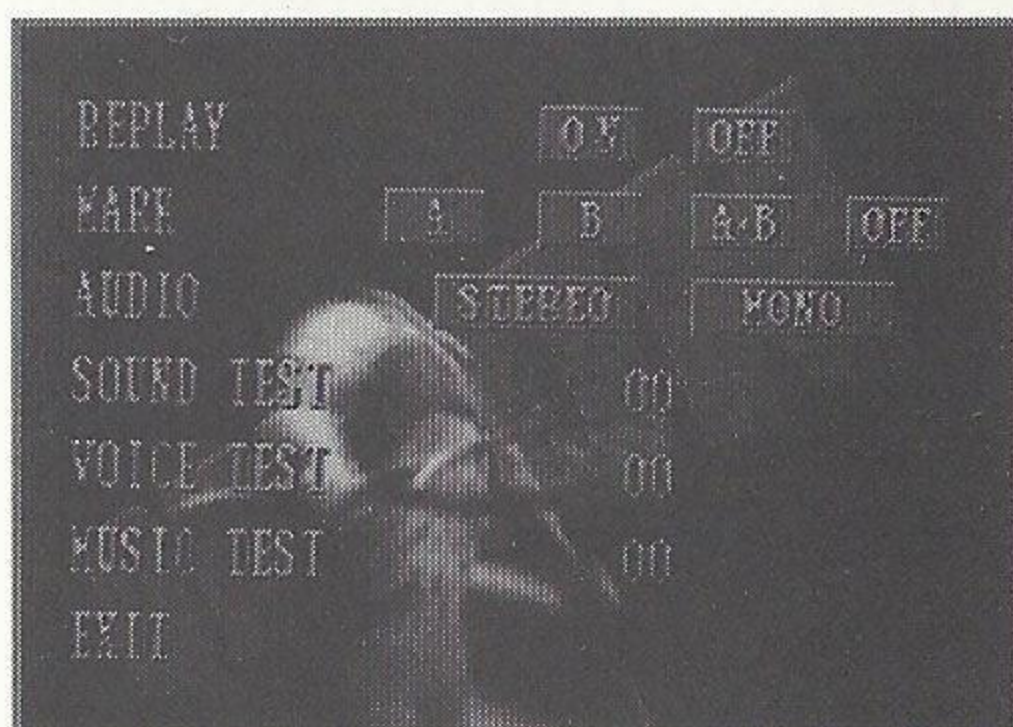
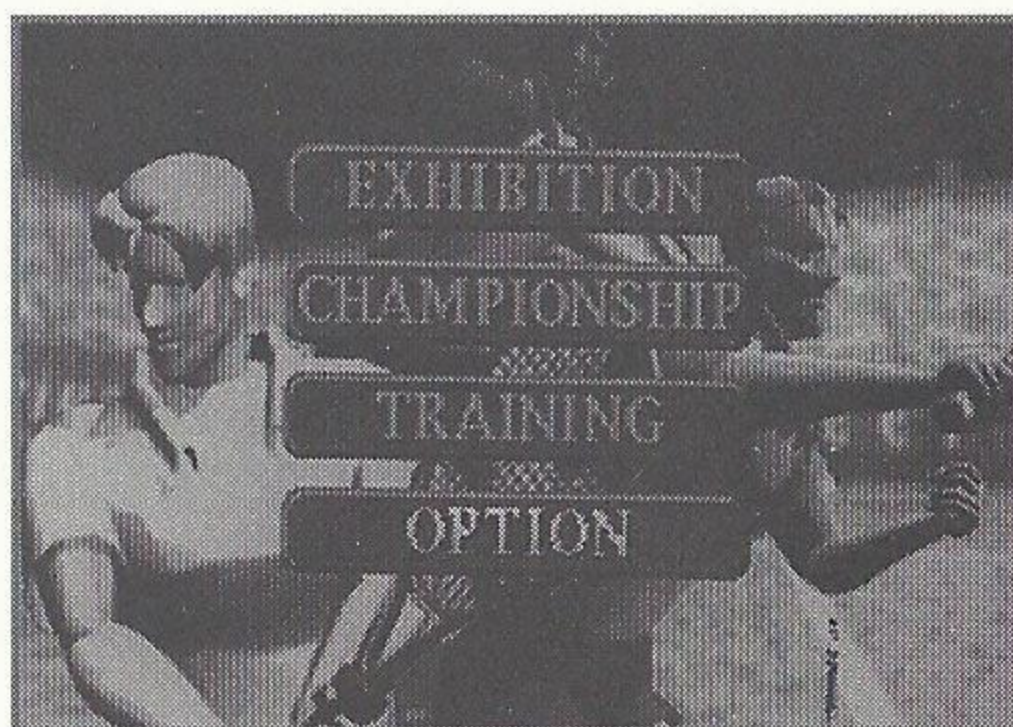



**AUDIO: STEREO/MONO** Select Mono or Stereo sound.

**SOUND TEST:** Listen to the various sound effects.

**VOICE TEST:** Listen to the various in-game announcer remarks.

**MUSIC TEST:** Listen to the different musical accompaniments

## About the screen during the match

During the match, various data are displayed in addition to the players and the ball.

**Score:** Displays the present game's score and whose service game it is.

**Set and Game:** Displays the current set and game before the service is hit.

**Speed of the service:** Displays the speed of the previous service.

**Server:** Displays the name of the server.

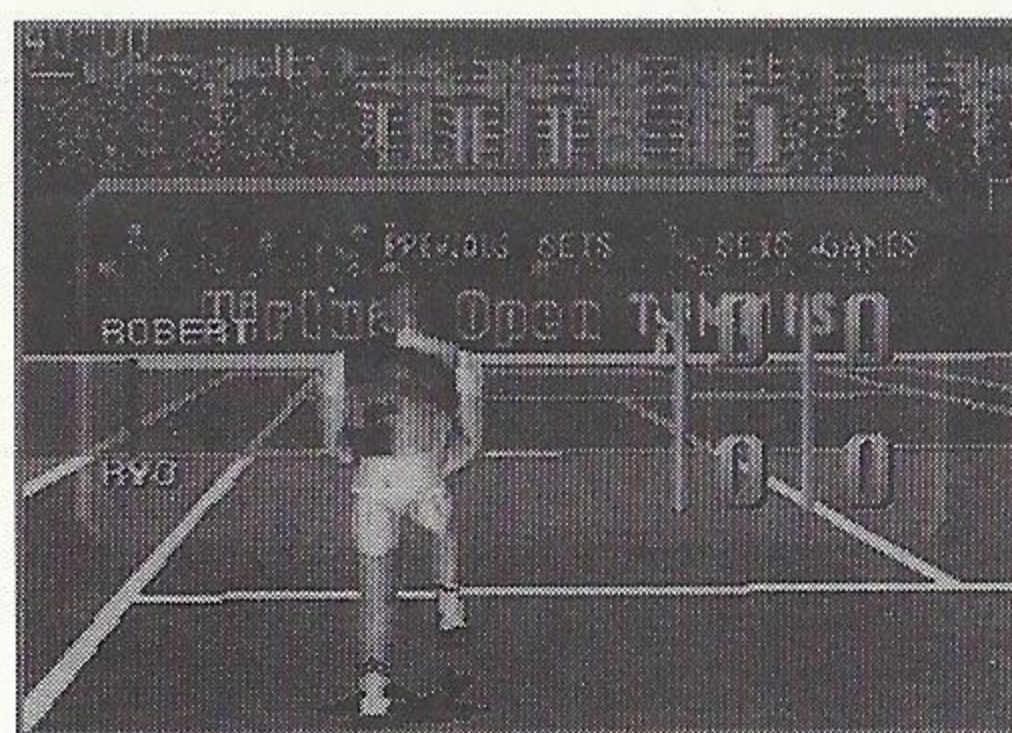
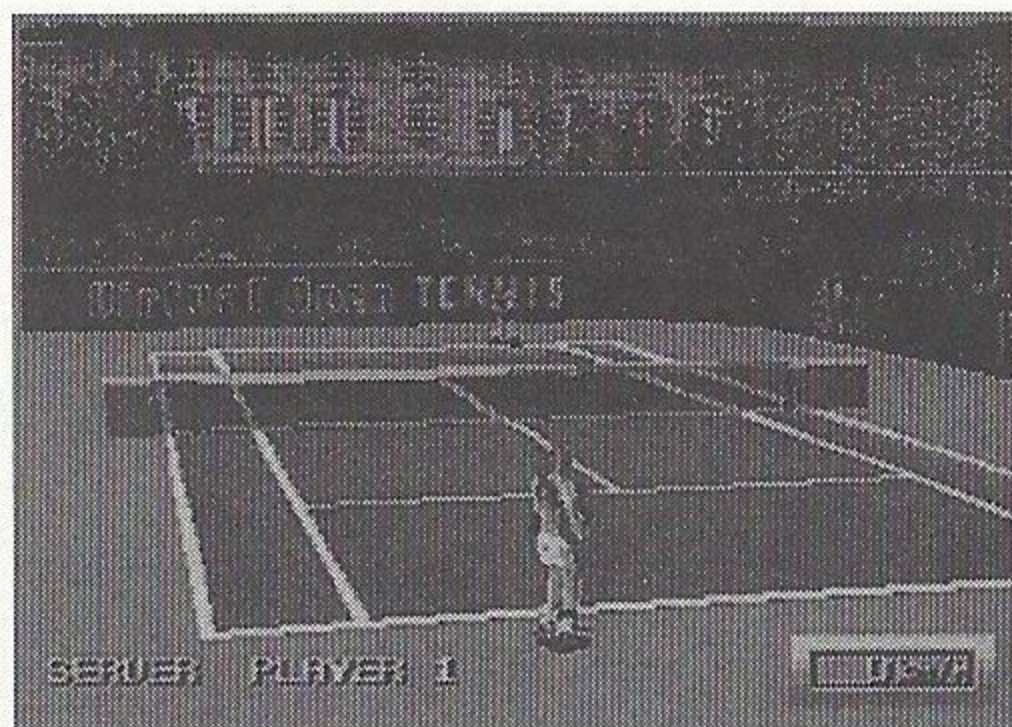



# ABOUT PLAYERS

There are 10 players in this game, each with different skills and attributes. See who you like best to play as —and who's toughest for you to beat!

## Allen West

Country: USA

Age: 24

Height/Weight: 6'1"/170 lb.

Backhand: One-handed

Strengths: He is an all-around player good at forehands, middle shots and flat strokes. His winners are mostly passing shots.

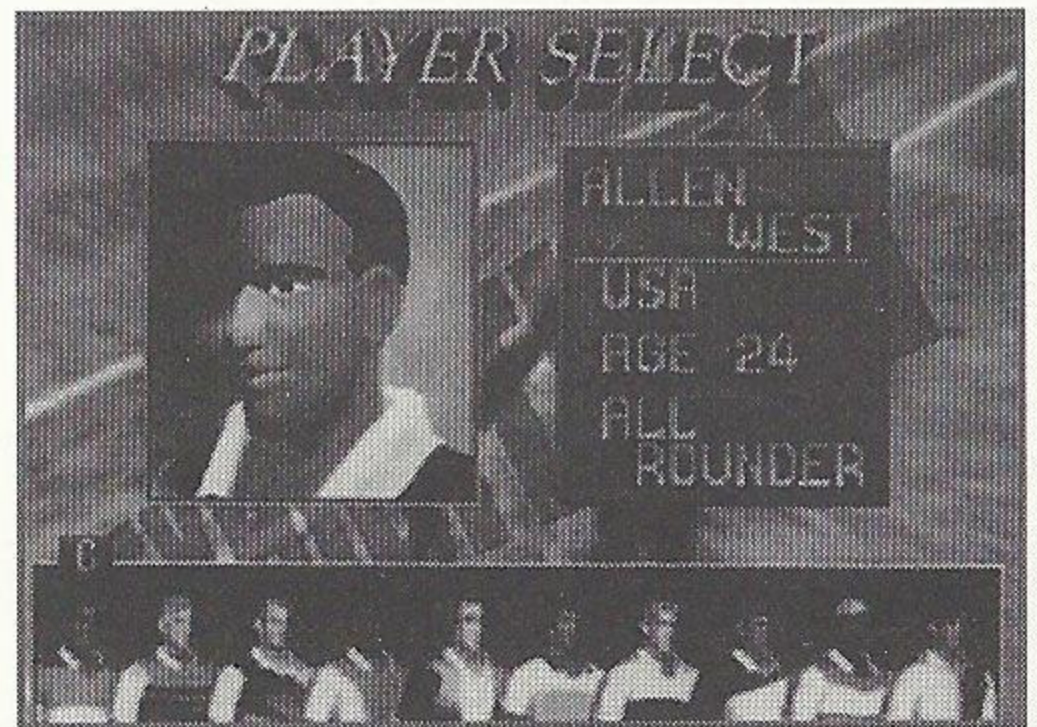



## Fox Rose

Country: USA

Age: 25

Height/Weight: 5'11/174 lb.

Backhand: Double-handed

Strengths: He is a ground-stroker

good at backhands, middle shots and top-spin strokes. He has an ingenious return, and rarely approaches the net.

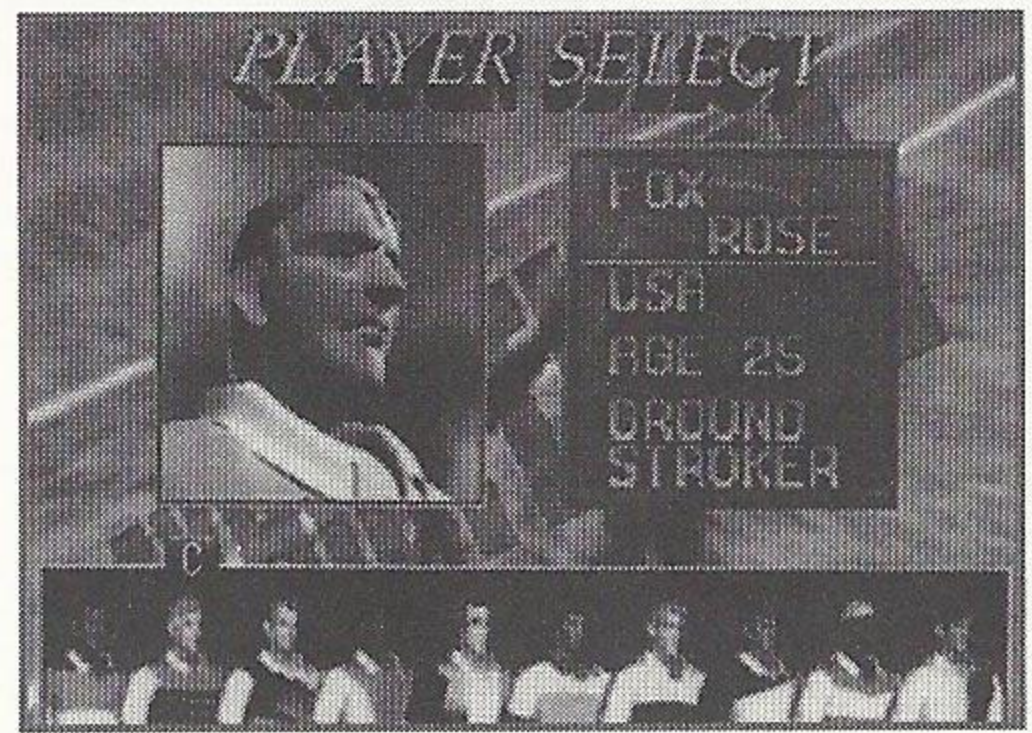

## Robert Schuldiner

Country: Germany

Age: 28

Height/Weight: 6'3/188 lb.

Backhand: One-handed

Strengths: His strength is a flat

serve, which leads him into an effective serve-and-volley game. On the other hand, he is weak in ground stroke games where he cannot utilize his serve-and-volley abilities.

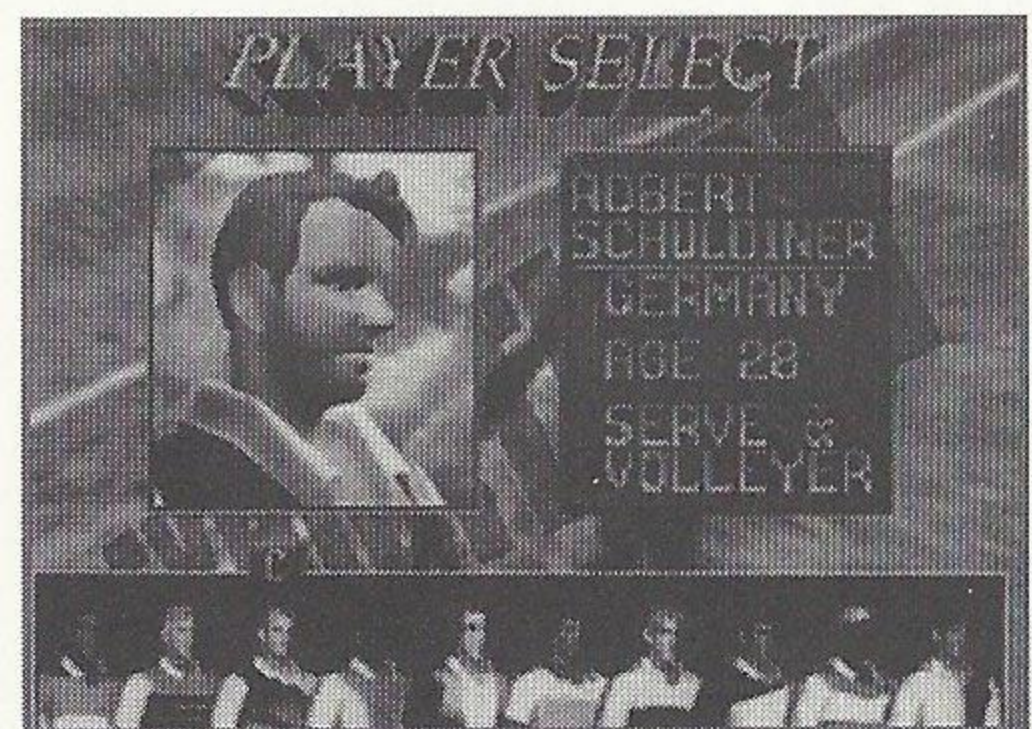



## Lorenzo Suarez

Country: Spain

Age: 24

Height/Weight: 6'1/168 lb.

Backhand: Double-handed

Strengths: He utilizes top-spin shots when he is in the middle of the court. His forehands, middle shots and top-spin strokes are his strengths.

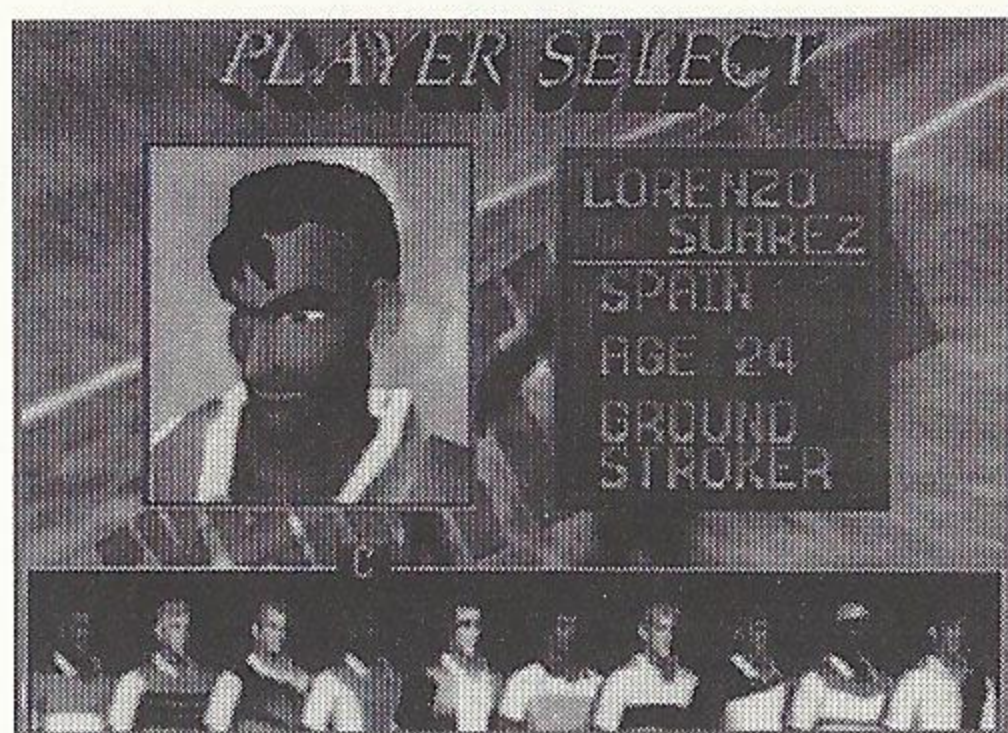

## Alexei Ivanov

Country: Russia

Age: 24

Height/Weight: 6'4/181 lb.

Backhand: Double-handed

Strengths: He has a powerful flat serve. He is good at aggressively approaching the net.





## Jason Lee

Country: Hong Kong

Age: 23

Height/Weight: 5'8/143 lb.

Backhand: Double-handed

Strengths: His forehands, middle-shots and top-spin lobs are very effective. He runs fast and has a good sense of balance. He returns the ball tenaciously. He is the type of player who waits for his opponent to make mistakes.

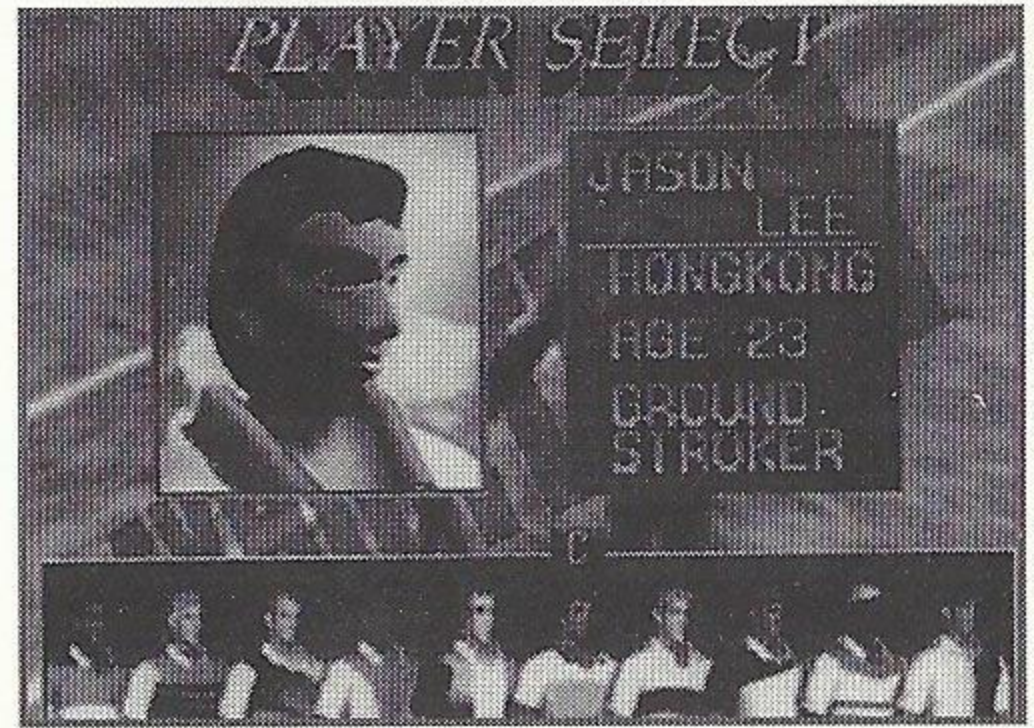

## Anders Rosenberg

Country: Sweden

Age: 29

Height/Weight: 6'2/170 lb.

Backhand: One-handed

Strengths: Forehands, middle-shots and low-volleys are his strengths. He tries to end the game quickly with his volleys. He sometimes attempts a drop-shot during his volleys.

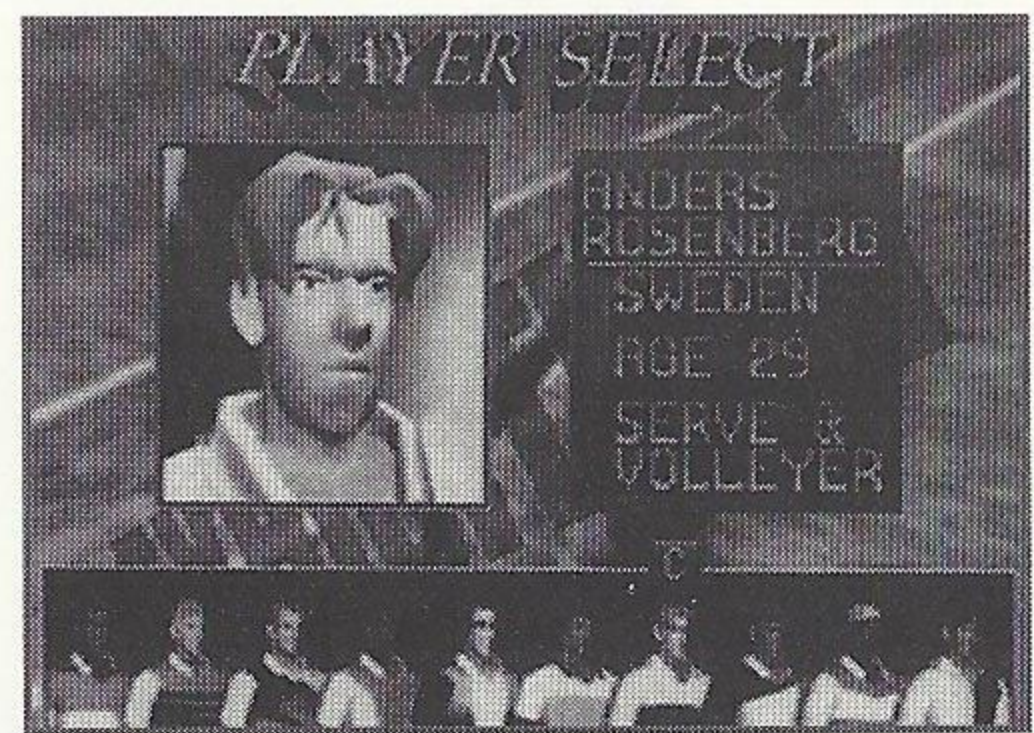



## Simon Lopez

Country: Chile

Age: 17

Height/Weight: 5'8/139 lb.

Backhand: Double-handed

Strengths: He is good at forehands, backhands, middle-shots and jump-shots. He carefully attacks his opponent's corner court with his strokes.

When he is on, he is dangerous!

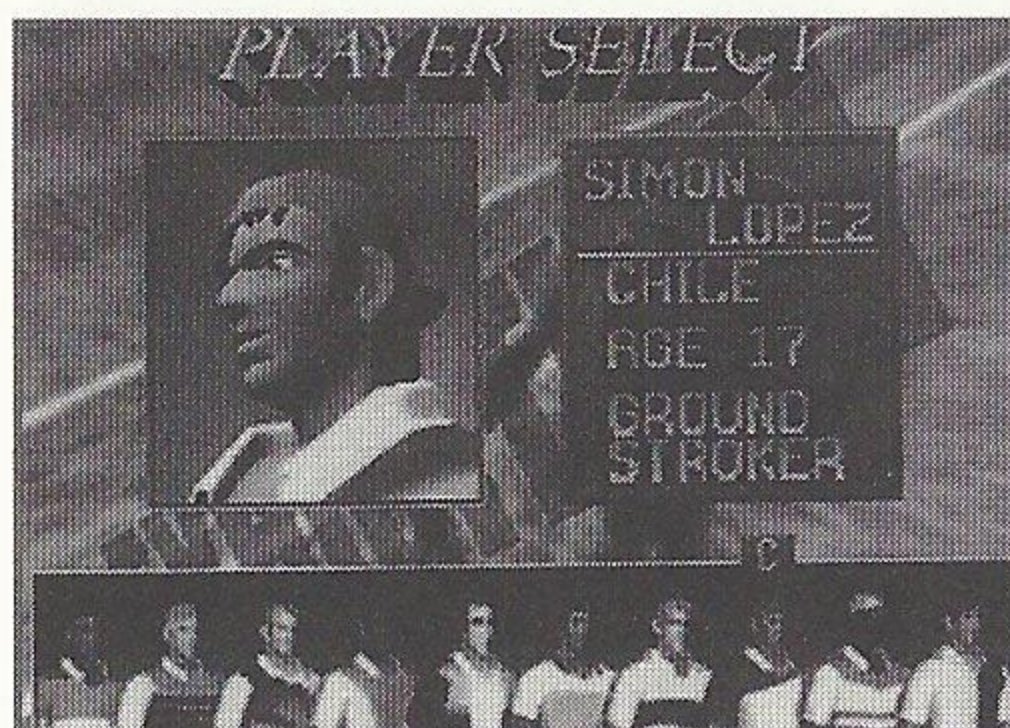

## Jimmy Walker

Country: South Africa

Age: 24

Height/Weight: 6'0/168 lb.

Backhand: Double-handed

Strengths: He is good at backhands, middle-shots and slice strokes. His slice-shot is his best shot, but he sometimes hits very fast top-spins and high lobs to his opponent's base-line, flustering his opponent.

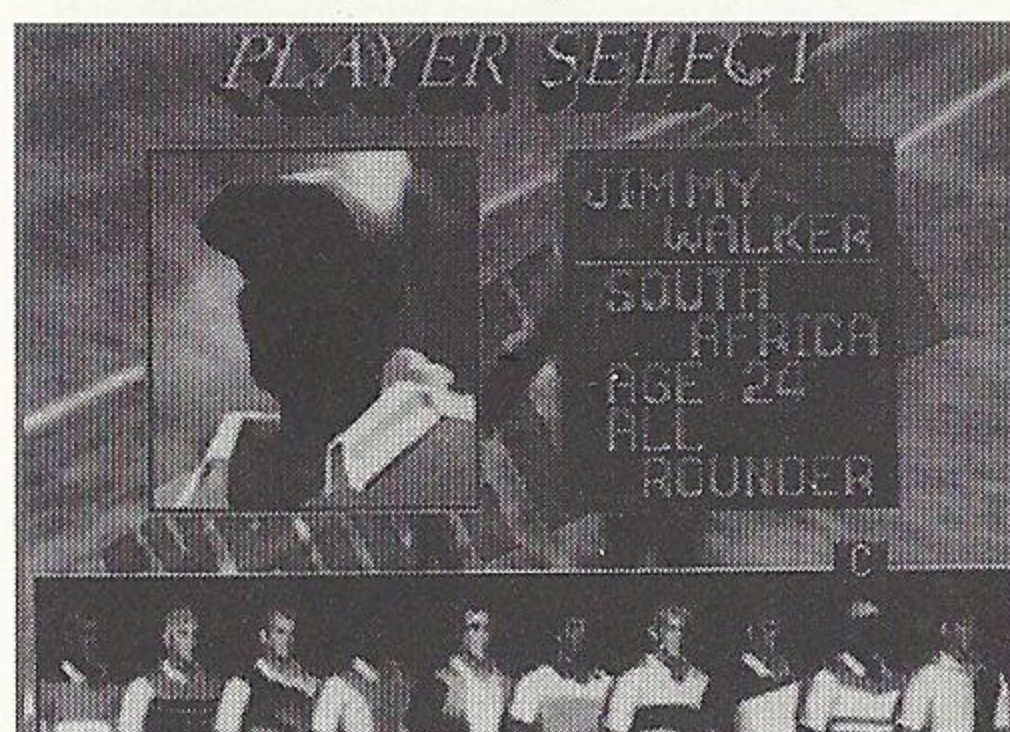



## Ryo Ibuki

Country: Japan

Age: 27

Height/Weight: 5'9/155 lb.

Backhand: One-handed

Strengths: Forehand, middle shots

and volleys are his best shots. He is a balanced player. He has no particular weaknesses but does not have any exceptional attributes, either.

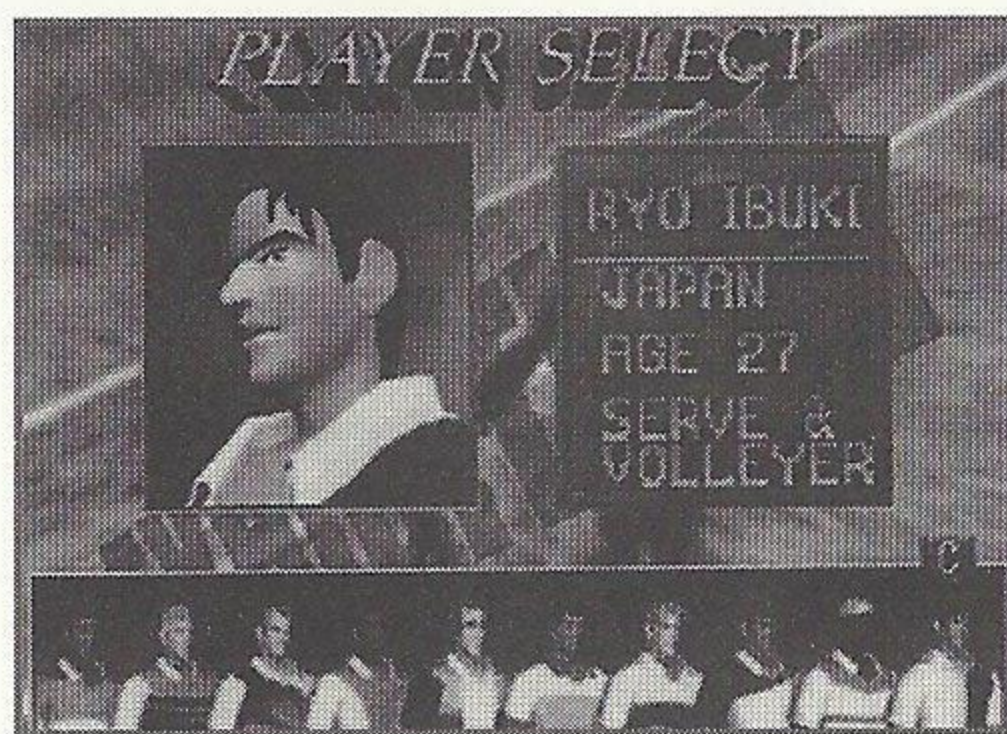







## ACCLAIM® LIMITED WARRANTY

ACCLAIM warrants to the original purchaser only of this ACCLAIM software product that the medium on which this software program is recorded is free from defects in materials and workmanship for a period of ninety (90) days from the date of purchase. This ACCLAIM software program is sold "as is," without express or implied warranty of any kind, and ACCLAIM is not liable for any losses or damages of any kind resulting from use of this program. ACCLAIM agrees for a period of ninety (90) days to either repair or replace, at its option, free of charge, any ACCLAIM software product, postage paid, with proof of date of purchase, at its Factory Service Center. Replacement of the software product, free of charge to the original purchaser (except for the cost of returning the software product) is the full extent of our liability.

This warranty is not applicable to normal wear and tear. This warranty shall not be applicable and shall be void if the defect in the ACCLAIM software product has arisen through abuse, unreasonable use, mistreatment or neglect. THIS WARRANTY IS IN LIEU OF ALL OTHER WARRANTIES AND NO OTHER REPRESENTATIONS OR CLAIMS OF ANY NATURE SHALL BE BINDING ON OR OBLIGATE ACCLAIM. ANY IMPLIED WARRANTIES APPLICABLE TO THIS SOFTWARE PRODUCT, INCLUDING WARRANTIES OF MERCHANTABILITY AND FITNESS FOR A PARTICULAR PURPOSE, ARE LIMITED TO THE NINETY (90) DAY PERIOD DESCRIBED ABOVE. IN NO EVENT WILL ACCLAIM BE LIABLE FOR ANY SPECIAL, INCIDENTAL, OR CONSEQUENTIAL DAMAGES RESULTING FROM POSSESSION, USE OR MALFUNCTION OF THIS ACCLAIM SOFTWARE PRODUCT.

Some states do not allow limitations as to how long an implied warranty lasts and/or exclusions or limitations of incidental or consequential damages so the above limitations and/or exclusions of liability may not apply to you. This warranty gives you specific rights, and you may also have other rights which vary from state to state.

This warranty shall not be applicable to the extent that any provision of this warranty is prohibited by any federal, state or municipal law which cannot be pre-empted.

**Repairs/Service after Expiration of Warranty-** If your game pak requires repair after expiration of the 90-day Limited Warranty Period, you may contact the Consumer Service Department at the number listed below. You will be advised of the estimated cost of repair and the shipping instructions.

### **Acclaim Hotline/Consumer Service Department (516) 759-7800**

Virtual Open Tennis ©1996 Imagineer Co., Ltd. Developed by Imagineer Co., Ltd. Big Hurt™ is a registered trademark of Frank Thomas and licensed for use to Big Hurt Enterprises, Inc. Unauthorized use is strictly prohibited. Big Hurt Enterprises has granted a limited license to Acclaim Entertainment, Inc. Officially licensed by the Major League Baseball Players Association MLBPA Logo © MLBPA MSA. Acclaim is a division of Acclaim Entertainment, Inc. ® & © 1996 Acclaim Entertainment, Inc. All Rights Reserved.

Patents: U.S. #'s 4,442,486/4,454,594/4,462,076/5,371,792; Europe # 80244; Canada #'s 1,183,276; Hong Kong # 88-4302; Singapore # 88-155; U.K. # 1,535,999.



# Frank Thomas Big Hurt Baseball™

whatever  
**Frank**  
wants  
**Frank**  
Gets...

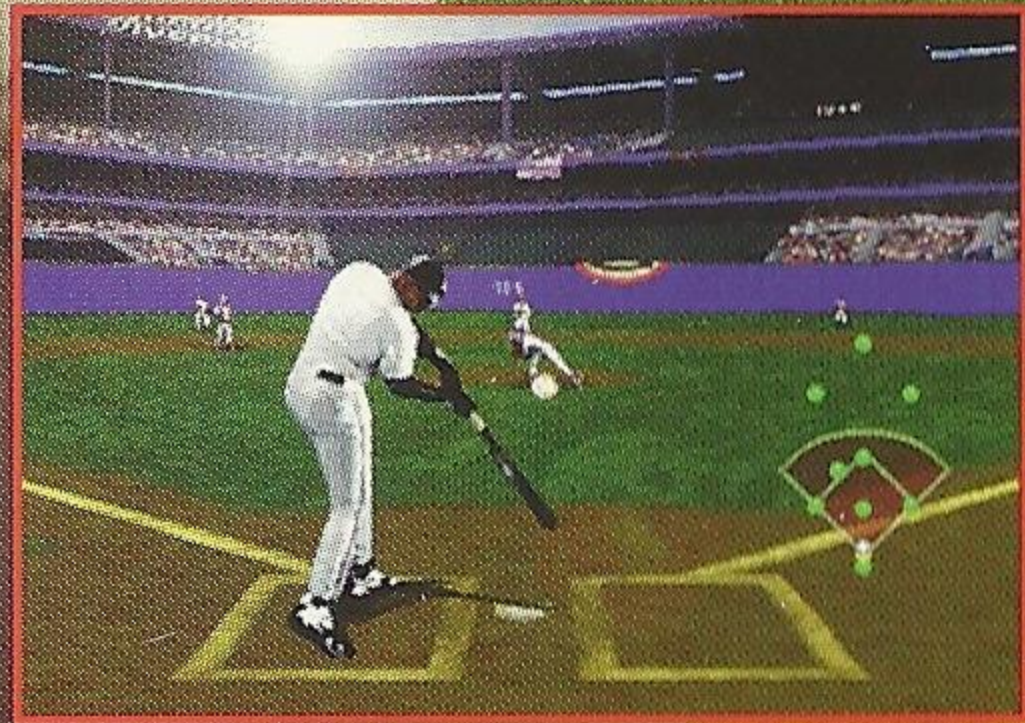
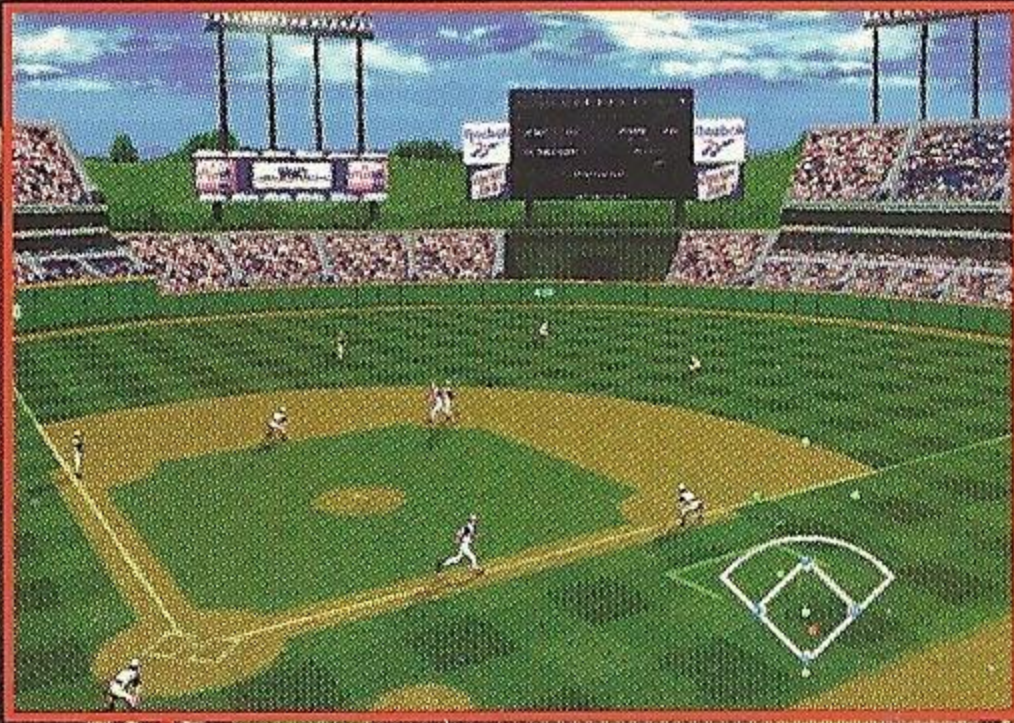

Sega and Sega Saturn are trademarks of SEGA ENTERPRISES, LTD.

Contact the ESRB at 1-800-771-3772 for more information on game ratings.

Marketed by Acclaim. Distributed by Acclaim Distribution, Inc., One Acclaim Plaza, Glen Cove, NY 11542-2777.

Acclaim is a division and registered trademark of Acclaim Entertainment, Inc.

® & © 1996 Acclaim Entertainment, Inc. All Rights Reserved.

This game is licensed for use with the Sega Saturn™ system only. Security Program ©SEGA 1994 All Rights Reserved. Unauthorized copying, reproduction, rental, public performance or broadcast of this game is a violation of applicable laws. Made and printed in the U.S.A. All rights reserved.