

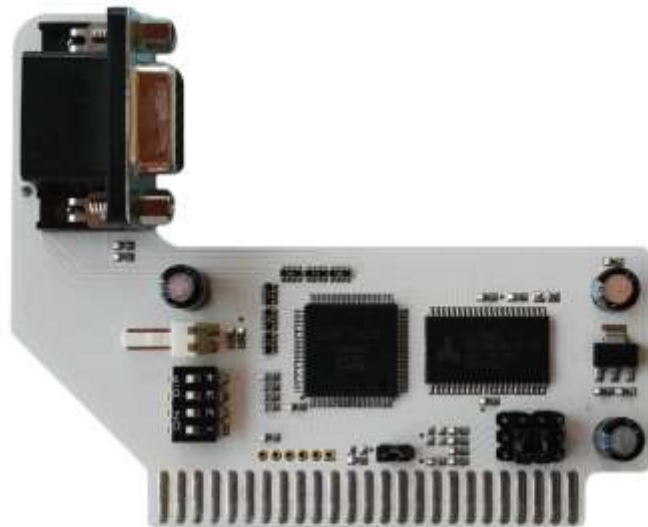

Apple II VGA Scaler ԳՈՒՆԳԳՆ User's Guide



DRAFT KFEEST 2016

Table of Contents

Description	5
Contents of Package	6
Connections	7
AIIVGAS Modes	8
Brief description of how AIIVGA works	8
What Apple II do I have?	10
Identifying your Apple II model by ID bytes	10
The Original Apple II Identification	10
Apple II Main board revisions	11
Apple II Motherboard part number versus Revisions	11
Apple II Plus Identification	12
Apple IIe Identification	12
Differences between the Standard and Enhanced Apple IIe	13
AIIVGAS Orientation	14
Apple II SLOT Connector Pin Definition	15
Typical installation in SLOT 7 of an Apple IIe	16
Installing AIIVGAS into an Apple II/II+ or Europlus – Slot 7	17
Installing AIIVGAS into an Apple II Rev 0 motherboard SLOT 7	18
Installing AIIVGAS into an Apple II Rev 1-4 motherboard SLOT 7	18
Installing AIIVGAS into an Apple II Rev 7/RFI motherboard SLOT 7	19
Installing AIIVGAS into an Apple II/II+ or Europlus – Slots 0 – 6	19
Typical installation in SLOT 1 of an Apple II	22
Installing AIIVGAS into an Apple IIe (standard or enhanced) – Slot 7	23
4 Way jumper block identification	24
4 Way Jumper Block Pin Identification	24
DIP Package Numbering	26
Installing AIIVGAS into an Apple IIe (standard or enhanced) – Slots 1 – 6	27
Setting the default video mode	28
VGA Port Pinout	29
Troubleshooting	29
Frequently Asked Questions	30
Appendix A	31
Apple II Rev 0 Main Board	31

Apple II Rev 1 Main Board 32

Apple II Rev 2/3 Main Board..... 33

Apple II Rev 4 Main Board 34

Apple II Rev RFI Main Board 35

Apple II RFI Board layout 36

Appendix B..... 37

Apple IIe NTSC Main Board..... 37

Apple IIe PAL Main Board 38

Apple IIe International NTSC Main Board..... 39

Where to find further help 40

About a2heaven.com 40

Warranty..... 40

Some other a2heaven products 41

DRAFT - K-FEST 2016

Description

The Apple II VGA scaler (AIIVGAS) is an Apple II compatible circuit board for converting Apple II, II+, Europlus and Apple IIe video to VGA compatible signals for displaying on a VGA monitor. The board is compatible with both NTSC and PAL systems. Due to the wide variation in Apple II models, there are some jumpers and in some cases additional jumper wires to be connected to enable full functionality. In this day and age, composite CRT monitors for these vintage/retro systems are becoming scarce and harder to obtain, mainly due to the attrition rate of monitors pushing 30 years of age. VGA LCD monitors are part of everyday life and can be had for a cheap price. The Apple II VGA Scaler (AIIVGAS), does as its name suggests. It converts the Apple II video into a VGA compatible signal. This means you can use almost any CRT or LCD VGA monitor on your Apple II series computer. The modes supported are dependent upon the Apple II that you have. For example the Enhanced Apple IIe supports Double-High-Resolution, whereas the Apple II, Apple II+, and Europlus do not. This is as a result of technological advances in the evolution of the Apple II design and not a limitation of the Apple II VGA Scaler. AIIVGAS does not add and graphics capability to the Apple II, it merely converts those modes that are supported in your model to VGA compatible graphics. AIIVGAS supports 20 display modes of operation, including, colour, monochrome and the ability to emulate scan lines for the retro look on modern VGA monitors. There is a degree of compatibility with the Apple IIgs, but this is not covered in this manual as there is an Apple IIgs specific product in the pipeline that will be much better.

Steve Wozniak Quote

My Goal wasn't to make a ton of money. It was to build good computers.

The Apple II VGA Scaler supports the following Apple II video modes

- 40 and 80 columns text, with 24 lines
- Low-Resolution: 40 × 48 (15 colours)
- High-Resolution: 280 × 192 (6 colours)
- Double-Low-Resolution: 80 × 48 (15 colours) *
- Double-High-Resolution: 560 × 192 (2 colours) *

* **Caveat**, due to advances in Apple II design, these modes are NOT supported on the earlier Apple II, Apple II+, Apple Europlus and un-enhanced Apple IIe.

Contents of Package

- 1 x Apple II VGA Scaler (AIIVGAS)
- 1 x VGA Extension cable
- 1 x Purple cable with clip
- 1 x Red cable with clip
- 1 x Yellow cable with clip (shielded cable for 14M signal)
- 1 x White cable with clip
- 5 x Jumpers, white, red, green, blue and yellow
- 1 x Switch Mode Button

N.B. Actual cable colours may vary, depending upon availability at the time of manufacture.

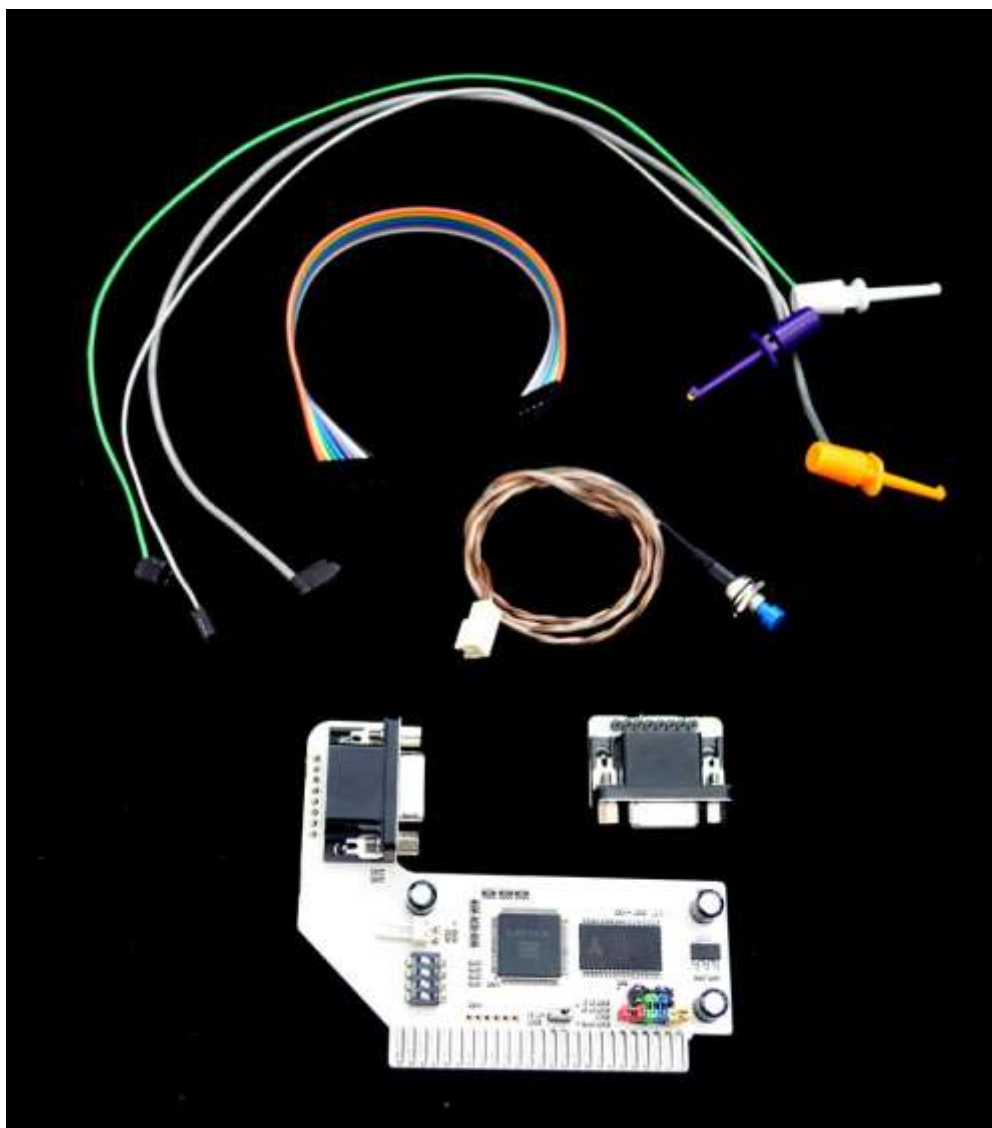

Connections

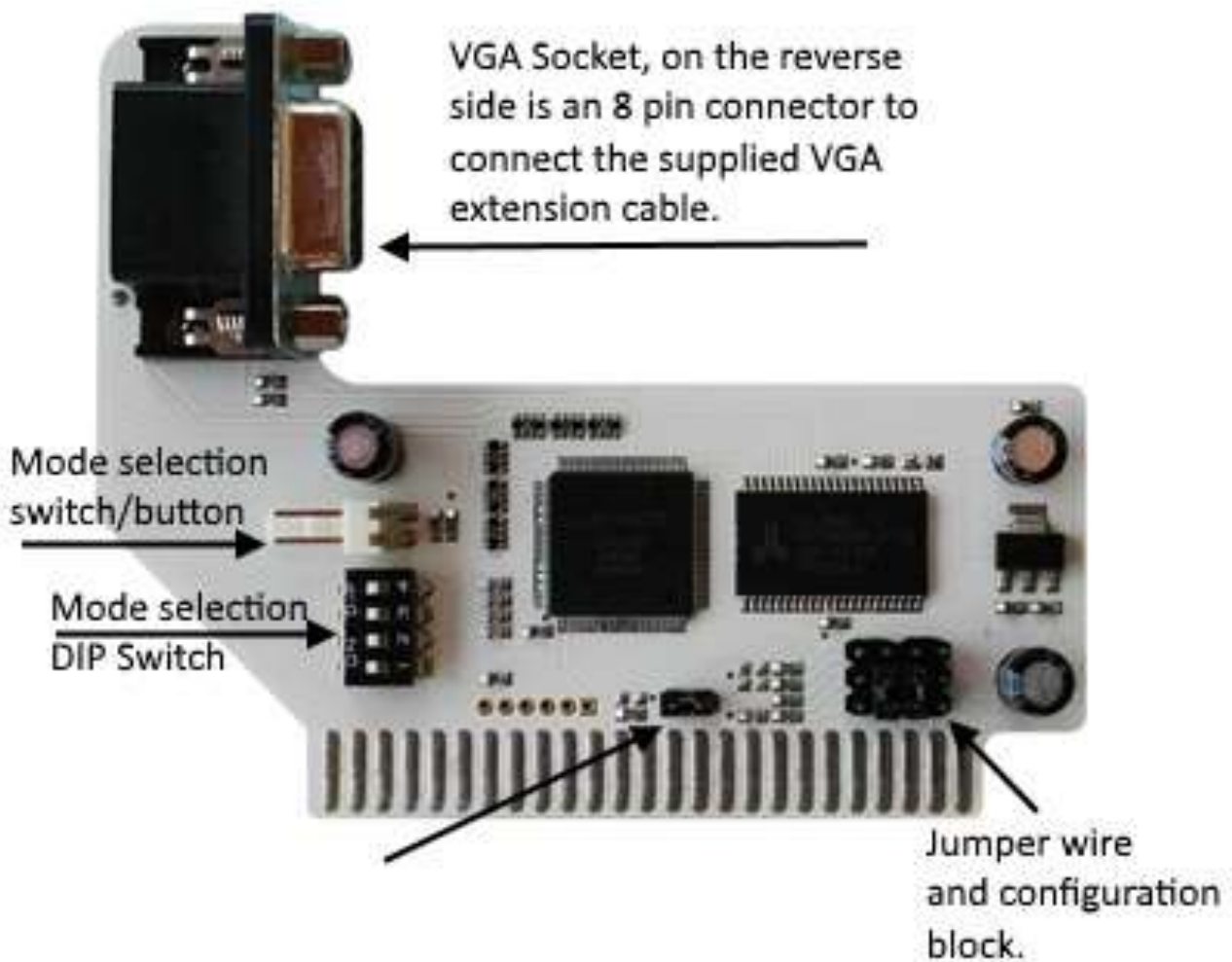

Due to the Apple II VGA scaler supporting all variations of the Apple II, II+, Europlus and IIe computers, there can be a bit of research required to configure the optional configuration jumper block and jumper wires. This will depend on the Apple II type, PAL or NTSC and which slot you intend to install the Apple II VGA scaler into. See the section on identifying the type of Apple II machine you own.

**** Please be aware, the AIIVGAS output is VGA 720x480 resolution. This may not work on some older VGA monitors. ****

AIIVGAS Modes

The AIIVGAS has 20 modes of operation, to allow you to tailor your retro experience. The 20 modes are as follows:

Mode #	Video Mode	Scanlines
1	Colour	OFF
2	Colour Alternative	
3	Shades of Green	
4	Shades of White	
5	Mono - Green	
6	Mono - White	
7	Mono - Amber	
8	Mono - Green (Bold)	
9	Mono - White (Bold)	
10	Mono - Amber (Bold)	
11	Colour	ON
12	Colour Alternative	
13	Shades of Green	
14	Shades of White	
15	Mono - Green	
16	Mono - White	
17	Mono - Amber	
18	Mono - Green (Bold)	
19	Mono - White (Bold)	
20	Mono - Amber (Bold)	

The modes are accessed sequentially by pressing the mode button, each press will change the mode, once you get to mode 20, pressing the button once more will return you to mode 1 and the sequence repeats. NB from the DIP switches you can set any one of 16 default modes, but from the mode button you can sequentially select one of 20 modes, commencing with the default mode as configured on the 4 way DIP switch.

Brief description of how AIIVGA works

AIIVGAS is a paradox of technology. Its form and function is simple, and yet internally it is complex. Thankfully, due to the excellent work done by Plamen, AIIVGAS is compatible with all variations of the Apple II computer and many Apple II clones. (Apple IIc and Apple IIgs excluded). AIIVGAS utilises 2 LSI devices, a CPLD and a 256K x 16 static ram. The CPLD (Complex Programmable Logic Device) is configured as a scan line doubler, in that it stores the video information from the Apple IIc (15Khz) frame by frame and then outputs the

video as VGA 720 x 480 (shows as 640 x 480 on some VGA monitors) at 31Khz. The 256K x 16 static RAM is used as a video frame buffer.

In addition it allows the video out to be adjusted to simulate various colour and monochrome modes as well as adding scan lines for that really retro look.

In most Apple II computers slot 7 is the best choice for installing AIIVGAS. The reason behind this is, there are additional video related signals present on slot 7 as compared to other slots. You can use AIIVGAS in any slot, but you will require additional jumper wires to connect the additional video related signals to AIIVGAS.

AIIVGAS requires (in addition to power), 5 mandatory signals from the Apple II circuitry. These signals are:

SYNC	This is the Sync signal from the video timing generator
GR	Graphics mode enable from IOU chip or 74LS174 pin 2 (B8)
14M	This is the master oscillator from which all other signals are derived
SEROUT	This is the raw serial, video data stream
CREF	Colour REF, this is the 3.58Mhz, NTSC Colour Burst signal

Some of these signals can be found on slot 7 or can be enabled on slot 7 by the soldering of specific jumper pads on the Apple II main board. These jumpers vary from model to model, revision to revision. It is most convenient to pick these signals up from slot 7, but they are present elsewhere on the Apple II main board and can be picked up via additional, optional jumper wires.

DRAFT

What Apple II do I have?

There are basically 4 varieties of the Apple II range of computers, these can be further broken down into sub-categories. Only the Apple II, Apple II+, Apple Europlus and the Apple IIe will be fully functional with AIIVGAS. The Apple IIc/IIc+ and Apple IIgs are not compatible. For the Apple IIc/IIc+ you should use the Apple IIc VGA adapter.

http://a2heaven.com/webshop/index.php?rt=product/product&product_ID=135

At this point in time, a2heaven does not make an Apple IIgs VGA scaler, but there is one in development and is currently at the prototype stage. Check back regularly in the Apple IIgs Facebook forums or on the a2heaven website for updates.

Of the supported machines, you will need to determine if you have an Apple II/II+/Europlus or an Apple IIe (normal and enhanced).

The following pages, on identifying your Apple II have been taken from Appendix F of "The New Apple II User's Guide" by David Finnigan with permission. This is the ultimate reference book on the Apple II range of computers and is a highly recommended purchase/read. ISBN-10: 0615639879. The information is not copied verbatim, but I have selected and added to portions relevant to this guide. I wish to personally thank David for the use of this information as it has saved me countless hours of research.

Identifying your Apple II model by ID bytes

Machine	\$FBB3	\$FB1E	\$FBC0	\$FBBF
Apple II	\$38		\$60	\$2F
Apple II Plus	\$EA	\$AD	\$EA	\$EA
Apple IIe	\$06		\$EA	\$C1
Apple IIe (Enhanced)	\$06		\$E0	\$00

The Original Apple II Identification

The original Apple II computer, released in 1977, included Integer BASIC ROMS and the old Monitor ROM.

Apple II Main board revisions

Revision	Description
0	Models with serial numbers less than 6000 are typically Revision 0. Only four high-resolution colours are available" green, violet, black and white. The speaker is wired to cassette out (this is a design mistake). On screen text always has a colour fringe (due to the presence of the colour burst signal).
1	Two additional HIRES colours are available, blue and orange. A colour killer modification removes the colour fringes on text. The Apple II automatically does a reset when powered on. In addition, 50Hz, Euro Apple jumpers were added. Wire-wrap video pin added, 20/24k RAM issue fixed and 2 additional video signals were available on slot 7 via solder pads located between B1 and C1 on the main board. These two additional video signals being 14M (Pin 24) and SEROUT (Pin 28).
3	Socketed memory configuration jumpers at positions D1, E1 and F1.
4	16K memory configuration jumpers are soldered directly to board, i.e. no sockets.
7	Memory select jumpers have been removed, 48K memory comes as standard. 74LS139 at location E2 (memory decode) has been removed.
RFI	Lid, base plate and back panel changed to limit RFI, 2 x 8T28 chips at locations H10 and H11 have been replaced with a single 8304.

Apple II Motherboard part number versus Revisions

	Part Number	Revision
Non-RFI	820-0001-00	Rev 0
	820-0001-01	Rev 1
	820-0001-02	Rev 2
	820-0001-03	Rev 3
	820-0001-04	Rev 4
	820-0001-07 and up	Rev 7
RFI	820-0044-01	RFI
	820-0044-C	
	820-0044-D	

See Appendix A for pictures of the various Apple II motherboard revisions.

Apple II Plus Identification

The Apple II Plus, released around June 1979, has at least a revision 1 motherboard, and also included the APPLESOFT and Auto-start ROMs. Most models of the Apple II Plus have a revision 7 or RFI motherboard and 48K of RAM.

The only functional difference between an original Apple II and the Apple II Plus is the firmware (ROMs), the motherboard and every other chip is the same.

Externally, the only difference between the original Apple II and the Apple II Plus were the name badge and the serial/model number sticker on the bottom of the case.

The final difference between the two models is the keyboard: only the oldest original Apple II models have the early, one piece (Datanetics brand) keyboard. All Apple II Plus models should have the new, 2 piece keyboard, and later original Apple II models came with this keyboard too.

- RAM: typically 48K
- CPU: 6502/6502A at 1.023Mhz
- Keyboard: uppercase only
- Slots: (8), 7 general purpose (Slots 0-6), 1 with additional video signals (Slot 7)
- ROM: 10K APPLESOFT basic (5 x 2K ROMs) + Auto-Start monitor ROM

Apple IIe Identification

The Apple IIe, which superseded the Apple II Plus on January 1983, was the first model of Apple II to support lowercase display and keyboard. Characters. It has 9 additional keys, totalling 63 and supports automatic key repeat with N-key rollover.

A language card is built-in, bringing the standard RAM configuration to 64K. As with the Apple II Plus, APPLESOFT BASIC is standard in ROM. In addition, 80-Column firmware is built into the system, but requires either an 80-Column card or extended 80-Column card in the Auxiliary slot. The extended card also adds an additional 64K of ram, bringing the total RAM to 128K.

The Apple IIe adds an additional port on the back, a DB-9 connector for paddle and joysticks, this is a direct replica of the internal 16 pin DIP socket provided on the main board.

The earliest model of Apple IIe had white lettered keys, later, the colour was switched to black.

The last revision of the Apple IIe was released in 1987. It has the same enhanced firmware as the previous revision but with a redesigned keyboard, pre-installed

extended 80-Column card, a reduced chip count, and a few other minor logic board changes.

- RAM: 64K or 128K
- CPU: 6502B or 65C02 at 1.023Mhz
- Keyboard: upper and lowercase
- Slots: 7 general purpose (Slots 1-7), plus Auxiliary Video slot
- ROM: 16K APPLESOFT BASIC + Monitor

Differences between the Standard and Enhanced Apple IIe

Hardware changes began with the 65C02 microprocessor replacing the 6502B. The 65C02 is more power efficient and introduces new instructions and addressing modes. The enhanced IIe sports a new video ROM containing MouseText characters equivalent to those found in the Apple IIc. There are also new CD and EF Monitor ROMs with the enhanced IIe firmware.

Revision	Description
A	No Double HIRES graphics, supports only the Apple II and Apple II Plus graphics modes.
B	Support added for Double HIRES and Double LORES graphics modes. Video signals added to slot 7 (via optional solder pads, located just below slot 7, labelled X7)
Enhanced	65C02 Microprocessor, MouseText characters and updated Monitor and Microsoft Basic firmware.

The machine identification byte at \$FBC0 distinguishes the Enhanced IIe from the standard IIe. As will the type of CPU, ie 65C02 vs 6502B in the standard IIe.

The Enhanced IIe firmware allows system startup from devices other than the standard Disk II or Apple 5.25" controller card.

The video firmware in the Enhanced IIe, better supports 80-Column mode. In addition, lowercase input and display are supported. Two new escape sequences control whether Control characters should be displayed on the screen or not.

MouseText can be used to simulate a windows based GUI on the Apple IIe. These additional 32 characters take the place of the alternative character set.

Several APPLESOFT statements that did not work properly in 80-Column mode were fixed, these include HTAB, TAB, SPC and comma tabbing in PRINT statements. Furthermore, APPLESOFT now recognises key-words and variables in lowercase.

Several new features are part of the Enhanced Apple IIe monitor:

- Lowercase input

- ASCII input mode
- Monitor search command
- Mini-assembler

Slot 3's behaviour is changed with the Enhanced IIe. Whereas with the standard IIe, a card in the Auxiliary slot would always disable the firmware of a card in slot 3, the Enhanced IIe allows the slot 3 card's firmware to be switched into memory if the card's ROM contains certain ID bytes.

In addition, the PAL version of the Apple IIe, moves the Auxiliary slot from in front of slot 0/1 (i.e. on the very left hand side of the main board), to being located directly in front of slot 3. In some cases the addition of the 80-Column or Extended 80-Column card in the PAL version of the Apple IIe, precludes the use of some expansion cards in slot 3, as they mechanically interfere with each other.

I have 3 variations of the Apple IIe machine motherboard, whilst offering similar functionality, they have different chip locations for connecting the additional jumper wires to. Thankfully the chips and pins seem to remain constant despite the position of the chips moving around from version to version.

See Appendix B for pictures of the various Apple IIe motherboard revisions.

AIIVGAS Orientation

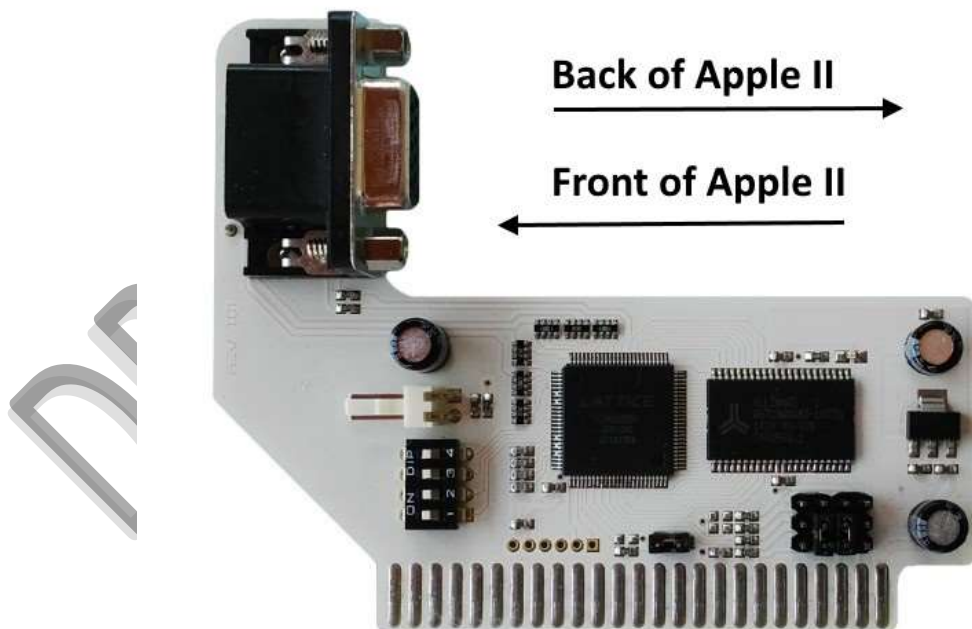

Apple II SLOT Connector Pin Definition

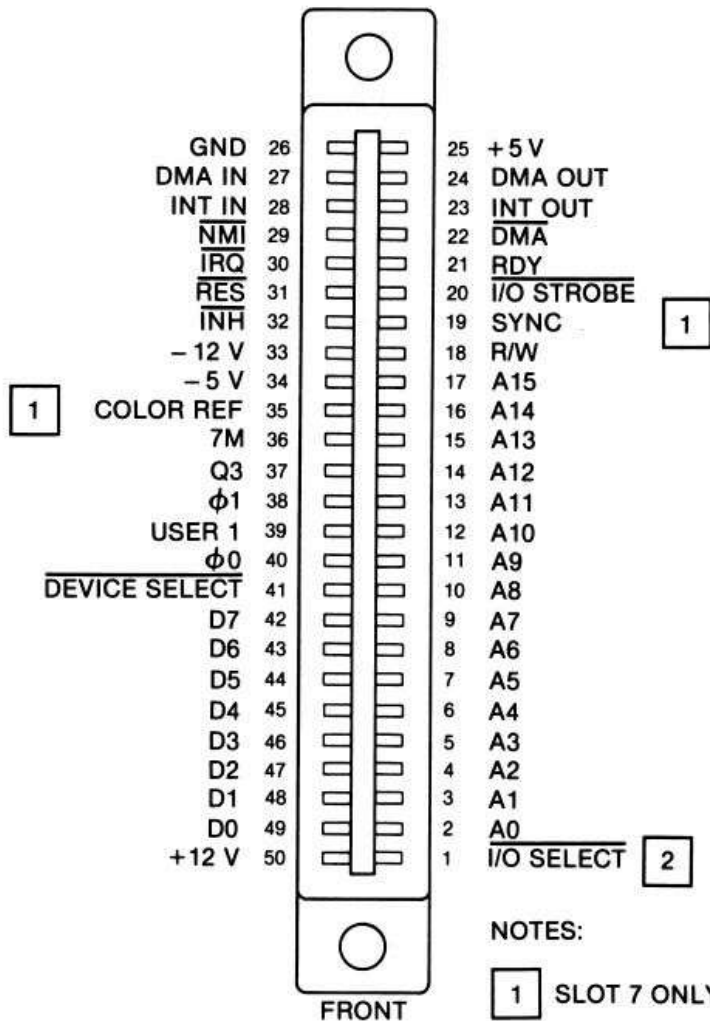

NOTES:

- 1 SLOT 7 ONLY
- 2 SLOTS 1-7 ONLY

Typical installation in SLOT 7 of an Apple IIe

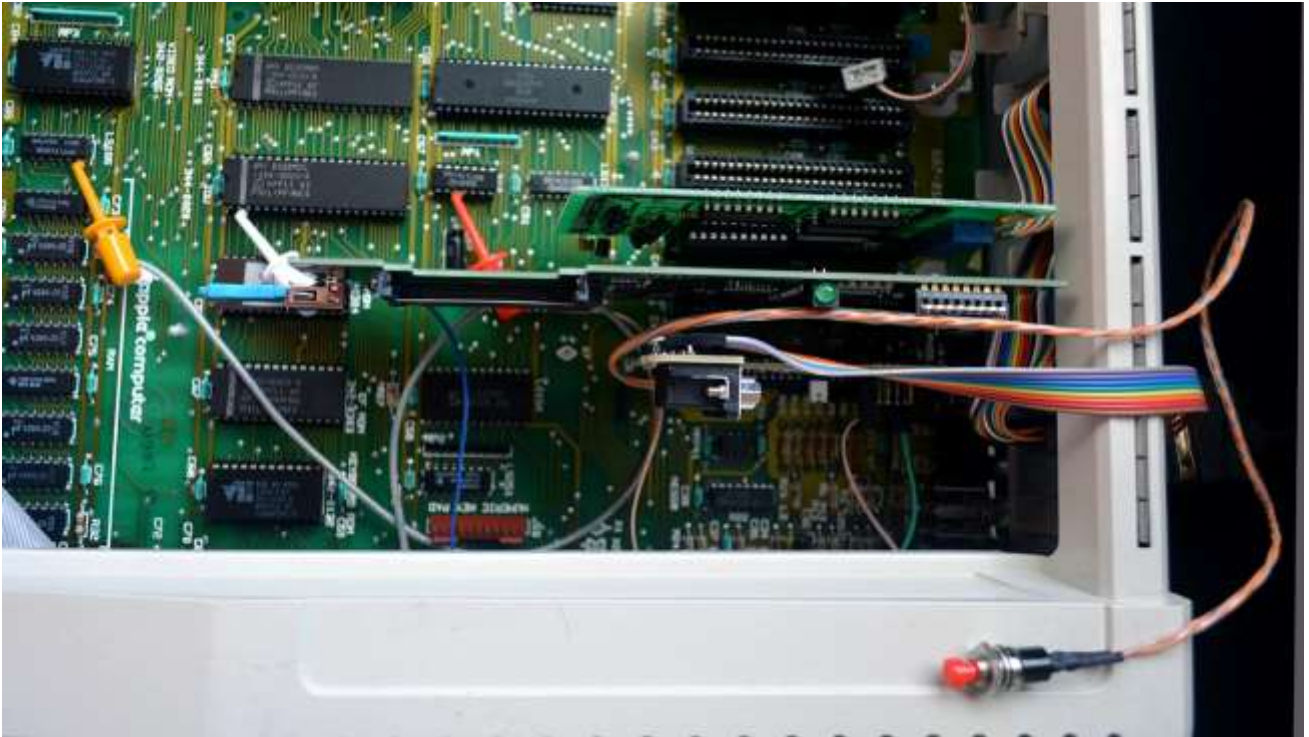

Installing AIIVGAS into an Apple II/II+ or Europlus – Slot 7

Despite being an older version of the Apple series of computers, the Apple II machine can be the easiest machine to install AIIVGAS into. Rev 0 machines require all 5 additional jumper wires. Rev 1 through Rev 4 require 3 additional jumper wires and Rev 7 and later (including the RFI models) require 1 additional jumper wire.

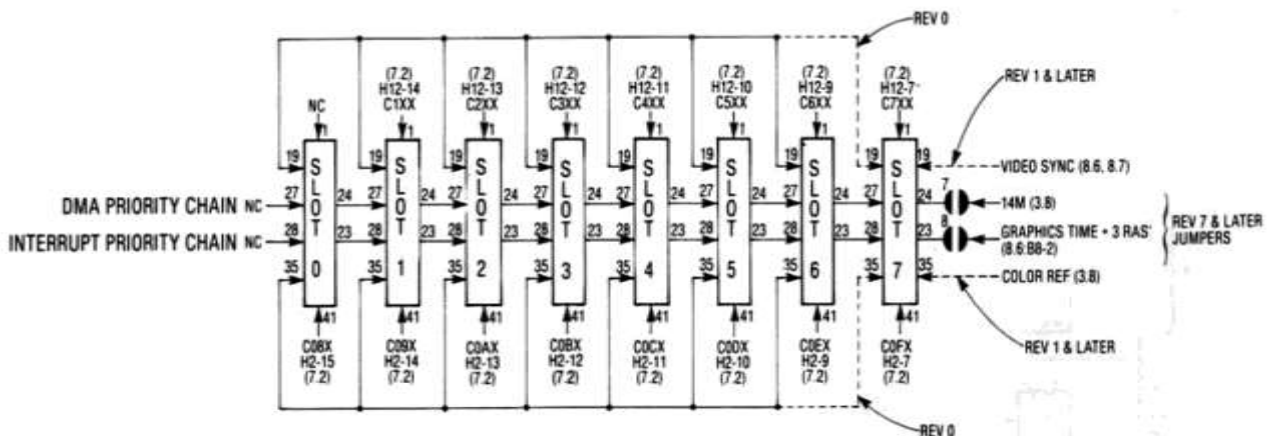

The only signal that is never connected in genuine Apple II/IIe machines is the SEROUT signal.

Pin 19 Sync (seems to be on all Apple IIs other than REV 0)

Pin 23 GR can be optionally connected to slot 7 by bridging an optional solder pad (X7 on IIe) and optional solder pads on Apple II Rev 7 and later),

Pin 24 14M, is not connected on the Apple IIe, but can be connected on Apple II Rev 7 and higher

Pin 35 CREF (3.58Mhz) is on all Apple II machines from Rev 1 upwards and is on all Apple IIe machines.

Installing AIIVGAS into an Apple II Rev 0 motherboard SLOT 7

Rev 0 motherboards slot 7 lacks any of the required video signals. Hence the instructions for a Rev 0 motherboard are the same as for Slots 0 – 6 for a later revision motherboard.

SEROUT: Remove the Red jumper from the 4 way jumper block. Connect one end of the Red jumper wire to Pin 2, the centre position of the 1st column. Connect the other end (with the clip) to the 74LS74 Pin 6, located at position B10.

SYNC: Remove the Green jumper from the 4 way jumper block. Connect one end of the Green jumper wire to Pin 2, the centre position of the 2nd column. Connect the other end (with the clip) to the 74LS51 Pin 8, located at position C13.

GR: Remove the Blue jumper from the 4 way jumper block. Connect one end of the Blue jumper wire to Pin 2, the centre position of the 3rd column. Connect the other end (with the clip) to the 74LS174 Pin 2, located at position B8.

14M: Remove the Yellow jumper from the 4 way jumper block. Connect one end of the Yellow jumper wire to Pin 2, the centre position of the 4th column. Connect the other end (with the clip) to the 74166 Pin 7, located at position A3.

CREF: Remove the White jumper from the single jumper position located in the centre just above the edge connector. Connect the White jumper wire to Pin 1 (the left hand most pin). Connect the other end (with the clip) to the 74LS02 Pin 2, located at position B13.

Installing AIIVGAS into an Apple II Rev 1-4 motherboard SLOT 7

Rev 1-4 motherboards slot 7 introduce 2 of the required video signals SYNC (Slot 7 Pin 19) and CREF (Slot 7 Pin 35). Consequently you will only need to connect SEROUT, GR and 14M.

SEROUT: Remove the Red jumper from the 4 way jumper block. Connect one end of the Red jumper wire to Pin 2, the centre position of the 1st column. Connect the other end (with the clip) to the 74LS74 Pin 6, located at position B10.

GR: Remove the Blue jumper from the 4 way jumper block. Connect one end of the Blue jumper wire to Pin 2, the centre position of the 3rd column. Connect the other end (with the clip) to the 74LS174 Pin 2, located at position B8.

14M: Remove the Yellow jumper from the 4 way jumper block. Connect one end of the Yellow jumper wire to Pin 2, the centre position of the 4th column. Connect the other end (with the clip) to the 74166 Pin 7, located at position A3.

Installing AIIVGAS into an Apple II Rev 7/RFI motherboard SLOT 7

Rev 7 and RFI motherboards slot 7 introduce 2 of the required video signals SYNC (Slot 7 Pin 19) and CREF (Slot 7 Pin 35) plus 2 additional signals if you connect 2 sets of jumper pads. Locate the jumpers labelled 7 (14M) and 8 (GR), they are located on the bottom left hand side of the Apple II Rev 7 and RFI motherboards between IC positions B1 and C1. If you solder these 2 sets of solder pads you will only need to connect SEROUT.

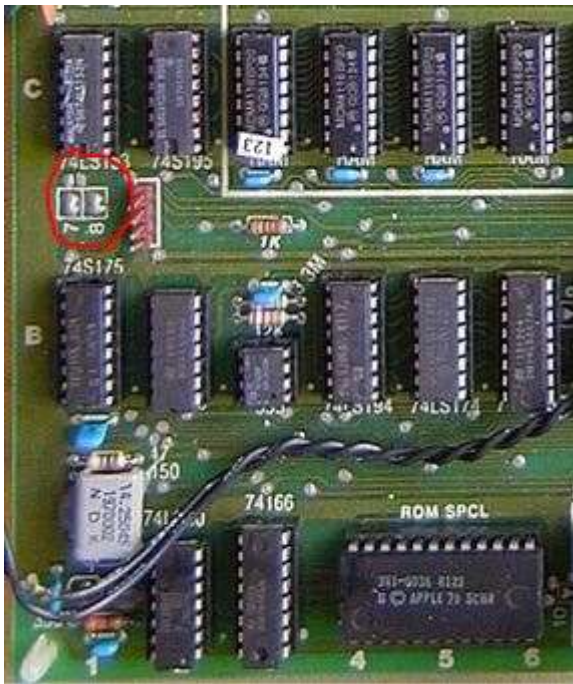

SEROUT: Remove the Red jumper from the 4 way jumper block. Connect one end of the Red jumper wire to Pin 2, the centre position of the 1st column. Connect the other end (with the clip) to the 74LS74 Pin 6, located at position B10.

Installing AIIVGAS into an Apple II/II+ or Europlus – Slots 0 – 6

Slots 0 – 6 on an Apple II, Apple II+ or Europlus, have very few of the necessary signals, hence slot 7 is a better option. However if for some reason you cannot use slot 7, you will need to supply all 5 of the video signals. Whereas if you use slot 7, you may only need to supply the SEROUT signal if you have a Rev 7 or RFI motherboard.

SEROUT: Remove the Red jumper from the 4 way jumper block. Connect one end of the Red jumper wire to Pin 2, the centre position of the 1st column. Connect the other end (with the clip) to the 74LS74 Pin 6, located at position B10.

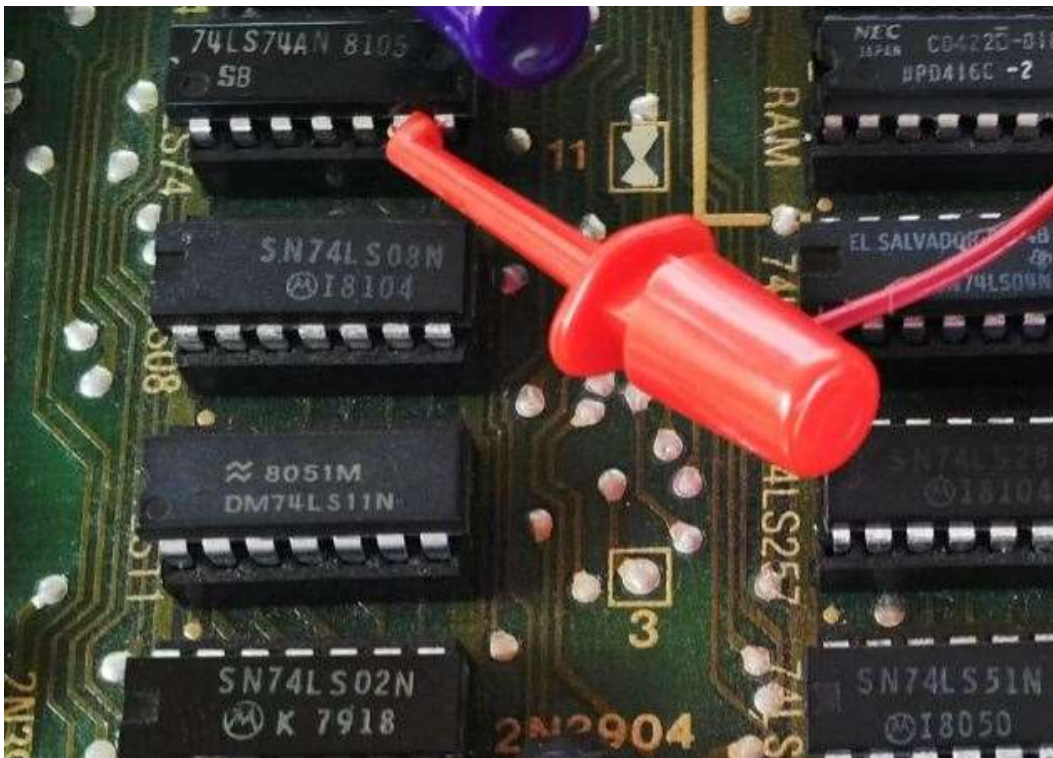

SYNC: Remove the Green jumper from the 4 way jumper block. Connect one end of the Green jumper wire to Pin 2, the centre position of the 2nd column. Connect the other end (with the clip) to the 74LS51 Pin 8, located at position C13.



GR: Remove the Blue jumper from the 4 way jumper block. Connect one end of the Blue jumper wire to Pin 2, the centre position of the 3rd column. Connect the other end (with the clip) to the 74LS174 Pin 2, located at position B8.



14M: Remove the Yellow jumper from the 4 way jumper block. Connect one end of the Yellow jumper wire to Pin 2, the centre position of the 4th column. Connect the other end (with the clip) to the 74166 Pin 7, located at position A3.



CREF: Remove the White jumper from the single jumper position located in the centre just above the edge connector. Connect the White jumper wire to Pin 1 (the left hand most pin). Connect the other end (with the clip) to the 74LS02 Pin 2, located at position B13.

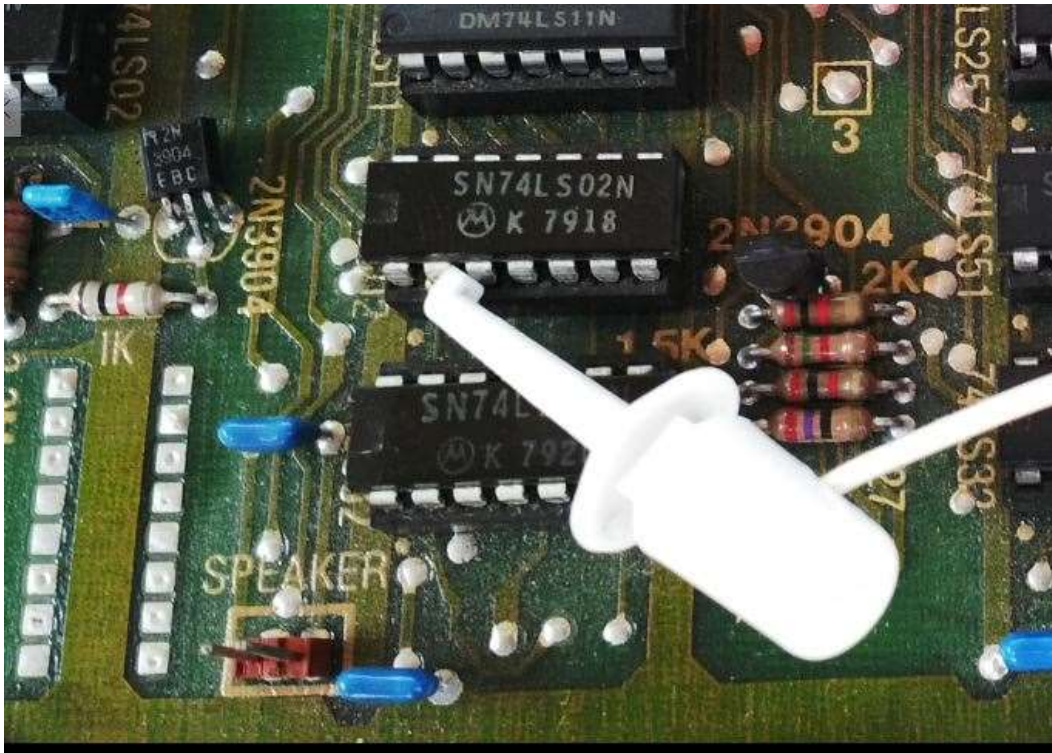

Typical installation in SLOT 1 of an Apple II

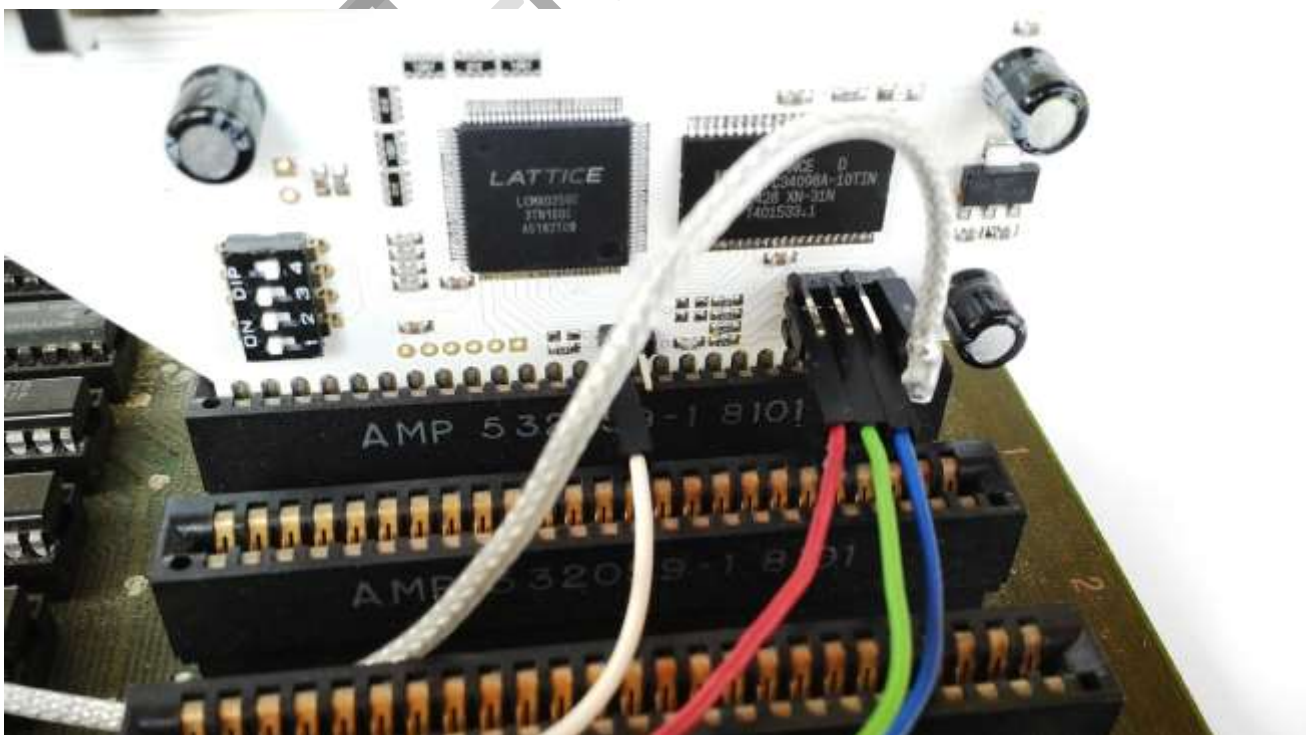

Installing AllVGAS into an Apple IIe (standard or enhanced) – Slot 7

These instructions apply to the Apple IIe, standard and enhanced, or, put another way all Apple IIe machines with a Rev B motherboard (most of them). This motherboard has some of the required signals present in slot 7. SYNC and CREF are present on SLOT 7, you can optionally enable the GR signal on pin 23 by soldering the solder pads labelled X7. This is located about 1 inch below SLOT 7.



If you connect these solder pads you will only need to use jumper wires for 14M and SEROUT. If you choose to keep your Apple IIe completely standard then you will also need to use the optional jumper wire for the GR signal. Making a total of three, optional jumper wires.

Connection of these three signals are as follows:

GR: Remove the Blue jumper (position 3 of the 4 way jumper block). Connect the Blue wire to position 2, the centre pin.

14M: Remove the Yellow jumper (position 4 of the 4 way jumper block). Connect the Yellow jumper wire to position 2 (centre pin). NB the yellow jumper wire is shielded and consequently thicker than the other colour jumper wires.

SEROUT: Remove the Red jumper (position 1 of the 4 way jumper block). Connect the Red jumper wire to position 2, the centre pin.

4 Way jumper block identification

The 4 way jumper block is located on the bottom right of the AIIVGAS board, just above the SLOT connector and in its default configuration, looks like this:

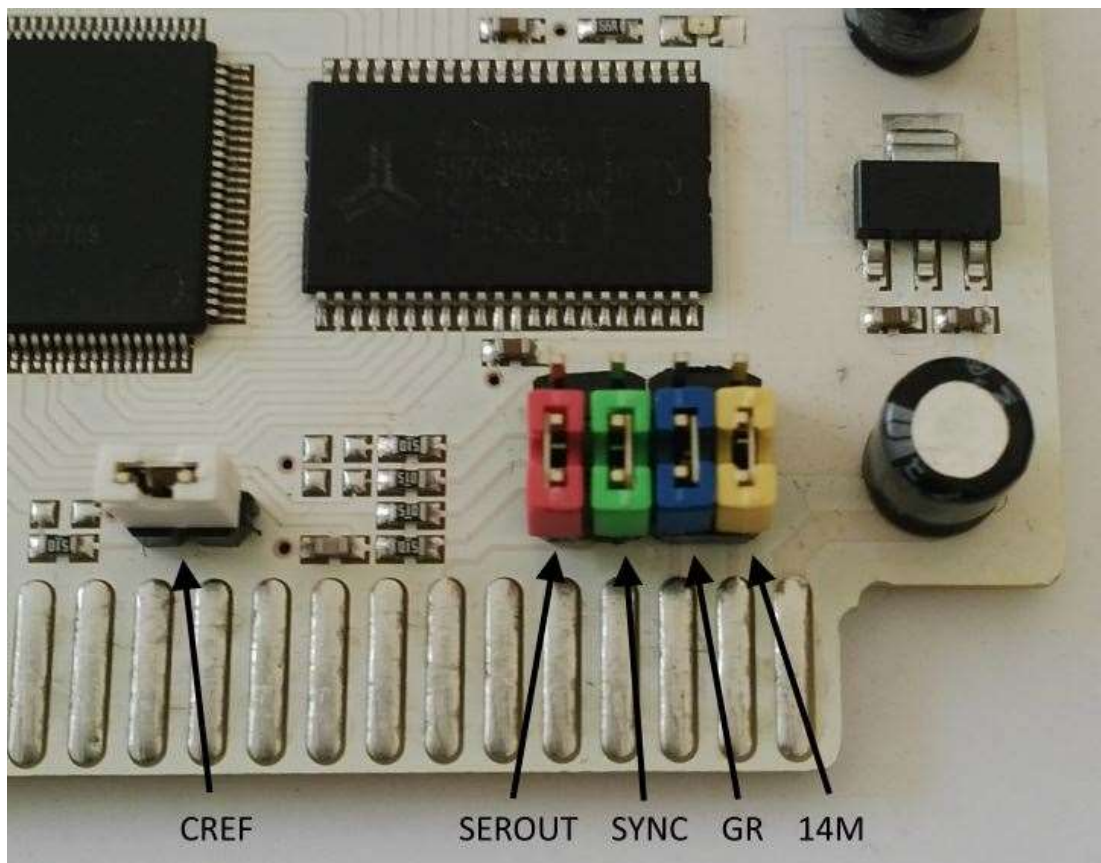

With the jumpers in the bottom position (jumpers between pins 2 and 3) the signals are assumed to be present on the SLOT connector. If you remove the jumper, the centre pin for each column (pin 2) needs to be connected to the jumper wire of the same colour. On the other end of those jumper wires is a clip, which in turn needs to be connected to the appropriate pins of the relevant integrated circuits on the motherboard.

4 Way Jumper Block Pin Identification

1	○	○	○	○
2	○	○	○	○
3	○	○	○	○
	SEROUT	SYNC	GR	14M

If the CREF signal is not present on SLOT 7, you will need to remove the CREF jumper and connect a jumper wire to the left hand pin (pin 1) of the CREF jumper block. Connect the other end (with the clip) to the 74S02 Pin 12 located at position B8. However CREF should be available on all Apple IIe slots.

Connect SEROUT from the centre pin (pin 2 of the jumper block), Red wire, to the IC S10 (as in 74S10, sometimes they use a 74LS10) pin 3

NTSC: Board coordinate C5

PAL: Board coordinate D12

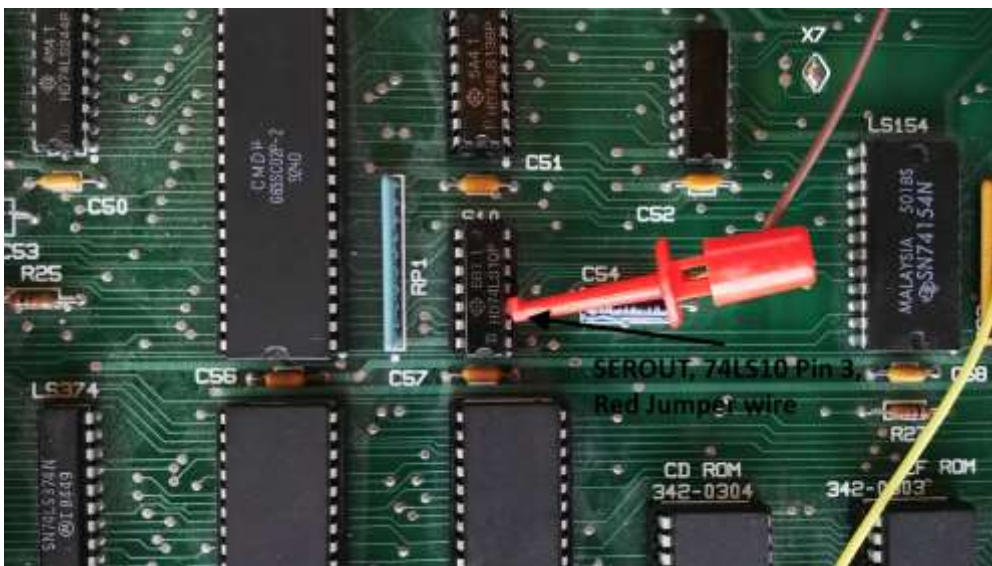

NTSC: Connect GR from the centre pin (pin 2 of the jumper block), Blue wire to the IC IOU (40 pin DIP, P/N 344-0020) pin 2 (board coordinate D5).

PAL: Connect GR from the centre pin (pin 2 of the jumper block), Blue wire to the IC IOU (40 pin DIP, P/N 344-0022) pin 2 (board coordinate C8).



Connect 14M from the centre pin (pin 2 of the jumper block), Yellow wire to the IC LS166 (as in 74LS166) pin 7

NTSC: Board coordinate F5

PAL: Board coordinate C13



DIP Package Numbering

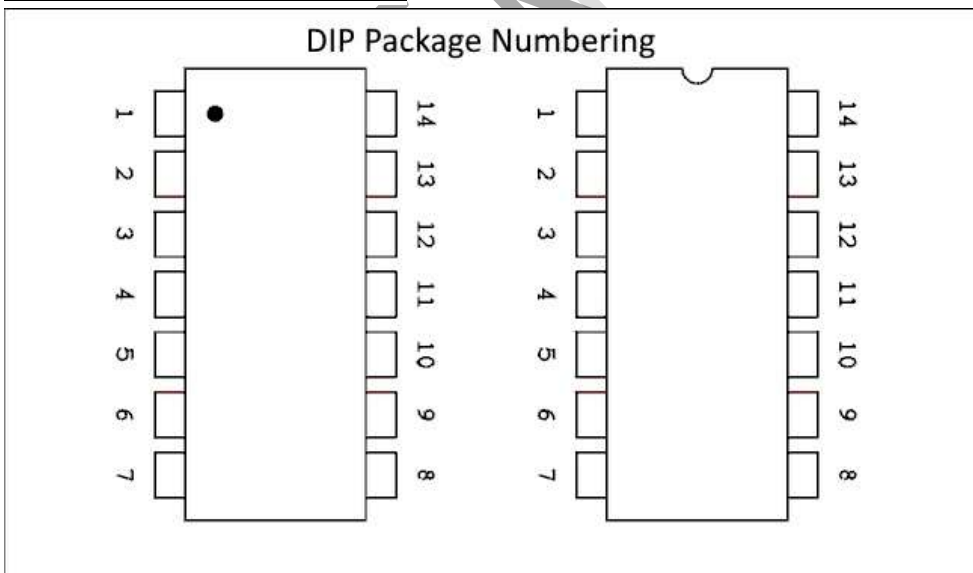

Installing AIIVGAS into an Apple IIe (standard or enhanced) – Slots 1 – 6

If you are reading this section, you have decided to install AIIVGAS into your Apple IIe into a slot other than SLOT 7. I would recommend reconsidering this decision, as you will need to install all 5 jumper wires if you use any slot other than slot 7. However there may be good reasons why you have made this decision. One might be you have a disk II controller in slot 6 and perhaps a SCSI card in slot 7, the higher slot number has a higher boot priority. In this case you want the SCSI hard drive to boot before the disk II. For whatever reason, you have selected another slot. Let's use slot 5 for this example, although the following procedure is relevant for all slots other than slot 7.

As slots 1-6 have no video signal support, you will need to install all 5 jumper wires. Follow the full procedure for a SLOT 7 install and then continue the install from here.

Connect SEROUT from the centre pin (pin 2 of the jumper block), Red wire, to the IC S10 (as in 74S10, sometimes they use a 74LS10) pin 3

NTSC: Board coordinate C5

PAL: Board coordinate D12

SYNC: Remove the Green jumper (position 2 of the 4 way jumper block). Connect the Green jumper wire to position 2 (centre pin). Connect the other end of the jumper wire (with the clip) to

NTSC: IC IOU (40 pin DIP, P/N 344-0020) pin 39 (board coordinate D5).

PAL: IC IOU (40 pin DIP, P/N 344-0022) pin 39 (board coordinate C8).

CREF: Remove the White jumper (single jumper in the middle of the slot connector). Connect the White wire to the left hand pin (pin 1) of the CREF jumper block. Connect the other end (with the clip) to 74S02 Pin 12

NTSC: Board coordinate C10

PAL: Board coordinate B8

GR: Connect GR from the centre pin (pin 2 of the jumper block), Blue wire to

NTSC: IC IOU (40 pin DIP, P/N 344-0020) pin 2 (board coordinate D5).

PAL: IC IOU (40 pin DIP, P/N 344-0022) pin 2 (board coordinate C8).

Connect 14M from the centre pin (pin 2 of the jumper block), Yellow wire to the IC LS166 (as in 74LS166) pin 7

NTSC: Bboard coordinate F5

PAL: Board coordinate C13

Setting the default video mode

Default Mode, DIP Switch Settings							
DIP SW				MODE	SCANLINE	COMPUTER	
4	3	2	1				
OFF	on	on	on	COLOR	OFF	Apple II	
	on	on	off	SHADE OF GREEN			
	on	off	on	MONO GREEN			
	on	off	off	MONO WHITE			
	off	on	on	COLOR	ON		
	off	on	off	SHADE OF GREEN			
	off	off	on	MONO GREEN			
	off	off	off	MONO WHITE			
ON	on	on	on	COLOR	OFF	Apple //e	
	on	on	off	SHADE OF GREEN			
	on	off	on	MONO GREEN			
	on	off	off	MONO WHITE			
	off	on	on	COLOR	ON		
	off	on	off	SHADE OF GREEN			
	off	off	on	MONO GREEN			
	off	off	off	MONO WHITE			

VGA Port Pinout

Pin	Name	Dir	Description
1	RED	OUT	Red Video (75 ohm, 0.7 V p-p)
2	GREEN	OUT	Green Video (75 ohm, 0.7 V p-p)
3	BLUE	OUT	Blue Video (75 ohm, 0.7 V p-p)
4	ID2	IN	Monitor ID Bit 2
5	GND	-----	Ground
6	RGND	-----	Red Ground
7	GGND	-----	Green Ground
8	BGND	-----	Blue Ground
9	KEY	-	Key (No pin)
10	SGND	-----	Sync Ground
11	ID0	IN	Monitor ID Bit 0 GND=Color, NC=Mono
12	ID1 or SDA	IN	Monitor ID Bit 1 NC=Color, GND=Mono Some systems only uses ID0 for monitor ID
13	HSYNC or CSYNC	OUT	Horizontal Sync (or Composite Sync)
14	VSNC	OUT	Vertical Sync
15	ID3 or SCL	IN	Monitor ID Bit 3

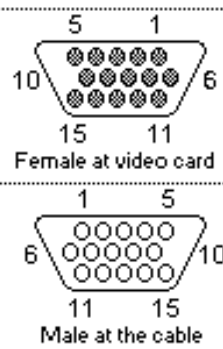

Troubleshooting

AIIVGAS can be complex to setup, but once configured is simple to use. It draws its power from the Apple II peripheral connector (slot). It is worth taking the time to research and identify the model, revision and video format of your Apple II. If you choose to install AIIVGAS in a slot other than slot 7, additional research and effort will be required to configure the jumper blocks and jumper wires. If the video is not as you expected, keep pressing the mode button until you see the image style you desire.

If you do not get any video signal to your VGA monitor, you can do some basic checks.

*Make sure the Apple II/II Plus/IIe is plugged in and switched on.
Do you get composite video out via the composite video port on the Apple II/IIe?
Is your VGA monitor plugged in and switched on?
Is your VGA monitor capable of 720x480 resolution?
Test the VGA monitor with another video source, i.e. a Mac or a PC.*

Frequently Asked Questions

Q. Who makes the AIIVGAS adapter?

A. The adapter was designed and built by Plamen from a2heaven.com. This includes the software/firmware, circuit design and the PCB.

Q. Can I use AIIVGAS on other computers?

A. Quite possibly yes, the Apple II/II+ was cloned, both officially and unofficially. The problem will be identifying the correct locations for the relevant signals required by the AIIVGAS board. AIIVGAS was designed exclusively for the Apple II/IIe series of computers, but may work in other Apple II/II+/IIe clones.

Q. My Pineapple, Apple II clone has identical slots and runs the same Apple II software, will AIIVGAS work with that machine?

A. Almost certainly YES, many Taiwanese clones were exact copies of the Apple II machines, consequently the required video signals can be found in the same locations as a genuine Apple II. However you use the AIIVGAS board in these machines at your own risk. Lack of documentation or subtle changes to the design, could damage the AIIVGAS or your main logic board if you get the signal locations wrong!

Q. How much does the A2VGA adapter cost?

A. At the time of writing this document (Late July 2016), the price was US\$85.00 which includes shipping to anywhere on the planet.

Q. I can't get Double HIRES on my Apple II/Apple II+?

A. AIIVGAS does not add video modes, it merely converts the Apple II video signal to VGA compatible signals. In the case of the Apple II/II+ this video mode is not supported as this was added in later model Apple IIe machines.

Q. I can't get Double HIRES on my Apple IIe but your guide says it is supported?

A. AIIVGAS does not add video modes, it merely converts the Apple II video signal to VGA compatible signals. In the case of the Apple IIe, very early versions of the Apple IIe (Rev A main board) do not support this mode. It could also be that you have not installed the 80-Column or extended 80-Column card into the Auxiliary slot.

Appendix A

Apple II Rev 0 Main Board

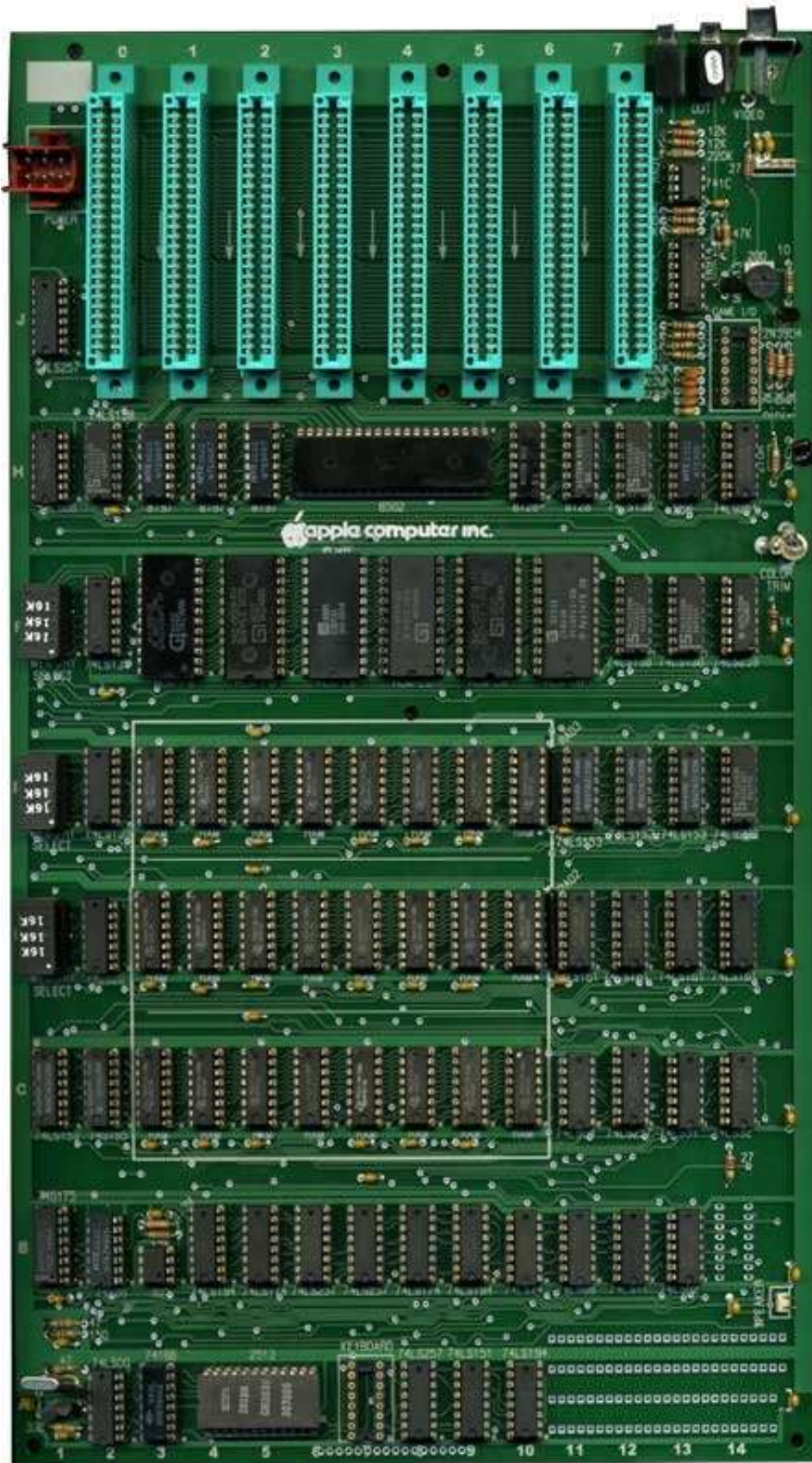

Apple II Rev 1 Main Board

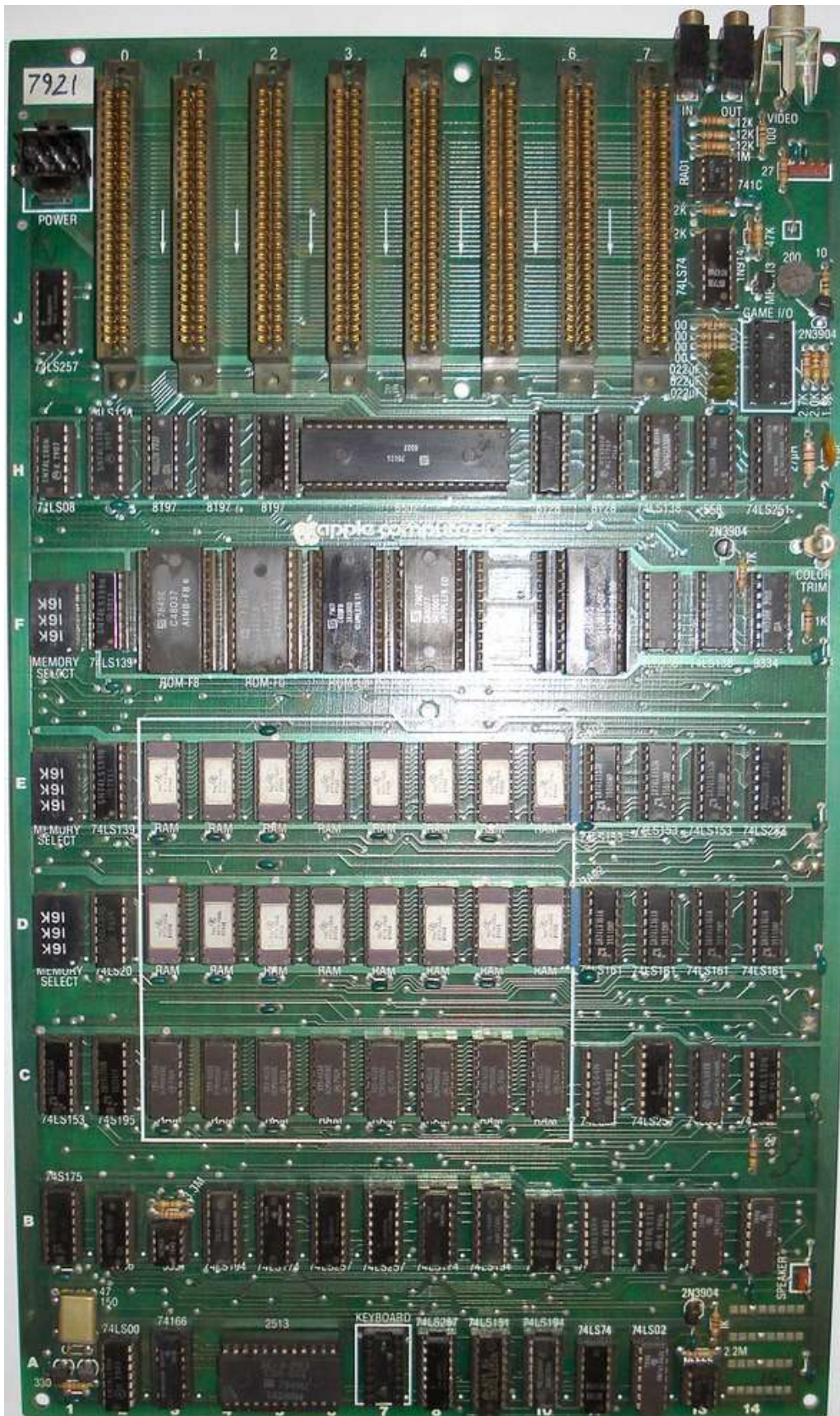

Apple II Rev 2/3 Main Board

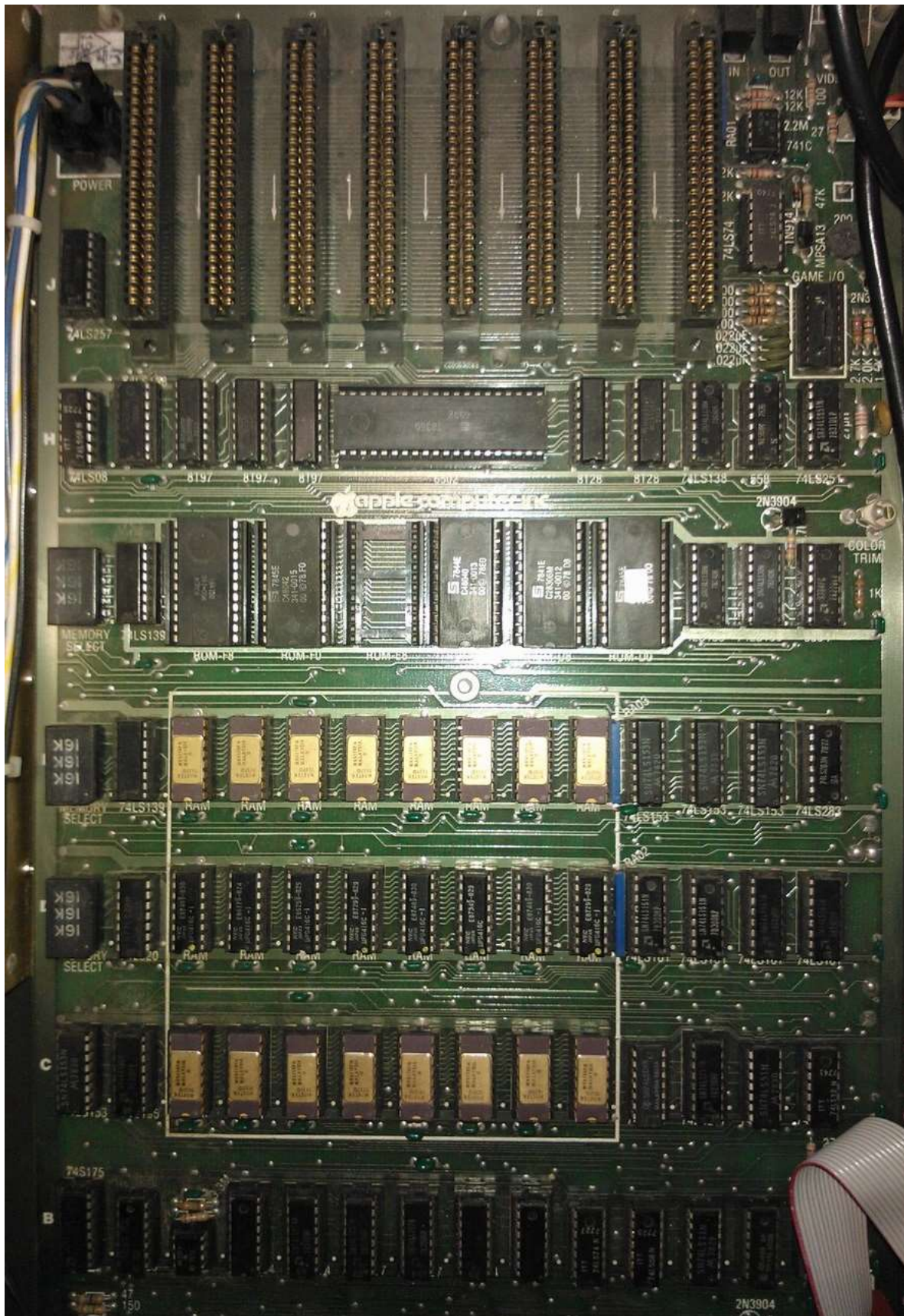

Apple II Rev 4 Main Board

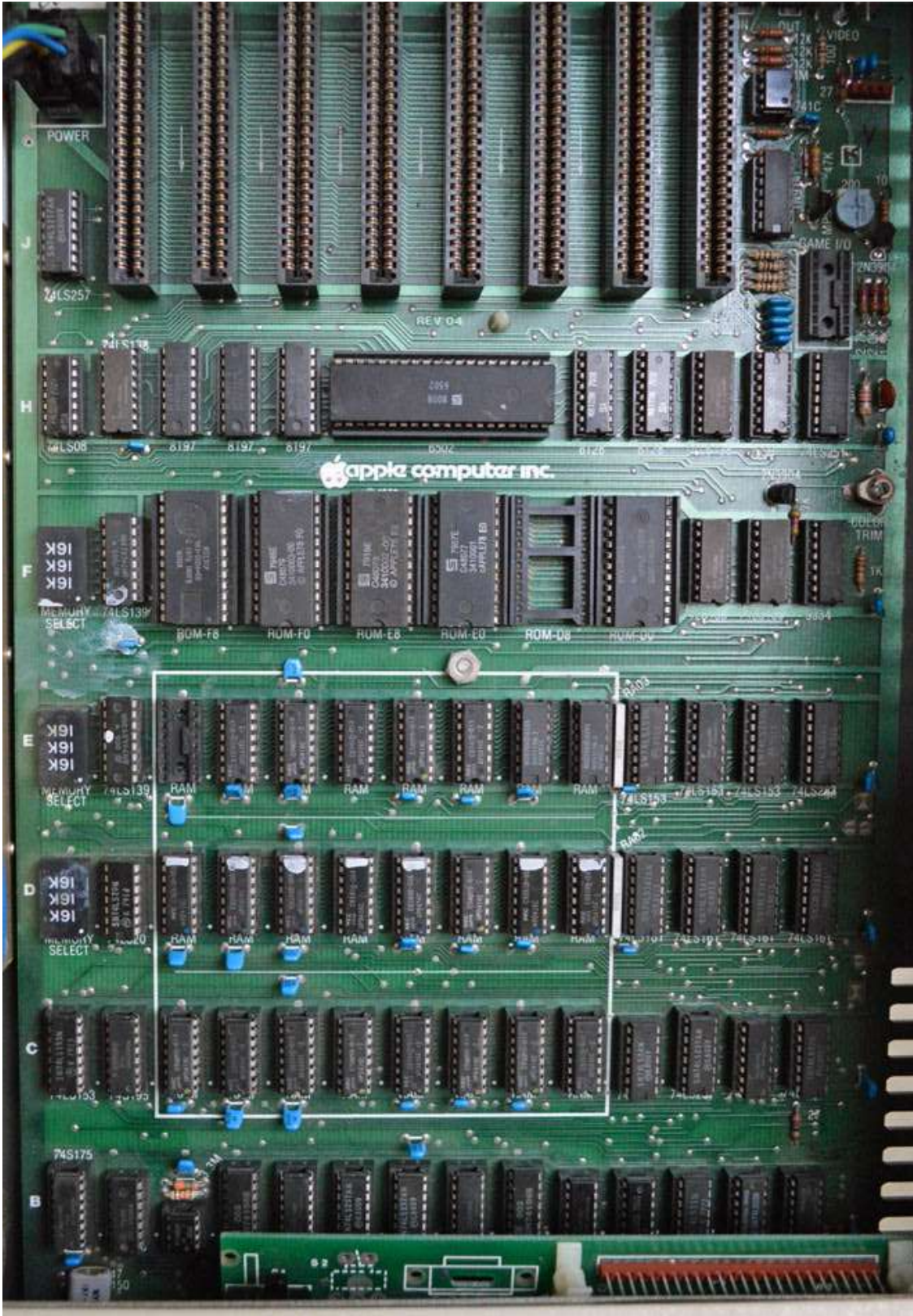

Apple II Rev RFI Main Board



Apple II RFI Board layout

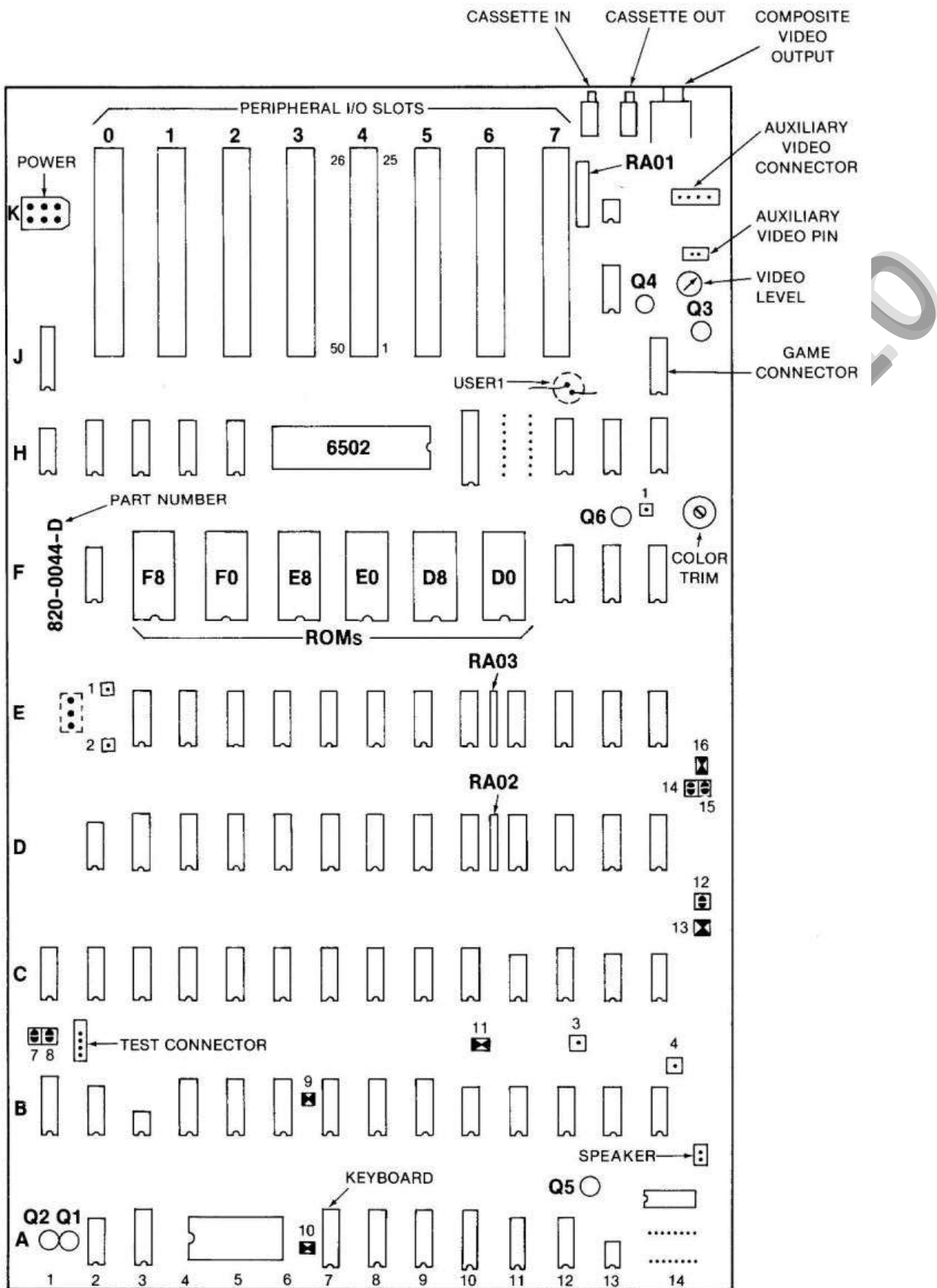

Whilst the diagram above is for the RFI board layout, the positions of most ICs are the same for all Apple II revisions.

Apple IIe International NTSC Main Board

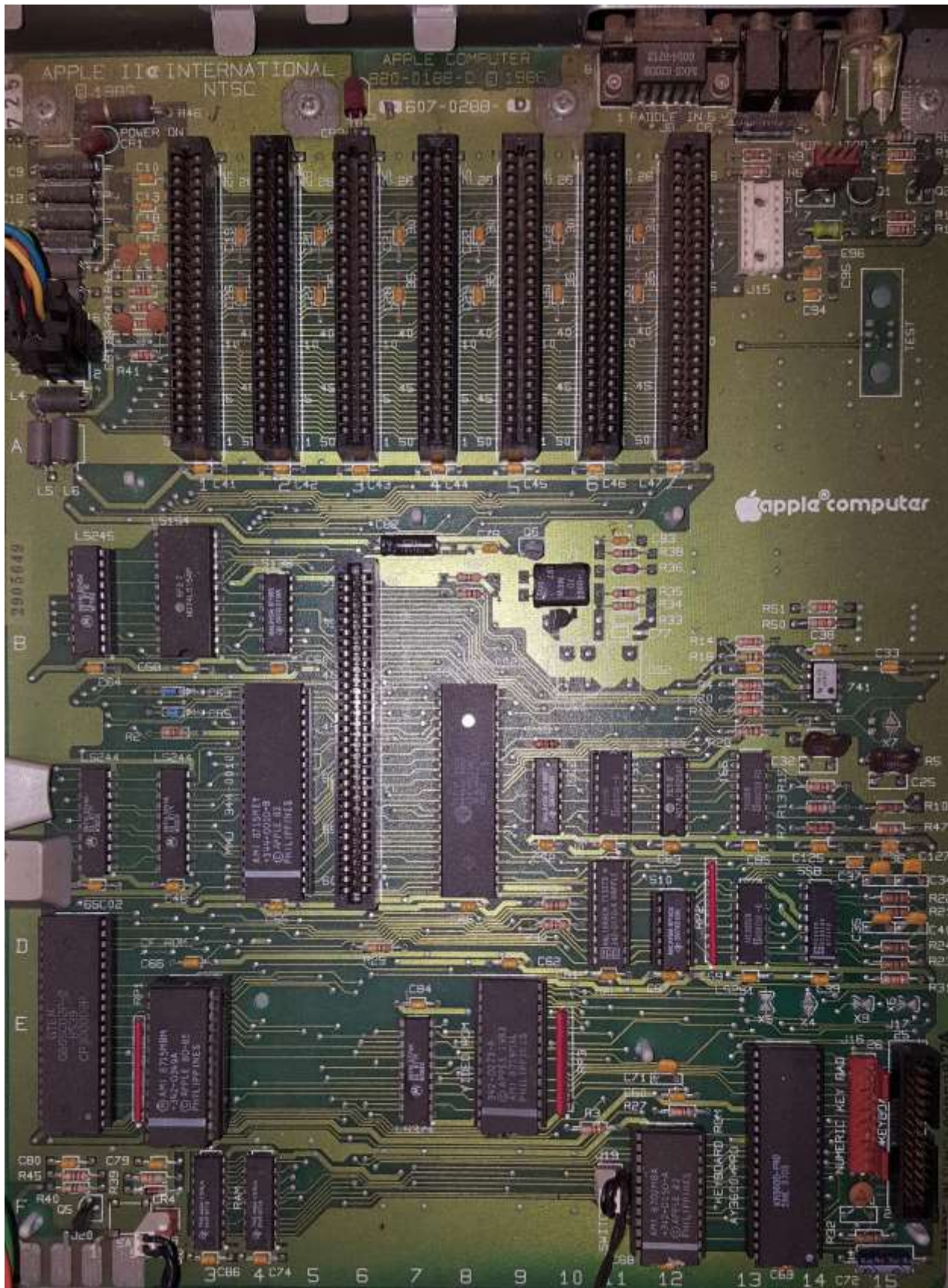

Where to find further help

Phone: +359 888 810 993

Email: info@a2heaven.com

Facebook: <https://www.facebook.com/Apple-IIc-VGA-177260632607299>

About a2heaven.com

A2Heaven is a small company that implements new technology for use on vintage computer hardware.

About this User Guide

This User Guide was written by Martin Crockett and Plamen Vaysilov, Version 1.10, July 15th 2016, Pre Beta release for K-Fest 2016.

Warranty

A2Heaven.com warrants the Apple II VGA scaler for 6 months or 180 days, from the date of purchase. This warranty assumes the Apple II VGA scaler has not been tampered with in any way. The necessary anti-static precautions need to be observed when installing and configuring the Apple II VGA scaler.

Some other a2heaven products

Apple SAM (Semi Automatic Mouth): A high quality speech synthesizer.

Mockingboard-T: A sound card for all Apple II computers, no speech chip.

ALF MC1 Clone: A music synthesizer that allows you to program music into your apple using standard musical notation.

Ramworks III Clone: Comes with 64k, expandable to 1M or 3M with 2M expander board. For apple IIe only.

Ramworks III VGA adapter: Option board for the Ramworks III Clone. Generates VGA compatible video, only for NTSC, 60Hz Apple IIe.

dClock: Clock option for Ram Express or Apple IIc Memory Expansion card.

Senior PROM IIe: Add debugging commands to your Apple IIe, such as entry to System monitor at any time, copy memory to and from auxiliary memory, plus much more.

Trak Star II: Gives constant digital read of any 5.25" Apple II drive, great for seeing what that pesky protection scheme is up to. Supports full, half and quarter track movement.

SDFloppy II: Store up to 16 .DSK images on an SD card, replaces 5.15" floppy drive.

A2VGA Adapter: Connect a VGA monitor (LCD or CRT) to your Apple IIc or Apple IIc+ computer. Works with both PAL and NTSC versions.

RAMFactor 8M: A 100% compatible, modern day equivalent of the Applied Engineering RAMFactor card with 8M of battery backed ram, plus LED display showing ram bank in use.

RAM Works 8M: A 100% compatible, modern day equivalent of the Applied Engineering RAMWorks III card for the Apple IIe. Comes with 8Meg of battery backed Auxiliary RAM and 80 column mode support, plugs into the Apple IIe AUX slot.

AppleIIgsxROM: Upgrade your revision ROM0 Apple IIgs to ROM1, Engineering Alpha 2.0, ROMBF or any custom ROM, configurable via DIP switches.