

COMPUTER: COMMODORE 16™

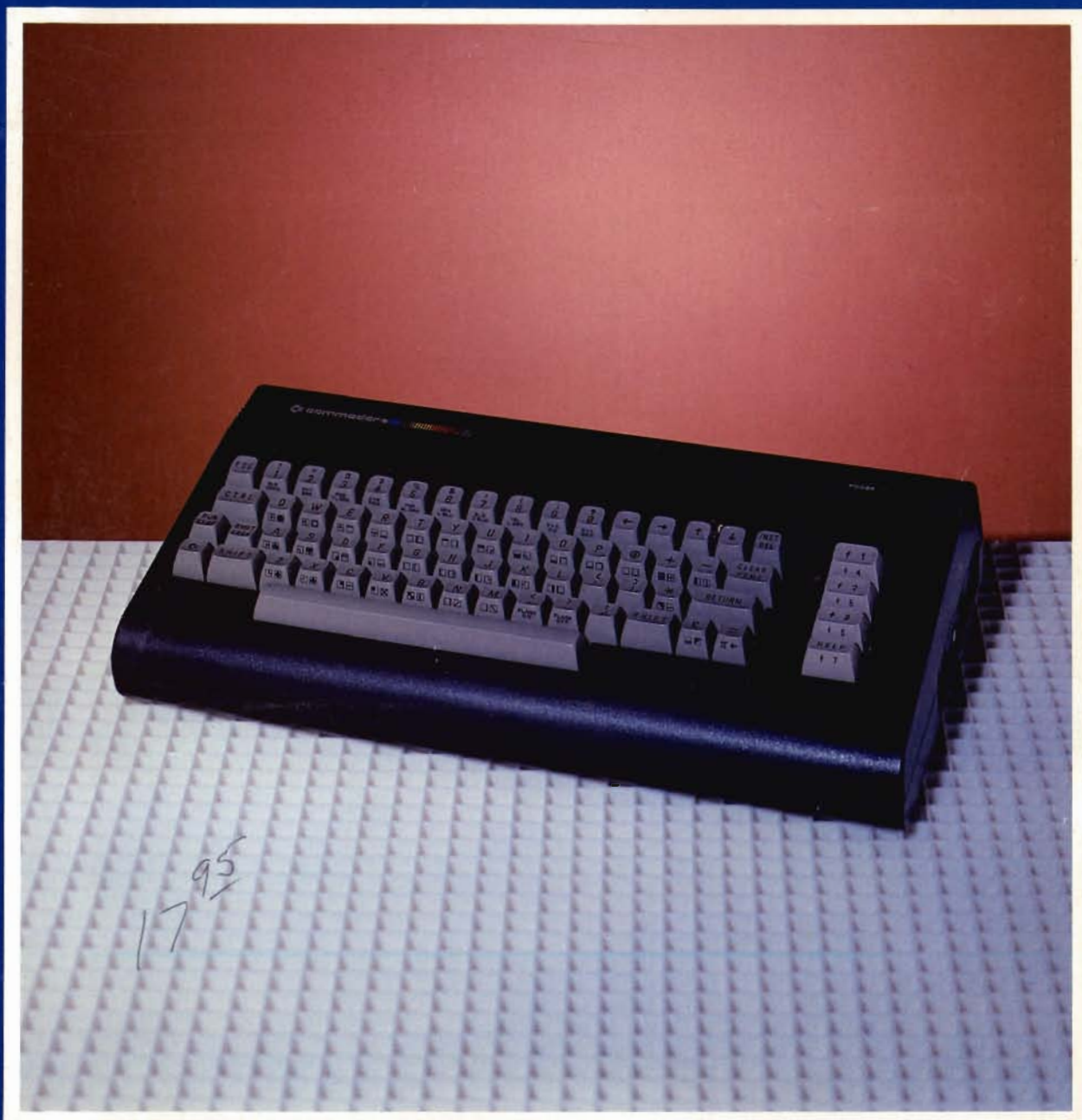

TECHNICAL SERVICE DATA FOR YOUR COMPUTER

PRELIMINARY SERVICE CHECKS

This data provides the user with a time saving service tool which is designed for quick isolation and repair of Computer malfunctions.

Check all interconnecting cables for good connection and hookup before making service checks.

Disconnect all external peripherals from the Computer to eliminate possible malfunctions.

Replacement or repair of the Main Board, Keyboard or connectors may be necessary after the malfunction has been isolated.

GENERAL OPERATING INSTRUCTIONS

POWER UP

The Computer will come up ready to program in Commodore Basic when turned On. For instructions on loading and saving programs see "Cassette or Disk Operation" section of the General Operating Instructions. To run a program when loaded, type RUN and press the RETURN key. To stop a program in progress, press the RUN/STOP key. A program can also be stopped by pressing RESET button on the right side of the Computer but the program will also be lost.

MONITOR PROGRAM

The Computer has a built-in Monitor Program which enables the user to program in machine language. To go from Basic to Monitor mode, hold down the RUN/STOP key and press the RESET key. The word Monitor will appear at the top left of the display screen. To go back to Basic from Monitor mode, type X and press the RETURN key.

CASSETTE OPERATION

Plug a Datassette cassette recorder onto the six pin edge Connector CN3 at the rear of the Computer. Note: A standard tape recorder will not work on the Commodore Model 16. To load a program type LOAD, press the RETURN key and follow the instructions displayed on the Monitor screen. To save a program, type SAVE, press the RETURN key and follow the instructions displayed on the screen.

DISK OPERATION

Connect Disk Drive unit to the Serial I/O Port (Connector CN7) located at the rear of the Computer. Carefully insert the diskette so that the label on the diskette is facing up and the notch on the diskette is on the left side. Once the disk has been inserted, close the protective gate by pushing down on the gate lever. To load a program from the diskette, type LOAD "PROGRAM NAME", 8 and press the RETURN key. To save a program, type SAVE "PROGRAM NAME", 8 and press the RETURN key.

NOTE: The number 8 is the Device number for which the Disk Drive is normally set up. The device number can be any number from 8 to 11 depending on how the device number jumpers are connected in the Disk Drive.

Datassette is a trademark of Commodore Business Machines, Inc.

SAMS™ **Howard W. Sams & Co., Inc.**
4300 West 62nd Street, P.O. Box 7092, Indianapolis, Indiana 46206 U.S.A.

The listing of any available replacement part herein does not constitute in any case a recommendation, warranty or guaranty by Howard W. Sams & Co., Inc., as to the quality and suitability of such replacement part. The numbers of these parts have been compiled from information furnished to Howard W. Sams & Co., Inc., by the manufacturers of the particular type of replacement part listed.

Reproduction or use, without express permission, of editorial or pictorial content, in any manner, is prohibited. No patent liability is assumed with respect to the use of the information contained herein.

© 1984 Howard W. Sams & Co., Inc.

4300 West 62nd Street, P.O. Box 7092, Indianapolis, Indiana 46206 U.S.A.

Printed in U.S. of America. 84CC14937

DATE 12-84

PRELIMINARY SERVICE CHECKS (Continued)

PRELIMINARY SERVICE CHECKS (Continued)

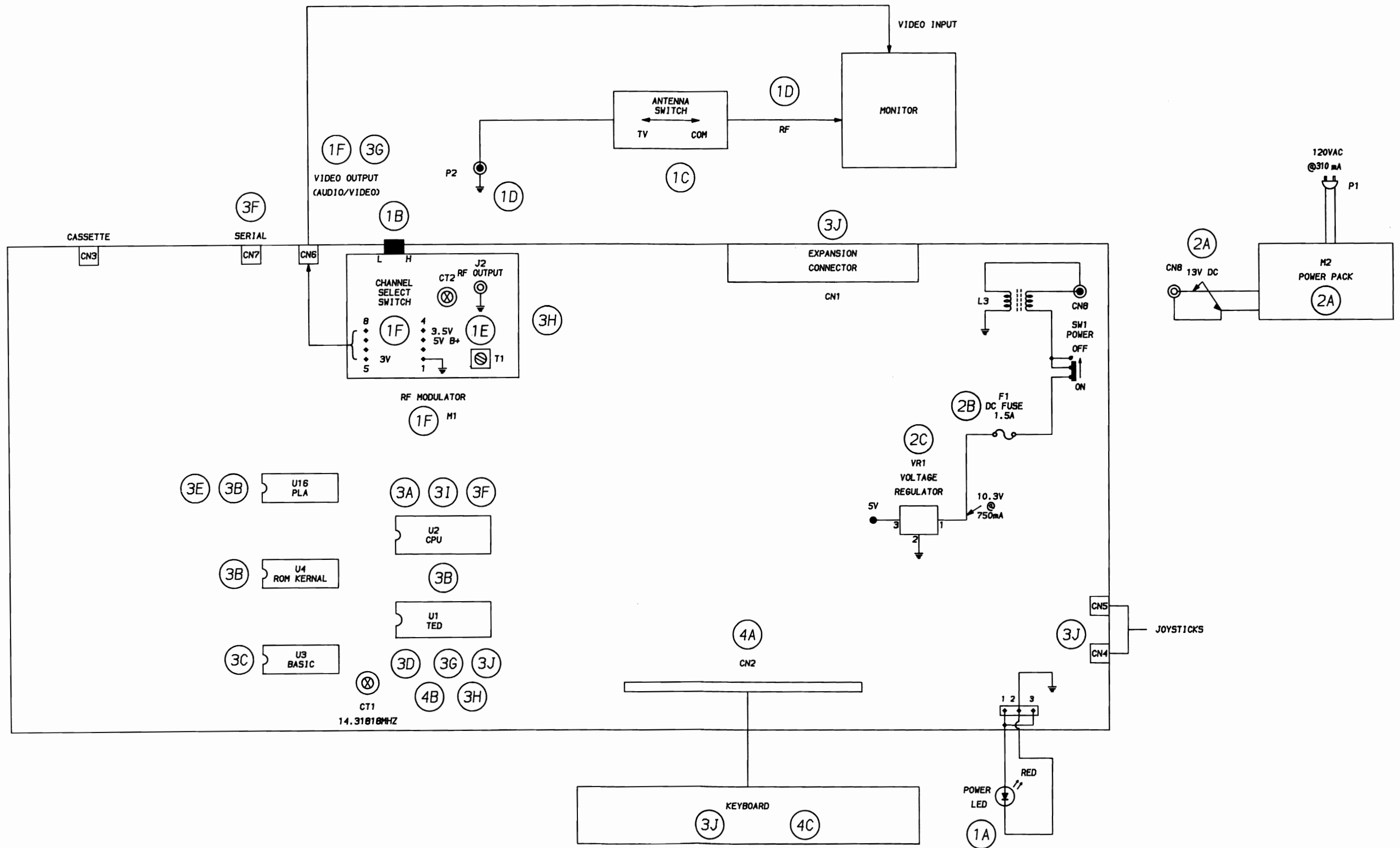

COMMODORE
MODEL 16

PRELIMINARY SERVICE CHECKS (Continued)

SERVICE CHECKS

SEE INTERCONNECTING DIAGRAM, PLACEMENT CHART, AND PHOTOS TO MATCH THE NUMBER IN THE CIRCLES WITH THOSE IN THE FOLLOWING DATA FOR SERVICE CHECKS TO BE PERFORMED.

① RF MODULATOR CHECK (SNOWY SCREEN)

- (A) Turn On Computer and verify the Power LED indicator is lit. If the power LED indicator is not lit, see "Power Supply Check" section of Preliminary Service Checks.
- (B) Verify the Channel Select Switch of the RF Modulator is set on the same channel as the Monitor channel selector.
- (C) Verify the Antenna Switch is in Computer position.
- (D) Check for bad connections and improper hookup at the Monitor or at the Computer.
- (E) Check the adjustment of the RF Frequency Transformer (T1) and the Video Level Trimmer (CT2) (See Miscellaneous Adjustments).
- (F) To isolate the problem area, connect a Monitor to the Video Output Connector (CN6) instead of the RF Output Jack (J2). If the video returns and the voltages on pins 3, 4 and 5 of the RF Modulator (M1) are correct, substitute the Modulator M1. If the video does not return, see "Main Board" section of Preliminary Service Checks.
- (E) If the function keys are inoperative, check PLA IC (U16) by substitution.
- (F) Disk Drive or Printer do not function properly. Check for bad connections at Connector CN7 and check CPU IC (U2) by substitution.
- (G) If Video Output (Audio/Video) Connector (CN6) is inoperative, check the TED IC (U1) by substitution.
- (H) If TED IC (U1) is normal, check the RF Modulator (M1) by substitution.
- (I) Datassette does not operate, check the CPU IC (U2) by substitution.
- (J) The Joysticks, Keyboard, or Expansion Connector (CN1) do not function, check TED IC (U1) by substitution.

② POWER SUPPLY CHECK

- (A) Connect the Power Pack (M2) to 120V AC. Disconnect Power Connector CN8 and check for 13VDC at Connector CN8. If the voltage is incorrect or missing, replace Power Pack.
- (B) Check DC Fuse (F1).
- (C) If DC Fuse (F1) is open, check Voltage Regulator IC (VR1) for a short to ground. If IC VR1 checks good, replace Fuse F1.

③ MAIN BOARD

- (A) If the power supply checks normal and the Computer does not function when powered, check the CPU IC (U2) by substitution.
- (B) If CPU IC (U2) is good and the Computer does not function, check ROM IC (U4), PLA IC (U16) and TED IC (U1) by substitution.
- (C) If Computer functions but not in the Basic Ready mode, check Basic IC (U3) by substitution.
- (D) If Computer does not function and the Monitor screen remains black, check TED IC (U1) by substitution.

④ KEYBOARD DEAD

- (A) Check the Keyboard Connector (CN2) for good connections.
- (B) Check the TED IC (U1) by substitution.
- (C) If one key operates erratically, clean the switch contacts with a contact cleaner.

MISCELLANEOUS ADJUSTMENTS

Alignment Tools **GC Electronics**
T1 5000, 5009, 8276

CRYSTAL OSCILLATOR

Connect a frequency counter to the base of Transistor Q1. Adjust Trimmer Capacitor (CT1) for a frequency of 14.31818MHz.

RF FREQUENCY

Connect the Computer to a TV and set the TV and Computer channel selector switches to the same channel [L(3) or H(4)]. Adjust T1 for the best picture with MINIMUM noise from the TV speaker.

VIDEO LEVEL

Connect the Computer to a TV and set the TV and Computer channel selector switches to the same channel [L(3) or H(4)]. Adjust the Video Level Trimmer Capacitor (CT2) for the best picture on the TV Monitor.

PRELIMINARY SERVICE CHECKS (Continued)

PRELIMINARY SERVICE CHECKS (Continued)

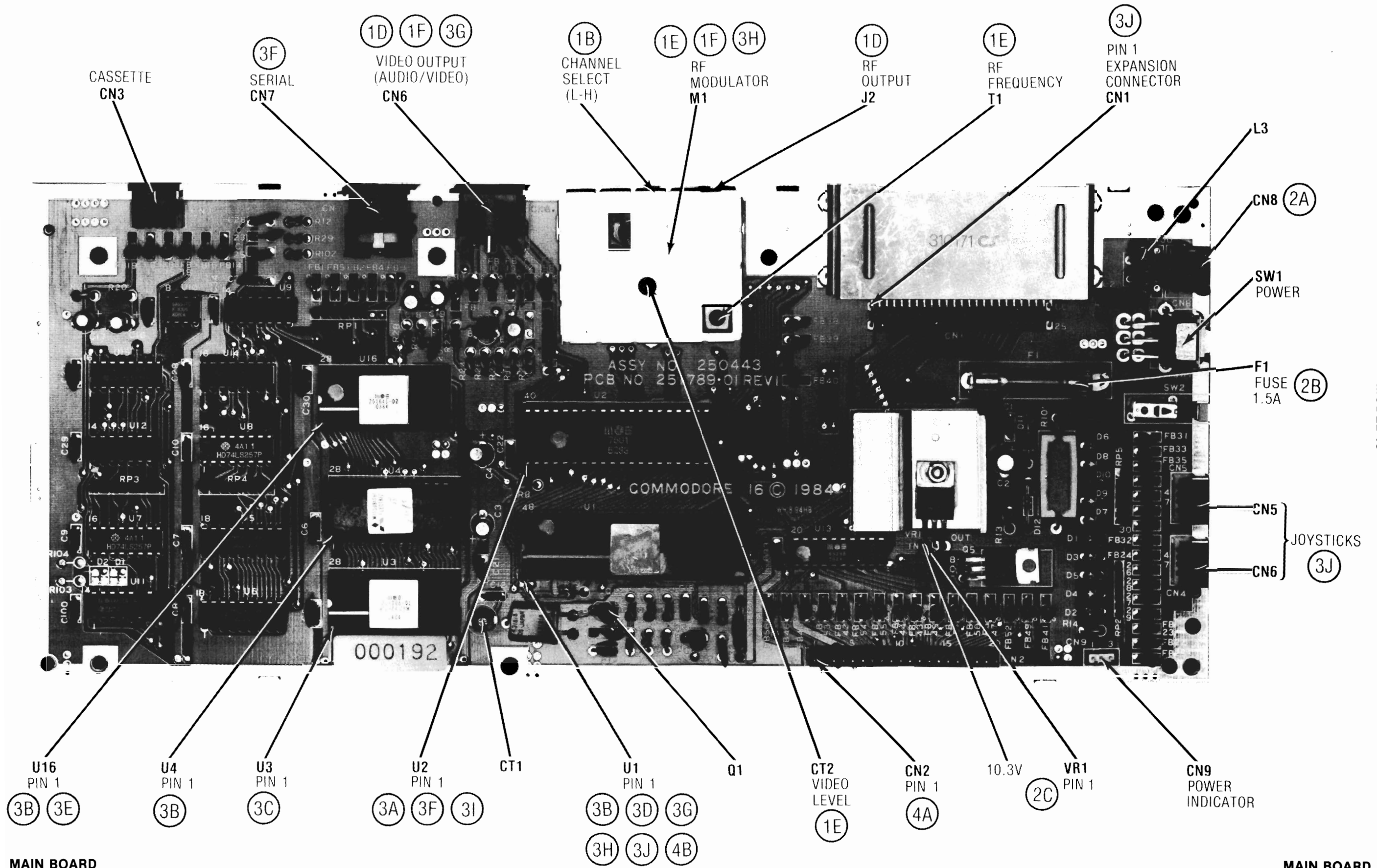

COMMODORE
MODEL 16

PRELIMINARY SERVICE CHECKS (Continued)

TEST EQUIPMENT AND TOOLS

TEST EQUIPMENT

Digital Volt/Ohm Meter
Monitor
Frequency Counter

TOOLS

Phillips Screwdriver
Small Screwdriver
Low Voltage Soldering Iron
Desoldering Equipment
Tuner or Contact Cleaner

REPLACEMENT PARTS

ITEM NO.	PART NO.	DESCRIPTION
CT1	251029-02	Trimmer, Oscillator
F1	903556-18	DC Fuse 1.5A/250V Slow-Blow
LED	900707-03	LED, Power (Red)
L3	251701-01	Line Filter
M1	251844-01	RF Modulator Module (Contains Channel Selector Switch Hi-Low)
M2	251539-01	Power Pack, AC
Q1	902693-01	Transistor, Oscillator, 2SC1815
SW1	251587-01	Switch, Power
T1		Transformer, RF Frequency
VR1	901527-02	IC, Regulator, 7805
U1	251535-01	IC, TED, MOS7360R7
U1	251535-02	IC, TED, 8360R1
U2	251536-01	IC, CPU, MOS7501
U3	318006-01	IC, BASIC ROM, 23128
U4		IC, ROM, MBM27128-25TED-K
	318005-03	IC, ROM, 23128
U16		IC, PLA, MOS251641-02
	251641-02	IC, PLA, 7700-010

DISASSEMBLY INSTRUCTIONS

CABINET TOP REMOVAL

Remove three screws from cabinet bottom. Carefully lift cabinet top and Keyboard from cabinet bottom. Disconnect the Keyboard connector and the Power Indicator connector from the Main Board.

MAIN BOARD REMOVAL

Remove eight screws holding Shield and Main Board to cabinet bottom. The Shield and Main Board may now be removed from cabinet bottom.

KEYBOARD REMOVAL

Remove eight screws holding Keyboard to cabinet top. Lift Keyboard assembly from cabinet top.

See Page II

PRELIMINARY SERVICE CHECKS (Continued)

SAFETY PRECAUTIONS

1. Use an isolation transformer for servicing.
2. Maintain AC line voltage at rated input.
3. Remove AC power from the Computer before servicing or installing electrostatically sensitive devices. Examples of typical ES devices are integrated circuits and semiconductor "chip" components.
4. Use extreme caution when handling the printed circuit boards. Some semiconductor devices can be damaged easily by static electricity. Drain off any electrostatic charge on your body by touching a known earth ground. Wear a commercially available discharging wrist strap device. This should be removed prior to applying power to the unit under test.
5. Use a grounded-tip, low voltage soldering iron.
6. Use an isolation (times 10) probe on scope.
7. Do not remove or install board, floppy disk drives, printers, or other peripherals with power On.
8. Do not use freon-propelled sprays. These can generate electrical charges sufficient to damage semiconductor devices.
9. The Computer cabinet is equipped with vents to prevent heat build-up. Never block, cover, or obstruct these vents.
10. Instructions should be given, especially to children, that objects should not be dropped or pushed into the vents of the cabinet. This could cause shock or equipment damage.
11. Never expose the Computer to water. If exposed to water, turn the unit off. Do not place the Computer near possible water sources.
12. Never leave the Computer unattended or plugged into the AC outlet for long periods of time. Remove AC plug from AC outlet during lightning storms.
13. Never use liquids or aerosols directly on the Computer. Spray on cloth and then apply to the Computer cabinet. Make sure the Computer is disconnected from the AC power line.

COMMODORE
MODEL 16
CC8



CC8
COMMODORE
MODEL 16

MODEL 16

SAFETY PRECAUTIONS

See Page 17.

PRELIMINARY SERVICE CHECKS

ENCLOSED

INDEX

	Page		Page
Block Diagram	16	Photos	
Disassembly Instructions	4	Main Board	5,6,11,12
General Operating Instructions	4	Safety Precautions	17
GridTrace Location Guide		Schematics	
Main Board	6,11	IC Pinouts & Terminal Guides	3
Line Definitions	17	Main Board	2
Logic Chart	14	Notes	15
Miscellaneous Adjustments	4	Troubleshooting	13
Parts List	7 thru 10		



Howard W. Sams & Co., Inc.

4300 West 62nd Street, P.O. Box 7092, Indianapolis, Indiana 46206 U.S.A.

The listing of any available replacement part herein does not constitute in any case a recommendation, warranty or guaranty by Howard W. Sams & Co., Inc., as to the quality and suitability of such replacement part. The numbers of these parts have been compiled from information furnished to Howard W. Sams & Co., Inc., by the manufacturers of the particular type of replacement part listed.

Reproduction or use, without express permission, of editorial or pictorial content, in any manner, is prohibited. No patent liability is assumed with respect to the use of the information contained herein.

© 1984 Howard W. Sams & Co., Inc.

4300 West 62nd Street, P.O. Box 7092, Indianapolis, Indiana 46206 U.S.A.

Printed in U.S. of America.

84CC14937

DATE 12-84

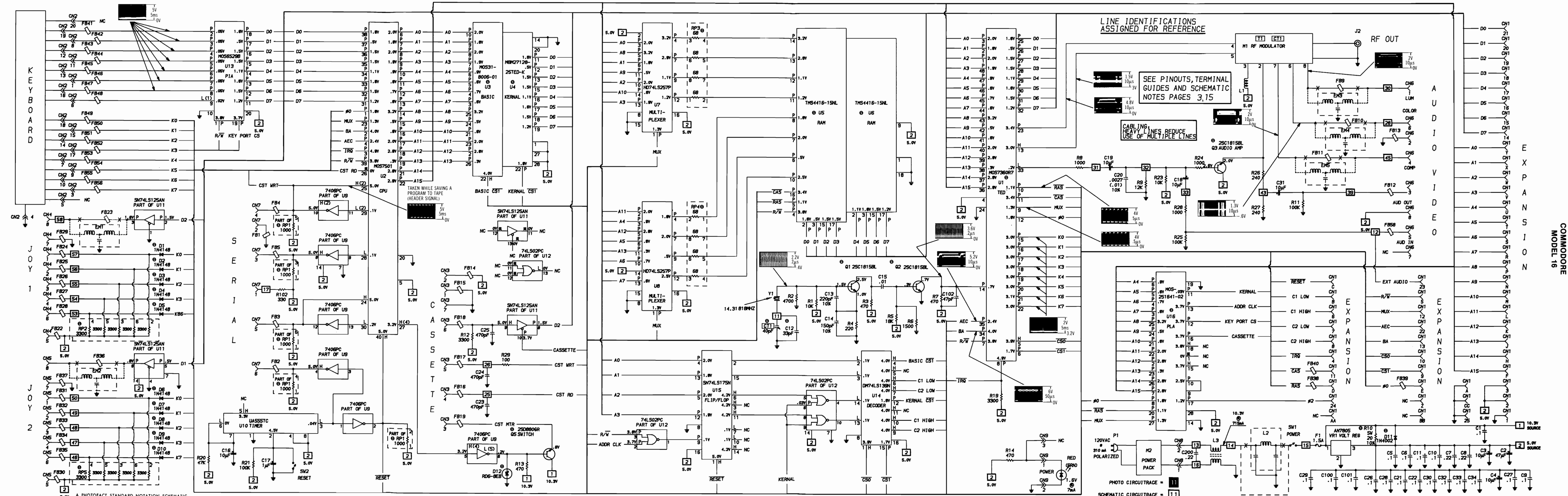

LINE IDENTIFICATIONS ASSIGNED FOR REFERENCE

Line	Component	Pin	Signal
A0	RAM	14	RAM
A1	RAM	13	RAM
A2	RAM	12	RAM
A3	RAM	11	RAM
A4	RAM	10	RAM
A5	RAM	9	RAM
A6	RAM	8	RAM
A7	RAM	7	RAM
A8	RAM	6	RAM
A9	RAM	5	RAM
A10	RAM	4	RAM
A11	RAM	3	RAM
A12	RAM	2	RAM
A13	RAM	1	RAM
A14	RAM	0	RAM
A15	RAM	15	RAM
A0	RAM	16	RAM
A1	RAM	17	RAM
A2	RAM	18	RAM
A3	RAM	19	RAM
A4	RAM	20	RAM
A5	RAM	21	RAM
A6	RAM	22	RAM
A7	RAM	23	RAM
A8	RAM	24	RAM
A9	RAM	25	RAM
A10	RAM	26	RAM
A11	RAM	27	RAM
A12	RAM	28	RAM
A13	RAM	29	RAM
A14	RAM	30	RAM
A15	RAM	31	RAM
A0	RAM	32	RAM
A1	RAM	33	RAM
A2	RAM	34	RAM
A3	RAM	35	RAM
A4	RAM	36	RAM
A5	RAM	37	RAM
A6	RAM	38	RAM
A7	RAM	39	RAM
A8	RAM	40	RAM
A9	RAM	41	RAM
A10	RAM	42	RAM
A11	RAM	43	RAM
A12	RAM	44	RAM
A13	RAM	45	RAM
A14	RAM	46	RAM
A15	RAM	47	RAM
A0	RAM	48	RAM
A1	RAM	49	RAM
A2	RAM	50	RAM
A3	RAM	51	RAM
A4	RAM	52	RAM
A5	RAM	53	RAM
A6	RAM	54	RAM
A7	RAM	55	RAM
A8	RAM	56	RAM
A9	RAM	57	RAM
A10	RAM	58	RAM
A11	RAM	59	RAM
A12	RAM	60	RAM
A13	RAM	61	RAM
A14	RAM	62	RAM
A15	RAM	63	RAM
A0	RAM	64	RAM
A1	RAM	65	RAM
A2	RAM	66	RAM
A3	RAM	67	RAM
A4	RAM	68	RAM
A5	RAM	69	RAM
A6	RAM	70	RAM
A7	RAM	71	RAM
A8	RAM	72	RAM
A9	RAM	73	RAM
A10	RAM	74	RAM
A11	RAM	75	RAM
A12	RAM	76	RAM
A13	RAM	77	RAM
A14	RAM	78	RAM
A15	RAM	79	RAM
A0	RAM	80	RAM
A1	RAM	81	RAM
A2	RAM	82	RAM
A3	RAM	83	RAM
A4	RAM	84	RAM
A5	RAM	85	RAM
A6	RAM	86	RAM
A7	RAM	87	RAM
A8	RAM	88	RAM
A9	RAM	89	RAM
A10	RAM	90	RAM
A11	RAM	91	RAM
A12	RAM	92	RAM
A13	RAM	93	RAM
A14	RAM	94	RAM
A15	RAM	95	RAM
A0	RAM	96	RAM
A1	RAM	97	RAM
A2	RAM	98	RAM
A3	RAM	99	RAM
A4	RAM	100	RAM
A5	RAM	101	RAM
A6	RAM	102	RAM
A7	RAM	103	RAM
A8	RAM	104	RAM
A9	RAM	105	RAM
A10	RAM	106	RAM
A11	RAM	107	RAM
A12	RAM	108	RAM
A13	RAM	109	RAM
A14	RAM	110	RAM
A15	RAM	111	RAM
A0	RAM	112	RAM
A1	RAM	113	RAM
A2	RAM	114	RAM
A3	RAM	115	RAM
A4	RAM	116	RAM
A5	RAM	117	RAM
A6	RAM	118	RAM
A7	RAM	119	RAM
A8	RAM	120	RAM
A9	RAM	121	RAM
A10	RAM	122	RAM
A11	RAM	123	RAM
A12	RAM	124	RAM
A13	RAM	125	RAM
A14	RAM	126	RAM
A15	RAM	127	RAM
A0	RAM	128	RAM
A1	RAM	129	RAM
A2	RAM	130	RAM
A3	RAM	131	RAM
A4	RAM	132	RAM
A5	RAM	133	RAM
A6	RAM	134	RAM
A7	RAM	135	RAM
A8	RAM	136	RAM
A9	RAM	137	RAM
A10	RAM	138	RAM
A11	RAM	139	RAM
A12	RAM	140	RAM
A13	RAM	141	RAM
A14	RAM	142	RAM
A15	RAM	143	RAM
A0	RAM	144	RAM
A1	RAM	145	RAM
A2	RAM	146	RAM
A3	RAM	147	RAM
A4	RAM	148	RAM
A5	RAM	149	RAM
A6	RAM	150	RAM
A7	RAM	151	RAM
A8	RAM	152	RAM
A9	RAM	153	RAM
A10	RAM	154	RAM
A11	RAM	155	RAM
A12	RAM	156	RAM
A13	RAM	157	RAM
A14	RAM	158	RAM
A15	RAM	159	RAM
A0	RAM	160	RAM
A1	RAM	161	RAM
A2	RAM	162	RAM
A3	RAM	163	RAM
A4	RAM	164	RAM
A5	RAM	165	RAM
A6	RAM	166	RAM
A7	RAM	167	RAM
A8	RAM	168	RAM
A9	RAM	169	RAM
A10	RAM	170	RAM
A11	RAM	171	RAM
A12	RAM	172	RAM
A13	RAM	173	RAM
A14	RAM	174	RAM
A15	RAM	175	RAM
A0	RAM	176	RAM
A1	RAM	177	RAM
A2	RAM	178	RAM
A3	RAM	179	RAM
A4	RAM	180	RAM
A5	RAM	181	RAM
A6	RAM	182	RAM
A7	RAM	183	RAM
A8	RAM	184	RAM
A9	RAM	185	RAM
A10	RAM	186	RAM
A11	RAM	187	RAM
A12	RAM	188	RAM
A13	RAM	189	RAM
A14	RAM	190	RAM
A15	RAM	191	RAM
A0	RAM	192	RAM
A1	RAM	193	RAM
A2	RAM	194	RAM
A3	RAM	195	RAM
A4	RAM	196	RAM
A5	RAM	197	RAM
A6	RAM	198	RAM
A7	RAM	199	RAM
A8	RAM	200	RAM
A9	RAM	201	RAM
A10	RAM	202	RAM
A11	RAM	203	RAM
A12	RAM	204	RAM
A13	RAM	205	RAM
A14	RAM	206	RAM
A15	RAM	207	RAM
A0	RAM	208	RAM
A1	RAM	209	RAM
A2	RAM	210	RAM
A3	RAM	211	RAM
A4	RAM	212	RAM
A5	RAM	213	RAM
A6	RAM	214	RAM
A7	RAM	215	RAM
A8	RAM	216	RAM
A9	RAM	217	RAM
A10	RAM	218	RAM
A11	RAM	219	RAM
A12	RAM	220	RAM
A13	RAM	221	RAM
A14	RAM	222	RAM
A15	RAM	223	RAM
A0	RAM	224	RAM
A1	RAM	225	RAM
A2	RAM	226	RAM
A3	RAM	227	RAM
A4	RAM	228	RAM
A5	RAM	229	RAM
A6	RAM	230	RAM
A7	RAM	231	RAM
A8	RAM	232	RAM
A9	RAM	233	RAM
A10	RAM	234	RAM
A11	RAM	235	RAM
A12	RAM	236	RAM
A13	RAM	237	RAM
A14	RAM	238	RAM
A15	RAM	239	RAM
A0	RAM	240	RAM
A1	RAM	241	RAM
A2	RAM	242	RAM
A3	RAM	243	RAM
A4	RAM	244	RAM
A5	RAM	245	RAM
A6	RAM	246	RAM
A7	RAM	247	RAM
A8	RAM	248	RAM
A9	RAM	249	RAM
A10	RAM	250	RAM
A11	RAM	251	RAM
A12	RAM	252	RAM
A13	RAM	253	RAM
A14	RAM	254	RAM
A15	RAM	255	RAM

SEE PINOUTS, TERMINAL GUIDES AND SCHEMATIC NOTES PAGES 3,15

CABLING HEAVY LINES REDUCE USE OF MULTIPLE LINES

PHOTO CIRCUITRACE = 11
SCHEMATIC CIRCUITRACE = 11

IC PINOUTS & TERMINAL GUIDES

TERMINAL GUIDES

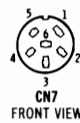
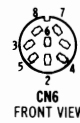
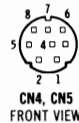
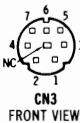
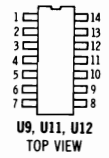
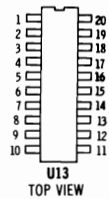
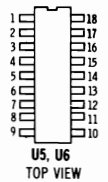
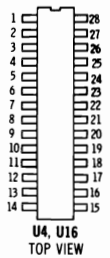
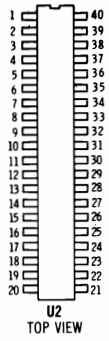
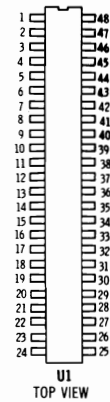
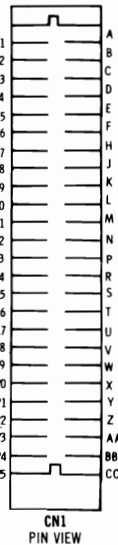
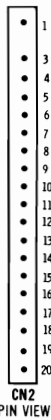
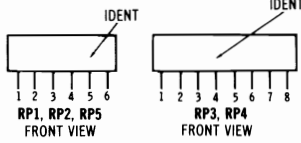
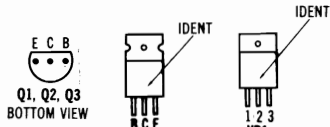

PIN OUTS

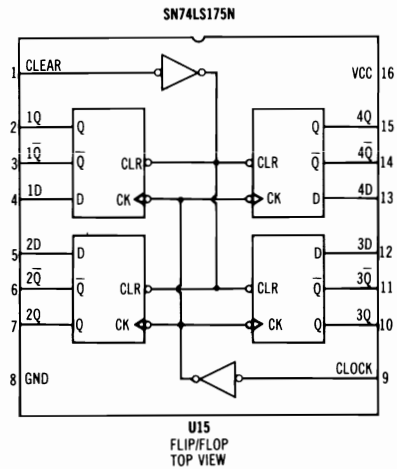
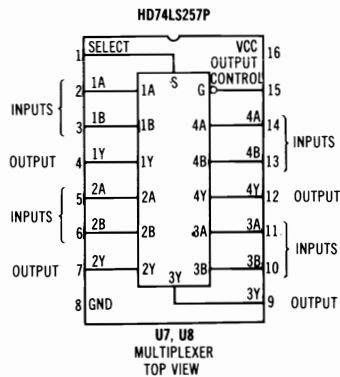
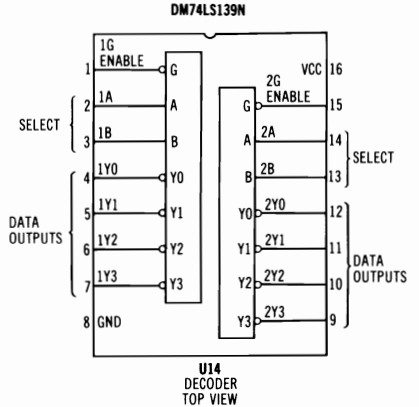
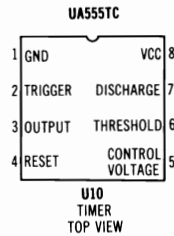
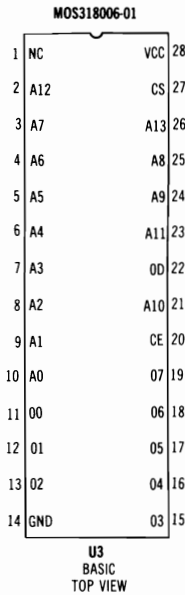

GENERAL OPERATING INSTRUCTIONS

POWER UP

The Computer will come up ready to program in Commodore Basic when turned On. For instructions on loading and saving programs see "Cassette or Disk Operation" section of the General Operating Instructions. To run a program when loaded, type RUN and press the RETURN key. To stop a program in progress, press the RUN/STOP key. A program can also be stopped by pressing RESET button on the right side of the Computer but the program will also be lost.

MONITOR PROGRAM

The Computer has a built-in Monitor Program which enables the user to program in machine language. To go from Basic to Monitor mode, hold down the RUN/STOP key and press the RESET key. The word Monitor will appear at the top left of the display screen. To go back to Basic from Monitor mode, type X and press the RETURN key.

CASSETTE OPERATION

Plug a Datassette cassette recorder onto the six pin edge Connector CN3 at the rear of the Computer. Note: A stan-

ard tape recorder will not work on the Commodore Model 16. To load a program type LOAD, press the RETURN key and follow the instructions displayed on the Monitor screen. To save a program, type SAVE, press the RETURN key and follow the instructions displayed on the screen.

DISK OPERATION

Connect Disk Drive unit to the Serial I/O Port (Connector CN7) located at the rear of the Computer. Carefully insert the diskette so that the label on the diskette is facing up and the notch on the diskette is on the left side. Once the disk has been inserted, close the protective gate by pushing down on the gate lever. To load a program from the diskette, type LOAD "PROGRAM NAME", 8 and press the RETURN key. To save a program, type SAVE "PROGRAM NAME", 8 and press the RETURN key.

NOTE: The number 8 is the Device number for which the Disk Drive is normally set up. The device number can be any number from 8 to 11 depending on how the device number jumpers are connected in the Disk Drive.

DISASSEMBLY INSTRUCTIONS

CABINET TOP REMOVAL

Remove three screws from cabinet bottom. Carefully lift cabinet top and Keyboard from cabinet bottom. Disconnect the Keyboard connector and the Power Indicator connector from the Main Board.

MAIN BOARD REMOVAL

Remove eight screws holding Shield and Main Board to cabinet bottom. The Shield and Main Board may now be removed from cabinet bottom.

KEYBOARD REMOVAL

Remove eight screws holding Keyboard to cabinet top. Lift Keyboard assembly from cabinet top.

MISCELLANEOUS ADJUSTMENTS

Alignment Tools

T1 GC Electronics 5000, 5009, 8276

GC Electronics

CRYSTAL OSCILLATOR

Connect a frequency counter to the base of Transistor Q1. Adjust Trimmer Capacitor (CT1) for a frequency of 14.31818MHz.

RF FREQUENCY

Connect the Computer to a TV and set the TV and Computer channel selector switches to the same channel [L(3) or H(4)]. Adjust T1 for the best picture with MINIMUM noise from the TV speaker.

VIDEO LEVEL

Connect the Computer to a TV and set the TV and Computer channel selector switches to the same channel [L(3) or H(4)]. Adjust the Video Level Trimmer Capacitor (CT2) for the best picture on the TV Monitor.

Datassette is a trademark of Commodore Business Machines, Inc.

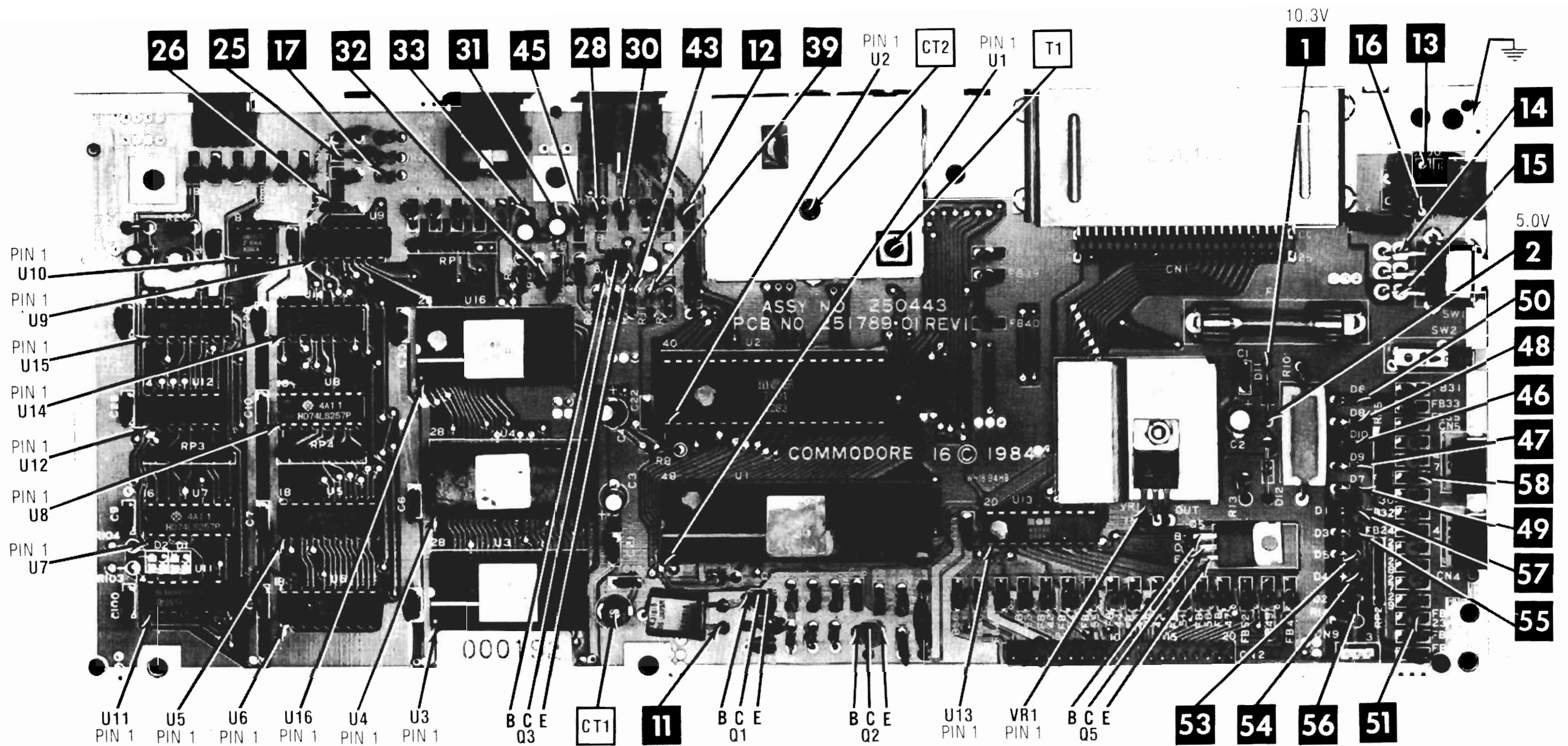

CC8 COMMODORE
MODEL 16

MAIN BOARD GridTrace LOCATION GUIDE

C1	G-25	C19	C-11	C101	D-3	D5	J-27	FB11	C-12	FB30	I-29	FB47	K-25	Q2	L-17	R20	C-3	U1	J-13
C2	H-25	C20	D-11	C102	K-17	D6	G-27	FB12	C-13	FB31	G-28	FB48	K-20	Q3	D-12	R21	C-2	U2	G-13
C3	I-12	C21	J-12	C200	B-29	D7	I-27	FB13	C-12	FB32	I-29	FB49	K-26	Q5	J-24	R23	D-11	U4	K-8
C4	G-12	C22	G-12	CN1	D-22	D8	G-27	FB14	B-5	FB33	G-28	FB50	K-24	R1	K-15	R24	E-11	U5	I-8
C5	K-8	C23	B-6	CN2	L-20	D9	H-27	FB15	B-4	FB34	H-29	FB51	K-24	R2	L-16	R25	E-13	U6	K-5
C6	I-8	C24	C-6	CN3	A-4	D10	H-27	FB16	B-5	FB35	H-29	FB52	K-25	R3	K-16	R26	E-12	U7	J-2
C7	J-4	C25	B-6	CN4	J-29	D11	G-26	FB17	B-3	FB36	I-29	FB53	K-20	R4	L-16	R27	E-12	U8	G-5
C8	K-4	C26	B-6	CN5	H-30	D12	H-25	FB18	B-4	FB37	H-29	FB54	K-21	R5	K-16	R28	D-10	U9	D-6
C9	J-2	C27	E-1	CN6	A-12	F1	E-24	FB19	B-3	FB38	D-20	FB55	K-22	R6	L-16	R29	B-7	U10	D-4
C10	G-4	C28	E-4	CN7	A-9	FB1	C-8	FB22	L-29	FB39	D-20	FB56	K-19	R7	K-18	R102	B-7	U11	K-2
C12	K-12	C29	G-2	CN8	B-30	FB2	C-9	FB23	L-29	FB40	E-20	FB58	C-13	R8	H-13	RP1	D-8	U12	G-2
C13	L-15	C30	E-7	CN9	L-27	FB3	C-9	FB24	J-29	FB41	K-26	J2	A-16	R9	D-10	RP2	J-28	U13	J-20
C14	L-15	C31	D-13	CT1	K-12	FB4	C-9	FB25	L-29	FB42	K-21	L1	D-13	R10	G-26	RP3	H-2	U14	E-5
C15	K-17	C32	L-18	D1	I-27	FB5	C-8	FB26	J-29	FB43	K-23	L2	C-28	R11	E-13	RP4	H-4	U15	E-2
C16	D-3	C33	J-19	D2	K-27	FB8	K-4	FB27	K-29	FB44	K-22	L3	C-28	R12	B-7	RP5	H-28	U16	E-8
C17	D-2	C34	D-5	D3	J-27	FB9	C-11	FB28	K-29	FB45	K-23	L4	K-18	R13	I-25	SW1	D-29	VR1	I-23
C18	C-10	C100	K-2	D4	K-27	FB10	C-12	FB29	K-29	FB46	K-19	Q1	K-15	R14	L-27	SW2	F-29	Y1	K-13

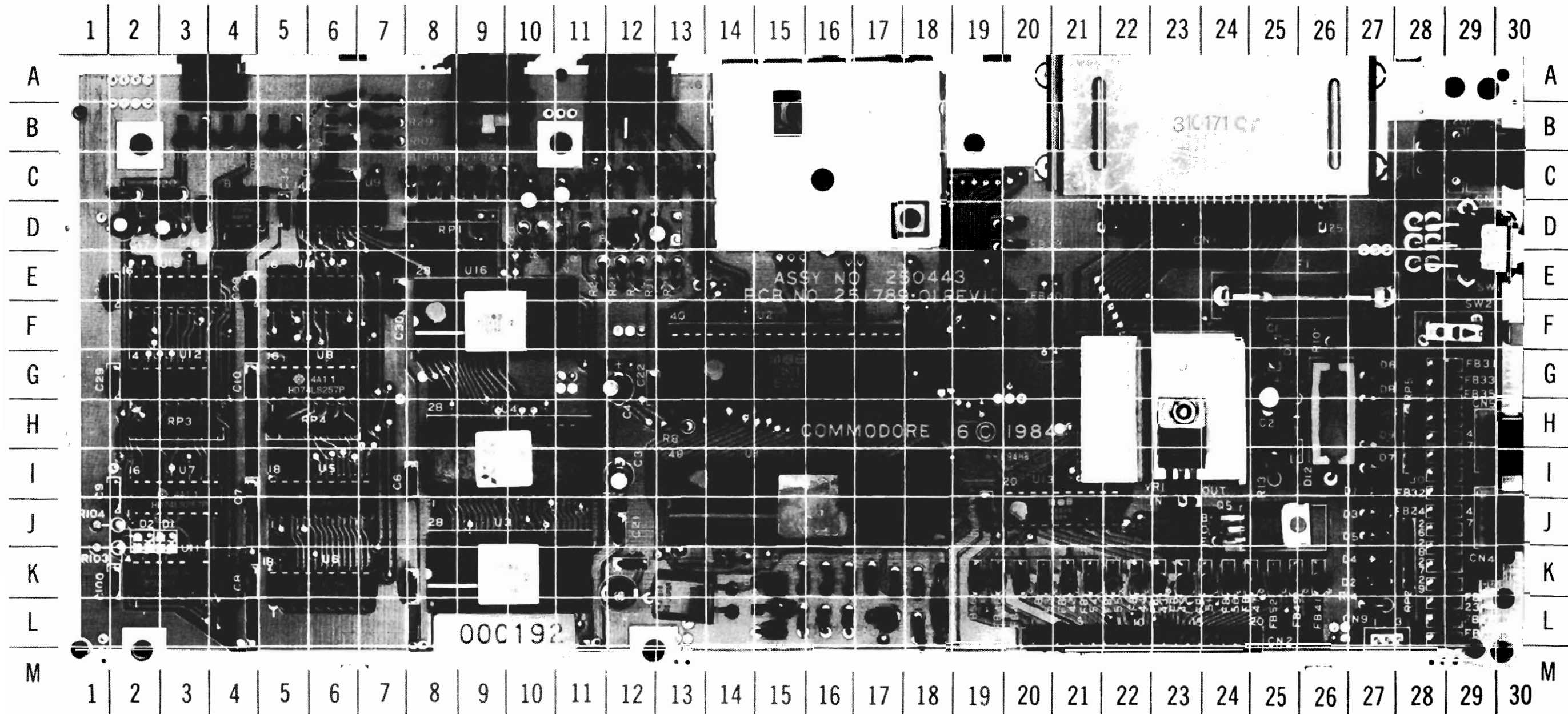

COMMODORE
MODEL 16

PARTS LIST AND DESCRIPTION

When ordering parts, state Model, Part Number, and Description

SEMICONDUCTORS (Select replacement for best results)

ITEM No.	TYPE No.	MFR. PART No.	REPLACEMENT DATA							
			GENERAL ELECTRIC PART No.	MOTOROLA PART No.	NEW-TONE NTE PART No.	PHILIPS ECG PART No.	RCA PART No.	WORKMAN PART No.	ZENITH PART No.	
D1 thru D10	1N4148 1N914B 1S953	251819-16 251819-07	GE-514 GE-300 GE-514	1N4935 1N4935 1N4935	NTE519 NTE177 NTE519	EG519 EG177 EG519	SK3100/519 SK9091/177 SK3100/519	WEP925/519 WEP1062/177 WEP925/519	103-131 103-131 103-131	
D11	1N4002 1N4001	900750-01	GE-504A GE-504A	1N4002 1N4001	NTE116 NTE116	EG116 EG116	SK3311 SK3311	WEP155 WEP154	212-76-02 212-76-02	
D12	RD6-8EB 1N754A	900927-01 900927-02	GEZD-6+8 GEZD-6+8	1N5235B 1N5235B	NTE5014A NTE5014A	EG5014A EG5014A	SK6A8/5014A SK6A8/5014A	WEP1415/5014 WEP1415/5014	103-Z9009 103-Z9009	
Q1 thru Q5	2SC1815BL 2SC1815 2SD880GR 2SD880	902693-01 902694-01	GE-62 GE-62 GE-66A GE-66A	MPSA05* MPSA05* TIP41A TIP41A	NTE85 NTE85 NTE152 NTE152	EG85 EG85 EG152 EG152	SK3124A/289A SK3124A/289A SK3440/291 SK3440/291	WEP66/199 WEP66/199 WEP745/152 WEP745/152	121-Z9065 121-Z9065 121-987-03 121-987-03	
U1	MOS7360R7	251535-01								
U2	8360R1	251535-02(1)								
U3	MOS7501 MOS318006-01 23128	251536-01 318006-01								
U4	MBM27128- 25TED-K 23128 23128	318005-03(2) 318004-03(3) 251538-02								
U5,6	TMS4416- 15NL TMS4416-20									
U7,8	HD74LS257P 7406PC	901521-57 901522-06	GE-7406	SN74LS257AN	NTE74LS257 NTE7406	EG74LS257 EG7406	SK74LS257 SK7406	WEP2119/955M	HE-443-802 HE-443-698	
U10	UA555TC	901523-01	GEIC-269	MC1455P1	NTE955M	EG955M	SK3564/955M		221-Z9042	
U11	SN74LS125AN	901521-20		SN74LS125AN	NTE74LS125A	EG74LS125A	SK74LS125A		HE-443-811	
U12	74LS02PC	901521-21		SN74LS02N	NTE74LS02	EG74LS02	SK74LS02		HE-443-779	

∞ PARTS LIST AND DESCRIPTION (Continued)

When ordering parts, state Model, Part Number, and Description

SEMICONDUCTORS (Select replacement for best results) (cont)

ITEM No.	TYPE No.	MFGR. PART No.	REPLACEMENT DATA								
			GENERAL ELECTRIC PART No.	MOTOROLA PART No.	NEW-TONE NTE PART No.	PHILIPS ECG PART No.	RCA PART No.	WORKMAN PART No.	ZENITH PART No.		
U13	MOS6529B	251640-03									
U14	DM74LS139N	901521-18		SN74LS139N	NTE74LS139	ECG74LS139	SK74LS139				
U15	SN74LS175N	901521-34		SN74LS175N	NTE74LS175	ECG74LS175	SK74LS175				
U16	MOS251641-02										HE-443-752
VR1	7700-010 AN7805	251641-02 901527-02	GEVR-102	MC7805CT	NTE960	ECG960	SK3591/960				221-Z9043

- (1) Used in United Kingdom and German versions, may be used in some USA versions.
- (2) Used in USA versions.
- (3) Used in United Kingdom and German versions.

WIRING DATA

Shielded Hook-up Wire	Use BELDEN No. 8401 or 8421 (Single-Conductor)
General-use Unshielded Hook-up Wire	8208 (Two-Conductor)
75-Ohm Input Lead	Use BELDEN No. 8529 (Solid) Available in 13 Colors
	8522 (Stranded) Available in 13 Colors
	8241

PARTS LIST AND DESCRIPTION (Continued)

When ordering parts, state Model, Part Number, and Description

CAPACITORS Items not listed are normally available at local distributors.

ITEM No.	RATING	MFGR. PART No.
C12	33 NPO 50V 22 50V	251070-14

ITEM No.	RATING	MFGR. PART No.
CT1	Trimmer 40pF	251029-02

RESISTORS (Power and Special)

ITEM No.	RATING	REPLACEMENT DATA		
		MFGR. PART No.	NEW-TONE PART No.	WORKMAN PART No.
R10 RP1	20 10% 5W WW Resistor Network	251756-01 (1)	5W022	24-3035
RP2	Resistor Network	902441-22 (2) (3)		
RP3	Resistor Network	902441-29 (4)		
RP4	Resistor Network	326149-06 (5)		
RP5	Resistor Network	326149-06 (5) (3)		
	Resistor Network	902441-29 (4)		

- (1) Contains five (5) 1000 5%.
- (2) Contains five (5) 1000 2% .19W.
- (3) Contains five (5) 3300 5%.
- (4) Contains five (5) 3300 2% .19W.
- (5) Contains four (4) 68 5%.

COMMODORE
MODEL 16

COILS (RF-IF)

ITEM No.	FUNCTION	MFGR. PART No.
L1 L2	Choke (1.2uH) Choke	325570-01 ZJK5103-05 (TDKq)

ITEM No.	FUNCTION	MFGR. PART No.
L3	Choke	251701-01

FUSE DEVICES

ITEM NO.	DESCRIPTION	MFGR. PART NO.		NOTES
		DEVICE	HOLDER	
F1	1.5A @ 250V Fast-Acting	903556-18	906102-01	

PARTS LIST AND DESCRIPTION (Continued)

When ordering parts, state Model, Part Number, and Description

MISCELLANEOUS

ITEM No.	PART NAME	MFR. PART No.	NOTES
EM1 thru EM5	Filter	251842-01	Electromagnetic Interference
FB1 thru FB5	Ferrite Bead	325563-01	
FB12 thru FB19	Ferrite Bead	325563-01	
FB22	Ferrite Bead	325563-01	
FB24 thru FB35	Ferrite Bead	325563-01	
FB37 thru FB56	Ferrite Bead	325563-01	
FB58	Ferrite Bead	325563-01	
M1	RF Modulator	251844-01	German and United Kingdom versions Alternately used German and United Kingdom versions
	RF Modulator	251847-01	
	RF Modulator	251312-01	
M2	Power Pack	251539-01	Canada version German version United Kingdom version
	Power Pack	251539-02	
	Power Pack	251539-03	
	Power Pack	251539-04	
SW1	Switch	251587-01	Power, On-Off
SW2	Switch	251260-01	Reset
Y1	Crystal	251081-03	14.31818MHz
	Crystal	251081-01	14.31818MHz Alternate
	Crystal	251082-03	17.734475MHz, German and United Kingdom versions
	Crystal	251082-01	17.734475MHz Alternate
	LED	900707-03	Power Indicator (Red), 1.6V @ 7mA
	LED	903811-03	Power Indicator (Green), German version
	P.C. Board	250443-01	Main Board
	P.C. Board	250443-02	Main Board, German version
	P.C. Board	250443-03	Main Board, United Kingdom version

CABINET & CABINET PARTS (When ordering specify model, chassis & color)

ITEM	PART No.	ITEM	PART No.
Cabinet, Top Assembly	250722-01	Cabinet, Bottom Assembly	250721-03
Cabinet, Top	251813-01	(United Kingdom version)	
Cabinet, Bottom Assembly	250721-01	Cabinet, Bottom	251790-01
Cabinet, Bottom Assembly (German version)	250721-02	Keyboard (66 Key)	251798-01

SEE Page 6

SEE PAGE 5

TROUBLESHOOTING

POWER SUPPLY

If DC Fuse (F1) is open, check Voltage Regulator IC (VR1) for a short to ground. If IC VR1 is good, check Capacitor C1 and Electrolytic C2 for shorts. If Fuse F1 is good, check for 10.3V at the fuse. If the voltage is missing, check the Power Switch (SW1) and the Power Pack (M2). If the 10.3V is normal, check for 5V on pin 3 of IC VR1. If the voltage is incorrect, check Resistor R10 and Diode D11.

MICROPROCESSOR CHIP (CPU) OPERATION

Check for 5V on pin 5 of the CPU IC (U2). To verify IC U2 is functioning, use a logic probe and check for pulses on address lines (pins 6 thru 22) and data lines (pins 31 thru 38) of IC U2. If the Microprocessor is not functioning, check pin 40 of IC U2 with the logic probe while the computer is turned Off and then On again. The logic probe should read Low for about two seconds after set is turned On and then read High as IC U2 is reset. If the logic readings are wrong, troubleshoot components associated with Timer IC (U10).

Check for clock pulses on pin 14 of the TED IC (U1). If the pulses are missing, check the Master Clock circuit, Transistors Q1 and Q2. If clock pulses are present on pin 14 of IC U1, check for clock pulses on pin 12 of IC U1 and if missing, check IC U1 by substitution. If CPU still does not function, check for clock pulses at pin 1 of CPU IC (U2). If clock pulses are present, check IC U2 by substitution.

VIDEO

Check for video waveforms on pins 13 and 23 of the TED IC (U1). If waveforms are missing, check IC U1 by substitution. If the waveforms are normal, check for video waveforms on pins 6, 7 and 8 of the RF Module (M1). If waveforms are missing, check Module M1 by substitution. If the waveforms are present at Module M1, check the Video Output Connector (CN6) for bad connections.

COLOR

No color. Check for a color waveform on pin 13 of TED IC (U1). If the waveform is missing, check IC U1 by substitution. If the colors are incorrect, check the adjustment of the 14.31818MHz Oscillator. (See "Miscellaneous Adjustments").

SOUND

If there is no sound, type and run the following program:

```
10 VOL 8: SOUND 2, 222, 22: GOTO 10
```

Check for the waveform shown in Figure 1 at pin 33 of TED IC (U1). If the waveform is missing, check IC U1 by substitution. If the waveform is present, check the voltages and

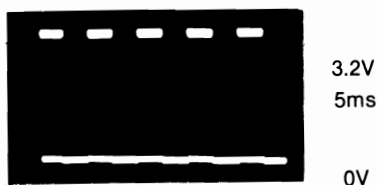

Figure 1

components associated with Audio Amp Transistor (Q3) and check RF Modulator (M1). If the sound is only missing when using a game cartridge, check Capacitor C18 and Resistor R28. Also, check for a bad connection on pin 28 of the Expansion Connector CN1.

KEYBOARD

Keyboard does not function. Check the waveforms at pins 2 thru 8 of PIA IC (U13). If any waveform is missing, check IC U13 by substitution. If the waveforms are good, check the Keyboard Connector CN2 for good connections. If the connections are good, check the TED IC (U1) by substitution.

If any one key is not working, check the key contacts for good connection. The contacts should measure about 100 Ohms each when depressed.

If any one key is erratic in operation, carefully clean the switch contacts with a contact cleaner.

JOYSTICK

Joysticks do not function. Check TED IC (U1) by substitution. If the joysticks function incorrectly, check Connectors CN4 and CN5 for bad connections. Also, check Diodes D1 thru D10 and Resistor Pack RP2.

CASSETTE

Check Connector CN3 for good connections. If a program will not save on tape, check for pulses at pin 29 of CPU IC (U2) while attempting to save a program. (See "General Operating Instructions"). If the pulses are missing, check IC U2 by substitution. If pulses are present at pin 29 of IC U2, check for pulses at pin 10 of IC U9 while attempting to save a program on tape. If pulses are missing at pin 10, check IC U9 by substitution. If pulses are present at pin 10, check Resistor R29 and Capacitor C24.

Program will not load from tape. Check for pulses at pin 26 of IC U2 while attempting to load a program (See "General Operating Instructions"). If pulses are present at pin 26, check IC U2 by substitution. If pulses are missing at pin 26, check Capacitor C23 and also check pin 4 of Connector CN3 for good connection.

Cassette motor does not run. Check for a Low logic reading at pin 9 and a High logic reading at pin 10 of IC U11 while attempting to save a program on tape. If the logic reading at pin 9 is incorrect, check pin 6 of Connector CN3 for a good connection. Also, check ICs U2, U11 and PLA IC (U16) by substitution. If logic reading is correct at IC U11, check for a Low logic reading at pin 27 of IC U2 while attempting to save a program on tape. If the logic reading is incorrect, check IC U2 by substitution. If the logic reading at pin 27 is correct, check for a High logic reading at pin 6 of IC U9. If logic reading at pin 6 is not correct, check IC U9 by substitution. If logic reading at pin 6 is incorrect, check the voltages and components associated with Switch Transistor (Q5). Also, check pin 3 of Connector CN3 for good connection.

DISK DRIVE

If Disk Drive does not operate with the computer, check the connections at Connector CN7. If the connections are good, check CPU IC (U2) and IC U9 by substitution.

MAIN BOARD LOGIC

PIN NO.	IC U1	PIN NO.	IC U1	PIN NO.	IC U2	PIN NO.	IC U2	PIN NO.	IC U3	IC U4	IC U5	IC U6	IC U7
1	P	25	P	1	P	21	P	1	H	H	L	L	P
2	P	26	P	2	P	22	P	2	P	P	P	P	H
3	P	27	P	3	P	23	P	3	P	P	P	P	P
4	H	28	P	4	P	24	H	4	P	P	P	P	P
5	H	29	P	5	H	25	H(2)	5	P	P	P	P	P
6	P	30	P	6	P	26	*(3)	6	P	P	P	P	P
7	P	31	P	7	P	27	H(4)	7	P	P	P	P	P
8	P	32	P	8	P	28	L	8	P	P	P	P	L
9	P	33	L	9	P	29	L(2)	9	P	P	H	H	P
10	P	34	P	10	P	30	L	10	P	P	P	P	P
11	P	35	P	11	P	31	P	11	P	P	P	P	P
12	P	36	P	12	P	32	P	12	P	P	P	P	P
13	H	37	P	13	P	33	P	13	P	P	P	P	P
14	P	38	P	14	P	34	P	14	L	L	P	P	P
15	P	39	P	15	P	35	P	15	P	P	P	P	P
16	P	40	P	16	P	36	P	16	P	P	P	P	H
17	P	41	P	17	P	37	P	17	P	P	P	P	
18	P	42	P	18	P	38	P	18	P	P	L	L	
19	P	43	P	19	P	39	P	19	P	P			
20	P	44	P	20	L	40	H	20	L	L			
21	P	45	P					21	P	P			
22	P	46	P					22	H	P			
23	P	47	P					23	P	P			
24	L	48	P					24	P	P			
								25	P	P			
								26	P	P			
								27	H	H			
								28	H	H			

PIN NO.	IC U8	IC U9	IC U10	IC U11	IC U12	IC U13	IC U14	IC U15	PIN NO.	IC U16	PIN NO.	IC U16
1	P	L	L	L	P	P	H	H	1	*	15	H
2	P	H	L	L	P	P	L	L	2	P	16	P
3	P	L	L	L	P	P	L	H	3	P	17	P
4	P	H	H	L	L	P	H	P	4	P	18	H
5	P	H(4)	H	P	H	P	H	P	5	P	19	L
6	P	L(5)	L	P	P	P	H	H	6	P	20	L
7	P	L	L	L	L	P	H	L	7	P	21	P
8	L	H	H	P	H	P	L	L	8	P	22	P
9	P	L		H	P	L(1)	H	P	9	P	23	P
10	P	H(2)		P	L	L	H	L	10	P	24	P
11	P	L(2)		*	*	P	H	H	11	P	25	P
12	P	H		*	*	P	P	P	12	P	26	P
13	P	L		*	L	P	L	P	13	P	27	P
14	H	H		H	H	P	L	H	14	L	28	H
15	L					P	P	L				
16	H					P	H	H				
17						P						
18						P						
19						P						
20						H						

NOTE: Logic probe readings taken with Computer turned On, no keys pressed, unless otherwise noted.

Logic Probe Display

L = Low

H = High

P = Pulse

* = Open (No Light On)

- (1) Probe indicates P when a key is pressed.
- (2) Probe indicates P while saving a program to tape.
- (3) Probe indicates P while loading a program from tape.
- (4) Probe indicates L while saving or loading a program from cassette.
- (5) Probe indicates H while saving or loading a program from cassette.

SCHEMATIC NOTES

—*— Circuitry not used in some versions

--- Circuitry used in some versions

⊙ See parts list

≡ Ground

⏏ Chassis

▽ Common tie point

Waveforms and voltages taken from ground, unless noted otherwise.

Voltages, Waveforms and Logic probe readings taken with computer turned On, no keys pressed, unless otherwise noted.

Waveforms taken with triggered scope and Sweep/Time switch in Calibrate position, scope input set for DC coupling on 0 reference voltage waveforms. Switch to AC input to view waveforms after DC reference is measured when necessary. Each waveform is 7 cm. width with DC reference voltage given at the bottom line of each waveform.

Time in $\mu\text{sec.}$ per cm, given with p-p reading at the end of each waveform.

Item numbers in rectangles appear in the alignment/adjustment instructions.

Supply voltages maintained as shown at input.

Voltages measured with digital meter, no signal.

Controls adjusted for normal operation.

Terminal identification may not be found on unit.

Capacitors are 50 volts or less, 5% unless noted.

Electrolytic capacitors are 50 volts or less, 20% unless noted.

Resistors are $\frac{1}{2}W$ or less, 5% unless noted.

Value in () used in some versions.

Measurements with switching as shown, unless noted.

NOTE: Logic probe readings taken with Computer turned On, no keys pressed, unless otherwise noted.

Logic Probe Display

L = Low

H = High

P = Pulse

* = Open (No Light On)

(1) Probe indicates P when a key is pressed.

(2) Probe indicates P while saving a program to tape.

(3) Probe indicates P while loading a program from tape.

(4) Probe indicates L while saving or loading a program from cassette.

(5) Probe indicates H while saving or loading a program from cassette.

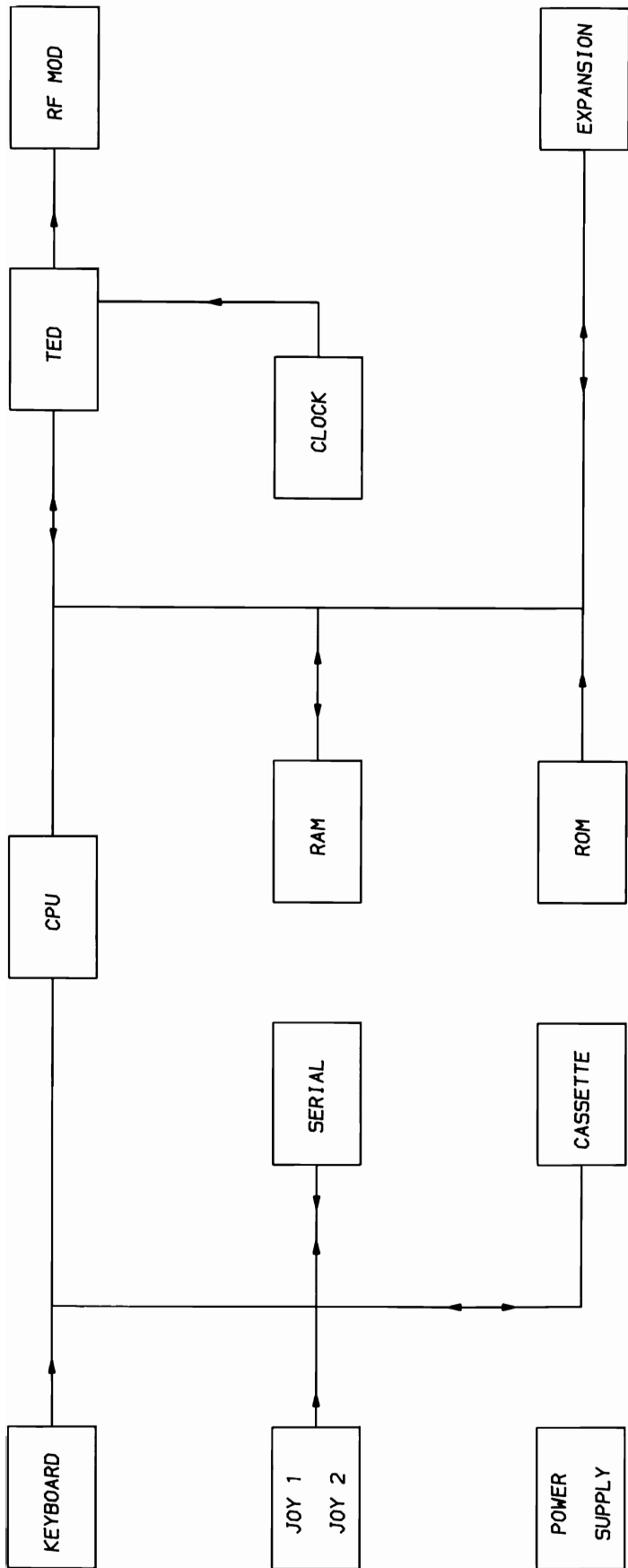

**COMMODORE
MODEL 16**

BLOCK DIAGRAM

LINE DEFINITIONS

A0 Thru A15	Address Lines	C2 HIGH	
AEC	Address Enable Code	D0 Thru D7	Data Lines
ADDR CLK	Address Clock	EXT AUDIO	External Audio
BA	Bus Available	IRQ	Interrupt Request
BASIC CS1	Basic Chip Select	K0 Thru K7	
CASSETTE	Cassette	KERNAL	
CAS	Column Address Strobe	KERNAL CS1	Kernal Chip Select
CS0, CS1	Chip Select Lines	KEY PORT CS	Key Port Chip Select
CST MTR	Cassette Motor	MUX	Multiplex
CST RD	Cassette Read	R/W	Read/Write
CST WRT	Cassette Write	RAS	Row Address Strobe
C1 LOW		RESET	Reset
C1 HIGH		O0	Phase 0
C2 LOW		O2	Phase Two

Any Bar above any alphabetical or numerical combination indicates line active in a low (0) state.

SAFETY PRECAUTIONS

1. Use an isolation transformer for servicing.
2. Maintain AC line voltage at rated input.
3. Remove AC power from the Computer before servicing or installing electrostatically sensitive devices. Examples of typical ES devices are integrated circuits and semiconductor "chip" components.
4. Use extreme caution when handling the printed circuit boards. Some semiconductor devices can be damaged easily by static electricity. Drain off any electrostatic charge on your body by touching a known earth ground. Wear a commercially available discharging wrist strap device. This should be removed prior to applying power to the unit under test.
5. Use a grounded-tip, low voltage soldering iron.
6. Use an isolation (times 10) probe on scope.
7. Do not remove or install board, floppy disk drives, printers, or other peripherals with power On.
8. Do not use freon-propelled sprays. These can generate electrical charges sufficient to damage semiconductor devices.
9. The Computer cabinet is equipped with vents to prevent heat build-up. Never block, cover, or obstruct these vents.
10. Instructions should be given, especially to children, that objects should not be dropped or pushed into the vents of the cabinet. This could cause shock or equipment damage.
11. Never expose the Computer to water. If exposed to water, turn the unit off. Do not place the Computer near possible water sources.
12. Never leave the Computer unattended or plugged into the AC outlet for long periods of time. Remove AC plug from AC outlet during lightning storms.
13. Never use liquids or aerosols directly on the Computer. Spray on cloth and then apply to the Computer cabinet. Make sure the Computer is disconnected from the AC power line.

If seal is broken, nonreturnable.



COMPUTERFACTS™ put easy to use, informative technical data right at your fingertips. Each edition includes specific service information on the individual component, along with some overall troubleshooting hints.

The following information is just a sample of the many valuable time saving features contained in this exclusive Sams COMPUTERFACTS publication:

- Preliminary Service Checks section is an easy to use, step by step guide for the experienced technician or hobbyist, and even beginners.
- SAMS famous industry accepted standardized notation schematics containing CIRCUITTRACE®, GRIDTRACE™, waveforms, voltages and stage identification.

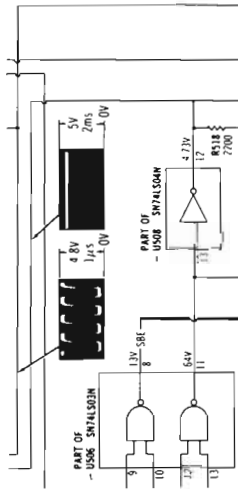

- Step by Step Troubleshooting guides the technician through the necessary procedures to quickly locate the problem.

TROUBLESHOOTING

MICROPROCESSOR CHIP (CPU) OPERATION

Verify the microprocessor is functioning by checking the signal on the address lines (pins 10 thru 24) or IC U100 and the data lines (pins 25 thru 39) using a logic probe or oscilloscope. The logic probe will make reading a logic probe more difficult. The oscilloscope will make reading the waveforms on the data lines (except pins 22 and 23 which have 5V and 0V Power Up modes) should be similar to Figure 1. The waveforms on the data lines should be similar to Figure 2.

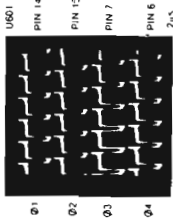

- Logic Chart containing logic probe readings to isolate defective circuitry and components.

LOGIC

PIN NO.	IC U100	PIN NO.	IC U100	IC U102	IC U103	IC U104	IC U105	IC U106	IC U107	IC U108	IC U109
1	P	21	P	L	L	L	L	L	L	L	L
2	P	22	P	P	P	P	P	P	P	P	P
3	P	23	P	H	H	H	H	H	H	H	H

- Quick Component Location using the SAMS exclusive GRIDTRACE, CIRCUITTRACE, and component photographs.

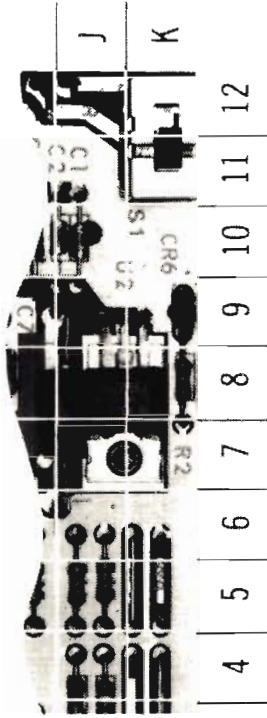

- Complete Components Parts List in an easy to use format with field replacements shown when possible. SAMS unique semiconductor, chip and IC cross-reference gives you many replacements to choose from and is available at your Electronic Distributor.

SEMICONDUCTORS (Select replacement for best results)

ITEM NO.	TYPE No.	MFR PART No.	REPLACEMENT DATA						WORKMAN PART No.	ZENITH PART No.
			ECG PART No.	GENERAL ELECTRIC PART No.	MOTOROLA PART No.	NTE PART No.	RCA PART No.	WORKMAN PART No.		
D102	1S553	1149-2576	EG519	GE-514	1N4935	NTE519	SK9091/177	WE925/519	103-131	
D103	1N60FM	1149-2527	EG5109	1N60	1N4004	NTE109	SK3088	WEPI34/109	103-29001	
Q201	1N4004GP	1201-4205	EG1116	GE-504A	1N4935	NTE116	SK3312	WEPI57	212-76-02	
Q501	1N49-2576	1149-2576	EG5519	GE-514	1N4935	NTE519	SK9091/177	WE925/519	103-131	

CircuitTrace is a registered trademark of Howard W Sams & Co., Inc. COMPUTERFACTS and GridTrace are trademarks of Howard W Sams & Co., Inc. Commodore 16 is a trademark of Commodore Business Machines, Inc.

To order, see your Sams Representative, or telephone 800-428-SAMS.



Howard W. Sams & Co., Inc.

4300 West 62nd Street, P.O. Box 7092, Indianapolis, Indiana 46206 U.S.A.

CC8
08930

