



MATH/LOGIC

GAME INSTRUCTIONS

MG-307

MATH/LOGIC

CONTENTS	Pages
1. GAME OBJECTIVES	2
2. GETTING STARTED	3
a) Insert Cartridges	
b) Hand Controllers	
c) Game Selection	
3. GAME ONE – MIND BREAKER	4
a) Start to play	
b) End of Game	
c) Start New Game	
d) Scoring	
4. GAME TWO – MAXIT	9
a) Start to play	
b) End of Game	
c) Start New Game	
d) Scoring	
5. GAME THREE – HANGMAN	15
a) Start to play	
b) End of Game	
c) Start New Game	
d) Scoring	
6. OPERATION FLOW DIAGRAMS	19

How resourceful and inventive are you?

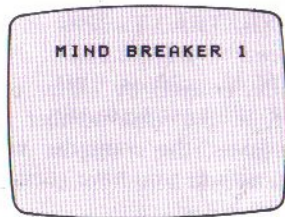

Mind Breaker

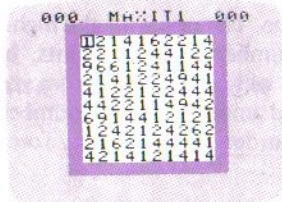

Maxit



Hangman

Test yourself with these three remarkable games, all contained within the same cartridge: break the mysterious hidden code; test your powers of logical deduction: beat the computer and/or your opponent by planning strategic moves; check your word power. Find out how you rate.

1. GAME OBJECTIVES

The cartridge contains three different games:—

a) **Mind Breaker**

Break the secret 5-digit code, entered by either the computer or your opponent, in the least number of guesses. As you make each guess, the computer will show you which digits and positions you have guessed correctly.

b) **MAXIT**

Score is the name of the game. The one with the highest score wins. Pick a black number to score points, but avoid the red numbers which will be deducted from your score. There is only a limited amount of black numbers, so you must plan ahead in order to avoid being forced to pick a red number.

c) **HANGMAN**

This is a game to check your knowledge of words. The aim is to guess the word thought of by your opponent as quickly as possible. Think twice before you make a guess because if you have ten unsuccessful tries, you will be hanged and will be forced to forfeit your turn.

2. GETTING STARTED

Plug in the antenna cable and AC adaptor plug of the Master Console in accordance with the instructions given in the Master Console Installation Manual (MPT-03).

a) INSERT CARTRIDGE

Slide the power switch of the Master Console to the **OFF** position. Hold the cartridge with the slots facing the player and insert into the cartridge opening.

Note: The Console should be switched **OFF** when inserting/removing the cartridge to avoid damage to the Master Console and the cartridge.

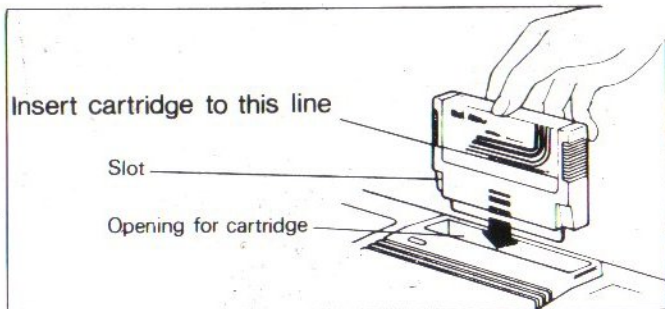

b) HAND CONTROLLERS

The joystick controls are not used for this cartridge. Instead, horizontal and vertical movements are controlled by the directional keys on the keypad. Inlay plates are provided for each game to indicate which keys to use.

c) GAME SELECTION

Switch on Master Console

The first game, version 1 of Mind Breaker, automatically appears on the TV screen. The other two games, Maxit and Hangman, are selected by pressing button A until the appropriate game appears. Various versions of each game can be selected by pressing button B until the desired version is shown on the screen.

3. GAME ONE – MIND BREAKER

Press button A –

to display MIND BREAKER 1 on top of the screen

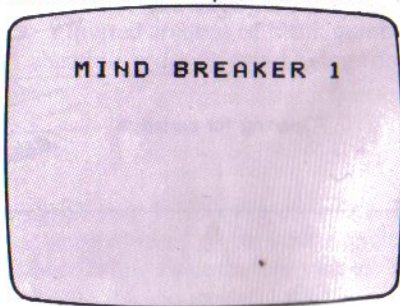

The initial display

Press button B —

to select version 2

version 1	player vs computer
version 2	player I vs player II

a) START TO PLAY

Version 1

Place Mind Breaker inlay plate onto the left hand controller.

Press GAME START button

A 5-digit number known only to the computer is established. Select and ENTER a 5-digit number from the left hand controller.

The entry is displayed on the TV screen. Under each correct figure a "\$" is displayed, and under each correct figure in the right position a "+" is displayed.

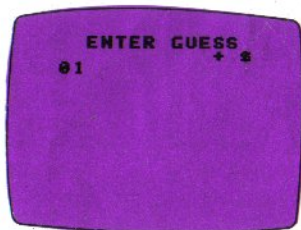

The "\$" display

The "+" display

Continue ENTERing 5-digit numbers —
 until you have guessed the mysterious number. If you
 have not broken the hidden code after 19 guesses, the
 mysterious number will be disclosed.

Note:

- (i) A wrong digit entered by mistake can be erased
 by pressing the DELETE button, if it has not
 already been ENTERed.
- (ii) The TV screen will only display up to 9 entries.
 Additional entries can be added to the bottom
 of the screen by clearing the upper-most entries.

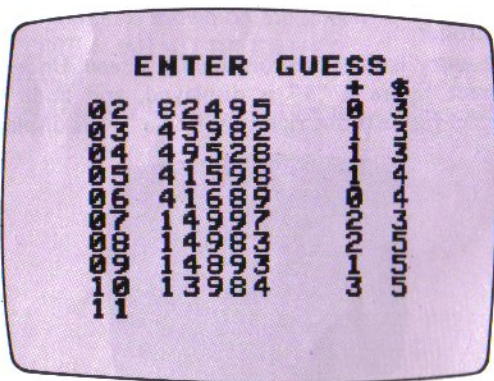

Diagram

Version 2

Press button B —

Until MIND BREAKER 2 is displayed on the top of the screen

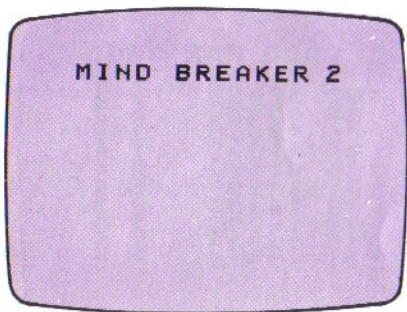

The initial display

Place both Mind Breaker inlay plates onto the left and right hand controllers.

Press GAME START button

Player I enters a secret 5-figure number from the right hand controller.

Player II then tries to guess the number and the game proceeds as for version I.

b) END OF GAME

The game is over when:

- you have guessed the number correctly, or
- you have had 19 unsuccessful guesses.



END OF Game Display

c) START NEW GAME

- (i) Press **GAME STARJ** button —
to retain previous secret number. Additional entries can then be made from the left hand controller.
- (ii) Press **CLEAR** button followed by **GAME START** button—
to delete previous number. A new secret number is then assigned by the computer, or in version 2, player 1 can enter a new number.

d) SCORING

How did you rate?

Number of guesses	Rating
1 – 6	WOW, THAT'S FAST!
7 – 14	GOOD FOR YOU
15 – 19	YOU'RE TOO SLOW

4. GAME TWO – MAXIT

Press button A –

until MAXIT 1 is displayed on the top of the screen.

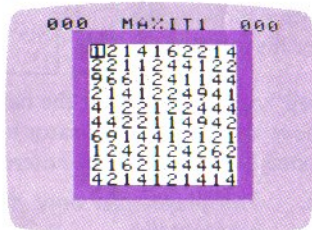

The initial display

Press button B –

to select the various options

- | | | |
|-----------|-------------|--------------|
| Version 1 | Easy | (one player) |
| Version 2 | Average | (one player) |
| Version 3 | Difficult | (one player) |
| Version 4 | Two Players | |

a) START TO PLAY

Versions 1 – 3 (one-player)

Place Maxit inlay plate onto the left hand controller.

Press GAME START button
Rows and columns of
black and red numbers
are displayed on the
screen. A flashing blue
square (Position Indicator)
indicates the player's turn
to make a move, and acts as
a pointer showing the
player his location.

A 10x10 grid of numbers. The top row contains the numbers 9, 1, 4, 3, 2, 4, 1, 1, 1, 6. The second row contains 2. The third row contains 6. The fourth row contains 4. The fifth row contains 4. The sixth row contains 1. The seventh row contains 4. The eighth row contains 6. The ninth row contains 2. The tenth row contains 1. A purple square highlights the number 2 in the fifth column of the first row. A purple arrow points from the top of the grid to the right, and another purple arrow points from the right side of the grid downwards.

9	1	4	3	2	4	1	1	1	6
				2					
				6					
				4					
				4					
				1					
				4					
				6					
				2					
				1					

Press “◀” or “▶” keys on the hand controller –
to move the Position Indicator horizontally in either direction
onto the number to be entered.

Note: The player can only move the Position Indicator
horizontally.

Press ENTER button –
to ENTER this number

Note:

- (i) the number chosen is added to (or subtracted from)
the player's score. The computer then moves the
Position Indicator vertically up or down in the

column in which the Position Indicator is then located, onto a number that is favourable to its score and automatically ENTERs this number. The player and computer take turns to choose a number – the player always selecting a number from a horizontal row and the computer picking a number from a vertical column – until the game is over.

For example, if the player enters the number “2” in the first row, the computer can choose only the numbers in 5th column. See diagram on page 9.

- (ii) A black number indicates a positive number and entering one of these will increase your score, while a red number indicates a negative number and will decrease your score.

Version 4 (two players)

Press button B —

until MAXIT 4 is displayed on the TV screen

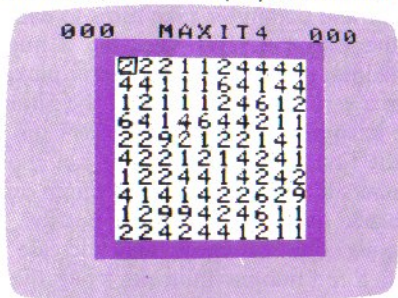

The initial display

Place both Maxit inlay plates on left and right hand controllers.

Press GAME START button

Player I controls the left hand controller and follows the same instructions as for versions 1–3, selecting and ENTERing numbers from horizontal rows.

Player II controls the right hand controller selecting and ENTERing numbers from vertical columns after each move made by player I.

Note: Player I can only select numbers from horizontal rows.
Player II can only select numbers from vertical columns.

b) END OF GAME

The game is over when:

- all numbers have been chosen, or
- there are no other numbers available in the row or column in which the Position Indicator is located.

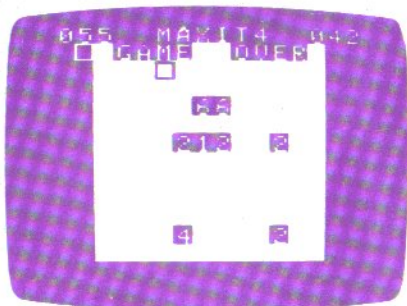

END OF Game Display

c) START NEW GAME

Press GAME START button

The previous score cannot be retained.

d) SCORING

Player I's score is displayed on the upper left hand corner of the screen.

The computer/Player II's score, is displayed on the upper right hand corner of the screen.



Total score = sum of the numbers ENTERed

Note: A red number is a negative score, therefore it will be subtracted from the sum when ENTERed.

$$\begin{aligned} \text{e.g. Total score} &= (+20) + (-10) \\ &= 10 \end{aligned}$$

5. GAME THREE – HANGMAN

Press button A –

until HANGMAN is displayed on the top of the screen.

The initial display



a) START TO PLAY

Place Hangman inlay plates onto the left and right hand controllers

Press GAME START button

The letters of the alphabet are displayed on the screen, together with a position indicator (RED square).

The display

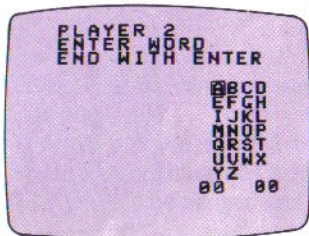

Player II selects letters to make up a word (of not more than 14 letters) by pressing the “◀”, “▶”, “▲” and “▼” keys on the controller to move the indicator onto the desired letter, and then pressing ENTER.

Example



Press WORD ENTER button

Player 1 press any key on his own keyboard. The word is now keyed in and the screen will display:

- the number of letters that player II has to guess (indicated by dashes ----)
- the letters of the alphabet;
- a position indicator (RED square); and
- a scaffold.

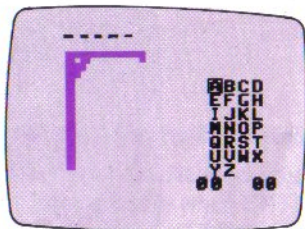

Player 1 selects and ENTERs a letter

If this letter is incorrect, part of a man's body (arm, leg, etc.) will be drawn on the scaffold.

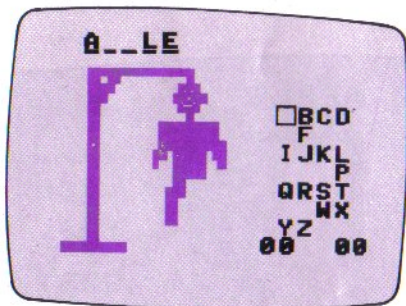

Diagram

Player II continues to ENTER letters –

until he has guessed the word, or the man's body has been drawn completely.

Note:

- (i) A wrong letter entered by mistake can be erased by pressing the DELETE button
- (ii) Players take turns to enter a word for the other player to guess. However, if you have not guessed the word after 10 tries, you will be hanged and lose your next turn.

b) END OF GAME

The game is over when:

- you have guessed the word correctly, or
- you have had 10 unsuccessful tries.

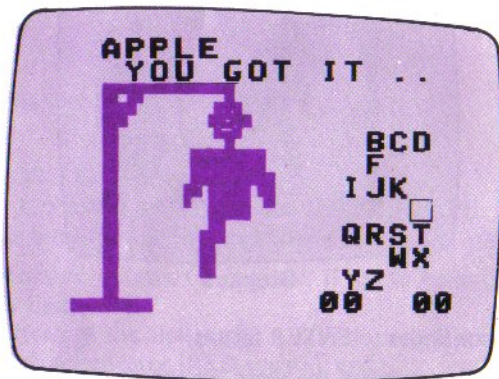

END OF Game Display

c) START NEW GAME

Press GAME START button

d) SCORING

10 points will be scored if you guess the word correctly. 1 point will be deducted for each incorrect letter. The first player to score 100 points wins the game.

6. OPERATION FLOW DIAGRAMS

Flow Diagram 1

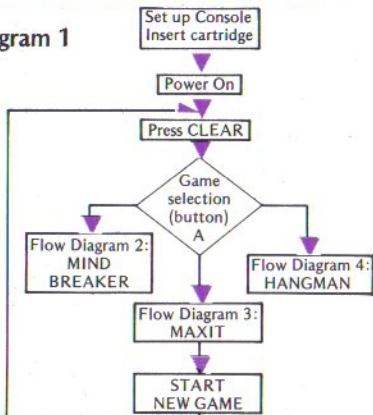

Flow Diagram 2: MIND BREAKER

