

Green Mountain Micro

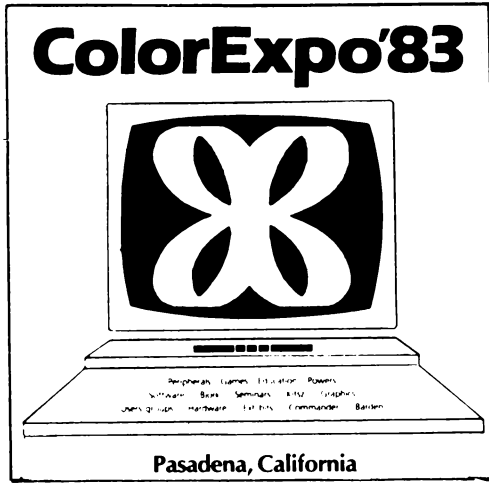

*Special
Expo
Catalog!*

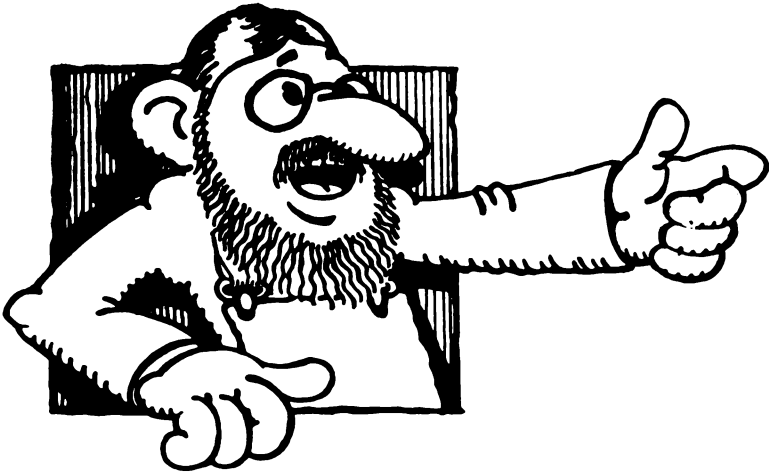

Bathory Road — Roxbury, Vermont 05669
(802) 485-6112



green mountain micro

ROXBURY, VERMONT 05669

Hello friends. This is Green Mountain Micro's first catalog, bringing together my software and hardware designs for the TRS-80 Color Computer. This is not just a collection of items for sale, but a selection of those pieces of hardware and those programs which I have created to use on my own computers.

Everything is economical, everything is reliable, and everything is created with my personal philosophy of elegance and simplicity. My Lowerkit was the original lowercase for the Color Computer, and still sets the standard. Color Quaver is the best software music synthesizer you can buy: versatile, listenable, and musical. The CoCoPort is simplicity beyond simplicity: an interface that serves as everything from a parallel printer port to a drill press controller.

Many items are breakthroughs, such as the Scroll-A-Roll rolling display software and the Micro Language Lab. Other things are standard, such as the 64K RAM upgrade and the ColorPack RAM/ROM cartridge. But what makes these familiar items different is really the support Green Mountain Micro provides.

I've put together a technical and support staff to help you with your questions. You won't get an answering machine here. RB, Jo or Steve can not only take your order, they can help you with installation and diagnosis. I'll take the call if you have special needs. Green Mountain Micro can also repair your computer if you ever need it.

Green Mountain Micro is here because I'm excited about the Color Computer, and because I felt it was time that Color Computer users got the products and support they deserved. You will find a select choice of products in this catalog for your needs, all provided with continuing technical and user support. Beyond that, I tell you all: you get software listings, hardware schematics, and the chance to preview just about everything in published articles.

I hope you will read through this catalog, and turn to Green Mountain Micro for your Color Computer needs. Thank you for your kind attention.

Sincerely,



Dennis Bathory Kitsz

Color Quaver

The ultimate all-software music synthesizer and the most economical all-software music synthesizer are one and the same: Color Quaver, the most realistic music experience you'll ever hear from your Color Computer!

The very first audition tape we sent received this reply:

"Quite the best software of any offered."
—E.S., Arletta, CA

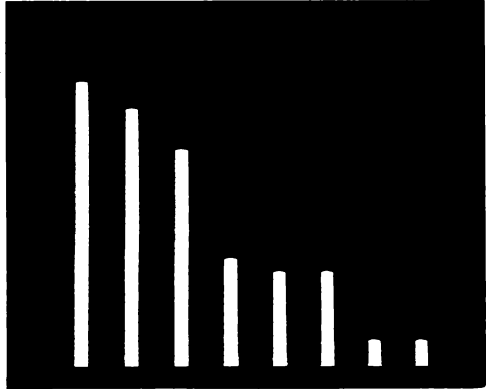

Features:

- Real electronic music synthesis that is more than bleeps.
- Full four-part harmony, all in precise tempered tuning.
- Versatile music editor/compiler/storage system for fastretrieval and performance of music.
- Entirely software — no hardware attachments needed — plays through TV speaker, cassette player or amp.
- Variable timbres (tone qualities for each part...create a combo or a quartet).
- 64-step variable envelope (embouchure) for each part guarantees no more organ-style music.
- Five usable octaves, variable tempos, rhythms from 32nd note to whole note.
- Fast compiler provides finished music in five seconds...up to 250 notes per voice line, 1000 notes in all.
- Five ready-to-play sample tunes and waveforms are included: pop, seasonal, classical, modern, and sacred.
- 64K computers can use double speed for improved sound.
- Spectral (Fourier) transform or joysticks provide two methods of creating timbres.
- Over 40 pages of instructions, explanations, hints, listings and samples.

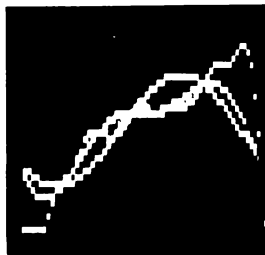
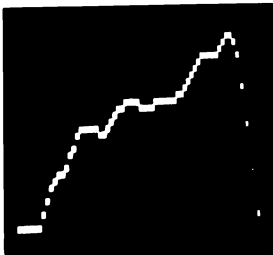

\$19.95 on cassette

Add \$2.50 shipping and handling

Audition tape, \$4.00

Green Mountain Micro's Software Policy:
Full Disclosure of Source Code
Complete Technical Information
Upgrade Information Service



MASTERCARD, VISA & COD's WELCOME.

The Lowerkit II

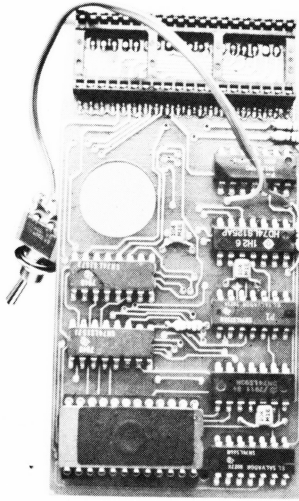

The Lowerkit II is the original true lowercase and special symbols generation system for the TRS-80 Color Computer. A simple hardware plug-in module, the Lowerkit fits inside the case, replacing the Radio Shack inverse video with Lowerkit's true lowercase characters. It takes up *no memory* (software lowercase grabs 7.5K!), *no soldering* or special wiring is necessary, and there is absolutely *no loss* of high-resolution or color. The unit can be in place and operating in just 15 minutes. A cut-out switch restores the former Radio Shack display whenever desired (Audio Spectrum Analyzer and some other programs actually look better in the original Radio Shack mode). A Scripsit-compatible word-processing module is standard with the Lowerkit, but character display plug-in modules are also available in Kata Kana, Green, APL, math symbols, gaming characters, generalized European, Cyrillic, Arabic, and Hebrew. Special character sets can be programmed on request; character-creation software CHARIT and the Color Burner can be used to develop your own specialized character sets.

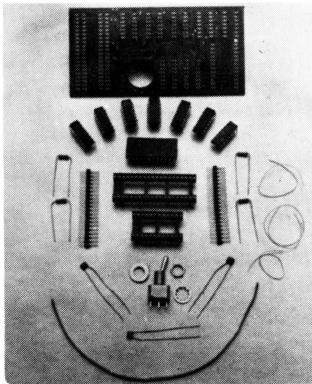

"The design is obviously the right one."
—Color Computer News

Specifications: Stock character generator includes 96 upper and lowercase characters, 8x12 dot matrix; 32 reverse numbers and symbols provided for Scripsit compatibility. Specify small Radio Shack type 5x7 dot matrix character set if desired. Special character sets may be substituted on request. Quick-change character generator socket available (optional extra). 140 mA current draw (max).

Featured in The Color Computer Magazine, August 1983.

\$79.95 assembled and tested
\$49.95 complete kit of parts
\$20.00 bare printed circuit board

Add \$2.50 shipping and handling

Assembled and tested by Green Mountain Micro. Note: We save labor, you save money by building a kit. Bare PC boards and hard-to-find parts also available separately.

Green Mountain Micro's Hardware Policy:
Full Disclosure of All Schematics
Complete Technical Information
Six-month Warranty
Upgrade Information Service

Specifications for the purpose of improvement subject to change without notice.

CharGens

Kata Kana

アチツテトナニスネカヒフヘト
ミムモヤヒヨリルロフンガ
。「」、・ヲアイウエオカキコサシセ
-アイウエオカキコサシセ
@ABCDEFGHIJKLMNO
PQRSTUVWXYZ[\]^_
!"#\$%&'()*+,-./
0123456789:;<=>?

Greek Alphabet

`abcdefghijklmnop
pqrstuvwxyz(:)~%
αβγδεζηθικλμνξοπ
ρστυφχψωΩΓ→←↑↓Σ≈
@ABCDEFGHIJKLMNO
PQRSTUVWXYZ[\]^_
!"#\$%&'()*+,-./
0123456789:;<=>?

APL Symbols

α|0|ε_∇Δι*^Π|rα
★?p[~↓0ω∞†c++→∫-
∩)⟨⟩(=)∨A≠=,+,./
0123456789(:;×∖
@ABCDEFGHIJKLMNO
PQRSTUVWXYZ(-)⊞
!"#\$%&'()*+,-./
0123456789:;<=>?

Math Symbols

`abcdefghijklmnop
pqrstuvwxyz(:)~%
ΔΣ∫≠Γαβγ∞θλμπσ
∩c∞∧∨~|∩∖×÷∫∇∞
@ABCDEFGHIJKLMNO
PQRSTUVWXYZ[\]^_
!"#\$%&'()*+,-./
0123456789:;<=>?

European Letters

`abcdefghijklmnop
pqrstuvwxyz(:)~%
ääåäçèéìíîïñóôö
øƒuúúÿßŁ#€¥ıç&*..
@ABCDEFGHIJKLMNO
PQRSTUVWXYZ[\]^_
!"#\$%&'()*+,-./
0123456789:;<=>?

Gaming Characters

`abcdefghijklmnop
pqrstuvwxyz(:)~%
0Γ_LJ|B/Qh→≡+≠00
B9000×π-|ξ†ç00000
@ABCDEFGHIJKLMNO
PQRSTUVWXYZ[\]^_
!"#\$%&'()*+,-./
0123456789:;<=>?

CHARIT

Custom character generators are always in demand for the Lowerkit. The cost of Green Mountain Micro developing these is prohibitive for a one-time use, so Charit has been created to fill in the user gap. Fonts developed using Charit can be programmed at low cost by Green Mountain Micro, or can be used with the Color Burner EPROM programmer.

Requires 16K Extended Color Basic.

\$14.95 on cassette

The CoCoPORT

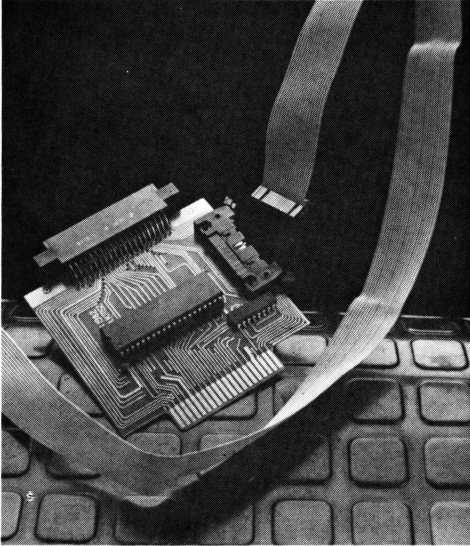

The CoCoPort is an interface from your computer to the real world: It is an input/output port arranged as a cartridge plug-in for the TRS-80 Color Computer. Your computer already has two dual ports built into it, dedicated to a wide variety of familiar tasks, including input from the keyboard, controlling the video graphics modes, sound output, joystick input, cassette motor, serial printer output, and RS-232 communications.

The CoCoPort adds 50% more of this input/output power to the Color Computer, power that is your own because you can decide exactly how you want information to flow to and from your computer. It is ideal for data acquisition and control applications such as measurement, switching and timing, signaling, and laboratory experimentation.

Gold edge connectors assure you of reliable interfacing, and because of its unique addressing and feed-through connector, the CoCoPort can be used together with ROM packs or the TRS-80 disk system. A cable and 3M-style header connector (optional extra) make interfacing to control signals, sensor, etc., fast and simple.

Use CoCoPort for ...

... A Parallel Printer Port. Just add a Centronics-type connector to your CoCoPort cable (we'll do it for you), plus a little software (we've got it), and you can use the speed and versatility of parallel printers! Cable wiring diagram and software listing provided with your CoCoPort documentation; wired cables and cassette software optional extra.

...Higher-Quality Sound. Two ways to go: with precision resistors and an operational amplifier, or with an 8-bit digital-to-analog converter (our choice). With the 8-bit CoCoPort patch to our acclaimed Color Quaver music program, you get refined musical sound.

...Process Control. Use all 18 control lines: connect output lines to low-cost driver transistors, output logic blocks, optical isolators; connect input lines to optical sensors, logic devices, switches. Add software — even in BASIC — to drive robotic arms or automate small-scale process control systems in the lab. With four CoCoPorts, you have 64 control lines at your disposal. CoCoPorts are already being used to control theatrical animation systems! A control “idea sheet” is provided with your documentation.

...Sports Displays. Use up to four CoCoPorts with driver transistors, optical isolators, relays, or other safe high-current components to illuminate scoreboards. Use one 8-bit port to provide the number or letter, and the other 8-bit port to “strobe” the information. One CoCoPort provides a 16-character alphanumeric display. Add simple BASIC software, and you have the most powerful and sophisticated scoreboard in town!

If it's in the real world, the CoCoPort can interface it to your TRS-80 Color Computer! Call Green Mountain Micro for assistance and guidance with your application.

Specifications: 6821 PIA at \$FF50 to \$FF53, on-board optional at \$FF54-57, \$FF58-5B, \$FF5C-5F. \$FF40-4F fully decoded for disk systems. 110 mA current draw (max). TTL-compatible inputs and outputs. 20-pin 3M-style I/O connector with latch/eject tabs.

Featured in The Color Computer Magazine, April-May 1983.

Green Mountain Micro's Hardware Policy:
Full Disclosure of All Schematics
Complete Technical Information
Six-month Warranty
Upgrade Information Service

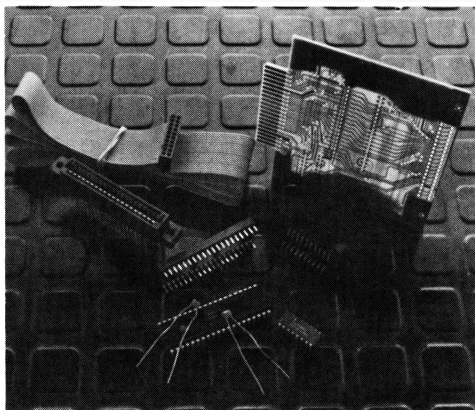

\$49.95 assembled and tested
\$39.95 complete kit of parts
\$20.00 bare printed circuit board

Add \$2.50 shipping and handling



MASTERCARD, VISA & COD's WELCOME.

Assembled and tested by Green Mountain Micro. Note: We save labor, you save money by building a kit. Bare PC boards and hard-to-find parts also available separately.

Specifications for the purpose of improvement subject to change without notice.

Learning the 6809

“Learning the 6809” is a guide to assembly language like there’s never been before. With the **Micro Language Lab**, you get it all — not only the theory of 6809 assembly language programming, but what you need to know to make your Color Computer really sweat for you.

Dennis Kitsz explains 6809 assembly language and shows you how to tame it. There are dozens of examples right on the tapes, ready to load, examine and run. The accompanying book of documentation helps with the teaching, and **Micro Language Lab** gives you what you don’t get anywhere else: programming information for every one of your Color Computer’s “smart” circuits.

“Learning the 6809” isn’t that same old isn’t-it-wonderful-you-can-put-the-dot-on-the-screen approach. **Micro Language Lab** will teach you numbers, graphics and sound, but won’t run away from you after the first lesson. You will really learn to program, learn to use those numbers, graphics and sound. You will find ways of using every electronic nook and cranny in your machine. You’ll stop wasting memory and make your programs run in seconds, not minutes. Each lesson is carefully paced, and the book contains exercises and self-tests.

Here is an outline of just the first six lessons:

1. Introduction: Necessary items; what you will learn; what assembly language is; how assembly language is not BASIC: comparisons and contrasts; speed and flexibility demonstrations.
2. Number systems; Introduction; everyday non-decimal systems; binary systems; Sherlock Holmes teaches binary; powers of two, bits, and the alphabet; hexadecimal names; counting; ASCII.
3. The Microprocessor: Introduction; names and terminology; ALU; accumulator, memory, and addresses; program counter and registers; moving a message to the screen; sample programs; condition codes; compares; source code.

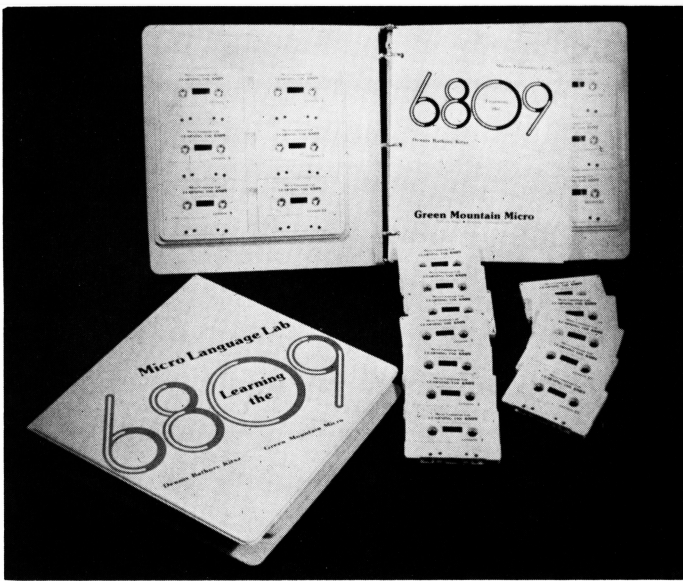

4. Mnemonics: Introduction and summary; mnemonics; opcodes and operands; tables, addresses, and offsets; labels; machine language and BASIC; stacks; subroutines; writing a program; origins and ends.

5. Editor/Assembler: Introduction and summary; source and object code; opcodes, operands and hex code; mnemonics; insert, delete, print, number, and edit; editor messages.

6. Addressing Modes I: Introduction; jargon; how information is stored in memory; inherent addressing; register addressing; immediate addressing; extended addressing; direct addressing; mnemonics and examples; review.

Learn the 6809 and learn how to program your Color Computer.

Micro Language Lab contains 24 half-hour lessons on 12 cassettes (both audio lessons and more than 40 demonstration programs), a 150-page instruction manual, and complete data sheets for the Color Computer's smart circuits (6809E, 6883, 6847 and 6821), all in a jumbo binder.

\$99.00 complete

Add \$2.50 shipping and handling

Green Mountain Micro's Software Policy:
Full Disclosure of Source Code
Complete Technical Information
Upgrade Information Service

Specifications for the purpose of improvement subject to change without notice.



MASTERCARD, VISA & COD'S WELCOME.

The ColorPack

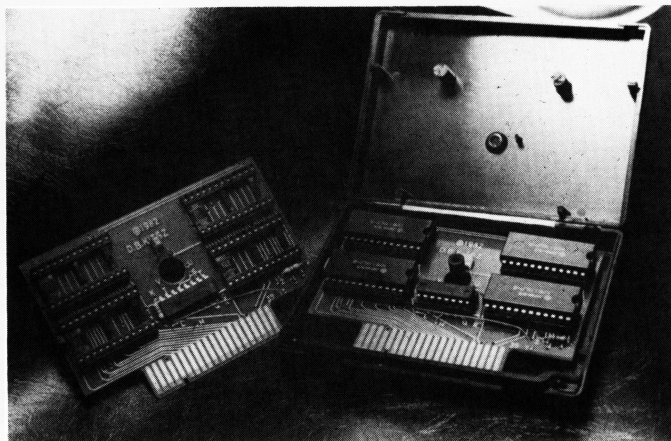

Perfect for one-of-a-kind programs or for small software firms, ColorPack accepts 16K worth of popular erasable, programmable memory (EPROMS), or 16K of static random access memory (RAM). The ColorPack has internal jumpers and sockets to select 2716, 2732 or 6116 memories. The ColorPack is the economical, reliable and space-saving alternative to other ROM packs: economical because of its low cost...reliable because of its gold edge connectors...space-saving because it can be housed in a standard plastic program pack case (optional extra).

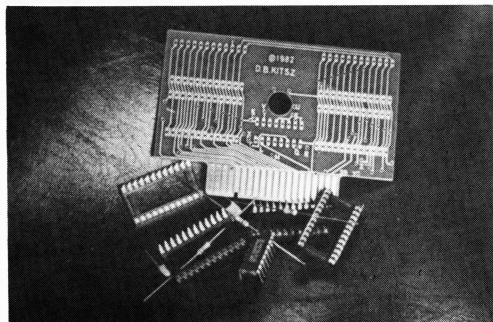

\$29.95 assembled and tested
\$19.95 complete kit of parts
\$15.00 bare printed circuit board

Add \$2.50 shipping and handling

Green Mountain Micro's Hardware Policy:
Full Disclosure of All Schematics
Complete Technical Information
Six-month Warranty
Upgrade Information Service

Assembled and tested by Green Mountain Micro. Note: We save labor, you save money by building a kit. Bare PC boards and hard-to-find parts also available separately.



MASTERCARD, VISA & COD'S WELCOME.

Specifications for the purpose of improvement subject to change without notice.

The Color Burner

An EPROM programmer is the perfect tool for creating your own program packs, but EPROM programmers have traditionally been expensive. If EPROM programmer prices make you flinch, then the Color Burner is for you. The Color Burner programs the most popular erasable, programmable read-only-memories: 2716 (2K), 2732 (4K), 2764 (8K) and 27128 (16K). It comes complete with cassette software to read, write, and verify memories. Here's how it works: Create your program using EDTASM+ or another editor / assembler / debugger, and save a CLOADM-type tape. Plug in the Color Burner, load our software and your program, and in minutes you have a finished, programmed EPROM ready for installation. The Color Burner also duplicates your programmed EPROMs. Gold edge connectors assure glitch-free, reliable programming.

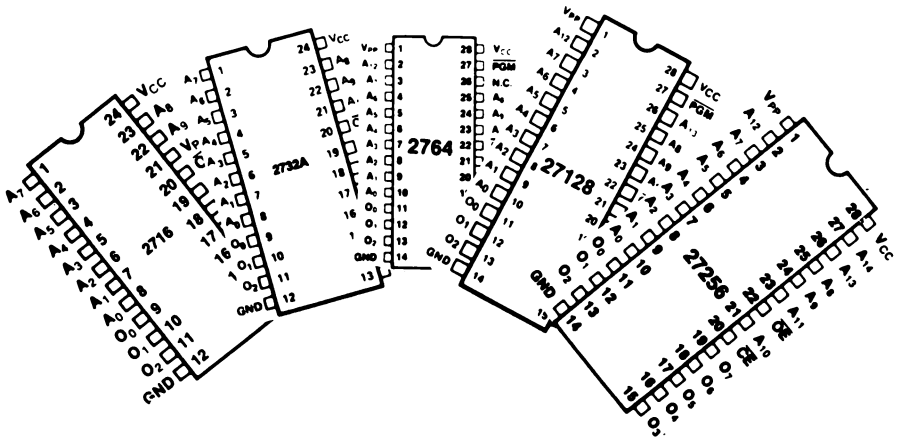

Programming software requires Extended Color BASIC, minimum 16K RAM. Personality module for 2716 provided; others optional extra. Not for the duplication of copyrighted material.

Specifications: Two 6821 PIAs plus voltage control logic, four transistors, personality module socket and zero-insertion-force EPROM socket. Requires three 9-volt alkaline batteries and EPROMs (not supplied). 230 mA current draw (max).

Featured in The Color Computer Magazine, February-March 1984.

\$49.95 assembled and tested
\$39.95 complete kit of parts
\$20.00 bare printed circuit board

Add \$2.50 shipping and handling

Available January 1, 1984

Assembled and tested by Green Mountain Micro. Note: We save labor, you save money by building a kit. Bare PC boards and hard-to-find parts also available separately.

Specifications for the purpose of improvement subject to change without notice.



MASTERCARD, VISA & COD's WELCOME.

Green Mountain Micro's Hardware Policy:
Full Disclosure of All Schematics
Complete Technical Information
Six-month Warranty
Upgrade Information Service

Scroll-A-Roll

A Display Breakthrough

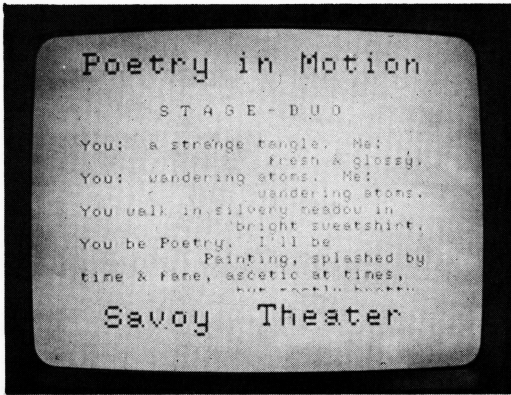

Scroll-A-Roll is a text editor and video system that provides a true rolling display with banners similar to television credits and other professional screen displays. Usual computer displays with their line-at-a-time scrolling result in bumpy, hard-to-read messages. Scroll-A-Roll smoothly rolls by and repeats up to 350 lines of text, using high-resolution graphics to create attractive, stylish upper- and lower case characters for a production-quality screen. A display text editor is an integral part of Scroll-A-Roll, with load-and-go tape storage and retrieval.

Features:

- A complete 96-character font of detailed 8 x 12 dot matrix characters are provided. These are legible, "museum quality" letters.
 - A full screen (without banners) can display from 12 to 24 lines of text. Choose the text density you like best, then add double-size banners for impact.
 - High-density information can be displayed using less detailed letters (5 x 6, for example) for 36 or more lines of text.
 - Use optional character sets, including Kata Kana. You can also build your own letters, numbers and symbols using ROLLIT, a character font development system especially for Scroll-A-Roll (optional extra).
- Scroll-A-Roll is already being used for these diverse applications:

- **Cable television news and information services**
- **Restaurant menus**
- **In-room scoreboards for motels, lodges, resorts**
- **Information services**
- **Movie theatre and arts text and poetry effects**
- **Museum events calendars**
- **Advertising displays**
- **Language instruction**
- **Rehearsal script prompts**

For 32/64K Extended Color BASIC (no disc system). For easiest editing of Scroll-A-Roll's upper/lowercase display, the Lowerkit II hardware upper/lowercase video system is recommended.

Featured in The Color Computer Magazine, June 1983.

\$24.95 on cassette

Add \$2.50 shipping and handling

Green Mountain Micro's Software Policy:
Full Disclosure of Source Code
Complete Technical Information
Upgrade Information Service



MASTERCARD, VISA & COD's WELCOME.

BannerBlast

BannerBlast is another companion program to Scroll-A-Roll. Character sets developed for Scroll-A-Roll can also be displayed in complete double-size format. With flashing words, and up to 2 separate messages, BannerBlast is a software tool for brightening up store displays, for advertising promotions, for short schedules, and for special announcements.



Requires 32/64K Extended Color Basic.

\$12.95 on cassette

Green Mountain Micro's Software Policy:
Full Disclosure of Source Code
Complete Technical Information
Upgrade Information Service

Rollit

Rollit software provides the key to developing your own custom character sets for Scroll-A-Roll. Any character can be created within the full 8 x 12 dot matrix used by Scroll-A-Roll, and will appear in both the normal text display, as well as during the creation of banners. Decorative and special graphics characters can be developed for borders, descriptive charts and graphs, or even for illustration.

Requires 16K Extended Color Basic.

\$14.95 on cassette



MASTERCARD, VISA & COD's WELCOME.

The TVBuff II

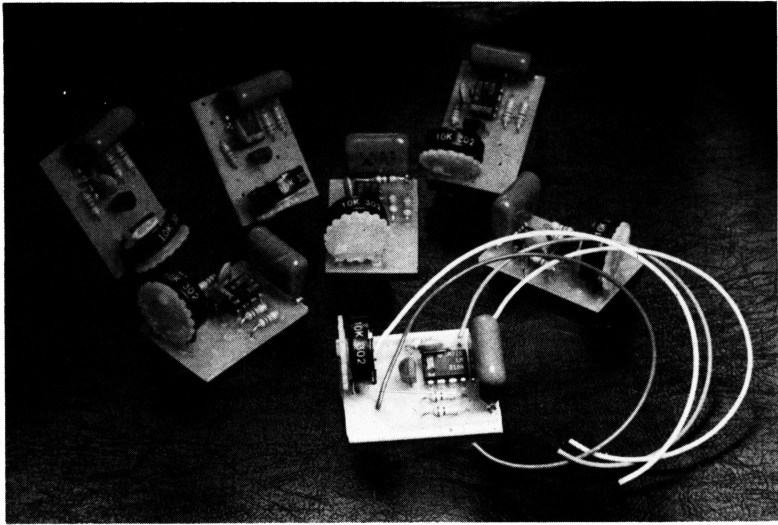

The TVBuff II is a direct video output buffer for displaying your Color Computer on a standard composite-video color monitor. There is no loss of built-in RF (television) output. TVBuff is easy to install and adjust, and works with expensive or low-cost color monitors. Small printed circuit board fits anywhere.

Specifications: 2N4401 transistor buffer and LM318 high-speed op amp. Low or high-impedance output. $\frac{3}{4}$ x $1\frac{1}{2}$ inches.

Featured in The Color Computer Magazine, March 1983.

\$14.95 assembled and tested only

Add \$2.50 shipping and handling

Specifications for the purpose of improvement subject to change without notice.



MASTERCARD, VISA & COD's WELCOME.

Replacement Parts

Replacement parts for your Color Computer are available from Green Mountain Micro. We stock 6809E processors (the CPU), 6847 video display generators (the VDG), 6821 peripheral interface adaptors (the PIA), and 6883 synchronous address multiplexers (the SAM), as well as small logic parts found inside the computer (voltage regulators, memories, capacitors, resistors, etc.). We do not stock Color Basic or Extended Color BASIC.

11. Replace the case top and screws. Your TVBuff II will not need adjustment unless you change monitors.

Problems?

No picture on new monitor setup:

- a. Wires hooked to the wrong locations.
- b. Wires reversed (especially blue and red).
- c. Output wire shorted or hooked to the wrong side of output connector.
- d. Variable resistor turned the wrong way.
- e. Poor solder connection.
- f. Bottom of TVBuff II touching video modulator case.
- g. Computer turned off or not plugged in.
- h. Monitor not connected at all, not turned on, not plugged in, or accidentally connected to RF output jack instead of TVBuff.
- i. Damaged TVBuff II.

No picture on original television setup:

- a. Wires hooked to the wrong locations.
- b. Computer turned off or not plugged in.
- c. Bottom of TVBuff II touching video modulator case.
- d. Television not connected, not turned on, not plugged in, or accidentally connected to new monitor output jack.

Poor color or contrast on monitor:

- a. Variable resistor not properly adjusted.
- b. White wire connected to wrong location.
- c. Incorrectly adjusted monitor input level (on some monitors such as Amdek green monitors).
- d. Damaged TVBuff II.

Poor color or contrast on original television setup:

- a. White wire connected to wrong location.
- b. Damaged TVBuff II.

Using a Monochrome Monitor??

A monochrome monitor -- green, amber, black-and-white, etc. -- reacts a little differently to a color signal. Expect to see a slight grid-like effect on the screen, a result of the unnecessary color information being displayed. It doesn't take long to get used to it, and adjusting the contrast on the monitor can reduce its appearance. The only way to eliminate the grid effect is to modify the computer itself, and build the monochrome display circuit provided by Motorola. We have the Motorola 6847 data sheets (\$1 plus 2 ounces postage) if this interests you.

Additional Notes

1. On most color monitors, the best video image is achieved with the control turned fully clockwise. On black-and-white monitors, anywhere over the full range of the control may result in the best image.
2. There are many so-called "video monitors" beings sold, especially surplus black-and-white or green computer pullouts. Be cautious with surplus monitors, or with any bargain machines. In some instances, it may be necessary to put a capacitor (0.22 mF, usually) in series with the yellow output wire (between the yellow wire and the connection jack you are using) to obtain a stable image.
3. To minimize any "glimmering" when using a color television along with or instead of a monitor (with the TVBuff II installed), make the wires to and from the TVBuff II as short as possible. This is particularly important on early (through revision E) computers.

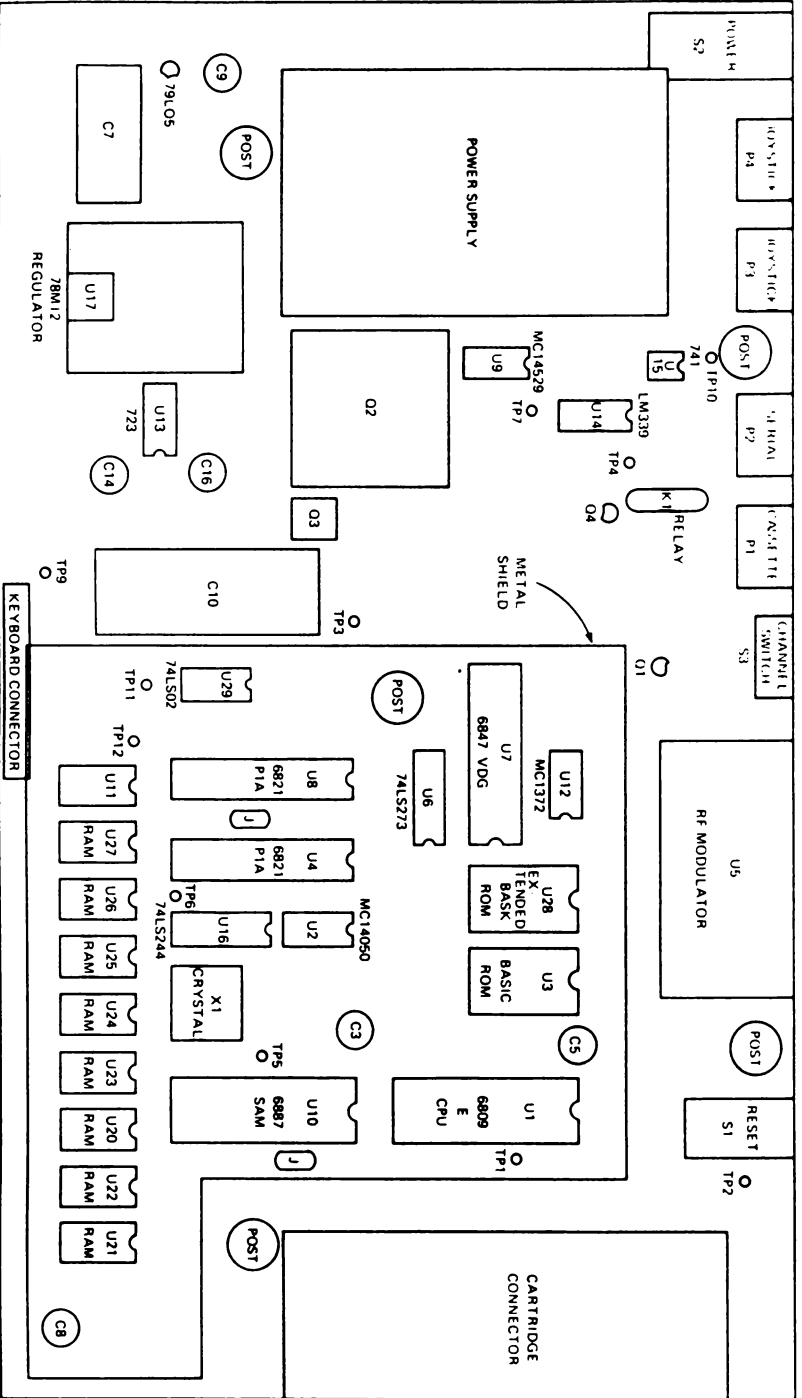

Board layout of Color Computers, Rev. C through Rev. E. Minor differences concern jumpers and piggybacking of integrated circuits.

The BackPack

At last...battery backup for your TRS-80 Color Computer. The BackPack provides 5 to 15 minutes of power backup to your Color Computer, enough to save valuable program or text material. Using rechargeable batteries, the BackPack stays at full power until you need it. Manual reset ensures that power is restored before the BackPack is turned off. BackPack plugs into edge connector but leaves space for your ROMpack or diskpack.

Specifications: +12V at 1A, +5V at 750 mA, -5V at 5 mA, -12V at 10 mA. Backup duration depending on system configuration: approx. 15 minutes for 16K Color BASIC, 5 minutes for 64K Extended BASIC with disk pack. Requires ten 1.25-volt rechargeable AA batteries (not included). Solderless version for 32/64K Color Computers. 16K computers require one wire connection inside computer. Does not power TV/monitor, disk drive motor (logic remains functional), or tape recorder. Not for Color Computer 2 disk systems.

\$54.95 assembled and tested

Add \$2.50 shipping and handling

Available February 1, 1984



MASTERCARD, VISA & COD's WELCOME.

Green Mountain Micro's Hardware Policy:
Full Disclosure of All Schematics
Complete Technical Information
Six-month Warranty
Upgrade Information Service

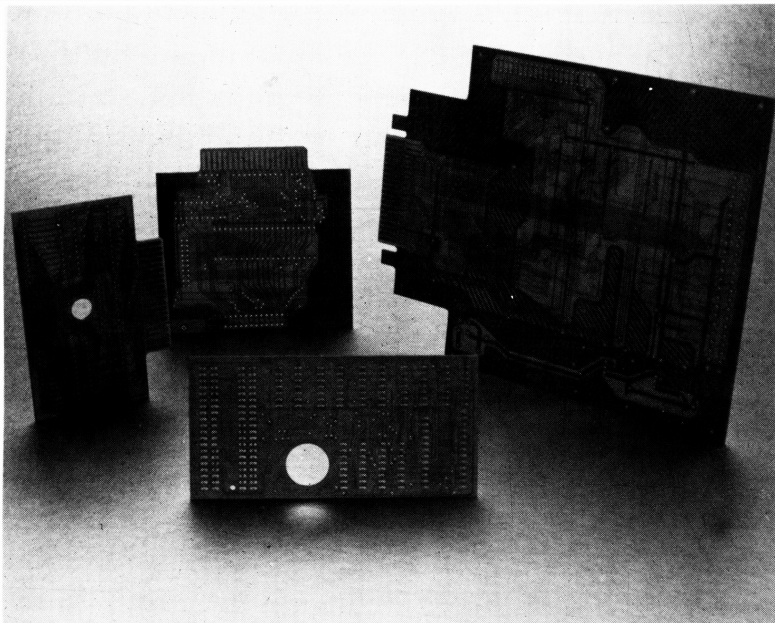

We save labor, you save money by building a kit. Bare PC boards and hard-to-find parts also available separately.

Specifications for the purpose of improvement subject to change without notice.

Prices subject to change without notice.

TRS-80, TDP-100, Scripsit, Radio Shack are trademarks of Tandy Corporation.

64K Memory Upgrade

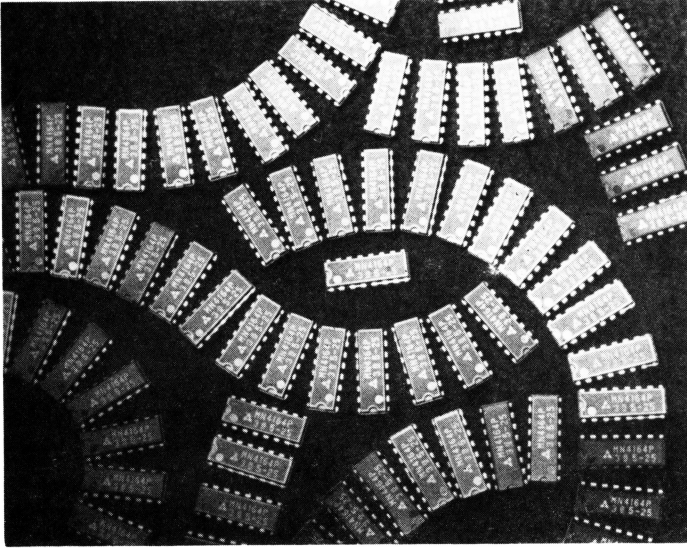

\$49.95 complete Add \$2.50 shipping and handling



MASTERCARD, VISA & COD's WELCOME.

**Green Mountain Micro
Bathory Road
Roxbury, Vermont 05669**

