

Cloud Master™

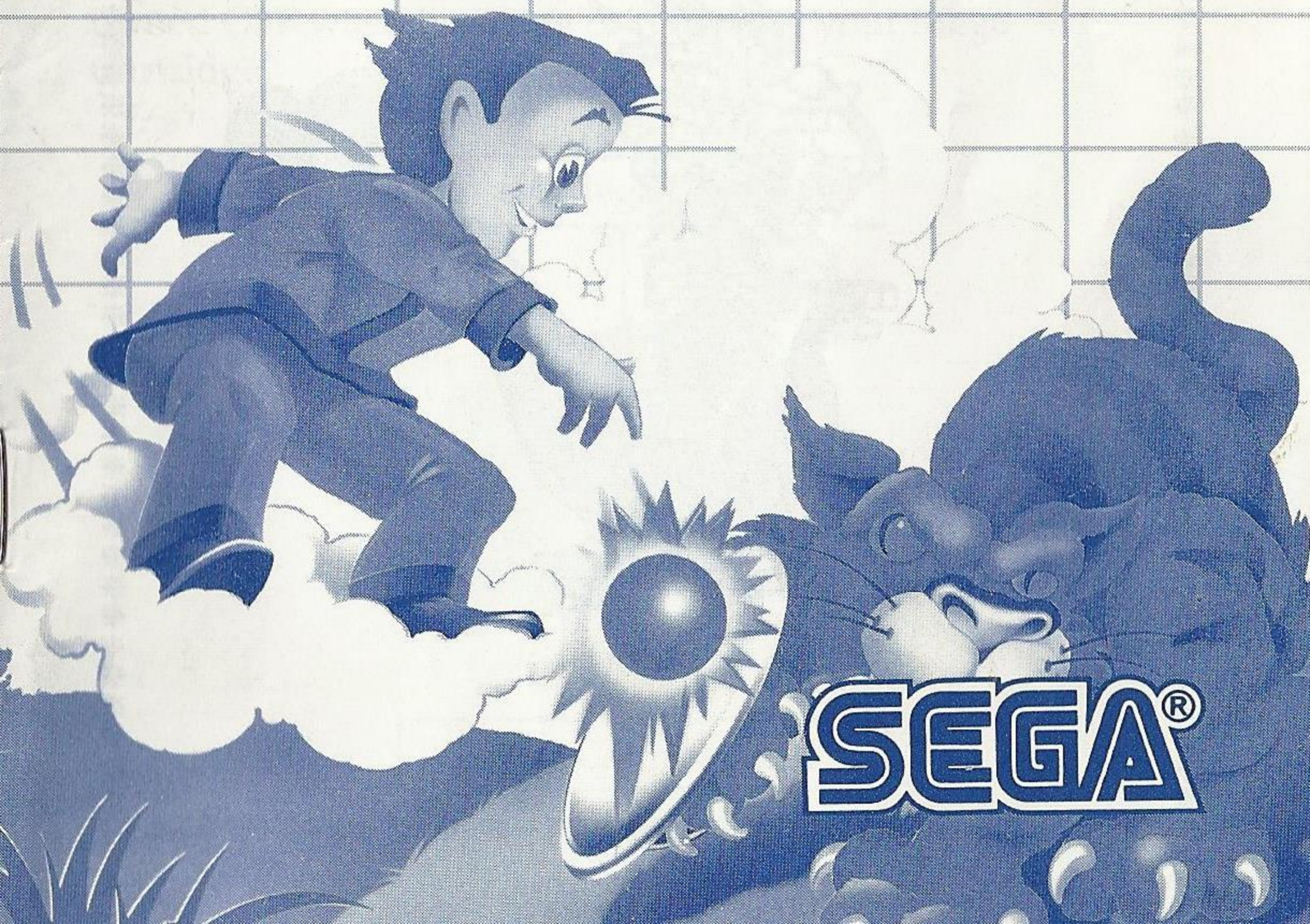

SEGA®

The dangerous journey of the great wise prophet Michael Chen begins in the sky somewhere deep in the heart of China. Help him find the path to enlightenment in this high-flying adventure from Sega.

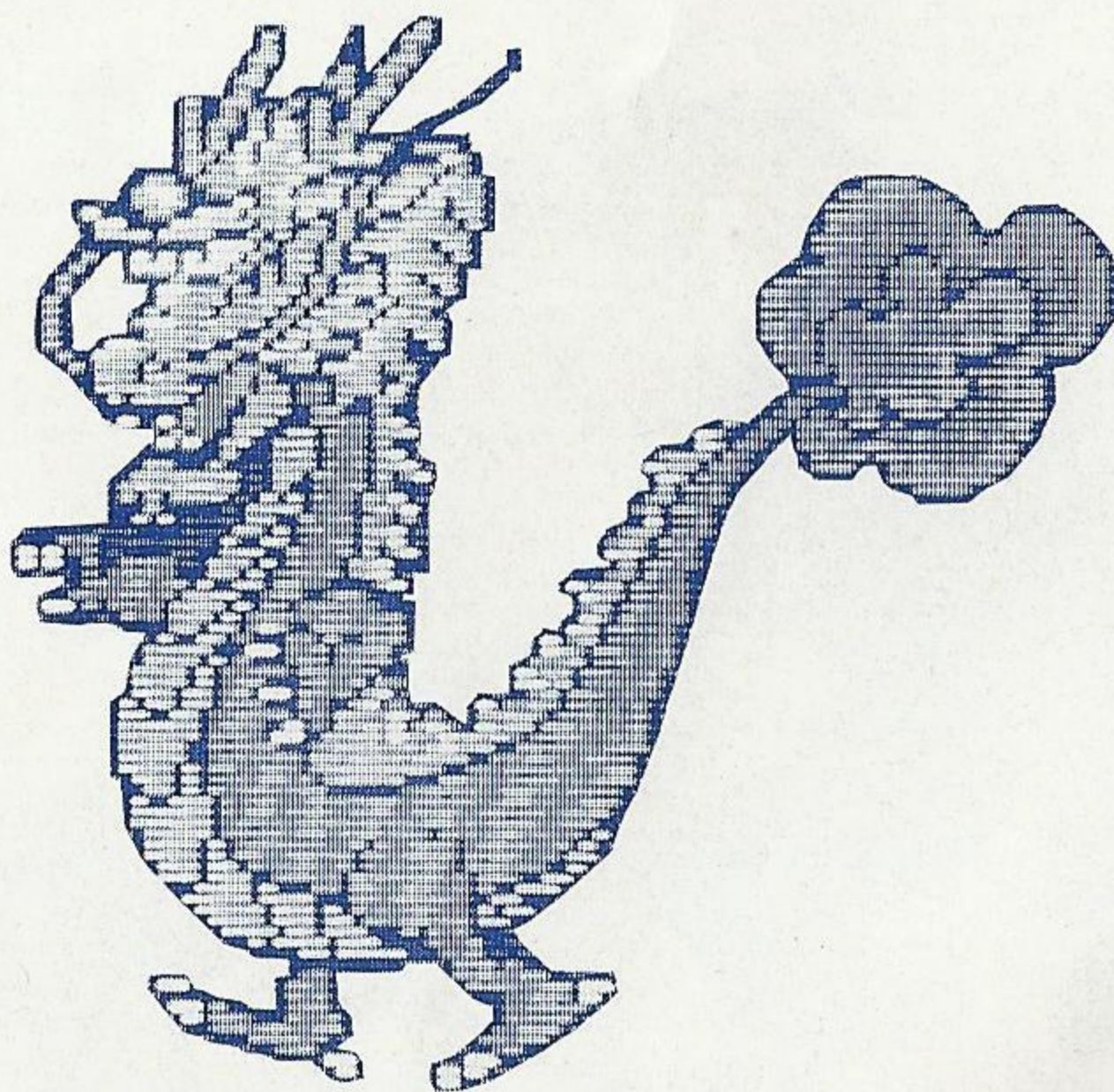

Loading Instructions:

Starting Up:

- 1) Make sure the power switch is OFF.
- 2) Insert the game cartridge in the Power Base (shown below) as described in your SEGA SYSTEM manual.
- 3) Turn the power switch ON. If nothing appears on the screen, turn the power switch OFF, remove the cartridge, and try again.
- 4) At the title screen, press Button 1 to start the game.

IMPORTANT: Always make sure that the Power Base is turned OFF when inserting or removing your Mega Cartridge.

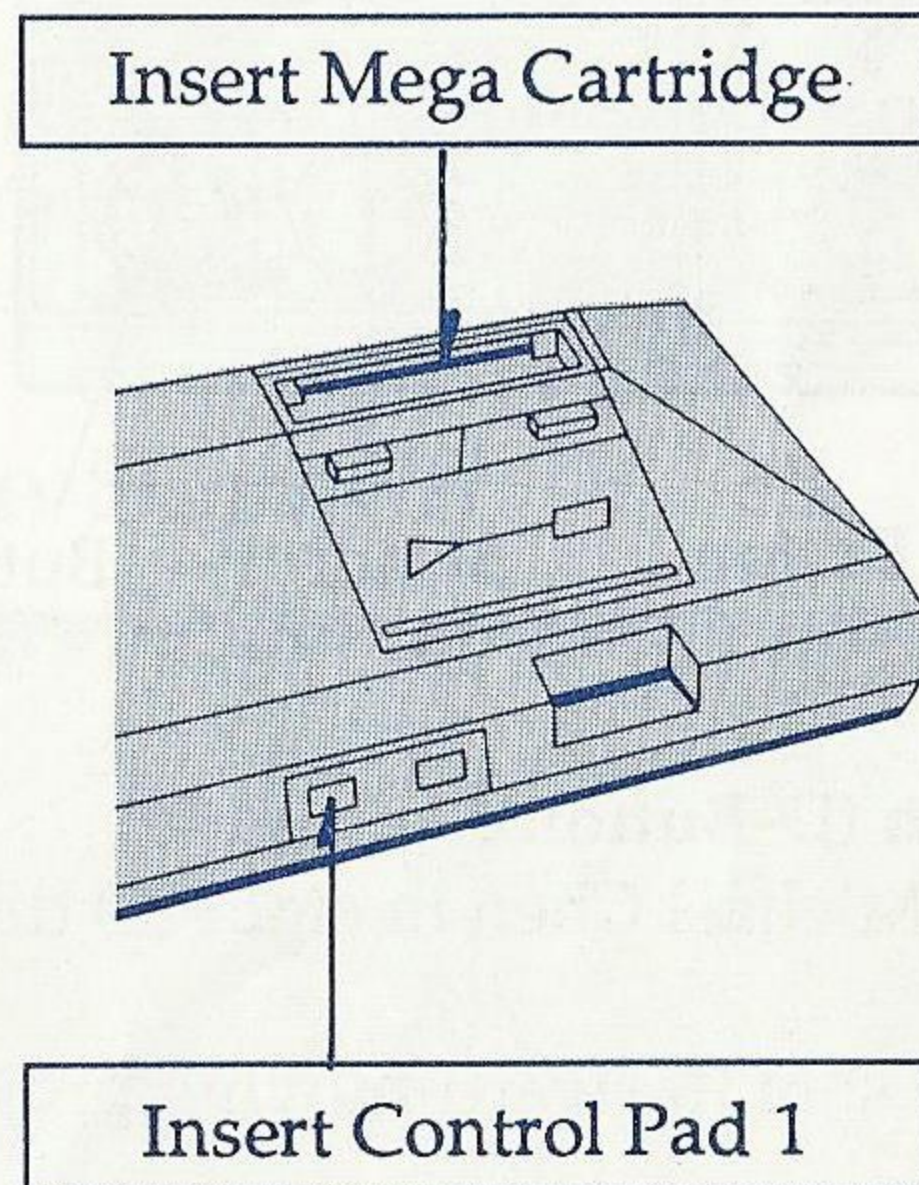

The Story of Michael Chen

Back when the Earth was young, there was a mysterious hermit named Michael Chen who rode the wind on a cloud-like chariot. He had meditated deep in the mountainous regions of central China for many years, and had grown powerful with the knowledge of the ancients. With luck and a little more study, he hoped to gain the title of "Cloud Master," which would make him a powerful mystic indeed.

But dark forces conspired against the young hermit, and attacked him one after the other, trying to interfere with his all-important studies. Help Michael Chen wipe out these evil powers and assist him in becoming a Cloud Master!

Taking Control

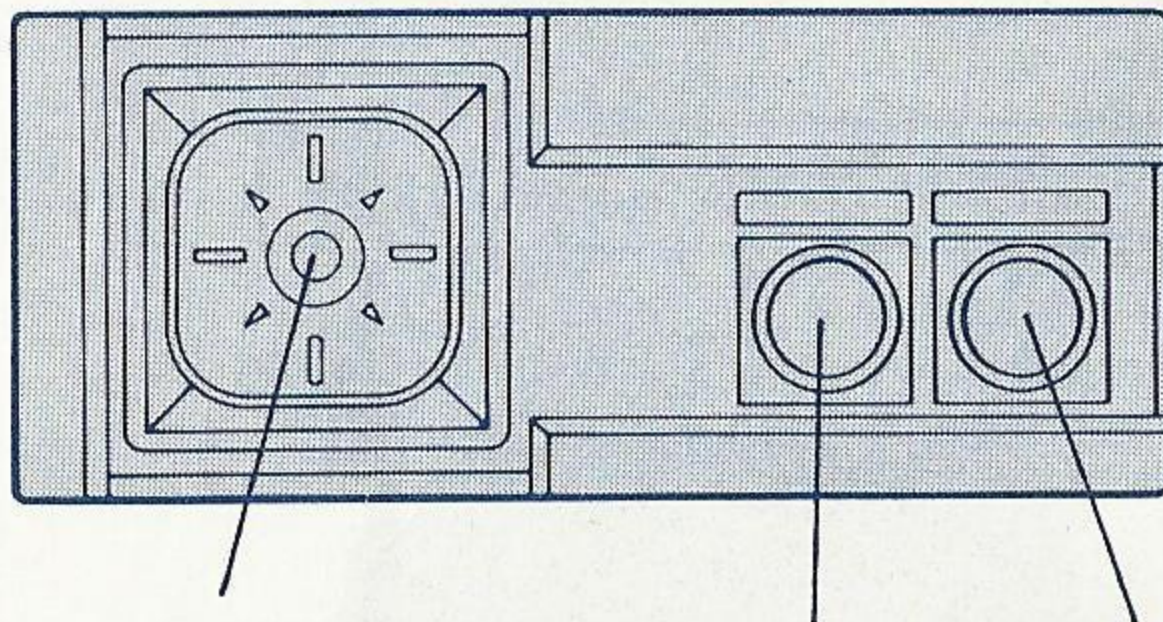

Directional Button
(D-Button)

Button 1

Button 2

Directional Button (D-Button):

Moves Michael Chen in eight (8) directions.

Button 1: Normal shot (forward-moving projectile).

Button 2: Power-up weapon.

Game Objective

At the title screen, choose one or two players. As the screen scrolls slowly to the left, you control Michael Chen, who rides on his cloud and shoots at oncoming enemies. The game is divided into five rounds. At the end of each round, a boss creature must be defeated in order to move on to the next round. Middle bosses also occupy each round. These must be defeated in order to obtain special power-up weapons. When the boss at the end of Round 5 is defeated, the game returns to Round 1, but with heightened action.

Game Over

Each player starts with four lives. You lose a life whenever you touch or are shot at by an enemy, or if you get squeezed to the edge of the screen by a rock. You gain a new life when you reach 30,000 points, and every 200,000 points after that.

When the game ends, you have the option of continuing at the point in the round you last occupied. You can use the Continue feature up to three (3) times.

The Game Screen



The Battle

At first, you'll have to destroy the enemy using a normal shot. Destroy the middle bosses in order to enter the power-up chamber. You see the chamber as a door with a (?) on it. Maneuver Michael Chen over the door and push the D-Button up. Once inside, you have your choice of various power-up weapons. Select the weapon you want with the D-Button and press Button 1 to obtain it. Once back outside, press Button 2 to activate the power-up weapon.

Once you've obtained a power-up weapon, it stays in effect as long as you don't lose a life. If you make it to the next power-up chamber, even more powerful weapons will be at your disposal. In addition, if you choose the same type of weapon twice in a row, its power will be increased.

Power-Up Weapons

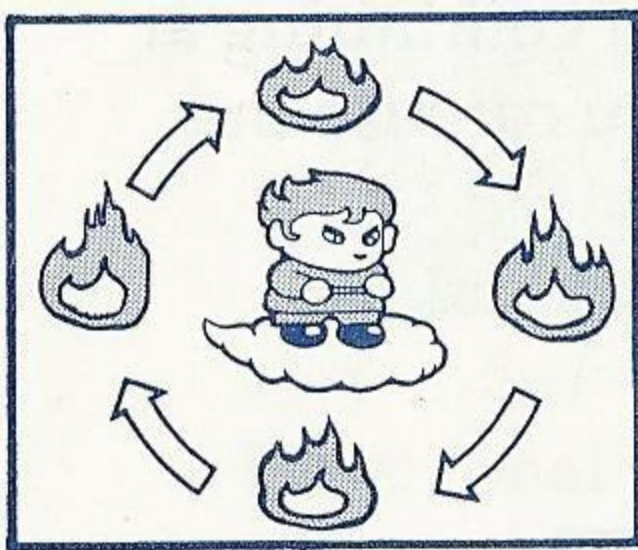

Four-Circle Guard:

Four fireballs encircle Michael Chen. They extinguish when they destroy an enemy, but when all have been used up, press Button 2 again for a fresh supply. (Attack power = 6.)



Two-Way Guard:

Two fireballs shoot out above and below Michael Chen. (Attack power = 4.)

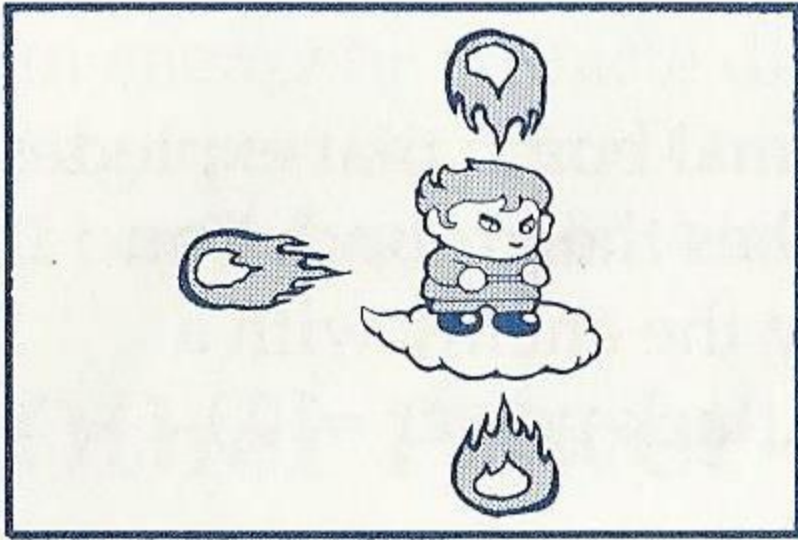

Three-Way Guard:

Three fireballs shoot out above, below and behind Michael Chen. (Attack power = 4.)

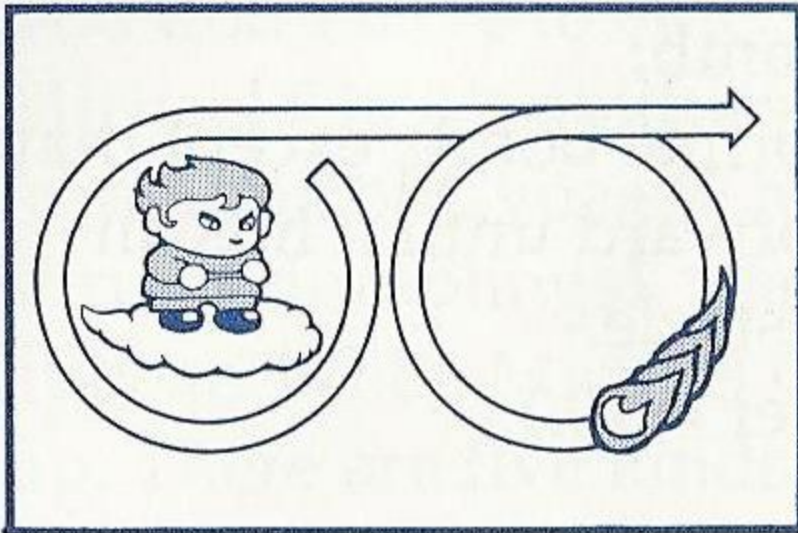

Dragon Fire:

Flame circles Michael Chen once and then shoots forward. It continues rotating, extinguishing as it travels forward.

(Attack power = 10.)

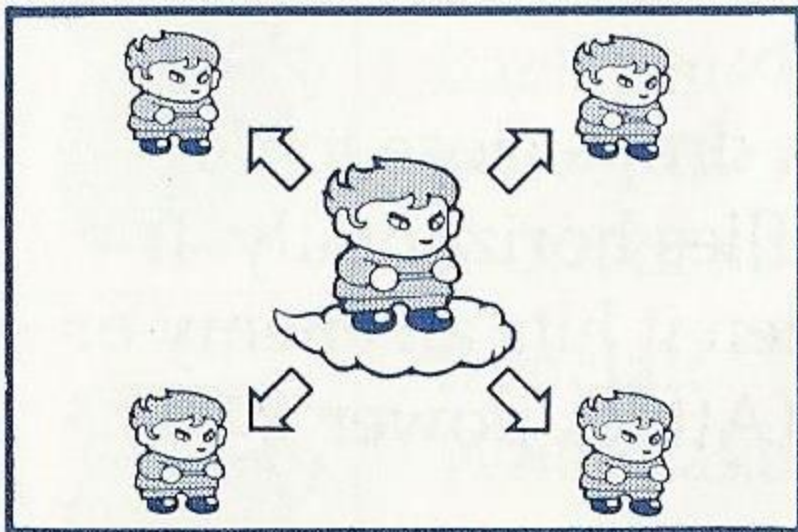

Four-Images:

Four images of Michael Chen fly off in separate directions.

(Attack power = 4.)

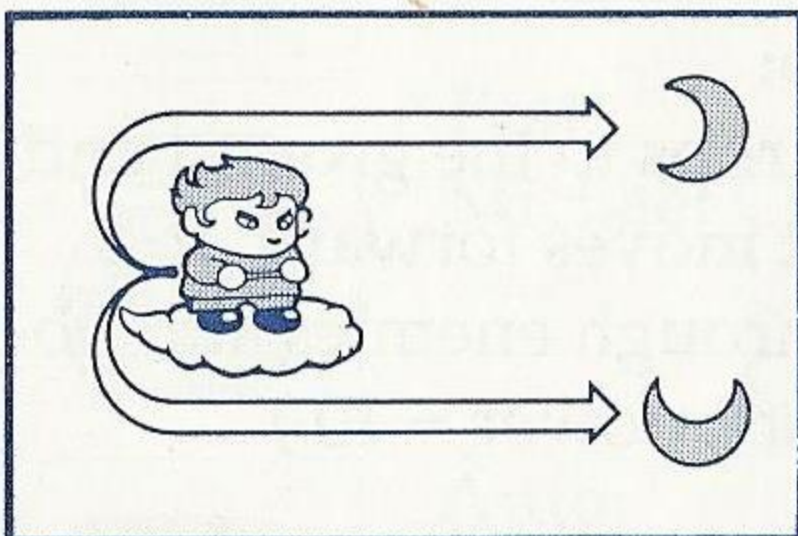

Two Crescents:

Two crescent-shaped shots are fired backward. They then separate and curve forward. (Attack power = 4.)

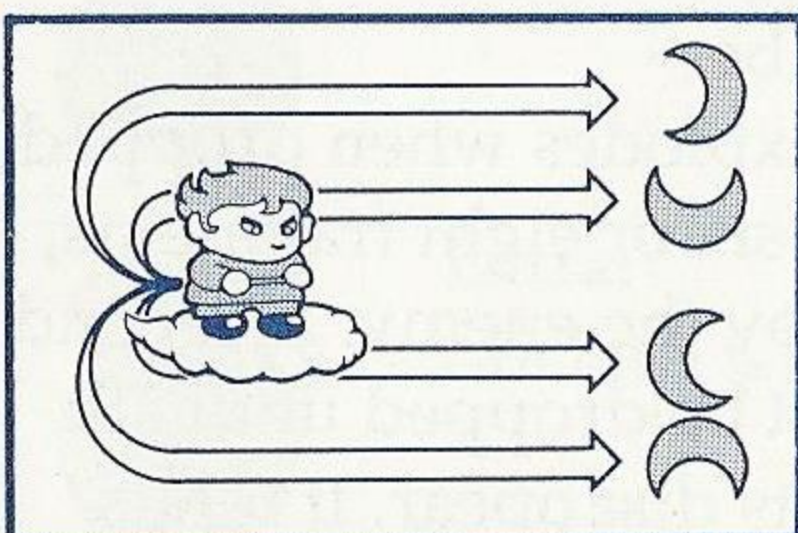

Four Crescents:

Four crescent-shaped shots are fired backward. They then separate and curve forward. (Attack power = 4.)

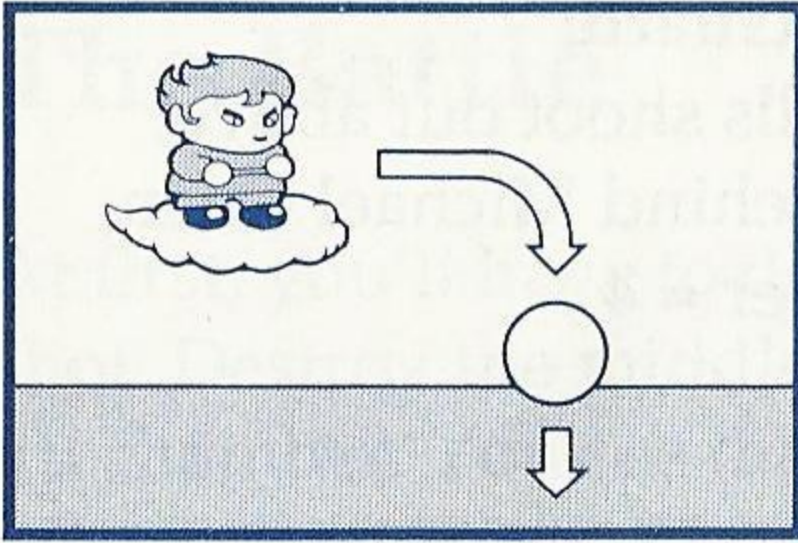
**Bomb:**

This is a normal bomb that explodes when it reaches the ground. You must destroy the enemy with a direct hit. (Attack power = 10.)

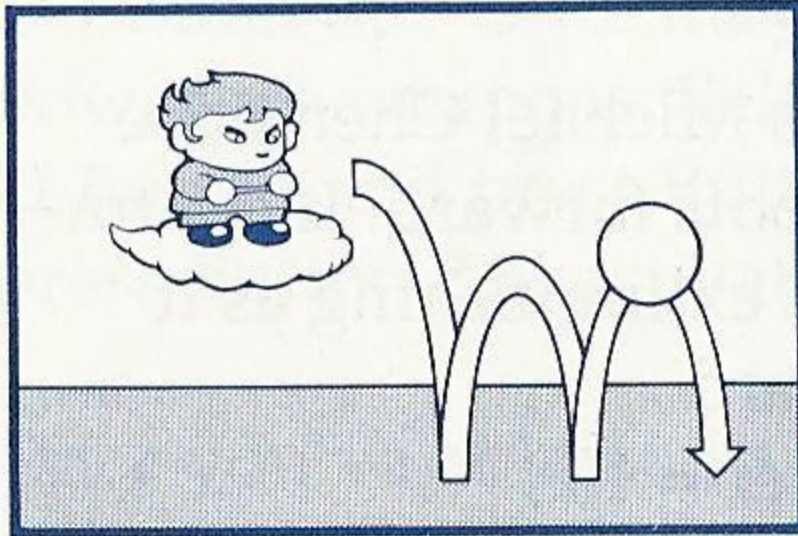
**Bouncing Bomb:**

Same as a normal bomb, except that it bounces forward until it hits an enemy or obstacle. (Attack power = 10.)

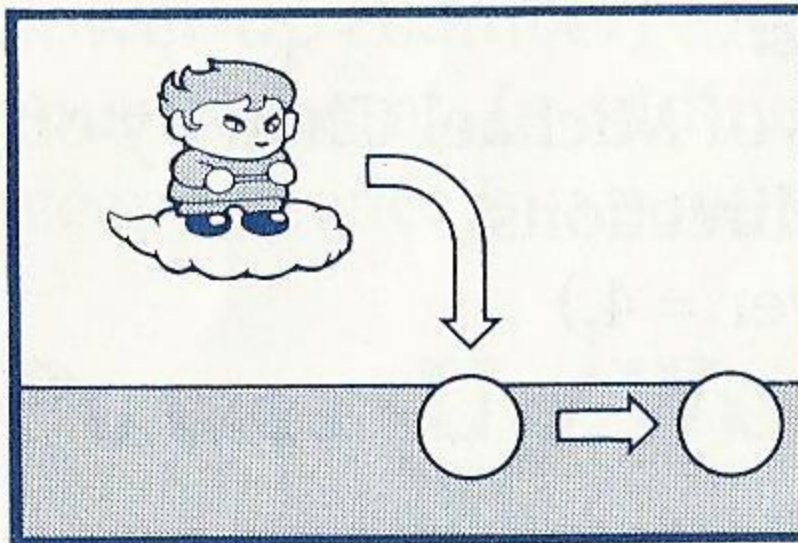
**Search Bomb:**

This weapon drops close to the ground and flies horizontally. It explodes when it hits an enemy or an obstacle. (Attack power = 10.)

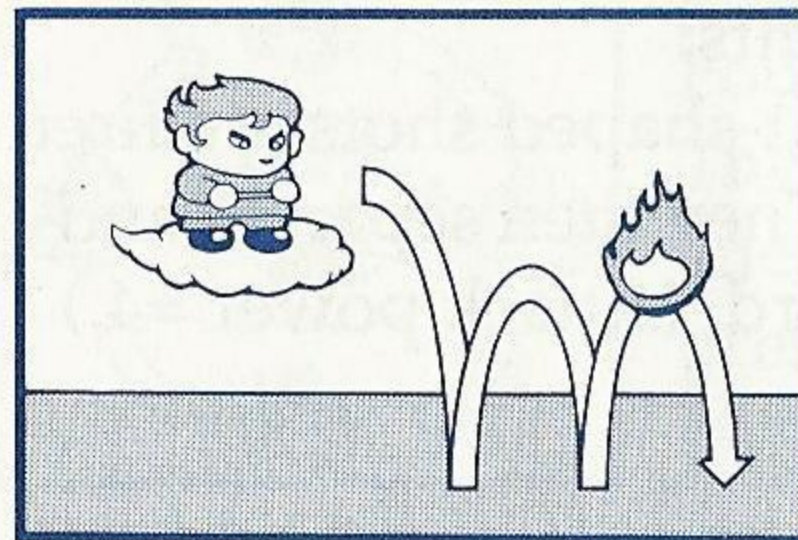
**Super Bomb:**

This bomb drops to the ground and bounces as it moves forward. It penetrates through enemies and obstacles. (Attack power = 10.)

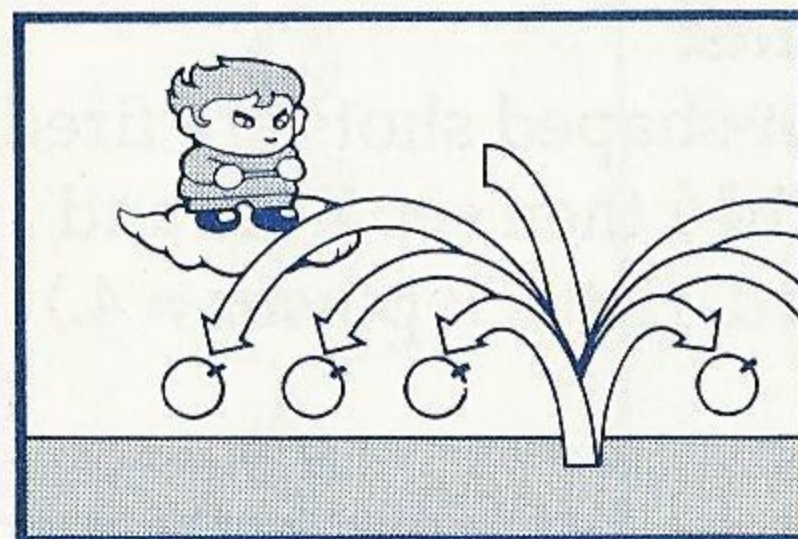
**Scatter Bomb:**

This bomb explodes when dropped and scatters six or eight fragments, which destroy the enemy. A second bomb cannot be dropped until all the fragments disappear. If it hits

an enemy or obstacle directly, it destroys them but does not fragment. (If a direct hit: Attack power = 10.
If bomb fragments: Attack power = 5.)

Other Power-Up Methods

You don't have to enter the power-up chamber to increase Michael Chen's abilities. Sometimes, when you knock down a formation of Gyoza (Chinese dumplings) or Shumai (Chinese shrimp dumplings), a jar containing a power-up item will appear. When Michael Chen touches the jar, his power goes up. There are five kinds of power-up jars:



Power:

Each time this is taken, Michael Chen's shot power increases by one (1) step, up to a maximum of six (6) steps.



Special:

When taken, Michael Chen's power goes up by two (2) steps.



Fast:

Michael Chen's speed increases by six (6) steps.

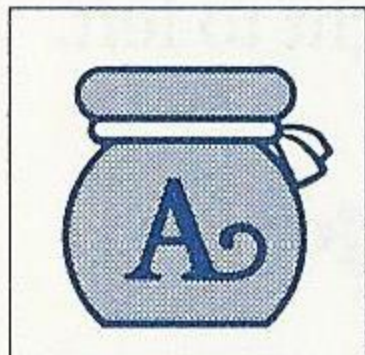

Auto:

Michael Chen's weapons shoot rapid-fire.



Extra:

Michael Chen's number of lives increase by one.

The Enemy



Gyoza: 100 points
Four per formation.



Shumai: 100 points
Four per formation.



Ramen: 100 points
Flies in a zigzag.



Kanton Man: 200 points



Pig Head: 200 points
Flies in a circle.



White Tile: 300 points
Pursues Michael Chen.



Flying Tiger: 200 points



Mushroom: 100 points
Flies toward Michael Chen in a circle.



Chu Tile: 100 points
Scatters shots in four directions. Also makes one shot aimed at Michael Chen.



Small Rock: 500 points
Flies horizontally at high speed from right to left.

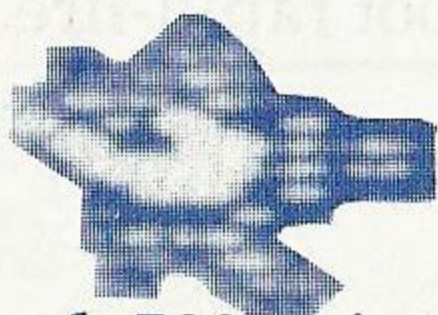

Sword: 500 points
Flies horizontally at high speed from right to left.



Cone Rock: 500 points
Drops slowly from top to bottom.

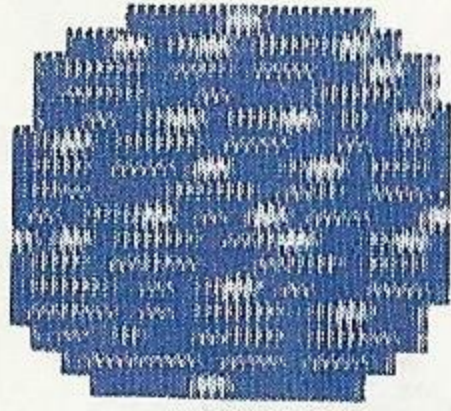

Big Rock: 500 points
Flies slowly and horizontally from right to left.



Panda: 100 points
Appears from the cloud in a group of three (3).



Piggoid: 300 points
Appears from the ground.

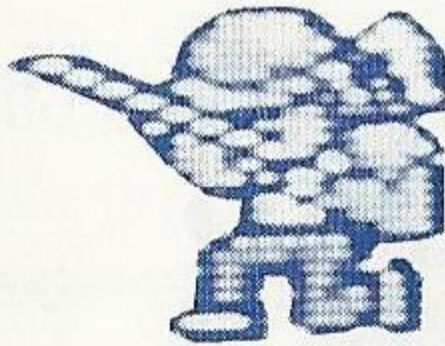

Soldier: 200 points
Takes 2~3 steps to right or left; rarely shoots.



Turtle: 100 points
Shoots from the ground.



Monkey: 200 points
Jumps backwards while running.

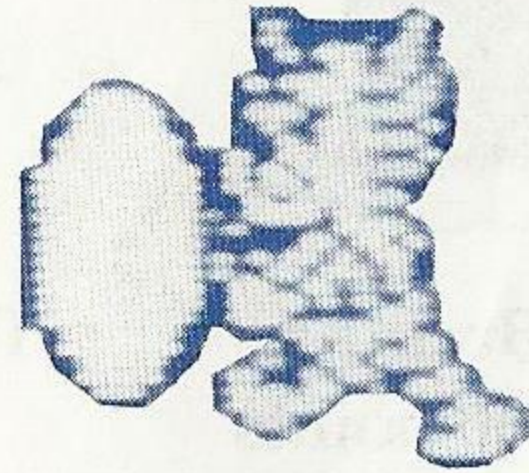

Tiger with Shield: 200 points
Runs out to screen from right and disappears tumbling.



Ground Dragon: 300 points
Shoots from the ground.



Rock on Ground
Nondestructive; cannot be destroyed. Will lose life if trapped between rock and edge of screen.

Middle Bosses



Lightning Boy: 5,000 points
Shoots lightning.
Appears twice. (Round 1)



Evil Hermit: 6,000 points
Appears twice. (Round 2)



Bad Buddha:
7,000 points
Appears twice.
(Round 3)



Two-Headed Demon:
8,000 points
Appears twice.
(Round 4)



Kaimyo Beast:
9,000 points
Appears 3 times.
(Round 5)

Round Bosses



Phoenix: 10,000 points



Kappa: 10,000 points

(Round 1)

(Round 2)

(Round 3)

**Giant Buddha:** 10,000 points

(Round 4)

**Shogun:** 10,000 points

(Round 5)

????: 10,000 points

Helpful Hints

- Your enemies will attack in patterns. Memorize these patterns and use to plan your attacks!
- Get the Power-Up items as quickly as you can. Fighting the mid and end bosses is difficult if your power is weak. Don't let the dumplings escape!
- Take out the enemies that attack from the ground first.

Scorebook

Name				
Date				
Score				

Name				
Date				
Score				

Name				
Date				
Score				

Handling The Mega Cartridge™

- The Mega Cartridge is intended exclusively for the Sega System™.
- Do not bend, crush or submerge in liquids.
- Do not leave in direct sunlight or near a radiator or other source of heat.

90-Day Limited Warranty Sega® Card/Cartridge

To validate the following 90-day limited warranty, your sales slip or proof of purchase should be retained at time of purchase and presented at time of warranty claim.

90-Day Limited Warranty

Sega of America, Inc. warrants to the original consumer purchaser that this Sega Card™ / Cartridge™ shall be free from defects in material and workmanship for a period of 90 days from the date of purchase. If defect covered by this warranty occurs during this 90-day warranty period, Sega will repair or replace the defective card/cartridge, at its option, free of charge.

This warranty does not apply if the defects have been caused by negligence, accident, unreasonable use, modification, tampering or any other causes not related to defective materials or workmanship.

To receive fast, reliable service, call the Sega Customer Service Department at the following numbers:

Outside California: 800-USA-SEGA

Inside California: 415-742-9300

Our Customer Service Department is in operation from 9:00 AM to 5:00 PM (Pacific Time), Monday through Friday. *Do not return your Sega Card/Cartridge to your retail seller.*

Sega's service center is located at the following address:

Sega of America, Inc.

Warranty Repair

573 Forbes Blvd.

South San Francisco, CA 94080

Limitations On Warranty

Any applicable implied warranties, including warranties of merchantability and fitness for a particular purpose, are hereby limited to ninety days from the date of purchase and are subject to the conditions set forth herein. In no event shall Sega of America, Inc. be liable for consequential or incidental damages resulting from the breach of any express or implied warranties.

The provisions of this warranty are valid in the United States only. Some states do not allow limitations on how long an implied warranty lasts or exclusion of consequential or incidental damages, so the above limitations of exclusion may not apply to you. This warranty provides you with specific legal rights. You may have other rights which vary from state to state.

Sega Customer Service, 573 Forbes Blvd., South San Francisco, CA 94080

(800) U.S.A.-S.E.G.A.

Distributed by Tonka Corp.

7027

SEGA[®]

F R O M T O N K A

CONTROL PAD and CONTROL STICK are trademarks of Sega of America, Inc. SEGA is a trademark of Sega Enterprises, Ltd., a CSK Group Company. ©1989 Sega. All Rights Reserved.

PRINTED IN JAPAN

©1989 Tonka Corp. All Rights Reserved.