

# Carriers At War

© SSG 1984

## GAME MENUS

### KEY SUMMARY

To cycle within a menu, type (RET) if Y/N; use the arrow keys if not.

To select from a menu, type (Y)(RET) if Y/N; just (RET) if not.

To recover the previous menu, type (f1).

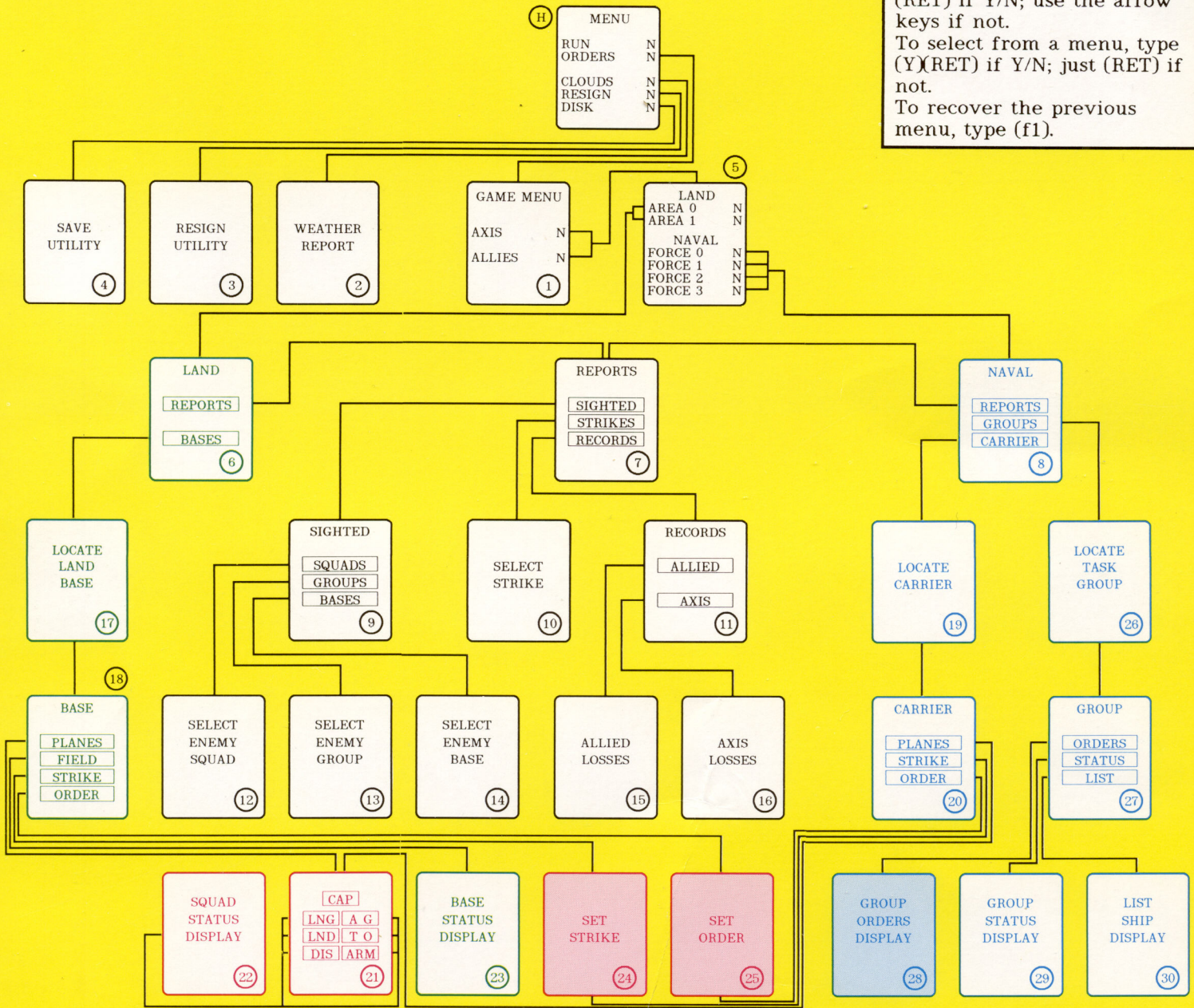

## INDEX TO GAME MENUS

- 1 - NATIONALITY SELECT
- 2 - WEATHER REPORT
- 3 - RESIGN UTILITY
- 4 - SAVE GAME UTILITY
- 5 - AREA/FORCE SELECT
- 6 - LAND COMMANDER
- 7 - REPORT SELECT
- 8 - NAVAL COMMANDER
- 9 - ENEMY SIGHTINGS SELECT
- 10 - FRIENDLY STRIKE SELECT

- 11 - RECORDS SELECT
- 12 - ENEMY AIR SELECT
- 13 - ENEMY NAVAL SELECT
- 14 - ENEMY LAND SELECT
- 15 - ALLIED LOSSES
- 16 - AXIS LOSSES
- 17 - FRIENDLY BASE SELECT
- 18 - BASE OPERATIONS SELECT
- 19 - FRIENDLY CARRIER SELECT
- 20 - CARRIER OPS SELECT

- 21 - PLANE STATUS DISPLAY
- 22 - SQUAD STATUS DISPLAY
- 23 - BASE STATUS DISPLAY
- 24 - SET STRIKE ROUTINE
- 25 - SET ORDER ROUTINE
- 26 - FRIENDLY TG SELECT
- 27 - TG OPERATIONS SELECT
- 28 - TASK GROUP ORDERS
- 29 - TASK GROUP STATUS
- 30 - LIST SHIP DISPLAY

## START MENU

### KEY SUMMARY

To cycle within a menu, type (RET). To select from a menu, type (Y)(RET). To recover the previous menu, type (f1). Note that the START MENU can not be recovered from the GAME MENU (H) or the DESIGN MENU (J).

## INDEX TO START MENUS

A - START UP MENU	G - GAME EDIT UTILITY
C - DISK UTILITY	H - GAME MASTER
E - SCENARIO SELECT	I - SCENARIO SELECT
F - PLAYER MENU	J - DESIGN MASTER

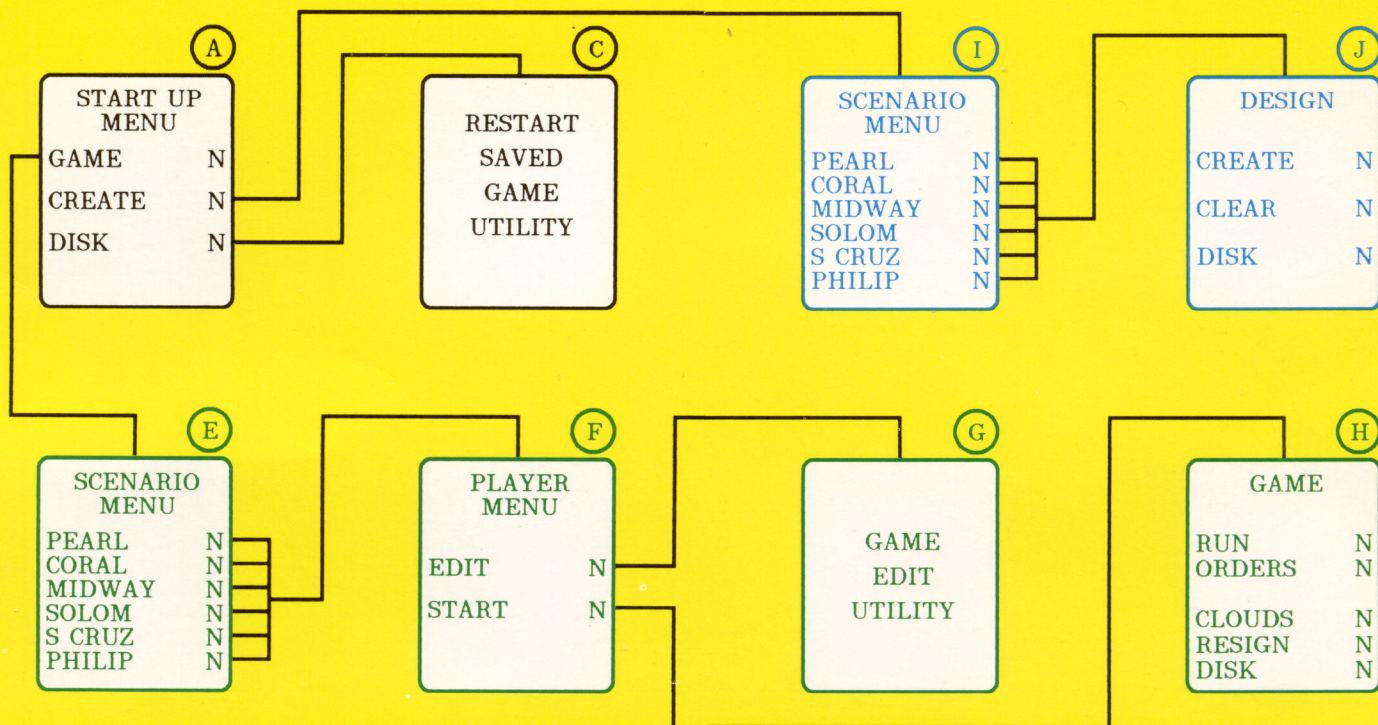

## STARTING THE GAME

Place the 'CAW' disk into the disk drive. Close the disk drive and turn on the monitor, disk drive and computer.

Type in the following instructions.

LOAD "CAW",8 (RET)

RUN (RET)

Note that (RET) means to hit the RETURN key.

Menu A (the Start Up menu) will appear on the screen after a short delay.

## FEATURES OF THE C-64 VERSION

1. In both the Player and Design Manuals you are frequently directed to hit the (ESC) key. There is no such key on the C-64. In all cases, substitute the (f1) key for the (ESC) key.
2. The left and right and up and down arrow keys referred to in the Player and Design Manuals are replaced by the cursor arrow keys on the C-64. For example, to move the cursor upwards, hold down the (SHIFT) key while tapping the up/down cursor key. To move the cursor downwards, just tap the up/down cursor key.
3. When editing the design routines you must hold down the (SHIFT) key should you wish to use lower case text at any time.
4. There are two changes to the Design Kit Menus displayed on the back cover of the Design Manual. The

<REBOOT> line in Menu J and the <PRINT> line in Menu 3 do not exist in the C-64 version. Thus Menu 5 from the Design Menus is also not available.

## THE INTRODUCTORY TUTORIAL

Once you have started up the game and familiarized yourself with the distinctive features of the C-64 version, we recommend that you begin with the Introductory Tutorial. This can be found at the front of the Player's Manual.

## SAVING OR RESTARTING A GAME

It is not necessary to go through this procedure until you have a need for it.

**(a) Saving a Game.** Select Menu H then Menu 4. Place a blank disk in the disk drive. Select the <INIT> line and type (Y)(RET) to initialize the disk if you have not previously done so. Select the <EDIT> line and type (Y)(RET). The save game disk is formatted to hold four saved games. Type (RET) until the cursor is positioned on the <SAVE> line in the top save location and then type (Y)(RET). You may enter a comment of up to 17 letters, then type (RET). Note that the scenario from which the game is saved will appear below the comment line. Type (f1) to continue playing the game.

**(b) Restarting a Saved Game.** Select Menu C from Menu A. Select the <EDIT> line and then position the cursor on the <LOAD> line of the chosen saved game. Type (Y)(RET) and then (f1) to restart the saved game.

# Carriers At War

BATTLE MAP B

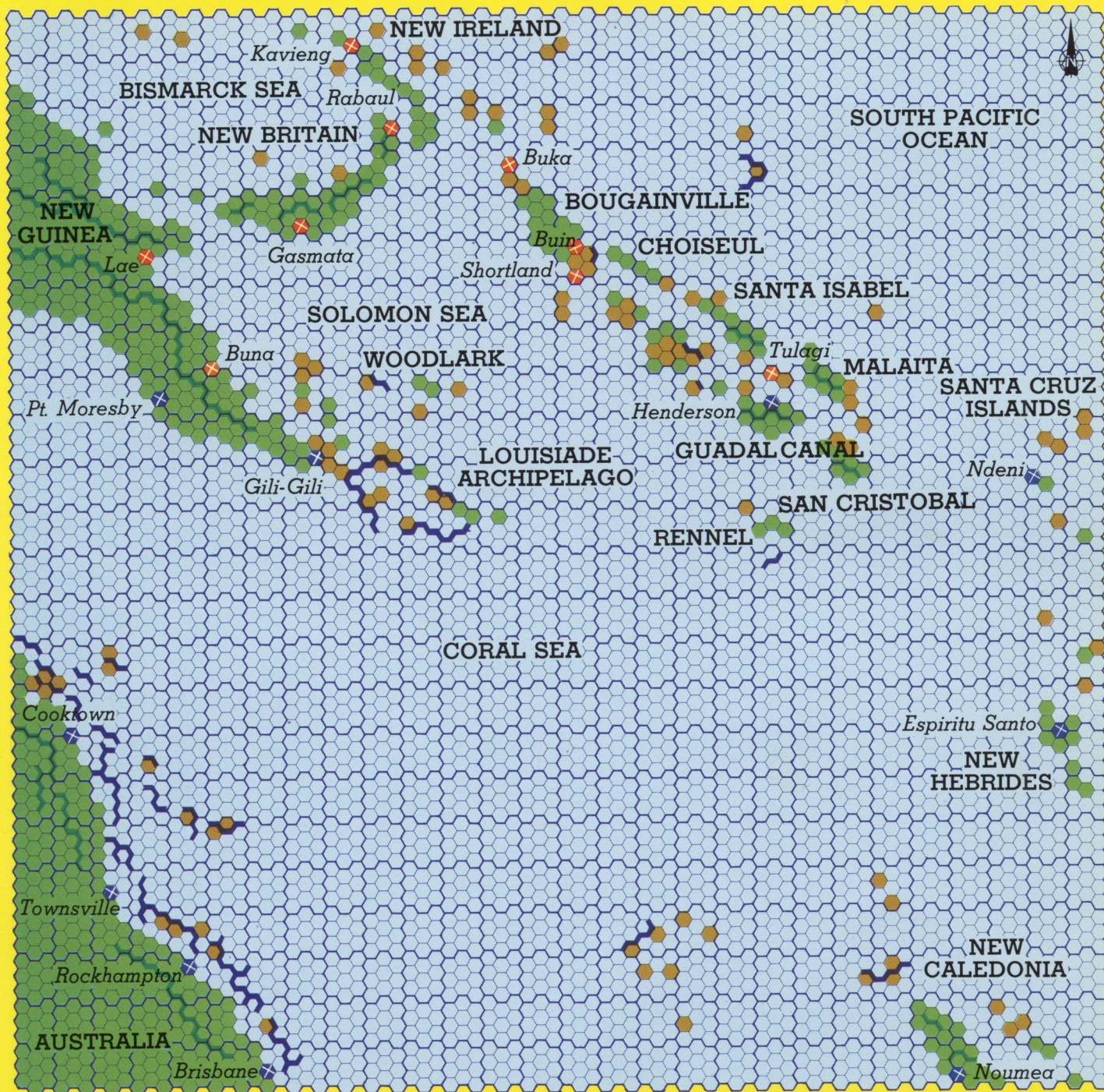

<p><b>SCENARIO 2</b>  <i>Battle of the Coral Sea</i>                      3-10 May, 1942</p>	<p><b>US BASES</b> – Noumea, Brisbane, Rockhampton, Townsville, Cooktown, Pt Moresby  <b>IJN BASES</b> – Rabaul, Lae, Kavieng, Shortland, Buin, Tulagi</p>
<p><b>SCENARIO 4</b>  <i>Battle of the Eastern Solomons</i>                      22-27 August, 1942</p>	<p><b>US BASES</b> – Noumea, Espiritu Santo, Ndeni, Henderson, Brisbane, Rockhampton, Townsville, Cooktown, Pt Moresby, Gili-Gili  <b>IJN BASES</b> – Kavieng, Rabaul, Gasmata, Lae, Buna, Buka, Buin, Shortland</p>
<p><b>SCENARIO 5</b>  <i>Battle of the Santa Cruz Islands</i>                      24-29 October, 1942</p>	<p><b>US BASES</b> – Noumea, Espiritu Santo, Ndeni, Henderson, Brisbane, Rockhampton, Townsville, Cooktown, Pt Moresby, Gili-Gili  <b>IJN BASES</b> – Kavieng, Rabaul, Gasmata, Lae, Buna, Buka, Buin, Shortland</p>

# Carriers At War

BATTLE MAP A

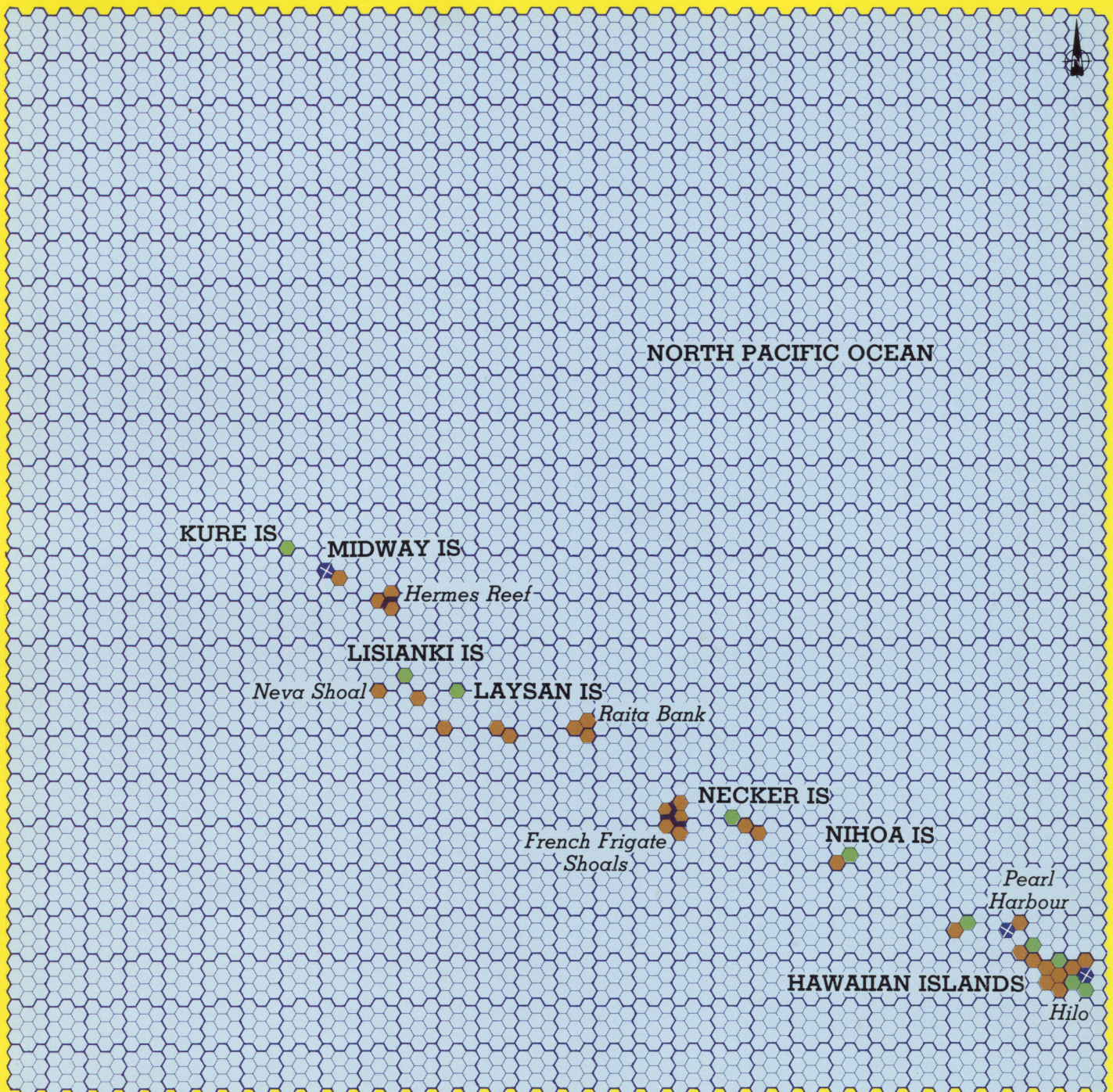

<b>SCENARIO 1</b> <i>Pearl Harbour</i> 6-8 December, 1941	<b>US BASES</b> – Pearl Harbour, Hilo, Midway <b>IJN BASES</b> – none
<b>SCENARIO 3</b> <i>Battle of Midway</i> 3-6 June, 1942	<b>US BASES</b> – Midway, Pearl Harbour, Hilo <b>IJN BASES</b> – none



# Carriers At War

DESIGN MAP

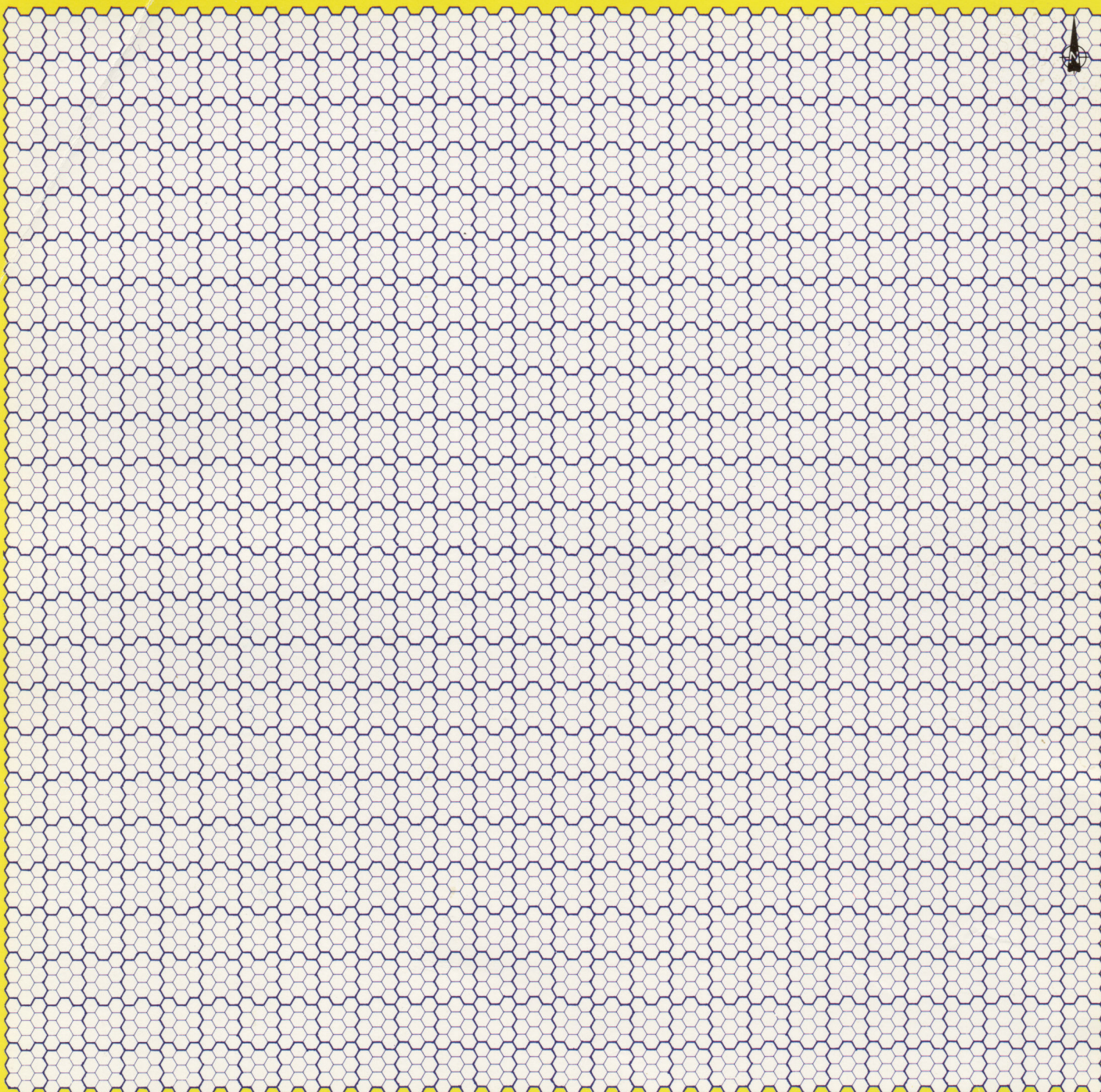

**SCENARIO**

**SCENARIO**





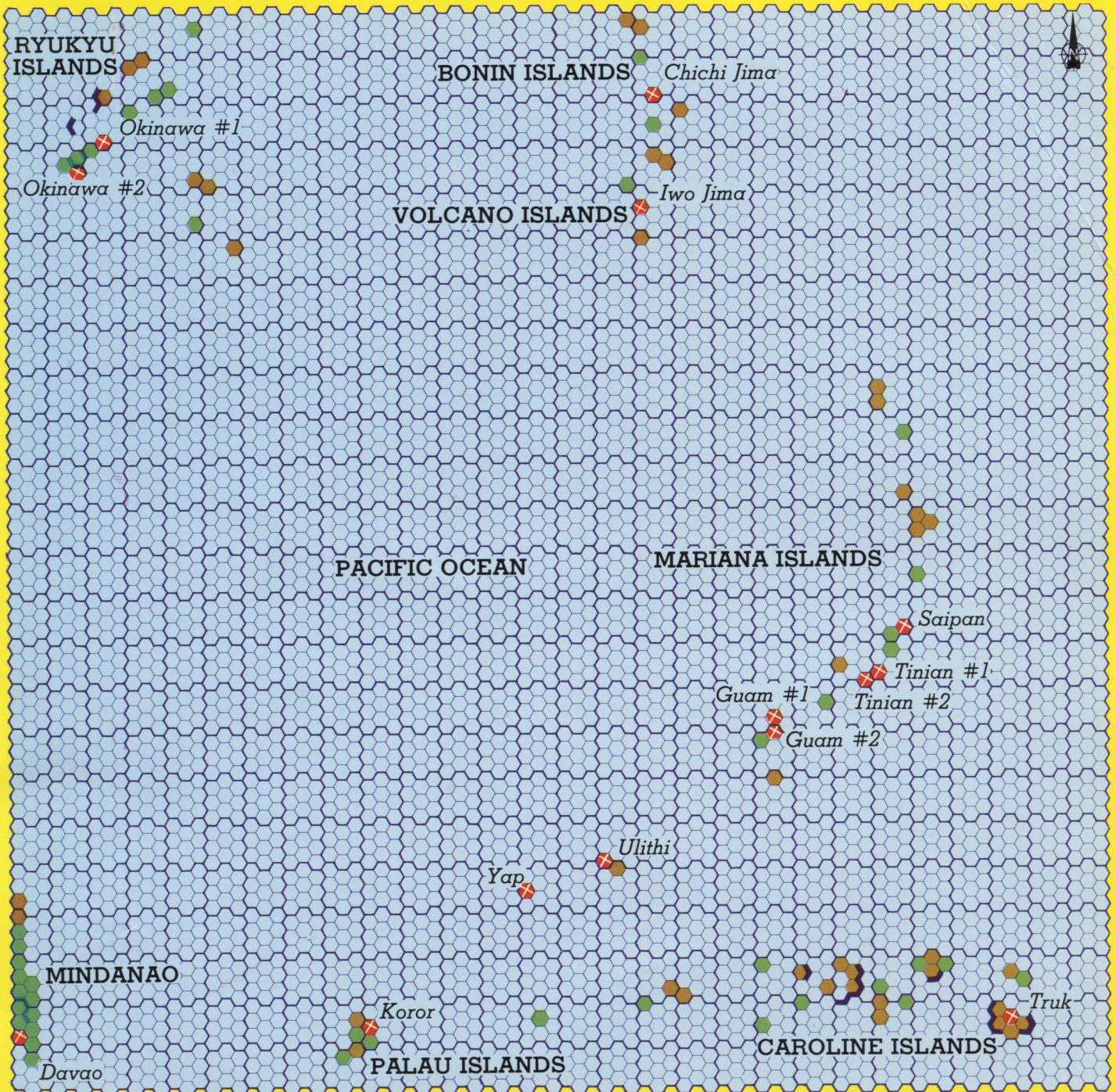

# Carriers At War

BATTLE MAP C



<b>SCENARIO 6</b> <i>Battle of the Philippine Sea</i> 16-21 June, 1944	<b>US BASES</b> - none
	<b>IJN BASES</b> - Okinawa No 1 & No 2, Chichi Jima, Iwo Jima, Davao, Koror, Yap, Ulithi, Saipan, Tinian No 1 & No 2, Guam No 1 & No 2, Truk

**KEY TO MAP FEATURES**

 OCEAN	 LAND	 MOUNTAIN RIDGE
 ATTOL/SHOAL	 AIRBASE	 IMPASSABLE REEF