

Super PONG Ten, by Atari

MODEL N° C-180

Owner's Manual



Scanned by **lulrik**

<http://lulrikgames.canalblog.com>

<http://gamopat.com>

<https://www.atariage.com>

Super BORG Ten

1 to 4 Players
OWNER'S MANUAL

MODEL NO. C-180
Atari, Inc.
Consumer Division
1195 Borregas Avenue
Sunnyvale, CA 94086



UNPACK GAME

When you remove game from box and Styrofoam protection, you should have:

- SUPER PONG TEN Control Unit (with 4 size "D" batteries)
- Game Cable to Switch Box
- Switch Box (with twin-lead wire)
- 2 Hand-Held Controls

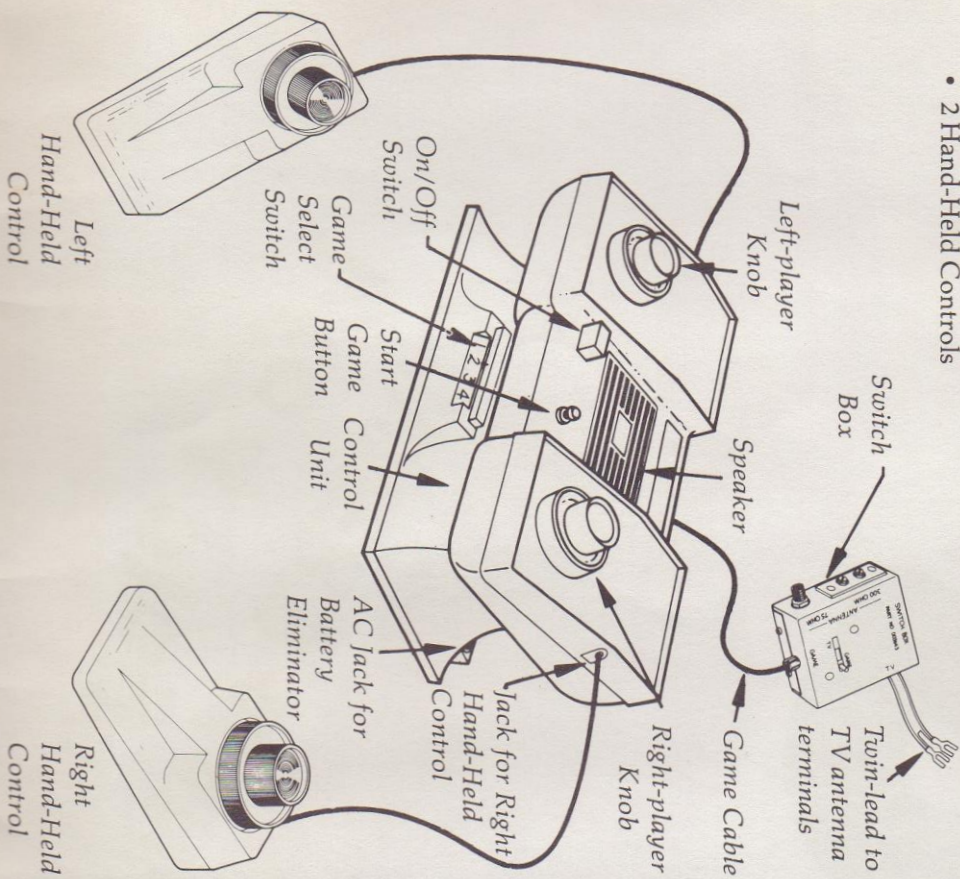

INSTALL SWITCH BOX, CONT.

If your television has a short round cable:

1. Disconnect long cable from television and plug it into SUPER PONG TEN Switch Box at "75 OHM" connector.
2. Connect TV's short loose-hanging cable to the connector next to it on television set.
3. Connect twin-lead wire from SUPER PONG TEN Switch Box "TV" screws to VHF terminals on your television set.

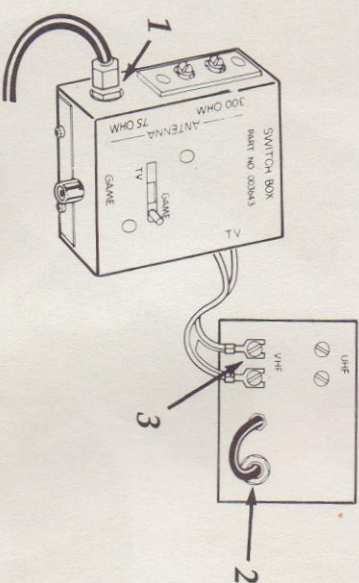

To attach SUPER PONG TEN Switch Box to your television set, peel off protective paper on Switch Box. Press the exposed adhesive surface onto any clear area at rear of television near antenna terminals. Plug Game Cable into Switch Box at "GAME" connector. The SUPER PONG TEN Switch Box may be left on the set permanently without impairing your television reception.

EXTRA SWITCH BOXES

If you have more than one television set in your home, you may purchase a Switch Box for each TV. This arrangement will let you easily move your SUPER PONG TEN from room to room. The Switch Box, part no. 003643, is available from Atari, Inc.: see back page of this manual for ordering information.

INSTALL SWITCH BOX

SUPER PONG TEN hooks up easily to your television's VHF screws. Simply find the illustration below that most closely matches rear of your TV set, and follow those instructions. The only tool required for this step is a flat screwdriver.

If your television has four screws only:

1. Disconnect twin-lead wire from television and connect to "300 OHM" screw terminals on SUPER PONG TEN Switch Box.
2. Connect twin-lead wire from SUPER PONG TEN Switch Box "TV" screws to VHF terminals on your television set.

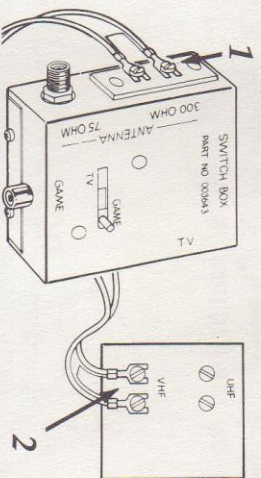

If your television has a slider:

1. Move slider on back of set to make connections between two screws.
2. Disconnect cable from television and plug it into SUPER PONG TEN Switch Box at "75 OHM" connector.
3. Connect twin-lead wire from SUPER PONG TEN Switch Box "TV" screws to VHF terminals on your television set.

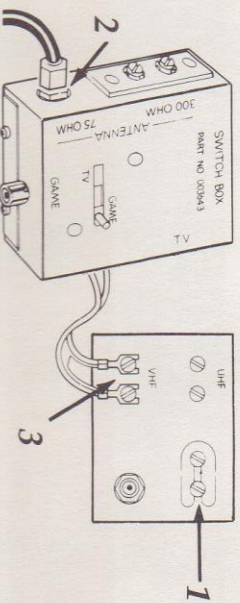

FEDERAL COMMUNICATIONS COMMISSION REGULATIONS REQUIRE THE FOLLOWING:

Avoid using any more twin-lead wires from Switch Box to television set than are supplied with SUPER PONG TEN Switch Box. Avoid connecting twin-lead wire coming from Switch Box to any television antenna or cable television outlet. Avoid attaching loose wires to your television antenna terminals when using SUPER PONG TEN. Doing any of the above may cause interference to nearby television sets and is against Federal Communications Commission (FCC) regulations.

INSTALL BATTERIES

If no station in your area is broadcasting on Channel 3:

Remove Battery Cover Plate with a flat screwdriver (see below). Install four batteries supplied with the game by following diagram. Be sure that batteries are facing in correct directions. Another electronic innovation from Atari is that if batteries are facing in the wrong direction, they will not damage the game. However, game will not operate until they are turned to correct positions.

Replace Battery Cover Plate with slot facing front of SUPER PONG TEN Control Unit. Cover will snap into place after rear tabs are positioned in case.

INSTALL BATTERIES CONT.

Push down gently on screwdriver to release Battery Cover Plate and expose battery compartment.

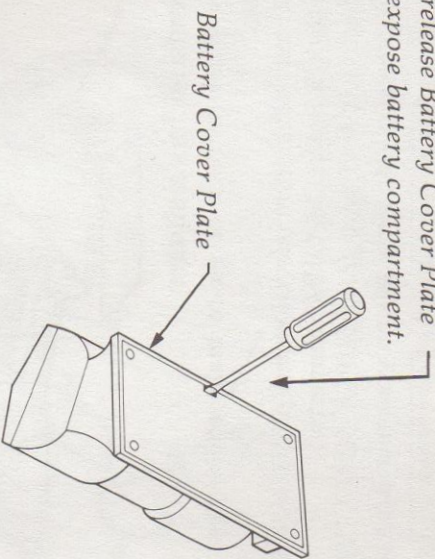

SUPER PONG TEN is factory-set to operate on Channel 3. However, if Channel 3 is broadcasting in your area, you may receive interference. In that case, you need to change your game to Channel 4. The only tool required for this change is a small Phillips screwdriver.

Remove all four Phillips screws that hold down the Battery Compartment. Carefully lift up Compartment, taking care not to pull on the wires. Find Channel Switch in the small rectangular access hole underneath Battery Compartment. It will be set at CH 3. Push Switch over to the side marked CH 4 with a screwdriver.

Next carefully replace Battery Compartment and its four Phillips screws; then install all four batteries to face in correct positions. Replace Battery Cover Plate with slot facing front of SUPER PONG TEN Control Unit. Cover will snap into place after rear tabs are positioned in case.

TURN GAME ON CONT.

has an *automatic* fine-tuning control, turn this off. Set your television to Channel 3 or 4, depending on how you adjusted the Channel Switch inside the SUPER PONG TEN Control Unit (see "INSTALL BATTERIES" section of this manual).

Turn television volume completely down. The buzzing sound from your TV's speaker is normal; turn it down to hear the ball bounce sound coming from the Control Unit's Speaker.

Push On/Off Switch on SUPER PONG TEN Control Unit to "ON" position, and watch your television screen become filled with the colorful SUPER PONG TEN "light show."

Turn your television's fine-tuning *knob* to get the best picture image. Press Start Game Button on Control Unit. The light show pattern will convert instantly to a playfield.

Slowly move the Game Select Switch through its four positions, and watch the five different games immediately appear on your television screen—Game #1 Catch, Game #2 Basketball, Handball (also set at Game #2), Game #3 Super Pong, and Game #4 Pong. Five more games are available when you plug in one or both of the Hand-Held Controls. Altogether, these 10 games represent the *Ten* in SUPER PONG™ TEN.

GENERAL GAME RULES

Your SUPER PONG TEN can be played with 1 through 4 players. For 3-player or 4-player games, simply plug the wires of one or both Hand-Held Controls into the special Jacks. These Jacks are located at the right and left ends of the Control Unit. Each Hand-Held Control that you plug in will cause a new paddle, pair of paddles, or a "hole" to appear on your television screen. *What happens when you plug in a Hand-Held Control is described under the rules of play for each of the four games.*

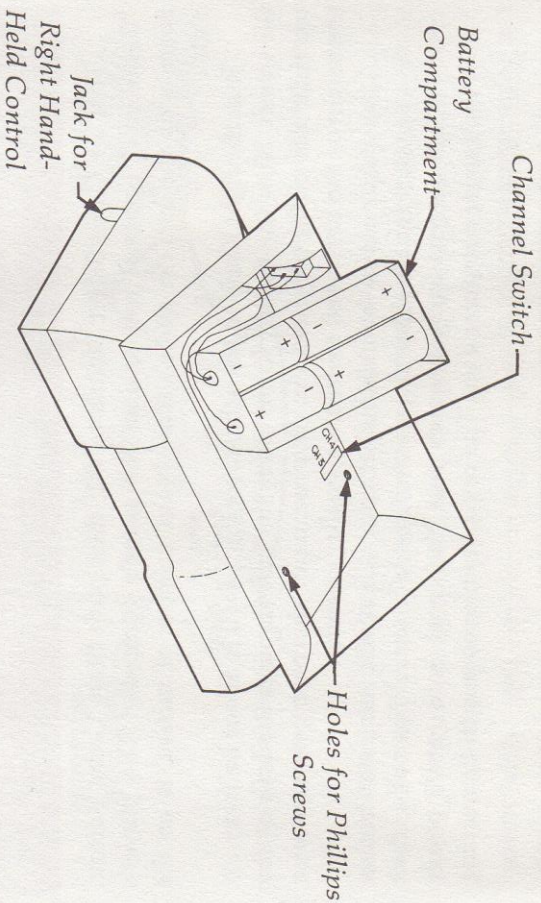

BATTERY ELIMINATOR

If you wish to use normal house current instead of batteries, you may purchase a Battery Eliminator, part no. 004720, from Atari, Inc. See back page of this manual for ordering information. Plug Battery Eliminator into wall outlet. Plug other end of Eliminator wire into AC Jack on rear of Control Unit base. You do not need to remove batteries from the Battery Compartment; using the Eliminator automatically shuts off power from the batteries.

TURN GAME ON

On Switch Box that you've now attached to your television set, push the TV/Game Switch to "GAME" and turn television set on. If your set

TO RETURN YOUR TELEVISION SET TO REGULAR PROGRAMS:

(The following applies to your SUPER PONG TEN Control Unit, regardless of how the Game Select Switch is set.) Turn off SUPER PONG TEN Control Unit's On/Off Switch. Slide the TV/Game Switch on Switch Box to "TV" position, then leave on only the television set. If your set has an automatic fine-tuning control, turn it back on.

NOTE: Failure to turn Control Unit to "OFF" may cause battery drainage in your SUPER PONG TEN Control Unit.

As a reminder to turn off your Control Unit, the game will continue making a ball bounce sound after you turn off your television set. The sound will not stop until you push the On/Off Switch to "OFF"

PLAYING CATCH (GAME #1)

First set Game Select Switch to #1, then push Start Game Button. Turn each Knob to move one of the "holes" up or down, and catch the ball through your hole. The ball never goes out of bounds, but stays in action until one of the players catches it. That player then scores one point on his or her side of the screen. The ball is automatically served again towards the player who *caught* the ball.

The first player to earn 15 points wins the game. When 15 points are scored, the playfield disappears and the light show comes back on the screen. To get the playfield back and start another game, depress the Start Game Button again.

USING HAND-HELD CONTROLS

Plugging in one or both Hand-Held Controls will add a hole to the appropriate side of the television screen. These holes can now "cross

PLAYING CATCH (GAME #1) CONT.

over" each other because each one has the full range of movement from top to bottom of the screen. The scores will still reflect points earned by one or both holes on the same side of the television screen.

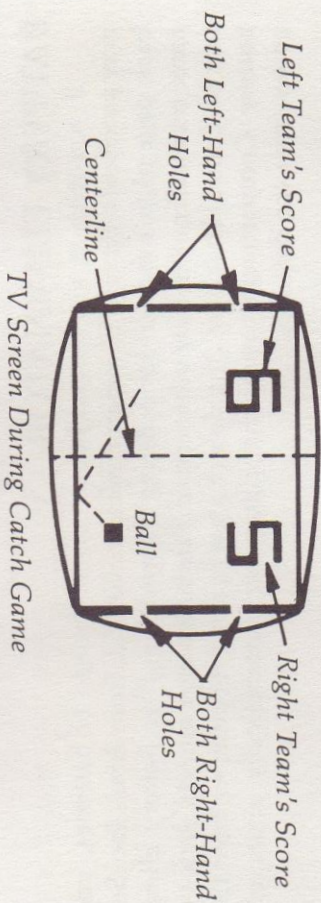

PLAYING BASKETBALL (GAME #2)

First set Game Select Switch to #2; then push Start Game Button. "Basketball" opposes you against the game's computer. The player's score is on the left; the game's score (your number of misses) is on the right.

Turn the right Knob so the adjustable back wall is about halfway up the screen. Now use the left Knob to hit the ball through the hole at the top right side of the playfield. As your technique sharpens, you can raise the height of the back wall to create a smaller opening.

A missed or out-of-bounds ball at your side of the television screen scores one point for the game's computer, and vice versa. The ball is then served again automatically towards you. Your goal is to get 15 points before the game's computer does. The best possible score is 15-0, meaning the game never scored at all.

USING HAND-HELD CONTROL

Similar to the one-player version described above, you should only use the *left* Control Unit Knob and the *left* Hand-Held Control. (Do not

the television screen; these paddles can "cross over" each other. The right-hand score will still reflect points earned by one or both of these paddles.

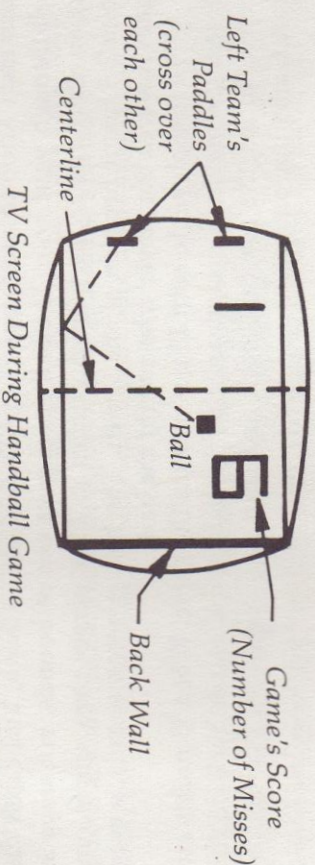

PLAYING SUPER PONG™ (GAME #3)

First set Game Select Switch to #3; then push Start Game Button. In this exciting game, each player controls two paddles together with his or her Knob. Turn each Knob to move the pair of paddles up or down.

Both the Forwards and Backs reflect the ball if it bounces off the side facing the net. If the ball approaches a Forward from behind, however, the ball will simply pass right through the paddle.

A missed or out-of-bounds ball at your side of the television screen scores one point for your opponent. The ball is then served again automatically towards you. The first player to earn 15 points wins the game.

USING HAND-HELD CONTROLS

Plugging in one or both Hand-Held Controls will add a pair of paddles to the appropriate side of the television screen. These paddles can now "cross over" each other. Each score will still reflect points earned by one or both pairs of paddles on one side of the screen. The SUPER PONG 4-player game (using both Hand-Held Controls) is especially challenging because there are *eight* paddles on the television screen at one time.

plug in the right Hand-Held Control.) You will now have two paddles or a team appearing on the left side of the television screen; these paddles can "cross over" each other. The scores will still reflect points earned and misses made by one or both paddles on the left half of the screen.

If you prefer using only the Hand-Held Control in this game, you may plug it into the left Jack. Then turn the left Knob on the Control Unit until its paddle disappears. Now you have the convenience of using the Hand-Held Control and can still play "Basketball" as a one-player game.

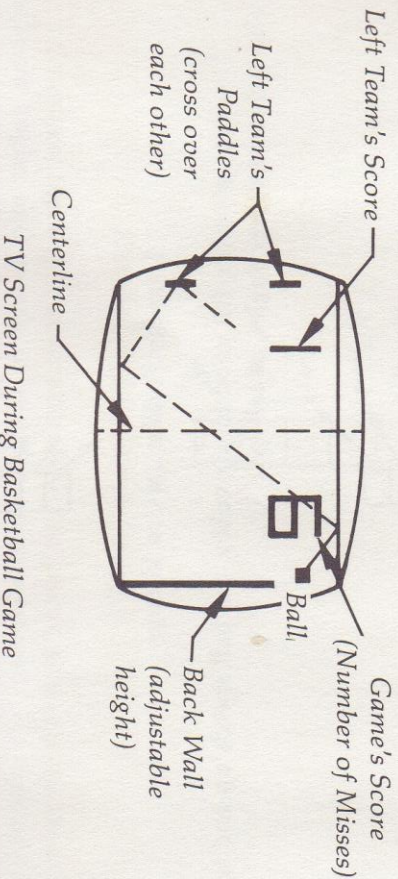

PLAYING HANDBALL (also set at #2)

Keep the Game Select Switch set at #2, but turn the right Knob so the adjustable back wall is *all the way* up the screen (see drawing below). Now use the left Knob to hit the ball against this wall. Try to avoid missing the ball as much as possible. If the ball should go out of bounds, one point is scored for the game's computer (on right-hand numerals). The ball is then served automatically towards you.

Your goal is to keep the score as low as possible. The left-hand numerals will always read "0".

USING HAND-HELD CONTROLS

Similar to the one-player version described above, you should only use the two left Knobs. (Do not plug in the right Hand-Held Control.) You will now have two paddles or a team appearing on the left side of

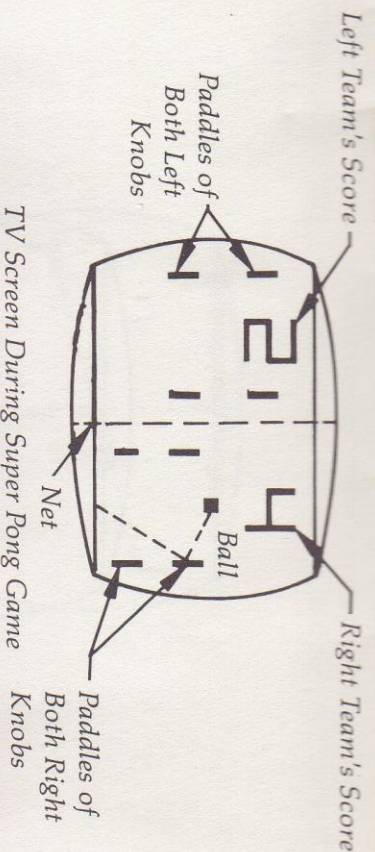

PLAYING PONG™ (GAME #4)

First set Game Select Switch to #4, then push Start Game Button. PONG is the classic video game for the purist—unadulterated fun. It has the same rules as SUPER PONG (game #3), except that each player has one paddle instead of a pair.

USING HAND-HELD CONTROLS

Plugging in one or both Hand-Held Controls will add a paddle to the appropriate side of the television screen. As with the other three games of SUPER PONG TEN, these paddles can "cross over" each other. Each score reflects points earned by one or both paddles on one side of the screen.

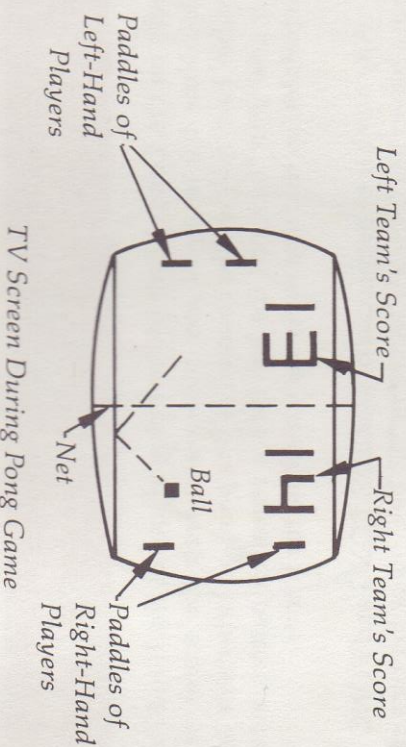

SECRETS OF SUPER PONG™ TEN

(Applies to the paddles in games #2, 3, and 4)

To really enjoy SUPER PONG TEN, you should learn some of its fine points. One of the most important things to remember is that the paddle is made of eight "parts." Each part reflects the ball at a certain angle as shown below—regardless of how the ball has approached the paddle. (The middle two parts *always* reflect at a right angle or 90°.)

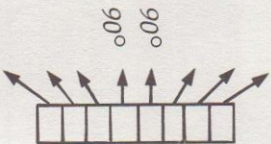

Detail of Paddle: 1st-3rd Volleys

However, after the 4th good hit or volley, the ball speeds up and is reflected at narrower angles, as follows:

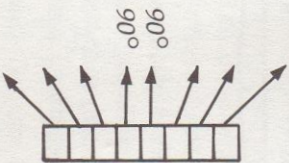

Detail of Paddle: 4th-7th Volleys

SECRETS OF SUPER PONG™ TEN, CONT.

Knobs on the Control Unit (do not plug in any of the Hand-Held Controls). Now try to avoid any misses and keep the scores as low as possible. Each miss will be counted as one point on either side of the net. Your goal is to "lock up" the ball into a repeating pattern between the two paddles, so that you never need readjust the Knobs.

Any number of people can play SUPER PONG and PONG solitaire. Once a player has definitely locked up the ball, his or her turn ends. Add up any points on both sides of the net, and that is your score. The winner has the lowest score, with 0-0 being the best possible.

You can lock up the ball into a repeating pattern of one angle. The easiest lockup means the ball bounces horizontally straight back and forth across the playfield (see below), between the *center* of each paddle:

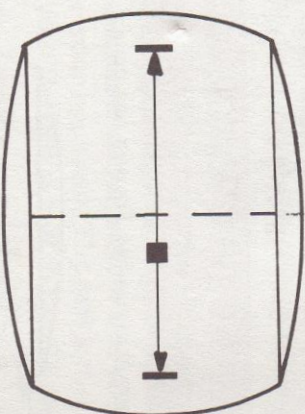

Easiest Lockup Pattern

Finally, after the 8th volley, the angles become very narrow and the ball reaches its maximum speed, as shown below:

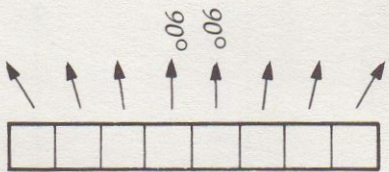

Detail of Paddle: 8th + Volley

Once you become familiar with these fine points, you can use these different angles and speeds to surprise your opponent. By carefully selecting where your paddle hits the ball, you can choose where the ball will go.

You can add special rules to a four-player game, such as requiring partners on a team to never cross paths. In other words, each player should stay in either the top or bottom half of the TV screen. Another special rule is requiring each partner to alternate with the other partner in hitting the ball: no player should hit the ball twice in a row. A third special rule applies to games #1, 3, and 4 only: plug in only *one* of the Hand-Held Controls. Now you can play any of these games "cut-throat" style or two against one.

SOLITAIRE

Sharpen your game or just have fun playing SUPER PONG (#3) or PONG (#4) by yourself. In the solitaire game, one player uses both

The hardest lockup of all is similar to the one above, except that the ball bounces at a slight diagonal across the screen, hitting near the *end* of each paddle:

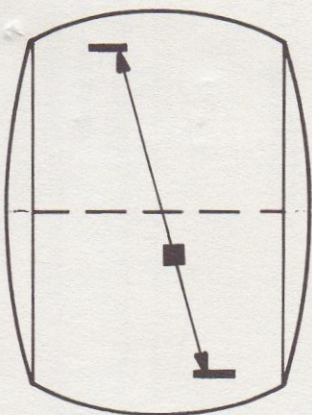

Hardest Lockup Pattern

The medium-difficulty lockups allow the ball to bounce at various angles off the top and bottom playfield borders. Narrower angles are easier to accomplish than wider angles. Playing solitaire at various angles is especially challenging, because the ball cannot be locked up until the game has gone through all of the ball speedup sequence. If you remember from the "SECRETS OF SUPER PONG TEN" section of this manual, the ball speed and bounce angles will not be constant until 8 successful volleys are made. That is why you must make 8 good hits before trying to lock up the game at a certain angle. The simplest version of angle solitaire is a top bounce, then bottom bounce, using one of the narrower angles:

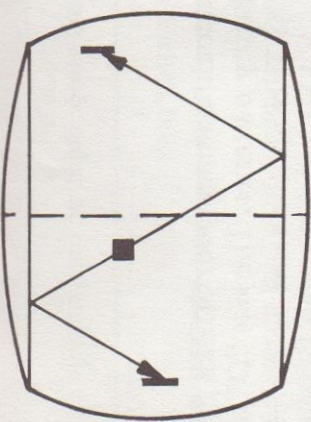

*Angle Lockup Pattern
(Medium Difficulty)*

MAINTENANCE

DO NOT:

Pour liquid in speaker opening or on Hand-Held Controls;

Leave batteries in SUPER PONG TEN Control Unit when not in use;

Drop any part of game on hard surface;

Leave game on when not in use;

Expose game to excessive heat.

DO:

Avoid leakage that could damage your SUPER PONG TEN game, by using high-quality batteries. The size "D" batteries required for SUPER PONG TEN are the same as in a regular flashlight;

Clean all exterior parts of game with a soft, slightly damp cloth when necessary;

Wrap the cable and wires around base of SUPER PONG TEN Control Unit for easy storage.

NOTE: On some television sets, particularly black and white, phosphor memory may show the Super Pong Ten center court net and score digits when the set is off. This has no adverse effect on a television's performance. The effect may be avoided by turning the game off when not in use.

TROUBLESHOOTING CHECKLIST

SYMPTOM	CAUSE AND REMEDY
Picture flickering when scoring.	<ul style="list-style-type: none"> • Low voltage. Change batteries. • Batteries low, dead or not correctly installed. • Switch Box set at "TV." Change to "GAME." • Game Cable not properly plugged into Switch Box. • Twin-lead wire not properly attached to rear of TV. • Battery Eliminator not plugged into wall and/or Control Unit. • On/Off Switch not pushed to "ON" position.
No playfield image on TV screen or whitish-gray screen.	<ul style="list-style-type: none"> • Switch Box set at "GAME." Change to "TV." • Twin-lead wire not properly attached to rear of TV. • Antenna wire not properly attached at "300 OHM" screws on Switch Box.
No regular TV programs.	<ul style="list-style-type: none"> • Antenna wire not properly attached at "300 OHM" screws on Switch Box.
Buzzing sound from TV loudspeaker.	<ul style="list-style-type: none"> • Television volume on too loud. Turn volume control all the way down.
Playfield image clear and sharp, but bars or lines move across the screen.	<ul style="list-style-type: none"> • Local TV station broadcasting on same channel as SUPER PONG TEN is operating on. Change Channel Switch in Control Unit to other channel (see page 3). • Cable TV or community antenna leads in room or nearby are carrying both Channel 3 and 4 programs. In addition, owner has wired up • cable to SUPER PONG TEN Switch Box using the small transformer with twin-lead wire supplied by cable TV company. In rare cases, owner should simply remove this transformer and connect cable directly to SUPER PONG TEN Switch Box at "75 OHM" antenna connection.
Playfield fuzzy like weak TV station signal.	<ul style="list-style-type: none"> • Poor connections at antenna terminals of TV set or Switch Box.
Playfield unsharp, unsteady or no color.	<ul style="list-style-type: none"> • TV set not fine-tuned for best picture. Use fine-tuning knob, color or tint controls on TV set to adjust.
SUPERPONG DOUBLES worked before, but picture suddenly unsharp, unclear or unstable.	<ul style="list-style-type: none"> • Batteries need to be replaced or fine-tuning knob on TV set was changed. Readjust fine-tuning control.

The Model Number of your SUPER PONG TEN game is stamped on the Battery Cover Plate. Always mention the Model Number when requesting service or repair parts for your SUPER PONG TEN.

<i>Part No.</i>	<i>Part Name</i>
C010019	Hand-Held Control
A003640	Control Knob
003643	Switch Box
CA010059-06	Battery Cover Plate
004720	Battery Eliminator
Purchase Locally	Battery, size "D"



The parts listed above should be ordered directly from Atari, Inc., Consumer Division, Parts Department, 1195 Borregas Avenue, Sunnyvale, CA 94086. When ordering replacement parts, always give the following information:

1. Part number
2. Part name
3. Model number
4. Name of game