

Macintosh™

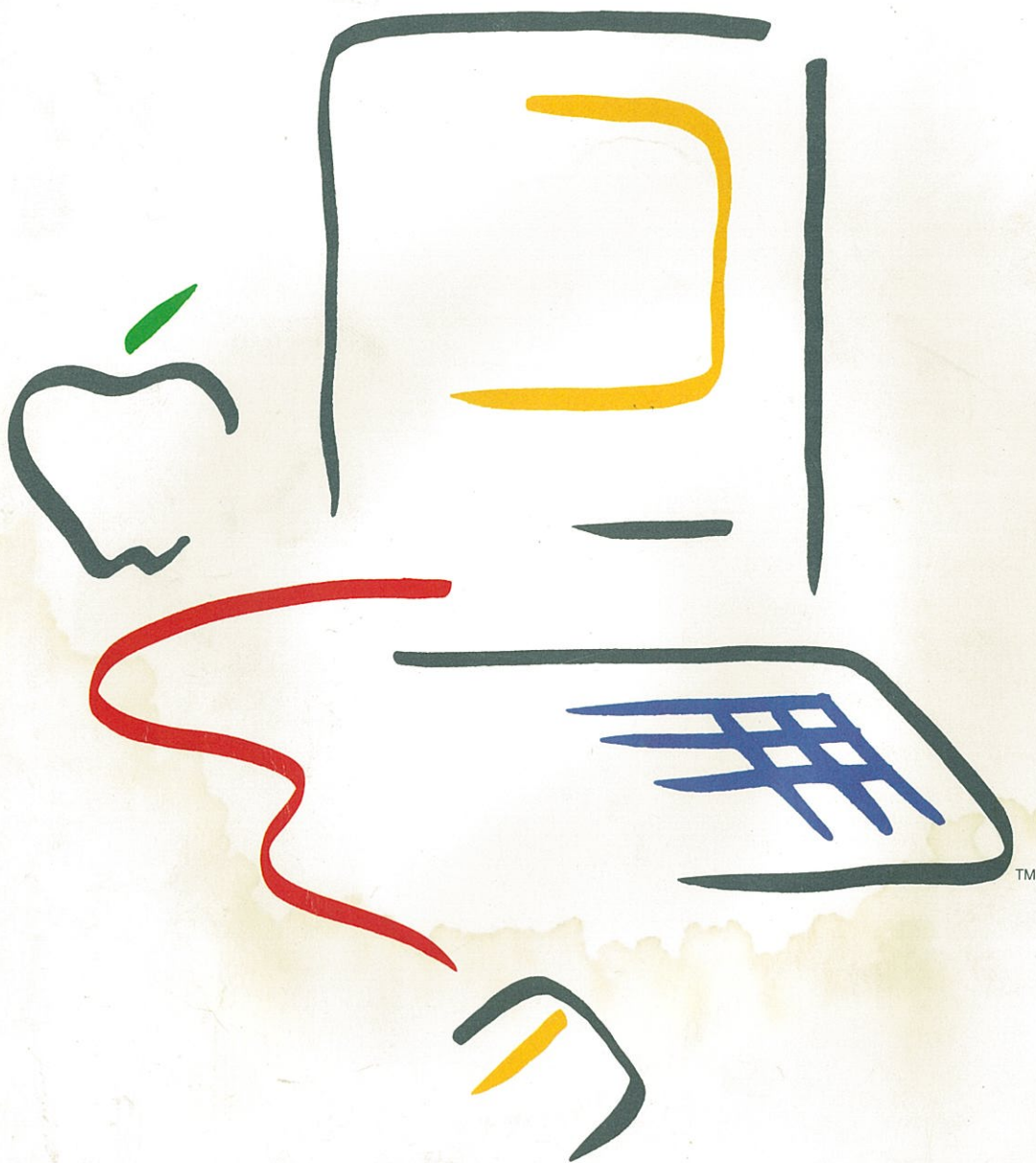



## Copyright

This manual and the software described in it are copyrighted with all rights reserved. Under the copyright laws, this manual or the software may not be copied, in whole or part, without written consent of Apple, except in the normal use of the software or to make a backup copy. The same proprietary and copyright notices must be affixed to any permitted copies as were affixed to the original. This exception does not allow copies to be made for others, whether or not sold, but all of the material purchased (with all backup copies) may be sold, given, or loaned to another person. Under the law, copying includes translating into another language or format.

You may use the software on any computer owned by you but extra copies cannot be made for this purpose. For some products, a multi-use license may be purchased to allow the software to be used on more than one computer owned by the purchaser, including a shared-disk system. (Contact your authorized Apple dealer for information on multi-use licenses.)

©1984 Apple Computer, Inc.

20525 Mariani Ave.  
Cupertino, CA 95014  
(408) 996-1010

Macintosh is a trademark of McIntosh Laboratories, Inc. and is being used with express permission of its owner.

Apple, the Apple logo, the Macintosh logo, MacWrite, MacPaint, MacTerminal, Mac Project, and MacDraw are trademarks of Apple Computer, Inc.

The Source is a service mark of Source Telecomputing Corp. Compuserve Information Service is a trademark of Compuserve Inc. Dow Jones is a trademark of Dow Jones & Co., Inc.

Simultaneously published in the U.S.A. and Canada. Written by Carol Kaehler of the Macintosh User Education department. The Finder program by Bruce Horn with Steve Capps.

## Warning

Caution: To prevent electrical shock, do not remove the Macintosh cover. No user servicable parts inside. Refer servicing to qualified service personnel.

This equipment has been certified to comply with the limits for a Class B computing device, pursuant to Subpart J or Part 15 of FCC Rules. Only peripherals (computer input/output devices, terminals, printers, etc.) certified to comply with the Class B limits may be attached to this computer. Operation with non-certified peripherals is likely to result in interference to radio and TV reception.

Reorder Apple Product #M1500

## Limited Warranty on Media and Manuals

If you discover physical defects in the media on which the software included with this Macintosh is distributed, or in the manuals distributed with the software, Apple will replace the media or manuals at no charge to you, provided you return the item to be replaced with proof of purchase to Apple or an authorized Apple dealer during the 90-day period after you purchased the software. In some countries the replacement period may be different; check with your authorized Apple dealer.

**ALL IMPLIED WARRANTIES ON THE MEDIA AND MANUAL, INCLUDING IMPLIED WARRANTIES OF MERCHANTABILITY AND FITNESS FOR A PARTICULAR PURPOSE, ARE LIMITED IN DURATION TO NINETY (90) DAYS FROM THE DATE OF THE ORIGINAL RETAIL PURCHASE OF THIS PRODUCT.**

Even though Apple has tested the software and reviewed the documentation, **APPLE MAKES NO WARRANTY OR REPRESENTATION, EITHER EXPRESS OR IMPLIED, WITH RESPECT TO THIS SOFTWARE, ITS QUALITY, PERFORMANCE, MERCHANTABILITY, OR FITNESS FOR A PARTICULAR PURPOSE. AS A RESULT, THIS SOFTWARE IS SOLD "AS IS," AND YOU THE PURCHASER ARE ASSUMING THE ENTIRE RISK AS TO ITS QUALITY AND PERFORMANCE.**

**IN NO EVENT WILL APPLE BE LIABLE FOR DIRECT, INDIRECT, SPECIAL, INCIDENTAL, OR CONSEQUENTIAL DAMAGES RESULTING FROM ANY DEFECT IN THE SOFTWARE OR ITS DOCUMENTATION,** even if advised of the possibility of such damages. In particular, Apple shall have no liability for any programs or data stored in or used with Apple products, including the costs of recovering such programs or data.

**THE WARRANTY AND REMEDIES SET FORTH ABOVE ARE EXCLUSIVE AND IN LIEU OF ALL OTHERS, ORAL OR WRITTEN, EXPRESS OR IMPLIED.** No Apple dealer, agent, or employee is authorized to make any modification, extension, or addition to this warranty.

Some states do not allow the exclusion or limitation of implied warranties or liability for incidental or consequential damages, so the above limitation or exclusion may not apply to you. This warranty gives you specific legal rights, and you may also have other rights which vary from state to state.

See inside back cover for warranty information on hardware products.



Macintosh





## Contents

<b>5</b>	<b>About This Manual</b>
5	How to Use This Manual
<b>6</b>	<b>Chapter 1: Learning Macintosh</b>
8	Contents
9	Introduction
10	Meet Your Macintosh
13	Using the Mouse
13	Moving the Pointer by Moving the Mouse
14	Selecting by Clicking an Icon
15	Dragging an Icon
17	Selecting and Choosing
17	Selecting the System Disk Icon
17	Pulling Down a Menu
18	Choosing a Command From a Menu
20	Manipulating Windows
20	Changing the Size of a Window
21	Moving a Window
22	Opening Another Icon
22	Making a Window Active
24	Opening Other Icons
25	Closing a Window
26	Using Scroll Bars to See More
28	Using an Application
28	Creating a New Document
30	Saving Your Work on a Disk
31	Editing Text: Cutting and Pasting
35	Organizing Documents
35	Using Folders
37	Selecting More Than One Icon
40	Changing Your View
40	Using a Desk Accessory
41	Starting Your Own Work
<b>42</b>	<b>Chapter 2: Finding Out More About Macintosh</b>
44	Contents
45	What Can You Do With Your Macintosh?
47	What Macintosh Is: Its Parts
48	Where Does Your Information Go?
49	Working With Your Macintosh



<b>50</b>	<b>Chapter 3: Using the Finder</b>
52	Contents
53	Introduction
54	Summary of Mouse Techniques
56	Handling Windows
58	Scrolling
59	Selecting Icons
60	Editing Text
62	Using the Scrapbook to Store Frequently Used Images
65	Managing Documents
66	Creating a New Document
67	Opening an Existing Document
68	Renaming
69	Copying a Document, Folder, or Application to the Same Disk
70	Copying a Document, Folder, or Application to a Different Disk
71	Moving a Document, Folder, or Application
72	Printing
74	Removing a Document, Folder, or Application
75	Recovering a Removed Document, Folder, or Application
76	Summary of Document Managing Within an Application
78	Managing Disks
80	Ejecting a Disk
81	Initializing New Disks
82	Creating a Startup Disk
83	Copying an Entire Disk
84	Using Font Mover to Claim More Space on a Disk
<b>86</b>	<b>Chapter 4: Reference</b>
88	Contents
89	Introduction
90	Keyboard
90	Character Keys
90	Special Keys
92	Disks
92	Initializing Disks
92	Ejecting Disks
92	Startup Disks
93	Locked Disks
93	Names of Disks and Documents
95	Windows



96	Clipboard: Cutting and Pasting
97	Dialog Boxes
98	Desk Accessories
98	Calculator
98	Alarm Clock
99	Key Caps
100	Puzzle
100	Note Pad
101	Scrapbook
101	Control Panel
103	Shortcuts
104	Finder Reference
104	Overview
105	What the Finder Manages
106	Selecting Icons
107	Dragging Icons
108	Finder Menus
<b>114</b>	<b>Chapter 5: Adding to Your Macintosh System</b>
116	Contents
117	Applications
120	Additional Disk Drive
121	Apple Imagewriter Printer
127	Apple Modem
128	Numeric Keypad
129	Macintosh Carrying Case
130	Security Accessory Kit
131	Programmer's Switch
<b>132</b>	<b>Chapter 6: Taking Care of Your Macintosh</b>
134	Contents
135	Keeping It in Good Shape
140	If Something Goes Wrong
144	Radio and Television Interference
<b>148</b>	<b>Appendix A: Optional Character Set</b>
<b>149</b>	<b>Appendix B: Macintosh Specifications</b>
<b>151</b>	<b>Glossary</b>
<b>159</b>	<b>Index</b>

## About This Manual

This manual introduces you to the Apple® Macintosh™ computer. Use it now to learn the basic Macintosh skills, and pick it up again later to use as a reference. You don't need to know anything about Macintosh or any other computer to use this manual. And you won't have to keep learning new ways of doing things. Once you've mastered a few new techniques, you'll use them whenever you use your Macintosh.

You can also take a guided tour of Macintosh by listening to the cassette tape (use it in any cassette player). In the guided tour, your Macintosh demonstrates itself, introducing—in a different way—the same skills this manual teaches.

This manual tells you how to:

- use the mouse and keyboard to control your Macintosh (Chapter 1)
- get started with your own work, make changes to it, and save it (Chapter 1)
- find out more about Macintosh concepts and how to use your new techniques to establish a daily working routine (Chapter 2)
- organize your documents on the Macintosh (Chapters 2 and 3)
- get the most out of your Macintosh system by adding other products to it (Chapter 5)
- care for your Macintosh (Chapter 6)
- do simple troubleshooting and find further help (Chapter 6)

### How to Use This Manual

Read Chapter 1 to learn the basics and to get started using one of the **application programs** you probably purchased along with your Macintosh. Then continue on with this manual or go to the manual that came with the application you're going to use. Return to Chapter 3 of this manual when you want to know more about organizing your work. Use Chapter 4 for reference. Read Chapter 6 soon after you get your Macintosh to learn how to care for it.

The appendixes contain technical information. A glossary of Macintosh terms and an index are also included.

Now turn to the first chapter and get started.

## Chapter 1:

Learning  
Macintosh

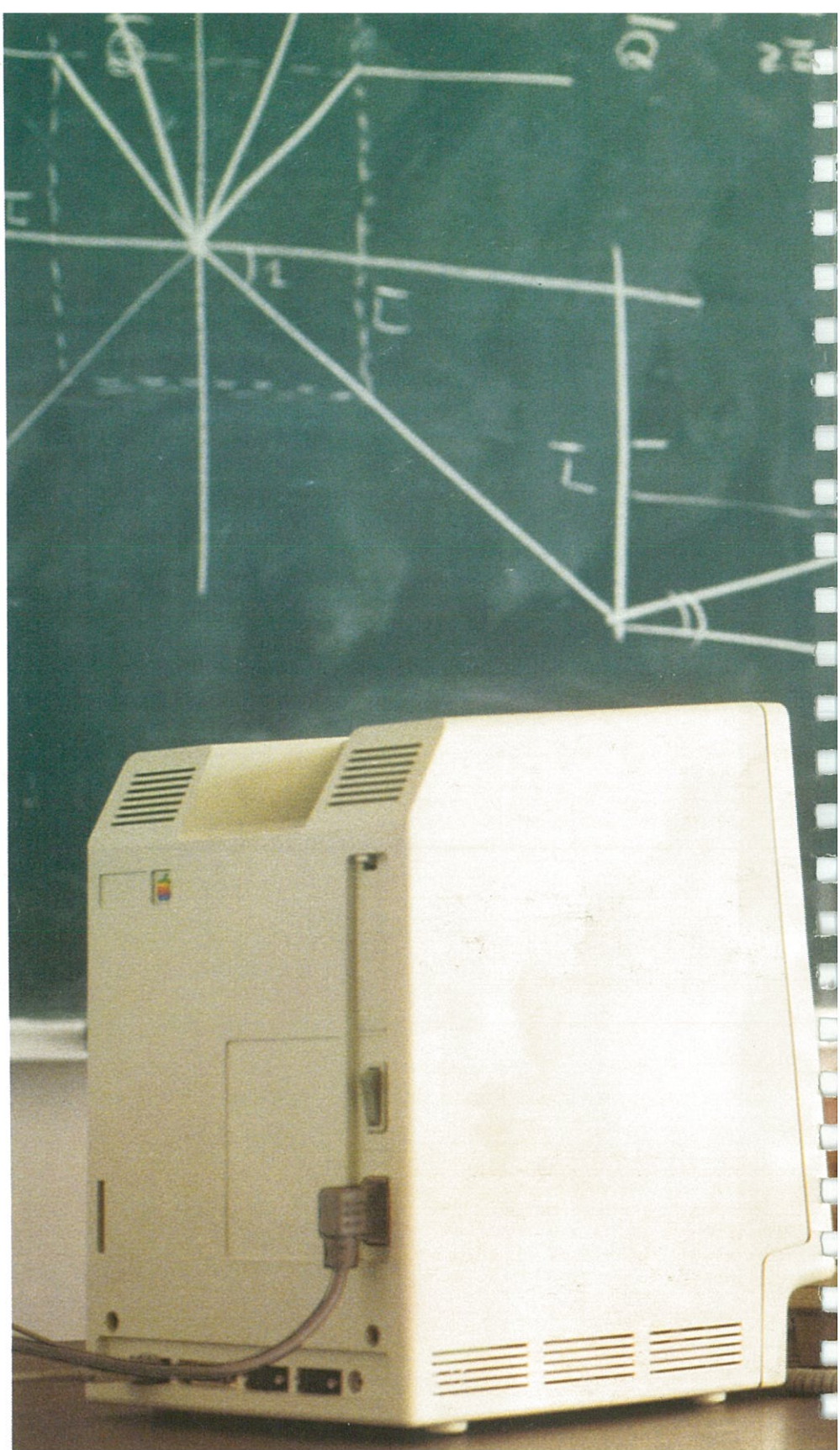



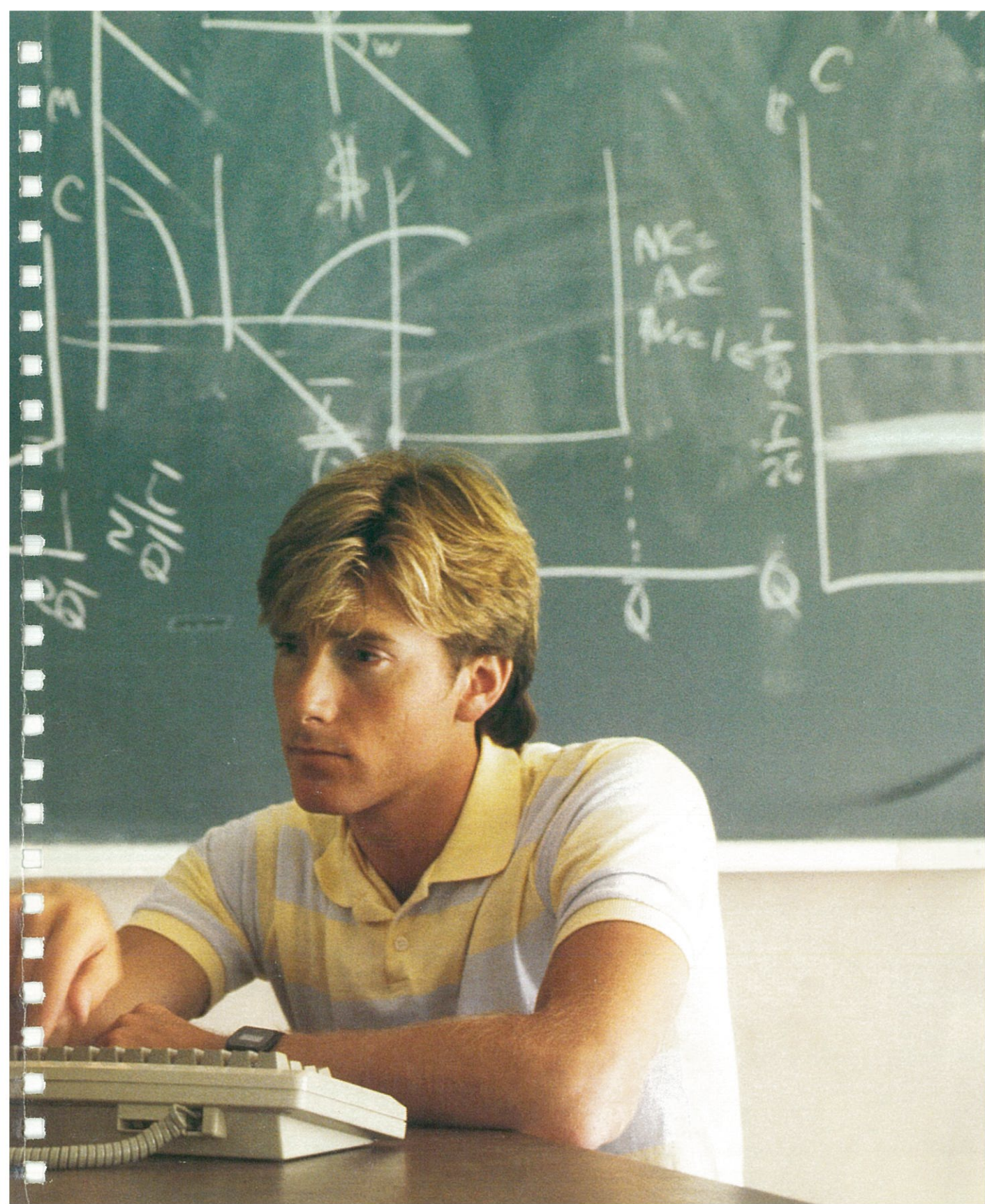

$1/10$   
 $2/10$

$MC = AC$   
 $MC = 10$

$1/10$   
 $2/10$

## Contents

<b>9</b>	<b>Introduction</b>
<b>10</b>	<b>Meet Your Macintosh</b>
<b>13</b>	<b>Using the Mouse</b>
13	Moving the Pointer by Moving the Mouse
14	Selecting by Clicking an Icon
15	Dragging an Icon
<b>17</b>	<b>Selecting and Choosing</b>
17	Selecting the System Disk Icon
17	Pulling Down a Menu
18	Choosing a Command From a Menu
<b>20</b>	<b>Manipulating Windows</b>
20	Changing the Size of a Window
21	Moving a Window
22	Opening Another Icon
22	Making a Window Active
24	Opening Other Icons
25	Closing a Window
26	Using Scroll Bars to See More
<b>28</b>	<b>Using an Application</b>
28	Creating a New Document
30	Saving Your Work on a Disk
31	Editing Text: Cutting and Pasting
<b>35</b>	<b>Organizing Documents</b>
35	Using Folders
37	Selecting More Than One Icon
40	Changing Your View
40	Using a Desk Accessory
41	Starting Your Own Work

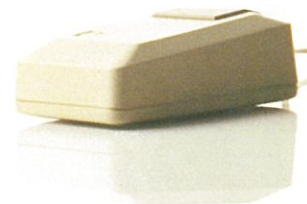



## Introduction

You're about to learn a new way to use a computer. If this is your first experience with a computer, you're starting at a great time. If you've used "traditional" computers, you'll really appreciate the Macintosh difference. No more guessing what the computer wants. No more memorizing long commands with names only a programmer could love. With Macintosh, you're in charge.

This chapter teaches what you need to know to use your Macintosh—how to create **documents** (the name for anything you create on Macintosh), make changes to them, and put them away. It all happens with a few basic techniques, the same techniques you'll use whenever you work with any application on your Macintosh.





## Meet Your Macintosh

Before you start, make sure you plug your Macintosh into a grounded outlet and attach the keyboard and mouse to the main unit.

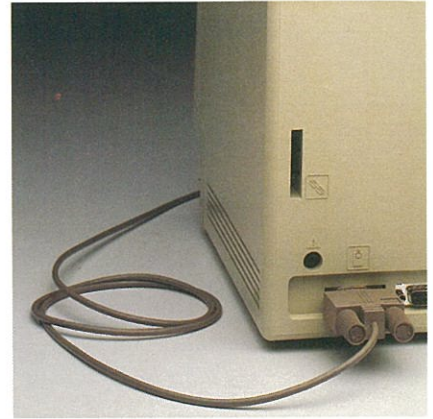

### ■ Switch the Macintosh on if it's not already on.

A beep lets you know it's started, and an icon (a small picture) representing a Macintosh disk appears on the screen. The blinking question mark shows that the Macintosh is ready for you to insert a disk.

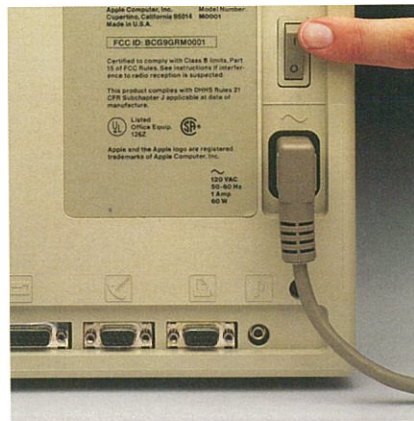

### ■ Insert the Macintosh System Disk into the disk drive, metal end first, label side up.

Push the disk until it clicks into place. The soft hum is your Macintosh getting information from the disk. A message appears, welcoming you to Macintosh.

■ Adjust the brightness control to the level you want.



A few seconds later, your screen looks like this:

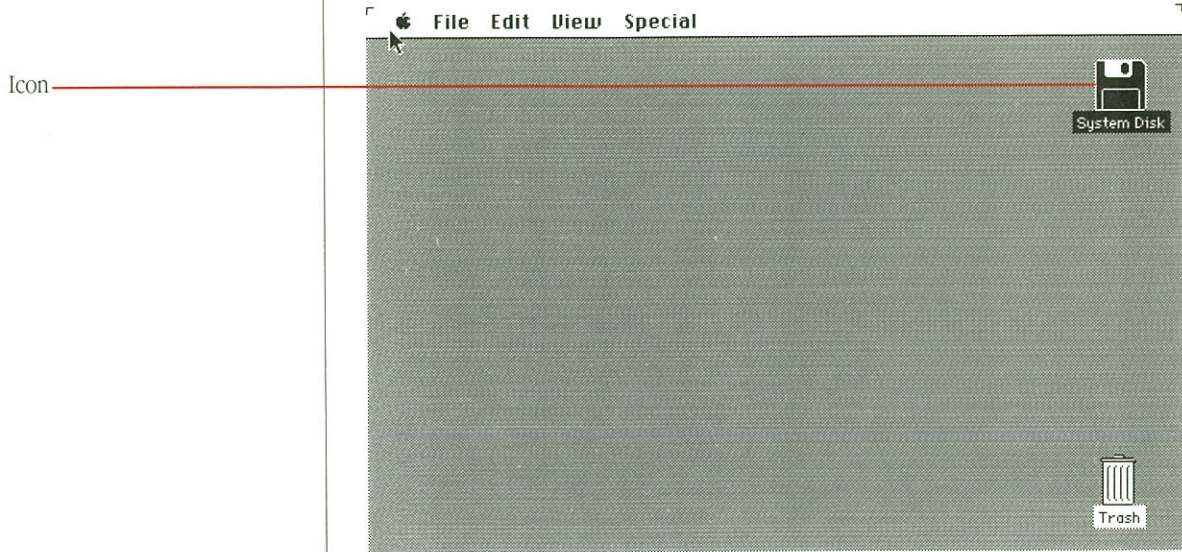

This is the Macintosh **desktop**. Most computer screens look like the departing flight schedule at a busy airport, but the Macintosh screen looks like a light gray desktop. And you can arrange your desktop any way you want. You can slide documents around, organize your work in folders, throw things away, or get what you want to work on next—just by moving the mouse and pressing the mouse button. The bar at the top of the screen contain menus; you'll see how to use them a little later. The icons on your desktop always let you know what's available. Right now you see icons that represent:

- the System Disk you inserted
- the **Trash**, where you can discard what you don't need anymore

If your screen doesn't look like this, someone else has probably used this lesson and arranged the desktop in a different way. See "Handling Windows" in Chapter 3 to close all windows that may have been left open.



## Using the Mouse

Your Macintosh responds instantly to every movement you make with the mouse. You can start applications and get documents, work on them, and put them away again—just by moving the mouse and pressing the mouse button. The best way to see how this works is to try it.

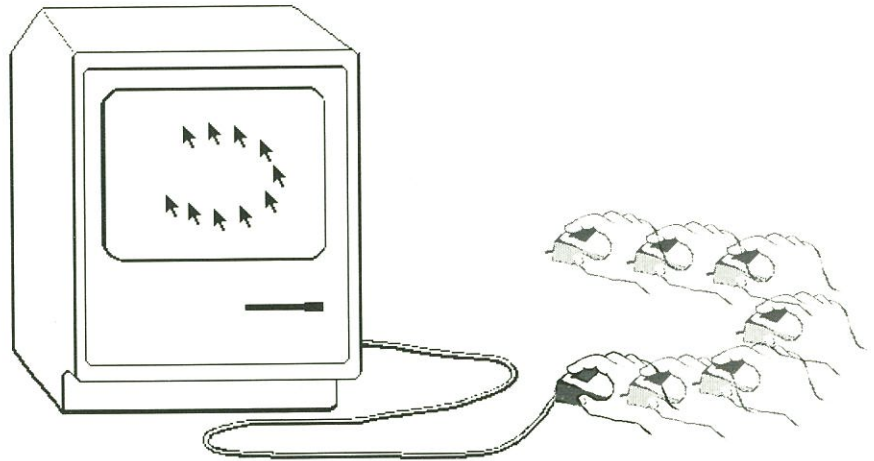

### 1 Moving the Pointer by Moving the Mouse

- **Watch the screen while you roll the mouse on a flat surface next to your Macintosh. For now, don't press the mouse button.**

Every move you make with the mouse moves the **pointer** in exactly the same way. Usually the pointer is shaped like an arrow, as it is now, but it changes shape depending on what you're doing. For instance, it becomes an **I-beam** when it's positioned over text you can edit and a **wristwatch** when your Macintosh is doing something that takes a little time.

You'll have the best control if you hold the mouse with the mouse cable pointing directly away from you.

If you run out of room for the mouse—if it goes off the table, for instance, or runs into the Macintosh itself—lift the mouse and put it down again where you have more room. Lifting the mouse doesn't move the pointer.

Using the mouse might feel a little awkward at first, but it will soon be second nature.

## 2 Selecting by Clicking an Icon

You probably have your own idea of how your desktop should be organized, so the first thing to do with your mouse is arrange your electronic desktop to suit you. To move an icon, you first **select** it to let your Macintosh know this is what you want to work on next. You select icons using a technique called **clicking**.

### ■ Position the pointer on the Trash icon.

Make sure the tip of the pointer is on the icon itself. Putting it on the word “Trash” below and clicking produces a slightly different effect, which you’ll see later.

### ■ Click the icon by pressing and quickly releasing the mouse button.

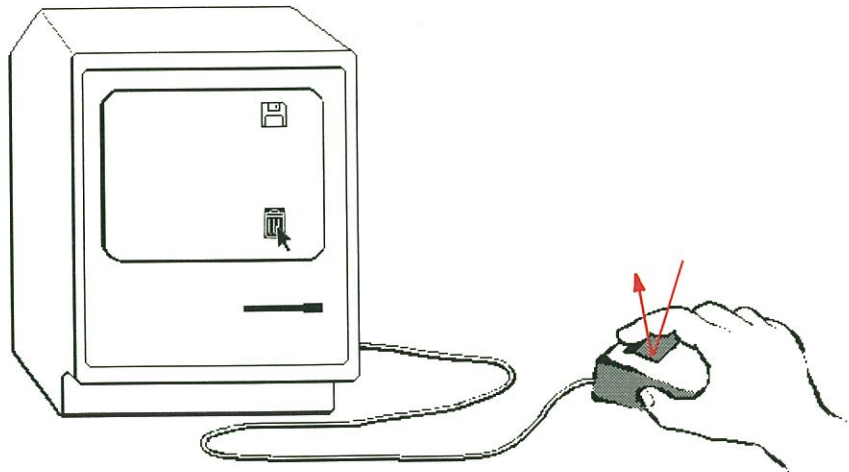

As you click the icon, it’s **highlighted**. What was black is now white and vice versa. The highlighting shows that you **selected** it. Notice that the System Disk icon is no longer selected. Selecting is an important idea with Macintosh, and it has a specific meaning: you always **select** the information you want to work on next.

### ■ Click the System Disk icon.

Now the System Disk icon is selected, and the Trash icon is no longer selected.

### 3 Dragging an Icon

When clicking, try not to move the mouse as you release the mouse button. Practice clicking each icon in turn until you can click without moving the mouse at all.

Once you've selected an icon, you can use the mouse to move it with a technique called **dragging**.

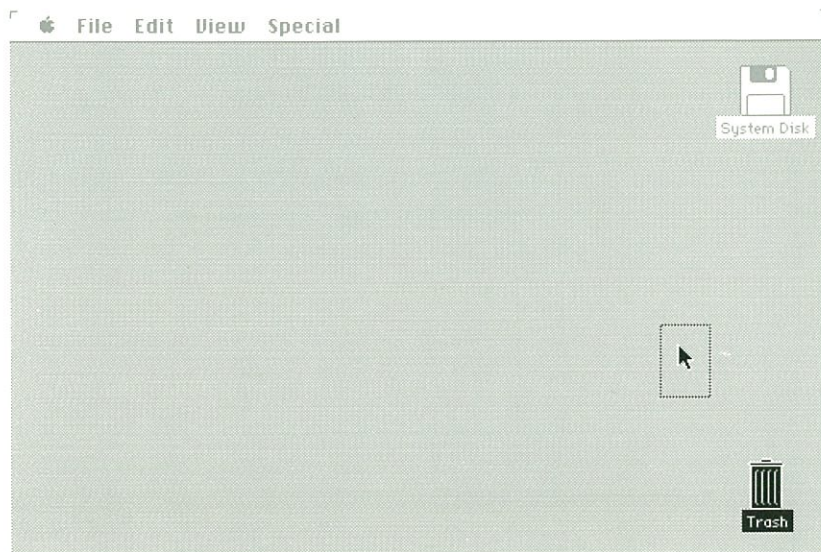

- **Position the pointer on the Trash icon.**

- **Press and hold the mouse button while you move the mouse.**

When you press the mouse button, you select the icon. As you move the mouse, the pointer moves and drags an outline of the icon and its title along with it. So you always know where you were—and where you're going.

- **Release the mouse button.**

The icon snaps to its new place.



Try this again with the System Disk icon. Move the icon all the way to the left. Notice that it won't go off the edge of the screen, so you don't have to worry about losing it. Remember, lifting the mouse has no effect on what you're doing (but releasing the mouse button does end the current dragging). You can cancel a drag in progress by moving the pointer into the menu bar at the top of the screen. Practice dragging until you can easily put the icons wherever you want them.

You've learned how to use the mouse to point to and select information you want to work on, and you've seen how you can drag icons to arrange your desktop. Next you'll learn how to act on what you select by choosing a command from a menu.

By the way, you can take a break from this lesson at any point. Leave the Macintosh switched on and pick up where you left off. If it's been switched off, switch it back on, make sure the System Disk is inserted, and start over.

## Selecting and Choosing

### 1 Selecting the System Disk Icon

Whenever you work with your Macintosh, you tell it two things: what you want to work on, and what you want to do. First, you tell the Macintosh what you want to work on by selecting it as you've been doing with icons on the desktop. Then you tell the Macintosh what you want to do with the selection. You usually do this by **choosing** a command from a menu.

Right now what you want to work on is the System Disk, and what you want to do is open its icon so you can examine its contents. Here's how to do this:

#### ■ Position the pointer on the System Disk icon and click.

This is the same thing you've done before. Now the System Disk icon is selected, and you can choose a command for it.

### 2 Pulling Down a Menu

Along the top of the screen, in the **menu bar**, are titles of the menus you can choose from.

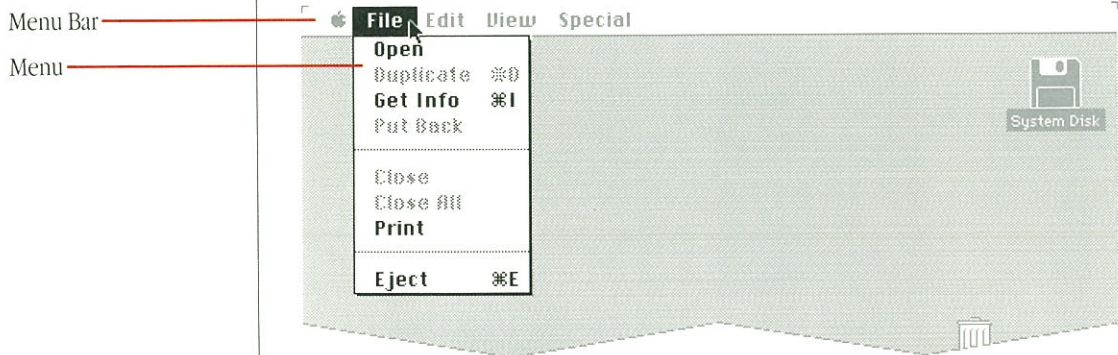

#### ■ Position the pointer on the word “File” in the menu bar.

Among other things, the File menu lets you open icons.

#### ■ Without moving the mouse for now, press and hold the mouse button. Release it when you're finished looking.

Pressing the button while you're pointing to a menu title causes the title to be highlighted and a menu to appear. The menu contains **commands** you can carry out on what you've selected. Commands that you can't use right now (Close, for instance) appear **dimmed** in the menu. When you release the mouse button, the menu disappears.

### 3 Choosing a Command From a Menu

To choose a command from a menu, you use the same dragging technique you used to move icons.

- Position the pointer again on the menu title “File” in the menu bar.
- This time, press the mouse button and hold it down while you drag the pointer to the word “Open,” then release the mouse button.



As you drag through the menu, each command is highlighted in turn. When you release the mouse button with the Open command highlighted, an outline zooms out of the icon and the screen is almost filled by a **window**. This window displays a **directory** of icons that represent the contents of the System Disk.

If a window doesn't appear, make sure the System Disk icon is selected before you choose Open from the File menu.

The System Disk icon is hollow now to show that the icon has been opened into a window.

If you change your mind about choosing something from a menu, you can move the pointer off the menu. Nothing is chosen unless you release the mouse button while one of the commands is highlighted.



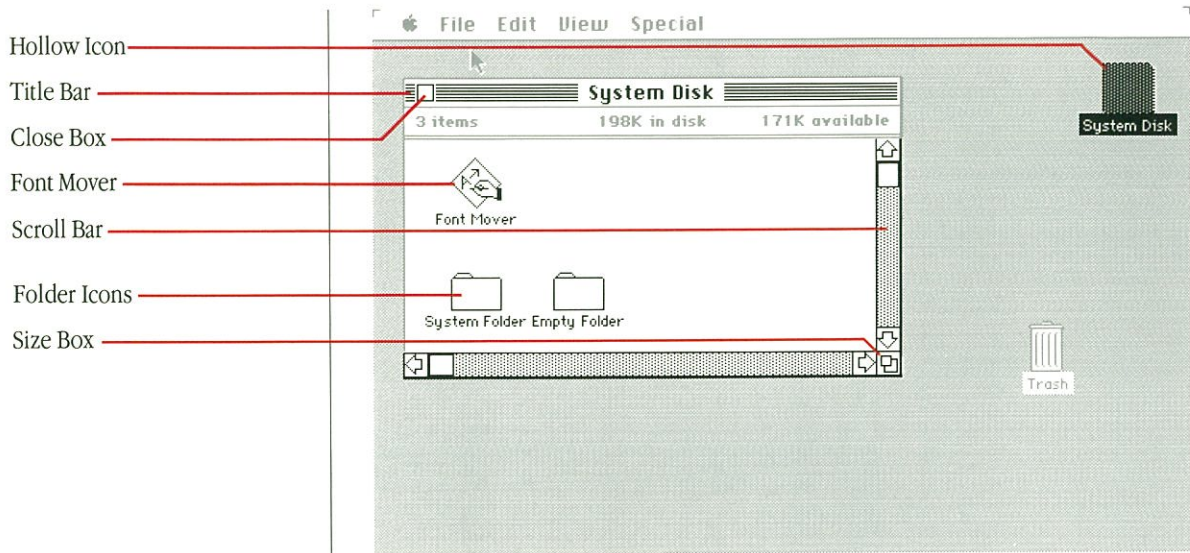

The System Disk window's **title** appears in the **title bar** at the top of the window. Below the title bar is information about the directory's contents. Along the right and bottom are **scroll bars** that let you get around in large directories or documents. In the bottom right corner is the **size box** you use to change the size of a window. In a few minutes, you'll see how to use these parts of a window to manipulate it.

To sum up what you've done so far: First you selected something (the System Disk icon), then you chose a command (Open). You'll follow this same pattern whenever you work with Macintosh: *select* some information, then *choose* an action for it.

There are three icons in the System Disk window, this time representing an application for adding and removing fonts, and two **folders** that are on the disk you inserted into the Macintosh's disk drive. One of the folders holds system information the Macintosh needs, and the other is an empty folder for your own documents.

You can move icons in the System Disk window the same way you moved icons on the desktop—by dragging them. Go ahead and try this. For now, keep them inside the System Disk window.

## Manipulating Windows

### 1 Changing the Size of a Window

When you're working on a document at your desktop, it's great to have a wide open window on it so you can really see what's there. But small windows also have their advantages. You can move small windows around on your desktop, and you can see more than one at a time. To change a window's size, you use the size box in the bottom right corner of the window.

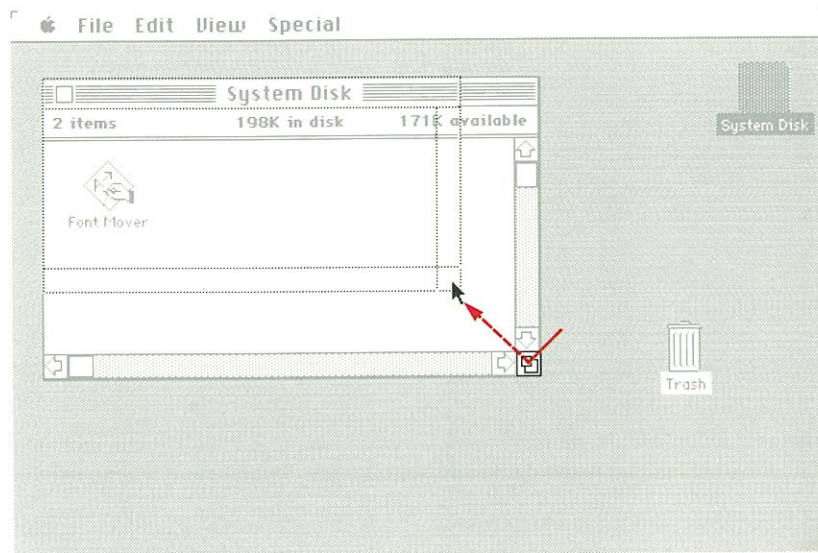

#### ■ Position the pointer on the size box, and drag it up and to the left.

As you drag, a dotted outline follows. The farther to the left you drag, the narrower the outline becomes; the farther upward you drag, the shorter it becomes. When the outline's as small as you can make it, it stops moving. When you release the mouse button, the window changes size.

The contents of the window don't change at all when you change a window's size. The only thing that changes is how much you can see.

Experiment with controlling the size of the System Disk window. Drag the size box down and to the right to make the window bigger again. Then try all different lengths and widths.



## 2 Moving a Window

You can move windows on your desktop just as you moved icons. To move a window, you drag it by its title (or anywhere in the horizontal title bar at the top of the window). Don't, however, drag it by the small box in the title bar. That's the close box, and it's just for closing the window.

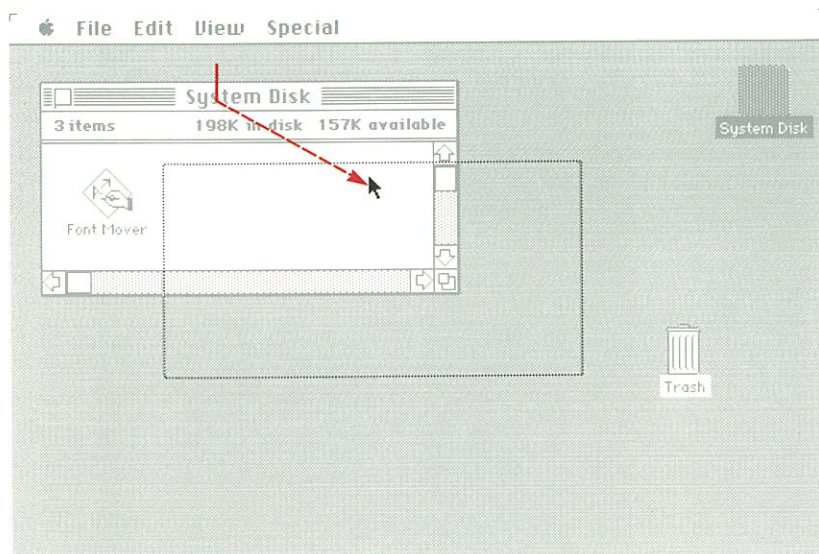

- **Position the pointer anywhere on the title of the System Disk window.**
- **Drag the System Disk window by pressing the mouse button and holding it down while you move the mouse.**

Just as when you dragged icons, a dotted outline of the window follows your movements. When you release the mouse button, the window moves where the outline was.

If you release the mouse button before you have the window where you want it, just “pick the window up” again. If you change your mind about moving it, cancel the drag by moving the pointer into the menu bar.

Just as icons stayed within the limits of the desktop, so do windows. You can't lose them by dragging too far.

Practice your new skills. When you can manipulate the window easily, making it any size and putting it anywhere you want on (or partially off) the desktop, go on to the next step.



### 3 Opening Another Icon

Use your new window-handling expertise to get the System Disk window out of the way if you need to. Shrink it down and move it around so you can see the Trash icon.

#### ■ Open the Trash icon.

Use the same technique you used a few minutes ago. Select the Trash icon by clicking it, then choose Open from the File menu by positioning the pointer on the menu title, pressing the mouse button, dragging to the Open command, and releasing the mouse button.

A second window appears on the desktop, probably overlapping the first (depending on where you left the first window and what size you made it).

### 4 Making a Window Active

With Macintosh you can have many windows on your desktop at the same time. When there's more than one window, your Macintosh needs to know which one you're working on at the moment, so that the commands you choose and the text you type end up in the right place. The window you're working on is always in front of all the others. It's called the **active window**, the place you want the next action to happen.

The active window's title bar is highlighted with narrow horizontal lines on either side of the title. The active window usually has a size box in the bottom right corner and scroll bars on the right and bottom sides.

Active Window

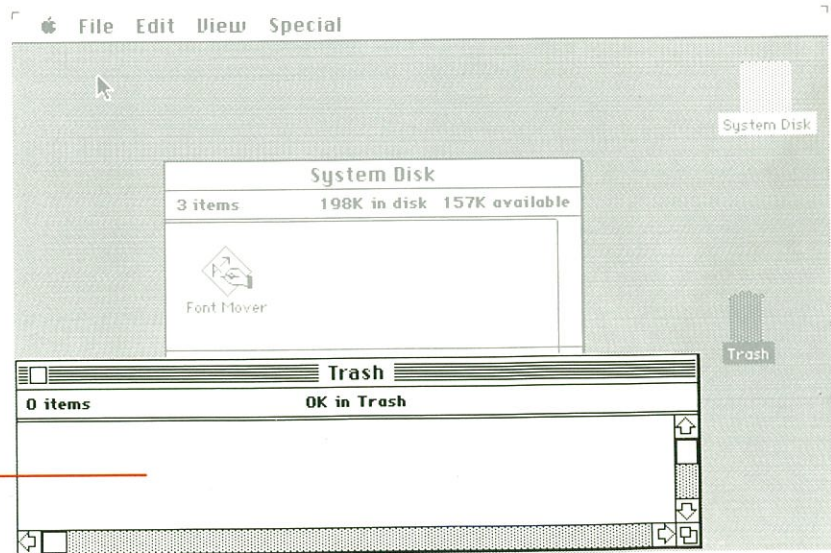

When you opened the Trash icon, it automatically became the active, frontmost window—the window you're working in. The System Disk window is also open on the desktop, but it's no longer the active window. To work in the System Disk window again, you make it active by clicking anywhere inside it.

If you left the System Disk window small before you opened the Trash window, it may be completely hidden by the Trash window now. You know how to move windows and change their size, so if you can't see the System Disk window, move the Trash window or change its size until you can see the System Disk window again. It doesn't have to be completely visible; as long as you can see part of it, you can make it active.

■ **Click in the System Disk window.**

The window is brought to the front of the desktop; its title bar is highlighted and scroll bars and a size box appear to show it's the active window. Whenever you want to work in a window that isn't already active, you first make it active by clicking in it.

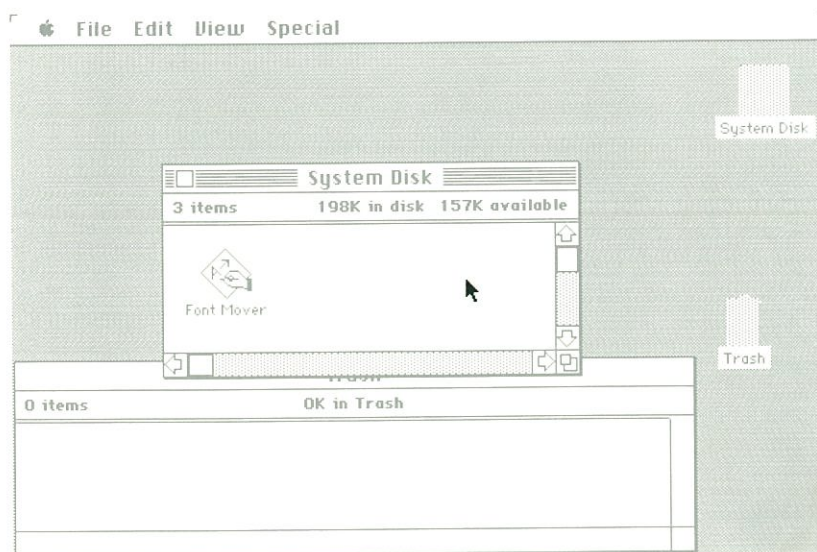

Your desktop might not look exactly like the one here. Your Macintosh does exactly what you tell it to do; the size and position of your windows are up to you.

## 5 Opening Other Icons

### ■ Click in the Trash window.

Now it moves in front of the System Disk window again.

Experiment with arranging your desktop—making each window active in turn, changing its size, and moving it.

Notice that you sometimes need to move a window in order to see its size box. And you sometimes need to change a window's size or move it to see a window it's covering. By the way, moving a window also makes it active if it's not already, so you don't have to make a window active before you move it.

You can open icons in a directory window, such as the System Disk window, just as you opened icons on the desktop. You know how to open an icon by selecting it and choosing Open from the File menu. There's a shortcut: you can do the same thing with a technique called **double-clicking**. Try it to open the System Folder icon in the System Disk window. (If necessary, first make the Trash window smaller; then make the System Disk window active and large enough that the System Folder icon is visible.)

### ■ Position the pointer on the System Folder icon and quickly press and release the mouse button twice.

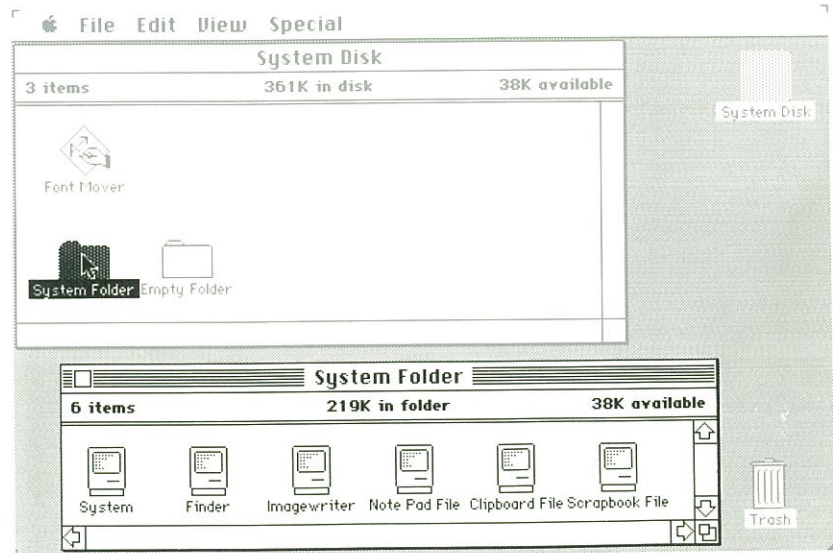



## 6 Closing a Window

Inside the System Folder are icons that represent information the Macintosh needs. If the System Folder window doesn't appear when you double-click, speed up your clicking. That way the Macintosh will be able to interpret your actions as a double-click, and not just as insistent single clicks. Now you have two ways to open icons.

- **Open the Empty Folder icon, either by double-clicking it, or by selecting it and choosing Open from the File menu.**

If necessary, first move the System Folder window. The Empty Folder window is—surprise—empty. You'll use folders later to organize the documents you create.

You can have many windows on your desktop, but to keep things tidy, you might want to close some when you're finished working on them, and open them again when you need them.

- **Make the Trash window active by clicking in it.**
- **Choose Close from the File menu.**

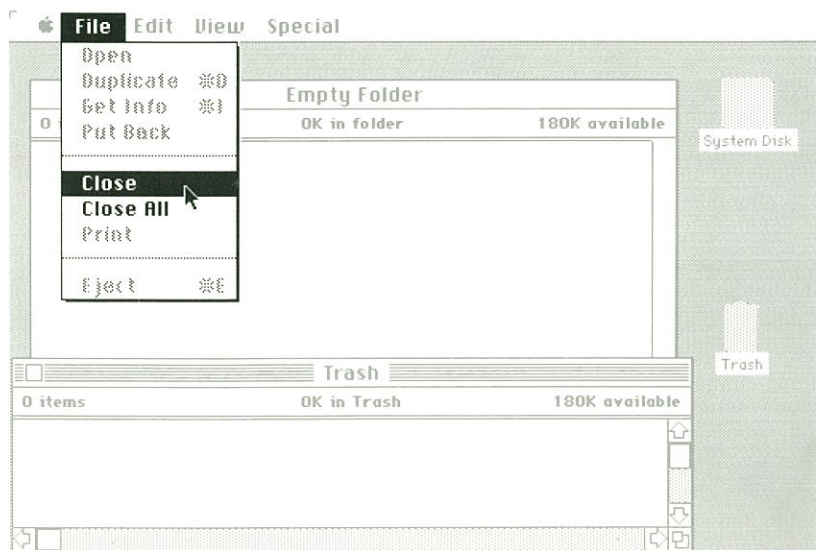

The window zooms closed. Whenever you choose Close from the File menu, the frontmost, active window is closed and the next window behind it becomes active.

Now close the Empty Folder window using another shortcut. The close box in the title bar lets you close an active window with a single click.

- **Make the Empty Folder window active if it's not already.**
- **Click the close box.**

Close Box

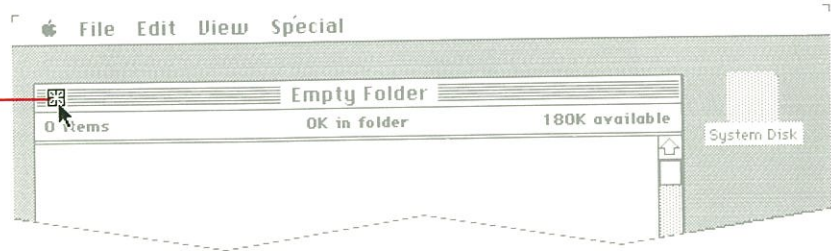

It's the same as choosing Close from the File menu.

## 7 Using Scroll Bars to See More

Most of the time, a window on the desktop can't show you the entire directory or document all at once, even when you've made the window very large. There's often more information than can fit in the window at one time.

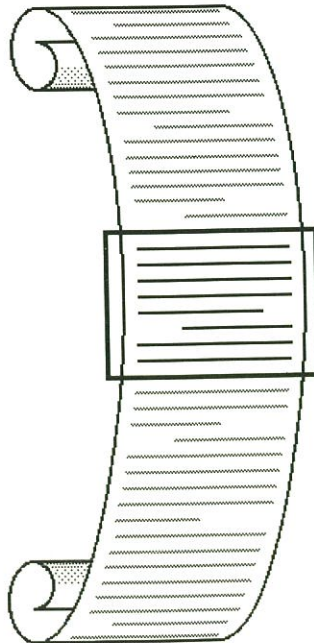

The scroll bars in an active window let you move what's in the window so you can see more of it.

- **Make the System Folder window small enough that some of the icons are hidden from view.**

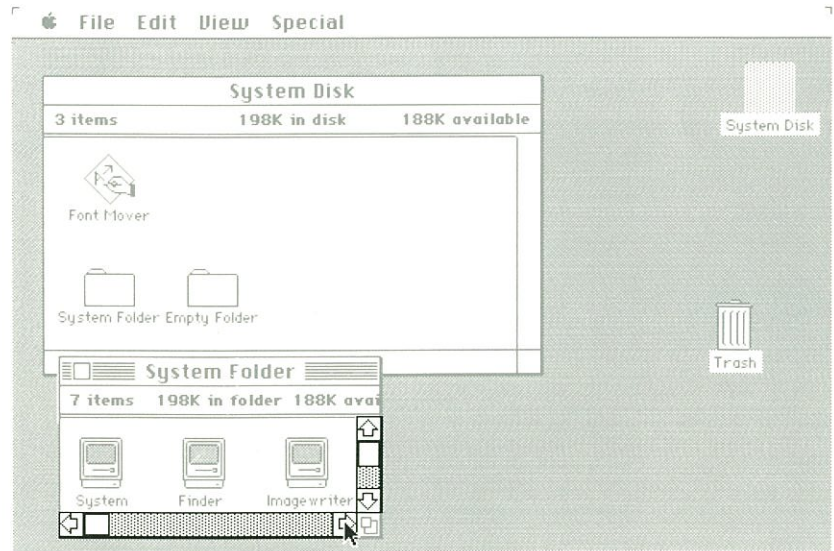

- **Click the scroll arrow that points to the right.**

More icons come into view. You can also scroll left, up, or down.

If you want to know more about scroll bars, see “Scrolling” in Chapter 3.



## Using an Application

### 1 Creating a New Document

You might be wondering what all of this has to do with your work—the documents you'll create with the Macintosh applications. First, you'll use the skills you've just learned whenever you work with your Macintosh, in nearly all the applications. You usually select information and choose commands in consistent ways. And windows are always opened and closed, changed in size, moved, and made active using the same techniques you've just learned.

Second, this chapter introduces the **Finder**, the built-in application for organizing and managing your documents. The Finder is available every time you start your Macintosh or whenever you move from one application to another. In fact, you've been using the Finder all along.

In addition to helping you manage your documents—copying them, renaming them, removing them, for example—the Finder lets you start applications and get documents, and then put your documents away when you're done working on them.

You probably purchased an application or two along with your Macintosh. Each Macintosh application disk also contains the Finder that's on the System Disk you've been using, so from now on keep the System Disk as a spare copy of the contents of the System Folder.

#### ■ Close first the System Folder window, then the System Disk window.

Use either of the methods you know—make the window active, and then click the close box or choose Close from the File menu.

#### ■ Choose Eject from the File menu.

The System Disk is ejected.

#### ■ Insert the application disk you want to use.

A Macintosh application package may include two copies of the application disk. Put one of these away in case your working copy ever becomes unusable. If this does happen, make a copy of the spare to replace your old working copy. (See Chapter 3 to find out how to copy a disk.) That way you'll always have a spare copy.

- **Open the icon that represents the application disk by double-clicking it or by selecting it and choosing Open from the File menu.**

The System Disk icon is still there, but it's dimmed to show it's not currently available. If the window was left open, its icons are dimmed.

- **Open the icon that represents the application you want to use.**

Each application icon looks like the work you do with that application.

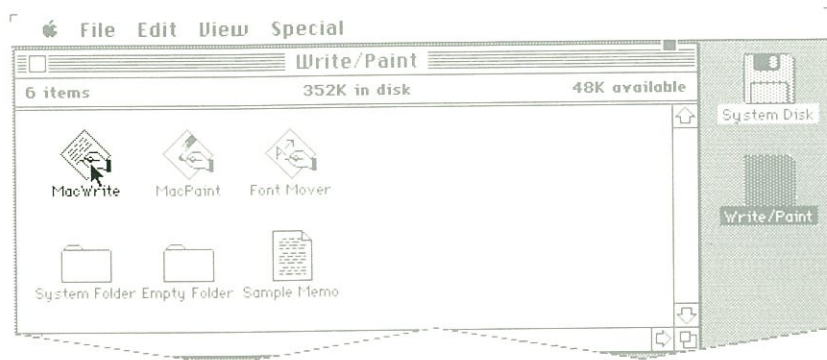

That's all there is to opening an application.

- **Do some work on your new document.**

You don't really need to know how to use these applications to finish this chapter. For example, just use the keyboard to type your name with MacWrite™ or draw a squiggly line with MacPaint™ (position the pointer anywhere in the drawing window and drag). You need to save only a small amount of work in order to see how the Finder helps you keep track of your documents.

## 2 Saving Your Work on a Disk

Whenever you're finished working on a document, you decide whether you want to keep what you've done or throw it away.

### ■ Choose Save from the File menu.

A dialog box appears, with a space for you to type the name of your document. A blinking vertical bar marks the insertion point, where text you type will be inserted.

You might also have noticed the Save As command in the File menu. You'll choose Save As when you want to save your document with a different name. Usually, you'll choose Save.

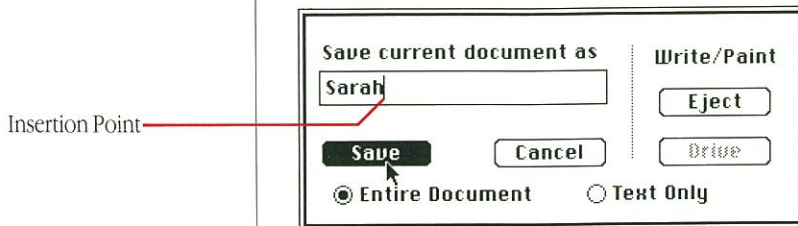

Whenever your Macintosh needs more information from you, it presents a dialog box, with buttons to click, such as OK or Cancel, and sometimes with a place for you to type additional information. These messages can also alert you if you're about to do something that could cause you to lose information, giving you a chance to cancel what you were about to do. When they're alert messages, they're often accompanied by a beep.

The Macintosh keyboard is very similar to a typewriter keyboard. Use the Shift key for capital letters. If you make a mistake, use the Backspace key to erase characters back to where the mistake is, and then start typing again.

### ■ Use the keyboard to type your name or any other name you want to give your document.

### ■ Click Save.

Your document is saved on the disk just as it is now. Make a habit of choosing Save about every 15 minutes or so while you're working with your Macintosh. (It's a good thing to do while you're waiting for your next inspiration.) That way, if your Macintosh gets switched off or there's a power failure, you'll never lose more than 15 minutes' worth of work.



With your work saved on the disk, you can leave the application you've been using and return to the Finder.

■ **Choose Quit from the File menu.**

The desktop appears again just as you left it. But now the icon of your new document appears in the application disk window.

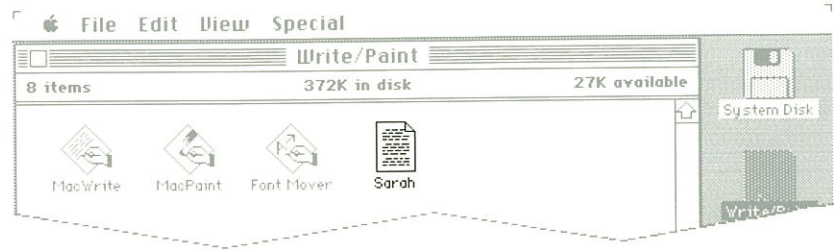

This new icon represents the document you created. It shows which application was used to create it, and below it is the name you gave it. The next time you want to work on this document, you select and open it just like any other icon. Opening the document you want to work on also starts the application you need to do the work. You don't have to open the application, then open the document; once a document's been saved, you can open it directly from the Finder.

**3** **Editing Text:  
Cutting and  
Pasting**

The Macintosh keyboard is mainly for typing text and numbers. You'll see the way you'll usually type and edit text, no matter which application you're using, by adding some comments about the document you just created.

■ **Select the icon that represents your document.**

■ **Choose Get Info from the File menu.**

An information window appears, showing some useful information about this document, such as which disk it's on, how big it is, and so on.

There's also room for you to add comments about the document. The comment box will save you time when you want to know more about a document without opening it. You might have a note explaining that this is your smash hit sales presentation of last November, or the play that won you the Pulitzer Prize. Of course, you'll also know which application you used to create the document by its icon.

The blinking vertical bar appears again, marking the insertion point for text you type.

You'll use the keyboard to add your comments. You don't have to press the Return key when you come to the end of a line of text; the next line starts automatically.

■ **Type:**

-----  
This is the first document I created on my Macintosh. It has great  
sentimental value.  
-----

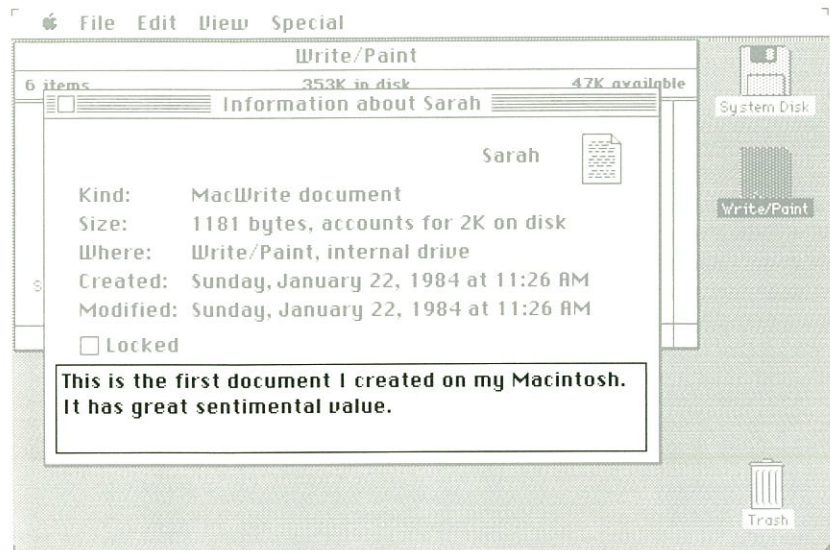

You can edit your comments by **cutting** and **pasting** with the Cut command and the Paste command. First, select some text to cut.

■ **Position the pointer at the beginning of the word “great” and drag to the end of the word.**

You're selecting information to work on, as you did when you selected icons. You selected icons by clicking them; you select text by dragging across it.

If you move the pointer off the word, you might select more than the word “great”. If this happens, just start selecting over again; nothing unexpected can happen while you’re just selecting.

This is the first document I created on my Macintosh.  
It has **great** sentimental value.

■ **Choose Cut from the Edit menu.**

The word “great” vanishes and in its place is the insertion point, where new text you type will be inserted.

Whenever you choose Cut from the Edit menu, whatever you cut or copy is put in a holding place called the **Clipboard**, ready for you to paste it to a different location if you want.

■ **Type:**

.....  
absolutely no  
.....

What you type appears at the insertion point.

■ **Select a new place for the insertion point by clicking after the space following the word “first”.**

This is the first|document I created on my Macintosh.  
It has absolutely no sentimental value.



■ **Choose Paste from the Edit menu.**

The contents of the Clipboard—the word “great”, in this case—are pasted into the location you selected. You can add a space at the insertion point by typing one. See “Editing Text” in Chapter 3 for a summary of how to enter and edit text.

The contents stay on the Clipboard until you choose Cut or Copy again, so you can continue to paste them. You can paste within one document or between two documents created with the same application. The contents also stay on the Clipboard when you leave an application, so you can cut and paste between applications.

For example, you can draw a picture with MacPaint and use it to jazz up a report you create with MacWrite. Or borrow an especially eloquent passage from a MacWrite document and paste it into an overhead slide you’re preparing with MacPaint.

Whether you’re using an application or the Finder, you can usually view the contents of the Clipboard.

■ **Choose Show Clipboard from the Edit menu.**

The Clipboard window appears, with the word “great” in it.

The Clipboard window doesn’t have to be open for you to paste its contents.

■ **Close the Clipboard window.**

Either choose Close from the File menu or click the close box. The Close command closes the active window, and close boxes appear only in an active window.

■ **Close the information window.**

## Organizing Documents

### 1 Using Folders

You've seen how the Finder helps you start an application and get a document, save it, and leave the application. It also helps you organize your documents—grouping them together with related documents, duplicating them, renaming them, or throwing them away.

You'll soon accumulate many documents on the application disk you've been using. At some point you might want to arrange your desktop so that related documents are grouped together. Macintosh **folders** work just like ordinary file folders to help you organize your documents. For instance, you could keep all your monthly status reports together in one folder. Or group all your MacPaint illustrations together or keep each one with the report it illustrates. Macintosh lets you organize your documents however you want them (or keep them scattered about your desktop if clutter makes it easier for you to think).

Information the Macintosh system needs is grouped in the System Folder. You have an endless supply of empty folders to organize your own work in. The Empty Folder icon in the application disk window can be duplicated whenever you need a new folder to put new documents in.

- **Duplicate the Empty Folder by selecting its icon and choosing Duplicate from the File menu.**

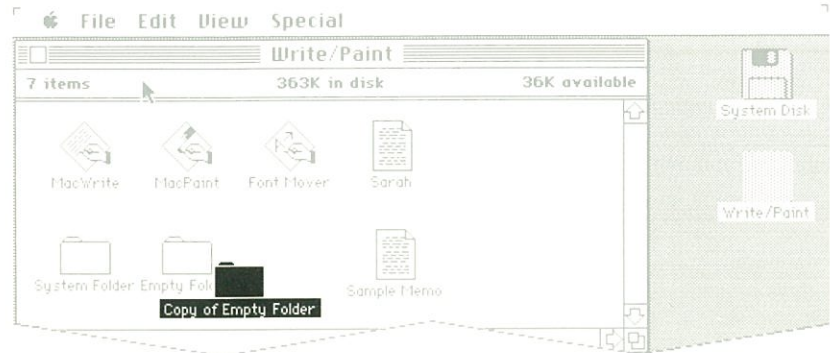

Another folder appears, slightly below and to the right of the first. It's given the temporary name "Copy of Empty Folder."

Whenever you choose Duplicate from the File menu, the copy you make has the same name as the original, with the words “Copy of” added in front. (This is to prevent ever having more than one document or folder with the same name on the same disk.) It’s usually a good idea to rename the copy.

The copied folder is automatically selected when you create it. Whenever an icon is selected, you can rename it just by typing. If you can’t see the entire icon, you can make the window larger or move the icon.

■ **Type:**

Manila Folder

Or type any name you want. “Copy of Empty Folder” is renamed “Manila Folder.” Any time text is selected, text you type replaces the selected text.

You can also select, cut, and paste the title text, as you did when you edited the comments about the document you created. Usually, however, when you want to rename an icon, it’s easiest just to select the icon and replace the old name by typing a new one.

■ **Drag the icon that represents the document you created so that it covers the Manila Folder icon.**

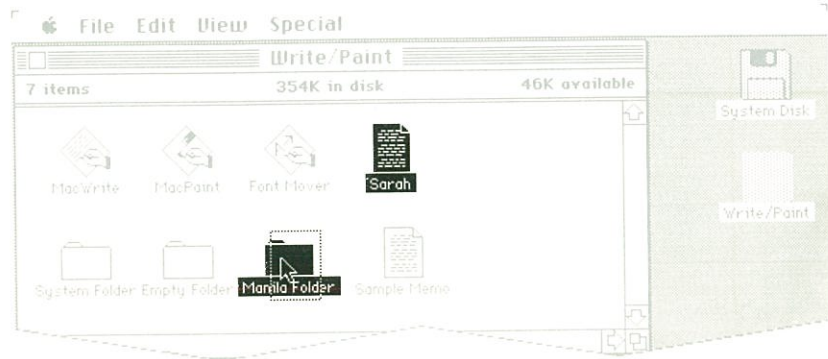

When you cover the folder icon with the document icon, the folder is highlighted. When you “drop” the document icon into the folder by releasing the mouse button, the folder icon is no longer highlighted.



## 2 Selecting More Than One Icon

### ■ Select and open the Manila Folder icon.

There's the icon that represents your masterpiece.

Dragging a document icon to a folder will file the document there. You can also drag an icon into an open folder window; the result is the same.

Documents and applications can be left on your desktop as well as placed in folders or on disks. You might want to leave the applications you use most often (or the documents you're working on for a presentation that day) on the desktop so you can get at them easily.

Any application or document you leave on the desktop is automatically put back on its disk if you eject the disk. When you insert that disk again, whatever you left on the desktop reappears there.

### ■ Drag the icon that represents the application you were using out of the application disk window onto the gray desktop.

Whenever you use this disk, this application will appear on the desktop where you left it. (Of course, you can also drag it back to the disk or leave it in the folder with your document.)

You can take most actions on several documents at once. For example, you can move several documents from one place to another, discard them in the Trash, or find out information about them. One of the ways to select more than one icon is by using the dragging technique.

### ■ Make the application disk window open and active if it's not already.

If it's closed and you open it, it automatically becomes the active window. If it's open but not the active window, click anywhere inside it to make it active.

### ■ Use the size box to make the window bigger so you'll have plenty of room.

- **Position the pointer outside one corner of a group of icons (any corner) and drag diagonally to the opposite corner of the group.**

Be sure you start dragging outside an icon. If you position the pointer on an icon, you select just that icon. As you drag, a dotted rectangle appears around the icons you're selecting. When you release the mouse button, the icons are selected. You can select any group of icons that can be enclosed in a rectangle.

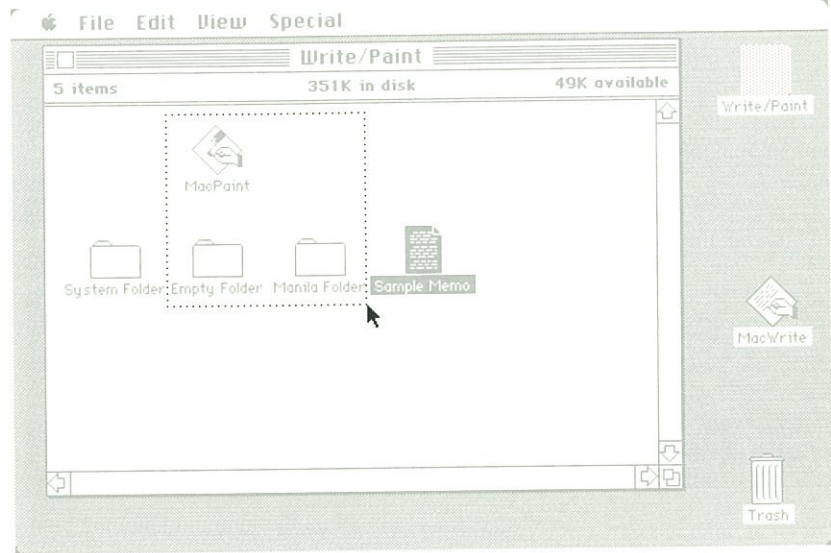

All icons you outline are selected. Now you can drag the whole group.

- **Position the pointer on any one of the icons and drag the whole group to another part of the window.**

Make sure the pointer is on one of the icons (it doesn't matter which one). They keep their arrangement and move in "formation." The icons stay selected until you click anywhere outside any of them.

You can also choose a command to act on a group of selected icons. For example, you can find out information about an entire group of selected documents.

■ **Choose Get Info from the File menu.**

An information window appears for each icon that's selected. As each new window appears on the desktop, it overlaps the window that appeared before it.

You can move these information windows or make them active like any other windows on the desktop, but you can't change their size or scroll through them.

■ **Close each information window in turn by choosing Close from the File menu or clicking its close box.**

Each time you choose Close or click its close box, the active window closes. Or choose Close All from the File menu to close all information windows and the application disk window as well.

There's another way to select more than one icon. Sometimes the icons you want to select aren't lined up in a way that you can drag a rectangle around them. If they're scattered about, you can select more than one by **Shift-clicking**.

■ **If necessary, open the application disk window.**

■ **Select any icon in it by clicking it.**

If any icons are still selected, first click outside of any of them before you select one again.

■ **Hold down the Shift key on the keyboard while you click a second icon.**

The second icon can be any icon in the same window. You can even scroll to a different part of the window and Shift-click.

You can continue to select more icons as long as you hold down the Shift key while you click.

Any action you choose now will affect all the icons that are selected. You can choose a command for them or move them by dragging the whole group.



### 3 Changing Your View

You can use the Finder's View menu to look at your documents in whatever order you want.

#### ■ Choose By Name from the View menu.

The contents of the active window are arranged alphabetically by name. You can also view them chronologically, by size, or by kind.

### 4 Using a Desk Accessory

Macintosh desk accessories—an Alarm Clock, a Calculator, and a Note Pad, for example—are always available on the Macintosh desktop, no matter what application you're using or whether you're using any application at all.

You choose desk accessories from the Apple menu on the left side of the menu bar.



#### ■ Choose Alarm Clock from the Apple Menu.

Lever

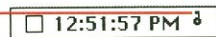

#### ■ Click the “lever” on the right side of the Clock.

The Alarm Clock expands to display and let you set whatever is highlighted in the bottom panel—the time, date, or alarm.

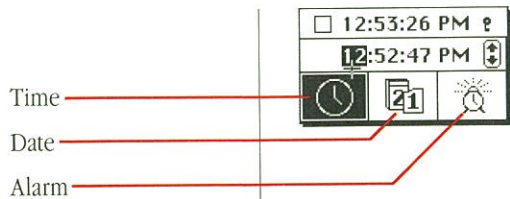

Click the icon that represents what you want to set, then click the digits you want to change. Click the up arrow to advance the numbers, or click the down arrow to go backward. Click in the top panel to set.

To display the simple Clock again, click the lever to return it to the horizontal position.

See “Desk Accessories” in Chapter 4 for descriptions of the other accessories in the Apple menu.

## **5** Starting Your Own Work

You probably have some work you want to use your Macintosh for. If you'd like to know a bit more about Macintosh before you start using an application, read Chapter 2. Then read the manual that came with the application you want to use. When you want some reminders or more information about using the Finder to organize your work, come back to Chapter 3 of this manual—“Using the Finder.” Enjoy!



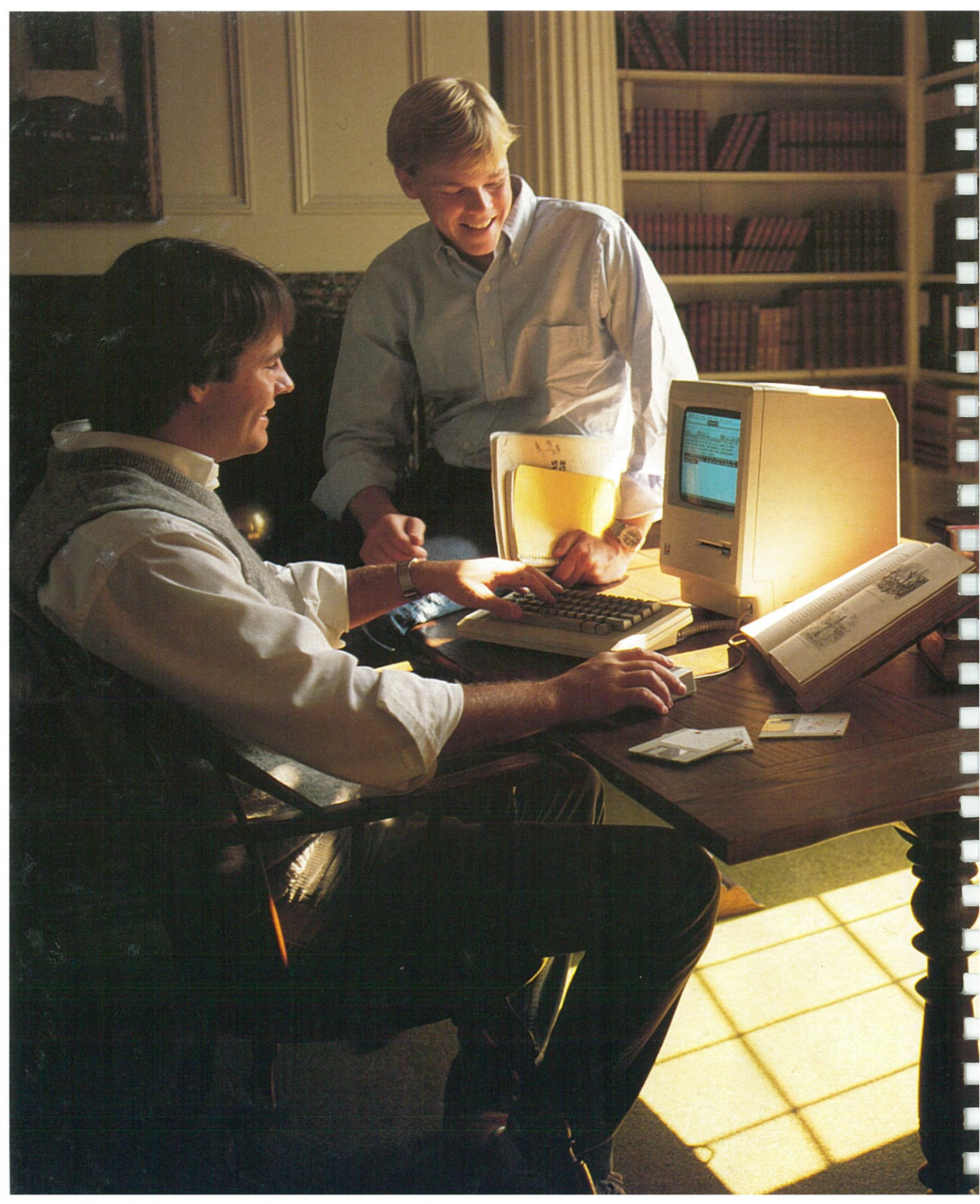



Chapter 2:  
Finding Out  
More About  
Macintosh



# Contents

- 45 What Can You Do With Your Macintosh?
- 47 What Macintosh Is: Its Parts
- 48 Where Does Your Information Go?
- 49 Working With Your Macintosh





## What Can You Do With Your Macintosh?

What can you do with your Macintosh? Your work! Your Macintosh can help you with almost all of it. You can prepare illustrations, draw charts and graphs, write and edit text, keep your files, and maybe even organize your life. You can also use your Macintosh just to have fun, doodling away or playing games. But you might just decide that working hard can be the most fun of all.

Macintosh removes a lot of the mystery about using computers. Every action you take has an effect you can see—so you're always in control of what happens. And you don't have to keep tedious details in your head, because Macintosh keeps track of them for you. You're free to think about what you want to do, rather than how to get the computer to do it.

The Macintosh stays out of the way of your work. Think of watching a good movie: You quickly become involved in the plot and don't think too much about the screen or the mechanics of making the movie. It's like that with Macintosh: Nothing intrudes on the work you're doing or the fun you're having.

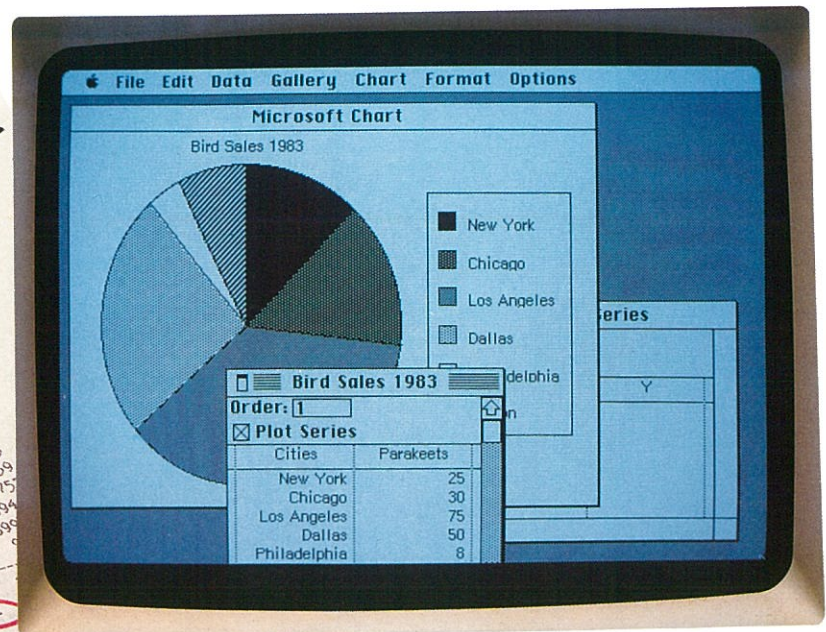



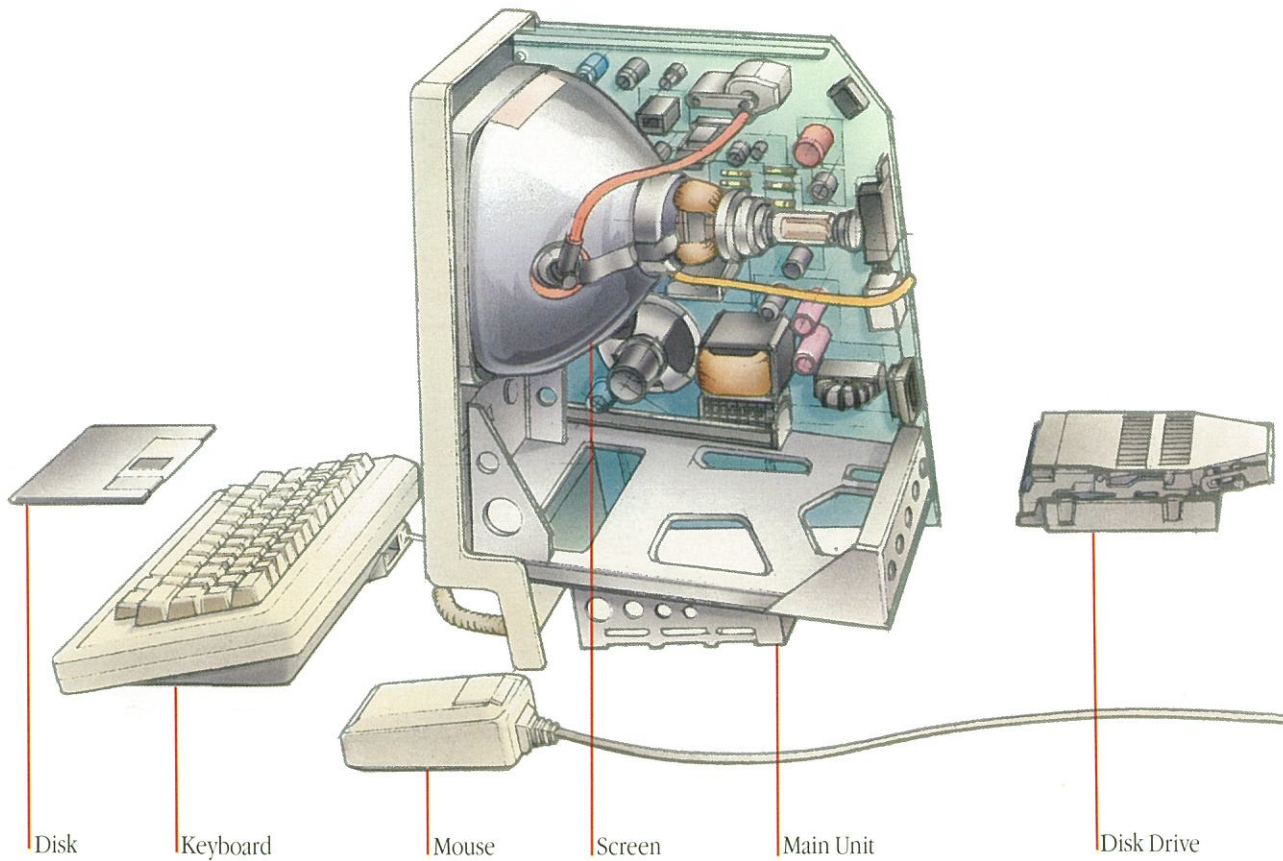

## What Macintosh Is: Its Parts

The basic Apple Macintosh system includes the main unit, the keyboard, and the mouse. The **main unit** contains the processor, memory, the built-in disk drive, and the screen. The **processor** does the actual work of the computer. **Memory** is where the Macintosh stores the information you're currently using. The Macintosh can get this information from a **disk** in the **disk drive**. (The disk drive records and retrieves the information that's stored on the disks.) The Macintosh can also get information directly from you through the **keyboard** or the **mouse**. The **screen** is where you keep track of what you're doing. These parts of Macintosh that you can see and touch are called **hardware**.

One of the really exciting things about Macintosh is the **software**, or application programs you can use—like MacWrite for words or MacPaint for pictures. Depending on what you want to do, you choose an application that will help you do it.

See “Applications” in Chapter 5 for some of the applications you can use with your Macintosh.

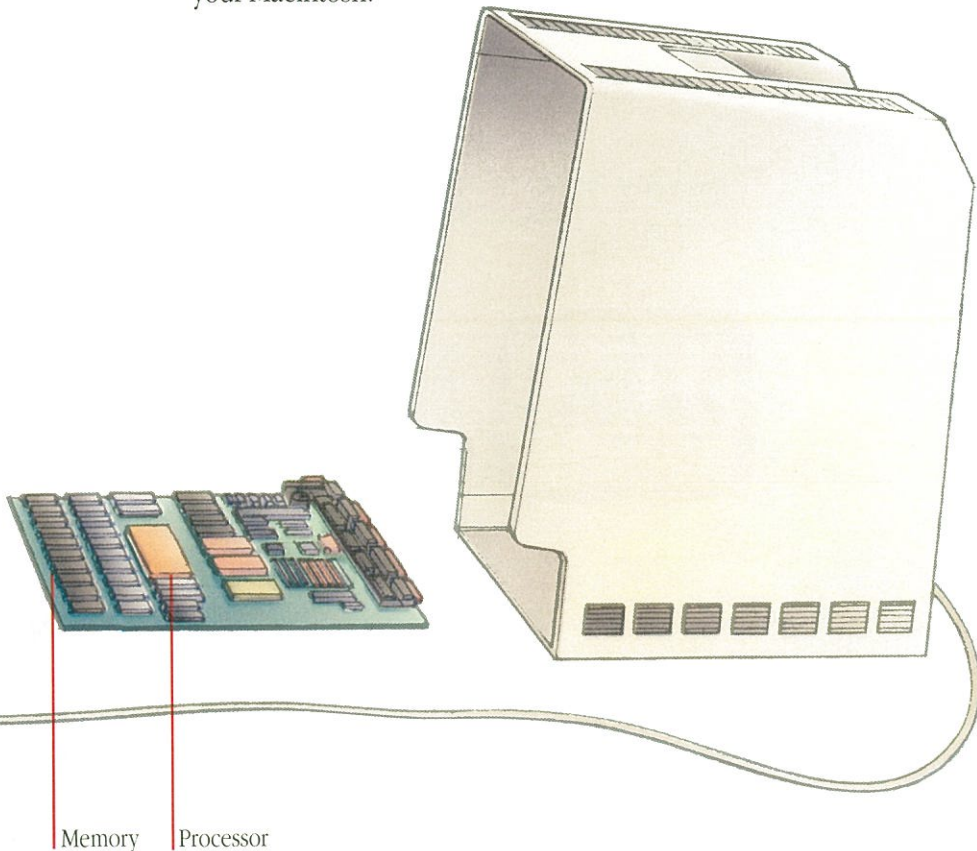

## Where Does Your Information Go?

When you get an existing document so you can revise it (the perfect first draft has yet to be created), the Macintosh leaves the original on the disk and makes a copy for you to work on. When you're done working on the copy, you decide whether you want to keep the new version or not.

If you save the new version, it replaces the "original" on the disk. If you don't, nothing on the disk is changed at all. You always have the option of saving the new version with the original name, saving it with a different name, or not saving it at all. It's like having an original document and making photocopies of it to edit. When you're satisfied with the changes, you change the original.

The document in the Macintosh's memory—the version you're working on—is stored only temporarily. So if you accidentally trip over the power cord, or the electricity goes off, everything you're working on—whatever's in memory—vanishes forever. To count on your work being there when you need it, save it on a disk by choosing Save from the File menu every 15 minutes or so. That way you'll never lose more than a coffee break's worth of work.

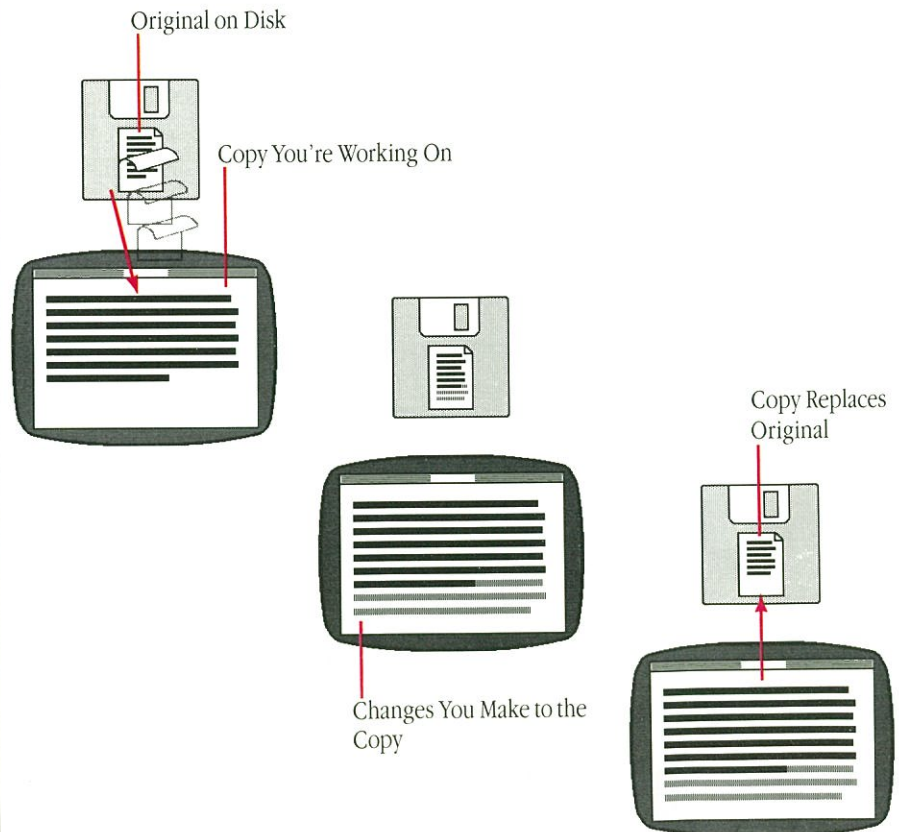



## Working With Your Macintosh

Working with Macintosh is very different from working with other computers. You use the mouse to point to things on the screen and to cause most of the action to happen. Usually, you use the keyboard only to type text and numbers.

Your everyday routine with the Macintosh will probably be something like this:

1. Switch the Macintosh on and insert a disk with the application you want to use and the documents you want to work on. (You can keep your Macintosh always switched on if you like; just turn down the brightness control whenever you finish working with it.)
2. Open the document you want to work on or open a brand new document by opening the application you want to use.
3. Use the mouse and the keyboard to create or change the document.
4. Save your work frequently by choosing Save from the File menu.
5. Use the Clipboard to move things from one document to another by choosing Cut and Paste from the Edit menu. Add pizzazz to sales reports with a picture from MacPaint, or drop the proposed budget into your department's monthly status report.
6. If you have an Apple Imagewriter printer and you want a printed copy of your document, choose Print from the File menu.
7. When you're finished working on a document, choose Save from the File menu to save your last changes, and then choose Quit from the File menu.
8. Always eject the disk before you switch the Macintosh off.

### Arranging Your Work on Disks

You can arrange your work on disks by moving documents, folders, and applications between disks, or by removing what you don't need. See "Moving a Document, Folder, or Application" and "Removing a Document, Folder, or Application" in Chapter 3.

If you're using a one-drive system, you can minimize the amount of disk "swapping" you have to do, by keeping just one application and documents you create with that application on a startup disk. (Drag any other application to another disk.)

If you're using a two-drive system, you might decide to keep more than one application on a startup disk, and keep documents you create with those applications on separate disks in the external disk drive.

You can also have more space available on a disk by removing fonts from it. See "Using Font Mover to Claim More Space on a Disk" in Chapter 3.

Chapter 3:  
Using the Finder





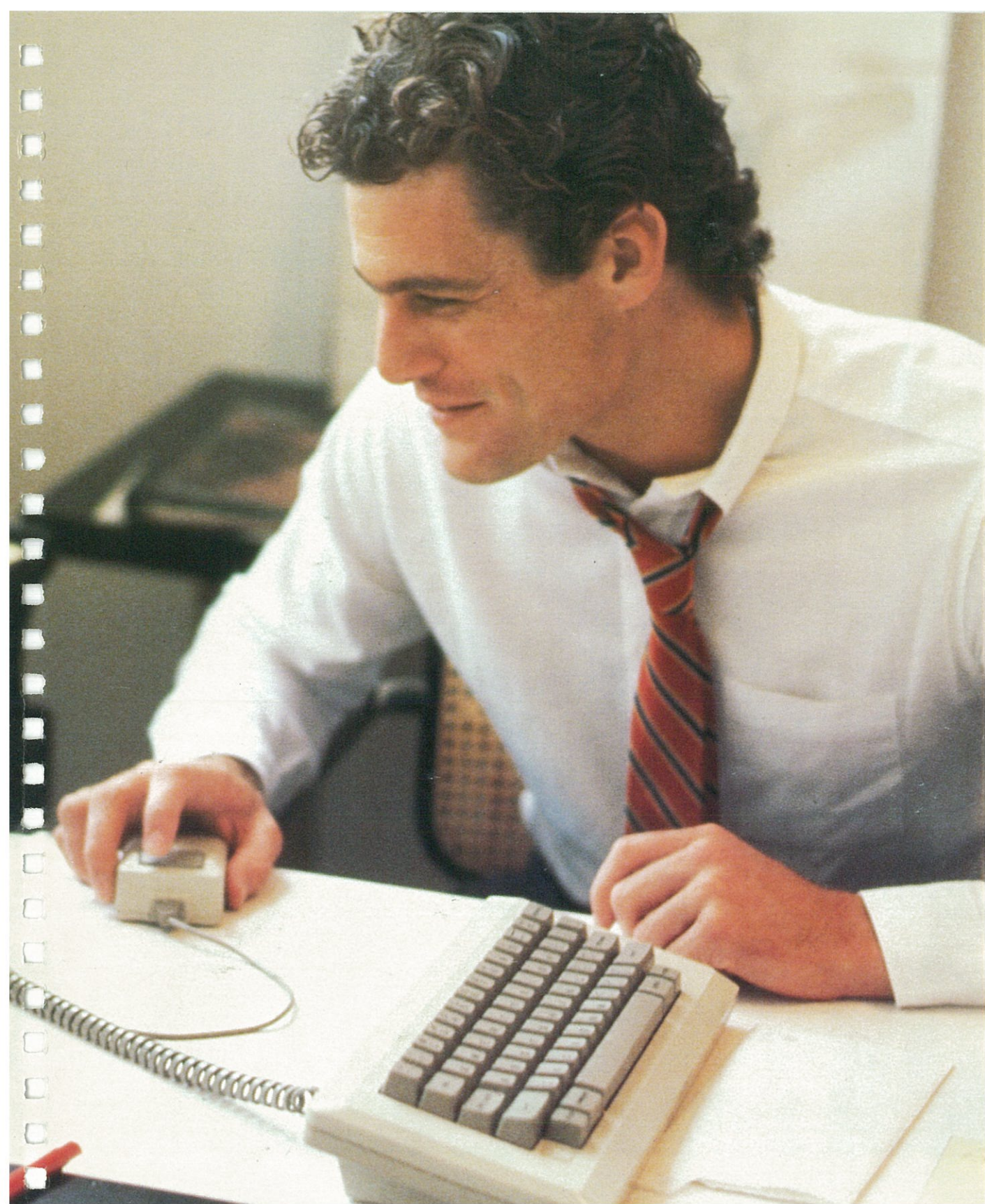



## Contents

<b>53</b>	<b>Introduction</b>
54	Summary of Mouse Techniques
56	Handling Windows
58	Scrolling
59	Selecting Icons
60	Editing Text
62	Using the Scrapbook to Store Frequently Used Images
<b>65</b>	<b>Managing Documents</b>
66	Creating a New Document
67	Opening an Existing Document
68	Renaming
69	Copying a Document, Folder, or Application to the Same Disk
70	Copying a Document, Folder, or Application to a Different Disk
71	Moving a Document, Folder, or Application
72	Printing
74	Removing a Document, Folder, or Application
75	Recovering a Removed Document, Folder, or Application
76	Summary of Document Managing Within an Application
<b>78</b>	<b>Managing Disks</b>
80	Ejecting a Disk
81	Initializing New Disks
82	Creating a Startup Disk
83	Copying an Entire Disk
84	Using Font Mover to Claim More Space on a Disk

## Introduction

This chapter summarizes the basic techniques you'll use whenever you work with your Macintosh. It also describes the steps to take when you want to use the Finder to manage your documents and disks. For example, it tells you how to move a document from one disk to another, how to copy a document or an entire disk, and how to remove documents (easy!).

Although you'll use the Finder to do most of your document managing, you can also do a subset of these tasks while you're using an application. This subset is summarized here; see each application's manual for more detailed descriptions.

You don't have to read this chapter in any particular order; each topic is independent of the others.



## Summary of Mouse Techniques

You can do all your work on Macintosh (except type text and numbers) with five mouse techniques.

- click**, to select or make active
- press**, to cause a continuous action
- drag**, to select or move
- double-click**, to open icons quickly
- Shift-click**, to extend a selection

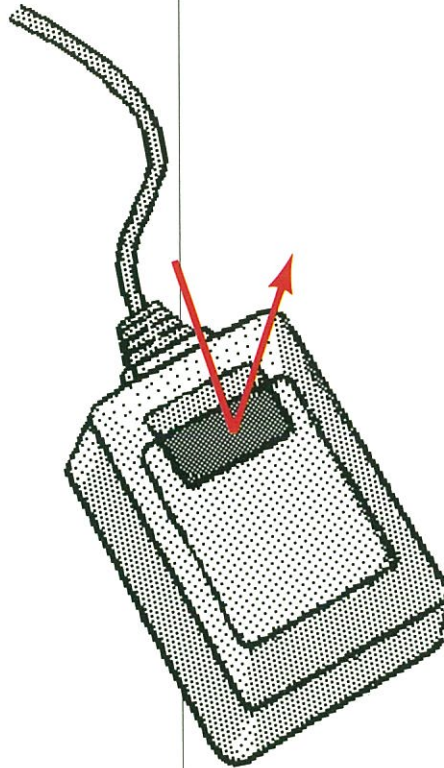

### To Click

- Position the pointer on what you want to select or make active.
- Press and quickly release the mouse button.

### To Press

- Position the pointer on a menu title, a scroll bar, or wherever you want the action to occur.
- Without moving the mouse, press and hold the mouse button.

As long as you hold down the mouse button, the effects of pressing continue. Pressing on scroll arrows results in continuous scrolling. Pressing on a menu title pulls down the menu and keeps it down until you release the mouse button.

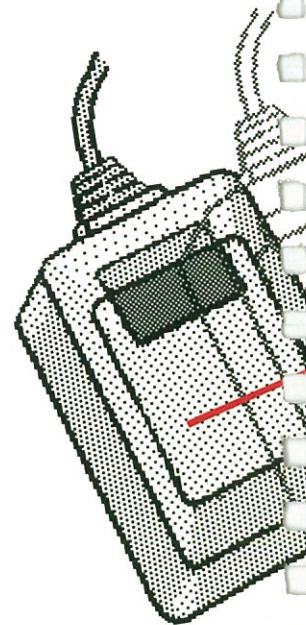



### To Drag

- Position the pointer on something.
- Press and hold down the mouse button, and move the mouse.
- Release the mouse button.

You can usually cancel a drag in progress by moving the pointer back where it started. Cancel a drag in a menu by moving the pointer off the menu. Cancel moving an icon or window by moving the pointer into the menu bar.

### To Double-Click

- Position the pointer on something.
- Press and release the mouse button twice in quick succession.

### To Shift-Click

- Select something by clicking.
- Hold down the Shift key while you continue to select by clicking.

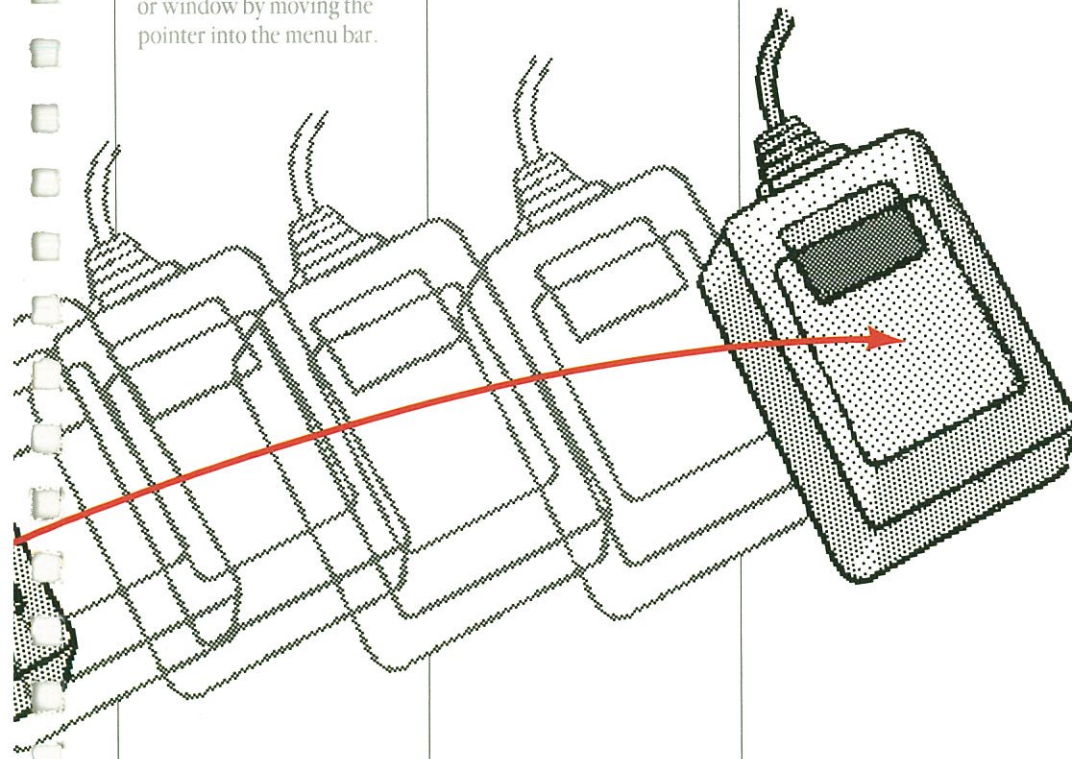

## Handling Windows

A window frames its contents. The contents may be a directory of a disk or folder, a desk accessory, or a document you create with an application.

A window always has a title bar and may have:

- scroll bars
- a close box
- a size box

Each application's manual tells you more about windows in that application.

### To Move a Window

- Position the pointer anywhere in the title bar of the window except the close box (if any).
- Drag the window to a new location.

The window becomes the active window if it's not already.

To cancel the move, move the pointer into the menu bar. You can't drag a window off the desktop.

To move a window without activating it, hold down the Command key while you drag.



Command Key

### To Activate a Window

- Click anywhere in the window.

Activating a window brings it to the front, where it may overlap or completely cover other windows. To see covered windows, move the active window or make it smaller.

Title Bar

Pointer

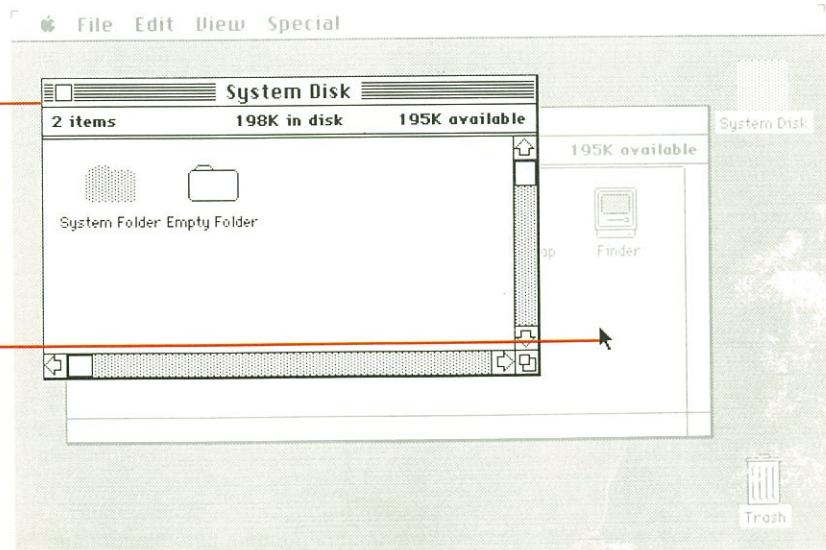

## To Change a Window's Size

- Activate the window by clicking in it.
- Move the window so that the size box in the bottom right corner is visible.
- Drag the size box.

Dragging horizontally changes the width, dragging vertically changes the height, and dragging diagonally changes both. The new dimensions take effect only when you release the mouse button.

Some windows don't have a size box.

## To Close a Window

- Activate the window by clicking anywhere inside it.
- Choose Close from the File menu, or click the close box on the left in the title bar.

Some windows don't have a close box.

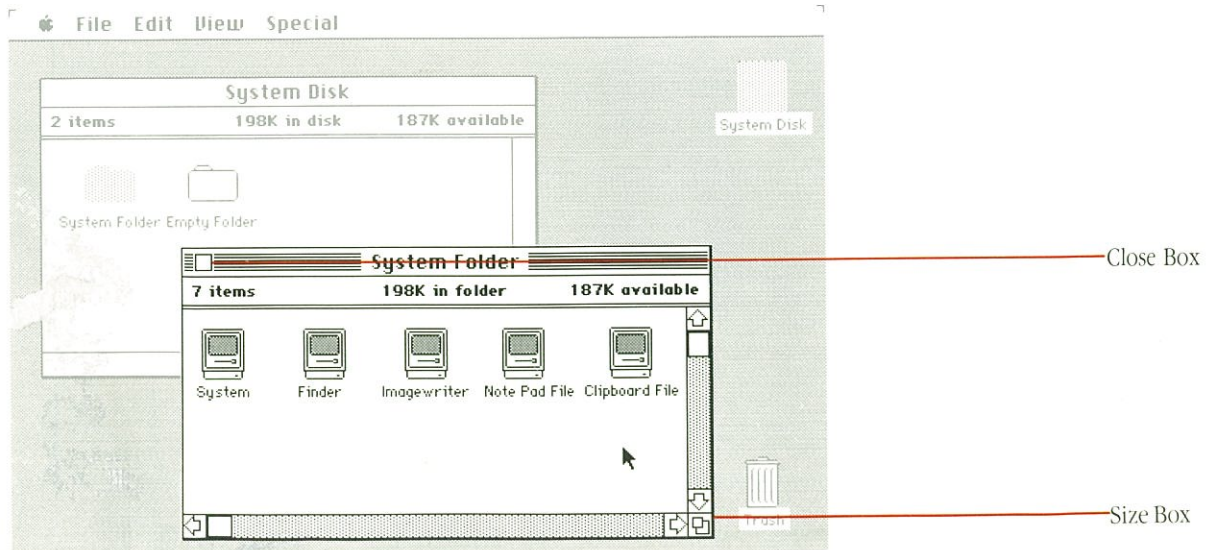



## Scrolling

Scroll bars let you see more of a directory or document's contents.

### To Scroll Line-by-Line

- Click the arrow that points in the direction of what you want to see.

You can scroll continuously line-by-line by pressing the scroll arrow.

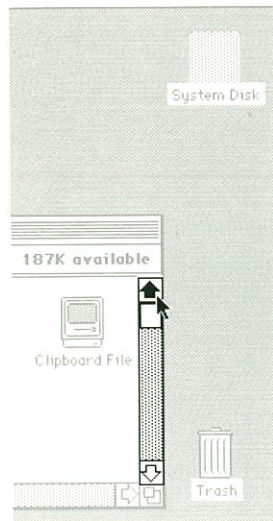

### To Scroll by the Windowful

- Click in the gray area of the scroll bar.

You can scroll continuously by the windowful by pressing in the gray area of the scroll bar.

### To Scroll Quickly to Any Part of a Directory or Document

- Drag the scroll box to a place in the scroll bar that represents the approximate position that you want to see.

The scroll bar represents the length of the directory or document; for example, if you want to go to about the middle of a directory or document, drag the scroll box to the middle of the scroll bar.

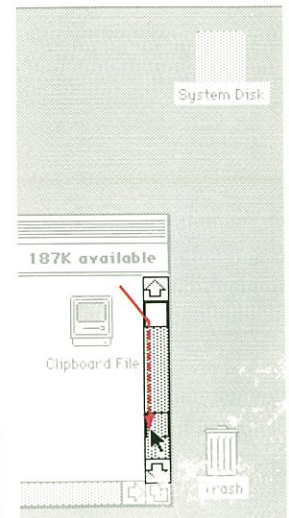

## Selecting Icons

In the Finder, you select by clicking or dragging.

See each application's manual for how to select information in that application. See "Editing Text" in this chapter for more about how to select text in the Finder.

### To Select an Icon

- Click anywhere on it. Clicking its title will also select the icon.

Holding the Shift key down while you click a selected icon unselects it.

### To Select More Than One Icon

When they're grouped together:

- Position the pointer outside one corner of a group of icons.

- Drag to the opposite corner.

When they aren't grouped together:

- Select one icon by clicking.
- Hold down the Shift key while you continue to select icons by clicking or dragging.

You can select more than one icon only when they're in the same window or they're all on the desktop.

### To Select Text in Icon Titles

- Drag across the text (diagonally if there's more than one line) to the end of the text you want to select.

Select an entire word quickly by double-clicking it.

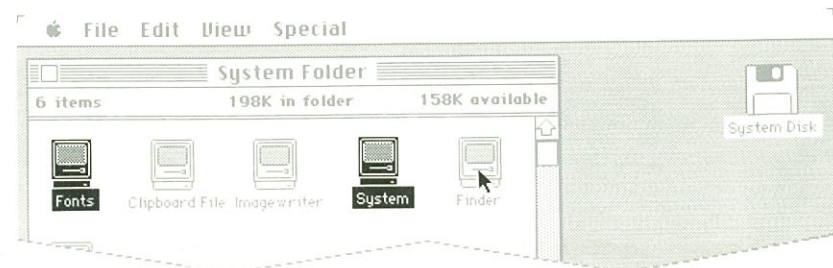
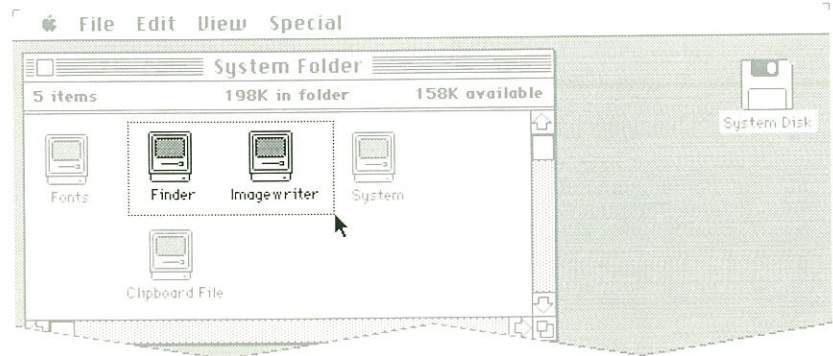

## Editing Text

In the Finder, you can enter and edit:

- the names of disks, documents, folders, and applications
- text in desk accessories such as the Note Pad and Key Caps
- text in the comment box of information windows (which you open by choosing Get Info from the File menu)

See each application's manual for more on how to enter and edit text in that application.

### To Insert Text

- Click to select the insertion point.
- Type to add text at the insertion point.

When there's no existing text (sometimes in dialog boxes, for example), the insertion point may already be selected.

### To Select Text

- Drag across the text (diagonally if there's more than one line) to the end of the text you want to select.

OR

- Double-click a word to select it quickly.

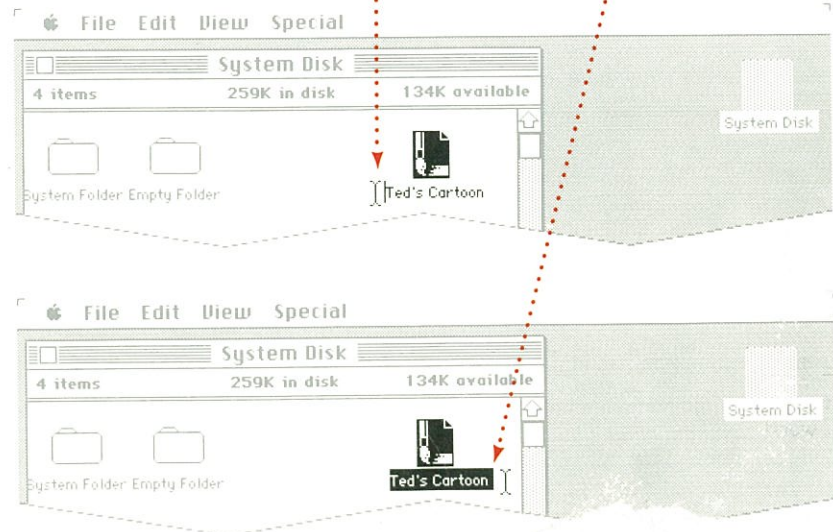



### To Move Text

- Select by dragging across the text.
- Choose Cut from the Edit menu.
- Select the insertion point by clicking where you want the text to go.
- Choose Paste from the Edit menu.

### To Copy Text

- Select the text by dragging across it.
- Choose Copy from the Edit menu.
- Select the insertion point by clicking where you want the copied text to go.
- Choose Paste from the Edit menu.

### To Replace Text

- Select the text by dragging across it.
- Type what you want to replace the text with, or choose Paste from the Edit menu to replace with what was last cut or copied.

### To Remove Text

- Select the text by dragging across it.
- Press the Backspace key or choose Cut or Clear from the Edit menu.

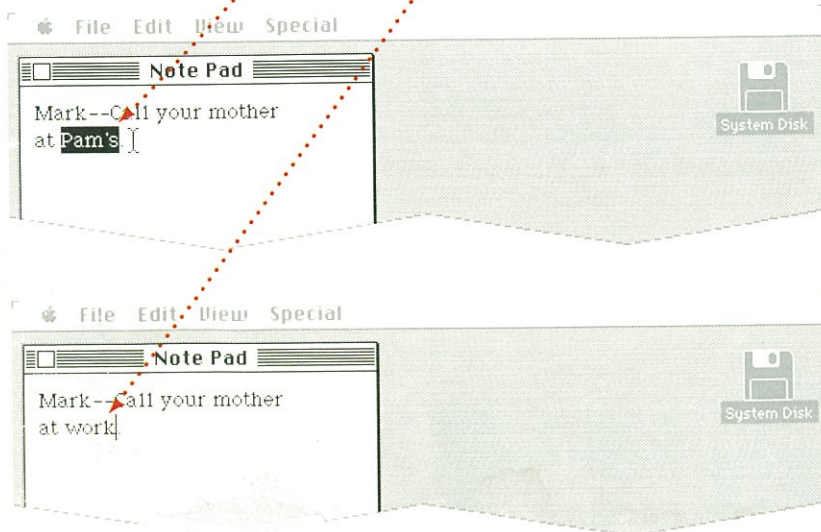

## Using the Scrapbook to Store Frequently Used Images

You can paste your favorite pictures and text into the Scrapbook and retrieve them whenever you want to use them again. For example, you might keep your letterheads there. You can cut and paste images among the Scrapbook, your documents, or any desk accessory that uses text.

### To Add an Image to the Scrapbook

- With a document or desk accessory open, select the text or picture you want to add to the Scrapbook.

See each application's manual for how to select using that application.

- Choose Cut or Copy from the Edit menu.

Choosing Cut removes the original; choosing Copy just copies it. What you selected is placed on the Clipboard, where it remains until you next choose Cut or Copy.

- Choose Scrapbook from the Apple menu.
- Choose Paste from the Edit menu.

The image is pasted into the Scrapbook. The text on the bottom left tells you the position this image has in the Scrapbook. The text on the bottom right tells whether the image is text or a picture and, if it's from a document rather than a desk accessory, which application you used to create the image. You can use the scroll bars to look through the Scrapbook. See "Scrolling" in this chapter.

### To Remove an Image from the Scrapbook

- Make the Scrapbook open and active
- Scroll to the image you want to remove.

See "Scrolling" in this chapter. Whatever is visible in the Scrapbook is automatically selected when the Scrapbook is active.

- Choose Cut from the Edit menu.

The image is removed from the Scrapbook.

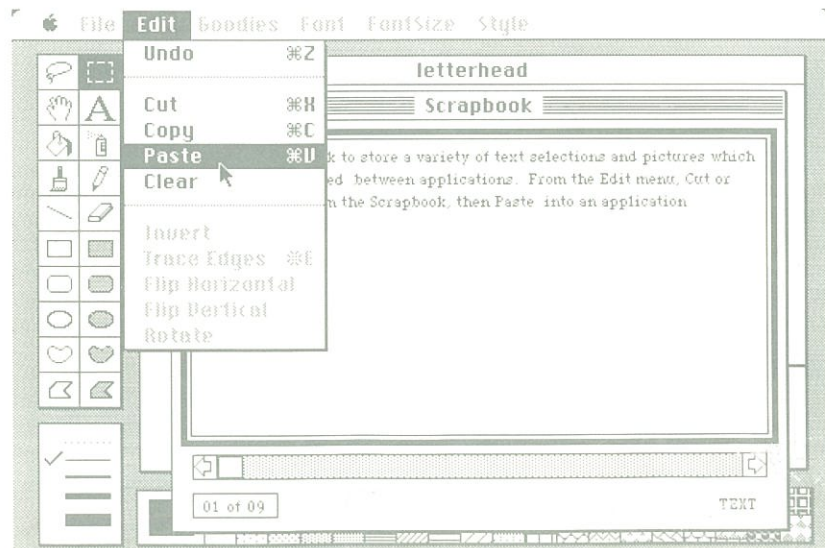

## To Move or Copy an Image from the Scrapbook to a Document

- Make the Scrapbook open and active.
- Scroll to the image you want to remove.

See “Scrolling” in this chapter.

- Choose Cut or Copy from the Edit menu.

The text or picture currently displayed is placed on the Clipboard, where it remains until you next choose Cut or Copy.

- If necessary, open the document you want to add the image to. If the document is already open, just click in it to make it the active window.

- Choose Paste from the Edit menu.

The image is pasted into the document.

You may not be able to see the entire image in the Scrapbook or Clipboard windows.

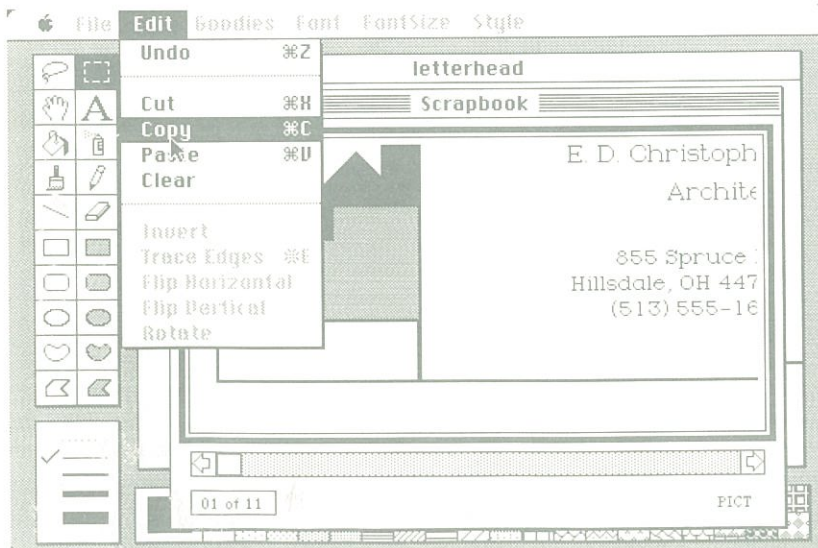



GENERAL SPROCKET

flange sales remaining unexpectedly strong  
brisk pulley and...

4th Quarter Summary

GENERAL SPROCKET

4th Quarter Summary

to inc

DATE: 12 January, 1984  
M: David Allison

MEMORANDUM

**ACME Detective A**  
P.O. Box 2554 Altco

Dear Sid:

Just got back from the  
never did find the mis-  
an interesting camer-  
shop, though--sho-  
Lightweight, wa'

You've finished  
and use the ok  
typing feature  
and change it,  
text anywhere

Go ahead and  
style command  
fonts to choe

[ There is a  
menus. How  
select a whc  
these kinds  
procedures,  
with explain  
these basic  
basic form

5 Saving Again

When you'  
your first  
second ha

Choose S.

The Save

Click S.

Once yo  
this or

Experience:

9/75-Present  
Product Manager  
General Sprocket  
Responsible for all 2'-4' aluminum sprocket and flange  
product lines. Developed marketing and advertising  
plans for multi-product worm gear family.  
6/71-9/75  
Marketing

Resume  
**ROYCE WALTHROP**

**PRODUCT TESTING** - This is the biggest of our potential  
The testing that will be required falls into the following  
categories:

Boundary (Range/Limit) testing - Accomplished through  
defined testing organization.

Error Testing - Accomplished through a yet to be c  
organization.

User Acceptance Testing - Alpha and beta testing  
time permits will give a couple of degrees of

**FORECASTING:**

Clement

Exempt Sr  
Nonexempt

Payro  
Furn  
Off  
Pr  
D

Marketing Budget -1984

	Feb	Mar	Apr	May
	15750	15750	15750	15750
	9700	9700	9700	9700

Date: July 16, 1984  
To: Robert  
From: Elizabeth

Re: Finance Meeting Agenda  
Here are my comments on your proposed agenda for the Finance  
group meeting next week.

1. Moving: Discussing the moving date seems premature  
because there are so many unknowns. Let's wait a while.
2. Manufacturing Presentation: I'm concerned about job  
attending the technical presentation. I really think...

Sarah Walthrop

A frog's eyes are its most  
attached to the eyeballs  
sockets, press





## Managing Documents

Most Finder “housekeeping” tasks—like copying, moving, and removing a document, folder, or application—happen only when you can see and point to an icon.

Using the Finder, you open the window that contains what you want to take the action on, choose By Icon from the View menu if necessary, and scroll until the icon is visible. Use the other commands in the View menu for specialized tasks like finding your oldest documents or the documents that are taking the most space.

Most of the actions you take on documents apply to applications, folders, and sometimes disks as well. For example, you rename folders, disks, or applications the same way you rename documents.



## Creating a New Document

You create a new document by opening the application you want to use. You can open an application whenever its icon or title is visible.

When you're using an application, you can create more documents by choosing New from the File menu. See "Summary of Document Managing Within an Application" in this chapter.

**1. Select the icon that represents the application you want to use.**

If necessary, insert the disk that contains that application, open the disk icon, choose By Icon from the View menu, and scroll until the icon is visible.

You can also select the application in a non-pictorial directory window by clicking it.

**2. Choose Open from the File menu.**

The appropriate application starts, and a new, untitled document appears; you'll name it the first time you save it.

You can also double-click the icon (or title in a non-pictorial directory window) to open it.

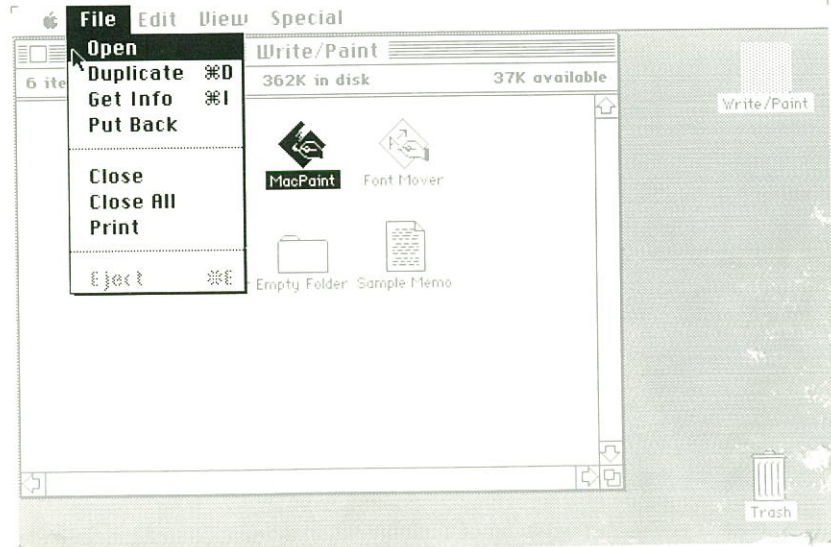



## Opening an Existing Document

You open an existing document from the Finder by opening the icon that represents the document you want to work on. The application you'll use with that document starts automatically.

You can also open an existing document while working in an application. See "Summary of Document Managing Within an Application" in this chapter.

**1. Select the icon that represents the document you want to work on.**

If necessary, insert the disk or disks that contain that document and the application you used to create it, open the disk icon, choose By Icon from the View menu, and scroll until the icon is visible.

You can also select the document in a non-pictorial directory window by clicking it.

**2. Choose Open from the File menu.**

You can also double-click the icon (or title in a non-pictorial directory window) to open it.

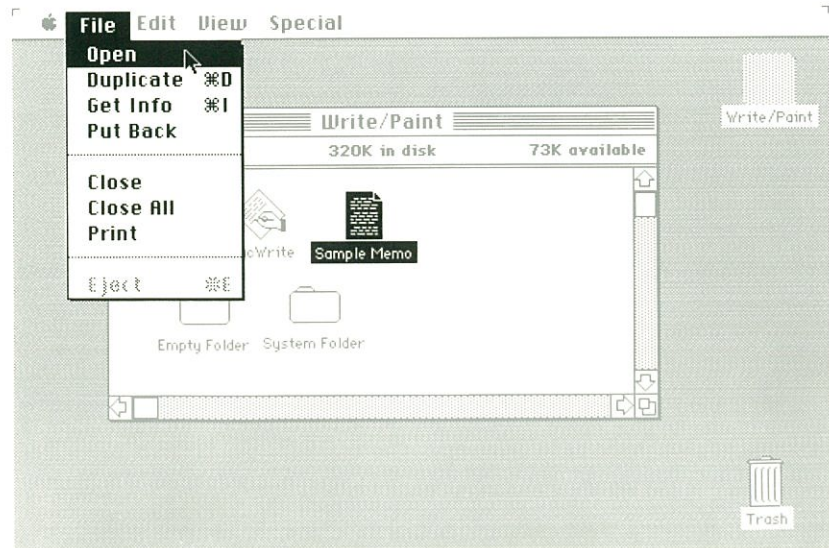

## Renaming

You can rename a document, folder, application, or disk whenever its icon is visible.

### 1. Select the icon that represents what you want to rename.

If necessary, insert the disk that contains what you want to rename, open the disk icon, choose By Icon from the View menu, and scroll until the icon is visible.

The icon and its title are selected.

### 2. Type the new title.

Use names that will help you identify the contents—the more specific the name, the better. Document names can be up to 63 characters long (though a name that long would be a little unwieldy when you drag its icon around), and disk names can be up to 27 characters. You can use any character you can type on the keyboard, except colons (:).

Typing always replaces any text selection. The selected text (the old title) is replaced by the new text you type.

### 3. Or use the Edit menu to edit the text.

See “Editing Text” in this chapter.

Write the name of the disk on the disk label. That way, when the Macintosh asks you to insert a disk, you’ll know which one it needs. Also, write the names of the disk’s documents on its label.

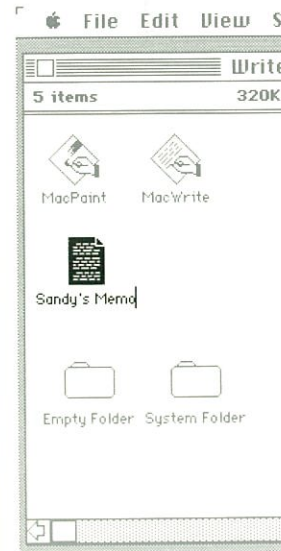
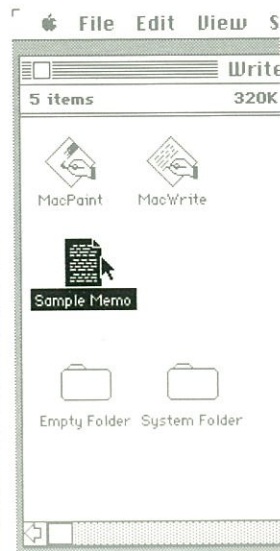

## Copying a Document, Folder, or Application to the Same Disk

You can use the Finder to copy a document, folder, or application whenever its icon is visible. You might do this to make a backup copy. (See also “Copying an Entire Disk” in this chapter.) Or you might want to make a copy of a document to work on without altering the original. For example, you might do this to create forms, letterheads, or templates.

To make a copy of a document while using an application, see “Summary of Document Managing Within an Application” in this chapter.

The Empty Folder icon represents an endless supply of folders. Duplicate it whenever you need a new folder.

**1. Select the icon that represents the document, folder, or application you want to copy.**

If necessary, insert the disk or disks that contain what you want to copy, open the disk icon, choose By Icon from the View menu, and scroll until the icon is visible.

You can use the dragging or Shift-clicking technique to select more than one icon to duplicate. See “Selecting Icons” in this chapter.

**2. Choose Duplicate from the File menu.**

A new icon appears, below and to the right of the first. The duplicate icon has the same name as the original, preceded by the words “Copy of.”

You can drag the duplicate copy to any folder or disk icon or window.

The destination disk or folder can be arranged either by icon or in any other arrangement.

**3. Rename the duplicate.**

See “Renaming” in this chapter.

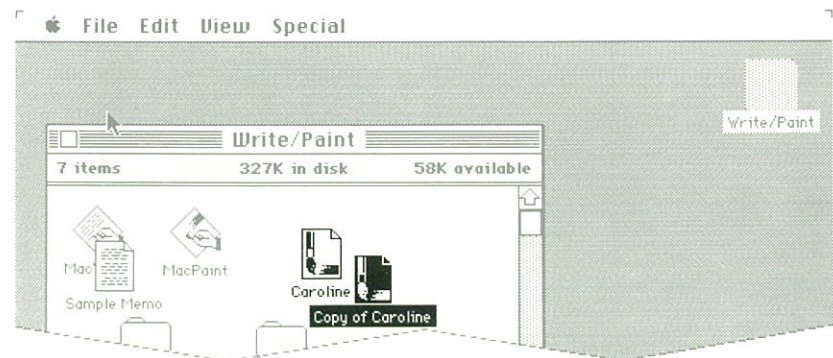
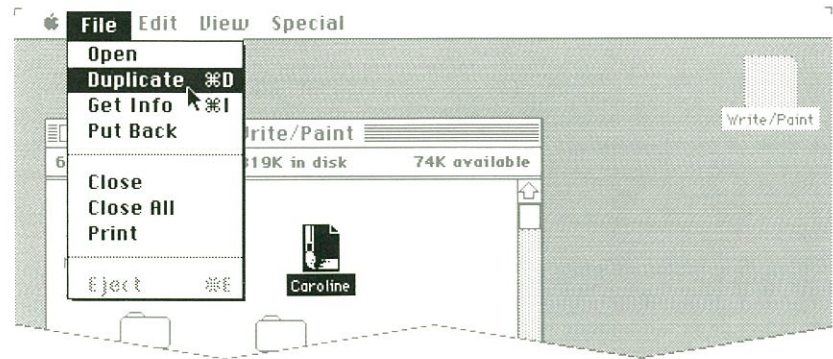



## Copying a Document, Folder, or Application to a Different Disk

You can copy a document, folder, or application to another disk whenever both icons—the one that represents the source and the one that represents the destination—are present. The source must be in icon form and its icon must be visible; the destination can be visible either in icon form or opened into a directory window.

**1. If necessary, insert the disk you want to copy to, so its icon will be present.**

**2. Select the icon that represents the document, folder, or application you want to copy.**

If necessary, insert the disk or disks that contain what you want to copy, open the disk icon, choose By Icon from the View menu, and scroll until the icon is visible.

You can use the dragging or Shift-clicking technique to select more than one icon to copy. See “Selecting Icons” in this chapter.

**3. Drag the icon to where you want to copy it.**

You can drag it either to a folder or disk directory window, or to an icon that represents the folder or disk you want it to be in.

The destination disk or folder can be arranged either by icon or in any other arrangement.

If you're using a one-drive system, the Macintosh will present a series of dialog boxes, asking you to insert alternately the disk you're copying from and the disk you're copying to.

If the destination disk already contains an item with the same name, you'll be asked to confirm that you want to replace the current contents with what you're copying.

What you copied appears in the window you dragged to. (If you dragged to a disk or folder icon, what you copied will appear in the directory window when you open the icon.)

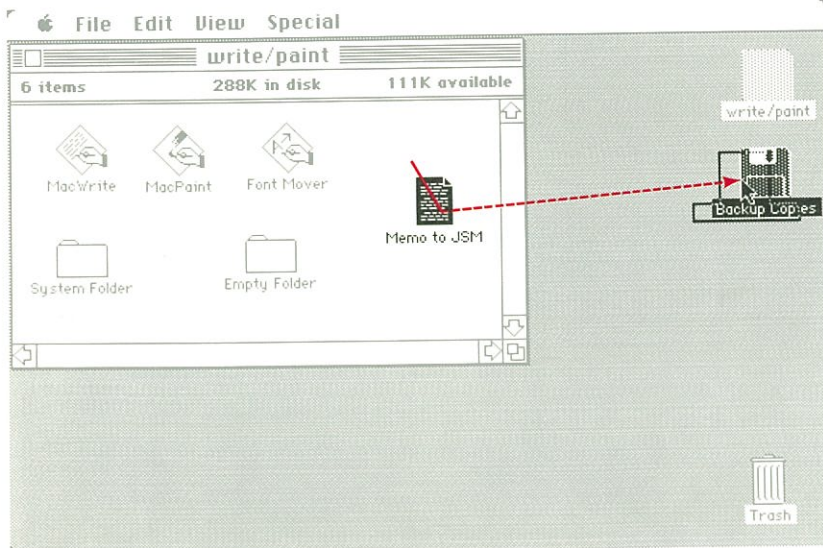

## Moving a Document, Folder, or Application

You can move a document, folder, or application to another disk whenever both icons—the one that represents the source and the one that represents the destination—are present. The source must be in icon form and its icon must be visible; the destination can be visible either in icon form or opened into a directory window.

**1. If necessary, insert the disk you want to move to, so its icon will be present.**

**2. Select the icon that represents the document, folder, or application you want to move.**

If necessary, insert the disk or disks that contain what you want to move, open the disk icon, choose By Icon from the View menu, and scroll until the icon is visible.

You can use the dragging or Shift-clicking technique to select more than one icon to move. See “Selecting Icons” in this chapter.

**3. Drag the icon to where you want to move it.**

You can drag it either to a folder or disk directory window, or to an icon that represents the folder or disk you want it to be in.

The destination disk or folder can be arranged either by icon or in any other arrangement.

If you're using a one-drive system, the Macintosh will present a series of dialog boxes, asking you to insert alternately the disk you're copying from and the disk you're copying to.

If the destination disk already contains an item with the same name, you'll be asked to confirm that you want to replace the current contents with what you're moving.

What you moved appears in the window you dragged to. (If you dragged to a disk or folder icon, what you moved will appear in the directory window when you open the icon.)

Whenever you drag from one disk to another, a copy of what you move is left behind for safety. If you want to reclaim space on the original disk, drag the remaining icon to the Trash.

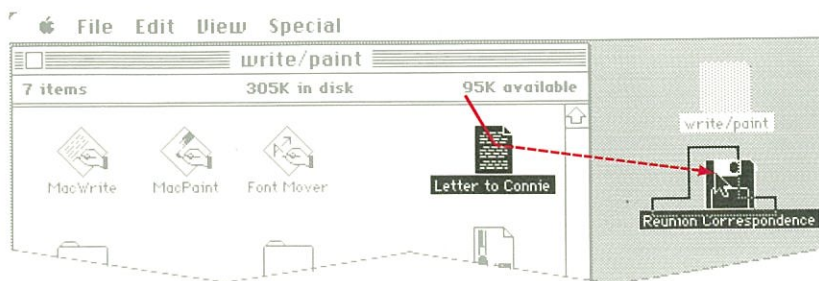

## Printing

In the Finder you can print a document, a group of documents, the contents of the entire screen, the contents of the active window, or a directory. You can also create a MacPaint document from the contents of the screen for later printing. You can print a document whenever its icon is visible and a disk that contains its application is currently inserted.

To print a document while using an application, see “Summary of Document Managing Within an Application” in this chapter.

Before printing, make sure that the printer is ready, the select light is on, and the paper is at the top of a form.

### To Print a Document

- Select the icon that represents the document you want to print.

If necessary, insert the disk or disks that contain that document and the application you used to create it, open the disk icon, choose By Icon from the View menu, and scroll until the document icon is visible.

- Choose Print from the File menu.

If necessary, first close any open desk accessories.

### To Print a Group of Documents

- Select the icons that represent the documents you want to print.

■ Use the dragging or Shift-clicking technique to select more than one icon. You can scroll between Shift-clicks if necessary. See “Selecting Icons” in this chapter.

If necessary, insert the disk or disks that contain those documents and the application or applications you used to create them, choose By Icon from the View menu, and scroll until the document icons are visible.

- Choose Print from the File menu.

### To Create a MacPaint Document With the Current Contents of the Screen

- Hold down both the Command and Shift keys while you type the number 3

If you're also pressing the mouse button, the action will start when you release the button.

You can take up to 10 “snapshots” from the time you start up the system. Each snapshot you take will be named sequentially from Screen 0 to Screen 9. A beep means the snapshot wasn't successful; perhaps the disk is full, or there are already snapshots with those numbers on that disk. You can open and make changes to these documents as you do to any existing document. See “Opening an Existing Document” in this chapter.

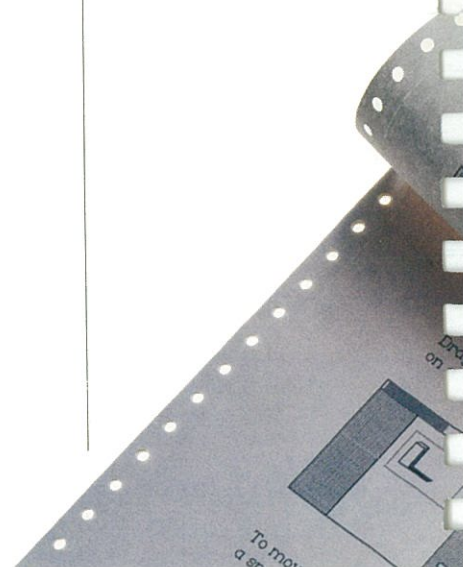



## To Print the Entire Screen

- With Caps Lock down, hold down both the Command and Shift keys while you type the number 4.

If you're also pressing the mouse button, the action will start when you release the button.

## To Print the Active Window

- Hold down both the Command and Shift keys while you type the number 4.

If you're also pressing the mouse button, the action will start when you release the mouse button.

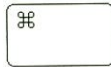

Command Key



## Removing a Document, Folder, or Application

You can discard a document, folder, or application whenever its icon is visible. The Trash can be visible either as an icon or opened into a window.

**Drag the icon or icons that represent what you want to remove to the Trash icon or window.**

If necessary, open the window that contains what you want to remove, choose By Icon from the View menu, and scroll until the icon or icons are visible.

You can use the dragging or Shift-clicking technique to select more than one icon to discard. Discard an entire disk by selecting all icons in the disk directory window. See "Selecting Icons" in this chapter.

What you discard can usually be recovered until you start an application or eject the disk. See "Recovering a Removed Document, Folder, or Application."

To reclaim the space immediately, choose Empty Trash from the Special menu.

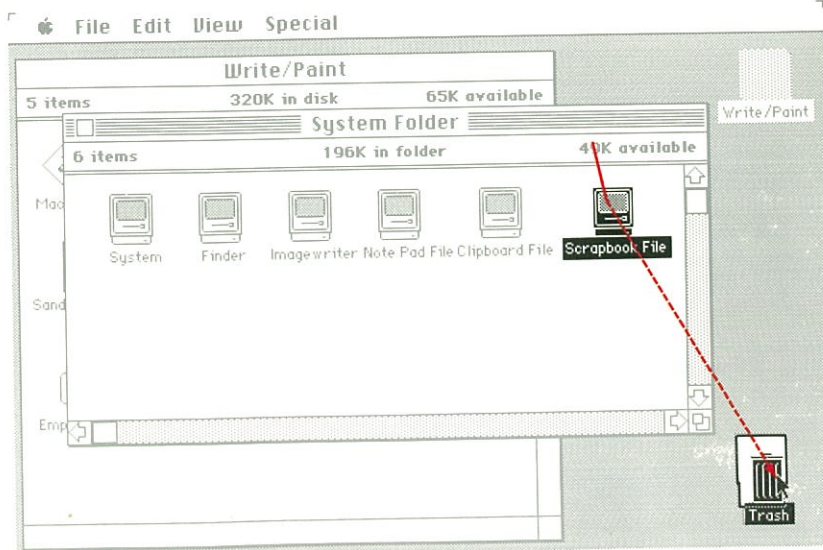

## Recovering a Removed Document, Folder, or Application

Any document, folder, or application you discard can usually be recovered until you eject the disk or open an application or document. You can recover a removed document, folder, or application if its icon is visible in the Trash window.

**1. Select the icon in the Trash window that represents the document, folder, or application you want to recover.**

If necessary, open the Trash window, choose By Icon from the View menu, and scroll until the icon is visible.

You can use the dragging or Shift-clicking technique to select more than one icon to recover. See "Selecting Icons" in this chapter.

**2. Drag the icon that represents what you want to recover out of the Trash window onto the desktop or into another window.**

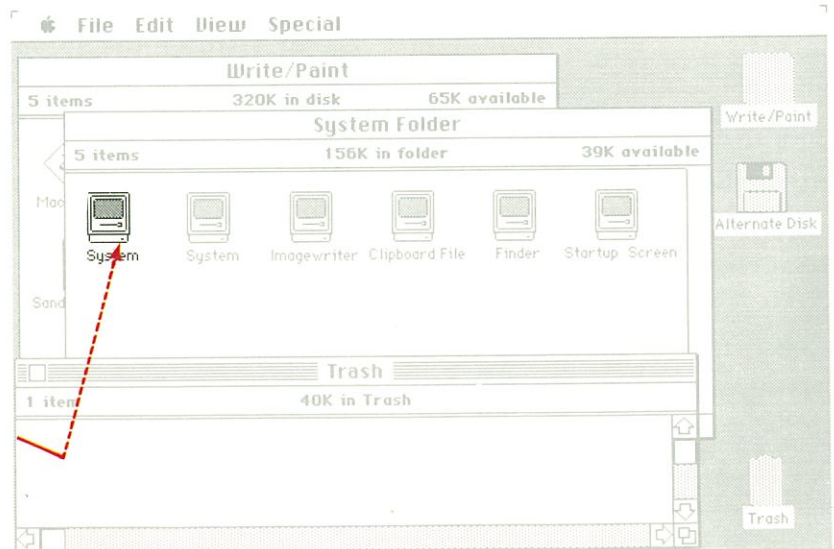



## Summary of Document Managing Within an Application

See each application's manual for detailed information about these tasks.

### To Create a New Document

- Choose Close from the File menu to close the current document.
- Choose New from the application's File menu.

A new document appears; you'll name it the first time you save it.

### To Open an Existing Document

- Choose Close from the File menu to close the current document.
- Choose Open from the File menu.

A dialog box appears.

- If the document is on a different disk, click the Eject button and insert the second disk; if you have two disk drives, insert the disk in the other drive and click Drive.
- Select the document you want to work on by clicking its name in the list of documents that appear.
- Click the Open button.

### To Name an Untitled Document

- Choose Save from the application's File menu.
- Type a name for the document.

You can use any character or symbol on the keyboard except a colon. You can use uppercase or lowercase letters and put spaces between words. Names can be any length up to 63 characters, but long names can become unwieldy. It's usually best to limit them to the space you have to type them in.

- Click the Save button.

You'll get a message if the disk is full. Eject and save on a different disk.

## To Save a Document

A document is stored only temporarily until you save it on a disk.

- Choose Save from the application's File menu.

For routine, periodic saving of your document, always choose Save rather than Save As. The Save command saves a document only with its original name on the same disk. Choose Save As only when you want to make a copy of the document with a different name, or copy it to a different disk.

- If this is a new document, type a name for it.

## To Save a Copy of a Document

When you give a document a different name while you're using an application, you're actually creating another document in which to save your most recent changes. This lets you keep more than one version of the document.

- Choose Save As from the File menu.

- Type a name for the new version.

Whatever you type replaces the current name.

- Click the Save button.

This saved version includes the changes you made to the document since the last time you saved it. Choosing Save will now save the document with the new name you gave it.

## To Save a Document on a Different Disk

- Choose Save As from the File menu.

- Click the Eject button to eject the current disk; insert the disk you want to save the document on.

- Or click Drive if you have two disk drives and the disk you want to save on is in the other drive.

- Type a new name for the document if you want; otherwise it will be saved with the same name.

You can use any character or symbol on the keyboard except a colon. You can use uppercase or lowercase letters and put spaces between words. Names can be any length up to 63 characters, but long names can become unwieldy. It's usually best to limit them to the space you have to type them in.

It's usually easier to keep track of documents if you give each version a unique name.

- Click the Save button.

## To Print a Document

- Choose Print from the File menu.

In some applications, one or more dialog boxes will appear. You can click the various buttons to control the way your printed document will look. See each application's manual for details.

## Managing Disks





You'll use the Finder to manage entire disks as well as the documents, folders, and applications on them. Renaming disks works the same as renaming any icon. See "Renaming" in this chapter.

Chapter 4, "Reference," contains additional information about disks.



## Ejecting a Disk

To get information from or save information on a disk not currently inserted, you first eject a currently inserted disk.

If the Macintosh needs the ejected disk later, it'll ask for it.

**1. Select the icon that represents the disk you want to eject.**

If the disk has already been opened, just activate its window by clicking inside it.

**2. Choose Eject from the File menu.**

Or hold down the Command key and type the letter "e".



Whenever the Macintosh encounters a disk it can't interpret, a dialog box appears and asks whether you'd like to initialize the disk for the Macintosh. The box gives you two choices—to initialize or to eject without initializing.

You can also initialize disks that have information on them by choosing Erase Disk from the Special menu. This initializes the disk whose icon is selected, erasing everything on the disk.

### **1. Insert the new disk.**

### **2. Click the Initialize button.**

You can initialize disks from within an application without losing any information in memory, so you can initialize them as you need them.

To avoid confusion, be sure to give disks you initialize different names.



## Creating a Startup Disk

The Macintosh needs certain information to be able to start the system. Disks that contain this information are called “startup disks.” Since this information takes room on a disk, you might not want to have all your disks be startup disks. But you do need to use a startup disk each time you start your Macintosh, and you’ll probably want at least one application on this disk as well.

### 1. Insert a startup disk.

If you’re using a one-drive system, eject this disk before going on to the next step, by choosing Eject from the File menu.

### 2. Insert a new disk (or any disk less than half full).

If the disk isn’t initialized for the Macintosh, you’ll be asked if you want to initialize it. Click the Initialize button.

### 3. Drag all system icons (initially they’re in the System Folder) and any application you want to the new disk icon.

See “Selecting Icons” in this chapter.

If all the system icons are in a folder, you can just drag the folder.

To turn a startup disk into a non-startup disk (a disk just for storing documents): start the system using any disk other than the one you want to be a non-startup disk. Insert the disk you want to change to a non-startup disk. Select and drag all system icons to the Trash. See “Selecting Icons” in this chapter.

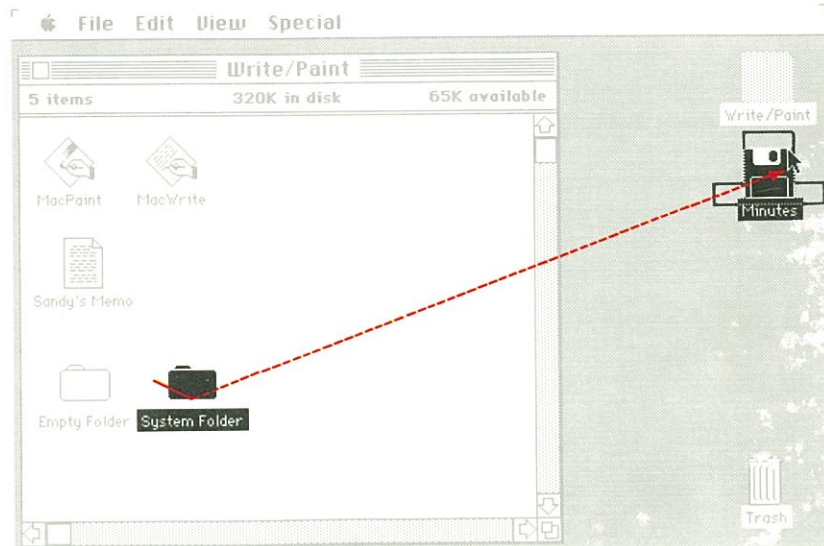

## Copying an Entire Disk

You can copy an entire disk whenever both its icon and the destination disk's icon are visible.

Give each disk a unique, meaningful name (either when you're asked to name a new disk or after you finish the copying process). If each disk has its own name, it'll be easier to keep track of your documents, and you'll know which disk to insert when the Macintosh asks you for a specific disk. See "Names of Disks and Documents" in Chapter 4.

### 1. Insert both the source disk and the destination disk.

If necessary, first eject any other disk by selecting its icon and choosing Eject from the File menu.

If the destination disk is a new disk, you'll be asked if you want to initialize it. Click the Initialize button and type a name for the copy.

### 2. Drag the source disk icon to the destination disk icon.

You'll be asked to confirm that you want to replace the existing contents of the destination disk with the contents of the source disk.

If you're using a one-drive system, there's a faster way to copy entire disks: Use the Disk Copy application, which is initially in the System Folder. When you open the Disk Copy icon, you'll be asked to insert alternately the disk you want to copy and the disk you want to copy it to.



## Using Font Mover to Claim More Space on a Disk

Macintosh gives you a wide variety of fonts to choose from. These fonts take a fair amount of space on your disk, so when you don't need them all, you can use the Font Mover to remove them. You can also use Font Mover to add fonts.

Another way to have more space on a disk is to keep your documents and applications on separate disks. Or, if there are two applications on a disk—MacWrite and MacPaint, for example—you might move one application and its documents to a different disk. See "Moving a Document, Folder, or Application to a Different Disk" in this chapter.

### 1. Open the Font Mover icon.

A window appears with two lists. On the left are the fonts currently in the System file (usually in the System Folder). These fonts are available whenever you use an application from this disk. On the right is a list of the fonts in the Fonts file, a special file for adding and removing fonts. Any font in the System file except the ones marked with an asterisk (which the Macintosh needs) can be removed, and any of the fonts can be copied to a Fonts file.

### 2. In the System File list, select the font or fonts you want to remove.

Click to select a single font; hold down the Shift key while you click additional single fonts; or drag through a group of fonts.

When a single font is selected, the name, size, and space that font occupies on the disk are shown, as well as a sample of the font; when more than one font is selected, only the total space occupied by those fonts is shown.

### 3. Click Copy.

This places a copy of the fonts you're going to remove in the Fonts file. (The arrows always indicate the direction of the copying.) It's a good idea to copy fonts to another disk for safekeeping before you remove them from a disk. That way you'll later be able to drag the Fonts icon back to the original disk or to another disk.

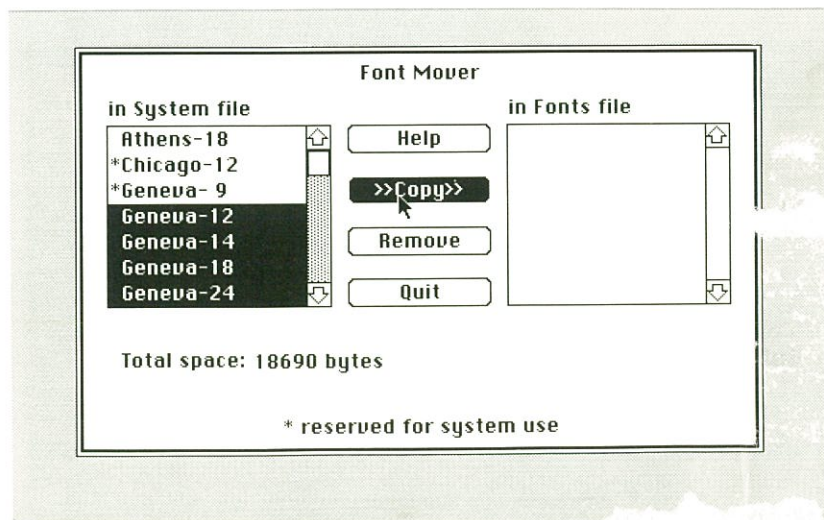



**4. Click Remove.**

The selected fonts are removed from the System file.

**5. Click Quit.**

**6. In the Finder, drag the Fonts icon to another disk.**

**7. Drag the copy of the Fonts file that remains behind to the Trash.**

To add fonts to a disk from a Fonts file, drag the Fonts file to the disk you want to add the fonts to, open the Fonts file icon, select the fonts you want to add from the Fonts file list, and click Copy.

The Fonts file is created automatically the first time you use Font Mover on this disk. The Fonts file itself can be opened, moved, removed, or renamed like any other document. If you rename it, the Font Mover will no longer "recognize" it as the Fonts file, so the next time you open Font Mover, it will create a new Fonts file. If you want to work with the fonts in the renamed fonts file, open the icon that represents it.

The Macintosh actually uses a font twice the size you choose from a menu to print high-quality characters. To maintain this high quality, don't remove the doubled size of any fonts you want to use for printing. For example, keep New York 24 to get a high-quality New York 12.

Click the Help button in the Font Mover for a summary of how the Font Mover works.

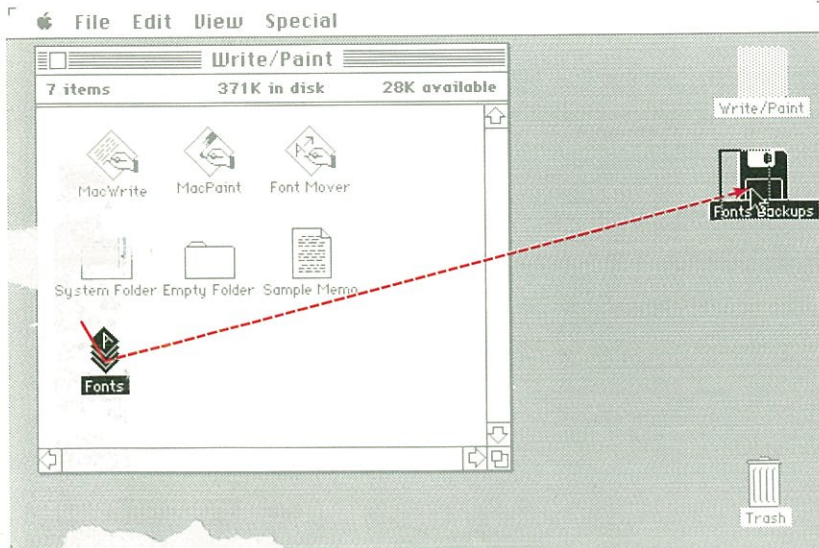

## Chapter 4:

Reference

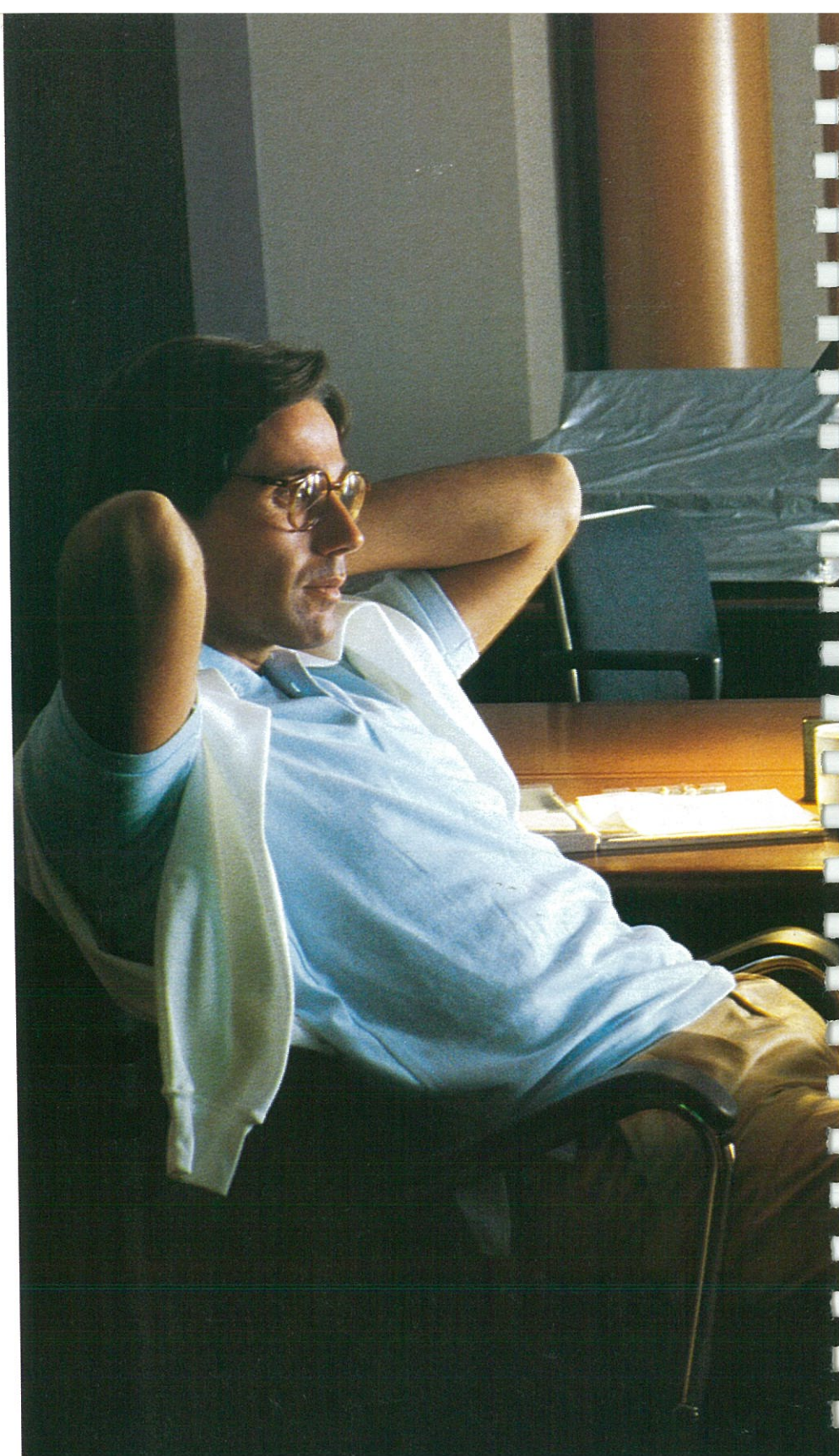







## Contents

<b>89</b>	<b>Introduction</b>
<b>90</b>	<b>Keyboard</b>
90	Character Keys
90	Special Keys
<b>92</b>	<b>Disks</b>
92	Initializing Disks
92	Ejecting Disks
92	Startup Disks
93	Locked Disks
93	Names of Disks and Documents
<b>95</b>	<b>Windows</b>
<b>96</b>	<b>Clipboard: Cutting and Pasting</b>
<b>97</b>	<b>Dialog Boxes</b>
<b>98</b>	<b>Desk Accessories</b>
98	Calculator
98	Alarm Clock
99	Key Caps
100	Puzzle
100	Note Pad
101	Scrapbook
101	Control Panel
<b>103</b>	<b>Shortcuts</b>
103	Double-Click
103	Shift-Click
103	Return and Enter Keys
103	Tab Key
103	Backspace Key
103	Close Box
103	Command Key
<b>104</b>	<b>Finder Reference</b>
104	Overview
105	What the Finder Manages
106	Selecting Icons
107	Dragging Icons
<b>108</b>	<b>Finder Menus</b>
108	The Apple Menu
108	The File Menu
110	The Edit Menu
111	The View Menu
112	The Special Menu

## Introduction

The first part of this chapter describes Macintosh in general: what you can do with its keyboard; general information about disks, windows, the Clipboard, and dialog boxes; capabilities of the standard desk accessories; and shortcuts to speed your work. Though some details may change from application to application, this is the way Macintosh works.

“Finder Reference” and “Finder Menus” get specific about the Finder, the built-in application for organizing and managing your documents. This second part of the chapter describes the functions and effects of windows, icons, and menus in the Finder, and also talks a little about the things the Finder manages.



## Keyboard

The Macintosh keyboard is much like the familiar typewriter keyboard, with a few notable exceptions. Certain keys let you do things you never could do with a typewriter.



### Character Keys

The character keys are just like keys on a typewriter, use them to type any character, including numbers and symbols like =, [, and so on. Character keys repeat when held down. Use the Control Panel to set the rate of repeating. See “Desk Accessories” in this chapter.

### Special Keys

Some of the Macintosh keys are used with character keys to produce different characters, or to issue menu commands. Others perform more specific actions.

#### Shift Key

When Shift is held down, character keys produce uppercase letters or the upper character on the key. Sometimes Shift modifies other actions: for instance, in the Finder, holding down the Shift key while you click lets you select more than one icon.

#### Caps Lock Key

A Shift for letters only. When Caps Lock is engaged, letter keys produce uppercase letters, but number and symbol keys aren’t affected.



### Option Key

Generally gives an optional character set of accented and special characters. The Option key can be used with Shift and Caps Lock. All optional characters are illustrated in Appendix A.

Using the Option key with certain character keys lets you enter accented characters.

Option-`	~	grave accent
Option-e	´	acute accent
Option-i	¨	circumflex
Option-u	¨	umlaut
Option-n	~	tilde

Typing the Option key combination followed by another character produces that character accented with that diacritical mark. If the character can't be accented by the mark, you get the mark followed by the character. Typing the Option key combination *twice* gives you the diacritical mark alone.



### Command Key

The Command key used in combination with another key is a shortcut to choosing a command from a menu. Commands that have Command key equivalents list them in the menu. Sometimes Command modifies other actions: for instance, holding down the Command key while typing a period cancels a long operation in progress.

### Enter Key

Confirms whatever entry (usually text) you've made—an entry typed into a blank to name a document, for example. In a dialog box, pressing the Enter key is the same as clicking the button that confirms the command (such as OK) or the outlined button if there is one.

### Return Key

Moves the insertion point to the beginning of the next line. In a dialog box, pressing Return is the same as clicking the button that confirms the command (such as OK) or the outlined button if there is one.

### Backspace Key

Deletes the current selection. If the selection is the insertion point, backs over and deletes text.

### Tab Key

Moves the insertion point horizontally to the next stopping place (such as a tab stop). In dialog boxes, pressing Tab usually selects the next place to supply information.

## Disks

Disks store information. Apple 3½-inch disks store 400 kilobytes (a kilobyte being about a page of text or a small picture). Each disk uses about 15kb of overhead for keeping track of its contents (this is where its directory information is actually stored), leaving 385kb per disk for you to store your own information.

### ■ Initializing Disks

Before your Macintosh can get information from or save information on disks, they need to be **initialized** in a format it understands. (A blank disk is like a parking lot without divider lines. Before it can “park the cars,” your Macintosh has to “draw in the white lines.”) Any time you insert an uninitialized disk or any disk your Macintosh can't read because it's damaged or initialized for a different computer, a message will appear, asking if you'd like to initialize the disk for the Macintosh. Clicking the Initialize button will do it, and it'll be ready for use almost immediately.

### ■ Ejecting Disks

If you need information on a disk not currently inserted, or if you want to save on a disk not currently inserted, you may first need to eject a currently inserted disk. See “Ejecting a Disk” in Chapter 3.

### ■ Startup Disks

The System Disk that came with your Macintosh contains system documents needed to start up the Macintosh when you turn it on. Disks that contain these documents are called **startup disks**. These system documents are usually stored in the System Folder, though they don't have to be.

System documents on a startup disk include System, Finder, Imagewriter, and Printer. You may also find other system documents on the startup disk from time to time: Scrapbook File, Clipboard File, Note Pad File, Fonts, etc. These contain information that's used only by certain applications and desk accessories. You can't open or edit any of these documents.

Of course, there's a cost—startup disks leave only about half the disk available for your own applications and documents. So it's best to keep your applications on startup disks, and keep your documents on separate disks. Chapter 4 shows you how to make and “unmake” startup disks, and how to move applications and documents from disk to disk.

## Locked Disks

You can prevent information on a disk from being changed by sliding the small red tab toward the edge of the disk. This is called **locking** a disk; do it when you want to make sure that the disk won't get altered by mistake. To allow the disk to be altered again, slide the red tab to cover the hole.

When a disk is locked, you can't add new information to it, or change any information on it. You can open (and perhaps print) the documents it contains, but you won't be able to save, delete, rename, move, duplicate, or change any information on it.

Some applications (MacPaint, for instance) won't work with a locked disk, and the Finder can't reconstruct anything you've done on the desktop when you're using a locked disk. Some desk accessories may not work properly if your startup disk is locked.

Locked

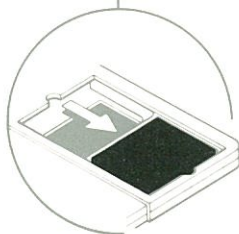
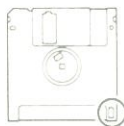

Unlocked

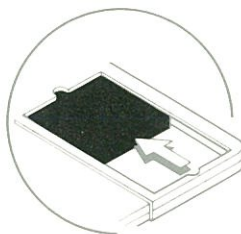

## Names of Disks and Documents

Every disk, document, application, and folder has a name. You name disks when you initialize them; you name documents when you save them for the first time. You can change a name at any time with the Finder.

There are a few restrictions to the names you can give. A disk name can contain up to 27 characters; a document, application, or folder name can contain up to 63 characters (although there's a practical limit of around 40 characters).

A name can't contain a colon (:), and shouldn't begin with a period (.). Other than that, you can use any characters you can type on the keyboard.



No two items on the same disk can have the same name. When comparing names, your Macintosh considers uppercase and lowercase letters to be equal, so "saturday" and "Saturday" are the same. You can have separate items with the same name if they're on separate disks.

It's a good idea to keep disk names different, too: sometimes the Macintosh will ask you for a specific disk by name, and it's confusing to have a lot of disks with that same name (your Macintosh can be quite picky about which one it wants). It's also a good idea to write the disk's name on its label.

## Windows

Windows present information. You can have multiple windows on your desktop, so you can view more than one set of information at the same time. Most windows can be moved, changed in size, scrolled through, or closed. They can also overlap each other. When more than one window is open, one is frontmost, and that's where all the action happens. Clicking anywhere in a window brings it to the front and makes it active.

Although a window may be "buried" under others, it cannot be dragged completely off the screen, or made so small that you can't see it.

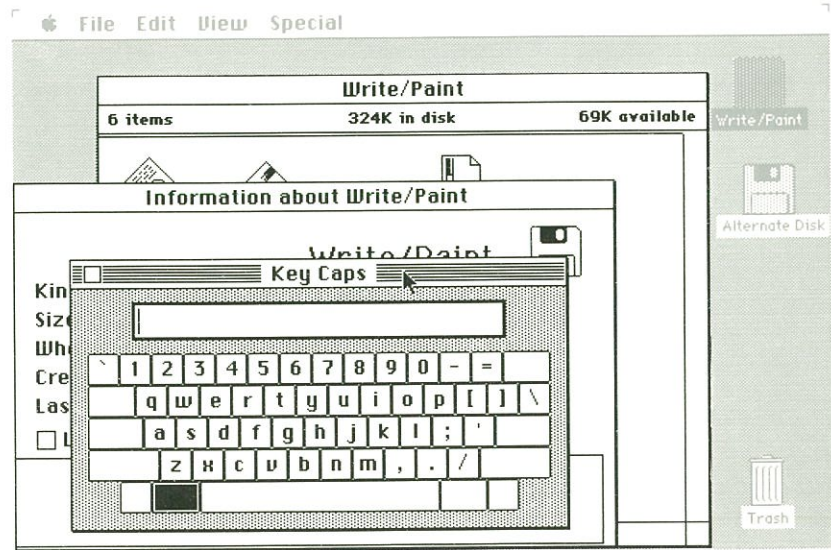

Windows may behave a little differently within an application. See each application's manual for an explanation of windows in that application.

## Clipboard: Cutting and Pasting

You can move information within a document, among documents created with the same application, among documents created with different applications, or among desk accessories and documents. The information you're moving or copying is held on the Clipboard. The Cut, Copy, and Paste commands in the Edit menu let you move information between the Clipboard and the active window. Most applications have a Show Clipboard command in their Edit menu that shows you the current contents of the Clipboard.

Within an application, the contents of the Clipboard keep attributes such as text sizes and styles, or any information unique to that application. When moving between applications, usually only the text or the picture, in a fixed format, is exchanged.

The Clipboard contents are kept in the Macintosh memory, if possible. If the contents grow too large, they are temporarily saved in the Clipboard File on the startup disk.



## Dialog Boxes

Whenever the Macintosh needs more information from you, it displays a dialog box, with buttons to click and sometimes with space for you to type additional information, such as the name for a new document.

If you are about to do something that could cause you to lose information, a message in the dialog box alerts you, and asks you to confirm that you want to proceed anyway. In boxes containing these messages, one of the buttons—the “safest” alternative—is usually boldly outlined. Pressing the Enter or Return key is the same as clicking the boldly outlined button or, if none, the button that confirms the command.

A warning message may be accompanied by one or more beeps. If loud beeps annoy you, use the Control Panel desk accessory to lower the speaker volume. A blinking menu bar is a subtle alert that your Macintosh can't respond to what you're asking it to do.

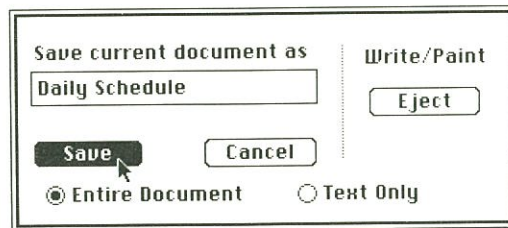

## Desk Accessories

You choose desk accessories from the Apple menu on the far left side of the menu bar. Desk accessories are available while you're using any application or the Finder. You can use the Cut, Copy, and Paste commands in the Edit menu to move or copy text or pictures among desk accessories or to or from another window. (See "Editing Text" in Chapter 3.)

With most applications, you can keep one or more desk accessories open on your desktop while you work on documents. Like any windows, desk accessories may be obscured by other windows that are made active. The accessories can be made active by clicking them or choosing them again from the Apple menu, and moved by dragging their title bars. You close them either by clicking their close boxes or by choosing Close from the File menu.

With some applications (MacPaint, for example), you need to close desk accessories in order to work on a document.

All desk accessories are closed automatically when you open a document or application from the Finder or quit an application.

### Calculator

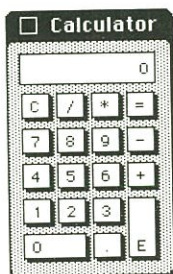

The Calculator works like an ordinary four-function pocket calculator, except that with your Macintosh calculator you can copy the calculation results (which are automatically selected) and paste them into any document or another desk accessory. You can also copy numbers from a document and paste them into the calculator's display.

Click the buttons or type on the keyboard or the numeric keypad if you have one. The \* key is multiplication; the / is division.

### Alarm Clock

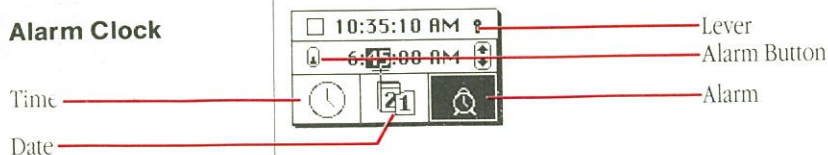

When you choose Alarm Clock, a compact clock displays the hour, minute, and second. To see more, click the **lever** on the right side of the clock. (Click the lever again to go back to the compact clock.) With the lever down, two more panels appear. The middle panel displays and provides a place to set whatever you select by clicking in the bottom panel—the time, date, or alarm setting.

Set what's currently displayed in the middle panel by clicking the digits you want to change. Arrows appear on the right. Click the up or down arrow to scroll the numbers higher or lower. Or use the keyboard to type the numbers. Click the top panel to set.

Click the **alarm button** to switch the alarm on or off. Your Macintosh beeps when the alarm goes off, and the Apple menu title blinks until you click the alarm button off.

When the clock is active, the time and date are automatically selected, so you can copy and paste them into the document you're working on or into a desk accessory that accepts text.

## ■ Key Caps



Press the Option, Shift, or Caps Lock key on the Macintosh keyboard; the Key Caps desk accessory displays the characters you can type while holding down that key.

You can either type the character you want on the keyboard or just click it in the Key Caps accessory.

See “Keyboard” in this chapter for how to produce accented characters using the diacritical marks in the optional character set.

When the Key Caps desk accessory is active, text you type on the Macintosh keyboard or “type” by clicking Key Caps keys appears in the blank at the top of the Key Caps window. You can edit this text in the usual way and cut and paste it among other desk accessories or any document.



## Puzzle



The Puzzle gives you something to play with when you need a short break. Click a “tile” to slide it into the empty space. Try to place the numbers in order. The Puzzle rescrambles whenever you close it or when it’s active and you choose it again from the Apple menu. Unfortunately, you can’t pry out the little plastic tiles when you get frustrated.

## Note Pad

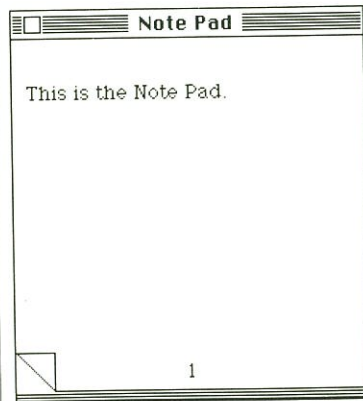

With the Note Pad you can jot down a few notes and keep them separate from the document you’re working on. Or type text and edit it even if you’re using an application that doesn’t allow text editing in the usual way. Use the Edit menu to cut and paste into and out of the Note Pad.

You have eight numbered pages of Note Pad paper. Turn to the next page by clicking the turned-back corner of the previous page. Turn to the previous page by clicking the bottom left corner of the Note Pad.

Notes you type are automatically saved in the Note Pad File on the startup disk.

## Scrapbook

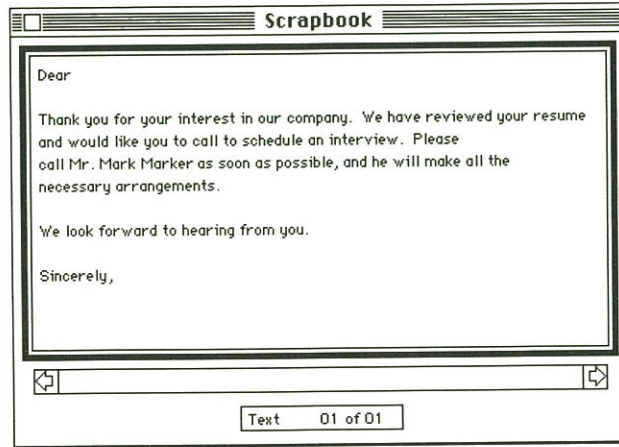

Keep pictures and text you use frequently in the Scrapbook. For example, you might keep your letterhead there, or favorite illustrations from MacPaint. Paste something you cut or copied from another desk accessory or a document. And copy or cut the current picture or text (which is automatically selected) to paste into other documents or desk accessories. Use the scroll bar to look through the Scrapbook.

The contents of the Scrapbook are stored in the Scrapbook File on the startup disk.

## Control Panel

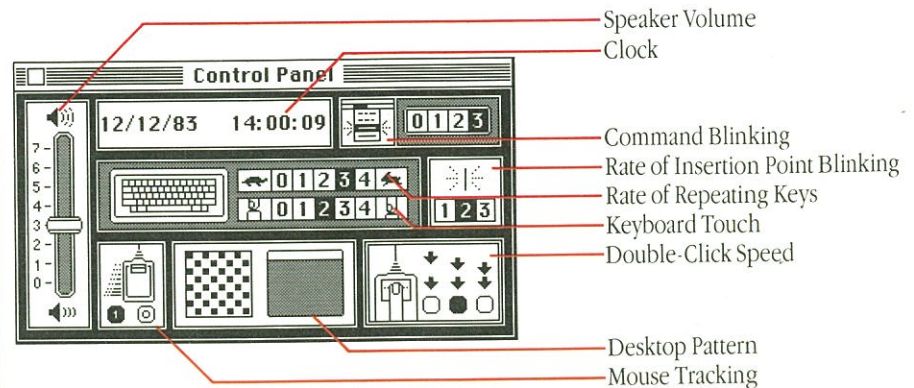

The Control Panel lets you set your preferences for speaker volume, repeating key rate, and even the background pattern of your desktop. Most control panel settings are remembered even when you turn the power off.

### **Speaker Volume**

Dial the volume you want by dragging the knob up or down.

### **Rate of Repeating Keys**

Lets you vary the rate at which a pressed key will repeat. Lower numbers make a pressed key repeat slowly. Higher settings produce faster repeating.

### **Keyboard Touch**

If you want a light touch to produce repeating characters, click a high number; click a low number to require a longer press to produce a repeating character (if you're getting a lot of repeated keys when you don't intend them). Click 0 to turn off repeating.

### **Rate of Insertion Point Blinking**

Lets you vary the rate at which the vertical bar marking the insertion point blinks.

### **Command Blinking**

Click 1, 2, or 3 to control the amount of visual feedback you get—how much a command blinks when you choose it from a menu. Click 0 to turn off command blinking.

### **Desktop Pattern**

Click dots to change them from black to white or vice versa, or drag through a group of dots to change all of them. To set the pattern, click the "desktop" below the white bar. Click the "menu bar" to see a sample pattern. (Click on the right side of the bar to see the next pattern; click on the left side to back up.)

### **Double-Click Speed**

Click the leftmost square for the Macintosh to interpret fairly slow successive clicks as a double-click. The rightmost square setting requires a faster mouse-button finger. The middle button produces, not surprisingly, an in-between response.

### **Mouse Tracking**

The "1" setting makes the pointer move farther when you speed up mouse movement. When you want to jump to another part of the screen, you don't have to move the mouse as far as you normally would. The "0" setting keeps the pointer speed constant.

### **Clock**

The Macintosh clock runs on battery power. It will need resetting only when the battery runs out. To set the time or date, click the digits you want to set. Click arrows to go forward or backward, or use the keyboard to type the numbers. Click anywhere else in the Control Panel to set the clock.



## Shortcuts

### Double-Click

In general, Macintosh shortcuts are just quicker ways to do things you can ordinarily do “the long way.” Some shortcuts apply only to a specific Macintosh application; each application’s manual explains its own.

Lets you open icons just like using the Open command. Double-clicking an icon opens it. In text, double-clicking a word selects the entire word.

### Shift-Click

This combination lets you add to a previous selection. As long as you hold the Shift key down, the first selection isn’t unselected when you make a new selection. In some applications, Command-click also performs a similar function.

### Return and Enter Keys

Pressing the Return or Enter key in response to a dialog box is the same as clicking the button that confirms the command or the outlined button, if there is one.

### Tab Key

Pressing the Tab key in a dialog box usually selects the next place to supply information.

### Backspace Key

Using the Backspace key with a selection is the same as choosing Clear from the Edit menu. Unlike using the Cut command, using the Backspace key doesn’t put what’s deleted on the Clipboard.

### Close Box

Clicking the close box in the title bar of the active window closes it, just like choosing Close from the File menu.

### Command Key



You can issue many commands (including most commands in the Edit menu) by holding down the Command key while you type a character. Commands that have Command-key equivalents list the key to type to the right of the item in the menu.

Holding down the Command key while typing a period (.) usually stops whatever’s happening—printing a document, for example.

Holding down the Command and Shift keys while typing the number 1 usually ejects the internal disk; holding them down while typing the number 2 ejects the external disk.

See “Printing” in Chapter 3 for how to use the Command key to print.

## Finder Reference

### Overview

The Finder is Macintosh's built-in application for managing documents and directing traffic between you and the disk.

The Finder is like a central hallway in the Macintosh house. It manages moving from one application to another (like rooms in the house) and organizing the documents you create with those applications. It's also like a front door—the way you enter the Macintosh house—and it's the link between you and your disks, giving you access to the documents you store on them.

Common Finder tasks include:

- opening, closing, copying, discarding, moving, and renaming documents and disks
- organizing documents on the desktop, in folders, and on disks
- ejecting and initializing disks

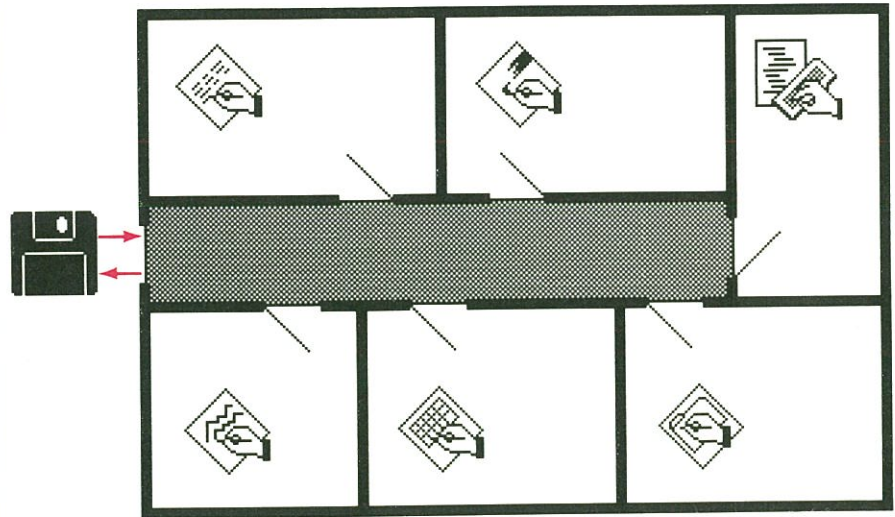

Some of the Finder's capabilities are also available while you're using an application. You can open new documents, save work on a disk, examine the contents of disks, eject disks, print the current document, or revert to a previous version of a document without returning to the Finder.



## What the Finder Manages

You work in the Finder by selecting and dragging icons (see “Selecting Icons” and “Dragging Icons” later in this chapter) and by choosing commands from menus (see “Finder Menus” later in this chapter).

### Applications and Documents

Applications and documents are represented in their closed state as icons. You can rename, duplicate, discard, or organize applications and documents on disks and in folders.

### Disks

The contents of a disk are displayed in a directory window. A disk can contain documents, applications, and folders. Usually each item is represented by an icon that you can select and drag; you can choose to see the disk’s contents arranged in other ways with the View menu.

Disks currently inserted into either the built-in or additional disk drive appear as white disk icons. The icon becomes hollow when its window is opened. Icons for disks that have been ejected appear dimmed in gray. (Both inserted and ejected icons are highlighted when selected.) The Macintosh remembers the contents of disks inserted and then ejected. You can open ejected disks (or any folders inside them) into directory windows; any items on ejected disks also appear dimmed. You can manipulate dimmed icons just like white icons. The Macintosh will ask you to reinsert the ejected disk when it needs it.

### Folders

Folders are receptacles that allow you to arrange your applications and documents hierarchically on a disk. When opened, folders display their contents in directory windows, just like disks. Folders can contain other folders.

To make new folders, duplicate the Empty Folder (which appears automatically on every disk).

When you’re using an application, folders are “transparent”; when you choose Open from the application’s File menu, all available documents on that disk appear in a list, regardless of what folders they may be in.



### **Desktop**

The Desktop in the Finder is a handy temporary resting place for icons. If you're concentrating on only a few documents and applications at a time, and they're on different disks or in different folders, you can drag all the documents to the desktop and work on them there. You can even close the windows for the folders and disks they came from; the Finder will remember where the documents belong.

Documents are automatically put back when you open a document or application, and brought back out to their previous positions when you quit the application and return to the Finder.

### **Trash**

The Trash is a receptacle for discarding documents and folders. You can't discard disks this way. When you discard a folder, the folder and its entire contents disappear. Locked documents can't be discarded; you must unlock them (in their information windows) before discarding.

When you open the Trash icon, it shows the last few documents you discarded. You can recover those documents by dragging them out of the Trash back onto the desktop. But documents stay in the Trash only for a short while; the Finder empties the Trash when you start an application, eject the disk, or try to add more documents to the disk. To claim space on the disk immediately, you can empty the Trash yourself by choosing Empty Trash from the Special menu (but who wants to empty their own trash?).

Once an icon is selected, the Edit menu commands operate on that icon's name, and the File menu commands work on what the icon represents.

When more than one icon is selected, the Edit menu commands are dimmed.

You can select a group of icons only if they're all in the same window or all on the desktop. If you want to work on a number of documents in different folders or disks, drag them to the desktop and select them all there.

Operations on a group of icons are performed one by one. The icons are taken in order from left to right, top to bottom.

## **Selecting Icons**

## ■ Dragging Icons

Dragging an icon from one place to another moves that icon to the new place. You can drag an icon onto the desktop, onto a folder, disk, or Trash icon, or into an open folder, disk, or Trash window.

Dragging an icon from one place to another on the same disk (or to a folder on that disk) merely moves the icon to the new place. Dragging an icon to another disk (or to a folder on that disk) leaves a copy behind on the original for safekeeping. If you don't want the copy left behind, just drag it to the Trash afterward.

If you drag an icon to another disk, and there's already an icon with that same name on that disk, you're asked if you want to replace it with the icon you're dragging.

	Drag document	Drag folder	Drag application	Drag disk
to folder on same disk	moves it there	moves it there	moves it there	
to folder on different disk	copies it there	copies it and its contents there	copies it there	
to a different disk	copies it there	copies it and its contents there	copies it there	copies it there
to Trash	discards it	discards it and its contents	discards it	

In general, dragging an icon on the same disk moves it; dragging an icon to a different disk copies it.

To copy on the same disk, use the Duplicate command in the File menu.

You can drag an icon to another icon, or to that icon's window; the effect is the same, although dragging into a window lets you drag to a specific location in the folder or disk window.

You can drag locked documents; you can't drag anything to or from a locked disk. See the Get Info command in "Finder Menus" in this chapter.

## Finder Menus

### ■ The Apple Menu

Each Macintosh application presents the commands it can carry out in menus you pull down from the menu bar. Together with dragging icons, the Finder's menus allow you to do all your desktop-management tasks.

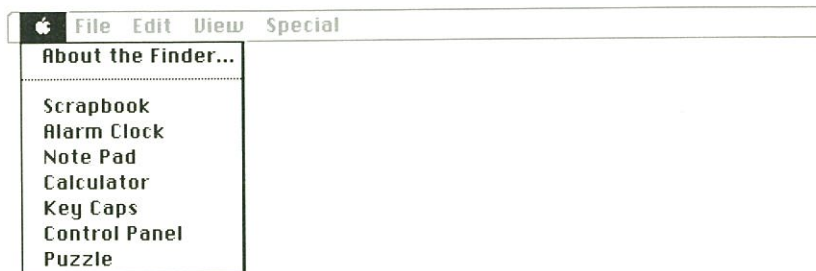

#### About the Finder

Shows the version number and the authors of the Finder—Bruce Horn with Steve Capps.

#### Desk Accessories

Choosing any of the desk accessories causes that accessory to appear on the desktop. You can use the Edit menu to cut, copy, and paste the information in most desk accessories. The desk accessory stays on your desktop until you close it, with either its close box or the Close command in the File menu.

The desk accessories are explained more fully in “Desk Accessories” earlier in this chapter.

### ■ The File Menu

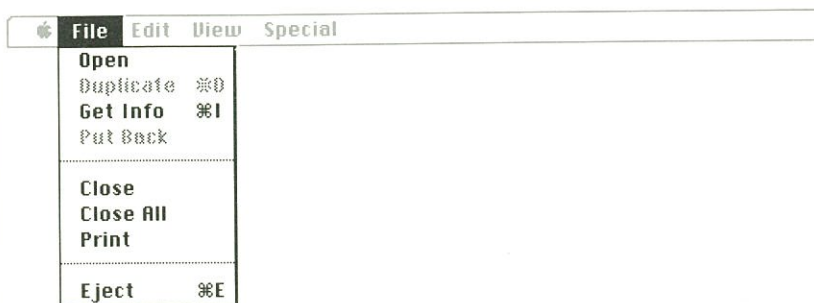

The commands in the File menu operate on icons and windows.

#### Open

Opens the selected icon into a window. If the icon represents a document, opening it also starts an application that you can work on the document. If the icon represents an application, opening it gives you an untitled document.



In order to open a document, the application that created it must be on a currently inserted disk.

Selecting more than one icon and choosing Open attempts to open the first icon's application to work on all the other selected icons. For example, you can open the word processor with a text-only document from MacTerminal.

### **Duplicate**

Duplicates the selected items on the same disk. The duplicates are named "Copy of" followed by the name of the original.

Duplicating a folder duplicates the folder and all its contents, even if the contents are out on the desktop rather than inside the folder.

### **Get Info**

Opens a window that displays information about whatever the selected icon represents. The displayed information includes its size, kind (document, folder, or application and, if it's a document, which application created it), the date it was created, the date it was last changed, and which disk or folder it belongs to. You can still drag or open a selected icon while its information window is open.

You can add text by typing in the comment box and editing it as you edit any text.

The Locked check box allows you to lock a document or application. When the Locked box is checked, that document or application can't be disposed of and its name can't be changed. It can, however, be modified in any other way.

### **Put Back**

Puts the selected documents, applications, or folders back into the folder or disk they came from most recently.

### **Close**

Closes the active window, zooming it back down to its icon. The icon remains selected. (If the active window is a desk accessory, it just disappears into thin air.) The next frontmost window, if there is one, then becomes the active window.

### **Close All**

Closes all windows to their icons, just like closing each in turn. Desk accessories just disappear.

## The Edit Menu

### Print

Prints the document represented by the selected icon or icons, in left to right, top to bottom order. The icons can be of different kinds; the Finder will print all selected documents of one kind before printing documents of the next kind.

In order to print a document, the application that created it must be on a disk whose icon appears on the desktop. Document printing from the Finder follows the same rules and procedures of printing in that document's application; see each application's manual for more information on how to print with that application.

### Eject

Ejects the selected disk, or the disk represented by the active window. Whenever a disk has been ejected, its icon and the icons belonging to it are dimmed to show they're no longer available.



The Finder's Edit menu allows you to edit:

- the names of icons
- text in an information window (opened by selecting the icon and choosing Get Info from the File menu)
- text or pictures in desk accessories

You cannot use this menu to cut or copy icons. You do this by dragging icons. (See "Dragging Icons" in this chapter.)

Selecting an icon also selects the text below it. Anything you subsequently type replaces the old text. Clicking the text itself causes an insertion point to appear. You can edit this text as you edit any text.

**Undo**

Undoes your last text-editing action in a desk accessory.

**Cut**

Removes the selection and places it on the Clipboard, replacing the previous contents if any.

**Copy**

Places a copy of the selection on the Clipboard, replacing the previous contents if any.

**Paste**

Puts a copy of the contents of the Clipboard at the insertion point. You can continue to paste copies until you cut or copy a new selection, which replaces the old contents of the Clipboard.

**Clear**

Removes the selection, without placing it on the Clipboard.

**Select All**

Selects all icons in the active window.

**Show Clipboard**

Displays a window with the current contents of the Clipboard—that is, whatever you cut or copied.

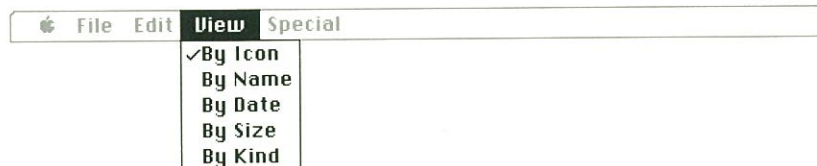
**The View Menu**

You'll probably keep your directory windows showing icons most of the time, so you can rearrange your documents and folders, duplicate them, and move or dispose of them. But the commands in the View menu also let you view directories of disks, folders, or the Trash in other arrangements. When the arrangement is other than pictorial, you select by clicking a name rather than an icon.



The current view of the active window is marked in the View menu by a check.

In all arrangements other than By Icon, you can manipulate documents, applications, and folders only with the commands in the File menu. You cannot drag items or edit their names.

### **By Icon**

Shows the contents of a directory window as icons, just as on the desktop. Only in By Icon arrangement can you drag icons and edit their names.

### **By Name**

Lists the contents of a directory window alphabetically by name. Uppercase and lowercase are considered equal.

### **By Date**

Lists the contents of a directory window chronologically by modification date. The document you changed most recently is listed first.

### **By Size**

Lists the contents of a directory window by size, largest first. Useful for seeing which of your documents are taking the most room on the disk. Folders are listed according to the size of their contents.

### **By Kind**

Lists the contents of a directory window by kind—whether each item is an application, folder, or document. For documents, it tells which application created it.

## **The Special Menu**



### **Clean Up**

Used only in By Icon view. Arranges all icons in the frontmost window in neat rows and columns. If no directory windows are open, Clean Up cleans up the desktop.

**Empty Trash**

Removes the contents of the Trash.

**Erase Disk**

Initializes (and completely erases) the disk whose icon is selected. You can't erase the startup disk because the Macintosh needs information on that disk in order to work. If you want to erase a certain disk, start the Macintosh using a different disk, eject that disk if necessary, and insert the disk you want to erase.

**Set Startup**

Lets you jump immediately into the application whose icon is highlighted whenever you start your Macintosh using that disk. You can reset the startup to the Finder by selecting the Finder icon (first open the System Folder if necessary) and choosing Set Startup again.







## Chapter 5:

### Adding To Your Macintosh System



## Contents

<b>117</b>	<b>Applications</b>
117	MacWrite
118	MacPaint
118	MacTerminal
118	Macintosh Pascal
118	Macintosh BASIC
119	MacProject
119	MacDraw
119	And Many More...
<b>120</b>	<b>Additional Disk Drive</b>
<b>121</b>	<b>Apple Imagewriter Printer</b>
121	Setting Up the Printer
122	Adding Pin-Feed Paper
124	Adding Plain Paper
124	Using the Controls
125	Attaching the Imagewriter to Your Macintosh
<b>127</b>	<b>Apple Modem</b>
<b>128</b>	<b>Numeric Keypad</b>
<b>129</b>	<b>Macintosh Carrying Case</b>
<b>130</b>	<b>Security Accessory Kit</b>
<b>131</b>	<b>Programmer's Switch</b>



Depending on the kind of work you want to use your Macintosh for, you can choose an application best for helping you do it.

## ■ MacWrite

MacWrite is a radical change in word processing. With MacWrite you create documents that look the same on the screen as they'll look when you print them. Rather than working around a lot of commands embedded in your text, you always see what you've really got. You use the mouse to select text and remove, copy, or move it. You can customize your documents with many fonts and styles, and you can control margins or line spacing with a single click.

You can add MacPaint drawings to documents you create with MacWrite or vice versa. With Macintosh, words and pictures mix beautifully.

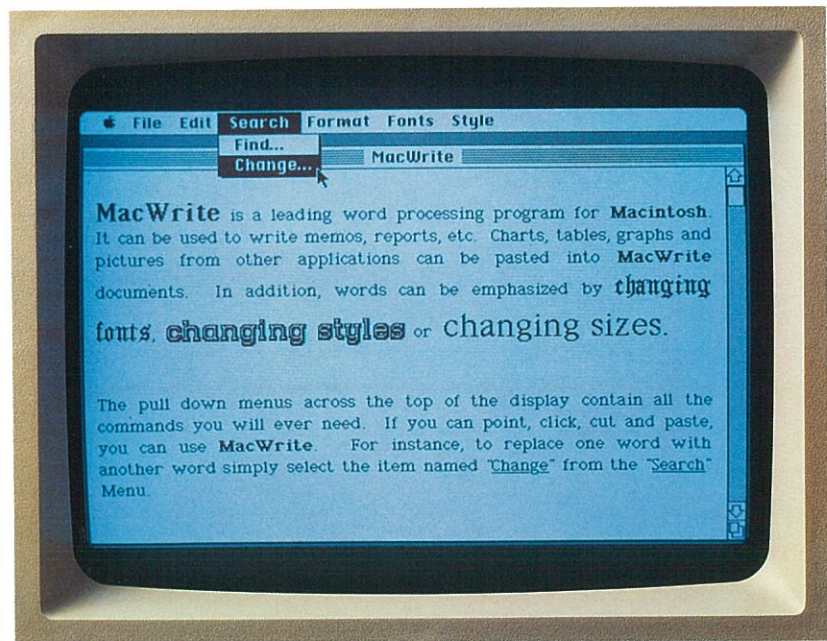



## MacPaint

MacPaint brings out the artist in everyone. Whether it's a technical illustration for a research project or a sketch for a party announcement, you can do it with MacPaint. You can use MacPaint's drawing tools to draw perfect structured shapes or your own freehand designs. You can type text in beautiful fonts and styles and add text from other applications as well.

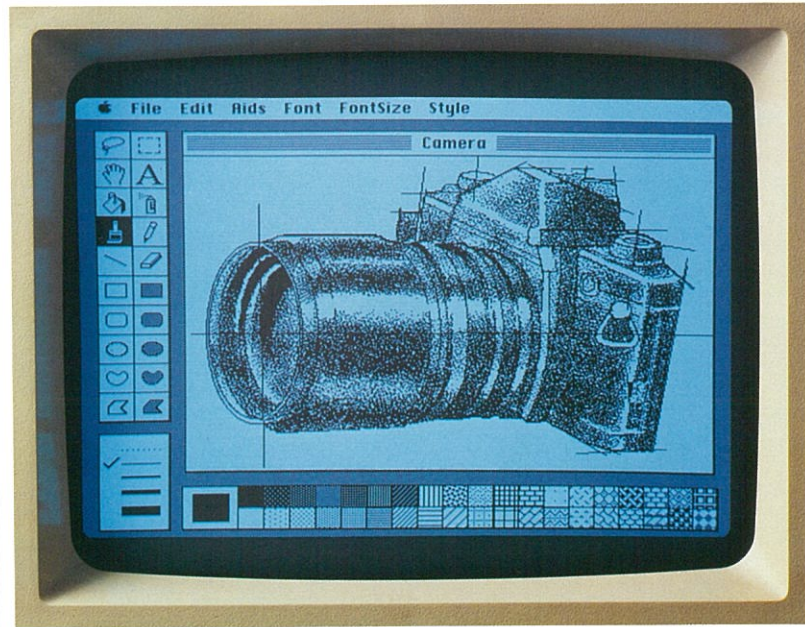

## MacTerminal

MacTerminal™ lets you communicate with the rest of the world. You can access information services such as The Source<sup>SM</sup>, CompuServe™ Information Service, or Dow Jones News™; exchange information with another computer; and send and receive electronic mail.

## Macintosh Pascal

This highly interactive Pascal language lets you bypass time-consuming compiling. Debugging is faster and simpler than with traditional Pascal. Of course, Macintosh Pascal also uses the Macintosh mouse and multiple-window capabilities.

## Macintosh BASIC

Macintosh BASIC greatly extends the world's most popular programming language. Highly evolved control structures, no line numbers, and an advanced debugger and screen editor allow you to write programs never before possible in BASIC. You can also save programming time by cutting and pasting between programs.

## MacProject

Project management and scheduling have never been easier. You tell MacProject™ what tasks are involved in your project and what resources you have. MacProject calculates the “critical path” to completion and estimates costs in money and time. If you miss (or beat!) a deadline or if your available resources change, MacProject recalculates everything in a flash.

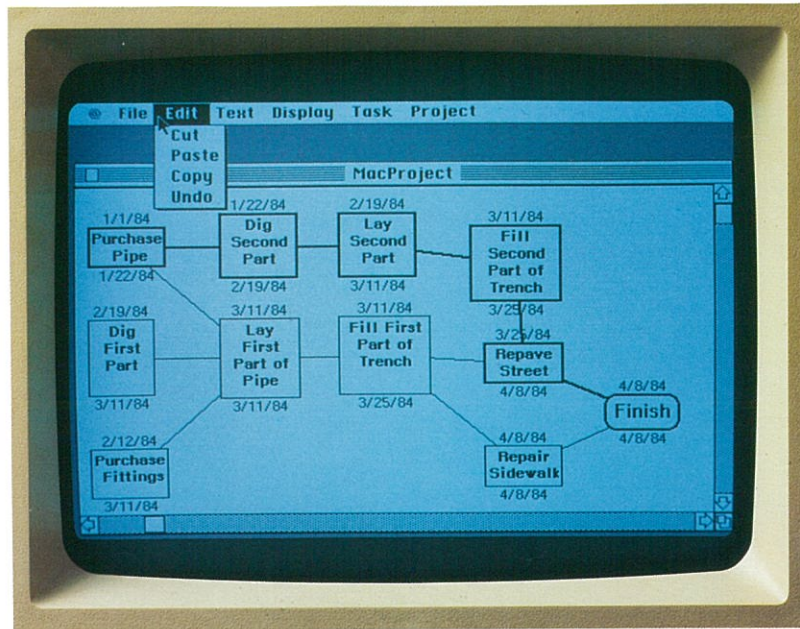

## MacDraw

MacDraw™ lets you create structured graphics on the Macintosh. You can prepare perfect flowcharts, diagrams, graphs, technical drawings, and organizational charts, as well as freehand drawings. You can add text in different fonts, sizes, and styles.

## And Many More...

Top software developers are introducing many more applications for the Macintosh. (Contact your authorized Apple dealer for availability.) You can choose from:

- electronic spreadsheets for budgeting, forecasting, and answering “What if?” questions
- data base management programs that help you keep track of your files—everything from prospective clients to your favorite restaurants
- charting programs that turn numbers nobody understands into charts everyone understands



## Additional Disk Drive

With an additional disk drive attached to your Macintosh, you can have two disks available at the same time. This can speed your access to information on disks and make it easier to copy information from one disk to another.

To attach the additional drive, do the following:

1. With the Macintosh plugged in and switched off, touch any one of the metal connectors on the back of the Macintosh. This discharges any static electricity that may be on your body.
2. Remove the anti-static bag from the end of the disk drive cable. Without touching the metal pins in the disk drive cable connector, attach the cable to the back of the Macintosh by inserting the connector into the socket marked with a picture of the disk drive. (Keep the anti-static bag so that you can protect the pins from static discharge whenever the drive isn't connected to the Macintosh.)
3. Tighten the thumbscrews on the connector to prevent radio and TV interference. The metal plate makes contact with the screws and grounds the disk drive. Tightening the screws prevents the connection from coming loose.

When you insert a disk into the additional disk drive attached to your Macintosh, the icon that represents that disk will appear on the desktop. You can open the icon to see its contents, just as you do for the disk in the built-in drive.

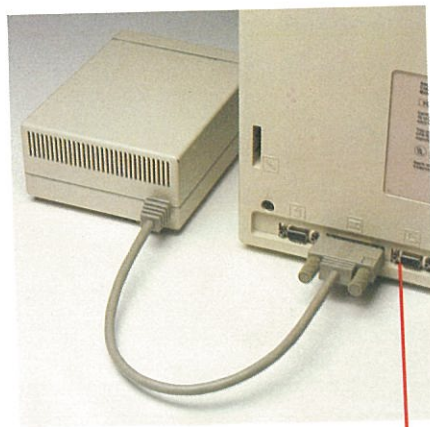
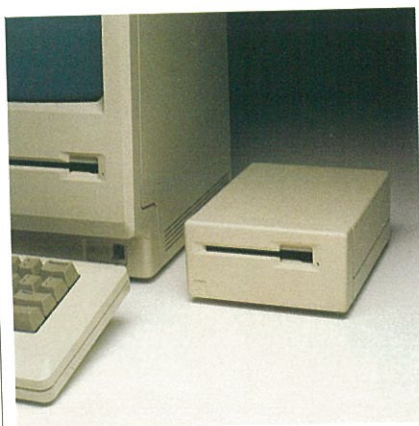

Disk Drive Socket



## Apple Imagewriter Printer

### Setting Up the Printer

With an Apple Imagewriter printer attached to your Macintosh, you can get printed copies of your work. With most computers, what you see on the screen and what you get from the printer look very different. With Macintosh, what you see is pretty much what you get.

After you've unpacked the Imagewriter, set it up as follows:

1. Make sure the **on/off switch** is off. (It's like a ballpoint pen—the first click switches it on, the second switches it off.)
2. Remove the **carrier cover** and the **paper cover** if you haven't already.
3. Tighten the ribbon in the **ribbon cartridge** by turning the **ribbon knob**.

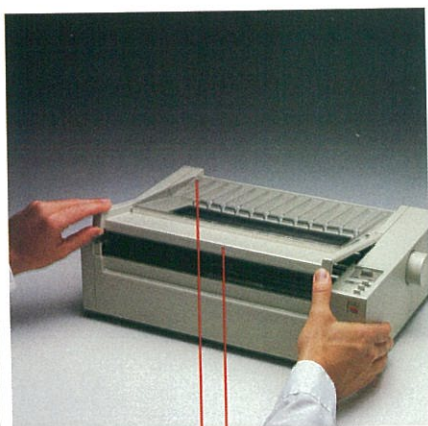

Carrier Cover  
Paper Cover

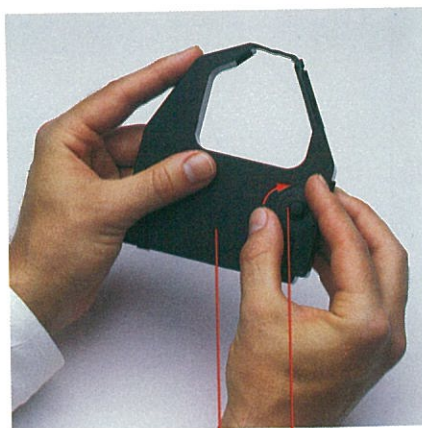

Ribbon Knob  
Ribbon Cartridge



4. Snap the ribbon cartridge into place.
5. Wind the ribbon knob again to take up any slack in the ribbon.

Make sure you always have clear, crisp-looking copies by changing the ribbon cartridge whenever the print quality begins to look faded. Ribbon cartridges are available from your authorized Apple dealer.

## ■ Adding Pin-Feed Paper

If you're using pin-feed paper (which has holes along the edges and is perforated):

1. Set the **release lever** to the pin-feed (back) setting. This lets you move the paper freely around the **platen**.
2. Lift the **paper clamps** upward and push the white **sprocket release levers** backward. This lets you move the **sprockets** freely.

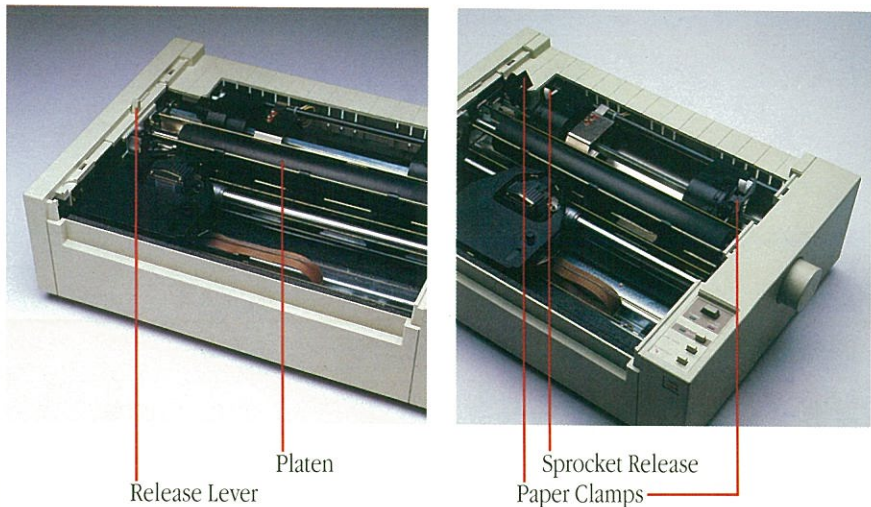

3. Position the paper holes over the **sprocket pins**, sliding the sprockets horizontally if you need to make the paper fit, and close the paper clamps over the paper.
4. Pull the **roller shaft** away from the platen.
5. Feed the paper through by turning the **platen knob** clockwise.



Sprocket Pins  
Roller Shaft

6. With the releases still open, make any adjustments you need to. Pull the sprockets outward to the sides so the paper is fairly taut. Adjust the sprockets (and the paper) so the printing area (marked by red rings on the roller shaft) is where you want it on the paper.
7. Bring the sprocket release levers forward again and press the roller shaft back against the platen. Replace the carrier and paper covers.



## ■ Adding Plain Paper

If you're using paper without pin-feed holes (either single sheets or rolls):

1. Set the **release lever** to the pin-feed (back) setting and lift the clear plastic lid on the **carrier cover**.
2. Pull the **roller shaft** away from the **platen**.
3. Feed the paper into the slot in the **paper cover** and guide it around the platen (the same way you put paper into a typewriter).
4. Adjust the paper so the printing area (marked by the red rings on the roller shaft) is where you want it on the paper.
5. Press the roller shaft back against the platen.
6. Set the release lever to the friction (front) position.

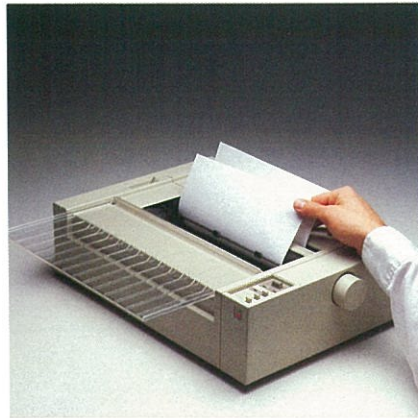

## ■ Using the Controls

To use the controls on the Imagewriter control panel, do as follows:

1. Plug it into a grounded outlet and switch it on.  
The **power light** and the **select light** come on. When the select light is on and the printer is attached to the Macintosh, the Imagewriter gets its directions from the Macintosh; when you choose Print from a File menu, you'll get a printed copy.
2. To use the **line-feed button** (to advance the paper one line at a time) or the **form-feed button** (to advance the paper one page at a time):
  - turn the select light off by pressing the select button
  - press the line-feed or form-feed button
  - turn the select light on again

The **paper error light** comes on if you're out of paper or the paper is inserted incorrectly.

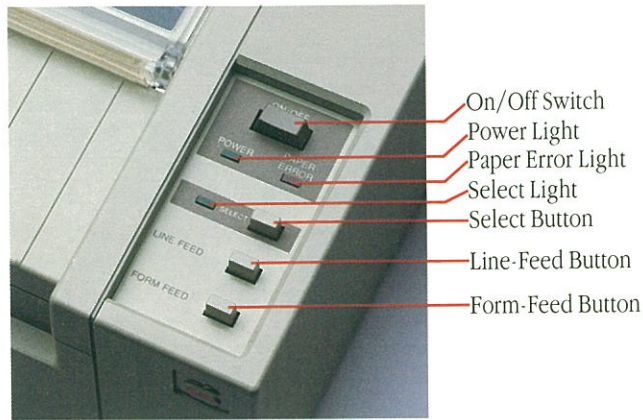

### Attaching the Imagewriter to Your Macintosh

Attach your Imagewriter to your Macintosh using the cable packed in the Imagewriter accessory kit.

1. Make sure both the Macintosh and the Imagewriter are switched off.
2. Connect the smaller of the two cable plugs to the **socket** in the back of the Macintosh. The socket is marked with a symbol of the printer.
3. Connect the other end of the cable to the **socket** in the back of the Imagewriter.
4. Tighten the thumbscrews on both **connectors** to prevent radio and TV interference. The metal plate makes contact with the screws and grounds the printer. Tightening the screws prevents the connection from coming loose.

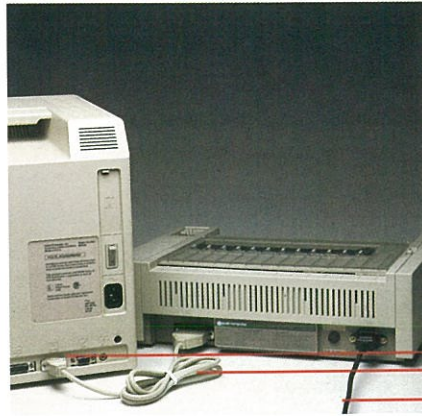

Printer Socket  
Cable  
Power Cord

For more detailed instructions on setting up and using the ImageWriter, see Part I of the *Apple ImageWriter User's Manual*.



## Apple Modem

An Apple modem lets your Macintosh communicate with the rest of the world using telephone lines. So you can send and receive messages through electronic mail, subscribe to news services, find out the latest price of your stocks, or access an entire university library from your Macintosh. Your Apple dealer can tell you about the Macintosh telecommunications possibilities, including MacTerminal.

Attach the Apple modem to your Macintosh as follows:

1. Switch your Macintosh and the Apple modem off.
2. Unplug the modular cord from the base of your telephone and plug it into either of the telephone jacks on the back of the modem.
3. Plug one end of the modular cord that comes with your modem into the other telephone jack on the back of the modem and the other end into the base of your telephone.
4. Attach the data cable that comes in the modem accessory kit for the Macintosh to the socket marked with a symbol of a telephone on the back of the Macintosh and to the 9-pin socket on the back of the modem.
5. Attach the modem power cord to the connector on the back of the modem and plug it into a grounded electrical outlet.

For more detailed instructions on setting up and using the Apple modem, see Part I of the *Apple Modem User's Manual*.

Instructions to operate the modem are included with the MacTerminal application.

The Apple modem is available with either a 300 or a 300 and 1200 baud rate.



Modem Socket

## Numeric Keypad

If you do a lot of work with numbers, you may want to add a numeric keypad to your Macintosh system. It lets you enter numbers much more quickly than you can using the standard keyboard and it also includes several keys for special functions.

You can do all of these functions using the standard Macintosh keyboard; the numeric keypad just helps you do them faster.

Attach the keypad to the Macintosh as follows:

1. Unplug the standard keyboard cable from the standard keyboard.
2. Insert the free end of the cable into the socket on the keypad marked by a symbol representing the main unit.
3. Plug the cable that comes with the keypad into the remaining socket on the keypad (it's marked with a keyboard symbol).
4. Plug the other end of that cable into the socket on the keyboard.



## Macintosh Carrying Case

The Macintosh Carrying Case lets you carry your Macintosh easily from one place to another—back and forth from the office, on a weekend trip, or just over to a friend's house. Your Macintosh will fit under the seat in most commercial airplanes and in the overhead compartment of others. (If you're going to ship it somewhere, or you want to check it as luggage, repack it in its original box. Or you can look in the phone book under "Air Cargo Service" to find an approved shipping container, or ask your authorized Apple dealer for information.)





## Security Accessory Kit

If the Macintosh is going to be used in a public place and you want to make sure it stays where you put it, you can secure the main unit and the keyboard using the security accessory kit.

1. Insert the **brackets** into the back of the Macintosh case and the back of the keyboard. Once inserted, these brackets lock into place and can't be removed from the main unit or the keyboard.
2. Wrap the **cable** around an immovable object and pull the straight end of the cable through the loop. Thread the straight end through the eyelets in the brackets and secure the cable-end **nut** with the tamperproof **screws**.
3. Slide the **cowling** over the nut and lock all in place with a padlock you purchase separately.
4. Replace the screws on all cable connections with the tamperproof screws provided.

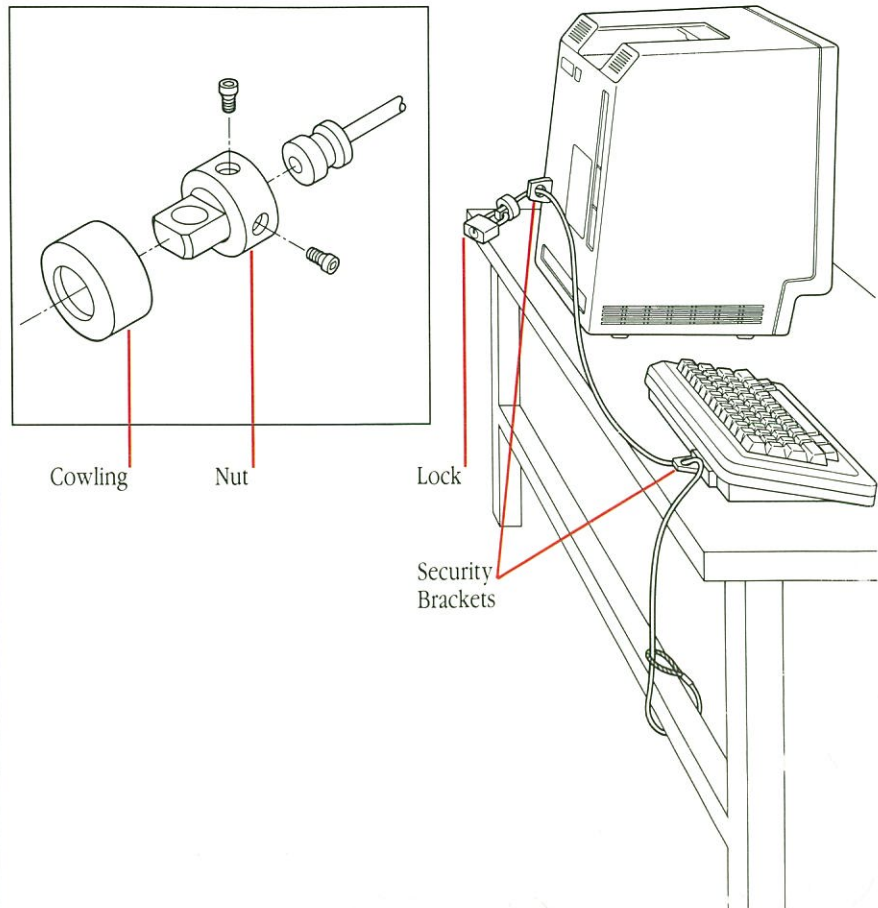

## Programmer's Switch

The programmer's switch is included for people who want to write their own application programs for the Macintosh.

The switch snaps into place on the left side of the Macintosh. If you're not going to do application development for the Macintosh, don't install the switch; using it in the wrong way could cause you to lose information.

If you want to do Macintosh application development, ask your Apple dealer about technical documentation. Or write to:

Macintosh Developer's Group  
Mail Stop 23-AF  
Apple Computer, Inc.  
20525 Mariani Avenue  
Cupertino, CA 95014

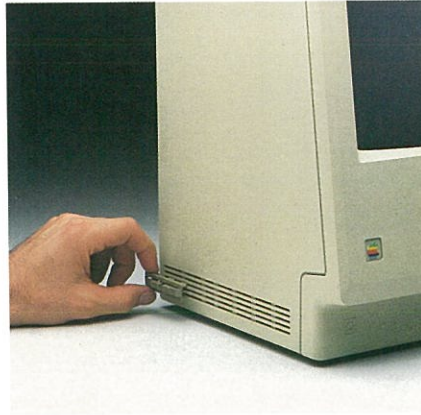



## Chapter 6:

### Taking Care of Your Macintosh

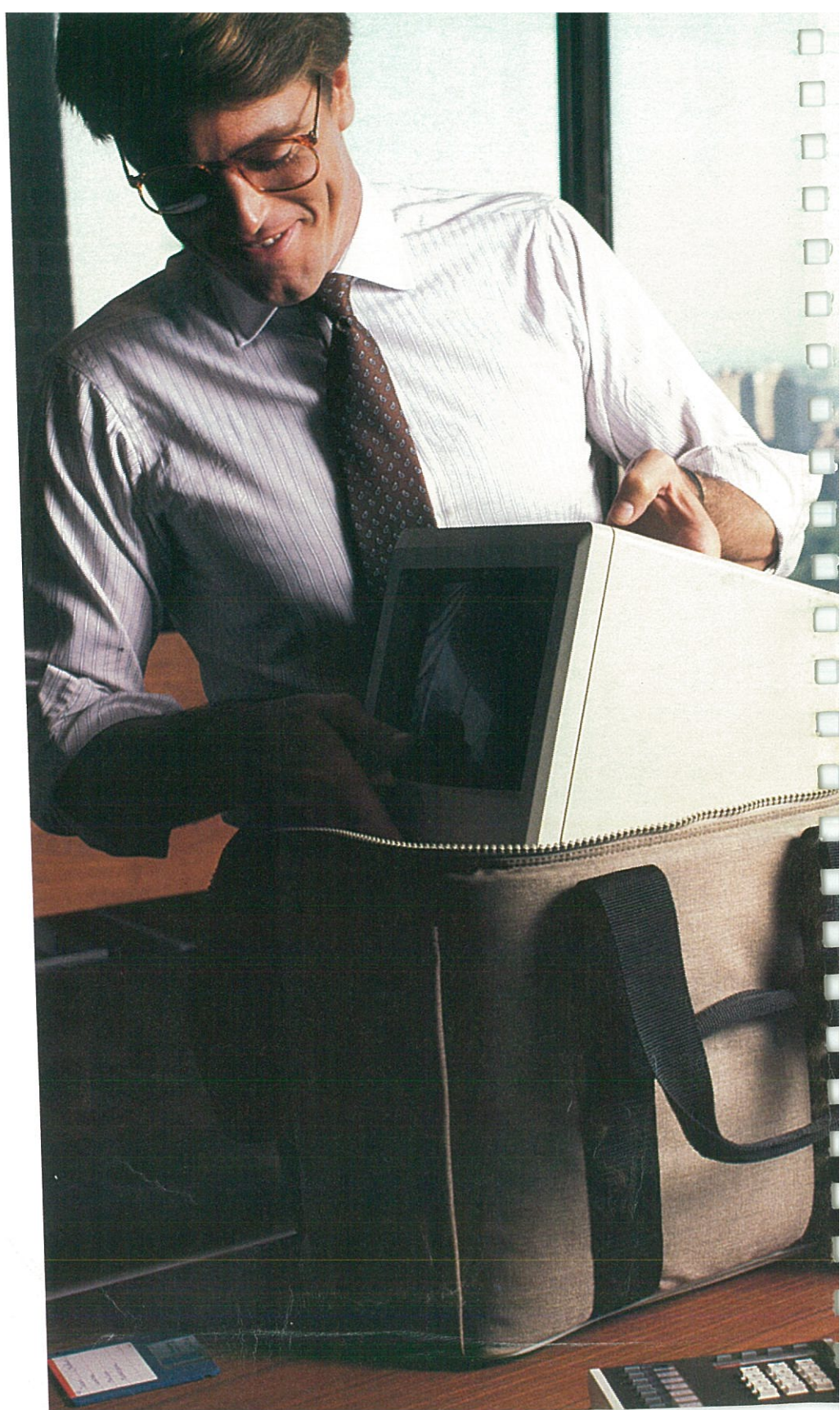





## Contents

<b>135</b>	<b>Keeping It in Good Shape</b>
135	Main Unit
136	Keyboard
136	Mouse
137	Disks
139	Clock Battery
<b>140</b>	<b>If Something Goes Wrong</b>
140	The screen is dark.
140	When you insert a disk, the screen is bright, but the desktop doesn't appear.
141	Moving the mouse has no effect on the pointer.
142	Typing on the keyboard produces nothing on the screen.
142	You can't save anything on a disk.
142	You can't eject the disk.
143	General Symptoms and Solutions
<b>144</b>	<b>Radio and Television Interference</b>



## Keeping It in Good Shape

### Main Unit

The first thing to know: You'll never hurt your Macintosh by clicking in the wrong place or pressing the wrong key. Your Macintosh is no more fragile than a television set. And if you follow the few suggestions here, you and your Macintosh will be together for a long time.

Give your Macintosh plenty of space—enough so air can circulate on all sides, even the bottom. Make sure air can circulate around each of the ventilation slots on the top and sides of the main unit. Don't use it on thick-pile carpet or upholstery, and don't set anything on top of it while it's switched on. You can store your Macintosh in a bookcase, but it shouldn't be crammed into a small space while you're using it.

Be careful not to spill liquids on your Macintosh. The main unit is reasonably safe from small splashes, but probably won't survive a cup of coffee spilled into it.

The Macintosh can tolerate about the same range of temperatures as you can, but don't let it sit outside in direct sunlight or expose it to rain (much less hail, sleet, or snow). The top of the main unit will feel warm to the touch (about 85 to 90 degrees F.) after it's been on for a while. This is just the heat generated inside rising to the top and escaping.

It's fine to keep your Macintosh switched on even when you're not using it. It uses very little electricity (about the same as a 60-watt light bulb), and it makes a fine night light. Just remember to turn down the brightness, because if your Macintosh is left on for long periods (days or weeks), the image on the screen will start to "burn in," and the screen may be permanently damaged.

**Warning:** *Never try to remove the cover from the main unit. The Macintosh contains extremely high-voltage components that retain an electrical charge, even after the unit is switched off.*

**Important Safety Instructions:** *The Macintosh is intended to be electrically grounded. It's equipped with a three-wire grounding type plug, a plug having a third (grounding) pin. This plug will only fit into a grounding-type AC outlet. This is a safety feature. If you are unable to insert the plug into the outlet, contact a licensed electrician to replace the outlet and, if necessary, install a grounding conductor. Do not defeat the purpose of the grounding-type plug.*



## Keyboard

The keyboard cable connectors are just like those used in modular telephones; however, the cables themselves are not. *Never* connect these cables to your telephone and never connect a phone cable to your Macintosh. Doing so may cause permanent damage.

Try not to spill anything on the keyboard. It can be ruined by a spilled soft drink or anything that leaves a sticky residue. If you spill something on the keyboard and it stops working:

- If the liquid is sweet or sticky, unplug the keyboard and take it to your authorized Apple dealer for repair or replacement.
- If the liquid is thin and clear, try unplugging the keyboard, inverting it to let the liquid drain out, and drying it for 24 hours at room temperature. If it still doesn't work, take it to your Apple dealer.

## Mouse

Be careful not to drop the mouse or let it hang from a table by its cable. Just use common sense in treating it as carefully as you can.

The surface your mouse moves on should be as smooth, clean, and dust-free as possible. And give the mouse itself an occasional cleaning.

How to clean the mouse:

1. Turn the mouse upside down and rotate the black plastic dial counterclockwise as far as it will go.
2. Holding one hand over the ball and dial to catch them, turn the mouse back right side up. The dial and the ball will drop into your hand.



3. Inside the case are two rubber rollers, similar to those on a tape recorder. Using a cotton swab moistened with alcohol or tape head cleaner, gently wipe off any oil that has collected on the rollers, rotating them to reach all surfaces.
4. Wipe the ball with a soft, clean, dry cloth. (Don't use tissue or anything that may leave lint, and don't use a cleaning liquid.)

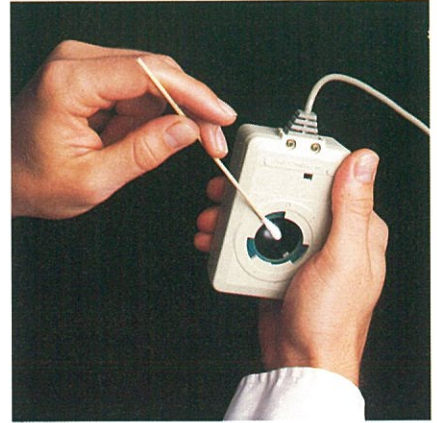

5. Blow gently into the case to remove any dust that has collected there.
6. Put the ball back into its case and, lining up the indicator on the dial with the "O" on the back of the case, reinsert the dial and turn it clockwise as far as it will go. (It will click when firmly in place.)

## **Disks**

Although Apple 3½-inch disks are much tougher than the flexible (or "floppy") disks used with most personal computers, they do have a few modest physical requirements—about the same as audio cassette tapes have. Your Macintosh disks should be kept dry, away from extreme temperatures (don't lay them on top of your Macintosh or store them on the seat of your car), out of direct sunlight, and out of reach of anything that contains a magnet, like a telephone. (Magnetic fields can scramble the information on the disk.)

When the disk is inserted into the disk drive, the metal covering on the disk case slides to the left, so the Macintosh can get information from and save information on the disk. When the disk is out of the disk drive, the metal covering closes by spring action to protect the disk underneath it. Never touch the exposed disk under the metal covering.

Other than that, you don't have to treat disks especially carefully. You can carry them around in your purse or shirt pocket or mail them to your aunt in Cooperstown. (Two fit nicely in a business envelope.)

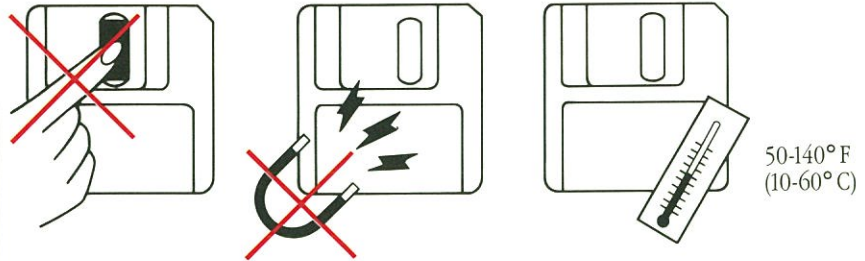

Be sure to make a copy of any disks you can't do without. (See "Copying an Entire Disk" in Chapter 3.) It's no fun losing a report the night before you were going to make final corrections.

You can purchase disks in a 10-pack from your authorized Apple dealer.



## Clock Battery

Your Macintosh has a clock that runs continuously, even when the Macintosh is switched off. (Choose Clock from the Apple menu to see it.) When the Macintosh is off, the clock runs on battery power. The battery will probably last about two years. If the clock begins to lose accuracy, replace the battery.

To do this, open the battery door on the back of the Macintosh by pressing the latch, allowing the door to pivot out. Replace the old battery with a new 4.5-volt battery (Eveready No. 523 or equivalent). Make sure you insert the battery so that its plus and minus indicators match those on the Macintosh cover. Put the battery cover back on. Reset the Macintosh clock if you need to: choose Control Panel from the Apple menu.



## If Something Goes Wrong

### ■ The screen is dark.

*Do not attempt to open the cover of your Macintosh.* The Macintosh was designed so that you never need to remove the cover of the main unit or the keyboard; everything you connect to your Macintosh can be connected from the outside. If your Macintosh stops working, try the suggestions that follow; if it still doesn't work, take it to your authorized Apple dealer, who's been specially trained and authorized and has the necessary tools to service your Macintosh.

#### **What's Probably Wrong**

The Macintosh isn't getting power or the brightness control is turned way down.

#### **What to Do**

Check the brightness control under the left side of the screen; turn it clockwise to make the screen brighter. Make sure the Macintosh is switched on and the power cord is firmly attached to both the main unit and the wall outlet. If the outlet is controlled by a wall switch, is the wall switch on? Is the outlet controlled by a dimmer switch? (Use a different outlet if it is.)

### ■ When you insert a disk, the screen is bright, but the desktop doesn't appear.

#### **What's Probably Wrong**

Usually an icon will indicate the problem, or a message will appear. The disk may be damaged or it might not be a startup disk. There may be problems with the main unit.

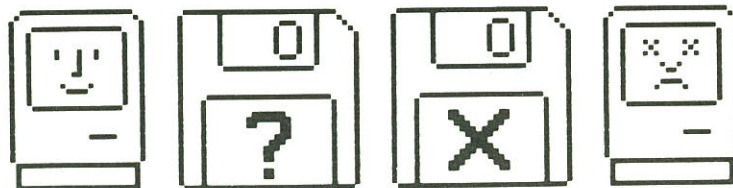

**Moving the mouse has no effect on the pointer.**

### **What to Do**

The “happy Macintosh” means everything’s fine to this point.

The question mark means the Macintosh is ready for you to insert a disk.

If the disk isn’t initialized for the Macintosh, you’ll be asked if you want to initialize it.

An “X” means the disk may be damaged. Try restarting the Macintosh by switching it off briefly and then on again. This lets the Macintosh get another copy of the software and start over; sometimes that’s all it needs. Try restarting with a different disk.

The “sad Macintosh” appears when the Macintosh can’t go any further. Often this indicates a hardware problem. See your dealer.

You may have to eject the disk manually. To do this, press and hold the mouse button while you switch the Macintosh off and then on again. (The groaning sound is normal.)

### **What’s Probably Wrong**

The mouse might not be firmly connected to the main unit, or the mouse isn’t working properly. There may be a problem with the software.

### **What to Do**

Is the mouse firmly connected to the Macintosh? Is it moving on a smooth, clean surface? Does the mouse need cleaning? (See “Keeping It in Good Shape” in this chapter.)

If the problem doesn’t seem to be with the mouse, check the software by first restarting the Macintosh, then trying another disk. If there seems to be a software problem you can’t solve by restarting or by trying another disk, tell your authorized Apple dealer about it. Your dealer can get the answers you need.



**Typing on the keyboard produces nothing on the screen.**

**What's Probably Wrong**

You might be in a situation that doesn't allow typing. (For example, MacPaint has a tool just for entering text.) The keyboard connection may be loose, or the keyboard broken.

**What to Do**

Make sure you're in a situation that allows typing. Make sure the keyboard is connected securely. If this doesn't help, see your Apple dealer.

**You can't save anything on a disk.**

**What's Probably Wrong**

Either the disk can't accept the information because it's full, not initialized for the Macintosh, locked, or damaged, or the disk drive isn't working.

**What to Do**

Usually a message appears in a box describing the exact problem. If not, take the following steps. Eject the disk and see if the Lock tab is in the protect position. (If you can't eject it in the usual way, see the next section.) Reinsert the disk. Check to see if there's room for more information on the disk by selecting the disk and choosing Get Info from the File menu. Try using a different disk.

If you still have trouble saving anything, the disk drive probably isn't working correctly. Take the Macintosh to your Apple dealer for help.

**You can't eject the disk.**

**What's Probably Wrong**

Your Macintosh can't get the information it needs to eject the disk in the usual way.

**What to Do**

Press and hold the mouse button down while you switch the Macintosh off and then on again. This should eject the disk. As a last resort, find the small hole beneath the disk drive. Insert a straightened paper clip or similar small object and push. This ejects the disk if all else fails.

## ■ General Symptoms and Solutions

If none of these specific symptoms or solutions seem to fit, consider the three general ways in which your Macintosh could be ailing:

- The application you're using could have gone wrong just this once after it was copied from the disk into the Macintosh's memory.
- The disk you're using has bad information on it.
- The Macintosh is on the blink.

If you've checked the specific symptoms in this chapter, and you still can't get any response from your Macintosh, try turning it off briefly and then on again. If this works and this time you're able to complete what you tried before, it was just a glitch. (That's a technical term.) If you find yourself in the same dilemma after restarting the Macintosh, the problem is with the disk. Try another disk (one without any valuable documents on it, if possible, so you don't risk losing them). If you have the same problem with all disks, the Macintosh most likely has a problem. Take it to your Apple dealer.

## Radio and Television Interference

The Macintosh generates and uses radio frequency energy. If it is not installed and used properly, that is, in strict accordance with our instructions, it may cause interference to radio and television reception.

Your Macintosh has been tested and complies with the limits for a Class B computing device in accordance with the specifications in Subpart J of Part 15 of FCC rules. These rules are designed to provide reasonable protection against such interference in a residential installation. However, there is no guarantee that the interference will not occur in a particular installation, especially if a “rabbit ear” TV antenna is used. (A “rabbit ear” antenna is the telescoping rod type usually contained on TV receivers.)

You can determine whether your computer is causing interference by turning it off. If the interference stops, it was probably caused by the computer or its peripherals. To further isolate the problem:

- Disconnect the peripheral devices and their I/O cables one at a time. If the interference stops, it is caused by either the peripheral or its I/O cable. These devices require shielded I/O cables. Your Macintosh and all Macintosh peripherals come with shielded cables. For non-Apple peripherals, contact the manufacturer or dealer for assistance.
- If you are using a non-Apple peripheral with your Macintosh, be sure that it is supplied with a shielded I/O cable. Macintosh has been tested with shielded cables and may not comply with the class B limits when used with nonshielded cables.

If your computer does cause interference to radio or television reception, you can try to correct the interference by using one or more of the following measures:

- Turn the TV or radio antenna until the interference stops.
- Move the computer to one side or the other of the TV or radio.
- Move the computer farther away from the TV or radio.
- Plug the computer into an outlet that is on a different circuit from the TV or radio. (That is, make certain the computer and the TV or radio are on circuits controlled by different circuit breakers or fuses.)
- Consider installing a rooftop TV antenna with coaxial cable lead-in between the antenna and TV.



If necessary, you should consult your dealer or an experienced radio/television technician for additional suggestions. You may find helpful the following booklet, prepared by the Federal Communications Commission:

“How to Identify and Resolve Radio-TV Interference Problems”

This booklet is available from:

U.S. Government Printing Office  
Washington, DC 20402  
Stock Number 004-000-00345-4

Appendixes

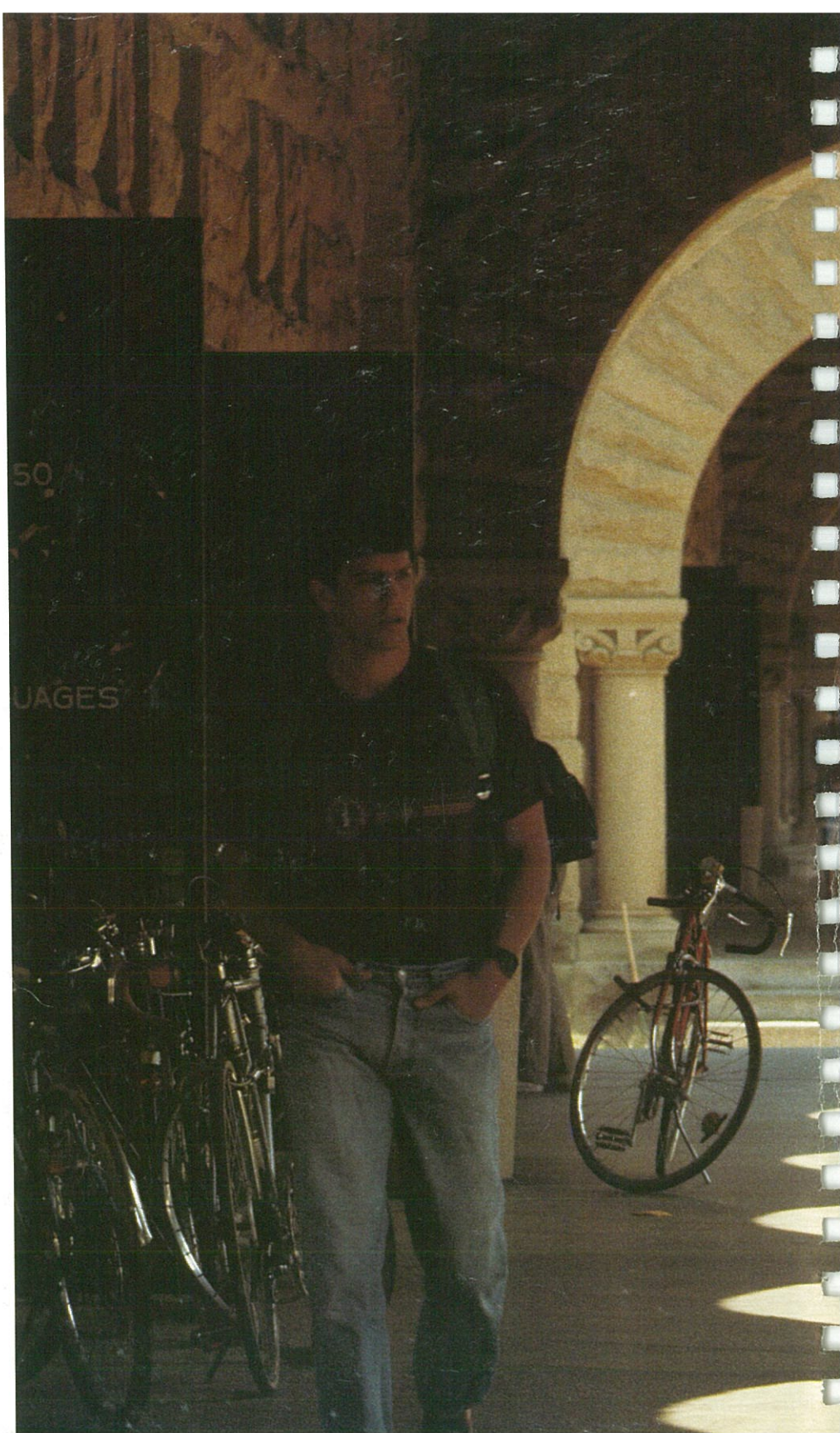



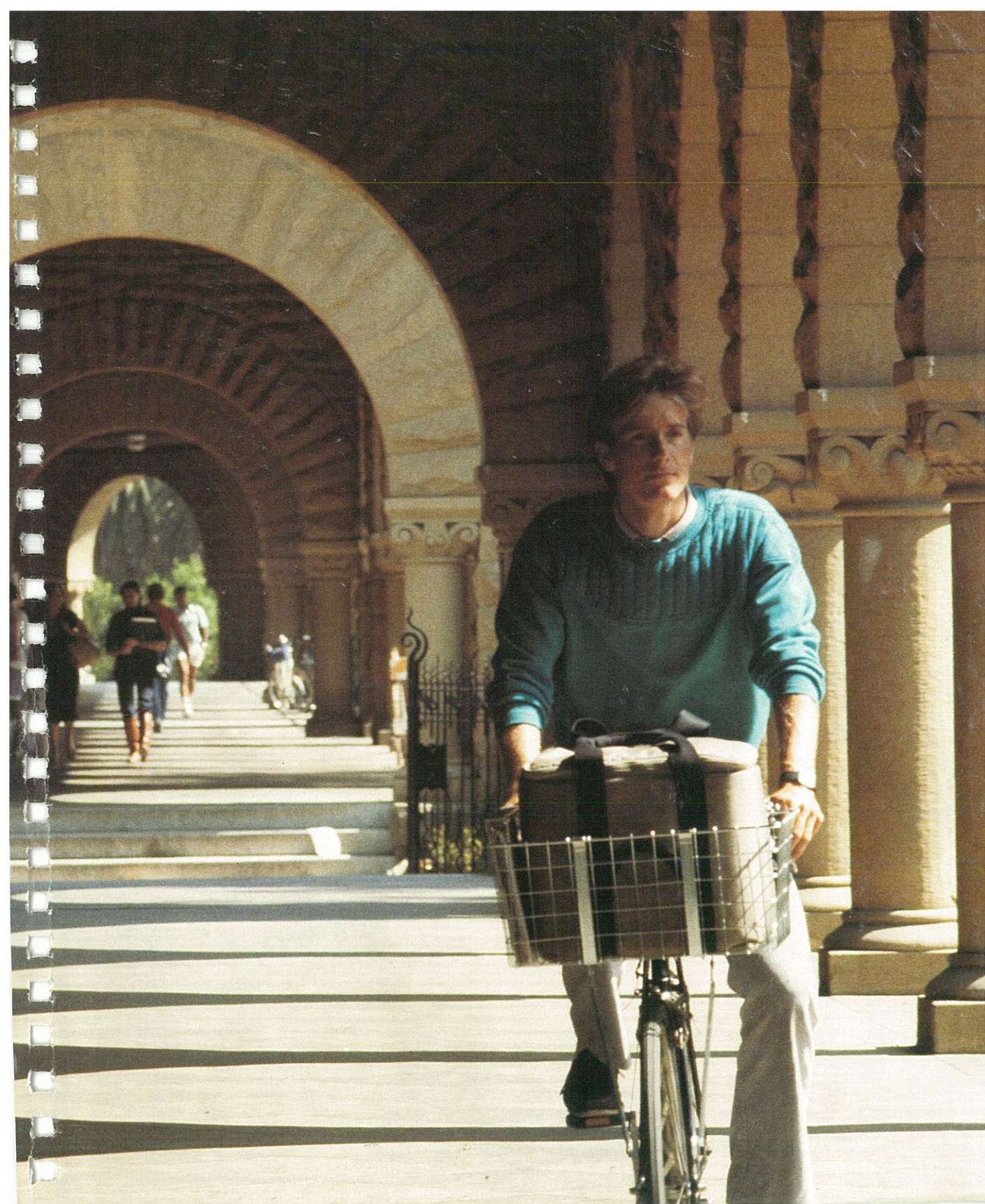



## Appendix A: Optional Character Set

Holding down the Option key while you type another key on the keyboard produces the following characters (shown on the right side of each key).



White = Character produced by holding down the Option key while you type another character

Red = Character produced by holding down the Option key and the Shift key while you type another character

You produce accented characters by combining optional characters with standard characters. See “Keyboard” in Chapter 4.

You can also view the optional character set by choosing the Key Caps desk accessory from the Apple menu. See “Desk Accessories” in Chapter 4.

## Appendix B: Macintosh Specifications

Processor:	MC68000, 32-bit architecture, 7.8336MHz clock frequency
Memory:	128K bytes RAM 64K bytes ROM
Disk capacity:	400K bytes per formatted disk, 3½-inch diameter hard-shell media
Screen:	9-inch diagonal, high-resolution, 512-pixel by 342-pixel bit-mapped display
Interfaces:	Synchronous serial keyboard bus Two RS232/RS422 serial ports, 230.4K baud maximum (up to 0.920 megabit per second if clocked externally) Mouse interface External disk interface
Sound generator:	4-voice sound with 8-bit digital-analog conversion using 22 KHz sample rate
Input:	Line voltage: 105 to 125 volts AC, RMS Frequency: 50 or 60 Hz Power: 60 watts
Keyboard:	58 key, 2-key rollover, software mapped
Mouse:	Mechanical tracking, optical shaft encoding 3.54 pulse per mm (90 pulse per inch) of travel
Clock/calendar:	CMOS custom chip with 4.5 volt (Eveready No. 523 or equivalent) user-replaceable battery backup

Size and Weight:

	Weight	Height	Width	Depth
Main Unit	7.5 kg (16 lb. 8 oz.)	344 mm 13.5 inches	246 mm 9.7 inches	276 mm 10.9 inches
Keyboard	1.2 kg (2 lb. 8.5 oz.)	65 mm 2.6 inches	336 mm 13.2 inches	146 mm 5.8 inches
Mouse	.2 kg (7 oz.)	37 mm 1.5 inches	60 mm 2.4 inches	109 mm 4.3 inches

Environment:

Temperature: operating: 10° C. to 40° C.  
(50° F. to 104° F.)  
storing: -40° C. to 50° C.  
(-104° F. to 122° F.)

Humidity, all conditions:  
5% to 90% relative humidity

Altitude: 0 to 4615 M  
(0 to 15,000 feet)



## Glossary

Menu Title  
 Menu Bar  
 Pulled-Down Menu  
 Active Window's Title Bar  
 Commands  
 Command Key Equivalent  
 Dimmed Command  
 Pointer  
 Application Icon  
 Folder Icon  
 Document Icon, Selected  
 Selected Text  
 Scroll Arrow  
 Scroll Box  
 Scroll Bar  
 Disk Icon  
 Size Box  
 System Icon  
 Directory Window  
 Desktop  
 Trash

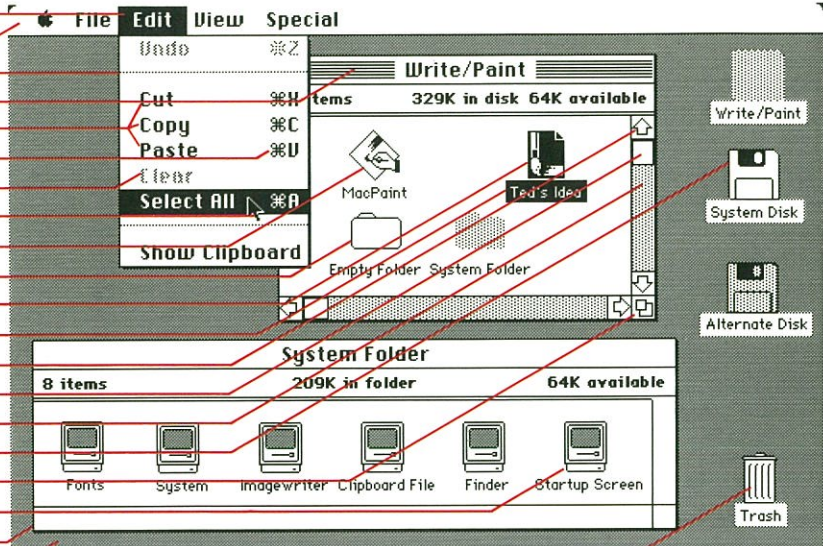

Button  
 Insertion Point  
 I-Beam Pointer  
 Dialog Box

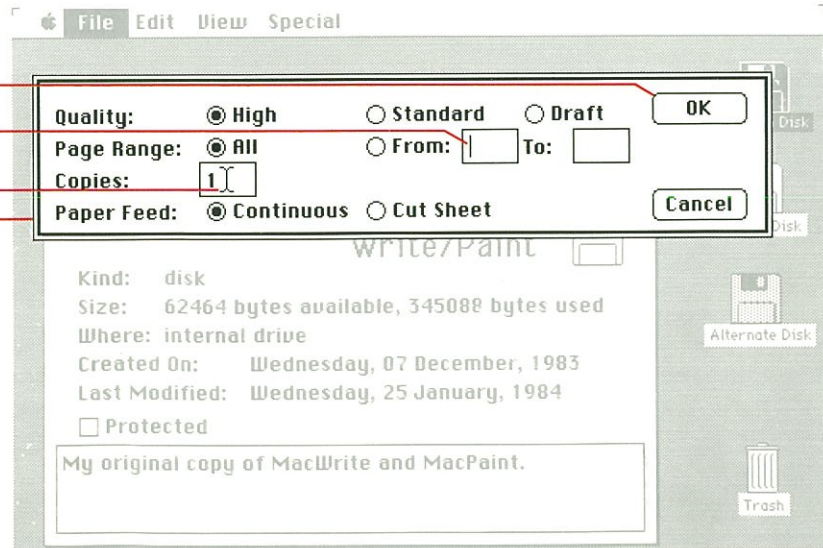



**active window**

The frontmost window on the desktop; the window where the next action will take place. An active window's title bar is highlighted.

**Apple menu**

The menu on the far left in the menu bar. Its title is an apple symbol.

**application program**

A tool to manipulate information, sometimes called an "application." Macintosh applications include MacPaint and MacWrite.

**Backspace key**

A key that backspaces over and erases the previously typed character or the current selection.

**button**

Buttons appear in dialog boxes and are clicked to designate, confirm, or cancel an action. See also mouse button.

**Calculator**

A desk accessory that works like a four-function pocket calculator. Calculation results can be cut and pasted into your documents.

**Cancel button**

A button that appears in dialog boxes. Clicking this button cancels the command.

**Caps Lock key**

A key that, when engaged, causes subsequently typed letters to appear in uppercase. It works like a Shift key except that it doesn't affect numbers or symbols.

**choose**

To pick a command from a menu by dragging. Usually you do this after you've selected something for the Macintosh to act on.

**click**

To position the pointer on something, then press and quickly release the mouse button.

**Clipboard**

The holding place for what was last cut or copied.

**Clock**

A desk accessory that displays the current date and time.

**close**

To turn a window back into the icon that represents it.

**close box**

A small white box on the left side in the title bar of an active window. Clicking a close box closes the window.

**command**

A word or phrase, usually in a menu, describing an action for the Macintosh to perform. Also, a combination of the Command key and a character key that accomplishes the same thing.

**Command key**

A key that, when held down while another key is pressed, causes a command to take effect.

**Control Panel**

A desk accessory that lets you change the speaker volume, the keyboard repeat speed and delay, and other preferences.

**cut**

To remove something by selecting it and choosing Cut from the Edit menu. What was cut is placed on the Clipboard.

**desk accessories**

“Mini-applications” that are available from the Apple menu regardless of which application you’re using. Examples are the Calculator, Note Pad, Clock, and Puzzle.

**desktop**

Macintosh’s working environment—the menu bar and the gray area on the screen.

**dialog box**

A box containing a message requesting more information from you. Sometimes the message is a warning that you’re asking your Macintosh to do something it can’t do or that you’re about to destroy some of your information. (In these cases the message is often accompanied by a “beep.”)





Cut  
Copy

**dimmed command**

A command that appears dimmed compared to other commands in the menu. A dimmed command cannot be chosen.

**dimmed icon**

An icon that represents a disk that has been ejected, or a document, folder, or application on a disk that has been ejected. Dimmed icons can be selected and opened, but the documents on them cannot be opened.

**directory**

A pictorial, alphabetical, or chronological list of the contents of a folder or a disk.

**disk**

The magnetic medium on which the Macintosh stores information. Macintosh uses a 3½-inch disk.

**disk drive**

The mechanism that holds the disk, retrieves information from it, and saves information on it.

**document**

Whatever you create with Macintosh applications—information you enter, modify, view, or save.

**double-click**

To position the pointer where you want an action to take place, and then press and release the mouse button twice in quick succession without moving the mouse.

**drag**

To position the pointer on something, press and hold the mouse button, move the mouse and release the mouse button. When you release the mouse button, you either confirm a selection or move an object to a new location.

**Enter key**

A key that confirms or terminates an entry or sometimes a command.

**file**

A collection of information stored on a disk, usually a document.

**Finder**

An application that's always available on the desktop. You use it to manage documents and applications, and to access disks.



**folder**

A holder of documents and applications on the desktop. Folders allow you to organize information in any way you want.

**font**

A collection of letters, numbers, punctuation marks, and other typographical symbols with a consistent appearance. An example of a Macintosh font is New York.

**hardware**

Anything about the Macintosh that you can see or touch.

**highlight**

To make something visually distinct from its background. An item is usually highlighted to show that it has been selected or chosen.

**I-beam**

A type of pointer used in entering and editing text.

**icon**

A graphic representation of an object, a concept, or a message. Icons are often objects associated with the Finder.

**information window**

The window that appears when you select an icon and choose Get Info from the File menu. It supplies information such as size, type, and date, and it includes a comment box for adding notes.

**initialize**

To prepare a disk to receive information.

**insertion point**

The spot in a document where something will be added. An insertion point is selected by clicking and is represented by a blinking vertical bar.

**lock**

To prevent documents from being discarded or their names from being changed, or to prevent entire disks from being altered.

**main unit**

The Macintosh console, which contains the processor, memory, the built-in disk drive, and the screen.

**memory**

The place in the Macintosh main unit that stores information while you're working with it.

**menu**

A list of commands that appears when you point to and press the menu title in the menu bar. Dragging through the menu and releasing the mouse button while a menu item is highlighted chooses that item.

**menu bar**

The horizontal strip at the top of the screen that contains menu titles.

**menu title**

A word or phrase in the menu bar that designates one menu. Pressing on the menu title causes the title to be highlighted and its menu to appear below it.

**mouse**

A small device you roll around on a flat surface next to your Macintosh. When you move the mouse, the pointer on the screen moves correspondingly.

**mouse button**

The button on the top of the mouse. In general, pressing the mouse button initiates some action on whatever is under the pointer, and releasing the button confirms the action.

**Note Pad**

A desk accessory that allows you to enter and edit small amounts of text while working on another document.

**numeric keypad**

An accessory keyboard like a calculator keypad; used with some applications for numeric input.

**open**

To create a window from an icon so you can view a document or directory.

**Option key**

A key used like the Shift key to give an alternate interpretation to another key you type. You use it to type foreign characters or special symbols.

**paste**

To reposition the contents of the Clipboard—whatever was last cut or copied.

**pointer**

A small shape on the screen, most often an arrow pointing up and to the left, that tracks the movement of the mouse.

**press**

To position the pointer on something and then hold down the mouse button without moving the mouse.



**Return key**

A key that causes the insertion point to move to the beginning of the next line. It's also used in some cases to confirm a command.

**save**

To store information on a disk.

**Scrapbook**

A desk accessory in which you save frequently used pictures or passages of text.

**scroll**

To move a document or directory in its window so that a different part of it is visible.

**scroll arrow**

An arrow on either end of a scroll bar. Clicking a scroll arrow moves the document or directory one line. Pressing a scroll arrow scrolls the document continuously.

**scroll bar**

A rectangular bar that may be along the right or bottom of a window. Clicking or dragging in the scroll bar causes the view of the document to change.

**scroll box**

The white box in a scroll bar. The position of the scroll box in the scroll bar indicates the position of what's in the window relative to the entire document.

**select**

To designate where the next action will take place. To select, you click or drag across information.

**selection**

The information or items affected by the next command. The selection is usually highlighted.

**Shift-click**

A technique that allows you to extend a selection by holding down the Shift key while you make an additional selection.

**Shift key**

A key that, when pressed, causes subsequently typed letters to appear in uppercase, and causes the upper symbol to appear when number or symbol keys are typed.

**size box**

A box on the bottom right of some active windows that lets you control the size of the window.

Tab

**software**

Programs, or instructions for the Macintosh to carry out. The Macintosh reads these instructions from disks inserted into the disk drive.

**startup disk**

A disk with all the necessary files to use the Finder and possibly one or more application programs.

**style**

A stylistic variation of a font, such as italic, underline, shadow, or outline.

**Tab key**

A key that, when pressed, moves the insertion point to the next tab marker or, in a dialog box with more than one place to enter information, to the next rectangle.

**title bar**

The horizontal bar at the top of a window that shows the name of the window's contents and lets you move the window.

**window**

Displays information on a desktop. You view documents through windows. You can open or close them, change their size, edit their contents, scroll through them, and move them around on the desktop.

## Index

### A

- accented characters 91, 99, 148
- accessories, desk *See* desk accessories
- accessories, Macintosh *See also* disk drive and Imagewriter
  - printer
    - carrying case 129
    - modem 127
    - numeric keypad 128
    - security accessory kit 130
- activating a window 22-23, 56
- active window 22, 23, 56, 95
  - closing 25, 39, 57
  - highlighted 22
  - printing 73
- advanced techniques *See* shortcuts
- alarm button 99
- Alarm Clock 40-41, 98-99
- alert message 30, 97
- Apple menu 40, 108
  - About the Finder 108
  - Alarm Clock 40-41, 98-99
  - Calculator 98
  - Control Panel 97, 101-102
  - Key Caps 99, 148
  - Note Pad 100
  - Puzzle 100
  - Scrapbook 62-63, 101
- application(s) 105, 117-119
  - arranging on disk 49
  - copying 69-70, 107
  - icon 29
  - moving 37, 71, 107
  - opening 28-29, 66
  - problems with 141
  - quitting 31
  - recovering a removed 75
  - removing 74, 107
  - renaming 68
  - starting 28-29, 31, 66
- arranging desktop 12, 14, 24, 35
- arranging work on disks 49
- arrow, scroll 27, 58
- audio cassette tape 5

### B

- backing up a disk *See* disk, copying
- backing up a document *See* document,
- Backspace key 30, 61, 91, 103
- bar, scroll 19, 27, 56, 58
- battery, clock 102, 139
- beep 10, 30, 97 *See also* alert message
  - adjusting volume 97, 101-102
- blinking
  - command 102
  - menu bar 97
  - question mark 10
  - vertical bar 30, 32, 102
- booting *See* starting
- box, scroll 58
- box, size 19, 37, 57
  - dragging 20, 57
- brightness control 135
- button, dialog box
  - Cancel 30
  - Drive 30, 76, 77
  - Eject 30
  - Initialize 81
  - OK 30
  - Open 76
  - Save 30, 76, 77
- button, mouse 13, 15, 16, 17, 54, 55
- by Date command 112
- by Icon command 63, 65, 66, 112
- by Kind command 112
- by Name command 40, 112
- by Size command 112

### C

- Calculator 98
- Cancel button 30
- canceling
  - command 18
  - drag 16, 21, 55
- capitalizing letters 76, 90, 94
- Caps Lock key 90, 99
- care
  - disk 137-138
  - keyboard 136
  - main unit 135
  - mouse 136-137



- carrying case 129
- cassette tape 5
- changing
  - disk name 68
  - document name 68
  - size of window 20, 23, 57
  - windows 22, 56
- choosing a menu command 17, 18, 19
- Clean Up command 112
- Clear command 61, 111
- clicking 14-15, 54
- Clipboard 33-34, 49, 62-63, 96
- Clipboard File 96
- clock, Macintosh 102, 139 *See also* Alarm Clock
- Close All command 39, 109
- close box 21, 26, 34, 57, 103
- Close command 25, 34, 57, 109
- closing
  - application 31
  - document 76
  - window 25, 28, 39, 57
- Command key 56, 91, 103
  - to eject a disk 80
  - to print 72, 73
  - to stop action 103
- command(s) *See also* specific command
  - blinking 102
  - canceling 18
  - choosing 17, 18, 19
  - dimmed 17
  - highlighted 18
  - keyboard *See* Command key
- Command-E 80
- Command-period (.) 103
- Command-Shift-1 103
- Command-Shift-2 103
- Command-Shift-3 72
- Command-Shift-4 73
- comment box 31, 109
- communications *See* modem and MacTerminal
- confirming an entry *See* Return and Enter keys, and OK button
- Control Panel 90, 97, 101-102
- Copy command 61, 62-63, 96, 98, 111
- copy protect *See* locking

- copying *See also* Copy and Paste commands
  - application 69-70, 107
  - disk 83, 107
  - disk with one-drive system 83
  - document 69, 70, 107
  - folder 69, 70, 107
  - text 61
- creating
  - document 28-29, 66, 76
  - snapshot 72
- cursor *See* pointer
- Cut command 32-33, 96, 98, 111
  - to move text 61
  - to remove text 61, 62-63

## D

- date, setting 41, 99
- deleting *See* Backspace key, Clear and Cut commands, and removing
- desk accessories 40-41, 98-101, 108
  - activating 98
  - Alarm Clock 40, 98-99
  - Calculator 98
  - closing 98
  - Control Panel 97, 101-102
  - Note Pad 100
  - Puzzle 100
  - Scrapbook 62-63, 101
- desktop 12, 35, 37, 106
- desktop pattern 102
- development, software 131
- diacritical marks *See* accented characters
- dialog box 30, 81, 97
- dialog message 30, 97
- dimmed command 17
- dimmed icon 29, 105
- directory window 18, 67, 105, 111

disk 47, 92, 105  
arranging work on 49  
care 137-138  
claiming space on 49, 71, 84, 106  
copying 83, 107  
copying with one-drive system 83  
ejecting 28, 80, 103, 110  
ejecting manually 141, 142  
initializing 81, 83, 92, 93  
inserting 10  
locking 93  
naming 68, 93-94  
non-startup 82, 92  
problems with 140-141  
renaming 68  
saving work on 30, 48, 77  
startup 82, 92  
Disk Copy 83  
disk drive 47  
additional 49, 76, 77, 120  
attaching 120  
problems with 142  
document(s) 9, 37, 105  
closing 76  
copying 69, 70, 107  
creating 28-29, 76  
locking 109  
moving 37, 71, 107  
naming 30, 36, 68, 76, 93-94  
opening existing 31, 67, 76  
opening new 28-29, 76  
organizing 12, 35, 104  
printing 77  
recovering a removed 75  
removing 74, 106, 107  
renaming 36, 68  
saving 30, 48, 77  
storing in folder 35-36  
untitled 66, 76  
double-clicking 24-25, 54-55, 59-60, 67, 103  
adjusting speed of 102

dragging 54-55, 107  
canceling 16, 21, 55  
icon 15, 16, 107  
scroll box 58  
size box 20, 57  
through a menu 18  
title bar 21  
to select 32, 59, 60-61  
drive, disk *See* disk drive  
Drive button 30, 76, 77  
Duplicate command 35-36, 69, 109

## E

Edit menu 68, 106, 110-111 *See also* Cut and Paste commands  
Clear command 61, 111  
Copy command 61, 62-63, 96, 98, 111  
Select All command 111  
Show Clipboard command 34, 96, 111  
Undo command 111  
editing text 31-34, 60-61  
Eject button 76  
Eject command 28, 80, 110  
ejecting a disk 28, 76, 80, 92, 103, 110  
manually 141, 142  
problems with 142  
electricity, static  
discharging 120  
Empty Folder 25  
duplicating 35, 69, 105  
Empty Trash command 74, 106, 113  
Enter key 91, 97, 103  
Erase Disk command 81, 113  
erasing *See* Backspace key, Clear and Cut commands, and removing  
error message *See* alert message

## F

file *See* document(s)  
File menu 17, 106, 108-109  
Close All command 39, 109  
Close command 25, 34, 57, 109  
Duplicate command 35-36, 69, 109  
Eject command 28, 80, 110  
Get Info command 31, 39, 109  
Open command 18, 22, 66, 67, 76  
Print command 72-73, 77, 110  
Put Back command 109

filing documents *See* folder(s)

## Finder

defined 28, 104-105  
locked disk and 93  
menus 108-113  
returning to 31  
tasks 35, 65, 104  
folder(s) 19, 35, 105 *See also* Empty Folder and System

### Folder

copying 36, 69, 107  
creating 36, 69, 105  
moving 71, 107  
naming 36, 93  
recovering a removed 75  
removing 74, 106, 107  
renaming 36, 68

## font

adding 85  
removing 84-85  
Font Mover 84-85  
Fonts file 84-85  
formatting *See* initializing a disk

## G

Get Info command 31, 39, 109

## H

hardware, Macintosh 47  
highlighted 14 *See also* selecting  
command 18  
icon 14  
title bar 22

## I

I-beam 13  
icon titles  
selecting text in 36, 110  
icon(s) 10, 12  
clicking 14-15  
dimmed 29  
double-clicking 24, 54-55, 67, 103  
dragging 15, 16, 107  
highlighted 14  
hollow 18  
moving 15, 16  
opening 18, 22, 24, 66  
renaming 36, 68  
selecting 14, 17, 37-38, 59, 106, 110

## Imagewriter printer

attaching 125  
controls 124  
paper 122-124  
setting up 121  
information window 31-34, 39, 109  
Initialize button 81  
initializing a disk 81, 83, 92, 93  
inserting  
disk 10  
text 32-33, 60  
insertion point 30, 32, 33, 60-61  
rate of blinking 102

## J

## K

Key Caps 99, 148  
keyboard 30, 31, 32, 47, 49, 90  
adjusting touch 102  
care 136  
character keys 76, 77, 90  
commands *See* Command key  
optional character set 91  
problems with 142  
special keys 90  
keypad, numeric 128  
keys *See also* specific key  
rate of repeating 102

## L

locking  
application 109  
disk 93  
document 109  
lowercase letters 76, 94

## M

MacDraw 119  
Macintosh BASIC 118  
Macintosh Pascal 118  
MacPaint 118  
MacProject 119  
MacTerminal 118  
MacWrite 117  
magnetic fields 137  
main unit 47, 135  
memory 47, 48



menu *See also* specific menu  
  choosing from 17, 18, 19  
  dimmed command 17  
  pulling down 17  
menu bar 17, 18  
  blinking 97  
menu title 17  
modem 127  
mouse 13, 15, 16, 47, 49, 54-55  
  care and handling 136-137  
  feeding 163  
  problems with 141  
  tracking 102  
moving *See also* Copy, Cut, and Paste commands  
  application 71, 107  
  document 37, 71, 107  
  folder 71, 107  
  icon 15, 16  
  mouse 13, 15, 54-55  
  pointer 13, 33  
  text 61  
  window 21, 24, 56

## N

naming 30, 76  
  disk 68, 93-94  
  document 68, 93-94  
  folder 93  
  icon 36, 68  
non-startup disk 82, 92  
Note Pad 100  
numeric keypad 128

## O

OK button 30  
on/off switch  
  Imagewriter printer 121  
  Macintosh 10  
Open button 76  
Open command 18, 22, 66, 67, 76  
opening  
  application 29, 66  
  existing document 31, 67, 76  
  icon 18, 22, 24, 66-67  
  new document 28-29, 76  
  window 18, 22-23, 66-67  
Option key 91, 99, 148  
optional character set 91, 99, 148  
organizing documents 12, 35, 104

## P

paper error light 125  
Paste command 33-34, 96, 98, 111  
  to copy 61, 62-63  
  to move 61  
  to replace 61  
pointer 15  
  moving 13, 33  
  taking different shapes 13  
pressing 54  
  in scroll bar 58  
  menu title 18  
  mouse button 13, 15, 16, 17, 54-55  
  scroll arrow 58  
Print command 72-73, 77, 110  
printer *See* Imagewriter printer  
printing  
  active window 73  
  document 77  
  entire screen 73  
  group of documents 72  
  stopping 103  
processor, Macintosh 47  
programmer's switch 131  
programs, application *See* application(s)  
Put Back command 109  
Puzzle 100

## Q

Quit command 31  
quitting an application 31

## R

radio, interference with 120, 144-145  
recovering removed items 75  
removing *See also* Backspace key, Clear and Cut commands  
  application 74, 107  
  document 74, 106, 107  
  folder 74, 106, 107  
  text 61  
renaming 36, 68, 69  
replacing text 61, 68, 110  
retrieving documents *See* opening existing documents  
Return key 32, 91  
  to confirm a command 97, 103

## S

- safety instructions 135
- Save As command 30, 77
- Save button 30, 76, 77
- Save command 30, 48, 76, 77
- saving
  - document 30, 48, 77
  - problems with 142
- Scrapbook 62-63, 101
- Scrapbook File 101
- screen 47, 140-141
- scroll arrow 27, 58
- scroll bar 19, 27, 56, 58
- scroll box 58
- scrolling 27, 58
- security accessory kit 130
- Select All command 111
- selecting 14, 17, 19, 32, 59 *See also* clicking and dragging
  - by Shift-clicking 39, 69
  - group of icons 37-38, 59, 69, 90, 106
  - icon 14, 17, 59, 106, 110
  - text 32, 59, 60
- Set Startup command 113
- Shift-clicking 39, 54-55, 69, 103
- Shift key 30, 39, 55, 59, 90, 99
- shortcuts 24, 103
- Show Clipboard command 34, 96, 111
- size box 19, 37, 57
  - dragging 20, 57
- sizing a window 20, 23, 57
- snapshot, creating 72
- software *See* application(s)
- software development 131
- speaker volume 97, 101-102
- Special menu
  - Clean Up command 112
  - Empty Trash command 74, 106, 113
  - Erase Disk command 81, 113
  - Set Startup command 113
- specifications, Macintosh 149-150
- starting
  - application 29, 31, 66
  - Macintosh 10
  - startup disk 82, 92

- switch, on/off
  - Imagewriter printer 121
  - Macintosh 10
- System Disk 17, 28
- system documents 35, 92
- System Folder 24-25, 35, 92

## T

- Tab key 91, 103
- television, interference with 120, 144-145
- text *See also* Cut and Paste commands
  - copying 61
  - editing 31-34, 60-61
  - inserting 32-33, 60
  - moving 61
  - removing 61
  - replacing 61, 68, 110
  - selecting 32, 59, 60
  - typing 32, 33, 68
- time, setting 41, 99
- title bar 19, 56
- Trash 12, 71, 74, 106
  - emptying 106
  - window 74
- trouble-shooting, Macintosh 140-143
- typing text 32, 33, 68

## U

- Undo command 111
- untitled document 66, 76
- uppercase letters 76, 90, 94
- utilities *See* Finder

## V

- vertical bar 30, 32, 102
- View menu 40, 65, 105, 111-112
  - by Date 112
  - by Icon 63, 65, 66, 112
  - by Kind 112
  - by Name 40, 112
  - by Size 112
- volume, speaker 97, 101-102

## **W**

warning message *See* alert message

window(s) 95

activating 22, 23, 56

changing 22, 56

changing size of 20, 23, 57

closing 25, 28, 39, 57

directory 18, 67, 105, 111

information 31, 39, 109

moving 21, 24, 56

opening 18, 22-23, 65

overlapping 22, 39, 56

wristwatch 13

write-protect *See* locking

## **X**

## **Y**

## **Z**



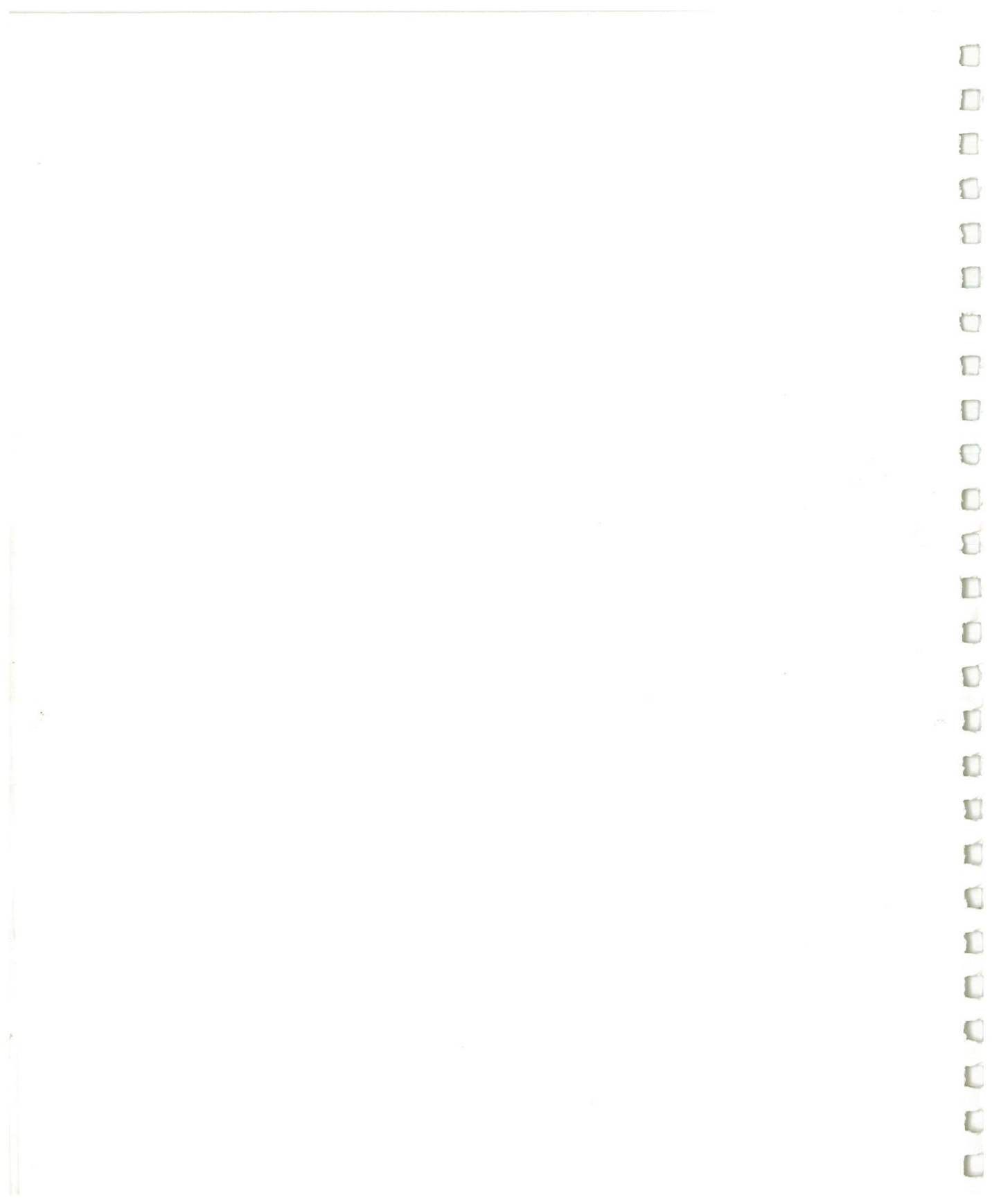

**Limited Warranty on**  
APPLE COMPUTER, IN  
Main Unit, Keyboard, M  
materials and workman  
from the date of origin

If you discover a defect  
or refund the purchase,  
provided you return it c  
transportation charges,  
from whom you purcha  
dealer within the count  
obtain additional inform  
address printed in the in  
attach your name, addr  
the problem and a copy  
appropriate Apple seria  
retail purchase, to each

This warranty applies o  
software media and ma  
separate written staten

This warranty does not  
by accident, abuse, mis  
modified without the v  
Apple serial number ha

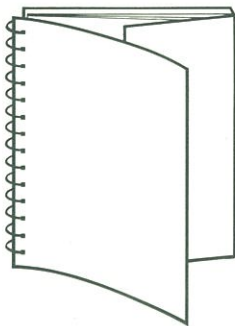

This book's binding lets it lie flat while you're working with your Macintosh. When you're using the book, keep the wraparound endflap tucked inside the back cover. To make it easy to spot the title when the book's on a shelf, fold the flap inside the front cover and set the book on the shelf with the title visible.



Macintosh

**Apple Computer, Inc.**

20525 Mariani Avenue  
Cupertino, CA 95014  
(408) 996-1010  
TLX 171576

