

SEGA™



32X™

GENESIS

INSTRUCTION MANUAL



# AFTER BURNER

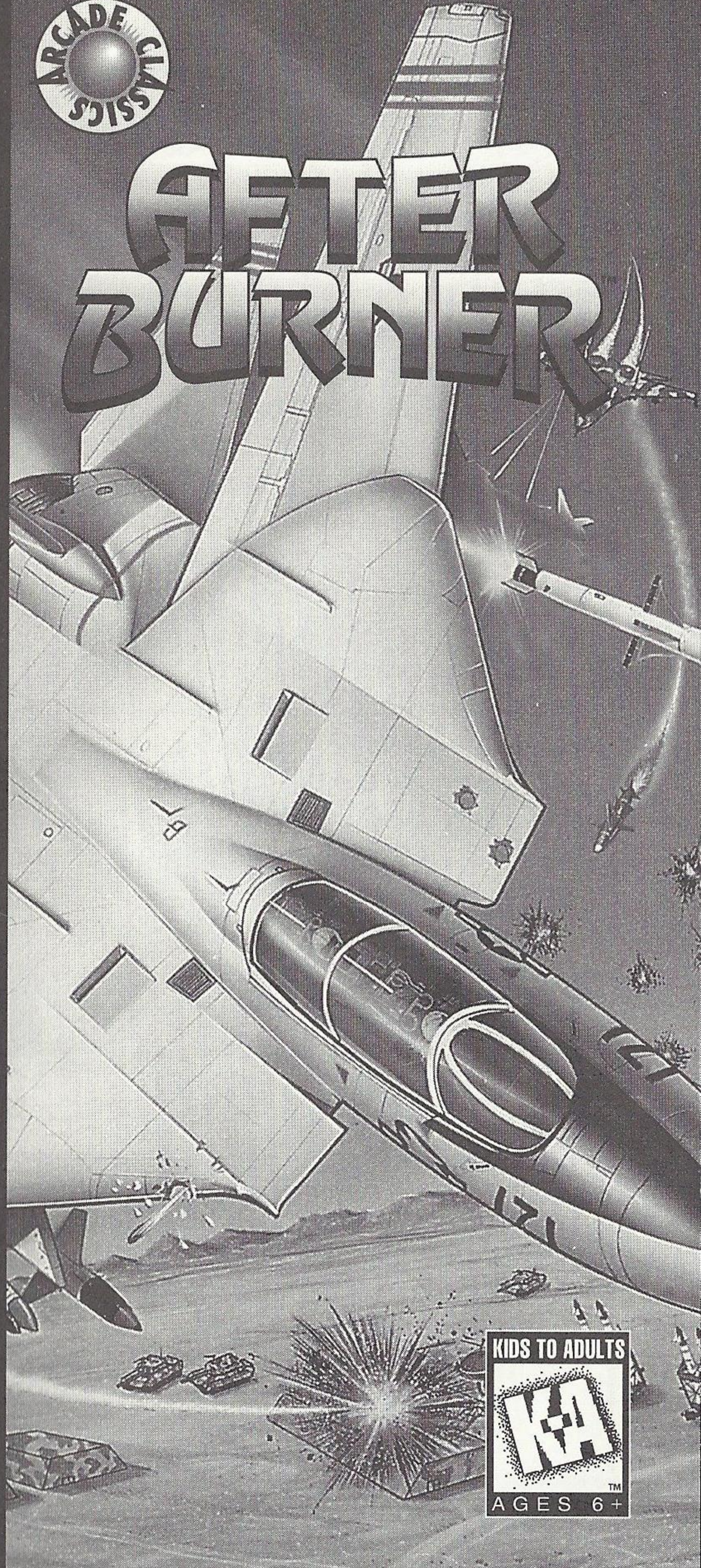

## **EPILEPSY WARNING**

### **WARNING: READ BEFORE USING YOUR SEGA VIDEO GAME SYSTEM**

A very small percentage of individuals may experience epileptic seizures when exposed to certain light patterns or flashing lights. Exposure to certain patterns or backgrounds on a television screen or while playing video games may induce an epileptic seizure in these individuals. Certain conditions may induce undetected epileptic symptoms even in persons who have no history of prior seizures or epilepsy. If you, or anyone in your family, has an epileptic condition, consult your physician prior to playing. If you experience any of the following symptoms while playing a video game: dizziness, altered vision, eye or muscle twitches, loss of awareness, disorientation, any involuntary movement, or convulsions, **IMMEDIATELY** discontinue use and consult your physician before resuming play.

# STARTING UP

1. Set up your Genesis 32X system and other Sega systems by following the instructions in the system instruction manuals. Plug in Control Pad 1.
2. Make sure the power switch is OFF. Then insert the *Afterburner* cartridge into the console.
3. Turn the power switch ON. You'll see the Sega screen. Then in a few moments, the Title screen appears.
4. If the Sega screen doesn't appear, turn the power switch OFF. Make sure your system is set up correctly and the cartridge is firmly inserted in the console. Then turn the power switch ON again.

**Important:** Always make sure the power switch is OFF before inserting or removing the cartridge.

*Afterburner* is for one player.

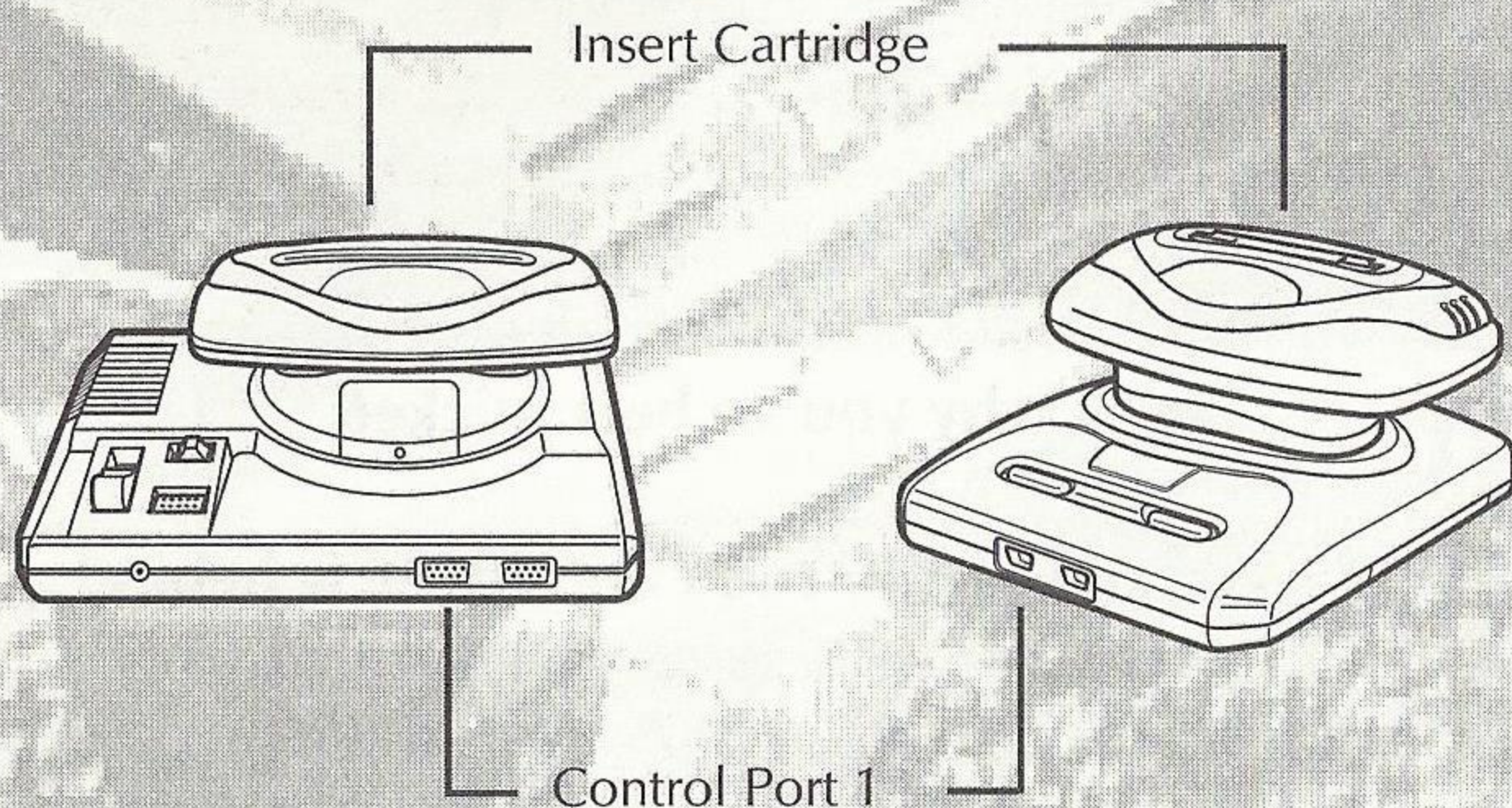

**For Game Play Assistance, call  
1-415-591-PLAY.**

## AGAINST THE ODDS

Doesn't this pilot look happy? He should be—he's just been told he wasn't chosen to fly what's potentially the most dangerous solo air combat mission ever assigned. And who has been chosen, you ask? Why you, of course!



But all is not lost. Remember, you'll be at the controls of the most feared fighter in the skies—the SSF-14. Two Vulcan guns, guided missile capability and an afterburner to blast you out of trouble spots. Feel better?

Strategic Command has identified two enemy microwave communications booster stations that they want taken out. Destroying these two installations will severely hamper the enemy's global communications capabilities. The stations are heavily fortified and positioned deep inland. The mission requires skill, absolute dedication and courage. That's why you've been picked.

The crew of the carrier *Sega Enterprise* is behind you, and you have the respect and trust of your superior officers. And the baddest bird in the air.

Strap in, lieutenant. Time for pre-flight.

# TAKE CONTROL!

The Options screen (page 6) allows you to set the configuration of your Control Pad. There are four types of configurations—two each for the 6-Button Arcade Pad and the 3-Button Control Pad.

## 6-Button Arcade Pad

Directional Pad (D-Pad)

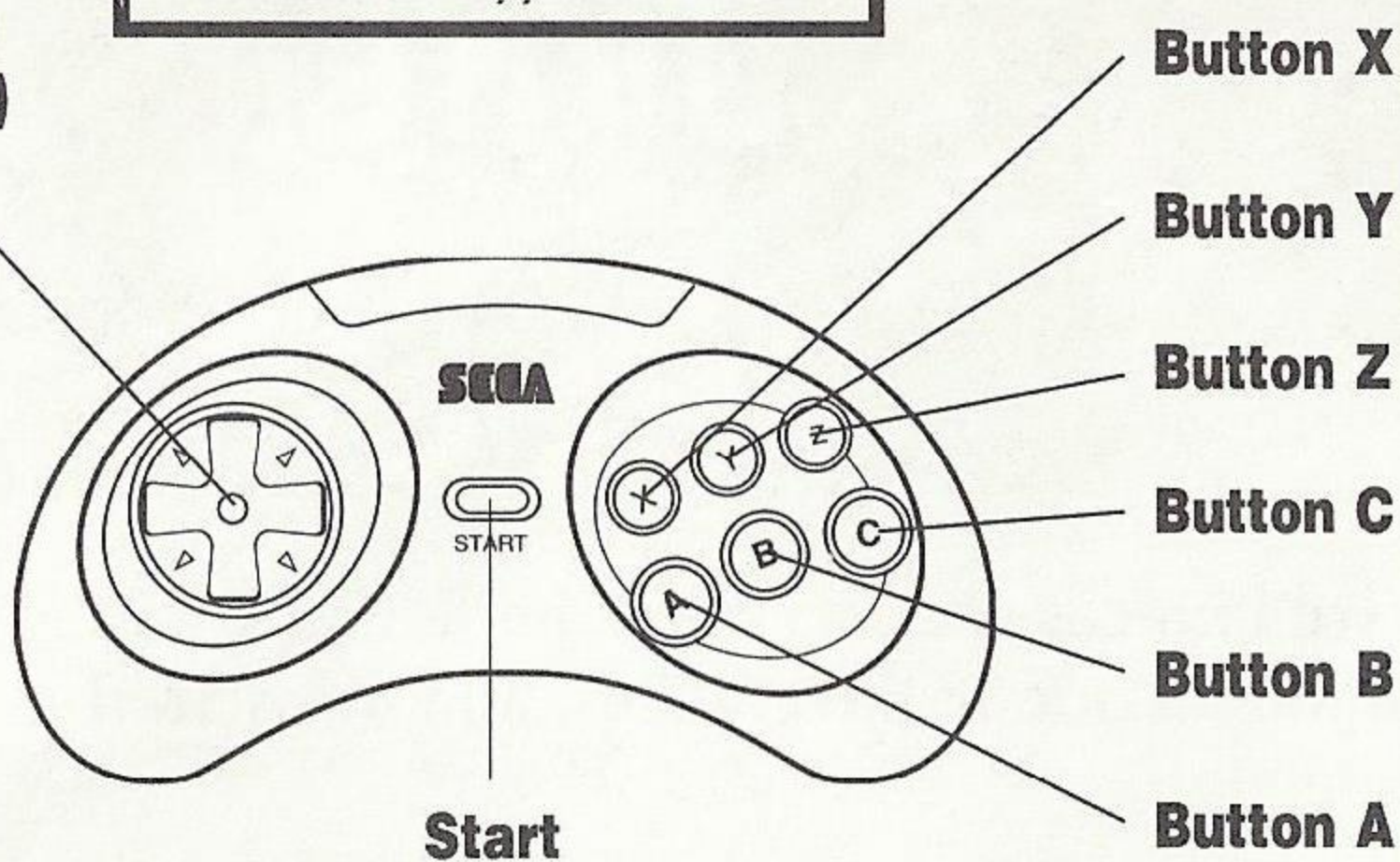

## 3-Button Control Pad

Directional Pad (D-Pad)

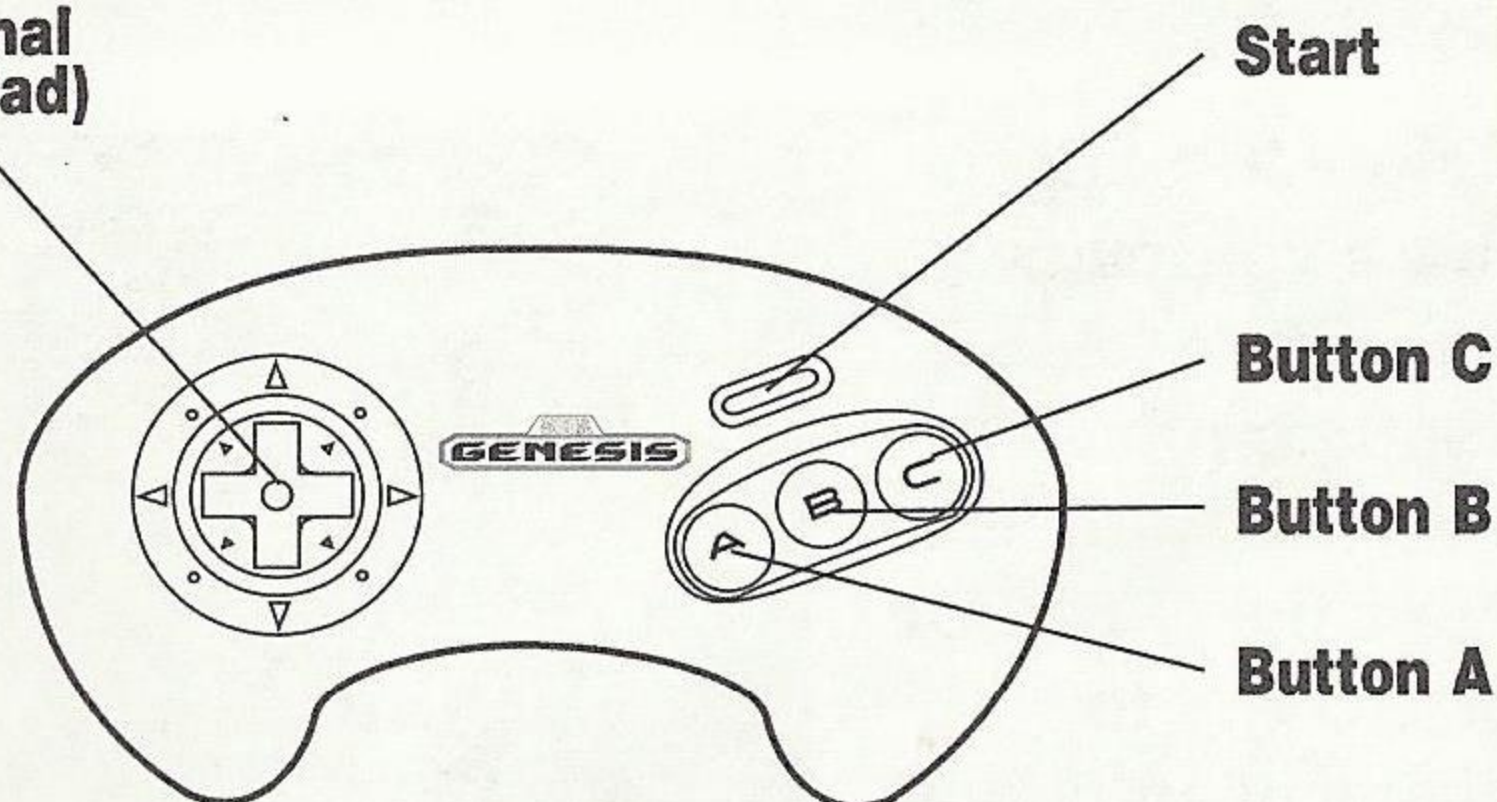

# GETTING STARTED

Press the Start Button at the Title screen or at any time during the demo to bring up the Main Menu.

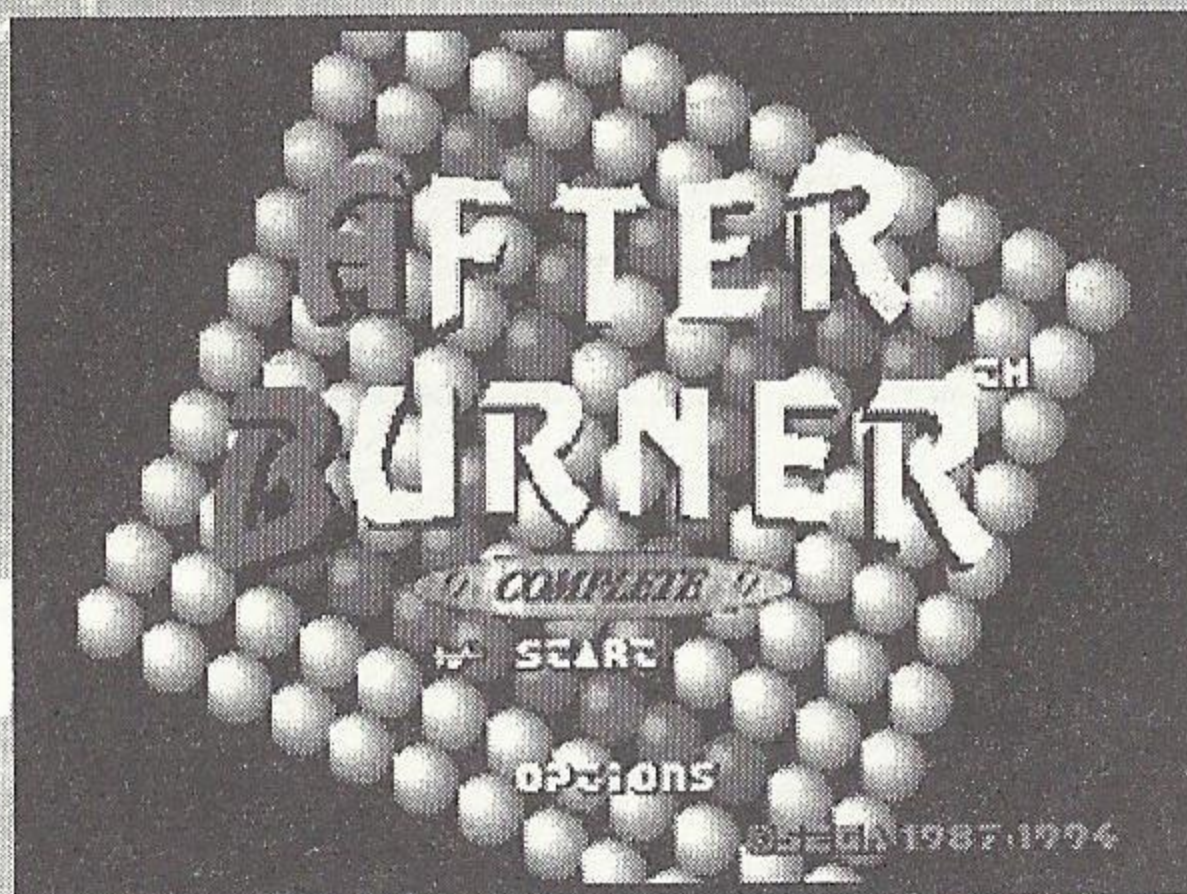

Two choices appear. Press the D-Pad UP or DOWN to highlight one of the choices, and press Start to enter your selection.

Choosing START sends you right into action.

Choosing OPTIONS allows you to change game conditions before beginning play.

## OPTIONS MODE

Before heading into those unfriendly skies, set game conditions just the way you want 'em. Press the D-Pad UP or DOWN to highlight an option and LEFT or RIGHT to enter selections.

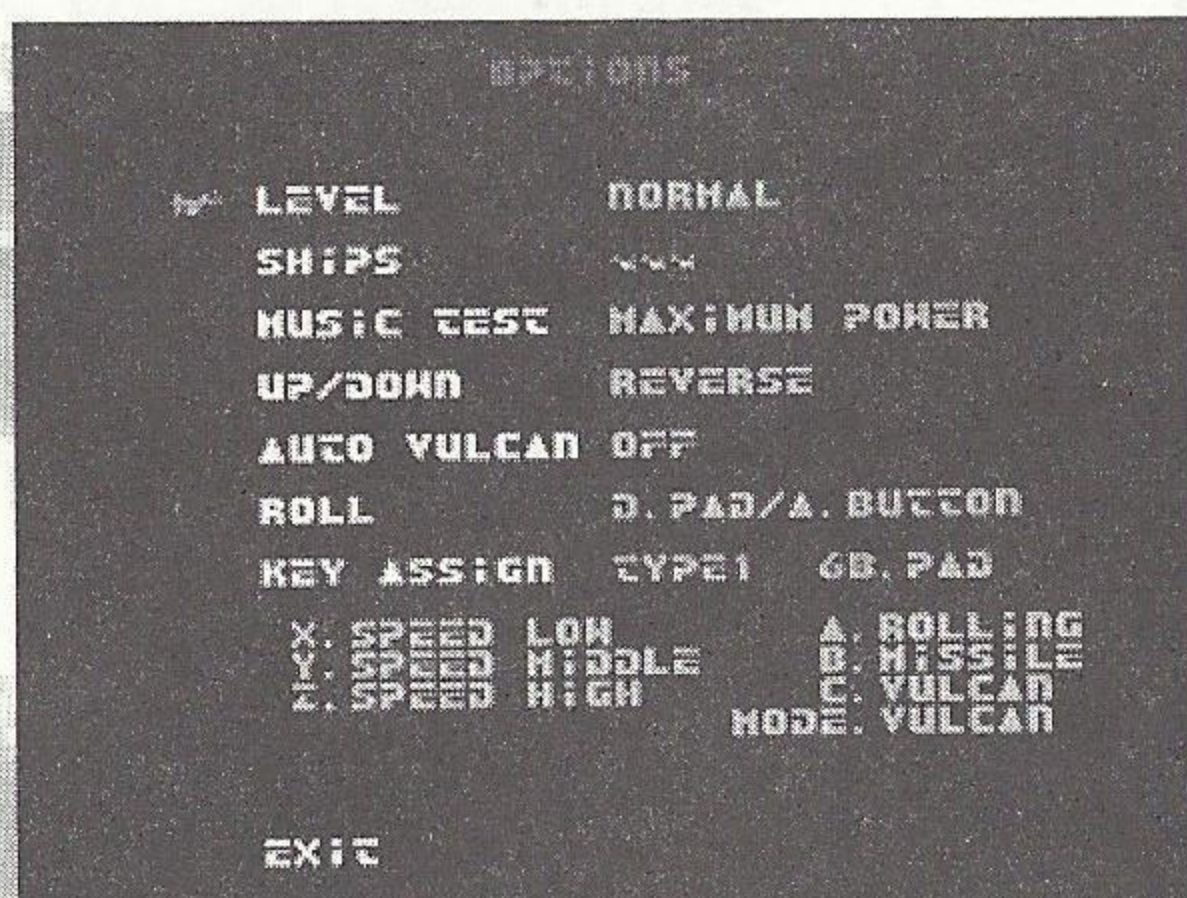

**LEVEL** — Play an EXTRA EASY, EASY, NORMAL, HARD, or HARDEST game. The harder the level, the tougher the enemy's defense.

**SHIPS** — Begin play with 3, 4, 5 or 6 lives.

**MUSIC TEST** — Press the D-Pad LEFT or RIGHT to cycle through the BGM tracks. When the name of one you want to hear appears, press Button A, B, C, X, Y or Z to start the track.

**UP/DOWN** — Choose REVERSE (pressing UP on the D-Pad makes your fighter descend and pressing UP makes it climb — just like a real fighter) or NORMAL (press UP to climb and DOWN to descend).

**AUTO VULCAN** — Leave it OFF to control your Vulcan rounds, or set it ON to have Vulcan rounds fired without you needing to press a button.

**ROLL (6-Button Arcade Pad ONLY)** — Set for D-PAD/ BUTTON A, D-PAD ONLY or BUTTON A ONLY.

**Note:** If you select D-PAD ONLY, Button A on the 6-Button Arcade Pad has no function in the game.

**KEY ASSIGN** — Here's where you choose the configuration of your Control Pad. Your choices are as follows:

### 6-Button Arcade Pad

BUTTON	TYPE 1	TYPE 2
Button A	Roll	Roll
Button B	Missiles	*Vulcan
Button C	*Vulcan	Missiles
Button X	Speed Low	Speed Low
Button Y	Speed Middle	Speed Middle
Button Z	Speed High	Speed High

## 3-Button Control Pad

### TYPE 1

### TYPE 2

Button A	Speed Low	Speed High
	*Vulcan	*Vulcan
Button B	Missiles	Missiles
Button C	Speed High	Speed Low
	*Vulcan	*Vulcan

\*When AUTO VULCAN option is turned OFF

**Note:** When the AUTO VULCAN option is turned ON, Buttons A and C control the speed of your fighter. Tap once and then press and hold to either slow down or speed up.

**EXIT** — Highlight using the D-Pad, then press any button to return to the Title screen.

**Note:** You can exit the Options screen at any time by pressing Start.

## SCREEN SIGNALS

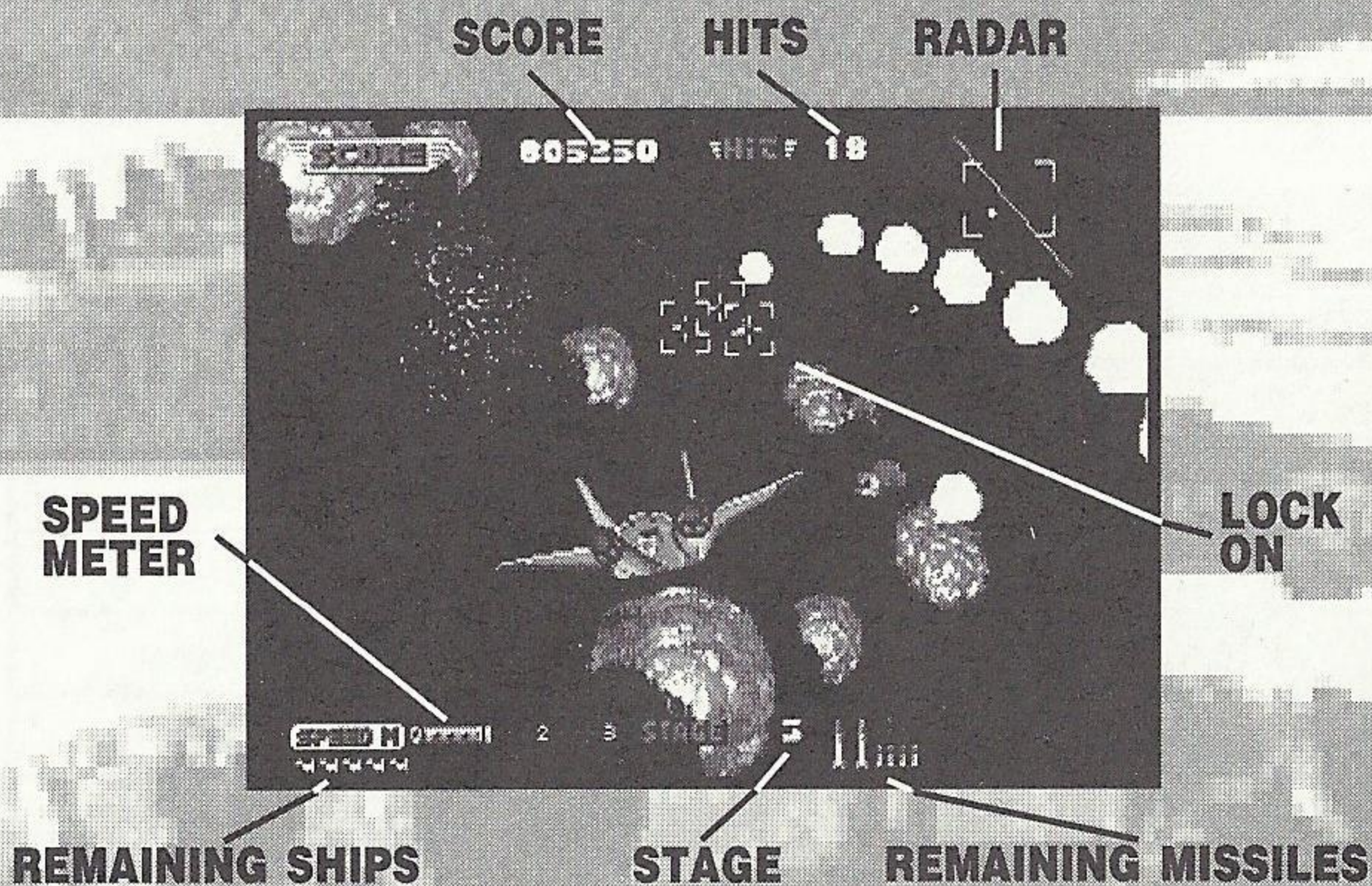



**SCORE** — Your current score. Amass points by downing enemy aircraft and clearing stages. Tack on even more points at the Bonus Stages (see "Paydirt" on page 12).

**HITS** — The number of enemy aircraft you've blown to smithereens in the current stage. This number increases as you continue to shoot the bad guys down.

**RADAR** — Keep an eye on this display as it detects approaching aircraft.

**LOCK ON** — Your Missile sight. If you're able to lock on and you hear a voice shout, "Fire," press the Missile Button and you've just ended the career of an enemy pilot.

**REMAINING SHIPS** — The number of lives you have left.

**SPEEDOMETER** — Your current airspeed. As you speed up the gauge fills to the right.

**STAGE** — The number of the current stage. There are 23 stages in all.

**REMAINING MISSILES** — The number of Missiles you still have. A large Missile icon represents ten Missiles in your supply.

## **IN-FLIGHT ENTERTAINMENT**

Your SSF-14 fighter is equipped with two Vulcan guns and an unlimited ammo stock, as well as the ability to fire heat-seeking Missiles. You can also perform an evasive technique known as a "roll," and to get away from enemy fighters attacking from the rear flank, you can kick in your afterburner and leave them shaking their heads.

# YOUR MISSION

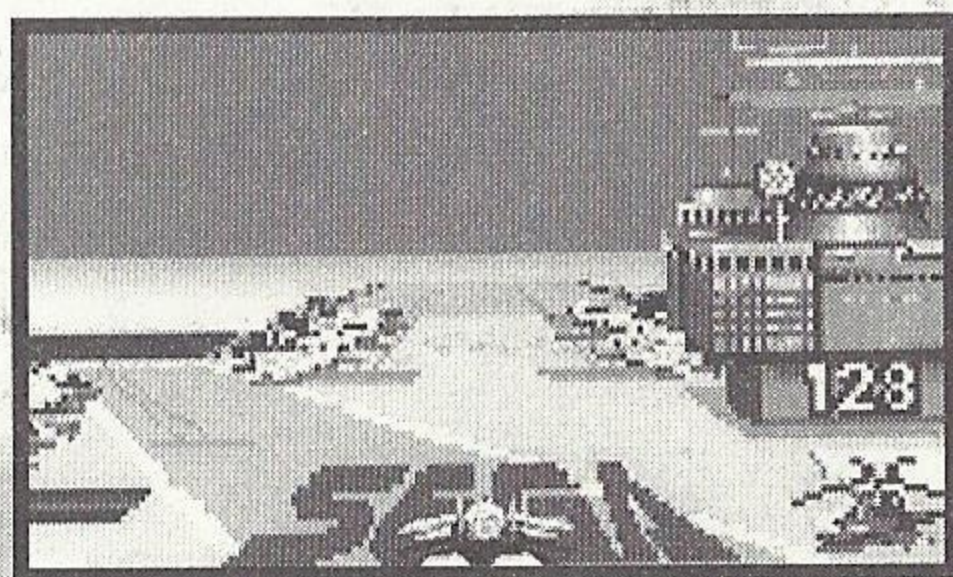

You're on the carrier *Sega Enterprise*, positioned 250 miles off shore. The enemy has established two bases at which they've set up microwave boosters. These links are vital to the

enemy's global communications system. They're deep inland and heavily fortified. Your job is to get through the enemy's air defenses and strafe each base, destroying everything in sight. Your main targets are the antennas and barracks, but you should also try to take out as many ground weapons and vehicles as you can.

You'll encounter several varieties of aircraft, from slick, quick fighters to attack choppers. They'll attack alone and in formations of varying sizes, from the front and the rear. You'll face daytime and nighttime battle, over land and sea. There'll be no let up in the enemy onslaught, 'cause they're defending their territory. You're an uninvited guest, a party crasher. They'll be trying to show you to the door!

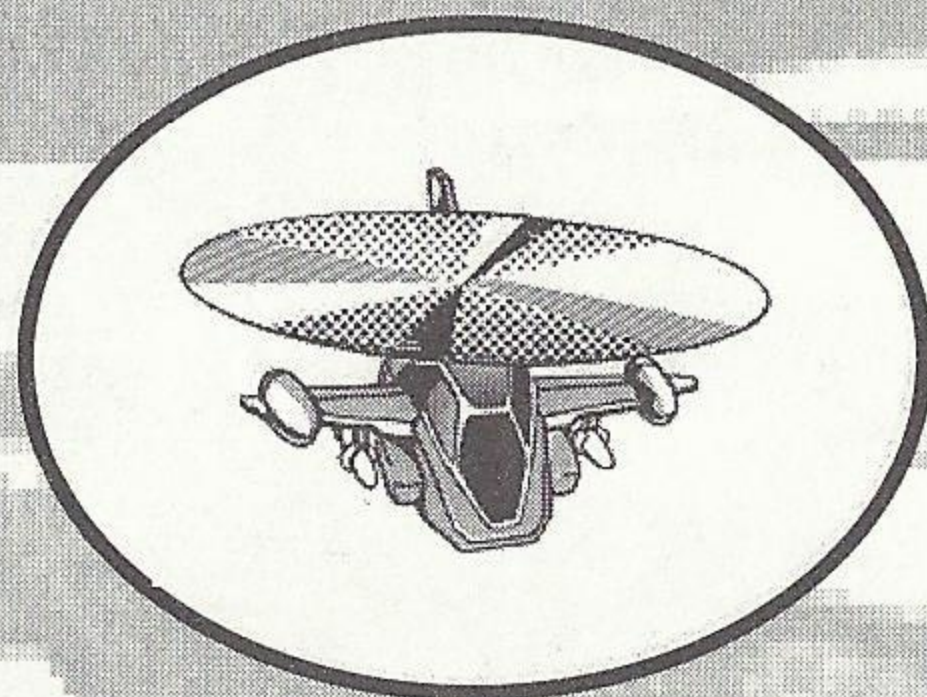
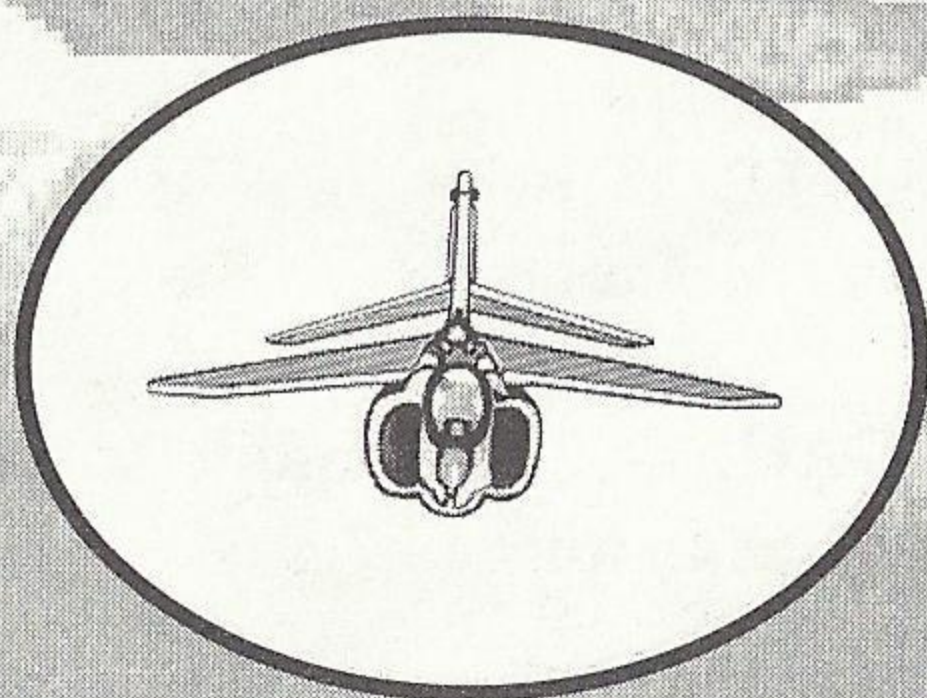

Get in, level the two bases, and get out. Sounds easy, doesn't it? If you think it's tough to get in, just wait 'til you have to get out! They'll throw everything they've got

at you! Once you've flattened their bases, you're flying for yourself. A celebration awaits if you can make it back to the carrier.

## REPLENISHING MISSILES

You start the mission with 50 Missiles. Your supply is replenished at certain points, either in-flight or as you land on one of the two allied air strips on your route.

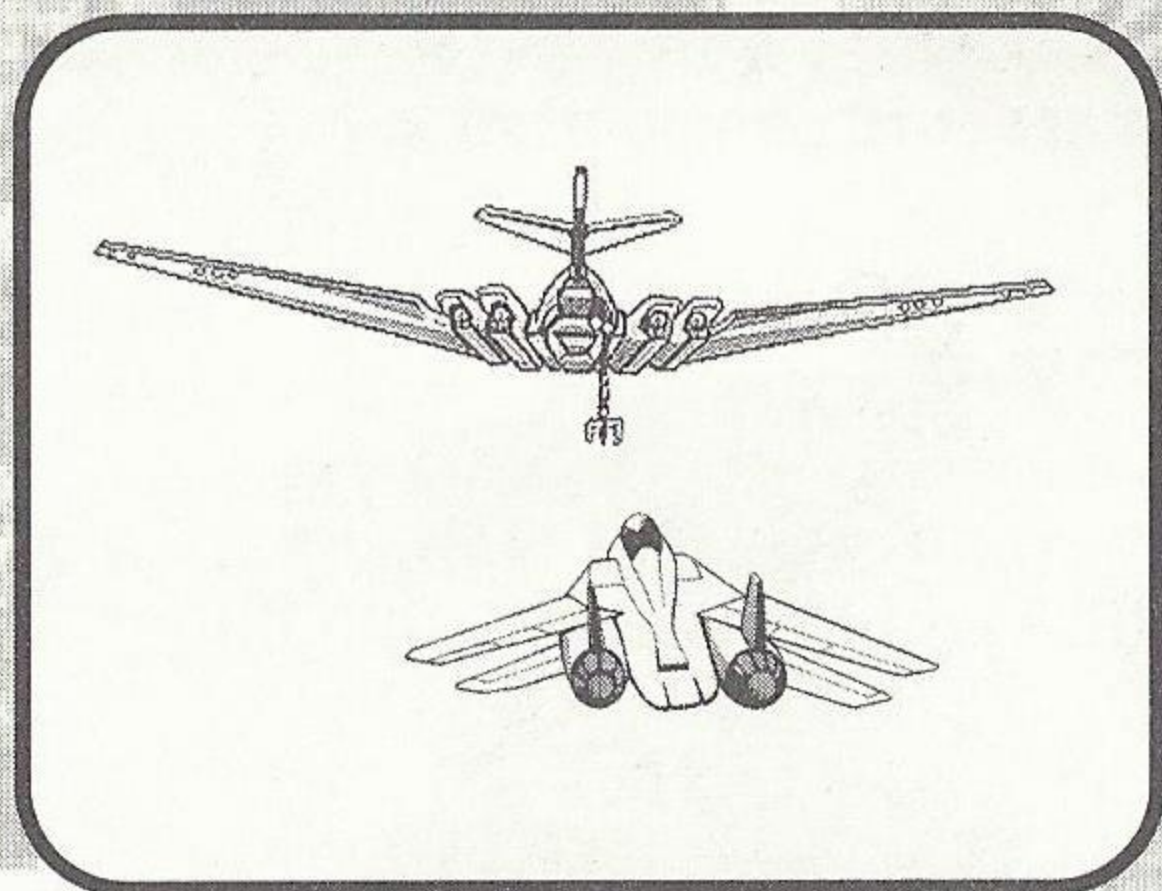

**IN-FLIGHT  
RELOADING**

**ALLIED BASE**



Your Missiles are your deadliest weapon. Run out and, well . . . it won't be pretty, that's for sure. Keep an eye on your supply. That doesn't mean you have to be stingy. Your supply will be replenished — we just won't tell you where.

# PAYDIRT!

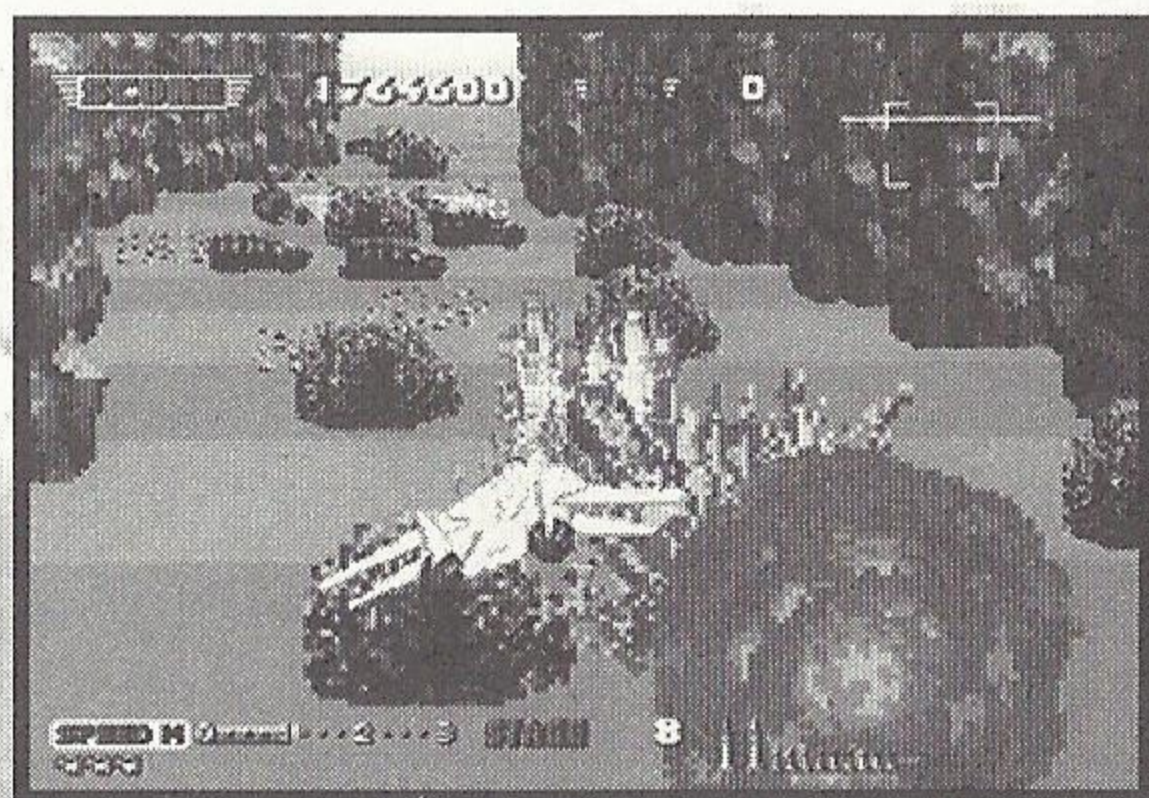

Stages 8 and 17 are the enemy positions you must take out. They're known as "Bonus Stages" 'cause you can rack up big points. The point values for each object you demolish

appear beneath your total score as you attack.

## 1 UP

An extra life is available when your score reaches 3,000,000 and 10,000,000 and for every 10,000,000 points after that.

## A SECOND CHANCE

The game ends if you crash or are destroyed by enemy fire. To keep fighting, you must get to at least Stage 5. If you do get that far and are wiped out, the Title screen

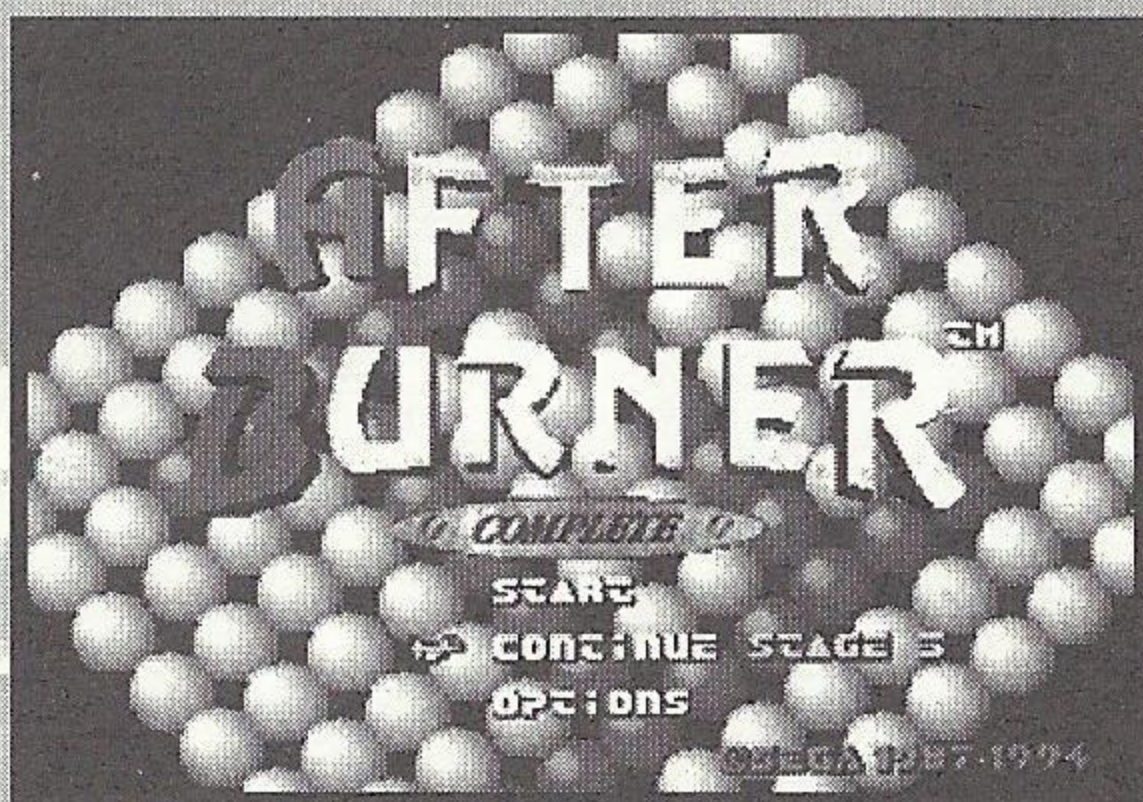

reappears with the CONTINUE option available. Select it with the D-Pad and press Start, and you resume the battle from Stage 5. The other Continue points are at Stages 9, 13 and 19.

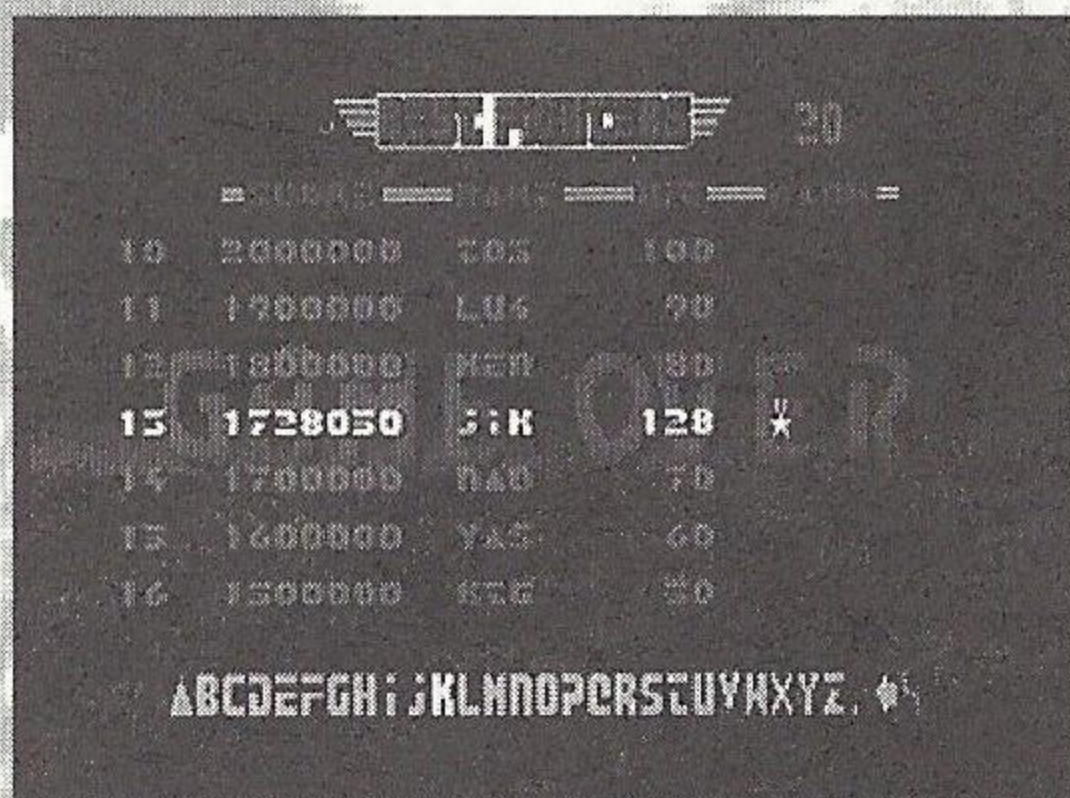

If you did enough damage, you may be eligible to enter your initials in the High Score screen. Press the D-Button LEFT or RIGHT to highlight a letter, then Button A, B, C, X, Y or Z to enter your selection.

## STAYING ALIVE . . .

- Enemy missiles can track your movements and change course in flight. When you see one coming, wait until the last possible moment to perform a roll or other evasive action. This gives the missile no time to adjust, and sends it buzzing by harmlessly.
- Enemies also have Vulcan ammo. Once fired, Vulcan rounds soon begin descending. Climb slightly to evade them.
- Enemies come at you from the front and the rear. If you're targeted from behind, dodging and rolling techniques can be effective. But the best way to get out of trouble is to kick in the afterburner and speed out of the enemy's range!
- Once you lock on to a target, you have a short time before the lock disappears. During that time, you can shoot down an entire formation! However, if the formation is particularly wide, locking on from the center of the screen makes it impossible for you to shoot down all enemy craft to the left and right. For maximum body count, move to the left or right of the screen and sweep the formation.

## HANDLING YOUR CARTRIDGE

- The Sega Genesis 32X Cartridge is intended for use exclusively for the Sega Genesis 32X System.
- Do not bend it, crush it or submerge it in liquids.
- Do not leave it in direct sunlight or near a radiator or other source of heat.
- Be sure to take an occasional recess during extended play, to rest yourself and the Genesis 32X Cartridge.

Warning to owners of projection televisions: Still pictures or images may cause permanent picture-tube damage or mark the phosphor of the CRT. Avoid repeated or extended use of video games on large-screen projection televisions.

### LIMITED WARRANTY

Sega of America, Inc., warrants to the original consumer purchaser that the Sega Genesis 32X Cartridge shall be free from defects in material and workmanship for a period of ninety days from the date of purchase. If a defect covered by this limited warranty occurs during this 90-day warranty period, Sega will repair or replace the defective cartridge or component part, at its option, free of charge.

This limited warranty does not apply if the defects have been caused by negligence, accident, unreasonable use, modification, tampering, or any other causes not related to defective materials or workmanship. To receive warranty service, call the Sega Consumer Service Department at the following number: 1-800-USA-SEGA

To receive Canadian warranty service, call the SEGA Consumer Service Department at the following number:

1-800-872-7342

**DO NOT RETURN YOUR SEGA GENESIS CARTRIDGE TO YOUR RETAIL SELLER.** Return cartridge to Sega Consumer Service. Please call first for further information.

If the Sega technician is unable to solve the problem by phone, we will provide you with instructions on returning your defective cartridge to us. The cost of returning the cartridge to Sega's Service Center shall be paid by the purchaser.

### Repairs After Expiration of Warranty

If your Sega Genesis Cartridge requires repairs after termination of the 90-day limited warranty period, you may contact the Sega Consumer Service Department at the number listed above. If the technician is unable to solve the problem by phone, he will advise you of the estimated cost of repair. If you elect to have the repair done, you will need to return the defective merchandise, freight prepaid and insured against loss or damage, to Sega's Service Center with an enclosed check or money order payable to Sega of America, Inc. for the amount of the cost estimate provided to you by the technician. If, after inspection, it is determined that your cartridge cannot be repaired, it will be returned to you and your payment will be refunded.

### Limitations on Warranty

Any applicable implied warranties, including warranties of merchantability and fitness for a particular purpose, are hereby limited to ninety days from the date of purchase and are subject to the conditions set forth herein. In no event shall Sega of America, Inc., be liable for consequential or incidental damages resulting from the breach of any express or implied warranties.

The provisions of this limited warranty are valid in the United States only. Some states do not allow limitations on how long an implied warranty lasts, or exclusion of consequential or incidental damages, so the above limitation or exclusion may not apply to you. This warranty provides you with specific legal rights. You may have other rights which vary from state to state.

Sega, Genesis 32X and After Burner are trademarks of Sega Enterprises, Ltd. All rights reserved.

Patents: U.S. Nos. 4,442,486/4,454,594/4,462,076/4,026,555; Europe No. 80244; Canada No. 1,183,276/1,082,351;  
Hong Kong No. 88-4302; Germany No. 2,609,826; Singapore No. 88-155; U.K. No. 1,535,999;  
France No. 1,607,029; Japan No. 1,632,396/82-205605 (Pending)