

PERSONAL SOFTWARE
VISICALCTM
TRS-80 MODEL I



Radio Shack[®]

TRS-80

WMICROLEY
COMPUTER
SYSTEM

1000 PARK LN.
SAN ANTONIO, TX 78201

First Edition

TRSDOS™ Operating System:
© © 1979 Tandy Corporation
All Rights Reserved.

VisiCalc™ Program:
© 1979, 1980 Software Arts, Inc.
Manufactured by Personal Software Inc.
Exclusively for Tandy Corporation.
All Rights Reserved.

“VisiCalc™ Program Manual”:
© 1980 Personal Software Inc.
All Rights Reserved.

Reproduction or use, without express written permission from Tandy Corporation, of any portion of this manual is prohibited. While reasonable efforts have been taken in the preparation of this manual to assure its accuracy, Tandy Corporation or Personal Software Inc. assumes no liability resulting from any errors or omissions in this manual, or from the use of the information obtained herein.

Please refer to the Software License on the back cover of this manual for limitations on use and reproduction of this Software package.

VisiCalc is a trademark owned by Personal Software Inc.

VISICALC™

Program by
Software Arts, Inc.
Cambridge, Massachusetts

Manual by
Dan Fylstra and Kathleen Mandis

Manufactured for
Radio Shack®
A Division of Tandy Corporation
Fort Worth, Texas 76102

by
PERSONAL SOFTWARE INC.
1330 Bordeaux Drive, Sunnyvale, CA 94086

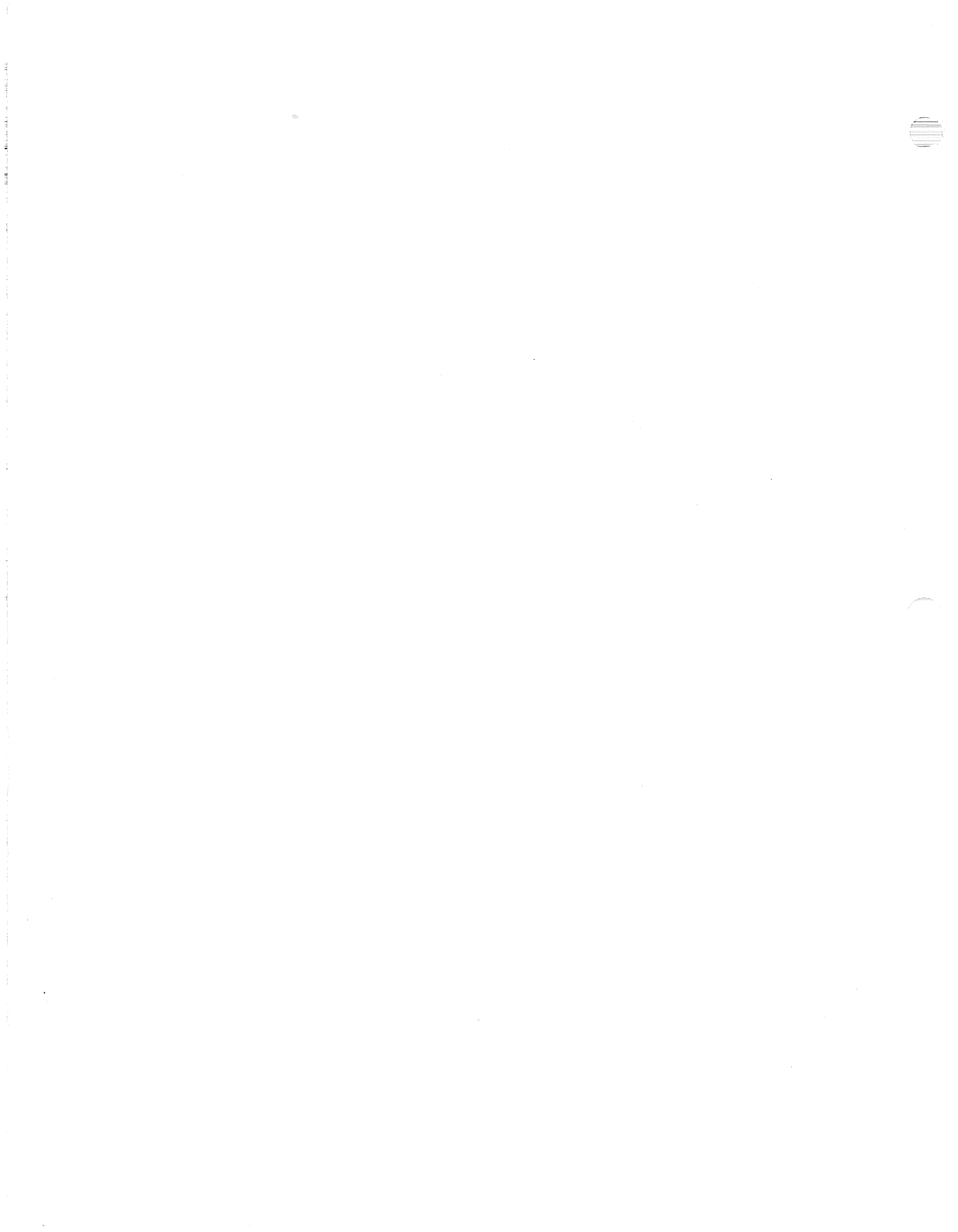

WRIGHT HUNTLEY
2483 SOUTH PARK LN.
SANTA CLARA, CA 95051

WELCOME TO TRS-80 MODEL III VISICALC

In this binder you will find:

- o The TRS-80 Model I VisiCalc Manual which has a tutorial and a VisiCalc Command Reference section.
- o The TRS-80 Model III Update which contains specific information for Model III VisiCalc.
- o An addendum to the Model III Update, with the latest information on the backup procedures for TRS-80 Model III VisiCalc.
- o The TRS-80 Model III VisiCalc program diskette.
- o The VisiCalc Reference Card.
- o The Exchange Card with information if you wish to obtain a future enhanced version of TRS-80 Model III VisiCalc.

VisiCalc Update Addendum

The TRS-80 Model III VisiCalc Update gives information specific to the Model III that is not included in the TRS-80 Model I Manual which follows it. Be sure you have read the Update and your Model III Disk System Owner's Manual, Part I, before you start using the Model I VisiCalc Manual.

In the Update on page 3, "Backing Up the VisiCalc Diskette", you need to make two backup copies of the VisiCalc program diskette immediately, and label them. The Model III VisiCalc program diskette comes with a small square notch cut out of one side. Make sure this write protect notch on all diskettes, including the original VisiCalc diskette, is uncovered when you use BACKUP.

Put the original program diskette and one backup copy away in a safe place, like the front cover of the manual. Then use the other backup copy as a working copy only to load VisiCalc. If your working copy is destroyed or no longer usable, use the original program diskette as your working copy. Keep the second backup copy stored in a safe place. If for some reason the original program diskette also becomes unusable, contact your Radio Shack store or Computer Center for instructions on how to exchange your original VisiCalc program diskette for another. You will be required to present the original diskette to your dealer. By following these procedures, you will still have the second backup copy to use until the original has been replaced.

TRS-80 MODEL III VISICALC UPDATE

Table of Contents

Preface	1
What You Need	1
Setting Up Your Equipment	1
Starting Up	2
Backing Up the VisiCalc Diskette	3
Instructions for Using BACKUP	3
Initializing VisiCalc Storage Diskettes	5
Loading VisiCalc	5
Some Notes on Your Keyboard	6



100-100-100

Preface

The TRS-80 Model I VisiCalc Manual applies to the TRS-80 Model III version of VisiCalc with the exception of a few equipment configuration and loading instruction changes in Part I, the Introduction. Ignore the sections in Part I of the TRS-80 Model I Manual titled "What You Need", "Setting Up Your Equipment", "Initializing VisiCalc Storage Diskettes", and "Loading VisiCalc". Read the sections titled "How To Use This Manual", "Overview of VisiCalc: The 'Electronic Sheet'", "About VisiCalc Storage Diskettes", and "Some Notes on Your Keyboard" (there are some changes in the update below to this last section). Then follow the directions below to set up your equipment, make backup copies, initialize storage diskettes, and load VisiCalc.

What You Need

To use VisiCalc, you will need the following:

1. The TRS-80 Model III Desktop Business computer with Model III BASIC, 32K of RAM memory and disk drives.
2. The VisiCalc program diskette. This is enclosed in the inside front cover of the binder holding this manual.
3. At least three blank 5" floppy diskettes. This will be enough to get you started, but you will eventually need more and should plan for it.
4. If you want printed copies of your VisiCalc electronic sheets you need a TRS-80 Printer.

Setting Up Your Equipment

Set up all the equipment according to the instructions in the manuals that accompany the Model III.

The TRS-80 Model III computer drives are referenced in this update as follows: the bottom drive is DRIVE 0 (zero), and the top drive is DRIVE 1.

TRS-80 Model III VisiCalc Update

Starting Up

Now let's begin by loading TRSDOS.

1. Turn all peripherals on.
2. Turn on your computer. Drive 0 will whirl and the DRIVE SELECT LIGHT will come on.

Wait until all disk drives stop and the lights are out.

3. Insert the VisiCalc diskette in DRIVE 0 with the label facing up, close the door, and press the RESET button. The TRSDOS version number and date of creation will be displayed, followed by the amount of RAM (32K or 48K) and the number of drives in the system. At the end of the copyright statement you will see

Enter Date (MM/DD/YY)?

4. Type the date in the exact format requested. For example, you would type 07/04/80 for July 4, 1980. Then press the ENTER key. TRSDOS will not continue until you have entered the date correctly. A prompt for the time will appear.

Enter Time (HH:MM:SS)?

5. TRSDOS uses a 24 hour format so you would enter 15:32:00 for 3:32 p.m. If you don't want to set the time, just press ENTER and TRSDOS will set the time to 00:00:00.

TRSDOS will now display the message

TRSDOS Ready

You can now use TRSDOS commands to backup and initialize storage diskettes before you begin using the VisiCalc program.

If your computer does something different at any point in the above instructions, remove the VisiCalc diskette from DRIVE 0, turn off your computer, wait 15 seconds, and try again.

Backing Up the VisiCalc Diskette

The first thing you must do is to make a backup copy of your VisiCalc program diskette. Your VisiCalc program can be "backed up", or copied, only twice. Create the first backup copy of VisiCalc for everyday use following the instructions for using BACKUP given below.

You may backup your original VisiCalc program diskette more than twice, however the actual VisiCalc program will only appear on the first two backup copies. Data files and other program files always transfer during the backup.

Put the original program diskette away in a safe place like the inside front cover of the VisiCalc manual. Be sure to label your working copy with a distinctive title such as VISICALC WORKING COPY and place a tab over the write protect notch. To minimize wear on the working VisiCalc copy, use it only to load VisiCalc into memory at the beginning of each session. Then remove this diskette and put it away--you will not need it again until the next time you turn on your computer and load VisiCalc. Next insert a VisiCalc storage diskette in DRIVE 0. This diskette must contain TRSDOS. Instructions for making VisiCalc storage diskettes are in the section titled "Initializing VisiCalc Storage Diskettes" below. You will load and save VisiCalc worksheets to and from that diskette.

By using your VisiCalc working copy only to load VisiCalc at the beginning of each session you will extend the life of the diskette. However, diskettes do eventually wear out. (Remember you still have the original diskette stored in a safe place.) If your working copy is destroyed, or is no longer usable for whatever reason, use your original VisiCalc program diskette to make one more copy of the VisiCalc program. Again, store the original in a safe place and use this second copy for your working diskette. If for some reason both this working copy and the original VisiCalc program diskette are inadvertently erased, written over, or otherwise become unusable, contact your Radio Shack store or Computer Center for instructions on how to exchange your original VisiCalc program diskette for another. The original program diskette will be required for exchange.

Instructions for Using BACKUP

If you have followed the procedures on page 2, your screen should now show:

TRSDOS Ready

Next type the word

BACKUP

TRS-80 Model III VisiCalc Update

and press ENTER. The words

TRSDOS Model III Backup Utility Ver 1.1

will appear on the screen followed by

SOURCE Drive Number?

Type 0 (zero) which is the number of the source drive and press ENTER.
The next prompt is

DESTINATION Drive Number?

Type 1 which is the number of the destination drive. (If you are using a drive other than DRIVE 1 as your destination drive, type the number of that drive instead of 1.) Be sure the diskette you wish to copy onto is in the drive and the door is closed. Press ENTER. You will see the prompt

SOURCE disk Master Password?

The VisiCalc disk is your source diskette and its password is: PASSWORD.
Type PASSWORD and press ENTER.

This is the next message that will appear on the screen.

Source Drive 0 Destination Drive 1

The next two prompts will appear only if you are backing up onto a diskette which previously contained data. You will be told

Diskette contains DATA. Use Disk or not?

You may answer Y (Yes) or N (No). (If you answer N, the prompt TRSDOS Ready will appear on the screen and the BACKUP procedure will be terminated.) Press Y to continue and you will see

Do you wish to RE-FORMAT the diskette?

(If you press N, BACKUP will use the format that is already on the diskette and skip the formatting and check of flawed tracks below.) Press Y to continue, and the BACKUP utility program will run.

If your BACKUP was successful you will see:

* * Backup Complete * *

followed by

TRSDOS Ready

If you don't get this message, read the instructions in your TRSDOS Manual again carefully, and try BACKUP again.

Remember: Now that you are finished making a backup copy of VisiCalc, put the original program diskette away in a safe place and use your new copy as your working diskette.

You now need to make at least two storage diskettes for saving VisiCalc worksheets.

Initializing VisiCalc Storage Diskettes

To initialize storage diskettes for use with VisiCalc, follow the procedures above for making a copy using BACKUP with the TRSDOS diskette as your source diskette instead of the VisiCalc diskette. Put a distinctive label on each diskette such as VISICALC STORAGE DISKETTE 1 and VISICALC STORAGE DISKETTE 2.

Since you have more than one drive, you can use diskettes formatted with the TRSDOS FORMAT Command as storage diskettes (see your Disk Operating System Manual). Remember you must always have a diskette with TRSDOS on it in Drive 0. Diskettes formatted with the FORMAT Command can only be used in a drive other than DRIVE 0.

Loading VisiCalc

Now you are ready to load VisiCalc.

Insert your working copy of VisiCalc into DRIVE 0 and load using the "Startup Procedures" described on page 2 of this update, beginning with step 3.

Then type

VC

and press ENTER.

The VisiCalc screen will appear and you are ready to begin using VisiCalc.

As we said earlier, to minimize wear on your working copy of VisiCalc,

remove it from the drive and put it away. You will not need it again until the next time you turn on your computer and load VisiCalc. Insert a storage diskette containing TRSDOS in DRIVE 0 and you are ready to save VisiCalc worksheets.

Some Notes on Your Keyboard

The information in the Model I manual in the section titled "Some Notes on Your Keyboard" applies to the Model III with a few exceptions.

Your keyboard has a number pad built in at the right of the regular keyboard. The numbers on it may be used interchangeably with the numbers on the top row of the regular keyboard.

The character for raising a number to a power (exponentiation) will appear differently on the screen, even though you use the same SHIFT-@ to indicate exponentiation. The screen will show a carat (^) instead of an up arrow.

Your Model III computer types in both upper and lower case letters. In VisiCalc, you will automatically get lowercase letters except in commands. To use upper case, hold down the SHIFT key while you are typing a letter--there is no shift lock. VisiCalc will change some letters to upper case automatically if it is necessary. For example, all file names and all commands will be in upper case even if you type them in lower case. All the computer prompts in the Model I manual are shown in upper case--what you see on your screen will be in both upper and lower case.

When you've finished making the VisiCalc program backup diskette and the storage diskettes and have loaded VisiCalc, you'll be ready to start Lesson One and begin to use VisiCalc.

Table of Contents

VisiCalc

PART I. INTRODUCTION

How To Use This Manual	3
Overview of VisiCalc: The "Electronic Sheet"	3
What You Need	6
Setting Up Your Equipment	6
About VisiCalc Storage Diskettes	6
Initializing VisiCalc Storage Diskettes	7
Instructions for One-Drive Systems.....	8
Instructions for Multiple-Drive Systems	10
Diskette Labels	11
Loading VisiCalc	12
Some Notes On Your Keyboard	13

PART II. VISICALC TUTORIAL

Lesson One

Introduction	17
Moving the Cursor	18
Scrolling the Window	18
Automatic Repeat	19
Direct Cursor Movement	19
Backing Up the Cursor	20
Writing on the Electronic Sheet	21
Formulas and Recalculation	22
More on Labels and Values	22
Cursor Moves in Formulas.....	24
Saving the Electronic Sheet on Diskette.....	26
Postscript: Protecting Yourself From Disaster	27
Save Your Work As You Go.....	28
Making Backup Copies of Diskettes.....	28

Lesson Two

Introduction	32
Loading the Sheet from Diskette	32
Replicating a Formula	33
Replicating a Range of Formulas	35
Formatting the Screen Display	37
Fixing Titles In Place	37
Now, For a Quick Recalculation	38
Adjusting Column Widths	39

Splitting the Screen.....	41
Global Commands in Separate Windows	42
Summary.....	43
Postscript: Memory and the Electronic Sheet	44
How the Sheet Is Reconfigured.....	44
The Memory Indicator	46
Dynamic Memory Allocation	46
Shrinking the Sheet.....	47

Lesson Three

Introduction	50
Typeahead.....	50
Replicating Numbers and Labels	51
Using Formulas For Flexibility	52
Replicating Down a Column	54
Replicating a Column Several Times.....	54
Fixing Titles In Both Directions.....	55
The Built-In Function @SUM	56
Formatting a Single Entry.....	58
Replicating a Format Specification	59
Using Replicate To Copy a Row or Column	59
Changing Windows and Titles.....	60
The @NA and @ERROR Functions	62
The Insert and Delete Commands	63
Calculating Interest On a Savings Account	64
The Move Command.....	66
Obtaining Monthly Expense Percentages	67
Synchronized Scrolling.....	69
The Order of Recalculation	70
Forward and Circular References	72
Summary.....	73
Postscript: The Print Command.....	73

Lesson Four

Introduction	76
More on Numbers and Formats	76
Scientific Notation	77
More On Value References.....	78
More On Formulas	78
More On Built-in Functions	79
Transcendental Functions and Graphing	84
Manual and Automatic Recalculation	89
Summary.....	90

PART III. VISICALC COMMAND REFERENCE

The VisiCalc Screen	94
The Control Panel.....	94
The Window and Sheet	95
Entry Positions.....	95
The Cursor	95
Moving the Cursor	95
Automatic Repeat.....	96
Pointing with the Cursor	96
Typeahead	96
Correcting Mistakes	96
The Memory Indicator	96
Command Structure Chart	98
GO TO Command	101
LABEL ENTRY Command	102
VALUE ENTRY Command	103
About Value References.....	106
Use of ! and #	107
Recalculation Order	109
Forward and Circular References	109
VisiCalc's Built-In Functions.....	110
Function Arguments	110
BLANK Command	114
CLEAR Command	115
DELETE Command.....	116
FORMAT Command	120
Default Display Format-/FD	121
General Format-/FG.....	122
Integer Format-/FI.....	122
Left Justification-/FL	123
Right Justification-/FR.....	123
Dollars and Cents Display-/F\$	123
Bar Graph Format-/F*	123
GLOBAL Command	124
Global Column-/GC	124
Global Order of Recalculation-/GO	125
Automatic or Manual Recalculation-/GR	128
Global Format-/GF.....	129
INSERT Command	130
Inserting a New Row-/IR	130
Inserting a New Column-/IC	131

MOVE Command	133
To Move a Row	133
To Move a Column	136
PRINT Command	141
Print File Option.....	143
REPLICATE Command	144
Copying from One Entry Position to Another.....	145
Creating a Column by Making Several Copies of One Entry	146
Copying a Column from One Position to Another	146
Making Several Copies of a Column	147
Copying a Row from One Position to Another	148
Replicating Value References.....	149
STORAGE Command	154
Storage Load Command-/SL	154
Storage Save Command-/SS	155
Storage Delete Command-/SD	157
Storage Quit Command-/SQ	157
Saving Files in the Data Interchange Format	157
Saving a Data Interchange Format File-/S#S	158
Loading a Data Interchange Format File-/S#L	159
TITLE Command	160
VERSION Command	162
WINDOW Command	163
Horizontal Split-/WH	163
Vertical Windows-/WV	165
Return to One Window-/WI	166
Synchronized Scrolling-/WS	166
Unsynchronized Scrolling-/WU.....	166
REPEATING LABEL Command	167

PART IV. INDEX

Index	170
-------------	------------

PART I. INTRODUCTION

How To Use This Manual	3
Overview of VisiCalc: The "Electronic Sheet"	3
What You Need	6
Setting Up Your Equipment	6
About VisiCalc Storage Diskettes	6
Initializing VisiCalc Storage Diskettes	7
Instructions for One-Drive Systems.....	8
Instructions for Multiple-Drive Systems	10
Diskette Labels	11
Loading VisiCalc	12
Some Notes On Your Keyboard	13



How To Use This Manual

This manual is divided into four parts. It has been designed with the consideration that different people using VisiCalc will have differing levels of computer experience.

Part I contains an overview of VisiCalc, information about your equipment needs, and complete instructions for loading VisiCalc and making blank diskettes ready for use with VisiCalc.

Part II is a step-by-step Tutorial in the use of VisiCalc with your computer. Those with little or no experience with personal computers will find that it anticipates many of the questions and problems that may arise. The Tutorial comprises four lessons which guide you from the point at which you finish loading VisiCalc in Part I, through several examples that show you how to use VisiCalc and your computer to solve problems in your professional work and your everyday life. Each lesson shows you what to type keystroke by keystroke, and should be done with the computer in front of you. As you practice, you'll gain familiarity and confidence in using some of the more advanced features of VisiCalc. Before long, you'll need only Part III and the VisiCalc Reference Card.

Part III is the VisiCalc Command Reference. It contains a chart of VisiCalc commands illustrating their relationship, notes on the elements of the VisiCalc screen display, and a detailed discussion of each command with examples. You will probably find yourself referring to this section frequently, especially as you use the advanced features of VisiCalc to speed your work and do complicated applications. The commands presented in this section of the manual are summarized on the VisiCalc reference card which you'll find in the pocket on the inside back cover of this binder.

Part IV is the Index for this manual, listing subjects alphabetically and relevant page numbers.

The best way to learn to use VisiCalc is to try it. Don't be afraid to experiment and make mistakes. You can't hurt either the computer or the VisiCalc program, no matter what you type at the keyboard.

Overview Of VisiCalc: The "Electronic Sheet"

VisiCalc was born out of the observation that many problems are commonly solved with a calculator, a pencil and a sheet of paper—three nearly universal tools. Calculating sales projections, income taxes, financial ratios, your personal budget, engineering changes, cost estimates, and even balancing your checkbook, is done with a calculator, pencil and paper.

VisiCalc combines the convenience and familiarity of a pocket calculator with the powerful memory and electronic screen capabilities of the personal computer. With VisiCalc, the computer's screen becomes a "window" which looks out upon a much larger "electronic sheet." You can move, or "scroll," this window to the left, right, up, or down, to look at any part of the sheet, or you can split the computer screen into two "windows" to see any two parts of the sheet at the same time.

Overview Of VisiCalc: The "Electronic Sheet"

The sheet is organized as a grid of columns and rows. The intersecting lines of the columns and rows define thousands of entry positions. At each position you can enter an alphabetic title, a number or a formula to be calculated. Just by "writing" on the sheet, you can set up your own charts, tables and records. Formatting commands let you individualize the appearance of each entry, row or column. If you wish, for example, you can make your VisiCalc checkbook record look just like your bank statement.

The power of VisiCalc is that your computer *remembers* the formulas and calculations you use as you work through a problem. If you change a number you had previously written on the electronic sheet, all other related numbers on the sheet change before your eyes, as VisiCalc automatically recalculates all of the relevant formulas.

Recalculation makes VisiCalc a powerful planning and forecasting tool. Not only can you effortlessly correct mistakes and omissions, you can also examine various alternatives.

PERIOD	10	11	12	TOTAL	PERCENT
1 INCOME	2000	2000	2000	23000	
2					
3					
4 MORTGAGE	600	600	600	7200	0.31
5 UTILITIES	50	100	140	1030	
6 TELEPHONE	75	75	75	900	
7 FOOD	350	350	350	4200	
8 CLOTHING	120	120	120	1440	
9 CAR EXPEN	80	80	80	960	
10 CAR INSUR				320	
11 SAVINGS	150	150	150	1800	
12					

Grid labels: E F G H I J ... BH BI BJ BK
 Row labels: 1 2 3 ... 252 253 254

YOUR SCREEN IS A WINDOW INTO THE ELECTRONIC SHEET IN THE COMPUTER'S MEMORY

For example, imagine that you are doing sales projections using VisiCalc. You may want to know what the impact on your company will be if a specific product doesn't sell as well as you anticipate. What if you sell only 200 "widgets" a month instead of 250? What if you sell 300? What if one of your salesmen quits and it takes his replacement six weeks to come up to speed?

Playing "what if" with VisiCalc is simply a matter of changing a single number. Doing the same thing with a calculator, pencil and paper might take hours of erasing and recalculating.

VisiCalc's editing features let you change, insert or delete titles, numbers, or formulas. The existing VisiCalc chart or table is instantly restructured, with all of the columns, rows, and other formulas edited to reflect your changes.

If you've entered a formula at one position, VisiCalc lets you replicate it at any number of other positions. VisiCalc will also add up, average, or otherwise manipulate rows, columns, or other ranges of numbers.

You can increase or decrease the number of positions displayed at any one time, without affecting their content. To see the complete title or the formula that produced a number, you simply move the screen highlight or "cursor" to rest on that number or title.

Once you've established the format for a particular application, you just enter or change numbers. You can save the entire electronic sheet on your diskette, and you can print all or part of the sheet on a printer.

You can learn the elementary features of VisiCalc in an hour, and you'll find that you are immediately able to solve simple problems. As you use VisiCalc for more complicated applications, you'll discover that it has a broad range of features and commands.

What You Need

To use VisiCalc, you will need the following components:

1. A TRS-80 Model I computer with Level II BASIC and 16K of RAM memory. This includes the Keyboard unit and the Video Display.
2. An Expansion Interface totalling 16K of RAM memory.
3. One or more TRS-80 Mini Disk Drives and the TRSDOS diskette which comes with the main drive.
4. The necessary connecting cables for all of the above equipment.
5. The VisiCalc program diskette. This is enclosed in the inside front cover of the binder holding this manual.
6. At least three blank 5" floppy diskettes. This will be enough to get you started, but you will eventually need more and should plan for it.
7. If you want printed paper copies of your VisiCalc electronic sheets:
A TRS-80 Printer (either a Quick Printer or Line Printer).

Setting Up Your Equipment

Set up all the equipment according to the instructions in the manuals that accompany each piece but do not turn any piece on yet. Be especially careful that all cables are connected right side up. If you have more than one disk drive, drive #26-1160 must be the last one on the connecting cable, farthest from the Expansion Interface. You will find the number on the back of the drive above the power switch.

About VisiCalc Storage Diskettes

Since most of the electronic sheets you develop with VisiCalc will contain valuable data which you'll want to keep, you must make some storage diskettes. The new, blank diskettes that are listed in the section "What You Need" to use VisiCalc must have special instructions written on them by the TRS-80 TRSDOS (Disk Operating System) before you can actually use them to store your data. **You must have a storage diskette already made before you try to save the data from an electronic sheet.** You should always have at least one extra initialized storage diskette on hand. Having this extra storage diskette will help insure that you don't lose data because a diskette is full and VisiCalc cannot save a sheet on it. To do the initialization procedure, you will need the diskette labelled TRSDOS which comes with your disk drive.

A word of caution about the handling of diskettes—you can't be too careful with them. Each diskette is a small, magnetically coated plastic disk, sealed in a protective square plastic cover. This cover has an oval cutout in it and sometimes a small square notch cut out of one side. The square notch is sensed by the disk drive and tells the computer that it is OK to write information on the diskette surface. For its protection, the VisiCalc program diskette does not have this notch; hence it is said to be "write protected." Through the oval cutout in the square cover, you can see the magnetic surface of the actual diskette. *Never* touch the exposed magnetic surface.

Protect the diskette from dust by storing it in the paper sleeve that accompanies it. Keep it at least 6 inches from magnetic fields such as those generated by a TV. Extremes of temperature (such as keeping it in a car trunk on a warm day) could destroy a diskette, and you would lose your data, or your program. Don't bend, staple, or write on the square plastic cover with a hard pen or pencil. Use only the soft felt tip pens.

Do not turn off the power to a disk drive when there is a diskette in the drive.

Initializing VisiCalc Storage Diskettes

Open the door on drive 0 (the first drive on the connecting cable #26-1161 and closest to the Expansion Interface) by pulling gently on its left edge. Now insert the TRSDOS diskette into the drive. The oval cutout in the square diskette jacket should enter the drive first. The label should be at the bottom and enter the drive last as shown in the illustration below. Gently push the diskette all the way in, and close the drive door.

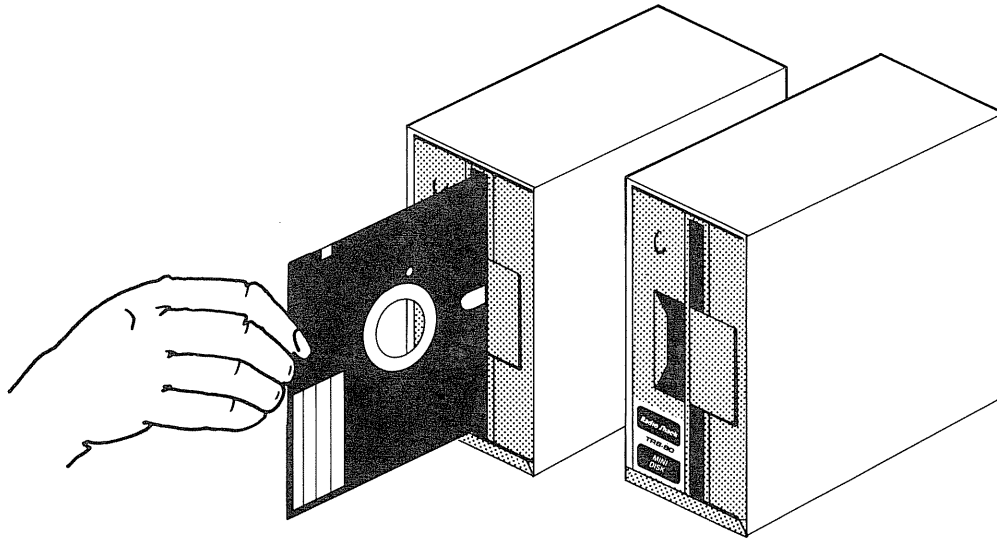

Now turn on the power switches for each piece of equipment. Turn on the keyboard unit last.

1. The Expansion Interface
2. Disk Drive #26-1161 (drive 0, the first on the connecting cable and the one closest to the Expansion Interface.)
3. Any other Disk Drives if you have them
4. The Video Display
5. The Keyboard Unit

Your screen should look like this photo:

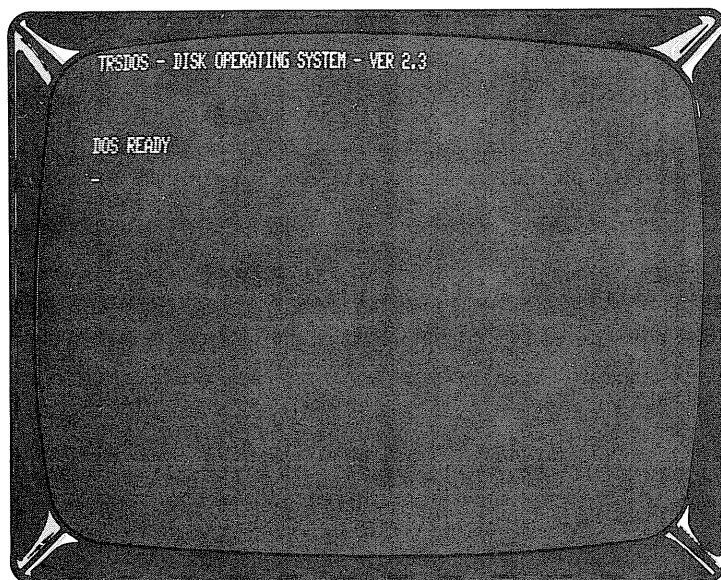

You're now ready to make the storage diskettes. The procedure uses the TRSDOS "BACKUP" feature and varies depending on the number of disk drives you have connected to your computer. Use the instructions below that are suitable for the number of drives you have. Any typing mistakes you make can be erased by pressing the key with the left-pointing arrow on it.

Instructions for One-drive Systems

Connect and turn on the Mini Disk System as described on the Mini Disk Operation chapter of your TRSDOS Disk Operating System manual. Be sure your TRSDOS diskette is in drive 0 (zero) when you turn on the keyboard unit.

On your screen you should see a dash (-) under:

```
TRSDOS - DISK OPERATING SYSTEM - VER 2.3
DOS READY
-
```

Now type:

BACKUP

and press the **ENTER** key. The disk drive will whirl and the screen will then read:

```
TRSDOS DISK BACKUP UTILITY - VER 2.3
SOURCE DRIVE NUMBER? -
```

Press the zero key:

0

and then press the **ENTER** key. The next message asks for the:

DESTINATION DRIVE NUMBER?—

Press zero again:

0

followed by the **ENTER** key. Now you must give the:

BACKUP DATE (MM/DD/YY)?

Type in the date in MM/DD/YY format with M=month, D=day, and Y=year. For example, if it's June 2, 1980, type: **06/02/80** Then press the **ENTER** key. The screen will then read:

INSERT SOURCE DISK (ENTER)

The source diskette in this case is the TRSDOS diskette which is already in the drive, so just press **ENTER**. The next message instructs:

INSERT DESTINATION DISK (ENTER)

Remove the TRSDOS diskette from the drive and put in your blank diskette. Press **ENTER**. FORMATTING and VERIFYING messages will appear on the screen, followed by:

INSERT SOURCE DISK (ENTER)

Remove your blank diskette from the drive and put in the TRSDOS diskette. Press **ENTER**. LOADING and VERIFYING messages will appear on the screen, followed by:

INSERT DESTINATION DISK (ENTER)

Remove the TRSDOS diskette from the drive and put in your blank diskette. Press **ENTER**. When the process has finished, the screen will read:

BACKUP COMPLETE
HIT 'ENTER' TO CONTINUE

Initializing VisiCalc Storage Diskettes

Press **ENTER** and you will again see:

WRIGHT HUNTLEY
2483 SOUTH PARK LN.
SANTA CLARA, CA 95051

DOS READY

Remove the blank diskette which is now initialized. It is ready to use as a VisiCalc storage diskette. If the screen displays the following instead:

BACKUP REJECTED DUE TO (. . .)

remove the extra diskette and erase it with a bulk eraser (Radio Shack catalog number 44-210) or use another blank diskette. Try initializing again. Repeat all the steps carefully!

When you've finished, continue reading at the section below entitled "Diskette Labels."

Instructions for Multiple Drive Systems

Make sure the Mini Disk System is connected as described in the Mini Disk Operation chapter of your TRSDOS Disk Operating System manual. Be sure the TRSDOS diskette is in drive 0 (zero) (the first drive on the connecting cable), and that your blank diskette is in drive 1 (one). After you turn on the TRS-80 the screen will read:

TRSDOS — DISK OPERATING SYSTEM — VER 2.3
DOS READY

Type:

BACKUP

and press the **ENTER** key. The screen will then read:

TRSDOS DISK BACKUP UTILITY — VER 2.3
SOURCE DRIVE NUMBER?—

Press the zero key:

0

and then press the **ENTER** key. The screen will then read:

DESTINATION DRIVE NUMBER?—

type:

1

and press the **ENTER** key. The screen will then read:

BACKUP DATE (MM/DD/YY)?

Type in the date in MM/DD/YY form with M=month, D=day, and Y=year. For example, if it's June 2, 1980, type: **06/02/80** Then press the **ENTER** key and wait about thirty seconds. FORMATTING, LOADING, AND VERIFYING indicators will appear on the screen. When the process has finished, the screen will respond:

BACKUP COMPLETE — HIT 'ENTER' TO CONTINUE

Press **ENTER** and you will again see:

DOS READY

Your diskette is now initialized. It is ready to use as a VisiCalc storage diskette. If the screen displays the following instead:

BACKUP REJECTED DUE TO (. . .)

remove the diskette which was rejected and erase it with a bulk eraser (Radio Shack catalog number 44-210) or use another blank diskette. Try initializing again. Repeat all the steps carefully!

Diskette Labels

After the disk drive has quieted down and the red ACTIVE light has gone off, open the drive door and carefully remove the newly initialized diskette. (Never open the door or insert or remove a diskette while the drive is whirring or the ACTIVE light is on; this will probably damage the diskette, and may also damage the drive.)

Look for the adhesive labels that normally come with a box of blank diskettes. Write a note to yourself, such as "VisiCalc Storage Diskette" and the date, on an adhesive label, and apply this label to the diskette jacket near the manufacturer's label. You can write directly on the label on the diskette, but be sure to use a felt tip pen, not a ballpoint.

At this point, you may wish to initialize some additional diskettes for use with VisiCalc. Remember that you must initialize the storage diskettes before you can use them. Simply insert a new blank diskette, close the drive door, and follow the initialization procedure which corresponds to the number of drives you have. When you have finished remove the TRSDOS diskette from the disk drive and put it away. You'll need it only for initializing storage diskettes for VisiCalc.

Now you're ready to load VisiCalc.



Loading VisiCalc

You must now get the VisiCalc program diskette, which is kept in the pocket on the inside front cover of the binder holding the manual. Remove the diskette from the paper sleeve and insert it into drive 0, exactly as you did when you were initializing VisiCalc storage diskettes. If you already have the prompt

DOS READY

on your screen, simply type:

VC

(for VisiCalc) and press **ENTER**. The disk drive will whirl and after a few seconds the VisiCalc screen will appear, looking like the photo below.

If your computer is turned off, make sure the VisiCalc program diskette is correctly inserted in drive 0 and turn on power to each piece of equipment, turning on the Keyboard Unit last.

After about 5 seconds, the following message will appear on your screen:

```
TRSDOS — DISK OPERATING SYSTEM — VER 2.3  
DOS READY
```

Now type the letters VC (which stand for VisiCalc) and press the key labelled **ENTER**. Drive 0 will again become active and after a few seconds the VisiCalc screen will appear, looking like the photo below:

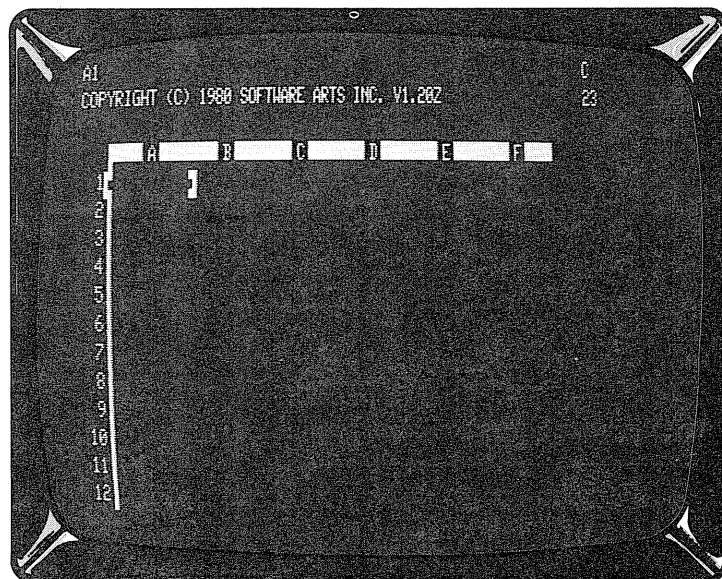

If your screen doesn't look like this, you may have made a mistake or there may be a problem with your hardware. Sometimes your TRS-80 gives you helpful messages. If you see the message:

PROGRAM NOT FOUND

you did not have the VisiCalc program diskette in drive 0. Find it, insert it correctly, and then press the RESET button on the back of the Keyboard unit. When the message DOS READY appears on the screen, type VC and press ENTER

If some other message appears, you can look it up in the section entitled "ERROR MESSAGES" in your TRS-80 DISK OPERATING SYSTEM manual.

If you have no idea what is wrong, **remove your VisiCalc program diskette from the drive** and turn off all power switches. Check to see that all the equipment is connected exactly as their manuals instruct, and that the connectors are firmly in place. Then insert the VisiCalc diskette, turn on the power switches and try loading VisiCalc again.

Some Notes On Your Keyboard

You may have a numeric keypad installed to the right of your regular TRS-80 keyboard; this keypad may be used interchangeably with the top row of numbers on the regular keyboard. You may also have had your TRS-80 modified by Radio Shack so that you have both upper and lower case letters available. This modification will not affect VisiCalc's operation. You will be able to use the upper/lower case letters for titles on your sheet; however, you will notice that VisiCalc will automatically change letters to upper case when it is necessary.

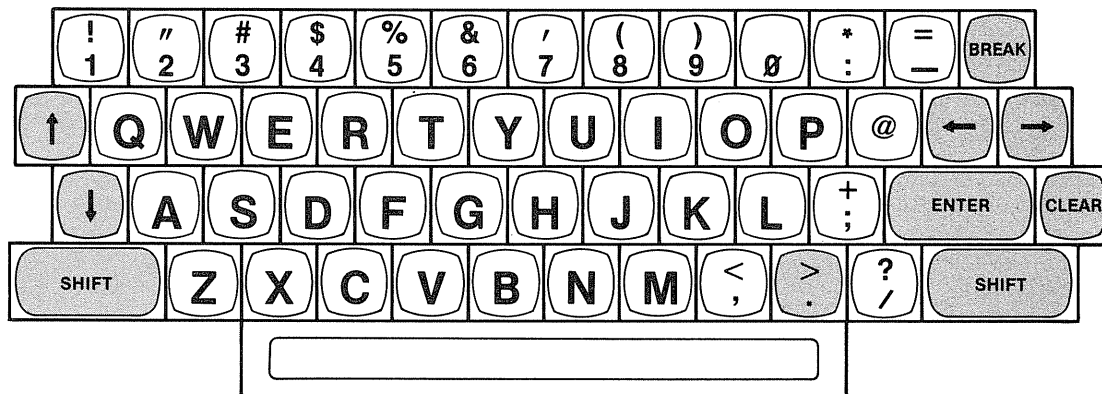

Some Notes On Your Keyboard

Several characters that are used repeatedly in VisiCalc must be typed with the **SHIFT** key depressed. These are:

*

"

>

/













!

#

↑

Except for an occasional reminder, we do not instruct you to hold down the **SHIFT** key to type the characters. Also note the positions of the keys that are shaded on the keyboard. You will use them a great deal. You will see the key labelled **ENTER** represented by this symbol,  throughout this manual.

The keys with arrows on them at the extreme left and right sides of the keyboard are used to move the highlight you will see on your VisiCalc sheet. The following are the special symbols we use in this manual and the keystrokes they refer to:

Symbol	Keystrokes
	Press 
	Press 
	Press 
	Press 
	Press 
↑	Hold down  and press 

When you've finished making the VisiCalc storage diskettes and have loaded VisiCalc, you'll be ready to start Lesson One and begin to use VisiCalc.

PART II. VISICALC TUTORIAL

Lesson One

Introduction	17
Moving the Cursor.....	18
Scrolling the Window	18
Automatic Repeat	19
Direct Cursor Movement	19
Backing Up the Cursor	20
Writing on the Electronic Sheet	21
Formulas and Recalculation	22
More on Labels and Values	22
Cursor Moves in Formulas.....	24
Saving the Electronic Sheet on Diskette.....	26
Postscript: Protecting Yourself From Disaster	27
Save Your Work As You Go.....	28
Making Backup Copies of Diskettes.....	28



Lesson One

When you have loaded VisiCalc into your computer, as described in the section entitled "Loading VisiCalc," the image on your screen should resemble the photo shown in that section. The same photo is reproduced below. If your screen is different, type the following keys: /CY This will clear the sheet and it will look like the photograph. Here we'll examine the components of this screen image more closely.

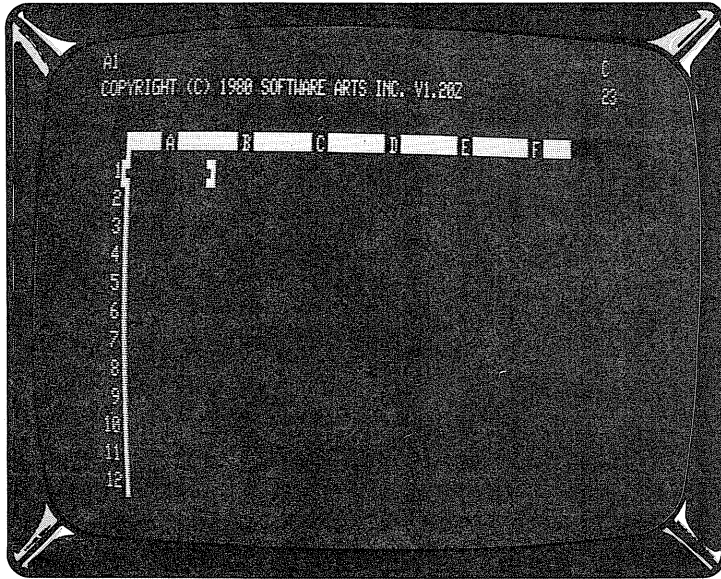



Your screen has become a **window** into the computer's memory, which VisiCalc has organized like an **electronic sheet**. As you can see, the sheet is divided into rows which are numbered 1, 2, 3, and so on, and columns which are lettered A, B, C, and so on. At each intersection of a row and column there is an **entry position**, with a **coordinate** such as A1, B3, C17, and so forth. At each entry position you can "write" a message or title, a number, or a formula of the kind you might enter, keystroke by keystroke, on a calculator. In a moment we'll demonstrate how you move around and write on this electronic sheet.





Above the white border with the column letters, there are three additional lines which make up VisiCalc's **control panel**. The middle line of this control panel displays the VisiCalc copyright notice and **version number**, for example:

COPYRIGHT © 1980 SOFTWARE ARTS, INC. V1.20Z



Should you ever need to call or write to Radio Shack to ask questions about VisiCalc or to report problems with VisiCalc, please be sure to include this version number and the model of your computer.





Moving the Cursor

At the upper left corner of the control panel you can see the coordinate A1 displayed. Notice that there is a pair of brackets over the entry position at column A, row 1. These highlight the entry position and are called the **cursor**, or **highlight**. You always write on the electronic sheet at the position marked by this cursor; you can think of it as the point of your pencil or pen. You move the cursor with the four arrow keys located to the left and right of the keyboard. These keys control the direction of movement of the highlight. Throughout this manual, the symbols  and  will mean to move the highlight down or to the right with these keys.



Try pressing the right arrow key  once. Notice that the cursor moves to the position at column B, row 1, and the cursor coordinate in the upper left corner of the control panel changes to B1. (The copyright notice and version number will also disappear with your first keystroke.) Now press the left arrow key  and watch the cursor move back to its original position. Try moving the cursor down to row 2 of column A with  and then back to position A1 with .

Scrolling the Window

When you first load VisiCalc, your screen window is positioned to let you look at the upper left hand corner of VisiCalc's electronic sheet. The window allows you to see the first six columns (A through F) and the first twelve rows (1 through 12) of the sheet. Now, with the cursor at A1, press the right arrow key  several times until the highlight is at the right edge of the window. Now press the right arrow key  again. Notice that the next column to the right comes into view, while column A disappears off the left edge of the window. When this happens, we say that the window has **scrolled** to the right. Try pressing  a few more times, watching more columns appear to the right edge of the window, and disappear at the left.

The screen window will also scroll to the left. (In fact, it will scroll in all four directions.) Press the left arrow key  until the cursor is at the left edge of the window. Then press  several more times and notice that the columns that had disappeared as you scrolled the window to the right come back into view. Press  until the cursor is back at position A1. Now try pressing  one more time. You should see the row and column borders on the screen flash at you. This is VisiCalc's way of telling you that you are bumping into the edge of the sheet.

Just for fun, press the up-pointing arrow key  which would normally move the cursor up. You are bumping into the edge of the sheet again. So far we have encountered the left edge and the top edge of the sheet. Now, we will go looking for the other two edges.

Press the down arrow key  until the cursor has moved down to position A12. Then press  again, and notice that row 13 comes into view, while row 1 disappears off the top of the screen window. Continue pressing the  key until your finger starts to get tired (actually, a few more presses will do). As you can see, the electronic sheet is quite a bit larger than an ordinary sheet of paper.

Automatic Repeat

We can speed our search for the bottom edge of the sheet by using the automatic repeat feature of the computer. To see this in action, press the \blacktriangledown key again, and this time *hold it down*. Much better, isn't it? (The cursor and the window should be scrolling downwards automatically.) Continue to hold down the \blacktriangledown key until you bump into the bottom edge of the electronic sheet. The cursor will be at position A254.

Now, let's search for the right hand edge of the sheet. Press \blacktriangleright and hold it down. The cursor and window will go scrolling off to the right. As the cursor and window scroll to the right, notice how succeeding columns are lettered. After A, B, C, . . . , X, Y, Z comes AA, AB, AC, . . . , AX, AY, AZ, and then BA, BB, BC, The cursor finally stops at position BK254, as it bumps into the right hand edge of the sheet. You are now at the lower right hand corner of VisiCalc's electronic sheet.

Direct Cursor Movement

Even with the aid of automatic repeat, it took a while to scroll the cursor and window all the way to the lower right corner of the VisiCalc sheet. There's an easy way to move an arbitrary distance across the sheet with a few keystrokes.

Type the character $>$. You must hold down the SHIFT key to generate this character. If you make a mistake, press the CLEAR to correct what you've typed. The next section "Backing Up the Cursor" explains the use of this key in detail.

Two things will happen: 1. The message GO TO: COORDINATE appears on the middle line of the control panel, at the top of the screen. 2. Directly below this message, a dash appears. You have discovered two new components of the VisiCalc control panel: the **prompt line** and the **edit line**.

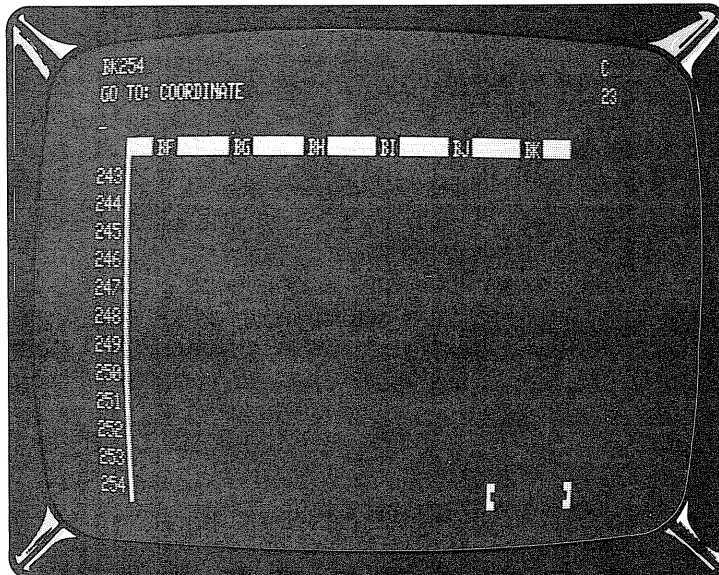

VisiCalc communicates with you on a keystroke by keystroke basis, just like a pocket calculator. Each time you press a key, VisiCalc tells you, on the prompt line, what you can type next. Right now, the prompt line is telling you that VisiCalc has recognized your keystroke command **>**, which means **GO TO** an arbitrary position on the sheet, and that next, VisiCalc expects you to type the **COORDINATE** of the position to which you want the cursor to move.

Press the **A** key once: The letter **A** will appear on the edit line (third line from the top of the screen), followed by the dash. If you have the upper-lower case keyboard modification, notice that you get a capital **A**, whether you press the **SHIFT** key or not. VisiCalc knows that you are entering a coordinate and so takes care of upper case for you. The **SHIFT** key matters only when you press a key with two symbols on it, or as you will see, when you are entering labels. Now press the number **1** key: we want to move the cursor back to position **A1**. On keyboards with number pads installed, you may use either number. Do not use lower case **"L"** or upper case **"I"** instead of the **1** key or the letter **"O"** for a zero. So far, we have **A1** on the edit line, followed by the dash. VisiCalc is still waiting for you to type something: it doesn't know yet whether you want to go to position **A1**, or position **A11**, or **A121**, or some other position. Now press the **Ⓢ** key. The information on the prompt and edit lines disappears, and the cursor and window move back to the upper left corner of the sheet.

Try another example. Press the keys **>C10Ⓢ** Does the cursor move to the expected position?

Backing Up the Cursor

VisiCalc has several error correction features, each of which will be covered in this lesson. The first of these is the key labelled **CLEAR**.

Press the following keys: **>A11** Then pause for a moment before pressing **Ⓢ**. Suppose that you intended to move the cursor to position **A1**, but you accidentally pressed the **1** key twice. You now have **A11** on the edit line, followed by the dash.

Press the key marked **CLEAR** once. Notice that the dash "backs up" one character and erases the extra **1**, leaving you with **A1**. Now press **Ⓢ**. The cursor will move back to the upper left hand corner of the sheet. In general, VisiCalc will let you correct typing errors by backing up with the **CLEAR** key. You can back up more than one character. For example, to change **A11** to **A2**, you would press the **CLEAR** key twice, backing up to leave just the letter **A**, and then you would press the **2** key to get **A2**.

Besides backing up, you can "back out" with the **CLEAR** key. Press the following keys: **>B5** Then pause. Suppose that you change your mind and decide that you don't want to move the cursor at all. Press the **CLEAR** key once, and the number **5** will disappear from the edit line. Now press the **CLEAR** key again. The letter **B** on the edit line disappears, and so does the prompt **GO TO: COORDINATE**. You have backed out of the **>** or **GO TO** command completely, and you can now type something else.

There's an even faster way to back out of a command. Press these keys: >C12 Suppose you decide you don't want to use the **GO TO** command. Find the key labelled **BREAK** and press it once, watching the screen as you do so. The screen flashes and the prompt and edit lines are blank. You have backed out of the **GO TO** command with one key: **BREAK**. No matter what you are typing, you can always back out and leave the sheet unchanged by pressing the **CLEAR** key a few times or pressing the **BREAK** once, as long as you notice your error before pressing the last keystroke of the command or other entry.

Before going on, spend a few more minutes moving the cursor around with the arrow keys, and the > or **GO TO** command. Try moving the cursor to a nonexistent position such as AB525. What happens? Giving an invalid coordinate to VisiCalc in the **GO TO** command causes the top lines of the screen to flash, and the cursor does not move.

Now, get back to the upper left hand corner of the sheet with >A1[Ⓢ] Next, we're going to learn how to write with VisiCalc.

Writing On the Electronic Sheet

As you have seen, moving the cursor and window around is pretty easy, but so far your electronic sheet is (or should be) empty. You'll find that writing on the sheet is even easier. Before proceeding further, type the following keys: /CY The screen will go blank, then reappear with the copyright on the prompt line. This will make sure that the sheet is clear and that the cursor is at position A1.

Now type the following keys: **SALES** (If you mistype a letter, you can back up with the **CLEAR** key.) Stop and look at the screen. On the prompt line is the word **LABEL**. This is VisiCalc's term for any type of alphanumeric message that won't be used in calculation which you write on the sheet. On the edit line is the word **SALES**, followed by the dash. The dash indicates that you can still use the **CLEAR** key to back up and retype the message, or to back out completely. **SALES** also appears under the cursor highlight at position A1 on the sheet. If your computer has the lower case alphabet, all letters you type for labels will appear in lower case unless you use the **SHIFT** key for capitals, as you would on a typewriter. Use the **CLEAR** or the **BREAK** to back up and retype any characters in the **SALES** label, if necessary. When you are satisfied, press the **␣** key. The information on the prompt and edit lines disappears, and the cursor moves to position B1, leaving the label **SALES** at A1. (Throughout the rest of this tutorial, all alphabetic characters will be shown upper case in the text. If you have upper-lower case, you can use it as you prefer for your labels—you won't hurt anything.) Try pressing the **CLEAR** key and then the **BREAK** key. (Nothing happens except for VisiCalc flashing the screen at you.)

Now type the following keys: **100** Stop and look at the screen. The prompt line says **VALUE**, which is VisiCalc's term for a number or formula. On the edit line is the number 100, followed by the dash. Press the **CLEAR** key four times, and watch the number disappear: First 0, then 0, then 1, then finally the prompt **VALUE**. Position B1 is still blank. You could, of course, have done the same thing by pressing **BREAK**.

Now press the following keys: **75 + 25** If you make a typing error, watch the edit line carefully and use the CLEAR key to back up. The word VALUE is again on the prompt line, and the edit line reads 75 + 25, followed by the dash. Now press the ! key once (don't forget to SHIFT). In place of 75 + 25, you now have 100 (the answer) on the edit line. You can use this "exclamation key" feature to perform quick calculations before writing a number on the sheet. (Much more will be said about formulas and calculations later.)

Notice that, so far, nothing has appeared under the cursor highlight at B1. Everything has been happening on the edit line. Now press $\text{\textcircled{E}}$. The information on the prompt and edit lines disappears, and the number 100 appears at position B1 on the sheet. Try pressing CLEAR. (The screen flashes and nothing happens.) There is one other change on the screen since you pressed $\text{\textcircled{E}}$. Can you spot it? The top line of the screen now reads: B1 (V) 100. This line is called the **entry contents line**, because it gives the full explanation of the contents written in the entry position highlighted by the cursor. Right now, the entry contents line says (V), for VALUE, and shows the number 100. Press the \blacktriangleleft key, and the cursor will move back to position A1. Now the entry contents line reads A1 (L) SALES. The (L) stands, of course, for label.

Formulas and Recalculation

Now move the cursor to position A2 by pressing the \blacktriangledown once. Next, type the letters **COST** and then press the \blacktriangleleft key. The cursor moves to B2, leaving the label COST at A2. Now we are going to write a different kind of formula. We want the entry at position B2, for COST, to be 60% of the number for SALES. Press the following keys: **.6*B1** The "*" symbol is used to indicate multiplication. The edit line should now read .6*B1 (If it doesn't, remember CLEAR.) Assuming that you are satisfied, press $\text{\textcircled{E}}$, and watch what happens. The information on the prompt and edit lines disappears. On the entry contents line, you should now see B2 (V) .6*B1 And at position B2 is the number 60, the result of multiplying .6 times 100, the number at B1.

Now for a bit of magic. Press the \blacktriangleup key to move the cursor up to position B1. Now press the following keys: **200** $\text{\textcircled{E}}$ and watch the screen. The number behind the cursor highlight at B1 changes to 200. What else happens? The number opposite COST, at B2, changes to 120. Notice that COST is still 60% of SALES.

Press the \blacktriangledown key, moving the cursor to B2. On the entry contents line at the top of the screen, the formula you had typed earlier, .6*B1 is still there. When you changed the number at B1 to 200, VisiCalc automatically recalculated the formula at B2 as .6*200, or 120. You'll see many more examples of this powerful recalculation feature as we progress.

More on Labels and Values

Let's look more carefully at labels and values, and explore an even simpler way to write formulas.

Press the following keys: **>A3**Ⓢ to move the cursor to position A3. We're about to write a formula to calculate gross profit as sales minus cost.

First, we'll write the label GROSS. Press the **G** key. Notice that the prompt line immediately says: LABEL. When you write at an entry position, VisiCalc looks at the first key you press to determine whether you are typing an alphabetic LABEL or a numeric VALUE. If you start with one of the letters **A** through **Z**, as you did here, VisiCalc assumes that you are typing a label. If you start with one of the digits **0** through **9** or a decimal point, ".", or with something that could begin a formula such as plus, "+", minus, "-", parenthesis, "(", "@", or "#" (which will all be explained later), VisiCalc assumes that you are typing a VALUE. For now, press BREAK to back out of LABEL.

What happens if you want to write a message such as **-GROSS** or **1ST QTR**? Try it. Press the following keys: **-GROSS**— You may as well stop, because VisiCalc will be flashing the control panel at you. VisiCalc took the initial dash (or minus sign) to mean that you were typing a formula, the letter **G** as part of an entry position coordinate and then complained as you typed something that couldn't be a formula. Press BREAK to back out of this mistake.

To remedy this situation, press the " key (you have to hold down SHIFT). VisiCalc takes the " to mean that you want to type a LABEL, but this quote symbol will not be a part of the message itself. As soon as you press the " key, the prompt line says LABEL. The edit line shows just the dash. Now you can type: **-GROSS**— As usual, you can use the CLEAR key to back up and correct mistakes. You don't have to type a closing quote symbol. Now press the ↵ key, and the cursor will move to position B3, leaving the message **-GROSS**— at A3.

Now we're ready to calculate SALES minus COST. The formula you'd expect would be **B1-B2**. What will happen when you type **B1-B2**? Try it: Type **B1-B2** No screen flashes so far, so press Ⓢ. What happened? If you've been watching the prompt line, you already realize that VisiCalc took the initial letter **B** to mean that you were entering a LABEL or message. **B1-B2** is a perfectly legitimate message or comment, but it doesn't calculate anything. Under the cursor highlight you have, not the result of calculating SALES minus COST but the message **B1-B2**.

Try again. First, we'll eliminate the erroneous message **B1-B2**. Try pressing CLEAR and then BREAK. Nothing happens, since we've already pressed Ⓢ. But we can use a new VisiCalc command to blank out an entry position at any time. Press the following keys: **/B**Ⓢ The message **B1-B2** under the cursor highlight disappears, and the entry contents line goes blank except for the cursor coordinate B3.

Remember that we used the " key to type a label when VisiCalc would otherwise have tried to treat it as a value. We can use a similar trick to type the formula **B1-B2** as a value, instead of a label. One way to do this would be to type the formula as **Ø+B1-B2**. VisiCalc would take the initial digit **Ø** to signify that we were typing a value. An equivalent formula is **+B1-B2**; VisiCalc will take the **+** to indicate a value. Press the following keys: **+B1-B2**Ⓢ Now we have what we want. The entry contents line reads **B3 (V) +B1-B2**. Under the cursor highlight is the number 80, the result of calculating **+B1-B2**, or **+200-120**.

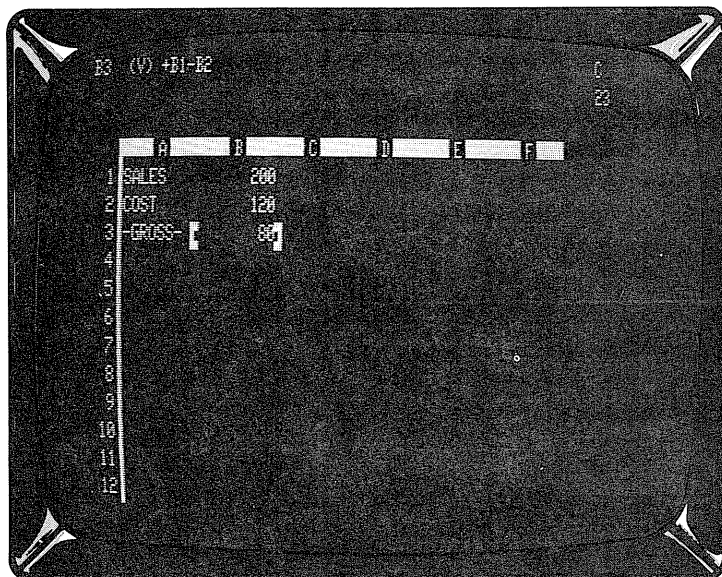

Cursor Moves in Formulas

So far, you know how to move the cursor to an entry position, and write a message, a number, or a formula which refers to other positions on the electronic sheet, such as $+B1 - B2$ in the previous example. By now you probably also realize that if you change the numbers at B1 or B2, the formula $+B1 - B2$ at entry position B3 will be recalculated, and the new result will be displayed at B3.

As you wrote the formula for sales minus cost, you probably had to check the screen to see that the number for sales was at position B1, and the number for cost was at B2. Now, imagine that you have already written a large number of formulas on the sheet. Keeping track of which numbers are at which coordinates would become time-consuming. Columns A and B might have scrolled off the left edge of the window as you moved it to display other parts of the sheet. Then you wouldn't even be able to see the numbers next to SALES and COST, so writing a new formula involving sales and cost might be a problem.

There's an easy way to solve this problem: you write the formula, but let VisiCalc fill in the coordinates! Let's try it. First, blank out the formula at B3 by typing: $/B$

Press the **+** key. The prompt line reads VALUE, and the **+** appears on the edit line, followed by the dash. At this point, we would normally type the coordinate B1, but what we really want is the number next to the label SALES (currently 200). Point at that number on the screen with your finger. We are about to do the same thing electronically, by **pointing** with the cursor.

Watch the edit line and press the **▲** key once. The cursor moves up to highlight the number 120, and the coordinate of that number, B2, appears on the edit line. Now press **▲** again. Do you see what we mean by “pointing” the cursor? The edit line now reads **+B1** followed by the dash. Now press the **–** key. The cursor jumps back to B3, the entry at which we are writing the formula. The edit line now reads **+B1 –** followed by the ubiquitous dash. In general, after pointing the cursor at the position you want to include in the formula, you simply continue the formula by typing an arithmetic operation symbol such as **–, +, *, or /**.

Watch the edit line again, and press the **▲** key once more. The cursor moves up to 120, the number next to COST, and the edit line now reads **+B1 – B2**. This is the formula we want! To end the formula as it stands on the edit line, press **Ⓢ**. The information on the prompt and edit lines disappears; the entry contents line reads B3 (V) **+B1 – B2**; and under the cursor highlight is the number 80, the result of calculating B1 minus B2.

To demonstrate VisiCalc’s recalculation feature again, press the **▲** key twice to move the cursor up to B1, and change the number there by typing: **100**Ⓢ Notice that B2 changes back to 60, or .6 times 100, and B3 changes to 40, or 100 – 60.

The idea of moving the cursor as you write a formula may seem a little strange at first, and if you wish you can always type the position coordinates yourself. But as you gain experience and familiarity with VisiCalc, you’ll probably find that the technique of moving the cursor to the positions you want will become easier and more natural. In time, you’ll find that you can almost forget about coordinates entirely, and think in terms of the visual positions of numbers and formulas on the sheet.

To test your understanding of the process of moving the cursor as you write formulas, you may wish to try an example yourself. Move the cursor down to position B5, and write a formula there for gross profit as a percentage of sales. (Hint: The desired formula is **+B3/B1*100**. Try to obtain this formula by moving the cursor and typing the **+** and **/** keys.)

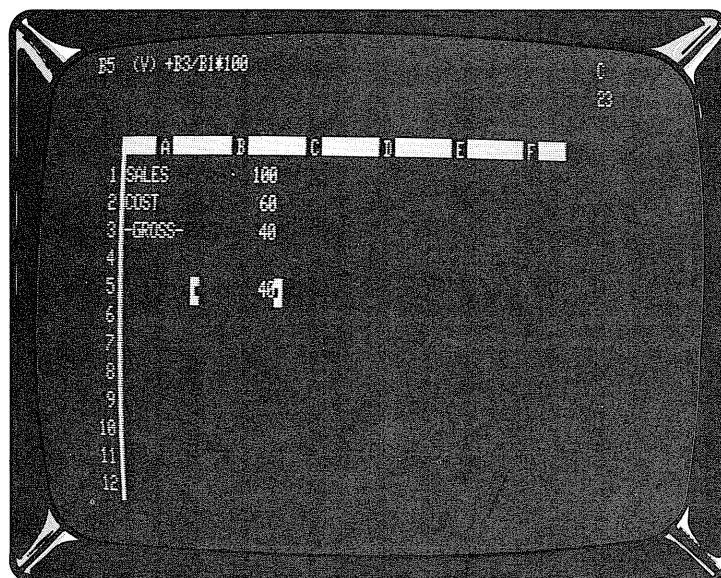

Saving the Electronic Sheet on Diskette

As we wrap up this first lesson, you'll have a chance to use one of the storage diskettes you created when you read the section entitled "Initializing VisiCalc Storage Diskettes" in Part I. We'll save the contents of the electronic sheet from this lesson on diskette, and load the sheet back into memory as we begin Lesson Two. If you skipped the discussion of diskette initialization when you read Part I, the Introduction, you can save your sheet on the VisiCalc diskette for now, by following the instructions below. After your sheet is safely saved, go back to the section entitled "Initializing VisiCalc Storage Diskettes" and make some. If you don't have any blank diskettes available right now, get some from your dealer as soon as possible.

For insurance, in Lesson Two we'll give brief instructions for setting up the electronic sheet with exactly the same labels, numbers and formulas which you have now.

If you have an initialized storage diskette, insert it into drive 0. Gently push the diskette all the way in, and close the drive door pushing it down. If you haven't made any VisiCalc storage diskettes, insert your VisiCalc program diskette into drive 0 and save your sheet on it for the time being.

Now type the VisiCalc STORAGE command `/S`. The prompt line reads STORAGE: L S D Q #. VisiCalc is telling you that it recognizes `/S` as the storage command, and that next it expects you to press one of the keys L S D Q or #. These keys have the following meanings:

- L** Load the sheet contents into the computer's memory from a diskette file.
- S** Save the sheet that is in memory by "writing" it into a diskette file.
- D** Delete a previously saved file from its place on the diskette.
- Q** Quit the VisiCalc program.
- #** Save or load a sheet in the Data Interchange Format (see Part III, the STORAGE Command).

Press the letter **S**. Now the prompt line reads FILE FOR SAVING, and a dash has appeared on the edit line. There is room on the diskette to hold several electronic sheets. So that you can find the particular sheet you want later, you give each sheet a name when you save it on diskette. The saved information is called a diskette **file**, and the name you give it is called a **file name**. VisiCalc will find an empty area on the diskette and will write the sheet contents there. Then, in a special area on the diskette called its directory or catalog, VisiCalc will save the file name you specified and a note about where on the diskette it saved the sheets contents.

When you are saving a file, the first thing you must tell VisiCalc is the file name. A file name can be up to eight alphanumeric characters beginning with a letter. After the file name, you will add the characters /VC. This allows you to differentiate the VisiCalc files saved with the command /SS from any others you may save on the diskette.

Let's name the file we are saving EXAMPLE/VC. Since we instructed you to place the storage diskette in drive 0, we want VisiCalc to save the file on the diskette in that drive. Press the keys: **EXAMPLE/VC**. As usual, you can correct typing errors with the **CLEAR** key. When you are satisfied, press **Ⓢ**. The disk drive should begin whirring and the **ACTIVE** light should come on. After a moment, the drive should quiet down, the **ACTIVE** light will go off, and the prompt and edit lines will go blank. Your work is safely filed away on the storage diskette.

This completes Lesson One. You may wish to experiment for a while, moving the cursor around and writing your own labels, numbers and formulas. Try writing some formulas by pointing the cursor to obtain the coordinates. There are, of course, many more features of VisiCalc which we haven't discussed yet, and you may stumble upon one of them. As you experiment, if something happens that you don't understand, make a note of it, and then continue with the next lesson. Most of your questions will be answered as you go. Already, though, you know enough about VisiCalc to use it for some simple applications. Try it!

Postscript: Protecting Yourself From Disaster

Have you ever worked out a problem or made some notes to yourself on a sheet of paper, only to find out later that the sheet had been lost, or that someone had accidentally thrown it away? Or perhaps you've lost the results of some calculation you were performing on an electronic calculator, because power was turned off, or the battery died. Things can and do go wrong.

As you begin to use VisiCalc, you'll find that at times the results you see on the screen may be quite important to you. Losing that information at the wrong time would be at best a real nuisance, and at worst a minor disaster, if, say, you needed the results for a presentation the next morning. How can you protect yourself?

VisiCalc is designed to be as foolproof as possible. It is quite difficult to mess things up badly by anything you might type at the keyboard. For example, if you give the command to clear the screen (intentionally or accidentally) by typing /C, VisiCalc will display on the prompt line CLEAR: Y TO CONFIRM. Only if you type the letter Y at this point will the contents of the sheet be erased. If you type any other key, the clear command will be "aborted", and the sheet will be left unchanged. Similarly, if you type /B to blank out an entry, nothing will happen unless and until you press one of the keys \downarrow , \leftarrow , \rightarrow , \uparrow , or ⓔ . Any other key will abort the blank command.

Save Your Work As You Go

VisiCalc does its best to protect you, but other things can go wrong. What if your building has a power failure? What if someone pulls the plug from the socket? What if you are called away by some emergency and the janitor turns off your computer?

To protect yourself, you should save the electronic sheet periodically on diskette. As you work, think of how long it has been since you last saved the sheet. If you have spent more time than you would wish to lose if something went wrong, or if you have new results which might be difficult to reconstruct, then it's time to save the sheet again. To keep track of several versions of the same information on diskette, you can append a sequential number (such as FORCAST1/VC) to the file name you use when you save the sheet. Remember that only eight alphanumeric characters are allowed for the file name and spaces may not be used.

Another option is to print out the sheet on a printer. (See the discussion of the print command at the end of Part II, Lesson Three and in Part III, The PRINT Command of this manual.) Although you would not be able to examine the formulas, or change the numbers and recalculate, this "hard copy" would at least survive through most interruptions and emergencies.

Making Backup Copies of Diskettes

Saving your work periodically on diskette is only the first step in protecting yourself. A diskette is a safe and reliable medium for storing information; however, to be used, a diskette must be handled and transported from place to place. Think pessimistically. A diskette may be scratched, or it may pick up grease or dust; it may be damaged by heat, exposed to a magnetic field, or accidentally reinitialized (which erases its contents). And a diskette will eventually wear out: its average lifetime is about 40 hours of active use (being read from and written to in the disk drive). Hence, to protect yourself, you should always make extra copies of your important files on separate "backup" diskettes.

To make a backup copy of your files, you must leave the VisiCalc program. Save the sheet you have been working on, then type /SQ. The prompt line will read: QUIT: Y TO CONFIRM. Press Y After a few seconds your screen will display: DOS READY. Now you will use the normal TRSDOS BACKUP command which is provided with the TRS-80 Disk Operating Systems (DOS). Follow the same procedure you used to make your VisiCalc storage diskettes, described in Part I, the section entitled "Initializing VisiCalc Storage Diskette". The TRSDOS BACKUP command will copy the entire contents of your storage diskette onto a blank diskette, so you have an identical backup copy of the original. The TRSDOS BACKUP command is also discussed in the *Dos User's Manual* that comes with your disk drive. *Test your understanding of the procedures on a data diskette you make expressly for experimentation.* Until you thoroughly understand the procedures, don't risk using diskettes containing valuable data; you may lose the data while learning.

Making backup files is important. It's all too easy to read about these protective measures, use them once or twice, and then when you're in a hurry, skip the backup steps. When disaster strikes, you'll curse your carelessness. The time it takes to make backup files will be amply repaid the first time you try to load a file from a diskette, only to get the message that an error occurred while trying to read the disk.

Remember Murphy's Law:
if anything can possibly go wrong, it will.

Protect yourself.



Lesson Two

Introduction	32
Loading the Sheet from Diskette	32
Replicating a Formula	33
Replicating a Range of Formulas	35
Formatting the Screen Display	37
Fixing Titles In Place	37
Now, For a Quick Recalculation	38
Adjusting Column Widths	39
Splitting the Screen.....	41
Global Commands in Separate Windows	42
Summary	43
Postscript: Memory and the Electronic Sheet	44
How the Sheet Is Reconfigured.....	44
The Memory Indicator	46
Dynamic Memory Allocation	46
Shrinking the Sheet.....	47



Lesson Two

In this lesson, the “fireworks” begin as we show how VisiCalc extends and generalizes the basic principles you have seen so far. We will begin with the example built up in Lesson One, showing a figure for SALES, and formulas to calculate COST of goods sold and GROSS profit.

If you have just finished Lesson One, everything you need should still be present on the electronic sheet. Check your screen against the screen photo below, and continue with the text from that point. If you want to practice loading the sheet you just saved, anyway, type /CY and then follow the instructions in the next section.

If you’re tackling Lesson Two in a new session, your first step is to load the VisiCalc program into your computer’s memory. The instructions to do this are in Part I in the section entitled “Loading VisiCalc.”

If you saved the results of Lesson One on diskette, you can easily reload the same information now by following the instructions below for “Loading the Sheet from Diskette”. If you don’t have the file EXAMPLE/VC saved on diskette, you can type in the same information from the keyboard. To practice moving the cursor and writing labels, numbers and formulas, you can go through the steps in Lesson One, or, if you’re comfortable with these VisiCalc features, you can type exactly the characters you see below. Remember you may have to use the SHIFT key to type some of the characters.

```
>A1Ⓢ  
SALESⓈ100Ⓢ  
>A2Ⓢ  
COSTⓈ.6*B1Ⓢ  
>A3Ⓢ  
“-GROSS -Ⓢ+ B1 - B2Ⓢ  
>B1Ⓢ
```

Now go on to “Replicating a Formula”.

Loading the Sheet from Diskette

Make sure that your disk drive’s ACTIVE light is off, then open the drive door and (if you haven’t done so already) carefully remove your VisiCalc program diskette and replace it in the pocket on the inside front cover of the binder holding this manual. Now insert the storage diskette holding the file named EXAMPLE/VC which you saved at the end of Lesson One into drive 0. Be sure that the write protection notch on the diskette jacket is up and the oval cutout enters the drive first. Gently push the diskette all the way in, and close the drive door.

Now type the VisiCalc STORAGE command /S The prompt line reads STORAGE: L S D Q #. (To review the meanings of the characters L S D Q #, check the section entitled “Saving the Electronic Sheet on Diskette” at the end of Lesson One.) Press L The prompt line reads FILE TO LOAD. At this point, you could simply type the name

EXAMPLE/VC, ending with the **Ⓢ** key. But let's try something else. Press the **⏏** key once. Your disk drive will whir for a moment as VisiCalc looks at the directory and the **ACTIVE** indicator lights on each drive will come on.

Then the name **EXAMPLE/VC** appears on the edit line! (If a different name appears, press the **⏏** key repeatedly until you get the name **EXAMPLE/VC**. When you press the **⏏** key, VisiCalc looks in the diskette's directory or catalog for the name of a file which could be a saved VisiCalc sheet. On the edit line, VisiCalc presents the first qualifying file name it finds in the directory for your inspection. If this file name is not the one you want, you would simply press the **⏏** key again and VisiCalc would show you another file name from the diskette directory. Eventually you will reach the name of the desired file or else you'll realize that you have the wrong diskette.)

Assuming that you have the name **EXAMPLE/VC** on the edit line, press **Ⓢ**. Watch the characters flashing by at the left end of the edit line. These are the same keystrokes you would type from the keyboard to set up the sheet, but they are being "typed" automatically at high speed as they come back from the diskette. After a moment, the disk drive **ACTIVE** light goes off, the information on the prompt and edit lines will disappear, and the screen should look just like the screen photo below. You can continue with the instructions following the photo.

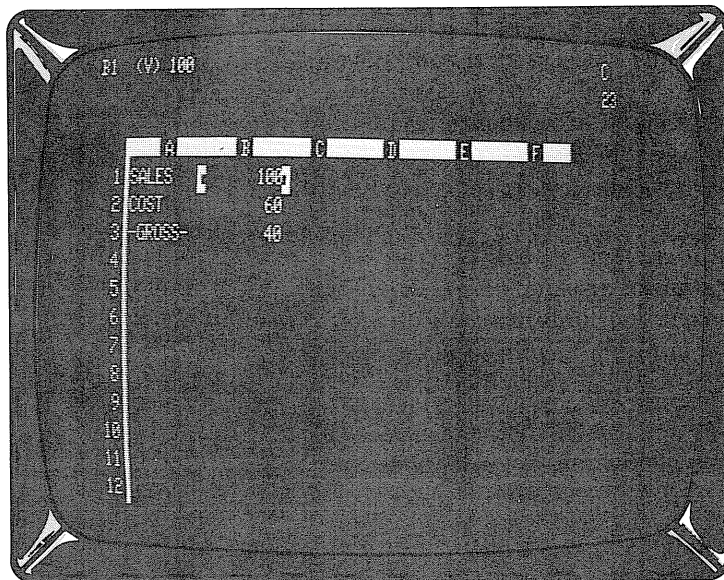

Replicating a Formula

Your screen should look exactly like the one pictured above. The cursor should be at B1. If the number under the cursor is not 100, just type **100** and press **Ⓢ**

At present, we have figures for sales, cost of goods, and gross profit for only one month (or year, or other period). Now, we'll project these figures out for twelve months. Let's assume that sales will increase by 10% each month. Press the \blacktriangleleft key to move the cursor to C1, and type: $1.1*\blacktriangleleft$ \textcircled{E} Notice that we used a cursor movement to fill in the coordinate B1 in the formula for the next month's sales. The entry contents line at the top of the screen now reads C1 (V) $1.1*B1$, and the number under the cursor highlight at C1 is 110, or $1.1*100$

To calculate sales for the remaining ten months, we would have to move the cursor to D1 and type the formula $1.1*C1$, then move on to E1 and type $1.1*D1$, and so forth. Since this is such a common operation and it requires so many keystrokes, VisiCalc provides a shortcut way to do it. The shortcut is the **REPLICATE** command, and it can be used to make copies of, or "replicate" formulas, labels, numbers, blank entries, etc. across columns, down rows and so forth. In this lesson, we'll use the replicate command in just a couple of simple examples. The many uses of this command are covered more fully in Lesson Three.

With the cursor at C1, type **/R** The prompt line reads REPLICATE: SOURCE RANGE OR ENTER, and on the edit line is C1, the coordinate of the formula under the cursor, followed by the dash. Press \textcircled{E} The prompt line now reads REPLICATE: TARGET RANGE, and the edit line reads C1 . . . C1: followed by the dash. So far, we have indicated that we want to replicate just the formula at C1, and VisiCalc is asking us where we would like to put copies of this formula.

Our intent is to project sales out for twelve months. The first month is shown at B1, the second at C1, and the twelfth month will be at M1. Hence, we want the formula replicated in the range of positions from D1 to M1. Press the \blacktriangleleft key, then type a period. The edit line now reads C1 . . . C1: D1 . . . _ As you can see, by moving the cursor, we are indicating where we want copies of the formula to be placed. Now press the \blacktriangleleft key ten times. Notice that as you move the cursor to D1, E1, F1, and so on, the "target range" on the edit line reads D1 . . . D1, D1 . . . E1, D1 . . . F1, and so on: VisiCalc is "filling in" the ending coordinate of the target range, just as it did when we moved the cursor in the middle of typing a formula.

When you have finished pressing the \blacktriangleleft key ten times, the cursor will be resting at M1, and the edit line will read C1 . . . C1: D1 . . . M1_ (If you moved too far with \blacktriangleleft , you can move back with \blacktriangleright .) Now press \textcircled{E} The cursor jumps back to C1, where the original formula is stored. The edit line reads C1: D1 . . . M1: $1.1*B1$ and the dash follows the coordinate B1 on the edit line. The prompt line reads REPLICATE: N=NO CHANGE, R=RELATIVE VisiCalc is asking whether we want the same formula, $1.1*B1$, at each of the positions in the target range D1 . . . M1, or whether the coordinate B1 should be interpreted as *relative* to the position of the formula.

We want sales to increase by 10% in each month, so we want the formulas to be $1.1*B1$, $1.1*C1$, $1.1*D1$, etc. In other words, each new sales figure should be 1.1 times the previous month's sales. Press **R** and watch the screen. The information on the prompt and edit lines disappears; the cursor remains at C1, where we started; and numbers have appeared in the visible columns.

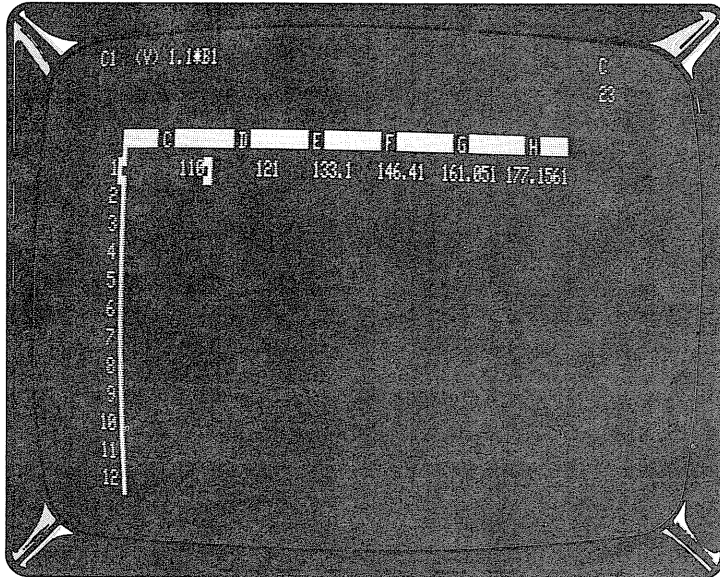

Use the \blacktriangleright key to move the cursor to D1, E1 and F1, and notice what appears on the entry contents line: $1.1 * C1$, $1.1 * D1$, and $1.1 * E1$. Press the \blacktriangleright key seven more times to move the cursor over the entries G1 through M1, scrolling the window to bring them into view. VisiCalc has “typed” the formulas for you, and calculated the sales values for all twelve months. At M1, the twelfth month’s sales should be shown as 285.3117 (to four decimal places).

Much has happened during the last few keystrokes, and of course there are many more options for the replicate command which we haven’t used in this case. But what you must remember to type to replicate a formula is very simple:

1. Point the cursor at the first entry position in the range you want to replicate;
2. Press $/R\textcircled{E}$ to start the replicate command;
3. Press $.$ and indicate the last entry position in the range to be replicated and then press \textcircled{E} or $:$;
4. Point the cursor at the first entry position in the range of positions where you want the formula replicated, press $.$ and point to the last entry position (or you can type in the entry coordinates); and
5. For each coordinate in the formula, press either **N** or **R** depending on whether that coordinate should be left unchanged, or interpreted as relative to the position of each copy of the formula.

Replicating a Range of Formulas

Type $>A2\textcircled{E}$ to scroll the window all the way back to the left edge of the sheet, and then press \blacktriangleright to move the cursor to B2. To complete our twelve month projection, we would like to replicate the formulas for cost of goods sold and gross profit. At the moment, the entry contents line shows the formula for cost of goods, $.6 * B1$. If we were to move the cursor to B3, we would see the formula for gross profit, $+B1 - B2$. We can replicate both of these formulas at once across the sheet.

Replicating a Range of Formulas

Press **/R** The prompt line reads REPLICATE: SOURCE RANGE OR ENTER and on the edit line is B2, followed by the dash. If you were to press **Ⓔ** at this point, as we did before, you would replicate just the formula for cost of goods sold at B2. When you were finished, you would come back to the formula for gross profit at B3, and replicate it into the same range of columns as you did for B2. We can accomplish both of these steps at once: Press **.B3Ⓔ** The edit line now reads B2 . . . B3:_ VisiCalc acknowledges that we want to replicate a "source range" of formulas B2 through B3. The prompt line reads REPLICATE: TARGET RANGE Instead of pointing at the first and last positions as we did before, we will simply type the coordinates of the target range. Type **C2.M2Ⓔ** For a source range of B2 . . . B3, and a target range of C2 . . . M2, VisiCalc will assume that the formula at B2 (for cost of goods) is to be replicated at positions C2 through M2, and the formula at B3 (for gross profit) is to be replicated at positions C3 through M3.

The prompt line now reads REPLICATE: N=NO CHANGE, R=RELATIVE and the edit line reads B2: C2 . . . M2: .6*B1 with the dash following the coordinate B1. How do we want the coordinate B1 to be interpreted? Our intent is that cost of goods sold in any given month will be 60% of that month's sales. Hence we want B1, the coordinate for SALES, to be interpreted as *relative* to the position of each copy of the formula. For the formula at B2, we want the sales figure just above it, or B1. For the formula at C2, we want the sales figure just above *it*, or C1; and so on. Press **R** Almost instantly, numbers appear in the other columns, and the edit line now reads B3: C3 . . . M3: +B1 with a dash following B1. VisiCalc is ready to replicate the formula for gross profit, at B3, into positions C3 through M3. The +B1 is the beginning portion of the formula +B1 - B2. Again, we want B1 to be interpreted as relative to the position of each copy of the formula. Press **R** Now the rest of the formula appears on the edit line, as +B1 - B2 this time with a dash following B2. B2, or cost of goods, is also relative in the gross profit formula. Press **R** once more. Numbers will appear in the other columns of row 3, and the prompt and edit lines will go blank. The REPLICATE command has finished its work.

	A	B	C	D	E	F
1	SALES	100	110	121	133.1	146.41
2	COST	60	66	72.6	79.86	87.846
3	GROSS	40	44	48.4	53.24	58.564
4						
5						
6						
7						
8						
9						
10						
11						
12						

Use the arrow keys to move the cursor to the right and up and down to examine the formulas and calculated results displayed in columns C, D, E and so on. Finally, type >M1[®] to display the last month's sales, cost of goods, and gross profit in column M. VisiCalc has saved you a good deal of work already. But these numbers are somewhat hard to read, because they fill the columns and don't always line up. Can we do better than this?

Formatting the Screen Display

Of course. Type /GFI (for "global format integer," as explained below), and watch what happens. Is the new display easier to read? If you scroll the window to the left, you will see that all of the numbers which come into view on the screen have been rounded to integers and lined up on the right. However, this does not mean that VisiCalc has actually rounded the numbers that it uses in its calculations. Each number is calculated and maintained with up to eleven significant digits or decimal places (so that, for instance, each new period's sales is based on an accurate rendition of the previous period's sales). The numbers are rounded only as they are displayed on the screen.

Perhaps you'd prefer to see two more decimal places, for "dollars and cents." Press / the keystroke which starts all commands. The prompt line reads COMMAND: BCDFGIMPRSTVW— Each of the keys, B, C, D, and so on through '—' is the keystroke for a different command. So far, we have seen the commands /B (for **BLANK**), /C (for **CLEAR**), /R (for **REPLICATE**), and /S (for **STORAGE**). Now, press G. The prompt line reads GLOBAL: C O R F VisiCalc has recognized the GLOBAL command, which is used to change something about the entire screen display. Next, VisiCalc expects one of the keystrokes C, O, R or F. Press F Now the prompt line reads FORMAT: D G I L R \$ * VisiCalc is ready for a change to the "global format," or the way in which numbers and alphabetic labels are displayed on the screen. A moment ago, you used the letter I to change all of the numbers to integer format. Now, press \$ (you need to use the SHIFT key on your keyboard). Remember that you can use the CLEAR key to stop the command and start over. Notice how the screen display changes to show everything in dollars and cents form.

As you might guess from the FORMAT prompt list D G I L R \$ *, there are many other ways to format numbers and alphabetic labels. It is also possible to set the format of each entry position individually. These options will be covered more fully in Lessons Three and Four of this Tutorial.

Fixing Titles In Place

If the cursor is not on M1, type >M1[®] Only the numbers for each month's sales, cost of goods and gross profit are shown on the screen. The titles SALES, COST and —GROSS— have scrolled off the screen window to the left. Imagine the situation if you were preparing a more complex income projection, with many rows of numbers for selling and administrative costs, taxes, and so on. It would be difficult to remember what each row of figures represented, once the titles had scrolled off the screen. We'd really like the titles to stay visible at the left edge of the screen window.

No more easily said than done. Type **>A1** to bring the titles SALES, COST and -GROSS- into view. Now type **/T** (the **TITLES** command). The prompt line says TITLE: H V B N The possible keystrokes are:

- H** To fix horizontal titles.
- V** To fix vertical titles.
- B** For both horizontal and vertical.
- N** For neither.

For now, press **V** You have asked VisiCalc to fix the vertical column A, where the cursor lies, in its present position, no matter where the cursor is moved subsequently. Press the **↵** key eight times, watching the screen as you do so. Notice that column A stays fixed in place, while the remaining columns scroll to the left, disappearing when they reach column A. Now press the **↵** key nine times. (If you aren't sure of what happened, press the **↵** key again.) You are "bumping" into column A, just as you bumped into the left edge of the sheet once before. Next, type **>M1** Column A is still visible, making it easy to identify each row of numbers.

	A	I	J	K	L	H
1	SALES	194.87	214.36	235.79	259.3	285.31
2	COST	116.92	128.62	141.48	155.62	171.19
3	-GROSS-	77.95	85.74	94.32	103.75	114.12
4						
5						
6						
7						
8						
9						
10						
11						
12						

Now, For a Quick Recalculation

So far, with the aid of the **REPLICATE** command, you have written one number (the beginning number for sales at B1), and thirty-five formulas on the electronic sheet. How are these formulas related? Press **>B1** to bring the first columns into view,

leaving the cursor on the initial sales figure. The formula for cost at B2 is $.6*B1$ which depends on the figure for sales at B1. The formula for gross profit at B3, in turn, depends on both sales and cost ($+B1 - B2$). What about succeeding columns? At C1, the formula is $1.1*B1$ so this entry also depends on the initial sales figure. And cost of goods at C2 depends on the figure at C1, while C3 depends on both C1 and C2. At D1 we have $1.1*C1$, and so on. As you can see, a change to the initial sales figure at B1 will affect every other number on the sheet. Try it. Just type a new number, such as 123.45, and press $\text{\textcircled{E}}$. How long did it take to recalculate twelve months' worth of sales, cost of goods and gross profit formulas? Type **100** (and $\text{\textcircled{E}}$) again, and watch the changes ripple through the other figures on the screen. Scroll the screen window to the right to view M1, the ending month's sales.

At this point, if you're intrigued by this example, you'd like to know how to change the sales growth figure of 10%, or the cost of goods percentage of 60%, and recalculate gross profit. For simplicity's sake, we've designed this example so that the only changeable figure is the initial sales. Since the figures 1.1 and .6 are built into each of the twelve formulas for sales and cost of goods, we can't change these percentages without replicating all of the formulas again. A better approach would be to write the factors .1 and .6 into separate positions on the sheet, and make the sales and cost of goods formulas refer to these positions. If we did this, changing the sales growth and cost of goods percentages would be as easy as changing the initial sales. We'll make use of techniques like this in Lesson Three. (If you're *not* intrigued by this business-related example, bear with us; Lesson Three deals with personal budgeting.)

Adjusting Column Widths

Type $>B1\text{\textcircled{E}}$ For some time now, you've been scrolling the window back and forth across the sheet to view the figures for different months. You might be wishing for a larger screen that would display more columns at once. Well, you *can*.

Type another GLOBAL command: $/GC7\text{\textcircled{E}}$ In an instant, the screen changes to display more columns. Each column has been narrowed from nine characters to seven characters in width. You can use the command $/GC$ to set the "global column width" to anywhere from 3 to 60 characters per column. Given a column width, VisiCalc will fit as many columns as it can across the screen.

Right now, the dollars and cents figures just about fill up the available space in these 7-character columns. But we already know how to round the numbers to integers: Type $/GFI$ Now, we have some extra space, so let's narrow the columns further: Type $/GC4\text{\textcircled{E}}$ That gives us even more columns of figures in the window, each column four characters wide.

	A	B	C	D	E	F	G	H	I	J	K	L	M	N
1	SALE	100	110	121	133	146	161	177	195	214	236	259	285	
2	COST	60	66	73	80	88	97	106	117	129	141	156	171	
3	-GRO	40	44	48	53	59	64	71	78	86	94	104	114	
4														
5														
6														
7														
8														
9														
10														
11														
12														

Pause for a moment. Look at the titles, SALES, COST, and -GROSS- in column A. SALES has been shortened to SALE, and -GROSS is now -GRO. Have we lost the rest of the labels SALES and -GROSS-? Move the cursor to position A1 to find out. If you press the \leftarrow key, you'll bump into column A, which we fixed in place as a title area. Type $>A1$ $\text{\textcircled{E}}$. The entry contents line reads A1 (L) SALES. Press \downarrow twice to reach A3. The entry contents line reads A3 (L) -GROSS-. Even though the columns have been narrowed, the full alphabetic labels are preserved.

Can these labels be more than nine characters long? Of course; in fact, you can type an alphabetic label as long as you like, regardless of the current column width, and the full label will be preserved. Try this: with the cursor still at A3, type **GROSS PROFIT**. Then press the \uparrow key to move up to COST, and type **COST OF GOODS SOLD** followed by $\text{\textcircled{E}}$. Next, type $/GC12$ $\text{\textcircled{E}}$. Notice that the entire label GROSS PROFIT comes into view, while the number of columns in the window is reduced. Now, type $/GC18$ $\text{\textcircled{E}}$. Notice the prompts GLOBAL: C O R F and COLUMN WIDTH, and the dash on the edit line as you type. As usual, the CLEAR key can be used for corrections as you enter the number 18. The entire label COST OF GOODS SOLD can be seen. Let's go back to $/GC7$ $\text{\textcircled{E}}$.

The ability to fix titles in place and adjust column widths gives us some compensation for the limited size of the screen. But, suppose we'd really like to keep the wider columns and the cursor at B1, the initial sales figure, and change it, while watching what happens to the final sales and gross profit at column M. If only we had two screens

Splitting the Screen

Type **>E1** to move the cursor to column E. Now, type the **WINDOW** command **/W**. The prompt line reads **WINDOW: H V I S U**. Press **V** (for vertical). Your screen should look like the photo below.

	A	B	C	D		A	F	G	H
1	SALES	100	11	121	1	SALES	146	161	177
2	COST OF	60	66	73	2	COST O	88	97	106
3	GROSS P	40	44	48	3	GROSS	59	64	71
4					4				
5					5				
6					6				
7					7				
8					8				
9					9				
10					10				
11					11				
12					12				

You have created two screen windows. Each one can be scrolled independently to view any portion of the electronic sheet. At present, the cursor is in the left hand window. Use the **↓** key to move the cursor downwards to row 12 and beyond. The left window will scroll downwards to follow the cursor, but the right window will remain still. Bring the left window back to the top of the sheet with **>B1**.

Now press the **;** key (you won't need to press the SHIFT key). The cursor jumps into the right hand window. Press the **→** key to scroll the right window across to column M. We now have both the beginning and ending months' sales, cost of goods and gross profit figures visible at the same time. Press **;** again. The cursor jumps back to the left window. (Each time you press the **;** key, the cursor jumps from one window to the other.) Notice that the cursor has landed at the same position it was on when we last jumped out of the left hand window.

Now we can change the initial sales figure, and watch what happens in the final month. Type **123** followed by **↵** and let VisiCalc recalculate. Sales in column M should be 351. Try typing a few more numbers with the cursor at B1. See if you can find, by trial and error, the initial sales figure which gives you an ending month's sales of 1000 (rounded to the nearest integer). (Hint: You can type a number with a decimal point, even though it will be displayed in rounded form.)

When you are finished experimenting with recalculation, type the **WINDOW** command **/W** again. This time, press **1**. The screen returns to normal (1 window). We have

seen that the idea of a split screen is useful. Can we get any more mileage out of this approach? Take a look at the screen, and notice how much of it is empty. Perhaps we can use the lower part of the screen to better advantage.

Type **>B7** to move the cursor down to the middle row of the screen. Now type **/WH** (for horizontal). Your screen should look like the photo below.

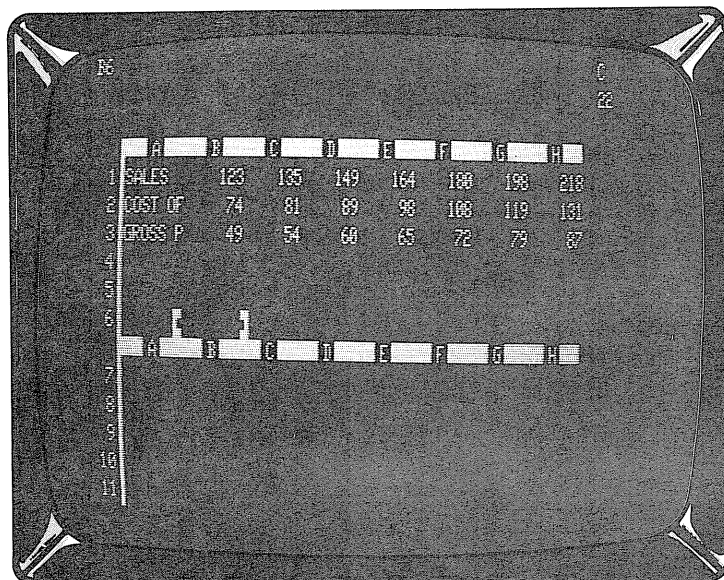

This time the screen is split horizontally, into a top and bottom window. Press the **;** key to move the cursor into the bottom window. Next, hold down **↑** to scroll the window upwards, until the cursor bumps into the top edge of the sheet. Both windows are now displaying the same portion of the electronic sheet! The cursor should be at B1 in the bottom window. Just for fun, change the number at B1 to 100 in the bottom window, and watch what happens. The recalculation affects both windows. Use the **→** to scroll the bottom window rightwards until column M comes into view. Now we can see the first and the last months at the same time.

Global Commands in Separate Windows

Press **;** to move the cursor into the top window, and type **/GC4**. Once again, we have more columns on display at the top of the screen, each column four characters wide. As you can see, the column widths can be different in the two screen windows. The global commands **/GC** and **/GF** affect only the window in which the cursor rests at the time the command is typed. Press **;** once more, moving the cursor to the bottom window, and this time type **/GF\$**. We have dollars and cents displayed in the bottom window, and integers at the top.

Press **;** to jump the cursor into the top window, and type **>B1** to highlight our original sales figure. At B1, type the number **300** followed by **↵** and watch the changes ripple through all the columns as VisiCalc recalculates all the formulas. Now type the

number 600[®] What happens? Columns H through M show > symbols in some positions instead of numbers. As you can probably guess, the calculated results are too large to display in integer form in the narrow columns of the top window, or with two decimal places in the bottom window. You can press ; and type /GFI to see the final sales figure at M1 in the bottom window. It should be 1712

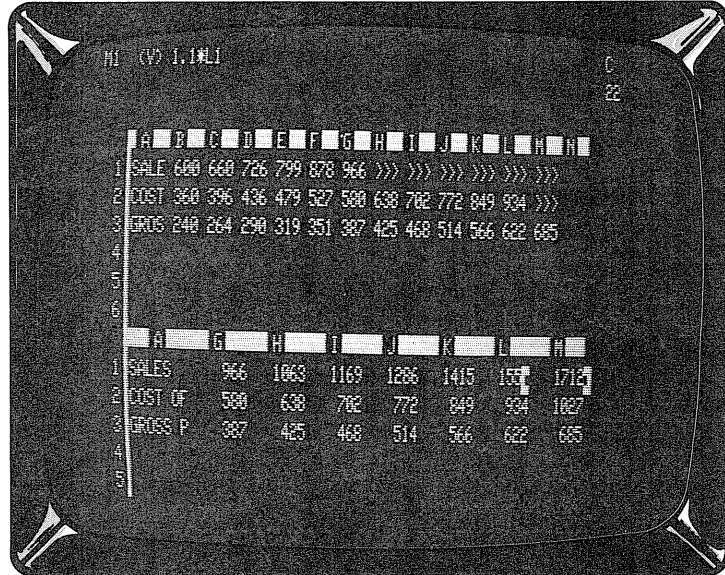

Summary

We have covered a lot of ground in this lesson and, at this point, after the many examples we've shown here, you may be a little hesitant to even touch the keyboard, in view of the radical changes to the appearances of your work which can result from just a few keystrokes. The features and commands you have seen here can be mastered more easily than you might think. Remember the following key points:

1. No matter what you type at the keyboard, you cannot hurt either the computer or the VisiCalc program. Moreover, it's fairly difficult to destroy your own work on the electronic sheet, particularly if you watch the prompt line for keystroke-by-keystroke feedback and save the sheet periodically on diskette.
2. Throughout this lesson, we have introduced only four new commands. They are:

The **REPLICATE** command /R which gives you a shortcut way of writing similar formulas in adjacent rows and columns.

The **GLOBAL** command /G which lets you change the column width (/GC) and the way numbers are formatted (/GF)

The **TITLES** command /T which lets you fix rows or columns of alphabetic titles in place as part of the top or left hand "border".

The **WINDOW** command **/W** which lets you split the screen, either horizontally or vertically, into two independently scrollable windows.

Much of the power of VisiCalc is due to the simple and highly consistent way in which these commands interact with one another. In almost any context, a command will do what you would logically expect.

3. Aside from the replicate command, which basically saves you time as you write formulas, all of the commands discussed in this lesson affect only the *appearance* of your work on the screen (generally in an effort to compensate for a small screen size). Nothing you might do with the **/G**, **/T** or **/W** commands can affect the labels, numbers or formulas actually written on the sheet. When in doubt, you can always type **/W1/N /GFG/GC9**® to return everything to normal.

Armed with these assurances, you should be ready to *experiment*. Clear the screen and try out these commands with a problem of your own. If you don't understand something, go back through this lesson to see what you might have missed, and check Part III of this manual (the VisiCalc Command Reference) and the reference card for more complete explanations. You now know enough about VisiCalc to begin to use it really effectively. Good luck!

Postscript: Memory and the Electronic Sheet

As you may know, your computer contains two kinds of fast semiconductor memory: RAM and ROM. ROM, or "read only memory," is manufactured with a fixed pattern of data or program instructions stored in it, whereas RAM, or "random access memory" is made in such a way that it retains data which is put into it only as long as the memory's electric power is left on, or until new data is put into the memory in place of the old data. Data or program instructions are put into RAM memory either by typing at the keyboard or by loading prerecorded programs or data from cassette or diskette.

The VisiCalc program is loaded into RAM memory from diskette, and it, together with some RAM which the computer itself requires, takes up about 25K bytes. The remainder of RAM memory is devoted to the VisiCalc electronic sheet. VisiCalc manages this area of memory automatically. You never have to concern yourself with the details of how the electronic sheet is maintained. But you will find it useful to have a general idea of how the sheet works, as you being using VisiCalc to its fullest capacity.

How the Sheet Is Reconfigured

Let's try some experiments. If you have not already done so, load VisiCalc into your computer. (You can refer to the instructions in the section entitled "Loading VisiCalc.") If you already have VisiCalc running, type **/CY** to clear the sheet.

Now type **>BK254** to move to the lower right hand corner of the sheet. Let's try to write a number at this position. Type **1** What happens? As usual, VALUE appears on the prompt line, and 1 appears on the edit line, followed by the dash. But when you press VisiCalc simply flashes the screen and leaves nothing at position BK254. Think for a moment. Just how large is this electronic sheet? The columns are lettered A through Z, AA through AZ, and BA through BK, for a total of 63 columns. There are 254 rows, so that makes a total of 63×254 , or 16,002 entry positions. Right now, each position is nine characters wide. If all 16,002 entry positions were filled with alphabetic labels nine characters long, they would take up $16,002 \times 9 = 144,018$ bytes of memory. That's considerably more RAM memory than you can possibly have on your computer! What's more, as you saw in Lesson Two, the columns can be widened and the wider you make them, the more bytes would be needed.

You can conclude that, even though VisiCalc lets you scroll down to position BK254, the electronic sheet is not really this large, because of RAM memory limitations. Just how far does the sheet actually extend? Let's try some experiments to find out.

Type **>BK1** to move the cursor to the upper right hand corner of the sheet. Now try typing **1** It works: the number 1 is recorded at position BK1. Apparently, the sheet extends as far as column BK. Now, let's try the lower left hand corner. Type **>A254** then try typing **1** VisiCalc flashes the screen and refuses to record a number there. So the sheet doesn't seem to extend all the way down to row 254.

Before you draw conclusions from this experiment, let's try another one. Type **/CY** again to clear the sheet. Then type **>A254** once more. Let's try writing the number 1 in this position again: Type **1** It works! This time, the sheet seems to extend down to row 254 after all. Now type **>BK1** to move to the upper right hand corner of the sheet, where we recorded the number 1 a moment ago, before clearing the sheet. Type **1** What happens? VisiCalc refuses to record the number. Obviously, something unexplained is going on here.

The explanation is that the electronic sheet is dynamically reconfigured: it grows to be the size and shape you need as you use it. You actually start with a 1 by 1 sheet, starting and ending at position A1. Although you can move the cursor to any position up to BK254, no memory is actually allocated for the sheet until you write something on it. Then the sheet grows into a rectangle just large enough to include the rightmost and bottommost positions in which something is written. As you move further downwards and to the right, writing labels, numbers and formulas, this process continues, until the available memory is exhausted.

When you wrote the number 1 at position BK1, the sheet grew to a size of 1 row by 63 columns. Then, when you tried to write in position A254, VisiCalc tried to extend the sheet to be a rectangle of 254 rows by 63 columns, but there was not enough memory available. The reverse happened when you cleared the sheet and wrote the number 1 at position A254: The sheet grew to a rectangle of 254 rows by 1 column. Then it was unable to grow to be 254 by 63.

The Memory Indicator

Type **/CY** again to clear the sheet. Look in the upper right corner of the screen on the prompt line. Just below the letter C is a two digit number called the **memory indicator**. This number is the amount of memory still available for additional entries on the sheet in K bytes. With 48K of memory, this number should be 23 (or close to it). The memory indicator will vary as you write information on the sheet or use commands, such as replicate, to write information. If you finally exhaust all of the available memory, VisiCalc will flash the control panel and refuse to write anything more on the sheet, as it did when you tried to write at position BK254.

One question remains unanswered: How many bytes of memory does each entry position take up? You know that labels, numbers and formulas can be of different lengths and that column widths can be adjusted from as few as 3 to as many as the full width of your screen. The answer is not obvious, so let's experiment.

Type **>Z100** Since we cleared the sheet a moment ago, we currently have just a 1 by 1 sheet. As soon as we write something at Z100, the sheet will expand to be 26 columns by 100 rows, for a total of 2600 entry positions. If each position takes, say, 9 characters (the current column width), the sheet might use up $2600 \times 9 = 23,400$ bytes. With 32K of memory, a sheet of 2600 positions of 9 characters each might more than exhaust available memory. Let's try it: **Type 1** What happens? The memory indicator changes from 23 to about 18. The sheet has grown to 2600 entry positions, but only about 5K bytes have been used. Since most of the newly created sheet is blank, VisiCalc reserves a minimum amount of memory—only 2 bytes—for each entry position.

Dynamic Memory Allocation

If you type a long message or formula at a particular entry position, VisiCalc will reserve additional bytes of memory for the position; but all of the other positions on the sheet will remain just large enough to hold the information which you have written in them. This is called "dynamic memory allocation." Let's see how it works. Type **>Z1** At Z1, type the label **A LONG MESSAGE TO FILL MEMORY** and press **Ⓜ**. So far we have used only a few bytes, so the memory indicator is unchanged at 18. Now we'll use up a lot of memory quickly. With the replicate command, we'll create 100 copies of the label **A LONG MESSAGE TO FILL MEMORY**. Type **/R** and for the target range of the replicate command type **Z2.Z100** Watch the memory indicator: After a few seconds, as the replicate command does its work, the indicator changes from 18 to 14 (or, on some computers, 15). We have used up about 3–4K bytes.

One more experiment: Let's erase all the messages we have written at Z1 through Z100. Once again, we'll enlist the aid of the replicate command. First, type **/B** to blank out position Z1. Then type **/R** The target range is again **Z2.Z100** As the messages disappear, watch the memory indicator: It changes from 14 (or 15) back to 18! As you can see, VisiCalc reclaims the extra memory space used for long labels or formulas when they are erased from the sheet.

To sum up, VisiCalc manages memory efficiently and automatically. Because memory is dynamically allocated and the sheet is reconfigured to suit your needs, you can, for all practical purposes, work on a sheet that is much larger than you could actually fit into the computer's RAM memory. Aside from noticing from time to time how much space is still available for you to write in more entry positions, you need not concern yourself with problems of memory management.

Shrinking the Sheet

One thing VisiCalc does not do automatically, however, is to "shrink" the sheet. Suppose that you have written on various portions of the sheet, causing it to grow to a size of 100 by 100 positions. Later, having finished with this information, you might have erased or blanked out the entry positions near the right and bottom edges of the 100 by 100 sheet. The sheet will remain configured as 100 by 100, although each empty position will require only 2 bytes. If you begin using additional memory by writing lengthy labels and formulas in other positions, you may want to shrink the sheet to the smallest possible configuration for the information still written on it. To do this, you must save the sheet on diskette with the /SS command (as discussed in Lesson One), clear the sheet with /CY and reload the saved sheet with the /SL command (as discussed in Lesson Two). As the disk file is loaded, VisiCalc will enter on the sheet only those labels, numbers and formulas actually saved, and in the process the sheet will grow from a 1 by 1 configuration to just the size you need for the information remaining. This will make available more memory space for additional labels and formulas.



Lesson Three

Introduction	50
Typeahead.....	50
Replicating Numbers and Labels	51
Using Formulas For Flexibility	52
Replicating Down a Column	54
Replicating a Column Several Times.....	54
Fixing Titles In Both Directions.....	55
The Built-In Function @SUM	56
Formatting a Single Entry.....	58
Replicating a Format Specification	59
Using Replicate To Copy a Row or Column.....	59
Changing Windows and Titles.....	60
The @NA and @ERROR Functions	62
The Insert and Delete Commands	63
Calculating Interest On a Savings Account	64
The Move Command.....	66
Obtaining Monthly Expense Percentages.....	67
Synchronized Scrolling.....	69
The Order of Recalculation	70
Forward and Circular References.....	72
Summary.....	73
Postscript: The Print Command.....	73

Lesson Three

In Lessons One and Two, we used several examples to illustrate both the simplicity and the power inherent in VisiCalc's concepts and features. Although each individual VisiCalc command is quite simple, the various commands can be used in combination with each other to achieve a wide range of useful effects. As with any tool, there is a skill involved in using VisiCalc effectively, and you will gain this skill through experience. In this lesson, we will begin to illustrate some of the techniques you can use to get the most out of VisiCalc's commands. We will also introduce more VisiCalc commands and features in this lesson.

Let's begin with a clean slate. Load the VisiCalc program into your computer as described in the section entitled "Loading VisiCalc," or, if you already have the program running, clear the sheet by typing /CY

In this lesson we'll outline a household budget application, with suggestions as to how you might adapt it for your own use. To prepare a budget, we'll first project our income for the next twelve months. We'll also project various necessary expenses such as food, rent or mortgage, telephone, etc. as well as semiannual expenses such as car insurance. Then we'll use VisiCalc to find out how much of our income is left for leisure and for savings and what percentage of our income is going for each category of expense. Finally, we'll consider various enhancements such as calculating the interest on our savings account.

Typeahead

First, we'll lay out twelve months or periods across the sheet. Type the word **PERIOD** and press the \blacktriangleright key to move on to position B1. Now, as fast as you can, type the following keys: $1\blacktriangleright 2\blacktriangleright 3\blacktriangleright 4\blacktriangleright$ and watch what happens on the screen. Were you typing faster than VisiCalc could move the cursor and write the numbers on the sheet? If so, you noticed a feature called **typeahead**: VisiCalc remembers the keystrokes you type, no matter how fast you go, and it catches up with you as soon as it can. (If you are wondering why VisiCalc was so slow in the first place, read the section in Lesson Two entitled "Memory and the Electronic Sheet" and you'll realize that the sheet was actually "growing" as you typed.)

Before going on to type the numbers 5 through 12, let's ask ourselves: Is there a better way? Let's use the replicate command and let VisiCalc **calculate** the numbers 1 through 12. Use $>A1\textcircled{R}$ to move the cursor back to C1, where the number 2 is written. Can you obtain the number 2 from a formula? It's simple: Type $1+\blacktriangleright\textcircled{R}$. The entry contents line should read C1 (V) 1+B1 and the value 2, now the result of $1+B1$ or $1+1$, should still be present at C1. Now, let's replicate. Type $/R\textcircled{R}$. The prompt line reads REPLICATE: TARGET RANGE and the edit line reads C1 . . . C1: fol-

lowed by the dash. Press \blacktriangleright to obtain the starting position, D1; then press . and finally, hold down the \blacktriangleright key to move the cursor to column M, which will be period 12. (If you overshoot, back up with the \blacktriangleleft key.) The edit line should read C1 . . . C1: D1 . . . M1_ Now press $\text{\textcircled{E}}$ The prompt line reads REPLICATE: N=NO CHANGE, R=RELATIVE and the edit line reads C1: D1 . . . M1: 1+B1 with a dash after B1 as in the photo below.

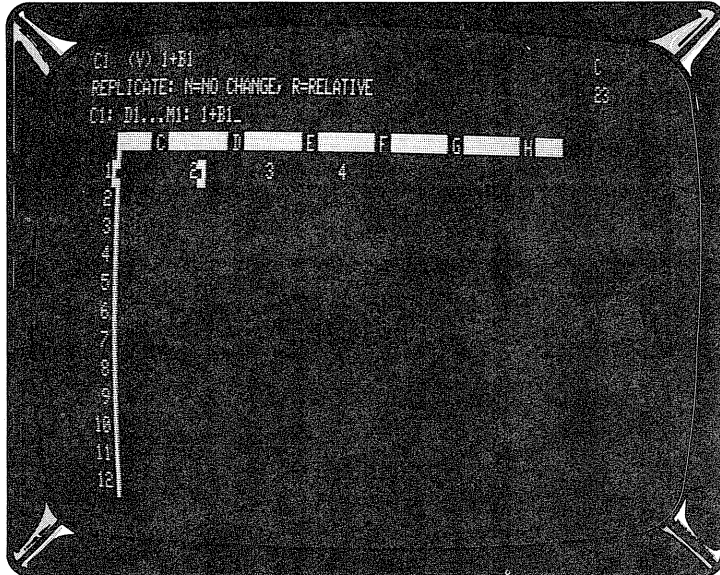

Press **R** to make the coordinate relative: This will give us 1 + C1, 1 + D1, etc. The prompt and edit lines should go blank. Move the cursor out to column M to check your work: Position M1 should show the number 12.

Replicating Numbers and Labels

Type the following characters, ending with the $\text{\textcircled{E}}$ key as shown:

```
>A2 $\text{\textcircled{E}}$ 
INCOME $\blacktriangleright$ 1800 $\text{\textcircled{E}}$ 
```

We'll assume that \$1800 is your monthly "take-home pay" after taxes and other deductions. Now, let's fill in the figure 1800 for all twelve months. Press **/R** $\text{\textcircled{E}}$ Can you replicate a single number as well as a formula? Of course: A number is actually the simplest case of a formula. For the target range, type **C2.M2** $\text{\textcircled{E}}$ You aren't asked whether the new formula is relative or not, because there are no coordinates in the "formula" 1800. The number 1800 should now appear in all twelve columns, in positions B2 through M2.

Next, we'll draw a line across the sheet. Move the cursor with **>A3** and then type **/-** The prompt line reads LABEL: REPEATING and a dash appears on the edit line. Whatever character or characters we type next will be repeated to fill the entry position A3. Type **-** followed by **9** You should now have a line of nine hyphens at A3. Is this any different from simply typing the hyphens manually? Type **/GC12** As you can see, the repeating label expands to fill the widened entry position. Now, go back to **/GC9**

How can we easily extend the line across all twelve columns? The ever-useful replicate command will also replicate labels. Type **/R** For the target, type **B3.M3** It's that simple. You should now have a line of hyphens extending all the way to column M.

Using Formulas For Flexibility

Before we go any further, let's think about what we've done. To save ourselves the trouble of typing the number 1800 twelve times, we replicated this number. That's fine as far as it goes, but is it the best way to handle our income? It would be better if we could change the income figure for all twelve months by simply typing a new figure for the first month and taking advantage of VisiCalc's recalculation feature. Let's replicate a formula instead of a number. Type:

>C2
+B2

We have defined the second month's income to be the same as the income for the first month. Next, let's replicate: Type **/R** The target range is **D2.M2** Now the prompt line reads REPLICATE: N=NO CHANGE, R=RELATIVE. Do we want the same formula, **+B2**, in all of the remaining positions, or would we prefer **+B2, +C2, +D2**, etc.? Either way we can change the income for all twelve months simply by typing a new number at B2. Think further: What if we should get a raise in the sixth month? If the formulas refer to the previous month, we can simply type a new number in month 6 and "propagate" the change through months 7-12. Let's try it. Type **R** to make the coordinate B2 relative. When the replicate command has finished, use the **↓** key to move to month 6 (position G2). Now type **2000** Press **↓** a few more times to verify that each succeeding month's income has changed to 2000. Were you able to foresee the way in which the change would be propagated? If you weren't sure, move the cursor over all twelve income figures and imagine what would have happened if all of the formulas were **+B2**.

Our next task is to list our expense categories and estimate monthly amounts for each category. (Some expenses will vary from month to month, and other expenses will occur perhaps only every six months. We will leave these blank for the moment.) You can either type the following exactly as shown, or you can use the arrow keys to move the cursor and save yourself some keystrokes. (Hint: To take full advantage of the arrow keys, type all the alphabetic labels first.)

>A4Ⓞ
MORTGAGE↵600↵
 >A5Ⓞ
UTILITIES↵
 >A6Ⓞ
TELEPHONE↵75↵
 >A7Ⓞ
FOOD↵350↵
 >A8Ⓞ
CLOTHING↵100↵
 >A9Ⓞ
CAR EXPENSE↵80↵
 >A10Ⓞ
CAR INSURANCE↵
 >A11Ⓞ
SAVINGS↵150↵
 >C2Ⓞ

At this point your screen should look like the screen photo below:

	A	B	C	D	E	F
1	PERIOD	1	2	3	4	5
2	INCOME	1000	1000	1000	1000	1000
3						
4	MORTGAGE	600				
5	UTILITIES					
6	TELEPHONE	75				
7	FOOD	350				
8	CLOTHING	100				
9	CAR EXPEN	80				
10	CAR INSUR					
11	SAVINGS	150				
12						

Next, we would like to replicate the monthly expense figures in column B across for the remaining eleven months. Remember our discussion of the merits of replicating a number versus a formula for our monthly income? To give ourselves maximum flexibility, we should also replicate formulas for the monthly expenses. At C4 we want the formula +B4; at C6 we want the formula +B6; at C7 we want +B7; and so on. (We'll fill in figures for UTILITIES and CAR INSURANCE later.) These formulas are so similar to each other and to the income formula +B2 that it's tempting to look for a shortcut way of typing them. Once again, the replicate command comes to our aid. This time, we'll replicate a formula down a column instead of across a row.

Replicating Down a Column

Make sure that the cursor is at C2. The entry contents line reads C2 (V) +B2. In a relative sense, C2 is to B2 as C4 is to B4, and so on: We want to treat the coordinate B2 as **relative**. Type /R[Ⓢ]. The prompt line reads REPLICATE: TARGET RANGE and on the edit line is C2 . . . C2: followed by the dash. Press the \blacktriangledown key twice. Now the edit line reads C2 . . . C2:C4. Type a period. The cursor jumps back to C2; VisiCalc acknowledges that the target range will start at C4. Next, press the \blacktriangledown key nine times (or hold it down to utilize the auto repeat ability) to reach position C11, opposite the figure for SAVINGS. The edit line now reads C2 . . . C2:C4 . . . C11_ so the target range will be C4 through C11. Press [Ⓢ]. The cursor jumps back to C2, and the prompt line reads REPLICATE: NO=NO CHANGE, R=RELATIVE. The edit line reads C2:C4 . . . C11: +B2 with the dash following the coordinate B2. We want this coordinate to be relative: Press R. A column of numbers, from 600 to 150, appears in column C. Use the \blacktriangledown key to move the cursor downwards, pausing to look at the formulas we've replicated. We have what we wanted: At C4 is +B4, at C6 is +B6, and so on. We also have formulas at C5 and C10, but we can easily eliminate them. You can use \blacktriangledown and /B to do this, or you can type exactly the following:

```
>C5Ⓢ
/B $\blacktriangledown$ 
>C10Ⓢ
/B $\blacktriangledown$ 
>C4Ⓢ
```

Replicating a Column Several Times

We now have the formulas we want for each expense category. The next step is to replicate these formulas across the rows through month 12. Do you remember how we replicate a source range of formulas, for both cost of goods sold and gross profit, across the rows in Lesson Two? We can do the same thing here. Press /R. The prompt line reads REPLICATE: SOURCE RANGE OR ENTER and on the edit line is C4 followed by the dash. Press the \blacktriangledown key seven times to move the cursor down to C11. The edit line reads C4 . . . C11 followed by the dash. Now press [Ⓢ]. The cursor jumps back to C4, and the prompt line asks us for a TARGET RANGE. Type D4.M4[Ⓢ]. We have asked VisiCalc to replicate the formula at C4 into positions D4 through M4; the formula at C5 into positions D5 through M5; the formula at C6 into positions D6 through M6; and so on, through the formula at C11. Notice that we gave only the first coordinate in each column in the target range. Now the prompt line reads REPLICATE: N=NO CHANGE, R=RELATIVE. On the edit line is C4: D4 . . . M4: +B4 with a dash following B4. This is the formula for the first expense, mortgage. As was the case for B2 (income), B4 should be relative. Press R and watch the screen. Several things happen:

1. The cursor disappears (don't worry).
2. The number 600 appears at positions D4, E4, and F4.
3. The edit line now reads C6: D6 . . . M6: +B6.

VisiCalc has finished replicating the formulas +B4, +C4, +D4, etc. in row 4, and has also replicated the blank entry at B5 into C5, D5, E5, etc. Next, VisiCalc wants to know how to handle the formula +B6 on row 6. All of these formulas will be relative; press **R** five more times, and then sit back and relax. You have written a total of 80 numbers and formulas on the electronic sheet, with the aid of the replicate command.

Think about the technique we used to replicate the expense formulas: starting with the prototype formula +B2 at position C2, we created six more prototype formulas by replicating down a column: +B4 at C4, +B6 at C6, etc. Then, we used these formulas as our source range to replicate similar formulas across on rows 4 through 11. Each of the resulting monthly expenses can be changed for all twelve months simply by typing a new number for the first month. For example, type >**B8**Ⓔ and change the number there to **120**Ⓔ Your clothing budget is raised to \$120 for all twelve months.

To complete our projection of expenses, we'll fill in figures for those expenses which cannot be replicated across because they vary from month to month. Our utilities bill will vary depending on the season and the need for heating or air conditioning. Our car insurance premiums are due every six months; we'll pay a premium in month 1 and month 7. Type the following exactly as shown:

```
>B5Ⓔ
140Ⓔ140Ⓔ80Ⓔ80Ⓔ40Ⓔ40Ⓔ85Ⓔ85Ⓔ50Ⓔ50Ⓔ100Ⓔ140Ⓔ
>B10Ⓔ
160Ⓔ
>H10Ⓔ
160Ⓔ
```

We do not have to fill in zeros for the other ten months in the row for car insurance, because VisiCalc treats any blank entry as equivalent to zero. (In fact, any entry containing an alphabetic label will have a "value" of zero if it is referenced elsewhere in a formula.)

Now is a good time to save your work on diskette, if you have not already done so. Make sure that your disk drive's ACTIVE light is off, then remove your VisiCalc program diskette and replace it in the pocket on the inside front cover of the binder holding this manual. Now insert a storage diskette into drive 0; the write protect notch should be up, and the oval cutout should enter the drive first. Close the drive door, and type /SS In response to the prompt FILE FOR SAVING, type **LESSON3A/VC**Ⓔ The disk drive should whirl for a few seconds, and, if all is well, the drive will quiet down and the prompt and edit lines will go blank. You should also, at this time, make a backup copy of this file on another diskette which you do not use except for storing the backup files. If you should decide to end this session at this point, **be sure to remove any diskettes from the disk drives before you turn off the disk drives.**

Fixing Titles In Both Directions

We again have a situation where, if we scroll the window to look at the later months, we will lose the descriptive titles INCOME, MORTGAGE, etc. Let's fix them in place. This time, we'll create a border of titles along both the left and top edges of the sheet.

Move the cursor with **>A3**Ⓢ Now type **/T** The prompt line reads TITLES: H V B N. (The meanings of the keystrokes H, V, B and N are described in Lesson Two and in Part III, The VisiCalc Command Reference.) Press **B** to fix titles in **both** directions. The position of the cursor has a dual significance for this command. If you type **/TV** to fix titles vertically, VisiCalc will fix in place the **column** in which the cursor rests, and all columns currently on the screen to the left of the cursor. If you type **/TH** to fix titles horizontally, VisiCalc will fix in place the **row** in which the cursor rests, and all rows currently on the screen above the cursor. Typing **/TB** is equivalent to typing both **/TV** and **/TH**, so the exact position of the cursor is important. In this case, we have created a border consisting of column A along the left edge of the screen window, and another border consisting of rows 1, 2 and 3 along the top edge of the window. To check this, hold down the **⏴** key to scroll the window downwards past row 12. Notice how rows 1, 2 and 3 remain in place. Now, type **>B4**Ⓢ and press the **⏴** key to see how the window scrolls horizontally, leaving column A in place. (Since all other numbers are the same from column to column, only the period and income figures in rows 1 and 2 will change.) Continue pressing the **⏴** key until columns A, M, N and O are in the window. We'll use columns N and O to obtain totals and percentages for our income and expenses.

The Built-in Function @SUM

Type the following:

```
>N1Ⓢ  
TOTAL⏴
```

The cursor should be at N2. How can we find our total income for twelve months? You could always type

```
+ B2 + C2 + D2 + E2 + F2 + G2 + H2 + I2 + J2 + K2 + L2 + M2
```

but there's a simpler way. Press **@** watching the prompt line as you do so. As soon as you type the **@** symbol, the prompt line says VALUE. Now type **SUM(** and the edit line reads **@SUM(** followed by the dash.

Our next step is to indicate what numbers we want to sum up. Hold down the **⏴** until you begin "bumping into" the left hand border. The cursor should be at B2, and the edit line should read **@SUM(B2** followed by the dash. Press **.** The cursor jumps back to N2, where we started, and the edit line now reads **@SUM(B2 . . .** As you can see, we are specifying a range of entries, just as we have done several times for the replicate command. To finish this range, press **⏴**Ⓢ The entry contents line now reads **N2 (V) @SUM(B2 . . . M2)**, and under the cursor highlight is the number 23000, our total income for the year.

	9	10	11	12	TOTAL
1 PERIOD					
2 INCOME	2000	2000	2000	2000	20000
3					
4 MORTGAGE	600	600	600	600	
5 UTILITIES	50	50	100	140	
6 TELEPHONE	75	75	75	75	
7 FOOD	350	350	350	350	
8 CLOTHING	120	120	120	120	
9 CAR EXPEN	80	80	80	80	
10 CAR INSUR					
11 SAVINGS	150	150	150	150	
12					

The @ symbol is used to begin the name of a VisiCalc built-in function. When you began the entry at N2 with the symbol @, VisiCalc immediately knew that:

1. The entry was going to be a numeric VALUE.
2. The next few letters you typed would be the name of a built-in function.

Each built-in function, such as @SUM, performs some sort of calculation on the list of values given to it, and yields a numeric result. Other examples of built-in functions are @MIN, @MAX and @AVERAGE; see the reference card and Part III, The VisiCalc Command Reference for a complete description of all the functions. Functions such as @SUM will operate over a range such as @SUM(B2 . . . M2); a list of particular values such as @SUM(B2, B7, C3, D8); or a list of ranges, values, numbers or formulas, such as @SUM(B2 . . . B7, C3 . . . C6, 25, D8, 4*C8). And the numeric result of the function can be used wherever an ordinary number could be used: for example, in a function or another formula.

For our personal budget, we would like to obtain totals for each of our expense categories, just as we did for income. Once again, a replication is called for. With the highlight on N2, which is our prototype formula, press /R[Ⓢ]. The target range is N4.N11[Ⓢ]. Now the prompt line reads REPLICATE: N=NO CHANGE, R=RELATIVE. The edit line reads N2: N4 . . . N11: @SUM(B2 with the dash following B2. Think for a moment about what will happen if we make B2 . . . M2 relative. Since we are replicating down a column, the replicated formulas will be in positions N4, N5, N6, etc. We want N4 to be the sum of B4 . . . M4; N5 to be the sum of B5 . . . M5 and so on, which is what will happen if the replicated formulas are relative. Press R twice. In an instant, the expense totals, from 7200 to 1800, appear in column N.

Let's find out what percentage of our income is accounted for by each expense total. Type the following:

>O1[Ⓢ]
PERCENT

What formula will give mortgage as a percentage of income? Type: +N4/N2[Ⓢ] We are dividing the mortgage total at N4, or 7200, by the income total at N2, or 23000. The result is .3130435, or approximately 31%.

Formatting a Single Entry

The number .3130435 is unnecessarily messy. This is the general format (showing as many significant digits as the column width will allow), which VisiCalc uses in all cases unless we ask for something else. For our purposes, two decimal places should be enough. The global format command /GF\$ which we used in Lesson Two, displays everything to two decimal places. Type /GF\$ Our mortgage percentage at position O4 now appears as 0.31, but every other number on the screen is also displayed in dollars and cents form. Even the month number 12 at M1 appears as 12.00. This is still messy. Change the global format back to "general" by typing /GFG What we really want is to display just the number at O4 in dollars and cents form. With the cursor still at O4, type /F\$ That's it! Just as the command /GF\$ affects everything in the screen window, the command /F\$ affects only the entry highlighted by the cursor.

Now that the percentage 0.31 is pretty, look at the label TOTAL at the top of column N. It is hard to read, because it's too close to the number 12 in column M, and it doesn't line up with the numbers below it. Move the cursor to the label TOTAL with >N1[Ⓢ] VisiCalc normally starts alphabetic labels from the left side of an entry position (the **general** format for labels, which currently applies **globally** to all entries including PERIOD, INCOME, etc.), whereas numbers have their last digits lined up on the right. To change the format of TOTAL, type /F The prompt line reads FORMAT: D G I L R \$ * The possible keystrokes are:

- D The format **defaults** to be the same as the global format. In other words, there is no special format for this entry.
- G Use the **general** format for this entry. You can use this, for example, to display a particular number with several decimal places even if the global format is I (integer).
- I Display this entry in **integer** format.
- L Start this entry (either a label or a number) at the **left** side of the entry position.
- R Make the last letter or digit of the entry line up at the **right** end of the position.
- \$ Display this entry in **dollars and cents** format.
- * Display this entry in **graph** format. For examples, see Part II, Lesson Four, Part III, The FORMAT Command and the reference card.

For TOTAL, type **R** Now TOTAL is lined up with the column of figures below it. Now press **▶** to move the cursor to O1, and press **/FR** to “right-justify” the label PERCENT.

	A	K	U	M	N	O
1	PERIOD	10	11	12	TOTAL	PERCENT
2	INCOME	2000	2000	2000	23000	
3						
4	MORTGAGE	600	600	600	7200	0.31
5	UTILITIES	50	100	140	1030	
6	TELEPHONE	75	75	75	900	
7	FOOD	350	350	350	4200	
8	CLOTHING	120	120	120	1440	
9	CAR EXPEN	80	80	80	960	
10	CAR INSUR				320	
11	SAVINGS	150	150	150	1800	
12						

Replicating a Format Specification

Type **>O4Ⓢ** to move to the formula for mortgage expense as a percentage of income. We'll replicate this formula down column O to obtain percentages for all of the other expenses. Type **/RⓈ** The target range is **O5.O11Ⓢ** Now the prompt line reads REPLICATE: N=NO CHANGE, R=RELATIVE and the edit line reads O4: O5 . . . O11: +N4 How should we handle the formula +N4/N2, which is mortgage as a percentage of income? For utilities at O5, we want +N5/N2. The first coordinate changes, but the second, N2 or income, does not. Press **R** to make N4 relative; then, with the dash following N2 on the edit line, press **N** to indicate “no change.” Now we have all of our expense percentages, from 0.31 for mortgage to 0.08 for savings. Notice that all of the percentages are displayed to two decimal places. Press **▼** a few times, looking at the entry contents line. At O5, for instance, the line reads O5 /F\$ (V) +N5/N2 The format specification /F\$ has been replicated along with the formula. In fact, it's possible to replicate a format specification even if the entry being replicated is blank! We'll use this trick a little later.

Using Replicate To Copy a Row or Column

Type **>A12Ⓢ** Now we'll draw a line under our list of expenses; then calculate how much money we have left for leisure. You already know one relatively easy way to draw a line of hyphens, by using the **/-** command at A12 and replicating the hyphens

across. But let's try using the replicate command a little differently. Type **/R** The prompt line reads REPLICATE: SOURCE RANGE OR RETURN and on the edit line is the cursor coordinate, A12, followed by the dash. Now press **CLEAR** The A12 disappears, leaving only the dash on the edit line. Let's type a new source range: **A3.M3** As usual, the prompt line reads REPLICATE: TARGET RANGE. Type **A12.A12** Just what are we doing? The source range, A3 . . . M3, is the line of hyphens already written on the sheet. We're asking VisiCalc to replicate the entry at A3 into position A12; the entry at B3 into position B12; and so on. Press **↵** There's your line. (Incidentally, it would have been sufficient to type **A12** for the TARGET RANGE; VisiCalc will take this to mean A12 . . . A12.)

Finally, let's add LEISURE to our budget. The money we have available for leisure will simply be our income minus the sum of our expenses. Type the following:

```
>A13  
LEISURE + B2 - @SUM(B4.B11)
```

The figure for leisure, 125, appears at B13. Then replicate this formula across with **/R C13.M13** and press **R** three times to make the formula coordinates relative. Now start pressing the **→** key to scroll the window rightwards, and examine the encouraging results VisiCalc has calculated for us. Our leisure money starts small, at \$125 in the first month, but it increases fairly steadily thereafter. After the first month, we don't have a car insurance premium, and in months 3, 4 and 5 our utilities bill goes down. In month 6, we get our raise, which increases our income and leisure money. Continue pressing **→** until you have brought columns M, N and O into view, showing TOTAL and PERCENT, and then press **↵** to leave the cursor at N13. To obtain a total and percentage of income for leisure, we can use the same method we used earlier to copy the line of hyphens. Press the following keys, and watch what happens on the prompt and edit lines (here, we'll use **:** in place of **↵**)

```
/R CLEAR N11.O11:N13 RRRR
```

You should have a total of 5150 and a percentage of 0.22 for LEISURE.

Changing Windows and Titles

As we found in Lesson Two, the screen is too small to display both our starting expense figures in month 1 and our calculated totals and percentages in columns N and O. We can solve this problem by splitting the screen into two windows. With the cursor still at N13, press **/WV** Your screen should look like the photo below. The titles in column A and rows 1-3 are fixed in place in both windows.

	K	L	M		N	O
1 PERIOD	10	11	12	1 PERIOD	PERCENT	
2 INCOME	2000	2000	2000	2 INCOME		
3				3		
5 UTILITIES	50	100	140	5 UTILITIES	0.04	
6 TELEPHONE	75	75	75	6 TELEPHONE	0.04	
7 FOOD	350	350	350	7 FOOD	0.18	
8 CLOTHING	120	120	120	8 CLOTHING	0.06	
9 CAR EXPEN	80	80	80	9 CAR EXPEN	0.04	
10 CAR INSUR				10 CAR INSUR	0.01	
11 SAVINGS	150	150	150	11 SAVINGS	0.08	
12				12		
13 LEISURE	575	575	485	13 LEISURE	0.22	

Press ; to jump the cursor over to the right window, bringing columns A and N into view. Then press /TN to eliminate the fixed titles from this window. The title or "border" column A disappears, exposing column M. The top row containing the titles TOTAL and PERCENT also disappears. Finally, press ⏴ once to bring the TOTAL and PERCENT columns N and O into view, and press ; to jump the cursor back to the left window. Press and hold down ⏴ to scroll this window back to the first month. (Notice that you bump into column A. The fixed titles are still in effect in this window.) Your screen should look like the screen photo below.

	B	C	D		H	O
1 PERIOD	1	2	3	2	23000	
2 INCOME	1800	1800	1800	3		
3				4	7200	0.31
5 UTILITIES	140	140	80	5	1630	0.04
6 TELEPHONE	75	75	75	6	900	0.04
7 FOOD	350	350	350	7	4300	0.18
8 CLOTHING	120	120	120	8	1440	0.06
9 CAR EXPEN	80	80	80	9	900	0.04
10 CAR INSUR	160			10	320	0.01
11 SAVINGS	150	150	150	11	1800	0.08
12				12		
13 LEISURE	125	285	345	13	3150	0.22

Let's try changing one of our expenses to see how VisiCalc recalculates the expense totals and income percentages. Type **>B9 @ 100 @** What happens? Your available leisure money decreases by \$20 each month; the car expense total goes from \$960, or 4% of your income, to \$1200, or 5% of income; and your leisure total for the year goes from \$5150, or 22% of income, to \$4910 or 21%.

The @NA and @ERROR Functions

Press **↵** to move to position B10. Let's suppose that you were about to change your car insurance policy, and the new premium was not yet known. How would you deal with this in your budget? VisiCalc has a special way: Replace the number 160 at B10 by typing **@NA@** and watch the screen. As you might have guessed, **@NA** stands for "Not Available." When you write this function at an entry position, that entry takes on the special value NA. When VisiCalc recalculates, any formula which refers to an entry containing NA will itself have a value of NA. In this case, your car insurance premium for month 1 at B10 became Not Available. Because of this, there was no way to calculate your leisure money (income minus the sum of expenses) for month 1, and so position B13 (for leisure) became Not Available. Moreover, your total car insurance expense for the year could not be calculated and also became NA, which meant that the corresponding percentage of income became NA. And, since one month's leisure expense was NA, the total was NA, and so was leisure as a percentage of income. Change B10 back to **160@** and all of the calculated values will be restored.

Here's a related issue: Suppose that, instead of typing a number, you were trying to calculate your own car insurance premium as the insurance company does, but you made a mistake and tried to divide by zero. Type **1/0@** As the screen shows, when VisiCalc evaluates the formula 1/0, the result is the special value ERROR. Like NA, the value ERROR "propagates:" Any formula which refers to an entry with the value ERROR will itself have the value ERROR. There are several ways to obtain a value of ERROR: dividing by zero, taking the logarithm of a negative number, calculating a value that is simply too large for the computer to represent, etc. You can also deliberately obtain the value ERROR, just as you did for **@NA**, by typing the function name **@ERROR**. For now, change the value at B10 back to **160@** so that the totals and percentages can be calculated.

To make sure that we can continue from this point if something goes wrong, let's save the sheet on diskette again. The storage diskette which you used earlier in this lesson should still be in place in your disk drive. Type **/SS** and, in response to the prompt FILE FOR SAVING, press the **↓** key. The disk drive should whir, and a file name should appear on the edit line. Continue pressing the **↓** key, if necessary, until you have the name LESSON3A/VC:0 on the edit line. Then press the **CLEAR** six times until the dash is sitting where the A was. Now type **B/VC:0@** watching the edit line as you type the characters. You are saving the sheet under the revised name LESSON3B/VC:0. Once you've started, all it takes is a few keystrokes to protect yourself from disaster.

Now, press **;** to jump the cursor into the right hand window. There are no fixed titles in effect in this window, and if you look closely, you'll notice that the columns are slightly narrower here than in the left hand window. (VisiCalc automatically adjusted the column widths to make room for the extra vertical border of row numbers which runs

down the center of the screen.) Next, press /W1 This leaves the narrowed columns on the screen. When you type /W1 to return to one screen window, the global column, format, and title settings for the full screen are obtained from the window where the cursor lies at the time you type the /W1 command. If you had typed /W1 with the cursor in the left hand window, the screen would now have fixed titles and columns nine characters wide. For now, type /GC9[Ⓢ] and >A7[Ⓢ] to adjust the column widths and scroll the screen back to the left edge of the sheet. The cursor should highlight the label FOOD.

The Insert and Delete Commands

Let's say you decide to take on a life insurance policy which has monthly premiums of \$115, and you want to incorporate this expense into your budget. If you were working on an ordinary sheet of paper with the same arrangement of figures which we have on the screen, you'd have to erase something, or write in tiny letters or off to the side to make room. But VisiCalc's electronic sheet is more flexible. Type /IR for "insert row" and watch the screen. Everything at or below the cursor moves down to make room, leaving you with a blank line at row 7 where you can enter the life insurance figures. Notice that, for example, the amounts for savings, which used to be on row 11, are now on row 12. This may remind you of the formula you wrote for leisure, which was income minus the sum of expenses: +B2-@SUM(B4...B11). Now savings at B12 is outside this range. But the figures for leisure haven't changed. Type >B14[Ⓢ] and look at the entry contents line. The formula has changed to be +B2-@SUM(B4...B12)! Whenever you insert (or delete, or move) a row or column, VisiCalc automatically adjusts all of the formulas on the sheet so that they refer to the same entry positions as before, even though the coordinates have changed.

Now type the following to fill in the life insurance expense figures. Since all we have is a blank line at row 7, we will also have to add the formulas to calculate total and percent for this new expense.

```
>A7Ⓢ
LIFE INS♦115♦+♦Ⓢ
/RⓈD7.M7:R
>N6Ⓢ
/R♦:N7:RRRN
>A10Ⓢ
```

Notice that our leisure money has decreased by the amount of the life insurance premiums each month. Position B14 is now -10, meaning that we're overspending our income in month 1. Perhaps we should ride the bus to work, and in that way all but eliminate our car expense. Type >B10[Ⓢ] and then press /D watching the screen as you do so. The prompt line reads DELETE: R C (With the cursor at B10, you could delete row 10 by pressing R, or column B by pressing C.) Press R The title and figures for car expense disappear completely from the screen, and everything below the cursor moves up one row to take up the slack. Car insurance is now at row 10, and savings is back at row 11. Our leisure money has increased, back to \$90, for example, at position B13. (If you were to check the formula at B13, you'd find that it has been adjusted back to +B2-@SUM(B4...B11).)

Calculating Interest On a Savings Account

You can also insert columns. Say, for example, that you wanted to obtain six month totals for your income and expenses. Type **>H4**Ⓢ The formula there is +G4, and you know the formula at I4 is +H4. Now press **/IC** A new, blank column appears in place of column H. (Notice that the insert command always inserts a row or column before, meaning "closer to row 1 or column A than," the row or column where the cursor lies.) Press **⏏** to bring into view the old column H, now relettered column I. The formula at I4 is +G4, so the propagation of the income and expense amounts skips over the newly created blank column. Press **⏏** twice more, and notice that the next formulas are +I4 and +J4. Now move back with **>H4**Ⓢ and type **/DC** Now the blank column has been deleted, all of the other columns to the right have moved back to eliminate the empty space, and everything has returned to normal. (If you've made any mistakes in this section, you can clear the screen, reload the diskette file name LESSON3B/VC:0, and try each step again.)

To test your understanding of the insert and replicate commands, try the following on your own, then compare your approach with the instructions below: Insert the names of the months, such as JAN, FEB, MAR, etc. just below the month numbers 1 through 12.

Have you succeeded? Here's one way to do it. Type exactly the following:

```
>A2Ⓢ  
/IRMONTH⏏/FR/R:C2.M2Ⓢ (This replicates the format /FR)  
JAN⏏FEB⏏MAR⏏APR⏏MAY⏏JUN⏏JUL⏏AUG⏏  
SEP⏏OCT⏏NOV⏏DECⓈ  
>A2Ⓢ
```

Calculating Interest On a Savings Account

According to our present budget, we are setting aside \$150 each month for savings. Part of the motivation for doing this, of course, is that we would like to earn interest on this money. Let's use VisiCalc to project the interest and the accumulated balance we would have if we put this money into a savings or other investment account.

We'll assume that interest on a savings account is paid at the rate of 5% per year, compounded monthly. But, to give ourselves flexibility, we'll write this interest rate into a separate position on the sheet, so that we can change it later and let VisiCalc recalculate the interest and accumulated balance. Type **>A15**Ⓢ **SAV ACCT**⏏**.05**Ⓢ

On the first day of each month, our account will be credited with interest for the balance in the account during the previous month, and then we'll deposit our monthly \$150. Type the following:



```
>A17Ⓢ  
/F$100⏏  
>A16Ⓢ  
INTEREST⏏
```

The \$100 at A17 is the previous balance in the savings account before our budget begins. The interest paid for one month will be one twelfth of the yearly rate (e.g. .05 divided by 12) times this previous balance. Type:

/F\$ + B15/12*A17 

The calculated result of this formula should be 0.42, shown at B16. Does this figure make sense? A year's simple interest at 5% on \$100 would be \$5.00. One twelfth of this would be \$5.00/12, or \$0.41666 (which rounds to \$0.42).

Press  to move to B17. Our new savings account balance will be the previous month's balance, plus the interest, plus the savings deposit for this month. Type:



/F\$ + A17 +  + B12 

(If you like, you can point with the cursor to fill in all three coordinates in this formula.) The result, as expected, is \$250.42.

Now, we can replicate both the interest and account balance formulas across for twelve months. Type:

>B16 
/R:C16.M16:NRRRR

As you type the N and R's to determine whether each coordinate should be unchanged or relative, think about what each one means. The interest rate at B15 is clearly N. The R for A17 means "use the value of the entry one position down and to the left of each copy of the formula," and so on for the other coordinates. Press  to examine the calculated results. The interest paid each month increases, since both our monthly deposits and the accumulated interest are added into the balance on which the interest is based. Continue scrolling the window rightward until column N comes into view, and then type the following:

>N17 
/F\$ + M17 + N14 

This is the combined total of our savings and leisure money, or our "discretionary income." It should currently be 6676.94.

6	85	50	50	100	140	1000
7	75	75	75	75	75	900
8	115	115	115	115	115	1300
9	350	350	350	350	350	4200
10	120	120	120	120	120	1440
11	150	150	150	150	150	1800
12	150	150	150	150	150	1800
13	505	540	540	490	450	4730
14	4.86	5.50	6.15	6.80	7.45	
15	1321.63	1476.53	1632.69	1789.49	1946.54	6676.94

The Move Command

Type **>A11** The cursor should highlight the label CAR INSURANCE. Paying that insurance premium in month 1 is taking a big bite out of our available leisure money in month 1 (which is \$90, as opposed to \$250 in month 2). Perhaps we can pay the insurance premium by taking money out of the savings account.

On an ordinary sheet of paper, more erasures and writing in the margins would be necessary. Not so on VisiCalc's electronic sheet. Type **/M** The prompt line reads MOVE: FROM . . . TO and on the edit line is A11 the cursor coordinate, followed by the dash. Now press **↓** The cursor moves down to highlight SAVINGS, and the edit line reads A11 . . . A12 Press the **↓** key four more times, watching the edit line change from A11 . . . A12 to A11 . . . A16 much as it did for the **@SUM** function and the replicate command. The cursor highlights INTEREST at A16. Now press **Ⓢ** and watch the screen. The following things happen:

1. The entire row for CAR INSURANCE moves down from row 11, reappearing just above INTEREST at row 16.
2. The rows for SAVINGS, LEISURE and SAV ACCT move up, taking up the space vacated by the old CAR INSURANCE row, and making a new space just above INTEREST for the new CAR INSURANCE row.
3. The cursor remains where it was when we started the **/M** command: at A11, which is now SAVINGS.

Now look at the figure for leisure in month 1. It has increased from 90 to 250. The car insurance premium has been taken out of the sum of expenses used to calculate leisure (the formula at B13 now reads **+B3 - @SUM(B5 . . . B11)**). Hence, the car insurance

expense is currently unaccounted for. We must revise the formulas in row 17 to take the car insurance premium out of the savings account balance. Type $>B17\textcircled{E}$ and look at the entry contents line. The formula reads $+A17+B16+B11$ meaning the previous account balance, plus a month's interest on that balance, plus this month's savings deposit. To this we must add "minus the car insurance premium (if any)." Type the following:

$+A17+B16+B11-\text{car insurance premium}\textcircled{E}$
/R:C17.M17:RRRR

This will replicate the new account balance formulas $+A17+B16+B11-B15$, $+B17+C16+C11-C15$, etc. across the row.

Now type $>N17\textcircled{E}$ to examine our total discretionary income: It has declined from 6676.94, before we took the insurance premiums out of savings, to 6666.10. We are now saving less and spending more on leisure, so we have lost about \$10 interest on our savings account. (Notice that our leisure total at N14 has increased from 4730 to 5050.) Perhaps we should save a little more each month to replenish the funds taken out to pay the insurance premiums.

Type $>A11\textcircled{E}$ to bring the titles back on the screen and highlight our initial SAVINGS figure at B11. Since the \$160 expense for car insurance at B15 covers our premiums for six months, we should save one sixth of this amount each month, in addition to our usual savings deposit. Type $150+(B15/6)\textcircled{E}$ (The parentheses in the formula tell VisiCalc to calculate that portion of the formula first. See the section entitled "The VALUE Command" in Part III for a full discussion of precedence.) Thanks to our earlier use of formulas, VisiCalc automatically propagates the adjusted savings figure across all twelve months, and also recalculates leisure and our new savings account balance. This recalculation has made the screen display somewhat messy, because the global format for numbers is still the standard format, or "general." We can clean up the display by typing **/GFI**. The interest and savings account figures still show dollars and cents, because each of these entries has the "local format" **/F\$**. Now, type $>N17\textcircled{E}$ to reexamine our total discretionary income. It has increased to 6673.53. By saving about \$27 more each month, we have reduced our leisure total back to 4730, but we have regained most of the interest we had lost before. VisiCalc can really help you budget in ways that you wouldn't have contemplated before!

Obtaining Monthly Expense Percentages

This lesson has given you a lot of practice in techniques for using commands such as replicate effectively. Here's a challenge to test your mastery of the replicate command: Give yourself monthly percentages for each of your expenses, from mortgage through savings. It's possible to accomplish this by typing just one formula and using the replicate command twice. Before trying, save your work by typing **/SS** and using \blacklozenge as necessary to bring the file name LESSON3B/VC:0 onto the edit line, and press **CLEAR**

Obtaining Monthly Expense Percentages

six times, then type **C/VC:0** (If you need them, here are some hints: Use the area of the sheet directly below your list of monthly expenses. Remember that you can replicate format specifications. If you want to get fancy, you can label each row of percentages with one more use of the replicate command.)

If you've succeeded, congratulations. You can probably do anything you want with VisiCalc from now on. Whether you've succeeded or not, let's make sure that your budget matches the one in this lesson: Clear the sheet with **/CY** and reload the file you just saved by typing **/SL** then pressing **↓** until the file name **LESSON3C/VC:0** appears, and then pressing **Ⓜ** Now type exactly the following:

```
>A20Ⓜ  
/R CLEAR A5.A11:A20:  
↓/F$+B5/B3Ⓜ  
/R:B21.B26:RN  
/R.B26:↓.M20:RRRRRRRRRRRRRR (Type R fourteen times)  
>A26Ⓜ
```

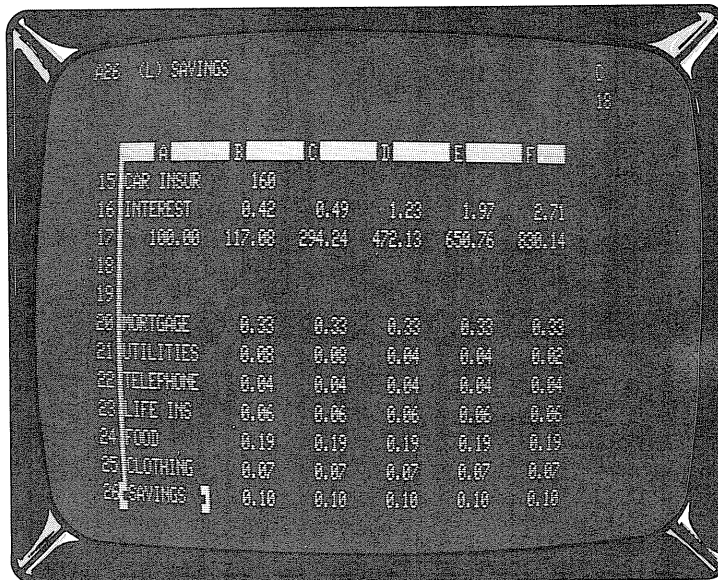

The screenshot shows a VisiCalc spreadsheet window titled "ABC (1) SAVINGS". The spreadsheet has columns labeled A through F and rows numbered 15 through 26. The data is as follows:

	A	B	C	D	E	F
15 CAR INSUR	160					
16 INTEREST	0.42	0.49	1.23	1.97	2.71	
17	100.00	117.00	294.24	472.13	650.76	830.14
18						
19						
20 MORTGAGE	0.33	0.33	0.33	0.33	0.33	
21 UTILITIES	0.08	0.08	0.04	0.04	0.04	0.02
22 TELEPHONE	0.04	0.04	0.04	0.04	0.04	0.04
23 LIFE INS	0.06	0.06	0.06	0.06	0.06	0.06
24 FOOD	0.19	0.19	0.19	0.19	0.19	0.19
25 CLOTHING	0.07	0.07	0.07	0.07	0.07	0.07
26 SAVINGS	0.10	0.10	0.10	0.10	0.10	0.10

The first replication in this sequence illustrates another use of the replicate command: You can copy a range of entries into another part of the same column (in fact, to any other area on the sheet) simply by specifying the destination starting coordinate for the target range. Check row 21, for utilities, to verify that the percentages may change from month to month.

Synchronized Scrolling

As you can see, the area of the sheet which we have used extends beyond the screen window in both the horizontal and vertical directions. The window has begun scrolling downwards, and our month labels, income, and our first few expenses have disappeared from view. Let's split the screen so that we can see both the expense amounts and the percentages at the same time. Move the cursor up to A19, just above MORTGAGE. Now type **/WH** The screen splits horizontally, leaving just enough room for the expense percentages in the bottom window (which we'll attend to in a moment). Now type **>A2** This should leave rows 2 (MONTH) through 5 (MORTGAGE) on display in the top window, with the cursor at A4. Next, type **/TB** to fix the horizontal and vertical borders in place. (Notice that the columns and rows forming the borders do not have to start from the edges of the sheet.) Finally, type **;>A26** to bring all of the expense percentages into view, and **/TV** to fix the labels MORTGAGE through SAVINGS in place.

Now press **↓** until the bottom window begins scrolling rightward. The problem is that we can't easily tell which months these expense percentages refer to. The month labels, such as JAN, FEB and MAR, are visible only in the top window, which isn't scrolling. We'd really like the two windows to scroll together horizontally, but remain independent vertically so that we can view different areas of the sheet through the two windows, as we are now (with rows 2-5 in the top window and rows 20-26 in the bottom). Press **/W** again, and look at the prompt line. The possible keystrokes are:

- H** To split the screen horizontally.
- V** To split the screen vertically.
- 1** To return to one screen window.
- S** To synchronize the two windows.
- U** To unsynchronize the windows.

Press **S** and watch what happens in the **top** window. Notice that this window scrolls over so that portions of the same columns are visible through the top and bottom windows. Now press **↓** a few times: The two windows move together "in sync." Type **;** to jump the cursor into the top window, and then type **>B7** Try changing the telephone expense to something else, say \$100 per month, and watch the line of percentages opposite TELEPHONE in the bottom window. Now, let's use the two windows for a different purpose. Type **/WU** to unsynchronize the windows. Then move to the bottom window with **;** and type **>A1/TB>O17** to bring your leisure total and percentage, your final savings account balance, and your combined discretionary income into view. Then press **;** to jump back to the top window, landing at B7, and change the telephone expense back to 75, watching how this effects the leisure percentage in the bottom window. You can also experiment with the budget in other ways. At this point, you may wish to save the results of this lesson by typing, for example, **/SSMYBUDGET/VC**

2	MONTH	JAN	FEB	MAR	APR	MAY
3	INCOME	1800	1800	1800	1800	1800
4						
7	TELEPHONE	75	75	75	75	75
8						
9	PERIOD	10	11	12	TOTAL	PERCENT
12						
13	LEISURE	513	463	423	4730	0.21
14	SAV ACCT					
15	CAR INSUR				320	0.01
16	INTEREST	5.81	6.57	7.33		
17		100.00	1576.30	1759.53	1943.53	6673.36

The Order of Recalculation

So far, we've simply noticed that VisiCalc recalculates the values of all the formulas on the sheet, but we haven't looked closely at how this is done. There are some subtleties to the process of recalculation which can affect your results when you set up a complex problem with many interdependencies. We'll consider these issues here.

VisiCalc recalculates by starting at the upper left hand corner of the sheet and working its way downward and to the right until it reaches the lower right hand corner of the sheet. Each formula is evaluated only once, unless you ask for an extra recalculation by pressing !

VisiCalc will evaluate the formulas on the sheet in either of two possible orders: "down the columns" or "across the rows." Look again at the letter C just to the left of the direction indicator at the upper right corner of the screen. This is the **recalculation order indicator**, and it can be either C, for columnwise recalculation, or R, for rowwise recalculation. When you load the VisiCalc program or clear the sheet, VisiCalc is set to recalculate "columns first." It will evaluate first A1, then A2, A3, . . . , etc., then B1, B2, B3, . . . , etc., Then C1, and so on. If you change the recalculation order to "rows first," VisiCalc will evaluate first A1, then B1, C1, . . . etc., then A2, B2, C2, . . . , etc., then A3, and so on.

For many problems, the choice of row versus column recalculation has no effect on the results displayed on the screen. But there are cases where you must use the right recalculation order to obtain correct results, and it's important to recognize these cases when they arise. So let's consider an example. Clear the sheet with /CY and type the following:

```
1↵-A2Ⓢ
>A2Ⓢ
1+A1↵2*B1Ⓢ
>C5Ⓢ
+A1↵1+C5Ⓢ
>C6Ⓢ
-D5↵2*C6Ⓢ
>A1Ⓢ
```

As you type the formulas, think about how each entry depends on the other entries. As you can probably see, the matrix of entries starting at A1 must be recalculated in the order A1, A2, B1, B2 (since B1 depends on A2). The matrix of entries at C5, however, must be recalculated in the order C5, D5, C6, D6 (since C6 depends on D5). With the cursor at A1, type 2Ⓢ and watch what happens. A2 becomes 3, B1 becomes -3, and B2 becomes -6, as expected; but while C5 becomes 2 and D5 becomes 3, C5 remains at -2, and D6 at -4. The formula at D5 **was** recalculated, but this occurred **too late** to affect the recalculation of C6 and D6. Now press ! to trigger an extra recalculation: This time C6 becomes -3 and D6 becomes -6.

Now we'll change the order of recalculation from "columns first" to "rows first:" Press /G The prompt line again reads GLOBAL: CORF. Press O Now the prompt line reads REEVAL ORDER: R C. Press R Notice that the recalculation order indicator at the upper right corner of the screen changes from C to R. Now type 1Ⓢ and watch the screen. This time, D5 becomes 2, C6 becomes -2, and D6 becomes -4; but while A2 becomes 2, B1 stays at -3, and B2 at -6. Our problem with B1 and B2 is, of course, symmetrical to our earlier problem with C6 and D6.

The moral of this example is that you should lay out your calculations with either columnwise or rowwise recalculation in mind, but not both. If possible, you should arrange things so that the results will be correct with **either** columnwise or rowwise recalculation. Then, if you decide to calculate something new that requires a particular order of recalculation, you won't be constrained by other dependencies on the recalculation order. For example, the personal budget outlined in Lesson Three is independent of the order of recalculation. Now, suppose that you want to adjust your life insurance policy and premiums to provide a benefit of three times your total annual income. You could do this by switching to "row first" recalculation, so that the life insurance premium in month 1 could be based on the total income calculated in column N.

If you find yourself with a problem of conflicting requirements for "row first" and "column first" recalculation, you can deal with these requirements, albeit awkwardly, by pressing ! for an extra recalculation each time you change a value and look for recalculated results. But first make certain that your row and column conflict is not actually due to a "forward reference" or a "circular reference," as discussed below.

Forward and Circular References

Clear the sheet with /CY and type the following: $1 \rightarrow - \rightarrow \text{E}$ The entry contents line reads B1 (V) - C1, and the value display at B1 is 0, as expected. Now type $\rightarrow 1 + \rightarrow \rightarrow \text{E}$ The entry contents line reads C1 (V) 1 + A1, and the value at C1 is 2, while the value at B1 has been updated to -2. Next, press $\rightarrow \text{B2} \rightarrow - \text{C1} \rightarrow \text{E}$ We now have the same formula, - C1, at both B1 and B2, and both positions display the value -2. Is there any difference between these two formulas? Indeed there is. One of these formulas will recalculate and display the correct value only if the order of recalculation is "row first." The other will never display the correct value after an automatic recalculation! To see this, type $\rightarrow \text{A1} \rightarrow \text{B2} \rightarrow \text{E}$ and watch the screen. A1 becomes 2 and C1 becomes 3, but both B1 and B2 remain at -2. Press ! and both B1 and B2 will be updated to -3. Now, type /GOR and note that the recalculation order indicator changes from C to R. Then type $\rightarrow 3 \rightarrow \text{E}$ and watch the screen. A1 becomes 3, C1 becomes 4, and now B2 becomes -4, but B1 remains at -3. You'll have to press ! again before B1 will change to -4. And if you change A1 again, B1 will display a value based on the previous contents of C1 and A1. The formula at B1 is an example of a **forward reference**: It contains a reference to an entry which will be recalculated after B1 is recalculated, regardless of whether rowwise or columnwise recalculation is used.

In pathological cases, forward references may refer to other forward references, so that correct results can be obtained only with several recalculations. For example, press $\rightarrow \text{IC} \rightarrow - \rightarrow \text{E}$ At the moment, A1 is 3, the new B1 is 4, C1 is -4, and D1 is 4. Now press $\rightarrow 1 \rightarrow \text{E}$ A1 becomes 1, D1 becomes 2, but B1 and C1 are unchanged. Press ! Now C1 is -2, but B1 is still 4. Only after you press ! again will B1 be updated to 2.

An effect even more startling is caused by a **circular reference**. The value of such a formula cannot be settled with any number of recalculations! Clear the sheet with /CY and type the following: $1 + \rightarrow \text{E}$ The entry contents line reads A1 (V) 1 + B1, and the value under the cursor is 1, as expected. Now type $\rightarrow 1 + \rightarrow \rightarrow \text{E}$ and watch carefully. What happened? The numbers at A1 and B1 actually changed **twice**. When the formula 1 + A1 was completed at B1, it was evaluated, yielding 1 + 1 or 2 at B1. Then, since the value of B1 had been changed, an automatic recalculation occurred. A1, or 1 + B1, became 1 + 2 or 3, and B1, or 1 + A1, became 1 + 3 or 4. Now press ! A1 increases to 5, and B1 becomes 6. These values will change every time you press !

The foregoing examples have been somewhat artificial: You probably recognized the forward and circular references as soon as you typed them. If you are planning your work carefully, you should never write such a formula. But some forward or circular references are not so obvious. For example, suppose that you are projecting future profits, taking into account various revenues and expenses. One of the expenses is employee salaries, and one part of salaries consists of profit-sharing. Unless you are careful, you may create a circular reference: Salaries with profit-sharing depend on profits, but profits depend on expenses including salaries. (To resolve this circularity, you must calculate a figure for profits before profit-sharing is taken out.)

Once you are aware of the issues involved in recalculation, it is not difficult to avoid conflicts in the order of recalculation or forward and circular references. Generally these problems arise when you are working too quickly without a plan, or "patching"

an existing layout on the electronic sheet. If your approach to the problem is orderly and well thought out, it is unlikely that you will encounter any problems with recalculation.

Summary

Once again, we have covered a great deal of ground in this lesson. We concentrated on a variety of techniques for using VisiCalc's flexible replicate command as effectively as possible. We also discussed a number of new VisiCalc features, including the formatting of individual numbers and labels, and the relationship between global and local formats; the order in which VisiCalc calculates and recalculates; built-in functions such as @SUM, and the special cases @NA and @ERROR; the insert, delete and move commands, which let you "stretch" the sheet and manipulate entire rows or columns; and synchronized scrolling of the two screen windows. By this time we have covered most of the important concepts and features of VisiCalc, and you should be able to use VisiCalc to considerable advantage. In Lesson Four we will cover a number of other features and fine points of VisiCalc, including scientific notation for numbers and the transcendental functions such as @EXP, @LN, @SIN, and @COS; more about the formatting of numbers, and the move command. You can go on to Lesson Four as soon as you are ready. But now is an excellent time to try out what you have learned on a problem of your own. In this way, you will consolidate your knowledge of VisiCalc's commands and features, and develop a measure of intuition about how they can be used. This will enable you to approach new problems and solve them even more rapidly with VisiCalc.

Postscript: The Print Command

Sometimes it's convenient to have a "hard copy" of the contents of the electronic sheet on a real sheet of paper. VisiCalc's print command lets you print all or any part of the electronic sheet on a printer. If you have a printer connected to your computer, you can try it out by printing a copy of the personal budget we've just created. The instructions for printing files you have made with VisiCalc are in Part III of this manual, in the section entitled "The PRINT Command".



Lesson Four

Introduction	76
More on Numbers and Formats	76
Scientific Notation	77
More On Value References.....	78
More On Formulas	78
More On Built-in Functions	79
Transcendental Functions and Graphing	84
Manual and Automatic Recalculation	89
Summary.....	90

Lesson Four

Lessons One, Two and Three have covered most of the essential features of VisiCalc. In this lesson, we'll be primarily concerned with features which extend VisiCalc's usefulness in applications where complex or lengthy formulas, numbers with very large or small magnitudes, or arithmetic operations other than simple addition, subtraction, multiplication and division are required. If you intend to use VisiCalc for business or financial applications, you can skim much of this material, concentrating on topics of interest such as the @NPV (Net Present Value) and @LOOKUP functions and the ability to create bar graphs using the /F* formatting option. If you have scientific or engineering applications in mind, you'll find this lesson particularly relevant to your needs.

More On Numbers and Formats

In Lessons Two and Three we illustrate some of the ways you can control the display of numbers on the screen with formatting commands such as /GFI and /F\$. In this lesson we'll examine the formatting options more closely.

Load the VisiCalc program into your computer (as described in Part I in the section entitled "Loading VisiCalc") or, if you already have the program running, clear the sheet with /CY. When you clear the sheet, the "global format" is set to general. This is the effect you obtain when you type the command /GFG. Each individual entry is set to **default** to the global format, just as it would if you had typed /FD with the cursor at that entry. Now type the following:

```
123.456Ⓢ
/R:♦.♦♦:
```

We now have the same number, 123.456, on display in three entry positions, A1, B1 and C1. Since we have not yet set any explicit formats, all three entries default to the global format. The global format, **general**, displays numbers in whatever form will show the value of the entry with the greatest precision. As you have seen, however, this may not be the most readable way to display a column of numbers.

Now press the following keys: /FI♦/F\$♦. We have set the "local format" of entries A1 and B1 to be **integer and dollars and cents**, respectively. The local format setting at the entry where the cursor lies, A1, is visible on the entry contents line, which reads A1 /FI (V) 123.456. Each entry is displayed in rounded form. At A1, for example, 123.456 is rounded to 123, since .456 is less than .5; but at B1, 123.456 is rounded to 123.46, since the last digit .006 is greater than .005. At C1, we still have 123.456.

Now type /GFI to change the global format from **general** to **integer**. Entries A1 and B1 are unaffected, because they have explicit local formats; but C1 now displays 123. With the cursor still at A1, change the local format there by typing /FG. The number at A1 now appears as 123.456, and the entry contents line reads A1 /FG (V) 123.456.

The local format overrides the global format integer. Next, press \blacktriangleright to move to B1, and “erase” the local format there by typing **/FD**. This causes the display format of B1 to default to the global format, which is currently **integer**; so the entry at B1 appears as 123. The entry contents line reads B1 (V) 123.456; the explicit format setting **/F\$** has disappeared. Finally, type **/GFG** to set the global format back to general. Now all three entries display the number as 123.456. Position A1 has a local format which overrides the global setting, but the local format is also general. Positions B1 and C1 have no explicit format, so they default to the general format.

The way in which numbers are displayed in the general format depends on the column width. Type **/GC7** Now the number appears as 123.46 at all three entry positions. VisiCalc always allows for one blank at the left end of the entry position, and then displays as many significant digits as it can. To compare the flexibility of the general format to an explicit local format, try the following: **>B1** and then type **/F\$** to set dollars and cents format at position B1. Then type **/GC6**. Positions A1 and C1 now display the number as 123.5, but B1 now shows **>>>>>** (an effect which we saw before in Lesson Two). VisiCalc is telling us that it cannot display a number as large as 123.456 with two decimal places in a column six characters wide. If you type **12.34** VisiCalc will be able to display this number at B1.

Scientific Notation

Type **/CY** to clear the sheet. At position A1, type **99999999** (that’s eight times) followed by \blacktriangleright . This is the largest number that we can display, with a leading blank, in a nine-character column. At B1, type **1+ \blacktriangleleft** followed by \blacktriangleright . The calculated result, **1+99999999** or **100000000**, is too large to display in ordinary form at B1, so VisiCalc has switched to **scientific notation**: The number appears as **1E8**, meaning “1 times 10 to the 8th power” or 1 followed by 8 zeros. Scientific notation can also be used to display very small numbers. At C1, type **.000000001** followed by \blacktriangleright . The number appears as **1.E-9**, meaning “1 times 10 to the -9th power,” or “1 with the decimal point moved left 9 places.” (Take a moment to convince yourself that this is correct.) Now at D1 type **- \blacktriangleleft** . The result is displayed as **-1.E-9**.

When a number is displayed in the general format, VisiCalc will automatically shift between conventional and scientific notation as required to display the calculated value with the greatest precision. Type **/GC12**. Notice that all of the values revert to conventional notation in the widened columns: at D1, for example, the number appears as **-.000000001**. Next, type **/GC7** and **>A1**. The number 99999999 at A1 has been rounded up and displayed as **10.0E7**, or “9.9999999 (rounded to 10.0) times 10 to the 7th power.” Finally, type **/GC5** and look at the screen. In order to fit the numbers in these narrow columns, VisiCalc has eliminated decimal points, displaying A1 as **10E7** and C1 as **1E-9**; but D1 show **>>>>** since there’s not enough room in a five-character column to display **-1E-9** (with a leading blank).

More On Value References

Clear the sheet with /CY and type the following:

1♦2♦+A1/B1Ⓔ

The entry contents line reads C1 (V) +A1/B1, and the value displayed is .5. We know that if the number at either A1 or B1 were changed, the formula at C1 would be recalculated. Now press ♦ to move to D1. Here we'll try something different. Press +A1/B1# watching the edit line as you do so. As soon as you press the # after the coordinate B1, the reference to B1 is replaced by its current value. The edit line now reads +A1/2. Press Ⓔ The entry contents line reads D1 (V) +A1/2, and the value displayed is again .5. The difference is that the current value of B1 is "fixed" into the formula at D1, whereas the value of B1 is changeable at C1. To verify this, type ♦♦4Ⓔ and notice that C1 changes to .25, but D1 does not.

The effect of # after a value reference on the edit line is similar to the effect of typing ! after a formula, as described in Lesson One. The difference is that the ! key evaluates the entire formula on the edit line, replacing it with a single number, while the # key fixes the value of a single coordinate, so that the rest of the formula can contain changeable elements. If the # is not preceded by a coordinate such as B1, it is replaced by the current value of the entry where the cursor lies (i.e. the entry you are changing). You can use this feature to take a look at the precise value of a formatted entry on the edit line. For example, set the global format with /GF\$ and then type 6Ⓔ The value at C1 is now displayed as .17. Press ♦ to move to C1, then press # The # immediately places the current value of C1 (1/6) to maximum precision (.166666666666) on the edit line.

A word on precision is in order here. VisiCalc maintains numbers internally in decimal form. Certain fractions (such as 1/6) cannot be expressed exactly with any fixed number of significant digits. VisiCalc uses decimal based arithmetic so that it can maintain accuracy in calculations involving dollars and cents. To accommodate large financial figures as well as high-precision engineering or scientific quantities, VisiCalc maintains numbers (where necessary) to a precision of eleven significant digits. The last 6 on the edit line at the moment is a "guard digit," which allows VisiCalc to determine which way to round the eleventh digit when a calculation is completed. After examining the number, you can press CLEAR a few times to "abort" the VALUE entry you have started on the edit line.

More On Formulas

In the examples from previous lessons, we have used only simple formulas (or **expressions**) whose meanings have been clear. As you begin to write more complex expressions involving several arithmetic operations, the way in which such expressions should be evaluated may not be so obvious. For example, to evaluate the expression $9 + 6/3$, should we first add 9 to 6 giving 15 and then divide by 3 to obtain 5; or should we first

divide 6 by 3 giving 2, and then add 9 to obtain 11? Try it: First type /CY to clear the screen and then type $9 + 6/3$ Ⓢ. The answer displayed at position A1 is 5. Evidently VisiCalc chose the first option. In this way, VisiCalc is similar to many keystroke calculators in that it always evaluates expressions strictly **from left to right**.

You can change the order of evaluation of arithmetic operations in an expression by using parentheses. For example, press ⌘ to move to A2 and then type $9 + (6/3)$ Ⓢ. The answer highlighted by the cursor is 11. Parentheses may be nested to any depth. Type

⌘ - (⌘ ⌘ + ((A2 - 1)/A1))Ⓢ

The answer displayed at A3 should be -7.

More generally, an expression consists of a series of **operands** separated by arithmetic **operators**. Each operand can be one of the following:

1. A number, optionally with a decimal point and/or an E exponent.
2. A value reference, obtained either with cursor movements or by typing the coordinate.
3. A function reference, with zero or more arguments in parentheses.
4. An expression surrounded by parentheses. (Such a subexpression is evaluated first.)
5. Any of the above, preceded by a - or + sign.

Each operator can be one of the following:

- | | |
|---|-----------------------------|
| + | For addition . |
| - | For subtraction . |
| * | For multiplication . |
| / | For division . |
| ↑ | For exponentiation . |

On your keyboard, you generate the exponentiation symbol (↑) by holding down the **SHIFT** key and pressing the @ key. The exponentiation operator ↑ lets you calculate “powers.” For example, type ⌘2↑3Ⓢ to calculate “2 to the 3rd power,” or 8. Try another example: Type ⌘2↑.5Ⓢ to calculate “2 to the power 1/2,” or the square root of 2. The result displayed at A5 should be 1.414214. To find the cube root of 5, type ⌘5↑(1/3)Ⓢ. VisiCalc will calculate and display the value 1.709976.

More On Built-in Functions

We first encountered built-in functions in Lesson Three, where we used the @SUM function to find yearly totals for our income and expenses and to calculate our available leisure money as $+B2 - @SUM(B4..B11)$, or income minus the sum of expenses. As

mentioned above, a function reference can appear in an expression wherever a number or coordinate could appear. Moreover, as we shall see shortly, an expression may also occur as an argument in a function reference. We also saw that one type of function argument is a range of entries, such as B4 . . . B11 in the LEISURE example. You need only type one period; VisiCalc will fill in the other two.

In general, a built-in function name is followed by a parenthesized **list of arguments** separated by commas. Each argument can be:

1. An **expression**, i.e. a series of numbers, value references, and/or function references separated by arithmetic operators and/or parentheses; or
2. A **range** of entries, i.e. a series of entries that are next to each other in a row or column, such as B2, B3 and B4, or B2, C2, D2, and E2. A range is specified by typing (or obtaining with cursor movements) the first and last entry separated by an ellipsis. For example, the ranges just mentioned would be specified as B2 . . . B4 and B2 . . . E2, respectively.

The exact number and type of argument(s) required varies from function to function. For example, the @NA and @ERROR functions which we saw in Lesson Three required no arguments. Some functions require exactly one or two arguments, while others, such as @SUM, take a variable number of arguments.

Let's try an example of the @SUM function using the general form for a list of arguments. Use the \blacktriangledown key to move to position A7, and type:

`@SUM(A1.A4,A5*A5,A6↑3)Ⓢ`

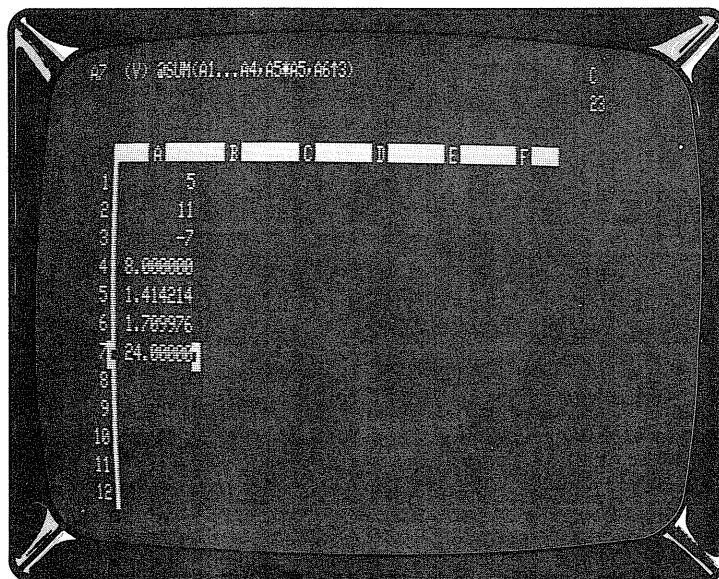

The result should be $5 + 11 - 7 + 8 + 2 + 5$ or 24. Let's experiment further with some other built-in functions:

@MIN and @MAX. These functions accept a list of arguments just like the @SUM function. The result is the minimum and maximum value in the list, respectively. Remember that the minimum value will be the negative number (if any) with the greatest absolute magnitude. To try out these functions, type the following:

```

↵@MIN(A1:A7)Ⓔ
↵@MAX(A7,@SUM(A1,A2,A4:A6))Ⓔ

```

The results should be -7 for @MIN at A8, and 27.12419 for @MAX at A9.

@COUNT and @AVERAGE. These functions also accept a list of arguments, which may be expressions or entry ranges. @COUNT determines the number of nonblank entries occurring in the range or ranges of the argument(s). (Note that arguments which are expressions rather than ranges always count as 1. This can be puzzling if the "expression" is a single coordinate such as B1: It will add 1 to the count **even if B1 is blank**. To avoid this, write B1 . . . B1.) @AVERAGE finds the arithmetic mean of the entries making up the argument(s); it is equivalent to @SUM(arguments)/@COUNT(arguments). To try out these functions, clear the sheet with /CY and type the following:

```

1↵↵3↵4↵↵6↵↵8↵/ --↵

```

The cursor should now be at A10. Type @COUNT(A1:A8)Ⓔ The count of nonblank entries displayed at A10 should be 5. Now type ↵@ AVERAGE (A1:A8)Ⓔ The average of 1, 3, 4, 6 and 8 should be 4.4 at A11. To check the equivalence mentioned above, type ↵@SUM(A1:A8)/A10Ⓔ The result should again be 4.4. Finally, let's change one of the currently blank entries in the argument range to a number: Type >A5Ⓔ5Ⓔ The @COUNT at A10 should change to 6, and the @AVERAGE at A11 and A12 should increase to 4.5.

The @NPV (Net Present Value) Function. This function accepts two arguments. The first is a single expression specifying a discount rate, such as .15 for 15% per period. The second argument is a range of entries; the first entry is the cash flow at the end of the first period, the second entry is the cash flow at the end of the second period, etc. The result of the function is the net present value of the cash flows in the range, discounted at the rate specified by the first argument. If we represent the function reference by @NPV(dr,entry1 . . . entryn) and let $DR = 1 + dr$, the result of the function is $(entry1/DR) + (entry2/(DR^2)) + (entry3/(DR^3)) + \dots + (entryN/DR^N)$. To illustrate the use of this function, type /CY/GC6Ⓔ to clear the sheet and make narrower columns. Suppose that we have a project which requires an investment or cash expenditure of \$5000 up front, and which is expected to generate cash over a period of five years. Type the following to lay out the cash flows:

```

1+1+1
/R:D1.F1:R
>A2
-500010001500250020001000
>A3
.15

```

At position A4, type `+A2+@NPV(A3,B2.F2)`. This causes the \$1000 cash flow in the first year to be discounted by 15%, the \$1500 cash flow in the second year to be discounted twice, etc. The result at A4 should be 288.3. Now press \blacktriangleleft and change the discount rate to 10% by typing `.1`. The net present value at the lower discount rate (which makes the future cash flows worth more today) is 1014. You can find the internal rate of return of this project by trial and error: Try higher and lower discount rates at A3 until the net present value of the cash flows is near zero. When A3 is `.17`, A4 will be 34.81. (If you are persistent, you can verify that the net present value is `.00000061` when the discount rate is `.1728674256`.)

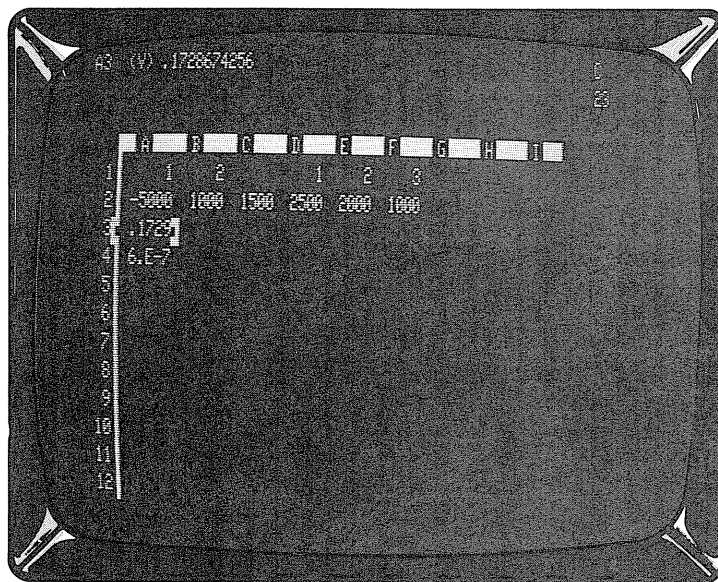

The @LOOKUP Function. This function also accepts two arguments. The first or “search” argument, an expression, is looked up in the table specified by the second argument, an entry range, and matched against one of the entries in this range. A table of function result values must be present in the column or row immediately to the right of or below the column or row range specified in the @LOOKUP function. The function result is taken from the entry corresponding to the matched entry in the table of result values. The values in the function argument range are ordinarily in ascending order. The search argument is compared against succeeding entries in the second argument range, until an entry greater than the search argument is found. The search argument is “matched” against the entry just before this one (i.e. one which is still less than or equal to the search argument), and the function result is selected from the corresponding entry in the table of result values. If the **first** entry in the argument range is greater than the search argument (i.e. if the search argument cannot be

matched against any entry in the range), the result of the function is NA or Not Available. To illustrate the use of this function, we'll list the first ten entries in the periodic table of the chemical elements, with their atomic weights and atomic numbers. Clear the sheet with /CY/GFL and type the following:

```
ELEMENT WEIGHT NUMBER
>A2
H HE LI BE B C N O F NE
>B2
1 4 7 9 11 12 14 16 19 20
>C2
1 1 + @/R:C4.C11:R
>A13
10.9 @LOOKUP(B2.B11)
```

The result of the @LOOKUP function at B13 should be 4. Given an experimental atomic weight of 10.9, the @LOOKUP function compared this value against successive values in column B, stopping at the value 11 at B6 which was greater than 10.9. Thus, the atomic weight of 9 at B5 is the matching value, and the corresponding entry, the atomic number in column C, is 4. If you change the value to be looked up with 12.1 the function result will become 6. If you then type an "atomic weight" of 0 the result of the @LOOKUP function will be NA.

Element	Weight	Number
H	1	1
HE	4	2
LI	7	3
BE	9	4
B	11	5
C	12	6
N	14	7
O	16	8
F	19	9
NE	20	10
B13	NA	

The @ABS and @INT Functions. Both of these functions accept a single argument, an expression. @ABS finds the "absolute value" of its argument: For example, @ABS(1)=1, @ABS(-1)=1, and @ABS(0)=0. @INT finds the "integer portion" of its argument, without any rounding. You can think of the @INT function as setting every digit to the right of the decimal point to zero. For example, type /CY/F11.7 @INT(1.7) At A1, the value 1.7 is rounded up to 2 by the local format integer; but at B1, @INT finds the integer portion of 1.7, i.e. 1.0 or 1.

Transcendental Functions and Graphing

So far, we've covered all of the built-in functions except for the transcendentals such as @EXP, @LN and @SIN, and all of the formatting options except for the "graph" format /F*. We'll illustrate these two features together with a more complete example. Our goal is to produce graphs of the transcendental functions. We'll have to do this within the limits of the /F* formatting option, which is really designed to draw simple bar graphs in a column alongside other columns of numbers.

Clear the sheet with /CY and type **13620** then **>A1**. The "star" format /F* simply displays the number of asterisks equal to the integer portion of the value of the entry where the format is set. Type /F* at A1: In place of the (right-justified) number 1, a single (left-justified) asterisk appears, after the usual leading blank. Now press **F***. The value 3 is replaced by three asterisks. Continue with **/F*/F***. Position C1 shows six asterisks, while position D1 shows eight (the maximum for a nine-character column). Type **/GC12** and notice that position D1 now displays 11 asterisks.

Now clear the sheet again with /CY. To graph a function, we must first supply a series of argument values for the function and calculate the function result for each argument value. For simplicity's sake, we'll begin with a linear function, e.g. $f(x) = 2.5 * x$. Type the following:

```
>A20
.1.1
>A1
+A20+ + B20
/R: .A17:RN
```

On row 20, we have defined a "start" value and "step" value for our list of function arguments. Then, using formulas and the replicate command, we calculated the argument values, from .1 to 1.7 in positions A1 to A17. Next, we'll calculate the corresponding function results for our linear function. Type the following:

```
>B1
2.5*A1
/R: .B17:R
```

The function results are .25, .5, .75, etc. up to 4.25. To see how this looks in the star format, we'll set the format specification and replicate again: Type **/F*/R: .B17:R**. How does the "graph" look? It's probably not the kind of graph you had in mind. The problem is that the function results do not fall conveniently in the range 1, 2, 3, etc. which would yield one, two, or three asterisks. Let's go back to a numeric display with **/FD/R: .B17:R**. How can we create a better star format display?

First, we'll set up a wider column in which the asterisks may appear, so that we can represent a wider range of function results with the best possible resolution. This will allow us to display a "bar" of up to 7 asterisks. Then we'll "scale" the function results, from .25 to 4.25, into the range 0 to 17. Type the following:

```
>B18Ⓢ
/---@MAX(B1.B17)Ⓢ
/GC8Ⓢ
>C1Ⓢ
/WV;/GC18Ⓢ
17/B19*@ABS(B1)Ⓢ
```

At B19, we've used the @MAX function to find the upper limit on the range of function results. (For simplicity's sake, we'll work with the absolute magnitudes of the function results, so the lower limit will be zero. You may wish to work out an approach to scaling which uses both @MAX and @MIN.) We've also set up a wide column in the right hand screen window for the asterisks. The formula at C1 is used to multiply each function result, such as B1, by the factor 17 (the maximum number of asterisks) divided by B19 (the maximum function result). The value of this formula will lie in the range from 0 to 17/B19*B19, or 17. Now type /F* to set the display format at C1, and type /R:↵.C17:NR and watch the screen. Now we have a reasonable approximation to a straight line. Moreover, if we've done our job properly, we should be able to graph any set of function results in column B, not just the linear function $f(x) = 2.5 * x$. (We will want to adjust the argument range so that we can graph an interesting portion of the function result range.) Your screen should look like the photo below.

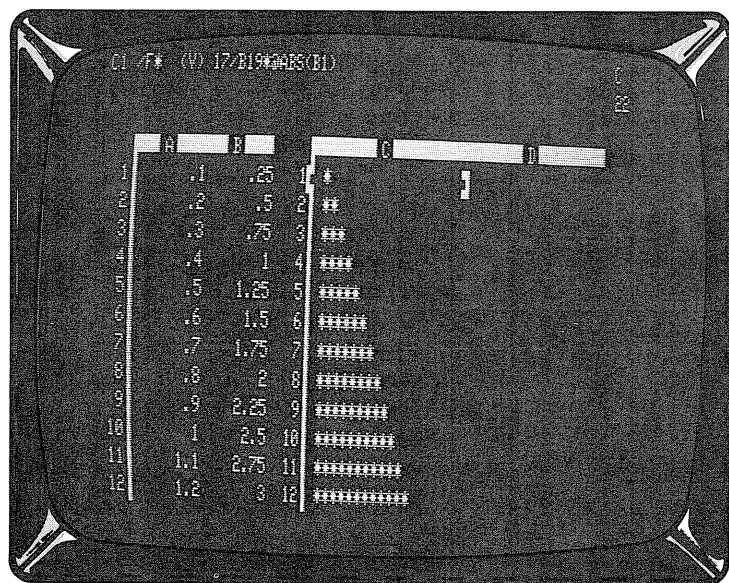

Transcendental Functions and Graphing

Now type the following:

```
; >A20Ⓢ
1Ⓢ.25Ⓢ
>B1Ⓢ
@LN(A1)Ⓢ
/R:B2.B17:R
```

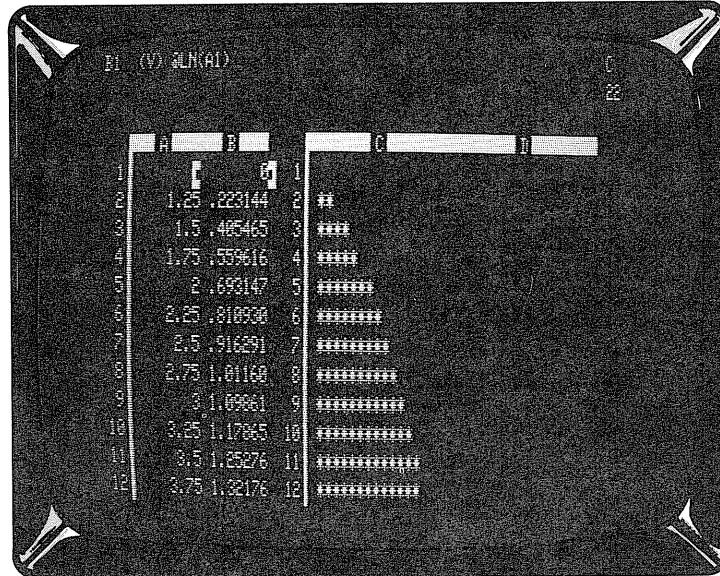

Notice that the value of @MAX(B1 . . . B17) at B19 changes to 1.60944. (Type >B19Ⓢ to see this, then type >B1Ⓢ to reposition the cursor at B1.) This value affects the formulas in column C so that the results still come out in the range 0 to 17. If the graph of the natural log function doesn't look completely familiar, tilt your head sideways and imagine the X axis on the column and the Y axis on the row.

Now, let's try the exponential function. Type:

```
/WS
@EXP(A1)Ⓜ
/R:B2.B17:R
>B19Ⓜ
```

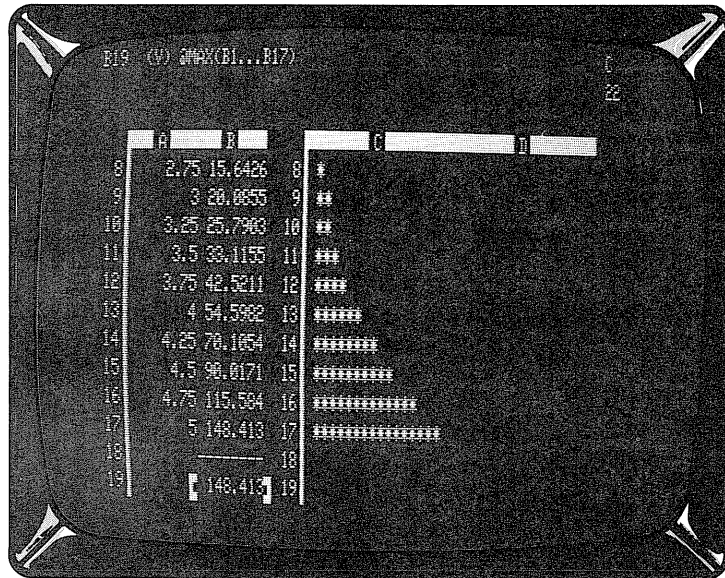

The maximum function result value is now 148.413, and each result is scaled into the range 0 to 17 in column C. Is the graph close to what you expected? Finally, we'll graph the sine function. Since the trigonometric calculations are done in radians, we'll use `@SIN(@PI*A1)` and a different argument range so that we can obtain a full sine curve in column C. Type the following:

```
>A20Ⓜ
.03Ⓜ.06Ⓜ
>B1Ⓜ
@SIN(@PI*A1)Ⓜ
/R:B2.B17:R
>A14
```

Transcendental Functions and Graphing

If all has gone well, you'll have a reasonable graph of the sine function in column C, looking like the photo below.

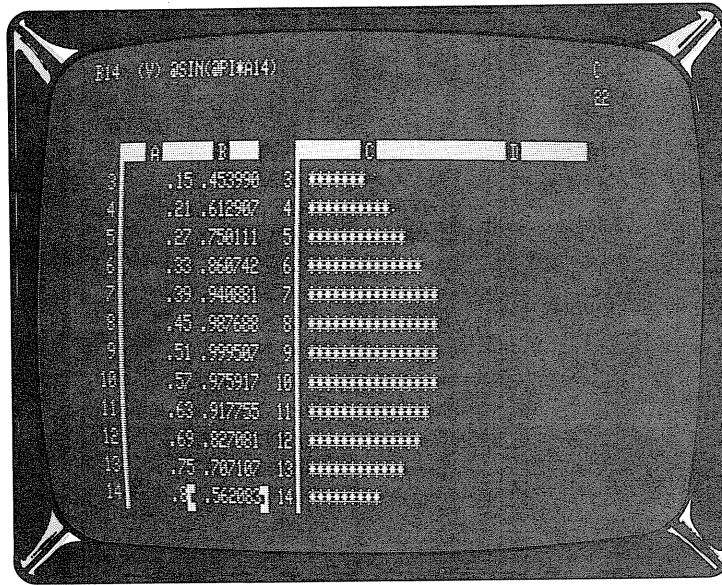

At this point, you may wish to experiment with different argument values and functions. When you're finished, you can go on with the next section.

Manual and Automatic Recalculation

If you've just worked through the example above at your keyboard, graphing the transcendental functions, you've probably noticed some significant delays as VisiCalc repeatedly recalculated the results of functions such as @EXP, @LN and @SIN. Because the function results are calculated to nearly eleven significant digits, each one takes a fraction of a second to evaluate, and a sheet full of function references can take several seconds to recalculate. This problem gets worse, of course, as the amount of information on the electronic sheet increases.

In many cases, you don't actually need to have all of the values recalculated every time you change an entry. It would be convenient if you could change several entries and then trigger a recalculation when you're ready to look at the results. VisiCalc lets you do this with the /GR command.

If you still have the graph of the sine function from the previous section on your screen, we'll try changing the argument range start and step sizes. (If you no longer have this graph on the screen, just read along.) Type >A20Ⓢ to move the cursor to the starting value, which is currently .03. When you load the VisiCalc program or when you clear the sheet, you are in **automatic recalculation** mode: As soon as you change the value at A20, VisiCalc will automatically recalculate the values of all the formulas on the sheet. Before doing this, however, type /G The prompt line reads GLOBAL: C O R F. Press R Now the prompt line reads RECALC: A M. The possible keystrokes are M, to switch to manual recalculation mode, and A, to return to automatic mode. Press M You have "turned off" automatic recalculation. Now you can change the values at A20 and B20 without waiting for a lengthy intervening recalculation. Type .06Ⓢ.12Ⓢ Now we're ready for a recalculation—but how do we make it happen? Press the exclamation key ! As you've probably noticed before, an exclamation point appears in the upper right corner of the screen and blinks while the recalculation takes place. Whether you're in manual or automatic mode, pressing ! triggers a recalculation of all formulas on the screen (unless ! is pressed while you're entering a LABEL or VALUE on the edit line). Notice how the graph changes to display the positive-going portion and the reflection of the negative-going portion of the sine curve.

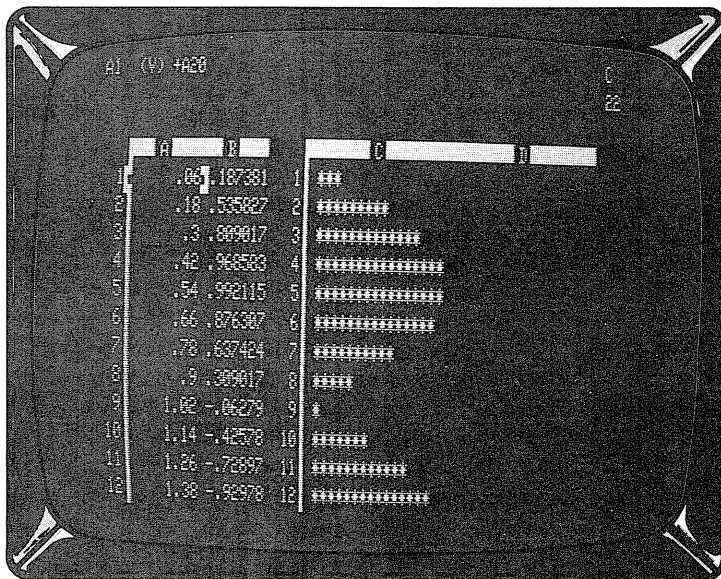

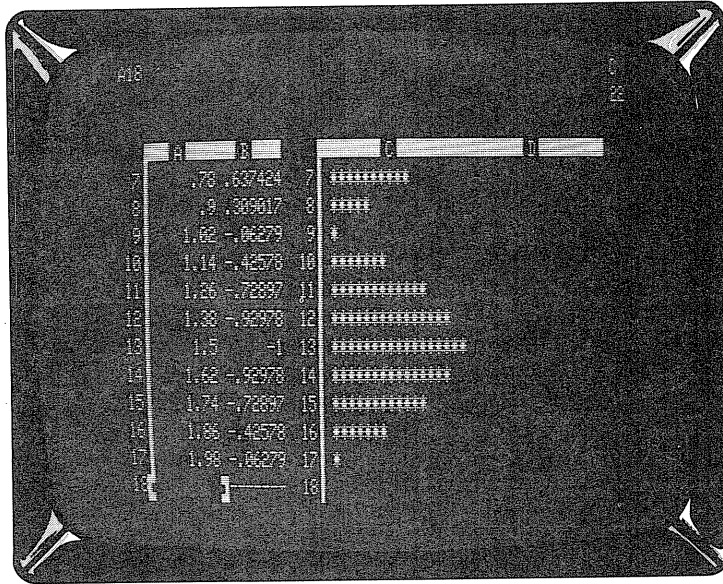

Now, type **.06↑.54Ⓢ** then return to automatic mode by typing **/GRA**. The first thing that happens as you return to automatic mode is, of course, a recalculation to update all the figures on the screen.

Summary

This lesson has introduced you to the full power of VisiCalc's calculation capability. Besides simple addition, subtraction, multiplication and division, VisiCalc provides exponentiation, transcendental functions, and scientific notation for numbers. You can use functions such as **@SUM**, **@MIN** and **@MAX** to manipulate entire rows, columns or other ranges of numbers at once. Functions like **@COUNT**, **@AVERAGE**, **@NPV** and **@LOOKUP** allow you to quickly handle common problems such as test score averaging, evaluating the terms of a loan, or looking up figures in the income tax tables. You can control the format of calculated results in a variety of ways—even

creating simple graphs with the /F* format. With practice, you'll be able to use the features described in this lesson in combination with VisiCalc's screen and window control and formula replication capabilities to solve complex problems quickly and easily.

Lesson Four concludes Part II, the Tutorial for VisiCalc. Look up commands, as you use them, in Part III, the VisiCalc Command Reference. You will discover still more fine points of VisiCalc not discussed here, and many straightforward examples which illustrate how to use each command. As you use VisiCalc, you will discover countless techniques and application ideas that may be useful in your work.

PART III. VISICALC COMMAND REFERENCE

The VisiCalc Screen	94
The Control Panel.....	94
The Window and Sheet	95
Entry Positions.....	95
The Cursor	95
Moving the Cursor	95
Automatic Repeat.....	96
Pointing with the Cursor	96
Typeahead	96
Correcting Mistakes	96
The Memory Indicator	96
Command Structure Chart	98
GO TO Command	101
LABEL ENTRY Command	102
VALUE ENTRY Command	103
About Value References.....	106
Use of ! and #	107
Recalculation Order	109
Forward and Circular References	109
VisiCalc's Built-In Functions.....	110
Function Arguments	110
BLANK Command	114
CLEAR Command	115
DELETE Command.....	116
FORMAT Command	120
Default Display Format-/FD	121
General Format-/FG.....	122
Integer Format-/FI.....	122
Left Justification-/FL	123
Right Justification-/FR.....	123
Dollars and Cents Display-/F\$	123
Bar Graph Format-/F*	123
GLOBAL Command	124
Global Column-/GC	124
Global Order of Recalculation-/GO	125
Automatic or Manual Recalculation-/GR	128
Global Format-/GF.....	129
INSERT Command	130
Inserting a New Row-/IR	130
Inserting a New Column-/IC	131

MOVE Command	133
To Move a Row	133
To Move a Column	136
PRINT Command	141
Print File Option	143
REPLICATE Command	144
Copying from One Entry Position to Another	145
Creating a Column by Making Several Copies of One Entry	146
Copying a Column from One Position to Another	146
Making Several Copies of a Column	147
Copying a Row from One Position to Another	148
Replicating Value References.....	149
STORAGE Command	154
Storage Load Command-/SL	154
Storage Save Command-/SS	155
Storage Delete Command-/SD	157
Storage Quit Command-/SQ	157
Saving Files in the Data Interchange Format	157
Saving a Data Interchange Format File-/S#S	158
Loading a Data Interchange Format File-/S#L	159
TITLE Command	160
VERSION Command	162
WINDOW Command	163
Horizontal Split-/WH	163
Vertical Windows-/WV	165
Return to One Window-/WI	166
Synchronized Scrolling-/WS	166
Unsynchronized Scrolling-/WU	166
REPEATING LABEL Command	167

The VisiCalc Screen

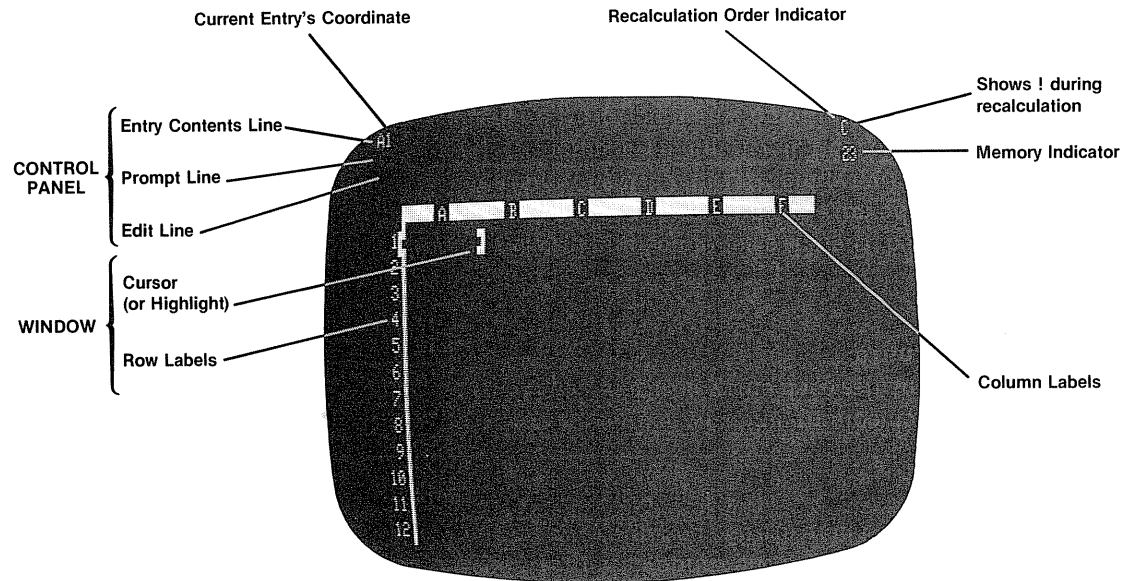

The Control Panel

The top three lines of the VisiCalc screen make up the **control panel**. Each line has a specific function:

The **entry contents line** is the top line of the panel. At the left, it will always show the coordinate on which the cursor is currently placed. Next to the cursor it displays the exact content (as it was entered) of that entry position, if there is anything written in it. Any explicit formats (see Part III, the **FORMAT** Command) that might have been set at the coordinate are also displayed here. At the right side of the entry contents line, the letter **C** or **R** appears, indicating that calculation and recalculation is being done down columns or across rows (see Part III, the **GLOBAL** Command).

The **prompt line** is the middle line in the control panel. At the left side, it displays the name of the command that is currently being used followed by a colon (:). Next comes a series of letters or words which indicate all possible choices offered by VisiCalc at this point. The number on the right indicates the amount of available memory left in the computer. On the command structure chart at the beginning of each command discussion in the VisiCalc Command Reference, each prompt line is enclosed in a box. Below the box are all the possible actions VisiCalc can take from that point in the command structure. The control panel is said to be "**clear**" when there is no prompt on this line. A command can be started only when this line is clear. (The memory indicator on the right will always be visible.) When a command is being used and there is a prompt on this line, pressing **BREAK** will cancel the command and clear the prompt line.

The **edit line** is the bottom line of the control panel. It displays each character you type or point to with the cursor while using a command. A dash always appears after the last valid character that was typed. Characters that are displayed on the edit line can be erased by backing up the dash with the **CLEAR** key and then retyping, if desired. VisiCalc will also, on occasion, use this line to display information which it wants you to confirm or clarify before it carries out a command.

The Window and Sheet

Below the control panel is the VisiCalc **window** which looks upon a portion of the VisiCalc electronic sheet. Across the top of the window there is a border of letters, each of which is a column heading. The sheet is divided into 63 columns, labelled A, B, C, . . . BI, BJ, BK. Down the left side of the window there is a border of numbers, which serve as headings for each row. There are 254 possible rows on the VisiCalc sheet.





Entry Positions

The intersection of each column and row defines an **entry position**. A column letter and a row number identifies each entry position, *i.e.*, D17. This identifier is called the entry position **coordinate**.

The Cursor

When VisiCalc is loaded, there is a set of flashing brackets highlighting entry position A1. This bar is called the **cursor** and sometimes the "highlight." The cursor can be removed from the screen by typing **SHIFT CLEAR** and replaced by typing **SHIFT CLEAR** again. Typing **SHIFT 0** will make the cursor stop flashing; **SHIFT 0** again will start it flashing. Any command which performs an action on a single entry position will do so in the entry position that is highlighted by the cursor when the command is started. This coordinate remains displayed at the left side of the entry contents line until the command is completed and the cursor moved, although, during the course of some commands the cursor can be moved (an action called **pointing**).

Moving the Cursor

The cursor can be moved to any position on the electronic sheet. The exact keys which cause the cursor to move are discussed in detail in Part I of this manual, in the section entitled "Some Notes on Your Keyboard." In the VisiCalc Command Reference, we continue to use the symbols , , , and  to indicate the use of these keys to move the cursor. The cursor will move one entry position in the direction of the arrow each time you press the cursor-moving key.

When the cursor has been moved to the right or bottom edge of the sheet visible through the window, VisiCalc will **scroll** the entire window across or down the sheet, following the cursor so that it is in view at all times. To jump around the sheet quickly, see Part III, the GO TO Command.

If the cursor is "bumping" into any of the four edges of the electronic sheet, the row and column borders will flash.

Automatic Repeat

Pressing **↖**, **↗**, **↘**, or **↙** and **holding** it down will automatically cause the cursor to move more quickly, in the direction of the arrow. The window will scroll to keep up with the cursor.

Pointing with the Cursor

Whenever you are using a command and can type in a formula (see the VALUE ENTRY Command) or an entry position coordinate, VisiCalc allows you to move the cursor to **point** to the coordinate you want. Check the prompt and edit lines to be sure you have begun the command and VisiCalc is waiting for you to enter a coordinate before you press one of the cursor-moving keys. Then move the cursor to the desired entry position. You will see the coordinate on the edit line change as you move the cursor. If you try to point with the cursor when it is not allowed, VisiCalc may end the command and move the cursor to the next entry position.

Typeahead

At times, you may type faster than VisiCalc reacts to your keystrokes. This is because VisiCalc may be doing any number of things in reaction to the last key you pressed, such as expanding the electronic sheet and recalculating formulas. VisiCalc has a feature called **typeahead** so that it remembers the keys you pressed, no matter how fast you go. It will catch up with you as soon as it can. Use typeahead cautiously when entering commands and data together. It is easy to mix up keystrokes and enter a command as a label.

Correcting Mistakes

When you have characters on the edit line, you may back up to erase them by using the **CLEAR** key and then typing in the correct characters. Each time **CLEAR** is pressed, the dash on the edit line will erase one character. Press it enough times and you'll back completely out of the command and have a clear control panel.

If you start a command and decide you don't want to complete it, press **BREAK** to cancel it and return to a clear control panel.

To change the contents of an entry position, move the cursor to the coordinate, and initiate the desired command. When you finish the command with its appropriate terminator, the old contents will be replaced by the new.

The Memory Indicator

The number at the right side of the prompt line is called the **memory indicator** and tells you how much memory is available as you write on the electronic sheet. There is a complete discussion of the computer's memory and the way VisiCalc uses it in Part II, Lesson Two in the sections entitled "Postscript: Memory and the Electronic Sheet," "How the Sheet is Reconfigured," "The Memory Indicator," and "Dynamic Memory Allocation."

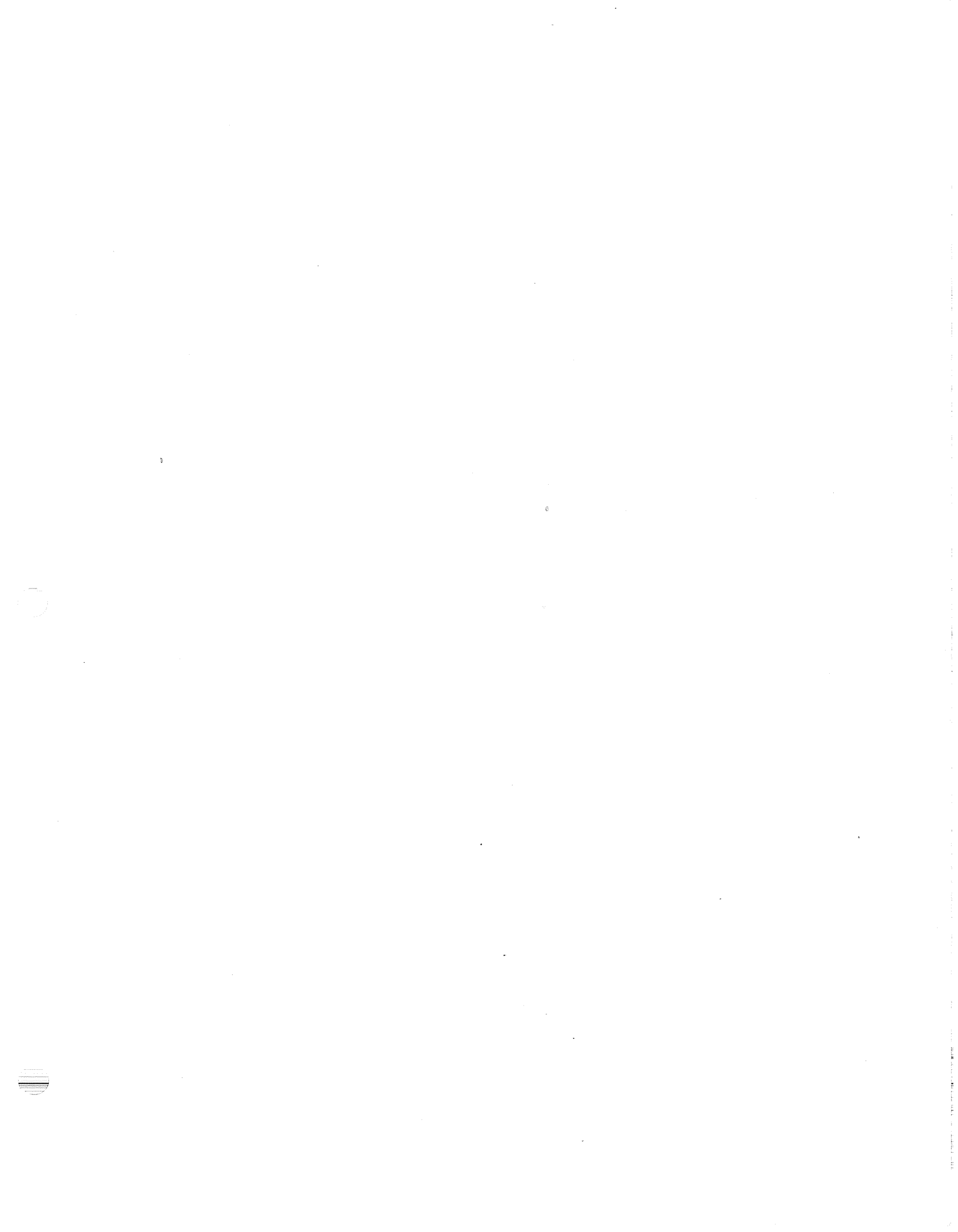

Visicalc Command

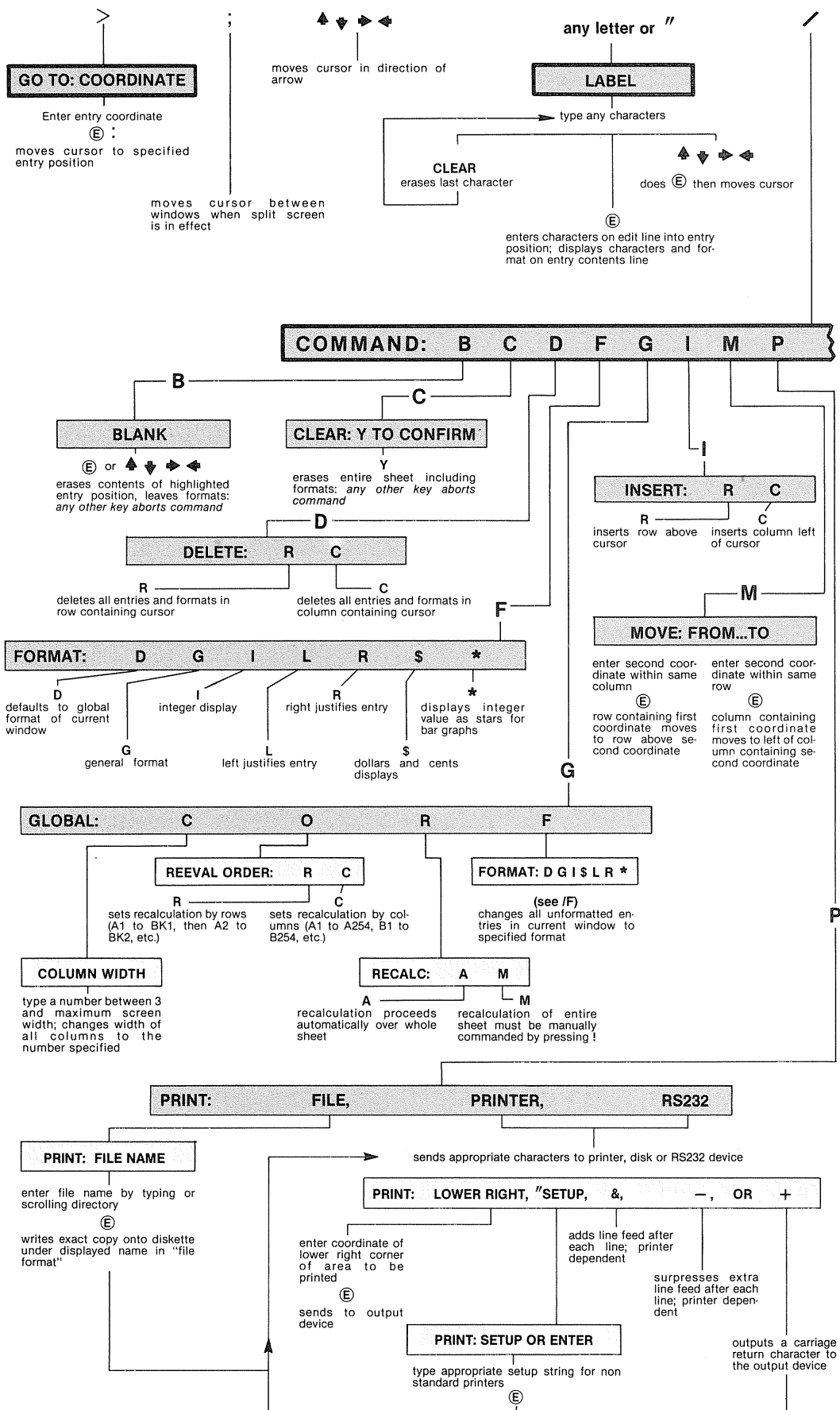

Structure Chart

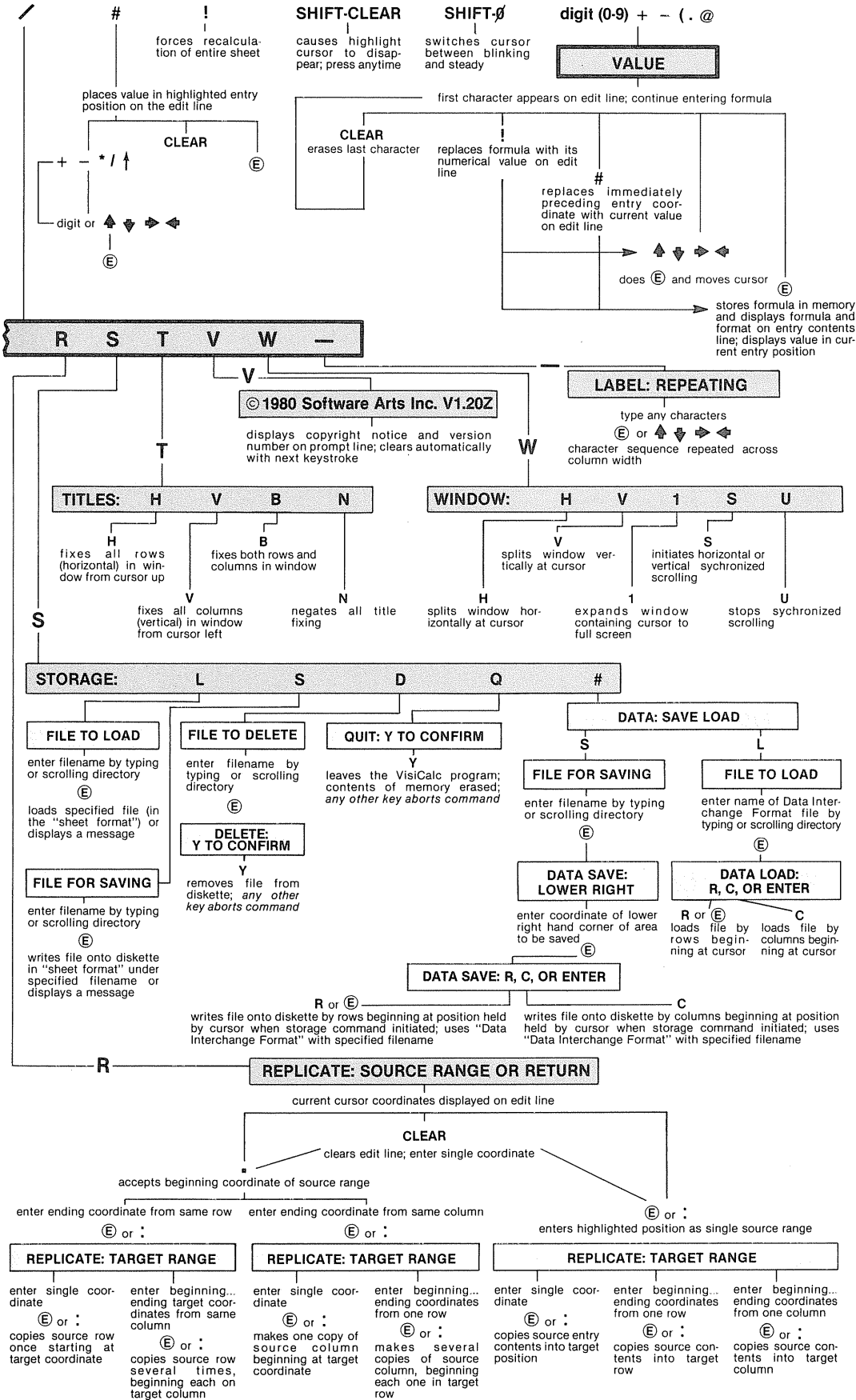



The GO TO Command

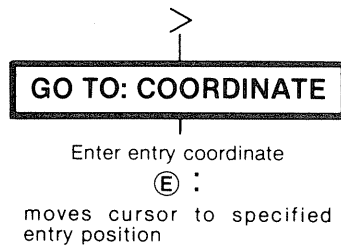

With this command, you have a fast way to move the highlight to any position on the sheet. To move the highlight cursor to a new entry position, type > followed by the coordinates of the entry position to which you want to jump, and then ⓔ

Example

- | | | |
|-----------------|--|-------------------|
| 1) Type > | prompt line: | GO: TO COORDINATE |
| 2) Type AM205 ⓔ | The highlight will be moved to column AM, row 205. | |

Entering an invalid coordinate, such as AB300, causes the control panel to flash, and VisiCalc to clear the prompt and edit lines.

The LABEL ENTRY Command

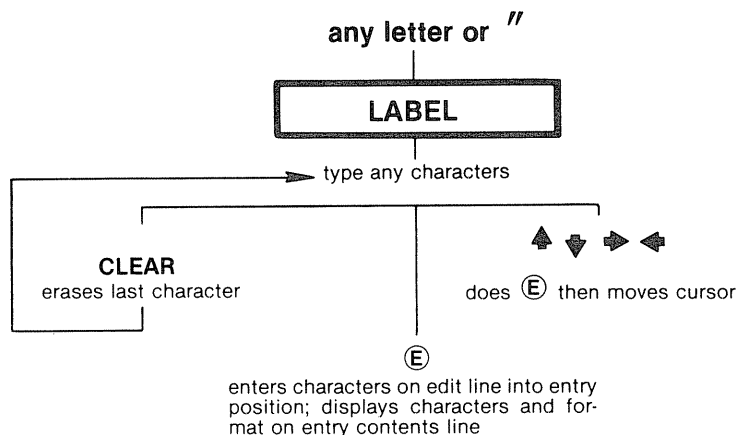

Any combination of alphanumeric characters can be put into an entry position. The character strings entered as labels are evaluated by VisiCalc as 0.

You begin the label entry command from a cleared control panel. The label will be entered in the entry position on which the cursor is sitting when you begin the label entry command. When the first character of the label is alphabetic, just begin typing the label. VisiCalc immediately recognizes that you are entering a label.

You may want to enter a label such as 2ND MONTH. In such a case where the first character is a digit or one of the arithmetic operators which automatically begin a value entry (see VALUE Command), you must type a quotation mark (") as the first character in the label. The " will not appear as part of the label.

As soon as you have pressed either the " or a letter, the prompt line will display LABEL and the characters of the label will appear in the edit line and in the entry position. Press CLEAR to back over any mistyped characters and retype them.

When the label is complete, terminate the command with either \textcircled{E} , \leftarrow , \rightarrow , \uparrow or \downarrow . The label will appear in the entry position with the first character at the left side of the column and will have replaced anything that you may have previously placed in that position. You may tell VisiCalc to display the label right-justified within the column with a special format (see the discussion of /FR in Part III, the FORMAT Command). All entries made with the label command are given the entry type L, which appears on the entry contents line as (L).

Example

- | | |
|----------------------------|--|
| 1) Type >A1 | The cursor is in entry position A1. |
| 2) Type P | prompt line: LABEL
edit line: P |
| 3) Type ERIOD | entry contents line: A1
prompt line: LABEL
edit line: PERIOD |
| 4) Press \textcircled{E} | entry contents line: A1 (L) PERIOD
prompt line: clear
edit line: clear |
- or press \leftarrow , \rightarrow , \uparrow , or \downarrow The label is entered and highlight is on the next entry position.

Suppose you want to use a label that looks like a formula.

Example

- | | |
|--|---|
| 1) Type >B1\textcircled{E} | |
| 2) Type " | prompt line: LABEL |
| 3) Type .575*B2 | prompt line: LABEL
edit line: .575*B2 |
| 4) Press \textcircled{E} , \leftarrow , \rightarrow , \uparrow or \downarrow | entry contents line: B1 (L) .575*B2
prompt line: clear
edit line: clear |

The (L) indicates entry type and allows you to distinguish the label entry from a value entry.

The VALUE ENTRY Command

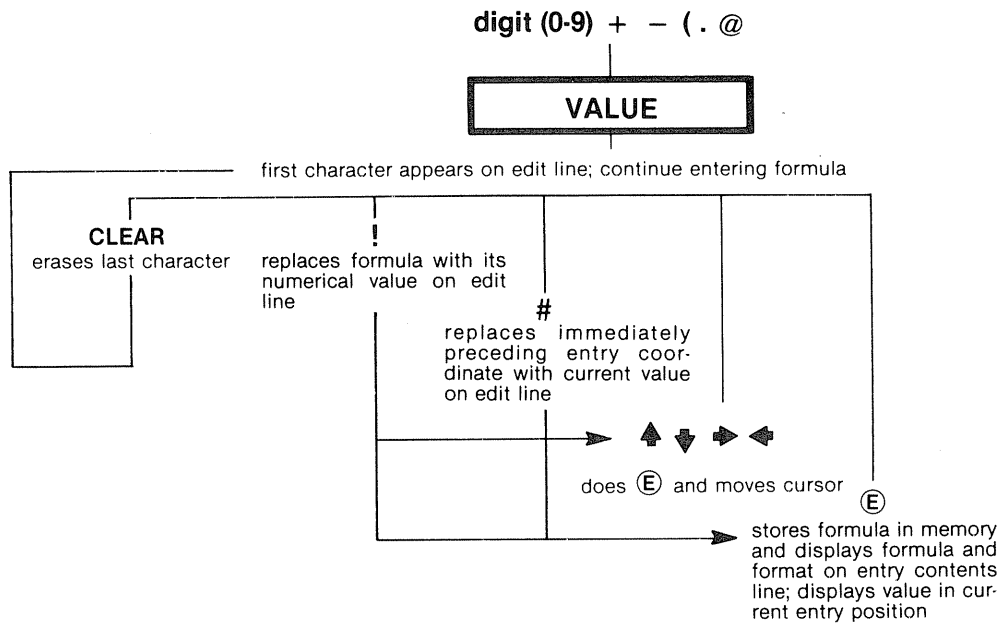

Value entry is the procedure by which you write numbers and formulas on the VisiCalc sheet. You may type a value entry on the keyboard and then enter it into the computer's memory by pressing **E** or one of the arrow keys (↑ ↓ ← →). When a value has been entered, its numerical equivalent will appear on the sheet, replacing any previous entry in the same position. A value entry may be a number, an arithmetic expression, or a "VisiCalc formula." In VisiCalc formulas, entry position coordinates, called **value references**, may be used as variables. VisiCalc's Built-In Functions may also appear in formulas. Value references and the Built-In Functions are covered in more detail below. Below are examples of several valid VisiCalc value entries:

1000

-13

+1.5/F3

+C2 - B2

6*(D2↑D5)

@SUM(A1 ... A0)+5

All values are stored with between 11 and 12 significant digits. When a number is displayed in the general format (see the **FORMAT** Command), VisiCalc will shift between conventional and scientific notation as required to display the calculated value

with the greatest precision. In scientific notation, the number 123456789123 becomes 1.235E11. The “E11” means “times 10 to the 11th power.” The largest number possible is .999999999999E62. The smallest is 9.999999999E-66. Except in \$ format (see the FORMAT Command), non-significant zeros are dropped from the display.

If the column is too narrow to display a number, even in scientific notation, VisiCalc will place as many right angle brackets (>) as it can in the entry position.

An illegal calculation, such as dividing by zero, will result in a value that is displayed as ERROR in the position where the illegal calculation occurs and in all other positions that reference the calculation.

Any of the following keystrokes will initiate the value entry command: **a digit**

+ - (. # @

The arithmetic operators which separate elements in formulas are:

- + addition**
- subtraction**
- / division**
- * multiplication**
- ↑ exponentiation**

VisiCalc performs the calculations in the order it encounters them, from left to right. To change the order of precedence, use parentheses to indicate “do this first.” If there are parentheses within parentheses, VisiCalc will calculate the innermost first. For example, $5 + 6/2*4$ will be evaluated as 22, but $5 + ((6/2)*4)$ will evaluate as 17.

The complexity of a formula, i.e., the number of value references, arithmetic operators, parentheses, functions and their arguments, and the amount of memory in your computer determine the maximum length of the formula you may enter. If the formula becomes too complex as you type it, VisiCalc will stop displaying your keystrokes. You will be able to enter everything in the formula up to that point. VisiCalc will not allow you to enter an illegal formula such as one which ends with an arithmetic operator. You must back up with the **CLEAR** key to erase the offending character(s).

A formula that does not contain values references may be one such as 1435, or - 14.35 or $5*12+1-60$. As soon as you type one of the characters that initiate a value entry (a digit + - (. # @) VisiCalc immediately places VALUE on the prompt line and displays the character you typed on the edit line. As you continue to type in the elements of the formula, they appear on the edit line. Until you have terminated the command (and entered the formula) by pressing **Ⓢ** or one of the cursor-moving keys, you can use **CLEAR** to modify what you’ve typed, or press **BREAK** to interrupt the value entry command and clear the control panel.

When the value entry has been made, VisiCalc displays the **calculated** value in the entry position on the sheet, but stores in its memory the actual formula that was on the edit line when you terminated the command. The formula that was on the edit line when you finished the value entry will always be displayed on the entry contents line when you place the cursor on the value.

Example

- | | |
|------------------|---|
| 1) Type /CY | This clears the sheet (Highlight is on A1). |
| 2) Type 5 | entry contents line: A1
prompt line: VALUE
edit line: 5 |
| 3) Type *12+1-60 | edit line: 5*12+1-60
position A1: blank |
| 4) Press ⓔ | entry contents line: A1 (V) 5*12+1-60
prompt line: blank
edit line: blank
position A1: 1 |

About Value References

VisiCalc permits entry position coordinates, such as D10, to be used as elements in formulas. These elements, called **value references**, take on the value in the entry position to which they refer. This value will change whenever you change the contents of the referenced entry position. You cannot just begin typing in a formula that begins with a value reference, since the first character you would type would be a letter and VisiCalc would assume you are typing a label (see the LABEL ENTRY Command). You must initiate the value entry command with a +, or a - and then type or point with the cursor to the value reference. If the next keystroke is an arithmetic operator, you may follow it with a number or a value reference. Until you've terminated the value entry command with ⓔ, ⏪, ⏩, ⏴, or ⏵, you can use **CLEAR** to back up and change the formula on the edit line, or press **BREAK** to interrupt the command and clear the control panel.

The cursor-moving keys (⏪, ⏩, ⏴, ⏵) will not terminate the value entry command if they were just used to point to a value reference that follows an arithmetic operator on the edit line. For example, if 1+ is on the edit line, and you point with the cursor to A5, the formula on the edit line will be 1+A5. Pressing a cursor-moving key at this point will not terminate the command, but will change the coordinate A5 to correspond to the new cursor position. In this case, ⓔ must be used to enter the formula.

Example

- | | |
|--------------|---|
| 1) Type /CY | This clears the sheet. Highlight is on A1. |
| 2) Type 1⏴1⏴ | position A1: 1
position B1: 1
Highlight is on C1. |
| 3) Type A1 | prompt line: LABEL
edit line: A1
Typing the letter A has started the label entry command. |

- | | |
|---|--|
| 4) Press BREAK | To clear the control panel.
Highlight should still be on C1. |
| 5) Type + | prompt line: VALUE
edit line: + |
| 6) Type A1+\uparrow | edit line: +A1+B1 |
| 7) Press Ⓢ | entry contents line: C1 (V) +A1+B1
prompt line: blank
edit line: blank
position C1: 2 |

Every time you change the value at A1 or B1 in the example above, you will see position C1 change accordingly.

If you are looking at different parts of the sheet through a split screen (see the WINDOW Command), you can use the ; to jump from one window to another to point to entry position coordinates you wish to use in the formula.

Use of ! and #

VisiCalc may also be used like a calculator as you are typing in a formula on the edit line. Suppose you wanted to store the result of $5*12+1-60$ as the value entry, and not the formula from which it was derived. Simply type the formula on the edit line and then press the exclamation point (!). VisiCalc immediately calculates the value. If Ⓢ or one of the cursor-moving keys is pressed at this point, the number will appear in the entry position and in the entry contents line. Alternatively, you could continue developing the formula for the value entry.

If a formula contains any value references, VisiCalc will get the current value in the entry position referenced and calculate the formula for you on the edit line.

Example

- | | |
|---|---|
| 1) Type /CY | This clears the sheet. Highlight is on A1. |
| 2) Type 4*5*7Ⓢ | entry contents line: A1 (V) 4*5*7
position A1: 140 |
| 3) Type \uparrow1+\uparrow | edit line: 1+A1 |
| 4) Press ! | edit line: 141 |
| 5) Press Ⓢ | entry contents line: B1 (V) 141
position B1: 141 |

Pressing # will place the numerical value of an entry position on the edit line. If you press # immediately after a value reference on the edit line, the value of the coordinate will replace the value reference on the edit line.

If you start the value entry command by pressing #, VisiCalc will place the value of the highlighted entry position on the edit line. A value of 0 will appear if the highlighted entry position is blank or contains a label (see the LABEL ENTRY Command) or if you've entered a value of 0.

VALUE ENTRY Command

Only the **calculated** value in the entry position will be placed on the edit line, and not the formula from which it was derived.

There are several ways you might want to use this feature: to place the value of a highlighted entry position on the edit line when you start the value entry command; to duplicate a value in one entry position into another; to place the value in an entry position onto the edit line when you are developing a formula.

Example

1) Type /CY

This clears the sheet. Highlight is on A1.

2) Type 10↔10↔10ⓔ

prompt line: blank

edit line: blank

Position A1, A2, and A3 each contain the value entries of 10. Highlight is on A3

3) Press #

prompt line: VALUE

edit line: 10

4) Type /2ⓔ

entry contents line: A3 (V) 10/2

position A3: 5

5) Type ⏏⏏

entry contents line: C3

position C3: blank

Note that the highlight has been placed on the position into which we want to make an entry.

6) Press +

prompt line: VALUE

edit line: +

7) Press ⏏⏏

edit line: +A3

8) Press #

edit line: +5

9) Press ⓔ

entry contents line: C3 (V) 5

position C3: 5

The cursor has returned to C3, the position at which the command was started when you typed + at step 6. Had you pressed # before +, 0 would have appeared on the edit line since a blank entry position has a value of 0.

10) Press ↵

Cursor is at C4, which is blank.

11) Type # + ⏏⏏ + ⏏⏏⏏⏏

edit line: 0+C3+A3

12) Press #

edit line: 0+C3+5

Note that # returned the value only for the value reference immediately preceding it.

13) Type *A1#

edit line: 0+C3+5*10

You may type in a coordinate as well as point to it.

14) Press ⓔ

entry contents line: 0+C3+5*10

position C4: 100

Example

This example illustrates the use of both ! and #:

- | | |
|--------------|---|
| 1) Type /CY | To clear the sheet. Cursor is at A1. |
| 2) Type 1 | position A1: 1
Cursor is on A2. |
| 3) Type + | prompt line: VALUE
edit line: + |
| 4) Press | edit line: +A1 |
| 5) Type +1 | edit line: +A1+1 |
| 6) Press | entry contents line: A2 (V) +A1+1
position A2: 2 |
| 7) Type 1+ # | edit line: 1+2
The value of A2 has replaced the value reference. |
| 8) Type ! | edit line: 3
The formula on the edit line has been evaluated |
| 9) Press | entry contents line: A3 (V) 3
position A3: 3
Notice that the formula used to derive the value of 3 has not been stored because of the use of !. |

In this example, every time you change the value of A1, you will see the effect of that change in position A2, which contains A1 as a value reference in the formula + A1 + 1. Try it by placing the cursor on A1 and typing 100. The value in A2 will be recalculated and replaced with the new value, 101.

Recalculation Order

VisiCalc formulas may contain as many value references as the complexity of the formula will allow. When any value entry is made, including changing an existing entry, VisiCalc automatically recalculates every value on the sheet. Recalculation always starts in the upper left hand entry position, A1. When first loaded, VisiCalc calculates a value for A1, then A2, then A3, then A4 to the end of column A. Then it calculates B1, B2, B3, B4 to the end of column B; then C1, C2, C3, C4 and so on. Note the letter C in the upper right corner of the control panel. This indicates that the order of recalculation for the whole sheet is by Column. The global command (see the GLOBAL Command) contains an option which lets you change the order of calculation from down columns to across rows. When row calculation is in effect the upper right corner of the control panel will display an R.

Forward and Circular References

Pay particular attention to the placement of any formulas which contain value references. When in column recalculation, be sure that all referenced entry positions are to the left of the formulas which cite them (or above a formula in the same column). If the sheet is not arranged in this way, the formula containing a value reference will be recalculated before the new value has been placed in the referenced entry position. When recalculation has been completed, the sheet will display the value of the formula as calculated using the **old** value from the referenced entry position. However, the **new** value of the referenced entry position will be displayed in the entry position.

This problem, called **forward referencing**, is often difficult to diagnose and one is tempted to conclude that VisiCalc has made an arithmetic error. If you suspect your sheet contains a forward reference which is causing a formula to be incorrectly updated, press the ! once. This will force another recalculation of the whole sheet. Watch the suspect formula. If a new value appears, look for forward references. You may choose to redesign your sheet to eliminate all forward references or to use multiple !'s for recalculation. In row calculation, referenced values must be placed in the rows above the formulas which use them or to the left in the same row.

A **circular reference** is one which cites itself. For example, placing the formula, $1 + A1$, in entry position A1 is a circular reference. Each time the sheet is recalculated the value of this formula will change, even if no other changes are made on the sheet. Circular references can be very useful when their results are correctly anticipated. However, they are disastrous when entered by mistake.

VisiCalc's Built-In Functions

Built-in functions are used within value entries to save you the effort of setting up commonly used formulas yourself. Each function begins with @, then comes the "function word," followed by an argument in parentheses. For example the SUM function might be written:

@SUM(B1,S2,A4*.23)

This expression would result in the sum of the values found in entry positions B1, S2, and .23 times the value in entry position A4. A built-in function may be placed in any entry position by itself or used as part of a larger expression. The @ may be used as the first character in a value entry (no preceding + is necessary). The function words are listed in the table below with the form of their arguments and their definitions.

Function Arguments

All but three of the built-in functions are followed by an argument written in parentheses. The arguments shown as "v" in the chart may be any legal VisiCalc values. The arguments shown as "list" may consist of any combination of values and entry ranges separated by commas. A range is a portion of a row or a column specified by its beginning entry position coordinate, an ellipsis, and its final entry position coordinate (A3 . . . A17, for example). A range may not be a diagonal across rows or columns. When entering a range, you may type in the coordinate or move the highlight to point at the desired entry position. Entry positions containing labels or blank entries are evaluated as zeros when they are used as value references in function arguments or in formulas.

@SUM(list)	adds the values of all entry positions cited in the list.
@MIN(list)	chooses the smallest value in the list.
@MAX(list)	chooses the largest value in the list.

@COUNT(list)	results in the number of non-blank entries in the list.
@AVERAGE(list)	@SUM(list) divided by @COUNT(list)
@ABS(v)	results in the absolute value of v.
@INT(v)	results in the integer portion of v.
@SQRT(v)	results in the square root of v.
@EXP(v)	returns e (2.71828 . . .) to the v power.
@LOG10(v)	results in the logarithm (base 10) of v.
@LN(v)	returns the natural log (base e) of a number.
@SIN(v), @COS(v), @TAN(v), @ASIN(v), @ACOS(v), @ATAN(v)	returns the appropriate trigonometric function of the value. Calculations are done in radians.
@NPV(dr,range)	calculates the Net Present Value of the cash flows in the range, discounted at the rate specified by dr (the discount rate expressed as a decimal). The first entry in the range is the cash flow at the end of the first period, the second entry is the cash flow at the end of the second period.
@NA, @ERROR, @PI	These three functions have no argument.
@PI	is evaluated as 3.1415926536.
@NA (not available)	is used when a sheet must be set up before the data to be evaluated is available. If entry positions which will later contain data are left blank, they will be evaluated as zero if used as value references in formulas. This will produce the entry ERROR on the sheet wherever zeros appear as denominators and may produce incorrect or misleading values elsewhere. Entering @NA into the blank data positions causes VisiCalc to evaluate all entries which refer to those positions as NA. Without entering the data, you can be assured that all your formulas are legal in VisiCalc. Any illegal calculations will show up as ERROR.

@ERROR

is also displayed in the entry position into which it is entered and all positions which refer to it. In addition, the @ERROR function is often generated by VisiCalc in such cases as when a deleted row or column contained entry positions that are value references in formulas.

@LOOKUP(v,range)

looks up a numeric value in a table and finds the value that corresponds to it.

For example, when you do taxes, you look up the gross pay in a tax table and then use a corresponding tax rate.

The table used by the @LOOKUP function may be a range within a column or a row. The value that is being looked up will be compared to successive values in that table until a value is found that is larger than the value being looked up (or until the end of the table is reached). The entry in the table that is before this entry is the one that VisiCalc will consider as the "match" for the value being looked up. If the table is in a column, VisiCalc returns the value of the entry that is immediately to the right of the "matching" entry as the value of the function. If the table is in a row, VisiCalc returns the value immediately below the "matching" entry as the value of the function. If the first value in the table is greater than the value being looked up, then the value of the function will be NA.

An example of the use of the @LOOKUP function would be the following invoice form. The total amount of the goods purchased is looked up in a table and the found value is used as a discount percentage. Finally, the dollar amount of the discount is calculated, and the total amount of the invoice is found. In this example, the order of calculation is by rows (see the GLOBAL Command, /GO).

B7 /FG (V) @LOOKUP(D6,A11...E11)*100 R 23

	A	B	C	D	E
1	ITEM	PRICE	QUANTITY	TOTAL	
2					
3	EE02	15.45	18	278.1	
4	L198	69.42	1	69.42	
5					
6			TOTAL	347.52	
7	% DISCT	10	DISCOUNT	34.75	
8			PAY AMT.	312.77	
9					
10					
11	0.00	100.00	250.00	500.00	1000
12	0.00	0.05	0.10	0.20	0.30

The formula at entry position B7 is @LOOKUP(D6,A11 . . . E11)*100 (by multiplying by 100, we make it a percentage). Although the lookup range is technically a forward reference (see the VALUE ENTRY Command), it makes no difference in this case because the values in that range are constants. The format of that entry position is /FG (see the FORMAT Command). The formula at D7 is +D6*B7/100*B9/100. The lookup table has been placed in positions A11 through E11.

If the total of the invoiced items was \$347.52, then the discount percent would be 10% (the value that corresponds to \$250.00). A total of \$3000.00 would have a discount of 25%, the same as for \$1000.00.

The BLANK Command

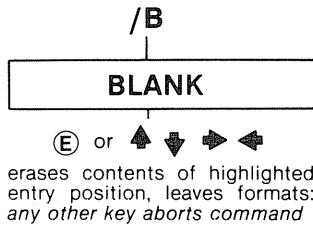

Blank removes only the label or value in the entry position on which the highlight cursor is located, but leaves the existing format setting for that position.

Use this command to erase an entry after you have pressed ⓔ or moved to another entry position.

- 1) Move the highlight over the entry position to be erased.
 - 2) Type /
 - 3) Type B
 - 4) Press ⓔ
- or press ⬆, ⬇, ⬅, or ➡

prompt line: COMMAND: BCDGIMRSTVW

prompt line: BLANK

The control panel will clear and the highlighted entry position will be blank.

The control panel will clear, the original entry position will be blank, and the highlight will be on the next entry position.

The CLEAR Command

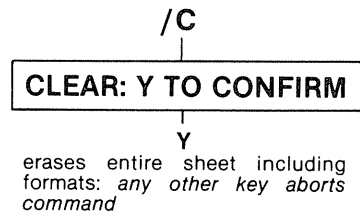

Clear sets all entry positions to blank, resets formats, titles, windows, and other information about the sheet to the initial specifications set by VisiCalc when you first load it into the computer. The entry position highlight is returned to entry position A1.

Use this command to start with an empty VisiCalc sheet. Before using the clear command, be sure you have saved the sheet (see the STORAGE Command) if you do not want to lose the information you had written on it. All information erased with the clear command is irretrievable.

Example

- 1) Type /C
- 2) Press Y

prompt line: CLEAR: Y TO CONFIRM

The screen will darken for a few seconds, then display the copyright and version notices. Your next keystroke will clear the prompt line.

The DELETE Command

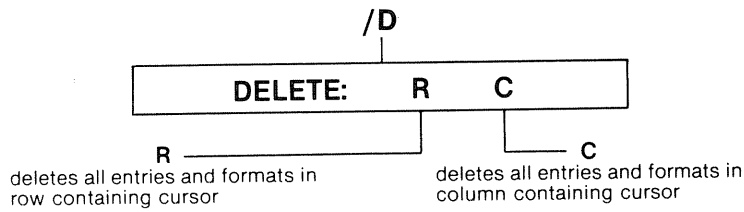

VisiCalc allows you to remove the entries from an entire column or row.

To use this command, first place the highlight in the row or column you want to delete. Then type /D. The prompt line reads DELETE: R C. Type **R** to delete the row in which the highlight is located or type **C** to delete the column. VisiCalc immediately deletes the information and moves all other rows or columns up to fill in the empty space.

VisiCalc also automatically looks up all value references (See the VALUE ENTRY Command) in formulas and changes them to correspond to the new coordinates resulting when the rows or columns are moved up. It then recalculates the whole sheet.

Example

- | | |
|---|--|
| 1) Type /CY | To clear the sheet.
Highlight is at A1. |
| 2) Type 1 → 2 → 3 → 1 + C1 Ⓢ | |
| 3) Type > B1 Ⓢ | Your screen should look like this: |

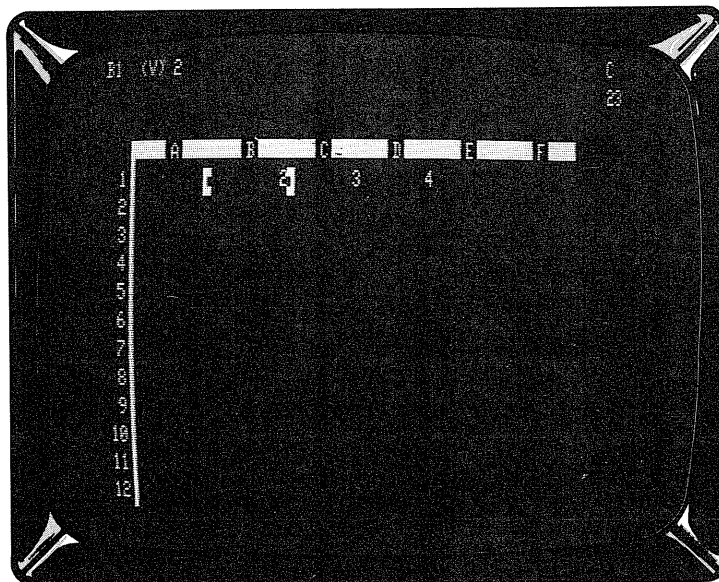

4) Type /D

prompt line:

DELETE: R C

5) Type C

Your screen looks like this:

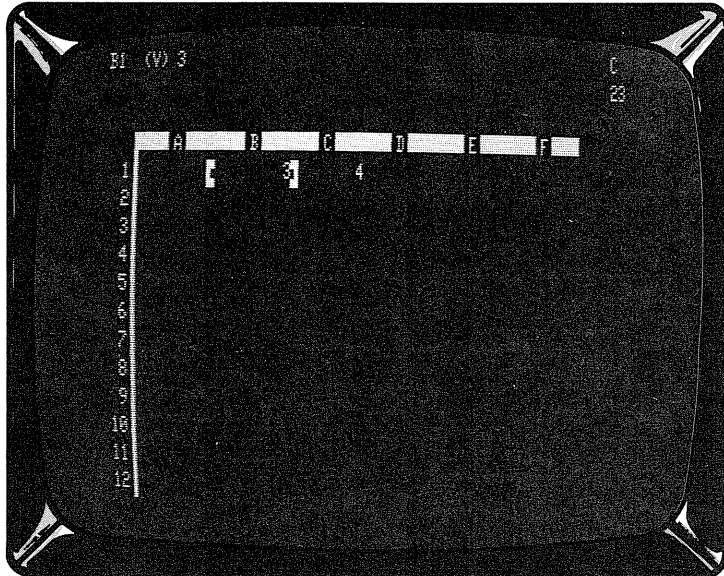

6) Press ↵

entry contents line:

C1 (V) 1 + B1

Note that the formula has been changed from 1 + C1 to 1 + B1 so that it still refers to the value 3, which you originally entered at C1 in step 2 of this example. When the entries in column B were deleted, VisiCalc moved all columns up, and then changed the value reference so that the formula is correct with the new positions.

Use the delete command with care: You cannot recover the information which was recorded in a deleted row or column. The insert commands (see the INSERT Command) can recreate the row or column space, but not the actual entries.

If you delete an entry which you use in a formula in some other part of the sheet (see the VALUE ENTRY Command), all entry positions affected will contain the message ERROR.

DELETE Command

Example

1) Type /CY

To clear the sheet.
Highlight is at A1

2) Type **1↓2↓1+B1**

The cursor is highlighting the 2 at B1.
Your screen should look like this:

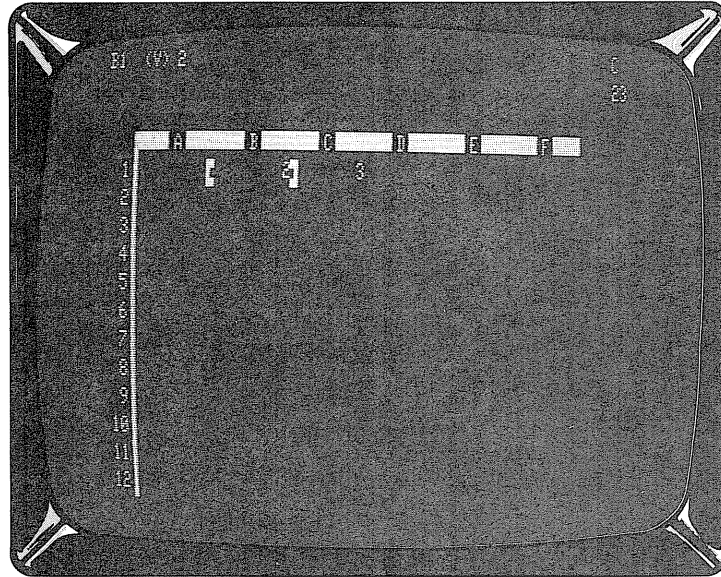

3) Type /D

prompt line:

DELETE: R C

4) Type C

entry contents line: B1 (V) 1+ ERROR
position B: ERROR
All information in column B was deleted and the contents of column C moved up. At step 2 in the example, you entered a formula with a value reference, 1+B1. VisiCalc replaced the B1 with @ERROR and alerts you by placing ERROR in the entry position containing the formula.

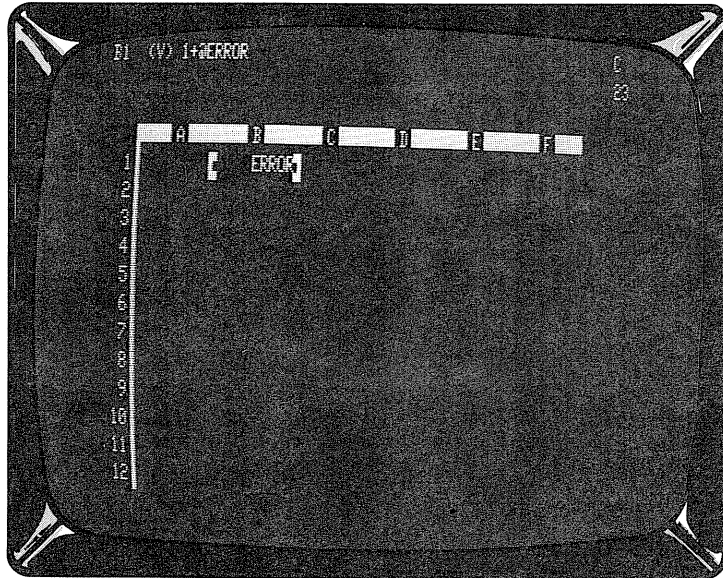

The FORMAT Command

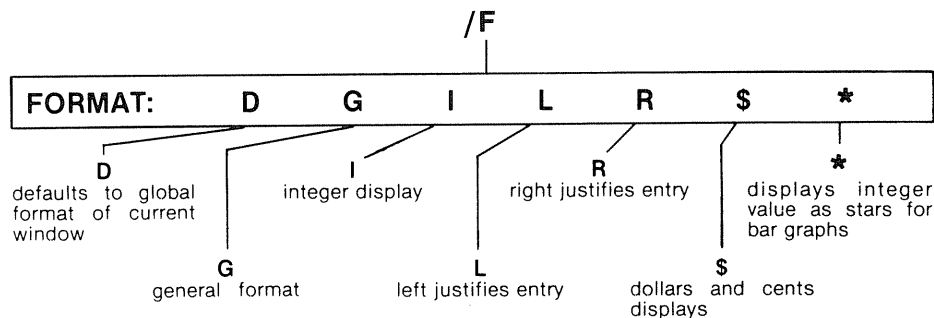

The format command adds an explicit display condition to the highlighted entry on the VisiCalc sheet. The original entry contents (LABEL or VALUE) remain unchanged in the computer's memory. They are always used in calculations and are displayed completely on the entry contents line. On the sheet, however, the entry will appear as formatted by this command. If the entry is moved to another position on the sheet (see the REPLICATE Command, the MOVE Command, and the INSERT Command), printed on paper or another device (see the PRINT Command), or stored on diskette (see the STORAGE Command) its format stays with it.

Once an entry position has been formatted, a format indicator will appear on the entry contents line between the current entry coordinates and entry contents. Erasing the contents of the entry position (see the BLANK Command) does not remove explicit formats, but clearing the sheet (see the CLEAR Command) does.

To format a row or a column before making entries, format the first entry and then use the replicate command (see the REPLICATE Command) to copy the format into the rest of the row or column.

It is not possible to change the number of character spaces in an individual entry position. To change the number of characters in every column throughout the window, use the global command for changing column width (see the GLOBAL Command).

To see how the format options affect the display, set up your sheet as instructed in the example below. All the examples in this section use this sheet for the format examples.

Example

- 1) Type /CY This clears the sheet, positions the cursor at A1, and resets all display characteristics.
- 2) Type LABEL ENTRY
#1.23456789#99.999[Ⓔ]

You now have one label and two values on your sheet. Any explicit format settings were removed when the sheet was cleared. You have one window (see the WINDOW Command), no titles (see the TITLE Command), your columns contain nine character spaces, which is the general column width (see the GLOBAL Command), and all entry positions display the general format (see the GLOBAL Command and the discussion below). These same display characteristics are set each time VisiCalc is loaded into your computer and whenever the clear command is used.

The Default Display Format—/FD

An individual entry position format is changed to whatever format has been previously set with the global command (see the GLOBAL Command). If no global setting is in effect, the default will be the general format, described in /FG below.

Example

- 1) Type >C1[Ⓔ]
- 2) Type /F\$ The highlighted entry (C1) changes to dollars and cents format; B1 is unchanged. The entry contents line displays the /F setting.
entry contents line: C1 /F\$ (V) 99.999
position C1: 100.00
- 3) Type /FD entry contents line: C1 (V) 99.999
position C1: 99.999
The default setting is general, as set by /CY.
- 4) Type /GFI All values in the window which have **not** received an individual format are displayed as integers. The global setting is now integer format (see the GLOBAL Command)
position B1: 1
position C1: 100
- 5) Type /FG entry contents line: C1 /FG (V) 99.999
position B1: remains in integer format
position C1: 99.999
The setting on C1 is now general, as shown on the entry contents line.
- 6) Type /FD entry contents line: C1 (V) 99.999
position B1: unchanged
position C1: 100
The setting on C1 has been removed and is no longer indicated on the entry contents line. However, since there is a global integer setting in effect, position C1 is displayed in integer format instead of general format.



The General Format—/FG

Labels begin in the leftmost space (left justified) and are cut off wherever the column width ends.

Values are moved as far to the right as possible (right justified) with a leading blank character in the leftmost position in the column. Decimal or scientific notation is selected to display the largest number of significant digits.

Example

- 1) Type >A1[Ⓢ]

Position A1 is now in general format for labels.
entry contents line: A1 (L) LABEL ENTRY
position A1: LABEL ENT
- 2) Press \blacktriangleright

position B1: 1
A global integer setting is still in effect from the previous example.
- 3) Type /FG

position B1: 1.234568
General format for numbers with few significant digits.
- 4) Type 123456789123456789[Ⓢ]

entry contents: 123456789123000000
position B1: 1235E17
General format for numbers with many significant digits. VisiCalc selects scientific notation when this permits a larger number of significant digits to be displayed within the current column width.

The Integer Format—/FI

All values are displayed rounded to the nearest whole number.

Example

- 1) Type 1.2[Ⓢ]

entry contents line: B1 /FG (V) 1.2
position B1: 1.2
- 2) Type /FI

entry contents line: B1 /FI (V) 1.2
position B1: 1
Entry contents are rounded to the nearest integer.

Left Justification—/FL

All labels begin in the leftmost character space; all values are moved to left, preceded by one leading blank. This command affects only the display of entries on the sheet which have fewer characters than the current column width.

Example

1) Type /FL entry contents line: B1 /FL (V) 1.2
 position B1: 1.2
 The value in B1 has been moved to the left.

Right Justification—/FR

The last character of a label or a value falls in the last character space of the entry position. This command affects only the display of entries on the sheet which have fewer characters than the current column width.

Example

1) Type /FR entry contents line: B1 /FR (V) 1.2
 position B1: 1.2
 The value in B1 has been moved to the right.

Dollars and Cents Display—/F\$

All values are rounded to two decimal places. No \$ is displayed in the entry position. Trailing zeros are shown. There is no effect on labels.

Example

1) Type /F\$ entry contents line: B1 /F\$ (V) 1.2
 position B1: 1.20

Bar Graph Format—/F*

All values are truncated to an integer. That integer is replaced in the entry position by an equal number of stars. If the number of stars is larger than the width of the entry position, extras are ignored.

Example

1) Type /F* entry contents line: B1 /F* (V) 1.2
 position B1: *

The GLOBAL Command

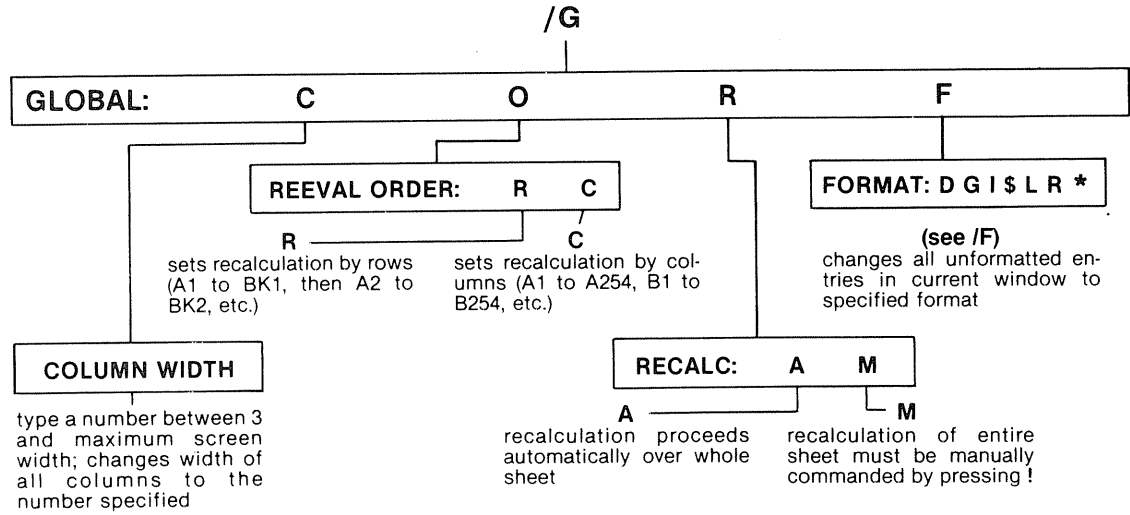

The four global command options affect the window display and the order in which rows and columns are calculated.

The Global Column Width—/GC

This command allows you to change the width of all columns in a window to any number of characters between 3 and the maximum width of your window. Different column widths may be set within each window but may not be set individually. VisiCalc will display as many whole columns of a given width as possible in the window containing the cursor. When changing to a single, wide column in a window, any vertical title areas previously set will be automatically removed (see the TITLE Command).

Example

- | | |
|--|--|
| <ol style="list-style-type: none"> 1) Type /CY 2) Type in position A1:
THIS LINE IS TOO LONG.® 3) Type /G 4) Type C 5) Type 18 ® 6) Type /GC24® | <p>This clears the sheet and resets the column width to nine characters.</p> <p>entry contents line: THIS LINE IS TOO LONG.</p> <p>prompt line: GLOBAL: C O R F</p> <p>prompt line: COLUMN WIDTH:</p> <p>entry contents line: THIS LINE IS TOO LONG.</p> <p>position A1: THIS LINE IS TOO L</p> <p>entry contents line: THIS LINE IS TOO LONG.</p> <p>position A1: THIS LINE IS TOO LONG.</p> <p>position C1: not displayed.</p> |
|--|--|

When displaying numbers on the sheet, VisiCalc may change the format from the way you originally entered it on the edit line. Numbers will be rounded off in the window display when necessary to fit into the column width. VisiCalc will use scientific notation if this will permit more significant digits to be shown at the current column width than regular decimal notation. If the column is too narrow to display the integer portion of a value in either decimal or scientific notation, VisiCalc will display as many > symbols as will fit in the entry position with a leading blank.

Regardless of how the values appear on the screen, the numbers stored in the computer's memory will remain unchanged and will be used in all calculations. The number, as you originally entered it on the edit line, will be displayed on the entry contents line whenever the cursor is over its entry position.

Example

1) Type **/CY**

2) Type **123456789**Ⓜ

entry contents line: A1 (V) 123456789
position A1: 1.2346E8

Note the leading blank, scientific notation, and final digit rounded up.

3) Type **1.23456789**Ⓜ

entry contents line: B1 (V) 1.23456789
position B1: 1.234568

Note the leading blank and the final digit rounded up.

4) Type **/GC3**Ⓜ

entry contents line: B1 (V) 1.23456789
position A1: >>
position B1: 1.

The number in A1 is too large to express with two characters, which is the space available for digits when the column width is 3, so VisiCalc displays >>. The number in B1 is rounded as shown.

The Global Order of Recalculation—/GO

This command allows you to set the order of calculation to Columns or Rows. In columnwise calculation and recalculation, entry position A1 is evaluated, then A2, A3 to the bottom of the sheet, then B1, B2, B3, to the bottom of the sheet in this column, then C1, C2, and so on. In row calculation, A1 is first, then B1, C1, and on to the right hand end of the sheet, then A2, B2, C2 to the end of the sheet. This order of calculation is indicated on the control panel by the letter C or R in the upper right hand corner of the entry contents line. When you first load VisiCalc, the calculation order is by column.

If VisiCalc appears to evaluate formulas incorrectly, you have placed formulas in entry positions so that they are calculated before the value references that they contain. Order of calculation and recalculation has been discussed at length in the VALUE ENTRY Command in Part III, and also in Part II, Lesson Three in the section entitled "The Order of Recalculation."

The following example illustrates the use of value references set up for column calculation, and shows what happens when they are calculated in a rowwise fashion.

Example

- 1) Type /CY
- 2) Type 1
- 3) Type +A1
- 4) Type >B1
- 5) Type +A2
- 6) Type +B1

This clears the sheet and sets column calculation.

Your screen should look like this:



7) Type >A1[Ⓜ]2[Ⓜ]

The value at A1 is changed to 2, and the other values are recalculated. Your screen should look like this:

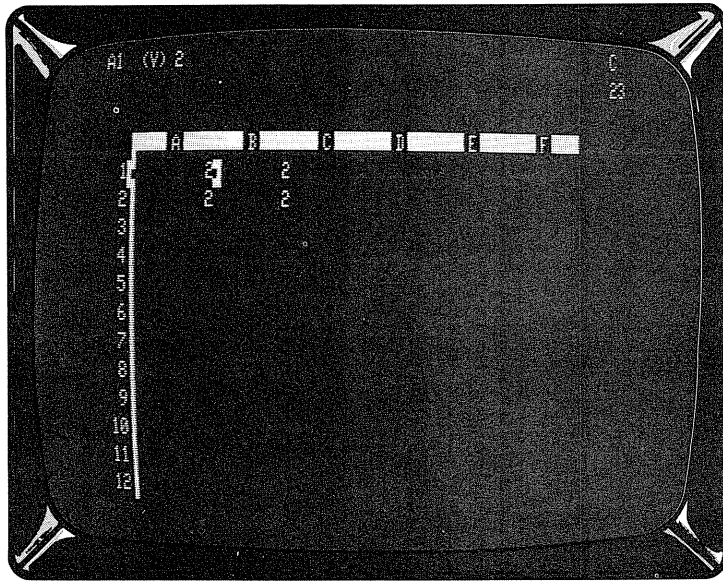

8) Type /GOR

The order of calculation indicator changes to R.

9) Type 3[Ⓜ]

Your screen looks like this:

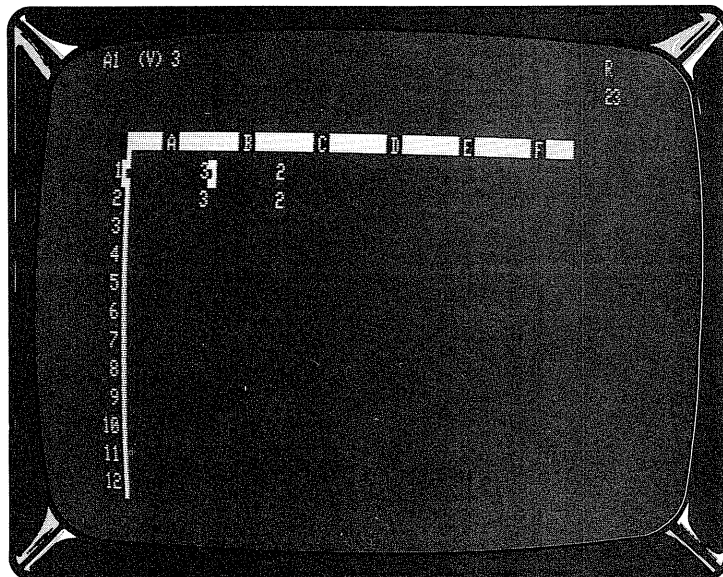

This is incorrect. B1 should be the same as A2, yet it displays a different value because B1 was recalculated **before** A2 was recalculated. In such instances, you can force a recalculation by pressing ! when the prompt line is blank. Press ! now and the screen shows the correct values as in the photo below.

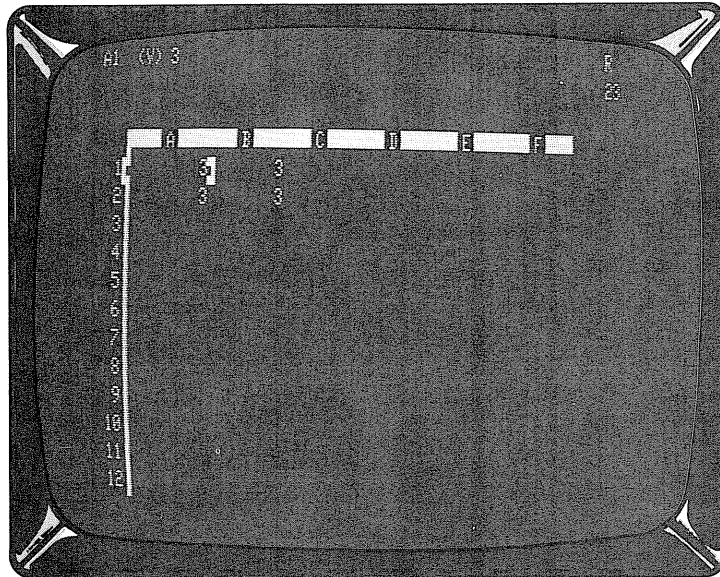

A similar example that works correctly for row order of calculation, but not for column order is this:

- | | |
|--|--|
| 1) Type /CY | The sheet is cleared and calculation is set to column order. |
| 2) Type /GOR | To change to row order of calculation. |
| 3) Type 1 + A1 | |
| 4) Type > A2 | |
| 5) Type + B1 + A2 | |

Automatic or Manual Recalculation—/GR

When first loaded, VisiCalc is set to recalculate all values as soon as any change is made in an entry position to which a formula may refer. Changes ripple rapidly across your sheet whenever you change a value. Sometimes, such as when you are typing in a column or row of figures, you would like to turn off recalculation completely to eliminate the pause that occurs when VisiCalc is recalculating. To turn it off, type /GRM which stands for GLOBAL:RECALCULATION MANUAL. Under manual recalculation, only the highlighted formula will be recalculated automatically. The whole sheet is updated only when you type ! There is no cue on the control panel to indicate whether you are in manual or automatic recalculation but the status should be evident from watching the behavior of the sheet. To resume automatic recalculation, type /GRA

The Global Format—/GF

This command allows you to assign a format setting for all entry positions in the window which have not been individually formatted. The global format command uses the same formatting options as are available for individual entry positions. See the FORMAT Command for an explanation of these options. If you have split your screen into two windows (see the WINDOW Command), you may use a different global format for each window. When you save your sheet with /SS all global formats are also saved (see the STORAGE Command).

The INSERT Command

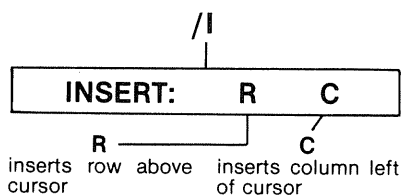

While developing a VisiCalc sheet, you may find that you need to insert additional rows or columns. The insert command gives you this ability. After you type /I VisiCalc expects you to enter **R** if you want a row inserted, or a **C** to insert a column. It is not possible to insert a single entry position—you may only insert an entire row or column.

Inserting a New Row—/IR

This command inserts a new, blank row in the row in which the cursor is situated when you give the command. All rows that were at or below the cursor are moved down one row to make room for the insertion. VisiCalc then changes all value references in formulas to reflect the new entry position coordinates in the rows that were moved. For example, if a formula contains the coordinate C2, and a row is inserted at row 2, VisiCalc will change the coordinate to C3. The cursor will remain in its old position in the new blank row.

Example

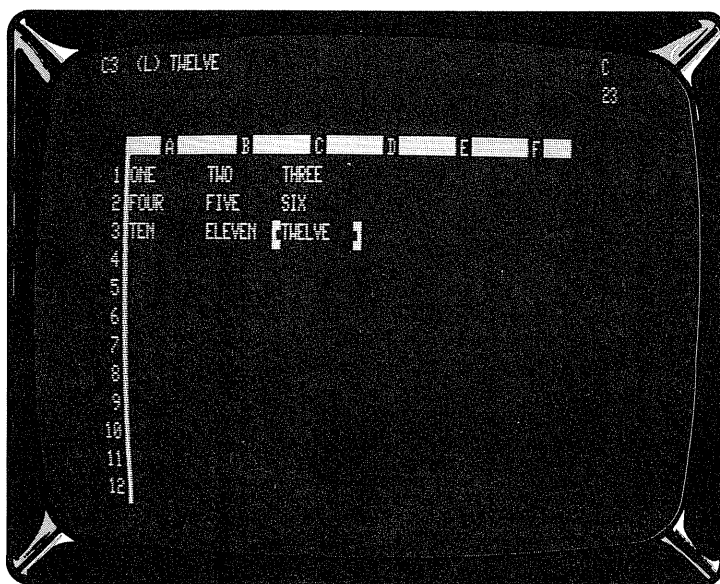

After typing /IR

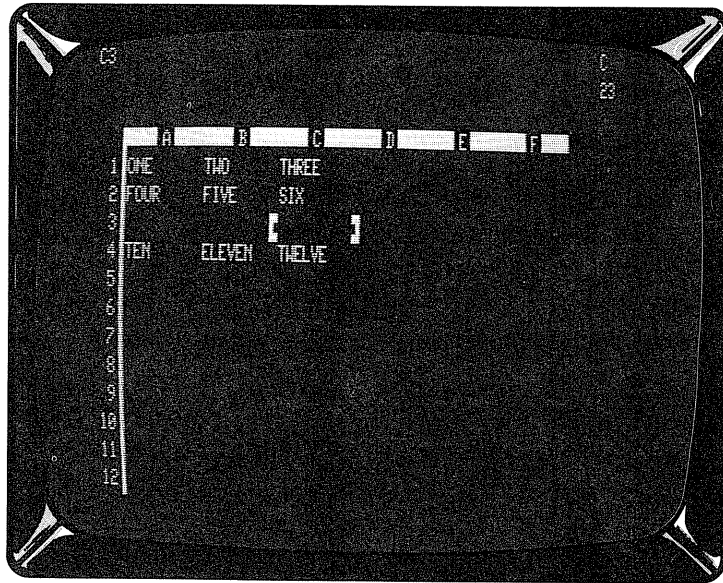

Inserting a New Column—/IC

This command inserts a new, blank column in the column in which the cursor is located when the command is given. All columns at and to the right of the cursor are moved one column to the right to make room. VisiCalc changes all value references in formulas to reflect the new entry position coordinates for the columns that were moved. The cursor remains in its original position in the new, blank column.

Example

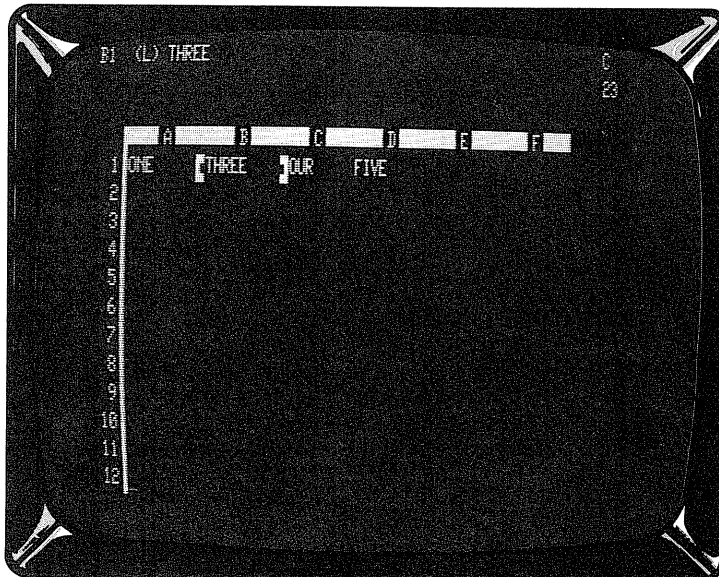

INSERT Command

After typing /IC

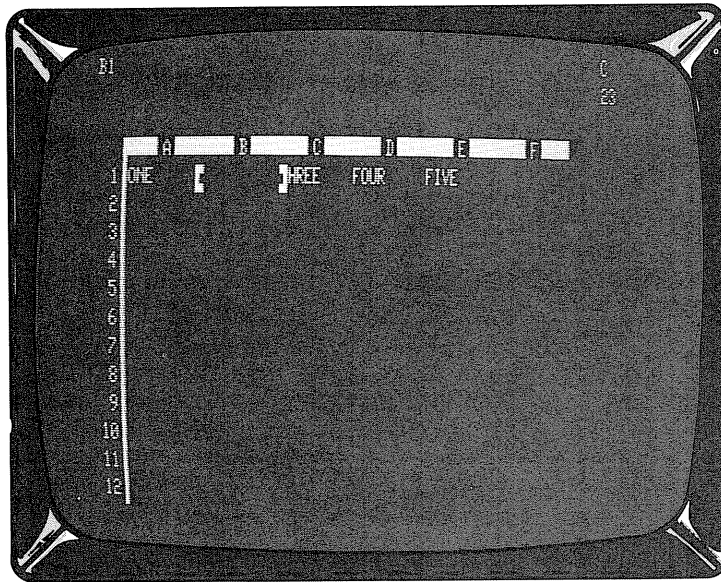

The MOVE Command

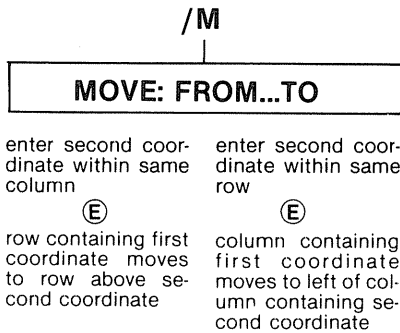

It is sometimes desirable to change the position of a row or a column. The move command lets you do just that. VisiCalc will automatically change all value references in formulas (see the VALUE ENTRY Command) to reflect the new coordinates which result when the rows or columns are moved. When you move a row or a column, be careful that you don't move formulas containing value references to positions where the formulas are calculated before the value references. Order of calculation and recalculation is discussed at length in the VALUE ENTRY Command in Part III and also in Part II, Lesson Three in the sections entitled "The Order of Recalculation" and "Forward and Circular References."

To Move a Row

When moving a row to a lower position on the sheet, row 1 to row 3 for instance, first place the cursor on the row you wish to move. Then type /M. The coordinate of the highlighted entry position will appear on the edit line. Press . and then use the cursor-moving keys to place the cursor on the row that is just below the row to which you want to move. In other words, the row will be moved to the position just above the cursor. When moving rows, the cursor may be in any position within the row when you initiate the command; however, when you indicate the new location, you must use the same column coordinate. For instance, moving C10 to C5 is valid, but moving C10 to D5 is not. Terminate the command with ⓔ. When a row is moved, all intervening rows and columns are moved up to fill in the place vacated by the moved row or column. VisiCalc then changes all values references to reflect the new position.

Example

1) Set up your sheet as in the photo:

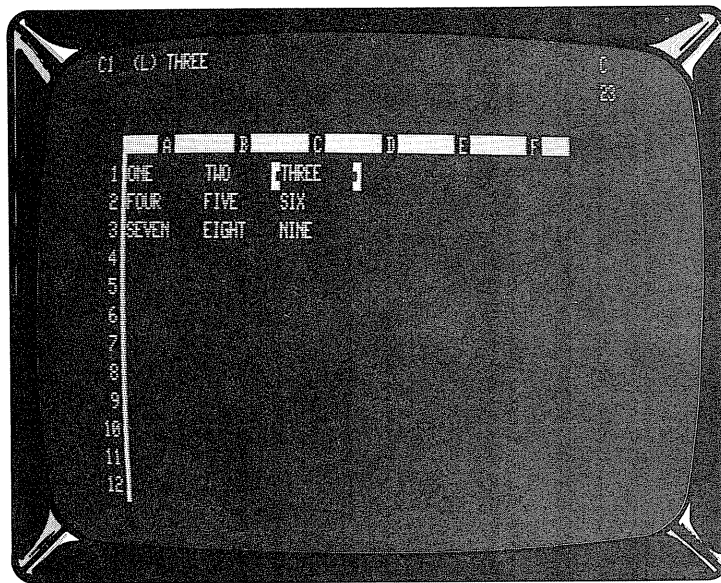

2) Type /M

prompt line:

MOVE: FROM ... TO

edit line:

C1

3) Type .

edit line:

C1 ...

Row 1 is going to be moved.

4) Press ←←←

edit line:

C1 ... C4

Row 1 is going to move to row 3.

5) Press ⓔ

The sheet should look like the photo below:

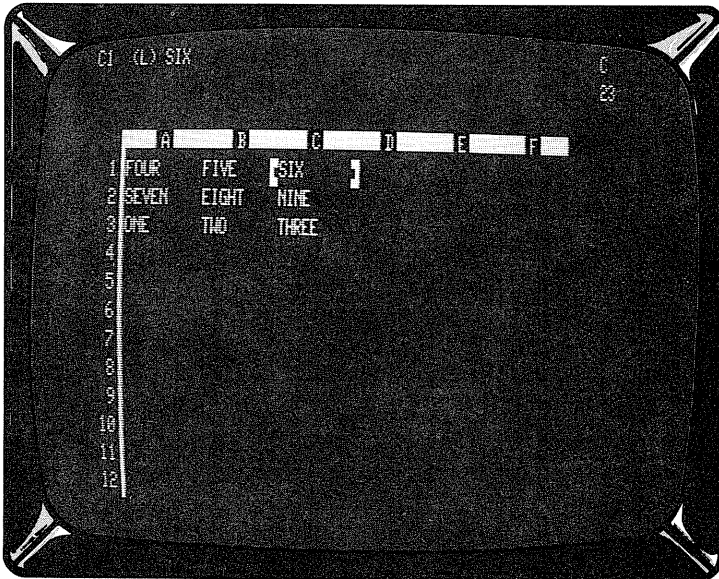

When you move a row to a higher place on the sheet, row 3 to row 2 for instance, either point with the cursor or type in the coordinate of the target row.

Example

1) Set up your sheet as in this photo:

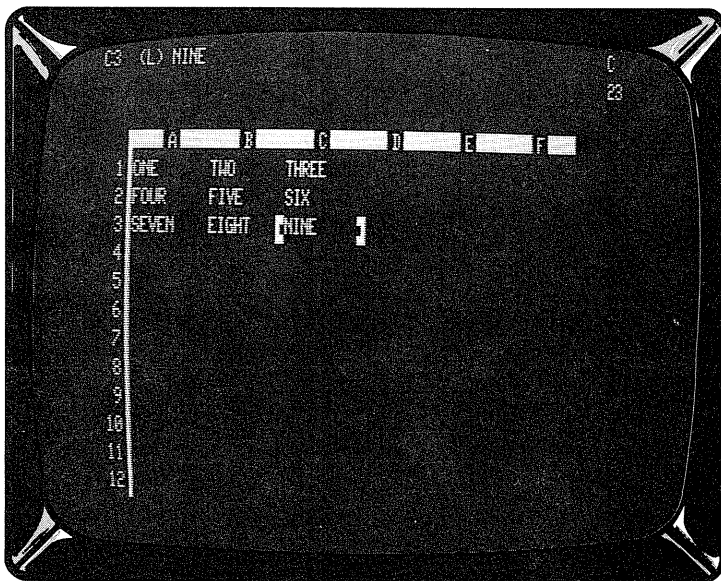

2) Type /M

prompt line:

MOVE: FROM ... TO

3) Type .

edit line:

C3

4) Press ↵

edit line:

C3 ...

Row 3 will be moved.

5) Press Ⓢ

edit line:

C3 ... C2

Row 3 has moved to row 2.

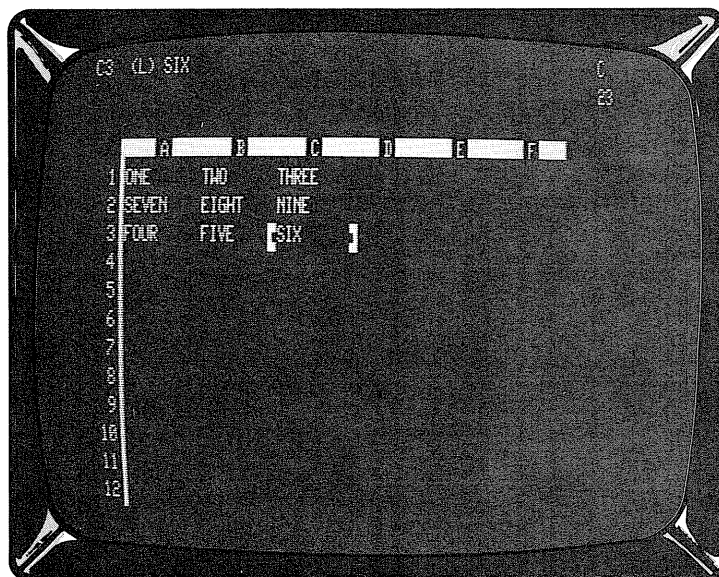

To Move a Column

To move a column to the right of its current position, first place the cursor on the column you wish to move. Type /M and the coordinate of the highlighted entry position will appear on the screen. Press . and then point with the cursor (or type in the coordinate) to the column just to the right of the desired new location. The column will be moved to the position just to the left of the cursor. When moving columns, the cursor can be in any position within the column when you start the command, but when you indicate the new location, you must use the same row coordinate. For example, moving A2 to D2 is valid, but moving A2 to D1 is not. End the command with Ⓢ. All intervening columns are moved up to fill the place vacated by the moved column.

Example

1) Set up your sheet like this, with the highlight on B1:

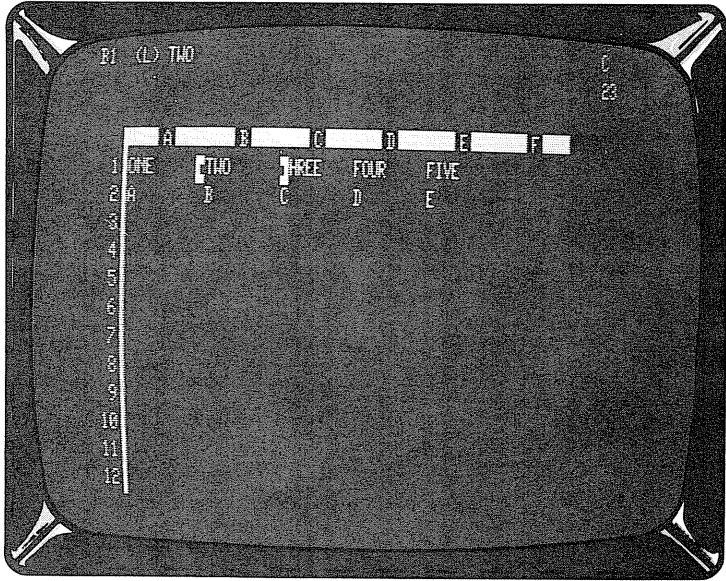

- 2) Type /M
- 3) Press .
- 4) Type D1
- 5) Press Ⓢ

prompt line: MOVE: From . . . To
 edit line: B1
 edit line: B1 . . .
 edit line: B1 . . . D1
 Column B has been moved to column C as in the photo:

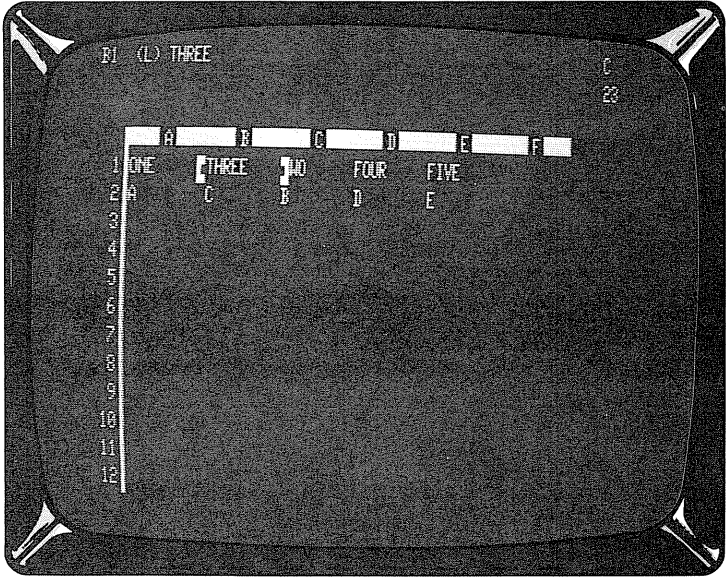

MOVE Command

When you move a column to the left of its present position, either point with the cursor or type in the coordinate of the target row.

Example

1) Set up your sheet as in this photo, with the cursor on E1:

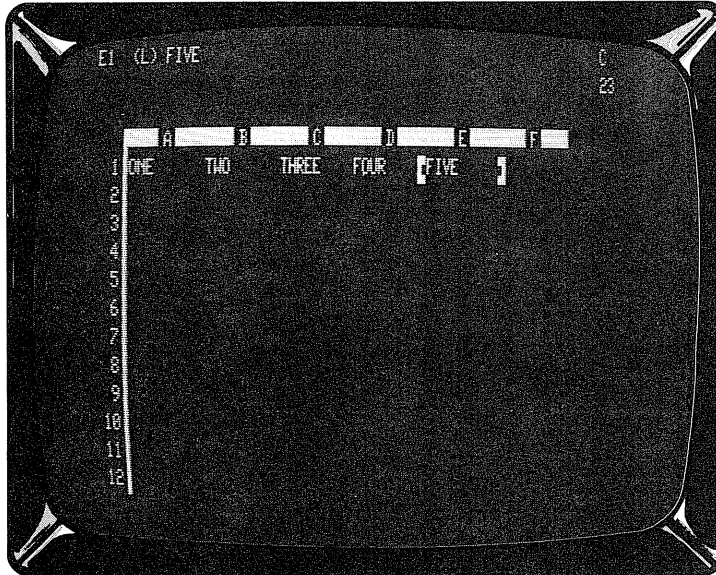

2) Type /M

prompt line:

MOVE: From . . . To
E1

edit line:

E1 . . .

3) Press .

edit line:

E1 . . . C1

4) Press ⬅

edit line:

Column E has moved to Column C.

5) Press Ⓢ

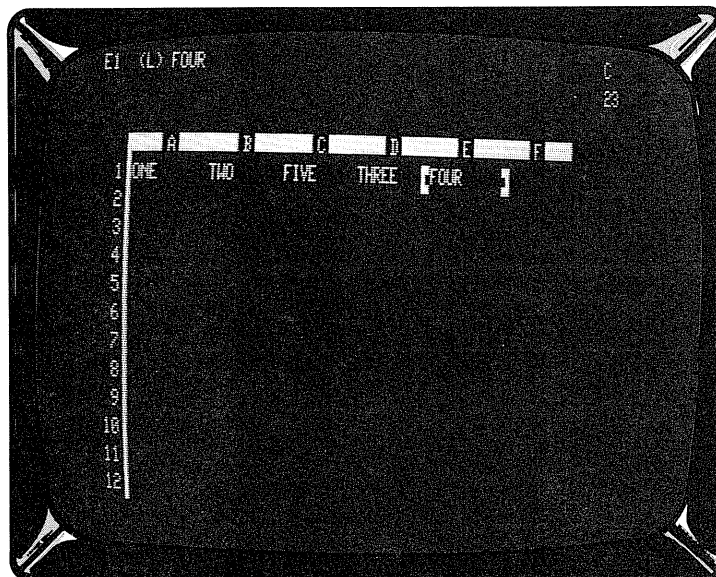

It is also possible to type in the coordinate of the row or column to be moved as well as the coordinate of the new location. Use the CLEAR key to erase any unwanted coordinate and replace it, either by typing or pointing to the coordinate with the cursor.

Example

- 1) Set up your sheet as in the photo below, with the highlight on E1:

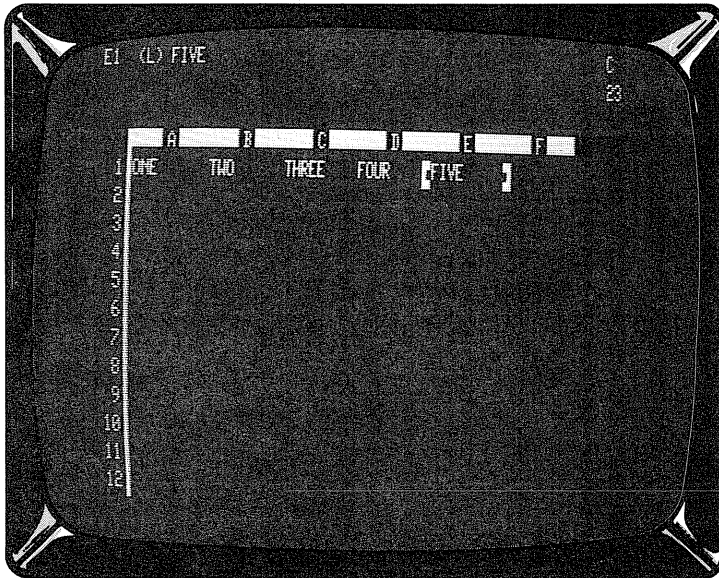

- 2) Type /M

prompt line:

MOVE: FROM . . . TO

edit line:

E1

- 3) Press CLEAR

edit line:

blank

- 4) Press ←←←←

edit line:

A1

Column A will be moved.

- 5) Press .

edit line:

A1 . . .

- 6) Type E1

edit line:

A1 . . . E1

Column A will be moved to column D. Although the cursor is on E1 at the end of step 5), pressing Ⓢ at that point will not enter E1 on the edit line.

MOVE Command

7) Now press ⓑ

The contents of column A are now in D. The columns that were previously B, C, and D have been moved to A, B, and C.

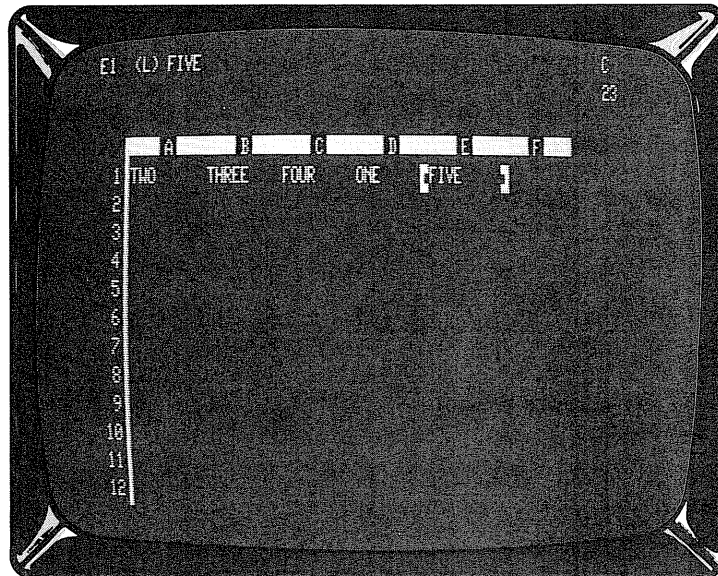

The PRINT Command

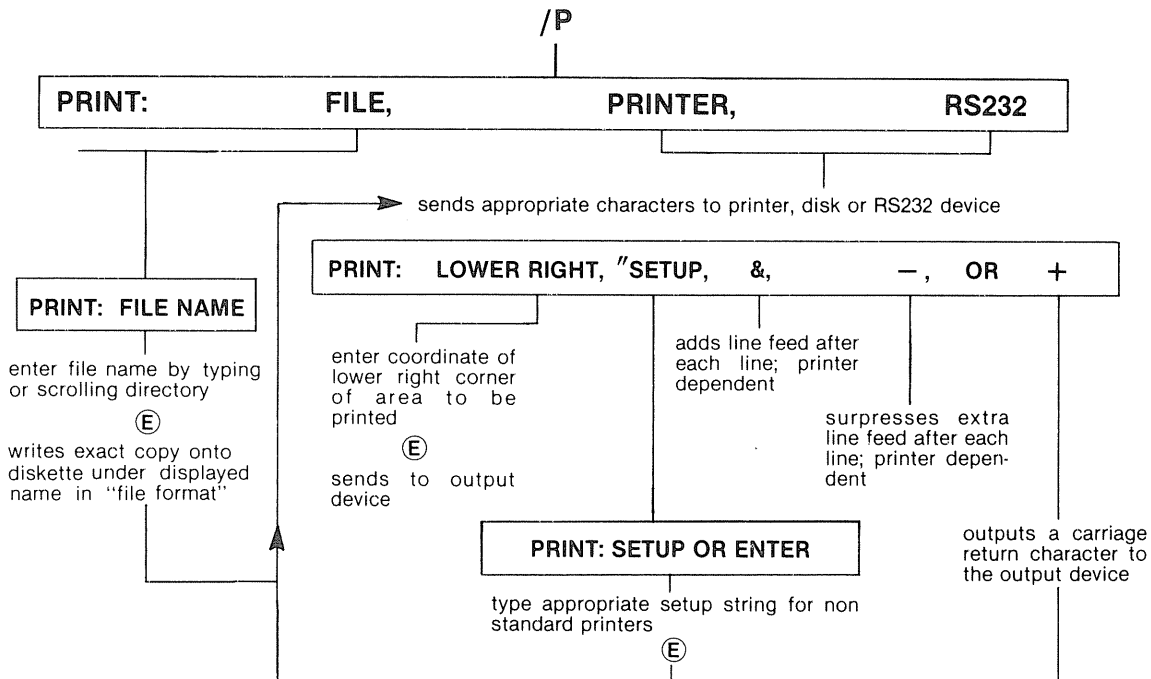

The print command sends a copy of all or part of a VisiCalc sheet to a printer. This manual gives instructions for printing on a TRS-80 Line Printer, a “daisy wheel” printer, or a serial printer. A special form of the print command can be used to “print” a VisiCalc sheet to a disk file, to a modem or to other devices.

Before you begin printing, make sure your printer is properly connected, supplied with paper, and turned on. For instructions on setting up a TRS-80 Line Printer, see the Line Printer Operator’s Manual (Catalog numbers 26-1150 or 26-1152). To use a serial printer, you must install the TRS-80 RS-232-C Interface board in your Expansion Interface unit. You will also need to set the switches in the RS-232-C Interface to work with your particular serial printer. For many serial printers, the standard switch settings (shown on pp. 8–9 of the RS-232 Interface Manual) will work with no problem. However, no two serial printers are quite alike, and you may need to read your printer manual carefully.

VisiCalc prints rectangular portions of the electronic sheet. The position of the cursor when you type the /P command marks the upper left corner of a “printing rectangle.” In giving the print command you will also specify the lower right corner of the rectangle. All rows and columns which lie within this rectangle will be printed. Window and title settings are ignored. If you try to print a row which has more characters than the line width of your printer, the extra characters in each row will either wrap around to a new line of printing, or will be ignored. Which of these two happens depends entirely on your particular printer. (See your printer specifications for this information.) The best way to print a sheet which is wider than what your printer can accommodate is to print it in separate sections and then tape the sections together to create a “hard copy” of the electronic sheet.

To begin the printing process, use the arrow keys to move the cursor to the coordinate that marks the upper left corner of the rectangle you want to print.

1) Type **/P** prompt line: PRINT: FILE, PRINTER,
RS-232

2) If you want to print to a TRS-80 Line Printer, type **P** (for Printer). If you have a serial printer, type **R** (for RS-232). The prompt line will display:

PRINT: LOWER RIGHT, ", &, —, OR +

This prompt means that you can now enter the coordinate of the lower right hand corner you want to print, or you can type one of the special setup characters (" , &, —, or +). For the moment, ignore the setup characters. To enter the lower right coordinate, either type its position, or use the arrow keys to move the cursor to that coordinate. When you have done this, type **Ⓔ** and the printing will begin.

To interrupt printing at any time, press the **BREAK** key.

Before entering the lower right coordinate, you may optionally use any of the special setup characters which appear on the prompt line (in step 2, above). The " and + characters have an immediate effect. Typing a " results in the following prompt line

SETUP OR ENTER

Whatever characters you type next will be transmitted to the printer immediately. End the setup string by pressing **Ⓔ**. The setup string may not be printed at this time because some printers wait until receiving a carriage return character before printing.

The + character transmits an immediate carriage return character to the output device. It's generally helpful to follow a setup string with a +, especially if your printer only prints after receiving a carriage return. The TRS-80 Line Printer will ignore all but the first in a series of consecutive carriage returns. This character may work differently on different devices. (See the output specifications.)

The & and — characters are complementary. & forces a line feed between successive lines of printing, while — suppresses one. The & should be used if the rows overprint one another. The — should be used if your printer adds an extra line feed between lines of printing. If you do use either of these, there will not be any immediate effect, but you should see the results in the actual printing. Most printers will not require the use of & or —. For those that do, it may be possible to reset switches on the printer itself to permanently generate or suppress line feeds, so that you do not have to use the & or — characters. These may work differently on your output device. See the specifications for your device for more information.

The REPLICATE Command

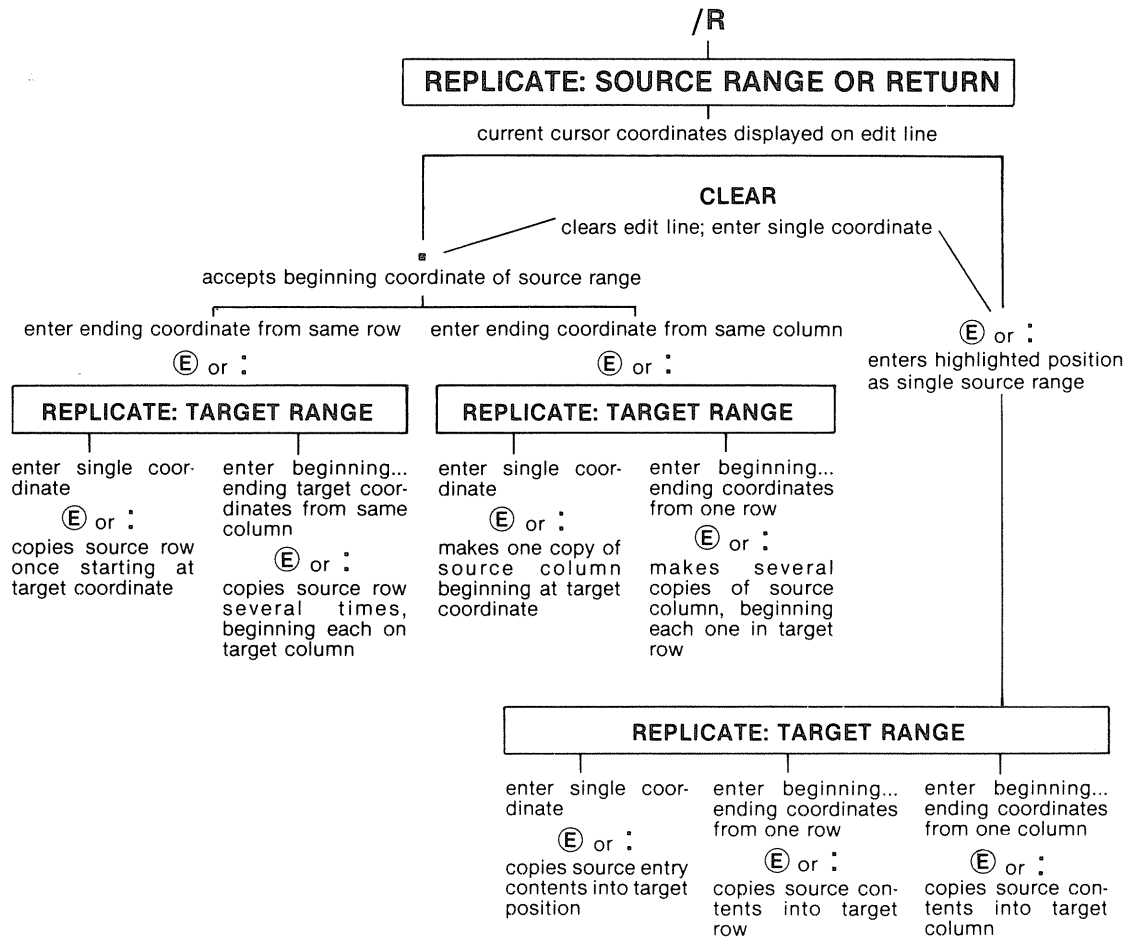

The replicate command allows you to copy the contents of any entry position, including labels, values (numbers, expressions, and formulas), formats (the **FORMAT** Command), and blank entries (the **BLANK** Command). You may copy a single entry from one place to another, copy a single entry position into a row or a column, or you may reproduce a single row or column as many times as you like. However, the replicate command does not permit you to copy a row into a column, or to copy a matrix (several rows or columns at once). Complex copying operations must be done with a series of replications or with the **/S#S** option (see the **STORAGE** Command).

To use the replicate command, you must supply two (and sometimes three) sets of information:

1. the source range
2. the target range
3. indication of the relationship of a value reference (see the **VALUE ENTRY** Command) to the new position

A range may be a single entry position, as well as a whole or partial row or column. Ranges are specified by typing or by pointing with the cursor to the desired beginning

entry coordinate, then typing a period, then typing or pointing to the ending coordinate. A range may not cross the sheet diagonally. A complete source and target range specification will appear on the edit line in the following pattern:

beginning source entry position coordinate . . . ending source entry position coordinate:
 first target entry position coordinate . . . ending entry position coordinate

If the beginning and ending coordinates in your **source range** are identical, you will copy one entry only. If they are different but fall in the same column, you will copy that section of that column. If they are different and fall in a row, you will copy that section of that row.

The coordinates you put in the target range tell VisiCalc the starting position for each copy to be made with the replicate command. If you want one copy of an entry position, a row, or a column, your target range should contain one coordinate (F9, for example). If you specify two different coordinates for your target range (F9 . . . F15, for example), you will get multiple copies of your source.

Copying from One Entry Position to Another

Give one coordinate as the source range and one as the target range.

Example

1) Type >A1Ⓢ

This places the cursor over the entry position you want to copy.

If A1 is bank, type 100Ⓢ

2) Type /R

prompt line:

REPLICATE:SOURCE RANGE OR ENTER

edit line: A1

By starting the command with the cursor on A1, VisiCalc automatically entered A1 to begin the source range.

3) Press Ⓢ

prompt line: REPLICATE: TARGET RANGE

edit line: A1 . . . A1:

You have told VisiCalc to begin copying the contents from entry position A1 and to end with A1. A1 is the “source range” consisting of one entry position.

4) Type D1

prompt line: REPLICATE: TARGET RANGE

edit line: D1

This identifies entry position D1 as the start of the “target range,” that is, the entry position to which the contents of A1 will be copied.

5) Press Ⓢ

The replication is completed. The value 100 is now in entry position D1 as well as A1, the highlight is still at A, and the control panel has been cleared for a new command.



Creating a Column by Making Several Copies of One Entry

Give one coordinate as the source range and two coordinates within a single column as the target range:

Example

Repeat steps 1 through 4 in the example above. Change step 5 to:

5) Type **.D100**Ⓢ

The contents of entry position A1 will now appear in entry positions D2, D3, D4, through D100, as well as in D1.

This procedure is especially useful for setting up display formats (see the **FORMAT Command**) before entering a large group of numbers. Assume, for instance, that a column will contain sales figures and therefore should always display numbers rounded to two decimal places. Place the cursor on a blank entry position and type **/F\$** (see the **FORMAT Command**) to attach the “dollars and cents” format to the position. Then replicate that entry position into the positions in the column that you want to have the dollars and cents format, using the procedure in the example above. The entry positions will not change in appearance if there are no values in them at this point. However, when you begin entering numbers into them, they will all be displayed with two decimal places.

Copying a Column from One Position on the Sheet to Another

Give the top and bottom entry position coordinates of the column as the source range: For instance, A1 . . . A32. For the target range, give only the coordinate of the top entry position of the new column.

Example

To set up your sheet for this example, enter the numbers 1 through 10 in positions A1 through A10. You need not clear the sheet because VisiCalc will write over any old entries.

1) Type **/R**

prompt line:

REPLICATE: SOURCE RANGE OR ENTER

edit line:

current cursor position coordinate.

VisiCalc will put the coordinate of the entry position to which the cursor is pointing on the edit line. If this is not the coordinate you want to begin your source range, press **CLEAR** to remove it from the edit line.

2) Press **CLEAR**

To erase first coordinate (this step is not necessary when the coordinate on the edit line is the one you want to begin the source range).

3) Type **A1**

edit line: A1

4) Type **.**

edit line: A1 . . .

5) Type **A10**

edit line: A1 . . . A10

6) Press **ⓔ**

prompt line: REPLICATE:TARGET
RANGE

7) Type **C4**

edit line: A . . . A10: _

8) Press **ⓔ**

edit line: A1 . . . A10: C4

The contents from your source range (A1 to A10) are now in your target (C4 to C13). Note that you must not type the ending coordinate of the target range. The cursor has been returned to the position it occupied before you typed /R.

Making Several Copies of a Column

Enter the top and bottom coordinates of the column as the source range and the beginning and ending coordinates of a row as the target range. Each copy of the source column will “begin” in the target row.

Example

Do the example above again, only this time change steps 7 and 8 to:

7) Type **D1.K1**

edit line: A1 . . . A10:D1 . . . K1

In the target range, D1 will be the top of the first new column, E1 the top of the second new column, and so on, ending with K1 as the top of the last new column. The target range must be adjacent coordinates in one row or VisiCalc will only copy the column once and stop.

8) Type **ⓔ**

The results will look like this:

	A	B	C	D	E	F
1	1					
2	2					
3	3					
4	4		1	1	1	1
5	5		2	2	2	2
6	6		3	3	3	3
7	7		4	4	4	4
8	8		5	5	5	5
9	9		6	6	6	6
10	10		7	7	7	7
11			8	8	8	8
12			9	9	9	9

You may wish to scroll your window over to J1 to see all of the effects of these few keystrokes on your sheet.

Copying a Row from One Position to Another

Specify the beginning and ending coordinates in that row as your source range. Then give the beginning coordinate only for the row in which you want the copy to appear. VisiCalc will automatically interpret this target coordinate as the first entry position in a row and will fill in the correct ending position.

Example

To set up for this example, clear the sheet with /CY and enter the numbers 1 through 5 across the top row on your sheet (positions A1,B1,C1,D1,E1). Then:

- 1) Type >A1Ⓜ
- 2) Type /R.C1Ⓜ
- 3) Type A5
- 4) Press Ⓜ

edit line:

A1 . . . C1:

The result should look like this:

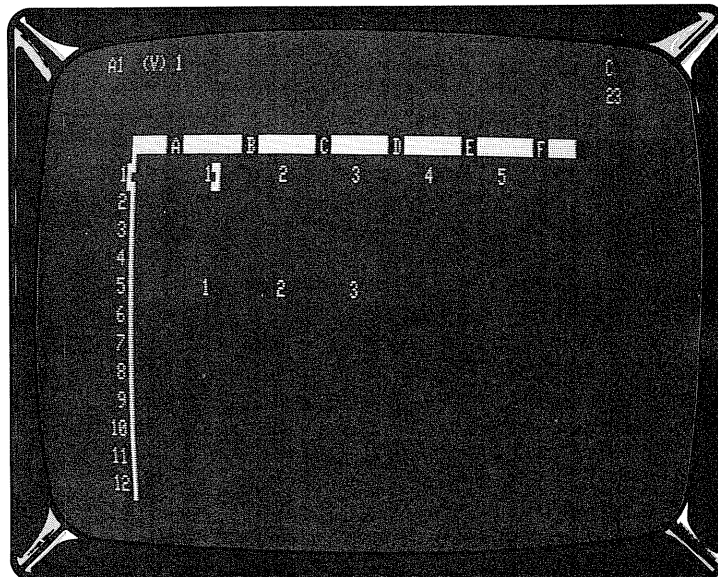

Give two coordinates for the target range (A5 . . . A10, for example) only if you want these results:

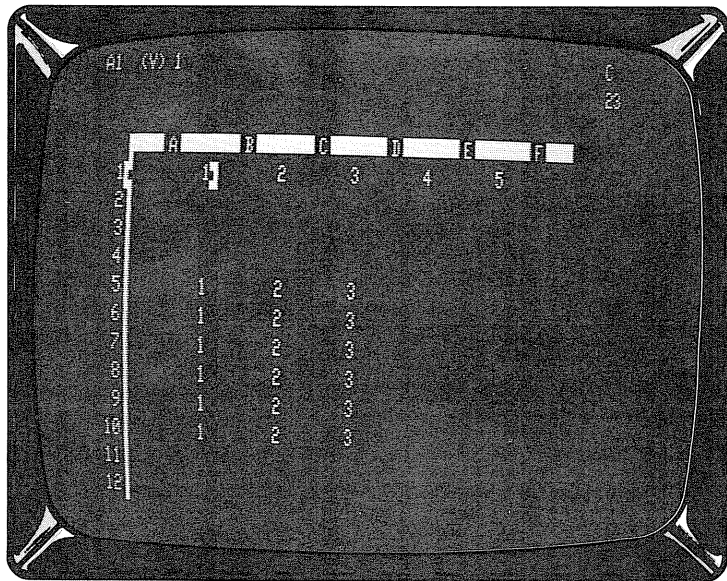

Replicating Value References

When you replicate a formula which contains entry position coordinates (value references), you must tell VisiCalc whether or not to copy each value reference exactly as it appears in the source range, or to change that value reference as it is copied. The change will replace the original value reference with the one that falls in the position that is relative to the location of the copied formula. Therefore, the replicated value reference will be to the replicated formula as the original value reference is to the original formula. The following examples will illustrate this relationship:

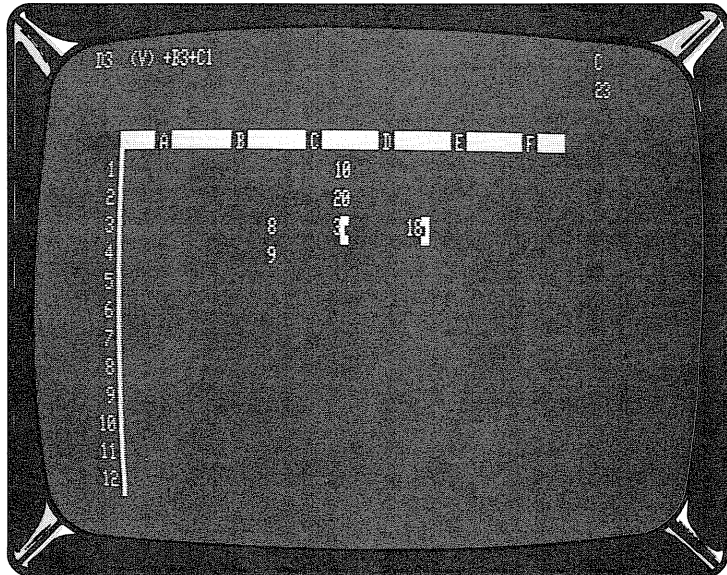

You can see from the entry contents line in the photo above that the formula in position D3 contains value references to positions B3 and C1. B3 is in the same row as the highlighted formula and two columns left. C1 is two rows up and one column over from D3.

REPLICATE Command

Look at the photo below.

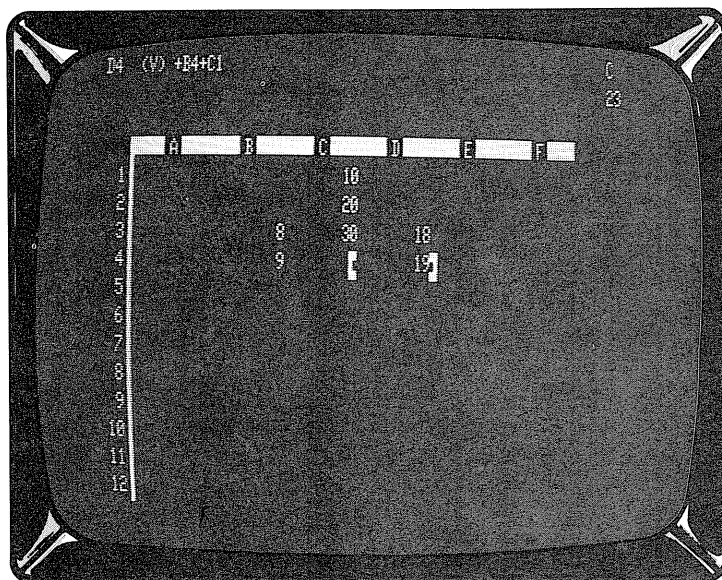

The formula in D3 has been replicated into position D4 but it has also been changed. The formula in D4 is now $B4 + C1$. The value reference B4 is in the same row and two columns left of the new formula in D4, i.e., it is in the same **relative position**. It was copied using the R indication. The value reference C1 is exactly the same in the formula at D3 and the formula at D4. In other words, it has not been changed to maintain the same position relative to the placement the formula. It was copied using the N indication.

When a source range that is being replicated contains value references, VisiCalc places each value reference on the edit line with a dash following it. The prompt line instructs you to type **R** if the value reference is to be relative, or **N** if it is not to be changed in the new formula. After this procedure has been completed for each value reference, VisiCalc will finish the replication.

Example

- 1) Type /CY To clear the sheet.
- 2) Set up your sheet as in this photo:

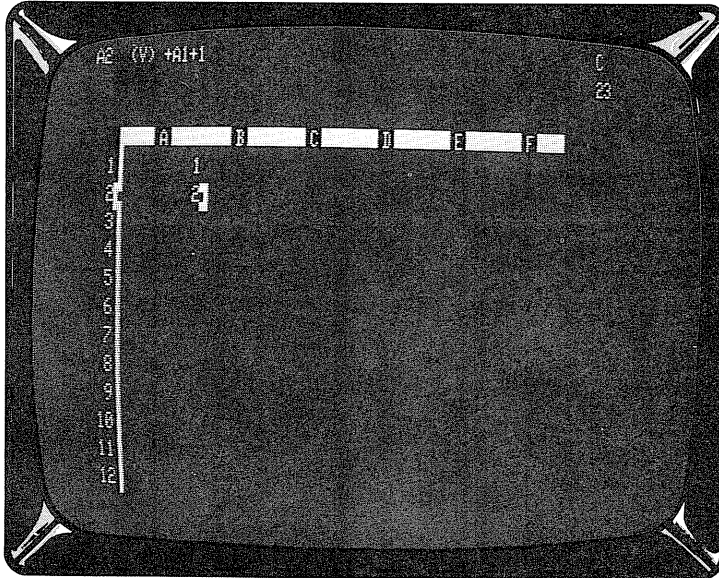

- 3) Type /R[Ⓡ]
- 4) Press ↵.
- 5) Press ↵↵↵[Ⓡ]

prompt line:

REPLICATE: TARGET
RANGE

edit line:

A2 . . . A2:

prompt line:

REPLICATE: TARGET
RANGE

edit line:

A2 . . . A2:A3 . . .

prompt line:

REPLICATE: N=NO CHANGE, R=RELATIVE

edit line:

A2:A3 . . . A5: +A1

The value reference A1 in the formula being replicated is followed by the dash. Replication actually takes place one entry position at a time. The edit line indicates that the first operation is copying from A2 into A3 and VisiCalc is waiting to be told whether to interpret the value reference, A1 as relative or unchanging.

6) Type N

Your sheet will look like this:

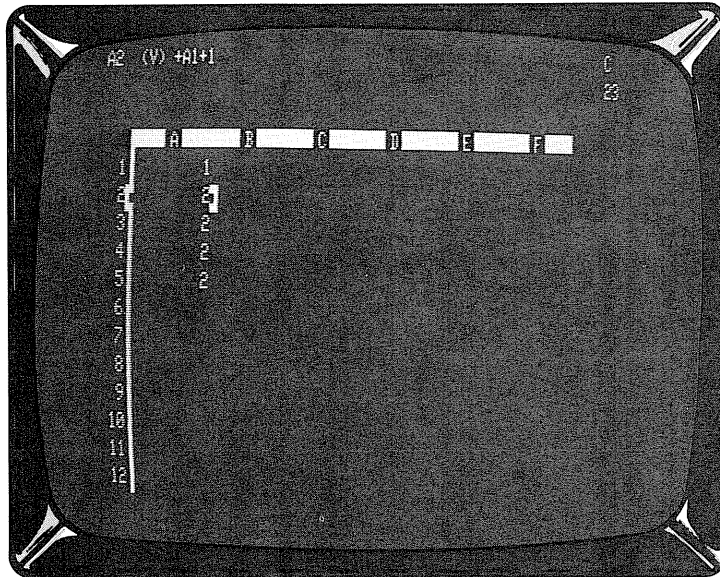

Move the cursor down the column. Notice that each copy of the formula contains the value reference, A1. It has not been changed from the way it appeared in the source range. Now repeat steps 1 through 5 in the example above. At step 6, type R. Your sheet should look like this:

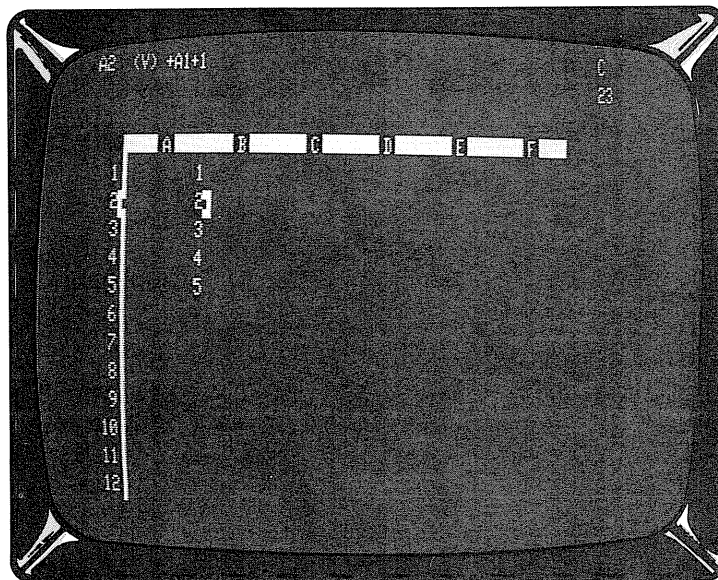

Move the cursor over A3, A4, and A5 again and check the formulas as shown on the entry contents line. The value reference in each entry position has been changed to cite "the position above" the highlighted formula (a relative description) instead of "the value reference which occurred in the source formula."

It is possible to replicate a formula into a position in which proper relative value references cannot be assigned. Turn back to the two screen photos at the beginning of this section ("Replicating Value References"). If, for example, you copy the formula at D3 into position A3, then the relative position of the value reference B3 will be located off the sheet to the left!

In Part II, Lesson Three of this manual, there are more examples of the use of the replicate feature. Also, you must be careful not to introduce forward or circular references or incorrect calculation order into your sheet when you replicate formulas. These topics are thoroughly discussed in Part II, Lesson Three in the sections entitled "The Order of Recalculation" and "Forward and Circular References" and also in Part III, the VALUE ENTRY Command.

The STORAGE Command

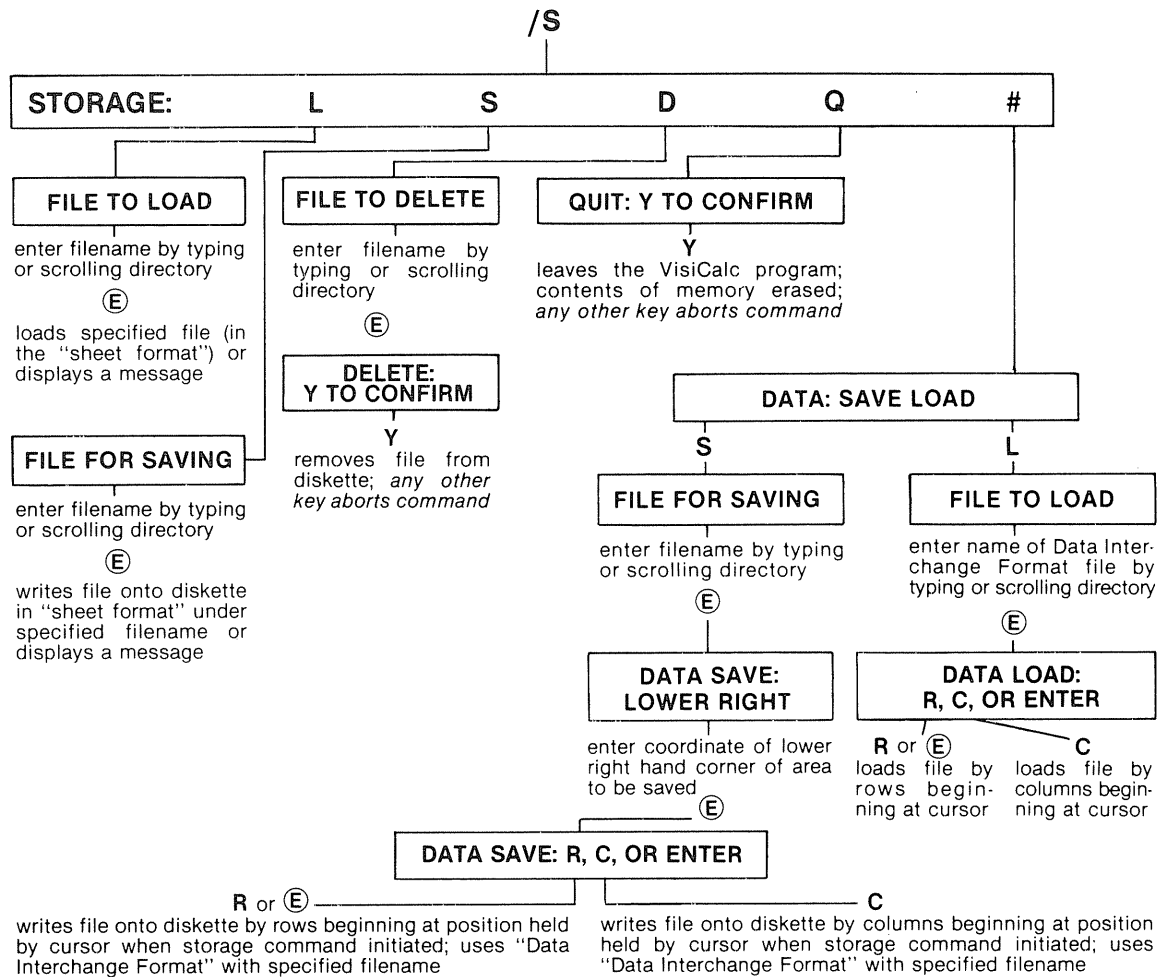

The storage command lets you save copies of your current VisiCalc sheet on diskette, load saved sheets back into the computer, and gives you a way to leave VisiCalc and return to the computer's Disk Operating System so you can use your computer for something else.

The Storage Load Command—/SL

This command loads back into the computer's memory a sheet which was saved with the /SS command, as discussed below. Only files which were saved in the VisiCalc file format with the /SS command can be loaded with the /SL command.

When the file has loaded, the sheet will appear in the window exactly as it was when you gave the /SS command to save it. VisiCalc will not clear the sheet that is in use when the /SL command is given, but will write the loaded sheet over it. Wherever an entry position has contents on both the current and the loaded sheet, the entry position contents of the just-loaded sheet will replace the previous contents. Blank entry positions in the loaded sheet will not erase the contents of corresponding entry positions in the old sheet. This over-writing characteristic gives you one way to combine sheets by loading previously saved sheets over one another.

Clear the sheet by typing /CY (see the CLEAR Command) before loading a sheet when you want only the contents of the saved sheet to be placed in the computer's memory.

Insert the diskette containing the file to be loaded and follow the steps below. You may put the diskette into any of your disk drives and VisiCalc will search through the file directories on each one until the requested file is found.

- | | | |
|--|--------------|--------------------|
| 1) Type /S | prompt line: | STORAGE: L S D Q # |
| 2) Type L | prompt line: | FILE TO LOAD |
| 3) Type the file name used when the file was saved with /SS
or
Press ⏏ | | |

The file name of the first file that was saved in the VisiCalc file format with the /SS command will appear. Each time you press the ⏏ key, VisiCalc will examine the directory and place the next qualifying file name it finds on the edit line. Continue pressing ⏏ to **scroll** through the directory until the name of the file you wish to load appears on the edit line.

- | | |
|------------|--|
| 4) Press Ⓜ | VisiCalc will load the file with the name that was on the edit line. While the file is loading, characters will flash at the left side of the edit line. These are the same keystrokes you had originally entered to create the sheet that is now being loaded. When loading is finished, the sheet will appear in the window, looking just like it did when you saved it. |
|------------|--|

The directory **scrolling** described in step 3, above, puts the existing file names on the edit line. When a file name is on the edit line, you may change the name by backing up the dash with CLEAR and then typing the characters you wish. This feature might be useful when, for example, you have forgotten a file name. As you scroll the directory a file name appears that jogs your memory as to the name of the file you want to load. Perhaps the name on the edit line is BUDGJAN/VC and you remember that the file you want is called BUDGAUG/VC. Press the CLEAR key until JAN/VC has been deleted from the edit line, type AUG/VC, then press Ⓜ and BUDGAUG/VC will be loaded (if it is on a diskette that is currently in one of the disk drives).

The Storage Save Command—/SS

This command will save an electronic sheet, just as you have created it, on a diskette in the VisiCalc format so that it can be loaded back into the computer's memory with the /SL command. Before you can use a diskette with the storage save command, a diskette must be made with the TRSDOS BACKUP or TRSDOS FORMAT command as explained in the Introduction to this manual. All formulas, labels, title settings, explicit and global formats and window settings as well as the position of the cursor will be saved and in force when the sheet is loaded.

Each sheet is saved, or recorded, on a diskette under a name you specify, called the file name. The file name is recorded in the diskette's "directory." Each file name is unique, so that if you save a sheet with a file name already in the directory, the file with that file name will be replaced by the most recent file saved with the name. There is enough room on a diskette to hold many electronic sheets. Should the disk become full while VisiCalc is recording a sheet into a file, an ERROR message will appear on the edit line. VisiCalc will have saved all that it could under the file name you gave so you will want to delete that incomplete file from the full disk (see /SD below) and then save the sheet on another, less full, storage diskette.

The file name may be made up of 1 to 8 alphanumeric characters beginning with a letter. Then add the extension /VC (for the VisiCalc file format). File names are part of a more complete description of your file called a file specification (fil spec, for short). Please refer to your TRS-80 DISK OPERATING SYSTEM/ DISK BASIC Manual, section entitled TRSDOS Overview, subsection File Specification for a full explanation of TRSDOS file specifications. All you need to give VisiCalc is the file name when saving a sheet. Following the file name you give a : and the number of the disk drive. You may type all or part of the complete file specification whenever you name a file. However, do use caution if you use a password in your fil spec. (1 to 8 alphanumeric characters preceded by a . (period)). Passwords are used to keep other people from tampering with your files. The password part of the file specification never shows up in the directory. To load such a file, you must type filename.password onto the edit line. If you forget your password you are in deep trouble!

When you load VisiCalc at the beginning of a session, the VisiCalc program diskette must be in drive 0. Unless you specify a drive number (with :number after the filename), the computer will automatically assume that the diskette on which you want to save a file is located in drive 0. Drive 0 is said to be the "default" drive. If you want to save the file on a diskette in drive 1, you must follow the file name you enter with the characters :1. For example, MYFILE/VC:1 would be saved on the diskette in drive 1. The :1 is the "drive specification."

To save a file, do the steps listed below. The cursor may be anywhere on the sheet when the /SS command is started.

- 1) Type /S prompt line: STORAGE: L S D Q #
- 2) Type S prompt line: FILE FOR SAVING
- 3) Type the file name and the disk drive number, if necessary. Or you can press **↵** key and VisiCalc will place the first file name it finds in the directory on the edit line. If there is no file name in the diskette's directory, VisiCalc will clear the control panel and wait for another command. **Note that your sheet has not been saved, because there is no file name.** (In this case, start at step 1 and type in a valid file name.) Each time **↵** is pressed, the next file name in the directory will appear, as VisiCalc scrolls through the directory. You may change the file name by pressing CLEAR to back up the dash and then type in the new characters. When you have the desired name do step 4. Be careful not to press **↵** by mistake because this will respond like **ⓔ**.
- 4) Press **ⓔ**

The disk drive will whir as the electronic sheet is saved on the diskette under the file name you specified on the edit line in step 3.

The option, in step 3, of letting VisiCalc put file names from the directory on the edit line can be very useful. For instance, if you wanted to keep a record of different versions of a VisiCalc sheet, you might identify the versions by changing only the last few characters of each file name. You could scroll the directory until the last version's file name appeared, then backspace with CLEAR to delete the version identifier, then type in the new version characters. For example, using this method, the file name BUDGETA /VC:1 could readily be edited to be BUDGETB/VC:1. It is also a convenient way to examine what file names are in the diskette directory so that you do not unintentionally use an existing file name for the file being saved. Only files with /VC extensions will be displayed.

The Storage Delete Command—/SD

This command will delete from the diskette the file whose name appears on the edit line.

- 1) Type /SD prompt line: FILE TO DELETE
- 2) Type the file name, followed by the drive number, if necessary. Or you may press \blacktriangleright and VisiCalc will place the first name it finds in the diskette's directory on the edit line. Each time you press \blacktriangleright , VisiCalc will examine the directory and place the next /VC file name it finds on the edit line. Continue pressing \blacktriangleright to scroll through the directory until the name of the file you wish to delete appears on the edit line.
- 3) Press $\text{\textcircled{E}}$ prompt line: DELETE: Y TO
CONFIRM
Any other key will cancel the command.
- 4) Type Y VisiCalc will delete the file from the diskette. This command will not work on diskettes with the write protect notch covered.

The Storage Quit Command—/SQ

This command will let you leave the VisiCalc program and return to the TRSDOS READY prompt (the same one that's on the screen when you first turn on the computer). **Any VisiCalc sheet currently in the computer's memory will be lost.** You will have to reload the VisiCalc program (see step 2 below) if you wish to continue using VisiCalc. You should have a diskette with TRSDOS on it in Drive 0.

- 1) Type /SQ prompt line: QUIT: Y TO CONFIRM
- 2) Type Y The computer leaves the VisiCalc program. Any other key cancels the command. To begin VisiCalc again, with a VisiCalc diskette in Drive 0, type VC $\text{\textcircled{E}}$

Saving Files in the Data Interchange Format

Files saved with the command /S#S are recorded on the diskette in the Data Interchange Format (extension /DIF). This format affords a way for other programs, such as those written in BASIC or FORTRAN, to use the data that is on the sheet. The data that was saved in files with the /S#S command can be loaded back onto a VisiCalc sheet with the /S#L (Load a Data Interchange Format file) command.

Saving a Data Interchange Format File—/S#S

This command saves a rectangular area of the sheet, which you define, in a file in the Data Interchange Format (the DIF). This command saves labels, blanks, and calculated values as they appear in the entry positions on the sheet. The formulas from which the values were derived are not saved (see the VALUE ENTRY Command for discussion of formulas and values). The DIF allows for two orientations of the data. You can specify to VisiCalc which orientation you want by pressing **R** or **C** at the appropriate time. For data that you are only going to use with VisiCalc, always save the data with the **R** specification. As an aid to remembering this, pressing **ⓔ** is same as typing **R**. To use the command:

1) Position the cursor at the entry position that is in the upper left hand corner of the rectangular area you want to save.

2) Type /S#

prompt line: DATA: SAVE LOAD

3) Type S

prompt line: FILE FOR SAVING

4) Type the file name

The file name must follow the same rules outlined in the discussion of /SS, above, except that VisiCalc will append the suffix /DIF to files saved with this command. Do not use the /VC suffix, which is for use with files saved with /SS.

Or press **⏏**

To look at the file names already in the directory. Continue pressing **⏏** until the desired file name appears on the edit line. You may change the name on the edit line by pressing **CLEAR** and typing other characters.

5) Press **ⓔ**

prompt line: DATA SAVE: LOWER
RIGHT

6) Type or point with the cursor to the entry position in the lower right corner of the rectangular area to be saved. You may save only one column or one row if you want.

7) Press **ⓔ**

prompt line: DATA SAVE: R, C OR
ENTER

8) Press **R** or **ⓔ**

The rectangular area of the sheet defined by the upper left and lower right cursor positions will be saved.

Loading a Data Interchange Format File—/S#L

This command will load back the data you saved with the /S#S command into any position on the sheet you indicate.

- 1) Position the cursor on the entry position in the upper left corner of the area to be filled by the data being loaded.
- 2) Type /S#L
 prompt line: FILE TO LOAD
- 3) Type the desired file name
 Or press **↓**
 The file name should be the one saved in the Data Interchange Format.
 To scroll through the directory as described in the /SL command discussion, above, until the desired file name appears.
 prompt line: DATA LOAD: R, C OR RETURN
- 4) Press **Ⓢ**
- 5) Press **Ⓢ** or **R**
 The selected file is read into the computer's memory and placed on the VisiCalc sheet starting at the current cursor position.

If you would like the data loaded transposed—what would have been loaded across the rows is loaded down the columns, and vice versa—press **C** at step 5.

The TITLE Command

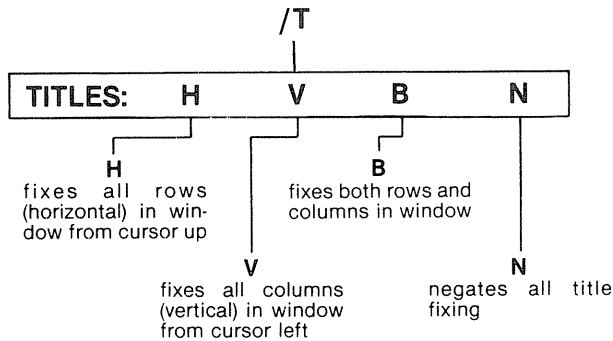

Most VisiCalc sheets are considerably larger than the screen display window. To see all the entries on the sheet, you must move the window away from the top and left edges, so that any row and column titles you may have entered move out of sight.

The title commands allow you to fix titles in place on the screen, so that they remain in view as you scroll the window about the sheet. Begin the command from a cleared control panel by typing /T. The prompt line on the control panel will display TITLES: H V B N. The possible keystrokes are:

- H** To fix **horizontal** titles.
- V** To fix **vertical** titles.
- B** To fix **both** horizontal and vertical titles.
- N** **No** titles (to “unfix” titles).

Which columns and/or rows are to be fixed is determined by the position of the cursor when you initiate the command. All rows at and above the highlight are fixed by H. All columns at and to the left of the highlight are fixed by V. B fixed all rows above and columns to the left of the highlight.

VisiCalc terminates the command automatically and clears the control panel immediately. There is no change on the sheet, but the effect of title fixing becomes apparent when you begin scrolling the window away from the top and left borders.

You cannot use the arrow keys to move the highlight to an entry position that is within a fixed title area. The row and column borders will flash when it bumps into the fixed titles. You jump the title barrier by using > (see the GO TO Command) and the coordinates of an entry position within the fixed title area; for example, >A1®

In certain circumstances, VisiCalc will automatically unfix vertical titles you have set. It does this when in order to follow your commands, the vertical titles must not be set. For instance, if you scrolled the window so that column B was at the left edge, then fixed vertical titles and then at some point gave the command to go to a coordinate in column A (see the GO TO Command), VisiCalc would unfix the vertical titles. In order to obey the command to go to column A, the window had to be scrolled to the left to bring A into view. If you have fixed vertical titles, and then you expand the column width (see the GLOBAL Command) so that only one column can be displayed on the screen at one time, VisiCalc will automatically "unfix" the vertical title settings. When you return to a narrower column width, you will have to refix the vertical titles.

The VERSION Command

/V

© 1980 Software Arts Inc. V1.20Z

displays copyright notice and version number on prompt line; clears automatically with next keystroke

To see the copyright notice and the version number of your VisiCalc program, type /V when the control panel is clear. You may use this command anytime, without disturbing the contents of a sheet. As soon as you press any key, the notice will disappear from the control panel.

Should you need to call or write with questions about VisiCalc, be sure to include the version number that appears when you give the version command. The photograph illustrates how the notice appears on the screen.

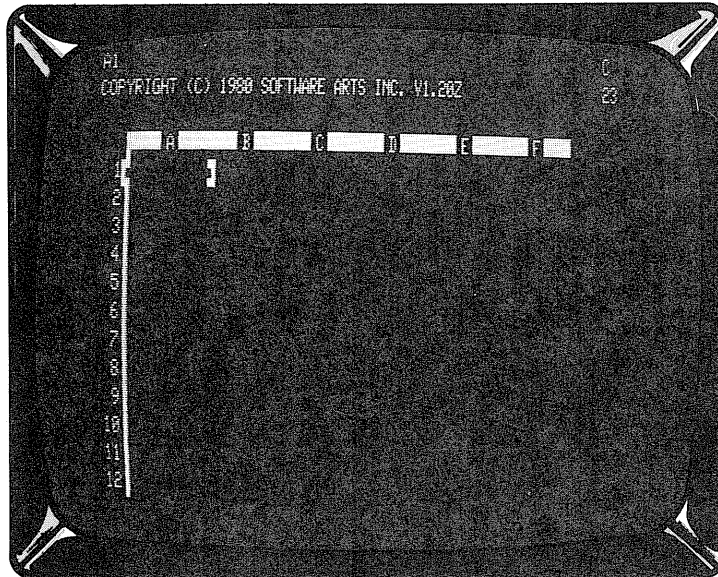

The WINDOW Command

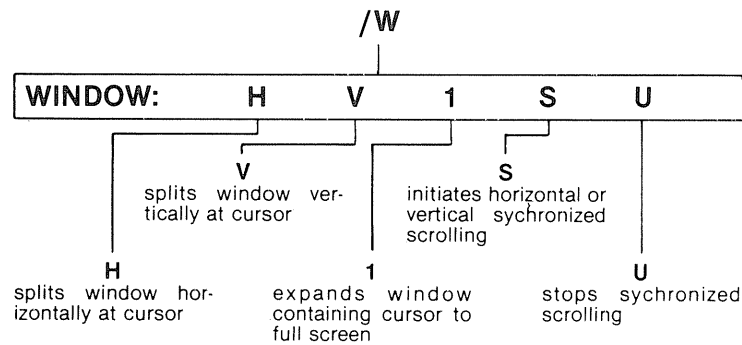

Often you will find yourself wishing to compare rows or columns which are too far apart on the sheet to be displayed in a single window on your computer screen. The window command allows you to split your screen so that you can view the sheet through two windows simultaneously. Each window may be independently scrolled around the entire sheet to let you see rows or columns which are widely separated on the sheet. You may also look at the same entry positions through separate windows with different global column widths and formats (see the GLOBAL Command) modifying the display in each one.

Horizontal Split—/WH

This command splits the window into two by placing a second column border (A,B, C, D, . . .) between the row containing the highlighted entry position and the next row down. Each window may be moved individually to view the same or different parts of the sheet.

Example

- 1) Type /CY
- 2) Type ONE↵TWO↵
THREE↵FOUR↵
FIVE↵SIX↵
SEVEN↵EIGHT↵
- 3) Type >A6↵
- 4) Type
JAN↵FEB↵MAR↵
APR↵MAY↵JUN↵
JULY↵AUG↵

This clears the VisiCalc sheet.

Your screen should look like this:

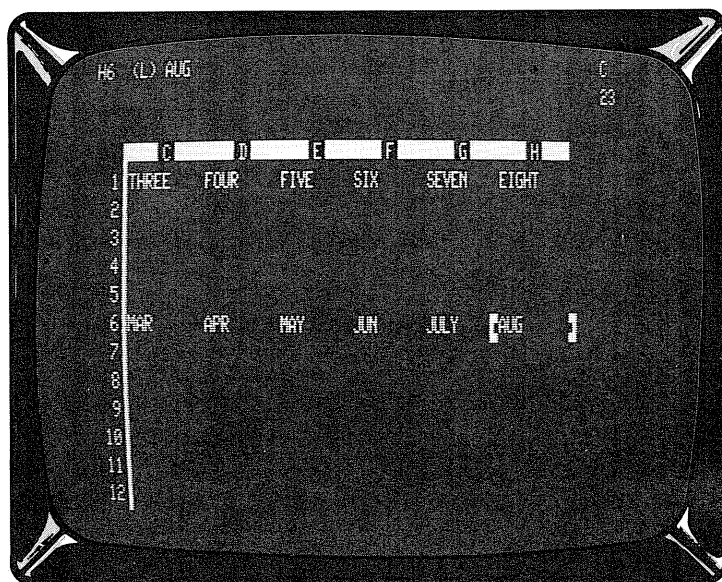

- 5) Type /W

prompt line:

WINDOW: H V 1 S U

6) Type H

Your screen will change to:

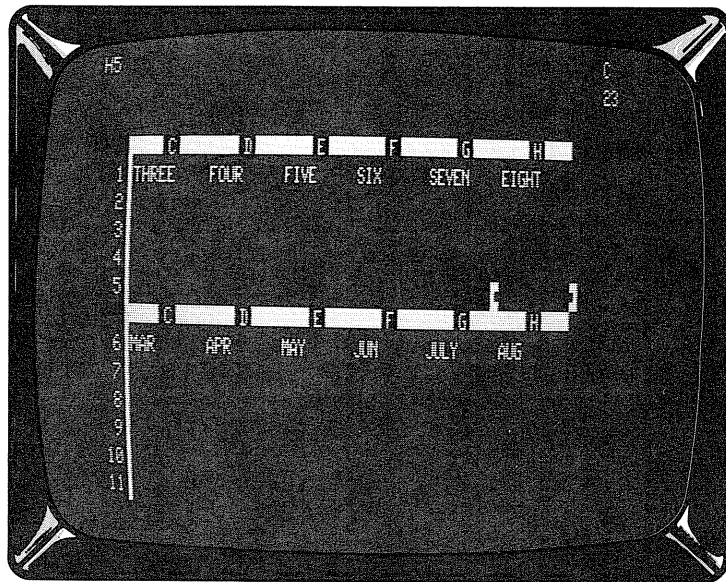

Each window will now view the sheet independently. The cursor can move around the sheet in the top window. Move it up and left until the ONE is highlighted in the top window. Press ; to move the cursor into the bottom window. Pressing ; will always make the cursor jump to the last position it had in the other window. All VisiCalc commands will work in both windows and you can see the effects on the sheet through either window. The two exceptions are the /GC (Global Column) and /GF (Global Format) commands, which are set in one window at a time (see the GLOBAL Command).

Remove the horizontal window by typing /W1 The window containing the cursor will then occupy the whole screen using the current format settings of that window. A horizontal window must be removed before a vertical window can be instated and vice versa.

Vertical Windows—/WV

This command splits the window by adding a second row border (1 2 3 4 5 . . .) after the column containing the cursor. When the screen has been split vertically, all the columns in the right window may be slightly narrower than those in the left window. This is to make room for the second row border. The vertical window behaves exactly like the horizontal window described above. Note that when you return to one window, the format settings of the window in which the cursor is sitting go into effect in the single window. The column width of the right window, which was automatically narrowed, will also be in effect if the cursor is in that window when /W1 is typed. To jump between windows, press ;.

Example

- 1) Type /CY
- 2) Type
JAN↵**FEB**↵
MAR↵**APR**Ⓜ
- 3) Type >**B1**Ⓜ
- 4) Type
100↵**200**↵
300↵**400**Ⓜ
- 5) Type /WV

Your screen should resemble the photo below.

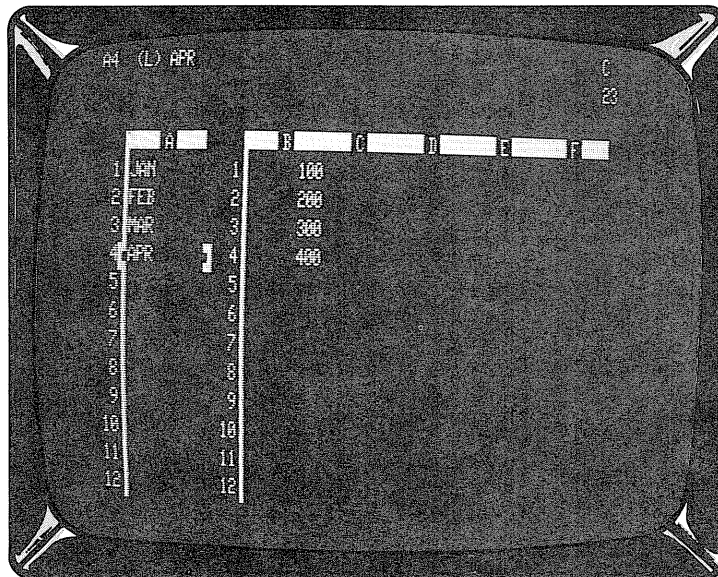

The vertical window can be particularly useful when you wish to keep a column of information visible in one window while you scroll the other window around to compare columns in different places on the sheet.

Return to One Window—/W1

This command displays the window containing the cursor in full screen position. All the global format settings in that window take effect in the one window.

Synchronized Scrolling—/WS

This command synchronizes horizontal motion in horizontal windows or vertical motion in vertical windows so that moving the highlight in one window also moves the other.

Unsynchronized Scrolling—/WU

This command turns off synchronized scrolling.

The last three window command options (/W1, /WS, and /WU) may only be used after a /WH or /WV is in effect.

The REPEATING LABEL Command

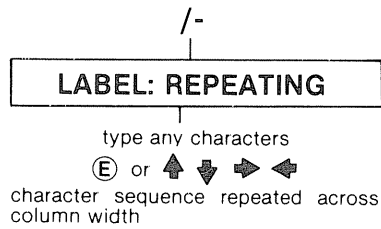

Sometimes it is useful to draw lines or other borders across an entire column or across several columns. The repeating label command will repeat any sequence of characters you enter across the entire width of a column. If you change the column width (see the GLOBAL Command), the continuous sequence will be modified so that it still fills the column. When you replicate (see the REPLICATE Command) the entry containing the repeating label, you can form a line or other visual break across your sheet.

Example

- 1) Type >A4
- 2) Type /-
- 3) Type -
- 4) Press ⓔ
- 5) Type /Rⓔ
B4.BK4ⓔ

prompt line: LABEL: REPEATING
 prompt line: LABEL: REPEATING
 edit line: --

VisiCalc will extend the sequence across the column. For example, with a general column width (9 characters) you see ----- in the entry position.

Use the replicate command to copy the continuous label as far across the sheet as needed.

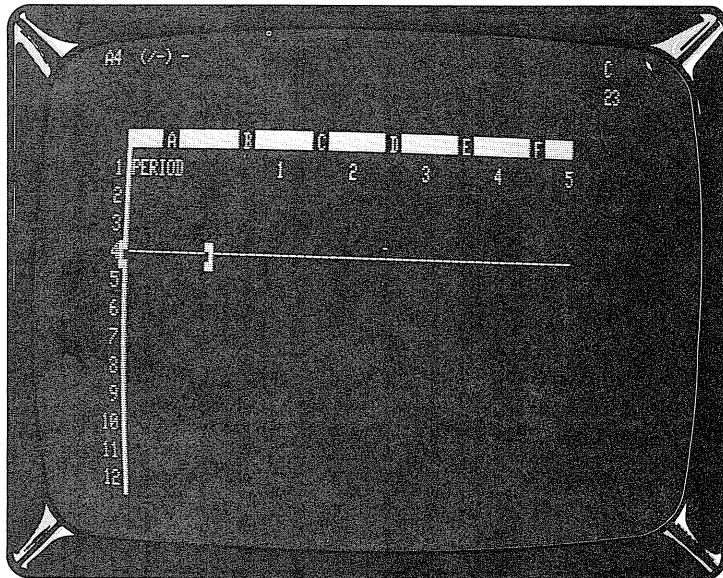



PART IV. INDEX

Index 170

-A-

@ symbol 57, 110–112
 aborting a command: see command
 @ABS (absolute value) function 83, 111
 alphanumeric characters 21, 102
 angle brackets (>) 77
 arguments in functions 79–84, 105, 110–112
 arithmetic operators 79, 105–106
 arrow keys, right, left, up, and down 14, 18–19, 21–22, 107
 automatic recalculation 89, 128
 automatic repeat 19, 96
 @AVERAGE function 57, 81, 111

-B-

backing out of a command 20, 95, 96
 backup copies of diskettes 8–11, 28–29
 BLANK command 28, 37, 114
 blank entry 23–24, 28
 box: see cursor
 BREAK key 21, 94, 95, 105, 107
 budget example 50–70
 built-in functions 56–57, 79–84, 104, 110

-C-

calculated value 108
 calculating interest 64–65
 calculation indicator 94, 125–127
 calculations 22, 94, 106
 catalog: see directory
 changing file names 156–157
 character string 102, 142
 circular reference 72, 109
 CLEAR command 28, 115
 CLEAR key 20–21, 95, 96, 105, 107
 clearing
 the control panel 94–95
 the sheet 17, 21, 27, 76, 115
 columns 5, 17, 116–119
 adjusting width 5, 39–40, 124
 deleting 116–119
 inserting 130–132
 replicating 60, 146–147
 command
 aborting 20–21, 28, 94, 95
 structure chart 98–99
 control panel 17, 94
 coordinate 17, 20, 95
 in replication 34, 37
 as a value reference 78
 copying diskettes 27–29
 correcting typing mistakes 20–21, 96, 107
 @COS 111
 @COUNT function 81, 111

cursor 18–20, 24–26, 95
 flashing 18
 –moving keys 18–20, 95
 pointing with the 24–26, 96
 removing the 95

-D-

data interchange format 157–159
 delete
 columns 63, 116–119
 entry contents: see BLANK command
 files from diskette 157
 rows 63, 116–119
 DELETE command 63, 116–119
 directory, diskette 27, 156
 scrolling 32–33, 155–157
 disk drive 6–12, 26, 55
 default 156
 specification 156
 diskette
 backing up 8–11, 28–29
 care and use 6–11, 28, 55
 initializing 7–11, 26
 saving files on 154–157
 dollars and cents format 37, 58, 123
 down-pointing arrow key 13–14, 18
 dynamic memory allocation 46

-E-

edit line 19, 21, 95, 102
 electronic sheet 3–5, 17–21, 38, 95
 clearing 28, 115
 combining sheets 159–160
 memory requirements 44–47
 printing 141–143
 reconfiguring 44–45
 saving on diskette 26–28
 shrinking 47
 entry contents line 22, 94, 120
 entry position 5, 17, 46–47, 95, 146
 adjusting width 106
 formatting (see format, local)
 equipment requirements 6
 erasing files: see delete, files
 from diskette
 ERROR 111, 119, 105
 @ERROR function 62, 80, 111–112
 errors
 arithmetic 106, 114
 erasing 20–21
 exclamation point key (!) 22, 70, 72, 89, 107, 109–110
 @EXP (exponential) function 87, 89, 111
 exponentiation 14, 80
 explicit formats: see formats
 expressions 80, 110

-F-

files 27, 154–159
 deleting 157
 directory of 156
 printing to 143
 VisiCalc file format 27
 file name 26, 62, 156
 fixing titles: (see titles)
 FORMAT command 36, 58–59, 120–123
 formats, file: see files
 formatting a single entry: see
 format, local
 formatting the screen display: see
 global commands
 format
 general 37–38, 58, 76–77, 120–123
 global: see global
 graph 84, 123
 indicator 120
 local (or explicit) 58, 120–123
 replicating 58, 120
 formulas 22–26, 52–53, 78–79, 106–109
 position on the sheet 37–38, 109–110
 replicating 33–37, 51–53, 149
 forward reference, 72, 109
 functions 56–57, 79–89, 110–113
 transcendental 84–89

-G-

general format 58, 76–77, 120–123
 GLOBAL command 37, 43, 58, 76, 90,
 124–129
 global commands
 columns 39–40, 124
 formats 37, 58, 76, 129
 general 58, 76
 integer 37, 58, 76
 in separate windows 42–43
 manual or automatic recalculation
 89, 128
 order of recalculation 70–73, 125–127
 GO TO command 20–21, 101
 graph format 58, 76, 84, 123
 graphing a function 84–88

-H-

hardcopy: see PRINT
 highlight: see cursor

-I-

initializing diskettes 7–11
 INSERT command 63, 130–132
 inserting
 columns 63, 131–132
 rows 63, 130–131

@INT (integer) function 83, 111
 integers 84, 111, 122
 rounding 37, 122
 interest 64–65

-J-

justification left and right 123

-K-

key
 automatic repeat 19, 96
 symbols 13–14
 BREAK 21, 94, 95, 105, 107
 CLEAR 20–21, 95, 96, 105, 107
 keyboard models 13–14

-L-

LABEL ENTRY command 21–24, 102
 labels 22–24
 formatting 58
 repeating 52, 167
 left justify 123
 left-pointing arrow key 14, 18–19, 21–22,
 95, 107
 @LN function 85–86, 89, 111
 loading
 a sheet from diskette 32–33, 47, 154
 Visicalc 12
 local formats: see formats
 @LOG 10 111
 @LOOKUP (table lookup) function 76,
 82–83, 112–113
 logarithm 111

-M-

manual recalculation 128
 @MAX 57, 81, 85, 111
 memory 17, 44–47
 memory indicator 46, 96
 @MIN 57, 81, 85, 111
 MOVE command 66, 133–140
 moving
 columns 136–139
 rows 66, 133–136
 the cursor 18–21, 24–25, 95
 the window: see scrolling
 multiplication 22

-N-

@NA (Not Available) function 62, 80, 111
 naming diskette files: see file name
 @NPV (Net Present Value) function 76,
 81, 111

numbers

- format 76–77
- replicating: see replicating
- scientific notation 77, 105, 124
- significant digits 37, 77, 124
- number sign (#): see pound sign

—O—

- order of precedence 105
- order of recalculation 70–73, 109, 125–127
- over-writing a sheet 154

—P—

- parentheses 79, 105, 110
- passwords 156
- percent 58, 67–68
- @PI function 87–88, 111
- pointing 96
 - in formulas 24–26
 - with replicate 35, 144–153
- pound sign (#) 78, 105, 107–109
- precision 105
- precedence in formulas 105
- PRINT command 73, 141–143
- print file option 143
- printers 6, 141
- printing 141–143
- prompt line 19, 21, 94, 102
- protecting yourself from disaster 27

—Q—

- quit VisiCalc 29, 157
- quote symbol (") 23, 102, 142

—R—

- RAM 44
- range 34–37, 111, 112
 - in functions 80
 - with REPLICATE 144–153
- recalculation 22, 38–39, 70–73, 94, 109
 - automatic 89–90, 128
 - manual 89–90, 128
 - problems with (circular or forward reference) 72, 109–110
- recalculation order indicator 70–71, 94, 109, 125–127
- relative, when using REPLICATE 34–37, 51, 57, 150–153
- REPEATING LABEL command, 52, 167
- REPLICATE command 34–36, 43, 50–55, 144–153
- replicating
 - a column 54–55, 59–60, 146–147
 - a format specification 59
 - a range of entries 34–37, 144–153

a row 59–60, 148

- across a row 59, 144, 148–149
- down a column 54, 56–57, 146
- formulas 33–36, 51–53, 149
- labels 51–52, 144–153
- numbers 51–52
- value references 149
- reversing rows and columns 159
- right-justify 123
- right-pointing arrow key 14, 18–19, 21–22
- ROM 44
- rounding 37, 122
- rows 5, 17, 63
 - deleting 63, 116–119
 - inserting 63, 130–131
 - moving 66, 133–136

—S—

- saving the electronic sheet on diskette 26–28, 55, 67–68, 155–156
- scientific notation 77, 105, 124
- screen
 - flashing 18
 - splitting: see splitting the window
- screen window: see window
- scrolling 95–96
 - the directory 155
 - the window 3, 18, 41–42, 69
- setting up the computer 6
- sheet: see electronic sheet
- SHIFT key 14, 20
- shrinking the electronic sheet 47
- @SIN (sine) function 87–88, 89, 111
- significant digits 37, 58, 105
- source range
 - in REPLICATE 34–37, 144–153
- splitting the window 41, 163–165
 - global command effects 42, 129
 - horizontally 42, 163–164
 - vertically 41–42, 60–61, 165
- @SQRT (square root) function 111
- STORAGE command 26–27, 32, 154–159
- storage diskette: see diskette
- @SUM 56–58, 80, 111
- synchronizing split windows 69, 166

—T—

- @TAN 111
- target range
 - in MOVE 133
 - in REPLICATE 34–37, 144–153
- TITLES command 38, 43, 160
- titles
 - in split window 60–61, 160
 - fixing in both directions 37–38, 55–56, 69, 160
 - fixing horizontally 38, 160

fixing vertically 38
 transcendental functions 84–89, 111–112
 trigonometric functions 111–112
 transposing rows and columns 159
 typeahead 50, 96

-U-

unfixing titles 160
 unsynchronizing split windows: see
 window
 upper/lower case 13, 21
 upward-pointing arrow key 14, 18–19,
 21–22, 95

-V-

value 22–24, 103
 ERROR 62
 VALUE ENTRY command 103–114
 value reference 78, 104, 106–109, 116
 in REPLICATE 144–153

VERSION command 162
 version number 17, 162
 Visicalc
 built-in functions 56–57, 79–84, 104, 110
 equipment requirements 6
 screen 17–21, 95
 Version 17, 162

-W-

window 3, 17, 41–44, 60–62, 69, 95
 scrolling 3, 18, 41–42, 69
 single 41, 62, 166
 splitting horizontally 42, 163–164
 splitting vertically 41–42, 60–61, 165
 synchronizing 69, 166
 titles in 60–61, 160
 unsynchronizing 69, 166
 WINDOW command 41–42, 44, 163–166
 writing on the electronic sheet 21–22

-X, Y, Z-**-INDEX OF SPECIAL CHARACTERS-**

> 19–21, 101, 124
 " 102, 142
 ! 107, 109–110
 # 105, 107–109
 ; 41–42, 164
 @ 105, 110
 & 142



IMPORTANT NOTICE

ALL RADIO SHACK COMPUTER PROGRAMS ARE LICENSED ON AN "AS IS" BASIS WITHOUT WARRANTY.

Radio Shack, Personal Software Inc., or Software Arts shall have no liability or responsibility to customer or any other person or entity with respect to any liability, loss or damage caused or alleged to be caused directly or indirectly by computer equipment or programs sold by Radio Shack, including but not limited to any interruption of service, loss of business or anticipatory profits or consequential damages resulting from the use or operation of such computer or computer programs.

NOTE: Good data processing procedure dictates that the user test the program, run and test sample sets of data, and run the system in parallel with the system previously in use for a period of time adequate to insure that results of operation of the computer or program are satisfactory.

RADIO SHACK SOFTWARE LICENSE

A. Radio Shack grants to CUSTOMER a non-exclusive, paid up license to use on CUSTOMER'S computer the Radio Shack computer software received. Title to the media on which the software is recorded (cassette and/or disk) or stored (ROM) is transferred to the CUSTOMER, but not title to the software.

B. In consideration for this license, CUSTOMER shall not reproduce copies of Radio Shack software except to reproduce the number of copies required for use on CUSTOMER'S computer (if the software allows a back-up copy to be made), and shall include the copyright notice on all copies of software reproduced in whole or in part.

C. CUSTOMER may resell Radio Shack's system and applications software (unmodified form only), provided CUSTOMER has purchased one copy of the software for each one resold. The provisions of this software License (paragraphs A, B and C) shall also be applicable to third parties purchasing such software from CUSTOMER.

RADIO SHACK A DIVISION OF TANDY CORPORATION

**U.S.A.: FORT WORTH, TEXAS 76102
CANADA: BARRIE, ONTARIO L4M 4W5**

TANDY CORPORATION

AUSTRALIA

**280 316 Victoria ROAD
RYDALMERC, N.S.W. 2116**

BELGIUM

**PARC INDUSTRIEL DE NANINNE
5140 NANINNC**

U.K.

**BILSTON ROAD WEDNESBURY
WEST MIDLANDS WSLO 7JN**