

Videogames Hardware Handbook

1977 to 2001

Consoles □ Computers □ Handhelds

From the
creators of
**retro
GAMER**

Over 45
consoles
covered

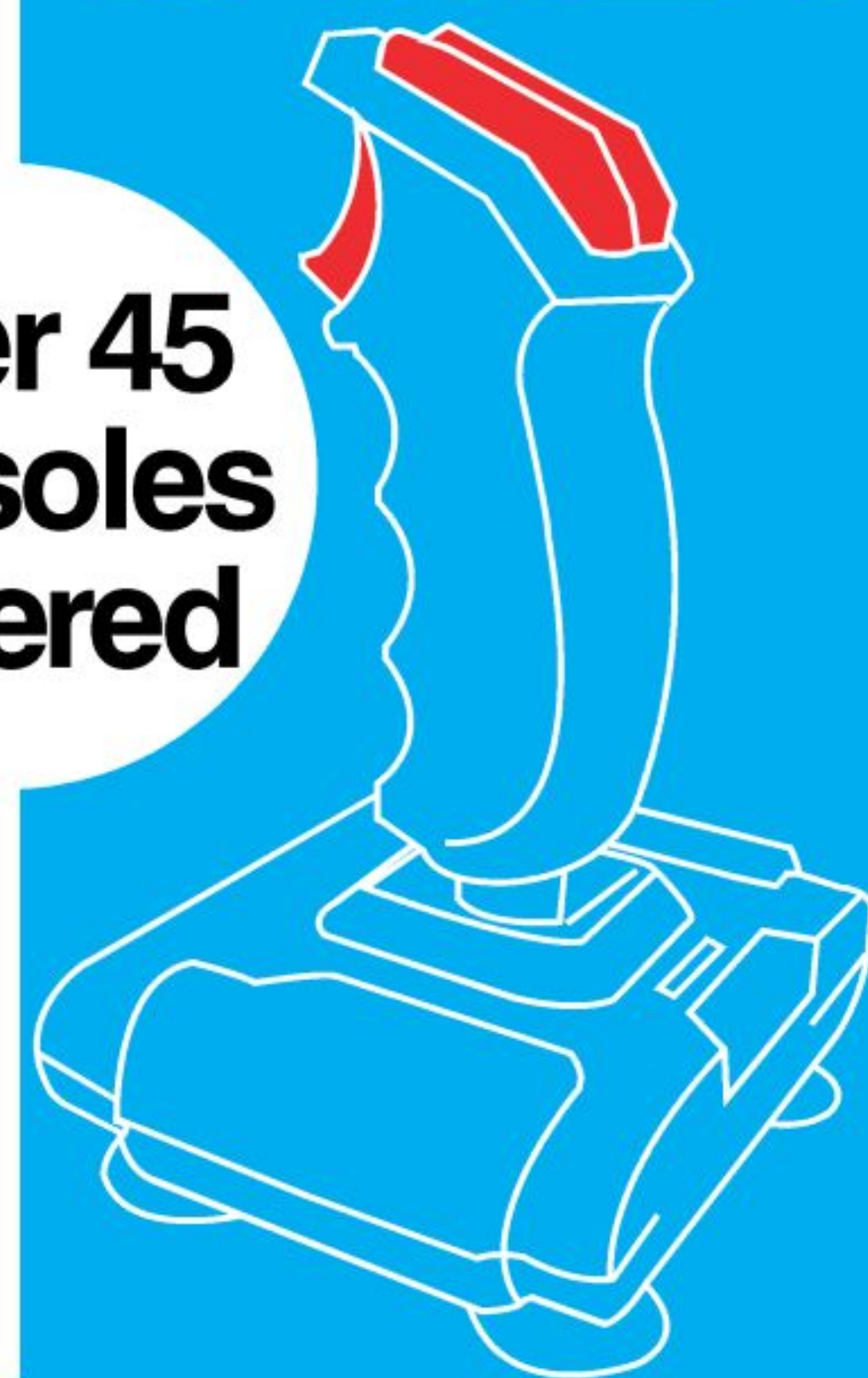

The Games Machine Collector's Manual



MEGA DRIVE



NEO GEO



VIC-20



PLAYSTATION



PC ENGINE GT



MICROVISION



APPLE II



GAMEBOY



ATARI 800XL



SEGA NOMAD



AMSTRAD CPC



RCA STUDIO II



ATARI 7800



AMIGA CD32

260
PAGES OF
HISTORY'S
GREATEST
VIDEOGAME
HARDWARE

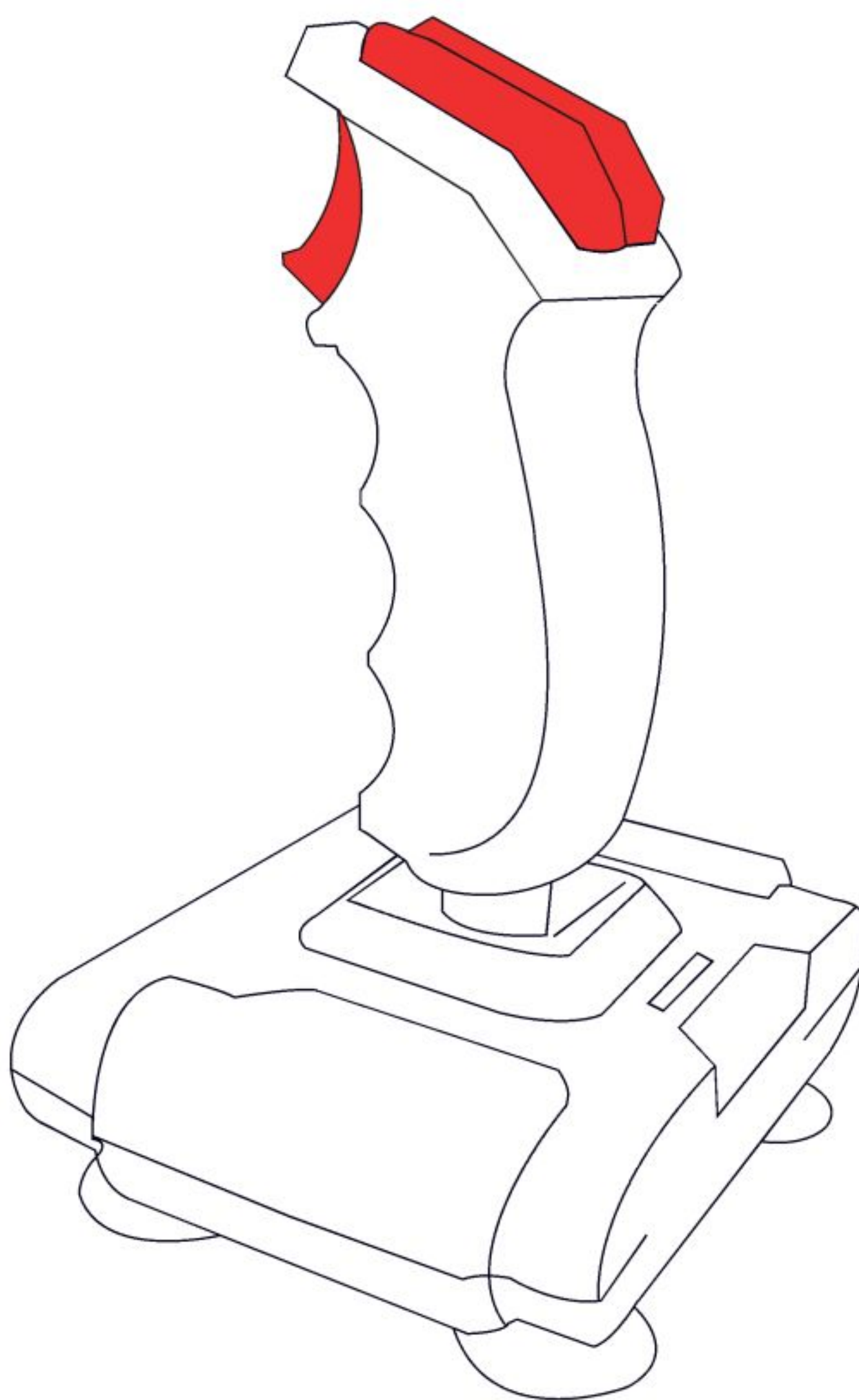

Welcome to

Videogames Hardware Handbook

Technological advancement and great gaming experiences go hand in hand, and this book details the extensive variety of videogame machinery from between 1977 to 1999, from iconic classics that set the standard for consoles to come, to the handhelds that pushed the envelope when it came to portable gaming. This period became an era of children growing up with videogames that would become timeless classics. Explore the science behind these twenty years of entertainment as we take you through the greatest consoles, the revolutionary computers and the most popular portables that dominated the market. As if that wasn't enough, we've included insightful features, from the best British game development has had to offer over the years to the thinking behind creating the best controls for a game. All of this comes together to form the essential companion piece to any videogame enthusiast or budding retro collector. There's something for every type of gamer in this book, whatever your preferences. Enjoy the book.

Videogames Hardware Handbook

Imagine Publishing Ltd
Richmond House
33 Richmond Hill
Bournemouth
Dorset BH2 6EZ

☎ +44 (0) 1202 586200

Website: www.imagine-publishing.co.uk

Twitter: @Books_Imagine

Facebook: www.facebook.com/ImagineBookazines

Publishing Director

Aaron Asadi

Head of Design

Ross Andrews

Production Editor

Alex Hoskins & Jen Neal

Senior Art Editor

Greg Whitaker

Photographer

James Sheppard

Printed by

William Gibbons, 26 Planetary Road, Willenhall, West Midlands, WV13 3XT

Distributed in the UK, Eire & the Rest of the World by

Marketforce, Blue Fin Building, 110 Southwark Street, London, SE1 0SU
Tel 0203 148 3300, www.marketforce.co.uk

Distributed in Australia by

Network Services (a division of Bauer Media Group), Level 21 Civic Tower, 66-68 Goulburn Street,
Sydney, New South Wales 2000, Australia, Tel +61 2 8667 5288

Disclaimer

The publisher cannot accept responsibility for any unsolicited material lost or damaged in the post. All text and layout is the copyright of Imagine Publishing Ltd. Nothing in this bookazine may be reproduced in whole or part without the written permission of the publisher. All copyrights are recognised and used specifically for the purpose of criticism and review. Although the bookazine has endeavoured to ensure all information is correct at time of print, prices and availability may change. This bookazine is fully independent and not affiliated in any way with the companies mentioned herein.

Videogames Hardware Handbook Volume 2 Revised Edition © 2015 Imagine Publishing Ltd

ISBN 9781785460685

Part of the

**retro
GAMER**

bookazine series



Videogames Hardware Handbook

The Games Machine Collector's Manual



CONTENTS

Over 20 years of classic machines.

CONSOLES

Mega Drive	18
PlayStation	46
Colecovision	96
Atari 5200	128
Amiga CD32	166
Neo Geo AES	182
RCA Studio II	198
Amstrad GX4000	212
Famicom Disk System	224
Atari 7800	230
Sega 32X	242

COMPUTERS

Amstrad CPC	06
VIC-20	26
Amiga 500	54
Oric-1	70
Spectrum 128	88
Apple II	108
Amstrad CPC 6128	136
Atari 800 XL	148
Sinclair QL	178
Sam Coupe	192
Acorn Archimedes	218
Sinclair ZX80	238
Acorn Electron	248

HANDHELDS

Pokemon Mini	14
PC Engine GT	34
Tiger game.com	64
Microvision	78
Game Boy	116
MB Simon	120
Gamate	144

GENERAL

Best Of British	42
Finaru Furantier	84
Controlling History	156
History In Your Hands	204



PlayStation



RCA Studio II

THE VERY BEST RETRO HARDWARE



Mega Drive



Atari 7800



Game Boy



Amstrad CPC 464



Colecovision





AMSTRAD CPC



AMSTRAD CPC



30 years.
3 million sales.
There is no doubt
the CPC range of
computers was
a success for
Amstrad, even if
it trailed behind
its competitors.
We take a look
back at why we
should learn to
love Lord Sugar's
plucky little
underdog

These days, a new product is a failure unless it attracts a queue around the block a week before it arrives

in the shops. It is common to see bedraggled shoppers wrapped up in sleeping bags, carriers filled with nibbles and anxious fingers drumming on warm cups of takeaway coffee.

It would be nice to say the same happened for the Amstrad CPC 464. It didn't – or it certainly didn't to the same degree. Some 60 shoppers waited outside retailer Rumbelows in London's Edgware Square for an hour when the 464 launched on 21 June 1984, although they "rushed forward" when the doors opened at 9.30am, according to *Amstrad CPC 464 User* magazine. By 10.30am 100 computers had been sold, but that kind of thing was deemed a success.

After all, this was only the beginning and similar stories were being told up and down the country. In competing on convenience (Amstrad made much noise about having a green screen or colour monitor bundled in the same package as the keyboard/computer)

and price (the 464 cost as little as £239, the price dropping to £199 months later), the CPC became, what the London *Evening Standard* had called the "People's computer", a machine that consumers were willing to hire rather than fire. By the end of 1984, 200,000 units had been sold.

But the story started in 1983 when Sugar – or Lord Sugar as he is known today – was in rather bullish mood, buoyed by considerable sales of his range of hi-fis. These all-in-one units did away with having to buy separate record players, tape decks and radio receivers and it was this allied with the Apple II clones that Amstrad was repeatedly offered for rebadging on its purchasing trips to the Far East that got the London entrepreneur's brain whirring. Lord Sugar felt there was a gap in the market that he could fill.

"So many computers were being aimed at people in technology but the market for the CPC was the lorry driver and his mate," says former group technical manager Roland Perry. "The idea was that the CPC should be a complete ready-to- ▶





AMSTRAD CPC

LORD ALAN SUGAR

Lord Alan Sugar is not known for his forgiving, sentimental nature but, exactly 30 years after he launched the CPC 464, he took to Twitter to profess: "11 Apr 1984 was a proud day for me". It led to a number of fellow users pointing out that Amstrad is no more today but Lord Sugar hit back. "Many asking 'Where is Amstrad now?'" he wrote. "I sold Amstrad to Sky for £125m in 2007". We briefly caught up with him about the time in between

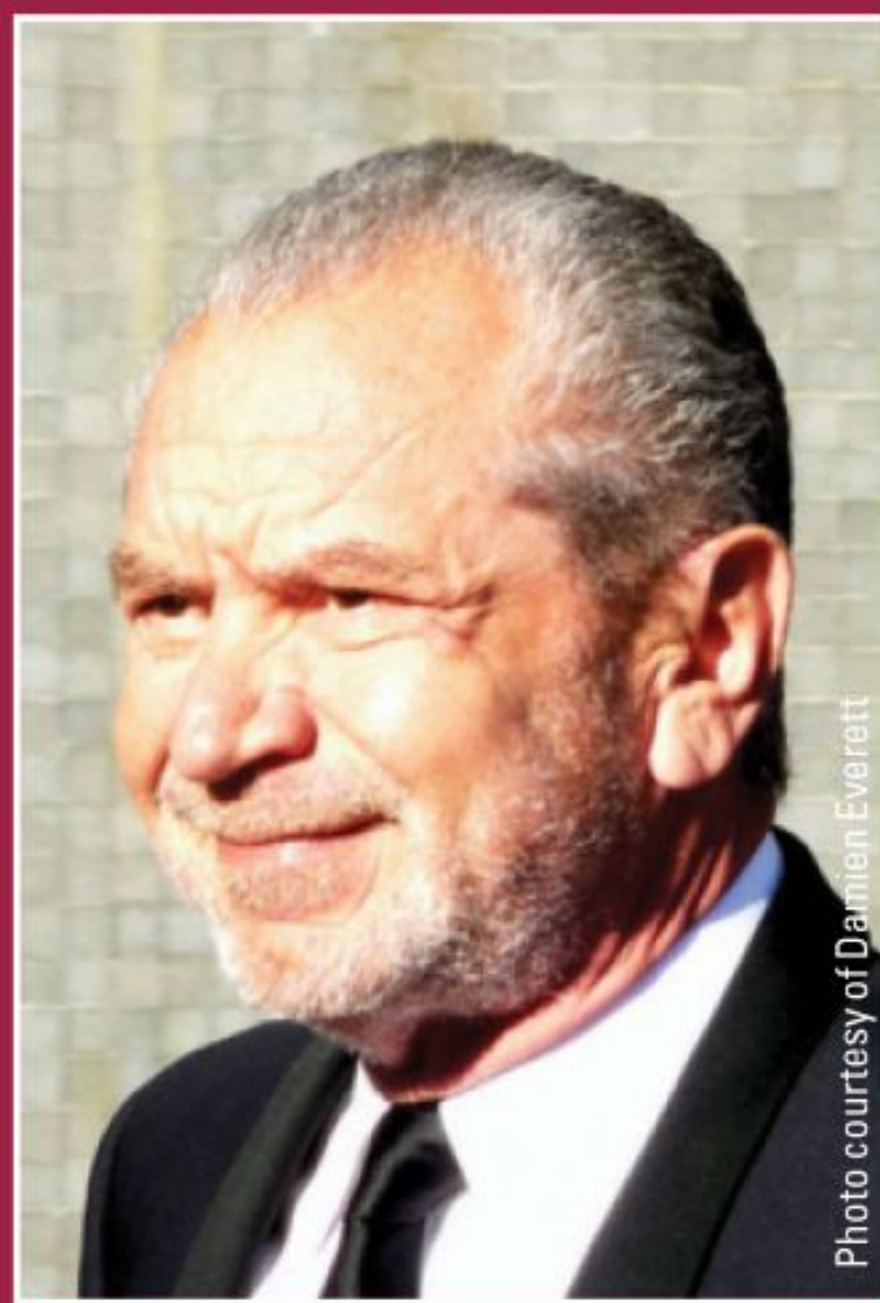

Photo courtesy of Damien Everett

Why did you decide to enter the home computer market?

I spotted that this was a massive growth market and it had suppliers that tried to make it sound like they were offering something special where hardware was concerned. They weren't. We took what we knew in consumer electronics and recognised that we could make them easily and add features and value to make the unit look like a computer and not a pregnant calculator.

Did you have a strong idea about what you wanted the computer to be?

A value-for-money unit that offered a fully integrated system of monitor and data recorder so that you didn't have to plug it into a television.

Was it important for the Amstrad CPC 464 to be an all-rounder?

We made the computer look like a computer and that is what the consumer warmed to as it was

not only a good product but it showed true value for money and [consumer's felt] they were buying a real good lump of hardware.

Were you surprised at its take-up, especially in France?

The computer took off well in France as it was a serious looking machine. It became one of our biggest markets.

Why did you buy Sinclair?

We bought Sinclair for its name but also to transform the unit with an integrated data recorder and to make it a proper computer. That's why we sold millions of them and followed on in other markets with the Sinclair success of branding. It allowed Amstrad to move on to more serious computing.

30 years on and people are still writing games for the CPC – did you ever expect that?

It is absolutely fascinating to see that the CPC still has a following 30 years on.

» Amstrad snapped up Sinclair, thereby swallowing its closest British rival – angering Speccy fans in the process.

» A big thanks to www.consolepassion.co.uk for kindly lending us a machine for hardware shots. Thanks guys.



► go machine; that you shouldn't have to roll around the floor plugging and unplugging things."

With this in mind, the CPC team aimed for simplicity. Lord Sugar had no experience of making computers so he assembled a team that could. Key players were Roland and his childhood friend, William Poel, both of whom were interested in computing and had lots of electronics experience. They took inspiration from the ZX Spectrum and C64, pitching a machine into the same bracket with similar specifications, and by the end of 1983 a prototype was ready.

"We had a prototype at Insight Software in St Helens," says programmer Paul Hughes. "It was pretty much of the final form factor when we got it, bar some bits Dremeled out where the mouldings didn't quite fit. If I remember correctly, there were some extra

components and wires soldered on to the PCB to fix teething problems before final manufacture but, all in all, it was pretty much there."

The CPC 464 was unveiled in Westminster School, London, on 10 and 11 April. It had an integrated tape deck and 64K of RAM, expandable to 512K – dK'Tronics sold memory packs but no games took advantage. It allowed for 27 colours in three different resolutions: 160x200 with the use of 16 colours on the screen at once, 320x200 with four colours and 640x200 with two colours (more commonly known as modes 0, 1 and 2). It ran with a 4MHz Z80 processor (in line with the Spectrum) running at 3.3MHz due to tech restrictions created to avoid display snowing. It had an AY-3-8912 sound chip that was nowhere near as good as the celebrated SID chip of the Commodore 64, but



» Like other 8-bit computers, it was possible to add a number of useful peripherals to the CPC.



» As you may have guessed, this is actually a Spanish CPC 464, giving a good indication of the machine's global reach.

“ The CPC also came with a welcome tape which I wrote with my fair hands ”

Roland Perry

headphones could be plugged in for stereo sound. There were colourful keys on the dark grey keyboard. The CPC would output PAL-frequency analogue RGB to the boxy, 14-inch monitor via a 6-pin DIN connector. The monitor also contained the power supply. Later, a bundled TV receiver peripheral was released that allowed the monitor to tune into analogue television signals. “The CPC also came with a welcome tape which I wrote with my fair hands,” recalls Roland. “You’d insert that, press Play and it would load and you’d see whizzy rays of sun. It looked like it was doing something straight away.”

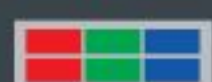

Software was important for Amstrad, the company figuring that the CPC needed a good range of readily available titles from day one. The CPC 464 came with 12 titles that the company claimed was worth more than £100. They included *Roland In The Caves* and *Roland On The Ropes* – two titles from a series named after Roland Perry – as well as *Bridge-It*, *Oh Mummy*, *Harrier Attack*, *The Galactic Plague*,

Sultan’s Maze, *Fruit Machine* and *Xanagrams*. It also came with the word processor, *Easi-Amword*. “We distributed between 40 and 50 prototypes to developers and they busily converted Spectrum and C64 games,” continues Roland. Amstrad founded a publisher called Amsoft to sell titles for the CPC 464 and it helped stoke the fires of competition. Indeed, when Acorn took out ads that quoted reports about the unreliability of Spectrums, much to Sir Clive Sinclair’s ire, Amsoft commissioned a game called *Business Is War* to parody the fight between the two. Programmer Marcus Altman of Alligata had a disaster and lost the source code so it was never released but lots of other games were. “One of the objectives was to launch the computer with 50 games available,” says Roland. “You couldn’t just launch a computer and say there would be lots of games along for it real soon – you had to produce the whole package.”

Spectrum ports were not to everyone’s taste, though. Games converted directly from Sinclair’s machines to the Amstrad were often slower and had fewer colours.



The similarity between the two machines was one of the reasons why developers ported but time and cost were the overriding factors. Porting marred games such as *Strider*, *Hard Drivin’* and *Vendetta*, but without it such games may never have seen the light of day on the Amstrad. The CPC was the subservient machine in terms of sales in the UK and it wasn’t always easy to produce Amstrad versions. “I found creating loading screens on the Amstrad a bit harder than making something on the Speccy,” says graphic artist Mark Jones who produced the Mag Max loading screen for the CPC. “Not only did I have to work in colour, which I hadn’t done before, I had about three days to do it. Simon Butler gave me a crash course on anti-aliasing, where you put colour between two touching colours to make the lines less jagged, and away I went. You never had to anti-alias with the Speccy.” It was notable that in Spain and France where the Amstrad dominated, porting was far less common. ▶



» Roland Perry was the technical guru brought in to work on the CPC 464. He worked on all of the other CPCs too.

KEY EXCLUSIVES

Five fantastic games that helped define the CPC range



SORCERY+

PUBLISHER: Virgin/Amsoft

GENRE: Arcade adventure

RELEASED: 1985

■ *Sorcery* was good; *Sorcery+* was better. In adding new screens and developing an extra chapter, Virgin put together a gripping, smooth and addictive disk-only sorcerer adventure that beat the original in every way possible. It combined the CPC’s low-res Mode 0 with a higher-res Mode 1 making for absolutely perfect presentation.



GET DEXTER

PUBLISHER: ERE Informatique

GENRE: Graphic adventure

RELEASED: 1986

■ Made in France, the CPC’s primary market – and where this game was known as *Crafton & Xunk* – *Get Dexter* was an isometric, puzzle-solving adventure exclusive to the CPC for around a year. Well-loved, its intricate nature stood it out: destroy a robot, for example, and it exploded with a splash, making the floor mightily slippery for poor Dexter.

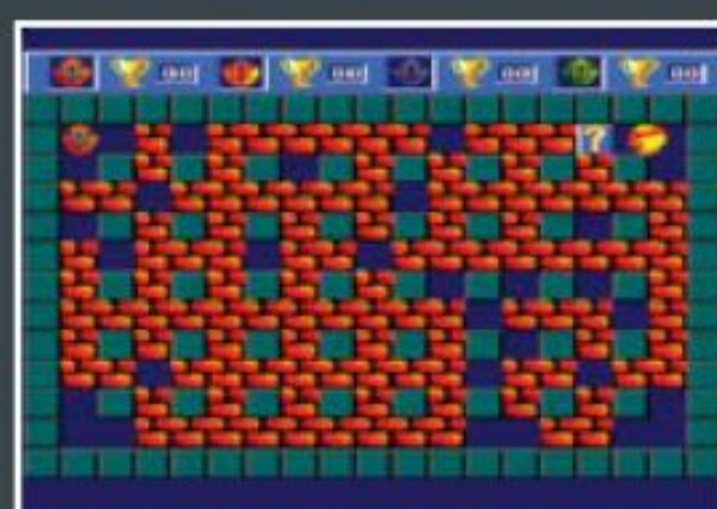

MEGA BLASTERS

PUBLISHER: Radical Software

GENRE: Action

RELEASED: 1988

■ Sold towards the end of the CPC’s life via mail order, *Mega Blasters* – a clone of *Super Bomberman* – became so highly regarded, it was named the best Amstrad game of all time by members of the CPC Wiki. It’s a mega game in every sense, it was spread over 90 levels and it took in 11 worlds. Given it took up 900K of data, it was disk-only.



BURNIN’ RUBBER

PUBLISHER: Ocean Software

GENRE: Driving RELEASED: 1990

■ Amstrad needed a title that could be bundled with the GX4000 and Plus range of computers and it found it in *Burnin’ Rubber*. Graphically head-turning but sonically ear bending, it was made by Ocean. The dev team seemed to unleash its creativity to produce the best-looking Amstrad game at the time. It boasted subtle shading and had a distinct 16-bit feel.

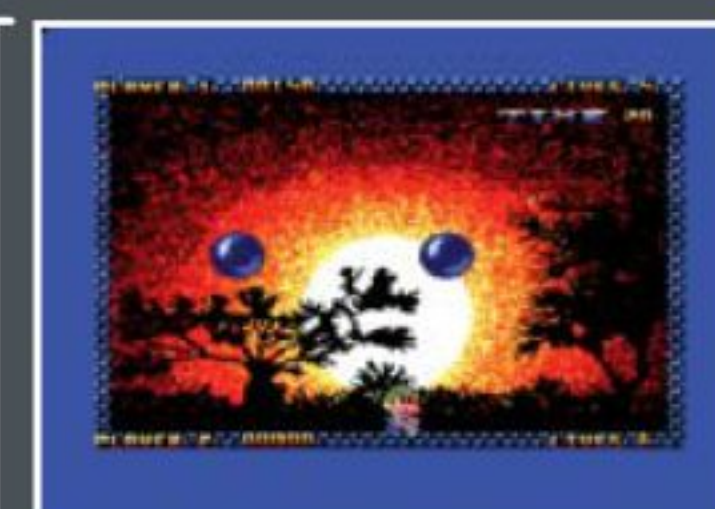

ZAP’T’BALLS

PUBLISHER: Elmsoft

GENRE: Arcade RELEASED: 1992

■ *Pang* was released solely on cartridge when the ball-popping game finally surfaced on the Amstrad so Elmsoft stepped forward with a CPC version that looked anything but normal. With experience in the boundary-pushing demo scene, Elmar Krieger gave the game a graphical flourish, yet the gameplay was criticised in the UK – much to the annoyance of European CPCers.



» The built-in tape deck proved so popular for Amstrad that it did exactly the same thing when it released the ZX Spectrum +2.

► Amstrad did try and encourage original games, though. Lord Sugar invited the top software publishers to his offices in Brentwood, Essex. He took them to a warehouse where he showed them the CPC 464 hoping to persuade them to develop but although many were impressed, even by March 1985, games for the CPC were hard to come by, making Amsoft even more crucial. One of those in attendance at that meeting was Geoff Brown, founder of US Gold. "I had never met Alan Sugar before then but I had heard about his blunt speaking reputation," he says. "It was obvious he knew nothing about computers, except selling them, and nothing about the games industry or its game fans." Geoff told Lord Sugar about the coin-op conversion of *OutRun* which had zoomed to the top of the charts for other formats. He told the Amstrad boss he would go back to Sega and

“ I had never met Alan Sugar before then but I had heard about his blunt reputation ”

Geoff Brown

ask for extra permission to port the game to the CPC 464. "He snarled back, 'bloody driving game; we can easily get one of those written, no problem'," says Geoff. "He told me he didn't need coin-op conversions or licences." The big games did eventually come in droves, though. Indeed, *OutRun* became one of the biggest successes on the Amstrad in 1987. Sadly, it was an awful conversion with a slow pace and ugly sound effects.

By this time, the CPC had evolved into a small family. The CPC 664 was

identical to the 464 except it came with a disc drive instead of tape (and was incredibly ugly with light blue keys). It was ditched within months to make way for the 128K CPC 6128. Other than the extra memory and the disk drive, it retained the core of the 464's tech complete with monitor and it retailed for £299 (green screen) and £399 (colour). It also had a tape port so that a cassette deck could be plugged in. Gamers could enjoy the likes of *Doors Of Doom*, *Hunchback I and II*, *Roland In Time*, *Nomad*, *Supertest - Day 1*

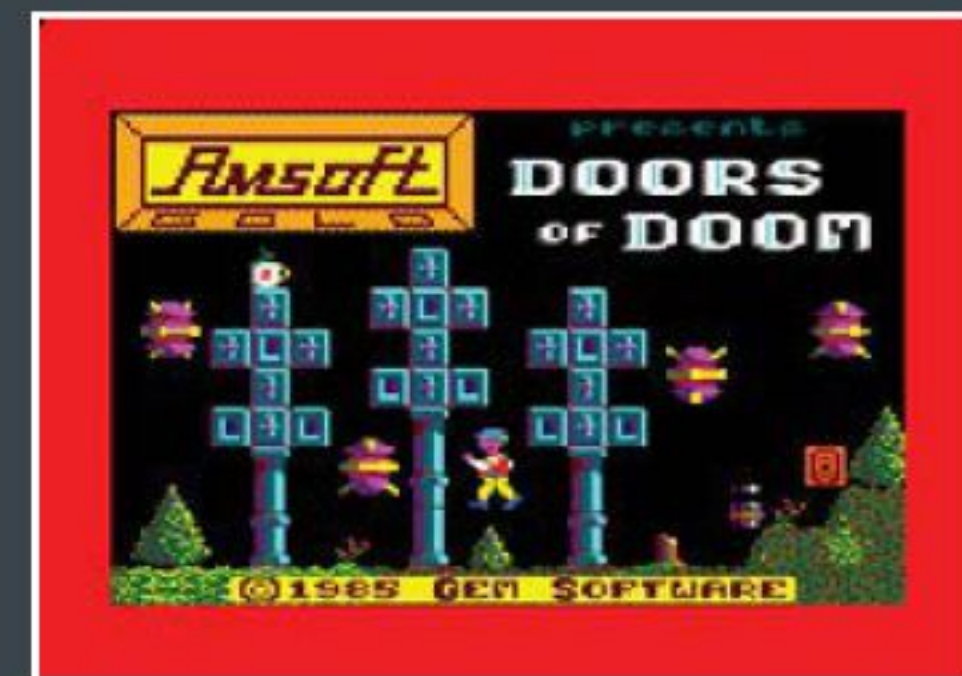

» [Amstrad CPC] Amsoft's *Doors Of Doom* was a decent platform-style game that proved to be rather difficult going.



» [Amstrad CPC] With big name backing, games like *Space Gun* showed the capabilities of the Amstrad CPC.

and *Day 2*, *Quabbalah*, *Tubaruba*, *World Series Baseball*, *Monopoly*, *Cluedo*, *Scalextric*, *Scrabble* and *Trivial Pursuit*, a rather solid selection of games that proved to be a reasonably good introduction to the CPC.

Both the 464 and 6128 proved to be an eventual hit for software developers. Ocean Software's David Ward said the Amstrad user base was newer and more active than those of other machines. "They buy more software," he said. Most games were released on both tape and disc in the UK but in France discs were more popular so many of their releases did not get an airing on tape and they tended to be 128K-only.

There was a feeling at times that the CPC was a money-making machine first and foremost, though. Lord Sugar was never interested in producing a cutting edge computer ("It doesn't put money in the bank," he told *Amstrad Action*) and he wasn't particularly interested in market share even though, by 1985, the Amstrad CPC had 25 per cent of the market ("I could have 100 per cent of the market in thimble holders but it wouldn't make me any money, would it?" he said). Neither, it seems, was Lord Sugar all that interested in powering up the blue



CPC 6128

■ A slimmer and more stylish computer than the 664, the 6128 doubled the memory and removed the colourful keys, making for a more serious-looking offering. "It's definitely not a Mickey Mouse machine," Lord Sugar said at the time. It became the computer of choice in France with some great, disc-only exclusives being made.

THE CPC RANGE



CPC 464

■ From the early white prototypes came the dark grey 464. Boasting a Z80A processor, 64K RAM, 27 colours, three screen modes ranging from 160x200 to 640x200 and support for up to two joysticks, buyers had a choice of colour or green monitor. And gamers cried if their parents got the latter.



CPC 664

■ The 664 was an ugly, 3-inch disc drive version of its cassette-based sister with some lurid blue keys and the same 64K of memory. It remained on the shelves for just five months and sold 10,000 units. But it introduced AMSDOS and came with CP/M 2.2, and it allowed games to run faster.

Photo courtesy of Bill Bertram

screen himself. Roland says Lord Sugar did not have a 464 on his desk but that he never expected him to. "Does the MD of a bicycle factory have to ride a bike to work?" Roland asks. "He can afford a Jaguar with a chauffeur. Alan was not the target market for the computer and he was building machines for other people, not himself."

But for those who used the machine, it opened up creative possibilities thanks to Amstrad wanting to have as open a system as possible. "We wanted people to use the machine and not feel that what was happening inside it was mysterious," says Roland. It worked well. "The CPC sat nicely in the midst of the computers that came out in the Eighties," says developer Philip Oliver. "It was cheaper and more accessible than a BBC Micro, with a better keyboard and graphics than a Spectrum. It was more British (and better) than the Commodore 64. We used the CPC to develop *Super Robin Hood* and we led on the CPC for all our games after that." To foster loyalty to the CPC and lend a helping hand, Amstrad formed an Amstrad User Club. It included a subscription to *Amstrad Computer User* magazine, which encouraged people to program ("We pay well," said an editorial in issue 10). "We



» Rod Lawton was *Amstrad Action's* longest serving editor from December 1989 to February 1993.

paid a lot of attention to making a computer that people could program themselves," said Roland. "The manual wasn't just about telling you where to plug things – it had a lot of stuff about Locomotive BASIC and it had tutorials. Programming was important to us."



The main independent publication, *Amstrad Action*, was also instrumental in building support but former editor Rod Lawton was acutely aware that the CPC was often given a rough ride. "We got on pretty well with the Spectrum community, even though we thought the computers (and the users) were a bit weird," he says. "It seemed all right for geeks and home programmers, but we thought the CPC was more of a finished product. The C64 was a different kettle of fish. It was an American import, it was used by gaming fans who thought they were a cut above the rest of the 8-bit

community, and we kept our distance. They were like, 'yeah, obviously, the C64 is much better for games,' and we were like, 'yeah, whatever'."

By 1990, six years after the CPC 464 had launched and five years after the 6128, Amstrad took the range in a new direction. Noticing the console market was growing, it redesigned the casing of the two machines and added a cartridge slot. The computers were relaunched as the 464 Plus and the 6128 Plus and there was a standalone console called the GX4000 that was styled like a spaceship. Suddenly, Amstrad wanted something more cutting edge – except it failed to deliver.

"All kinds of people were trying to adapt their general purpose computer designs to compete with games consoles so we tried the same," says Roland. "I think, in hindsight, that the only thing to do was design a console from scratch

and not try to bolt functionality to what we had."

The computers ran into problems straight away. A handful of existing games were not compatible which deterred a few potential upgraders. The 6128 Plus did not have a cassette deck port. But the instant loading cartridge slot, the 4,096-colour palette and the 16 hardware sprites, hardware scrolling, programmable interrupts and DMA for the AY soundchip certainly pushed the new CPCs closer to the Atari ST and Amiga. The bundled game, *Burnin' Rubber*, looked delicious.

It wasn't enough. Poor sales of the computers and the console – which was being discounted by £30 within six months – ensured there were too few games (and those that were released tended to be ports). The CPC was no more and Amstrad moved on. Developers found a way of harnessing the Plus capabilities with disc and tape-based games which ensured buyers hadn't wasted their money (benefiting from *Space Gun*, *Fluff* and *Prehistorik 2* among others) but it was clear the 8-bit era had come to a close.

During the Eighties, though, the CPC had become France's best-selling computer. The range had swallowed up 50 per cent of the market, selling 650,000 machines. In total, the CPC sold 3 million across the world and while that was fewer than the 17 million C64s and 5 million Spectrums, it was enough to ensure it was the third 8-bit machine and enough to declare it a resounding success.



» The colours were garish, but having a built-in tape deck was extremely useful. It was surprisingly handy as well.



464 PLUS

■ In 1990, Amstrad replaced the CPC range with the restyled Plus machines. The 464 Plus looked Amiga-esque and it had a slot for cartridge games as well as a tape deck. It came with a game controller paddle, the game *Burnin' Rubber* and a monitor. The Plus features allowed the use of a palette of 4,096 colours.



6128 PLUS

■ Like the 464 Plus, the 6128 Plus was basically the old CPC 6128 in a new style with a cartridge slot. The extra capabilities were supposed to be for cartridge games only but programmers were able to get around that. The 6128 Plus did not have a tape deck port, which persuaded a fair few against upgrading.



GX4000

■ Amstrad's 8-bit console had a Z80A processor running at 4MHz – identical to the CPC – but it had a Direct Memory Access controller so music could be played without burdening the processor. With 18 hardware sprites, 4,096 colours (32 displayable at once) and smooth scrolling, it would have been a hit – five years earlier.



CPC 472

■ It claimed to have 72K of RAM but it only allowed 64K to be accessed and it was designed to get around Spanish import tax laws. It said the extra memory supported BASIC. It didn't. The 474 did include the CPC 664 ROM with Locomotive BASIC 1.1, though. And Spanish keyboard versions added a statutory 'tilde' key.

Photo courtesy of Evan Amos



POKEMON MINI

POKÉMON MINI



Put aside your preconceptions for a second. Though each of its games featured the love-or-hate-them Pokémon, Nintendo's Pokémon Mini handheld has as much right to appear within these pages as any other system, as we explain

Rleased in 2001 and based around a brand very much aimed at today's children, the Pokémon Mini is a gaming system that arguably has no business appearing within the pages of *Retro Gamer*. But take a second look at this obscure part of Nintendo history and you might be surprised by how interesting, and how retro, it actually is.

The first and most important point to make about the Pokémon Mini is that it isn't a virtual pet device, it isn't a pedometer and it isn't a Game & Watch-style system with only one game built in. Such assumptions are understandable given the wide range of such Pokémon-branded items that have been released to date, but the Mini is actually a fully fledged handheld gaming system, just like a Game Boy. It uses interchangeable cartridges and plays simple dot matrix, monochrome games that have more in common with the technology of 1989 than 2001.

The great contradiction of the Pokémon Mini is that although it plays very simple videogames that use even simpler visuals, the interactive capabilities of the hardware did things the Game Boy Advance (released in the same year) could only dream of and were surely part of Nintendo's momentum toward the eventual creation of the DS and Wii. Hardware features include an internal real-time clock, an infra-red transmitter for multiplayer gaming and data transfer with up to five other players at once, in-built vibration for force feedback and a shock detector for very rudimentary motion control. All of which are crammed into a tiny 74mm x 58mm x 23mm casing, the smallest handheld ever to be produced by Nintendo.

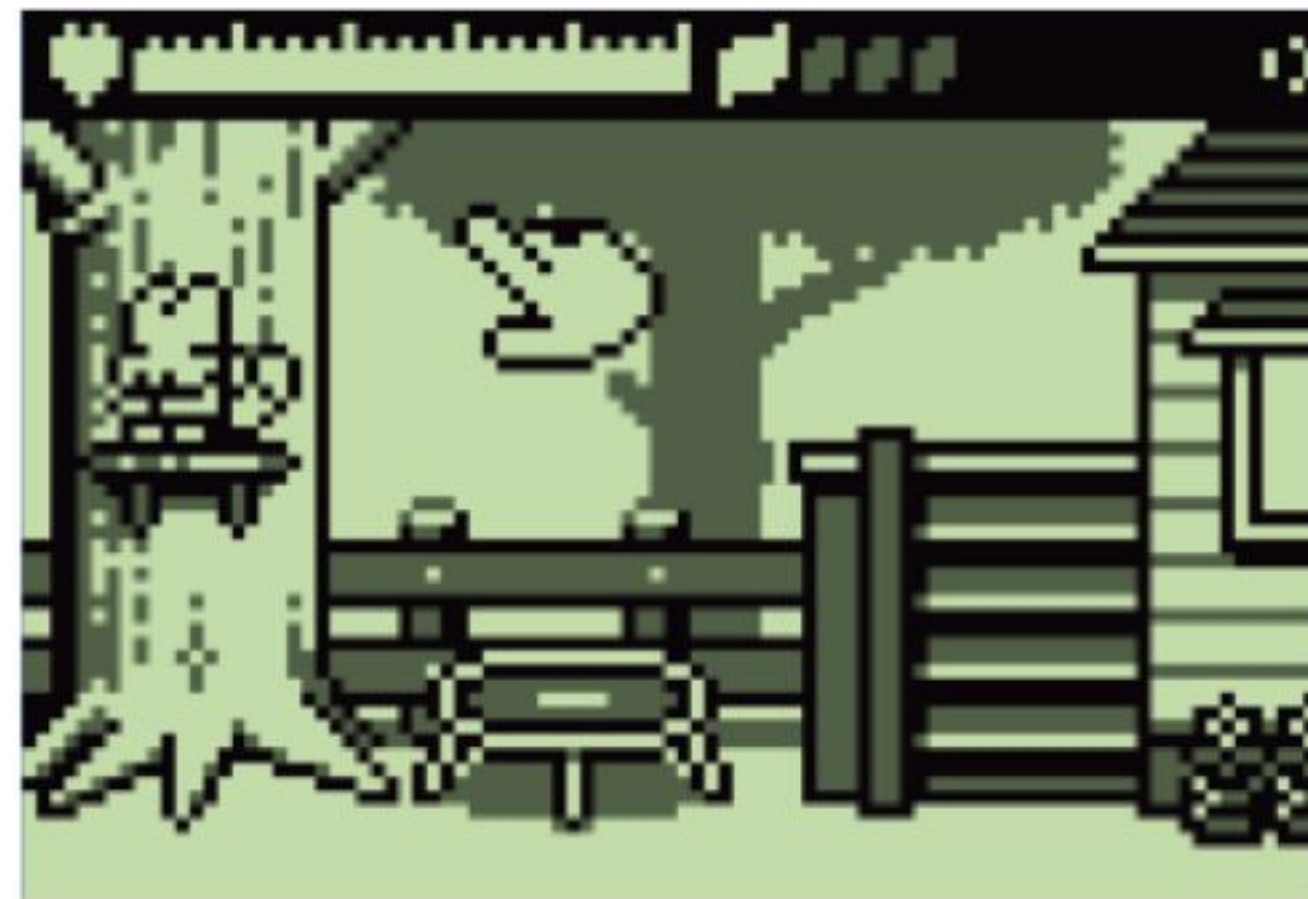

“The interactive capabilities of the hardware did things the GBA could only dream of”



» Sadly, this isn't a fully playable version of *Elite*. It's just a demo mock-up.

» *Pokémon Breeder* is one of the highlights of the limited Pokémon Mini library.

So why is the Pokémon Mini so undocumented? Undoubtedly it's because of the association with the Pokémon brand. Every single one of the ten commercial games released for the system used the Pokémon licence, positioning the handheld as more of a kids' toy than a hardcore gaming system. The Mini was only ever sold in toy stores rather than dedicated game shops and although the price tag of £40 was attractive for a new console, £20 per cartridge was very steep for games that offered only a fraction of the entertainment available on other systems of the time. And with the GBA and cheaper Game Boy Color both offering their own fair share of Pokémon fun in addition to a wide range of other games, it's easy to see why even parents would think twice about buying a Mini for their children.

Following its 14 November 2001 release in the US, the Pokémon Mini made its way to Japan and Europe and enjoyed a regular stream of games – about one per month – until its final release *Pokémon Breeder* exclusively hit Japanese shelves in December 2002. The one-year shelf life is about twice the lifespan of Nintendo's highest-profile failure, the Virtual Boy, but with about half the number of commercial games released, the Pokémon Mini can easily be considered Nintendo's least relevant games console and would have slipped into total obscurity were it not for a strange twist of fate spurred on by a quirky feature in one of Nintendo's GameCube games.

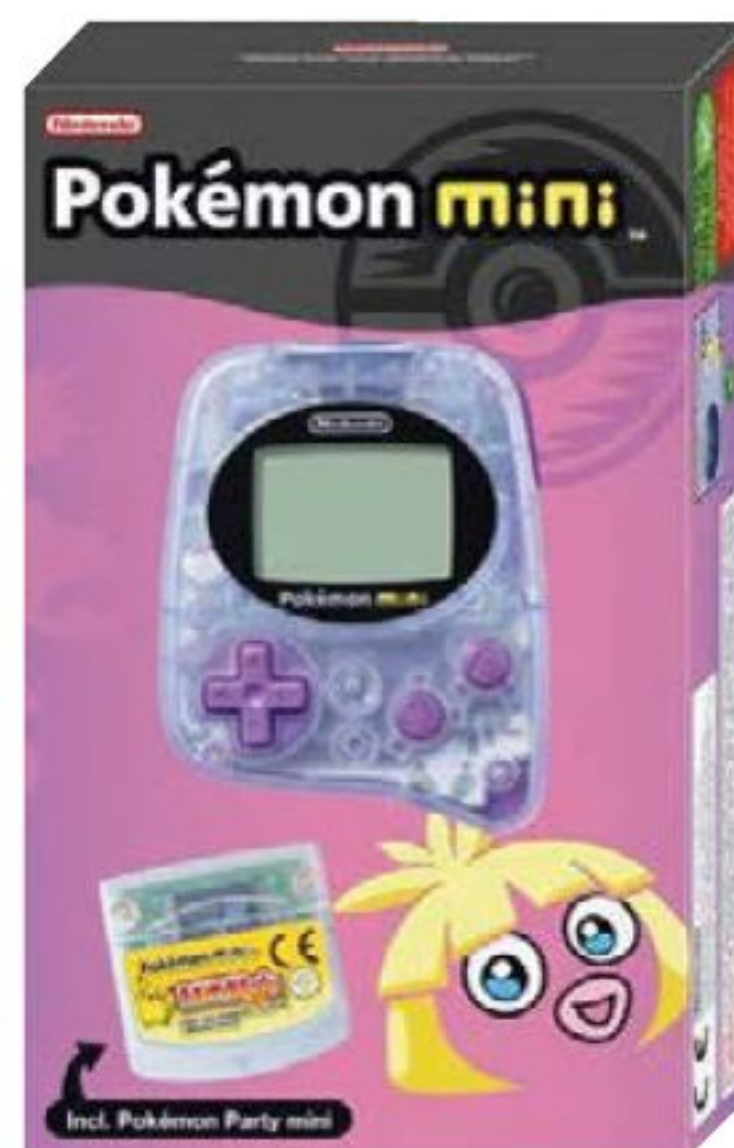

» The Pokémon Mini was released in a number of colour variations, each named after a different Pokémon.

2003's *Pokémon Channel* was a relatively forgettable virtual pet game for GameCube, except for the fact that it included a simulated software version of the Pokémon Mini, complete with demos of some games as well as a full exclusive game of its own, called *Snorlax's Lunchtime*. This official emulator was instrumental in helping a handful of Pokémon Mini enthusiasts reverse engineer the handheld, develop an emulator of their own and begin to produce their own tech demos and homebrew games. And it is these dedicated few who are best equipped to tell us about the inner workings of the Mini and how it might have developed had Nintendo offered more support.

Detlef Hastik is founder of Team Pokémé, a demo group that spent a year developing their debut Mini production, a homebrew cart tech demo called SHIZZLE that shows off a number of gobsmacking visual techniques previously thought impossible on the hardware, including high-res title screens, 3D text, multiple layered sprites, fractal landscapes, shading, light sourcing, reflective spherical surfaces, sprite rotation and scaling, blocky *Starfox*-style 3D environments and even digitised video.

“When I discovered the Pokémon Mini in a sale-out box of a local games store in 2004, I first thought ‘eek! Pokémon! What crap,’” says Hastik. “But the price of just five euros made me look a

» Some of the games are quite valuable. The Euro release of *Shock Tetris* proving particularly rare.





POKEMON MINI

(TM) PERFECT TEN

Only ten commercial games were ever released for the Pokémon Mini. But which, if any, were worth playing?

01 Pichu Bros. Mini

DEVELOPER: DENYUSHA

Mini-game collections were in abundance on Pokémon Mini... as much as you can have an abundance on a system with just ten games. This one stars Pichu, the cutesy pre-evolved version of Pikachu, in a series of small challenges including a nice little skateboarding sim.



02 Pokémon Pinball Mini

DEVELOPER: JUPITER

Pokémon Pinball on Game Boy Color is one of the greatest videogame pinballs ever created. Pokémon Pinball Mini, sadly, is not. You simply control a Diglett who's used like a bumper to launch the ball toward a number of hole targets. It's nothing like pinball at all.



03 Pokémon Breeder Mini

DEVELOPER: JUPITER

The last game to be released for Pokémon Mini is also one of the best. It enables you to raise one of three pocket monsters in a nice little virtual pet game that's big on physical interaction with the 'mon and features some nice interactive environments.



04 Pokémon Party Mini

DEVELOPER: DENYUSHA

Pokémon Party came bundled with the Mini and is a mini-game collection. Of the eight games on the cartridge, the best are Slowking's Judge, a tennis game where you have to declare if a ball lands in or out and Bellossom's Dance, a very simple Simon Says dancing game.



05 Pokémon Puzzle Collection

DEVELOPER: JUPITER

A collection of jigsaw and maze-style puzzles, completion of which fills up a "Mini Pokédex" directory of monsters. Finish that and you unlock a bonus puzzle called Power On, a nice little Pipe Mania clone where you arrange a circuit to connect Pikachu to a lightbulb.

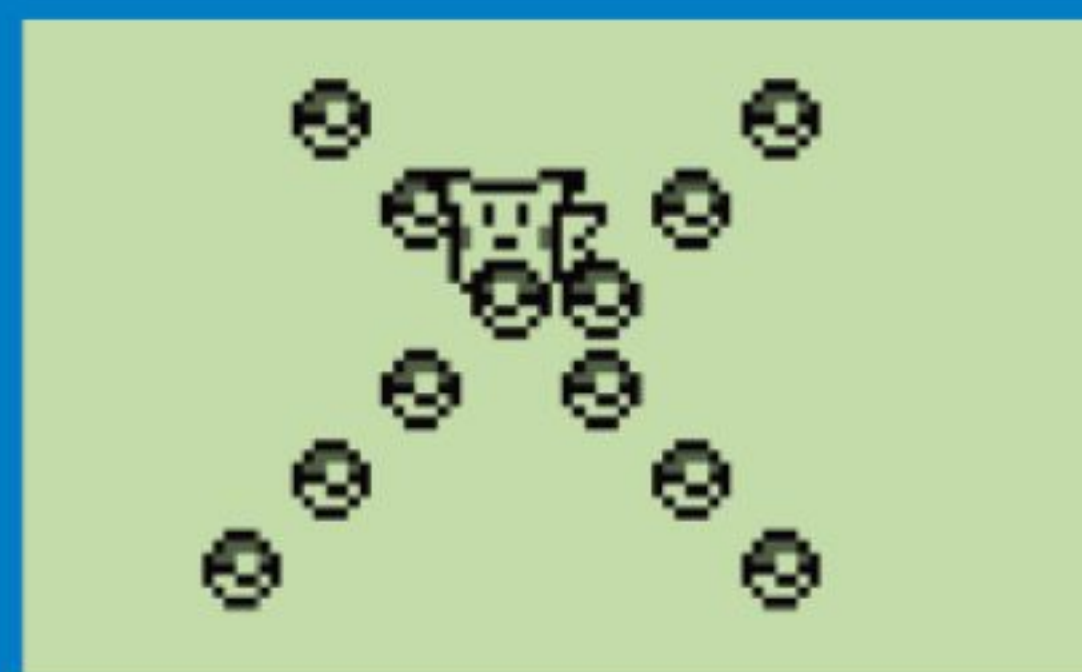

06 Pokémon Puzzle Collection 2

DEVELOPER: DENYUSHA

The only sequel to appear on the Pokémon Mini was also never released outside of Japan. This was more of the same, really, offering 80 new puzzles over four different game types that are very similar to those of the first.



07 Pokémon Race Mini

DEVELOPER: JUPITER

One of the true jewels of the Pokémon Mini, Pokémon Race asks you to compete against a second monster or another player in a side-scrolling marathon. Obstacles and multiple routes keep the races interesting, add replay value and enough depth to make things unpredictable.

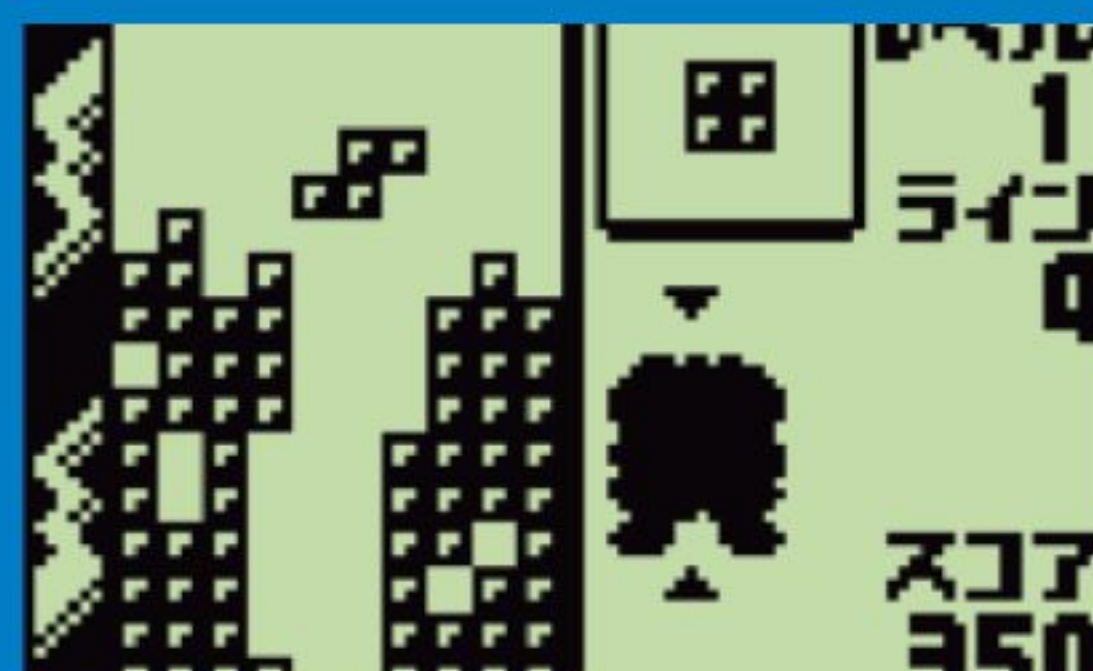

08 Pokémon Shock Tetris

DEVELOPER: NINTENDO

Without doubt the best game on the system and the main reason that many people seek out a Pokémon Mini at all. Shock Tetris delivers a classic Tetris experience with a couple of twists, including the ability to capture a random monster every time you clear four lines at once.



09 Pokémon Zany Cards

DEVELOPER: DENYUSHA

A series of four card games featuring a variety of Pokémon characters on the cards as well as various human characters from the main Pokémon games as the players. It can take a while to learn how the games function, but once you do they're a nice distraction.

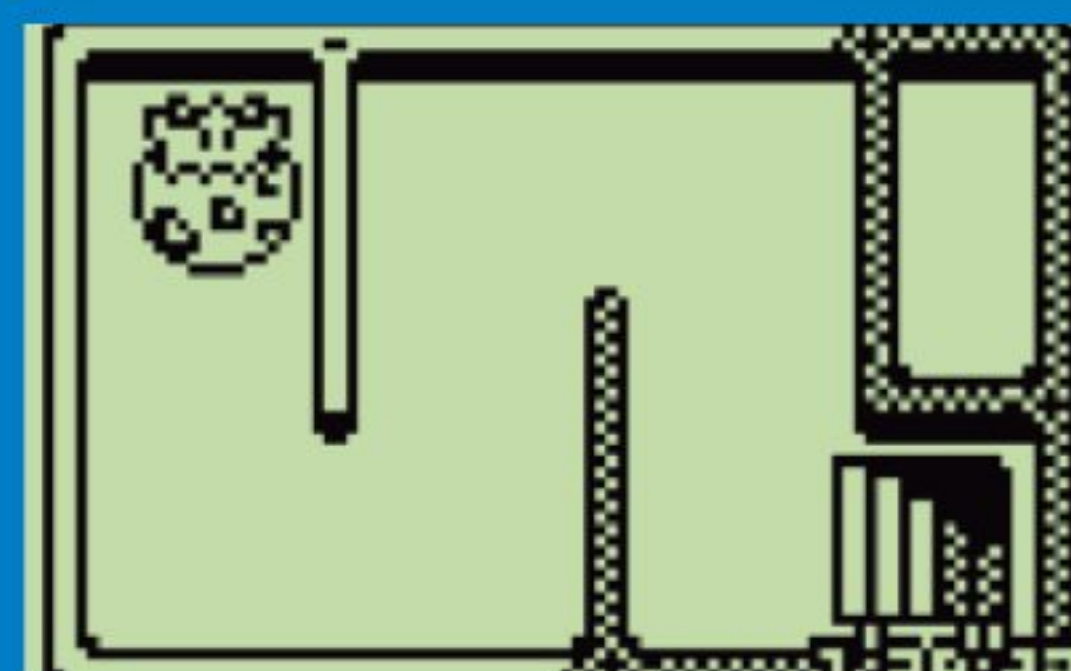

10 Togepi's Great Adventure

DEVELOPER: JUPITER

Another highlight, Togepi's Great Adventure asks you to roll the ovoid pocket monster through a series of 300 mazes of escalating challenge. As enemies and bottomless pits start to appear, things really become tough but ultimately rewarding.



» A few of the PM games were Japan-exclusive. Most import retailers still stock them, though.





little closer and I discovered that tiny cartridge sitting in the top-right corner of the box. My immediate idea was: 'It has cartridges, the data can be dumped and disassembled and it must be possible to code an emulator'. At this time I thought the Mini had a z80-based CPU, which turned out to be a big mistake. Nintendo designed a custom CPU and used custom maskROMs for its cartridge, but the motivation to hack this portable game console was unbreakable."

"Besides the fact that the Pokémon Mini is like a retro system with monochrome graphics, low resolutions and monophonic sounds – it was more or less unknown and 'untouched'," continues Hastik. "The scene had not taken notice of this handheld at the time. No development kits or programming manuals were available, no emulators or homebrew hacks were made. In fact, it was a crazy idea creating something like a scene milestone with this low-end hardware. We never expected SHizZLE to be referred to as the 'mother of all hacks' in the end."

Hastik describes the process of developing SHizZLE as "very complex and intense", particularly because of the undocumented nature of the hardware. "As a Nintendo system everything is custom made: CPU, ROM chips and so on. I tried getting some information on the ROM from Macronix, the maker of the chips. They were very informative until they recognised the internal markup 'top secret' in their database. So I started out with a logic analyser at a friend's company lab and modified the code of my ancient EPROM programmer to dump a cartridge. It took some weeks until I got the first good byte combination. Afterwards, Darkfader [another member of Team Pokémé] figured out the banking thing and did the first complete dump using an FPGA. It was

shocking: the bytes we got did not make sense in any disassembler available – we were stuck again. Then Nintendo released *Pokémon Channel* and opened the door. Using Parasyte's realtime GameCube debugger we worked ourselves through the code of the game and figured out which registers were modified by which byte combinations and then created our own instructions set – a mix of z80, 68k and other assembly languages."

Team Pokémé's demos have managed to make the Pokémon Mini sing in ways that were never apparently possible during the hardware's brief commercial existence and, more importantly, the growing number of playable homebrew games have expanded the range of available software beyond the limited potential of the Pokémon branding. "With 4MHz the CPU is quite fast, and because the display is very fast too, it is possible to do great stuff with it," says Hastik.

Of the homebrew games currently available, most are very simple programs that cover the same old bases as many other initial homebrew projects – *Pong* simulations and *Sokoban* clones, for example. But there are other developments, albeit incomplete, that hint at a much more ambitious future for the Pokémon Mini: a familiar-looking scrolling shooter called *P-Type*, a rolling demo of a *Final Fight* clone and a playable demo that does a rather convincing impression of *The Legend Of Zelda: Link's Awakening*.

"*Zelda Mini* is the most ambitious demo," says Hastik. "To finish a game in this dimension you need an excellent team to work on it. We've published all the stuff we did on Pokémon-Mini.net and are always waiting for people to continue this project. I have to admit that having some kind of adventure framework and a C compiler would make things a lot easier. But the Pokémon Mini community is just as small as the system itself. As a niche it is really cool and a nice experience for anyone who is willing to try coding assembly language."

Hastik is keen for more people to get involved with the Mini scene and help bring projects like *Zelda Mini* to fruition. "You can find everything you need on Pokémon-Mini.net", where the team's emulator/debugger is available alongside a good range of homebrew downloads, source code and a supportive community IRC channel to help get you started.

For everyone else who's just curious to try out the Mini for themselves, the unit is now available cheaply and easily. And while some of the games are a little harder to come by, as our accompanying guide shows, some of them are well worth tracking down. Team Pokémé also sells flashcards at Pokémon-Mini.net, so that the various homebrew games and tech demos can be enjoyed on the hardware they're supposed to be played on. So even if the sight of Pikachu and friends makes you a little queasy, you still might find something to enjoy on this unusual slice of Nintendo hardware history.

» Look at that! The cute little handheld is even smaller than the game packaging.

HOME BREW HIGHLIGHTS

All of the playable homebrew games currently available for the Pokémon Mini from www.Pokémon-Mini.net



01 Cortex

■ A block-pushing puzzler in which you have to clear the screen by pushing together three blocks of the same type. With 40 levels, *Cortex* is one of the most complete-feeling homebrew games available.



02 Galactix

■ A solid vertically scrolling shooter that, despite the name, doesn't have that much in common with *Galaga*. In a nice touch the developers have included a number of cheat codes, which can be found at the website.



03 Lights Out

■ A classic puzzle game that works particularly well on a monochrome screen. This Pokémon Mini version adds virtually nothing to original game which, if we're honest, has never been that entertaining anyway.

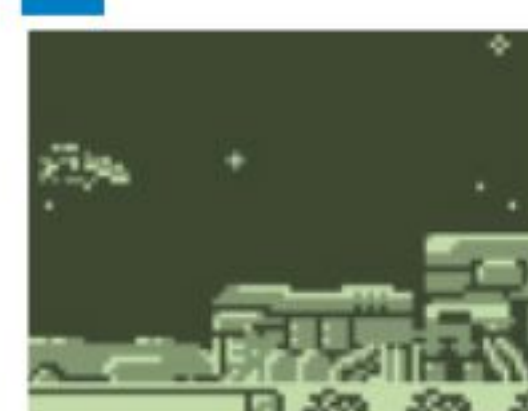

04 P-Type

■ Displaying some of most refined pixel art in a Pokémon Mini game, *P-Type* does its best *R-Type* impression, except without the Force or masterful level design. But that would be expecting a bit much now, wouldn't it?

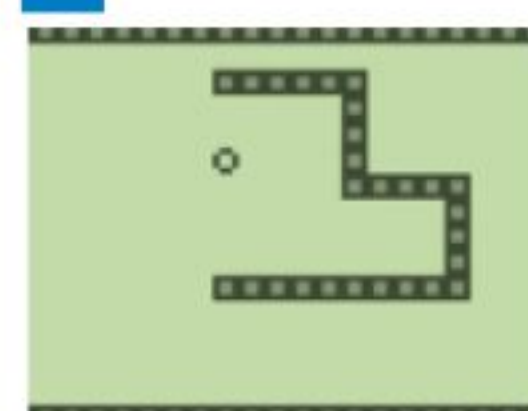

05 PokéSnake

■ If *Snake* could run on the mobile phones of the mid-Nineties then it can run on the Pokémon Mini too. This is nothing special, but it plays as well as you'd expect and works well within the confines of the Mini.



06 PokéSonic

■ Though *PokéSonic* is playable, it only lets you run left or right and jump up and down in an enemy-free area. There's little fun to be had here, but the promise of a decent *Sonic* tribute isn't outside the realms of plausibility.



07 Pongémon

■ It's *Pong* but on the Pokémon Mini. There's not much else to say really, so let's move along.



08 Sokomini

■ *Sokoban*, the game where you push blocks through a maze while trying not to push one into a dead end, is a classic puzzle game that's well suited to handhelds. And it works wonderfully on the Mini.



09 Zelda Mini

■ An impressive tech demo, *Zelda Mini* replicates the graphics of *Link's Awakening* and allows you to move Link around a small playable area. If this is ever expanded into even a small game it'll be an incredible feat.





SEGA MEGA DRIVE

SEGA

MEGA DRIVE

THE MEGA DRIVE WAS SEGA'S FIRST SUCCESSFUL CONSOLE. SOME ARGUE IT WAS ALSO ITS LAST, HAILING A BELLEROPHON STYLED RISE AND FALL. IT REPRESENTS SO MANY THINGS, TO SO MANY PEOPLE, FOR SO MANY REASONS. WE TRY TO CAPTURE SOME ESSENCE OF WHAT IT ALL MEANT



Modem Wars

Sega dabbled in modem usage for the Mega Drive. Nagumo-san explained, "It was called Mega-Modem, whose sales date was November 3, 1990. It is a modem unit for Mega Drive that enabled online game communication. It used analogue lines and its connection speed was 1,200bps. The service named 'Game Toshokan' enabled downloading of games, delivery of Sega-related news and online matches." Records vary wildly on how many games utilised online play (one source stating six). We only found solid confirmation regarding *TEL TEL Mah-Jong* and *Stadium* titles. More interestingly was the 'Game Toshokan', which allowed downloading of games like *Phantasy Star* text adventures, *Pyramid Magic* and *Flicky* to a special cartridge. Closing in 1993, fans worried the online-only games would be forever lost. Luckily in 1994 there were two Mega-CD compilations, *Sega Games Can Vol 1* and *2*, which included nearly all-available titles. Prized among *Phantasy Star* collectors, these are incredibly rare.



Nintendo's fate has often been intertwined with the Mega Drive system. It has long had a history of benefiting from Sega in one form or another, often due to the direct competitive challenge it posed. The SNES would have been nothing without the MD; the reverse is also true. It was the Mega Drive that pushed Nintendo's into updating its aged NES hardware, and it was also the Mega Drive that changed the market forever, cutting a trail towards the situation today. It is undeniably one of the most important pieces of hardware in gaming history. So it should have come as no surprise to find that MD games would support Nintendo's soon-to-be-released Wii system. In a moment of irony, it must be noted that Sega had already dabbled in downloadable MD games with The Sega Channel, making its announcement quite apt. The decision was obvious. Later Sega systems would prove difficult, technically, and also the MD was far more successful than the Master System. As will be shown, the MD can be credited for many things – it was a magical high Sega never again reached.

The Japanese debut was October 29, 1988. The widespread American release was less than a year later in 1989, while the United Kingdom had to wait roughly another year before it arrived in November 1990. To fully understand the importance of the Mega Drive's launch, you need to know what the international climate was like during the decadent Eighties.

Sega had already entered the console fray previously, with the successive releases of its SG-1000 Mark I, II and III systems in Japan (1981-1985), the 3rd model of which was redesigned as the Master System for Western countries. To be bluntly honest, despite it being technically superior to the Famicom/NES, it was a commercial failure that never gained more than a 5% market share. Only in Brazil was it able to officially eclipse Nintendo's 8-bit hardware. Throughout the mid-to-late Eighties Japan's console market was controlled almost entirely by the Famicom, which was popular beyond description. America was gripped by the NES, again with near total market dominance. The NES was also available in Europe and the UK, though Britannia was more enamoured with 8-bit micros than high-priced consoles.

In 1987 Hudson Soft and NEC jointly released the PC-Engine against the Famicom, two years later redesigning and releasing it in America as the TurboGrafx 16. When Sega decided to position its MD as a third competitor, the odds must have seemed impossibly high. According to David Sheff, Hiroshi Yamauchi dismissed Sega as not being a threat. Yamauchi was more concerned with NEC, which was investing roughly \$3.7 billion into R&D, an amount greater than Nintendo's then annual sales. Sega meanwhile was only a \$700 million company, and one founded by an American. As an underdog scrapping against NEC for second place, Sega and its MD was underestimated,

SEGA MEGA DRIVE

Year Released: Japan: 1988 USA: 1989 UK: 1990

Original Price: Japan: 21,000 Yen USA: \$189.99 UK: £189.99

Buy it now for: £10+ with games

Associated Magazines: Beep! Megadrive, Mega Drive Fan, GameFan, Mean Machines, Sega Visions Magazine

Why the Mega Drive was great... The Mega Drive ushered in the 16-bit era; some say the last golden era of gaming. It was a special kind of scene to be a part of. No explanation, no mix of words or screenshots or memories can ever touch that sense of knowing, that you were there, playing those great games during that point in time. Though this age has sadly passed, newcomers still need to understand.





SEGA MEGA DRIVE

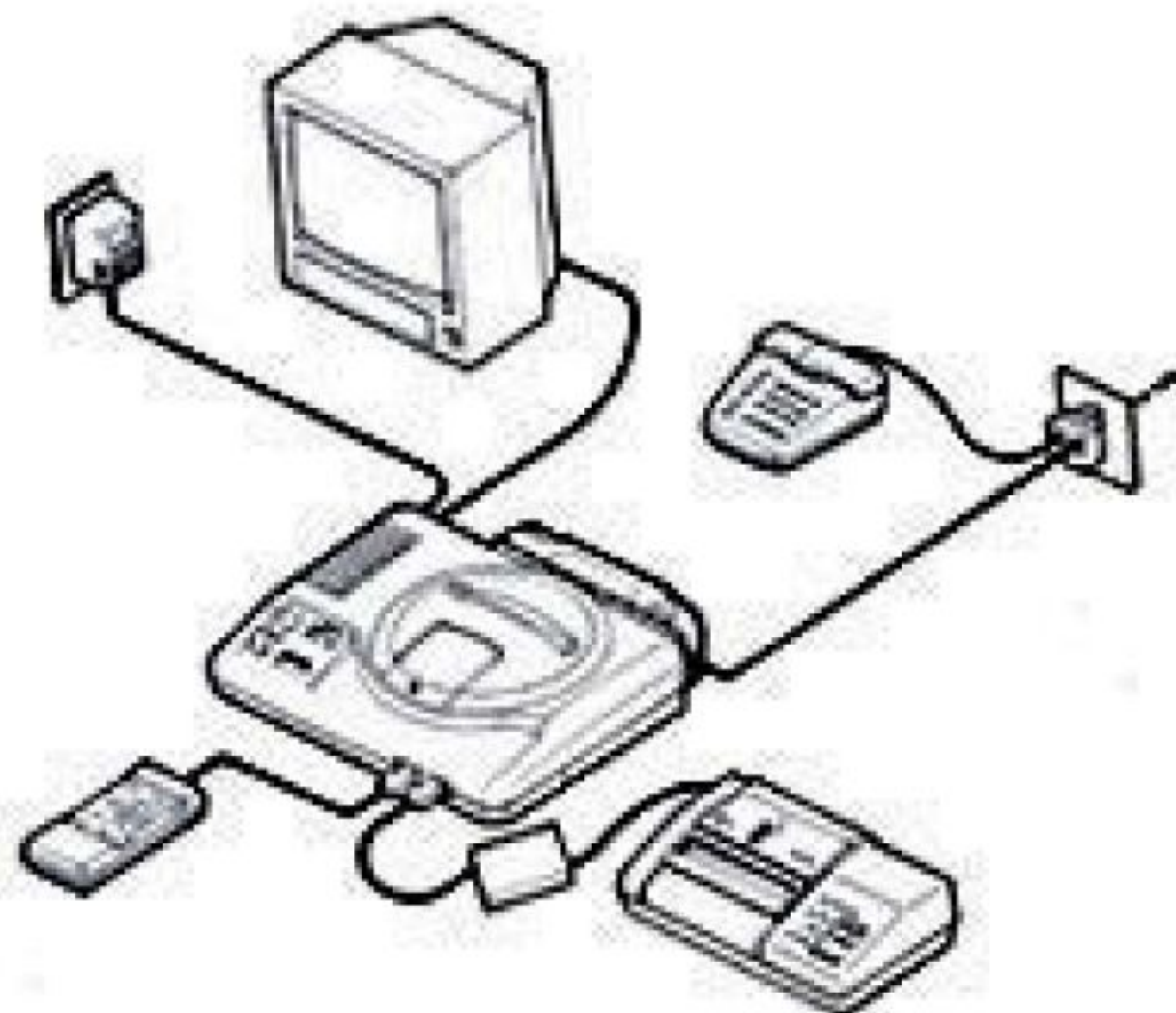

» Above and right: For ultimate collectors and those wanting to use the Mega Drive for online banking: the Sega Mega Anser (sic)

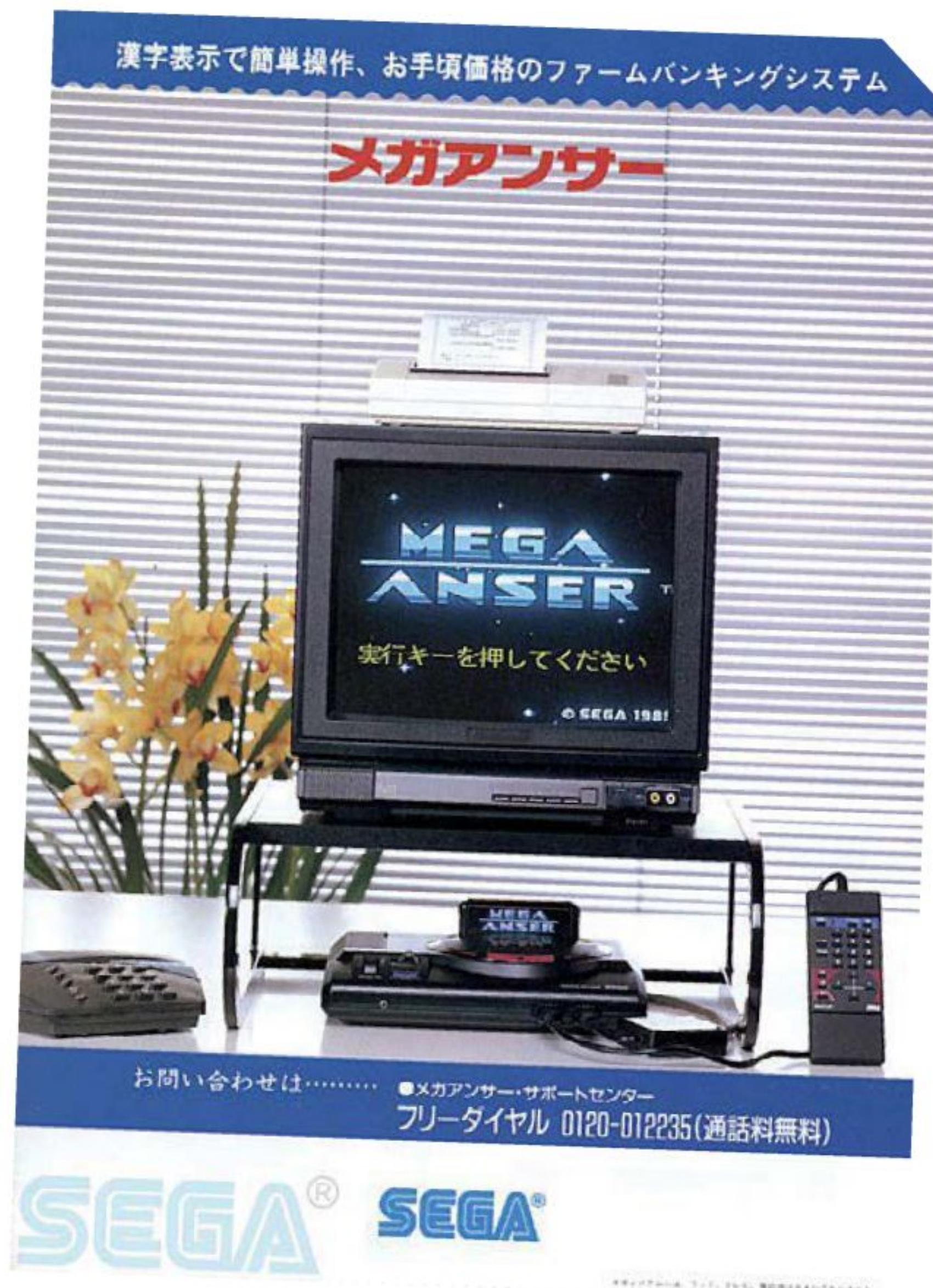

“ATARI WAS OFFERED THE GENESIS AND JACK TRAMIEL TURNED IT DOWN. JACK THOUGHT THE DEAL WAS TOO EXPENSIVE” MICHAEL KATZ



Hybrid Children

A sign of the Mega Drive's popularity is the number of variations that exist. Beyond your standard models, there was the JVC Wondermega (Xeye in America), which combined MD and Mega-CD. Then there was the much smaller combined Multi-Mega (CDX in America), doubling as a portable CD player. Following this musical theme, there was the Aiwa CSD-GM1, combining the MD/MCD with a portable "Boom Box" radio. From CD to LD, Sega's champion was also included with Pioneer's Laseractive. MSX fans will be interested to know it was integrated into the AX-330 and AX-990 models, for Arabic distribution in Kuwait and Yemen. Computer implementation didn't end there, since it was also hybridised into the Sega TeraDrive, a Japanese home computer. Meanwhile, the Western equivalent was the Amstrad Mega PC (see buyer's guide). Then there was the portable Nomad, and the Mega Jet, which was used by Japan Airlines. And the above doesn't even take into account the many bootleg clones about!



viewed by the industry itself as the weaker of the two. Retro Gamer spoke with Mr. Nagumo, the "Team Manager of SOJ CS Product PR", and asked many, many questions, few of them answered. When asked if, due to the impossible odds stacked against them, Sega had considered becoming a developer for either the Famicom or PC Engine, his answer was blunt. "No, we didn't."

Even so, Sega staff were curious about the Famicom. In two separate interviews (GameWeek and TNL) Yuji Naka admitted to making Famicom games run on the MD. His comments, amalgamated, were, "Oh my. [laughs] How do you people know about that one? Well yeah, actually I did. I once made a Famicom emulator for the Mega Drive. It was something fun to amuse myself with at the time. I couldn't play every game with it. But it was fun to call people over and show them Mario running around on a Mega Drive."

ORIGINS OF GENESIS

Sega's main source of profit during the Eighties was its hugely popular arcade games, like Yu Suzuki's *Space Harrier* and *Hang On*. To beat the competition the head of Sega, Hayao Nakayama, decided to create the first true arcade home system. He worked in secret with Hideki



» Most Mega Jets being sold come from an initial shipment hijacked by Indonesian sea-pirates. Their distribution was organised by underground collectors

Sato, modifying Sega's System-16 hardware – the same hardware that powered arcade versions of *Shinobi* and *Altered Beast*. This would have allowed superior visuals and audio, leagues ahead of the competition. It would also allow for easier, more accurate arcade ports (which gamers would be familiar with), and therefore plenty of games.

The new console had to be scaled down from the System-16, in terms of processor speed and available on-screen colours, but Hideki Sato planned ahead and included some extras. It was backwards-compatible with the Master System (using the Power Base Converter), and it was also designed with the future potential to use a mouse, keyboard, 2-inch floppy disk drive, modem, graphics tablet, and printer. He even considered the possibility of someday attaching a CD drive.

Beep!, a multiformat Japanese mag, first announced the system in June 1988 alongside an early prototype drawing, tentatively calling it the Sega Mark V (following on from previous names). The internal project meanwhile was called Mk-1601, but Sega wanted something stronger for the launch. It went through 300 different proposals, before finally settling on Mega Drive.

Disappointingly the Japanese launch was very understated. Their penchant for lengthy, mind-boggling queuing in Akihabara had been forgotten; there were no such queues for the MD! Supply and publicity had been well organised, but the machine was overshadowed by *Super Mario Bros 3*, released just one week earlier. Luckily magazines



» A young Hideki Sato working on a prototype Mega Drive; he was the main designer behind it



» There are countless unlicensed Chinese (and Korean) games, like *Barver Battle Saga – The Space Fighter*. It was renamed *Final Fantasy* when translated into Russian



» Above and below: By using the Power Base Converter, the Mega Drive could play Sega's back-catalogue of Master System games



like Famitsu and Beep! gave it positive coverage, and so a small but loyal following began. Reportedly 400,000 units were shipped in the first year.

Despite the low uptake in Japan, Sega went on to pursue highly risky and quite odd endeavours – bad for profits, great for collectors. Along with a gaming modem (see box-out), Sega created an online banking system for Nagoya Bank. The result was the Mega Anser (sic), complete with modem, numerical keypad, and grossly overpriced 'Mega Printer'. Sega also adapted the MD for arcade use, despite it already being based on the System-16 architecture. The results were the System C-2 board, and also the timed MegaTech and then MegaPlay systems; roughly, these three had a combined total of 80 games developed. Japan also received the rarest version of *Tetris* ever, and some sublime exclusive RPGs like *Rent-A-Hero* and *King Colossus* (both fan-translated).

But Japan was never what the Mega Drive was about. Success lay in the USA and Europe. Sega had the fight of its life ahead, and it would take not only gutsy determination to succeed, but also a damned excellent roster of games, and luck. Sega clearly had just enough of these, since it nearly conquered the industry.

GLOBALLY GAMED

To bolster the inside information available to Retro Gamer, Ken Horowitz of Sega-16.com kindly donated interviews he conducted with industry figures. One such individual was Michael Katz, former head of Sega's American branch, who presided over the Genesis' initial sales year. Katz explained the early days. "I arrived one month after Genesis launched. The company was small (under 50 people). They had gone through 2-3 Presidents (Gene Lipkin, Bruce Lowery) in the "Master System" days. Dave Rosen – Vice Chairman of Sega (and original founder), was overseeing the running of the company. I reported to him and Nakayama in Japan. Sega was basically a distribution company in the US. Hardware and software development came from Japan. I initially had to deal with keeping employees happy, determining the quality of the staff and getting into the job of building the Sega vs Nintendo juggernaut." Arriving after the American launch, Katz wasn't aware of the details surrounding the name change from Mega Drive to Genesis. Consensus states it was due to a trademark dispute. The facts are blurred, but point possibly to a US manufacturer of storage devices called Mega Drive Systems Inc.

We also questioned Katz ourselves, and he revealed a fascinating anecdote from before the Genesis launch. "I will tell you that Atari was offered the Genesis (when I was President of Atari Games Division) and Jack Tramiel turned it down. It would have gotten Atari back in the game with a 16-Bit system. I attended the meeting at Atari, when Dave Rosen (Sega Chairman) visited us (Jack and I) and made the offer. Jack thought the deal was too expensive, and he was more

interested in the Atari ST computer project." The system filtering into America and Europe raises an important question for importers. Why the deplorable need for regional lockout? Katz admitted he had no control over it in America, "Lockout decisions were made in Japan. The Sega Japan International VP handled international sales and marketing." Never knowing when to quit, Retro Gamer pushed Japan's PR man into a corner until he commented. As Nagumo puts it, "We implemented the security regionally to prevent game software being imported due to gaps of sales time between regions." As he wipes the sweat from his brow, we jovially comment that thankfully it wasn't successful. Enterprising young hackers soon bypassed the security with special contraptions, and later, easy methods for modifying the hardware were devised.



» The rarest most expensive version of *Tetris*. Ever. You need underground contacts and plenty of money to join this elite 'owners club'

IF FORCED TO SUMMARISE WHY THE MD IS SUCH A BLOODY FANTASTIC SLAB OF BLACK PLASTIC, IT'S BECAUSE IT'S ALL THINGS TO ALL GAMERS





SEGA MEGA DRIVE



Channel Control

The Mega Drive has so many unusual anecdotes you need a hundred box-outs like this. With the announcement of downloadable MD games for Wii, we're highlighting the revolutionary Sega Channel.

Speaking with Nagumo-san again, we hoped for a pride filled statement that championed this pioneering achievement. His answer was somewhat subdued, "It was a cable television service in the US from which videogames could be downloaded. We started the service in cooperation with Telecommunications, Inc. One could play his favourite games as much as he liked at a fixed amount every month. We also had the same services in cooperation with regional cable televisions in Japan."

From 1993 games were made available for download (divided by genre), at a cost of \$12.95 per month. Games were rotated every few weeks, encompassing nearly the entire library, plus a few unreleased titles and imports! They could be played indefinitely, but lasted only while the system was turned on.



» With an unprecedented comic book styling, *Comix Zone* was one of many exclusive titles that made the MD worth owning. An astoundingly good brawler

IT WAS A SYSTEM WHERE THE ALLURE WAS BORN NOT ONLY OF THE HARDWARE AND GAMES, BUT THE MAGAZINES, PLAYGROUND ARGUMENTS, CLIMATE, AND POLITICS OF THE TIME

Underground importing certainly didn't harm international sales. The MD is officially Sega's highest selling system. International figures are estimated to be between 30 and 35 million units, of which only 10% is attributed to Japan. Sega was determined to achieve those higher sales abroad; it demanded the American branch chant the Japanese word "HYAKUMANDAI" (that's "one-million" in English), in order to encourage sales. Katz elaborated, "The 'one million units' chant was representative of a goal set by Sega Japan. Did they just pluck the number out of thin air? I don't know. I think they thought that if we sold a million units in the first year that would make a big statement. They disregarded Nintendo's position and the fact that all key retailers would have to come on board immediately to hit the number, and also the need for a substantial software library from the get-go." Despite the daily chanting, sales only reached halfway. Katz went on, "We sold about 500K units — which I considered damn good — because Genesis was new, didn't have a large software library initially, and the Nintendo franchise was hard to crack."

In America it seemed Nintendo was unstoppable, and that was indeed its intention. It used some very unorthodox methods to maintain superiority. Stores were bullied into not carrying Sega products, and developers were forced to sign strict licensing agreements stating they'd only develop for Nintendo. But everyone loves seeing a tyrant deposed and a colossus fall, and so various developers began thinking of the Mega Drive as a serious, more profitable alternative. Popular companies like Namco changed allegiance, while EA reverse-engineered the system before developing high quality exclusives. This all helped make Sega a tempting alternative for consumers.

But as Katz explained, Sega wasn't too pleased with EA. "Sega was unhappy about EA reverse-engineering Genesis. We were in the process of giving EA/Trip a 'sweetheart' deal, then we needed a *Joe Montana* game in a hurry (the game being developed for us by Media Genic was way behind schedule), so I asked Trip for a back up *Madden* football game. He gave us one and that assured him a low/

royalty free deal on Genesis software. The first *Montana* game being a 'Madden back up' from EA is a little known fact."

The MD's huge success, of course, came with the arrival of *Sonic The Hedgehog*, a phenomenal mascot that endures to this day. But the question that has to be pondered is what if *Sonic* had not been a hit and never had the success that it did? When asked, Nagumo playfully hinted at the possibility that Sega had other titles, besides *Sonic*, with which to take on Nintendo and *Mario*. "We had the marketing and promotion strategies using various titles at that time. *Sonic* was one of them that led to a big hit." Katz saw things differently. When asked about SOA's initial dislike of the Sonic character, "I certainly underestimated the potential of *Sonic*. Thank God there was good and sustained gameplay (critical in any game success). I know that I thought it was nuts, when we were going for targeted and widespread awareness in everything we did, for the Japanese to develop a game based on a type of character — a hedgehog — that no kid in the American 6-16 year-old demographic would have any familiarity with. We knew we needed a great "character action" game to put in the line up. We were hoping for a *Donkey Kong* type hit. When *Sonic* was so hot, it was decided to bundle it with Genesis (just as ColecoVision was bundled with *Donkey Kong* in 1981). If Sega didn't have *Sonic*, Genesis sales would probably have been less, but it's hard to say. I don't know if Sega Japan had a back up — I think not. Sega Japan was responsible for developing the character action genre. We were responsible in the US for developing sports games."

Despite his great effort and the success he achieved in those early years, Katz was replaced by Tom Kalinske in 1990. Most agree that any successes were a result of combined team efforts, but that Katz is often unfairly overlooked in favour of his successor. In past interviews, Kalinske explained how *Sonic* became the pack-in title. "After my first month as CEO, I told Mr. Nakayama, 'You have to get rid of *Altered Beast*, the title that's bundled with Genesis. It sounds like devil worship. We have to get the price down to \$149, and we have to develop more American software.' The board spoke for two



» Japan's "Hyper Exciting Visual Game Magazine — Mega Drive Fan" was one of several dedicated publications



» Top and bottom: The anime influenced *Phantasy Star* series reached its peak with number 4. Few RPGs even come close to such magnificence



» Above and left: Smooth like liquid napalm, *Ranger X* by Gau Entertainment is a frenetic blaster, with audio and visuals that'd melt the brain of those unaccustomed to such splendour

hours in Japanese and I was just sitting there, not understanding a word. Finally Mr. Nakayama said, 'No one here agrees with anything you've said.' I thought mine was going to be the shortest career in the business. But as I was walking out, he said, 'But I hired you to make the decisions for Europe and the Americas, so go ahead and do it.'"

Sega eventually annihilated the TurboGrafx 16, and it was doing well against the NES, but the sleeping giant had awakened, and in 1990 Nintendo launched the SNES. The ultimate grudge match began, which even today, remains fresh in peoples' hearts and minds. Nintendo had on its side Japanese stalwarts Square and Enix, which made Sega's conquest of Japan nigh-on impossible, but it had already proven itself to be hip and cool in the West, and this is where it succeeded. Sega was out earlier, priced cheaply, and provided both what people wanted, and what its rivals weren't supplying.

Everyone deep down knew the MD couldn't outperform the SNES; it was the underdog in terms of graphical and audio power (it had a faster processor though). Developers had to work harder to get great results. This extra effort, and dare it be said, love, that went into the games, was very apparent – when they came up with a graphical trick, or something unique, it showed. The Genesis had more mature software and was also advertised on adult TV like *Saturday Night Live*, further cementing its reputation as "doing what Nintendo don't." But the big tipping of scales was *Mortal Kombat*. Sega's version had blood and included all arcade fatalities; Nintendo's version didn't. The atmosphere at the time was electric, and *Mortal Kombat* was a deciding factor for many people's purchases.

By 1992 Sega had 55% control of the market (up from around 8%), and by 1993 it had more than quadrupled its net worth (up to \$3.6 billion). Sega had reached its peak. But over the coming years it became like a leper, withering as its valuable bits fell off. The golden era ended, but if you look with the right kind of eyes, you can almost see the high water mark, where that glorious wave broke, and finally rolled back.

If forced to summarise why the MD is such a bloody fantastic slab of black plastic, it's because it's all things to all gamers. It appealed to hardcore elitist collectors, since it was great to import for. Plenty of action games (like *Alien Soldier*, and the explosively magnificent *Ranger X*), with sturdy boxes protecting beautiful Japanese cover-art. When SNES-owning friends had updates of Konami classics like *Contra* and *Castlevania*, MD owners were blessed with their own exclusive updates. They were no mere ports, but were designed from scratch, taking into account the hardware's limitations. And they were all the better because of this. There was no relying on vast colours or a custom Sony music chip; the gameplay had to be strong.

Importantly, it tapped in the mass market and appealed to families with low incomes. In impoverished areas in the USA it was popular among Black and Hispanic youths, who enjoyed the affordable easy-



» Top and bottom: *El Viento* and *Alisia Dragoon* are two very similar, very fun, and very Japanese action-platformers



» Top and bottom: Konami knew how to love MD owners: Insane hyper-exaggerated action in *Contra*, and classic vampire hunting in *Castlevania*

to-play arcade thrills provided. Children were also catered for, with both licensed and new IPs (*Quackshot* and *Toejam & Earl*). When the kids were tranquilised and asleep in bed, parents could indulge in a plethora of sports titles (*Madden* etc), violent brawlers (*Cyborg Justice*), or cerebral games like *Ecco*.

It was a system where much of the atmosphere and allure was born not only of the hardware and games, but the magazines, playground arguments, climate, and politics of the time. One of the most notable American magazines covering the system was GameFan, which, despite being multiformat, loved the Genesis. Its founder, Dave Halverson, understood, appreciated, and helped generate a lot buzz for Treasure too. GameFan praised their games, rightfully hyped up *Gunstar Heroes* to encourage sales, and were one of the very first English language magazines to conduct an interview with Treasure. Of course, not every multiformat magazine had quite the same views, which is why Edge infamously only gave *Gunstar Heroes* a half-page 6 out of 10 review. If you were an MD fan back in the early 1990s, Halverson's GameFan was the magazine you wanted to be reading!

We've not even yet mentioned subjects like the VR headset, Menacer Gun, Activator peripheral, *Virtua Racing's* 3D graphics, pirate flash carts, Brazilian rock band Megadrive, Boris Vallejo, or the million-and-one related subjects. But it doesn't matter. Experiencing the system will tell you more than these words ever could.



» Every kid wants to rip his best friend's spine out. The uncensored Sega version shifted the tides between MD and SNES popularity



» There was certainly no shortage of exclusive, epic, and utterly essential action-RPGs: *Beyond Oasis* (1), *Soleil* (2), and *Landstalker* (3) are all must-haves!

SPECIAL THANKS TO
Many special thanks to www.sega-16.com, the best unofficial Mega Drive site online, for donating interview segments and images. Visit them for the full interviews! Thanks also to www.segagadomain.com for images, Michael Katz for answering additional questions, and Sega's PR departments!



SEGA MEGA DRIVE

PERFECT TEN GAMES

Sega's most successful console is home to dozens of great title, but here are ten of the very best. Obviously, you may disagree with some of the entries, or perhaps with some of the omissions, and if you do let us know at the usual address. Then we can politely explain to you why we're right and you're wrong. Enjoy



01

SONIC THE HEDGEHOG 2

- » RELEASED: 1992
- » PUBLISHED BY: SEGA
- » CREATED BY: SONIC TEAM
- » BY THE SAME DEVELOPER: SONIC THE HEDGEHOG

01 After the success of the original *Sonic The Hedgehog*, it came as no surprise to see the lovable scamp returning a year later in a brand new adventure. With a refined engine, the addition of Miles "Tails" Prowler, a greatly enhanced bonus stage and an excellent two-player mode, *Sonic The Hedgehog 2* is easily one of the hedgehog's most memorable 16-bit outings. While the core gameplay is little different to that seen in the original, Sonic Team threw in plenty of new touches to ensure that gamers wouldn't feel short-changed. The end result is not only one of the Mega Drive's greatest platformers, but quite possibly the hedgehog's finest hours on any system.

GUNSTAR HEROES

- » RELEASED: 1993
- » PUBLISHED BY: SEGA
- » CREATED BY: TREASURE
- » BY THE SAME DEVELOPER: DYNAMITE HEADDY

02 Outrageously good platformer/shooter that features dazzling graphics, a crazy relentless pace and dozens of fantastic boss encounters. Created by a bunch of ex Konami staffers (you should all know the story by now) *Gunstar Heroes* does tricks with the Mega Drive's hardware that many thought impossible, and even today it has a freshness that belies its 13-year-old roots. While special mention must obviously go to the game's astounding visuals, Treasure also ensured that the gameplay was just as special and injected all manner of interesting play mechanics to ensure that every level remains as fresh as a proverbial daisy. If you're after a frenetic blaster then look no further. This is run-'n-gun heaven.



02

DEVIL CRASH

- » RELEASED: 1991
- » PUBLISHED BY: TECHNO SOFT
- » CREATED BY: IN-HOUSE
- » BY THE SAME DEVELOPER: THUNDER FORCE III

03 There's a few pinball games on Sega's Mega Drive but this superb 1991 offering from Techno Soft remains a firm favourite. While it only features one main table, it's well designed and boasts all manner of different bonuses that lead you to several smaller, mini-tables. While Techno Soft's previous pinball title *Alien Crush* featured an alien theme, *Devil Crash* has chortling knights, chanting monks and dragons occupying its tables. Released in the UK as *Dragon's Fury*, *Devil Crash* is a superb pinball game that should last you forever. Oh, and it's got one of the most rocking soundtracks we've ever heard.

STREETS OF RAGE 2

- » RELEASED: 1993
- » PUBLISHED BY: SEGA
- » CREATED BY: IN-HOUSE
- » BY THE SAME DEVELOPER: STREETS OF RAGE

04 As with *Sonic The Hedgehog 2*, Sega took everything that made the original *Streets Of Rage* so fun to play and turned it up to 11. The visuals have had an overhaul with all the heroes and enemies being beefed up and boasting greatly improved detail. Yuzo Koshiro is back with another thumping soundtrack and the game's many bosses are tougher than ever. Each character now has a selection of special moves and there are four different protagonists to choose from: Axel and Blaze from the original game and new boys Skate and Max. A magnificent scrolling fighter that's crying out for a next-gen remake.

STRIDER

- » RELEASED: 1991
- » PUBLISHED BY: SEGA
- » CREATED BY: IN-HOUSE
- » BY THE SAME DEVELOPER: AFTER BURNER

05 Oh come on, did you really think we'd do a Mega Drive top ten and not feature *Strider*? Despite Darran's obsessive love for Capcom's purple clad ninja (it's a long sad story) *Strider's* addition is easily justified, as it's quite simply the strongest arcade port on Sega's 16-bit console. Not only does it capture all the character of the coin-op classic, it goes one step further and delivers a stunning soundtrack that actually manages to improve on the arcade original. Sure there's a fair amount of flickering here and there but as far as capturing the essence of the original game goes no other Mega Drive conversion comes close. Essential.

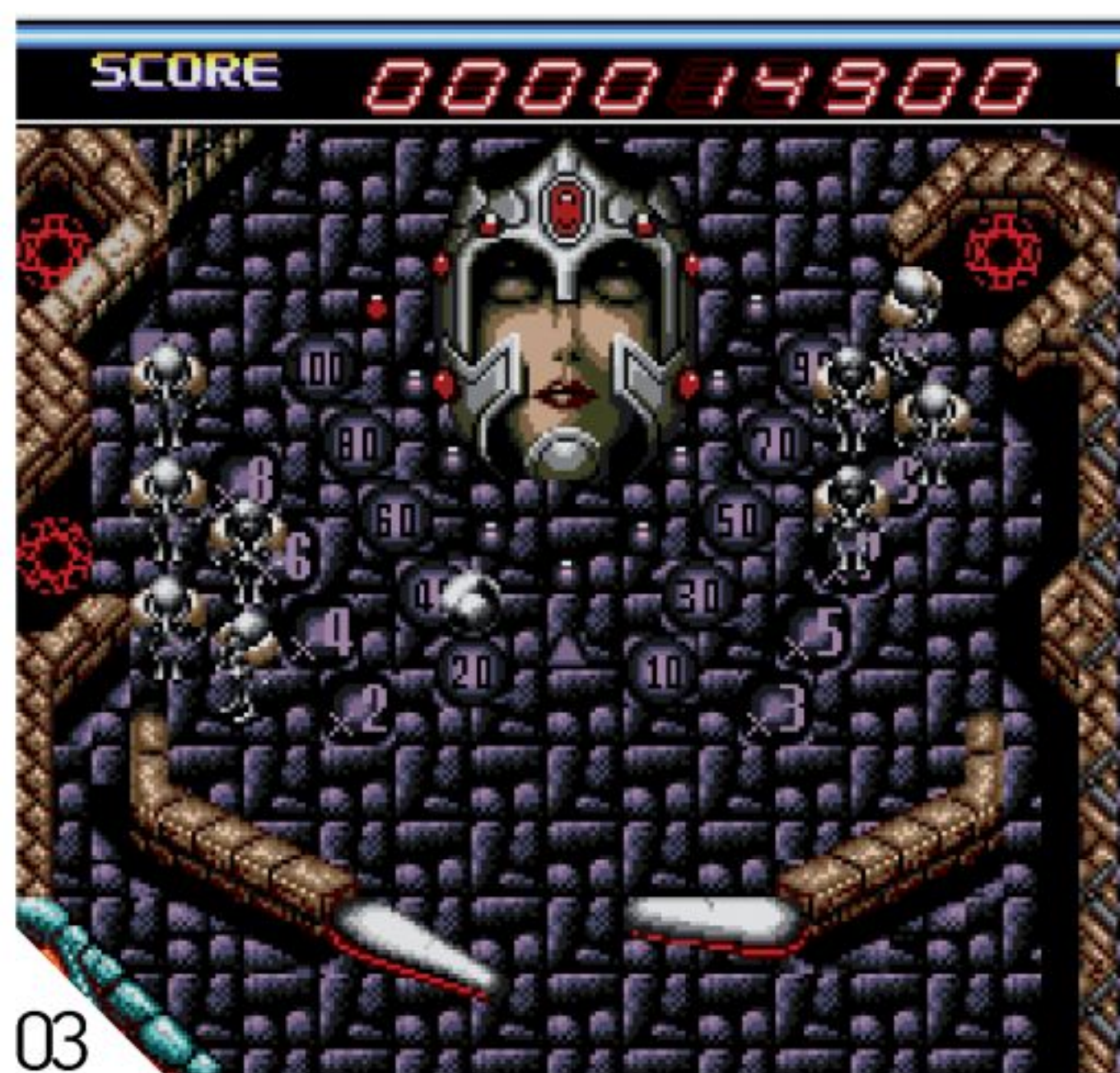

03



04



05



06

DESERT STRIKE: RETURN TO THE GULF

- » RELEASED: 1992
- » PUBLISHED BY: ELECTRONICARTS
- » CREATED BY: IN-HOUSE
- » BY THE SAME DEVELOPER: JUNGLE STRIKE

06 Set a year after the events in the Gulf War, *Desert Strike* sees you climbing into an Apache and using it to stop a despot in the Middle East from starting World War III. Utilising an isometric viewpoint, EA's blaster saw you storming into armed bases to rescue POWs, whilst using your firepower to take out anything that stood in your way. Despite the destruction you can cause, *Desert Strike* is quite a cerebral affair, with many of the later levels requiring a fair amount of strategy to complete. The thinking man's shoot-'em-up.



07

SHINOBI III: RETURN OF THE NINJA MASTER

- » RELEASED: 1993
- » PUBLISHED BY: SEGA
- » CREATED BY: IN-HOUSE
- » BY THE SAME DEVELOPER: THE REVENGE OF SHINOBI

07 Despite a lengthy development period, *Shinobi III's* four-year wait was worth it. Not only has the pace been increased, your ninja now knows a selection of new skills. Flying-kicks, a running dash and using your hands to swing across ceilings are just a few of the new abilities you can use and all have been perfectly integrated into the game. There are even sections where you can ride horses or surf along the crest of a wave, dispensing bad guys as you go. If only the later games showed a tenth of the imagination of *Shinobi III*...



08

ECCO THE DOLPHIN

- » RELEASED: 1993
- » PUBLISHED BY: SEGA
- » CREATED BY: NOVOTRADE INTERNATIONAL
- » BY THE SAME DEVELOPER: JAWS UNLEASHED

08 Delightful underwater adventure that sees you trying to rescue your dolphin friends when they all get sucked up by a mysterious hurricane. With its focus on exploring the expansive stages and its many devious puzzles, *Ecco The Dolphin* was quite unlike any other game at the time and instantly caught the public's attention. The underwater environments are full of detail and bursting with all sorts of exotic undersea creatures. Our only real complaints with Ecco is that some of the sections can be difficult to negotiate, ruining the otherwise tranquil atmosphere.



09

THUNDER FORCE IV

- » RELEASED: 1993
- » PUBLISHED BY: SEGA
- » CREATED BY: TECHNO SOFT
- » BY THE SAME DEVELOPER: ALIEN CRUSH

09 While *Thunder Force III* was never released in the UK, Sega atoned by releasing its superb sequel in 1993. Techno Soft's fourth *Thunder Force* title (and the third to appear on the Mega Drive) boasted amazing visuals, over-the-top weaponry and a stunning soundtrack that perfectly complemented the frenetic on-screen action. As with *Thunder Force III*, the first four levels could be approached in any order, but the stages themselves were far larger in scope and featured both vertical and horizontal sections. Throw in some insanely tough bosses, plenty of exotic locations and those stunning visuals and you have one of the Mega Drive's classiest shooters.

SHINING FORCE II

- » RELEASED: 1994
- » PUBLISHED BY: SEGA
- » CREATED BY: IN-HOUSE
- » BY THE SAME DEVELOPER: SHINING FORCE

10 While it essentially features the same combat system and gameplay mechanics as the original *Shining Force*, Sega's sequel is generally considered by many to be a far superior RPG. Take the combat for example: it's a lot quicker now, making fights far less of a chore than before, and the new counter-attacks add a great degree of spice to the proceedings. The interaction of items is also better integrated with little touches like automatically passing a picked up item to another character when your main hero's pockets are full, and being able to view an item's stats before you buy them means that everything flows along rather nicely. A superb RPG that shouldn't be missed under any circumstances.



10



VIC-20

Year released: Japan: October 1980 (69,800 Yen), US: May 1981 (\$299.99), UK: September 1981 (£199.99)

Buy it now for: £10-15

Associated magazines: Vic Computing, Commodore User and C&VG

Specifications: MOS 6502A processor running at approximately 1MHz; 5K RAM as standard (3.5K available for programming) that could be expanded further via memory cartridges; Tape and disk interfaces as standard, one joystick port, one user port; Four sound channels in mono provided by the VIC chip itself: three melodic, one noise



VIC-20

ACCORDING TO NEIL HARRIS, WHO JOINED IN EARLY 1981 AS PART OF THE AMERICAN PRODUCT LAUNCH TEAM, COMMODORE WAS A \$50 MILLION PER YEAR COMPANY WITH BARELY ANY PRESENCE IN THE US. THE VIC-20 COMPUTER WAS ABOUT TO CHANGE ALL THAT. WE TAKE A LOOK AT THE MACHINE DESTINED TO LEAVE COMMODORE'S FIRST FOOTPRINT ON VIDEOGAME HISTORY

The VIC-20 was such a success in the West that it led to the creation of the Commodore 64 and then the purchase and production of the Amiga. Of course what happened to the company several years down the line is now a major part of computing history, but we're getting ahead of ourselves here. Let's go back to the start, indeed before there was any thought of the computer itself.

One of Commodore's most stunningly brilliant pieces of acquisition had been to buy MOS Technology, creators of the 6502 CPU used in many electronics for the next ten years, in 1976. Two years later, in 1978, the VIC (Video Interface Chip) was designed by Alan Charpentier for third-party sales to arcade manufacturers. Although it could produce both graphics and sound, no one was interested. Their loss. It was kept in-house, awaiting some project to come up that it could be used in.

Although the VIC-20 had many notable people working on it, the most prominent and the person to whom a lot of credit should go is Mike Tomczyk. Hired in April 1980 as Jack Tramiel's assistant, within a month of joining he had managed to visit both Germany and Japan, fired the entire marketing division and come up with the outline to the machine that would eventually turn into the VIC-20. He would become known as the 'VIC Czar'.

His first day at work would be one that defined the rest of his career, due to his attendance at the now infamous meeting just outside London. Tramiel outlined his vision, possibly inspired by Sinclair, of producing a low-cost colour computer to complement the existing PET series. Most present were in favour of continuing the high-end business line, questioning whether such a move was economically feasible. Only a few supported the idea, including Tomczyk himself, Kit Spencer (head of Commodore UK) and Tony Tokai (head of Commodore Japan).

Tramiel listened to the arguments, pounded the table and announced, "The Japanese are coming, so we will become the Japanese." He had reason to worry, however. While Commodore was number one in Europe, it lagged behind Apple and Radio Shack in the US, and Texas Instruments was gradually nudging out its calculator business. Tramiel was worried that the wave of subsidised mid-priced computers in Japan could arrive in the US and do the same to his computer business. And so, he planned a pre-emptive strike to counter this threat.

As was the case when later designing the Commodore 64, the company was not averse to examining the competition and 'borrowing' good ideas from them. Tomczyk's visit to Japan proved fruitful, the function keys of the NEC line, for example, ending up on the VIC-20 but vertically instead. By the end of the month he had typed a 30 page

INSTANT EXPERT

The working title for the VIC-20 was Vixen.

However both 'VIC' and 'Vixen' sound like swear words in German, so it was called the VC-20 (or Volkscomputer) there. Commodore had considered this title for use worldwide but decided against it.

The VIC-20 was designed and launched to stem off potential Japanese competition to Commodore's computer business, going as far as launching in Japan first (as the VIC-1001).

It was the first home computer to sell one million units worldwide, beating the Apple II by a couple of months.

Jeff Minter's career arguably took off with a little game called *Gridrunner* when published in the US, and Satoru Iwata (now head of Nintendo) converted *Galaxian* (aka *Star Battle*) in his formative years with HAL Labs.

William Shatner was hired to promote the computer just before he signed on to play TJ Hooker as his fees were quite low at the time.

During its peak Commodore was manufacturing 9,000 units per day to cope with demand.

Memory expansions were available officially in 3K, 8K and 16K sizes, and although some third-parties produced bigger than this, no game ever needed more.

Commodore released a disk drive for the VIC-20 called the 1540, but it was hardly supported and no games were written (at the time) to take advantage of the format.

Although production of the VIC-20 was halted in late 1984, software companies continued programming and publishing commercial games well into 1985.





VIC-20

OTHER VERSION

VIC-1001

The original hardware is not very different from that released in the West. Aside from the foil and Japanese symbols on the keys, the only other extra is the Japanese ROM inside. In addition to the three standard character sets, by holding Shift and the 'C=' key together on power-up it would instead switch to 'katakana' mode.



Those 'banned' games?

Much has been theorised regarding the fate of two of Commodore's titles, but in light of some recent new information, here's the most likely series of events. Commodore actually had the licence from Namco to convert *Pac-Man*, *Galaxian* and *Rally-X* to the VIC-20, these cartridges do indeed exist. However because Namco had licensed the arcades for distribution in the West to other companies, this deal solely applied to Japan. Not one to let a minor triviality such as this get in the way of profit, Commodore released *Galaxian* as *Star Battle*, and transformed *Rally-X* into *Radar Rat Race* by way of altering the graphics. While the latter appeared to avoid the gaze of Bally Midway, the former did not and its sale ended up being restricted. Most likely as a way of placating Bally in this situation, Commodore set up a deal to officially convert some of its other arcades including *Seawolf*, *Gorf* and *Wizard Of Wor*. More was to follow for *Pac-Man*, now called *Jelly Monsters*, as the home licence was owned by Atari and it directly took out an injunction against the game. Curiously enough this was levelled against Commodore UK rather than the parent company; either Atari felt it better to use legal means in this country or the origin of the game was European (there is a rumour it was written by Handic not HAL Labs). Regardless of all the actions taken out against Commodore neither is that hard to find, certainly a lot less rare than many people make them out to be.

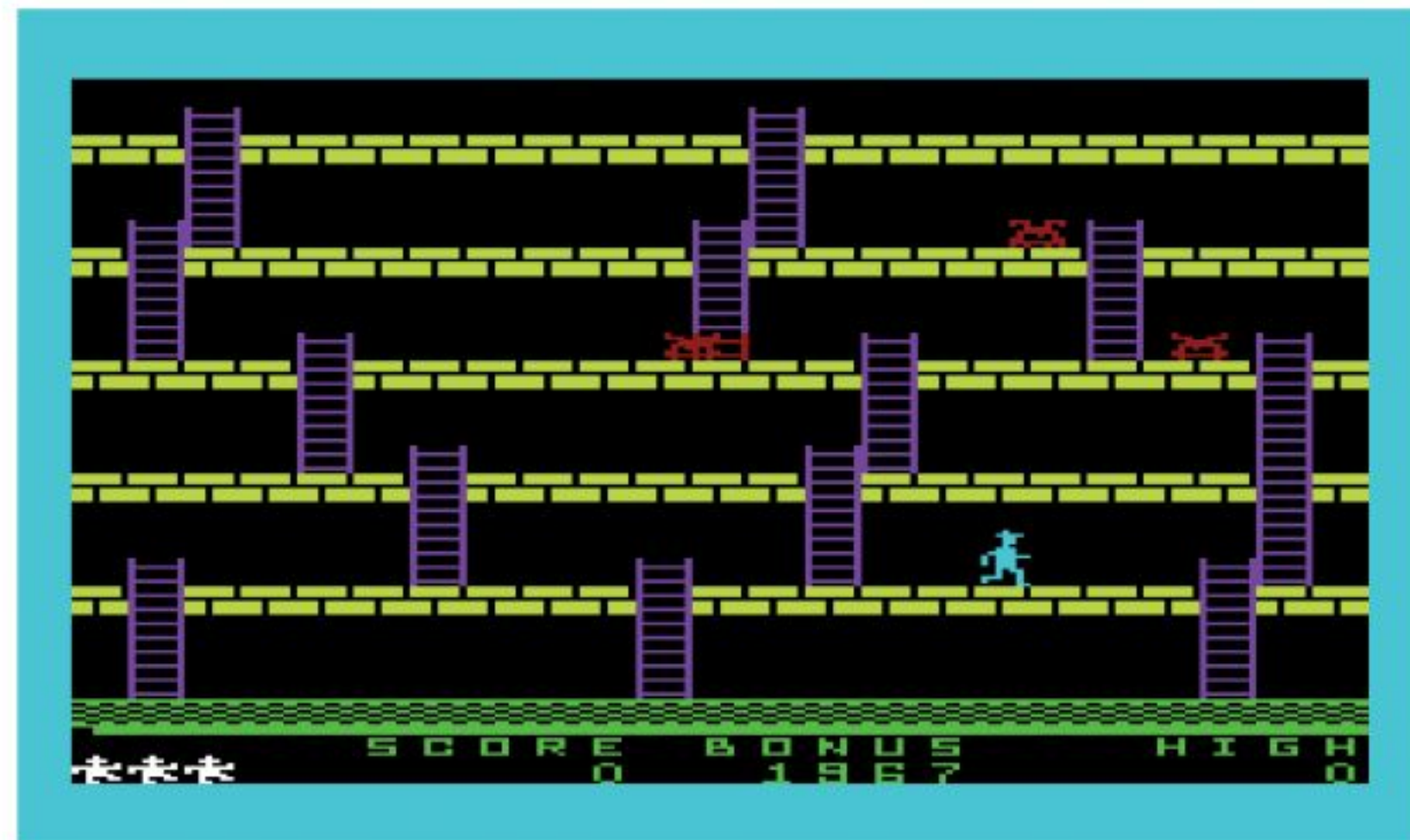

» Most machines got a version of *Space Panic*, and this was no exception (but no apples in sight).

memo to Tramiel outlining everything that needed to be done to turn the idea into an actual computer. Tramiel's sole response was to tell him to "make sure all this gets done", effectively making him head of the project.

In response, two teams at Commodore began work on producing a prototype utilising the VIC produced earlier. Within MOS Technology itself Robert Yannes, who would go on to design the SID chip, cobbled together one prototype from spare PET parts and a desktop-calculator casing. His aim was to promote it as a games machine, a concept that was carried forward to fruition.

The other prototype was constructed by Bill Seiler and John Feagans, literally from hacking bits of other machines together.

"FIFTEEN YEARS BEFORE SEGA KILLED OFF ITS OWN HARDWARE (THE SATURN), COMMODORE DID THE SAME BY RELEASING THE COMMODORE 64 IN AUGUST 1982"

The graphics half of the PET motherboard was removed and replaced with the VIC, and then a 9-pin joystick port and cartridge slot (à la Atari 2600) was added. Seiler felt the machine should be a computer, not just a games machine and insisted on having a BASIC language installed for programming. In the end, the finished prototype was a mixture of ideas from both teams.

With the machine receiving overwhelmingly positive feedback at the June 1980 CES, the PET engineers were corralled together to complete the final design in under a month. Although the cost of the computer could be kept low due to Commodore's vertical integration, only 5K of RAM could be installed per machine to keep it below Tomczyk's proposed \$300 price point (and leave enough margin). While the design was being finished, the team in Japan were busy putting together the first set of software titles for launch. The machine was truly a combined effort and would not have succeeded without either. All that was left was to decide on a name.

At the beginning it didn't have one except MicroPET, probably because it was created from hacked parts. Many people dubbed it the 'Vixen' as an extension of the VIC name, Tomczyk going as far as doodling little fox logos. In the end though he decided to name it after the primary chip inside. However, 'VIC' sounded incomplete

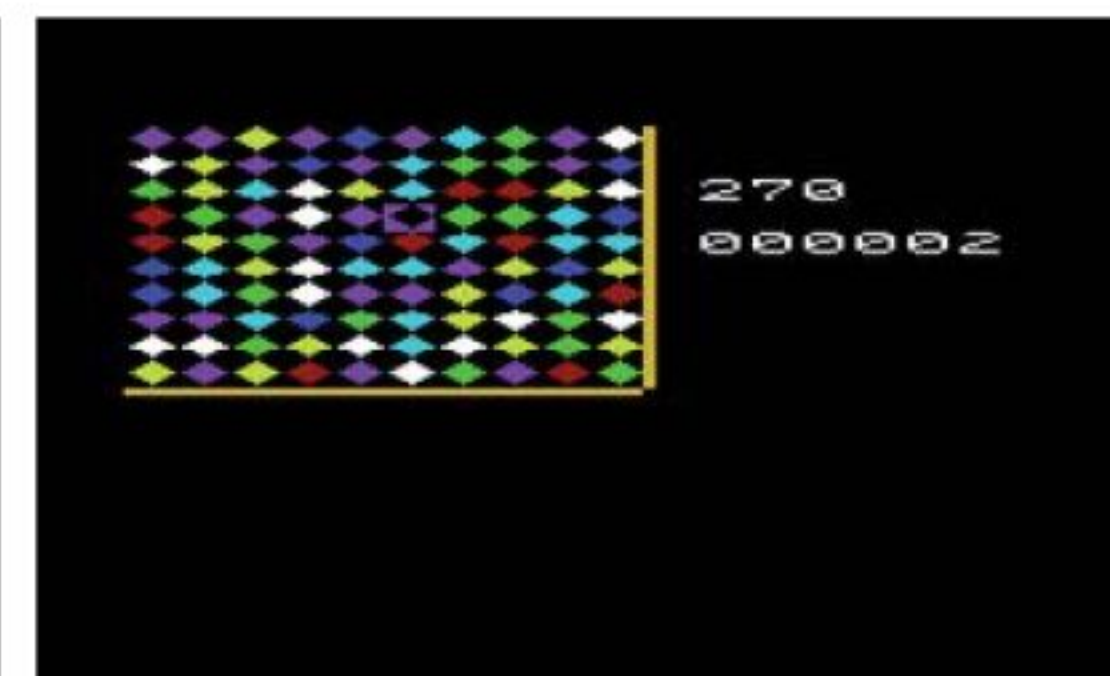
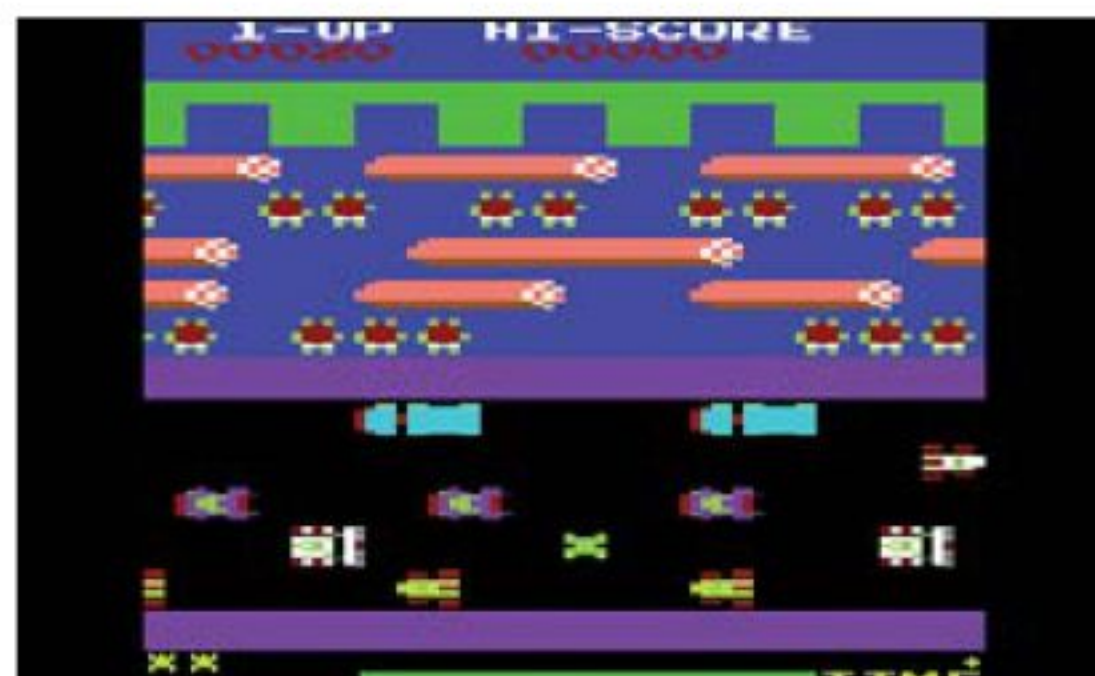

» Many new games are still being developed today as evidenced above by *Dragonwing*, *Frogger '07* and *Jewels Deluxe*.

on its own; he felt it needed a number afterwards. Tomczyk doesn't know why Tony Tokai chose the '1001' number for the Japanese launch, but he chose '20' because it sounded friendly. This was a theme he was to pioneer.

The VIC-1001 debuted at the Seibu Department store in Japan in September 1980, taking over 100 orders by the end of the month and officially launching in October. While Tomczyk calculated that NEC and other Japanese companies would take a few months to digest this new offering, it would give his team time to prepare for the US launch and hopefully arrive before the competition tried to conquer America. Having worked for two years in Asia he was familiar with their business practices. It was a tactic that worked.

Tomczyk's prime directive to marketers and developers at Commodore was to promote the VIC-20 as a "user-friendly computer", going as far as to trademark the phrase "the friendly computer." Part of this push was to make the VIC-20 available at general retail outlets instead of specialist dealers, putting it on a competitive front with consoles. As it turned out the VIC-20 was advertised positively, comparing its features to consoles as there were no computers available in the same price bracket.

The aim was that if an 'ordinary' person bought the computer, then it should be simple enough for them to understand. Tomczyk himself was responsible for a number of features including the use of symbols and the name of each colour of the front of the keys. The team attempted to make the user manual as friendly and uncomplicated as possible for new computer users, leaving the technical nitty-gritty to the Programmer's Reference Guide.

Helping Tomczyk for the American launch were some new recruits including Andy Finkel, Neil Harris (his eventual second-in-command) and Englishman Paul Higginbottom. They were responsible for preparing manuals, fixing the Japanese software for Western launch and getting new games ready. To assist, Tomczyk hired a group of 'hackers' dubbed the 'VIC Commandos' who wrote the initial batch of 12 tape games to complement the higher-priced cartridges. Finkel later wrote a number of games for the VIC and C64, while Higginbottom became one of the main product managers overseeing the computer's success.

Come the launch of the VIC-20 in the US and Europe during 1981, everything seemingly fell into place. The computer was a huge hit with the public and garnered mainly positive reviews from the specialist press. Promotion of the VIC-20 as a 'user-friendly' computer had struck a chord, helped by the use of a familiar face (William Shatner) in prominent TV and magazine adverts. Most major retail chains had their own VIC-20 demonstration display for potential customers to try out. Commodore really was operating at full throttle to promote the computer.

People saw the VIC-20 not only as a games machine, but a device that could help in everyday life by way of the available

COMMUNITY – THE BEST VIC-20 WEBSITES

Denial

<http://sleepingelephant.com/denial/>

Denial may seem a strange name (it's an anagram of the site owner's surname) but it definitely is the focal point of most VIC-20 activity today, especially the forum where details, reports and developments of everything current and past can be found.



Cosine Systems

www.cosine.org.uk

Although it's not Commodore VIC-20 specific, Cosine has been responsible for a number of high-quality demos and games in recent years, all available to download for free from its site. On top of this, the site also features a great links list and C64 downloads.



Digital Archaeology

www.digitpress.com/the_digs/vic20/

A lot of work documenting and archiving everything VIC-20 related was undertaken by Ward Shrake and his team during the Nineties. Now retired from the retro scene, this is a record of everything that is still (mostly) relevant today.



VIC-20 Online

www.eskimo.com/~areed/vic/

VIC-20 Online is a new site, with mostly personal related material featured, but there are a lot of really interesting and detailed scans from magazines and publications from the early Eighties relevant to the VIC-20. There are also reviews of a number of VIC-20 accessories.

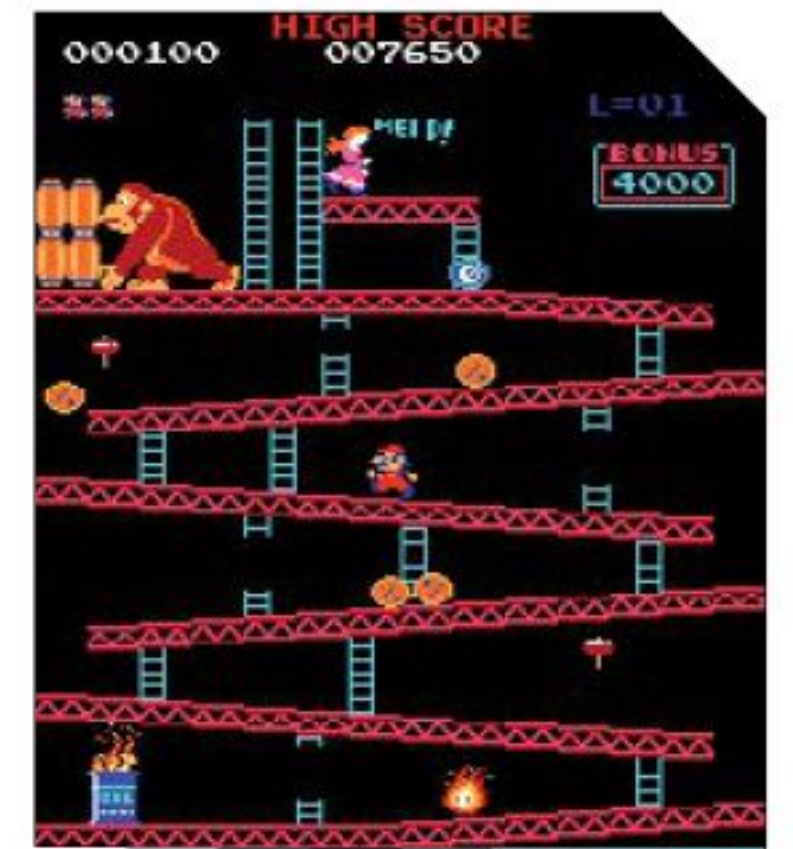

Turning down Nintendo

In today's climate that would be a rather foolish move to make. Back then though it was an entirely different world, one in which American companies mainly ruled the waves. According to Tomczyk, shortly after the release of the VIC-20 in the West, he was able to begin negotiations with Nintendo regarding converting some of its arcade titles, including *Donkey Kong*, to home formats. Such a deal would have been a coup but as Tomczyk was about to sign, Tramiel told him to cancel the agreement. Tomczyk believes that because of his enthusiasm in general for home formats, Nintendo decided to have a go itself. The timing would seem logical, as development on the Famicom began in August 1981 and the first wave of arcade conversions of Bally Midway titles (see 'Those 'banned' games' boxout) appeared on the VIC-20 in early 1982. Tomczyk believes Tramiel snubbed Nintendo due to the agreement now in place with Bally. Atari ended up with the licence to convert Nintendo's arcades to home format, although it wasn't immune to later following suit and screwing up royally on a potential deal...

software (or by creating their own programs). Programming was no longer confined to the hobbyist or professional as computing was brought into the homes of a wider demographic. As the Spectrum was about to do in the UK, the VIC-20 became a starting point for many people who would later go on to greater things.

Assisting Commodore's profit margins was the assertion by Tomczyk that each unit captured at least another \$1,000 worth of accessories and additional hardware. One of these was the VICModem, the first modem to retail at under \$100 and responsible for being the first footsteps of many home owners in going online. With the creation of the Commodore Information Network to take some of the strain off telephone customer support, it is no surprise Commodore claimed this board accounted for the largest amount of traffic on CompuServe in 1982.

Indeed, 1982 saw Commodore's fortunes go from good to spectacular, the VIC-20 recording approximately 800,000 units sold and revenue of \$300 million on the back of a peak production rate of 9,000 units per day. Tomczyk still expected the Japanese companies to launch their computers in the US and they did, but restricted themselves to the high-end market only. With 1983 in its infancy it became the first home computer to achieve a million sales worldwide. What could possibly halt the success of the VIC-20 now? Well, Commodore itself as it turned out.

Fifteen years before Sega killed off its own hardware (the Saturn), Commodore did the same by releasing the Commodore 64 in August 1982. It had always been part of the overall scheme of resisting the potential Japanese invasion that another computer would be released, but in such a short time frame it meant the VIC-20 would die before it had been able to live. It can be argued that it was 'sacrificed' for the future of Commodore and just two years

after its launch was priced at a mere \$200 (in the US) or £100 (in the UK), but still targeted as an entry-level machine.

Curiously enough such a fate was not to befall the C64 once the Amiga arrived a few years after, nor did it apply to the Spectrum. Both carried on into the Nineties with commercial software releases, leaving their predecessors choking on what might have been. By the end of 1984 the last VIC-20 had rolled off the production line and in early 1985 the last computers left the shops, although software was still available. Roughly 2.5 million VIC-20s had been sold; cementing Commodore's standing and defining its future.

And that is really the computer's legacy. Not only did the C64 carry on the look and style, but most of the peripherals and accessories that worked with the VIC-20, such as joystick, datasette, disk drive and printer worked with the new computer. Upgrading was suddenly a lot less painful than it used to be, and it was all part of the design, though it did cause some speed issues.

In its wake it left a host of quality titles that hark back to the simpler arcade days of the time and evoke bygone memories when they are fired up to play. It is a pity many of them are very hard to find, so in these cases emulation is something to be grateful for. It proves that the situation then is the same as now, in that sometimes excellent games don't sell. Today there is a small but dedicated group of programmers writing new games and demos; there may not be much quantity but there is always quality about each production. They are the ones keeping the spirit alive in the same way Tom Griner and Jeff Minter did more than 25 years ago.

The VIC-20 may have been eclipsed by its big brother C64 in the end, but it deserves to emerge from the shadow and stand on its own as a machine to be reckoned with.



» The closest that the VIC-20 ever got to *Wizard Of War*. Explore the caves, shoot the monsters and collect all of the treasure.

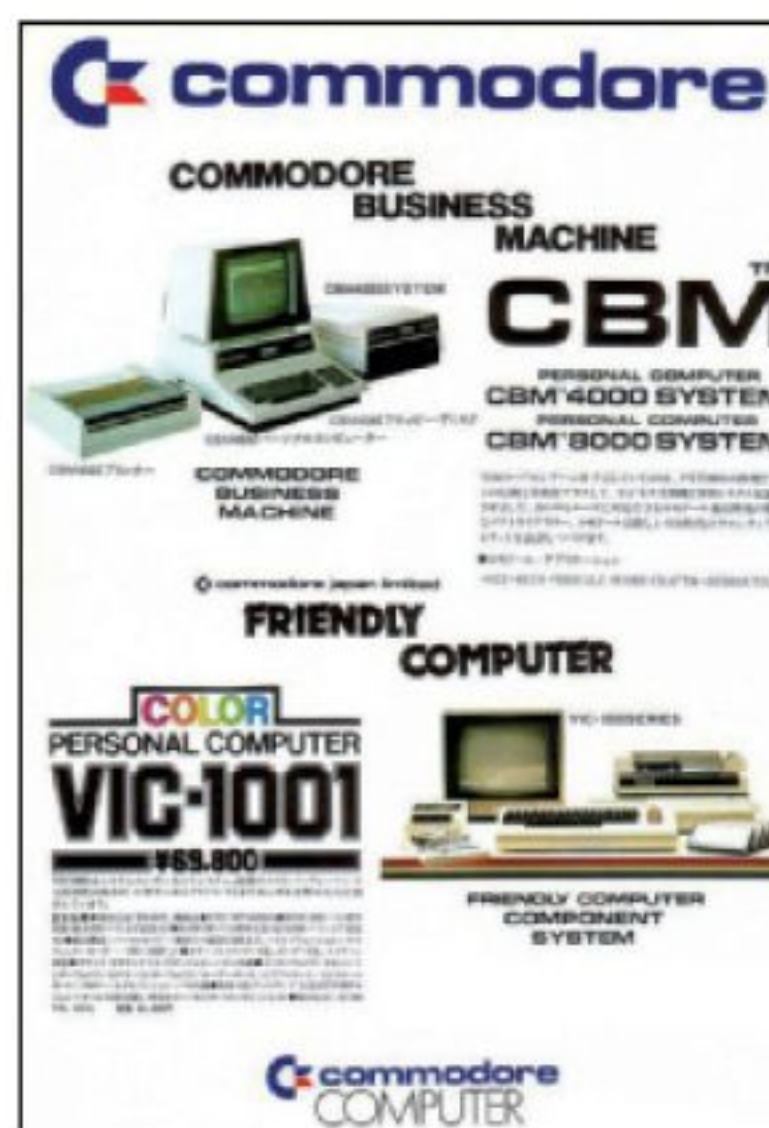

» Japanese launch advertising for the VIC-1001.



» A range of accessories for the VIC-20.

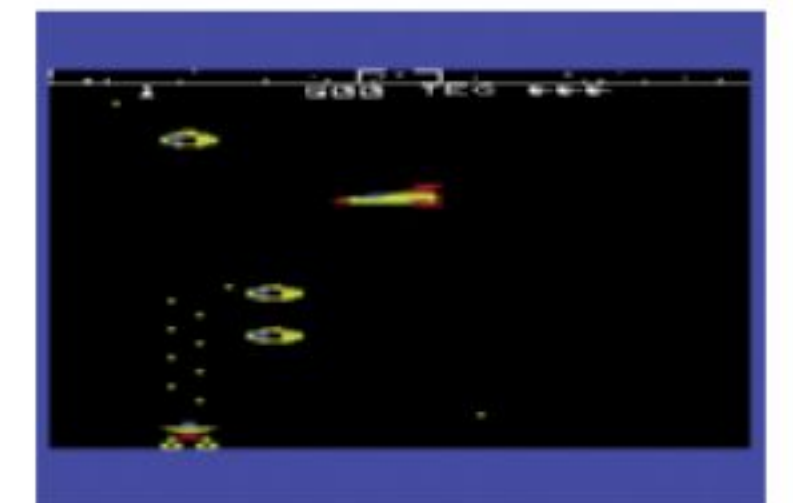

» Some examples of Tom Griner's ability: *Black Hole* (top) and *Astroblitz*.



» The six-port cartridge expander module.



VIC-20

PERFECT TEN GAMES

It may have only survived for five short years (four in the West) but Commodore's VIC-20 still had a healthy range of games available on it. So join us as we look back at ten of the machine's best games. If you're planning on entering the world of the VIC, then these are the games that you can't possibly do without

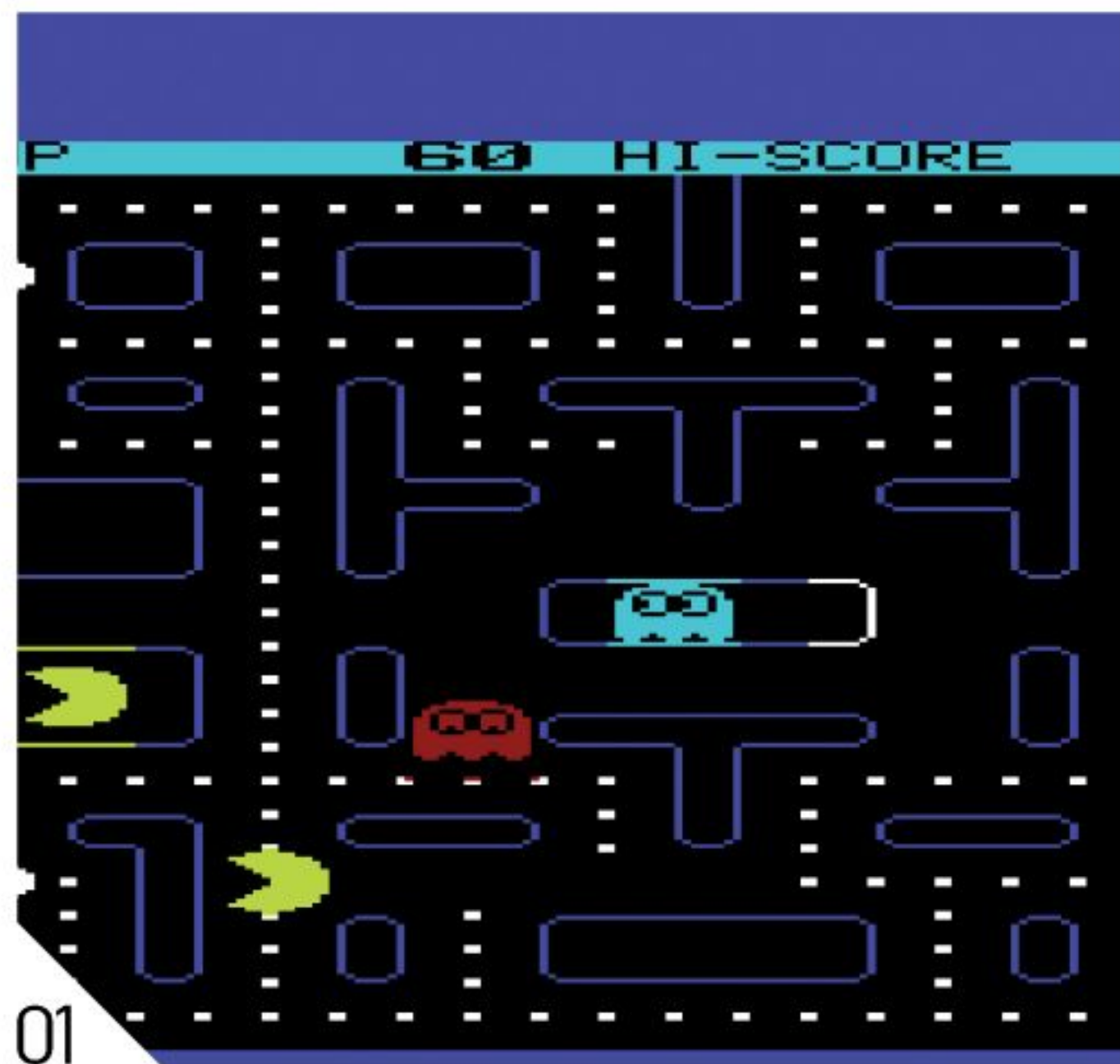

01

JELLY MONSTERS

- » RELEASED: 1981
- » PUBLISHED BY: COMMODORE
- » CREATED BY: HAL LABS
- » BY THE SAME DEVELOPER: SUPER SMASH BROS

01 With hindsight it may have been more than just a breach of licence that caused Atarisoft to be so keen to have this game removed from the shelves. The other reason strikes you soon after you start playing. This is actually an incredibly playable and fun version of *Pac-Man*, far more so than the effort Atarisoft itself later released on the VIC-20. Part of the attraction is the amazingly large software sprites representing the yellow marvel and his foes, as they waltz around the maze after one another. It may not be totally accurate, but then again it was a lot closer than a certain Atari release for the 2600.

OMEGA RACE

- » RELEASED: 1982
- » PUBLISHED BY: COMMODORE
- » CREATED BY: IN-HOUSE
- » BY THE SAME DEVELOPER: DRAGON'S DEN

02 Including another arcade conversion in the list may seem strange, for VIC-20 usually only went so far to reproduce the machines. There are always exceptions. The expertly programmed *Omega Race* by Andy Finkel is one such exception. *Omega Race* was Midway's only vector arcade game, and he managed to retain the complete look, feel, control and playability of the original. Even under the joystick the ship never feels out of control, and the fast-paced nature of the action makes it a greater draw than *Asteroids*. We'd go as far to say this edition was better than the later C64 conversion.

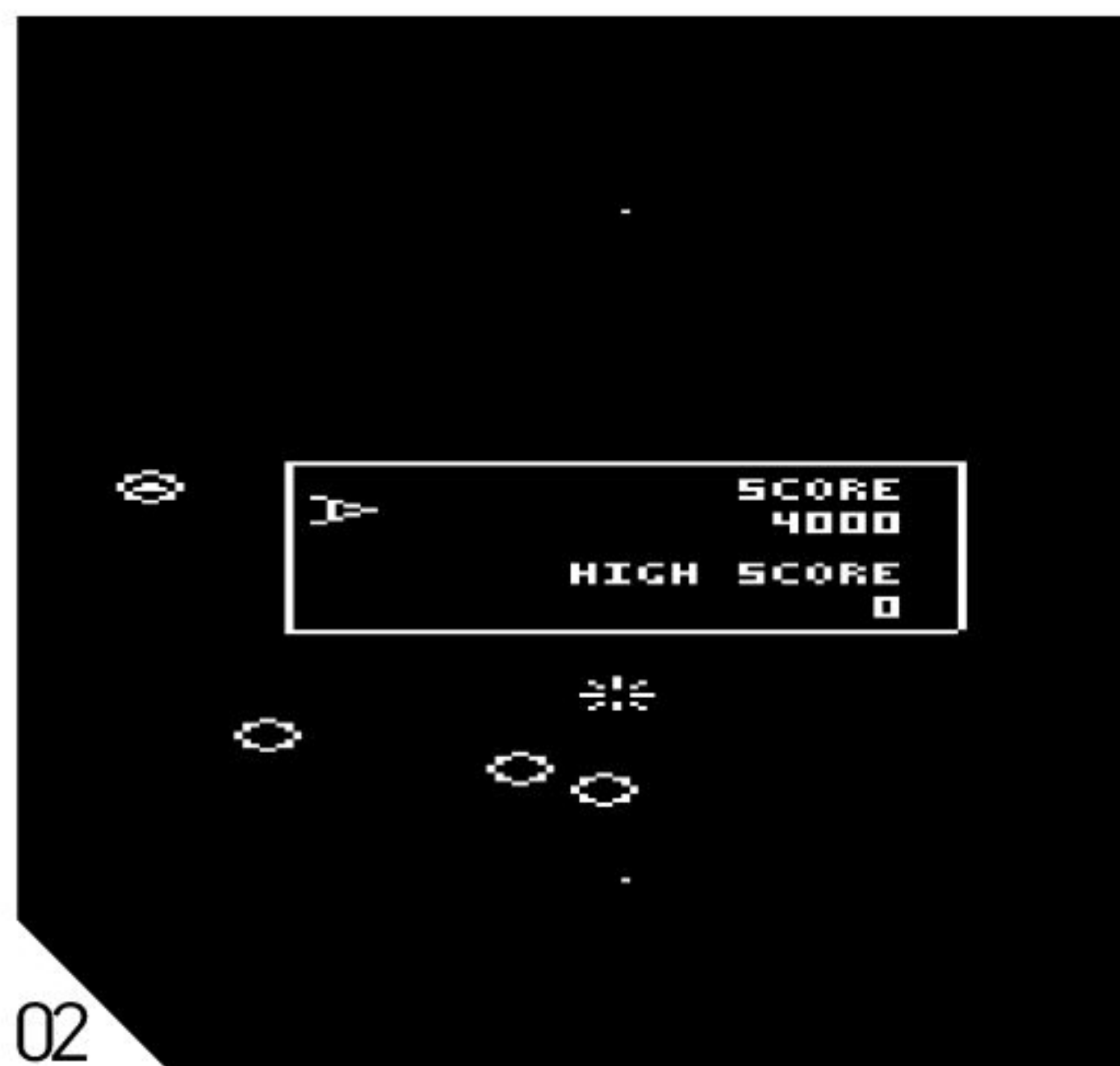

02

PIRATE COVE ADVENTURE

- » RELEASED: 1981
- » PUBLISHED BY: COMMODORE
- » CREATED BY: IN-HOUSE
- » BY THE SAME DEVELOPER: VOODOO CASTLE

03 While the adventures themselves were Scott (or Alexis) Adams' creations, the five licensed to Commodore were programmed by Andy Finkel, who squeezed the originals into 16K each without any loss of substance. Compression aside *Pirate Cove Adventure* is accepted as one of the best text adventures available, a two-word command assault upon the high seas to solve problems, acquire treasure and return it to the safety of your living room. Most of the puzzles are fairly logical and this will certainly present a challenge to all who attempt it.

MATRIX

- » RELEASED: 1983
- » PUBLISHED BY: LLAMASOFT
- » CREATED BY: JEFF MINTER
- » BY THE SAME DEVELOPER: SPACE GIRAFFE

04 Although *Gridrunner* started Jeff Minter along the path to worldwide notability, its sequel *Matrix* (aka *Attack Of The Mutant Camels in the US*) is the better game overall. It's harder, more varied, can often throw up a few surprises, and fixes some issues from the original (most notably the ability to 'camp' in the left-hand column to avoid the vertical zapper). The Score Panic mode of the camel waves raises the tempo, and the snitch character at the top keeps you from staying still too long. And we haven't mentioned the shot deflectors yet... one of the VIC's greatest blasters.

SWORD OF FARGOAL

- » RELEASED: 1982
- » PUBLISHED BY: EPYX
- » CREATED BY: IN-HOUSE
- » BY THE SAME DEVELOPER: TEMPLE OF APSHAI

05 Epyx had already begun the *Temple Of Apschai* trilogy when *Sword Of Fargoal* was released. This was an arcade-like, pared-down version of the dungeon crawler. Your task was to descend through many randomly generated levels in search of the legendary sword, returning to the surface intact. With the ability only to see where you've already explored, it made the game a tense, calculating affair as you decide when to fight, when to run and when to grab all that treasure lying about. Each level was confined to the visible screen, making it feel more claustrophobic in nature. More playable than its C64 cousin.



03

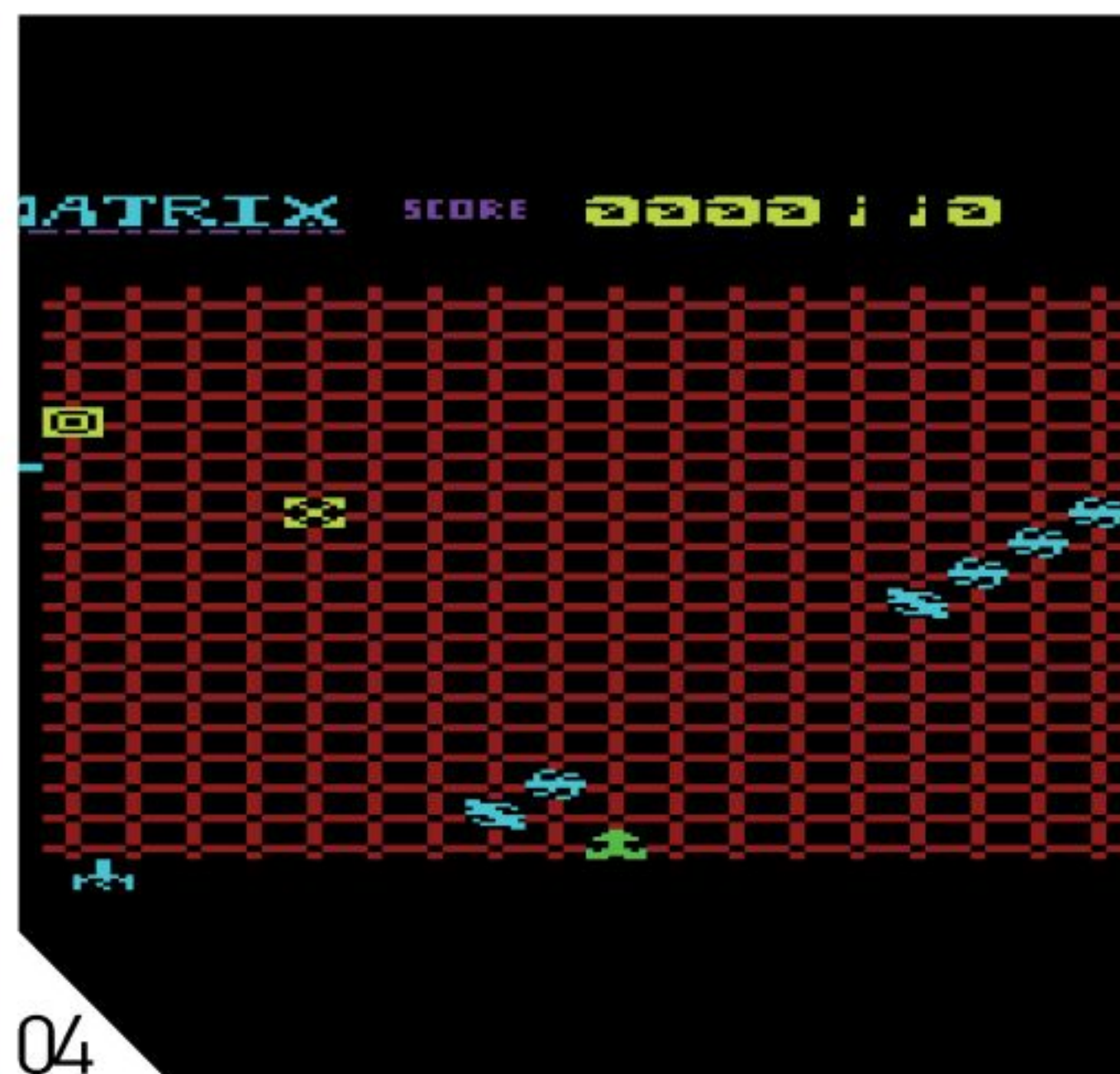

04



05



06

DEMON ATTACK

» RELEASED: 1983

» PUBLISHED BY: IMAGIC

» CREATED BY: IN-HOUSE

» BY THE SAME DEVELOPER:
ATLANTIS

06 “You not good enough for Demon Attack!” screamed the alien in the commercial.

As it transpires, however, the VIC-20 versions of Imagic’s Atari 2600 games were good enough, especially this *Phoenix* clone (allegedly). Take control of the lone fighter battling through 84 waves of demon birds that have various different behaviour patterns and quite often split in half when shot. Given the liberal fire that is raining down upon you, this is no easy task after a few waves have been cleared. *Demon Attack* maintains the look and feel of the original game, and, needless to say, it retains the difficulty level as well.

ASTRO NELL

» RELEASED: 2004

» PUBLISHED BY: COSINE

» CREATED BY: MATT SIMMONDS

» BY THE SAME DEVELOPER: VICCOLUMN

09 Software Project’s *Perils Of Willy* somehow managed to squeeze in 33 screens of action using the 16K memory expansion. *Astro Nell*, on the other hand, provides the VIC-20 with a *Jet Set Willy* multi-screen experience stuffed into... well, no expanded memory whatsoever. If you can see beyond the astonishment and wonderment of how this is all possible, you also discover that it is just as tricky, nasty and polished as the game it imitates. This is old-school gaming requiring accurate jumps, paper on which to map out the rooms, and a plan to collect all of the items. So much for concessions based on age.



07

KEY QUEST

» RELEASED: 1983

» PUBLISHED BY: TYMAC

» CREATED BY: COMPUTER
APPLICATIONS INC» BY THE SAME DEVELOPER:
N/A

07 There’s only one real downside to this game: there’s only one known copy.

Thankfully it’s been archived and made available for those who wish to try it out in emulation. It’s just a pity it wasn’t more widely available at the time as it’s a very good game. Much in the style of *Tutankham* you control an intrepid explorer through lots of different mazes collecting treasure, and despatching the continually multiplying enemies though you can only shoot left or right. Gaining 12 treasures in each maze opens the door to the next. Fast paced, challenging and addictive, *Key Quest* well worth checking out.

GAME THEORY

» RELEASED: 2007

» PUBLISHED BY: DENIAL

» CREATED BY: JEFF DANIELS

» BY THE SAME DEVELOPER: ZOMBIE YARD

10 *WarioWare* is a fairly new concept but it has already spawned a few imitators. But would you ever believe that one would appear on the VIC-20? While made simpler to control by requiring only the press (or presses) of the button as opposed to also moving the joystick, it doesn’t mean that there is a loss of difficulty. Far from it, many of them are no pushover. Jeff Daniels has also managed to cram a surprising number of different mini-games into just 3.5K, making it a varied and non-repetitive experience. If he carries through his plan for a sequel using the 8K expansion, it should be something worth looking forward to.



08

LASER ZONE

» RELEASED: 1983

» PUBLISHED BY: LLAMASOFT

» CREATED BY: JEFF MINTER

» BY THE SAME DEVELOPER:
TEMPEST 2000

08 Rest assured that Llamasoft barely ever released a dud for the VIC-20, which is why another of Jeff’s games features in the list. Controlling two guns at once, you must defend the outpost against the invading Zzyax aliens. While the C64 version allowed for simultaneous two-player action, the VIC-20 original is again arguably the better and more playable title. It is certainly harder by way of the smaller graphics, requiring more precise aiming especially if one of the nasties manages to land on a gun axis. At higher levels it needs total concentration, almost putting yourself “in the zone”, a state quite often achieved with Llamasoft titles.



09



10



VIC-20

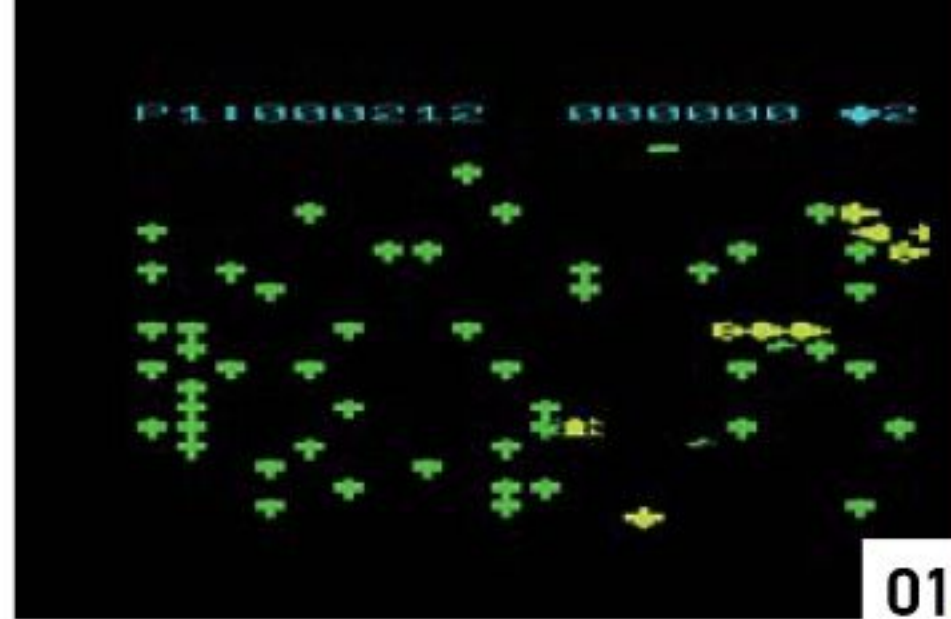

01



02



03



04

VIC-20 and the rest...

The VIC-20 certainly had its fair share of classic titles, as well as a fair few stinkers as well. Take a gander over the following two pages and see how many classics you can remember playing

- 01 CENTIPEDE
- 02 SEAWOLF
- 03 THE DUNGEONS
- 04 MAZE
- 05 PARATROOPER
- 06 DEADLY DUCK
- 07 SPACE JOUST
- 08 TUTANKHAM
- 09 RAT HOTEL
- 10 3D LABYRINTH
- 11 AVENGER
- 12 GOLD RUSH AND FROG
- 14 JETPAC
- 15 FAST EDDIE
- 16 RADAR RAT RACE
- 17 TEMPLE OF APSHAI
- 18 WACKY WAITERS
- 19 HEKTIK
- 20 BANDITS
- 21 AE
- 22 ENVAHI
- 23 MEDIEVAL JOUST
- 24 RENAISSANCE
- 25 SPACE ESCORT
- 26 TANK ATAK
- 27 GRIDRUNNER
- 28 BUCK ROGERS
- 29 ATLANTIS
- 30 OUTBACK
- 31 SPIDER CITY
- 32 SHAMUS
- 33 MISSION IMPOSSIBLE
- 34 GHOST
- 35 CATCHA SNATCHA
- 36 MONEY WARS
- 37 JAWBREAKER
- 38 RIVER RESCUE
- 39 SPIKE'S PEAK
- 40 COSMIC FIREBIRDS
- 41 FROGGER
- 42 Q'BERT
- 43 ROBIN HOOD
- 44 GALACTIC ABDUCTORS
- 45 MINE MADNESS
- 46 STAR DEFENCE
- 47 RAID ON FORT KNOX
- 48 TOPPER
- 49 DIGGER
- 50 BONGO
- 51 PREDATOR
- 52 POLE POSITION
- 53 SUPER ALIEN
- 54 THRESHOLD
- 55 TRAXX
- 56 DIG DUG
- 57 GHOST MANOR
- 58 BEEKEEPER
- 59 DEATH RACE
- 60 LUNAR LEEPER
- 61 ROAD RACE
- 62 THE SKY IS FALLING
- 63 WITCH WAY
- 64 PIPES
- 65 MINER 2049ER
- 66 APE ESCAPE
- 67 FORBIDDEN TOWER
- 68 MARTIAN RAIDER
- 69 PHARAOH'S TOMB
- 70 RICHOCHET
- 71 TERRAGUARD
- 72 CANNONBALL BLITZ
- 73 GARDEN WARS
- 74 JOHNNY JUMPET
- 75 AMAZING MAZE
- 76 K-STAR PATROL
- 77 RESCUE AT RIGEL
- 78 QUASIMODO
- 79 CHOPLIFTER!
- 80 SKRAMBLE
- 81 TRASHMAN
- 82 VISIBLE SOLAR SYSTEM
- 83 SCORPION
- 84 CLOWNS
- 85 MINITRON
- 86 PUNCHY
- 87 SUBMARINE COMMANDER



16

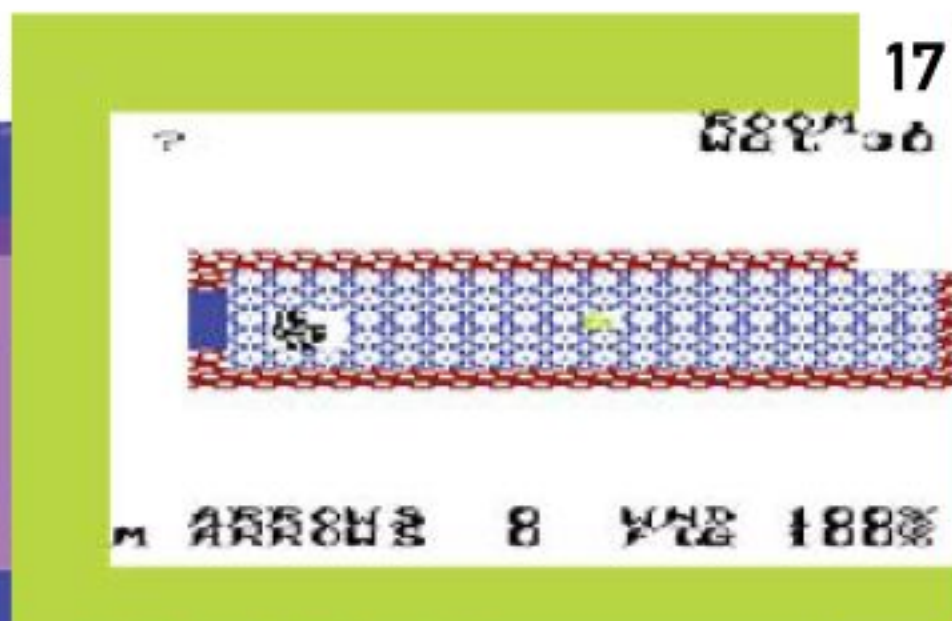

17

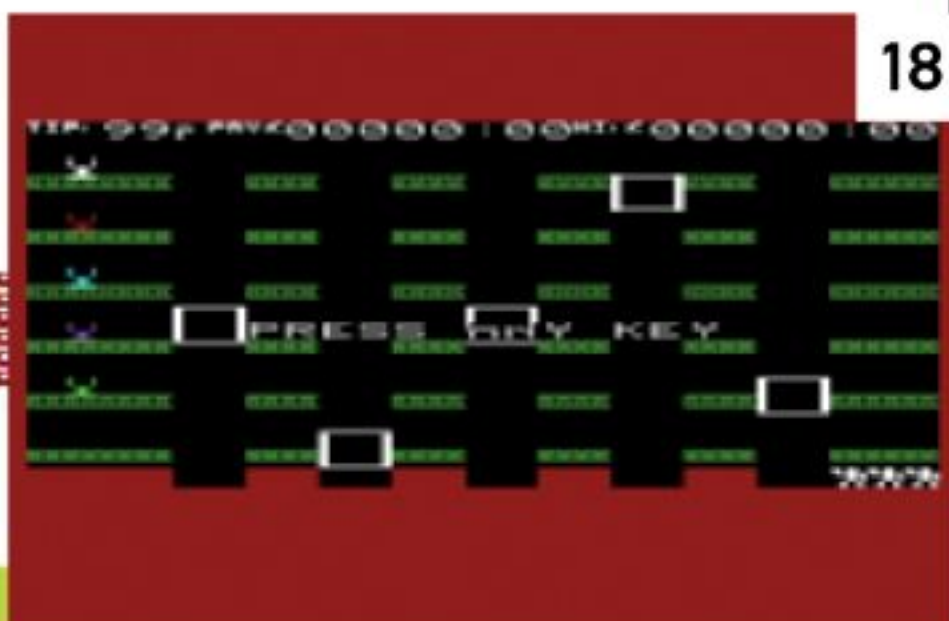

18



19



25



26



27



28



34



35



36

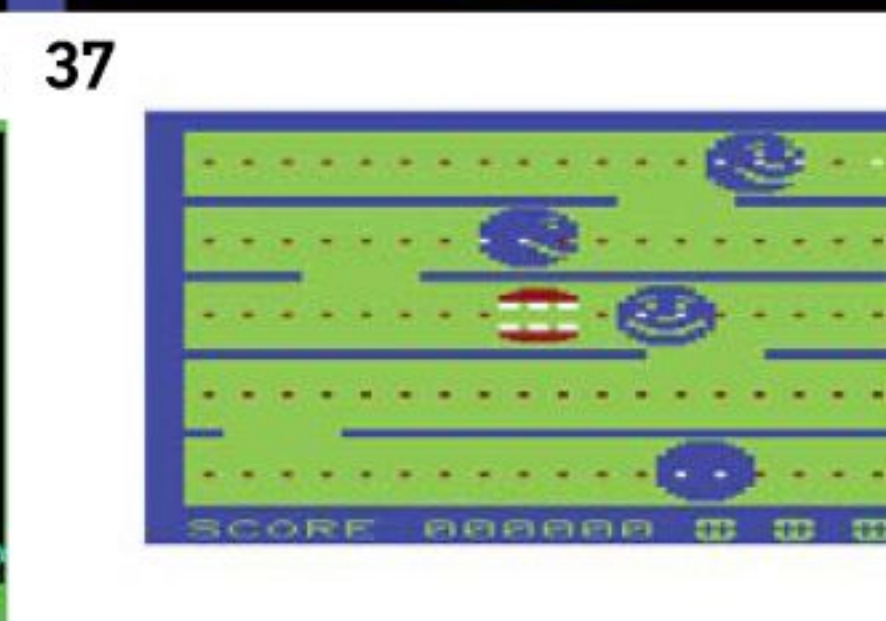

37



43



44



45



46



52



53

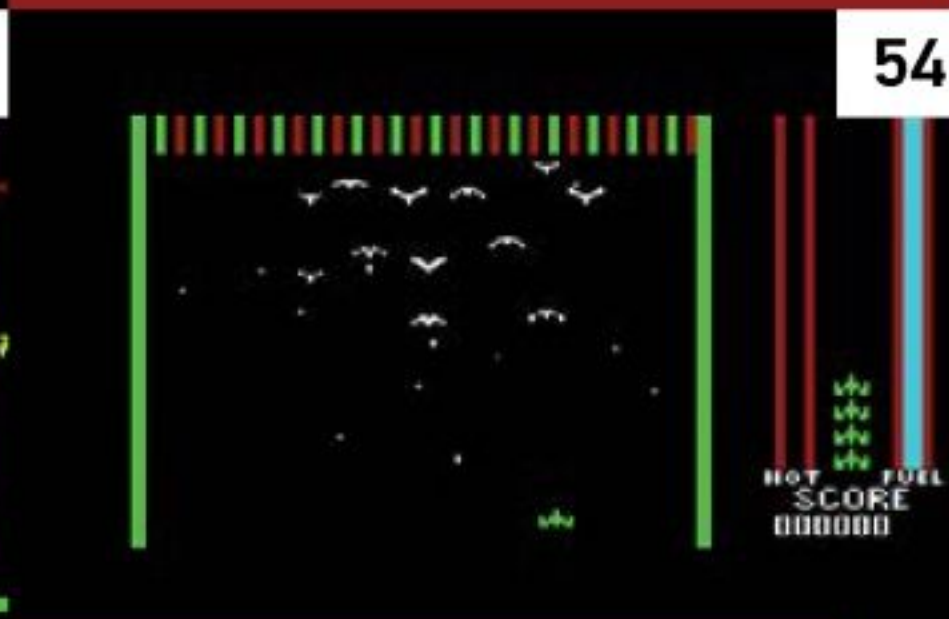

54



55



61



62



63



64



70



71

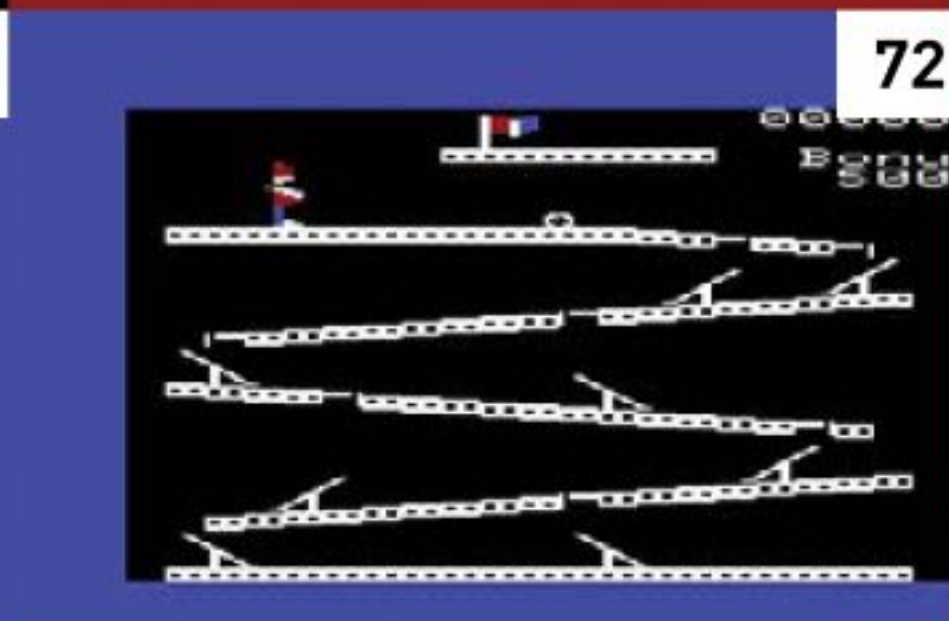

72

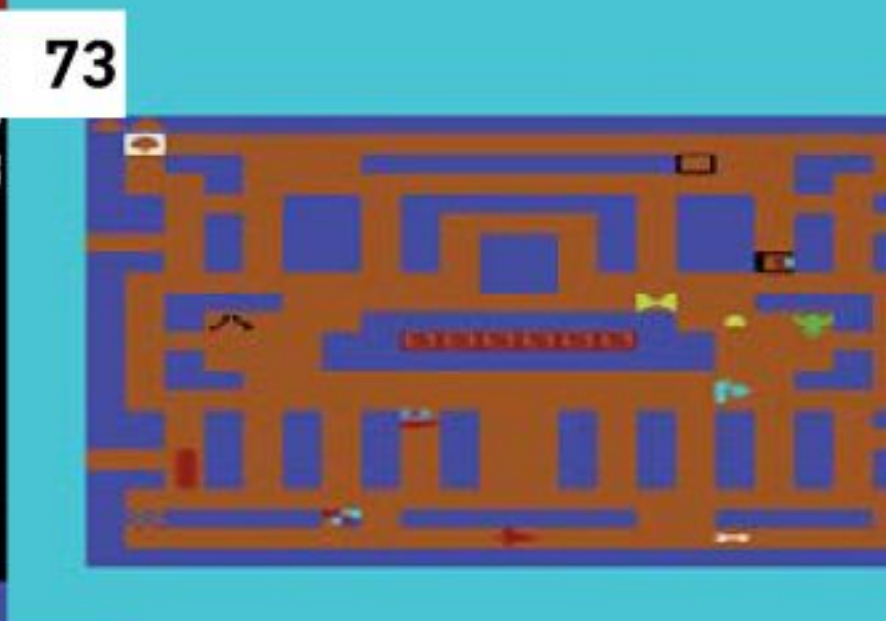

73



79



80



81



82



PC-ENGINE

“NEC AND HUDSON SOFT TURNED THEIR ATTENTION TO ANOTHER SECTOR OF THE MARKET DOMINATED BY NINTENDO THE PORTABLE ARENA – AND SET ABOUT PLANNING THEIR CONQUEST”



PC-ENGINE GT

IT MAY HAVE FAILED TO SELL IN THE NUMBERS EXPECTED BUT THE PC-ENGINE GT REMAINS ONE OF THE MOST DESIRABLE PIECES OF CONSOLE HARDWARE EVER PRODUCED. WE STOCK UP ON AA BATTERIES AND LOOK BACK ON THE MACHINE THAT DELIVERED PORTABLE GAMING IN A CLASS OF ITS OWN



Year released: 1990 (Japan)

Original price: \$299 (around £150)

Buy it now for: £50-£100

Associated magazines: TurboPlay (USA), Go! (UK, C&VG supplement), PCE Freak (Japan)

Why the PC-Engine GT was great... Being able to play cutting-edge HuCard software on the move made you an instant hero among like-minded gamers, and the cutting-edge LCD screen made rivals like the Lynx and Game Gear look decidedly dodgy in comparison.

Comfortably sitting here in 2008 it's hard to fully appreciate the impact the PC-Engine GT had when it was released nearly 20 years ago. To give this momentous hardware launch a touch of perspective, if it were to happen today it would be the equivalent of Sony releasing a portable PS3. Bearing this in mind it's relatively easy to see why this eminently desirable slab of plastic retains such an avid following nowadays; it is arguably the most elite portable console of its time, comfortably putting contemporary rivals in the shade and costing lucky owners an arm and a leg in the process.

To trace the genesis of the GT it's worth taking a look at the gaming landscape back in the late-Eighties. Looking to crack the rapidly expanding console market, Japanese companies NEC and Hudson Soft had entered into a deal whereby the former would provide capital and production facilities and the latter would contribute its newly developed chipset and a wealth of industry experience. The result was a console that took Japan by storm: the PC-Engine. With Nintendo's legendary stranglehold in Japan successfully broken, it's easy to see why NEC and partner Hudson Soft felt they could do no wrong. The ebullient cohorts turned their attention to another sector of the market dominated by Nintendo – the portable arena – and set about planning their conquest.

The monochrome Game Boy had built on Nintendo's experience with its seminal LCD Game & Watch range and had unsurprisingly sold by the bucket load. The triumphant performance of the PC-Engine bestowed its creators with a fair degree of confidence and buoyed by this success they evidently felt they could permit their R&D departments to go a little crazy. Not only did this productive union result in the console industry's first CD-ROM attachment in 1988, it also sired the stillborn SuperGrafx, an augmented version of the PC-Engine that was intended to take on Sega's Mega Drive, but failed miserably. The portable GT was yet another project to spring from the overactive minds of NEC and Hudson Soft's talented engineers.

Rather than follow Nintendo's lead and craft a console that was both highly portable and cheap to produce, so it could retail for a reasonable price, the decision was made to construct a product that would harness the very best technology the domestic market could offer and miniaturise it. Astonishingly, the GT was identical to NEC's home hardware, boasting the same HuC6280 processor technology and impressive sprite-handling capabilities of the custom HuC6270 16-bit graphics chip. Granted, Sega took a similar route with the Game Gear, basing it on the trusty 8-bit Master System hardware, but in terms of raw power there was little point in comparing the two. The PC-Engine was in a different league to Sega's machine.

As well as giving the GT technical parity with the phenomenally successful home hardware, the new console also utilised the same HuCard (or TurboChip if you were of the American persuasion) storage method for games. The ability to play your home console collection on the move cannot be understated; it's also important to keep in mind the uniqueness of the PC-Engine carts at the time. The credit card-sized HuCards were compact, highly portable and surprisingly sturdy, all



» A rather happy looking fellow helps promote the GT in this Japanese advert.

INSTANT EXPERT

Although the GT and its parent console the PC-Engine are often compared to machines like the NES and SMS thanks to their 8-bit CPUs, the graphics chip is in fact 16-bit. **Like the PC-Engine**, the PC-E GT featured some rather handy auto-fire switches.

The appeal of NEC's hardware was expandability, but sadly the GT couldn't be hooked up to any of the PC-Engine CD-ROM add-ons. **The TurboGrafx port** of flight simulator *Falcon* featured a dedicated two-player dogfight mode that could only be unlocked using the TurboLink.

Because you couldn't hook up the TurboBooster Plus memory backup device to the GT, games that required you to save in-between sessions were impractical.

A dedicated adaptor was produced to overcome region lock-out problems, which was handy for TurboExpress owners as very few quality games actually made it the United States.

As well as appearing in *Enemy Of The State*, the GT also cropped up in the lamentable *3 Ninjas* movie, as well as an episode of TV show *Doogie Howser, MD*.

The TurboVision TV tuner showcased additional audio and video inputs, which meant you could use your TurboExpress as a (very small) monitor.

Towards the end of the TurboExpress's life, the price was dropped and a four-game bundle pack was introduced to boost sales – neither tactic worked.

If you purchase a GT and find the sound is particularly low, you'll need to crack that baby open and get the soldering iron out, because the capacitors are faulty – an unfortunately common problem with NEC's portable.



PC-ENGINE

OTHER VERSIONS WHEN ONE MACHINE ISN'T ENOUGH

PC-Engine

Released in 1987, this is the machine upon which the GT is based. Diminutive and showcasing one of the most attractive designs in videogame history, it quickly became a bestseller in Japan. The CoreGrafx and CoreGrafx II soon followed, but both were essentially the same.



C'MON GUYS, ACCESSORISE

With every portable console there seems to be a tidal wave of additional accessories to purchase, and the GT was no exception to this rule. "The most common accessory for the GT is the TV Tuner, known as the TurboVision in the States," says Nanto. "The TV tuner allowed you to watch broadcast TV on your GT similar to what Sega did later with the Game Gear." It's prudent to bear in mind that this peripheral arrived a fair while before Sega's did. "The other accessories were pretty standard fare," continues Nanto. "The Car Adapter allowed you to operate your GT from a car charger, which was ideal for long journeys, the AC Adapter powered the console from an ordinary household outlet and the TurboLink allowed two consoles to play head to head on games that supported the feature."



TurboDuo

A PC-Engine and CD-ROM attachment, the Duo was meant to compete with the SNES. For NEC addicts, this is the only machine worth owning as you can play HuCard and CD-ROM games. The Duo-R and Duo-RX followed, but with only cosmetic alterations.

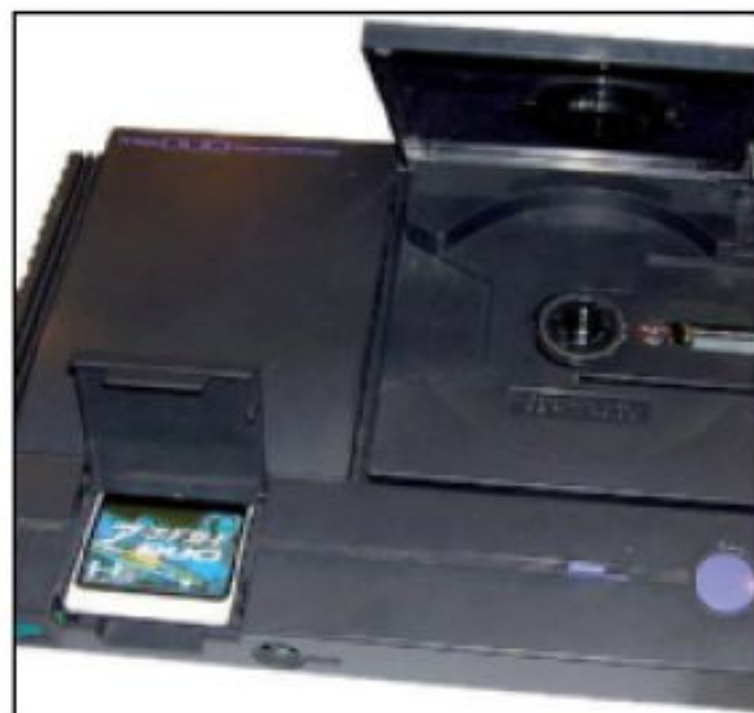

PC-Engine LT

An enhancement of the GT concept, this exclusive machine featured a superior screen and improved connectivity (it could link to the CD-ROM unit). It also cost the earth and wasn't that portable, nevertheless it still remains a highly sought-after entry in the NEC catalogue.



PC-Engine Shuttle

One of the most pointless releases in NEC's history, this was essentially a re-styled PC-Engine, but lacked the ability to link to the CD-ROM unit. It was aimed at children but the new casing design didn't find many fans, regardless of age. Nevertheless, it remains highly collectable these days.



of which tied in perfectly with the core ethos of the GT. It could be argued that Sega's Game Gear also offered the same connectivity, but it required an additional (and unofficial) adaptor in order to play Master System games and wasn't constructed with the implicit aim of enabling fans to carry their entire videogame library around with them. However, arguably the most instantly appealing aspect of the GT was the breathtaking 2.6" LCD screen, which stood apart from rival portables because it didn't suffer from washed-out colours or crippling motion blur. Taking all of these points into account it's little wonder that the GT was crowned by the gaming press as the 'Rolls Royce' of handheld consoles.

Unsurprisingly, such opulence came at a lofty price. When the GT was launched in the US (renamed TurboExpress) it retailed for a wallet-punishing \$299.99 (although some stores briefly sold it for \$50 less), which was nearly \$200 more than the market-leading Game Boy and around \$100 more than the TurboGrafx-16 – which was essentially the same system but without portability. Although



» Given the nature of the screen, shooters tended to be the best choice for GT owners – thankfully the PC-Engine has more than its fair share of these.

"THE GT WAS A SUPREMELY HUNGRY BEAST; TWO HOURS OF PLAY WAS THE BEST YOU COULD EXPECT TO GET OUT OF SIX AA BATTERIES. NEEDLESS TO SAY, SUCH RAVENOUS DEMAND FOR POWER MADE OWNING A GT EXCEEDINGLY COSTLY"

» The US packaging boasted of 16-bit colour visuals – something the Game Boy couldn't offer.

this premium cost was necessitated by the cutting-edge technology inside the unit, it nevertheless proved to be a fatal mistake on the part of NEC as it placed the machine firmly outside the reach of most gamers, rendering it uncompetitive in commercial terms. "The GT is still one of the most expensive portable game systems ever made," says NEC expert and PCEngineFX.com founder Aaron Nanto. "With the Game Boy, Game Gear and Lynx all being substantially lower priced at the time, the GT had no chance to sell better than those other systems. If NEC had priced

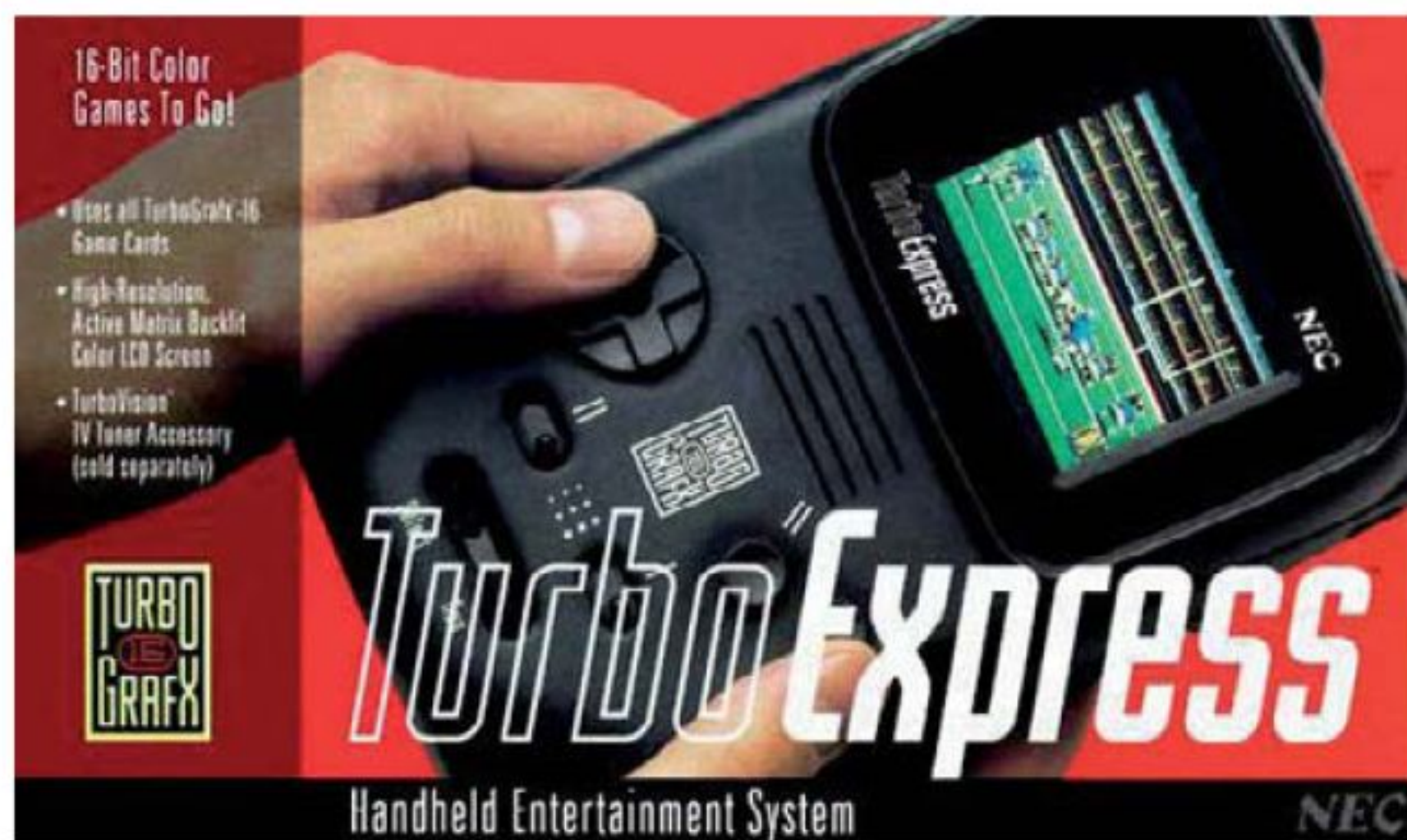

the unit competitively with the Game Boy or even the Game Gear from the start, things probably would have been a bit different."

To add to the issues the towering retail price presented, there were other niggles with the actual hardware itself. The LCD screen may have been better than anything previously seen on a portable console, but it wasn't perfect. It actually ran at a lower resolution than its domestic counterpart, which naturally caused headaches. "Since the resolution of the GT was so low, any game with text was almost impossible to read so the unit was only really suitable for games in the action/shooter genres, such as *Soldier Blade* and *Bonk's Adventure*," explains Nanto. This sadly meant that text-based adventures were practically unplayable on the machine.

Problems with the display didn't end there. The term 'dead pixel' may be commonplace these days, but back in the early Nineties consumers were less familiar with this issue; when several early adopters discovered that their newly purchased (and very expensive) GTs were missing pixels, the ensuing negative press did a lot to hurt the image of the fledgling portable. Another problem was encountered with the sound, which often came through very weakly or not at all; this issue was traced to faulty capacitors. The seemingly careless level of quality control displayed by NEC only added to the rather downbeat public perception of the console – which, it has to be remembered, was retailing for nearly three times the price of the market-leading (and very dependable) Game Boy.

Even the distinctive advantage of being compatible with PC-Engine software presented a rather strange situation for NEC when it came to promoting the machine. "The marketing strategy focused on the fact you could take the exact same game from



» The PC-Engine GT packaging was typically understated and made the machine even more desirable for anybody with money to burn.

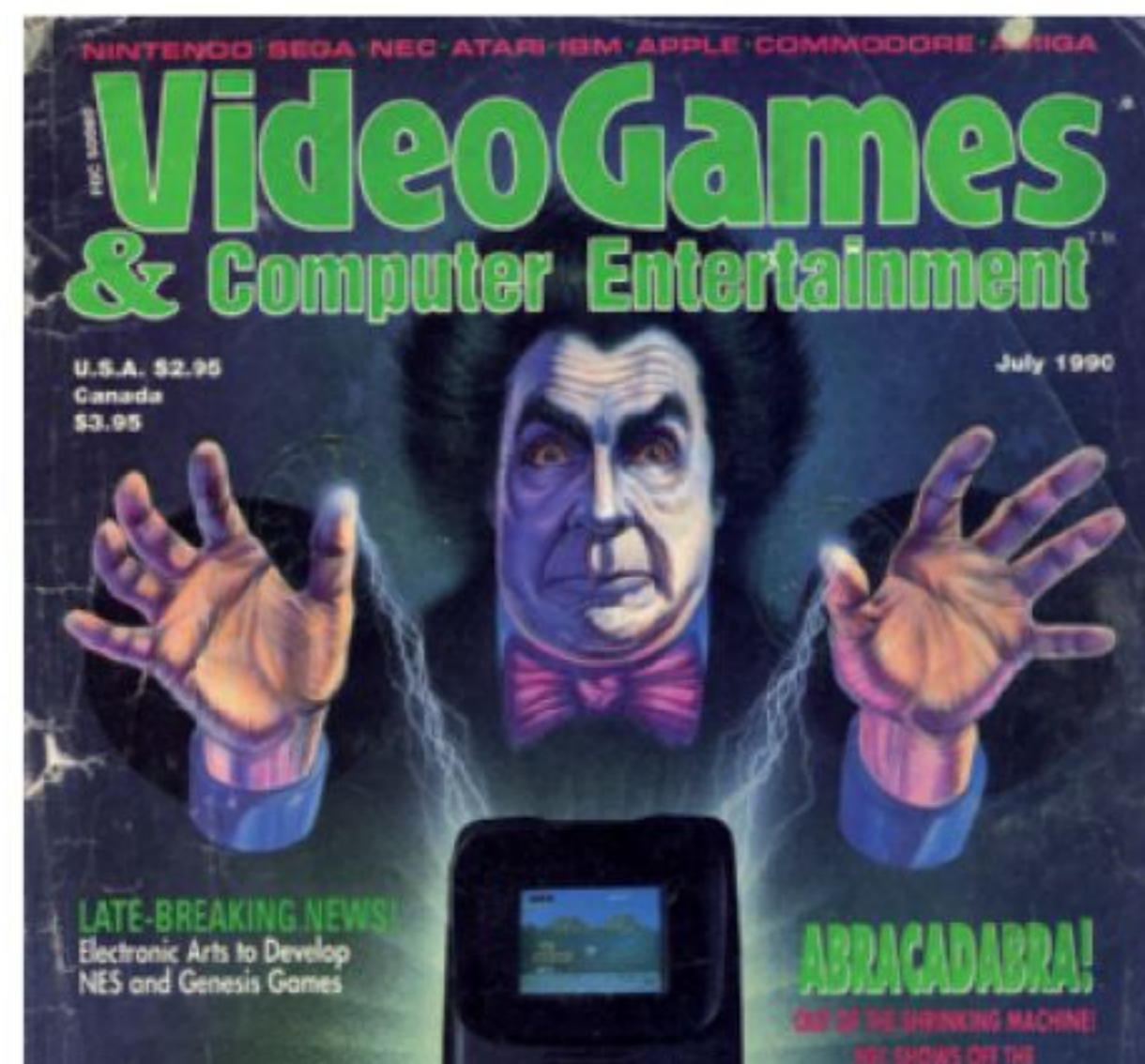

» US magazine *VideoGames & Computer Entertainment* broke the news of the PC-Engine GT with this rather disturbing cover.

the home console and play it on the portable,” recalls Nanto. It was an undeniably unique selling point, but the business model was critically flawed from the outset. Traditionally speaking, manufacturers expect to lose out financially on hardware but make profit on software. NEC’s plan seemed to ignore the fact that it was essentially preaching to the converted and in selling the GT to existing owners it would fail to benefit from the additional software sales that new customers would bring, as established PC-Engine fans would be unlikely to purchase any additional software purely because they owned the GT. As it turned out, the prohibitive price point dissuaded even these hardcore devotees from purchasing the console, and NEC’s already flimsy strategy fell to pieces.

Perhaps the most debilitating issue with the machine was power consumption. As was the case with other colour portable machines of that era, the GT was a supremely hungry beast; approximately two hours of play was the best you could expect to get out of a fresh set of six AA batteries. Needless to say this severely limited the portability of the console and in an era before rechargeable

batteries were commonplace, such ravenous demand for power made owning a GT exceedingly costly.

Although compatibility with PC-Engine software ensured that those gamers brave enough to pick up the machine were at least kept happy for a few years, the GT ceased to be a commercial force fairly swiftly and was steadily reduced in price until it was eventually discontinued. Getting trustworthy sales data from nearly two decades ago isn’t easy, but it’s believed that the machine shifted a disappointing 1.5 million units worldwide – well short of what NEC and Hudson Soft expected after the success of the PC-Engine.

The GT may have failed to seriously challenge the might of the Game Boy, but today it enjoys plenty of attention from keen gaming enthusiasts and despite its faults takes pride of place in any right-minded retro fan’s collection. While second-hand machines still manage to maintain their exclusive allure and similarly inflated price points, it’s not that hard to track down a console for a semi-reasonable sum. “The GT is fairly easy to obtain these days,” Nanto says. “The unit isn’t rare by any means, so if you wanted to buy one it would be an easy process. Units vary wildly in price, but you can expect to pay around \$100 (£50) to \$200 (about £100), depending on condition and whether it’s a US or Japanese unit.” Strictly speaking, the Eastern variant is the most appealing (and the most costly) as it grants access to a much wider range of software; like its domestic counterpart, the GT utilises region protection so US games will only work on a US TurboExpress, and vice versa.

The GT may have some serious niggles but it still makes a convincing argument for being one of the finest portable consoles ever produced; remembering the context of its release, it really was a revelation. The ability to take what was still a cutting-edge machine and play it on the move (albeit for short periods of time) was enough to make many hardcore gamers fall helplessly in love with the GT – thankfully that adoration is still alive and well today.

TAKING YOU TO THE MOVIES

It may well be common knowledge now but we couldn’t do a feature on the GT without mentioning what is arguably the console’s defining moment – appearing in its American TurboExpress guise in the 1998 Hollywood blockbuster *Enemy Of The State* alongside Will Smith and Gene Hackman. The TurboExpress is used to conceal a memory card containing footage of a murder, and is eventually planted on Will Smith’s character, which triggers a series of unfortunate events that transpire to make Smith a threat to national security. Although the TurboExpress isn’t actually shown in action (unsurprisingly, flash memory cards aren’t compatible with the machine) it nevertheless gets some impressive screen time. It’s a shame that by the time the movie was released, both the TurboExpress and American distributor TTI were both dead and buried – this kind of media attention would have been a massive boost in the dark days of the early Nineties.

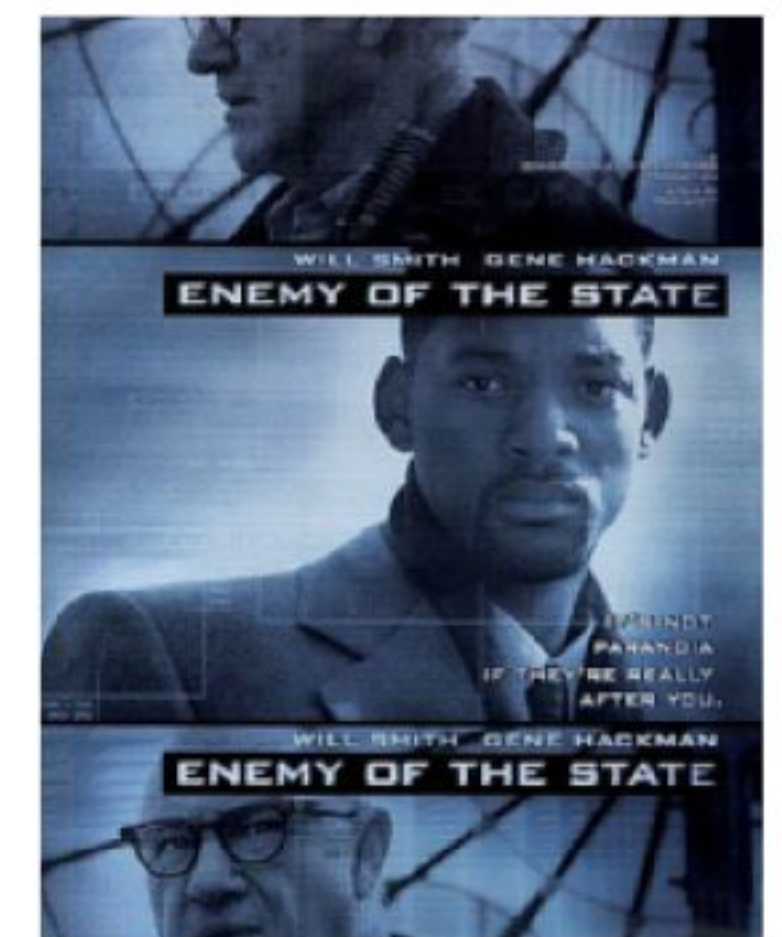

COMMUNITY PC-ENGINE SITES TO WATCH

PC-Engine FX

<http://pcenginefx.com>

The domain of NEC expert and all-round nice guy Aaron Nanto, this slick and highly professional site should be your first port of call if you’re new to the world of NEC. It contains news, videos, FAQs and even a store that sells brand new TG-16 software. Essential.

TurboGrafx-16.com

www.atari7800.com/turbo

This site documents the history of NEC consoles with a variety of documents and nostalgic musings. It also has a comprehensive ‘Tricknology’ archive packed with cheats for many titles. Some parts are still under development, but it’s a worthwhile visit nonetheless.

TurboPlay Magazine Archives

<http://archives.tg-16.com>

This site was set up to document all references to the TG-16/PC-E in printed media. It’s pretty incredible, with loads of high-quality scans. Magazines such as *EGM*, *TurboForce* and *GameFan* are all represented here.

The PC-Engine Software Bible

www.pcengine.co.uk

If you’re looking to buy PC-E software then this is the site for you. It has almost every release for the machine and gives a rating out of five. The reviews are short and sweet, so you’ll know pretty quickly if a game’s worth bothering with or not.





PC-ENGINE GT

PERFECT TEN GAMES

Okay, so we're obviously cheating here, as we've already published a perfect ten PC-Engine games in a previous issue. Still, due to the small screen and impossible-to-read text you have to be a little more careful when choosing your games. Pick any of the ten below and you'll be off to a perfect start

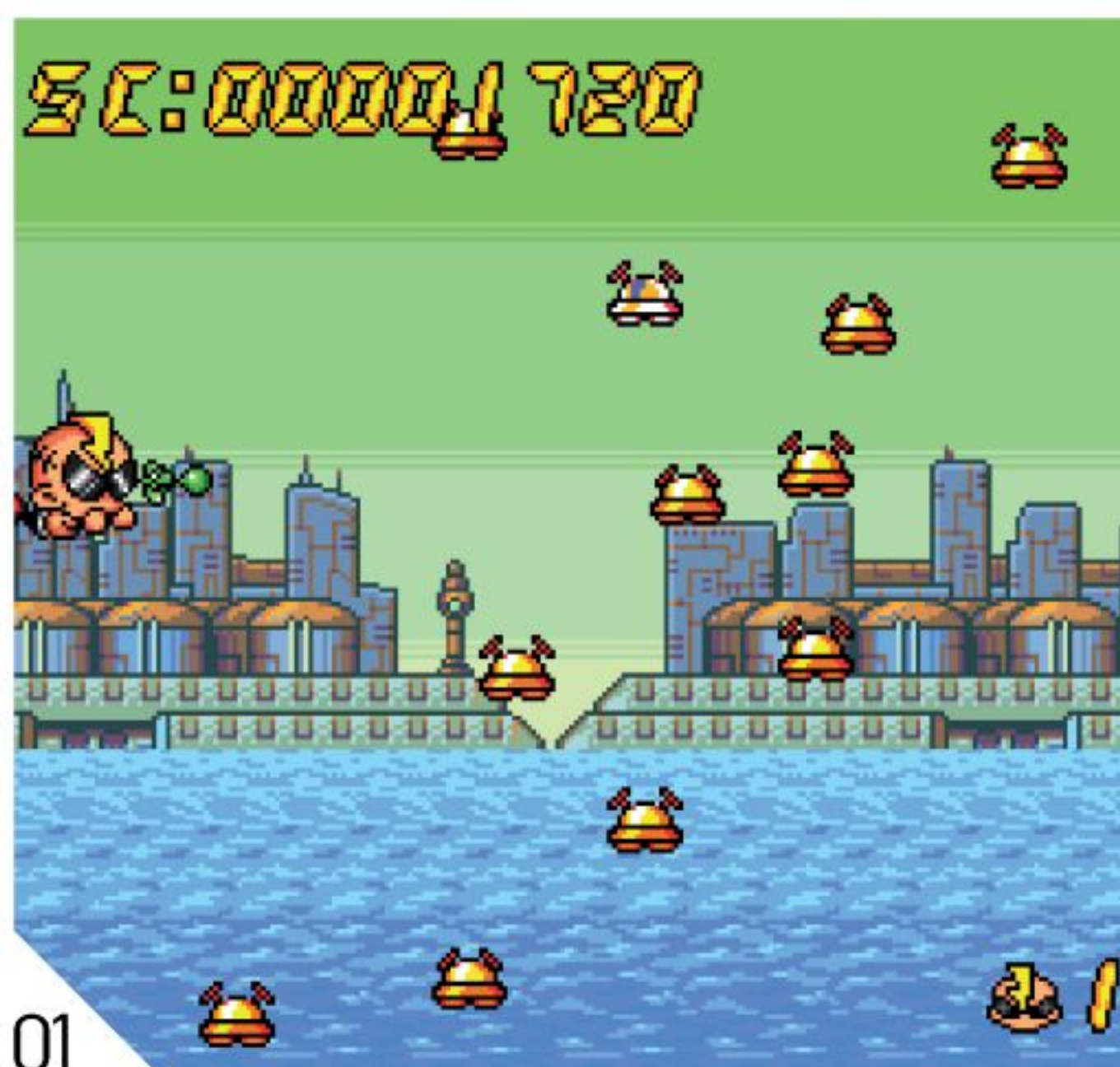

01

AIR ZONK/PC DENJIN

- » RELEASED: 1992
- » PUBLISHED BY: HUDSON SOFT
- » CREATED BY: RED/HUDSON SOFT
- » BY THE SAME DEVELOPER: BONK'S ADVENTURE

01 A side-scrolling shooter featuring a futuristic version of Hudson Soft's mascot Bonk (or PC Genjin as he was known to his Japanese fans), *Air Zonk* is one of the most visually accomplished games to be released on NEC's 8-bit wonder. Showcasing incredible multi-layer scrolling and some absolutely massive sprites, the game really does push the PC-Engine GT's hardware to the absolute limit. A CD version of *Air Zonk* was also released, but ironically it isn't quite as good as the HuCard variant – the two games are actually rather different in terms of structure. Given the stature of the game it should come as no surprise to learn that *Air Zonk* currently fetches a fair few bob on eBay these days.

SOLDIER BLADE

- » RELEASED: 1992
- » PUBLISHED BY: HUDSON SOFT
- » CREATED BY: RED/HUDSON SOFT
- » BY THE SAME DEVELOPER: SUPER STAR SOLDIER

02 Part of the influential *Star Soldier* lineage, *Soldier Blade* was the final game in the series to be released on the PC-Engine and remains a solid fan favourite. Graphically it remains impressive even today, featuring plenty of fast-moving and well-detailed sprites dashing around some sumptuous, eye-catching backgrounds. Debate still rages as to which is the finest shoot-'em-up on the format, but this certainly makes a very strong claim to that crown. *Soldier Blade* also looks absolutely gorgeous on the PC-Engine GT's 2.6-inch LCD screen, which effortlessly deals with the rapid nature of the gameplay. Second-hand prices are high, but still affordable, and an American release is also available.



02

SUPER ADVENTURE ISLAND

- » RELEASED: 1992
- » PUBLISHED BY: HUDSON SOFT
- » CREATED BY: IN-HOUSE
- » BY THE SAME DEVELOPER: ADVENTURE ISLAND

03 A very likeable offshoot of the *Wonder Boy* series, *Super Adventure Island* takes the core gameplay of the Sega original and adds some neat touches. The player takes control of Takahashi Meijin, who is based on a Hudson Soft employee. Visually it's a joy, with bold colourful sprites and wonderfully expressive characters. The light-hearted nature of the gameplay makes it an ideal companion for those trips into the outside world. To confuse matters, the previous PC-Engine *Adventure Island* title is a retooled version of *Wonder Boy III: The Dragon's Trap*.

DON DOKO DON

- » RELEASED: 1990
- » PUBLISHED BY: TAITO
- » CREATED BY: IN-HOUSE
- » BY THE SAME DEVELOPER: NEW ZEALAND STORY

04 This hugely underrated platform romp is often ignored thanks to its similarity to fellow Taito classic *Bubble Bobble*. While it certainly looks like its stable mate, *Don Doko Don* is very different in terms of gameplay. Instead of blowing bubbles, the player hurls mallets in the general direction of hostiles, stunning them on contact. They can then be picked up and thrown at other baddies. As is the case in *Bubble Bobble* and *Rainbow Islands*, defeated enemies leave behind fruit that can be gobbled in order to gain even more points. It's a brilliantly enjoyable title, and this is shown by its high second-hand value.

AERO BLASTERS

- » RELEASED: 1990
- » PUBLISHED BY: HUDSON SOFT
- » CREATED BY: INTER STATE/KANEKO
- » BY THE SAME DEVELOPER: DJ BOY

05 The Mega Drive version is arguably superior but this remains a fine conversion of a criminally ignored horizontal shooter. Tremendously close to its arcade parent visually, there are some minor changes that stop it being as faithful as it could possibly be, but they don't seriously impede on the abundance of enjoyment that is on offer. *Aero Blasters* (also known as *Air Buster*) is colourful, challenging and incredibly chaotic – everything you want from a decent blaster. It won't cost you the earth to locate a copy, and it even had the privilege of getting a US release – albeit with terrible box art.



03



04

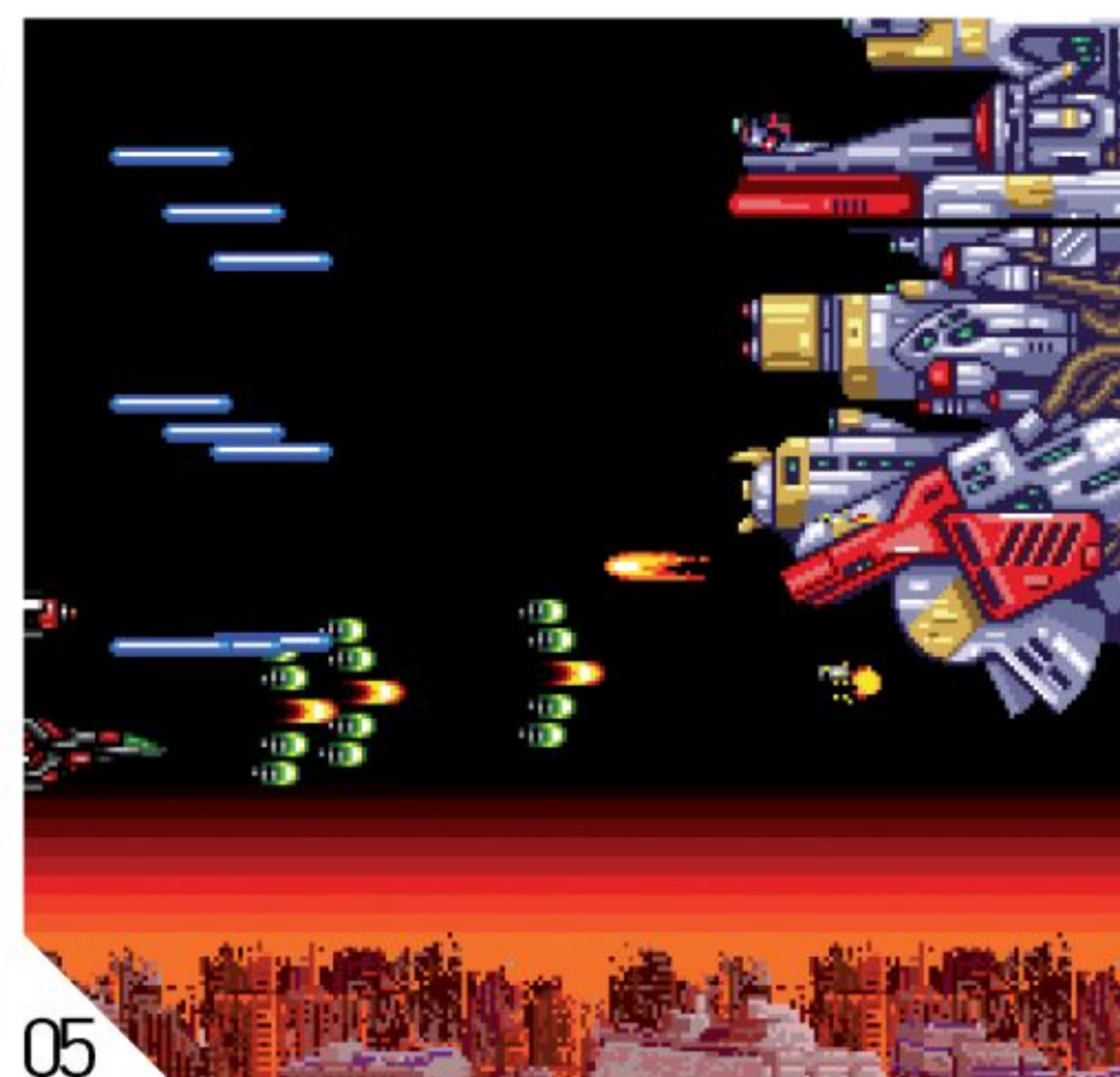

05



06

GALAGA '88

- » RELEASED: 1988
- » PUBLISHED BY: NAMCO
- » CREATED BY: IN-HOUSE
- » BY THE SAME DEVELOPER: WONDER-MOMO

06 The oldest game to be featured in our perfect ten GT games, *Galaga '88* is pure shooter brilliance. A sequel of the wonderful arcade classic *Galaxian*, the game contains some suitably hectic gameplay and becomes deliriously addictive after absolutely no time at all. The sparse visuals actually work in its favour when played on the GT's LCD screen, with the black background making it easy to see what's going on. Combined with the pick-up-and-play quality of the gameplay, it makes *Galaga '88* the ideal cohort for NEC's portable hardware. The TG-16 variant is confusingly called *Galaga '90* due to it having a later release date.

1943 KAI

- » RELEASED: 1991
- » PUBLISHED BY: NAXAT SOFT
- » CREATED BY: NAXAT/CAPCOM
- » BY THE SAME DEVELOPER: NAXAT OPEN

09 An absolutely brilliant conversion of Capcom's much-loved arcade title, this PC-Engine port actually features two different versions of the game. The Arcade version is a faithful copy of its coin-op parent, but the real attraction here is the Original mode, which is a suitably enhanced update with improved graphics, some slightly different levels and a wonderful soundtrack. One has to wonder just how Naxat Soft managed to do it, considering the generally average quality of its other games. Although many other shooters boast far more complex game mechanics and superior visuals, *1943 Kai* has bags of gameplay and is extremely worthy of a place in our perfect ten and is definitely worth a purchase, too.



07

DEVIL CRASH

- » RELEASED: 1990
- » PUBLISHED BY: NAXAT
- » CREATED BY: IN-HOUSE
- » BY THE SAME DEVELOPER: ALIEN CRUSH

07 Alien Crush was a fantastic simulation of pinball that contains lots of gruesome looking xenomorphs, but *Devil Crash* manages to better it in pretty much every way. Visually this is a real classic of the era, with distinctive 2D graphics that still look wonderfully repugnant even today. Like all truly great pinball simulations, the ball physics are absolutely spot-on (ironic given the supernatural nature of the tables) and the additional rooms add immeasurably to the overall experience. Rounded off with some excellent tunes and sound effects, this is an unforgettable experience that is deserving of any gamer's undivided attention.

MAGICAL CHASE

- » RELEASED: 1991
- » PUBLISHED BY: PALSOFT
- » CREATED BY: QUEST
- » BY THE SAME DEVELOPER: OGRE BATTLE

10 This is an extremely sought-after 'cute-'em-up' game in the same vein as the *Cotton* franchise. The player assumes the role of a kind-hearted witch, called Ripple, and must safely guide her through several horizontally scrolling levels, taking on hordes of wonderfully coloured foes in the process. It certainly looks harmless enough but the sickly sweet visuals belie the fantastic shooter action that is contained within. *Magical Chase* was lucky enough to get an American release, although for some inexplicable reason several sprites and some of the backgrounds were altered – the first level in particular looks very different in the US edition of the game. Both the Japanese and American versions carry a hefty price tag these days.



08

JACKIE CHAN

- » RELEASED: 1991
- » PUBLISHED BY: HUDSON SOFT
- » CREATED BY: IN-HOUSE
- » BY THE SAME DEVELOPER: THE KUNG FU

08 Everyone loves Jackie Chan, don't they? The seemingly indestructible martial artist is so likeable it's hardly surprising to discover that this platform action title is jolly good fun, too. Featuring amusing cartoon sprites and some seriously entertaining gameplay, this remains one of the finest examples of the genre available on the PC-Engine. As well as running and leaping through a series of oriental levels, Jackie is also able to dish out his own brand of slapstick violence via a series of punches, kicks and special moves, the latter being accessed by picking up special items dotted throughout the stages. A must-have for all GT owners.



09

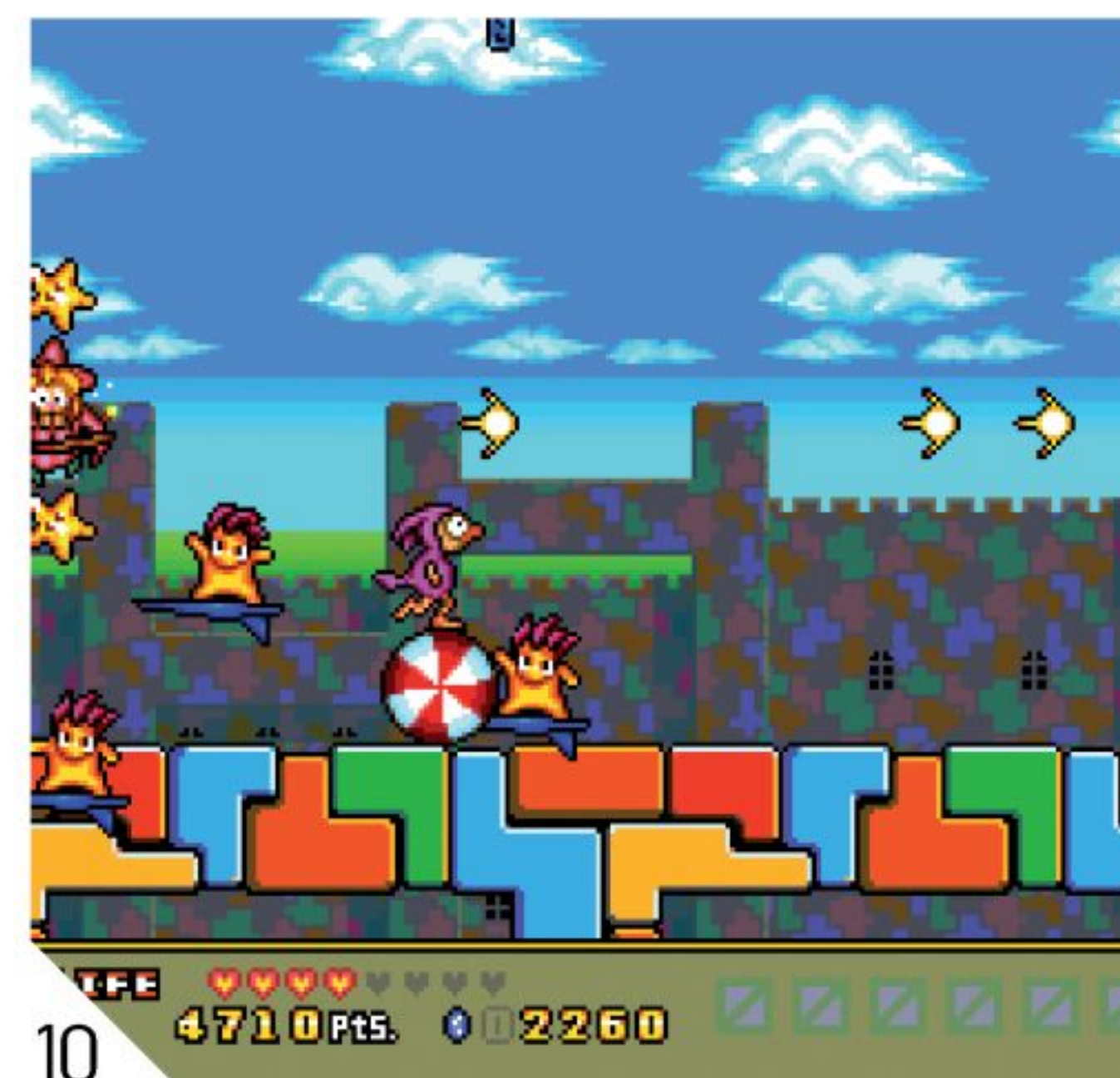

10



PC-ENGINE GT

PC-ENGINE GT and the rest...

Being able to play PC Engine games meant that the GT had an amazing wealth of titles to draw upon. To the right are just a few of them.

- 01 1941
- 02 AFTER BURNER II
- 03 BLUE BLINK
- 04 ALTERED BEAST
- 05 BATMAN
- 06 MONSTER PRO WRESTLING
- 07 BERABO MAN
- 08 KATO-CHAN & KEN-CHAN
- 09 GATE OF THUNDER
- 10 CITY HUNTER
- 11 CORYOON
- 12 DRACULA X
- 13 SNATCHER
- 14 ALIEN CRUSH
- 15 ENERGY
- 16 FI CIRCUS SPECIAL
- 17 POWER ELEVEN
- 18 ATOMIC ROBO KID SPECIAL
- 19 FIRE PRO WRESTLING
- 20 THE DYNASTIC HERO
- 21 GRADIUS
- 22 GUNBOAT
- 23 LODERUNNER
- 24 OUTRUN
- 25 PARODIUS
- 26 MAGICAL CHASE
- 27 KLAX
- 28 SPACE HARRIER
- 29 TIGER-HELI
- 30 VIOLENT SOLDIER
- 31 MR HELI
- 32 WONDER-MOMO
- 33 NINJA SPIRIT
- 34 TOILET KIDS
- 35 VIGILANTE
- 36 PAC-LAND
- 37 POWER DRIFT
- 38 THE KUNG FU
- 39 OPERATION WOLF
- 40 GUNHED
- 41 IMAGE FIGHT
- 42 JACKIE CHAN
- 43 KAZE KIRI
- 44 PANIC BOMBER
- 45 RAIDEN
- 46 RASTAN SAGA II
- 47 RED ALERT
- 48 TRICKY
- 49 PSYCHIC STORM
- 50 WORLD JOCKEY
- 51 TATSUJIN
- 52 THUNDERBLADE
- 53 S.C.I.
- 54 SHADOW OF THE BEAST
- 55 SHINOBI
- 56 PRINCE OF PERSIA

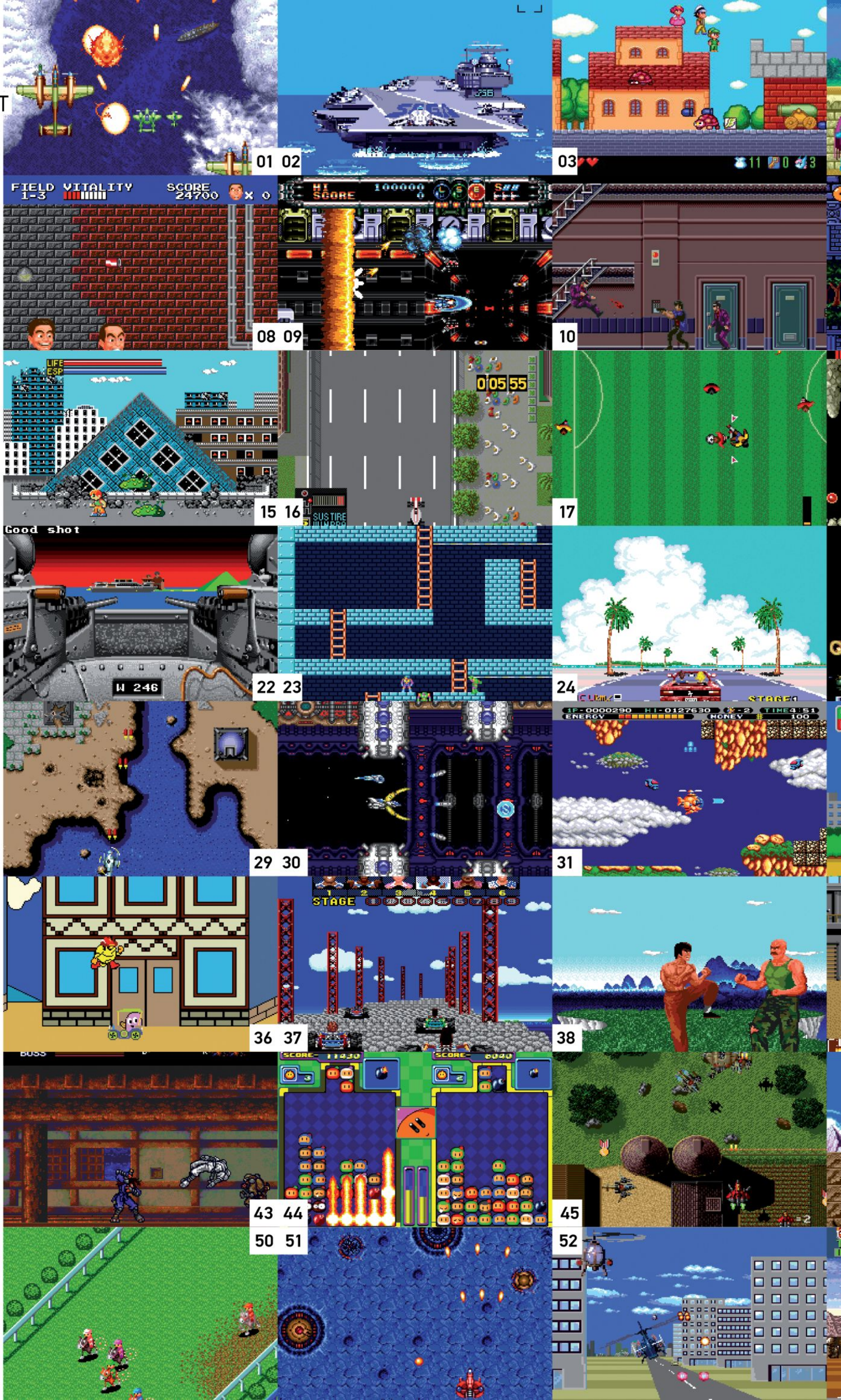



04 05



06

ドクロミドロのストマックロード



07



11 12



13

ギリアン 耐熱、耐ショック・シールドだ。 対スナッチャー用だろう。



14



18 19



20



21



25 26



27



28



32 33



34



35



39 40



41



42



46 47



48



49



53 54



55



56



BEST OF BRITISH

BEST OF BRITISH

THE EARLY EIGHTIES WITNESSED AN EXPLOSION IN THE UK COMPUTER MARKET, WITH MANUFACTURERS FALLING OVER THEMSELVES TO GRAB A SLICE OF THE ACTION. BUT WITH NO CLEAR STANDARDS AND LITTLE IDEA OF WHAT USERS REALLY WANTED, THE MARKET QUICKLY BECAME A MINEFIELD FOR THOSE LOOKING TO BUY THEIR FIRST MICRO. WE LOOK BACK AT THE BEST OF THESE BRITISH MACHINES AND ASK THREE QUESTIONS OF EACH ONE: WAS IT ANY GOOD? HOW DID IT FARE? AND, CRUCIALLY, COULD YOU PLAY MANIC MINER ON IT?

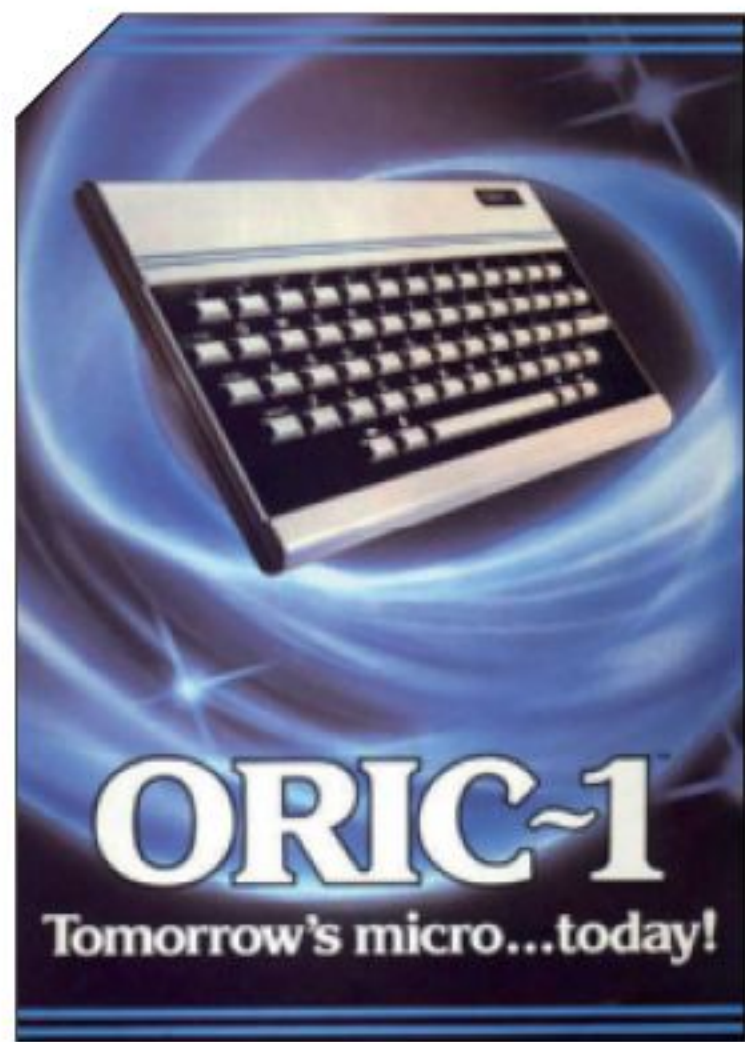

» Although Oric ran into difficulties in 1984, the Oric-1 was followed by the Atmos and Telestrat. The latter was not released in the UK.



» Despite the title the Jupiter ACE was anything but. Releasing a monochrome computer in 1983 was commercial suicide.

When it comes to developing and adopting new technology the UK has generally lagged behind the US by a good couple of years. By the time Clive Sinclair released the MK14 kit computer in June 1978, the States had already seen the launch of the Apple II, the Tandy TRS-80 and the Commodore PET. These pioneering machines were complete integrated computers, whereas the MK14 was little more than a fancy calculator with a hex keyboard and LED display. Obviously it would be unfair to compare a £40 kit with much more expensive machines (at the time of the MK14's launch an imported Apple II would cost a cool grand), but it highlights the maturity of the US market compared to the UK at the time. Sir Clive was well aware of the advances being made over the pond – he'd seen it for himself at an electronics fair in San Francisco in 1977. **Branching off into the micro market was an experiment that paid off – more than 50,000 MK14s were sold, and it paved the way for Sinclair's next machine, the ZX80.**

Released in February 1980, the ZX80 offered much more than the MK14. It had an alphanumeric keyboard, a cassette interface and a modulator for TV output. It had 1K of RAM, built-in BASIC, and at its heart was the popular low-cost Z80 microprocessor. It was heady stuff. By far its most attractive feature was the price – just £79 in kit form or £99 pre-built, making it the first ready-assembled computer to be available for under £100. Compare this to the TRS-80 or the PET, both of which would set you back five times that amount, a price your average punter was not prepared to pay. The ZX80 was affordable and accessible to the man on the street. It was the perfect entry-level machine for someone wishing to learn about computers.

With sales reaching over 100,000 in less than 18 months (of which a reported 60 per cent were sold overseas), the ZX80 was yet another Sinclair success story. But it was just the beginning. The ZX81, released in March 1981, clocked up sales of 400,000 in a single year. This new model introduced better BASIC and high-resolution graphics among a number of other improvements, but Sinclair actually sold the ZX81 for less money than the ZX80 (£49 for the kit, and £69 for the pre-built model). This was mainly due to a more efficient internal design, which reduced the number of chips, making it cheaper to manufacture. The price was right, and within two years of release the ZX81 rocketed past the magical 1 million sales mark. Home computing in the UK was no longer a niche.

A cottage industry sprang up to support the ZX81. The machine was better suited to running games than the ZX80, so the floodgates opened with a large volume



“THE PRICE WAS RIGHT, AND WITHIN TWO YEARS OF RELEASE THE ZX81 ROCKETED PAST THE MAGICAL 1 MILLION SALES MARK. HOME COMPUTING IN THE UK WAS NO LONGER A NICHE”



BEST OF BRITISH

EMULATOR RECOMMENDATOR

AH, THE JOY OF EMULATION. ALL OF THE COMPUTERS MENTIONED IN THE FEATURE CAN BE EMULATED ON A WINDOWS PC (AND QUITE POSSIBLY A MAC, TOO). HERE'S OUR LIST OF RECOMMENDED FREWARE EMULATORS AND WHERE TO GET THEM:

MACHINE	EMULATOR	HOME PAGE
Acorn Atom	Atom Emulator	www.stairwaytohell.com/atom/wouterras
ZX80/81	XTender2	www.delhez.demon.nl
BBC Micro	BeebEm	www.mikebuk.dsl.pipex.com/beebem/index.html
Spectrum	ZX Spin	www.worldofspectrum.org/emulators.html
Dragon 32	XRoar	www.6809.org.uk/dragon/xroar.shtml
Oric-1	Euphoric	http://oric.ifrance.com/oric/index_english.html
Computers Lynx	PALE	http://heraclion.users.btopenworld.com/palelynx.htm
Jupiter ACE	EightyOne	www.aptanet.org/eightyone
Grundy NewBrain	NewBrain Emulator	http://newbrain.50webs.org
Memotech MTX500	Mt Xemu	http://mtxemu.classicgaming.gamespy.com
Sinclair QL	QL2K	http://www.jadiahm.org/QL/index.php
Amstrad CPC	Caprice32	www.caprice32.cybercube.com

computer with a pleasingly chunky case and a finger-pleasing full travel keyboard. As was the norm back then, it came as a kit or pre-assembled, and with 2K RAM and 8K ROM as standard. What made the Atom special was that it was designed with expandability in mind. The RAM and ROM could be upped internally to 12K each (with more memory bolted on externally, if required) and various expansion cards could be slotted in place. Perhaps its greatest asset, however, came at no added cost. Atom BASIC was generally regarded as the best in the business, being much more powerful and intuitive than Sinclair's flavour.

At launch, a pre-assembled Atom with 12K RAM and ROM retailed for £330. At this price it attracted the more serious user, although games were available from familiar names such as Quicksilver, Bug-Byte (no *Manic Miner* though!) and, of course, Acornsoft. Perhaps its biggest claim to fame was that both



» We love Spectrum Man, if only because he somehow has the power to make the Speccy display an orange background.

of cassette-based software sold via mail order and through specialist dealers (after all, the ZX81's membrane keyboard didn't exactly lend itself to programming your own arcade clones). Sinclair's next machine, the ZX Spectrum, became even more synonymous with gaming thanks to the addition of colour graphics, sound support and extra memory. We won't dwell on the all-conquering Spectrum here as it's been covered in detail before, but its importance in the UK computing market cannot be overstated enough. We'd also like to reiterate the fact that iconic British platformer *Manic Miner* began life on the Speccy before being ported to just about every other 8-bit computer around. Some years later a guy named Ales Martinik even managed to shoehorn an amazingly faithful version of the game onto the ZX81.

David Braben and Ian Bell began coding games for the machine before collaborating to create the awesome *Elite* for the Atom's successor, the Proton. As you'll no doubt already know, the Proton was released in late 1981 under the name BBC Micro after Acorn was chosen by the broadcaster to provide a machine to feature in a television series about the exciting new world of micro computing. The 'Beeb' was a clear successor to the Atom, taking the basic 6502 setup and offering more memory (16 or 32K, depending on the model), a larger 32K ROM which held an enhanced version of Atom BASIC (dubbed BBC BASIC), and a whole host of expansion ports for connecting stuff. The Beeb really was feature rich, and you had to be rich to afford one. The premium Model B launched at £335, later rising to £399 to cover increased production costs. Still, more than 1.5 million Beebs were sold in total, mainly to the education market where around 70 per cent of schools chose the machine to place in their computing rooms. Although this gave the Beeb a stuffy image, a large library of gaming software was written for the machine, including classics like *Elite*, *Repton*, *Revs* and *Exile*. *Manic Miner* was ported to the machine, too. Just in case you were wondering.

The Beeb occupies an important place in the history of British computing, but it was the Spectrum that really kicked things into overdrive, building on the momentum of the ZX81. In the latter half of 1983, having reduced the 16K model to just £99, Sinclair was shifting 50,000 units a month and struggling to meet demand.

These numbers were unprecedented, and other manufacturers were attracted to the consumer end of this growing market like moths to a flame. And yes, many of them burnt their wings.

Let's look at some of the main contenders. There was the Dragon 32, forged in Port Talbot and unofficially based on the Tandy Color Computer. This versatile 32K micro launched in August 1982 at £175 (the same price as a 48K Spectrum) to encouraging sales (40,000

“OTHER BRITISH MICROS JOINED THE FRAY IN 1983 INCLUDING THE COMPUTERS LYNX, JUPITER ACE, GRUNDY NEWBRAIN AND THE MEMOTECH MTX. NONE ACHIEVED ANYWHERE NEAR THE SAME LEVEL OF MARKET PENETRATION AS THE SPECTRUM”

The downside of success for Sinclair was competition from rival manufacturers. This was nothing new, however, as Sinclair had been competing with fellow Cambridge company Acorn Computing for years. Chris Curry left Sinclair in 1978 to establish Acorn and released the System 1 in January 1979, a kit computer that shared many similarities with the MK14. This was not simple mimicry, however, as the System 1 was the first in a series of 6502-based machines aimed at serious enthusiasts. When it came to catering for the consumer market, Acorn developed the Atom, a computer that had more in common with the established US machines than the cheap, cheerful and relatively toy-like ZX80.

Released a few months after the ZX80, the Atom looked like a proper

» Where it all began. The MK14 was Sinclair's first microcomputer, paving the way for the hugely successful ZX range.

From Science of Cambridge: the new MK 14. Simplest, most advanced, most flexible microcomputer – in kit form.

only £39.95 (+ 8% VAT)

Labels on the board include: 4.43MHz crystal, Budget 7-segment LED display, Extra RAM (optional), PRCH-512 bytes, RAM-256 bytes, CPU, Display and keyboard, RAM I/O device (optional), Extra RAM (optional), RAM-256 bytes, PRCH-512 bytes, 5V regulator, Power rails and input/output edge connector, RAM I/O device (optional).

MK 14 including



» Sir Clive at the Sinclair QL's launch. We're guessing he wasn't as chuffed when he checked the order book.

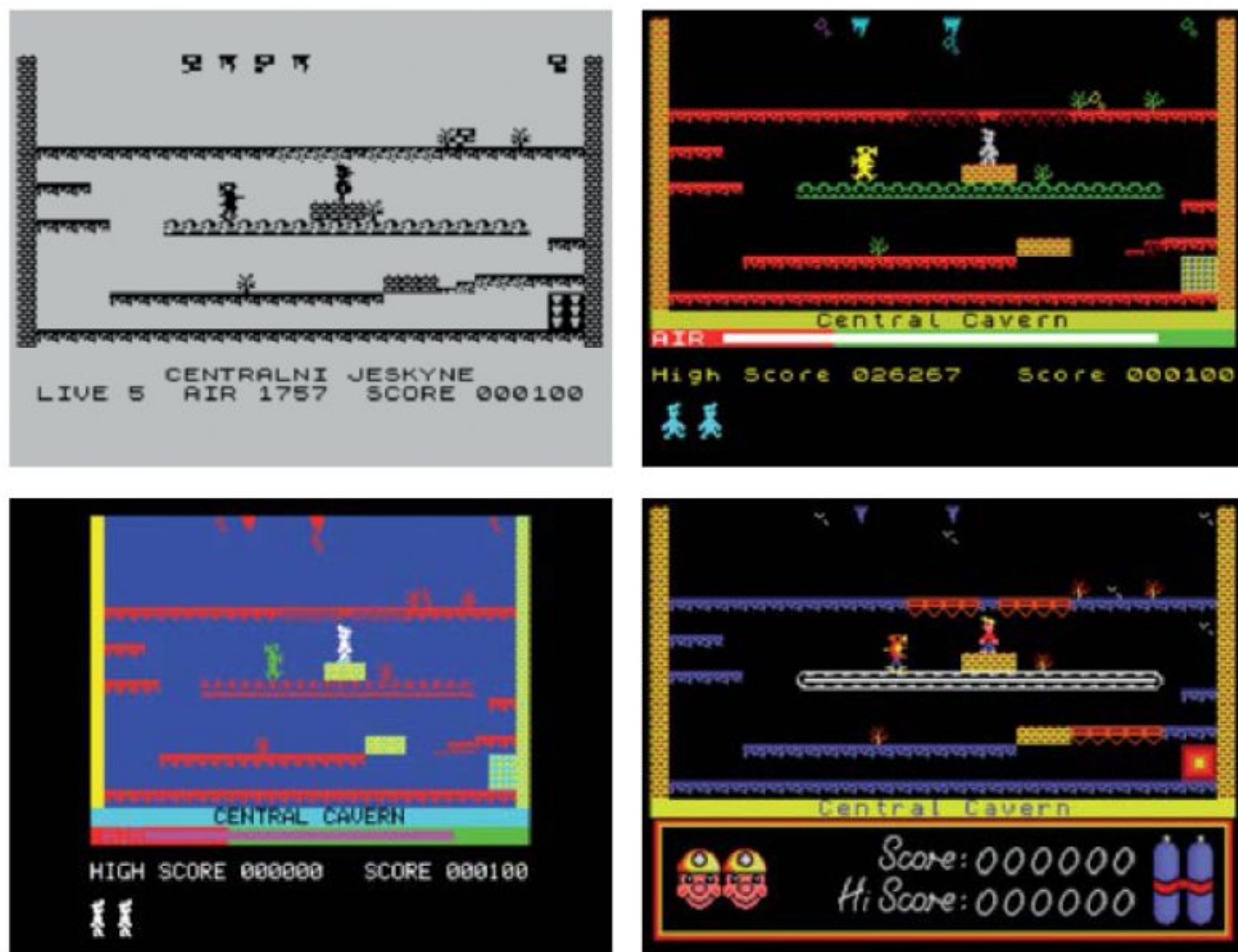

» The many faces of *Manic Miner*. The versions from top to bottom: ZX81, Spectrum, Oric-1 and SAM Coupé.

units sold in the first six months), but its unusual 6809 processor meant that it was difficult to port software across from the more popular Z80 and 6502 machines (Software Projects managed to release *Manic Miner* for it, of course, even throwing in a couple of bonus screens for good measure). Sales soon began to tail off and constant delays to the launch of the bigger memory Dragon 64 didn't help matters. Dragon Data was declared bankrupt in July 1984, and six months later Oric went the same way.

Oric's bold but slightly stupid plan was to try to steal a march on Sinclair by offering more machine for less money. It got things half right, as the Oric-1 was slightly ahead of the Speccy in terms of hardware (built-in Microsoft BASIC, better sound, more ports, less colour clash), but when it came to pricing Oric was unable to undercut Sinclair. In fact, Oric was unable to get the damned machine to market due to manufacturing problems, and when units did start to trickle through in early 1983, it was revealed that the ROM and the cassette loading system were bugged. At least there was uplifting news on *Manic Miner* front. The game was released for the Oric-1, complete with 12 extra screens, but even the magical influence of Miner Willy could not reverse Oric's fading fortunes.

Other British microcomputers that joined the fray in 1983 included the Computers Lynx, a relatively advanced computer available with 48, 96 or 128K RAM; the Jupiter ACE, a monochrome machine famous for including FORTH rather than

BASIC as its built-in language; the brilliantly named Grundy NewBrain, an odd little micro with a built-in 16-character display; and the Memotech MTX series of computers that were similar to the MSX standard. These machines were all Z80-based, just like the Spectrum, and each boasted their own unique features, but none of them achieved anywhere near the same level of market penetration as the Speccy. We'd suggest it was because you

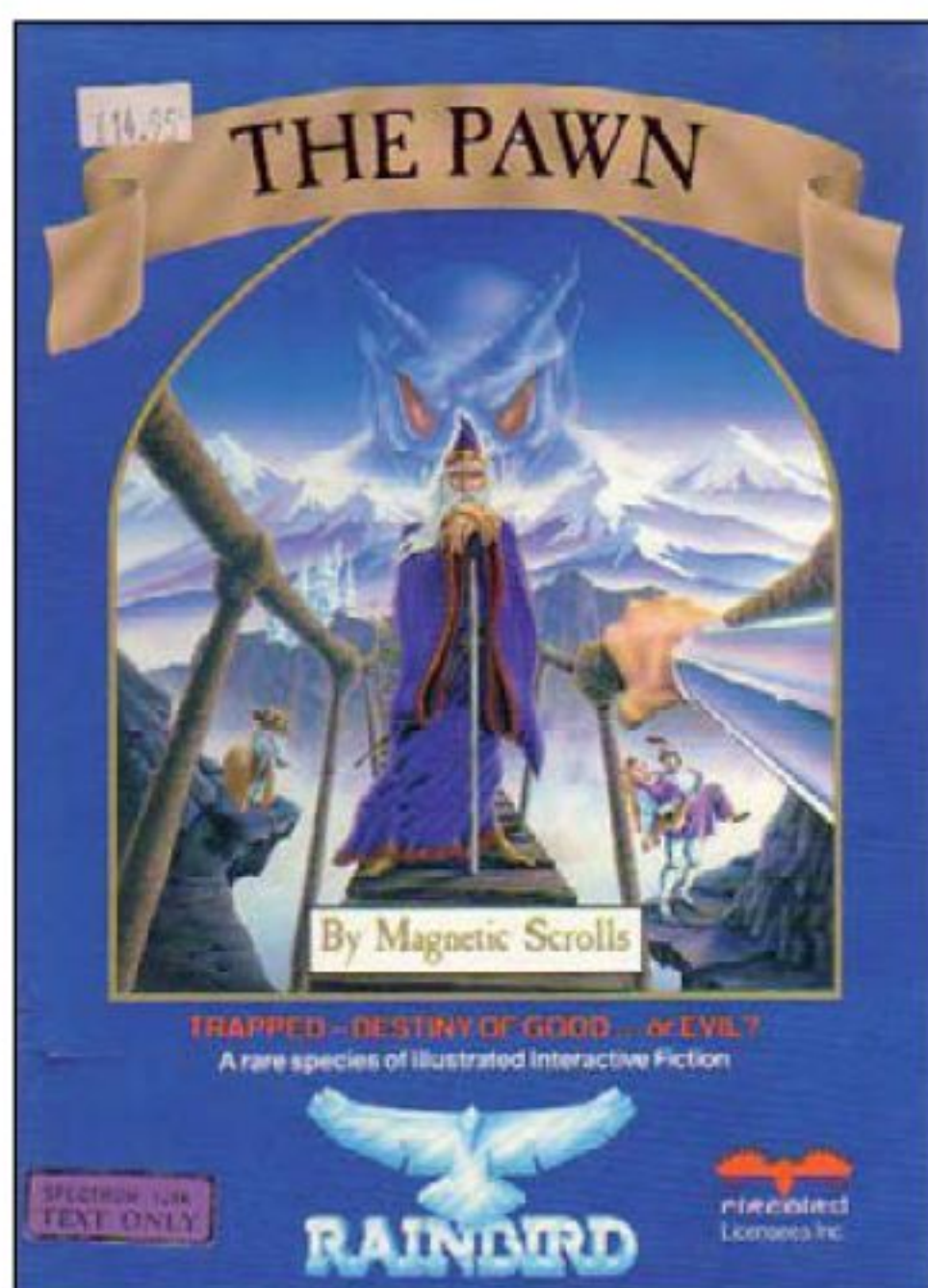

» Magnetic Scrolls' *The Pawn* was written for the QL before finding greater success on other platforms.

couldn't play *Manic Miner* on any of them, but that would make us sound slightly mad.

Seemingly no one could stop Sinclair at the time, so when Sir Clive turned his attention to business machines it was widely predicted that he would aggressively corner this lucrative market. The Sinclair QL (Quantum Leap, no less) was launched in January 1984, but things didn't exactly go to plan. On paper the QL looked formidable – a 32-bit machine with 128K RAM (easily expandable to 640K), built-in mass storage, a multitasking OS and a bundled office suite, all for £399. However, to hit this bargain price point compromises were made at almost every stage of development. The powerful Motorola 68000-series processor was hamstrung by an 8-bit databus that limited performance. For storage, Sinclair's clever but unreliable Microdrive cartridge system was chosen over a floppy drive. And then there was the low-cost keyboard that was far too unresponsive for business users. Production problems and buggy system software sealed the QL's fate, resulting in an expensive and high-profile failure for Sinclair. The machine did receive decent software support, mainly business

software as you'd expect, but also some games. While there was no *Manic Miner* port it was home to a great little homage called *QL Cavern*.

Thankfully the most significant event of 1984 was not the failure of the QL but the successful arrival of a British Z80-based machine that didn't fall by the wayside like all the others. The Amstrad CPC 464 [about time – Ed] was a machine aimed at the electronics-buying masses. It was a complete package, consisting of a 64K colour computer with integrated cassette deck and bundled monitor (either green-screen or colour). It really was plug in and play, and the green-screen monitor bundle retailed for a very reasonable £200. Amstrad's confidence in the machine (it committed to 100,000 units prior to launch) paid off when the 464 went on to rack up sales of 2 million in the UK and Europe. It may not have reached Spectrum numbers but it at least grabbed significant market share. CPC software was plentiful – even if a lot of games were ported directly from the Spectrum, *Manic Miner* included, naturally – and as we moved to the latter half of the Eighties, the CPC, Spectrum and Commodore 64 emerged as the big three for 8-bit publishers. Serious challenge soon arrived in the shape of the Atari ST, Commodore Amiga and PC, but that's another tale for another time.

Looking back, the UK computer scene in the early Eighties was a crazy mess, with very little direction and dozens of different machines all vying for attention. It was a time of innovation, experimentation and risk. For many computer owners it was also an incredibly exciting time; one that has never been bettered.



» To stay ahead, publishers had to release their games for as many systems as possible. Here's Durell's popular *Harrier Attack* running on the Oric-1.

ABOVE AND BEYOND

Our feature covers the first half of the Eighties, but obviously the development of UK computers did not stop with the release of the Amstrad CPC in 1984. Buoyed by the success of the CPC, Amstrad launched the PCW range in 1985. The PCW was designed as a dedicated word processor and was very successful as such, although other office apps and games were released for it. After Amstrad bought out Sinclair in 1986, Sir Clive set up Cambridge Computers and released the Z88 portable the following year. This portable was a typically sleek Sinclair product.

Acorn shifted things up a gear in 1987 with the release of its first Archimedes desktop. Featuring 32-bit RISC processor architecture, Acorn's range of RISC machines built up an enthusiastic following and really deserve more coverage than the cursory mention offered here. The same can be said about the SAM Coupé, the 8-bit Spectrum-compatible computer that arrived in 1989 when just about everyone was shifting to 16-bit computers. No doubt this intriguing machine will be given the full Retroinspection treatment in a future *Retro Gamer*.



» With its small screen the Z88 certainly wasn't designed for gaming, but nonetheless games were written for it. Including, you got it, *Manic Miner*!



» *Personal Computer World* magazine, which is currently enjoying its 30th anniversary, was launched in 1978 largely as a result of user interest in the MK14.

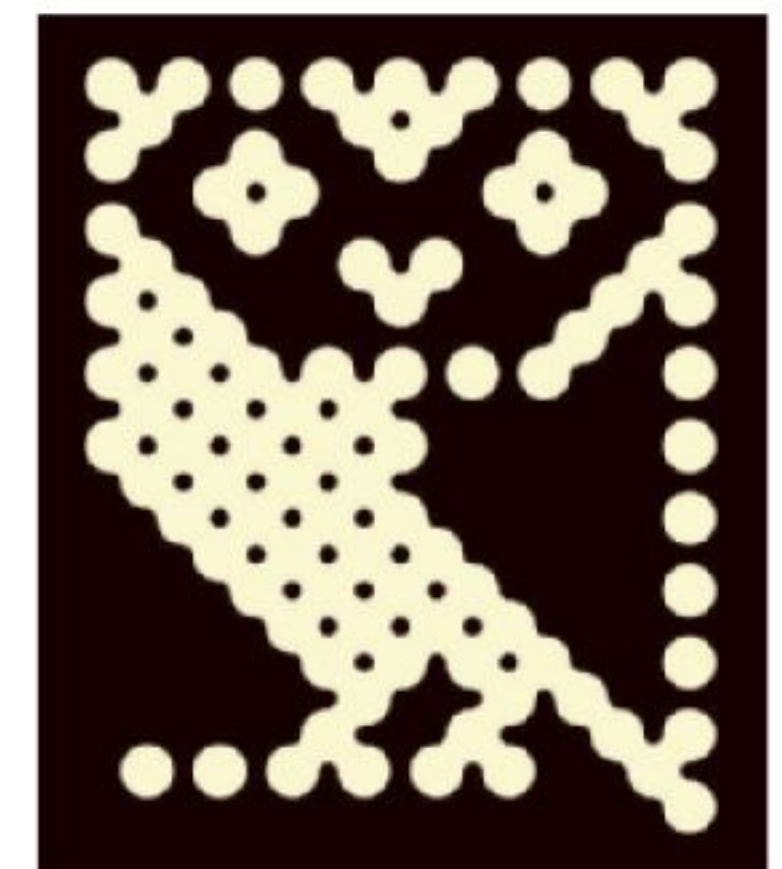

» The wide-eyed owl, perched on the top-right-hand corner of the BBC Micro keyboard, was the symbol for the BBC Computer Literacy Project.



PLAYSTATION



PlayStation

THE NAME PLAYSTATION HAS BECOME SYNONYMOUS WITH VIDEOGAMING, BUT SONY'S ROUTE INTO THE INDUSTRY WAS ANYTHING BUT STRAIGHTFORWARD. JOIN US AS WE CHART THE HISTORY OF WHAT IS ARGUABLY ONE OF THE MOST IMPORTANT CONSOLES OF ALL TIME

It's almost impossible to conceive it now, but prior to the 32-bit PlayStation's launch in 1994 there were real doubts in the media over its chances. Over 100 million hardware sales later, such pessimism seems woefully misplaced, but it's easy to forget just how many hurdles Sony had to overcome to make a success of its first piece of videogames hardware – and media scepticism was the least of those problems.

The PlayStation concept actually has its roots way back even before the 16-bit generation had hit the marketplace – 1988, to be precise. Always thinking a few steps ahead of its rivals, Nintendo was actively courting manufacturers to create some kind of expanded storage device for its Super NES console, which was in development and due to hit the market in just over a year. Sony – in conjunction with Dutch electronics giant Philips – was working on a new format called CD-ROM/XA, a new type of compact disc that allowed simultaneous access to audio, visual and computer data, making it thoroughly compatible with the medium of interactive entertainment. Because Sony was already being contracted to produce the SPC-700 sound processor for the SNES, Nintendo decided to enlist the electronics manufacturer's assistance in producing a CD-ROM add-on for its 16-bit console.

For Sony, it was a dream come true. Having been instrumental in the production of the ill-fated MSX computer format, the firm never hid its desire to become a key player in the burgeoning videogame business. Therefore, an alliance with what was unquestionably the biggest and most famous name in the industry would not only help elevate Sony's standing; it would also enable the company to set the wheels in motion for its ultimate plan: to put its consumer electronics experience

to good use and produce its own videogame hardware. The industry was growing at an alarming rate thanks largely to Nintendo's hugely successful NES and Game Boy systems, and Sony was keen to obtain a foothold.

The initial agreement between the two firms was that Sony would produce a CD-ROM expansion for the existing SNES hardware and would have licence to produce games for that system. Later, it was supposed, Sony would be permitted to produce its own all-in-one machine – dubbed PlayStation – which would play both SNES carts and CD-ROM games. The format used by the SNES-based version of the PlayStation was called 'Super Disc', and Sony made sure

that it held the sole international rights – in other words, it would profit handsomely from every single SNES CD-ROM title that was sold. It was a match made in heaven: Sony would instantly gain a potentially massive installed base of users overnight as the SNES was a dead cert to sell millions of units. SNES users would upgrade to the new CD-ROM add-on when they knew that Nintendo's cutting-edge games would be coming to it, and Sony would make money on each software sale. What's more, once the all-in-one PlayStation was launched, Sony would gain even more in the way of profits and become a key player in the videogame industry. The man behind this audacious scheme was Ken Kutaragi, the engineer also responsible for producing the aforementioned SNES sound chip.

However, behind the scenes Nintendo was predictably far from happy with the proposed arrangement. It was very protective of its licensing structure, which allowed it to extract massive royalties from third-party publishers. Allowing Sony leverage in this sector would only

damage Nintendo's profitability; the Kyoto-based veteran reasoned that it should be making the majority of the profit on SNES CD sales, not Sony. The plan – if it came to fruition – would ultimately benefit Sony far more than Nintendo: the former would merely be using the latter as a way of getting a ready-made market share and would eventually become

SPECIFICATIONS BOX

Year released:

1994 (Japan), 1995 (US/Europe)

Original price: ¥39,800 (Japan), \$299.99 (US), £299.99 (UK)

Buy it now for: £10+

Associated magazines:

PlayStation Plus, Official PlayStation Magazine, Play

Why the PlayStation was great...

Some would argue that the videogame industry in the mid-Nineties was in dire need of a boot up the backside, and the PlayStation delivered this kick. Technologically groundbreaking and supported by a wide range of third-party developers, the machine is home to countless classic titles. While some of these games have aged badly, most remain just as essential today as they were over a decade ago.



INSTANT EXPERT

■ The Sony PlayStation is the first videogames console to sell over 100 million units worldwide

■ *Gran Turismo* is the system's bestselling title, with 10.85 million copies sold

■ The PlayStation can generate 360,000 flat-shaded polygons per second

■ With only 2MB of main RAM, the PlayStation struggled with 2D titles that required lots of animation frames, while its rival the Saturn fared better thanks to the fact that it had twice the amount of memory and could be expanded still further with a separate cartridge

■ Approximately 7,900 different games were produced for the PlayStation during its 11-year lifespan

■ Cumulatively-speaking, PlayStation software sales stand at an astonishing 962 million units worldwide

■ Each Sony Memory Card came with 128KB of storage for save game data. Higher capacity third-party cards were also available

■ The console's impressive sound processor can handle 24 channels of audio

■ Early versions of the machine were afflicted with skipping FMV and sound, thanks to the poorly designed nature of the CD drive. Later models rectified this issue, but early adopters still shudder at the memory of having to place their beloved consoles upside down in order to get them to work properly

■ Early UK adverts for the machine featured SAPS – the Society Against PlayStation – a fictional organisation that was committed to preventing the console from ensnaring the country's youngsters



PLAYSTATION

▶ a determined rival as a result. Nintendo president Hiroshi Yamauchi was famous for being particularly ruthless in his business practices, but what happened next is one of the most infamous double-crosses in the history of the videogame industry.

It was at the 1991 Consumer Electronics Show that Nintendo dropped the bombshell. Sony went to the event full of enthusiasm and on the first day proudly announced the details of its new alliance with Nintendo, as well as news of the Super Disc format and the impending development of the SNES-compatible PlayStation. Sony had less than 24 hours to soak up the palpable level of excitement generated by this press conference before Nintendo confirmed that it was, in fact, working with Philips on the SNES CD-ROM drive. Yamauchi had gone behind Sony's back at the last minute to broker a deal with the Dutch company – a deal that was predictably skewed in Nintendo's favour – leaving Sony publicly humiliated at the

very moment it had expected to usher in a new era as a serious contender in the videogaming arena. At the time, Yamauchi and the rest of Nintendo's top brass were suitably pleased with their skulduggery; such swift action had prevented Sony from taking a sizeable bite out of the company's profits. As it happened, the planned Nintendo-Philips alliance resulted in little more than a handful of risible Nintendo licences on the CD-i, and the abject failure of Sega's Mega-CD seemed to lend credence to the viewpoint that expanding existing consoles was a mistake, so while Nintendo had protected its best interests by leaving Sony at the altar in such degrading fashion, it actually gained little else of note – aside from a dogged rival.

Sony had, by this point, poured a significant amount of cash into the proposed PlayStation concept. It had even moved as far as the prototype phase, with PC CD-ROM titles such as Trilobyte's *The 7th Guest* being mooted as possible launch games. Despite the tumultuous events of the 1991 CES, a deal was signed between Nintendo and Sony that would allow the latter to make its machine compatible with SNES CD-ROM titles – with the proviso that Nintendo would retain all software royalties. Although it was nothing more



» Although SNK's Neo Geo system had used the same concept some years beforehand, Sony's decision to go with removable data storage for save game files was regarded by many as truly groundbreaking.

than a clever stalling tactic by Nintendo to keep Sony from entering the market on its own, this proposed alliance nevertheless kept the increasingly frustrated Kutaragi and his team busy. However, by 1992 it had become clear that such a union was going nowhere. Sony cut off communication with Nintendo and the company was painfully close to withdrawing from the arena for good.

Only Kutaragi's intense resolve and determination prevented the PlayStation

dream from ending in 1992. During a meeting with Sony president Norio Ohga in order to decide the future of the project, Kutaragi made bold claims about the kind of machine he had been developing. He argued that the 16-bit PlayStation, with its reliance on a union with the incumbent – not to mention untrustworthy – Nintendo, was a dead end. The only option was to go it alone and create a brand new piece of hardware capable of shifting 3D graphics at a hitherto unprecedented rate. When Kutaragi's ambitious proposal was greeted with derision from the Sony president, he presented another side to his argument: could Sony's pride allow it to simply walk away when Nintendo had so blatantly abused its trust? By making

» UK gamers were treated to the amusing 'Society Against PlayStation' advertising campaign, complete with its dorky spokesman.



VARIANTS PLAYSTATION'S MANY FACES

SNES PlayStation

■ The fruit of Sony and Nintendo's ill-fated union, this machine would have played SNES carts and SNES CD-ROM software. Although it was never officially released, it formed the basis of the 32-bit machine. Legend has it that Sony still has 200 prototype units secreted within its Japanese headquarters.



Sony PlayStation

■ The groundbreaking original. This piece of hardware kick-started an era of Sony-led market dominance that would last for the best part of a decade. Early units suffered from skipping FMV and CD audio thanks to their entirely plastic CD-ROM mechanism; later versions had metal parts that fixed the issue.



Net Yaroze

■ Aimed at bedroom coders, the Net Yaroze came with development tools that allowed users to create their own games, some of which turned up on official demo discs. It also had no regional lockout, so games from any part of the world could be played on it. Naturally, it was far more expensive than the standard PlayStation.



PSone

■ Released in 2000, this revised machine was smaller than its predecessor, clocking in at a minuscule 38x193x144mm. An official LCD screen accessory could be attached to make this the first portable PlayStation, albeit without an official battery. It outsold the PS2 in its first year on sale.





COMMUNITY THE BEST PLAYSTATION RESOURCES ON THE WEB

The PlayStation Museum

playstationmuseum.com

■ A truly amazing site that is dedicated to preserving the history of Sony's machine. Here you will find reviews and features, as well as lots of data relating to unreleased titles or prototypes. Well worth a visit if you have a few hours to spare.



PlayStation DataCenter

psxdata.snesorama.us

■ A must for collectors, the PlayStation DataCenter has listings for almost every game released on the format. It even has high-quality cover scans to download. A real gold mine of information for dedicated PlayStation fans.



Push Square

www.pushsquare.com

■ While it's not strictly aimed at the PSone, Push Square is nevertheless one of the net's leading Sony sites. It covers retro-related news items as well as the PlayStation's offspring. If you're a Sony fanboy, then you should bookmark this site for sure.



Absolute PlayStation

absolute-playstation.com

■ Another site that covers the entire PlayStation brand, Absolute PlayStation is packed with reviews, guides, blogs and even a chat forum. It's also regularly updated with the latest and greatest Sony games, so if Sony is your passion, this is the place to be.



» [PlayStation] *PaRappa The Rapper* was one of the first music action titles and helped kick-start the recent explosion in rhythm-based gaming.



» [PlayStation] *Final Fantasy VII* was one of the PlayStation's most significant releases, not just in commercial terms but from a critical viewpoint as well. It became the first JRPG to gain truly international acceptance.

▶ the PlayStation project a success, the company would experience the sweet taste of revenge at the expense of its one-time ally.

Kutaragi's speech hit a nerve, and early in 1994 Sony confirmed that it was entering the videogame arena with its own console, and even formed subsidiary Sony Computer Entertainment in order to oversee the new venture. Keen to differentiate this new project from its previous namesake, Sony branded it the 'PlayStation-X' – this gave rise to the abbreviation 'PSX', which is still used even today, even though the 'X' was later dropped when the console was officially launched. Early reports were impressive, with some developers confidently proclaiming that Sony's console would blow away the competition. Despite the company's wide entertainment portfolio – which included music label CBS Records and Hollywood studio Columbia Tri-Star – Sony boldly decided not to focus on the multimedia market, as its rival Philips, with its CD-i and 3DO, had done, to its great cost. Instead, the PlayStation was unashamedly proclaimed as a dedicated

gaming machine, with SCE's director Akira Sato confidently stating that: "If it's not real-time, it's not a game" – a thinly veiled criticism of other CD-based consoles and their reliance on FMV titles that featured live actors but little interaction. The sheer power of the new system shocked other players in the industry; Sega of Japan president Hayao Nakayama was reportedly so furious when he read the specs for the

When you take into account Sony's position as one of the world's foremost electronics manufacturers, it's hardly surprising that the original PlayStation was a highly desirable piece of kit. Unmistakably a games console but showcasing a hint of mature design, the machine seemed to speak to those gamers who had cut their teeth on the likes of the NES, Mega Drive and SNES and were now ready to progress to

the videogames market very seriously indeed. Kutaragi – and the entire project in general – had come under fire from high-level Sony executives who argued that videogames were toys for children, and therefore, one of the PlayStation's key aims was to challenge that view. As a result, the final design for the machine was sleek and serious, mimicking the appearance of a top-end piece of audio-visual equipment rather than a games-playing device.

However, while this posturing caught the attention of gamers, some industry experts were less enthused, citing Sony's poor track record in the industry up to that point. The company's software publishing arm – Sony Imagesoft – had so far failed to generate any titles of note, pushing half-baked movie licences such as *Cliffhanger* and *Last Action Hero* onto store shelves to the complete indifference of the games-buying public. Indeed, software was one area in which Sony was at a distinct disadvantage, as Sega and Nintendo had highly talented internal development teams that traditionally produced the best software for their respective consoles. Sony

“ By making it a success, Sony would experience revenge at the expense of its one-time ally ”

PlayStation that he personally visited Sega's hardware division and gave them a stern talking to. His tirade would result in the Saturn, Sega's entrant in the 32-bit console war, getting an additional video processor to boost its graphical muscle, but this would make the system harder to program for – an issue that had severe ramifications in the future.

an entirely different level of challenge. Everything from the two-pronged joypads to the removable Memory Card storage system seemed to drip sophistication. Sony later revealed the numerous hardware designs that had been considered before the final version was decided upon; this was the work of a company that was taking its entry into



PLAYSTATION

Developer Viewpoint

Robert Troughton (programmer, *Destruction Derby*)

■ "IT WAS LATE in 1994 that Sony – and myself – were launching into the console games business. Straight out of university, I wasn't really sure what to expect. Reflections, a game developer based in the North East, were just beginning work on a new genre of racing game: *Destruction Derby*. The premise was simple: a racing game which you win not by coming first – although that helped – but by smashing your competitors' cars to a pulp. From starting in January '95, we had only nine months to complete the project, with a team consisting of just three programmers and one artist. The PlayStation was technically leagues ahead of the competition, with amazing 3D graphics and CD-ROM technology. I can't remember whether any of us saw daylight for those nine months, but I'm not sure that any of us cared all that much. Sony loved us for how fast we were creating the game – they gave us a release date that would tie in with the PlayStation's US and European launch – the press were all over us and it was clear that the game was going to be a success. *Destruction Derby* went on to sell millions. The PlayStation sold many times more, and I've stayed in the industry ever since, still doing what I was doing back then: hacking away at code and trying to squeeze every last bit of juice out of whatever platform I'm working on – and thankful to Sony for giving me this opportunity."



Station to Station



■ RELEASED LATE IN the machine's lifespan, the PocketStation was a self-contained handheld similar in design to Sega's Dreamcast Visual Memory Unit. Its announcement caused a surprising degree of excitement, and many industry insiders confidently predicted that this miniature console was Sony's attempt to crack Nintendo's stranglehold on the handheld market. Dubbed a "personal digital assistant", it stored save game data just like a typical PlayStation Memory Card but could also play crude games on its 32x32 dot matrix LCD display, although, predictably, the quality of these titles was well below

what could be experienced on Nintendo's Game Boy. An infrared connection was also included so users could exchange data without having to connect their PocketStations to their main console. Launched in 1999, it was only supported by a handful of titles and sadly never saw release outside Japan – although a release was obviously on the drawing board at some juncture as several Western games came with PocketStation functionality.

lacked this key feature, although it was at least attempting to rectify the issue by courting highly rated UK code shop Psygnosis, which would go on to publish vital launch titles such as *WipEout* and *Destruction Derby*. Still, there was an overwhelming feeling that although Sony was perceived to be doing everything right, it would ultimately fall at the final hurdle; Sega and Nintendo would continue to fight it out, just as they had done during the previous format war. 'Sony doesn't know games,' the critics cried. Thankfully, the firm managed to secure the assistance of a company that certainly did know something about the industry: Japanese arcade veteran Namco.

Pac-Man creator Namco was undergoing something of a resurgence thanks to the incredible impact made by its 3D coin-op *Ridge Racer*.

A texture-mapped tour de force, the game was unquestionably a cutting-edge piece of programming and had given its parent company the ability to leapfrog persistent rival Sega in arcades. When Namco revealed that it was porting its hugely successful racer to the PlayStation, it caused quite a stir. The notion that Sony's new console could replicate an arcade title that cost thousands of pounds created astonishing levels of expectation, and this only increased when the first shots of PSX-based *Ridge Racer* were released to the public. Coded in an incredible six months, the game might not have been arcade-perfect, but it did enough to cement Sony's position as a key player, purely because it made Sega's heavily delayed in-house conversion of its *Daytona USA* coin-op look decidedly second-rate by comparison. Elsewhere, the PlayStation's visual prowess was demonstrated by exquisite third-party titles such as *Jumping Flash* and *Battle Arena Toshinden*, the former being a groundbreaking, if shallow, 3D platformer and the latter a likeable, if uninspired, one-on-one brawler. *Toshinden* couldn't hold a candle to Sega's *Virtua Fighter* port when it came to gameplay, but it was nevertheless a fundamental game in Sony's arsenal because it looked far, far better. From screenshots alone, it was clear that the PlayStation had the edge in terms of raw power.

The Japanese launch took place on 3 December 1994 – a handful of days after Sega had shifted 200,000 Saturn consoles on its first day of sale. Priced at

¥39,800 (around £250 in today's money) the PlayStation sold strongly, although the Japanese public seemed to gravitate towards Sega's console more, possibly because *Virtua Fighter*, despite the slightly unimpressive Saturn conversion, was the country's number one arcade title at the time. Both formats started out fairly evenly, but as the months rolled by Sony was able to deliver on its promises thanks to sterling releases from Namco, Konami and Capcom, while Sega's in-house projects stalled. Ironically, Sony's reliance on third-party developers proved to be in its favour. Because it needed

outside assistance, the company had made great efforts to get software support, while it could be argued that Sega was less active in courting developers. Sony had made the PlayStation as accessible as possible, and it was paying dividends.

The technological gulf didn't do the PlayStation any harm, either; titles such

as *WipEout* looked gorgeous, with transparent textures and eye-popping flare effects. Sega's machine lacked both of these embellishments, and, thanks to its complex dual-CPU setup, required the best coders to really get the most out of it. Meanwhile, third-party studios were getting stuck in to PlayStation game production, and a string of classic titles began to emerge. *Tomb Raider* – ironically a Saturn title originally – along with *Tekken 2*, *Soul Blade*, *Ridge Racer Revolution* and *Resident Evil* all contributed to the PlayStation's wide and varied catalogue of titles.



» DMA's controversial *Grand Theft Auto* started its console life as a PlayStation release and made several appearances on the machine.

» [PlayStation] *WipEout* came to define the PlayStation's approach to gaming and is a staple of Sony's first-party lineup.

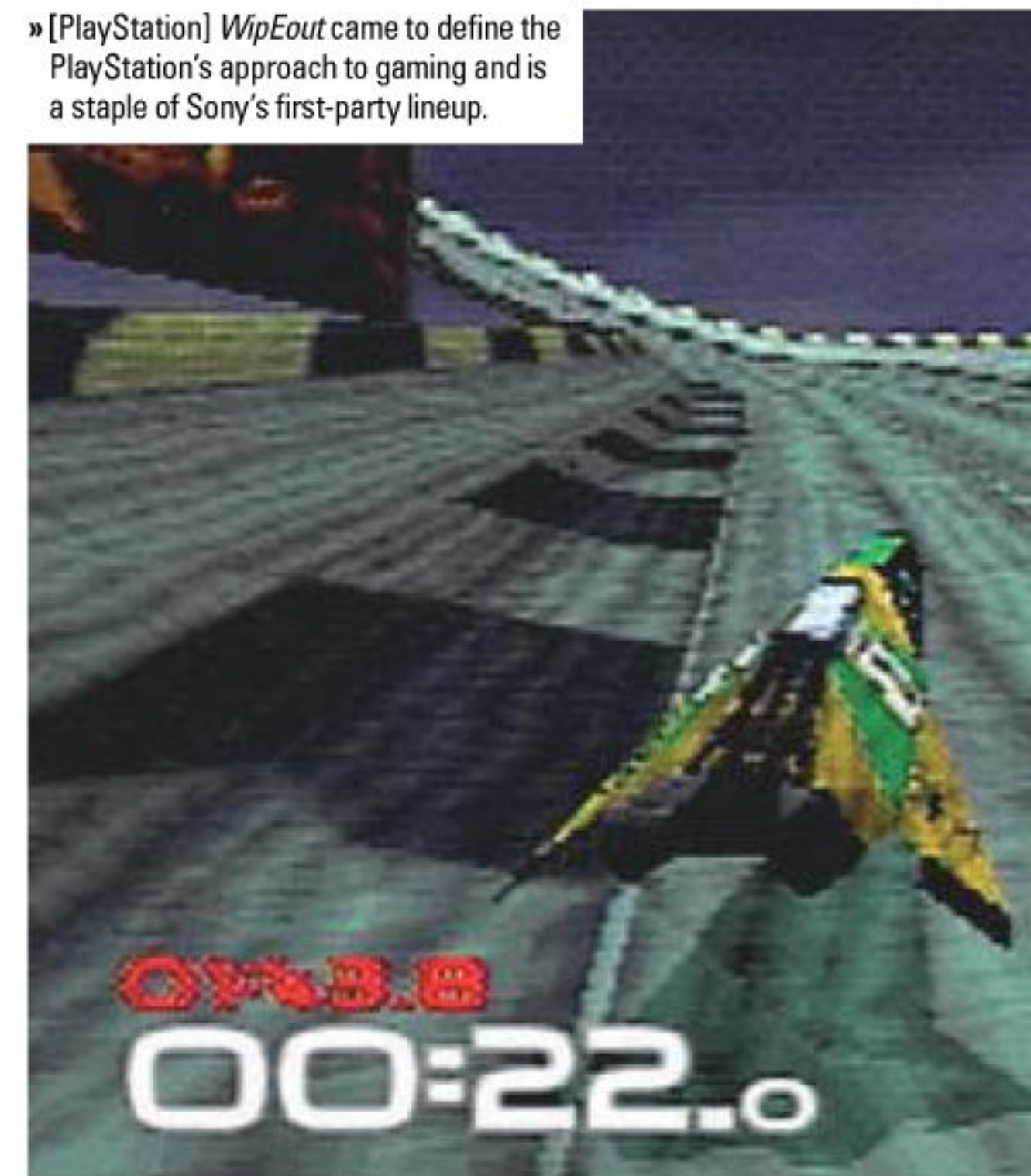

» Norio Ohga was Sony president during the genesis of the PlayStation project. He saw off apathy within the company to ensure that Kutaragi's dream came to fruition.



» Fraternalising with the enemy: Nintendo's Shigeru Miyamoto samples *Crash Bandicoot* during the 1996 E3 show.



» Sony developed several different logos before finally settling on the one we now know and love.

▶ The Western launches were equally successful, with Sony managing to undercut the retail price of Sega's Saturn in both North America and Europe. In Europe, especially, Sony displayed a masterly grasp of how to market a games machine to a more mature audience. The company knew that those gamers who had grown up with the 8-bit and 16-bit consoles were gradually reaching adulthood and would therefore require more 'grown-up' gaming experiences. While Sega and Nintendo focused on building recognisable mascots to appeal to youngsters, Sony released the PlayStation with a range of software that was unashamedly adult in tone: the aforementioned *WipEout* featured a soundtrack that showcased the talents of real recording artists, such as The Chemical Brothers and Leftfield, while visceral top-down shooter *Loaded* not only featured excessive gore and allusions to transvestism but also enrolled the assistance of grebo-rock outfit Pop Will Eat Itself. One thing was clear: Sony wasn't aiming for the *Mario* and *Sonic* audience with the PlayStation.

Sega's challenge soon began to falter, and so Nintendo became Sony's next opponent. The firm responsible for such classics as *Super Mario Bros* and *The Legend Of Zelda* had been making confident noises about its cartridge-based Ultra 64 (later Nintendo 64)

console for some time, and although it wouldn't be ready until 1996, Nintendo went to great lengths to encourage gamers to hold off on buying a 32-bit machine. Sadly, the decision to stick with the expensive cartridge format would cost the firm the support of one of its most prized third-party publishers: Squaresoft. Although the highly anticipated *Final Fantasy VII* had been confirmed as an N64 release, Square eventually switched development over to Sony's machine, citing the limited storage and high unit cost of cartridges. *Final Fantasy VII* was going to be the most epic game yet conceived, and it needed as much storage space as possible. Only CD-ROM could offer this, Square argued. Nintendo's loss was, of course, Sony's massive gain; published in 1997, *Final Fantasy VII* was a worldwide smash, selling 10 million copies in the process. This success established the console as the leading platform of its generation and subsequent system exclusives such as Konami's *Metal Gear Solid* and Polyphony Digital's seminal *Gran Turismo* cemented this lofty status even further.

With both Sega and Nintendo subdued, Sony's dominance was assured. So tight was the company's grip on the marketplace that even the launch of Sega's technically superior 128-bit Dreamcast in 1999 was unable to upset the status quo. With millions

» Sony Europe's Phil Harrison was instrumental in attracting quality developers to the machine and would eventually rise to the top of the company.



of units sold and a more powerful successor – the PlayStation 2 – waiting in the wings, 2000 saw Sony release a new iteration of its 32-bit console in the form of the PSOne. Smaller, sleeker and sexier, it boasted enhanced functionality that allowed it to link to mobile phones and even supported a fold-down LCD display, giving it a small degree of portability. The revision was a triumph and enabled the ageing machine to remain relevant in a marketplace that was gradually leaving it behind in technological terms.

Sony ceased manufacturing the PlayStation in 2006, giving the console an impressive production lifespan of 11 years. During that time it redefined the world of videogames, granting gamers a taste of 3D visuals and making the oft-derided hobby a cool and relevant pastime. Of course, such activity earned Sony – and, by association, its console – a fair degree of scorn also, but few would have the temerity to debate the PlayStation's incredible influence on modern interactive entertainment. Without it, the gaming landscape today would be near-unrecognisable.





PLAYSTATION



PERFECT TEN GAMES



01

TOMB RAIDER

- » RELEASE: 1996
- » PUBLISHER: EIDOS INTERACTIVE
- » CREATOR: CORE DESIGN
- » BY THE SAME DEVELOPER: FIGHTING FORCE

01 Although her star has waned a little over the past few years, there's no denying that Lara Croft remains one of videogaming's most enduring icons. Her 1996 debut was actually on the Saturn, as developer Core Design had traditionally supported Sega's consoles. However, it was the PlayStation version – released shortly afterwards – that was truly responsible for firing the delectable Miss Croft into the realms of global superstardom. Sequels followed as it firmly became a PlayStation series and arguably improved on the template, but the original game retains a near-legendary status.

GRAN TURISMO 2

- » RELEASE: 1999
- » PUBLISHER: SONY COMPUTER ENTERTAINMENT
- » CREATOR: POLYPHONY DIGITAL
- » BY THE SAME DEVELOPER: OMEGA BOOST

02 The first *Gran Turismo* was possibly the most technically groundbreaking release of the 32-bit era, and this sequel beefed up the already considerable experience by adding more cars, more tracks and even a rally mode. The title's visuals – already pretty mind-blowing in the original release – pushed the 32-bit hardware to the absolute limit, with Polyphony Digital's unique development software eking out every last drop of power from the PlayStation in its final years. Spanning two discs, *Gran Turismo 2* is arguably the definitive racing title of that era and still plays great today.



02

FINAL FANTASY TACTICS

- » RELEASE: 1997
- » PUBLISHER: SQUARE
- » CREATOR: IN-HOUSE
- » BY THE SAME DEVELOPER: DEW PRISM

03 With a limited release, this strategy RPG arrived around the same time as *Final Fantasy VII*, which caused some confusion when gamers discovered that they actually had very little in common. Developed by the team behind *Tactics Ogre* – Square snapped up studio Quest prior to producing the game – *Final Fantasy Tactics* showcases gorgeous visuals, breathtaking music and a surprisingly mature and complex plot. It was recently released on the PSP in a slightly enhanced form.

METAL GEAR SOLID

- » RELEASE: 1998
- » PUBLISHER: KONAMI
- » CREATOR: IN-HOUSE
- » BY THE SAME DEVELOPER: INTERNATIONAL SUPERSTAR SOCCER PRO

04 Hideo Kojima's magnum opus set a new high watermark for storytelling in videogames, as well as introducing a generation to the stealth sub-genre. Solid Snake has gone on to become a household name, starring in more technically impressive sequels on the PS2 and PS3 consoles. However, hardcore fans maintain that this instalment remains the best, thanks largely to its tight plotting, memorable characters and judicious use of the host hardware.

RESIDENT EVIL 2

- » RELEASE: 1998
- » PUBLISHER: CAPCOM
- » CREATOR: IN-HOUSE
- » BY THE SAME DEVELOPER: DINO CRISIS

05 The first title established Capcom's reputation as master of the 'survival horror' genre, but it was the second game in the series that truly confirmed the company's god-like status. Offering the ability to play the story with two different characters – one to each of the game's two discs, with differences depending on which you play first – *Resi 2* mixed relentless zombie slaughter with intriguing puzzles and some of the best visuals seen on the PlayStation up to that point. It's unsurprising that series fans hold this entry in the utmost regard.



03



04

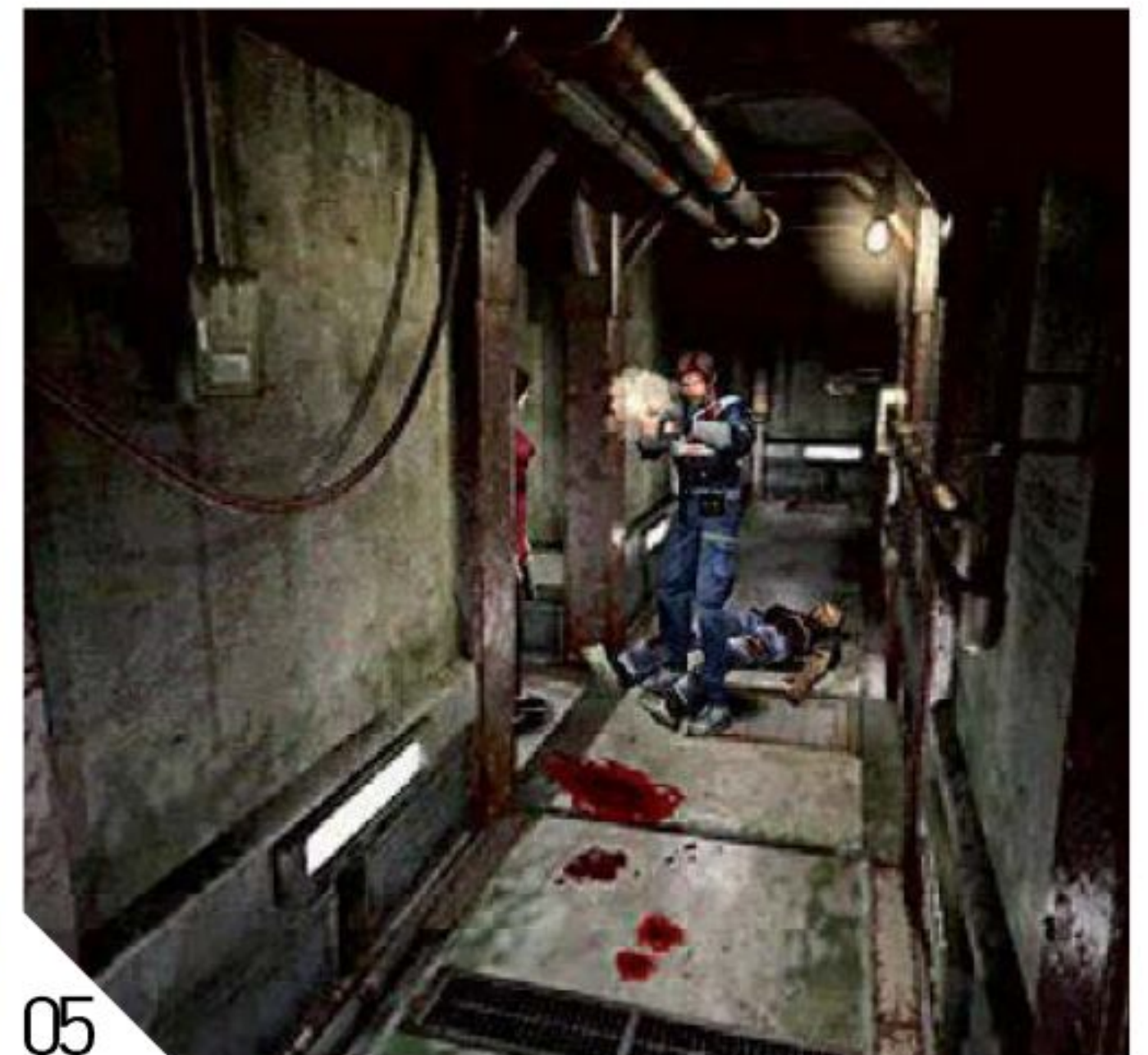

05

The original PlayStation brought us a massive number of franchises that have become part of the gaming landscape today. Just take a look at the list below...



06

TEKKEN 3

- » RELEASE: 1998
- » PUBLISHER: NAMCO
- » CREATOR: IN-HOUSE
- » BY THE SAME DEVELOPER: SOUL BLADE

06 *Tekken 2* had proven that Namco was more than capable of taking on Sega's illustrious *Virtua Fighter*, but it was the third game that dazzled the most. Sceptics had feared that it would never appear on the 32-bit console, but Namco's expert coders managed to squeeze in every aspect of the coin-op to create a fitting pugilistic swansong for the ageing PlayStation. While the *Tekken Force* and *Tekken Ball* modes were superfluous additions to the domestic port, all of the important features were present and correct.



07

EINHÄNDER

- » RELEASE: 1997
- » PUBLISHER: SQUARE
- » CREATOR: IN-HOUSE
- » BY THE SAME DEVELOPER: BRAVE FENCER MUSASHI

07 Famous for being Square's only entry in the shooter genre, *Einhänder* is an incredible achievement. The team involved had no previous experience with this type of game, yet it managed to create a classic that is still talked about in hushed, reverent tones even today. Featuring a unique weapon system based on grabbing the ordnance of fallen enemies, *Einhänder's* brilliance is made even more remarkable when you consider that Square hasn't ventured to the genre since its release.



08

FINAL FANTASY VII

- » RELEASE: 1997
- » PUBLISHER: SCE
- » CREATOR: SQUARE
- » BY THE SAME DEVELOPER: SAGA FRONTIER

08 Having sold over 10 million copies worldwide, *Final Fantasy VII* needs no introduction. Cited as the game that sold the Japanese RPG to the Western mainstream, this three-disc epic made the most of the PlayStation's technical capabilities to deliver hours of turn-based entertainment. It remains arguably the most popular entry in Square's evergreen franchise and has recently spawned several spin-off games and other projects, such as *Crisis Core* on the PSP and the *Advent Children* CGI movie.



09

CASTLEVANIA: SYMPHONY OF THE NIGHT

- » RELEASE: 1997
- » PUBLISHER: KONAMI
- » CREATOR: IN-HOUSE
- » BY THE SAME DEVELOPER: PROJECT OVERKILL

09 The PlayStation has a reputation for being something of a duffer when it comes to 2D titles, and to a certain extent, this is true. The console had only 2MB of RAM compared to the Saturn's 4MB, and this resulted in some lacklustre conversions. However, titles like *Symphony Of The Night* – coded with Sony's hardware in mind – were mind-blowing. Fusing 2D and 3D effects, Konami's designers created one of the most mesmerising titles of the generation. Look out for the limited edition European version, complete with art book and CD.

VAGRANT STORY

- » RELEASE: 2000
- » PUBLISHER: SQUARE
- » CREATOR: IN-HOUSE
- » BY THE SAME DEVELOPER: FRONT MISSION 2

10 One of the most ambitious role-playing games of the 32-bit era, *Vagrant Story* is epic in every sense of the word. Produced by the same team responsible for *Final Fantasy Tactics*, the game featured a deep and sometimes disturbing storyline, and lead character Ashley Riot has to rank as one of the most hard-edged protagonists in videogame history. *Vagrant Story* was recently re-released on Sony's PlayStation Network and can be purchased and downloaded for play on both the PlayStation 3 and PSP, and it even lives on through its shared universe with the *Final Fantasy Tactics* series and *Final Fantasy XII*.



10



AMIGA 500

Year released: 1987

Original price: £599

Buy it now for: £20

Associated magazines: Amiga World, Amiga Format, CU Amiga, Amiga Power, Amiga Action, Amiga Computing, Amiga Force, Amiga Mania, The One

Why the Amiga 500 was great... Why *wasn't* the Amiga great? During its early years, the A500 was the most desirable games machine on the planet thanks to several games that just wouldn't have been possible anywhere other than the arcades. As the years passed, its graphics became less relevant but the ease of development meant that there were hundreds of programmers pumping out classic after classic on a seemingly weekly basis.



AMIGA 500

FEW WORDS GET THE NOSTALGIA GLANDS FLOWING LIKE 'AMIGA' AND '500'. TO HEAR IT IS TO BE TRANSPORTED BACK TO A TIME WHEN NEW 2D VISUALS STILL HAD THE ABILITY TO SHOCK AND WHEN UK DEVELOPERS PRODUCED THE BEST COMPUTER GAMES IN THE ENTIRE WORLD. BUT HOW DID THE MUCH-LOVED HOME COMPUTER COME TO BE? WE REVEAL ALL...

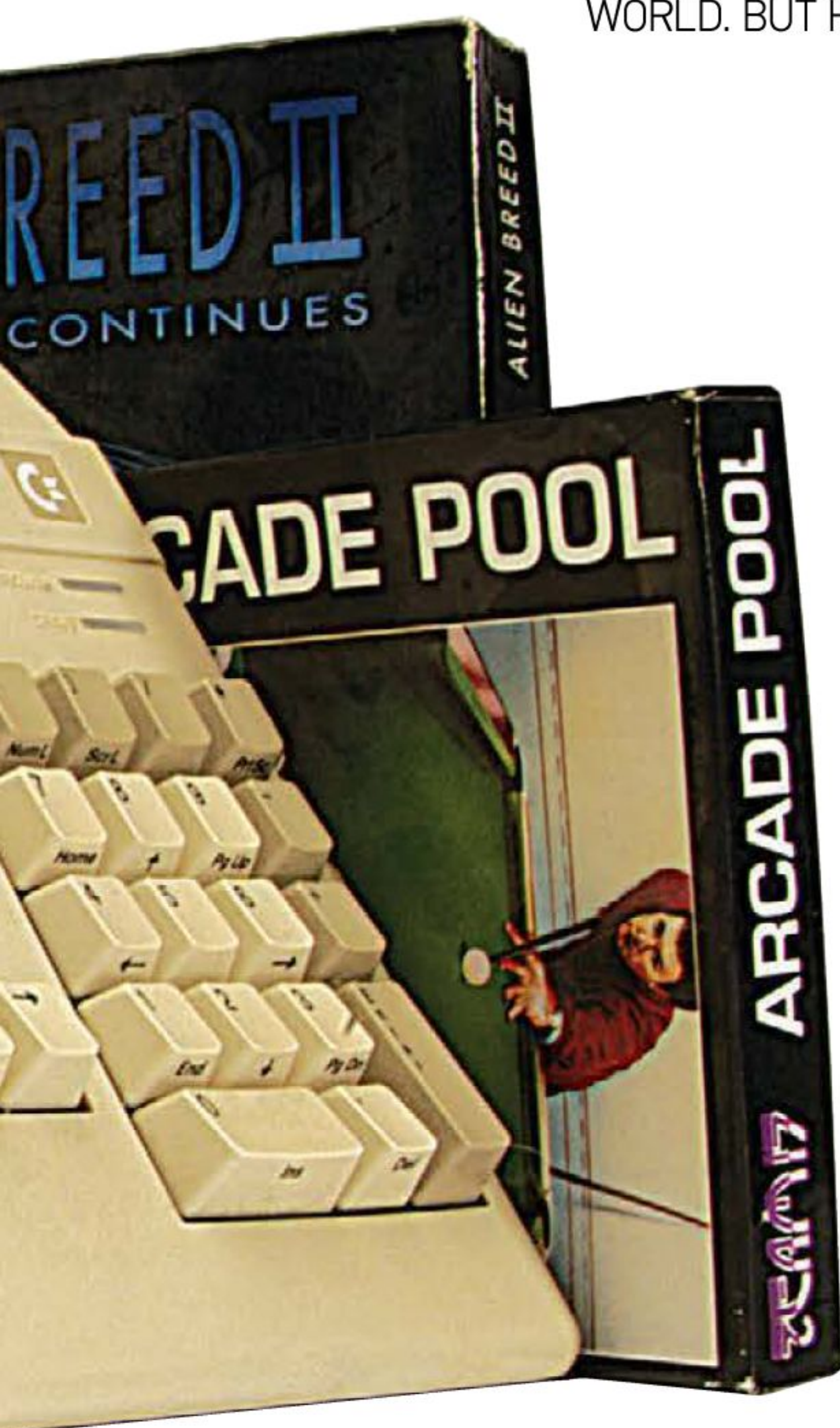

For a home computer that's so inextricably associated with the history and fate of Commodore, it's perhaps a little surprising that the Amiga's genesis can be tracked all the way back to Commodore's biggest rival: Atari. Jay Miner, a talented designer of integrated circuits had joined Atari during the boom period of the late Seventies and was responsible for designing the display hardware in the Atari 2600. With this achievement alone, Miner's place in the videogame history books

would be assured, but it was what he planned to create next that would really elevate him into the halls of fame. While at Atari, Miner had envisioned a new type of games machine that would make use of Motorola's powerful 68000 processor. Atari, which was then under the control of Warner Communications, had little interest in the 68000, however, and was much more interested in continuing to exploit the cheaper 6502 processors found in its 8-bit machines.

Disenchanted with the way Atari had been handled in the post-Bushnell organisation, Miner left the company in 1980 and, for a short time, he worked in the medical industry designing pacemakers. Two years later, however, Miner received a phone call that would rocket him back into the computer industry and change the history of gaming forever. On the end of the line was Larry Kaplan, another ex-Atari employee who had left to found Activision. Kaplan was keen to start a new videogame company and was looking for funding. Miner suggested a handful of dentist friends who were happy to invest in new projects and, before he knew it, he found himself working at a new company called Hi-Toro with Kaplan and a group of highly talented ex-Atari engineers.

In order to keep money rolling in, Hi-Toro was split into two divisions. The first would work on peripherals for games consoles like the 2600 and Colecovision whilst a second much more secretive division would experiment with the 68000 processor to create a killer 16-bit games machine. The computer was codenamed Lorraine (after the wife of Hi-Toro's chief executive) and was designed to be as open a development system as possible so that anyone could make a game if they wanted to: the strategy had worked wonders for the hugely successful C64 so it made sense for Hi-Toro to follow suit. It was also decided that, to take strain from the processor and ensure arcade-quality graphics, Lorraine would use custom-designed chips rather than off-the-shelf components. This meant that the computer would be more expensive to produce than its nearest rivals but the end results would be far better.

1983 was something of a turning point for Hi-Toro and Lorraine. While the rest of the Western videogaming world recoiled in horror from the disastrous videogames crash, Hi-Toro cunningly rethought its organisation in order to survive the harsh consumer climate. The peripherals division, now made redundant by the failure of the console market, was abolished whilst Lorraine was redesigned to be as much a computer as it was a games machine. A keyboard, mouse and expansion options were fitted as standard whilst new staff were hired to work on a fully fledged

"THE COMPUTER WOULD BE MORE EXPENSIVE TO PRODUCE THAN ITS NEAREST RIVALS"

Amiga 2600

Although some may know that the Amiga company (aka Hi-Toro) started out developing for the Atari 2600, few have actually played the games, mostly because they were developed for an obscure controller and released in limited quantities. Amiga's Joyboard was an Atari 2600 controller on which the player had to stand and control its games by moving from side to side. Three games were released for the Joyboard: *Mogul Mania*, a skiing game; the unreleased surfing game, *Surf's Up*; and a Simon Says clone called *Off Your Rocker*. Technically finished in 1983, *Off Your Rocker* never actually had an official release as Amiga couldn't afford to pay for the cartridges to be labelled. The labelling company held onto the cartridges and eventually sold them to Pleasant Valley Video, years later, who then sold them on to the 2600 community with homemade labels.





AMIGA 500



» Left: The Amiga 600 was basically an A500+ in a smaller case. Above: The original Amiga 1000 complete with handy keyboard garage.

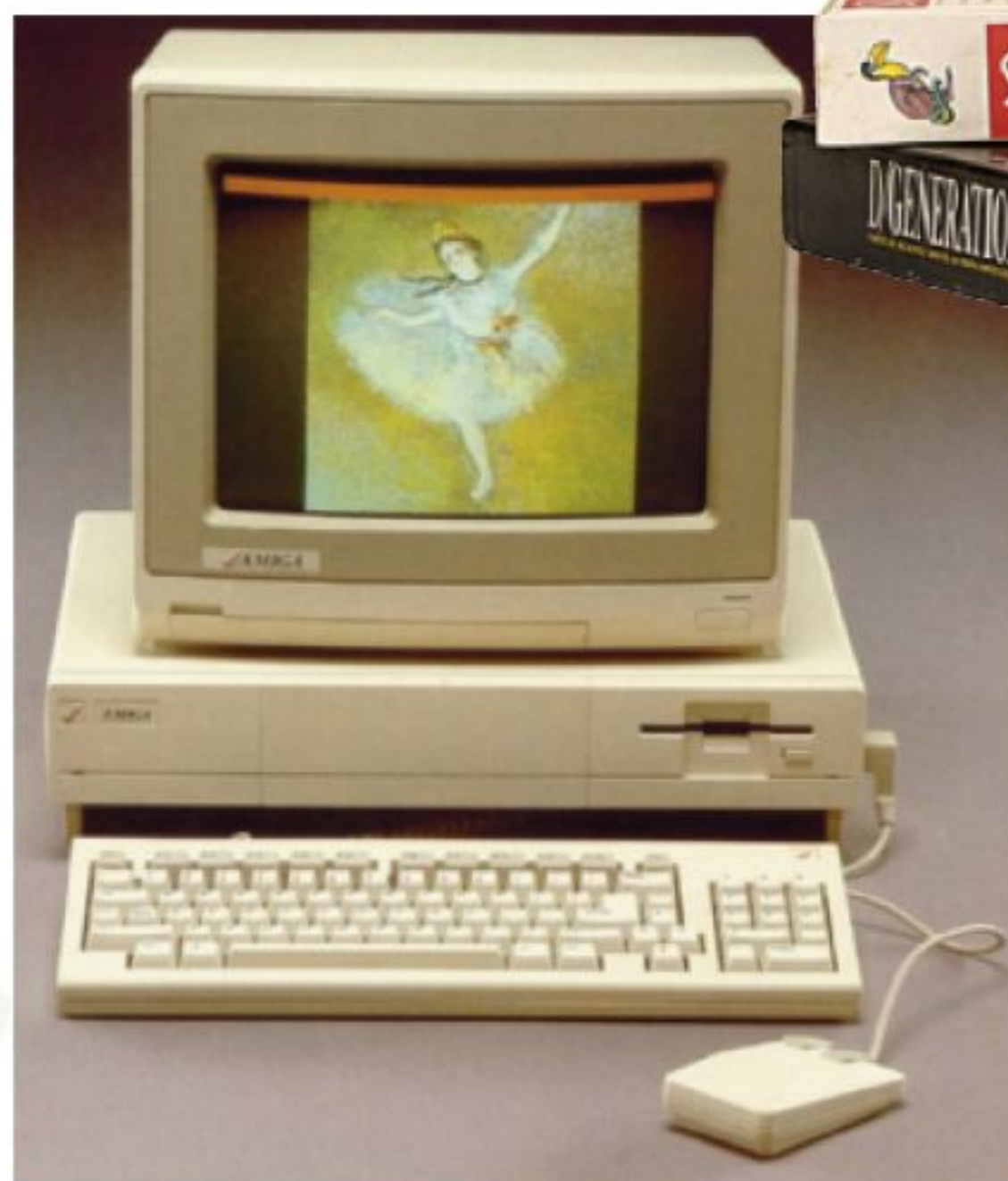

custom chips, rather than the computer itself, Atari offered to buy one million shares in Amiga for \$3 each and even loaned the firm \$500,000 to keep it afloat while the paperwork was finalised. The deal soon began to turn sour, however. Atari knew that Amiga could not afford to pay off its \$500,000 loan and so delayed paperwork on the buyout and, in the meantime, reduced its offer to 98 cents per share. Things were looking grim for Amiga. Atari was gearing up to buy the company at a bargain price and didn't even plan to finish the computer that Miner had dreamed of for the past four years. Just before the Atari deal could be finalised, however, Amiga managed to find another enterprising computer company which was both willing to pay a fair price for Lorraine and help develop it into the machine that Miner and company had intended. That company was, of course, Commodore, which swooped in at the last minute to buy Amiga for \$4.24 per share and even gave them \$1 million to pay off their debt to Atari.

With that sticky situation behind it and rejuvenated by a \$17 million investment from its new owner, Amiga set about finishing the Lorraine project, which was now to be known as the Commodore Amiga. The custom chipset was finally finished and reduced to a manageable size. Named after different people, so

operating system called Intuition. It is also around this time that Hi-Toro was renamed as Amiga. The Toro name had already been in use by a Japanese gardening technologies firm so it was thought that a new name was needed to avoid confusion. Amiga, a Spanish word meaning 'female friend', was picked for its non-threatening nature. Finally, in September 1983, Lorraine's three main custom chips (later known as Agnus, Denise and Paula) were completed but

“THE MACHINE ITSELF DIDN'T LOOK THAT IMPRESSIVE, BUT IT WAS HOW THE COMPUTER LOOKED ON-SCREEN THAT REALLY WOWED THE CES ATTENDEES”



» An original promo shot for the hugely successful 'Bat Pack'.

» Below: The original Kickstart came on floppy disk but by the time of the A500 it was a ROM chip on the Amiga motherboard.

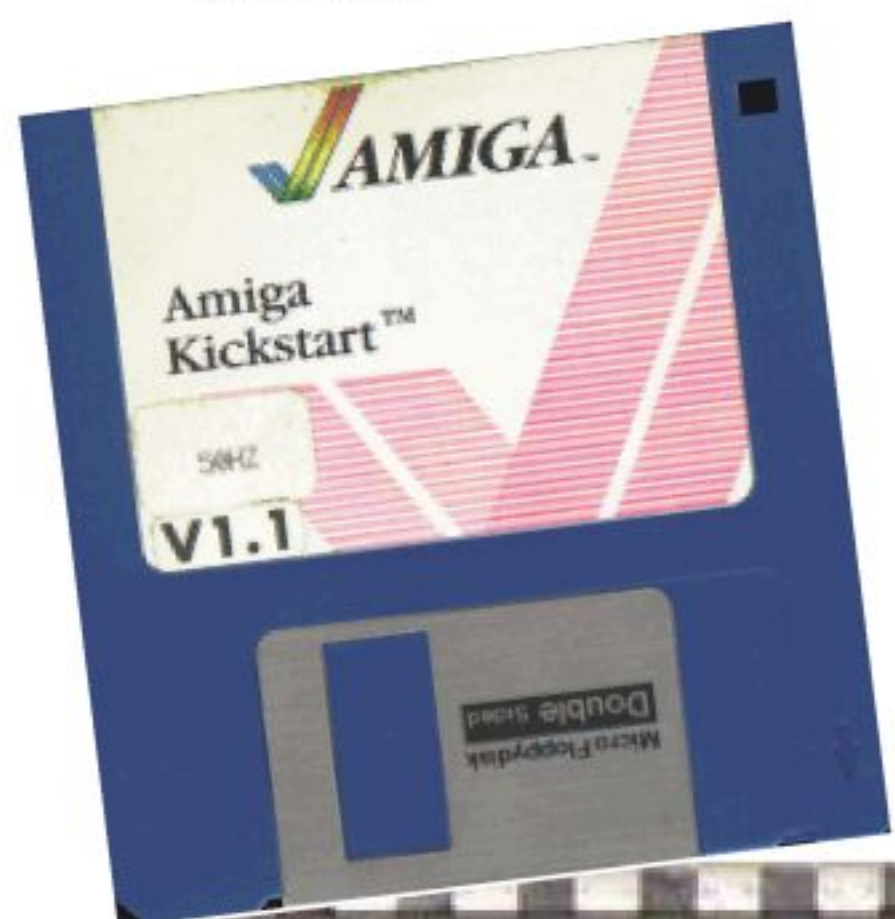

were far too big to be used inside a working home computer – each was the size of a large circuit board.

By 1984, Amiga was ready to show off its top secret project and, on 4 January, Lorraine was unveiled at the Consumer Electronics Show in Chicago. The machine itself didn't look that impressive – as it was still in the prototype stage and was made up of several circuit 'breadboards' joined together – but it was how the computer looked on-screen that really wowed the CES attendees. RJ Mical, one of the coders behind Intuition, had programmed the now legendary 'Boing Ball' demo. Boing Ball was demonstrated at the CES in an attempt to showcase Lorraine's graphical capabilities and did not disappoint. The red and white chequered ball, now an official logo for the Amiga, would bounce around the screen and alternate the direction of its rotations, all while an Intuition window functioned at 100% speed in the background.

The amazing graphical demo was enough to convince one company that Lorraine was worth investing in and, ironically enough, that company was Jay Miner's old employer, Atari. Interested in the

that competitors wouldn't realise what they were talking about in public, each of the chips performed a very specific task. Denise was the graphics co-processor and Paula controlled the sounds and external ports while Gary handled miscellaneous operations. Agnus, meanwhile, was the most important of the chips. Its main function was to regulate access to the on-board RAM but it also included two co-processors, known as Copper and Blitter, which allowed the Amiga to display the astounding graphics for which it became famous. Copper was designed to handle up to eight different sprites anywhere on screen at a single time whilst Blitter was responsible for moving bitmap images around in memory much faster than the

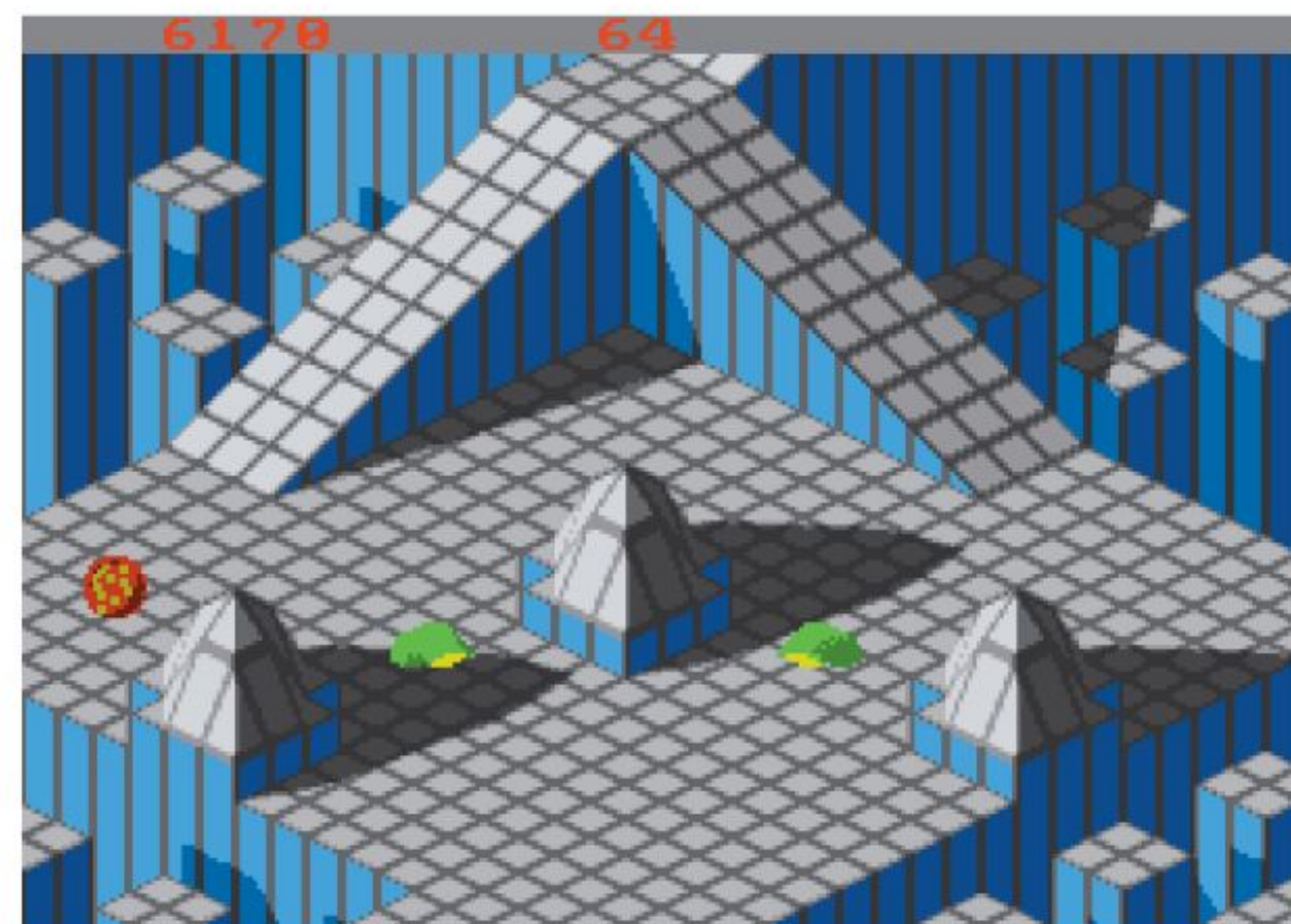

» Marble Madness was one of the first coin-op conversions on the Amiga and was virtually arcade perfect.

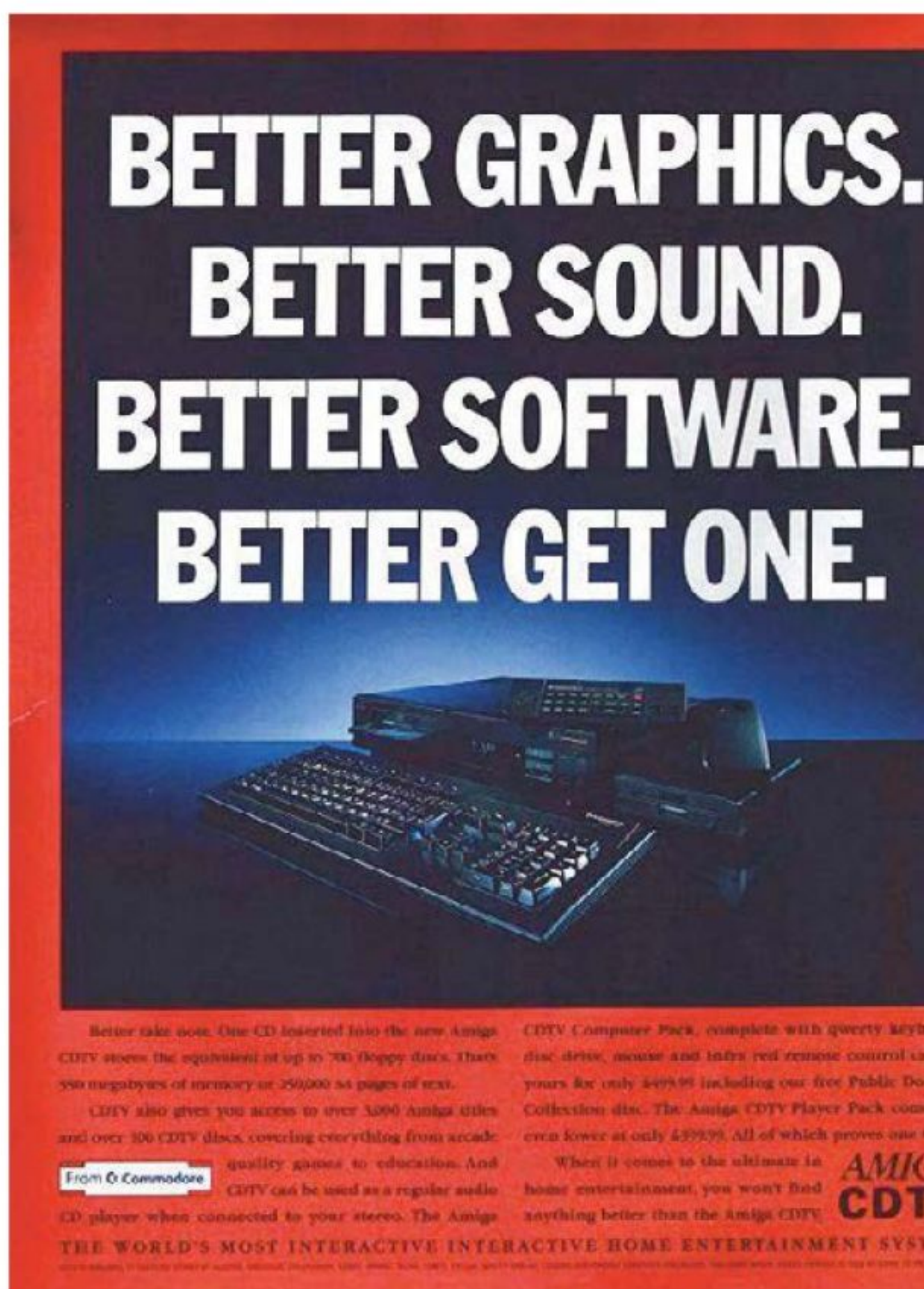

» An advert for the ill-conceived CDTV.

CPU would have been able to on its own. On the software side, the Amiga also saw major advancements during its final months of design. Intuition was renamed Amiga DOS (later shortened to Amiga OS) and was separated into two entities. Kickstart took care of the Amiga's basic needs, giving it just enough instructions to launch whatever program you fed into the floppy drive. Workbench, meanwhile, was the Amiga's Graphical User Interface. It was the Windows of its day and one of the first to offer a true multitasking environment, years before the PC.

On 23 July 1985, the Amiga 1000 made its first official public appearance at the Lincoln Centre in New York. In typical Commodore fashion, the latest fashionable celebrities, in this case Andy Warhol and Debbie Harry, were roped in to promote the computer. The pair were enlisted to demonstrate the Amiga's graphical capabilities in the program *Graphic Craft*, whilst *Music Craft* was shown off with a full synthesised score, written by the program's authors. The lavish launch ceremony worked and when



» *Code Name Hell Squad* was the last commercial game to be released for the A500.

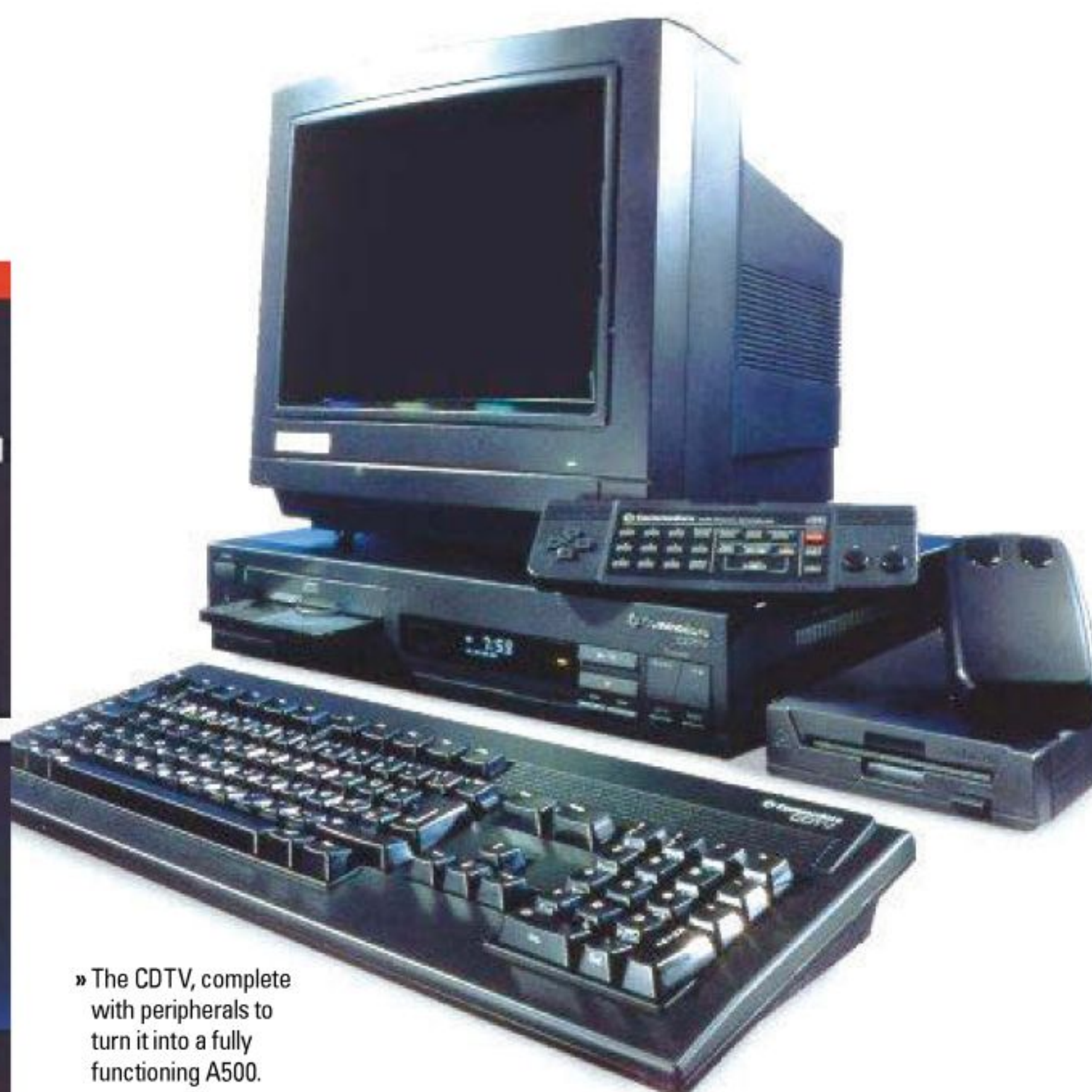

» The CDTV, complete with peripherals to turn it into a fully functioning A500.

the Amiga 1000 launched in September 1985 it was an instant hit with those who could afford it. But at \$1,295, the A1000 was twice the price of its nearest competitor, the Atari ST, and way out of the price range of the casual user. Those only interested in playing games weren't quite willing to pay up for an A1000 either, as aside from the stunning-looking *Defender Of The Crown* and the Commodore-published *Mind Walker*, the best games on the computer were all ports of existing Atari ST titles. Something would have to change if Commodore wanted the Amiga to dominate the home computer market in the same way as the C64 had.

In 1987 Commodore answered the prayers of those gamers with the launch of the Amiga 500. Essentially a cut-down version of the A1000, the 500 crammed a motherboard, several expansion ports and a disk drive into a slim keyboard casing. It was also compatible with household televisions and featured an upgraded version of Amiga DOS. The loss of a monitor and compact design also meant that the A500 was much cheaper to produce than the Amiga 1000 and could, crucially, be priced low enough to realistically compete with the Atari ST.

June 1987 saw the UK launch of the A500 at £599, which may seem expensive in an age where people cry and moan at the £425 PlayStation 3 but was actually very reasonable for a computer of the day and saw the 500 become a much more affordable system for computer gamers of the late Eighties. *Defender Of The Crown* made its UK debut alongside the 500 and had the same effect on gamers as it had the year before in the States. The detailed graphics, the number of colours on screen, the incredible musical score and the first-person-perspective jousting were like nothing anyone had ever seen on a computer or console before and as soon as those gamers saw it running they just had to have an Amiga. 1987 was also the year that many European developers began thinking about shifting development from C64 and Spectrum to the Amiga. The affordable A500 and open architecture of the computer made it the next logical step for Europe's smaller development houses and bedroom programmers. Great UK codeshops like Psygnosis, The Bitmap Brothers, Bullfrog and Sensible Software all began working on the Amiga around 1987/88 and slowly but surely the A500 began to build up a catalogue of games that made it one of the most desirable machines available. This was great for Commodore, of course, and even better for UK gamers but did, unfortunately, cause a bit of a headache for American Amiga fans. With most of the

“A CUT-DOWN VERSION OF THE AMIGA 1000, THE 500 CRAMMED A MOTHERBOARD, SEVERAL EXPANSION PORTS AND A DISK DRIVE INTO A SLIM KEYBOARD CASING”

» Jay Miner (1932 - 1994), the father of the Amiga.



» The Cartoon Classics Amiga 500 bundle included the brilliant *Lemmings*.

Links

One of the greatest things about old Amiga software is that it can be acquired for free on the internet, or bought for less than a pound per game at auction. For further information on the Amiga's vast number of releases, Retro Gamer recommends www.lemonamiga.com and hol.abime.net – both excellent databases of Amiga games. www.aminet.net should help those looking for shareware games and utilities and is also well worth visiting for its historical importance, as the website has been around since 1992 and was once an essential archive for web-surfing Amiga owners. Finally, fans of Team 17 may like to visit www.dream17.co.uk – the only place where Team 17's Amiga back catalogue can be legally downloaded for free.

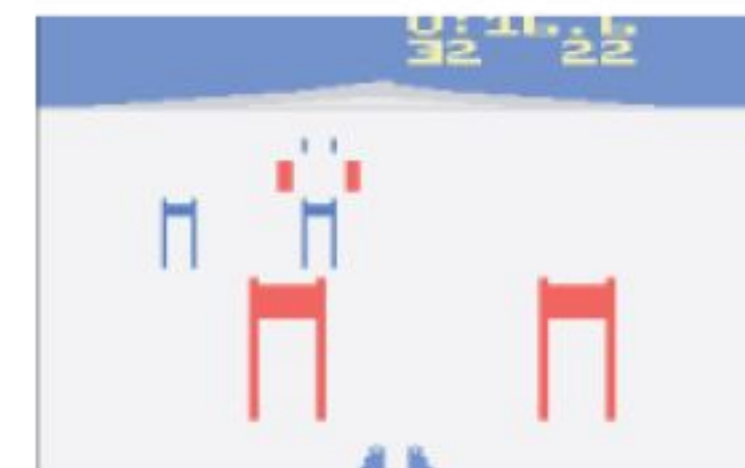



AMIGA 500

“COMMODORE HAD CREATED ONE OF THE WORLD’S FIRST MULTIMEDIA SET-TOP BOXES BUT IT SEEMED THAT NOBODY, INCLUDING COMMODORE, WAS READY FOR SUCH NEW TECHNOLOGY”

Back From the Dead

On 22 April 2007, Amiga Inc announced the development of the first mass-produced Amiga range in 13 years. Using Power PC technology, Amiga Inc, in association with ACK Software, plans to produce two new Amiga machines. One will be a compact, low-power computer, priced at \$500 and the other will be a pro-user computer at \$1,500. “ACK and Amiga have spent many months working on designs and working with various manufacturers to create great products with a competitive price point. We will be working with the Amiga retailers over the coming weeks to solidify launch and support plans”, said Bill McEwen of Amiga Inc. For more information, log on to www.amiga.com



» The Lorraine prototype as it appeared at the Consumer Electronics Show in 1984.

Amiga’s greatest games coming out of Europe, US gamers suffered the brunt of PAL/NTSC incompatibility problems and had to resort to fitting switches into their precious computers and even buying expensive multiformat monitors.

The UK’s favourable relationship with the Amiga didn’t end with the software developers as Commodore UK also seemed to have a better idea of how to promote the computer than their International counterpart. Seeing that the Amiga 500, like the C64 before it, was destined for success as a games machine rather than a business machine, Commodore UK began producing packages that bundled the computer with several games at a discount price. While Commodore International had packaged the A500 with business software and digital art packages, David Pleasance at Commodore UK negotiated with Warner Bros to create the Batman Pack, which bundled an A500 along with a copy of the new *Batman* game (based on the Tim Burton film) as well as copies of *The New Zealand Story*, *Interceptor* and EA’s incredible *Deluxe Paint 2* for just £399. In the run-up to Christmas 1989 the ‘Bat Pack’, as Amiga fans affectionately named it, helped raise the number of UK Amiga owners to over 2 million – a success that saw Pleasance promoted to managing director of Commodore UK.

The next few years saw several other games bundles released but it was the Bat Pack that really sealed the success of the Amiga 500 and helped sell enough machines to ensure that the Atari ST became a distant memory. But for every success that Commodore UK achieved, it seemed as though Commodore International was close behind with a disastrous plan, destined to sink the Amiga to the bottom of the sea. One of the first of these suicidal business decisions was the infamous CDTV. By stripping the keyboard

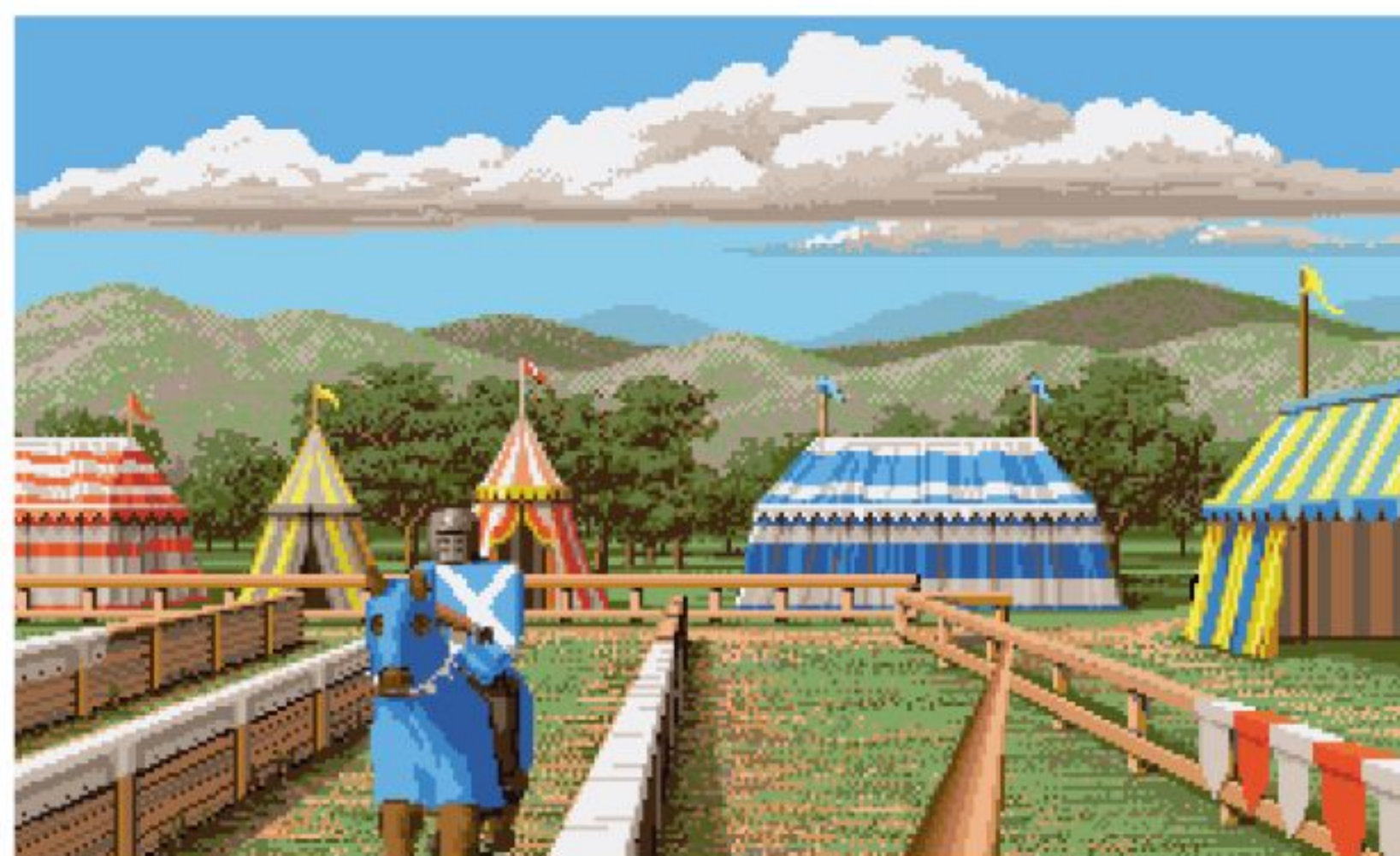

» For many early Amiga owners, the stunning *Defender Of The Crown* justified the purchase of the computer alone.



» *Shadow Of The Beast* was a UK-developed game that looked far better than anything the Americans had made.

and disk drive from the Amiga 500, adding a CD-ROM drive and packaging it in a sleek VCR style casing, Commodore had created one of the world’s first multimedia set-top boxes but it seemed that nobody, including Commodore, was ready for such new technology. Priced at £699, the CDTV was £300 more than the average Amiga 500 and compatible with far fewer games, whilst software manufacturers seemed to have little idea of how to take advantage of the CD-ROM medium. Needless to say, the CDTV was a huge flop and was discontinued a year later. The whole project was a huge financial loss and public embarrassment for Commodore and would not be their last needless folly.

For the time being, however, the traditional Amiga 500 continued to go from strength to strength with 1991 proving to be something of a golden year for the computer. Despite competition from the Super Nintendo and Mega Drive and a slight drop in A500 hardware sales, existing owners were rewarded with some of the greatest games in the history of the Amiga. Commodore UK launched the Amiga 500 Plus, which was virtually identical to the existing 500 but came with a full 1MB of RAM as standard. A whole new wave of quality games followed. *Another World*, *Full Contact*, *SWIV*, *Cruise For A Corpse*, *Lemmings*, *Moonstone*, *Leander*, *Alien Breed*, *Jimmy White’s Whirlwind Snooker*, *The Secret of Monkey Island*, *Mega Lo Mania*, *Exile*... the list of defining Amiga titles to appear in 1991 goes

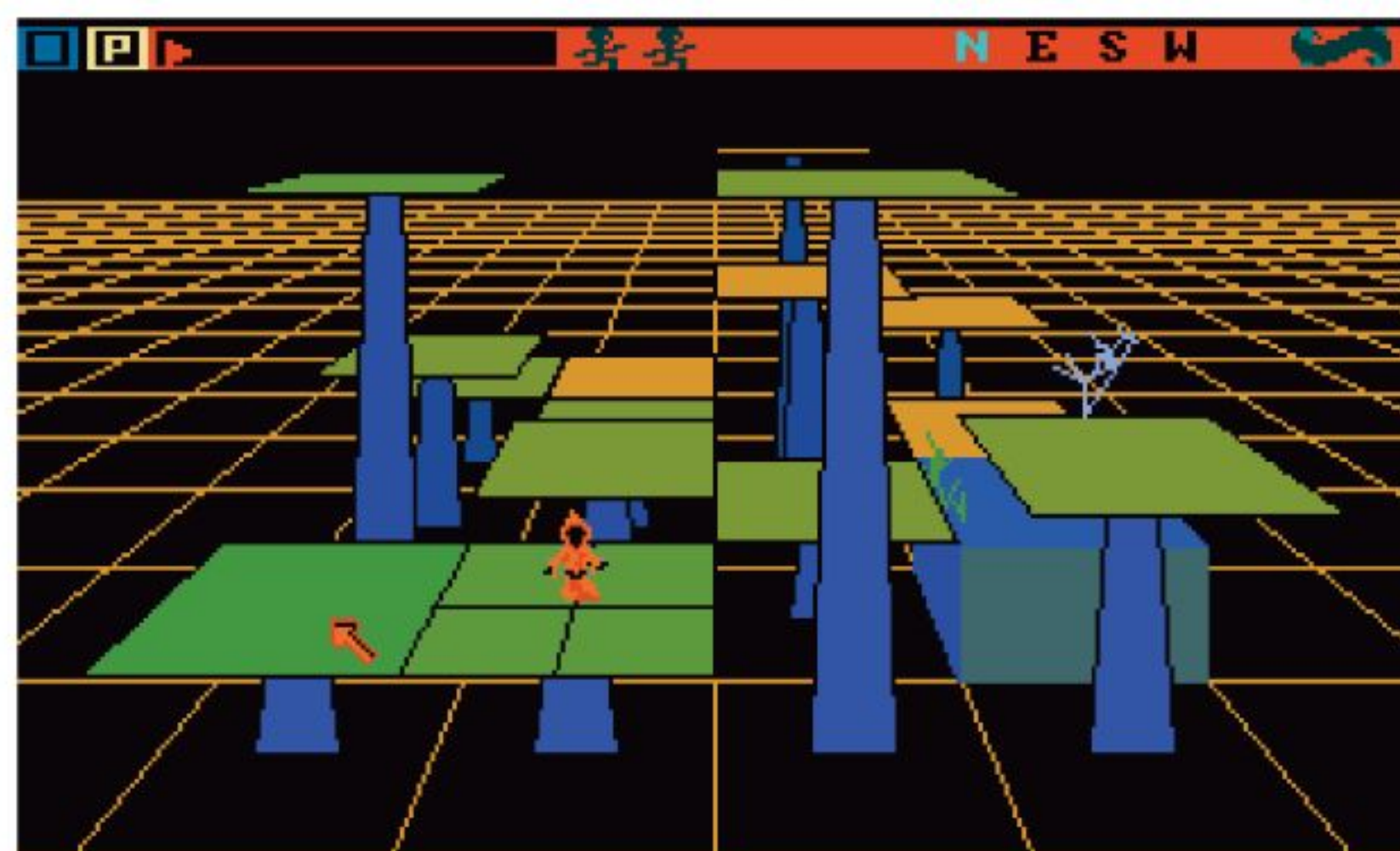

» Created by the late Bill Williams, *Mind Walker* is believed to be the first Amiga game ever made and was published by Commodore itself.

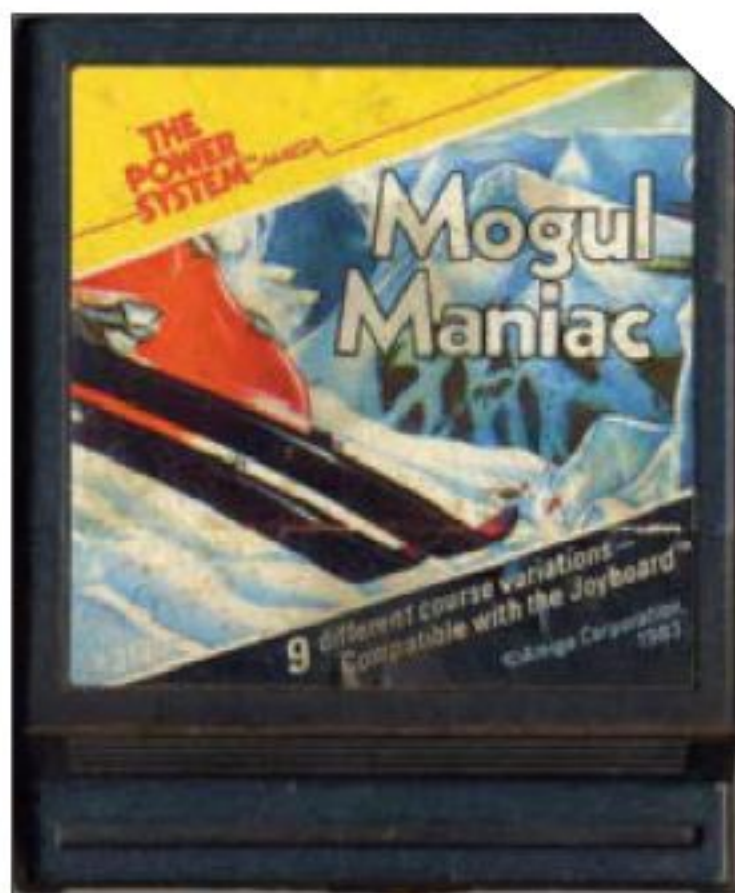

» Most of Commodore’s print ads missed the point of why the Amiga 500 was so popular.

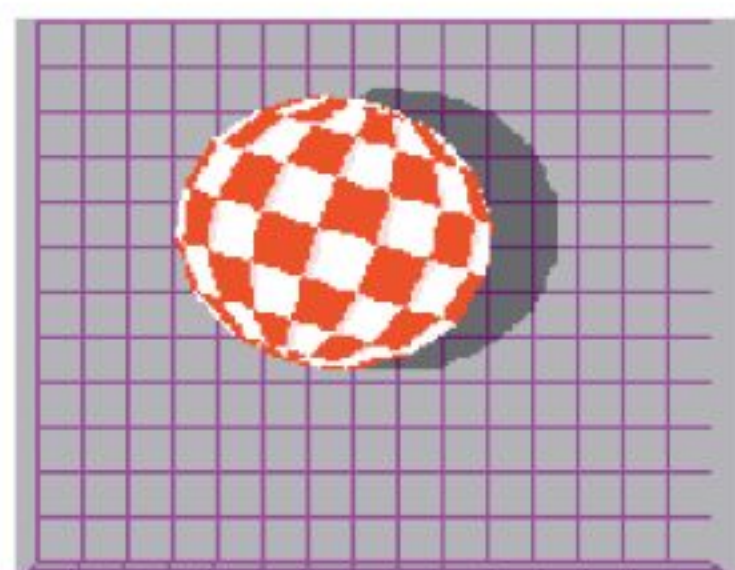

» The Boing Ball demo as it would have first appeared at the Consumer Electronics Show.



» *Metal Warrior*, one of the more recent home-brew games on the A500.

on and on. Some of these games even found themselves packaged into the Amiga's second most popular hardware bundle. Cartoon Classics cost £359 and included *Lemmings*, *The Simpsons*, *Captain Planet* and *Deluxe Paint 3*. Many of these games and others that followed in the coming months made use of the ECS chipset in the A500 Plus, which created another problem for American Amigans who never received an official release of the hardware update. Eager to play the European hits, they were forced to hardwire an extra 512KB of Chip RAM into their Amigas and even faced the prospect of having to pull out the Agnus chip and pop in the new Fat Agnus to cope with addressing the full megabyte of RAM.

The 500 Plus was soon discontinued, however, as Commodore made efforts to compete with the console market with the Amiga 600. Another variation on the 500 hardware, the A600 was launched in 1992 and featured a much smaller casing, presumably so that it could more comfortably occupy the space underneath a television set rather than hogging a computer desk. Some models of the A600 even came with internal hard drives, which reduced the need for messy disk swapping. But the 600 was ultimately seen as too little too late and was soon dropped by Commodore as its sales fizzled out.

While Commodore failed to re-ignite hardware sales, however, software sales continued to be very strong for Amiga developers.

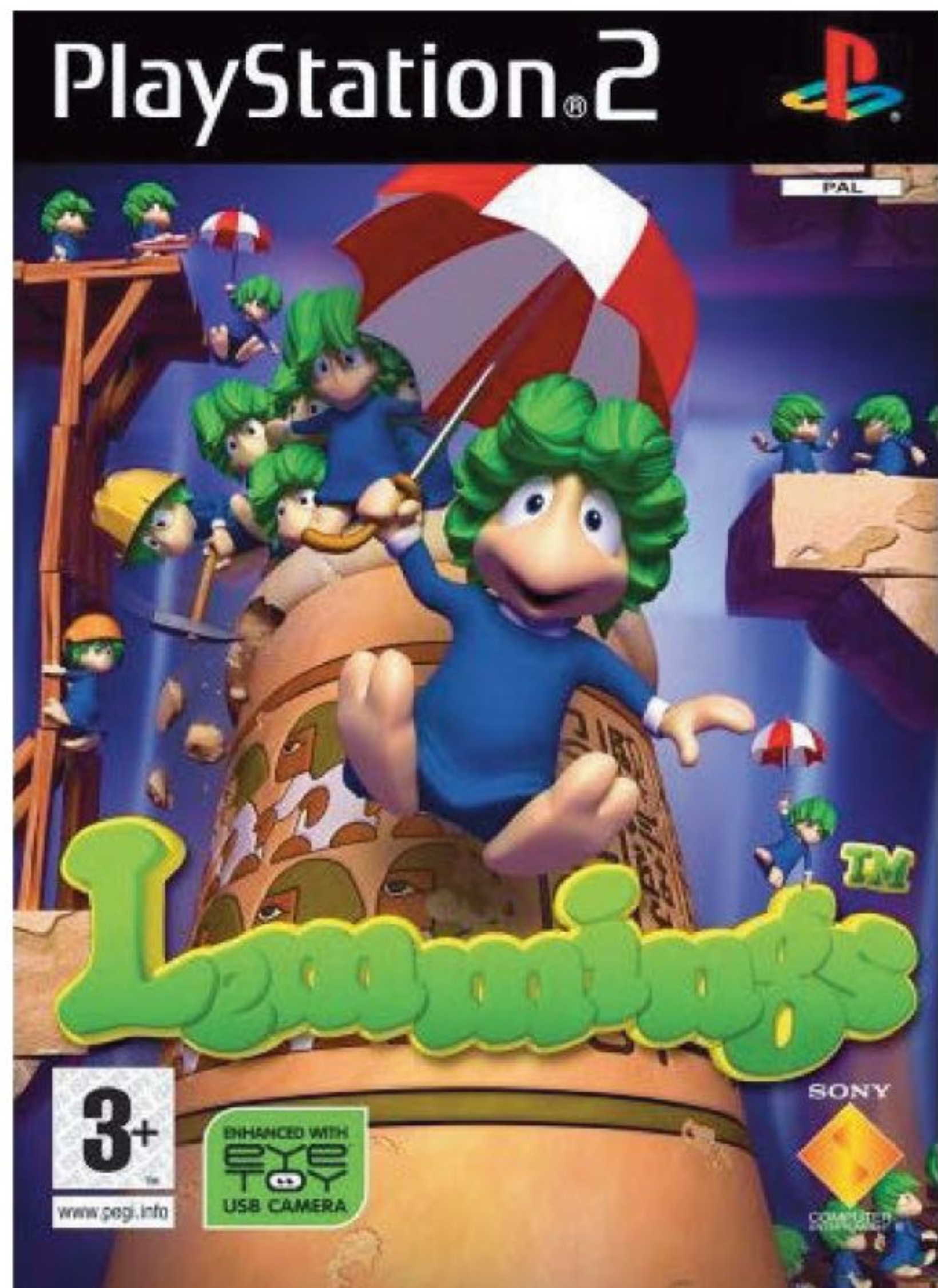

» The impact of the Amiga continues to be felt to this day.



Despite a rising threat from piracy, developers still managed to prosper on the Amiga. Team 17, for example, released a record nine Amiga games in 1993 and even shared a Publisher of the Year award with Electronic Arts that year. Public Domain houses also flourished during this period, distributing huge volumes of indie games long before the term 'home-brew' even existed.

The coming years saw Commodore stumble one too many times and eventually implode despite the brilliance of its second-generation Amigas, the 4000, 1200 and CD32, but that didn't stop the Amiga 500 from continuing to be a critical success. Even without an official hardware presence, over 150 Amiga games were released in 1994, another 90 in 1995 and a further 86 between 1996 and 2000. Amongst those releases were even more of the Amiga's all-time greats such as *Worms*, *Theme Park* and *Beneath A Steel Sky*.

The point-and-click adventure *Code Name Hell Squad* was the final commercial game to be compatible with the Amiga 500, although it did require a CD-ROM drive. That new games were being released 13 years after the launch of A500 and six years after the fall of Commodore is testament to the dedication of the Amiga user base and the passion of its software developers. Incidentally, many of those users are still around, still using their Amigas and even producing new software. The last three years have seen a handful of decent shareware releases such as *Metal Warrior* and *Tank Wars*, while advances in the Amiga emulation scene – most notably through the only legal solution, Amiga Forever – should see more new shareware games released for years to come.

Amiga itself is still around too. After being sold from company to company over the last 13 years, Amiga Inc is now mostly a software company, although it is working to produce new hardware. It should be noted, though, that the new Amigas are Power PC-based computers that have little in common with Jay Miner's original vision, other than the promising Amiga OS 4, and will not be compatible with any old Amiga software.

Regardless of the trials and tribulations of the hardware itself, however, the Amiga's greatest legacy is the excellent catalogue of games that were available for it and the huge number of European developers who cut their teeth on the Amiga and now create some of the greatest games of today. Rockstar North, Team 17, Sony Liverpool, Lionhead, Bizarre Creations... many of these developers, and more, might not be around today were it not for the power and accessibility offered by the Amiga 500 in 1987.



» The original Workbench operating system looks garish now but was a technical marvel in 1985.



» Two limited-edition A500s produced, in Germany, to commemorate the sale of 1 million Amigas in 1989.



AMIGA 500

PERFECT TEN GAMES

Amiga's Commodore 500 was a huge success, so it should come as no surprise that a variety of superb games are available for it. Indeed, it's practically impossible to name just ten games, as for every one we put forward, three other titles were just as deserving. Still, here's what we finally decided on. To have your own say, head on over to the forums at www.retrogamer.net/forum



01



02

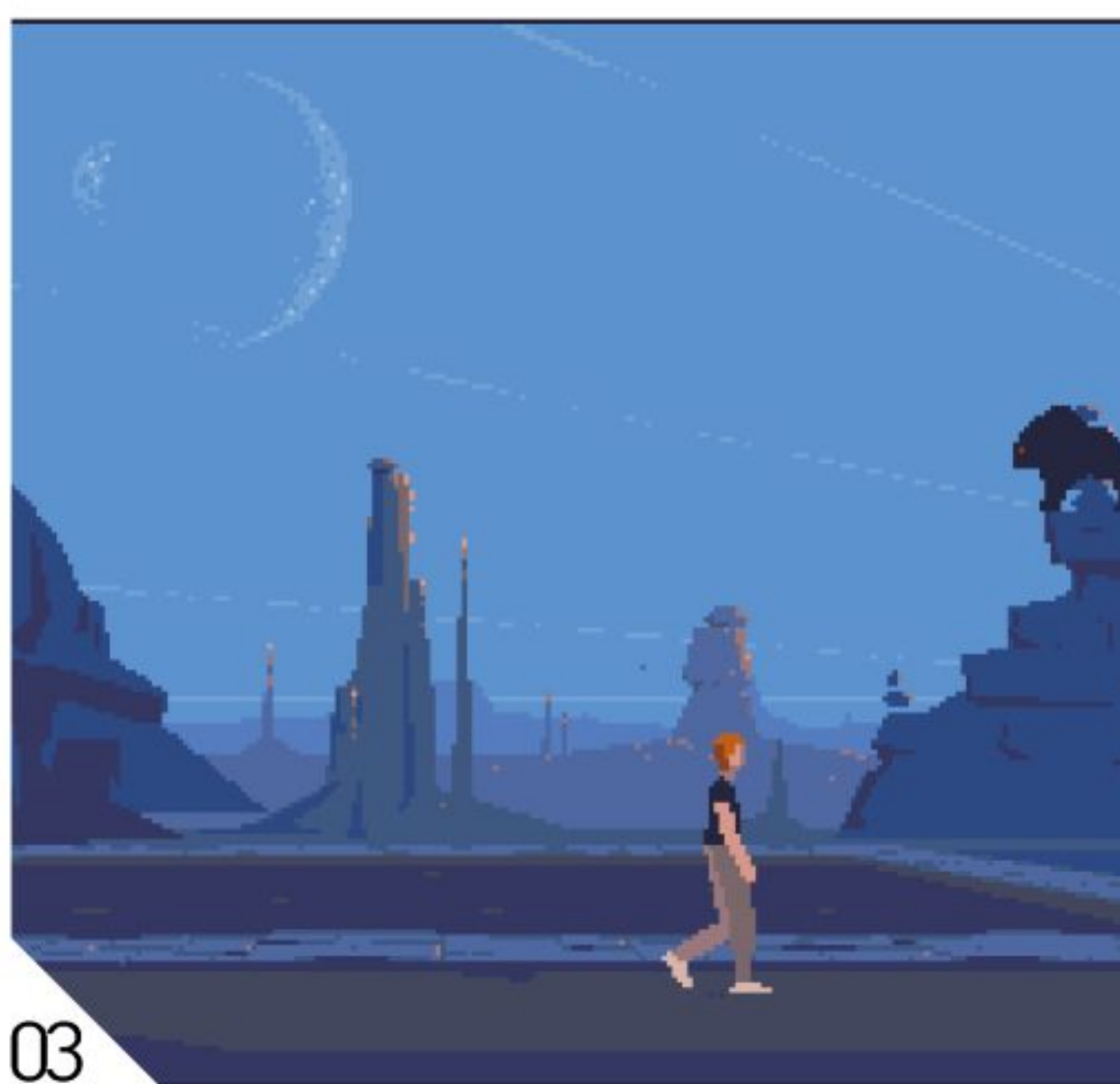

03

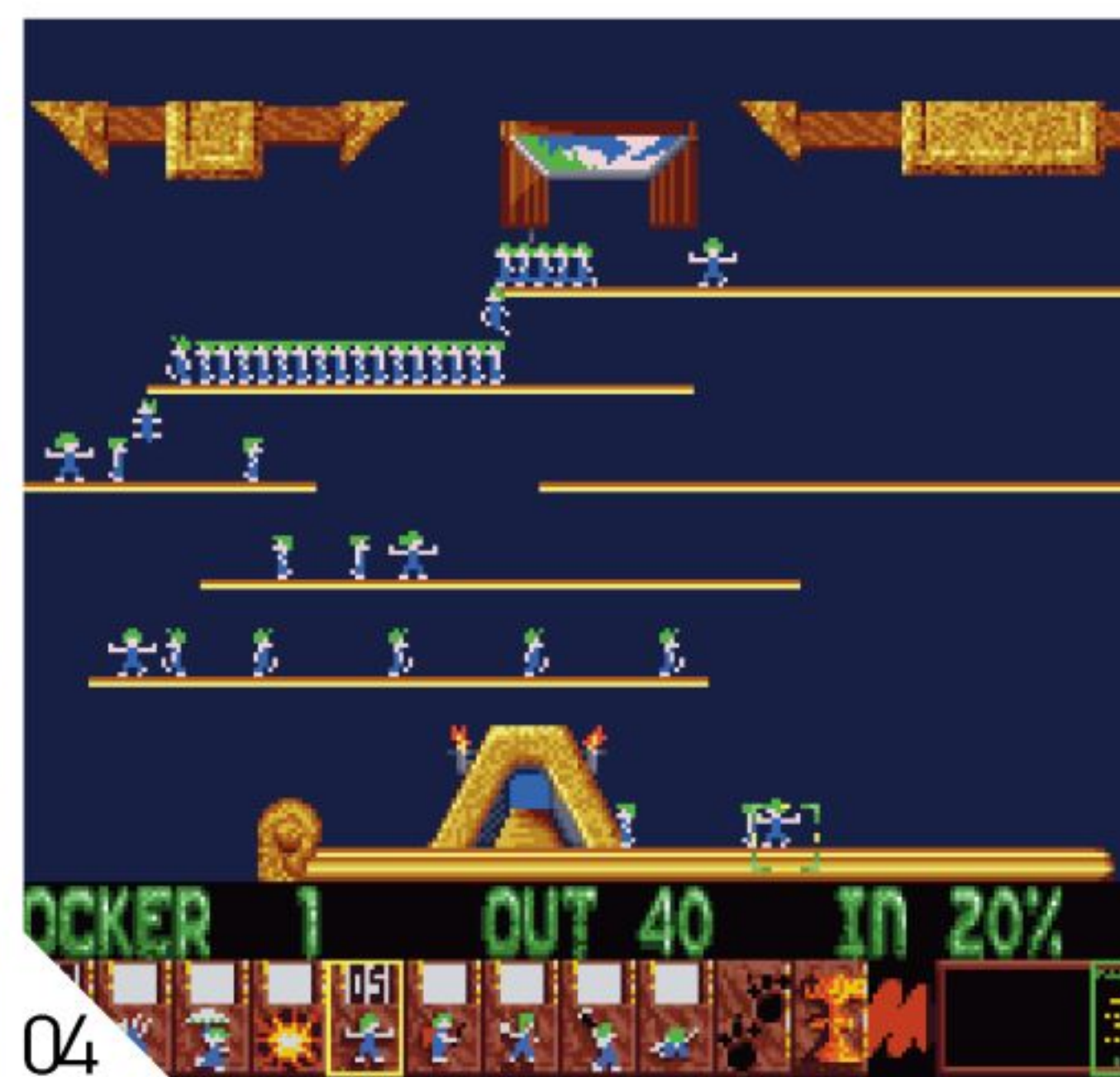

04

WORMS

» RELEASED: 1995

» PUBLISHED BY: OCEAN

» CREATED BY: TEAM 17

» BY THE SAME DEVELOPER: BODY BLOWS

01 You'd have thought that by 1995, ten years after the Amiga 1000's launch, it had seen every one of its defining games already. Well, Andy Davidson and Yorkshire-based Team 17 obviously thought there was room for one more and the world agreed with them. *Worms* was an absolute sensation and went on to sell millions of copies across countless formats, sequels and spin-offs. It's important to remember that the multiplayer strategy game began life on the Amiga, however, and was mostly a five year labour of love of just one man and a copy of Blitz Basic. And that was what was really great about the Amiga: it turned bedroom programmers into millionaires and created memorable franchises that endure for a lifetime. Can the same be said of the Xbox? We think not.

JIMMY WHITE'S WHIRLWIND SNOOKER

» RELEASED: 1991

» PUBLISHED BY: VIRGIN

» CREATED BY: ARCHER MACLEAN

» BY THE SAME DEVELOPER: DROPZONE

02 It may have been written by Retro Gamer's star columnist, but there's no favouritism here. *Jimmy White's Whirlwind Snooker* deserves to be in the Perfect Ten because it was the first game to really make snooker work on a home computer and remains a damn good sports title to this day. The 3D graphics and accurate real-time physics on each of the balls made *Whirlwind Snooker* a landmark game that pushed the hardware further than most gamers thought possible. It's arguable that the game has never been bettered, if not in its gameplay and graphics then definitely in its humour. Who can forget the cheeky faces the balls would pull if you didn't take a shot?

ANOTHER WORLD

» RELEASED: 1991

» PUBLISHED BY: VIRGIN

» CREATED BY: DELPHINE SOFTWARE

» BY THE SAME DEVELOPER: FUTURE WARS

03 *Defender Of The Crown* and *Shadow Of The Beast* may be the two games that wowed consumers enough to buy an Amiga but they were both severely lacking in the gameplay department. *Another World*, on the other hand, had both incredible graphics and utterly gripping gameplay to match. Essentially an evolution of the *Prince Of Persia* style of game, *Another World* swapped sword fighting for laser guns and added a bunch of fiendishly tricky action puzzles. The game looked stunning too; the use of vector graphics was a stroke of genius that ensured that *Another World* looked light years ahead of any other game of the time. Such a shame that Eric Chahi hasn't made another game since, although he's said to be working on an idea for a new strategy title.

LEMMINGS

» RELEASED: 1991

» PUBLISHED BY: PSYGNOSIS

» CREATED BY: DMA DESIGN

» BY THE SAME DEVELOPER: BODY HARVEST

04 What can be said about *Lemmings* that hasn't been said before? It's appeared on nearly every format known to man and is surely as much a household name as *Tetris* and *Space Invaders*. Sequels and updates continue to appear to this day and the little suicidal rodents show no sign of losing their popularity. Back in 1991, however, the release of *Lemmings* was a complete surprise. The concept was totally original and made for an instant hit. Its biggest achievement: the simple presentation and easy-to-use control system meant that anyone could pick up the game and play it. *Lemmings* had the whole family playing games together 15 years before the Nintendo Wii had even launched. Head to page 78 of this very issue for further proof of DMA Design's greatness.

SPEEDBALL 2

» RELEASED: 1990

» PUBLISHED BY: IMAGE WORKS

» CREATED BY: BITMAP BROTHERS

» BY THE SAME DEVELOPER: XENON 2

05 The recent news that a next-gen remake of *Speedball 2* is in the works has had the Retro Gamer staff drooling uncontrollably into their coffee cups every morning since the game's announcement. Why, you may ask? Because the original Amiga game was sheer digital perfection, the likes of which had never been seen before, or since. Oozing style from the Bitmaps' trademark metallic visuals to the cries of "Ice Cream!, Ice Cream!", *Speedball 2*'s greatest triumph was its imaginative rule set and peerless two-player gameplay. Many Amiga owners must remember whiling away the hours with a friend and probably do so to this day. A finer sports game it is impossible to find, in the past or present. It's so good, in fact, that we wish it was a real sport.



05



06



07

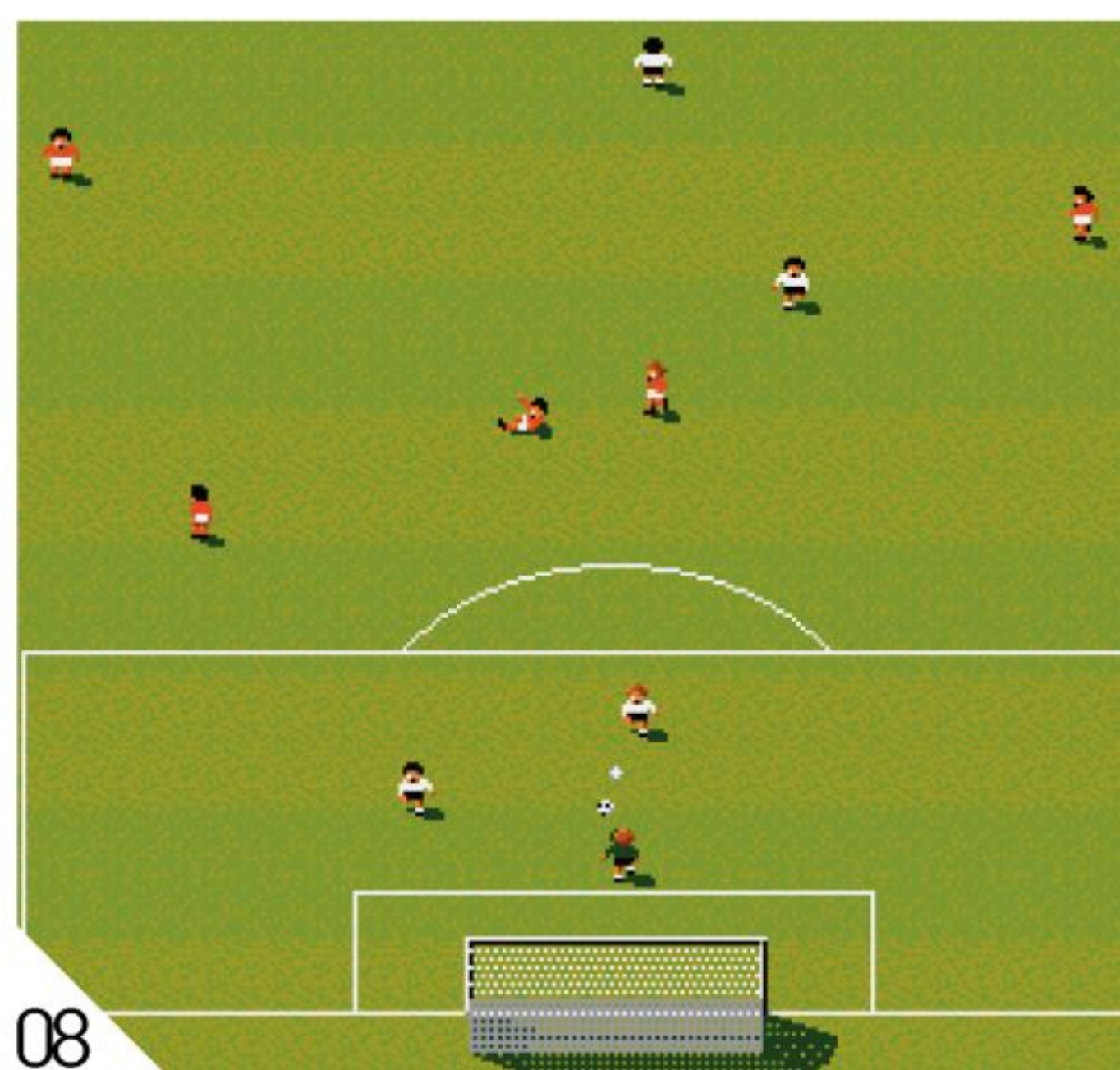

08



09

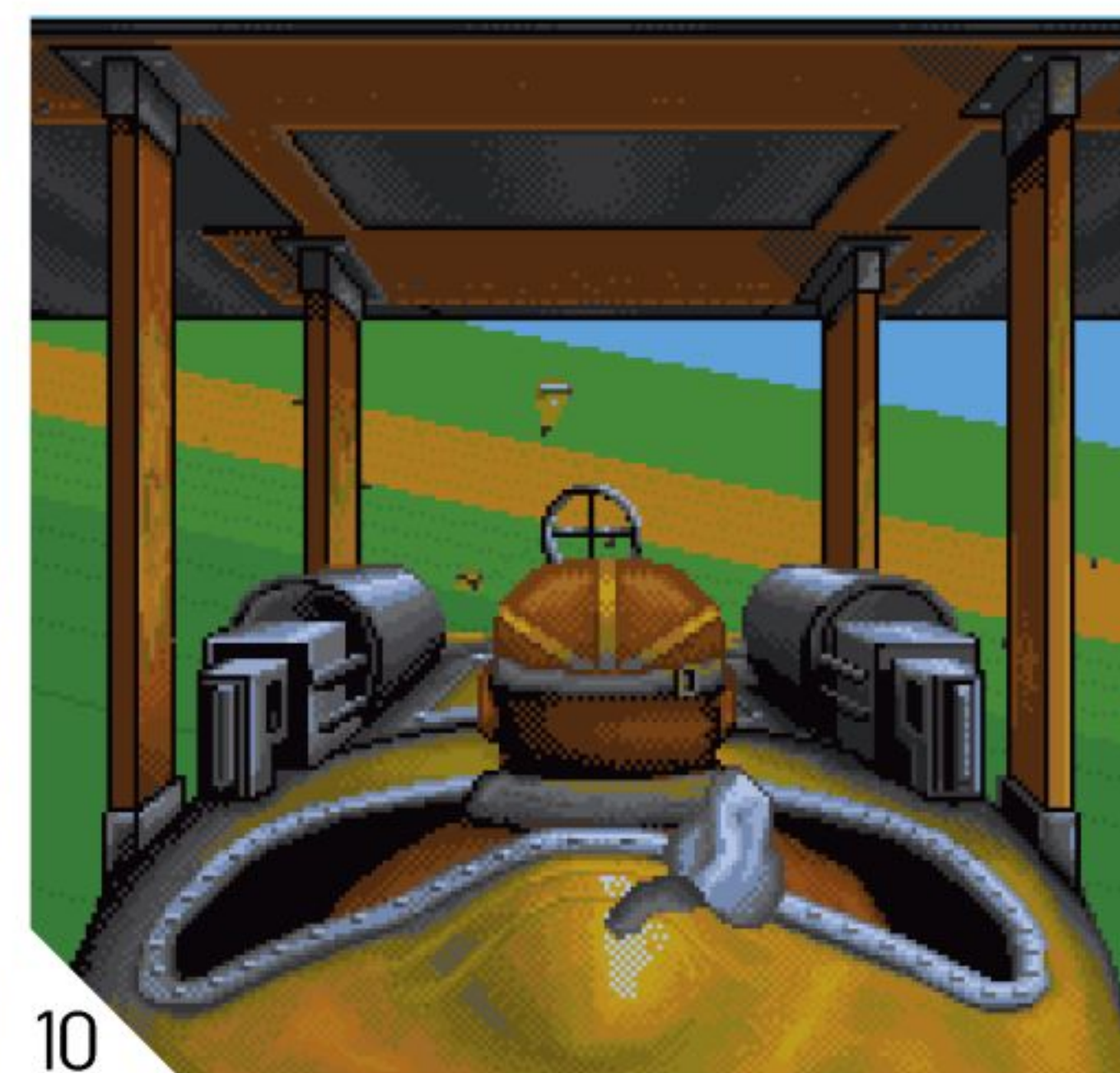

10

THE SECRET OF MONKEY ISLAND

- » RELEASED: 1991
- » PUBLISHED BY: US GOLD
- » CREATED BY: LUCASFILM GAMES
- » BY THE SAME DEVELOPER: INDIANA JONES AND THE LAST CRUSADE

06 The Amiga's incredible graphical capabilities and standard mouse controller made it a perfect machine for point-and-click adventures and there were plenty of them made over the years. Picking out a favourite is an incredibly difficult task but as *The Secret Of Monkey Island* will have been the first adventure that many of us actually played on the Amiga, we have to go for that. Using an enhanced version of the SCUMM engine from *Maniac Mansion*, *The Secret of Monkey Island* looked great and featured plenty of brilliant puzzles. But it was the insane humour that really set it apart from the competition. The world would be a much duller place without Insult Sword fighting now wouldn't it?

ALIEN BREED

- » RELEASED: 1991
- » PUBLISHED BY: TEAM 17
- » CREATED BY: TEAM 17
- » BY THE SAME DEVELOPER: QWAK

07 With only one previous title, the beat-em-up, *Full Contact*, to its name, few expected much from ex-PD codeshop Team 17 with its second title. That is until *Alien Breed* made its stunning debut and sent jaws hurtling towards the floor, up and down the country. One of the first Amiga games to use a full 1MB of RAM, *Alien Breed* looked incredible back in the day and played even better. Basically a sci-fi version of Gauntlet with a great two-player mode, tons of cool weapons and even sampled speech, *Alien Breed* set Team 17's standard for creating top-quality arcade-style titles on the Amiga. Later sequels were technically better but none quite had the shocking impact of the original. No wonder its Special Edition spent a whopping 33 weeks in the budget charts.

SENSIBLE SOCCER

- » RELEASED: 1992
- » PUBLISHED BY: RENEGADE
- » CREATED BY: SENSIBLE SOFTWARE
- » BY THE SAME DEVELOPER: CANNON FODDER

08 Football games have been around for as long as games machines themselves and, over the years, have become much more realistic simulations of the sport as technology has improved. There's one football game that managed to be extremely playable without being a simulation, however, and that game was the mighty *Sensible Soccer*. With the emphasis placed well and truly on the fun factor, *Sensible Soccer* was, for many gamers, the greatest football game of the Nineties and remains the superior choice to this day (although just as many prefer *Sensible World of Soccer*). There are still hundreds of people out there who kept hold of their Amigas just to play *Sensible Soccer*. Everyone else will have to wait for the imminent Xbox Live Arcade version later this year.

THEME PARK

- » RELEASED: 1994
- » PUBLISHED BY: ELECTRONIC ARTS
- » CREATED BY: BULLFROG
- » BY THE SAME DEVELOPER: SYNDICATE

09 Back in the early Nineties, resource management games were defined by one title alone: Will Wright's highly influential *Sim City*. A truly brilliant game, *Sim City*'s only problem was that constant town planning wasn't actually that much fun. The average sugar-fuelled kid needed something with a little more colour, something with fast-moving vehicles and something where little cartoon people throw up on screen. Those needs were answered by British coding legend Peter Molyneux and his ground breaking *Theme Park*. Designing stomach-churning rollercoasters was endless fun for the child in all of us, whilst adding extra salt to food in order to improve drinks sales appealed to the unscrupulous capitalist inside. The recent DS remake is well worth a look as well.

WINGS

- » RELEASED: 1990
- » FREELY RELEASED BY: CINEMAWARE
- » CREATED BY: CINEMAWARE
- » BY THE SAME DEVELOPER: DEFENDER OF THE CROWN

10 You couldn't ask for a more varied game than Cinemaware's *Wings*. Not only did the World War I game feature isometric shooting sections and two-dimensional bombing runs but it also had a tasty three-dimensional dog-fighting mode that was way ahead of its time. It's hard to believe that the game was made in 1990 as the 3D sections looked absolutely incredible and far in advance of anything that had appeared on consoles, PC or even the arcades at the time. Not just a graphical treat, *Wings* also had emotional impact and fully immersed you in its world. In between each level it would show pages of a diary, which told of the main character's eerily realistic wartime experiences, provoking an emotional response in the player that is all too rare in retro and modern gaming alike.



AMIGA 500



AMIGA 500

and the rest...

Commodore's 16-bit triumph features so many games that we'd need a whole mag just to feature them. Console yourself with the following shots

- 01 DOJO DAN
- 02 POWERDROME
- 03 WEIRD DREAMS
- 04 ALIEN BREED
- 05 DISPOSABLE HERO
- 06 MAGIC POCKETS
- 07 CARRIER COMMAND
- 08 RAMPART
- 09 LAST NINJA REMIX
- 10 SIM CITY
- 11 WINGS
- 12 DRAGON'S LAIR
- 13 MIDWINTER
- 14 SHADOW OF THE BEAST
- 15 TOTAL ECLIPSE
- 16 AGONY
- 17 GAUNTLET II
- 18 GRID RUNNER
- 19 MEGA LOMANIA
- 20 VIRUS
- 21 ROBOCOP
- 22 AIRBORNE RANGER
- 23 EXILE
- 24 CRYSTAL KINGDOM DIZZY
- 25 MOONSTONE: A HARD DAY'S KNIGHT
- 26 SKWEEK
- 27 PINBALL FANTASIES
- 28 WING COMMANDER
- 29 THE IMMORTAL
- 30 BUGGY BOY
- 31 FIRST SAMURAI
- 32 KATAKIS
- 33 OPERATION WOLF
- 34 STARDUST
- 35 FIRE AND ICE
- 36 ANOTHER WORLD
- 37 JET STRIKE
- 38 NEBULUS
- 39 UNREAL
- 40 RAINBOW ISLANDS
- 41 COOL CROC TWINS
- 42 GUNSHIP 2000
- 43 BATTLE CHESS
- 44 F29 RETALIATOR
- 45 THEME PARK
- 46 QWAK
- 47 EYE OF THE BEHOLDER
- 48 HEROQUEST
- 49 PIPE DREAM
- 50 LEMMINGS
- 51 WALKER
- 52 RISE OF THE ROBOTS
- 53 ZOOL
- 54 BARBARIAN
- 55 GOBLINS
- 56 IT CAME FROM THE DESERT
- 57 PINBALL DREAMS
- 58 CANNON FODDER
- 59 R-TYPE
- 60 STAR WARS
- 61 HEIMDALL
- 62 FALCON
- 63 LIONHEART
- 64 POPULOUS
- 65 SPACE ACE
- 66 SPEEDBALL 2: BRUTAL DELUXE
- 67 CRUISE FOR A CORPSE
- 68 OBLITERATOR
- 69 SENSIBLE WORLD OF SOCCER
- 70 CADAVER
- 71 JURASSIC PARK
- 72 THE NEW ZEALAND STORY
- 73 PAC-MANIA
- 74 SPINDIZZY WORLDS
- 75 WIZBALL
- 76 FORMULA ONE GRAND PRIX
- 77 PGA EUROPEAN TOUR
- 78 IK+
- 79 LOTUS ESPRIT TURBO CHALLENGE
- 80 TETRIS
- 81 GREAT GIANA SISTERS
- 82 RAMPAGE
- 83 XENON 2: MEGABLAST
- 84 LEGEND OF KYRANDIA
- 85 RODLAND
- 86 THE SECRET OF MONKEY ISLAND
- 87 ARCHER MACLEAN'S POOL

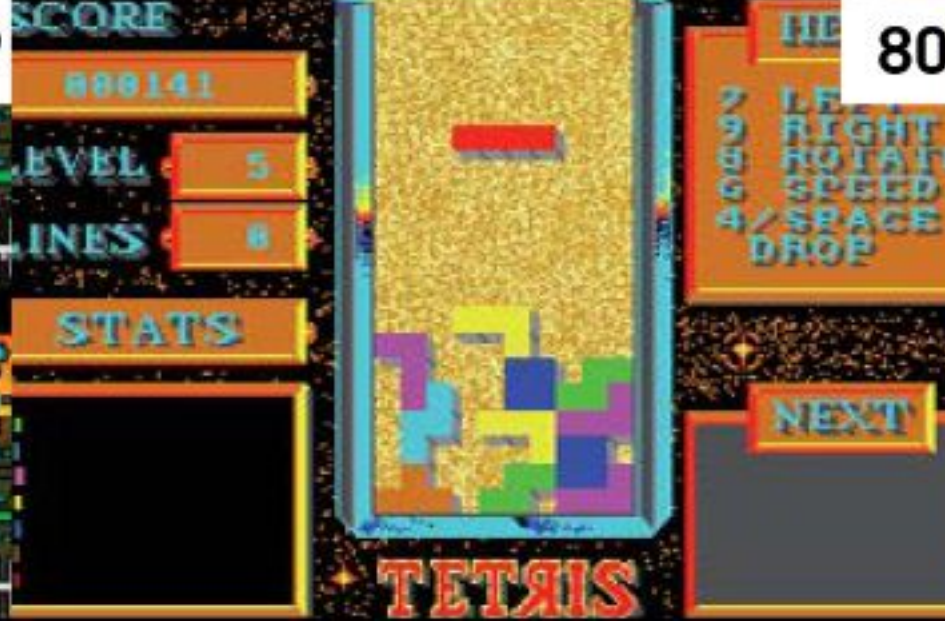
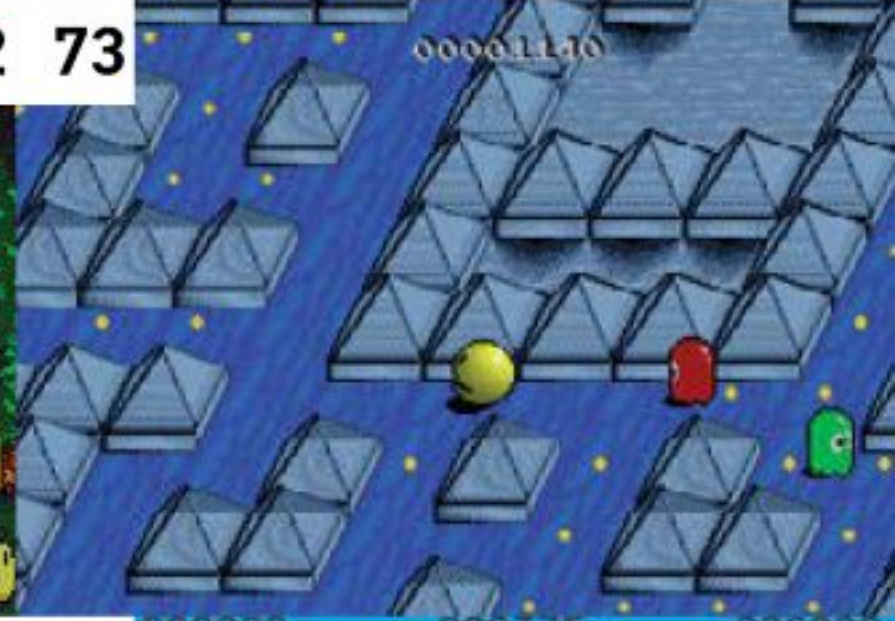
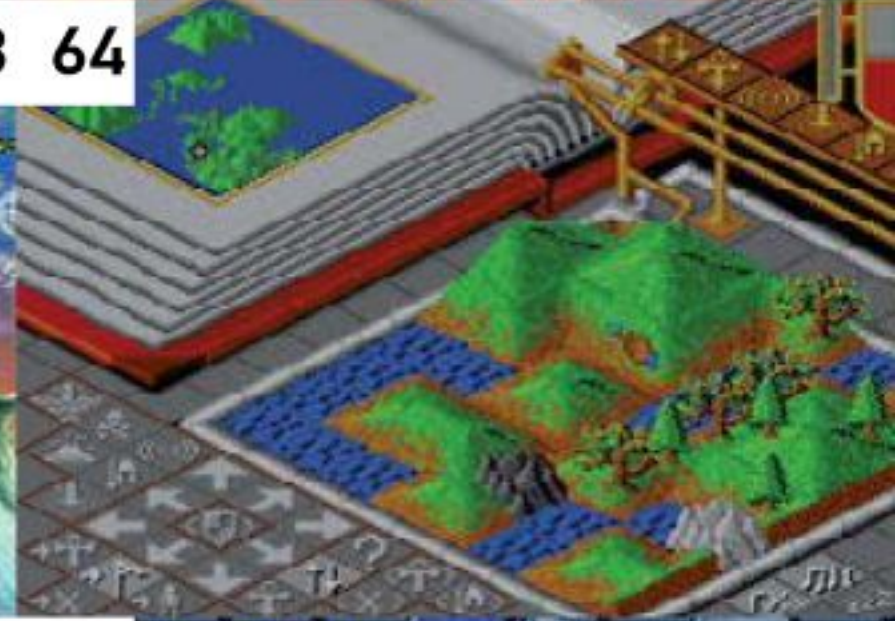
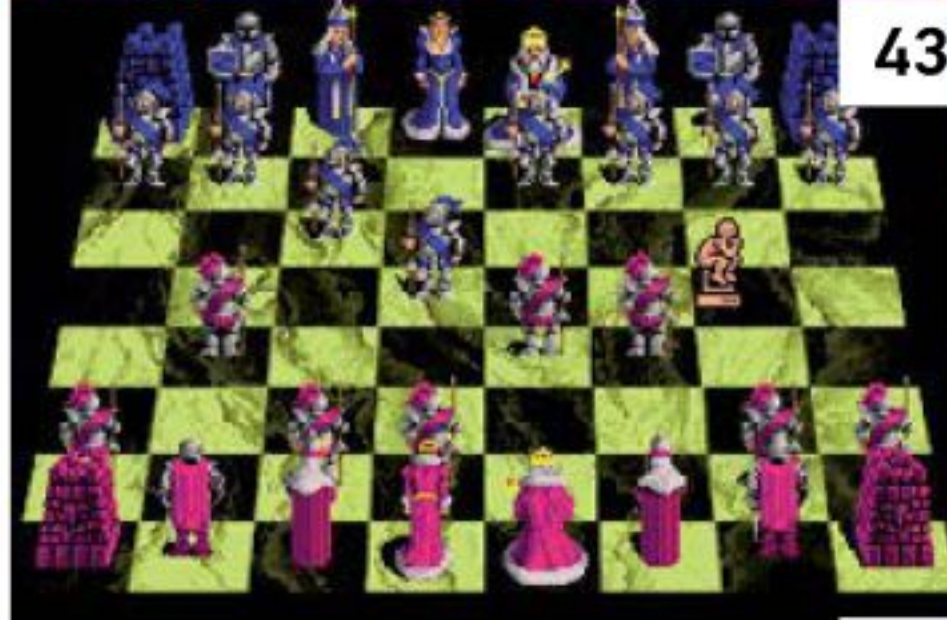
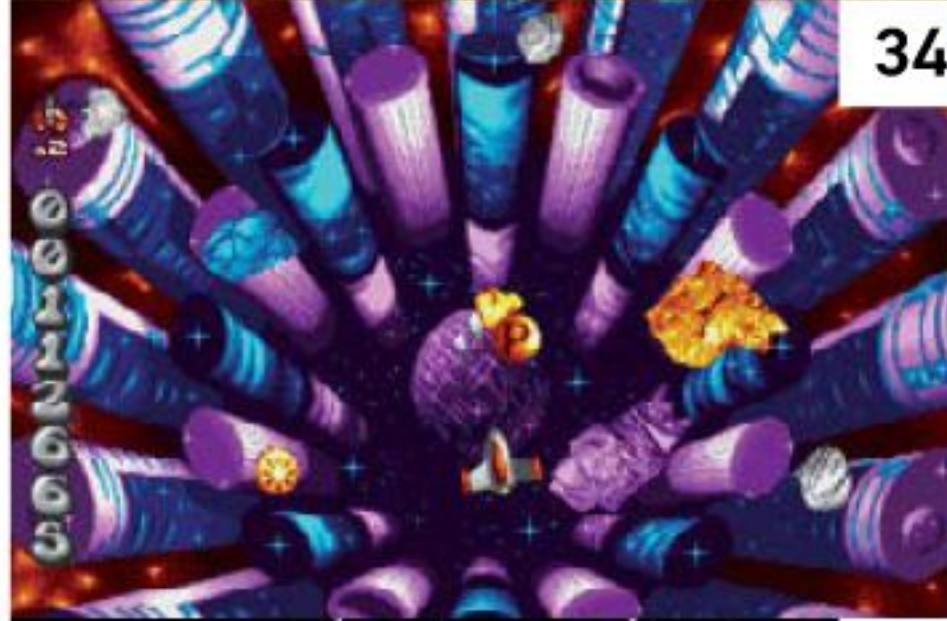





TIGER GAME.COM

game.com

MUCH IS WRITTEN ABOUT THE WINNERS OF EACH GENERATION'S CONSOLE WARS. BUT WHAT OF THE LOSERS? THEY, TOO, HAVE EQUALLY INTERESTING STORIES AND DESERVE A PAGE IN THE HISTORY BOOKS. WITH THAT IN MIND, WE LOOK AT ONE OF THE GAME INDUSTRY'S BIGGEST LOSERS

From 1989 to 2009, 20 years of handheld videogame history has been defined by one simple truth: no one can stop Nintendo.

Great industry legends like Atari, Sega, Sony and SNK have all tried over the years and all failed to scale the same heights as either the Game Boy or the DS. The story of the Tiger Game.com is no different.

Timing is one of the most important factors in any product launch, and Tiger Electronics must have considered September 1997 as its own window of opportunity for the handheld videogame market. By that time, Nintendo's Game Boy was eight years old and looking a little long in the tooth, while its main competitors, the Atari Lynx and Sega Game Gear, had died off a

couple of years previously. There was an opening in the market and Tiger, a Western company with extensive experience in electronic games, was poised to take advantage.

For many years previously, Tiger Electronics had enjoyed great success in the toy market with its pocket LCD games, which offered simple but fun distractions on the go. And just as Nintendo took what it had learned with Game & Watch and transformed it into

an interchangeable cartridge system, Tiger looked to do the same with its own handhelds.

Dubbed Game.com (with a silent dot), Tiger's handheld was named to take advantage of the explosion in popularity of the internet at the time and hoped to create an association with cutting-edge technology that would leave the Game Boy looking outdated by comparison. Pitched somewhere between a PDA and a games machine, it offered potential



users both serious applications and play, with some truly innovative features. The most obvious of these was the touch screen and stylus, which was way ahead of its time some seven years before the launch of the DS. The system also boasted on-board memory with four built-in pieces of software comprising a calendar, calculator, phone book and solitaire game, all of which used stylus control. In addition, the unit featured the unusual addition of two cartridge ports that could be switched between without powering down, and the enticing promise of online functionality with separately sold software.

When it came to games, Tiger knew it couldn't compete with the *Marios* and *Zeldas* of Nintendo's world, so wisely decided to play to its own strengths by leveraging its own intellectual properties and publisher relationships. Its own

line of handheld games as well as its experience of licensed properties meant that it could create a wealth of software based on instantly recognisable names, as demonstrated by its two pack-in titles: movie licence *Batman & Robin* and *Lights Out*, an adaptation of one of Tiger's most popular handheld games.

In terms of specifications, the Game.com was a mixed bag. Its monochrome screen was outdated and suffered from blurriness, while the reliance on four AA batteries was less than economical, but there was some impressive hardware to be found under the casing. The Game.com's processing chip was a proprietary Sharp SM8502 that handled every function of the portable, including sound, visuals and touch-screen input, and was, according to Tiger's contracted game programmer, Thomas Fessler, capable of performance

speeds up to eight times faster than the Game Boy's Zilog Z80 CPU.

"The major advantage to this design," says Game.com homebrew enthusiast Jason Oster, "is that the hardware was much less complex, and therefore easier to manufacture at a reduced cost." Furthermore, each game cartridge could be up to 16 megabits in size compared to the Game Boy's maximum of 12 megabits, while the screen offered five shades of grey in comparison to the Game Boy's four. Oster adds: "Game.com's proprietary MCU, the Sharp SM8502, had limited support for PCM wave output, which made it good at speech sampling," which Tiger proudly boasted on the box and was easily heard, along with some excellent chip music, in many Game.com games.

"Overall, from a developer's standpoint, Game.com is a very powerful

SPECIFICATIONS

Year released: 1997

Original price: \$69.95

Main Processor:

Sharp SM8502 MCU

Dimensions: 190x108x19mm

Screen: 192x160 resolution, 12x10 grid touch sensor

Colours: Five shades of grey

Sound: 8-bit PCM and FM synthesis



INSTANT EXPERT

The dot in '.com' is silent. So Game.com is actually pronounced 'Game com' in speech.

The Game.com pioneered many features. It was the first handheld games console to have a touch screen, internet capabilities and two cartridge slots.

It remains the only handheld to feature two cartridge slots. Although Nintendo's DSi prototype had two, it decided to remove one to keep the unit size down.

Despite its failure, Tiger's Game.com was not the last monochrome handheld released. SNK's Neo Geo Pocket followed in 1998 and the Bandai WonderSwan came in 1999. Both featured black-and-white screens before being hastily relaunched in colour in the wake of the Game Boy Color.

Footage of the abandoned Metal Gear Solid port was reportedly distributed to alt.games.video.tiger.game-com users in 1998, but neither screens nor the video have materialised since.

Future retro collectors be warned: the Game.com's internal calendar will only work up until December 2099. It's like the millennium bug all over again, except no one will care this time.

Search Hasbro's website and you'll find that it still has PDFs for a few Game.com game manuals available.

The Game.com Pocket Pro was briefly re-issued minus the front-lit screen and available in four different colour casings.

The console was actually Tiger's second handheld after the R-Zone – a unit similar to the Virtual Boy that projected LCD images onto a mirror to create a hologram effect.

Retro Gamer's sub editor, Olly, was actually given a Game.com in the Nineties and was (un)lucky enough to experience the internet cart first-hand.



TIGER GAME.COM



“ The monochrome screen was outdated and blurry, but there was some impressive hardware under the casing ”

machine,” claimed Fessler in a 1998 internet chat. “But with all new systems, it takes time for developers to learn how to use it to its fullest potential,” a fact that was brutally apparent from day one. Pack-in game *Batman & Robin* looked brilliant on paper. It had huge sprites, detailed backgrounds and arcade-style action, but the poor refresh rate of the LCD screen meant that the game was reduced to a blurry mess as soon as anything moved. *Lights Out*, the second pack-in, was a puzzle game with zero animation and consequently didn’t suffer from the same display problems. This presented Game.com developers with a real dilemma. Should they make impressive-looking games that would look brilliant on the back of the box but ultimately disappoint the buyer once they played the thing, or should they play to the handheld’s strengths and produce

simple but playable games that don’t as easily jump off the shelves? It would take Tiger well over a year to find the answer, at huge cost to the Game.com’s credibility.

Hardware capabilities weren’t the only problems facing Tiger, either, as the company found its previous success in LCD games had become as much a curse as a blessing. In a letter posted at the alt.games.video.tiger.game-com newsgroup on 17 June 1998, Tiger directly addressed its fans’ concerns over the availability of games with the following explanation: “Game.com has had a tough time establishing a strong presence at retail. This is largely because it originates from Tiger, which is a toy company, not a videogame company per se. As a result, many retailers have chosen to merchandise Game.com as a toy – not as the strong vid game system

it is. Because Tiger’s traditional toys don’t come in ‘multiple parts’ (such as a system and carts), retailers haven’t been mindful of the big picture, and carts have tended to languish in distribution centres instead of making their way to store shelves next to hardware.”

Tiger’s decision to develop every Game.com title in-house had also proved something of a double-edged sword. Without third-party support, the catalogue of software would be severely limited, but Tiger hoped to offset this by licensing properties from other publishers. As well as working with recognisable movie and TV IPs, Tiger also established deals with the likes of Sega and Capcom so that it could produce its own versions of popular Saturn and PlayStation games like *Fighters Megamix* and *Resident Evil 2*. Licences gained for Tiger’s standalone LCD handhelds also proved invaluable, as the rights to create games based on Sega’s *Sonic* property allowed Tiger to produce *Sonic Jam* for the Game.com without too much legal difficulty. The insistence on developing everything in-house or with contracted staff, however, slowed down production of new games significantly, and many titles suffered painful delays while the most



» Modems, power supplies and link cables were all available but so poorly stocked that many believed they never existed.



DotCom.com

The Game.com, rather confusingly, had two cartridges that enabled online functionality. Here's the difference: the first, known as the Internet Cart, granted access to the web as long as you connected the machine to an external modem. Functionality was limited, however, as it would only work with text-based ISPs and websites. AOL, America's most popular ISP at the time, was totally incompatible. The second cart was known as Web Link and actually allowed you to connect your Game.com to a PC and transfer data between the two. If the PC was connected to the net then you could upload your high scores to Tiger's website for all to see or download exclusive cheat modes for certain games. Game.com fan Steven Cox recalls the difficulty of using the device: "The Web Link cartridge was not user-friendly at all. A fun toy for tech geeks like myself, but I can only imagine how many kids picked one up – well, probably not that many kids – and outright failed to make it work with their dial-up ISP." Online play was never enabled, but a Tiger representative did once say that it was trying to get it to work by using a slow game, like an RPG, while also improving the transfer rate of the carts. Sadly, the Game.com's commercial life came to an end before such experiments bore fruit.



» A photo from 3D Realms' website shows the size of *Duke Nukem 3D*'s cartridge in comparison to the N64 version.

hotly anticipated games like *Castlevania* and *Metal Gear Solid* never made it to shelves. Movie and TV licences also proved troublesome, as Tiger had to occasionally work to the inconvenient schedules of external companies. An *X-Files* game, for example, was planned at one stage, but Fox requested that development of the game be postponed until the movie was complete, by which time Tiger had moved on and it was never finished. Likewise, a planned *Godzilla* game was abandoned following a licensing dispute that pulled the rights away from all of Tiger's toy divisions. The Game.com catalogue, it seemed, could be damaged by association with Tiger's portfolio as well as benefit from it.

If business was a struggle for Tiger in 1997, then 1998 was a true hardship.



» [Game.Com] The Game.com's GUI gave instant access to all the in-built features and any cartridges that were inserted.

This was the year that Nintendo fought back – and in typically aggressive style. The Game Boy Color was launched and though it was technically inferior to the Game.com, its colour screen and exemplary refresh rate made it much more palatable to consumers. And let's not forget the worldwide release of *Pokémon* that year, which created a media phenomenon and even helped the humble black-and-white Game Boy to enjoy a second lease of life.

Tiger Electronics needed to improve the Game.com and quickly, and at E3 that year it announced the Game.com Pocket Pro, a hardware variation that it hoped would keep the business going. The Pocket Pro improved on the original model by reducing the required number of batteries from four to two, reducing the size and weight of the device at the cost of one cartridge slot, and adding a new front-lit screen with a far better refresh rate, comparable to that of the excellent Game Boy Pocket. Tiger also announced its first original IP for the Game.com, an RPG called *Mutoids* that was said to play like *Pokémon* and would allow Game.com owners to link up and do battle with each other and even link up to a new line of electronic keychain games called *Mutoid Giga Fighters* – a particularly innovative way for Tiger to take advantage of its diverse toy range to help boost the Game.com's potential.

Not only was *Mutoids* a smart way to compete with the *Pokémon* boom, but it was also an experienced solution to the Game.com's performance problems – a killer app that, as an RPG, didn't have too much animation and therefore didn't cause the screen to blur during critical moments. It had taken a while, but Tiger was finally learning which games worked

best on the system and which didn't, and you could see the results in the later batch of releases. *Resident Evil 2* may have been an ambitious conversion, but it was also a much slower-paced game than your average action title, and its lumbering zombie enemies were perfect for the Game.com's motion-averse screen. Tiger was beginning to pick its licences much more carefully with these issues in mind, and later releases like *Monopoly*, *Jeopardy!* and *Frogger* were much better suited, showing that board games, TV shows and retro games could be perfect for the Game.com as long as the brand name was familiar enough to reel customers in.

Sadly, Tiger's refocused strategy was too little and too late to save the Game.com. The Pocket Pro was a marked improvement over the original model, but it still looked pathetic next to the Game Boy Color. Retailers continued to position the device poorly and not stock the full range of software, and specialist games magazines rarely, if ever, covered the system, leading to a critical lack of awareness among core gamers. The reputation of the handheld was still tarnished by the original model and lacklustre launch titles, making consumers reluctant to take a chance on the superior releases of late 1998.

Another problem was that Tiger failed to capitalise on many of the handheld's real selling points. With the exception of *Solitaire*, the in-built software was too basic or not useful enough when compared to proper PDA devices, while the machine's internet capabilities never came close to reaching their exciting potential (see 'DotCom.com'). And from a game design perspective, it was disheartening to see Tiger waste the



» *Small Soldiers* was announced for the Game.com but never released. Only this background shot and a couple of character models remain.



Only 20 games were ever released for the Game.com, and although most were junk, a **small minority** is worthy of note

01. FROGGER

A great classic arcade game that's almost done brilliantly on the Game.com. Only the blurry snakes let the conversion down.

02. BATMAN & ROBIN

Standard platform/action fare based on the terrible George Clooney movie. The action's good, but the visuals are so blurry that it borders on pointless.

03. CENTIPEDE

A crisp and clean remake of the arcade original. Not entirely faithful, but just as much fun to play. One of the better score-attack games out there.

04. DUKE NUKEM 3D

This isn't quite the FPS it appears to be in stills. The game moves along one tile at a time, like *3D Monster Maze*, and you can't really aim the gun.

05. FIGHTERS MEGAMIX

Lacks the full complement of characters as seen in the Saturn original. And if the full move list is there, it's impossible to pull off.

06. INDY 500

A "3D" racing game that has more in common with a simple LCD game than anything on consoles. Great speech, poor gameplay.

07. JEOPARDY!

This classic TV show should work great on the Game.com, but there usually isn't enough time to tap the answers in on the touch screen.

08. THE LOST WORLD: JURASSIC PARK

An action-adventure game with multiple gameplay modes, including driving, platform and so on. The objectives are often confusing and the graphics suffer from blur.

09. HENRY

Henry is a 'concentration'-based solitaire game with a twist. Instead of matching cards with pictures, you match audible sounds. A great idea, done well.

10. MORTAL KOMBAT TRILOGY

It might suffer from the blurs, but *MK Trilogy* does at least play well and has loads of features. It's miles better than any *Mortal Kombat* on the Game Boy, too.

11. MONOPOLY

The board game's turn-based gameplay and simple animations are well suited to the Game.com, but a standard game can drag on longer than some batteries last.

12. QUIZ WIZ: CYBER TRIVIA

A *Trivial Pursuit*-style quiz game with its own virtual host. Falls flat due to boring questions and the annoying, unfunny host. *Buzz*, this ain't.

13. SCRABBLE

Another game that should work great on the Game.com and... actually does. The touch screen is used especially well for moving tiles.

14. SONIC JAM

Four great Mega Drive games on one cartridge should be reason to celebrate, but *Sonic's* speed and the Game.com's blurry screen do not make good bedfellows.

15. RESIDENT EVIL 2

It shouldn't work, but it really does. Not an accurate adaptation, but as close as you could get in 1998 and something that the Game Boy never managed to do.

16. TIGER CASINO

Great presentation and good controls make this gambling compendium a solid release, but the subject matter is hardly the most inspiring content.

17. WHEEL OF FORTUNE

A good example of a 'does what it says on the tin' game. The quiz show translates well and is just as fun/boring as you'd expect.

18. WHEEL OF FORTUNE 2

The only sequel to a Game.com title! This one doesn't really make any improvements; it just adds more puzzles to extend the lifespan.

19. WILLIAMS ARCADE CLASSICS

Joust, *Defender*, *Robotron 2084*, *Sinistar* and *Defender II* all appear in this mixed bag. *Robotron* is the best, while *Sinistar* is unplayable.

20. LIGHTS OUT

This timeless puzzler translates perfectly to the Game.com touch screen, but the puzzles' difficulty soon hits a brick wall. Too hard.

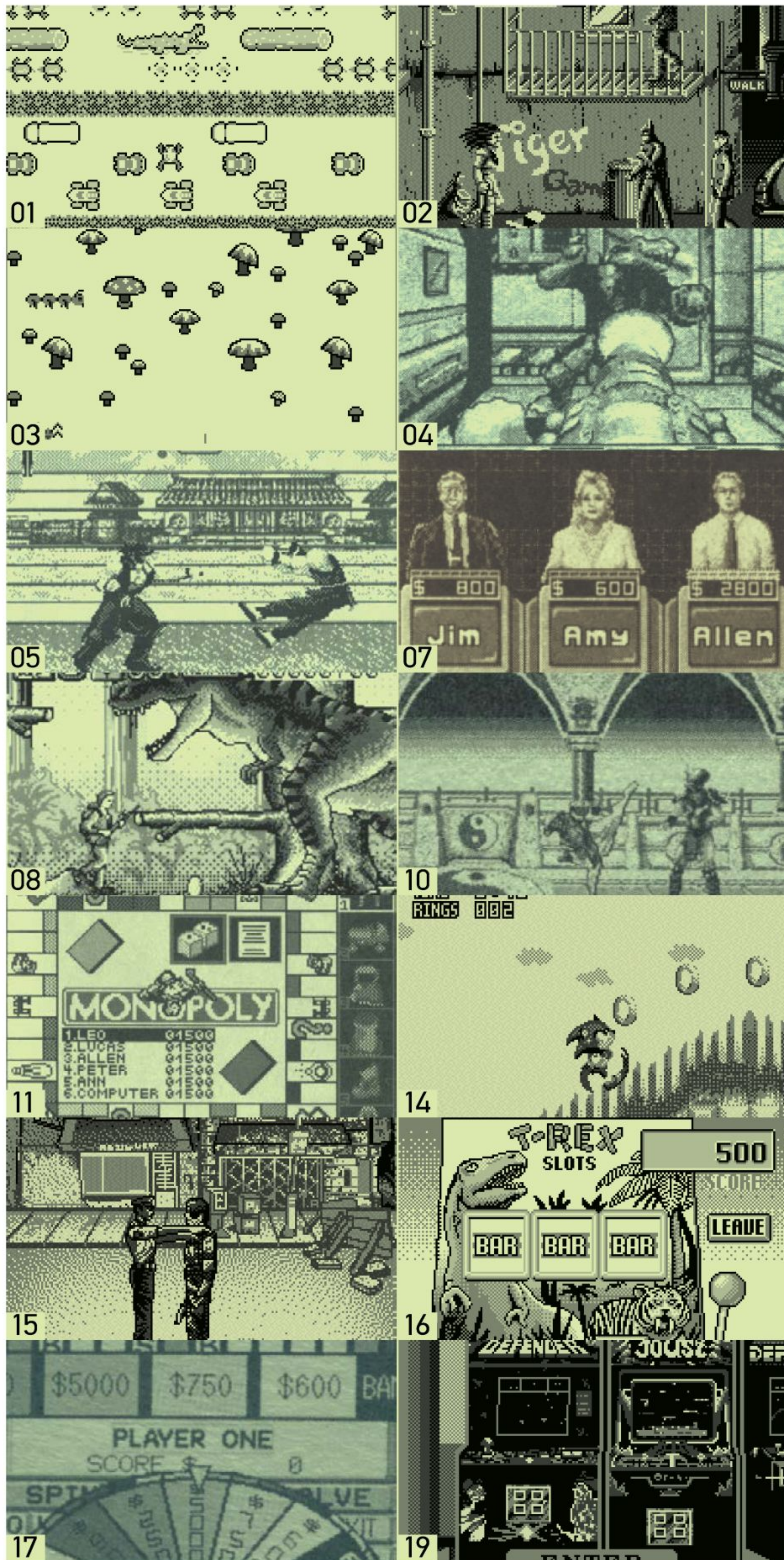



► The Game.com Pocket Pro was smaller and featured a better screen, but it was too little and too late to save the day.

potential of the touch screen by failing to make use of it in all but the most simple puzzle games, although some gamers, like Steven Cox, webmaster of a popular Game.com fan site in 1998, sympathise with Tiger on this particular issue. "Nintendo right now must force game developers to develop for the DS touch screen. It's simply easier for developers to follow the tried-and-true control pad paradigm," he argues. "Tiger Electronics was at least doing its stuff in-house, but even then I think there was a large conceptual wall to hurdle to get the developers to think in terms of the touch-screen interface. Porting their puzzle games over was surely easy, but what does the touch screen bring to games like the *Batman & Robin* movie property? It's a neat feature that ultimately looks better as a PR selling point than an actual gameplay addition."

Worst of all, many of the upcoming games failed to emerge from within Tiger's walls. Promising new games like *A Bug's Life*, *Small Soldiers*, *NBA Hangtime*, *Shadow Madness*, *Madden Football '98* and *Turok: Dinosaur Hunter* were all cancelled in addition to the previously mentioned *X-Files*, *Godzilla*, *Castlevania* and *Metal Gear Solid*, leaving the Game.com with more exciting games left on the scrap heap than on store shelves. And the final nail in the coffin for the few fans still left hanging on to their Game.coms was the cancellation of *Mutoids*, the only title that realistically stood a chance of saving the system.

Tiger Electronics quickly moved on. The company had recently been acquired by Hasbro and had a phenomenon to call its own in the form of the increasingly popular Furby toys. Development of new Game.com titles was eventually ceased, and although

the company continued to stock surplus units of the system on its online store for some time, the handheld was officially discontinued in 2000.

Only 20 games were ever released for the Game.com, and the handheld remains one of the most unarguable failures in gaming history nearly a decade on. Boxed Game.com systems and sealed games are easily available on eBay at extremely low prices, and the system doesn't even enjoy the cult status afforded to other doomed handhelds like the Neo Geo Pocket or Bandai WonderSwan.

In terms of the after-market scene, the Game.com barely registers a faint blip on the radar, but there are a small number of individuals hoping to kick-start an online community for the handheld in the next few years. Hacker and homebrew programmer Jason Oster was lucky enough to acquire an official Game.com development kit a few years ago and has made some progress in both emulation and homebrew development. "The development kit hardware is basically just an EPROM emulator," he says. "It connects to a PC through the now-outdated ISA slot. A Game.com

“ High-profile cancellations left the Game.com with more exciting games left on the scrap heap than on store shelves ”

cartridge ROM can then be uploaded to the emulator using a DOS program. And the modified Game.com can run it just like any other cartridge. One of the better finds in the development kit was a full-featured software emulator that can run and debug any of the Game.com game ROMs on a Windows PC. We were able to hack the emulator to discover so much previously unknown information about the MCU. Eventually, I released some of that info as part of an open-source assembler project for homebrew Game.com development."

"The emulator in the dev kit is great," Oster continues. "It's almost 100 per cent perfect. And you can actually see what you are doing in games, with an extremely high contrast and no blur. One of our members was working on Game.com support in MESS [Multiple Emulator Super System], but I'm not sure how far along he got with it. The MCU is pretty well-documented now, but fine details still need to be sorted. I think to really do that well, some homebrew demos need to be made and run on the hardware. The assembler, code-named 'as85', was the first

assembler I ever wrote and it's an essential piece of software for writing homebrew Game.com code. It just needs to be worked on a bit more until it's in a usable state, and then the real hacking and development can begin."

For regular gamers, however, the Game.com remains little more than a footnote in the history of videogames at worst, and a particularly relevant lesson in the difficulties of the handheld games market at best. For Steven Cox, whose Game.com now sits boxed up under his desk with his Lynx, Game Boy and C64, Tiger's handheld is a reminder of just how turbulent and open to change the game industry really is.

"If a little company like Tiger can make a go at it then the market is much more malleable than we often think," he argues. "Remember, it wasn't too long ago that industry analysts were laughing at Sony for daring to take on console giants Sega and Nintendo, and a single generation later the same analysts laughing at Microsoft for daring to take on Sony. The gaming market is a strange place and Game.com is part of its history".





ORIC-1

Year Released: 1983

Original Price: £129.95 (16K), £169.95 (48K)

Buy it now for: £20-30 loose, £50-70 boxed and complete

Associated Magazines: Oric Owner, Oric Computing, Micr'Oric, Théoric, Oric User Monthly, CEO-MAG, Rhetoric

Why the Oric was great... You probably wanted a Spectrum but your Dad came home with an Oric under his arm, after the sales guy in Rumbelows convinced him it was the right computer for you. But following the initial disappointment, you soon learnt to love your Oric-1. It didn't matter what the detractors said, as you were the proud owner of a great machine with more than its fair share of decent games.



“SINCLAIR MAY HAVE PRODUCED THE FIRST MICRO TO BE SOLD FOR LESS THAN £100 (THE ZX80), BUT ORIC WAS DAMN WELL GOING TO BE THE FIRST TO ACHIEVE THAT DISTINCTION WITH A COLOUR COMPUTER”

ORIC-1

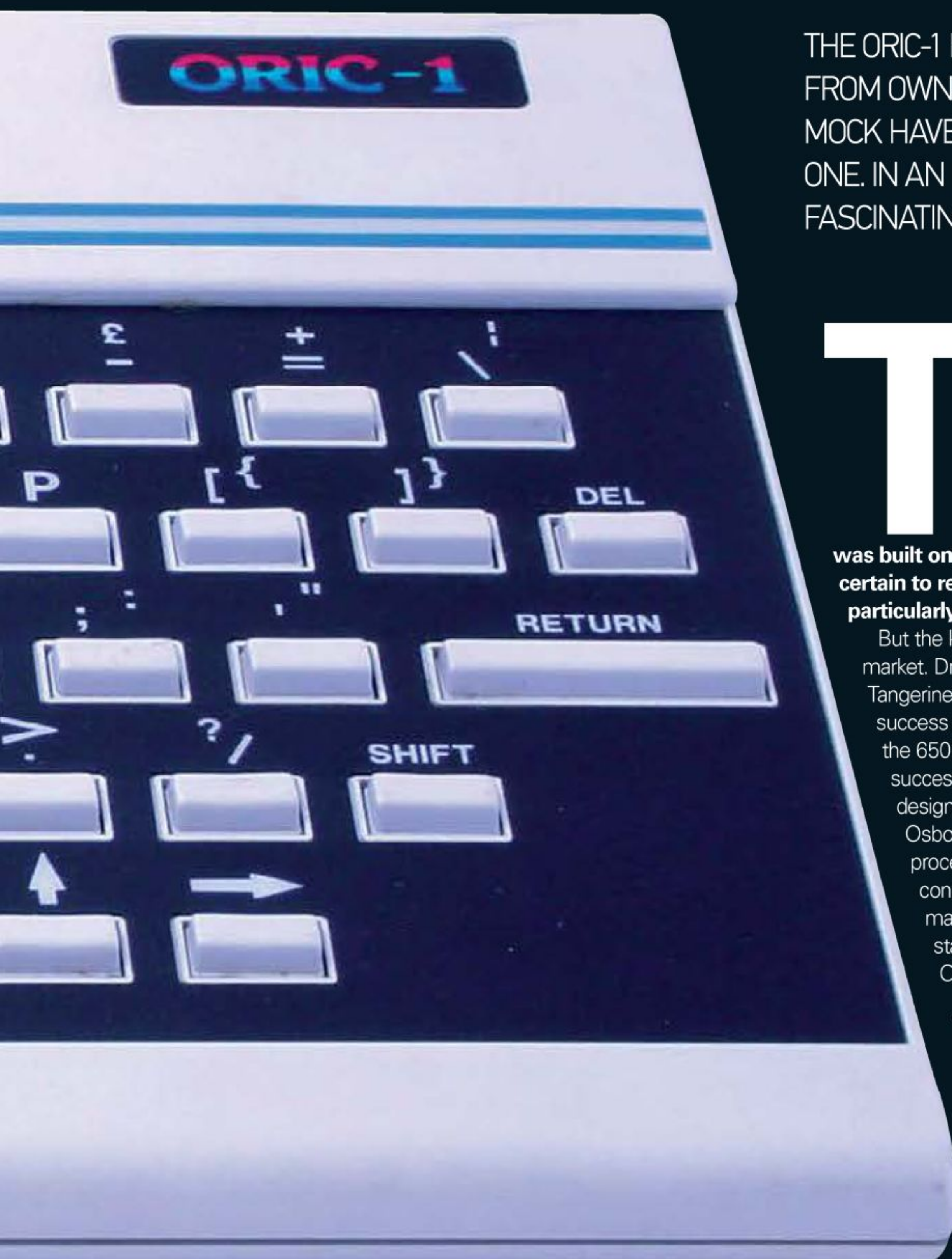

THE ORIC-1 HAS SUFFERED FROM YEARS OF UNDUE CRITICISM, USUALLY FROM OWNERS OF SUPPOSEDLY SUPERIOR MACHINES. THOSE WHO MOCK HAVE PROBABLY NEVER EVEN USED AN ORIC, LET ALONE OWNED ONE. IN AN EFFORT TO SET THE RECORD STRAIGHT, WE TRACE THE FASCINATING HISTORY OF THE MUCH-MALIGNED COMPUTER

The Oric-1 lived in the shadow of the Sinclair Spectrum. By the time Oric Products International launched the machine at a party in January 1983, the Spectrum had been available for six months with Sinclair unable to meet the huge demand, despite manufacturing 20,000 machines a month. The Spectrum was built on the success of the ZX81, and Sir Clive seemed certain to retain his grip on the UK home micro market, particularly the fiercely competitive sub-£200 sector.

But the key men behind the Oric-1 were not new to the market. Dr Paul Johnson and Barry Muncaster formed Tangerine Computer Systems in October 1979 and had some success with the Microtan 65, a kit computer powered by the 6502 processor. It was popular enough to spawn two successors – the Tiger and the Microtan 2. The Tiger was designed as a business machine to rival the Sirius and Osborne systems, and was to feature three different processors. The Microtan 2 was to be a low-cost, self-contained computer aimed at the low-end consumer market. The Tiger never progressed beyond the design stages, but the Microtan 2 evolved over time into the Oric-1, a computer to square up to the Spectrum.

TANGERINE DREAM

With financial backing secured (thanks to British Car Auctions), the design of the Oric-1 began in April 1982. Tangerine became Oric Products International, with Technical Director Dr Paul Johnson adopting the role of chief designer. He was assisted by Andy Brown and Chris Shaw, who were responsible for the ROM, Paul Halford who wrote the cassette routines, and Ian Redhead who helped with the hardware. Paul

Kaufman, who ran Tansoft (the company's software arm) and also edited the Tansoft Gazette, wrote the sound handling routines.

Oric gave itself a head start by opting to use the 6502 as the machine's beating heart. It already had in-house experience of the CPU, having used it in the Microtan 65, and it also meant that existing Microtan software could be ported over. For the system specs, Oric looked at the Spectrum and identified its limitations. There was the 'zombie flesh' keyboard for a start. Instead of 40 rubber keys, the Oric-1 featured 57 plastic keys that moved individually. It couldn't be classed as a 'proper' keyboard, but it was hardwearing and friendly on the fingers. And then there was the Spectrum's non-standard one-touch

French connection

The Oric brand was surprisingly strong in France, with the Oric-1 and Atmos dominating the country's computer market. Around 50,000 Oric-1s were sold over there in 1983, and it was voted Best Home Computer in October of that year. Some truly excellent software was released by French publisher Loricels, and the leading magazine *Théoric* stood head and shoulders above the UK offerings. So it was no great shock that following the collapse of Oric in the UK, the pieces were picked up by a French company. The new owners continued to sell the remaining Atmos stock, but their focus was the Oric Telestrat, an advanced computer aimed at the French market (it was designed to be used with the Minitel online network that existed in France). The Telestrat went on sale in September 1986 and hardly made an impression (the £400 price tag can't have helped). In total only 6,000 were sold, making it the rarest of the Oric computers. If you want a Telestrat then be prepared to dig deep – one recently sold on eBay UK for an impressive £250.



ORIC-1



» The two Pauls – chief Oric-1 designer Dr Paul Johnson (left) and all-round Oric good guy Paul Kaufman



» IJK Software was a prolific Oric publisher, responsible for a number of classic games including the *Xenon* trilogy



» Thanks to Tansoft, Melbourne House's epic adventure game *The Hobbit* was ported to the Oric, complete with colour graphics

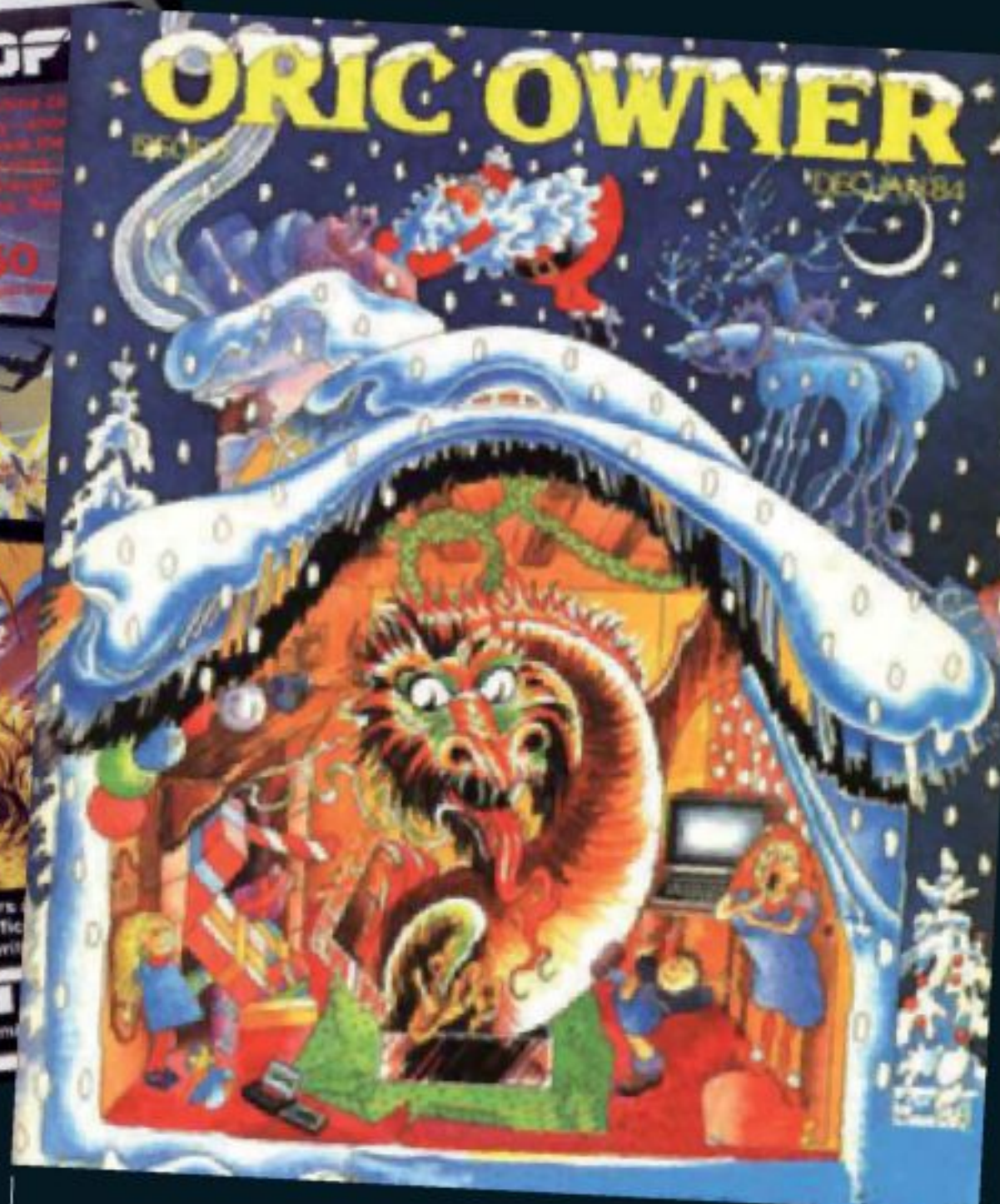

» The official Oric Owner magazine (formerly the Tansoft Gazette) ran for 10 issues, with issue one given away with the Oric-1 when it launched



» Ocean was an early Oric supporter, releasing high profile arcade games for the young platform



Paul Kaufman Q&A

As Editor of Oric Owner magazine, MD of Tansoft, and member of the Oric-1 design team, Paul Kaufman had a finger in a whole heap of Oric pies. These days he works for a music software company called IK Multimedia, but he's happy to talk about those heady days in the Eighties – indeed, he provided lots of vital information for this feature. We met up with Paul to ask him a few questions about his time at Tansoft...

Retro Gamer: Is it true you were offered a job by Tangerine after you complained about its customer service?

Paul Kaufman: It's true – I started out as a customer. I'd bought one of its Microtan 65 single board computer kits. I had some technical issues and had to keep phoning up to get help, but it was difficult getting info because Tangerine didn't have a full time support person. I kept complaining and one day I got a call asking if I would be interested in doing that job.

RG: And your role expanded?
PK: In an effort to get technical and product information out to customers, it was decided that an in-house magazine would be ideal, so I started putting

together the Tansoft Gazette. And as there was no commercial software available at that time, Microtan owners were always asking for programs. So we decided to produce a few titles and it was logical to use the name Tansoft. When the Oric-1 was developed, we expanded the magazine to support it and started producing software (mainly games). So my little tech support function had grown into a magazine publisher and a software producer.

RG: How successful was Tansoft in the end?
PK: It took off massively. Sales grew so quickly that Tansoft was set up as a separate company, and as I was already doing the job of running it, I was made MD. We produced a wide range of titles – everyday people at home were sending in products for us to publish.

RG: Do you think the Oric-1 suffered from a lack of third-party software support?
PK: I think in retrospect we should have courted developers earlier, but the earliest machines were reserved for our own developers who were writing for Tansoft. My biggest success was convincing Melbourne House to convert *The Hobbit* to the Oric. That gave us a lot of credibility, as that game was massive.

RG: It has been suggested that game designers struggled to get to grips with the Oric-1. Would you go along with this?
PK: The Oric was a pleasure to program and was very logical. I think most of the big developers concentrated on the competitor machines simply

because they were already

on the market, so they could guarantee reasonable levels of royalties. They were waiting for the Oric to reach the critical take-off point, which would justify them spending more time developing games for it.

RG: Which Tansoft games were your personal favourites?

PK: Technically, *Defence Force* and *Ultima Zone* were excellent – both very high quality arcade games. *Oric Chess* was fun, simply because you could never win as it cheated! We got no end of complaints about that.

RG: Is that really a drawing of you on the cover of *Rat Splat*?

PK: Yes indeed it is me! We used a local artist to design our cassette covers, so who better to model a psychotic hammer-wielding rat murderer than myself? I subsequently shaved off my beard in shame.



» Paul was immortalised on the cover of Tansoft's *Rat Splat*. The resemblance is almost uncanny...

BASIC that often hindered rather than helped programmers. The Oric-1 was supplied with Microsoft BASIC, although it was 'extended' in-house with Oric's own commands, increasing it in size from 8K to 10K.

There were more ports on the back of the Oric-1 as well. If you wanted to connect a printer to an out-of-the-box Spectrum then you were limited to the virtually obsolete ZX Printer; you would need to buy an additional interface if you wanted to connect a different make and model. The Oric-1, however, boasted an industry-standard Centronics printer interface, which was handy. There was also an RGB socket alongside the usual RF modulator, allowing you to connect to either a monitor or TV set.

So far so good, but what about under the hood? How did the Oric-1's sound and graphic capabilities compare to the Spectrum's? Well you might be surprised. In the sound stakes the Oric-1 was superior, which wasn't difficult when you consider how weak the Spectrum's barely audible 'beeper' was. Oric fitted its machine with the popular AY-3-8910 sound chip. The same chip, which provided three channel sound, was later used in the Atari ST, Amstrad CPC, and perhaps tellingly, the later 128K Spectrum models. A number of useful sound commands were resident in Oric BASIC, giving users fairly broad control over the chip, and there were even some custom sounds – Zap, Shoot, Explode and so on: the perfect accompaniment to your own arcade games.

As with the Spectrum, the Oric-1 could generate two screen modes – standard text mode and a high-res graphics mode. Eight basic colours were available in both modes, and the total screen resolution was 240x224 pixels, which in text mode equated to a 40x28 character grid (characters were made up of 8x6 pixels, rather than the usual 8x8). Sadly, pixels could not be coloured individually (each row of six pixels inside a character block had to be of the same colour), so this led to slight colour-clash problems, but it was less pronounced than on the Spectrum. Uniquely, the Oric-1 used serial attributes, so only one memory area was required for screen graphics compared to the Spectrum's two. This reduced memory usage and increased the speed at which graphics could be displayed on screen. In short, it's the reason the Oric-1 was particularly suited to playing fast-paced arcade games.

Taking Sinclair's lead, the Oric-1 was made available in 16K and 48K flavours. Crucially, Oric looked to undercut Sinclair, with the 16K model retailing for £99.95, £25 cheaper than the 16K Spectrum. Sinclair may have produced the first micro to be sold for less than £100 (the ZX80), but Oric was going to be the first to achieve that distinction with a colour computer. The 48K machine would retail for £169.95, a fiver less than the equivalent Spectrum model – a smaller saving, but it was still enough to make people (and the press) sit up and take notice. A four-colour printer and an external 5.25in disk drive were also promised,

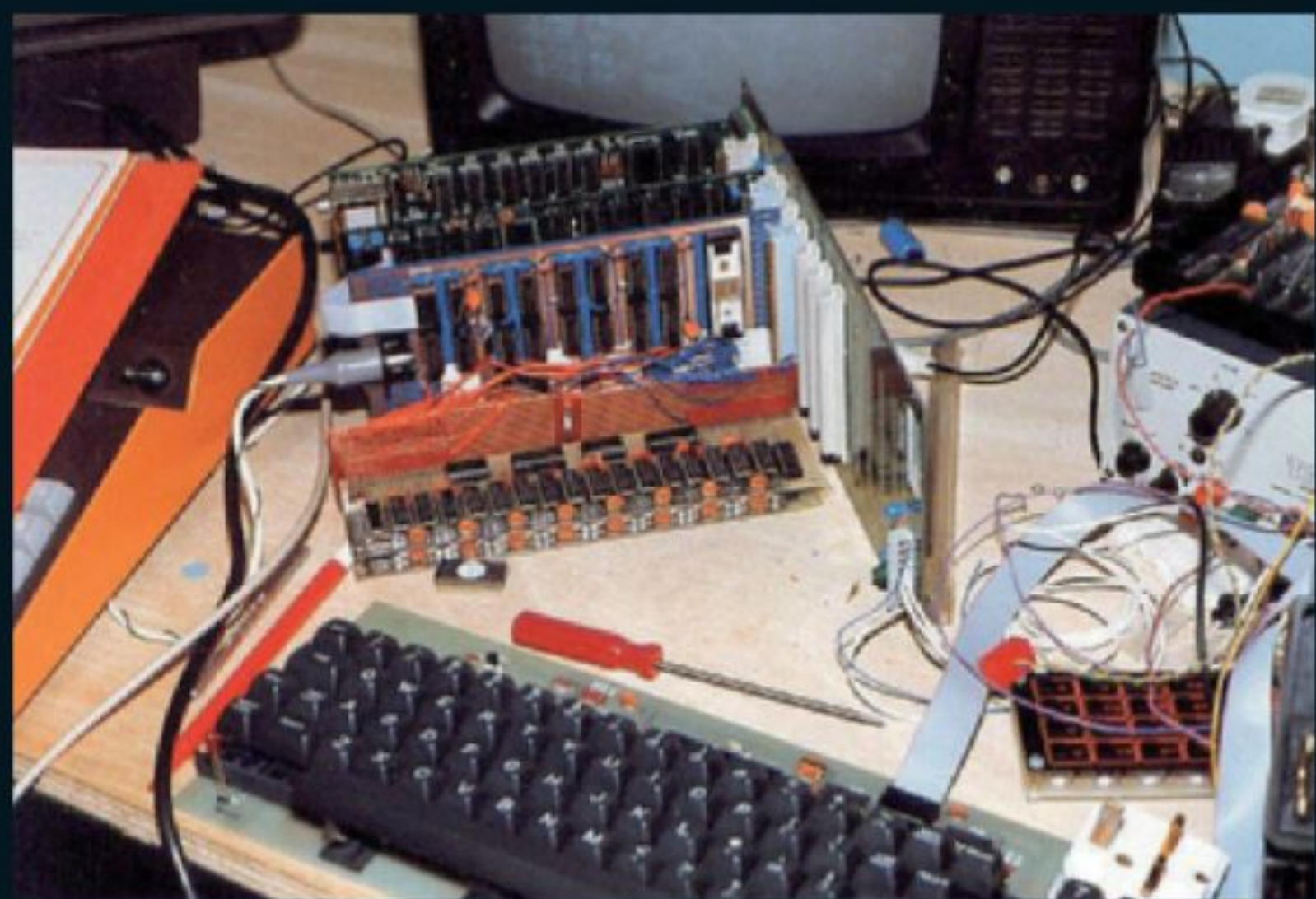

» A glimpse of the Oric-1 prototype, long before its innards were mass produced and stuffed inside a small plastic case

along with a £79 Oric modem that would allow users to access Prestel content. Sensing the buzz beginning to envelop the Oric-1, Sales Director Peter Harding proclaimed: "We're going to beat Clive Sinclair by offering much more for much less money." This comment came back to haunt him, as while Oric was indeed offering more for less, talk of toppling Sinclair would prove to be hopelessly optimistic.

BEST LAID PLANS

Oric had a great product and a competitive pricing policy, so what went wrong? In retrospect it's more a case of what went right, as

"ORIC-1 WAS ALWAYS SEEN AS THE SAD LAD OF THE 8-BIT PACK, BUT IT DOESN'T DESERVE THE RIDICULE IT RECEIVES. ON A TECHNICAL LEVEL IT WAS MORE THAN A MATCH FOR THE SPECTRUM"

the Oric-1 launch was plagued with problems from day one. Initial interest in the machine was strong, with over 30,000 pre-orders received prior to the official launch in January 1983, but Oric failed to supply the machines on time. This was mainly due to manufacturing problems, in particular the delayed delivery of ROM and RAM chips. And when the machines were finally available around March time, Oric's mail order department struggled to work through the backlog. The 16K model suffered further delays, with a last minute revision of the circuit board meaning that it didn't appear until May, 12 weeks

behind schedule. Worse still, it was priced at £129.95 – £30 more than originally planned. Thanks to the production and delivery woes, breaking under the £100 barrier was no longer on the agenda.

Then, when the hardware was readily available, there was a drought of commercial software during the summer. The games were out there – well-known publishers like Ocean, Durell and IJK pledged their support early on, and of course there was Tansoft – but retailers were sending thousands of cassettes back, reporting that they were faulty. Oric pointed the finger at Cosma Sales, its chosen tape duplicators, and Cosma Sales pointed it right back at Oric, claiming that the computer's cassette loading system was faulty. This echoed comments raised by magazine reviewers, who wrote of difficulty in getting games to load. It didn't help Oric's cause that faults in the ROM chip were already well reported, with Barry Muncaster admitting that Oric BASIC was bugged and a new ROM would be fitted inside all new Oric-1s leaving the factory. This never happened.

Smelling blood, Sinclair decided to stick the knife in. In May the price of the Spectrum was slashed, with the 16K and 48K models cut to £99.95 and £129.95 respectively. Its hand forced, Oric soon dropped its own prices to fall in line. Things started to look up. Sinclair had made its move and Oric was able to respond. The long-awaited colour printer was unveiled, available for £169.95 (no sign of the modem or disc drive however), and the profitable Christmas period was approaching. It was then that fate dealt its cruellest hand yet. In October, a fire ripped through the factory in Feltham where the Oric-1 was built, effectively wiping out the critical Christmas production. Manufacture quickly resumed in another factory, but stock was lost and the damage was done. Oric's aspirations had quite literally gone up in smoke.

COUNTING THE COST

The Oric-1 died in the shadow of the Sinclair Spectrum. By the time Oric announced that the Oric-1 would be discontinued in January 1984, the Spectrum had reached that magical one million sales mark. In comparison, it's estimated that around 160,000 Oric-1s were sold in the UK during 1983 – some way short of the 350,000 figure predicted by Financial Director Allan Castle.

Oric wasn't about to bail out of the market however. Thanks to £4million in funding provided by a company called Edenspring Investments, Oric pressed ahead with the Atmos, a new computer with a black and red livery and a proper moving keyboard. But beneath the improved exterior was the same old Oric-1 (albeit with an improved ROM). A high launch price of £170 took the machine out of direct competition with the Spectrum, pitting it against the Atari 600XL, Acorn Electron and C64. It was a battle it couldn't hope to win. Atmos sales were buoyant throughout 1984, boosted by a price drop of £50 prior to Christmas, but there were a growing number of debtors standing in line at Oric's door (the total debt stood at more than £5million). At the beginning of February 1985 the company called in the receivers.

Looking back, the Oric-1 has always been seen as the sad lad of the 8-bit pack, but it really doesn't deserve the ridicule it receives. On a technical level it was more than a match for the Spectrum, and had it not been for manufacturing problems, pricing issues and plain old bad luck, the machine would surely have made it into more homes. And anyone who questions its capabilities as a games machine needs to look no further than the later French titles or, indeed, the recent home-brew releases; the Oric-1 was able to cope with more than just first-generation arcade clones. It only enjoyed a brief commercial existence but it was not just another casualty of the Eighties computer wars. At the launch party mentioned at the beginning of this feature, Sales Director Peter Harding outlined the company's strategy for the future: "Sales of the Oric-1 will last for 15 to 18 months before being replaced by the Oric-2 with a typewriter keyboard, followed by the Oric-3." In the grander plan the little Oric-1 played a very big part.



» Sadly this is just an early mock-up and not a limited edition green coloured Oric-1. We wonder how much this curiosity would be worth today?



» An early concept drawing of the Tangerine Tiger, a business machine that was dropped in favour of the Oric-1



» Over in France, Loricels was the king of Oric gaming. It published *Doggy*, an early Eric Chahi effort, and the landmark graphic adventure *L'Agile D'Or* (The Golden Eagle)





ORIC-1

PERFECTTEN GAMES

Thanks to their short commercial lives, the Oric-1 and Atmos are not home to hundreds of great games, so selecting ten of the best is not the thankless task it is with some machines. But as it's obviously subjective, we implore you to discuss and dispute these choices in a hearty manner on the Retro Gamer forum



01

XENON1

- » RELEASED: 1983
- » PUBLISHED BY: IJK SOFTWARE
- » CREATED BY: JOHN SINCLAIR
- » BY THE SAME DEVELOPER: ZORGON'S REVENGE

01 Not to be confused with the Bitmap Brothers' shoot-'em-up series, this is the first of IJK's *Xenon* trilogy for the Oric. While the sequels (*Zorgon's Revenge* and *The Genesis Probe*) were multi-game affairs, the first outing is a straight-up, balls-to-the-wall blaster that plunders *Phoenix* without apology. Programmer John Sinclair can be forgiven however, as *Xenon1* stands out as one of the best versions of *Phoenix* ever released on any home computer. The graphics are large, colourful, and very well animated, whizzing around the screen with a fluidity not seen in many other arcade clones. *Xenon1* was easily the best reason to buy a (sturdy) joystick for your Oric.

RAT SPLAT

- » RELEASED: 1983
- » PUBLISHED BY: TANSOFT
- » CREATED BY: JOHN MARSHALL
- » BY THE SAME DEVELOPER: INSECT INSANITY

02 This frantic platformer from Tansoft's is one of the best-known and best-loved Oric games, and with good reason as it's perhaps the finest pure arcade game available for the machine. The graphics are not great – the main character looks like the stickman's ugly cousin – but the gameplay is ridiculously fun and fast-paced, as you run around a factory trying to flatten cheese-added rodents with a mallet. To complicate matters there's also a weird monster on the loose, which you must repel with a handy aerosol; having to switch quickly between your means of defence leads to many hair-raising moments. It's completely mad, but a classic nonetheless.

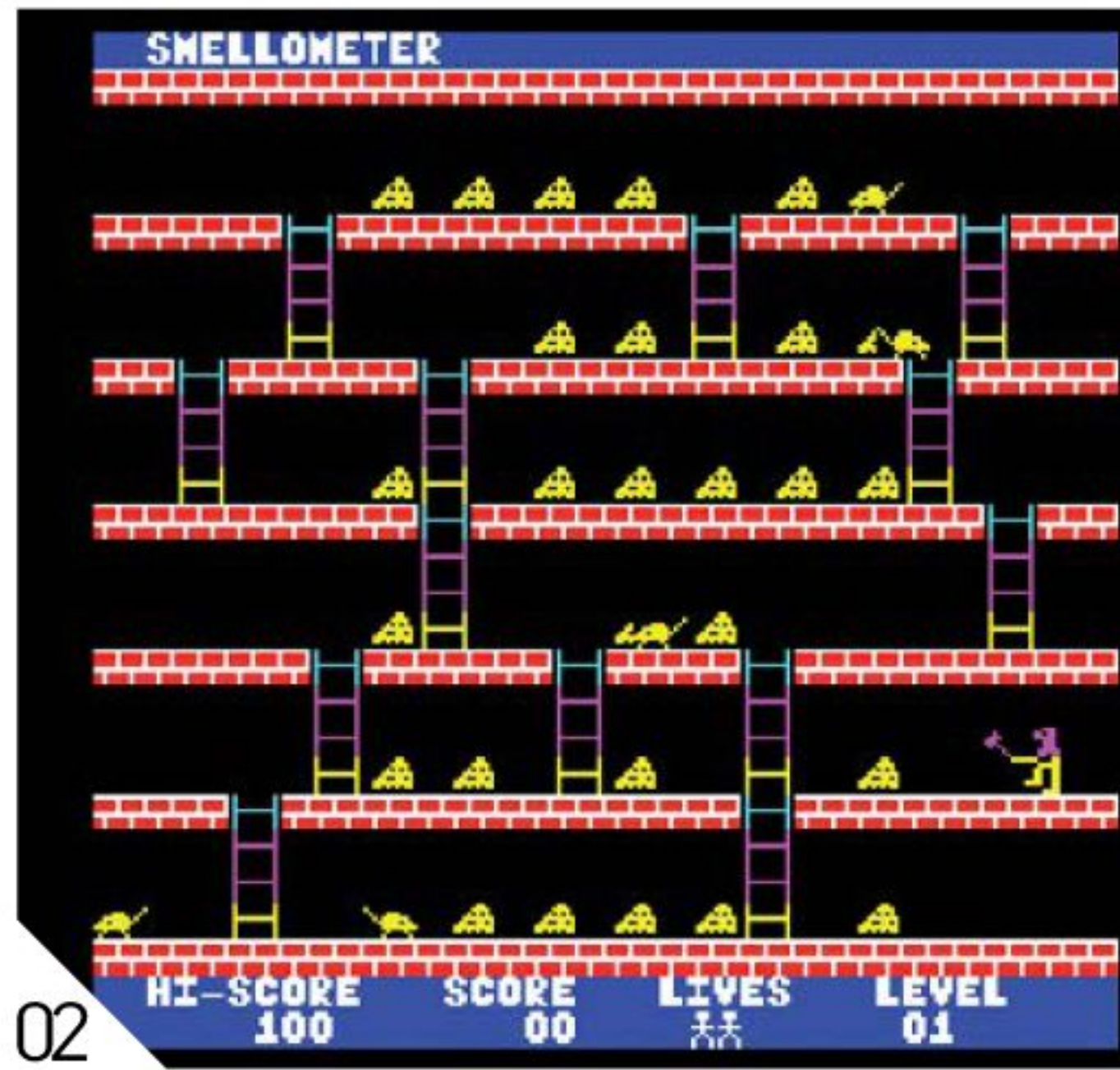

02

INSECT INSANITY

- » RELEASED: 1993
- » PUBLISHED BY: MIRAGE
- » CREATED BY: JOHN MARSHALL
- » BY THE SAME DEVELOPER: THE ULTRA

03 By the time John Marshall began work on his follow-up to *Rat Splat*, the UK Oric market was struggling and Tansoft was in trouble. The anticipated sequel was therefore shelved, but thanks to the sterling efforts of Oric User Monthly, the game was raised from the dead and released through the magazine's software label, Mirage, in 1993. Not only was this the perfect present for faithful Oric fans, but it just happened to be a great little game too. Taking control of a boot, you have to jump around a hive, crushing bugs beneath your size nines. Like John's earlier hit, the frenzied gameplay more than makes up for the lack of visual polish.

DON'T PRESS THE LETTER Q

- » RELEASED: 1984
- » PUBLISHED BY: IJK SOFTWARE
- » CREATED BY: ANDREW MOORE
- » BY THE SAME DEVELOPER: DEFENCE FORCE

04 Forget the cheap and cheerless *Cascade 50* collection – if you wanted variety and spice on your Oric then *Don't Press The Letter Q* was a far better choice. This overlooked gem caters for up to nine people and is a mini-game riot full of weird and wonderful mini-games. The challenges are all familiar as they're mainly clones of *Pac-Man*, *Space Invaders* and other arcade classics, but thanks to some bizarre character sprites and genuinely funny quips from the CPU (it seems to revel in your ineptitude), *Don't Press The Letter Q* plays more like a pastiche than a rip-off.

MR WIMPY

- » RELEASED: 1984
- » PUBLISHED BY: OCEAN
- » CREATED BY: IN-HOUSE
- » BY THE SAME DEVELOPER: HUNCHBACK

05 Ocean's cheeky *Burger Time* rip-off is superb fun and features lovely brash graphics, zappy sound effects and suitably fast gameplay. Playing as the Wimpy mascot, you have to first collect the ingredients and then assemble burgers while avoiding various kitchen nasties. It's repetitive and frustrating but madly addictive. Like *Hunchback*, this version of *Mr Wimpy* is vastly superior to the Spectrum equivalent, a sign that the Oric was arguably better equipped to cope with fast, vibrant arcade games. What a shame then that this excellent little Oric platformer never received a sequel of any sort.



03



04



05



06

MANIC MINER

- » RELEASED: 1985
- » PUBLISHED BY: SOFTWARE PROJECTS
- » CREATED BY: STEVEN GREEN (BASED ON MATT SMITH'S ORIGINAL)
- » BY THE SAME DEVELOPER: THE FALL GUY (C64)

06 Despite a lack of support from established publishers, the Oric is lucky enough to receive its very own version of Matt Smith's seminal platformer.

The port was fairly ropey, suffering from horrible squashed-up graphics, but what it lacked in looks it more than made up for in content. The Oric version packed in an extra 12 screens, taking the total to 32 and turning an already daunting challenge into an endurance test of epic proportions. In the school playground those 12 extra screens gave Oric owners rounds of verbal ammo to fire back at their smirking Speccy-owning pals.

L'AGLE D'OR

- » RELEASED: 1984
- » PUBLISHED BY: LORICIELS
- » CREATED BY: LOUIS MARIE ROCQUES
- » BY THE SAME DEVELOPER: MANHATTEN DEALERS (AMIGA)

09 Text adventures are ten a penny on the humble Oric, but decent graphic adventures are far less common. The best example is easily *L'Aigle D'Or* (*The Golden Eagle*), a stunning French game released by Loriciels. From the moment the game loads you know you're in for something very special. A picture of a creepy castle is seen, illuminated by occasional flashes of lightning. The atmosphere is carried into the game itself, as the castle interiors are depicted in pseudo 3D, with large high-resolution graphics. The main character is impressive too, and although he trundles about as if he's wearing concrete boots, it won't stop you from wanting to explore the castle's – and the game's – hidden depths.

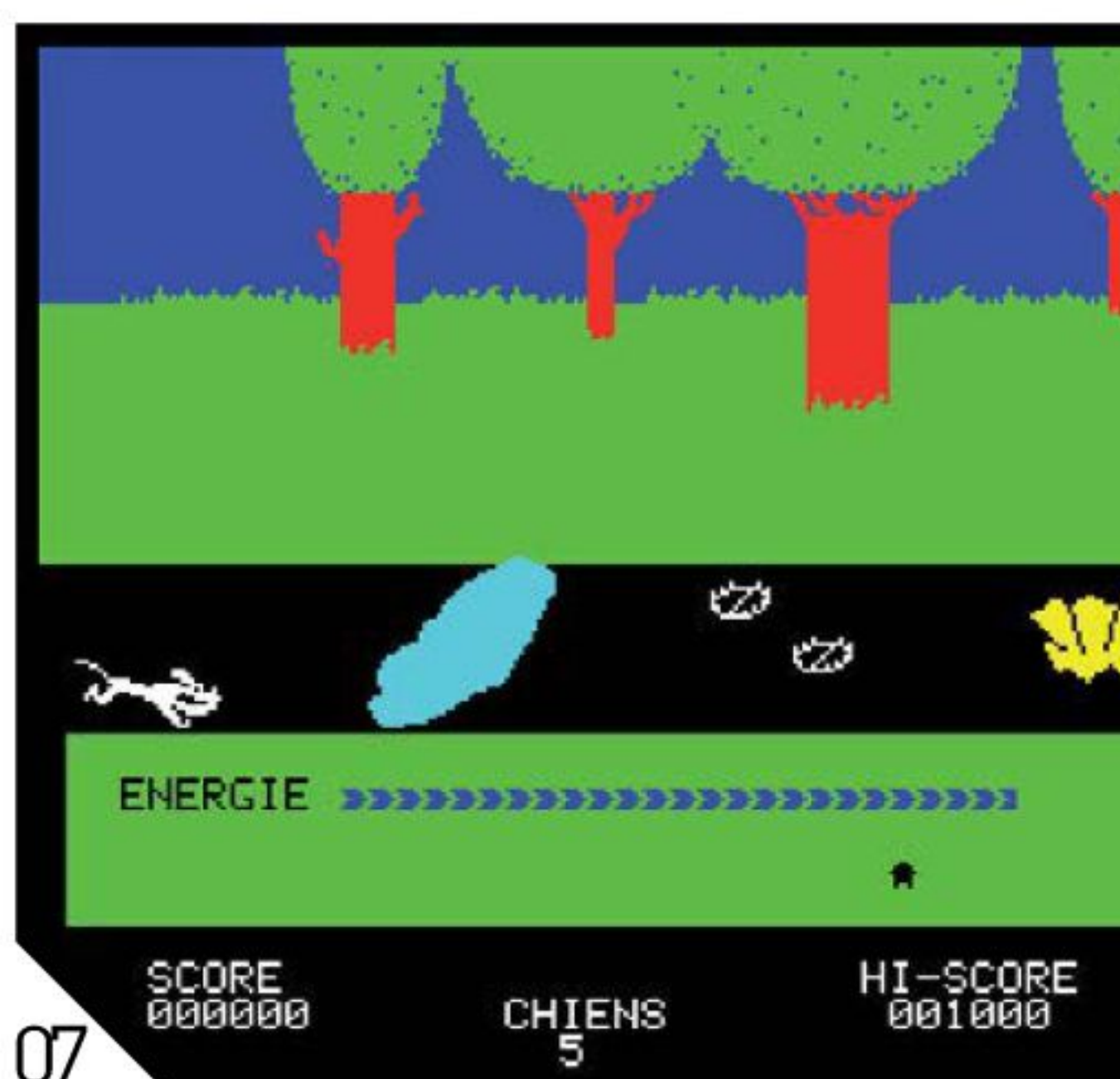

07

DOGGY

- » RELEASED: 1984
- » PUBLISHED BY: LORICIELS
- » CREATED BY: ERIC CHAHI
- » BY THE SAME DEVELOPER: LE SCEPTRE D'ANUBIS

07 Years before he created the masterful *Another World* on the Amiga, 17-year-old Eric Chahi honed his programming skills on the Oric's clicky keyboard. He coded four commercial games for the French Oric market, with *Doggy* being the most accomplished by far. At first glance the game looks like the perfect program for kids, with a floppy-eared chien bounding about in a world awash with primary colours. But at its heart lies a fiendish arcade game as you attempt to guide your canine friend along a pathway littered with deadly traps and obstacles. Eric went on to better things, but *Doggy* is certainly not something he'd need to hide on his gaming CV.

PULSOIDS

- » RELEASED: 2002
- » PUBLISHED BY: CEO/RHEOTIC
- » CREATED BY: JOHNATHAN BRISTOW
- » BY THE SAME DEVELOPER: MAGNETI

10 It's almost as if someone has charged Jonathan Bristow (aka Twilighte) with single-handedly keeping the Oric software scene alive. Like all the best home-brew titles, his sporadic yet significant releases succeed in pushing the hardware to its limits while still delivering very playable games. *Pulsoids* is a bat-'n'-ball game that builds on *Arkanoid* to the same extent that *Arkanoid* itself built on the original *Breakout*. In fact, if you compare the game to any of the early *Breakout* clones on the Oric you'll find it difficult to believe that they're running on the same hardware. The sound and graphics really are staggering. Visit Jonathan's site at <http://twilighte.oric.org> for loads more good stuff.



08

SNOWBALL

- » RELEASED: 1983
- » PUBLISHED BY: LEVEL 9
- » CREATED BY: THE AUSTIN BROTHERS
- » BY THE SAME DEVELOPER: ADVENTURE QUEST

08 The Oric-1 wasn't exactly blessed with the best keyboard, but this didn't deter publishers from releasing dozens of text adventures for the machine. Level 9, the champions of the genre (in the UK at least), released its first five adventures for the Oric, the best of which is *Snowball*, a gripping sci-fi fantasy set aboard a deep space transport ship on a collision course with a planet. *Snowball* is text-only with no location graphics, but the strength of the descriptions, the sophistication of the puzzles and the sheer number of locations lifts it high above any fancy-pants graphic adventure. One for the purists.



09

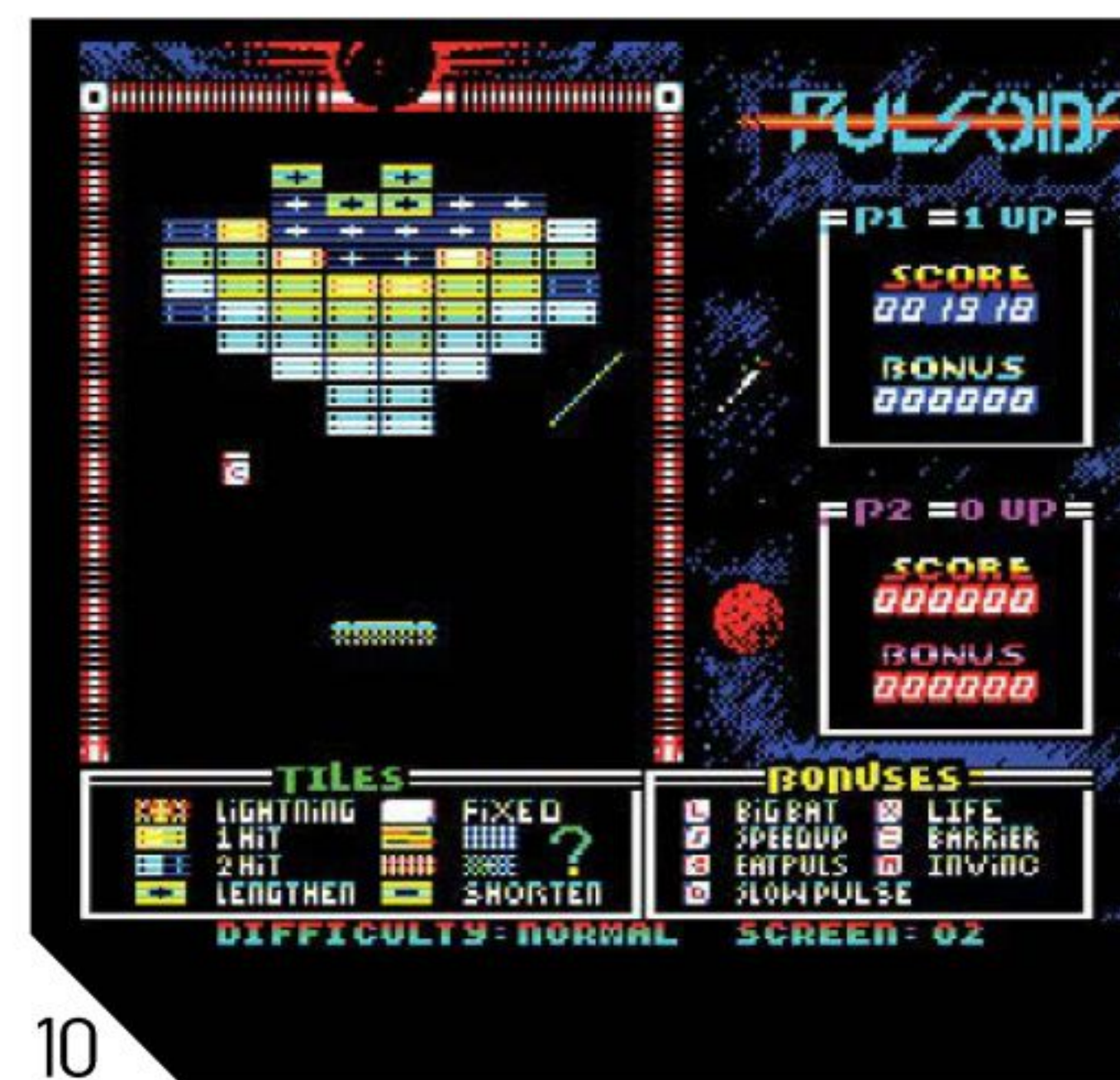

10



ORIC-1

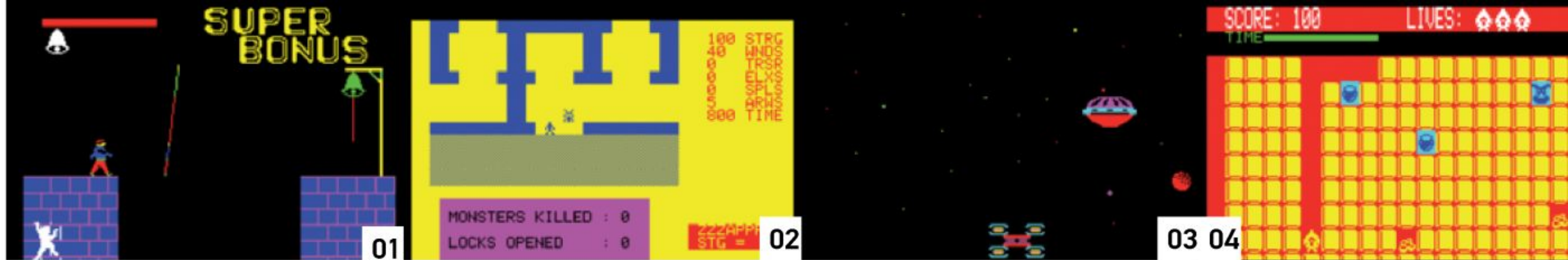

ORIC-1 and the rest...

Bring a little sunshine into your life by gazing at this wall of wonderfully garish Oric screenshots. Many of these games can be downloaded legally from www.oric.org. You will need to register your details with the site however.

- 01 HUNCHBACK
- 02 KEYS OF KRAAL
- 03 PROBES 3
- 04 QUAK-A-JACK
- 05 3D MUNCH
- 06 DONT PANIC
- 07 ELECTROSTORM
- 08 FELONS
- 09 INVADERS
- 10 ROAD FROG
- 11 DEATH DRIVERS
- 12 KRILLYS
- 13 THE BOSS
- 14 ZORON'S REVENGE
- 15 STYX
- 16 PERSEUS AND ANDROMEDA
- 17 MUSHROOM MANIA
- 18 SCUBA DIVE
- 19 FIRE FLASH
- 20 HU-BERT
- 21 ADVENTURE QUEST
- 22 ZIPNZAP
- 23 THE HOBBIT
- 24 SURVIVOR
- 25 TYRANN
- 26 LANCELOT
- 27 HELLION
- 28 DALLAS
- 29 FROG-HOPI
- 30 HYPER OLYMPICS
- 31 ATTACK OF THE CYBERMEN
- 32 FOOTBALL MANAGER
- 33 SUPER METEORS
- 34 ICE GIANT
- 35 ORIC FLIGHT
- 36 QUEST OF THE HOLY GRAIL
- 37 JOGGER
- 38 STARFIGHTER
- 39 TRIATHLON
- 40 ZODIAC
- 41 COBRA INVADER
- 42 HONEY KONG
- 43 KARATE
- 44 PAINTER
- 45 SHUTTLE SIMULATOR
- 46 SKRAMBLE
- 47 GHOSTMAN
- 48 ELECTRIC EEL
- 49 GREEN CROSS TOAD
- 50 MADACAM BUMPER
- 51 COCK IN
- 52 DAMSEL IN DISTRESS
- 53 ISLAND OF DEATH
- 54 PSYCHIATRIC
- 55 SPACE INVASION
- 56 SUPER ADVANCED BREAKOUT
- 57 DRACULA'S REVENGE
- 58 FRIGATE COMMANDER
- 59 TREK
- 60 ZEBULON
- 61 DEFENCE FORCE
- 62 WARLORD
- 63 SUPER JEEP
- 64 HELL'S TEMPLE
- 65 LE TRIDENT DE NEPTINE
- 66 TRICK SHOT
- 67 WATER PANIC
- 68 TIMES OF LORE (DEMO)
- 69 ULTRA
- 70 WAYDOR
- 71 FANTASY QUEST
- 72 GHOST GOBBLER
- 73 ULTIMA ZONE
- 74 HARRIER ATTACK
- 75 HOVER RESCUE
- 76 LE MANOIR DU DR GENIUS
- 77 ZEBBIE
- 78 HOUSE OF DEAD
- 79 PASTA BLASTA
- 80 GHOSTS AND GHOULS
- 81 LAND OF ILLUSION
- 82 LONE RAIDER
- 83 THE VALLEY
- 84 THEM: A PARANOID FANTASY
- 85 SAGA
- 86 VELNOR'S LAIR
- 87 MAGNETIX

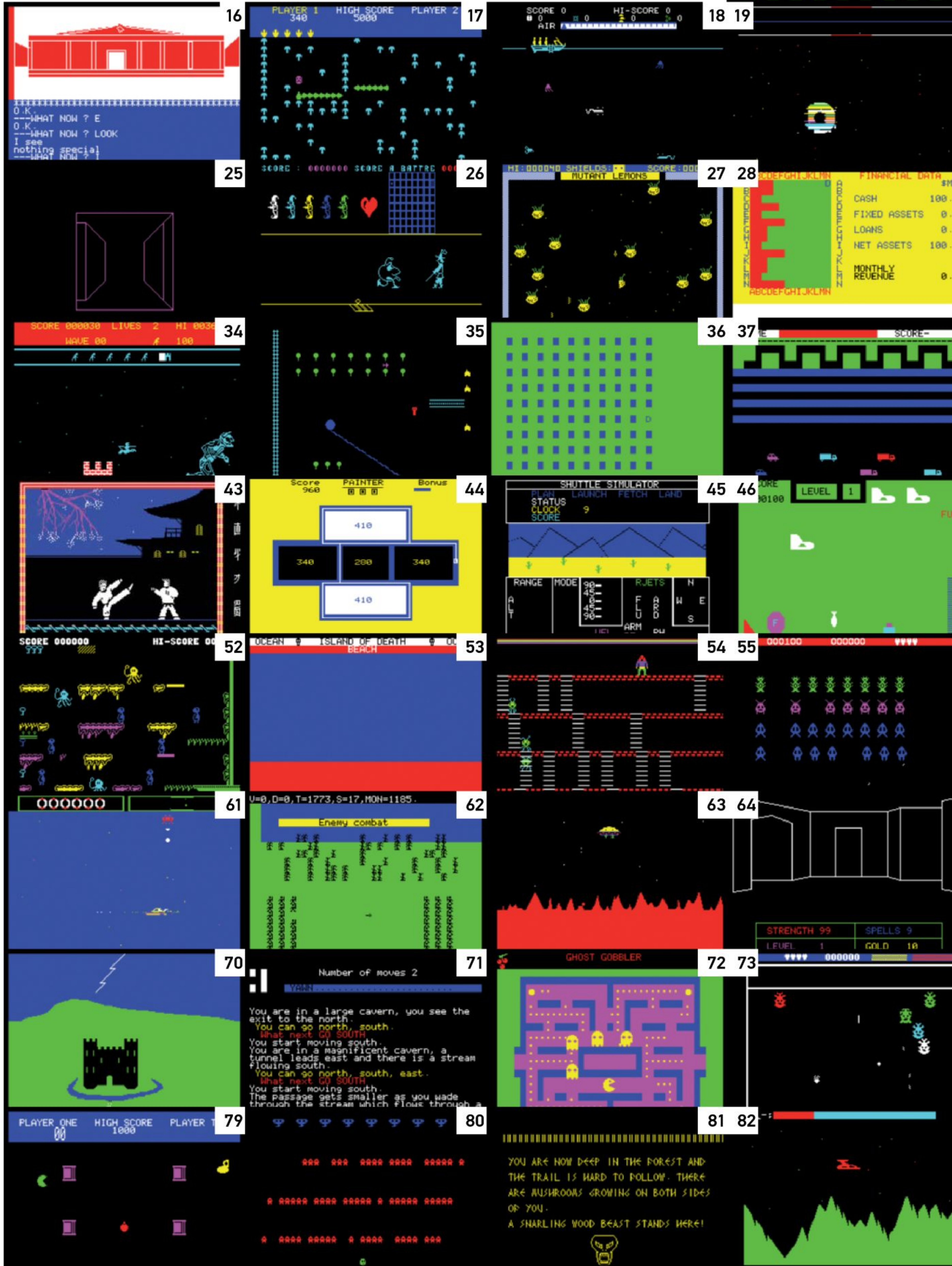

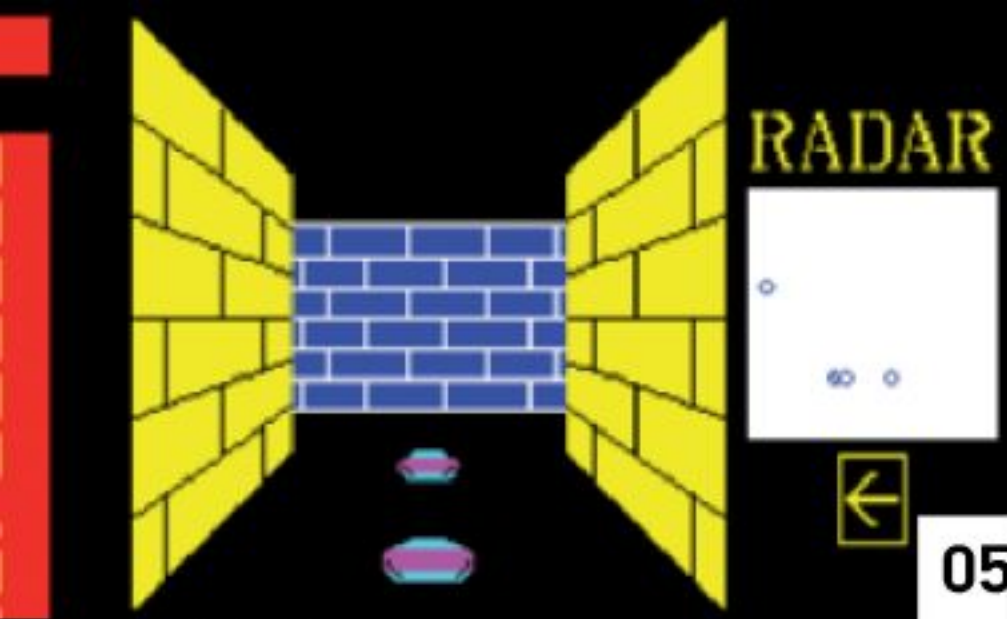

05

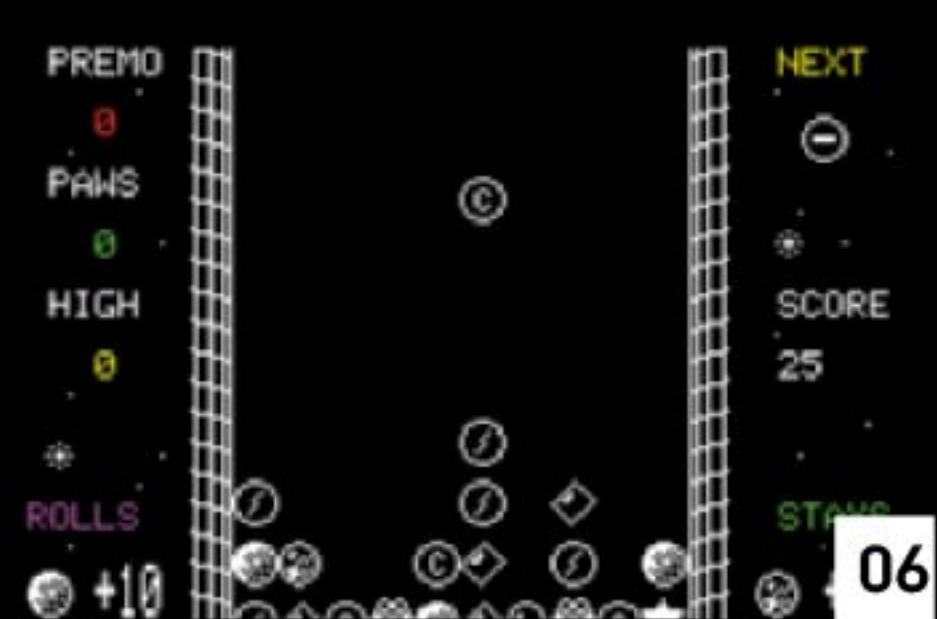

06



07



08

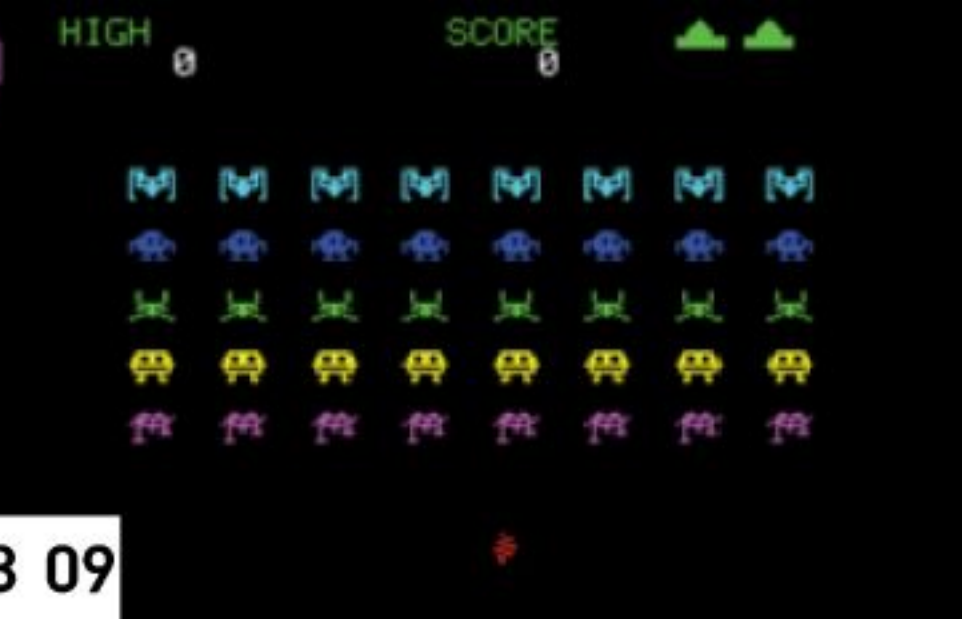

09



11



12



13

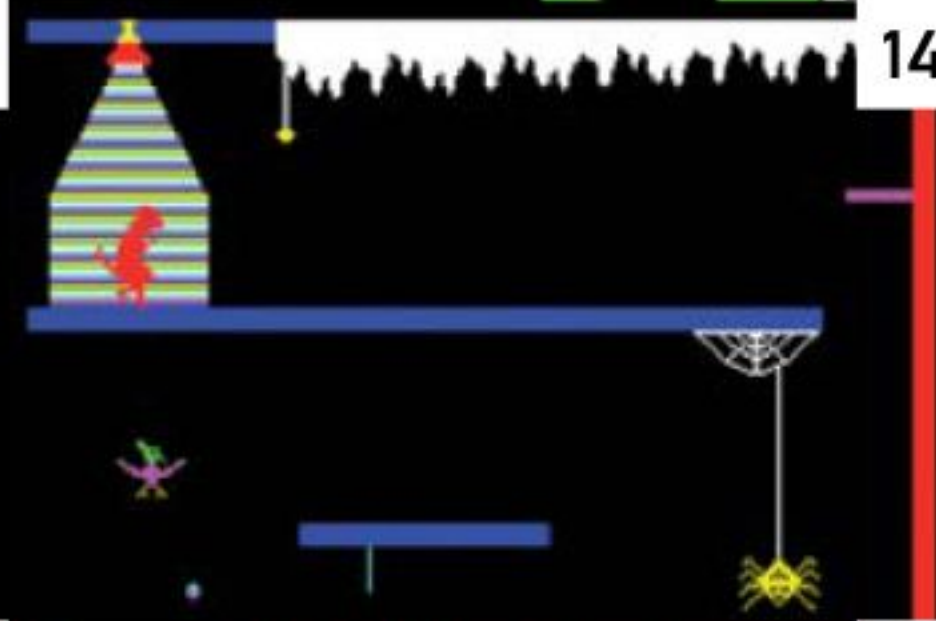

14



15



20

Welcome to Adventure Quest from Level 9. Enter English phrases (without punctuation) to play, find and defeat the Demon Lord AGALIAREPT to win. You are at the end of a road from the north, outside a small brick building. A river flows south through a narrow valley and there is dense woodland all around. What next?
IN
You are in the building. Steps lead down a well in the centre of the floor. A white dot is marked over the door. A bottle lies nearby: it is full of water.

21



22



23



24



29



30

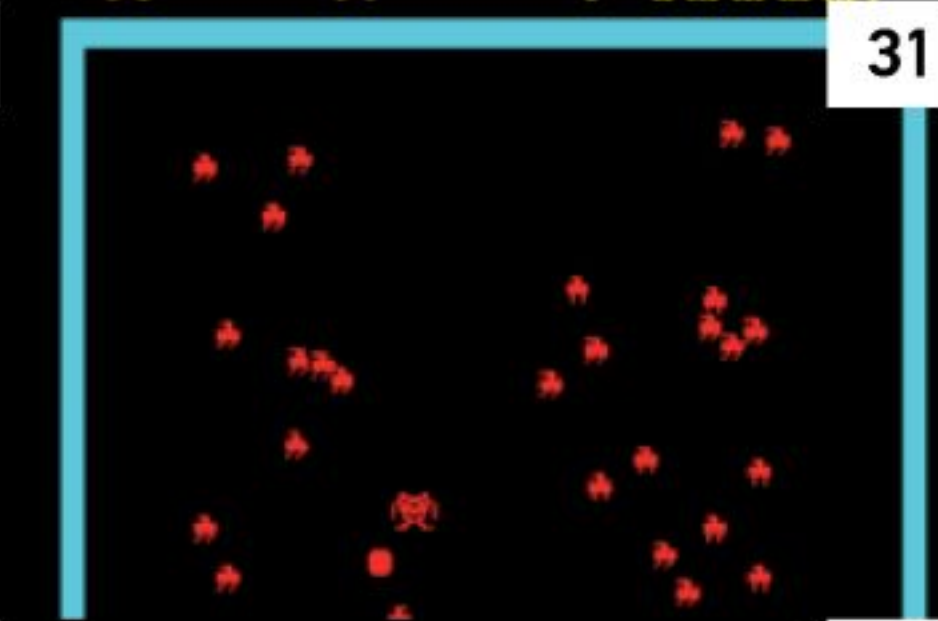

31



32



33



38



39



40



41



42

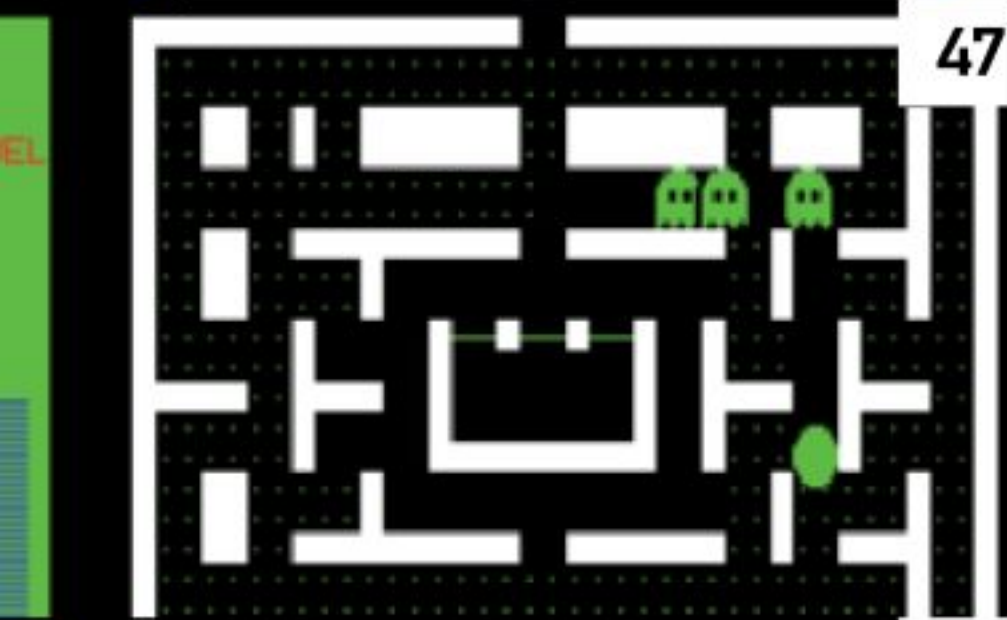

47



48

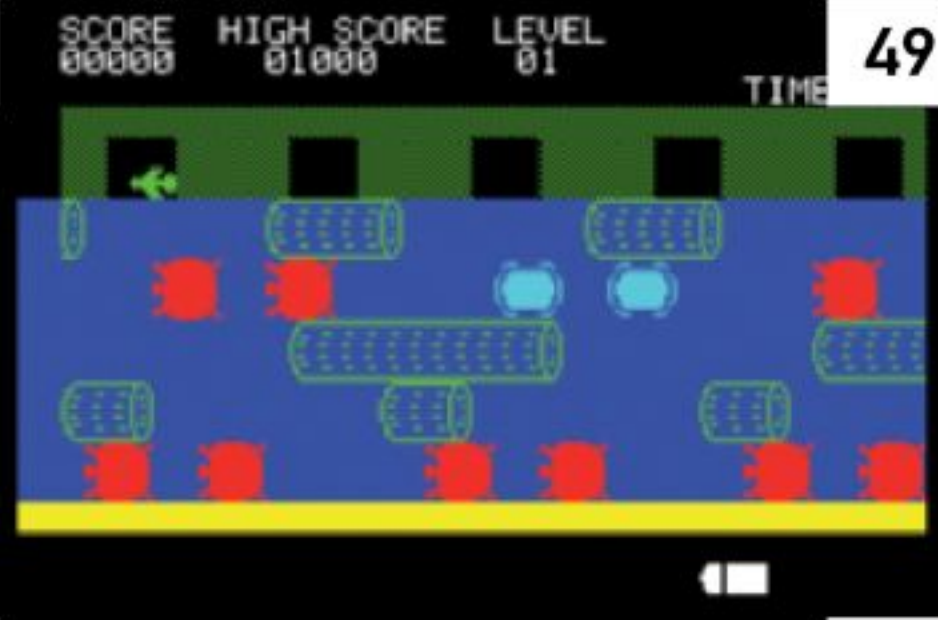

49

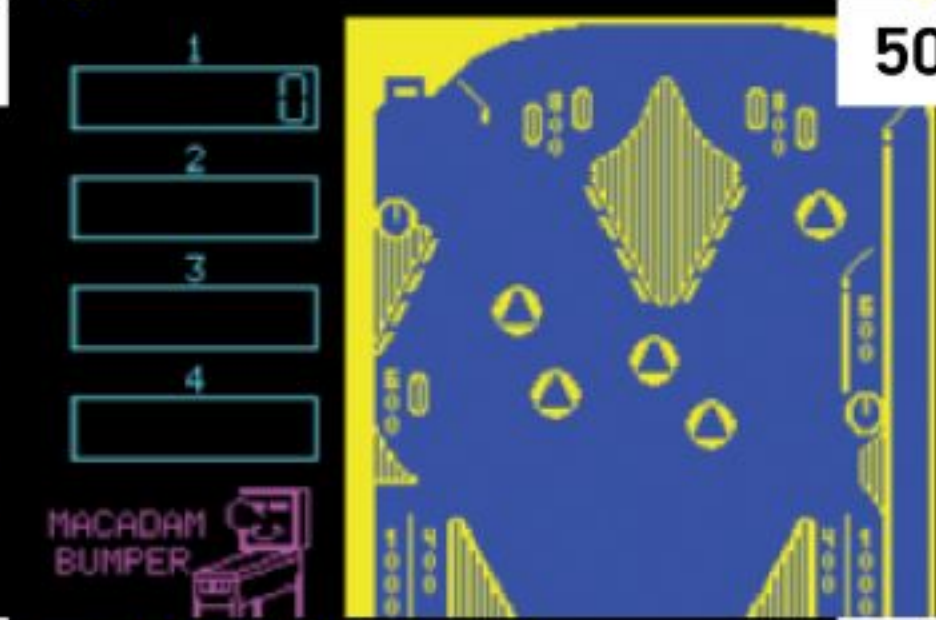

50



51



56



57



58

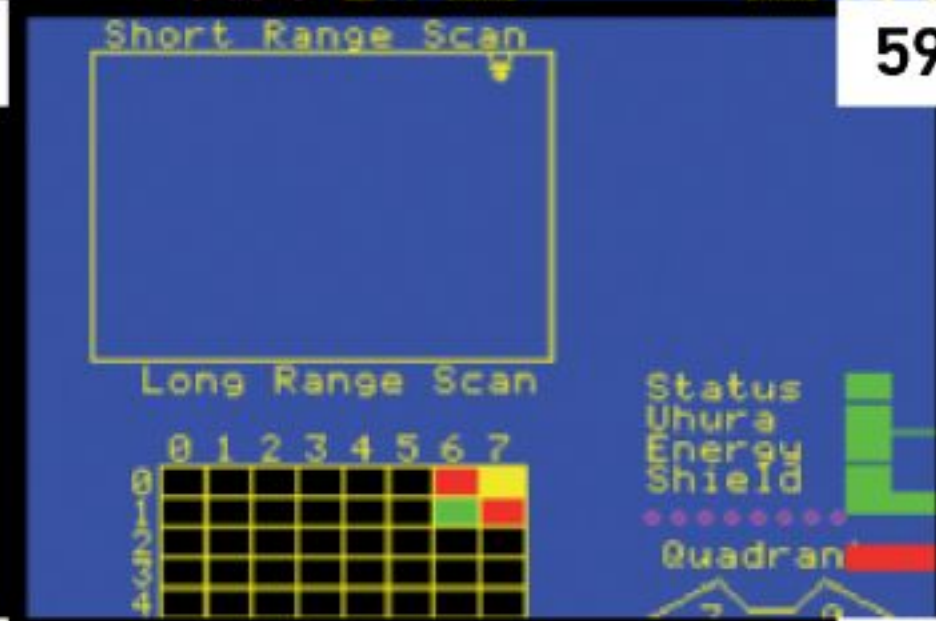

59



60



65



66

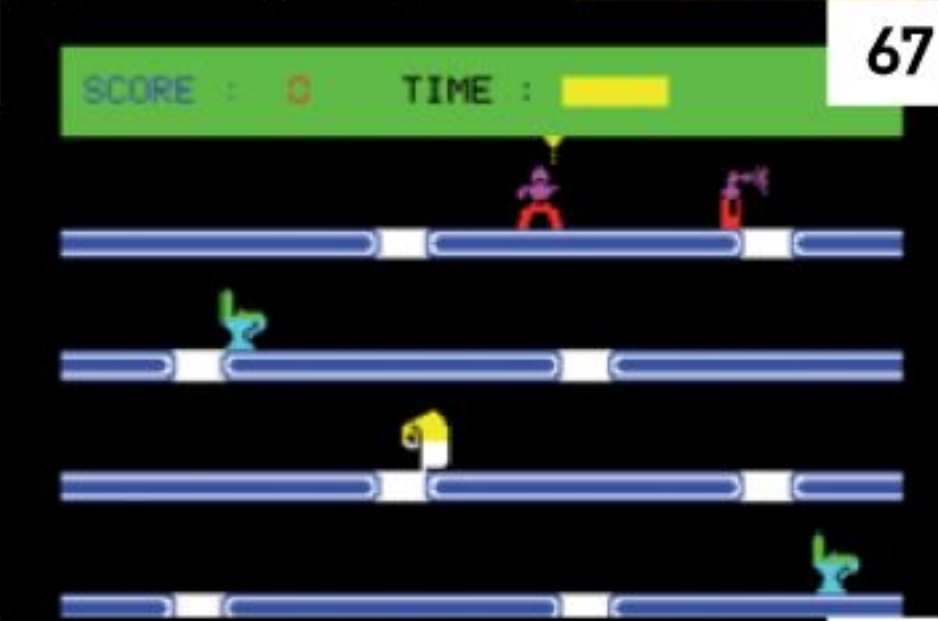

67



68



69



74



75



76



77



78



83



84



85

EXAMINE WEBS
SPELL STRENGTH 10 STRENGTH 10
A GIANT SPIDER IS HANGING FROM THE ROOF JUST WAITING FOR A VICTIM.
YOU ARE AT THE FOOT OF MT ELK. TO YOUR NORTH A NARROW PASSAGE LEADS INTO THE MOUNTAIN SIDE. IT'S TOO DARK TO SEE ANYTHING. TO CONTINUE YOU HAD BETTER GET SOME LIGHT. THE PASSAGE-WAY IS BLOCKED WITH THICK YELLOW WEBS
WHAT WILL YOU DO NOW ?

86



87

MICROVISION

Often billed as the first handheld game console, the Microvision is actually an evolutionary step in handheld electronic games, those distant cousins to videogames. We reveal the history behind this pioneering product





© Evan-Amos

Electronic gaming in the palm of your hand has been around almost as long as videogames. While the latter required a TV, the former arose in the mid-1970s as a way to use up excess calculator parts gathering dust in a market recently taken over

by the Japanese. The class of games was created in the US by Mattel after exec Mike Katz saw a new opportunity for those stagnant parts by repurposing them to play games on. Assigning some engineers to the project, they came up with a novel way of using microcontrollers (a small single-chip computer) with on-board game code to drive an LED display and the Mattel Electronics group was born. Comprising nothing more than glowing LED segments housed in patterned plastic, they were a far cry from actual videogames, but these small electronic games caught the imagination of a generation of children.

As other companies began to enter the market, a funny thing had happened by 1978: in the US, sales of electronic games actually outsold home videogames. In fact, while the magazine *Newsweek* was celebrating the high-tech toys and games on its cover that Christmas, home videogame sales were hit hard.

Additionally, a display shift had been brewing in the calculator market as LED-based calculators gave way to both vacuum fluorescent display (VFD) technologies – with crisp, glowing elements – and liquid crystal displays (LCD) offering lower power consumption.

“ [The chemicals] speed determined how many lines you could have in the display ”

Jay Smith recalls the problems with LCD screens

The stage was further set by the appearance of the handheld Merlin that year. Designed by Bob Doyle, this handheld electronic game was released by Parker Bros and went head to head with Milton Bradley's tabletop format Simon (designed by the legendary Ralph Baer) that Christmas season. Merlin's big advantage? It could play more than one game – switchable to several different built-in games, much like the dedicated videogame consoles of the mid-1970s.

It was during this backdrop of portable electronic dominance that the next generation of these handheld games were being designed at a small firm in Santa Monica, CA called Western Technologies. Jay Smith had founded Western Technologies on 19 September 1978 as an engineering firm to design electronic games and toys for the major toy companies of the era. A 'toy think tank' of sorts. Jay had come up with the concept of what became the Microvision thanks to a small side business of the company. "We were creating the chemicals that went into an LCD display and were selling them to Hughes Aircraft, a major manufacturer of LCD displays at the time," says Jay.

At the time, LCD displays were limited to a three-row display. As Jay illuminates, "Depending on the make-up of the chemicals, their speed determined how many lines you could have in the display. In



» *Sea Duel* is essentially a one-player version of Milton Bradley's popular board game, *Battleship*. It's certainly worth seeking out.

► general, three rows was about it." Realising that three rows of dots was not enough to do a meaningful game display, he came up with a novel idea akin to how today's 3D graphics engines 'clip' graphic elements not being used in order to save processing speed. "We realised the graphic displays at the time counted every pixel every minute, whereas in a game display we would only use about 20% of the pixels at a time. Why worry about rows not being used? So we created a display system that only governed the rows being addressed." In this method, pixel rows that are on most of the time and static require the least amount of attention. Rows with semi-moving objects require a little more, and rows with regularly moving objects (a shot, a ball etc) require the most. This advancement allowed a formerly unheard of 16 rows of pixels and in turn created an LCD display that was much more viable for playing games on.

Having to come up with a custom LCD driver chip, the thought became that if they were advancing the technology this much display-wise they might as well make it a programmable system that could swap out cartridges. The problem was, once again, the technology (and cost) wasn't there yet to support a full microprocessor with swappable game ROMs in a handheld format.

Most LED handheld games of the time (and electronic toys in general) used what are called microcontrollers. A microcontroller is a chip that is essentially a full 'computer' on a single chip. That means the processor, RAM, input/output and other related technologies that are all separate in a traditional computer are combined in a single chip. Now, that chip and its resources were nowhere near as powerful and plentiful as a regular microprocessor-driven system at the time, but they weren't intended to be. Microcontrollers were created to be used in small, compact devices. Devices such as... you guessed it, calculators. That's one of the reasons why Mattel's first handheld electronic game (*Auto Race*) uses a microcontroller and the technology became a staple

of the handheld electronic games industry and the electronic toy industry as well.



The actual software that was to run on the microcontroller was usually packaged within the microcontroller IC itself in ROM format, further adding to the compactness of the device. However, just like all the other resources in the microcontroller, this meant you had a very limited amount of ROM space to work with. The programmer of Mattel's *Auto Race*, Mark Lesser, had to fit the entire game (logic, scoring etc) into 512 bytes of code. A feat that makes the typical 2K available to Atari 2600 game developers of the time seem spacious.

Jay Smith's solution was to leverage microcontrollers in a way not unlike dedicated videogame console manufacturers had looked at that year with their single-chip 'Pong-on-a-chip' based systems: create the illusion of switching out games by switching out the dedicated systems themselves. In that format, the system is really just the controller and display mechanism and the 'guts' are all on the part being swapped out. Companies in Europe like Hanimex had started releasing SD 050-based consoles in 1977 that did just that, and Atari had its Game Brain it showed at the summer '78 CES but chose not to release. In the case of Jay Smith's proposed device, the handheld unit would only contain the electronics for the LCD and controls. The microcontroller that contained the system's main circuitry and game itself would be located on a portion of the unit that would swap in and out, plugging into the other circuitry when it was docked.

Building a prototype, Jay Smith shopped it around and Milton Bradley wound up biting at the opportunity. Milton Bradley had started in 1860 as a board game company located in Springfield, Massachusetts. By the early 1970s, it had released board and novelty game titles that had become staples of many a person's youth, such as *Mouse Trap*, *Operation*, *Battleship* and

“ We created a display system that only governed the rows being addressed ”

Jay Smith on how they solved the LCD issue

Connect Four. Following Mattel's lead, it tentatively stepped into the electronic toy and game market in 1977 with the tabletop *Comp IV* (released in the UK as *Logic 5*). A number sequencing game that was more an educational toy in the same class as Texas Instruments' *Little Professor*, it comprised a series of LEDs housed in a case meant to look like a child's version of a computer. It was joined that year by an updated electronic version of its classic board game *Battleship*. In 1978 Milton Bradley followed up with a new electronic board game called *Laser Attack*, a futuristic *Star Wars*-influenced electronic toy space fighter called *Star Bird*, and the aforementioned *Simon*. It was *Simon*, though, that Milton Bradley knew it had a hit with, and so it pulled out all the stops for its introduction. The game of glowing coloured lights and musical tones made its debut at New York's own location for dancing lights and musical sensations, the iconic *Studio 54*. When Jay approached Milton Bradley with the concept for his handheld electronic game with switchable games, the firm knew it had an appropriate follow-up to *Simon*.

The designers of the system – Jay Smith, Gerald Karr and Lawrence Jones – were awarded US patent number 4359222 for the Microvision. Entitled 'Handheld electronic game playing device with replaceable cartridges', it was originally filed on 30 October 1978.

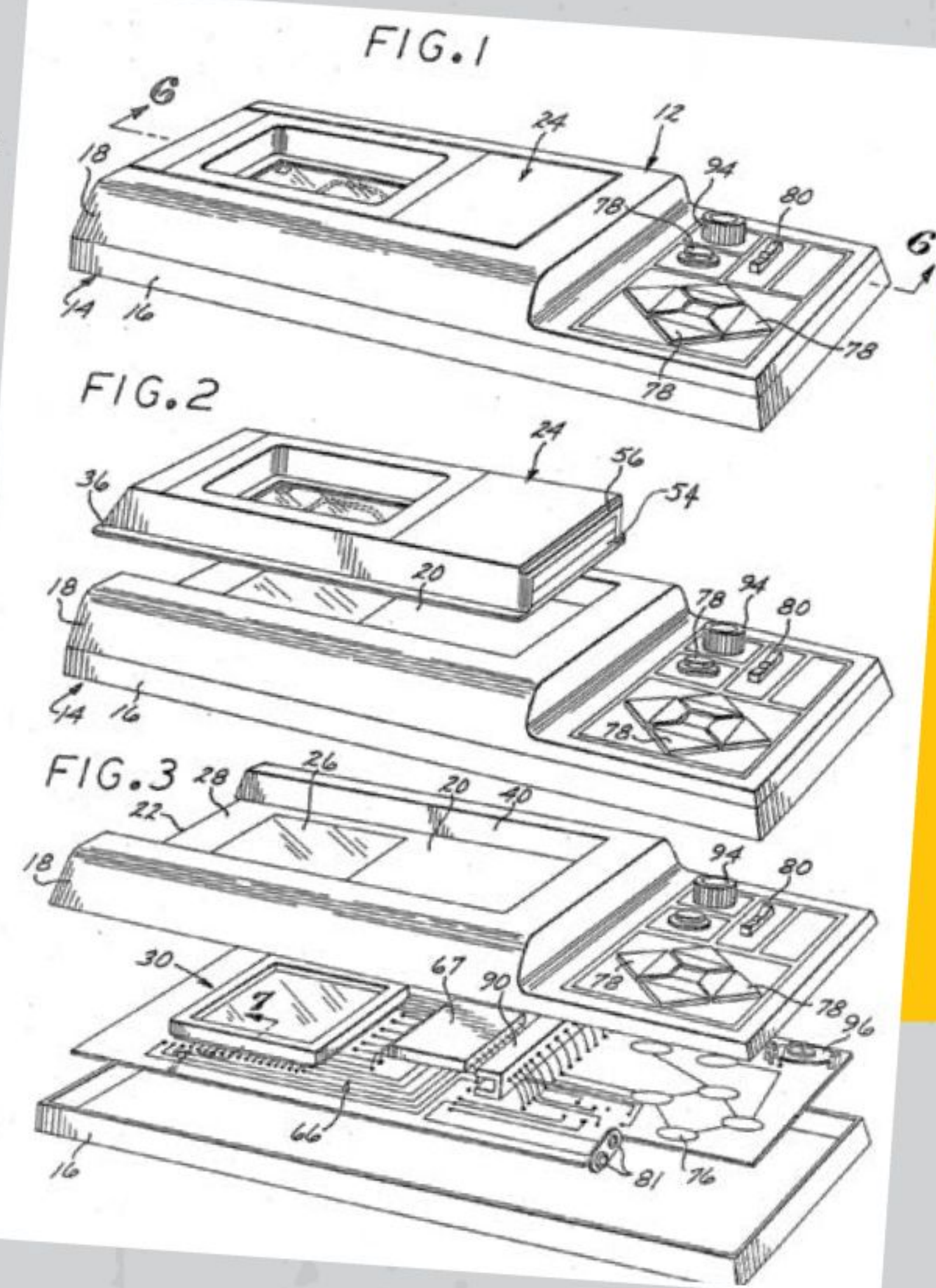

Described as a "A compact hand holdable electrical toy game assembly", the drawings show the initial proposed format for the Microvision which included both a primordial version of a 'd-pad' thumb controller and a spinner for playing paddle-style games. An alternate version shown in the same filing is a little closer to what became the actual Microvision, including a 12-button keypad, spinner and removable faceplate.

The development, from concept to full product, led to some interesting design work and changes from the initial concept. At first glance, the Microvision looks like an oblong version of the typical handheld electronic game of the time. This certainly wasn't needed for the electronics, as they take up about the same space (if not less) as the other games on the market. According to Jay Smith, the primary reason for all the extra space fell on Milton Bradley. Its reasoning being that the projected price would dictate the need for a larger size, as if the consumer would not understand they were paying for higher technology.

The main unit itself houses the LCD, its special controller chip, the controls and the connection to the system bus that works similarly to a cartridge slot. It's

used for nothing more than I/O and power (Tiger's R-Zone handheld in the Nineties is similar in construct, but with an LCD contained on the removable portion). The most interesting addition, though, which shows a lot of insight into its replayability potential, is the control pad. Instead of a defined keypad with raised buttons (as shown in the concept drawings) it features a flattened pad, allowing it to be defined as needed by the faceplate. Combined with the spinner control, it provides custom control options on a per-game basis. A feature not matched until touch-based games proliferated on smartphones and tablet devices.

The microcontroller initially chosen by Jay and company was the Intel 8021, an 8-bit microcontroller

in the same family as the 8048 processor used in Magnavox's Odyssey2 console (Philips Videopac series) and introduced in 1976. With 64 bytes of RAM and able to address a game up to 1K in size (the typical game size up to that point had been about half that), it held enough resources to get the job done. Interestingly though, the 8021 has a higher power requirement than the typical microcontroller used in these devices and, combined with the requirements of the LCD, it made the Microvision require two 9V batteries (which added to the size of the unit as well). The 8021 was replaced with the Texas Instruments TMS1100 not long into the system's lifetime, however, thanks to some ordering issues for the Intel chip. A 4-bit microcontroller that's part of the TMS1000 series introduced in 1974, the 1100 has less RAM and processing power but can address up to 2K in ROM space. The other plus it brought was the lower power requirement, allowing the Microvision to need only one 9V battery now. Milton Bradley responded to

INSIDE THE MICROVISION

Due to its rarity, it's not often you get to see inside this handheld

CASE

■ Here's what's holding the Microvision together. It's worth noting that the bottom half of each front faceplate is typically different for each game. *Connect 4*, for example, has six control points while *Block Buster* only uses four.

CONTRAST KNOB

■ A feature rarely seen on even later LCD-based handhelds, this enables the Microvision owner to adjust the contrast of the display – important considering it's not backlit.

BATTERY STORAGE

■ The original Microvision needed 9V batteries. Changes during the production run lowered power requirements. The second slot became extra battery 'storage'.

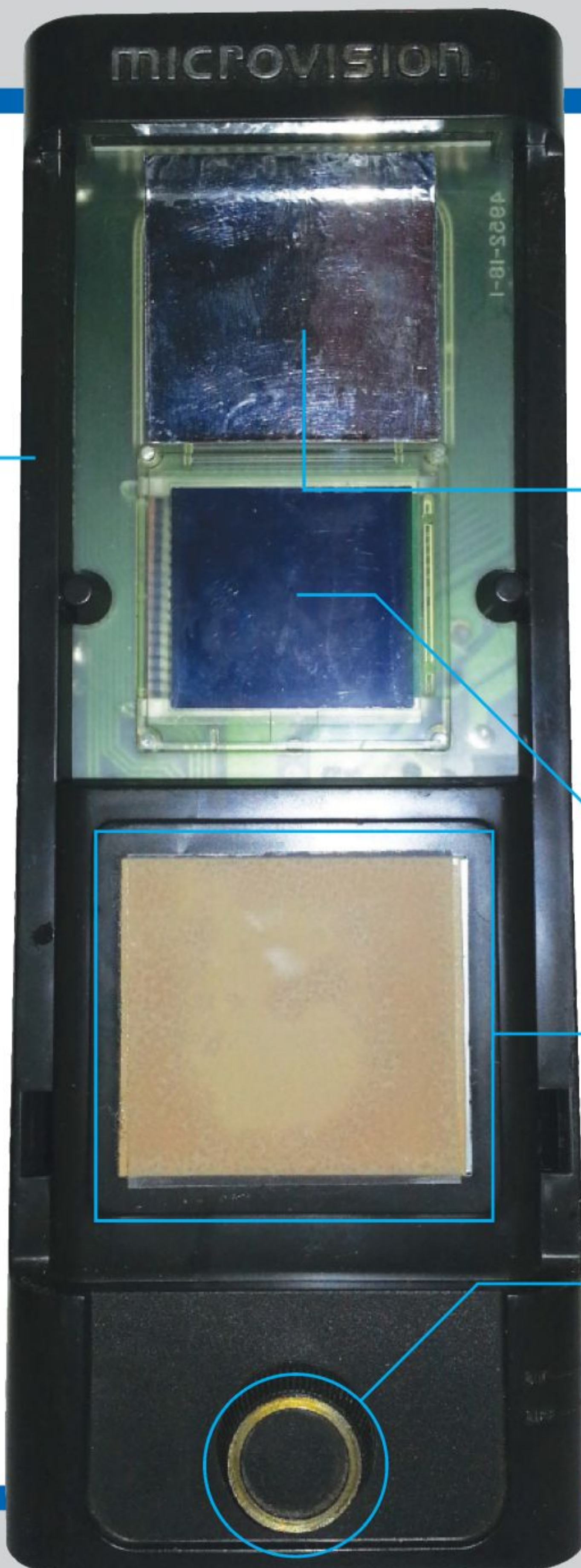

LCD CONTROLLER

■ The custom controller chip for driving the then groundbreaking LCD display. Commonly covered with a wound copper-backed foil sticker to protect from static discharge.

CARTRIDGE SLOT

■ This is where you can attach new cartridges for your handheld. In total just 12 different games were created for the machine, making it an interesting challenge for collectors.

LCD

■ Custom 16x16 LCD display designed by Jay Smith and his team. Unfortunately, because of early manufacturing limitations, it's prone to breakdown and a condition known as screen rot.

TOUCHPAD (12 KEY)

■ 12-key touchpad which has its areas defined by the faceplate. Technically similar to number pads on console controllers like Intellivision and Colecovision.

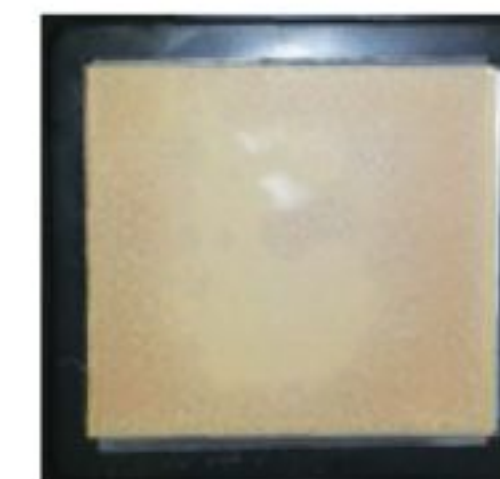

PADDLE

■ The Microvision's mounted spinner control. Its functions differ on a per-game basis and include everything from a traditional paddle control to adjusting range settings.

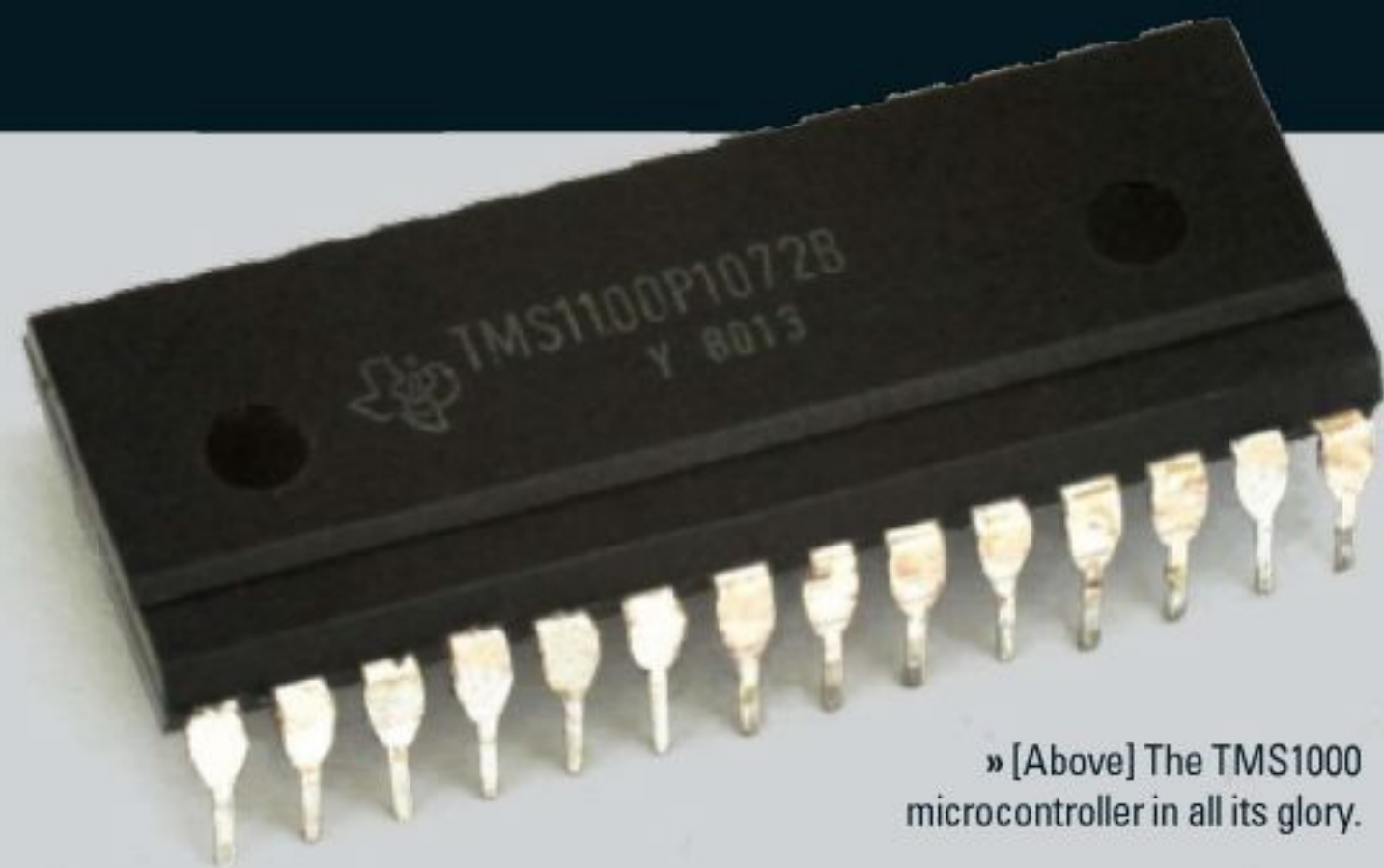

» [Above] The TMS1100 microcontroller in all its glory.

» [Right] Funnily enough, *Block Buster* is Milton Bradley's take on the arcade hit *Breakout*.

► the dropping of one battery by leaving in the extra battery port instead of redoing the system moulds, simply unwiring it. The old battery port was now redubbed as "extra battery storage". They couldn't escape the need to recode the software for the games, however, for the more primitive TMS1100.

The microcontroller, as mentioned, is housed in a removable faceplate. Each faceplate is designed to give a custom experience to the game, not unlike the elements of an arcade game. The game's name is provided in a unique and colourful 'marquee' and the screen bezel contains colourful surrounding graphics and sometimes overlaid markings relevant to the gameplay. Finally there's the control area. Using a combination of moulded plastic to 'expose' the relevant spots on the touch pad and coloured text or graphics that describe the button's function, the control customisation available for each game was unparalleled. On the reverse side of the panel is what looks like a 'dust protector' similar to the Atari 2600



protectors; however, that's not its function. While the problem of static discharge on the exposed contacts was solved in videogame consoles, it was a major issue for the Microvision. One wrong touch and 'poof' it would go, wiping out the game and microcontroller. The cover that flips off to expose the contact was meant to protect it from this mishap.

The Microvision was released in November 1979 for around \$40 along with another high-tech toy offering by Milton Bradley, the programmable Big Trak. It came with the *Breakout* clone *Block Buster* along with three available launch titles: *Bowling*, *Connect Four* (a version of Milton Bradley's popular 1974 board game) and *Pinball*.

The Microvision was of course not the only next-generation electronic game to hit the market in 1979 with an advanced display, as toy manufacturer MEGO (famous maker of superhero toy dolls and dolls based on movies like *Planet of the Apes*) came out with the Mini-Vid series of tabletop two-player games. Featuring a 16x20 VFD display, it came in versions for four different games: *Break Free*, *Dodge City Gunfight*, *Sea Battle*, and *Spacewar*. In fact, 1979 turned out to be the year of the two-player handheld electronic game: Coleco had the 'Head to Head' series of tabletop sports games, while Pulsonic released its classic two-player Baseball game.

While the ability for two players (one on each end of the unit) to play head to head was certainly an advantage, you still had to buy four separate units. Though Microvision was only one-player, the

ESSENTIAL GAMES If you do find a working machine, play these



BLOCK BUSTER

■ Use the console's built-in paddle to hit the ball and knock away bricks. What else can really be said of this pedestrian *Breakout* clone? What really makes it a notch above the rest isn't the version of the game itself, but the fact you can use an actual spinner to control the on-screen paddle. Digital thumb pads and analogue joysticks found on regular handheld videogame consoles two decades later just don't cut it for accurate control of the paddle. You need a spinner for the proper timing and feedback needed to enjoy paddle games and the Microvision has it!



SEA DUEL

■ A one-player version of Milton Bradley's *Battleship* board game. In fact, many of the games on the Microvision were versions of MB board games and toys (much to the dismay of Jay Smith who wanted to expand beyond those offerings). Here, a destroyer is pitted against a submarine with an emphasis on tactics. Designed for two players, both opponents separately 'program' their movements and fire shots ahead of time, then watch the game execute them. It plays similar to some of the American Football slideshow games of the early '70s.

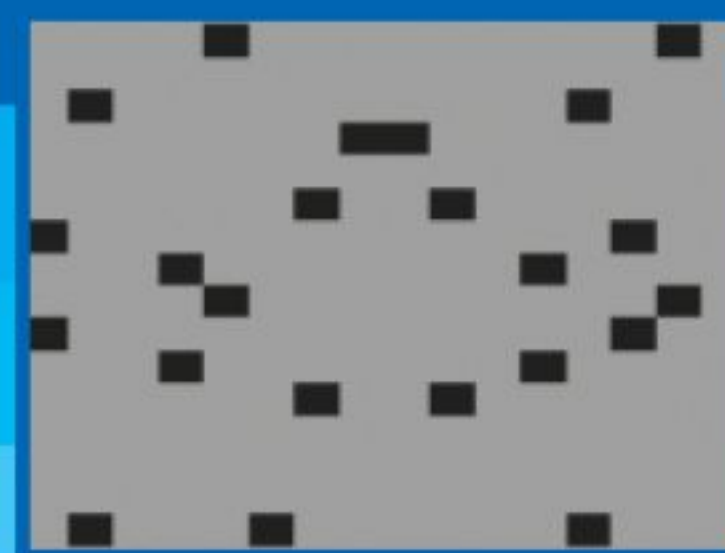

COSMIC HUNTER

■ In this space game you're hunting alien creatures while avoiding barriers, hidden traps, and being captured by said aliens. You only get five hunters and once they're all captured, your game is over. By the same token, you get to capture as many aliens as your hunting heart desires. A fun little game combining shooter and strategy mechanics. *Cosmic Hunter* is notable for providing the earliest instance of a D-pad (directional pad) in a game, a control Gunpei Yokoi used to great effect on Nintendo's Game & Watch games starting in 1982.



ALIEN RAIDERS

■ A *Space Invaders* clone, it's just different enough to avoid any legal issues. Horizontally orientated, 'aliens' race across the screen from right to left and try to reach your side of the screen. They don't fire, they just try to get at you before you can shoot them. With gameplay that's more of a cross between *Space Invaders* and Midway's then recently released arcade game *Space Zap*, your only recourse is to fire at them from one of three pre-ordained spots with a variable-length laser beam (whose length is decided by the system's spinner).



STAR TREK: PHASER STRIKE

■ The only licensed game on the Microvision, it was developed as a tie-in to the then new *Star Trek: The Motion Picture*. By the time of its European release, however, the Star Trek licence was dropped and the game was renamed *Phaser Strike*. The premise is what you'd expect for a *Star Trek* game: shoot Klingons. It plays a lot like Atari's *Missile Command* meets Midway's *Sea Wolf*. As the Klingons fly horizontally across the screen, you get to shoot at them from any one of three phaser banks.

advantage of being able to play different games on the unit outweighed that fact for parents. Likewise, the appearance of the Microvision disproved the statement by Dick Dalessio, Parker Brothers' director of product planning, who revealed in the December 1979 issue of *Popular Science* that: "The electronics are basically the same as last year, but the programming makes them entirely new." Although that was certainly true in relation to the expected updates to already popular Football and Basketball games by Mattel and Coleco, and the onslaught of Simon competitors.

The Microvision was a big success that first year, and according to some reports earned \$8 million in revenue. Over the next two years the library expanded to include *Mindbuster*, *Baseball*, *Seal Duel*, *Alien Raiders*, *Cosmic Hunters* and the licensed *Star Trek: Phaser Strike*. However, beyond that initial year the sales continued to steadily decline. Thanks to the runaway success of Atari's release of *Space Invaders* for its VCS console, the problem was that actual videogame consoles were fast becoming king again in 1980. The entire handheld electronic game market started dropping drastically and was relegated to a

|| A compact hand holdable electrical toy game assembly ||

The Microvision's US patent description

cheap portable gaming accessory for much of the 1980s until Nintendo released the first actual handheld console in 1989, its monochrome LCD-driven Game Boy (followed shortly after by Atari Corp's full-colour LCD Lynx handheld console). Milton Bradley stopped manufacturing the Microvision in the US in 1981 and dropped it in Europe in 1982.

Jay Smith had actually proposed two updates to the Microvision – one with a larger display and another with a colour LCD – but Milton Bradley declined, feeling the format had run its course. Not one to rest on his laurels, Jay Smith did move on to create an LCD game watch for manufacturer GCE and then the equally innovative vector gaming console the Vectrex. Milton Bradley wound up picking up the latter for European distribution, and Smith even looked at doing a portable version of the Vectrex in the late Eighties that never panned out.

Microvisions are actually extremely collectable items today, not as much for their uniqueness but for the

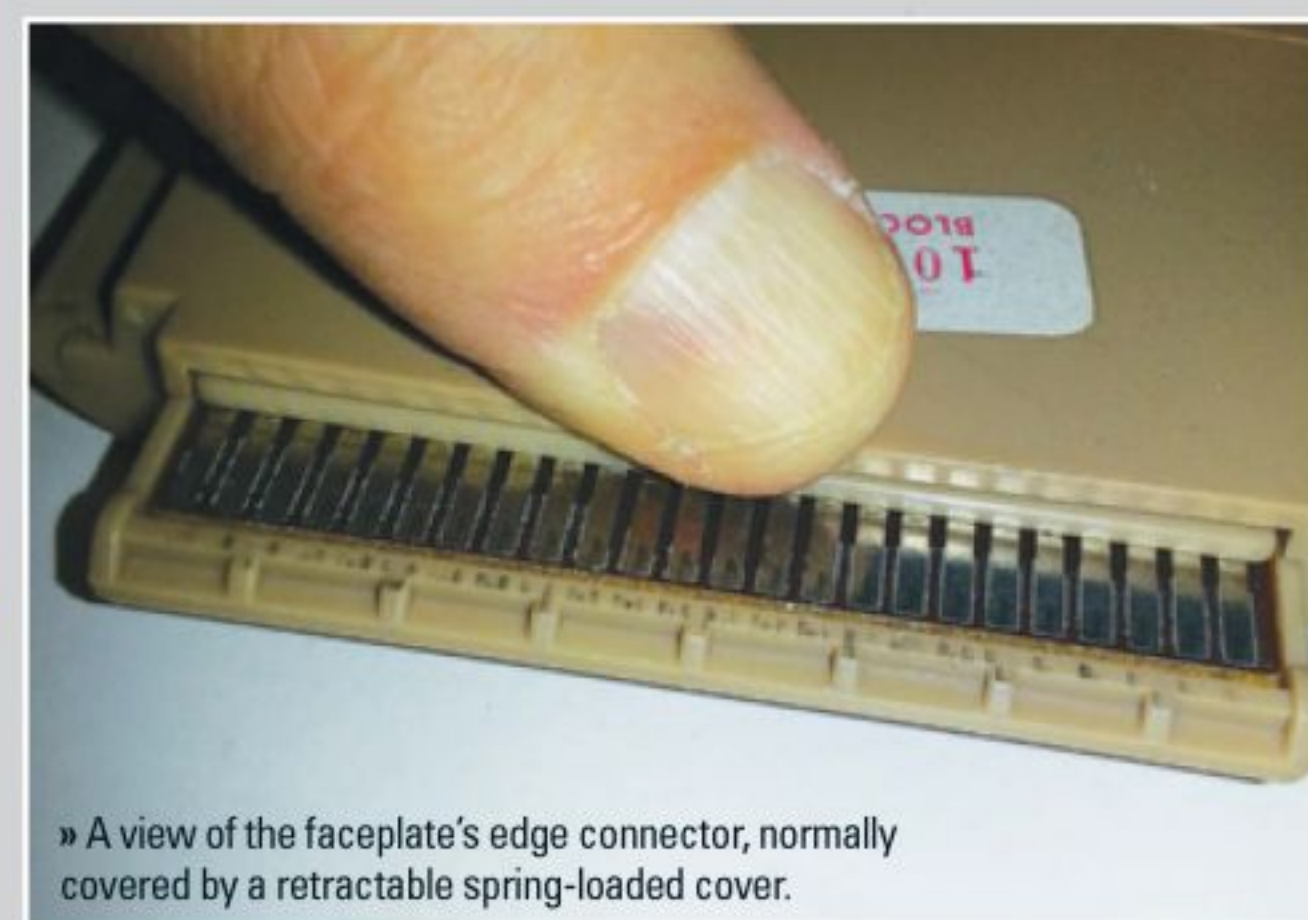

» A view of the faceplate's edge connector, normally covered by a retractable spring-loaded cover.

rarity of working models. Because of the 'primitive' manufacturing methods behind the groundbreaking LCD display, they are highly susceptible to temperature changes. The chemicals in the display are also prone to leakage, a condition known as 'screen rot' that eventually destroys the display.

Milton Bradley released a European version as well (which came with its own vinyl slip-on cover), along with European versions of the US games plus one exclusive: *Super Block Buster*. The Microvision might not have been the huge enduring success that Milton Bradley was hoping for, but it remains an important footnote in gaming's rich history.

Special thanks to Scott Schreiber, Benj Edwards and Dan Boris



INSIDE THE FACEPLATE/ CARTRIDGE

Each faceplate actually houses the main electronics of the unit and plugs in like a cartridge

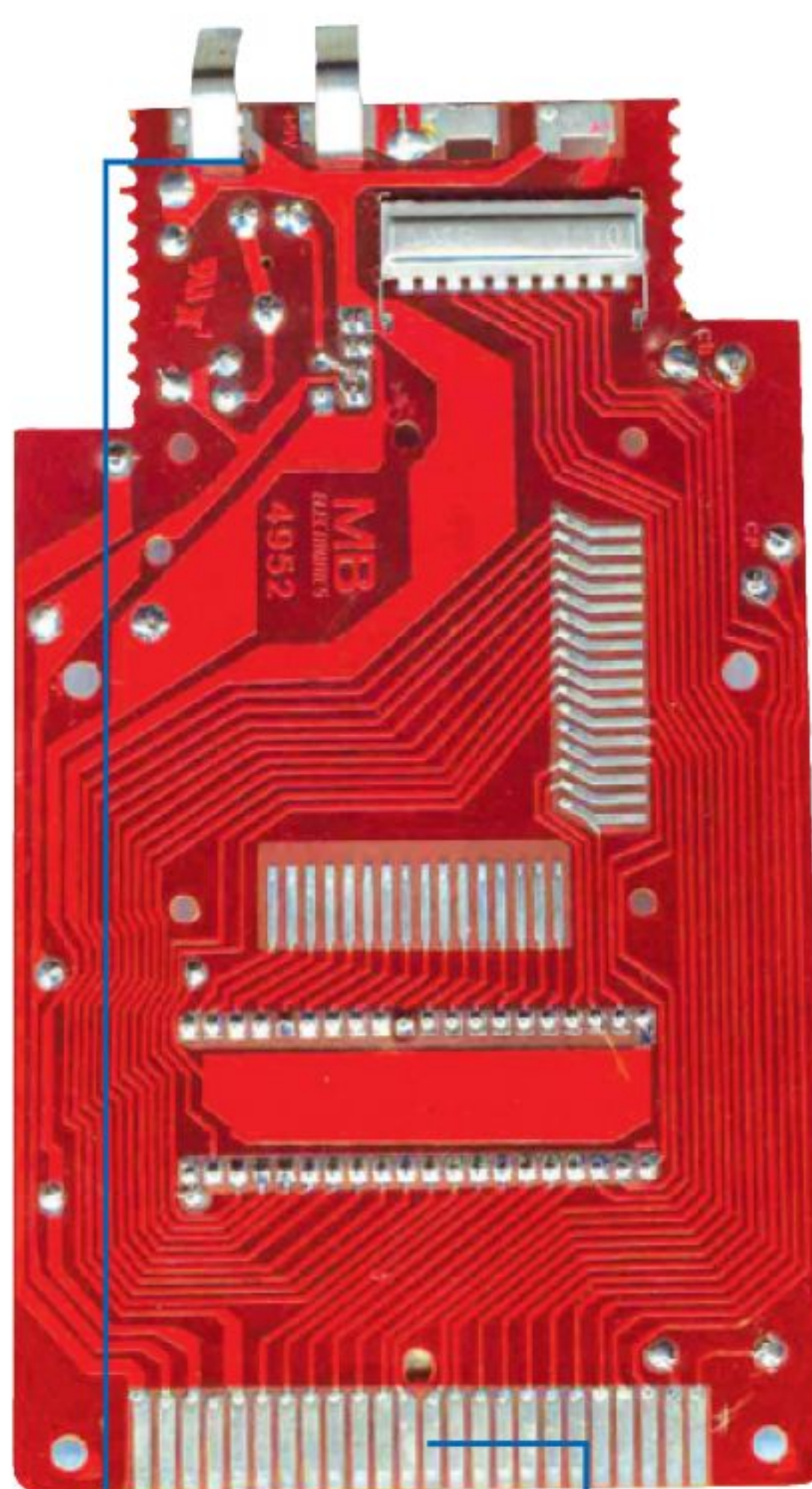

BATTERY CONNECTOR

■ These leaf terminals connect to the battery leaf terminals in the main unit when the faceplate is plugged in, providing power to the microcontroller.

SYSTEM BUS CONNECTOR

■ The part of the faceplate that plugs into the main unit, these edge connectors provide the microcontroller with access to the controls and display.

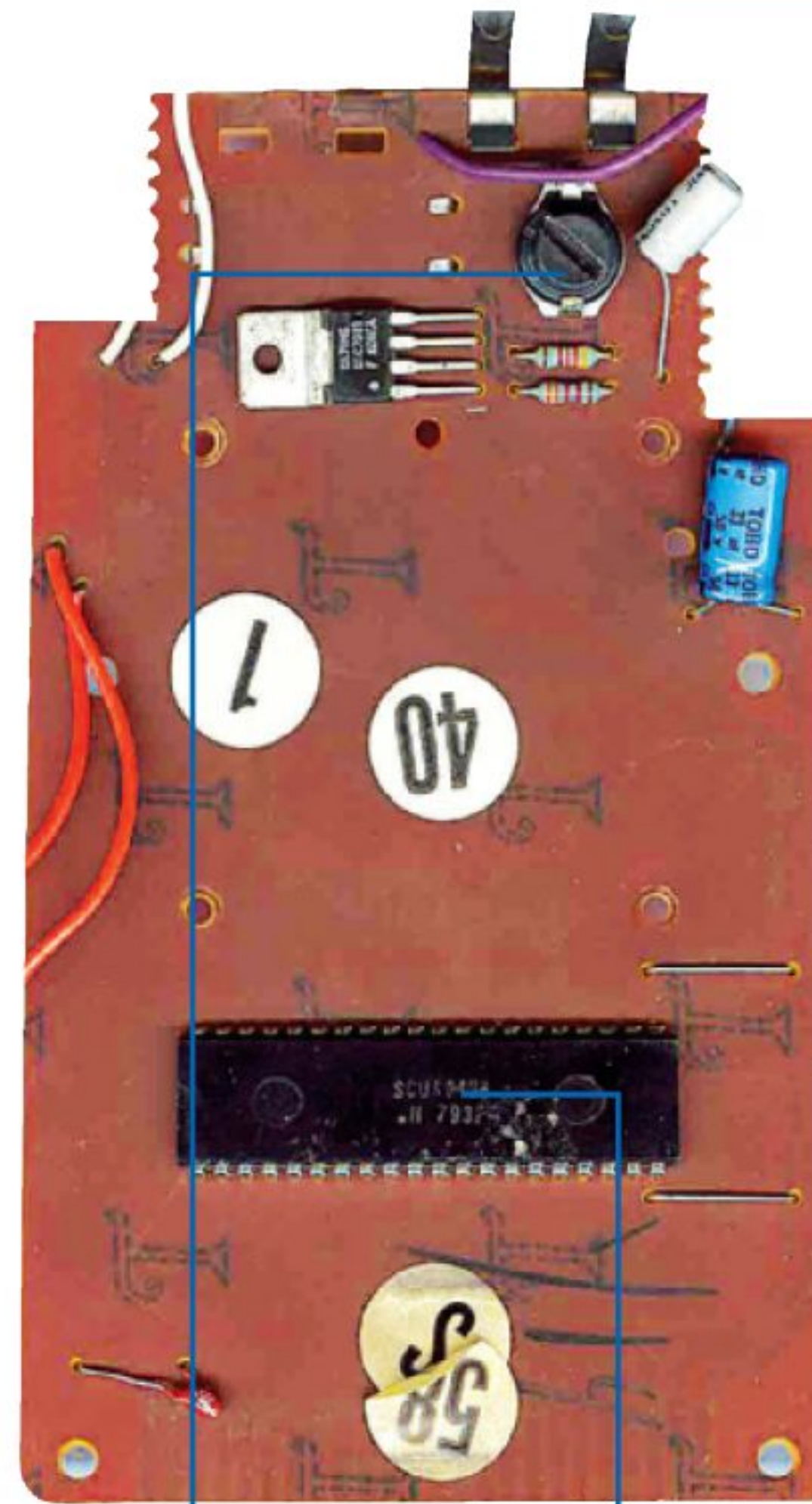

CONTRAST KNOB

■ Being able to change the brightness of your screen when there's no available backlight is always handy. Needless to say, you'd often be fiddling with this quite a lot while playing.

GAME CODE

■ The all-in-one microcontroller that includes the game ROM code as well. Originally based on the Intel 8021 and later replaced with the TMS1100.



FINARU FURANTIER

Finaru Furantier

Shrouded in a complex language and ocean of hentai, Japan's retro computer games have been overlooked by the West. We dig deep and explores this final frontier

There is nothing new in retro games any more. There is nothing left to discover. Well, maybe there are a few things, as Stuart Campbell proved with his Tetris article in issue 64. But thanks to the internet, nearly any game of any age can be downloaded and emulated, almost every piece of information documented...

Except perhaps the world of Japanese home computers, arguably the last uncharted frontier for English-speaking retro enthusiasts. During the Eighties and Nineties, while the rest of the world went with Apple, Atari, Commodore and IBM for its computers, Japan isolated itself and adopted non-compatible, domestically produced ranges. This was partly due to difficulties with converting Western computers to handle the Japanese language, and it resulted in an evolutionary bubble with some amazing hardware and games, very few of which left Japan.

Ignoring systems that saw a Western release, such as the MSX, conservative estimates put the number of officially released Japanese computer games at

well beyond five thousand. If you want to play them, however, you'll have to work at it as they're not easy to find. And those you do find are hidden under incomprehensible text and alongside 'eroge' (erotic games, or hentai).

Searching the internet with Romanised titles often turns up nothing, while using the original kanji names will only bring up Japanese websites, which Babelfish renders gibberish. Even downloading complete file archives, which are always missing titles due to a lack of definitive listings, will often present you with folders in kanji and kana (assuming your computer can even display them), making finding a good game a case of trial and error.

But nothing compares to discovering that Holy Grail: hearing music and seeing sights few others have, and clicking in that Saturn USB pad for some of the best gaming of your life.

A forgotten era

We're focusing on three hardware manufacturers in terms of personal computers that saw interesting games: NEC, Sharp and Fujitsu. Each developed

their own unique and non-compatible range of 8-bit micros and then more powerful follow-ups. Like the diversity found with IBM and Macintosh computers, counting the variants is pointless after they top 50 different models.

Along with these three manufacturers was the MSX standard and its seemingly infinite variations, including models by primarily mainframe developers Hitachi and Toshiba, and a strange selection of failures from the early-Eighties: Tomy's Pyuta range (or Tomy/Grandstand Tutor in the West), Casio's PV2000, and Sord's M5 computer range (one of which saw a European release). Plus others too poorly documented – even in Japan – to mention.

Japan's 18-year-long computer bubble is difficult to summarise due to poor documentation, excessive hardware variations, and an abundance of doujinsoft (hobbyist games). Videogame publishing in particular between 1979 and 1985 was chaotic, and some argue that all games prior to 1985 were doujinsoft.

Many publishing companies in the early days were simply computer shops with guys programming games in the back – often just as a hobby – and then selling them out front. Nihon Falcom started in 1981 selling Apple computers, before shifting focus to developing and publishing games, while Koei started as a single guy, Kou Shibusawa (aka Yoichi Erikawa), mailing out his home-programmed tapes to whoever ordered them. Japan had parallels with England's early computer scene, in that if you could program and had a good idea you could find success. Enix, which always had a good nose for finding them, held a contest enticing hopeful bedroom coders. So did ASCII.

The mid-Eighties saw the first big shift. Game Arts' *Thexder* was released in 1985 and became the benchmark for commercial quality, and the following year brought a big upgrade for the PC98. Subsequent years saw increasingly

“Publishing companies in the early days were computer shops with guys programming games in the back”



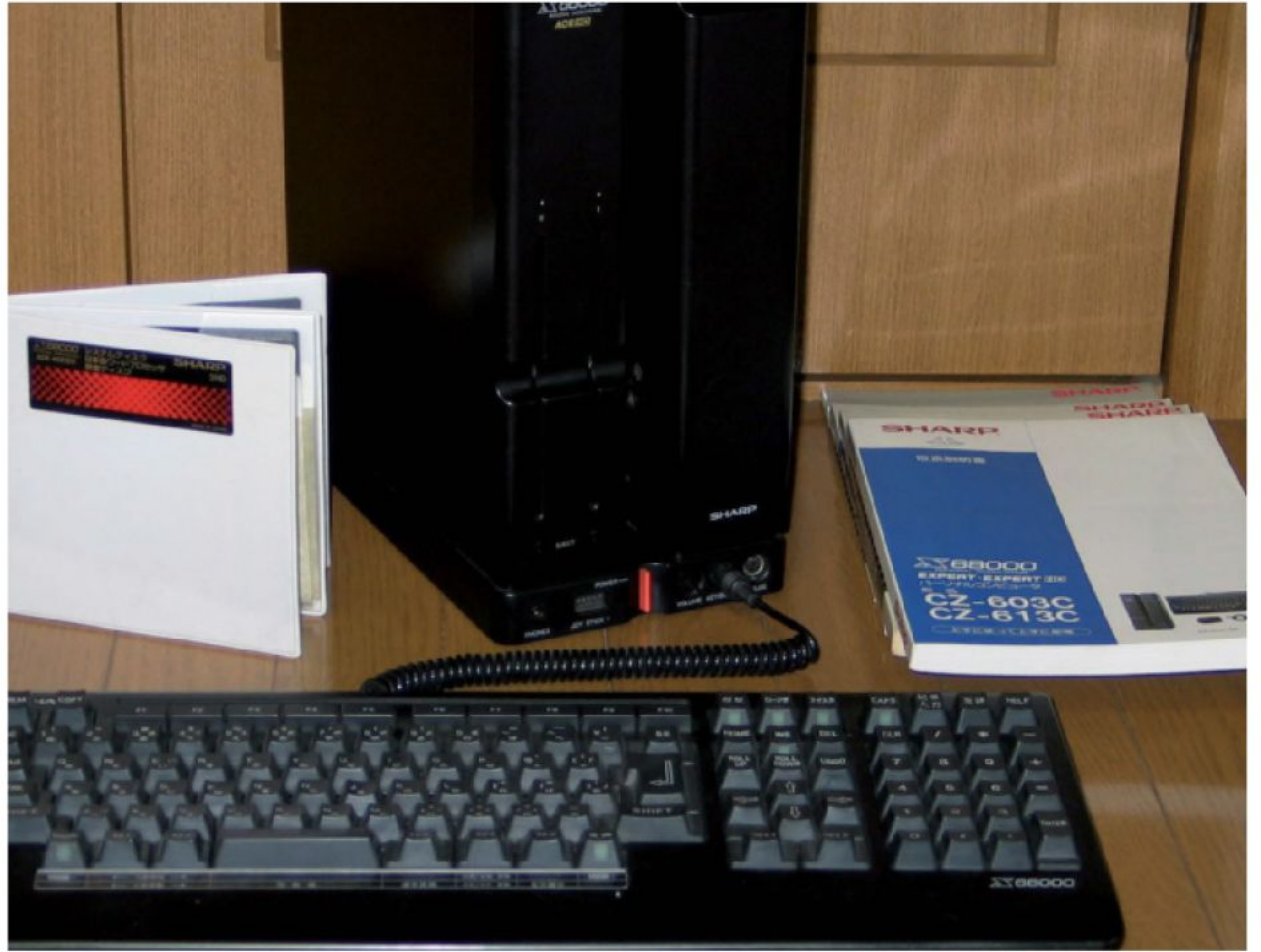

» For a computer that ended up gaining Fujitsu second place in Japan's market, the FM Towns has a lot of Western-developed games on it.





Five machines to discover

While there were many more diverging lines of hardware, with countless upgraded variations the following five 'brands' have some of the more interesting games

NEC PC88

Launched: 1981
Emulators: PC88Win, M88

The successor to NEC's PC8001 (1979) and follow-up PC6001, the PC88 saw several upgrades and became Japan's number one 8-bit computer, helping NEC to become the dominant force for nearly two decades, often holding over half of the market share. Although there is a lot of eroge, the PC88 also has hundreds of clean, fun games found nowhere else. Plus several conversions of Nintendo games by Hudson.



NEC PC98

Launched: 1982
Emulators: Neko Project 2, Anex

Japan's first 16-bit computer to support native scripts, PC98 was cloned by Seiko Epson, cementing NEC's control. Initially there was overlap between PC88 and PC98 software, but major updates meant that from 1986 there was a jump in quality. Final models incorporated a version of Windows, making them the best to import. For an article on buying one visit <http://fullmotionvideo.free.fr>.



Sharp X1

Launched: 1982
Emulators: Xmillennium

Sharp first competed against NEC with its MZ computer range, and later with its X1 range (based on the MZ2000). Though unsuccessful against the PC88, the X1 was generally a better gaming machine. Often when a game appeared on both, like the original *Thunder Force*, the X1 version was superior. Collectors should look out for the X1 Twin (pictured), which came with an integrated PC-Engine to play Hu-Cards.

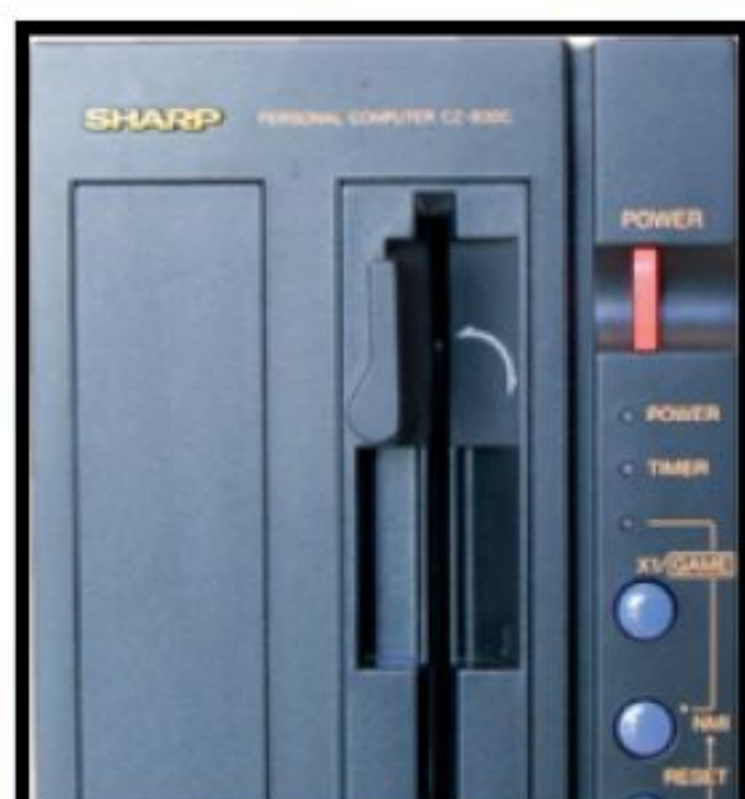

Sharp X68000

Launched: 1987
Emulators: WinX68k, XM6

In 1987 Sharp released the powerful X68000, best known in the West for its arcade ports and *Castlevania* spin-off. Although it didn't usurp NEC, the X68000 saw many awesome exclusives now overlooked by Westerners too focused on its arcade ports. Ignore these as there are dozens of games you won't find anywhere else. Be warned, emulators struggle to output at the X68000's native resolution.



Fujitsu FM Towns

Launched: 1989
Emulators: Unz

Fujitsu carved an 8-bit niche with its FM range of computers. In 1989 it followed up with the multimedia-capable FM Towns. By 1991 Fujitsu had 8.2% market share, just under Seiko Epson. By 1995 this had doubled, giving Fujitsu second place to NEC. The Towns is weird – many games, some exclusive, are Western-developed by the likes of Psygnosis, Infogrames and LucasArts. Original CDs will run in any PC under Unz.



“ For Bare Knuckle I used the PC88 and an original programming language I developed myself ”

powerful hardware launched by rival companies. Convergence with the West started in the early-Nineties, with manufacturers opting for Windows-compatible hardware that could handle Japanese scripts, and by 1996 the glorious era was over.

Lost origins

More of Japan's gaming history – and in turn today's market – has its roots in home computers, as opposed to Nintendo's Famicom, than many realise. For all that Nintendo started, it was the open hardware of NEC and other companies that allowed small groups to form and become giants.

The RPG tripod of Square, Enix and Falcom all started out on old computers. Square produced quite a few RPGs with very unusual battle systems for the PC88. Like *Cruise Chaser Blassty*, featuring a customisable first-person mecha, and *Genesis*, a *Mad Max*-style RPG. Enix, meanwhile, openly made adult-only titles. In fact, a lot of currently big companies like Koei once dabbled in pornographic games. They were young, they needed the money.

Falcom kept its nose clean and, shifting away from selling computers, created some of the best games in Japan, such as *Popful Mail* and *Sorcerian*, which made it Stateside. While it's true that the Japanese computer scene was mostly an isolated bubble, there was some minor cross-over. Examples include *Laser Squad*, the *Ultima* series and several LucasArts adventures reaching Japan, while Sierra ported Japanese games, such as *Silphed* and Falcom's *Sorcerian*, over to DOS.

Cing, the company behind *Hotel Dusk*, was formed from ex-Riverhill Soft employees who started out developing such adventures as the JB Harold murder detective series. Some were ported to consoles and released in English, including a couple of obscure Laserdisc releases.

Bangai-O's creation is also attributable to Japanese micros, as Yaiman of Treasure told Sega: “*Bangai-O* started off as a

remake of an X1 game called ‘*****’, but then I started to mix in anime influences from *Macross* and *Layzner*, and pretty soon it didn't resemble the original, so its being a remake became 120 per cent a bluff/lie. I think the president also liked it, since it was just before the industry turned cold.” While Sega's reporter purposely blanked out the name, the fan community searched the X1 archives until they discovered *Hover Attack*, also released on PC88, which, as the screenshots prove, is indeed similar.

Yuji Horii, best known for *Dragon Quest*, started programming on a PC6001, learning BASIC and then altering the code in commercial games. He went on to create one of Japan's earliest and much loved graphic adventures in 1983, *Portopia*, which has been fan-translated. Capturing Japan's imagination, countless other adventures went on to be made.

Koichi Nakamura, who went on to program *Dragon Quest*, achieved his first success with *Door-Door* in Enix's game-design competition, later forming his own studio, Chunsoft, when he was just 19.

Yuji Naka's introduction to computers was a Sharp MZ80, and at the start of the Eighties he bought his own PC8001, typing in games listings from magazines and improving his coding by finding and correcting the misprints. Several of his favourite games were arcade ports submitted by Koichi Nakamura.

Interestingly, systems such as the PC6001 are even where Fred Ford, of *Star Control 2* fame, started out. As he explains: “I was attending UC Berkeley and, responsible for paying my way, I answered a ‘help wanted’ ad for local software company Unison World. First I worked on some sort of Japanese monochrome handheld with a screen about one inch by four inches. I did a bowling game, a first-person biplane game, and a find-the-other-tank game. After that I moved onto the NEC, Fujitsu, and MSX. Some of the games I did for those systems were *Pillbox*, *Sea Bomber*, *Ground Support*,



» [X68000] Thumping rock soundtrack, sumptuous graphics, multiple crazy weapons and *Bionic Commando*-style swinging.



» [PC88] WiBArm has you roaming 3D worlds, fighting aliens in 2D and transforming from a mecha into a tank and flying jet.

Five games to discover

There were so many fantastic games we've had to narrow it down to the most interesting titles exclusive to each system

Battle Gorilla

Format: NEC PC88
Year: 1988
By: Xtalsoft

Of all the games listed, this is the most difficult to learn. It's also the most rewarding. Imagine a roguelike-styled, tactical version of *Commando* where bullets and enemies only move when you do. Using Numkeys, Space and Esc at the menu: 1) choose map, 2) stats, 3) free mode, 4) buy weapons, 5) check weapons, 6) start. During the game, Space accesses the inventory and Shift shoots.



Night Slave

Format: NEC PC98
Year: 1996
By: Melody

An action-packed *Assault Suits Valken* clone crossed with the weapons system of *Gradius* plus (optional) scenes of lesbian bondage. Although not the smoothest game, *Night Slave's* diversity makes it shine, as your mecha rampages through rainy jungles, snowy wastes and alien bases. The armaments system also has you levelling up your main- and sub-weapons in an RPG-like fashion using power-orbs.

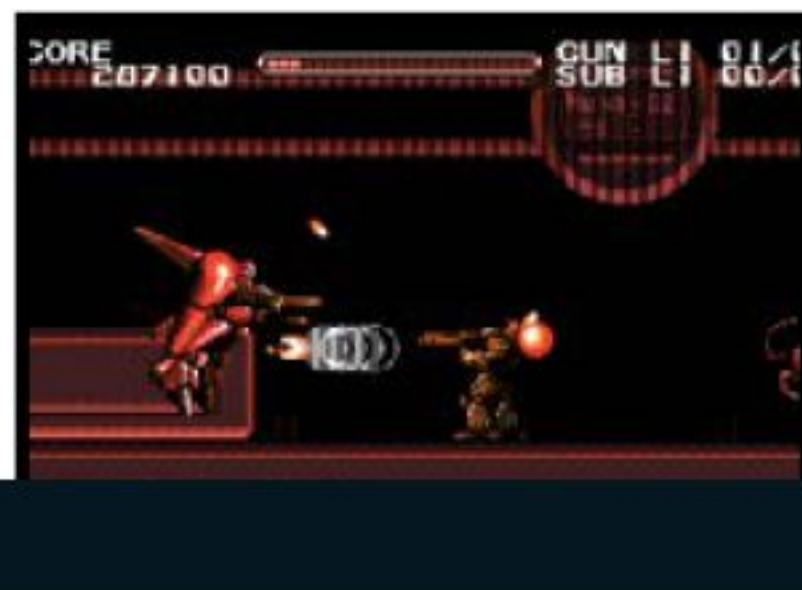

Kagirinaki Tatakai

Format: Sharp X1
Year: 1983
By: H Ishikawa (Enix)

With its non-mirrored, separately drawn sprites for the walking animations, a range of enemies, fully destructible environments and convincing physics, this is a forgotten gem. While carrying three weapons or more has been done by most games since (except *Halo*), and plenty feature destructible environments (except *Halo*), this was released in 1983 on cassette tape. Still, miles better than *Halo*.



Die Bahnwelt

Format: X68000
Year: 1992 (now freeware)
By: Glodia

Despite predating it by a year, *Die Bahnwelt* feels like a Japanese version of *Chaos Engine* because of its anime cut-scenes, bizarre plot, and sidekicks with good AI who you can order to adopt various tactics such as conserve ammo, cover me, and so on. As you wander the ruins, you can collect weapons that can be changed in real time, find items and maps, unlock doors and stockpile ammo.

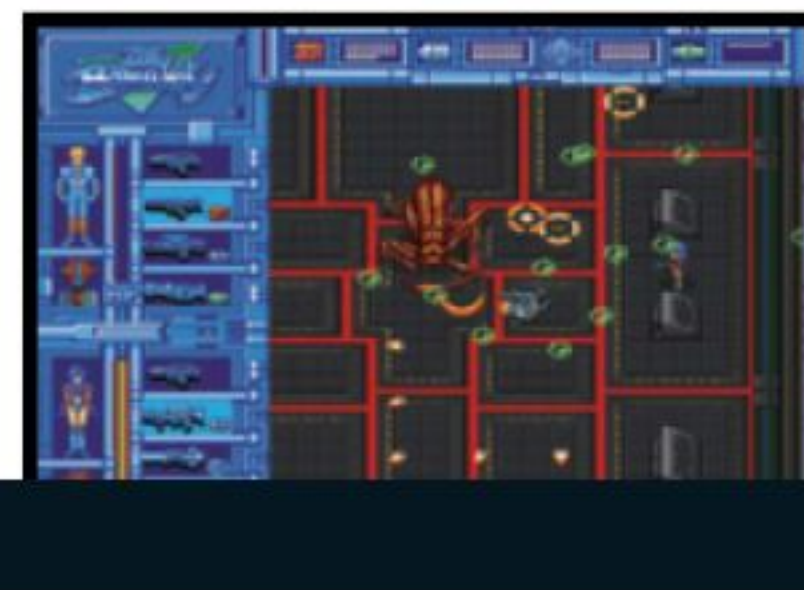

Tatsujin-Oh

Format: FM Towns
Year: 1993
By: Toaplan

We were tempted to go for *Wrestle Angels* for some girl-on-girl fun, a shmup seemed more appropriate (and *Rayxanber* sadly isn't as good). Also known as *Truxton II*, this was the only home version of Toaplan's frenetic arcade shooter, ported by Ving. With relentless waves of enemies, this was dangerously intense. A simple power-up system and super bombs keep everything intuitive despite the high difficulty.

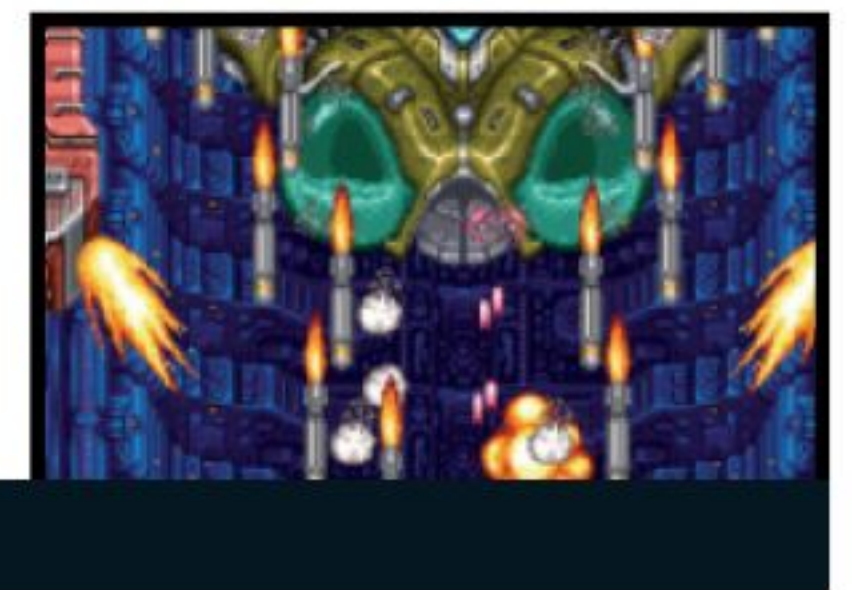

and some submarine game. During this time one of the two owners of Unison World split off to form Magicsoft [taking all employees with him]. I was working on a game for the MSX – I still have the eight-inch floppy – when Magicsoft ran out of money. Perhaps the most memorable thing of my time there was the hookers who would primp in front of the large, mirrored window that fronted our office on Adeline Street in Berkeley. Some things you can't forget even if you want to."

Yuzo Koshiro's early work was also on computers (lesser-known stuff includes music for *Misty Blue* and *Metroid*-inspired *The Scheme* on PC88), and after moving to consoles he continued to use older hardware. In an interview with Kikizo he explained: "For *Bare Knuckle I* used the PC88 and an original programming language I developed myself. The original was called MML, Music Macro Language. It's based on NEC's BASIC program, but I modified it heavily. It was more a BASIC-style language at first, but I modified it to be something more like Assembly. I called it 'Music Love'. I used it for all the *Bare Knuckle* games."

Hidden threads

With all of the above proving the importance of Japanese computers, it has to be asked: why aren't they archived online like, say, the Spectrum? Well, they are, except the Japanese tend to embed floppy and tape games inside JPG images, to deceive automated servers that would otherwise delete ZIP and RAR files.

The main English source for anything to do with Japanese computers is the Tokugawa forums, which we visited for information. Another reason for the lack



» [PC88] Flying mechas, maze-like levels, and missiles shooting everywhere – *Hover Attack* was the inspiration for Treasure's *Bangai-O*.



» *Technopolis* was a slightly naughty magazine that covered a variety of Japanese computers back in the day.

of downloads, as one insider reluctantly revealed, is that about a decade ago, prior to Tokugawa's formation, there had been collaboration between East and West to dump and share Japan's retro computer games. Except the games ended up being sold online by one of the Western members... Apparently, Japan has yet to forgive this treason.

Tokugawa's founder, Ben, reveals some other difficulties of the scene: "You have to know how to run a DOS game using Japanese DOS; how to install a Japanese game on a virtual HDD from several floppies; run a game in basic mode, since sometimes that game was originally a tape; and the list goes on. TOSEC tried to establish a data-set for several Japanese retro computers, but for some games, because the save file on disk 12 was changed by two bytes, we ended up with another set for the whole game. There is a variety of dump formats for almost all machines, over ten for PC98, and emulators don't come with English directions."

Tokugawa's resident PC88 expert, Danjuro, also spoke about the difficulties in dumping games, explaining that you need a five-and-a-quarter-inch Amiga drive to read the floppies correctly – many also need to be cracked afterwards.

Other members answered questions, and all shared software freely, but there's a sadness visiting Tokugawa forums. All the hard work that goes into collecting over five thousand scanned covers and manuals, and dumping, renaming and organising thousands of games, falls to the callous whims of imageshack and rapishare. The vast databank of knowledge accumulated over hundreds of forum pages, is at risk of a Home of the Underdogs-style disappearance. Were it not for the hard work of these few fans, there'd be little online in English regarding the history of Japanese computers and the games that you'll find nowhere else.





SPECTRUM 128

SPECTRUM 128

“THE MARKET WANTED MORE MEMORY AND BETTER SOUND IN ORDER TO HELP PRODUCE MORE ENGAGING GAMES, AND THAT WAS DONE IN THE MOST MECHANICAL WAY POSSIBLE”

RUPERT GOODWINS, SINCLAIR RESEARCH



Year released: September 1985 (Spain), February 1986 (UK)

Buy it now for: £50 (£179 at launch)

Specifications: Processor: Zilog Z80A CPU; Speed: 3.54MHz; RAM: 128K; ROM: 32K; Display: 256x192 pixels, 32x24 characters; Colours: 15 in total (eight basic plus seven 'bright' colours); Sound: AY-3-8912 chip outputting three channel sound

Why the Spectrum 128 was great... It was the machine that the Spectrum Plus should have been. Extra memory allowed for bigger and better games, and the AY chip made everything sound sweeter. It also holds the distinction of being the last 'proper' Speccy before Amstrad muscled in.

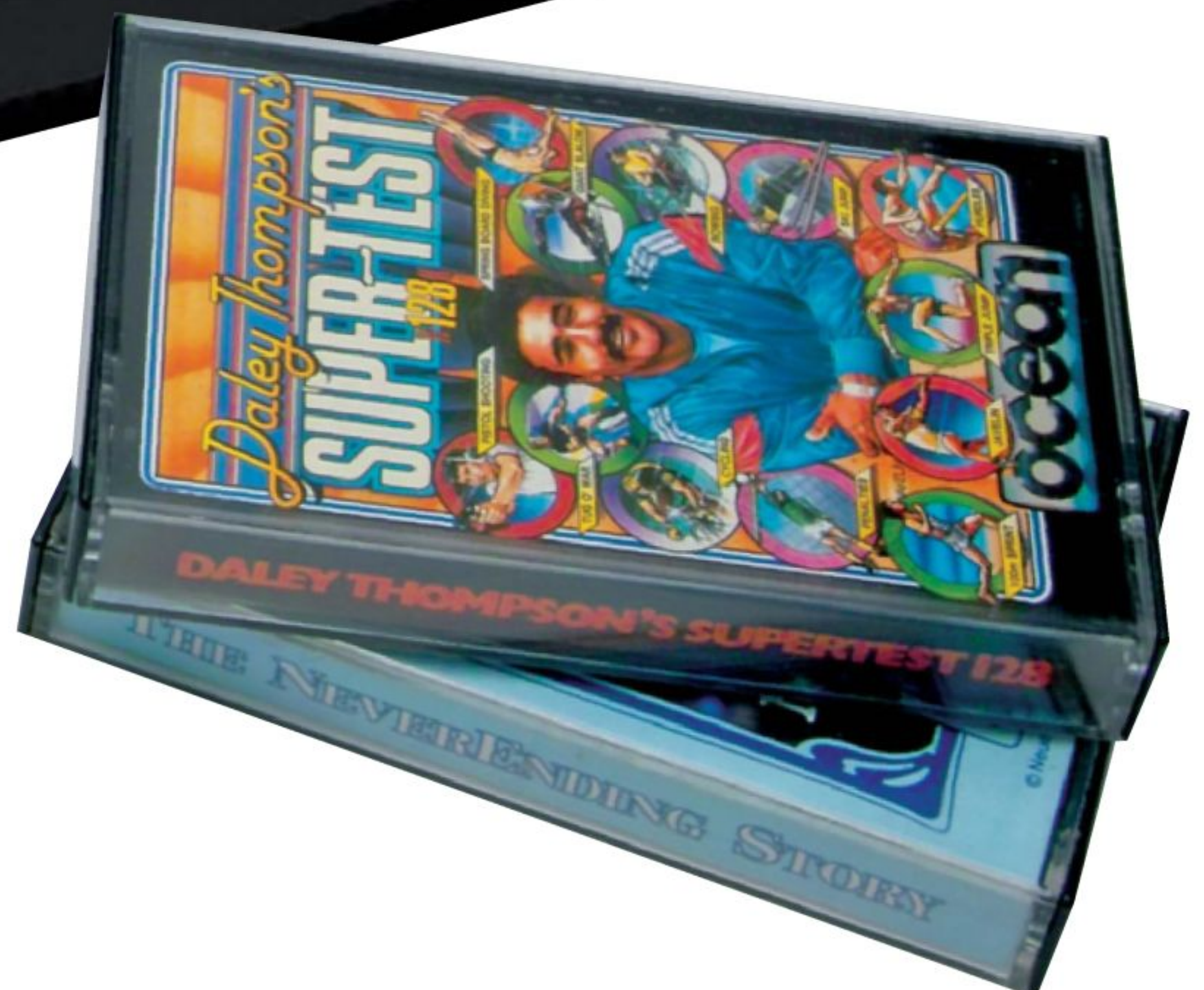

THE ZX80, ZX81 AND ZX SPECTRUM FOLLOWED IN QUICK SUCCESSION, BUT SINCLAIR BUMBLED AND STUMBLERD WHEN IT CAME TO EXTENDING THE ZX LINE, EVENTUALLY RELEASING THE SPECTRUM 128 IN 1985 AMID FEARS THAT THE COMPANY WAS FACING FINANCIAL RUIN. WE LOOK BACK AT THE COMPUTER THAT NEARLY NEVER HAPPENED

Back in the mid-Eighties, alliteration-loving journos used the term *Super Spectrum* to describe every new computer that Sinclair Research was rumoured to be working on. First to receive the honour was the LC-3 (Low Cost Colour Computer), but this was more of a colour ZX81 than anything else. Then there was Pandora, a portable Spectrum with a flat-screen monitor, and Loki, a Z80-based computer that would go toe to toe with the ST and Amiga. There was also a project predating Loki that was being developed with the codename 'Super Spectrum'. Sadly, none of these computers made the perilous leap from development to production and very few firm details exist.

"Sinclair was a rather secretive place," says Rupert Goodwins, who worked at the company as a programmer and helped develop the Spectrum 128's system software. "There were always projects on the go or in suspended animation, and ideas from abandoned projects often got revived in some form. Most of this stuff, if it existed at all, only got as far as breadboard prototypes. The decision to develop it properly, which would have meant serious money on integrated circuit design and system software, was never taken."

Money was not something Sinclair had a great deal of at the time. The QL, Sir Clive's great obelisk of hope, failed to wow the business machine market when launched in early 1984. It was an expensive failure and one that would have an impact on all future projects. Even so, punters and the press were surprised when, after all the speculation involving secretive new products, Sinclair could only muster up the Spectrum Plus. The Plus was just a standard Spectrum stuffed into a new case with a moving QL-style keyboard replacing the old rubber membrane. The hardware was unchanged, making it more Spectrum 1.1 than 2.0. The upgrade wasn't even launched as such – it just crept on to disgruntled retailers' shelves in October 1984.

This play-it-safe approach had nothing to do with the QL shambles, however. In fact, the focus shifted back to the Spectrum *because* the QL failed. "Clive always felt that games computers were a bit beneath the dignity of the company," reveals Rupert. "The Spectrum was seen as yesterday's computer and he wanted to stride ahead with wafer-scale integration, business machines and AI. There was a lot of snobbery involved. But when the QL misfired, more attention was paid to working out what had been a success and seeing how it could be best developed. Bright, shiny, noisy and cheap suddenly became desirable attributes."

"But then we hit other problems with Sinclair – a near-inability to get products out, lots of infighting and, in the latter days, all the money going away. I mean, we couldn't even get any memory expansion packs or disk interfaces out of the door – stuff that one-man bands were pushing out of sheds all the way from Penzance to Prestonpans."

For a while, it looked like a proper Spectrum successor might never happen, but then the solution – to the lack of money problem, at least – arrived from overseas. The Spectrum was performing

really well in Spain, where it was distributed by Madrid-based firm Investronica. Charles Cotton, Sinclair's sales and marketing director, claimed that the machine accounted for more than half of all home computers sold in the territory at the time. While the Spanish market was smaller and less developed than the UK's, the results were good enough to convince Investronica to invest in the development of a new machine. With fresh impetus and much-needed funds in place, Sinclair and Investronica worked to develop an upgrade that exploited the Spectrum's popularity as a gaming machine.

"The market wanted more memory and better sound in order to help produce more engaging games," says Rupert. "And that was done in the most mechanical way possible... take a standard sound chip, gate in some more RAM, futz around with the system software and get it out as soon as possible." The result of all this futzing around was the Spectrum 128.

The 128 may have been a quick and dirty upgrade but it did address most of the Spectrum's shortcomings. Perhaps the biggest criticism levelled at the original machine was its weedy sound capabilities. Rather than a dedicated sound chip, the Spectrum featured a small CPU-controlled speaker capable of playing a single note at a time. It was known as the 'beeper' because that's effectively what it did. For the 128, Sinclair replaced the beeper with the three-channel AY-3-8912 chip. Unlike the beeper, sound could be channelled through a TV without additional hardware, so you could finally pump up the volume, and sound output no longer impacted on the CPU, allowing for proper in-game music.

Next on the additions list was more memory. When the Spectrum launched in 1982, 48K was seen as a generous amount, but as we now know, you can never ever have enough RAM. When it came to the amount of extra memory, 128K was a given really as Commodore, Amstrad and Atari had already released 128K versions of their 8-bit machines.

The third main addition was 128 BASIC. The updated version introduced a number of new commands (to control the AY chip, for example), but the most obvious change was the overdue retirement of the one-touch keyword entry system. This idiosyncratic input method, where whole commands were entered by pressing one or more keys, was ditched in favour of a standard entry system where you typed out each command in full. An improved full-screen edit function was also added, enabling users to easily amend BASIC listings using the cursor keys.

Updating BASIC proved to be a rather big headache for all those involved. It was absolutely vital that the Spectrum 128 would run the huge library of existing Spectrum software, so the team had to ensure that it was fully compatible with the 48K ROM. They eventually did this by including the complete 48K ROM and allowing the user to switch from 128 to 48 mode on start-up, thereby circumventing the new 128 features that might cause compatibility problems with older software. This workable solution was complicated by the fact that the original BASIC source was broken. "The biggest shock I had when I started work was that the Spectrum source code within Sinclair was in an unusable state,"

INSTANT EXPERT

The 128 was codenamed 'Derby' during development.

The CPU in the 128 runs slightly faster than in the original 48K machine – 3.54MHz as opposed to 3.5MHz.

The extended 128K memory doubles as a RAM disk, allowing for rapid data access.

The AY-3-8912 sound chip had already been used in the Amstrad CPC, Oric-1 and Atari ST, making it a sensible off-the-shelf choice for the 128.

The Spanish 128 didn't show a system menu on start-up – users had to type 'spectrum' at the BASIC prompt to enter 48K mode – but it did feature a built-in text editor that was dropped from the UK release.

Despite claims that the 128 would support all existing Spectrum software, some games would not run, even in 48K mode, due to subtle changes made to the 48K ROM. *Elite* was one high-profile title that was incompatible with the 128.

Fans affectionately refer to the 128 as the 'toast rack' due to the distinctive heat sink bolted to the right side of the machine.

With the 128, Sinclair reluctantly targeted the gaming market. At the UK launch, chief executive Bill Jeffrey said, "We have focused the 128 on the entertainment sector. Recent market research has shown us that entertainment is easily the most common use of computers in the home."

The 128 was compatible with first-party add-ons including the Interface 1, Interface 2 and the ZX Printer.

Ben Cheese, who designed the 128's hardware, used to play saxophone with Eighties Brit funksters Shakatak.



» Rick Dickinson, the award-winning designer of every Sinclair computer going right back to the ZX80.



» Rupert Goodwins, currently technology editor at ZDNet UK, joined Sinclair in early 1985 and helped convert the 48K ROM to the Spectrum 128. However, he's most proud of coding the little Spectrum stripes on the on-screen menus.



SPECTRUM 128

OTHER VERSIONS WHEN ONE MACHINE ISN'T ENOUGH

THE +2 AND +3

Having swallowed up Sinclair Research in 1986, Amstrad spat out a couple of new computers based around the 128 hardware. The +2 was the Spectrum equivalent of a CPC464 with an integrated tape drive, while the +3 added a built-in three-inch floppy drive just like the CPC664. Both machines benefited from a decent keyboard and twin joystick ports. The +2 was later replaced by the +2A, a cost-reduced model that Amstrad continued to manufacture until the early Nineties.



» The Spectrum +2. We can't tell you what Rick Dickinson said about this Amstrad-designed machine for fear of upsetting younger readers.



» Sir Clive of Cambridge, undoubtedly the number one hero of the British people... ever!

says Rupert. "So we – or mostly me, if I remember correctly – had to practically retype it all in from Melbourne House's Complete Spectrum ROM Disassembly."

Much less time was spent on the 128's external appearance. To minimise costs and speed up production, the casing and keyboard was handed down wholesale from the Plus. Rick Dickinson, who designed all of Sinclair's computers, admits that the 128 didn't

"THERE WAS NOTHING PARTICULARLY UNIQUE ABOUT THE 128. IT WAS A QUICK JOB, BUT IT WAS A GOOD PRODUCT. GOOD AND RIGHT FOR THE TIME" RICK DICKINSON, SINCLAIR RESEARCH

require much effort on his part, and it certainly didn't sit well with his somewhat romantic notions of product design and innovation. "From my standpoint it was churn it out and get on with it," he tells us. "The sad thing is that we never designed a second-generation Spectrum where you could see a very clear migration from the original. With the Plus and 128 there was no similarity whatsoever with the Spectrum. They were just like the QL, which became our corporate style, and that was all down to the changes in the decision

making. In the earlier days the decisions were pretty much down to Clive, and then the company grew and there were marketing managers and stock managers and all the rest of it, and the decision making was done from a different perspective."

In this new corporate climate, Rick did at least manage to make his mark in one very noticeable way. Unlike the Plus, the 128 had a whacking great external heat sink running down its right-hand side. Due to the extra components that required power, the 128 generated more heat than the Plus, so Rick took the unusual step of adding cooling fins to the outside of the casing. "The 128 got very hot, and the main heat source was a single component, which was the voltage regulator, so I made a decision to move the voltage regulator off to one side and attach it directly to a heat sink, which was then bolted to the outside of the case. The heat sink was die cast in zinc, which conducts heat well enough, especially when you make it as big as I did! It certainly made it distinctive."



» Talk about a song and dance... The AY chip that generated the exciting new Speccy sound.

FULL SPEC SPECCY

When it came to developing the 128, it's a shame Sinclair didn't take a closer look at what Timex had done with the TS2068, the official Spectrum upgrade released in the US in late 1983. The TS2068 was essentially a 48K Spectrum with some neat extras designed to appeal to the American market. It boasted an AY chip (the same one that ended up in the 128), a ROM cartridge slot, twin joystick ports and additional video modes allowing for higher screen and colour resolutions. However, changes to the way the ROM was organised meant that the TS2068 wasn't compatible with more than 90 per cent of commercial Spectrum software. Maybe if the 128 had spent more time on the drawing board, Sinclair could've worked out a way of incorporating the TS2068's advanced features (particularly the extra video modes), while ensuring that compatibility with existing Spectrum software wasn't affected.



» In many ways the TS2068 was a more progressive machine than the Spectrum 128.

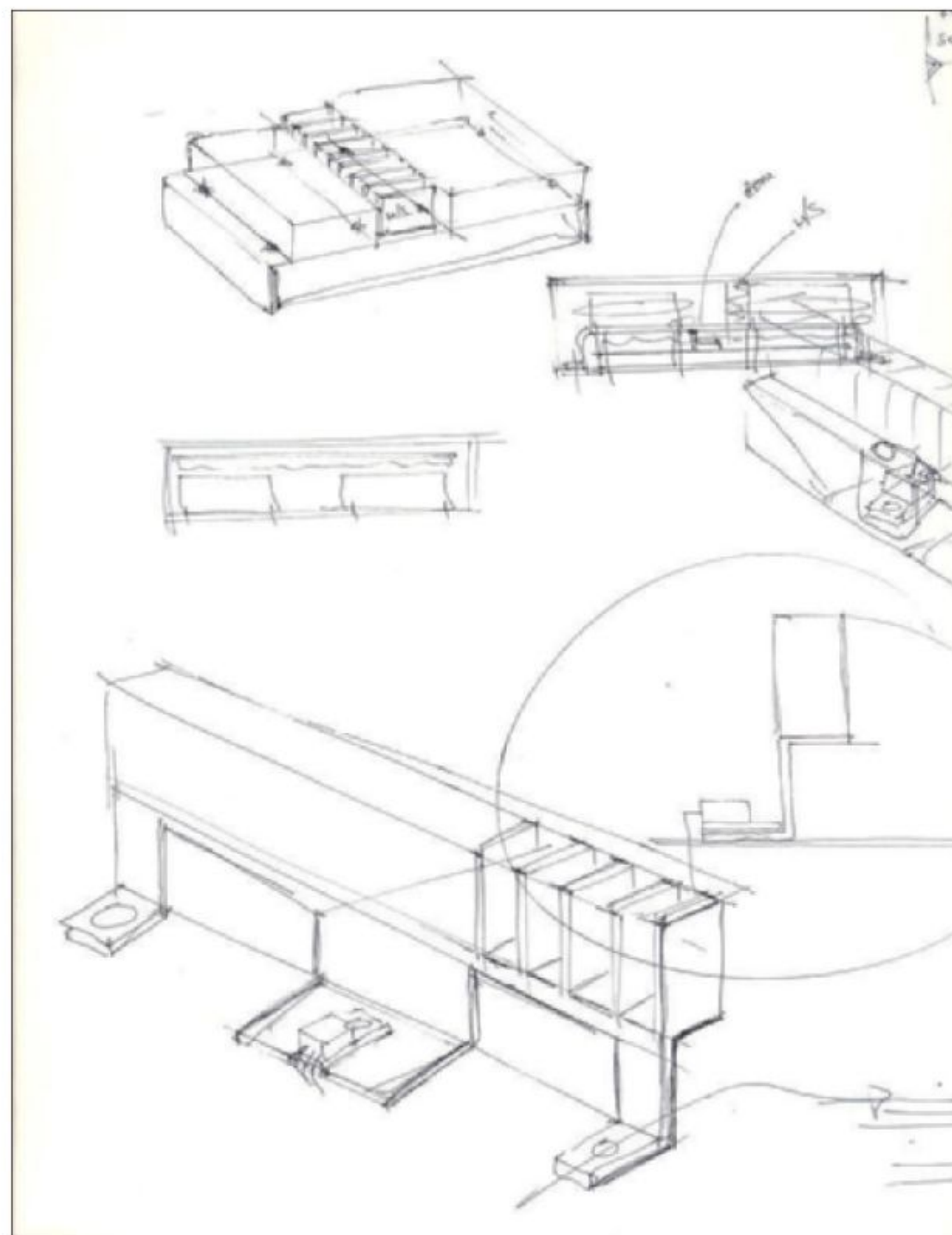

» One of Rick Dickinson's early production sketches, showing where the 128's heat sink would be positioned.

The 128 also received a couple of additional ports: video RGB-out for connecting the computer directly to a monitor, and RS232/MIDI-out for connecting various peripherals. An obvious omission was any kind of joystick interface, which was surprising seeing as the 128 was designed with gaming in mind.

Built-in joystick ports would have been welcome, but surely the most desirable addition on any fan's wish list would have been an end to attribute clash. Due to shortcomings in the Spectrum's display capabilities, only two colours could appear in any 8x8 pixel square, so colours would bleed all over the place. Programmers learnt to stem the flow as best they could, and Speccy owners grew used to the sight of it, but it was surely something that should have been fixed in the 128, even if it meant sacrificing resolution.

The 128 was launched in Spain in September 1985, with it making a belated appearance in the UK in February 1986. The delay was mainly due to an existing deal with Dixons. The high-street chain had paid £10m to secure a huge number of Plus machines and understandably didn't want Sinclair to release a shiny new model prior to the profitable Christmas period.

As the UK launch approached, computer journalists took a closer look at the 128 and the feedback was generally favourable. In *Your Spectrum*, Max Phillips wondered how much people would be



» The 128 system menu. According to Rupert Goodwins, on the 128 development machines the copyright message at the bottom read, "Hip hep snap the boogie". So now you know...

COMMUNITY THE BEST SPECTRUM WEBSITES

World of Spectrum

www.worldofspectrum.org
This site really doesn't need any introduction, so we're not even going to bother. If you haven't visited World of Spectrum before then go there straight away. Do not pass go, do not collect £200 and so on. With information on just about every single piece of Spectrum software that has ever been released, it's quite possibly the finest retro resource on the internet.



Planet Sinclair

www.nvg.ntnu.no/sinclair/
If you're really interested in Sinclair hardware then this site is definitely the right site for you and well worth delving into. The complete range of ZX computers is covered here, of course, and there is also tons and tons of information about Sinclair's other gadgets and gizmos, from the company's earliest radio right up until the infamous C5 electric buggy thingy.



Jonathan Cauldwell

<http://members.fortunecity.com/jonathan6/egghead/>
Homebrew hero Jonathan Cauldwell's website is always worth a visit because you never quite know exactly what you might find. There's likely to be news about his latest projects, possibly a bit of code to play around with and, if you're lucky, maybe even a full game to download for free (like the latest *Egghead* game).



Retrospec

<http://retrospec.sgn.net>
If retro game remakes make you grin from ear to ear then you have to stop by Retrospec and sample some of the best 8-bit updates available on the internet. Speccy fanatics are advised to seek out the brilliant remakes of *Atic Atac*, *Head Over Heels*, *Manic Miner*, *Halls Of The Things* and *Zub*. There are tons more remakes too, and all of them are really worth downloading.



prepared to pay for the new machine. "The price is crucial," he wrote. "At around £120 it's a goer, but if Sinclair does the dastardly and comes in at £160 then there will be fewer takers." The 128 launched in the UK at a double-dastardly £179.

Still, at the UK launch event, Sir Clive boasted that interest in the machine was unprecedented with orders worth £8m already secured. And of course there were all those full-fat double cream 128K games to lap up... "Software quite unlike anything seen before," claimed Sir Clive. It was deeply ironic then that the launch titles turned out to be *exactly* what we'd seen before, because they were all updated versions of existing 48K games with a few added

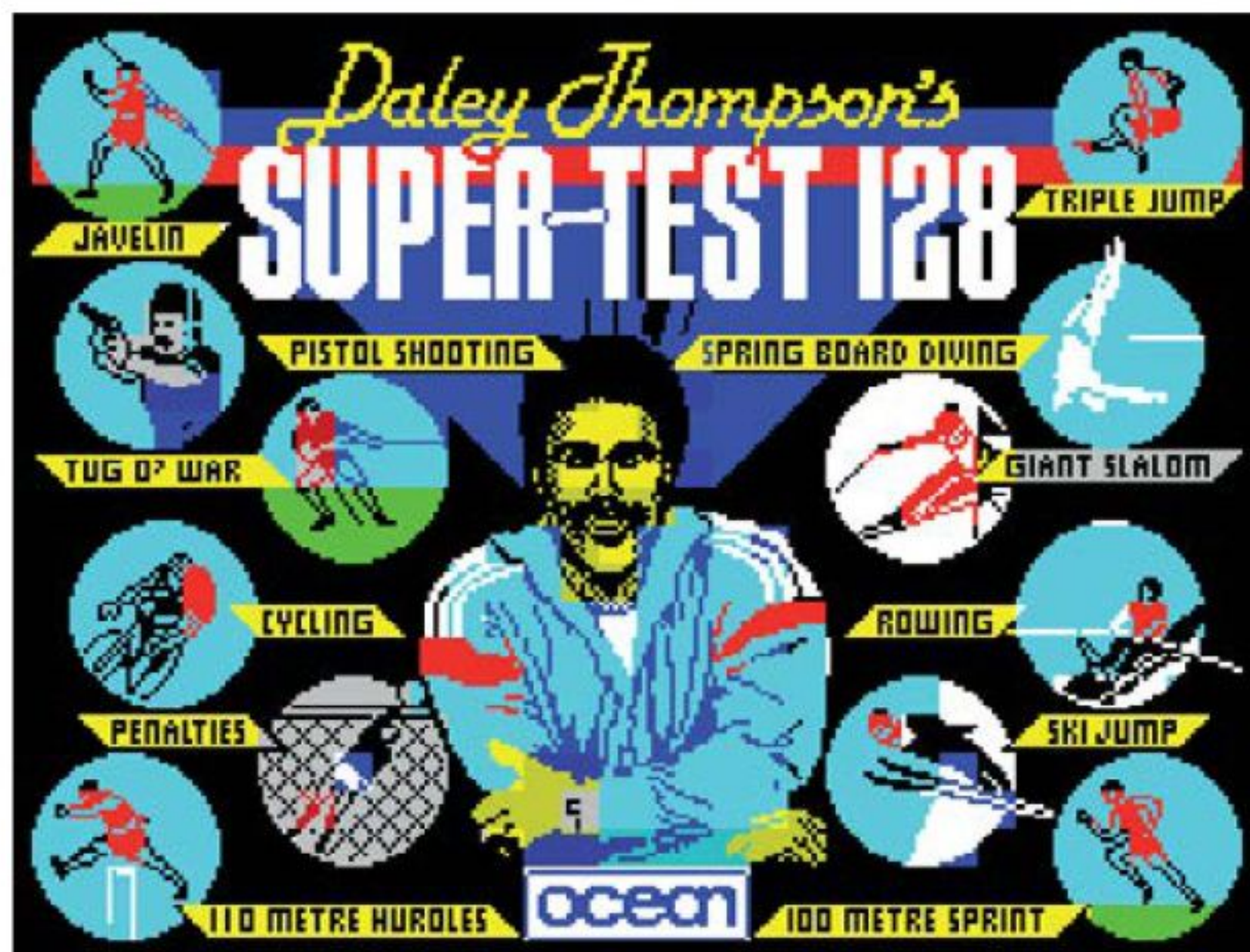

» Two Ocean games were given away with the 128 – frantic joystick-wrecker *Daley Thompson's Super-Test* and languid text adventure *The Neverending Story*.

extras, such as additional content or new AY music. Even the two Ocean games bundled with the 128 – *Daley Thompson's Super-Test* and *The Neverending Story* – were tarted-up 48K titles.

It seemed that publishers were unwilling to exclude the huge 48K user base by releasing 128K-only software, although as the 128 market grew it became the norm for new games to cater for both 48K and 128K owners.

Perhaps the 128's biggest claim to fame is that it enjoyed the shortest shelf life of any Sinclair computer. In April 1986, following months of speculation about Sinclair's financial woes, Amstrad acquired Sinclair Research from Sir Clive in a deal worth £5m. Amstrad moved quickly to align the Spectrum with its CPC range and in September it ushered in the +2, leaving the axe to fall on the 128 after just six months on sale.

Looking back, Rupert views the 128 as a missed opportunity. "The general feeling within Sinclair was that we needed something new and wonderful to get back into the swing of things, and the 128 wasn't that interesting," he says. "If we'd have been serious about it we would have put in a floppy interface, more video modes, and cost reduced it a lot more. It suffered from a lack of imagination."

"There was nothing very unique about the 128," agrees Rick. "It was a quick job, but it was a good product and right for the time."

It was the right product for Amstrad, who placed the 128's hardware and system software at the core of both its +2 and +3 machines. Ultimately, it may not have been the elusive Super Spectrum, but development of the 128 was key in breathing new life into the Speccy and prolonging its commercial life into the Nineties.

THERE'S A WORLD OF DIFFERENCE IN THE
ZX SPECTRUM 128

- 128K memory for bigger, better games.
- Improved features.
- Easier than ever to use.

CLEARER SCREEN DISPLAY

- Enhanced TV picture
- Built-in TV tuning guide
- Direct monitor connection

HOW ABOUT
GAMES?

- Runs ZX Spectrum Plus 48K and 16K programs
- Lots of new 128K titles are already available

EXTRA PROGRAMMING FEATURES

- Built-in Calculator
- New commands including PEN
- RAM Disk for rapid data access

» Sinclair produced a demo for retailers to play in their shops. It showcased the 128's capabilities and some of it was even true.



» In Spain it came with a numeric keypad. It's believed that the keypad was never officially released in the UK.

ROMANTIC ROBOT present

NEW multiface 128™
THE ULTIMATE BACK-UP DEVICE FOR ANY PROGRAM
- 48K & 128K ON ANY SPECTRUM - 48K & 128K
Just as perfect as MULTIFACE ONE, but with extra NEW FEATURES
!! FORMAT microdrive cartridges to 100-K !! SAVE to tape at TURBO SPEED !!
!! ...and of course - SAVE FULL 128K programs !!

for only **£44-95**

- Load ANY program - stop it at ANY point and SAVE it to TAPE (2 speeds), MICRODRIVE & DISCOVERY.
- Most powerful and efficient compressing for fast re-loading & using minimal room on tapes, discs and cartridges - combined with 100-K formatting, even 128K programs should fit on a single cartridge
- Fully automatic, 100% reliable, needs NO additional software, takes NO part of Spectrum RAM - has its OWN 8K ROM & 8K RAM
- Menu-driven with prompts and one-touch commands: 1) Push button 2) Select function: exit/return/save/look/print/jump 3) Input name 4) Save program or screen only to tape/hyper tape cartridge disc
- Built-in MULTI-TOOLKIT with extensive facilities for studying/modifying developing programs
- Extremely simple to use, user-friendly, fully error-trapped, fully guaranteed, PURE MAGIC *
- Through extension bus * Copy screen to printer
- Programs saved with any MULTIFACE can RUN independently (except turbo tape back-ups saved at turbo speed)

Owner of multiface one can get a 15% discount or upgrade for £24.95 (£19.95 if under guarantee)

The ORIGINAL multiface one available at £39-95 only
* SAVE 48K programs on any Spectrum to tape/microdrive/Discovery & also to wafadrive, BETA and KEMPSTON (please state if using BETA or Kempston disc interface) * with a built-in JOYSTICK INTERFACE (Kempston compatible)

SELENE plus ANACHRONISM
A fantastic fast moving series of sci-fi adventures for travellers in time - both very intriguing and exciting, consider and detailed, funny and witty, travel on time machines and transport at you never did before - certainly not in any adventure yet...

STEEPLEJACK
A great team stands in the way of evil... and only STEEPLEJACK can stand up to them! This is a superb game of lead heads in this highly funny, original, and screen-filling game. STEEPLEJACK must be very fast, light, alert and strong. There is a whole lot of adventure and fun in this game. It's a great team, so much to do in a little time!

GENIE
Perfect 200 DISASSEMBLER running in MULTIFACE 128's or ONE's RAM (leave state while version).
THE ONLY ONE that can freeze ANY RUNNING Spectrum program and disassemble it! View, time/crafts, alter, dump to printer, etc. ABSOLUTELY UNIQUE, ingenious, educational, SIMPLE TO USE.

MUSIC TYPEWRITER
Complete Spectrum music system for writing, editing, playing, printing & storing music with real notation graphics.

TRANS-EXPRESS
The software way of transferring Spectrum software.
* Utilises for mdmve 2 for wafadrive 2 for Opus Discovery

multiface THE ESSENTIAL SPECTRUM COMPANION
TOP SOFTWARE AT BOTTOM PRICE

» The ultimate accessory for any Spectrum 128 owner – Romantic Robot's Multiface 128, a wondrous box of tricks.



SPECTRUM 128

PERFECT TEN GAMES

Pure and simple – ten games that showcased the Spectrum 128’s capabilities. For argument’s sake, the titles that very nearly made the top ten are Fairlight 2 (The Edge), The Pawn (Magnetic Scrolls), Chase HQ (Ocean), Pang (Ocean), Little Computer People (Activision), HeroQuest (Gremlin) and Thundercats (Elite)

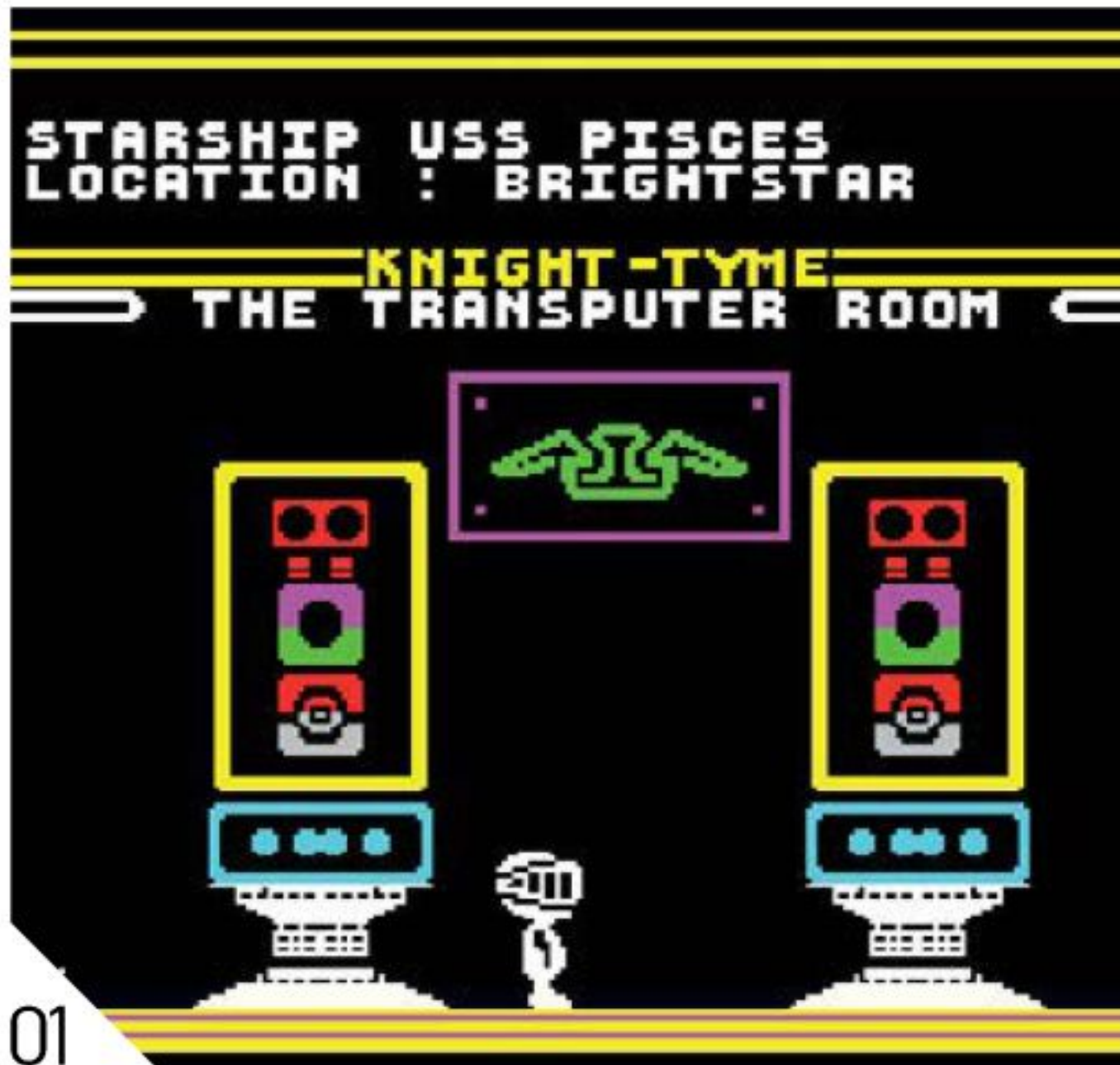

01

KNIGHT TYME

- » RELEASED: 1986
- » PUBLISHED BY: MASTERTRONIC
- » CREATED BY: DAVID JONES
- » BY THE SAME DEVELOPER: FINDERS/KEEPERS

01 If you'd just blown the best part of £200 on a 128 then it must have been soothing to see *Knight Tyme* available for just three English pounds. That's right, the first game to be developed specially for the 128 (rather than a lukewarm 48K update) was a Mastertronic budget title that showed full-price publishers how it should be done. Following directly on from *Spellbound*, the third entry in the *Magic Knight* series shifted the action forward in time to a faraway galaxy filled with weird and wonderful characters and head-flexing puzzles. It was witty and clever and, in all honesty, grossly underpriced. A great in-game tune sealed the deal.

AMAUROTE

- » RELEASED: 1987
- » PUBLISHED BY: MASTERTRONIC
- » CREATED BY: BINARY DESIGN
- » BY THE SAME DEVELOPER: ZUB

02 Along with the *Magic Knight* games, *Amaurote* was another budget title that was better than many full-price releases. Playing like an updated version of *Ant Attack*, you were dropped into a city swarming with oversized insects. But rather than running in the opposite direction, your job was to locate and destroy the insect queen and her workers in all 25 sectors. The presentation on the 128K version was superb, with a quirky in-game tune by David Whittaker and an animated 'drop' sequence playing as you move into each sector. Along with *Zub*, *180* and *Feud*, it was another slice of budget brilliance from the super Pickford Bros.

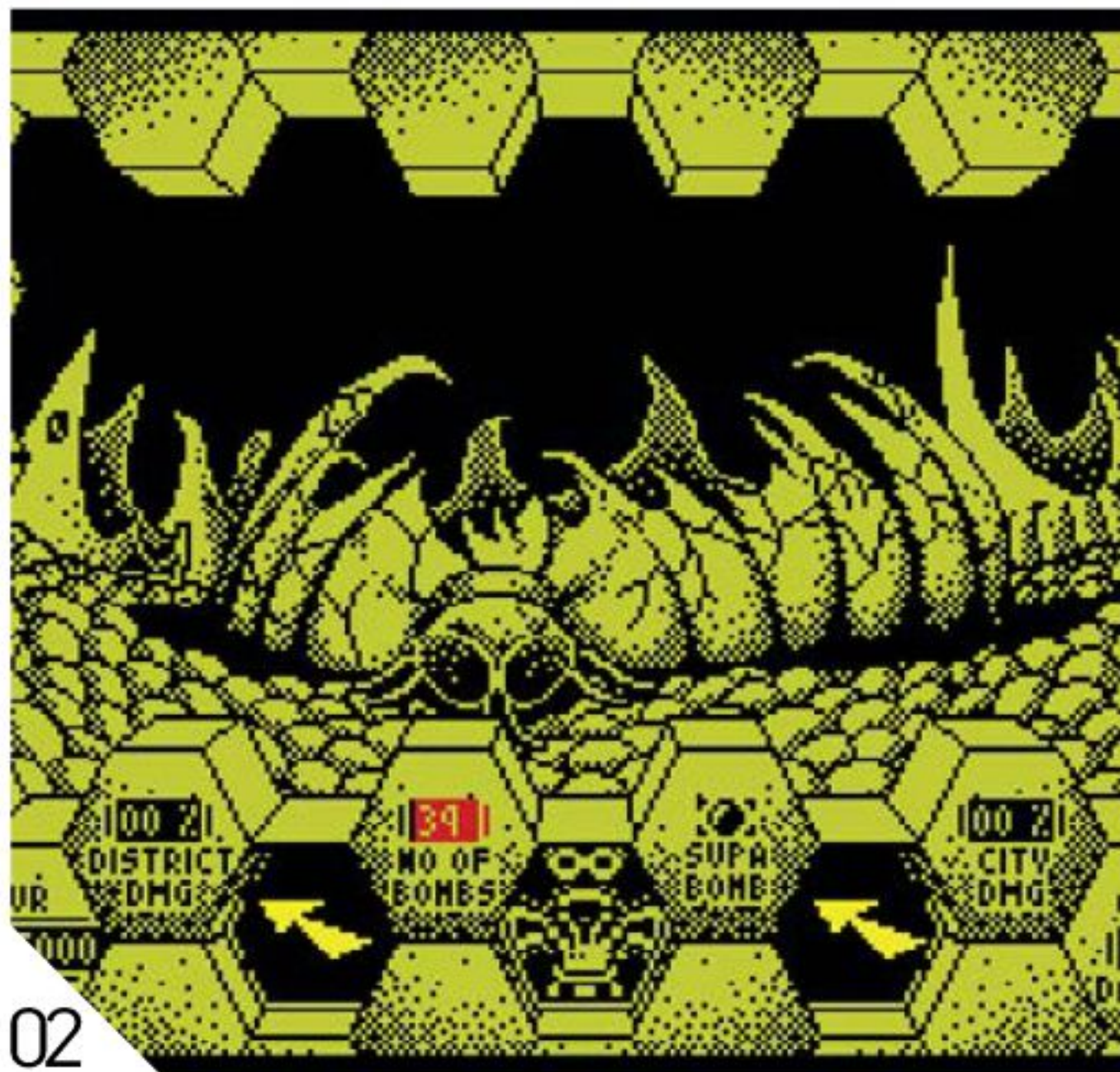

02

STARGLIDER

- » RELEASED: 1986
- » PUBLISHED BY: RAINBIRD
- » CREATED BY: REALTIME GAMES
- » BY THE SAME DEVELOPER: CARRIER COMMAND

03 Vector graphics games always fared well on the Spectrum so there were high hopes for its version of *Jez San's 16-bit classic*. Realtime Games handled the coding and the end result surpassed all expectations. The 48K version was great, although there was little to do beyond racking up a high score and progressing to the next level. The enhanced 128K version was the complete package with a number of special missions and touches like in-game speech, a rear-view scanner, and slo-mo replays when you destroy *Starglider One*. If only other publishers had lavished as much attention on their 128K games.

RENEGADE

- » RELEASED: 1987
- » PUBLISHED BY: IMAGINE SOFTWARE
- » CREATED BY: MIKE LAMB
- » BY THE SAME DEVELOPER: ROBOCOP

04 Was there a better version of this arcade game on any home computer? Doubtful, as *Renegade* on the Speccy was arguably better than the coin-op. It was more fun on the 128, as it featured a number of elements that had to be cut from the 48K version. There was music throughout (a different tune for each level) and an extra area to brawl in before the final encounter with the boss. More subtle was the useful shoulder-throw move that was unique to the 128 version. The sequel, *Target Renegade*, was also superb, although from a 128 perspective it didn't add any additional content beyond AY music.

TAI PAN

- » RELEASED: 1987
- » PUBLISHED BY: OCEAN
- » CREATED BY: SENTIENT SOFTWARE
- » BY THE SAME DEVELOPER: WECLE MANS

05 In the Eighties, Ocean liked to exploit pretty much everything and the 128 was no exception. It was responsible for the two titles bundled with the machine and was quick to create 128K versions of all its new games. Later on it was also the first major publisher to drop support for the 48K altogether. *Tai Pan* was the first game it developed from the ground up for the 128 (a 48K version was also available but it was a stripped down multi-load affair). Based on the book by James Clavell, this heady mix of arcade, adventure and strategy elements upon China's high seas was the first 128K mega game.



03



04

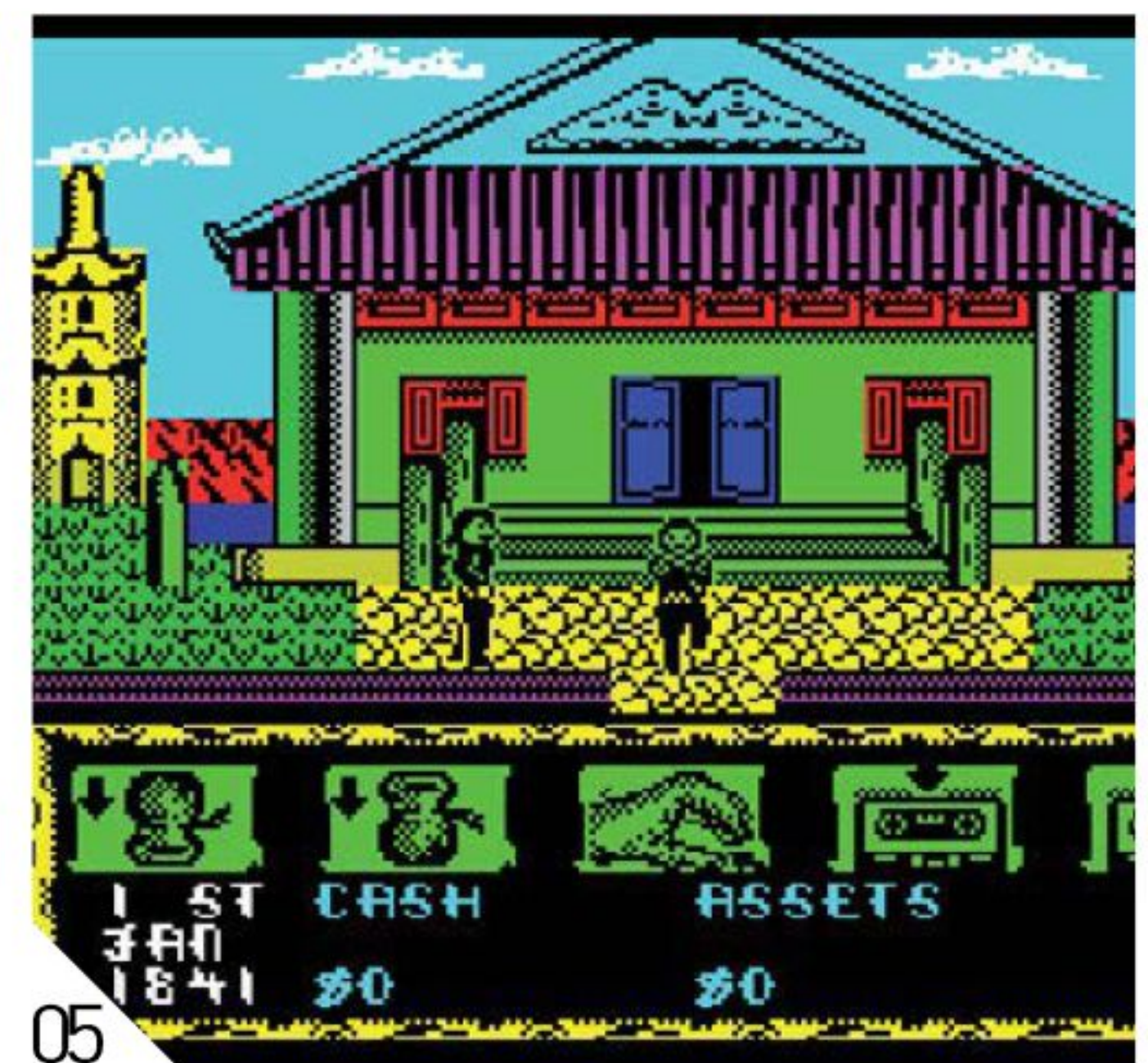

05

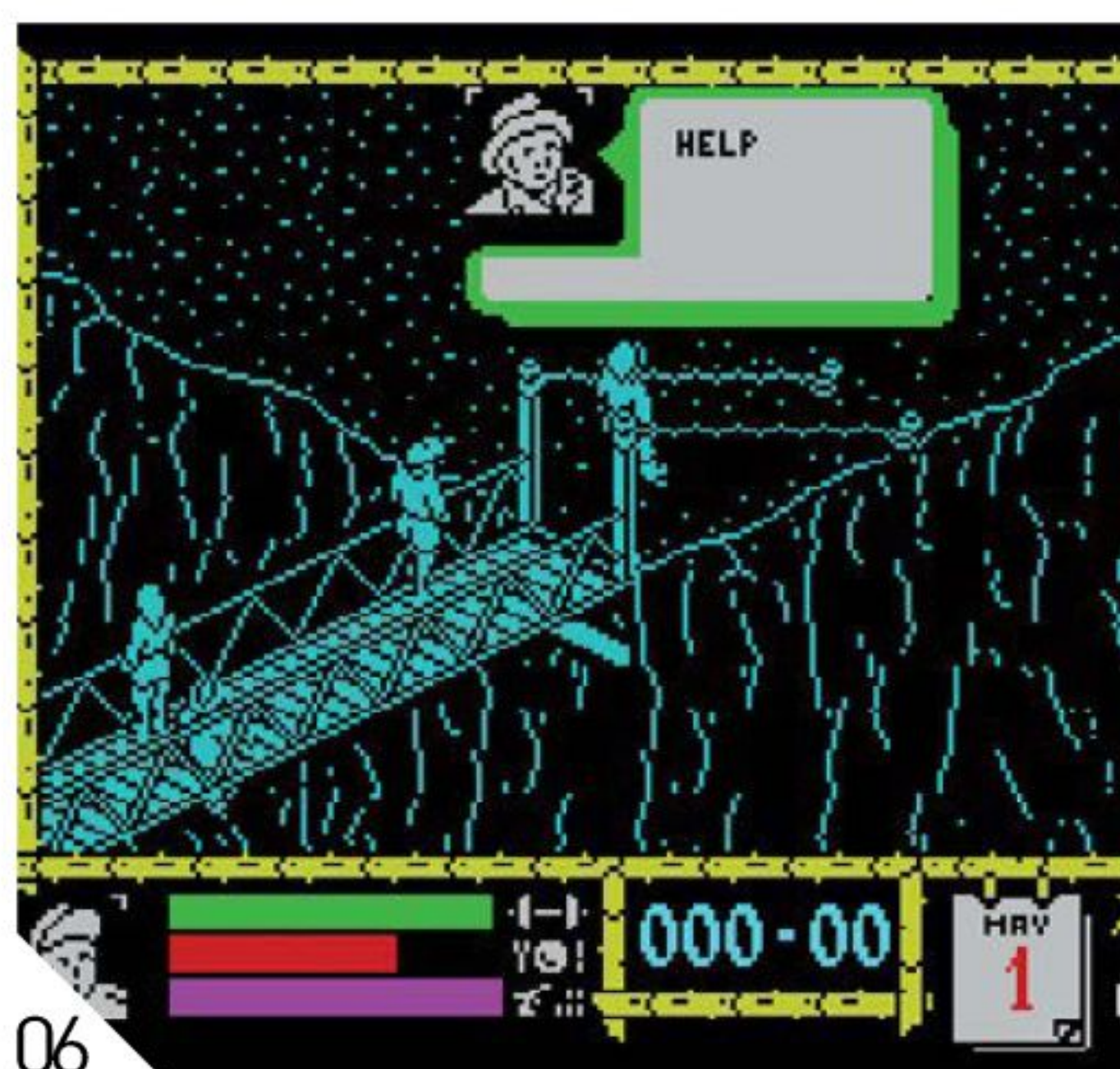

06

WHERE TIME STOOD STILL

- » RELEASED: 1988
- » PUBLISHED BY: OCEAN
- » CREATED BY: DENTON DESIGN
- » BY THE SAME DEVELOPER: THE GREAT ESCAPE

06 This was what 128 owners had been waiting for – a sprawling arcade adventure that was too big to cram into 48K. Inspired by Seventies movie *The Land That Time Forgot*, it time-warped you to a hostile world where everything wanted to eat you and your party. There were obstacles to overcome and puzzles to solve, but the emphasis was on exploring. Some set pieces, such as the swamp crossing, must rank among the Speccy's finest moments. With *WTSS*, Denton Designs built on the foundations laid in *The Great Escape* and created a gripping adventure.



07

CARRIER COMMAND

- » RELEASED: 1989
- » PUBLISHED BY: RAINBIRD
- » CREATED BY: REALTIME GAMES
- » BY THE SAME DEVELOPER: BATTLE COMMAND

07 With *Starglider*, Realtime showed it could take a complex 16-bit game and port it to the Speccy, particularly when there was 128K to play with. It delivered the goods again with this brilliant conversion that re-created the multi-faceted gameplay of the original. The graphics engine was particularly impressive, especially when you consider that the C64 version dropped the 3D viewpoint completely, in favour of a top-down 2D approach. This conversion spent two years in the making but it was well worth the wait. The sequel, *Battle Command*, is also recommended.

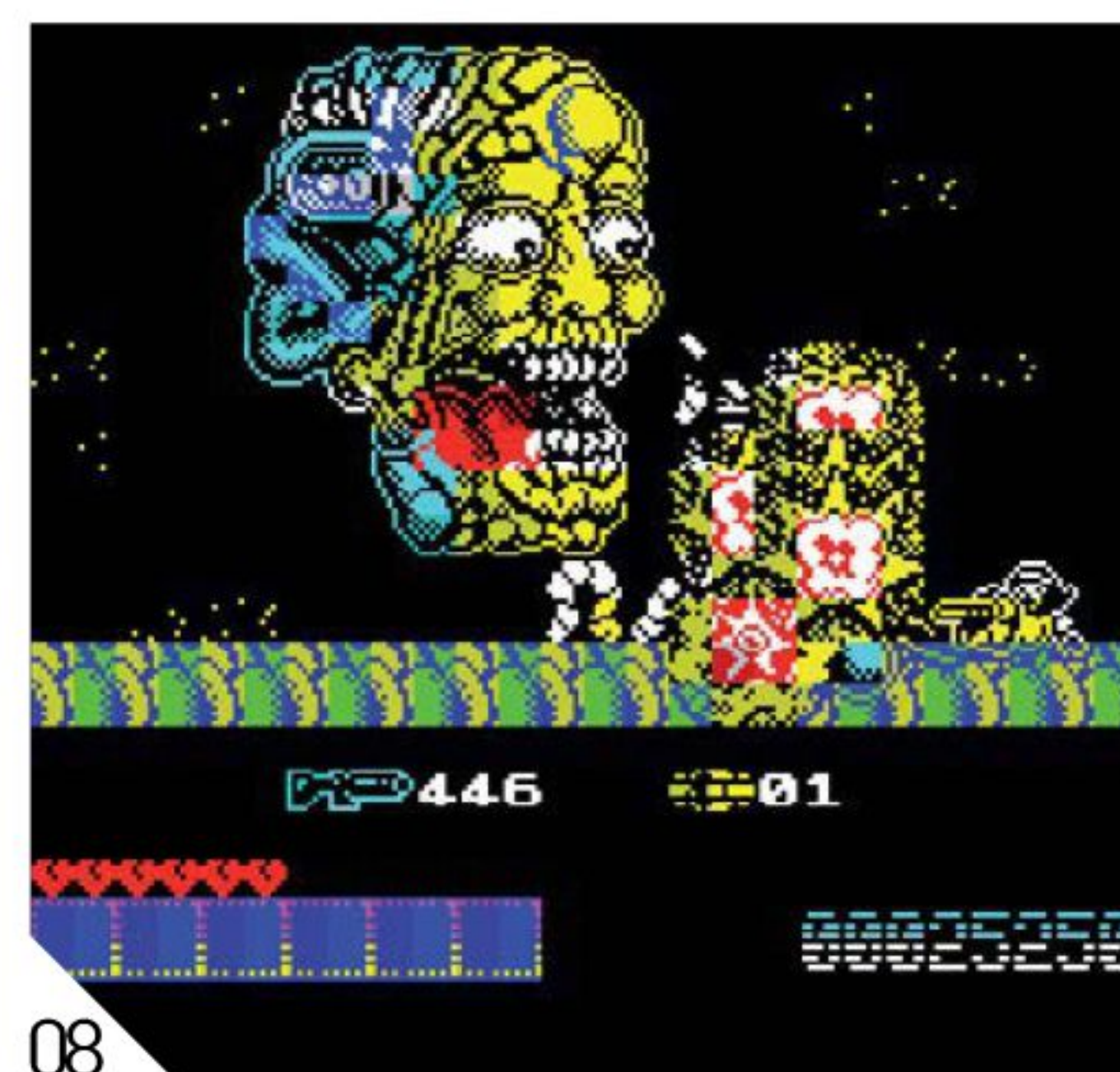

08

MIDNIGHT RESISTANCE

- » RELEASED: 1990
- » PUBLISHED BY: OCEAN
- » CREATED BY: SPECIAL FX
- » BY THE SAME DEVELOPER: CABAL

08 Colour clash was the bane of every Spectrum programmer, and in later years many sidestepped the problem by opting for a dull monochrome display. Thank God then for games like *Midnight Resistance*. Special effects went mad, splashing Speccy colour all over the place. This glorious graphical style really suited the run-'n'-gun format. The game would run on the 48K, but the only way to play it was on a 128 with all nine levels loading in one go and the excellent AY soundtrack complementing the on-screen carnage. The only thing missing was co-op play.



09

PRICE OF MAGIK

- » RELEASED: 1986
- » PUBLISHED BY: LEVEL 9
- » CREATED BY: LEVEL 9
- » BY THE SAME DEVELOPER: THE WORM IN PARADISE

09 Having spent a number of years cramming text adventures into the Spectrum's 48K RAM, Level 9 made the jump to the bigger memory Speccy without any hesitation. *Price Of Magik* – the third and final part of the *Time And Magik* trilogy – was the first to offer an enhanced 128K version. It featured the same location graphics as the 48K version, but the text descriptions were longer and loaded with extra detail, making for a much more involving adventure. Overall, *Price Of Magik* was one of the best games to come from developer Level 9, with a cracking Lovecraft-inspired storyline, tough but fair puzzles, non-linear progression and an intelligent parser. For us it just pipped *The Pawn*.

LA ABADIA DEL CRIMEN

- » RELEASED: 1988
- » PUBLISHED BY: OPERA SOFT
- » CREATED BY: PACO MENENDEZ
- » BY THE SAME DEVELOPER: SIR FRED

10 The Spectrum was popular in many European countries, particularly Spain, where home-grown software was developed to supplement titles exported from the UK. Opera Soft was one of the most successful Spanish developers and this classy 128K-only title helped cement its reputation at home and abroad. *La Abadia Del Crimen* (*The Abbey Of Crime*) was unofficially based on Umberto Eco's novel *The Name Of The Rose*, and put you in control of a Franciscan monk trying to solve a series of murders in a brilliantly depicted monastery. The game was not released outside its home country so the text is in Spanish, but don't let that put you off. This really is a game to discover.



10



SPECTRUM 128

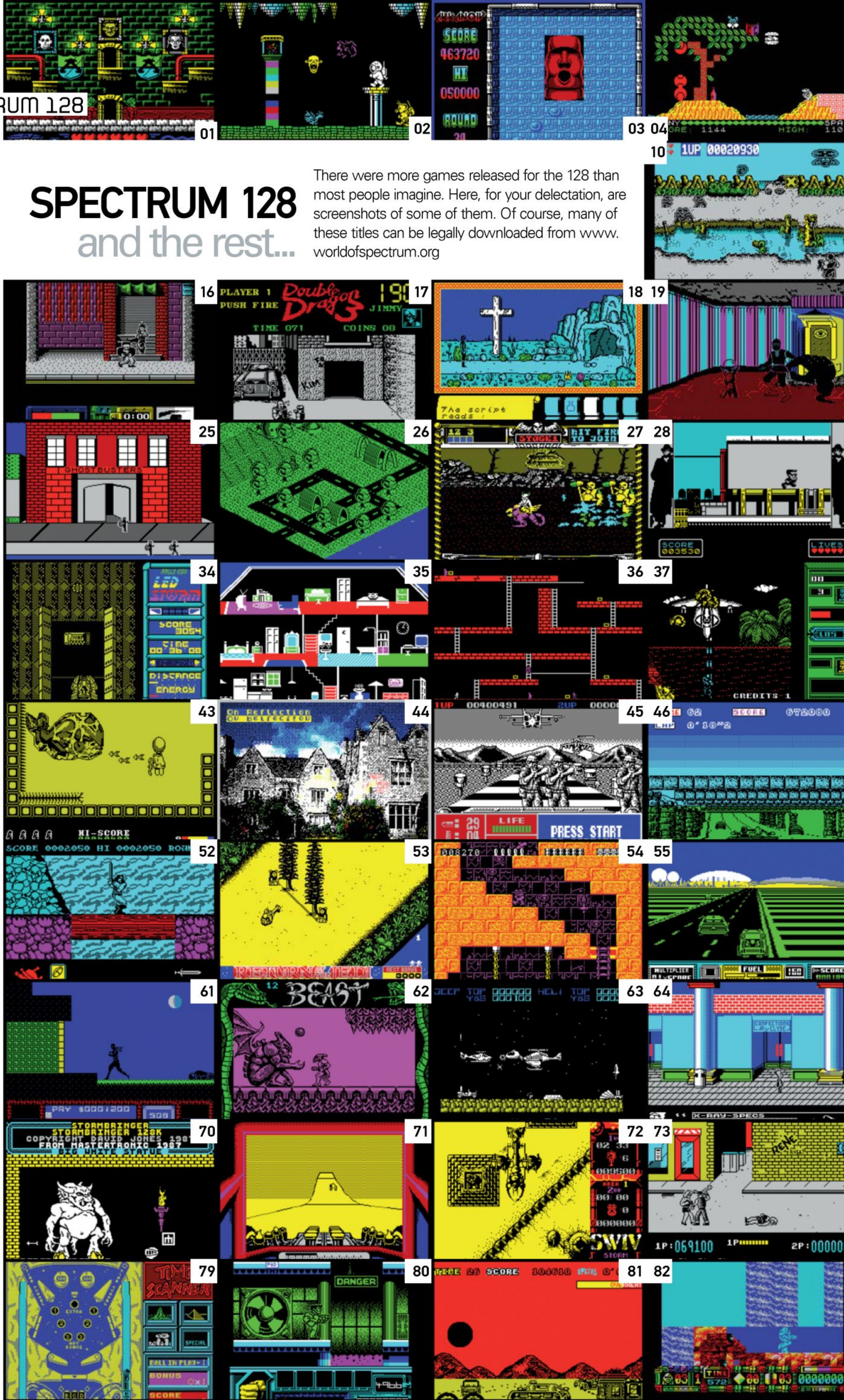

SPECTRUM 128 and the rest...

There were more games released for the 128 than most people imagine. Here, for your delectation, are screenshots of some of them. Of course, many of these titles can be legally downloaded from www.worldofspectrum.org

- 01 THE ADDAMS FAMILY
- 02 THE ARC OF YESOD
- 03 ARKANOID 2
- 04 AUF WIEDERSEHEN MONTY
- 05 BARBARIAN II
- 06 BATMAN THE MOVIE
- 07 BLIZZARD PASS
- 08 BLIZZARD'S RIFT
- 09 BUGGY BOY
- 10 CABAL
- 11 CANNON BUBBLE
- 12 CHASE HQ
- 13 DALEK ATTACK
- 14 DALEY THOMPSON'S OLYMPIC CHALLENGE
- 15 DAN DARE III
- 16 DARKMAN
- 17 DOUBLE DRAGON 3
- 18 DRAGONIA
- 19 DRAGON'S LAIR 2
- 20 ELITE
- 21 THE EMPIRE STRIKES BACK
- 22 ESCAPE FROM THE PLANET OF THE ROBOT MONSTERS
- 23 FAIRLIGHT
- 24 GAUNTLET III
- 25 GHOSTBUSTERS
- 26 GLIDER RIDER
- 27 GOLDEN AXE
- 28 HUDSON HAWK
- 29 HYDROFOOL
- 30 IMPOSSAMOLE
- 31 INDIANA JONES AND THE FATE OF ATLANTIS
- 32 INDIANA JONES AND THE LAST CRUSADE
- 33 INTERNATIONAL MATCH DAY
- 34 LED STORM
- 35 LITTLE COMPUTER PEOPLE
- 36 LODE RUNNER
- 37 MERCS
- 38 MINDFIGHTER
- 39 MONTY PYTHON'S FLYING CIRCUS
- 40 THE MUNCHER
- 41 NARC
- 42 NAVY SEALS
- 43 THE NEW ZEALAND STORY
- 44 ON REFLECTION
- 45 OPERATION THUNDERBOLT
- 46 OUTRUN
- 47 PANG
- 48 THE PAWN
- 49 PLATOON
- 50 RAINBOW ISLANDS
- 51 RAMBO III
- 52 RASTAN
- 53 RETURN OF THE JEDI
- 54 RICK DANGEROUS
- 55 ROAD BLASTERS
- 56 ROBIN OF THE WOOD
- 57 ROBOCOP 2
- 58 ROBOCOP 3
- 59 ROCKY HORROR PICTURE SHOW
- 60 ROD-LAND
- 61 SABOTEUR 2
- 62 SHADOW OF THE BEAST
- 63 SILKWORM
- 64 THE SIMPSONS
- 65 SKULL & CROSSBONES
- 66 SMASH TV
- 67 SPELLBOUND
- 68 SPELLBOUND DIZZY
- 69 SPITFIRE 40
- 70 STORMBRINGER
- 71 STUNT CAR RACER
- 72 SWIV
- 73 TARGET RENEGADE
- 74 TAU CETI - THE SPECIAL EDITION
- 75 TECHNICIAN TED: THE MEGAMIX
- 76 TERMINATOR 2
- 77 THUNDERBIRDS
- 78 THUNDERCATS
- 79 TIME SCANNER
- 80 TOTAL RECALL
- 81 TURBO OUTRUN
- 82 TURRICAN II
- 83 THE UNTOUCHABLES
- 84 WE'LE MANS
- 85 WWF WRESTLEMANIA
- 86 YIE AR KUNG-FU
- 87 ZUB



05



06



07

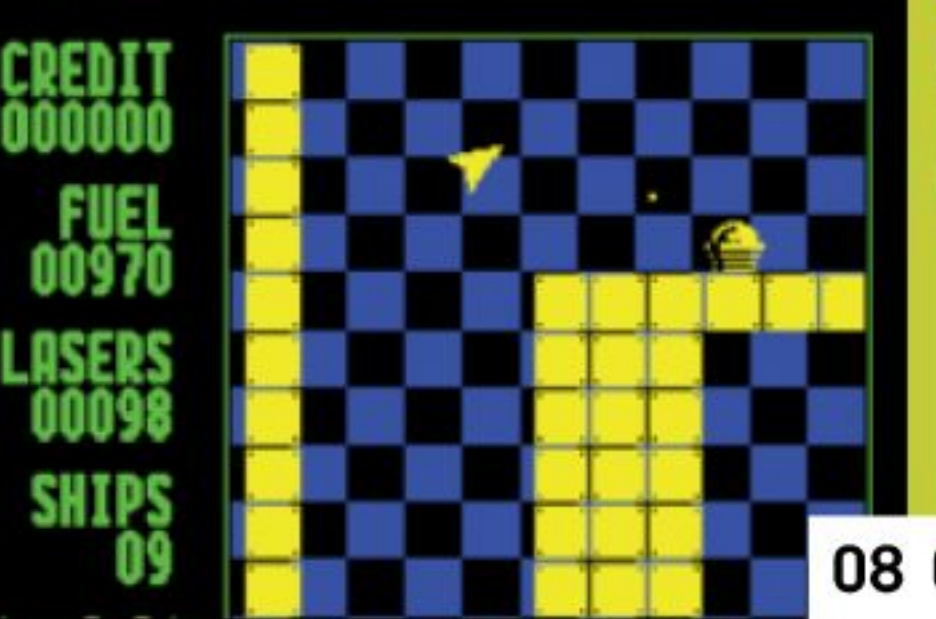

08



11



12



13



14



20



21



22

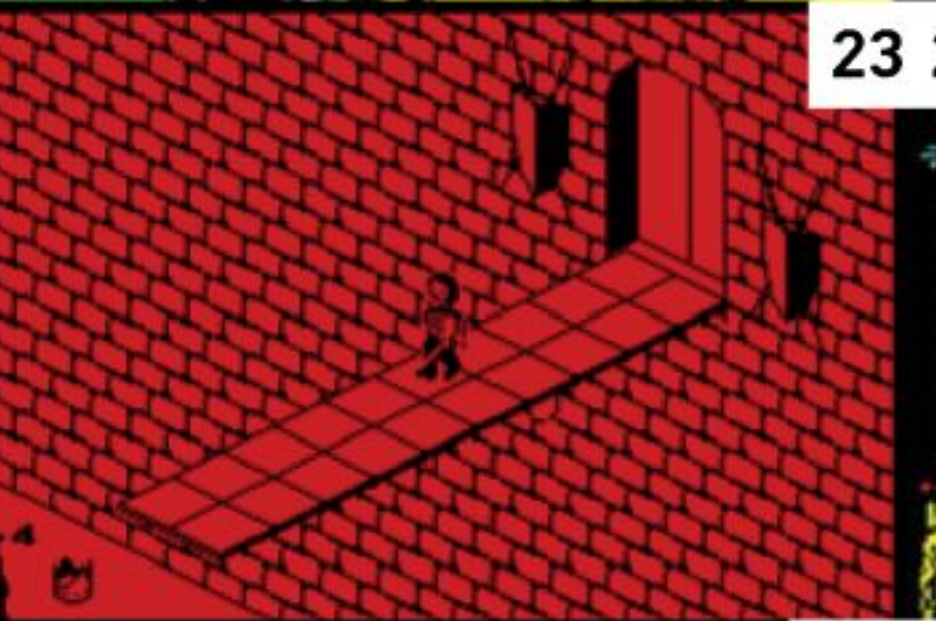

23

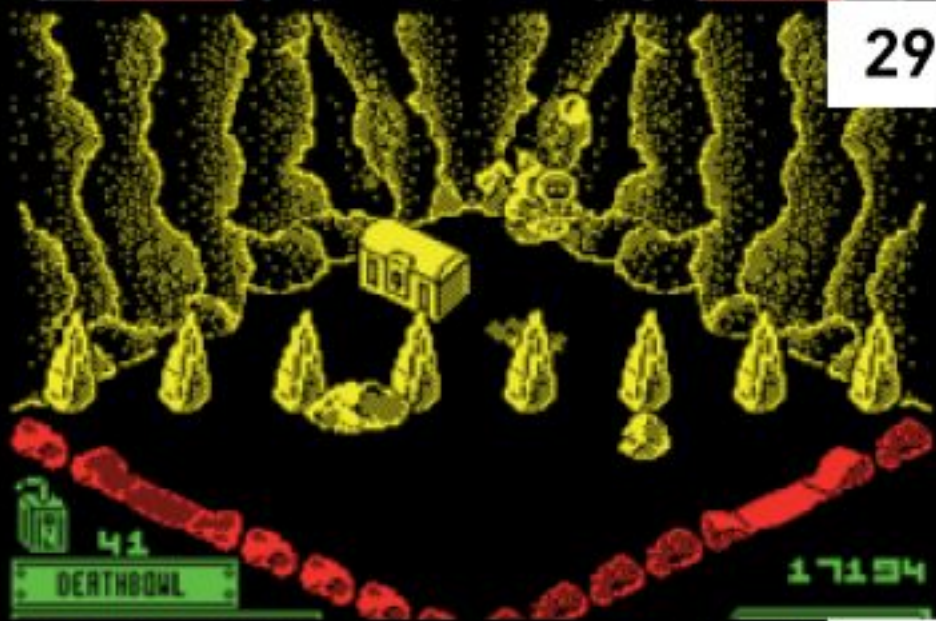

29



30



31

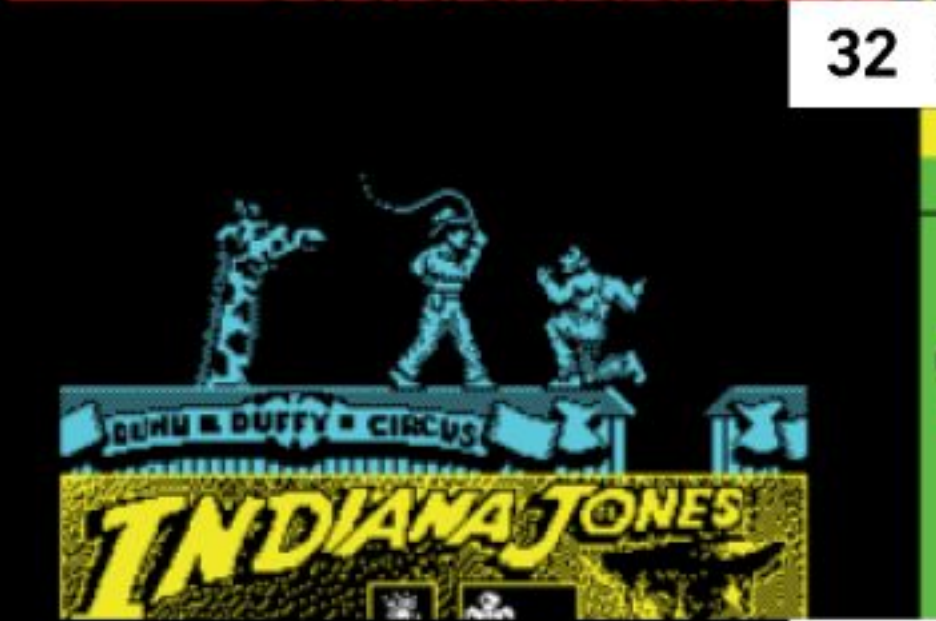

32



38

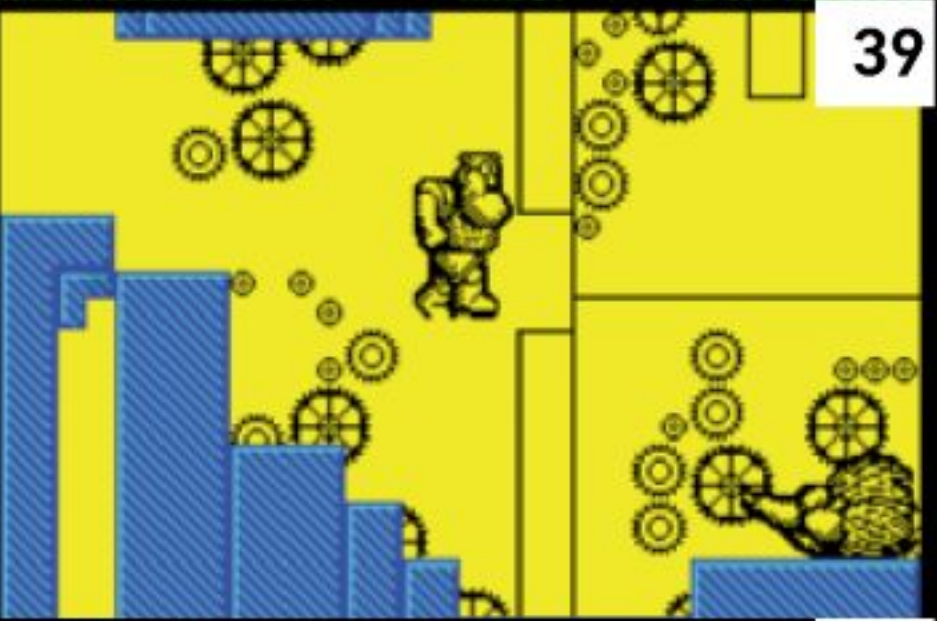

39



40



41



47



48



49



50

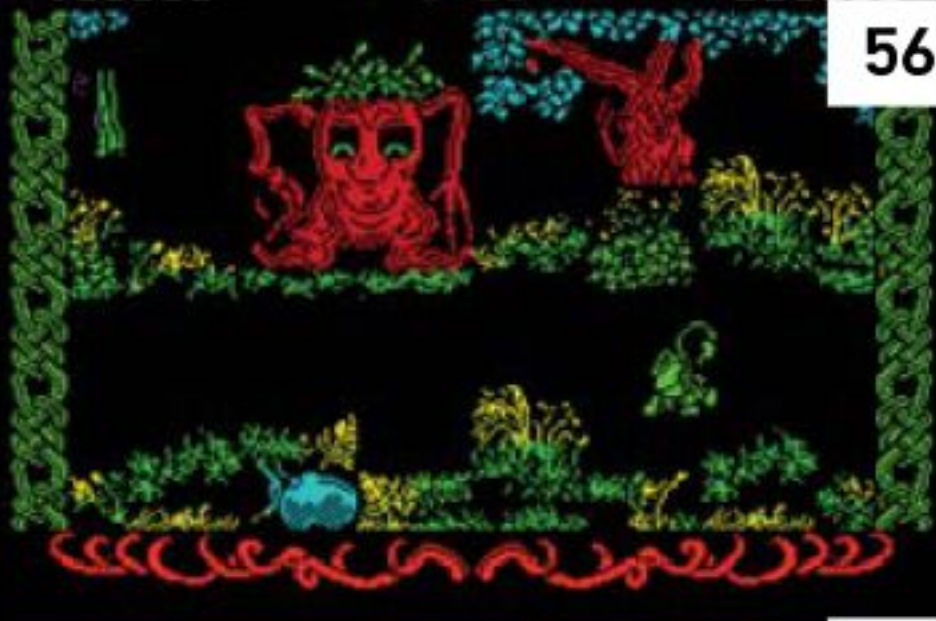

56



57



58



59

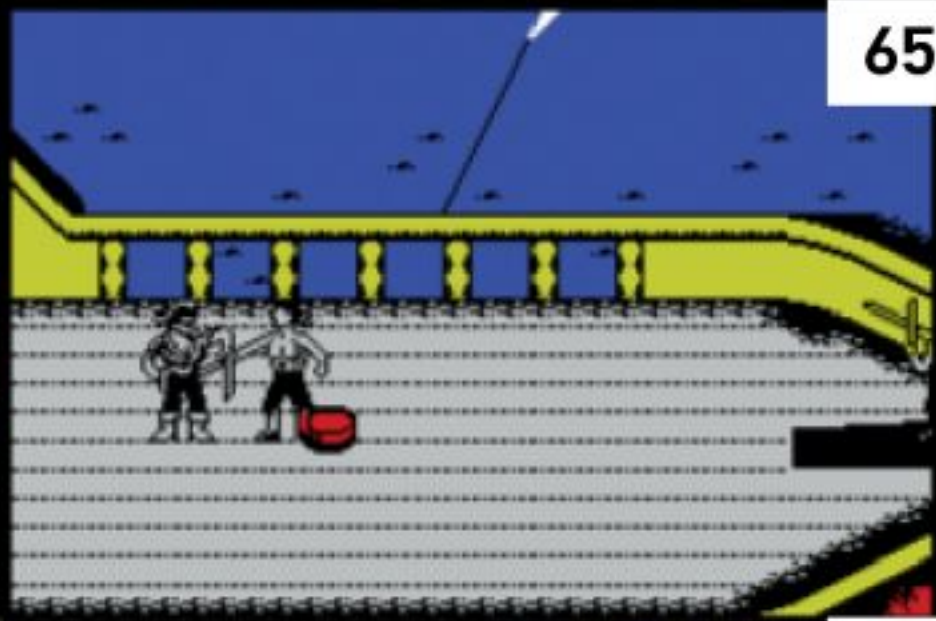
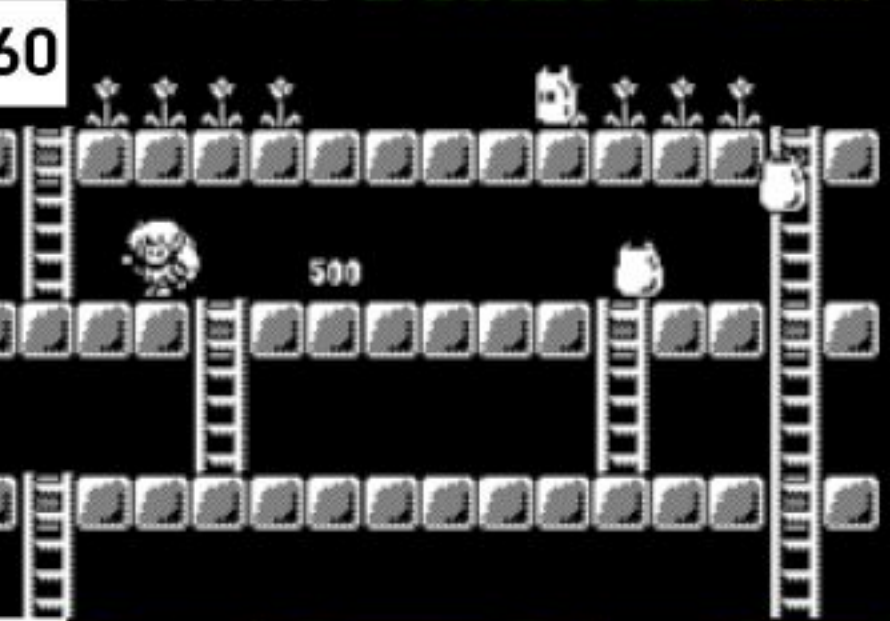

65



66



67



68

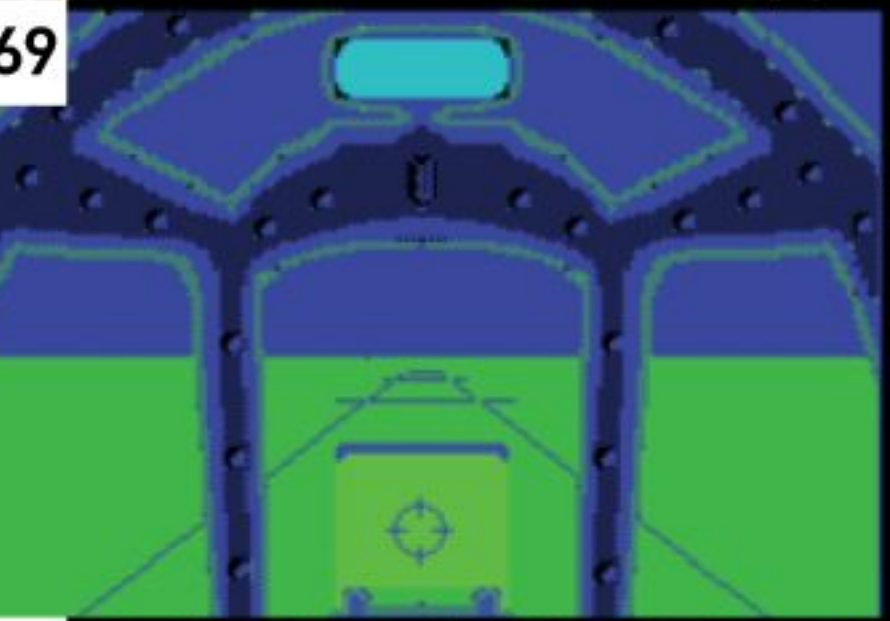

74



75



76



77



83



84



85

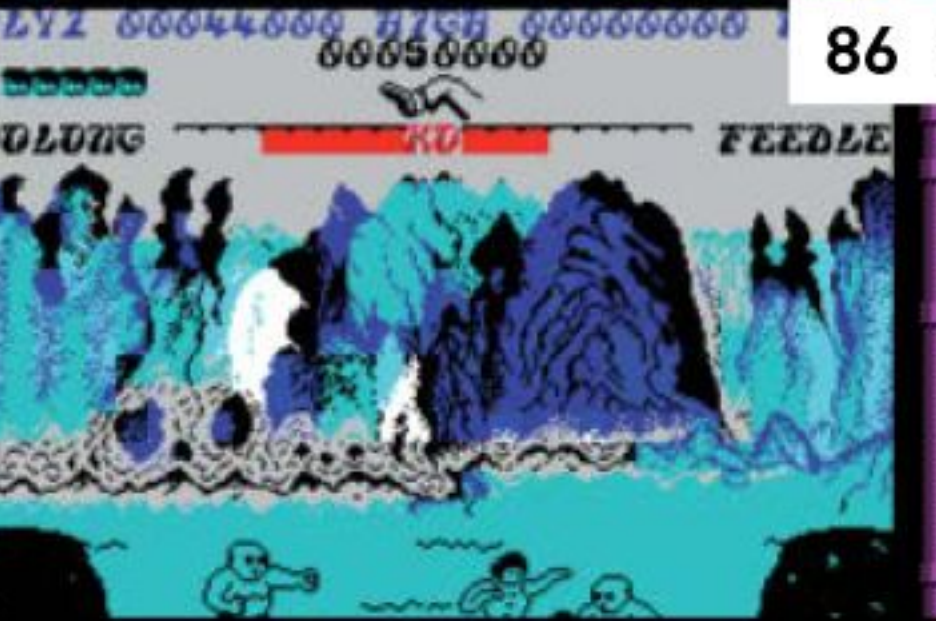

86





COLECOVISION

COLECOVISION



COLECOVISION



From the same company that would inflict the Cabbage Patch Kids upon the world, the ColecoVision entered an industry on the verge of collapse. We speak to the man behind the machine that could have ruled the world

There are some striking similarities between the ColecoVision and Sony's all-conquering PlayStation.

Both machines were released by companies that nominally operated outside the videogame industry – Coleco began life as Connecticut Leather Company before moving into children's toys, and Sony was, and still is, a purveyor of consumer electronics, movies and music. Both platforms were also more powerful than their closest competitors and relied heavily on third-party licences, with Coleco signing up some of the best arcade titles of the era, while Sony secured victory with the assistance of talented studios such as Namco, Square and Konami. However, it's there that the similarity ends: while the PlayStation went on to dominate the 32-bit era, the ColecoVision's potential was stymied by the videogame crash of the Eighties – a cataclysmic event brought on by market leader Atari's poor business strategy.

The ColecoVision hardware was the brainchild of Eric Bromley, a talented designer and engineer who had previously headed up R&D divisions within various coin-op firms, the most notable of which was Midway. He was in between jobs when Coleco's Mel Gershman asked him to come in for an interview. "He hired me within 15 minutes of my arrival," beams Bromley today. Coleco's output at that time was mostly electronic toys and play equipment, the former being something that caught Bromley's eye. "Coleco made one of my all-time favourite games: Rod Hockey," he explains. "They also made swimming pools, Holly Hobbie ovens, girl's playhouses, and various types of snow-riding items." However, with videogame sales booming and millions of dollars up for grabs, Coleco was looking to enter the market with its own home machine; the company knew the potential because it had already

tentatively dipped a toe in the water during the Seventies with a range of handhelds and a simplistic TV game.

"The game with which we had our initial success was Telstar, which was promoted in 1976 as the first arcade home videogame under \$100," says Bromley. The talented designer had an even grander vision in mind, but bringing it to fruition was difficult. "Coleco CEO Arnold Greenberg and I desperately wanted to make an arcade-quality, cartridge-programmable videogame," states Bromley. "I had started to do the preliminary design and costing for the ColecoVision three years – maybe even more – before its debut in 1982, but it was always shot down as too costly. Marketing a product at a magical retail price point was the key to everything Coleco produced; it was their mantra. Our team had developed a design around a Texas Instruments video chip and a sound chip from General Instruments, but it was RAM-intensive and therefore way above the cost limits." With the profit margin being the deciding factor, the situation remained static until 1981. "I picked up a copy of the *Wall Street Journal* and saw an article about how the cost of RAM had declined," explains Bromley. "I retrieved the latest cost analysis and substituted the new pricing. It came very close to the target price point. I ran to inform Arnold Greenberg and burst into his office without even asking his secretary; before he could react I showed him the new figures. Ten minutes later we were working on a new project with the working name 'ColecoVision'. We were going to find a really good name for it as soon as we could show something to our sales and marketing people." They never came up with a new moniker, and the working title stuck.

With the financial resources in place to make his dream a reality, Bromley set about engineering what would be considered the most powerful gaming machine of the period. "The key to the ColecoVision was that this was the first home videogame that could display



COLECOVISION

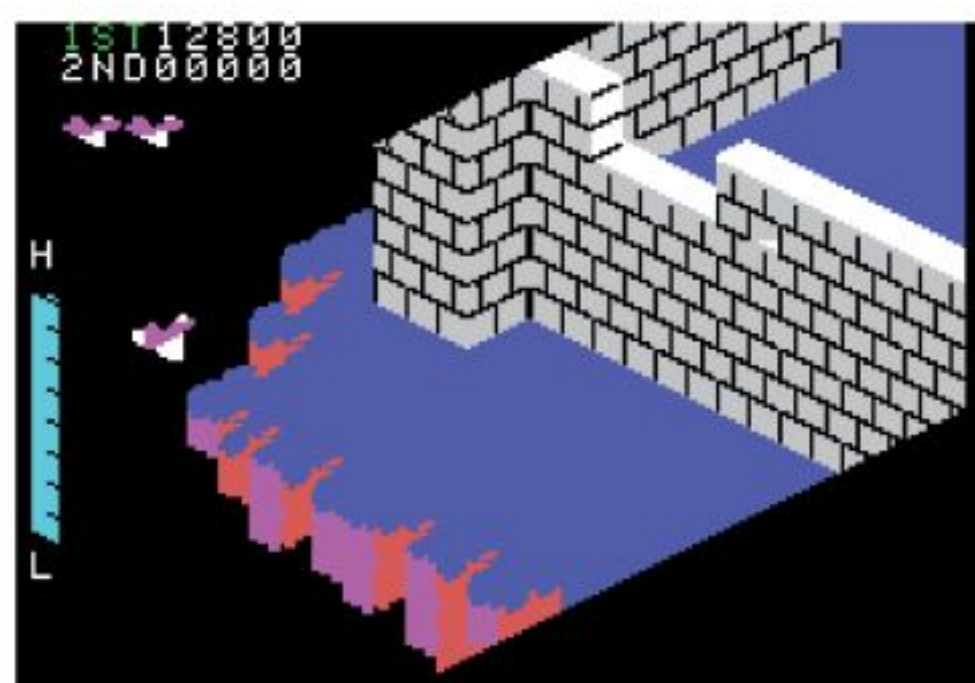

By picking up cutting-edge titles such as *Zaxxon*, Coleco was making a bold statement about the ColecoVision.

and update the entire screen at almost arcade resolution, which in 1982 was 256x192 pixels, and at the same time move objects around at a speed that would test the hand-eye co-ordination of teenagers," he comments. "In order to do that, we needed to employ an array of RAM chips, which could create a graphic matrix, which was then sent out to the TV. Texas Instruments' chip was extremely clever – it could move a limited number of foreground objects very rapidly on a second layer over the background without redrawing the entire screen. Both layers required RAM, but with cheaper RAM we could produce arcade-quality games rendered by a console that could be sold to retailers for under \$130."

Bromley was the perfect person to tackle such a project because he was a keen arcade gamer himself and instinctively knew what was required to replicate the thrills generated by cutting-edge coin-op hardware. "I was a coin-op alumnus," he says. "I knew almost everyone in the business and had access to the top people in each company. We

knew that in order to sell the console we needed to have a cartridge library – and thus began the licensing frenzy. I introduced Coleco's head of licensing Al Kahn to many of the coin-op game companies. He would spearhead the licensing while my team developed the console that could render them. I was part marketing and part design."

Arcade titles of the day had the power to make or break new home hardware – a fact that Bromley was acutely aware of, because acquiring killer titles was all part of his overall strategy for the ColecoVision. "Originally, I had two games in mind; if we could get the rights, we could blow everyone out," he states. "The first was *Zaxxon*, a 3D game which was one of the best-earning titles at the time. The other was *Turbo*, one of the best driving games ever – at least in the early Eighties. I would have liked *Space Invaders* and *Pac-Man*, but Atari had already gobbled them up. I argued against doing 'knock-offs', which was the custom of many home game companies at the time. I urged Arnold Greenberg to pay for the licences. Besides being the right thing to do, I argued that if we paid for the actual arcade game title, we did not have to describe the game or wait for customer word of mouth to promote its virtues. Just say *Turbo* or *Zaxxon* and every kid would know what you were talking about and immediately want it."

This approach – which seems obvious today but was considered high-risk at the time, hence the

“ We wanted to make an arcade-quality videogame, but it was always shot down as too costly ”

SPECIFICATIONS

Year released: 1982

Original price: \$174.99

Associated magazines:
ColecoVision Experience

Buy it now for: £40+

Why the ColecoVision was great: More powerful than its rivals and combining arcade-quality games with the tantalising promise of expandability, it's little wonder that the ColecoVision sold impressively when it was released. Official coin-op conversions of massive titles such as *Frogger*, *Zaxxon*, *Donkey Kong* and *Turbo* were light years ahead of what was available on the Atari 2600/VCS. Had the videogame crash not happened when it did, chances are Coleco would still be around and its console would be viewed in the same light as the NES.

proliferation of clones based on famous coin-op machines – had a two-way advantage. "When a toy company promotes its home games, usually months later than the arcade introduction, the TV ads and publicity create new interest in the original arcade game," elaborates Bromley. "Because we often could not completely fit most games onto a cartridge, the kids went back to the arcades to see all the levels and features not found in the home version. Thus, we created an amazing commercial symbiosis: because the kids already knew what the game was, home sales didn't ramp up; they exploded. Thanks to that explosion, the media covered the products and prolonged the revenue stream at the arcade venues. Both the coin-op operators and manufacturers benefited from this exposure."

However, despite Bromley's hard work and the creation of a visionary business strategy that had the potential to make the company millions of dollars, the plug was very nearly pulled on the entire ColecoVision project. "Even at a very late date, Coleco's



The Coleco Adam in its 'Expansion Module' variant. The machine was unfortunately dogged by technical issues.



sales and marketing was about to drop the product," he remembers with a grimace. "I had to privately talk Arnold Greenberg into going forward. My argument was that the Atari VCS/2600 and Mattel Intellivision could not do either *Zaxxon* or *Turbo* in any way close to the ColecoVision, which had twice the horizontal resolution of the Atari VCS and half again that of the Intellivision. Atari was using what was essentially a chip that directly wrote the screen on the fly; thus, any complex graphic would take too long to be displayed. Add to that speed limitations that made it impossible to render graphically interesting objects fast enough to create hand-eye coordination difficulties. It just could not be accomplished with Atari VCS technology. The Intellivision had even more issues. It used General Instruments' five-chip set with several chips used to write different sectors of the screen. There were extensive restrictions on moving from one sector to another, creating problems moving objects diagonally over the boundaries."

Bromley was very aware of the Intellivision's limitations because he had a hand in developing the hardware inside the rival console, as at one point Coleco was about to snap up the chipset itself. "I helped develop the chipset and its operating system," he reveals. "After spending almost two years working with General Instruments, trying to fix a myriad of problems, I suggested that Coleco walk away from it. We did, and much to my amusement Mattel bought it. I was wild with glee.

We knew that we could be vastly better than our competitors and they couldn't fight back."

Bromley's unwavering faith in his creation paid off, because the ColecoVision eventually made it into production. The machine's raw graphical power and clear technological advantage over the competition helped it sell 2 million units before the world came crashing down in 1983, but possibly the biggest contribution to the ColecoVision's success was the game that was given away free with each console: Nintendo's *Donkey Kong*. The story of how Coleco came to acquire this highly desirable licence from under the nose of the incumbent Atari is the stuff of videogame folklore, and Bromley is more than happy to exclusively reveal the entire gripping saga.

"It all began with a business trip to Kyoto," recounts Bromley. He was in Japan to meet with Nintendo president Hiroshi Yamauchi. "It was late afternoon when we were allowed to enter the supreme chamber. The room was one quarter the length and width of a football field and was completely done, floor to ceiling, in matched teak panels. I don't recall as much as a clock or any picture on the walls. The only thing that broke up this expanse was the doorway opening, one eight-foot desk in the centre of the room with nothing on it but a pad and pencil, two plain wooden chairs set in front of the desk and one very tall-backed leather chair behind it. When we entered, we were the fifth, sixth and seventh objects in the room. I

sat down in the left-most chair in front of the desk, and my friend, translator and mentor in all things Japanese, Makihara-san, sat next to me. Yamauchi-san's aide said 'Yamauchi-san will be in shortly,' and then, right on cue, he made his entrance. He came into the room via the parting of the wall behind the desk, which we soon realised was a door disguised as a panel. I then noticed that our entrance way was no longer visible – apparently all doors to this room were panels, or vice versa. I fully expected that behind every panel in the room was a samurai warrior ready to pounce, lest I make the smallest mistake in etiquette!" The intense formality of the setting was clearly intended to intimidate those who arrived at Nintendo's offices

Community

THE BEST COLECOVISION WEBSITES



ColecoVision Zone www.colecovisionzone.com

■ A superlative ColecoVision reference site with complete listings of games, a collection of vintage TV commercials, original documents, and photos of rare prototypes. The textual information is ably supported by some brilliant photographs and you can even browse issues of the short-lived *ColecoVision Experience* magazine.



ColecoVision.dk www.colecovision.dk

■ A Danish fan site that has a particular focus on the budding ColecoVision homebrew scene. As well as plenty of information about the console, it's also the home of CollectorVision, a group of coders that is producing games for the machine. A legally dubious version of *Mario Bros* is the most impressive effort, and more titles are promised.



■ This advert was released late in the console's life and shows the Super Game Module, which was never released.



COLECOVISION

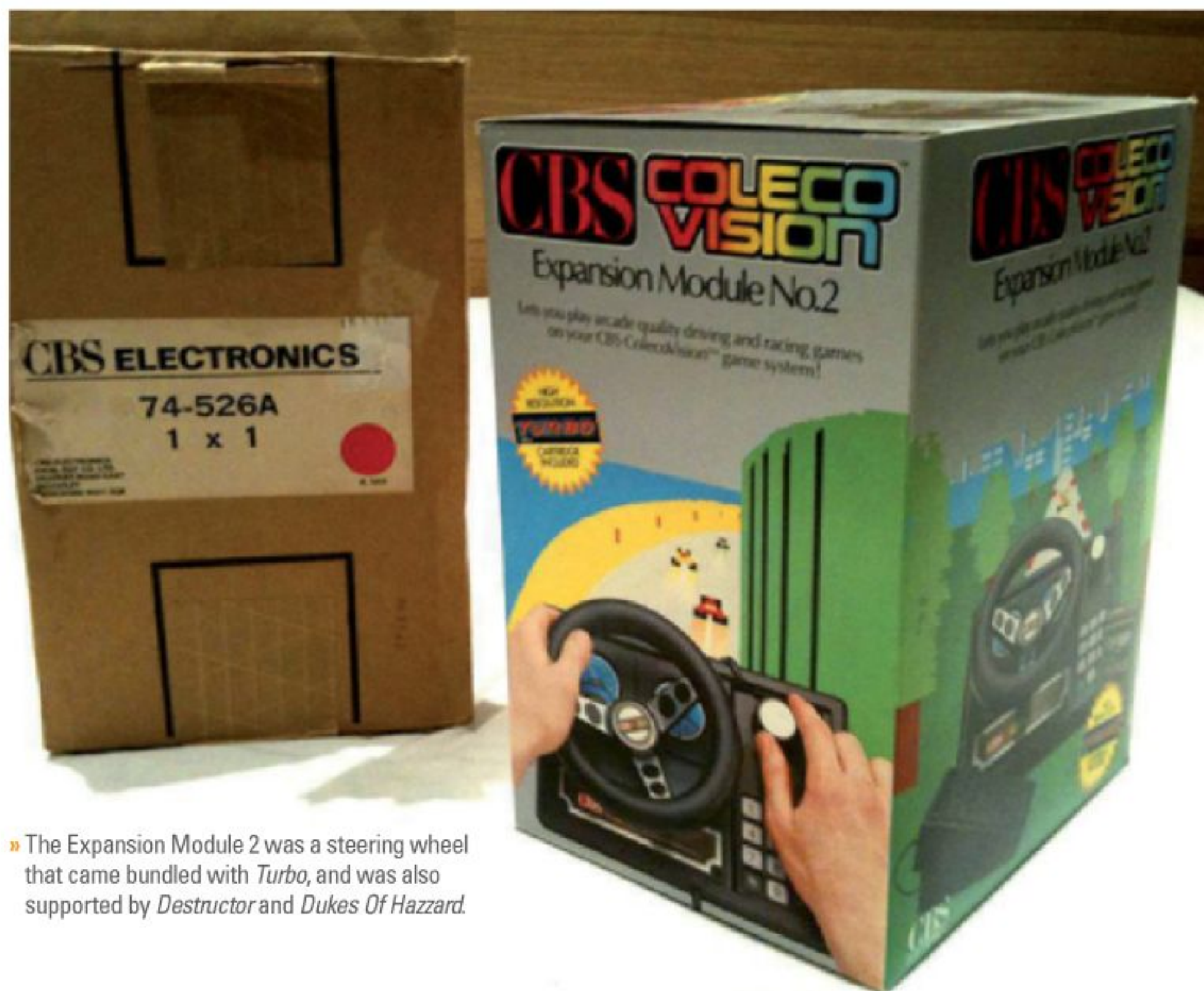

► The Expansion Module 2 was a steering wheel that came bundled with *Turbo*, and was also supported by *Destructor* and *Dukes Of Hazard*.

to do business, and the mind-games from its president continued as the discussions progressed.

"Yamauchi-san seemed not to understand a word of English," explains Bromley with a wry smile. "Every word we said was translated. A year later I found out that he understands English extremely well." Other nefarious tactics were employed to ensure that the Japanese firm was always in the strongest position. "I learned never to tell Yamauchi-san the correct day or even time of our departure," says Bromley, "because he played an effective negotiating game. He continuously discussed non-essential items and held back important responses, then, when there was very little time before we had to leave to make the train back to Tokyo, he began the real negotiations. At this point there was a terrible pull to give in

► This portable ColecoVision was produced by legendary hardware modder Ben 'Ben Heck' Heckendorn.



on any remaining points in order to make the train. Thus began my first lesson in commercial samurai strategy: always lie about when you must leave!"

Bromley returned to Nintendo the next day to resume negotiations, and it was on this fateful visit that he stumbled across the game that would become the ColecoVision's secret weapon. "We were shown some very unexciting videogames, as well as some handhelds that were very popular in Japan, but I felt these wouldn't work in the US," remembers Bromley. "Afterwards we had an informal late lunch at the headquarters. It was a very simple Japanese meal, not meant to impress. I enjoyed it thoroughly. After trying lots of unknown stuff – I ate these things with the conviction that they did not want me dead, and besides, they also ate it – I accepted many cups of tea, after which I asked about using the bathroom." What followed is probably the most famous trip to a toilet in videogame history.

"It turned out that the bathroom was on the floor above," explains Bromley. "I decided to find it alone, and when I came out I passed an open door that displayed a familiar silhouette – the standard upright cabinet seen in all videogame arcades. I turned on the light and there, for the first time, was *Donkey Kong*, complete with a picture of a gorilla on each side. I fell in love right there, no question." Bromley knew this title – which was hitherto unknown in the West – could be the game to propel his console into the public consciousness. He also knew he had to act fast. "A meeting was arranged for the next day," he reveals. "I said I wanted the rights to *Donkey Kong*. I didn't want Atari to find out about this

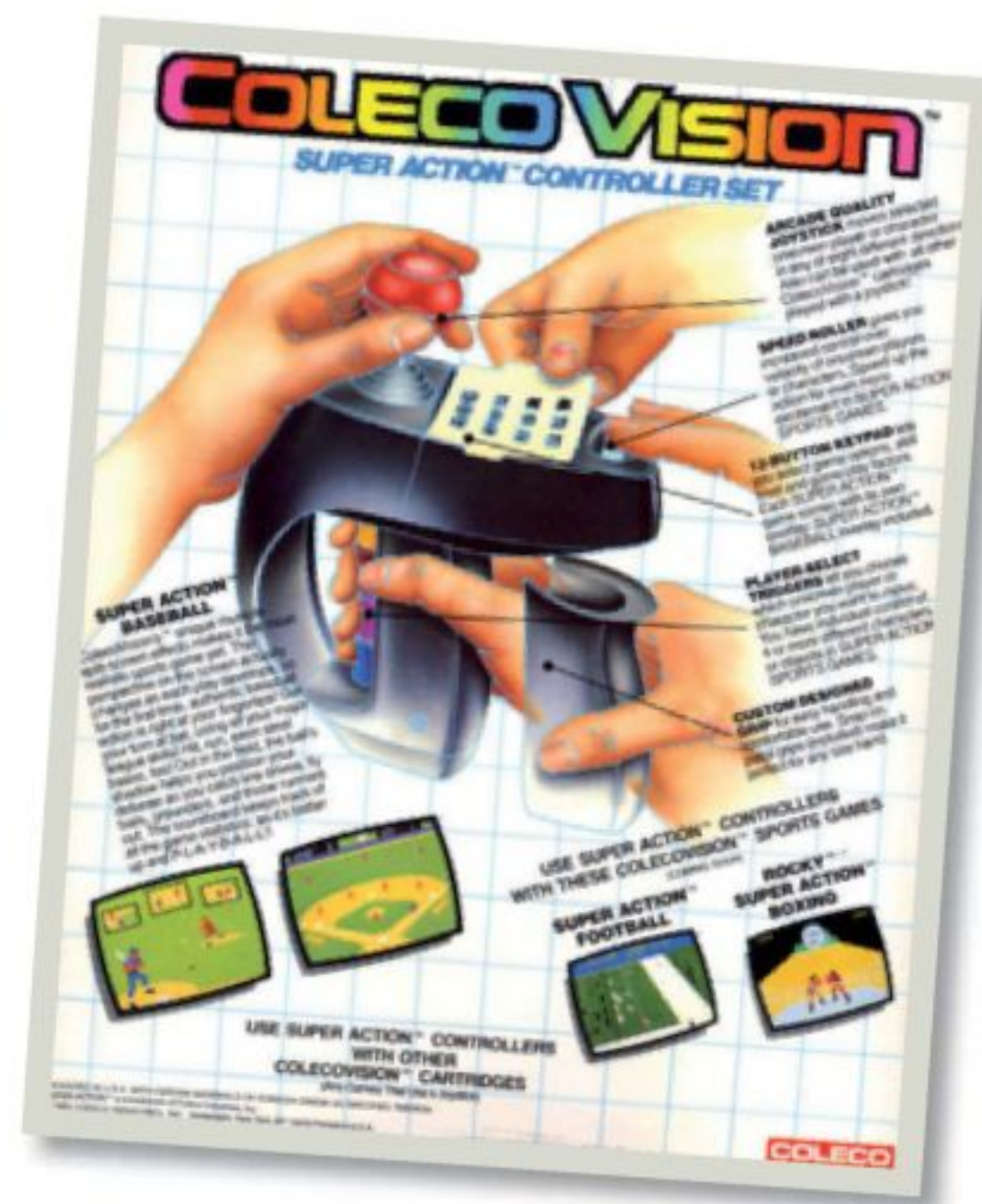

game. After a lengthy conversation, Makihara-san told me that Yamauchi-san wanted a \$200,000 advance and a \$2 per unit royalty. It was around 10am and Yamauchi-san knew that I needed to catch my train, so then he added the kicker: the \$200,000 must be wired to his account by midnight, or it's not a deal." The odds were most certainly against Bromley. "The most Coleco had ever paid for an advance for any licence up to then was \$5,000," he says. "Also, they never, ever paid more than five per cent of their selling price; the worst case would be about 90 cents. Now because of the need to wire the money before 12am Tokyo time, I needed to take the next available train. I would have to call as soon as I got back to my hotel in Tokyo, which would be in the afternoon and therefore wake up Arnold Greenberg in the US, the only one who could authorise an immediate wire transfer. I was to call him at home, wake him up, and then ask him to wire \$200,000 for a game he has never seen or heard of. If that wasn't bad enough, he then has to agree to more than twice the usual royalty amount!"

Bromley stayed firm, spurred on by the fact that he knew that *Donkey Kong* would be a smash hit once Western gamers laid eyes on it. "Upon my return to Tokyo, I called Arnold Greenberg from my room – I was shaking a little," he admits. "It was about four in the morning and I got: 'Whaaaaa? Do you know what time it is?' I referred him to a conversation we had days before with marketing and sales; we all agreed we needed a really spectacular game to bundle with the ColecoVision console to create an impact. I then told him of the conditions: \$200,000 advance and the \$2 per unit royalty. I said: 'I have found that game.' To my surprise, all he said was: 'Is it really that good?' I told him that it was as good as *Pac-Man*. He asked what it was called and I uttered '*Donkey Kong*'. Silence. For the first time

Variants



ColecoVision

■ The original machine was launched in 1982 with *Donkey Kong*. 500,000 units were sold, largely on the strength of this conversion. The all-important expansion slot offered the ability to upgrade, but sadly the console was discontinued in 1985.



ColecoVision Adam

■ The Adam came as an expansion for the core console or a standalone computer, capable of playing ColecoVision cartridges and more. Defects plagued the machine and it was discontinued in 1984; Coleco lost a reported \$80 million on it.



Super Game Module

■ The final expansion module was effectively an upgrade to boost its power. Similar to Nintendo's Famicom Disk System, games came on high-capacity 'wafers', with more memory for bigger games. *Super Donkey Kong* was planned, but the module never made it out.



Dina 2-in-1

■ A clone of the ColecoVision and Sega SG-1000 produced by Taiwan-based Bit Corporation, this machine had a cartridge slot for each format. The pads were more traditional, and the ColecoVision's numerical keypad was moved to the main body.

I realised how silly the name sounded. What seemed like an hour later he said, 'Okay. Let's do it,' and said he would wire over the money as soon as the banks opened that day." Bromley had just secured the home console rights to one of the hottest games of the Eighties – or at least, he thought he had, until the saga took an unwelcome twist thanks largely to the Japanese way of doing business.

"Legal contracts were not something that was part of Japanese culture at that time," he explains. "We were going to create the agreement over dinner. Makihara-san, who at this point was accepted as official translator for both sides, started the negotiations and wrote down six or seven points on a cloth napkin. I forget how many points we ended up with, but when translated into English on still another napkin, I could read them all without unfolding it. We had a deal. I took my \$200,000 napkin and went home." Upon returning to the US, Bromley began to have doubts about the strength of the deal he had just secured. "In the electric buzz of Tokyo, my linen napkin – now valued in the millions based on sales projections –

▶ Coleco's TV adverts went to great lengths to point out the console's superiority over the ageing Atari VCS/2600.



seemed adequate. I can't remember the look on Coleco's in-house

attorney's face when I pulled out the napkin, because I didn't want to see it. I tried to explain that this is how the Japanese do business: you all get high on sake, write down the points that matter, and try to get up in the morning without a hangover."

Bromley's sudden apprehensiveness was well founded; at the next Consumer Electronics Show, the house of cards very nearly collapsed completely. After months of trying to get Nintendo to

sign a contract that was legally binding in the eyes of US law, Coleco finally got Yamauchi to agree to hand over the vital document at the company's CES booth. Needless to say, it didn't exactly go according to plan. "His daughter Yoko spoke to me and said that Yamauchi-san had given *Donkey Kong* to Atari," says Bromley with a face that still displays the pain of the moment. "I froze. *Donkey Kong* was going to be the ColecoVision anchor. All our marketing plans were placed around that game. I was in a cold sweat. I sat down in my room and was thoroughly depressed for about two hours. I think it was 10 or 11pm



Collecto-Vision

Because the ColecoVision made such an impact at the time with its arcade-quality visuals, it's perhaps not surprising to learn that a sizable collector's market has grown up around it today. ColecoVision fanatic Ole Nielsen – the man behind ColecoVision.dk – vividly recalls the day his obsession started. "It was love at first sight," he says. "For me, it was primarily the graphics, tunes, and realistic game sounds the machine could deliver." The inherent appeal of the machine is amplified by the fact that it's ideal for people looking to build a complete anthology of titles in a short space of time.

"The Colecovision is perfect for collectors," states Junior Tétrault, founder of ColecoVision Zone. "The game's library is not too big – around 125 titles – and most of the games are fun." That said, there are a handful of super-rare carts that continue to elude devoted ColecoVision addicts. "Xonox games are hard to find," reveals Tétrault. "The company released 12 games and most of them are very bad and didn't sell well. Two of the double-headers, *Tomarc The Barbarian/Motocross Racer* and *Sir Lancelot/Robin Hood*, are the rarest. The late release of *Tournament Tennis* by Imagic, when the console was almost discontinued, makes this game a sought-after title. The four educational games made by Fisher-Price – *Dance Fantasy*, *Linking Logic*, *Logic Levels* and *Memory Manor* – are almost impossible to find boxed. Ironically, the most common cartridge, *Donkey Kong*, is also the rarest boxed game in North America. The cart came with the console without a box but the game was also sold as a standard retail release."

“ Yamauchi wanted a \$200,000 advance. The most Coleco had ever paid for an advance for any licence up to then was \$5,000 ”



DAVE JOHNSON

Director of video graphics, Coleco



■ How did you become involved?

I was working in New York as a graphic designer but, having studied computer graphics, I was looking for an opportunity to work in my field. I answered an ad and met with a headhunter who set up an interview with Eric Bromley, the head of electronic games at Coleco. He was in town for Toy Fair, an annual industry event.

■ What did you think of the ColecoVision when you first saw it?

My first exposure was at the aforementioned Toy Fair during my job interview. There was a video wall showing mock-ups of animated cardboard cutouts. I knew enough about video, animation and computer graphics to realise that the mock-ups were fake and I pointed this out to Mr Bromley. He then pointed to one video of a Smurf running across a side-scrolling background. It was clear that this was real and was several notches above the existing home game systems.

■ What did your role involve specifically?

I ran a department of artists who were responsible for the development of graphics for all of the games. Day-to-day involved visiting every artist and offering suggestions, technical help, art direction, options and so on. I worked, hands-on, on several games when there was time.

■ What was it like working at Coleco at this time?

It was a group of very talented, super-smart, very motivated people. At the beginning, we didn't know if the product would be a success, but it was great fun in any case. As the product took off, it was very rewarding. But, by the end, we were all a little tired of the place.

■ How did you go about converting arcade hits to the machine and what kind of support did you get from the original developer?

The deals with the coin-op manufacturers were usually a mystery to the design group, especially in the beginning. A new machine would appear from Japan and we would set to work studying it. We had no support from the manufacturers and, at that time, code was not at all portable. We would find someone who had a knack for the game and spend hours videotaping every level. Game designers would then sit, review the tapes and document the gameplay. The artists would reproduce the graphics.

■ You also created original titles for the console. How did the design process differ from the coin-op ports?

A similar production process as in the ports in some respects: a game design document, a set of graphics. The creative process, in some cases, was slower and more involving. *Smurf* was the first. Eric Bromley was the lead on the project. I have to give him credit with inventing the side-scrolling concept. I'll take credit for the idea of points as you pass certain hurdles. Seemingly simple concepts but they were new at the time.

■ Is it true you personally asked for Coleco to secure the rights to convert *Spy Hunter* because you were such a fan of the coin-op?

There was an annual trade show where coin-op manufacturers showed off their wares. I went with George Kiss, the head of software development and also my boss. I remember begging him on the plane home to buy the rights. I was like a kid asking for a Christmas present. I really thought the music was hot; the game itself was not that interesting. We did get the rights but who knows if my request had any effect.

■ Why was there such a long pause before each ColecoVision loaded? Was this a technical thing?

No, no, no! Please put that rumour to rest! One day, Eric Bromley stood at my desk with a bunch of marketing execs and watched a simulator of the console. They had their watches out and counted down, deciding how long the opening screen should last. It was all about branding. The later versions of the operating system fixed that, but it was too late.

when the depression turned to anger. I called Yamauchi-san's room and asked to talk with him. His daughter answered and said that he had gone to sleep and was not to be disturbed; she said it very politely and I hung up. But I got still angrier at having my dream disintegrated by Atari's money, so I called again. She answered and I poured my heart out; I told her how the ColecoVision was my dream, how I put together a great team to build the best home videogame console ever and that *Donkey Kong* would look like crap on the Atari VCS. I guess she liked me because she asked if I could be there in 15 minutes. It was apparent that she was my ally – she believed me that this was not just a product, but also my dream. I had someone who believed what I said about the virtues of the ColecoVision and could relate them to Yamauchi-san as no one else could." With Yoko Yamauchi's assistance, Bromley's passion clearly shone through, because he was again granted the domestic rights to the game – this time in a legally binding sense.

With the *Donkey Kong* saga at an end, the ColecoVision had a game that proved just how powerful the machine was. By this point Nintendo's title had become a worldwide smash. Released in August 1982 and bundled with *Donkey Kong*, the machine would find its way into half a million American homes by Christmas of that year.

Expandability was the key reason for the ColecoVision's admirable

performance at retail. "There were two reasons why the ColecoVision expansion slot was carefully placed in the front," explains Bromley. "It was the key to our differentiation from other manufacturer's products. When we showed the 'beauty shot' in our ads we did not need a second picture to show it. It was always there; it promised to take you to exciting, unknown realms. That alone sold a lot of ColecoVision consoles. Secondly, it was a promise that everyone could soon have a real computer just by adding a module to the videogame console."

The ColecoVision Adam was supposed to be this home computer module, but it morphed into a fully fledged machine in its own right. "We created ColecoVision's operating system and the expansion slot connector for, among other things, the Adam computer. It was part of our plans from day one. The Adam was originally a keyboard with a deck that extended about two inches beyond the function keys containing the other computer circuits. It fit snugly against the console at the same height." The Adam's story is too lengthy and remarkable to cover in depth here, but suffice to say that it wasn't the success that Coleco had envisaged. However, the expansion slot was invaluable for other uses.

"We were the first to make home videogames to closely resemble current arcade games," states Bromley. "But if we were to really push that claim, we needed to have a steering wheel controller – complete with gear shift

» [ColecoVision] (Below) Coleco's own Cabbage Patch Kids predictably starred in their very own ColecoVision adventure.

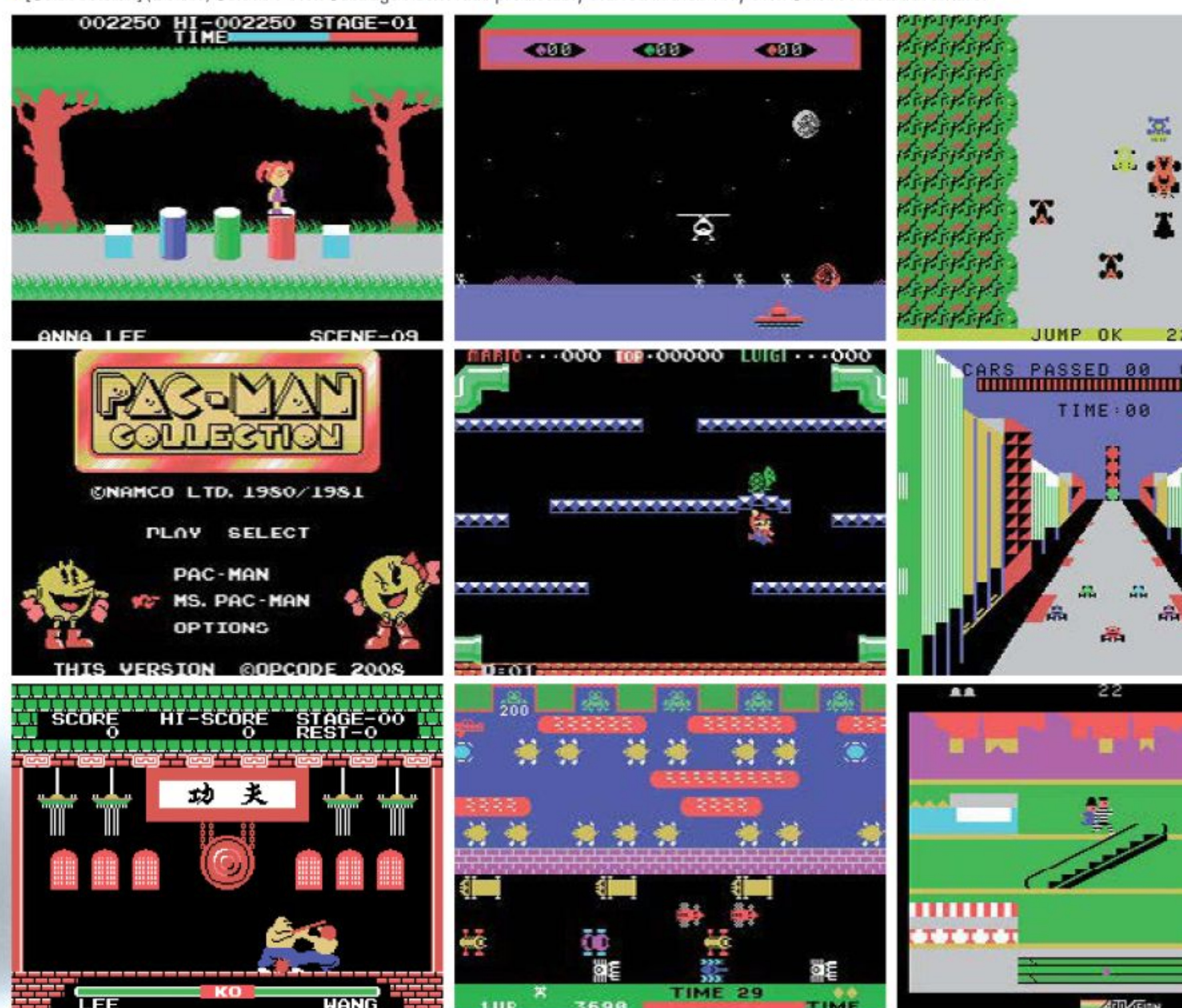



A massive thank you to **Andy Wareing** for kindly lending us his **ColecoVision**

ColecoVision Reborn

SCORE : 00001 TIME : 00116

HI SCORE : 00001

The ColecoVision may be nearly 30 years old, but that doesn't mean that games aren't still being cooked up. Thanks to the internet, a solid development community has sprung up and released several notable titles on the console.

"In 2009, *Mario Bros*, *Pac-Man Collection*, *Ghost 'N' Zombie*, and *Ghostblaster* were released by homebrew programmers," says ColecoVision Zone's Junior Tétrault. "A new expansion module is planned for some time this year, which will allow more sophisticated games. This will help the ColecoVision community to grow and will encourage people to rediscover the console they played 25 years ago."

Fellow ColecoVision enthusiast Ole Nielsen is an active part of this revival; he's involved in CollectorVision, which is the group responsible for many of the aforementioned new releases. "What appeals to me today is the homebrew games that many talented people have chosen to create," he says. "When the game is finished, they sell them complete with box, label and manual – just like an authentic ColecoVision release." As a gamer who has experienced the machine both in its prime and more recently thanks to its revival, Nielsen admits that it's the console's intrinsic appeal that keeps him coming back for more. "For me, it's still engaging regardless of whether the game is from the early Eighties or is a newer title, which attempts to replicate the experience."

and an accelerator – the ability to attach realistic weapons and the flexibility to match future arcade game controls. The expansion slot was a way to get beyond the 'joystick and button' control system. We also marketed a track ball controller and a 'Super Controller' for boxing and baseball games, which could control four or more objects at once. This was originally designed with 'tactile feedback' – a feature that could not be engineered at the time."

Arguably the most intriguing hardware add-on was a module that allowed ColecoVision owners to effortlessly increase their software library – providing they had owned an Atari VCS previously. "We had one of our better engineers work secretly on a circuit that would render Atari cartridges on the ColecoVision," Bromley recalls.

"The idea was if a kid already had those Atari games they could use them on the ColecoVision. This would counteract the parent's mantra: 'But you already have a videogame console.' The kid could say: 'But I can still use my old cartridges.' After several months of development, we finally saw the finished VCS player circuit and it worked perfectly. However, the module was more expensive to build than the actual Atari VCS was to buy. We toyed with the idea of buying Atari chips from one of their secondary suppliers, but that idea was dropped very quickly."

Atari took legal action when the module hit the market, but because it was possible to assemble a VCS-compatible device using standard parts, it was ultimately unsuccessful – although a royalty agreement was eventually put in place between the two firms.

Early in 1983, the ColecoVision passed the 1 million sales marker, and had the industry stayed buoyant, Coleco would have almost certainly been in with a chance of becoming the number one hardware manufacturer in the States. Sadly things didn't stay the same; the infamous crash of 1983 put the industry into a nosedive and all of Coleco and

Bromley's hard work was ruined. The company staged a retreat from the videogame arena, moving back into children's toys – the most notable range being Cabbage Patch Kids. "They bet on plush, Nintendo bet on electronics and video," says Bromley with a shrug of the shoulders. "Nintendo hung in until videogames took off again, while the Greenbergs instead blamed myself and the other ColecoVision guys for the failure; all the guys who took them in 1976 from bankruptcy to a million-dollar company and in the next eight years to almost a billion." However, even cute fabric babies couldn't save the firm's bacon. "It only took a couple of years after we left to get back to bankruptcy," Bromley comments. "If Coleco hadn't given up on videogames – crash or not – it would have been here today instead of Nintendo."



IP-000000 HI-000000 STAGE-01
HEIGHT-0000m

IP-003770 HI-003770 STAGE-01
TIME-0021 REST-0000km SPEED

-AUSTRALIA-

Expansion Module #2

ColecoVision Personal Computer Expansion Module

The above promotional flyer details the steering wheel – better known as Expansion Module 2 – and a brief description of what would eventually become the Coleco Adam personal computer system.



COLECOVISION

PERFECT TEN GAMES

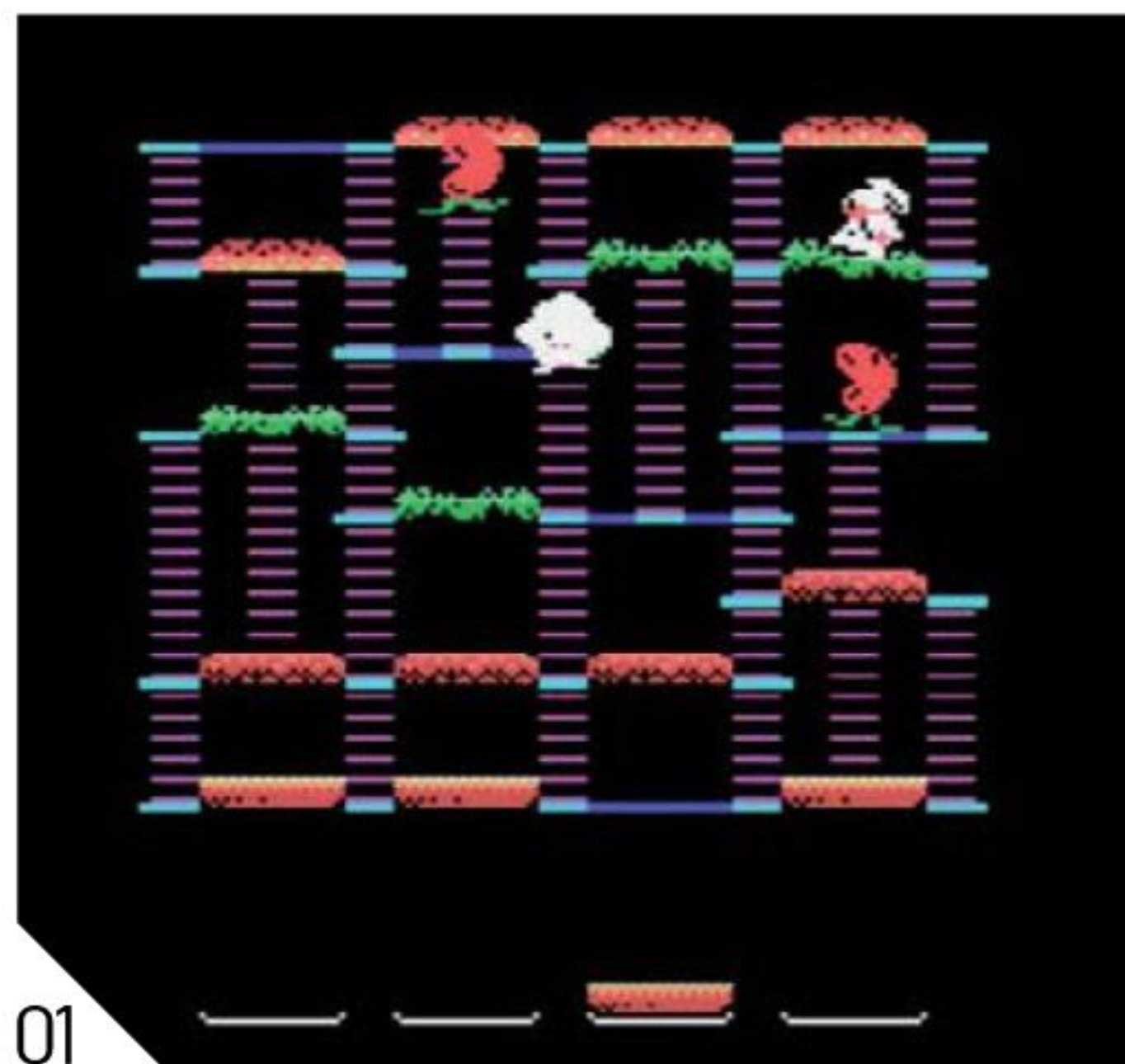

01

BURGER TIME

- » RELEASE: 1984
- » PUBLISHER: DIGIMAX
- » PRICE: £10+
- » BY THE SAME PUBLISHER: DEFENDER

01 One thing that constantly impresses with the ColecoVision is the sheer number of excellent arcade ports that are available for it. Coleco's port of *Burger Time* is easily one of its best, and the end result is an incredibly faithful conversion of the cult arcade coin-op. Animation throughout is superb, with the large, well-animated sprites rarely suffering from flickering, while the gameplay is extremely close to its arcade parent. Pete doesn't feel quite as fast as he did in the original game, but a choice of four difficulty levels and excellent, tight controls ensure that *Burger Time* will be a game that you'll constantly find yourself returning to. Highly recommended.

FORTUNE BUILDER

- » RELEASE: 1984
- » PUBLISHER: COLECO
- » PRICE: £40+
- » BY THE SAME PUBLISHER: MOUSE TRAP

02 Predating *SimCity* by a good five years, *Fortune Builder* is a polished sim that proves that there was more to Coleco's machine than just arcade conversions. Initially you're presented with a large space of land, but you're soon able to build a staggering range of items, ranging from simple roads to apartments and even casinos. The aim is to ensure that your city reaches a certain value, but your success can be hindered by random events like rampaging termites. For all its addictiveness, *Fortune Builder* really comes into its own with the addition of its insanely polished two-player mode that allows you to compete or work together in order to make the best city.



02

GORF

- » RELEASE: 1983
- » PUBLISHER: COLECO
- » PRICE: £7+
- » BY THE SAME PUBLISHER: ILLUSIONS

03 As with every other official port of Jamie Fenton's coin-op, the ColecoVision version is missing the 'Galaxians' stage. That omission aside, this is nevertheless an excellent arcade port and is miles above anything on similar consoles at the time. It's missing the cool speech from the original, but otherwise the sound is strong, mimicking its arcade parent. Visually it's also impressive, with well-detailed sprites that perfectly capture the spirit of the arcade hit. Best of all, though, is the gameplay. Yes, the missing stage is a pity, but the excellent collision detection and controls certainly make up for it.

TURBO

- » RELEASE: 1982
- » PUBLISHER: COLECO
- » PRICE: £20+
- » BY THE SAME PUBLISHER: MR DO!

04 The astonishing *Turbo* can only be played with the ColecoVision's steering wheel controller. With that caveat out of the way, let's examine one of the machine's most impressive games. While not a racing game like other titles on the system – you're simply rated on how many other cars you pass – *Turbo* remains one of the best examples of the genre. Not only is the sense of speed sensational, but the graphics are phenomenal, with huge buildings that other racers of the time could only dream of. An unforgettable experience and easily one of the ColecoVision's best ports.

RIVER RAID

- » RELEASE: 1984
- » PUBLISHER: ACTIVISION
- » PRICE: £13+
- » BY THE SAME PUBLISHER: PITFALL!

05 Activision released plenty of its Atari games on the ColecoVision, with many of them being superior to the 2600 versions. *River Raid* is no different, and even after a quarter of a century, this port remains brilliant fun. The sprites are more refined, the scrolling is smoother and everything feels that little more polished. Ultimately, however, it's the enduring gameplay that grabs you, and *River Raid*'s blend of strategic shooting – blowing up fuel barrels gives you points, but reduces the available fuel – and hectic blasting ensures that you'll never become bored of it.



03



04



05

If you want excellent arcade ports and original content, this really is a console you should own

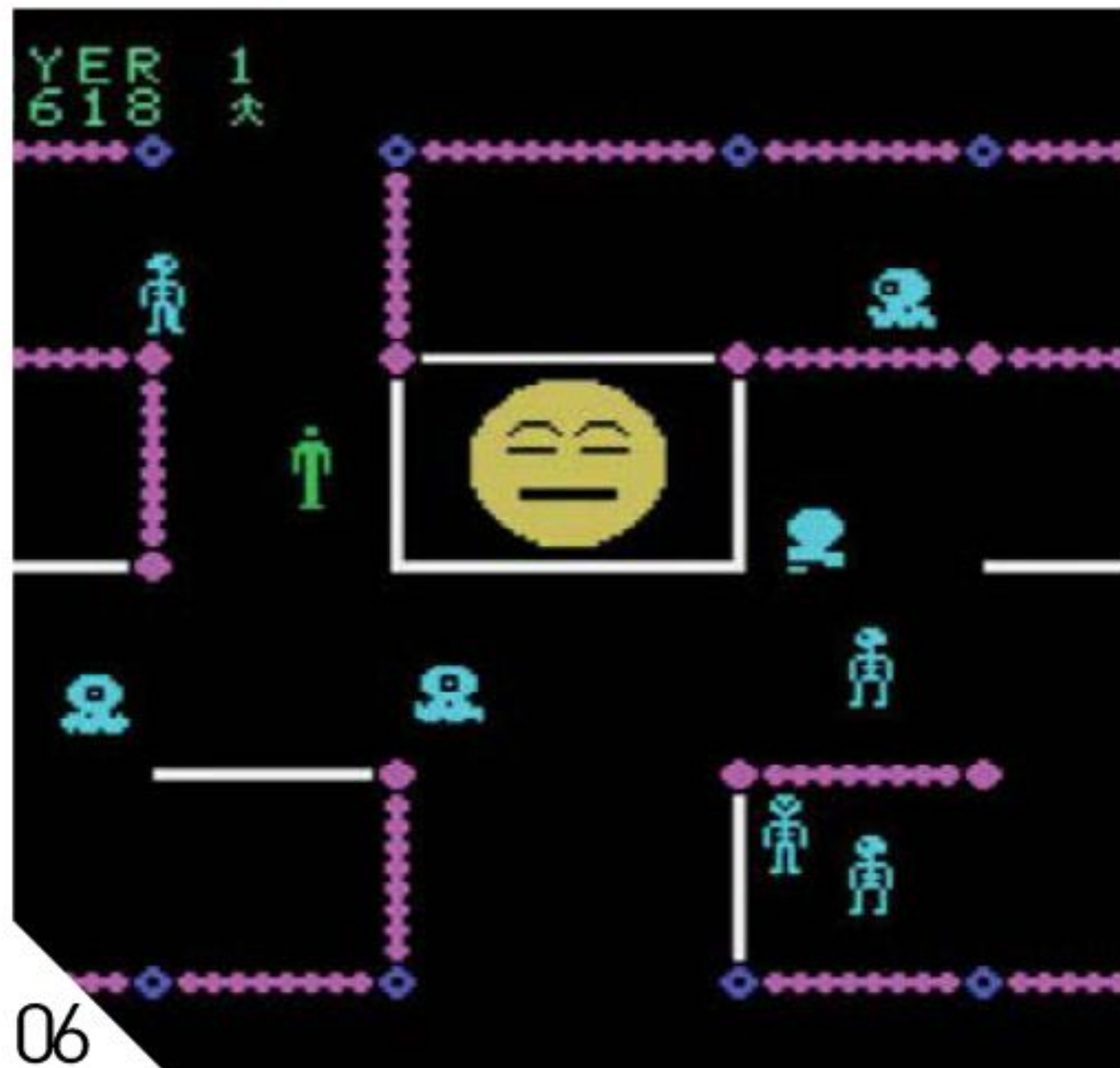

06

FRENZY

- » RELEASE: 1984
- » PUBLISHER: COLECO
- » PRICE: £13+
- » BY THE SAME PUBLISHER: LOOPING

06 *Frenzy* wasn't ported to many home systems, but the ColecoVision version really is an impressive port. The controls are responsive, allowing you to navigate each room with ease, and collision detection is as tight as a proverbial drum, while the AI ensures that you'll find plenty of challenge. Graphically it delivers thanks to a minimum amount of flicker, authentic sprites and solid animation of the lead character. Ultimately, though, it's *Frenzy's* frantic gameplay that will keep you returning. Another great game that shouldn't be missed under any circumstances.



07

WARGAMES

- » RELEASE: 1984
- » PUBLISHER: COLECO
- » PRICE: £20+
- » BY THE SAME PUBLISHER: SUPER ACTION FOOTBALL

07 With so many great arcade ports, it's refreshing to add an original ColecoVision game to the list. The nearest descendent to *WarGames* is Atari's *Missile Command*. The difference here, however, is that you're defending the United States, and you have to nip between each section and see off the incoming missiles. The end result is an amazingly hectic experience that really cranks up the tension as you desperately try to fend off tough waves of warheads. The aesthetics are fairly simplistic but you'll be having so much fun that you won't care.



08

JUMPMAN JR

- » RELEASE: 1984
- » PUBLISHER: EPYX
- » PRICE: £15+
- » BY THE SAME PUBLISHER: GATEWAY TO APSHAI

08 Yes, the conversion of *Donkey Kong* is impressive, and yes, *Miner 2049er* is extremely polished, but this superb effort is definitely our favourite ColecoVision platformer. The visuals are pretty uninspiring, but it matters not as the frantic gameplay is absolutely sublime. There are 12 stages to make your way through as Jumpman bounds across each stage in his pursuit of bomb. It may not be the most jaw-dropping-looking ColecoVision title, but in terms of gameplay it's virtually unmatched and a must for platform fans.



09

PEPPER II

- » RELEASE: 1983
- » PUBLISHER: COLECO
- » PRICE: £10
- » BY THE SAME PUBLISHER: Q*BERT

09 Think of a cross between *Pac-Man*, *Qix* and *Amidar* and you'll have something in your mind's eye that quite possibly resembles *Pepper II*. A port of Exidy's 1982 coin-op – we've no idea what happened to the original *Pepper*, or if it even existed – each screen is full of mazes and enemies and is highly reminiscent of Konami's excellent *Amidar*. The difference, however, is that if you re-cross a line you've re-painted it will open up again, which adds a great level of strategy to proceedings and is further enhanced by the fact that you can actually play across four different stages at the same time. Yes, it's another arcade port, but another we heartily recommend.

DONKEY KONG JR

- » RELEASE: 1983
- » PUBLISHER: COLECO
- » PRICE: £10
- » BY THE SAME PUBLISHER: DONKEY KONG

10 *Donkey Kong* may have been a pack-in and a huge success for Coleco's marvellous machine, but we actually prefer *Donkey Kong Jr*. It's missing one of the levels from its arcade parent, but this is another predictably good arcade conversion that has you scaling chains as you try to rescue your dad from an irate Mario. Gameplay is extremely smooth; the large visuals do a great job of capturing the cartoony sprites of the arcade original, while spot-on collision detection means that you'll never lose a life unless you messed up yourself. It's not quite arcade perfect, but this is another cracking conversion that leaves the Atari 2600 effort on the starting blocks.



10



COLECOVISION

COLECOVISION and the rest...

A powerhouse when it came to spectacular arcade conversions, Coleco's machine also boasted plenty of original games. Here are just a few of its best...

- 01 ALPHABET ZOO
- 02 FRANTIC FREDDY
- 03 SLURPY
- 04 TUTANKHAM
- 05 BOULDERDASH
- 06 DONKEY KONG JR
- 07 MOONSWEEPER
- 08 FRENZY
- 09 BURGER TIME
- 10 MR DO!
- 11 2010: A GRAPHIC ACTION GAME
- 12 FROGGER
- 13 DEFENDER
- 14 CHUCK NORRIS SUPERKICKS
- 15 PITSTOP
- 16 H.E.R.O.
- 17 MONTEZUMA'S REVENGE
- 18 TIME PILOT
- 19 EVOLUTION
- 20 TOURNAMENT TENNIS
- 21 GYRUSS
- 22 VICTORY
- 23 WING WAR
- 24 BEAM RIDER
- 25 GORF
- 26 CARNIVAL
- 27 JUNGLE HUNT
- 28 Q*BERT
- 29 THE HEIST
- 30 ANTARCTIC ADVENTURE
- 31 SMURF: RESCUE IN GARGAMEL'S CASTLE
- 32 GALAXIAN
- 33 VENTURE
- 34 LADY BUG
- 35 TAPPER
- 36 WAR ROOM
- 37 BUCK ROGERS: PLANET OF ZOOM
- 38 DANCE FANTASY
- 39 MOTOCROSS RACER
- 40 ILLUSIONS
- 41 POPEYE
- 42 SPY HUNTER
- 43 UP 'N DOWN
- 44 JAMES BOND
- 45 CHOPLIFTER
- 46 ROBIN HOOD
- 47 BC'S QUEST
- 48 KEYSTONE KAPERS
- 49 AQUA ATTACK
- 50 TOMARC THE BARBARIAN
- 51 AMAZING BUMPMAN
- 52 MINER 2049ER
- 53 WIZARD OF ID'S WIZ MATH
- 54 ARTILLERY DUEL
- 55 CABBAGE PATCH KIDS: ADVENTURES IN THE PARK
- 56 DONKEY KONG

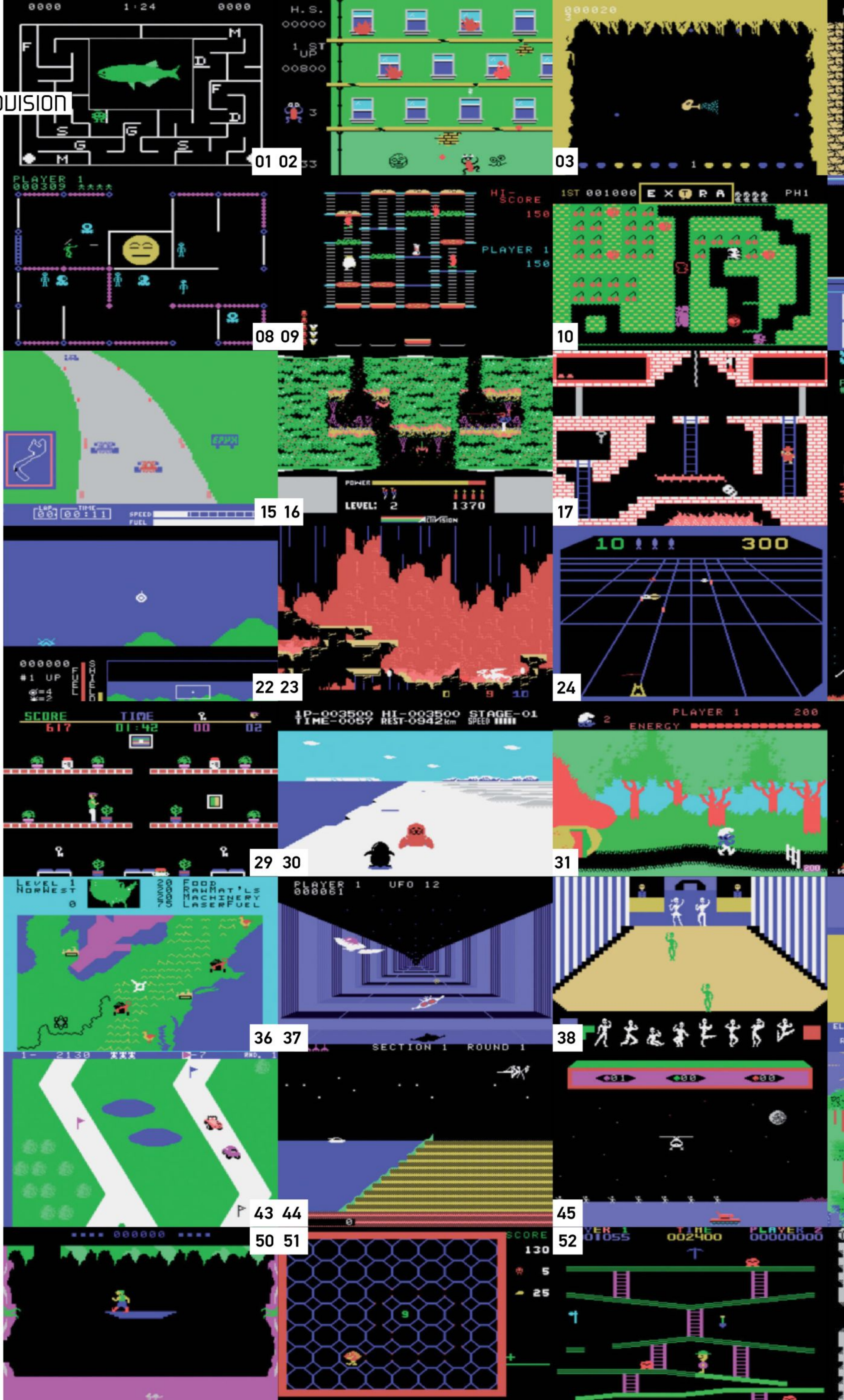

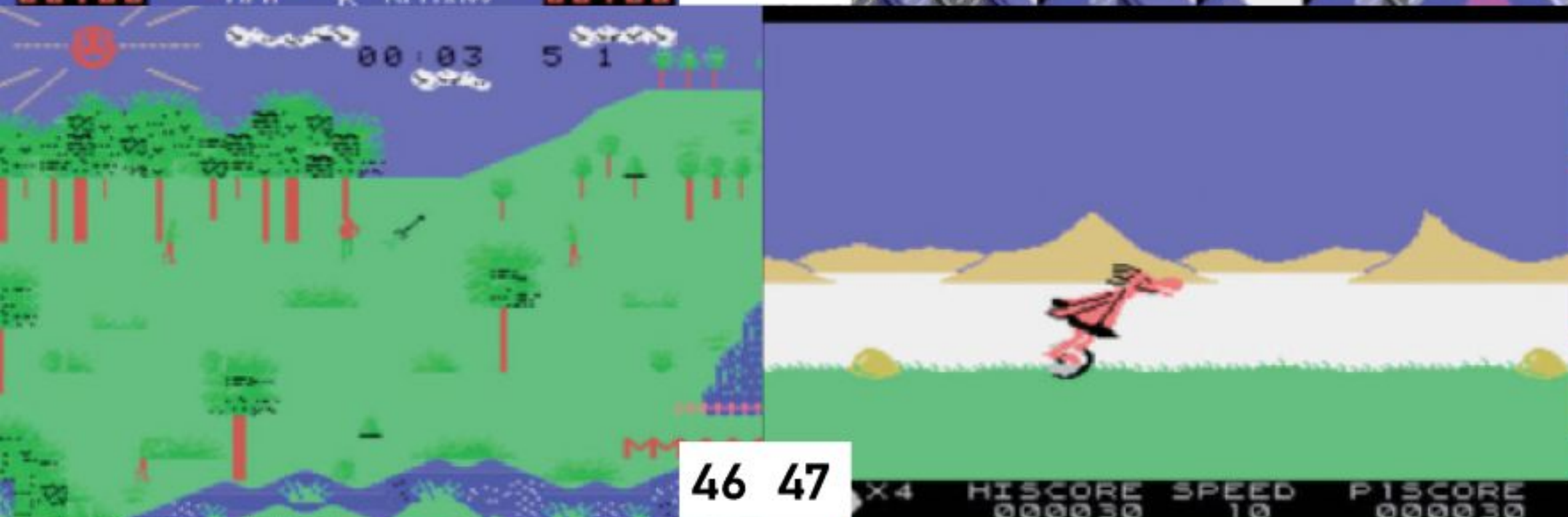
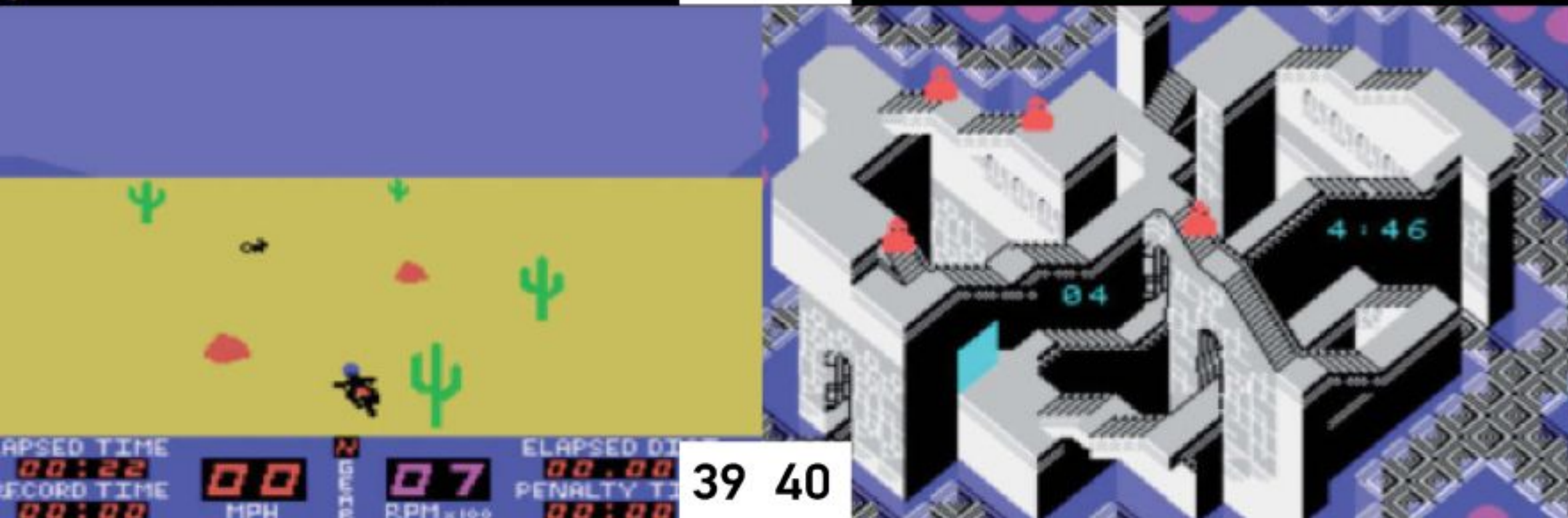



APPLE II

apple II

Specifications

Year released: 1977

Original price: \$1,298 for 4K version (board only for \$598); \$2,638 for 48K version

Buy it now for: £50+ for an Apple II+

Processor: MOS 6502 (1 MHz)

RAM: 4KB (expandable to 48KB)

ROM: 12KB

Display: 280x192 (4 colours/6 colours in rev 1 motherboard); 40x40-48 (16 colours)

Sound: One-channel

Associated magazines: *inCider*, *A+*, *Nibble*, *Softdisk*, *Juiced.GS* (still in print)

Why the Apple II was great: The Apple II boasted a number of firsts, including its prebuilt nature, colour graphics, sound, paddles and game commands in BASIC. Although the line itself eventually stumbled and fell, the original Apple II lived on in terms of inspiring products from myriad competitors. The Apple II also enabled an entire generation of primarily US-based gamers and programmers to start making their own games, and their creations have gone on to be hugely influential and important.

Although eventually eclipsed by Commodore and Atari machines, the Apple II began its life by revolutionising home gaming in the USA. We find out about the platform's origins and talks to former Apple II developers about what made the machine so great for gaming

It's fair to say that if we ignore Apple's relatively recent onslaught on the games industry via iPhone OS devices and the App Store, few would consider the Cupertino-based company one that makes products for videogamers, let alone an industry leader in the field.

Even modern Apple Mac owners lack choice when it comes to games, often having to put up with late, expensive, imperfect ports of old Windows titles, or the odd indie creation that trickles through – a situation that hasn't changed a great deal in over two decades. But things weren't always this way: for a brief, glorious time, Apple had one of the best home gaming systems around, courtesy of the Apple II. It wasn't a hugely powerful piece of hardware, although it was impressive for the time, but the Apple II caught the imagination of programmers and fans of videogames – then a very new concept – some of which subsequently became major players in the industry.

Apple's beginnings were in the hobbyist market. This mentality would be retained for the first revision of the Apple II, before a larger Apple's overtly corporate-minded direction resulted in the ill-fated decision to ignore the people who first supported the company and focus entirely on business. But at the start, it was a tale of two Steves: Jobs and Wozniak. Even in his early 20s, Jobs was a shrewd businessman, tactician and visionary, and Wozniak was an engineering genius. An oft-told story of the pair involves *Breakout*: Atari founder Nolan Bushnell offered \$100 for every chip that could be reduced from the circuit board. Jobs agreed to split the bonus with Wozniak, who dropped *Breakout's* chip count by 50, but nonetheless ended up with just a few hundred bucks, Jobs allegedly pocketing the rest. (Wozniak has since stated that he "gladly would have designed the *Breakout* game for Atari for free, just to do it", and admits that he was hurt when he found out about the "dishonesty", although he's over that now.)

In 1976, mostly in Jobs' garage, history was made: the Apple I was created and offered to HP. It declined, and Apple

Computer was born. The Apple I was the first single-board computer, sold fully assembled – users had to supply a keyboard, case, monitor and power supply – and innovated by relying on things that we now take for granted: keyboard input and the use of a television for output, rather than the tried-and-tested toggle switches and LEDs that its contemporaries used. For the day, this was impressive stuff, but Wozniak wasn't satisfied.

In Jack Connick's 1986 feature for *Call-A.P.P.L.E.* magazine '...And Then There Was Apple', Wozniak revealed that he wanted a faster, more colourful and noisier machine – and the Atari videogame he'd worked on was the driving force behind many of the technical decisions made. "A lot of features of the Apple II went in because I had designed *Breakout* for Atari. I

had designed it in hardware. I wanted to write it in software now," he said. Colour was added first, so games could be programmed: "I sat down one night and tried to put [*Breakout*] into BASIC. Fortunately I had written the BASIC myself, so I just burned some new ROMs with line-drawing commands, colour-changing commands, and various BASIC commands that would plot in colour." Having got a ball to bounce around, Wozniak realised that sound was required and so a speaker was added to the Apple II – something that, he said, wasn't planned, but was "just accidental". Paddles were the next addition, implemented via a simple paddle circuit. "So a lot of these features that really made the Apple II stand

out in its day came from a game, and the fun features that were built in were only to do one pet project, which was to program a BASIC version of *Breakout* and show it off," explained Wozniak.

Continuing to effectively design for himself, Wozniak fashioned a computer with a number of firsts – the first machine of its kind to be sold completely assembled; the first boasting a plastic case; the first with colour graphics, hi-res, sound and paddles; the first with BASIC game commands and the BASIC in ROM – and only the Apple I had beaten



» The Apple II and III in harmony in an ad. Off-camera, they were punching each other's expansion slots in.

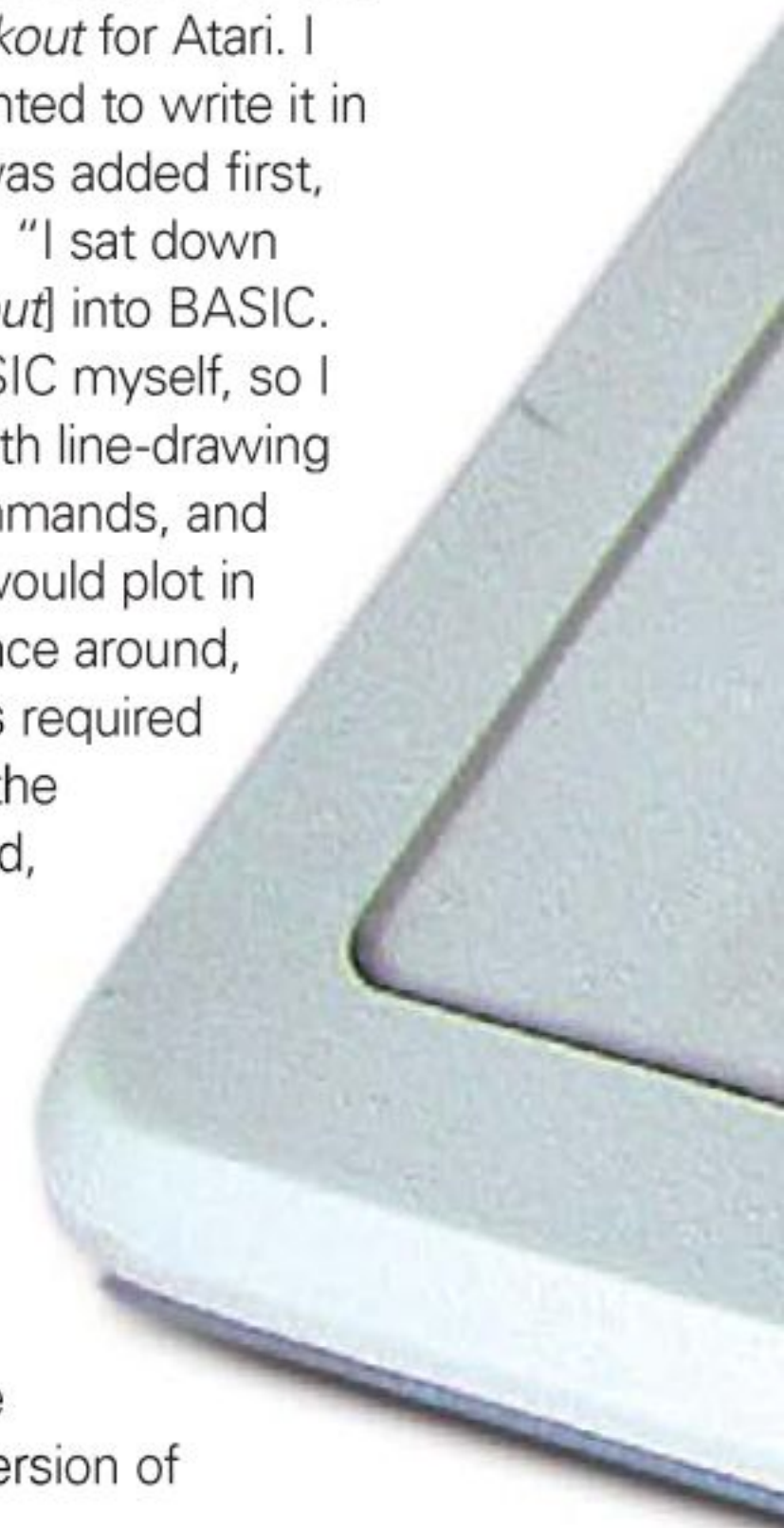

“The Apple II was architecturally very simple and open. A game program could essentially take over the entire machine”

Bill Budge





APPLE II

“The Apple II didn’t have the best graphics and sound capabilities, but it was a machine you could push, and that was satisfying”

Jordan Mechner

it to the punch regarding using a home TV as a monitor. Although the machine’s specs – four colours (six after the first revision, adding orange and blue to black, white, green and violet), one-channel sound via a click-emitting toggle circuit, 4KB of RAM by default – would soon be eclipsed and seem restrictive compared to rival machines released in the early Eighties, they were instrumental in sparking the imagination of people who would go on to work wonders with the platform. “There were several microcomputers available in 1979, and my friend, Andy Hertzfeld, had just bought an Apple II and was doing interesting programming on it,” recalls Bill Budge, creator of landmark Apple II pinball simulators *Raster Blaster* and *Pinball Construction Set*. “The fact that it had colour swayed me from buying a TRS-80 or one of the other small business machines that were coming to market.”

Budge wasn’t the only person seduced by the Apple II’s graphics capabilities. “My parents bought me an Apple II when I was 15, since we used them at school, and I wanted to produce animations,” recalls Jordan Mechner. “I knew from making those animations that the computer was powerful, and that it was capable as a games machine, and so I created *Karateka*. I’d been learning about silent film techniques in my history of cinema classes, and so I needed to produce something that was visually amazing. The Apple II was equipped to do that.” Although Mechner reckons that many felt that the Apple II was a dying platform by the time he started producing *Prince Of Persia*, it nonetheless still worked for him at the time: “The Apple II was a platform I understood. It was a lovely machine.”

On experiencing Apple II games today, it’s interesting to note that many play better – despite looking worse – than ports made to other platforms. It seems this, along with the Apple II’s general suitability regarding gaming, was down to the level of control it afforded. “The Apple II was architecturally very simple and open. A game program could essentially take over the entire machine, and clever people could make the machine do amazing things that probably weren’t foreseen by Wozniak and Apple,” thinks Budge, who fondly remembers the machine’s processor: “The Apple II’s 6502 wasn’t very fast, but it was simple. To get the highest speed, self-modifying code was necessary. There were no penalties for this technique like there are now, and this added a very interesting dimension to game design, which has been largely lost with modern hardware.”

Choplifter creator Dan Gorlin has similar memories: “One thing I really enjoyed about the Apple II was that you had absolute control over timing. Everything was real-time – no hardware interrupts, no other programs running – so you could polish the timing of things perfectly.”

John Romero, whose first published videogame was on the Apple II, in the form of a *Scout Search* listing in *inCider* magazine, suggests that this openness, combined with any perceived limitations, was hugely beneficial to Apple II gaming,

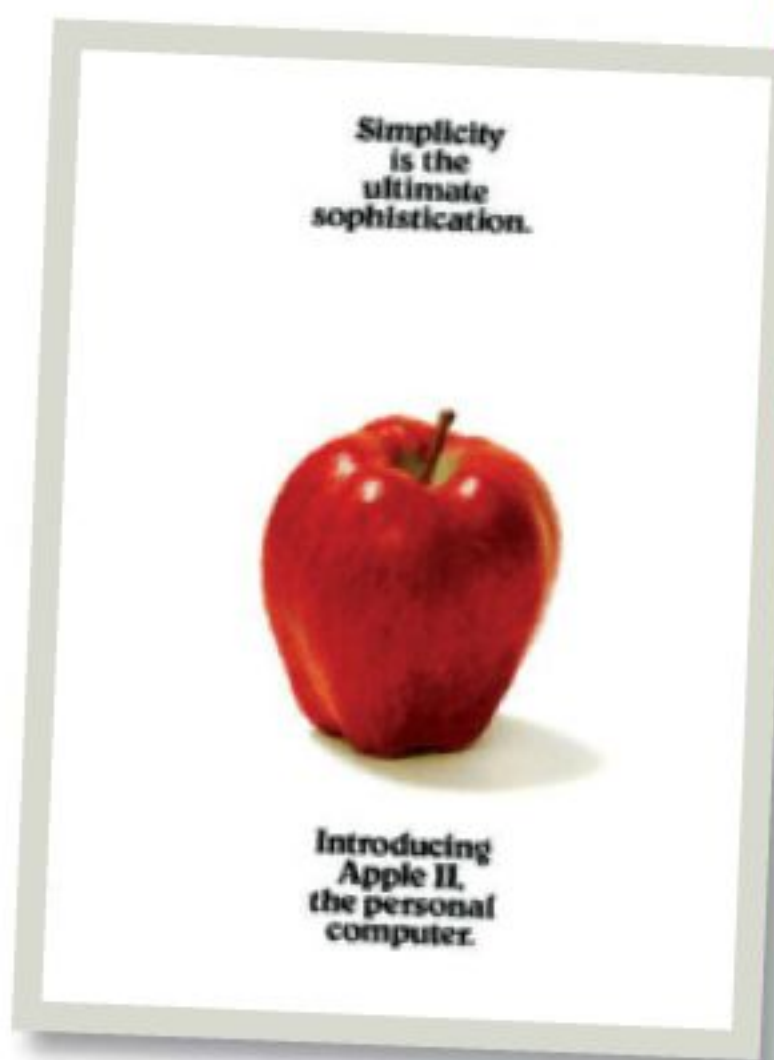

» And you thought modern Apple print adverts were minimal. Here’s how the Apple II was introduced.

» The 16-bit Apple IIGS boasted an interface akin to a colour Mac, but the system retained backwards compatibility with the original Apple II.

Apple Community



A2Central a2central.com

Describing itself as “your total source for Apple II computing”, A2Central is the best place to go for current news on Apple’s platform. Along with various links to user groups and a developer directory, the site also backs the last surviving Apple II publication, *Juiced.GS*.



Juiced.GS juiced.gs

As already noted, *Juiced.GS* is the last surviving Apple II publication, and, having recently celebrated its 15th anniversary, overtook *Softdisk* (1981-95) as the longest-running Apple II periodical. It now has a quarterly schedule and back issues are available in annual ‘volumes’.



Apple II History apple2history.org

Based around a series of articles printed in the early Nineties in a Nebraska newsletter, this site provides an in-depth history and analysis of the Apple II platform, including hardware, software, related publications and more. For offline reading, visit the downloads section for a text copy.



Virtual Apple II www.virtualapple.org

The Virtual Apple II website enables you to play thousands of Apple II games using your browser. To start playing, simply install the plug-in, which works on Windows and Mac OS X and is compatible with Firefox, Safari and Internet Explorer, select a disk, and load a game.

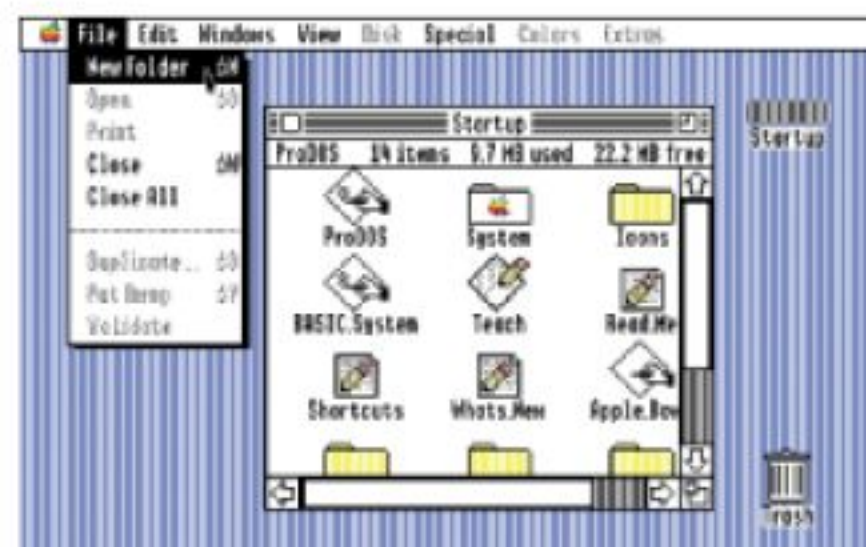

» [Apple II] The superb *Stellar 7* recreated the *Battlezone* coin-op inside the humble Apple II, and then added many more enemies and missions.



» [iPhone] With the likes of *Lemonade Stand*, *Mystery House*, *Oregon Trail* and *Transylvania* on the App Store, Apple gaming comes full circle.



» (left) A revision of the original Apple II ad, amended after accusations of sexism. See kelleyad.com/history.htm for more on the incident.

Instant Expert

When the first advert for the Apple II ran, Steve Jobs got a complaint from a woman in Oregon, who considered it sexist. It was revised to show a woman using a sophisticated display and the male account manager using a low-res version.

Apple's famous 'rainbow' logo, designed by Rob Janoff, was in part designed to showcase the Apple II's colour graphics capabilities. It replaced a fussy illustration designed by Steve Jobs and Apple co-founder Ronald Wayne, and its silhouette still forms the basis of current Apple logos.

According to Steve Wozniak, he was the sole designer of the 'computer' part of the Apple II. Allen Baum contributed some debugging software, Steve Jobs dealt with the machine's appearance, and Rod Holt designed the power supply.

Apple II creator Steve Wozniak was involved in a plane crash in early 1981, which resulted in short-term memory loss. Wozniak spent some of his free time playing videogames on the Apple II, which aided his recovery.

The Apple II's original Integer BASIC was superseded by Applesoft BASIC, which offered floating-point calculations. The name was derived from 'Apple' and BASIC supplier 'Microsoft'.

The Apple III, released in 1980, was intended to succeed the Apple II, and resolutely focused on business users. To stop overlap between the systems, hardware was added to prevent Apple II emulation mode using Apple III advanced features, and Apple II emulation was also inaccurate. The machine was a flop, and the Apple II line outlived it. apple3.org has more on the platform.

the problem I saw on those systems was that games tended to look similar because they were all rendering through the same API, the same graphics chip," he says. "The Apple II had no hardware for those things and so programmers had to invent their own ways of getting graphics on the screen, and these different approaches led to a vast array of rendering techniques that could provide you with unique identification of a programmer. I could look at a game and be able to tell you who wrote it because of his technique. That's one striking way that the Apple II allowed you to express your creativity: with a very open canvas."

In hindsight, the only real criticism of the system that developers have regards sound. Budge calls the audio on the Apple II "extremely primitive", adding: "It was really hard to make sounds because there were no timers or interrupts. The only way to make sound was to toggle the speaker bit in various places in your program's main loop." However, he says that in some areas the hardware bettered its rivals for years to come: "For example, the Apple II had the fastest and most reliable floppy disk of any early home machine, which was great for distributing games. On Atari and Commodore, disk manufacture was a nightmare, and the drives were extremely slow."

Over the years, Apple's hardware continued to evolve. The Apple II+ (sold in Europe as the Apple II Europlus) boasted improved start-up and BASIC, included 48KB of RAM as standard, and had enhanced graphics capabilities. However, between 1979 and 1983, no new hardware appeared. During that time, internal politics and squabbling caused Apple to drop the ball with the botched, business-focused Apple III, and it took a surprisingly hostile attitude towards the consumer market and hobbyists that had made the Apple II a success. Only when Apple finally twigged that the Apple II was stubbornly refusing to die did the IIe project kick into gear, eventually producing an impressive low-cost machine – due to using a quarter of the integrated circuits of the II+ – with 80-column display capabilities, modifier and cursor keys, an

improved case, and another RAM bump. The compact IIc (integrated floppy drive, 128KB RAM) followed in 1984, before the line was radically revised with the Apple IIGS, essentially a powerful and highly capable next-generation 16-bit response to the Amiga and Atari ST, retaining backwards compatibility with older Apple II software via the Mega II: an entire Apple IIe's functionality on a chip.

But this was the beginning of the end for the Apple II line. No one at Apple was willing to champion the platform, instead concentrating on products that the company itself had led, such as the Macintosh. Left to sell itself, the IIGS initially outperformed the Mac, but then stumbled and limped on until the early Nineties, when it was quietly put down by Apple to stop perceived competition with its own Macintosh LC.

Anyone with a love for videogames – players and creators alike – had long since seen the writing on the wall, and had mostly deserted the ailing platform. Although the likes of *Zany Golf* and *The Immortal* originated on the Apple IIGS, the platform that had practically been responsible for founding home computer gaming in the USA was resigned to receiving an ever-dwindling number of ports from rival systems. "Things were moving fast during that time," remembers Gorlin. "The Apple II was king of the market for years, but what initially made it good for games was its primitive nature. Naturally, then, it was soon replaced by better options for developers, and they moved on accordingly, as did the gamers."

Fast-forward to 1996 and Steve Jobs made a triumphant return to Apple, reversing the company's fortunes – at the time, it was suffering from record losses and a confused product line. Much of this success was down to re-embracing the consumer space that Apple had shunned for so long. While we'll

never know if the Apple II could have survived to the present day in some form or remained a major player in gaming had the company that created it actually offered some support, its spirit lives on in the innovation of modern Apple consumer products, and the energy and novelty of myriad iPhone games, a number of which are conversions of or tributes to much-loved Apple II classics. And for the likes of Mechner, Gorlin, Romero and Budge, and many gamers of the day, the Apple II will forever represent a magical time in home gaming that will never be forgotten.

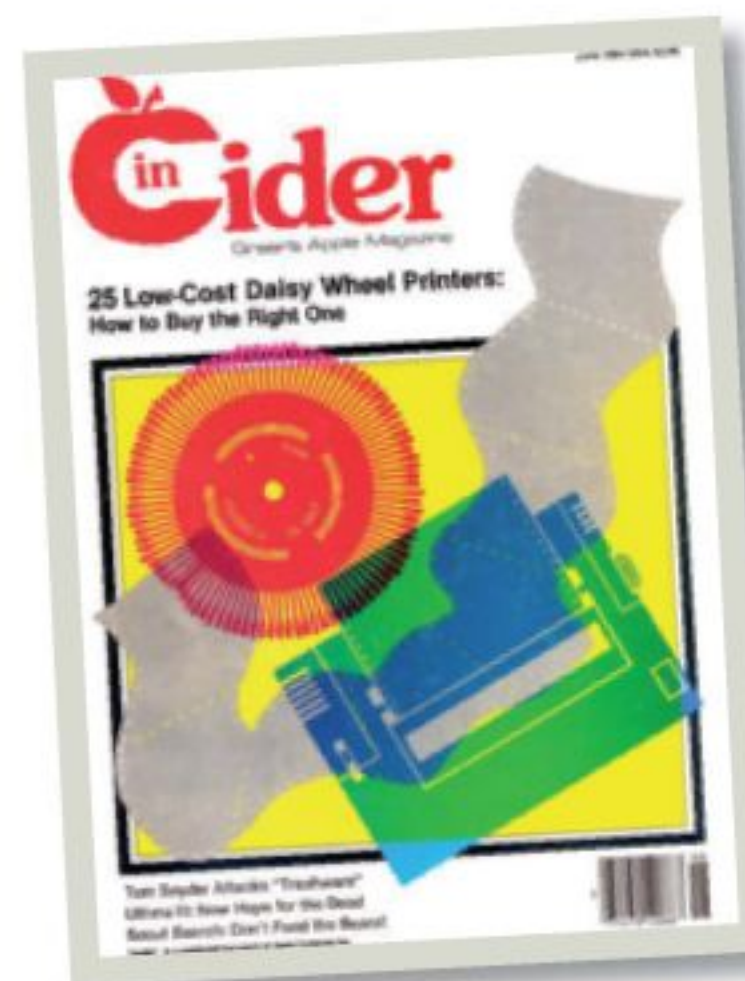

» The June 1984 issue of *inCider* magazine, which included John Romero's first published game, *Scout Search*.



APPLE II

PERFECT TEN GAMES



01

THE BARD'S TALE

- » RELEASE: 1985
- » PUBLISHER: MICHAEL CRANFORD
- » BY THE SAME PUBLISHER: DONKEY KONG (APPLE II)

01 As with the excellent *Ultima* series, *The Bard's Tale* takes inspiration from TSR's *Dungeons & Dragons*. Here, though, the influences are far more pronounced, with the player able to take control of a group of up to six adventurers whenever he wants to go dungeon-delving. Famed for its impressive 3D visuals and excellent animated portraits – although combat itself is text-based – *The Bard's Tale* is a magnificent adventure that offered a huge amount of choice to the player and improved immeasurably on previous dungeon crawlers. Originally released on the Apple II and published by EA, it went on to be ported to numerous home computers and spawned three sequels and a construction set.

PINBALL CONSTRUCTION SET

- » RELEASE: 1983
- » PUBLISHER: BILL BUDGE
- » BY THE SAME PUBLISHER: RASTER BLASTER

02 Bill Budge's 1983 effort holds the record for being the first construction game to appear on any home system. Following on from his popular pinball effort *Raster Blaster*, *Pinball Construction Set* featured an amazingly easy control system that made creating tables an absolute breeze. Objects could simply be dragged and dropped around the screen, while the already-impressive physics could be tweaked. Another fantastic touch was the ability to save your created tables to a floppy disk and trade them with friends. It also happened to play a great game of pinball. The game was honoured at the 59th annual Technology & Engineering Emmy Awards in 2008.



02

THE OREGON TRAIL

- » RELEASE: 1978
- » PUBLISHER: MECC
- » BY THE SAME PUBLISHER: AMERICAN GENERATION X

03 Unlike the other titles in this top ten, *The Oregon Trail* is an educational game. Don't let that put you off, though, for like the Beeb's *Granny's Garden*, it's a highly entertaining piece of work. Following the famous trail, your travellers can die, and you must hunt for food by typing in words as fast as you can. Due to its popularity across American schools, it was re-released in 1985 with greatly improved visuals and expanded hunting, with the ability to use a rifle to gun down targets. *The Oregon Trail* was originally built on a mainframe computer before it appeared on the Apple II.

KARATEKA

- » RELEASE: 1984
- » PUBLISHER: JORDAN MECHNER
- » BY THE SAME PUBLISHER: PRINCE OF PERSIA

04 Before *Prince Of Persia* became a success there was *Karateka*, a surprisingly refreshing fighter that made its debut on the Apple II. Designed by Jordan Mechner while he was still attending university, *Karateka* features many of the blueprints that would eventually mould *Prince Of Persia*. Animation is wonderfully fluid; combat, while simplistic, works extremely well; and there's an epic feel that's missing from many similar fighters. *Karateka's* most impressive trick, though, is how it was able to tell a convincing story through animation and gameplay. An utterly captivating experience.

CHOPLIFTER

- » RELEASE: 1982
- » PUBLISHER: DAN GORLIN
- » BY THE SAME PUBLISHER: AIRHEART

05 If you want to know just what Apple's machine was capable of, *Choplifter* is a perfect example. Amazingly slick with polished visuals, it's a startlingly good blaster that is beautifully balanced. While it initially appears to be a straightforward shoot-'em-up at its core, the lack of an actual scoreboard means that you'll spend just as much time working out how to save hostages as you will trying to blast the enemies that are intent on stopping you. Immediately accessible yet extremely hard to master, *Choplifter's* quick gameplay and instant appeal saw it translated into a Sega coin-op in 1985.



03

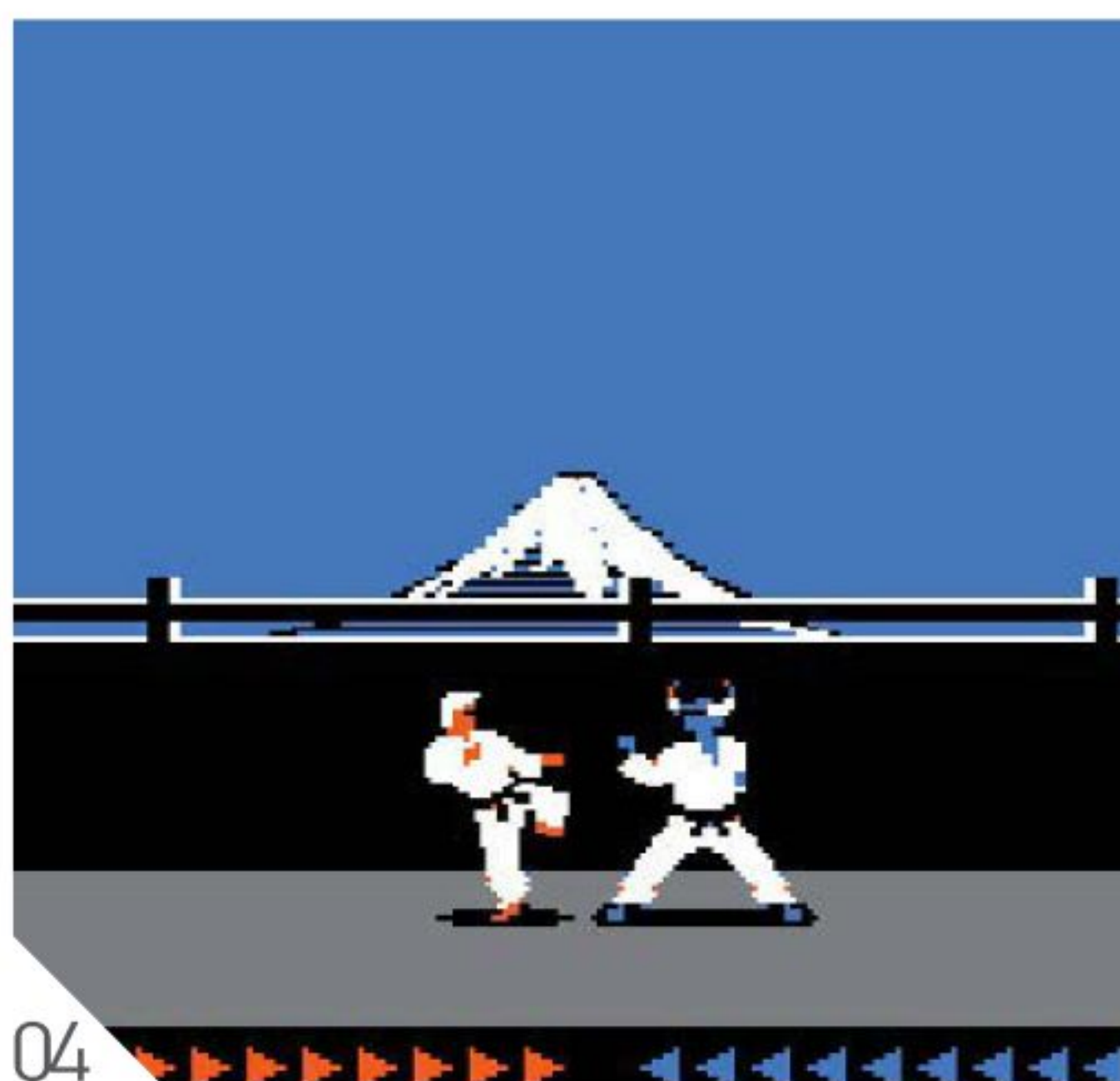

04



05

Apple's 8-bit computer offered an astonishing variety of choice when it came to games and was also the birthplace of many popular franchises



06

ULTIMA I: THE FIRST AGE OF DARKNESS

- » RELEASE: 1981
- » PUBLISHER: RICHARD GARRIOTT
- » BY THE SAME PUBLISHER: CITY OF HEROES

06 With its dramatic box art, *D&D* influences and atmospheric visuals, it's little wonder that *Ultima* became such a success. Its plot – an evil wizard plots to take over the world – may seem trite, but it's an immersive experience. It obviously drew influences from popular role-playing games and the works of Tolkien, but Garriott's attention to detail gave players an experience unlike anything else.

Interestingly, it was remade for the Apple II in 1986 and not only enhanced the visuals but also sped up the gameplay considerably.



07

LODE RUNNER

- » RELEASE: 1983
- » PUBLISHER: DOUGLAS E SMITH
- » BY THE SAME PUBLISHER: BODY HARVEST

07 We've lost count of the numerous iterations of *Lode Runner*. In fact, the only thing our addled brains can remember is that the Apple II version felt like the arcades had come home when we first laid eyes on it.

Like the best Apple II titles, *Lode Runner* impresses because it feels so polished when placed against many of its peers. While the visuals are on the tiny side, it allowed Smith to create some truly memorable levels that still prove challenging today.

Such was its popularity, it was ported to the arcades a year later and received countless conversions.



08

PRINCE OF PERSIA

- » RELEASE: 1989
- » PUBLISHER: JORDAN MECHNER
- » BY THE SAME PUBLISHER: THE LAST EXPRESS

08 Released five years after *Karateka*, *Prince Of Persia* was a revelation to Apple II owners.

Inspired by *Raiders Of The Lost Ark*, Mechner's masterpiece was a fantastic fusion of hardcore platforming, exploration and exhilarating combat that captured the spirit of adventure flicks. A sensation thanks to its incredibly slick visuals – Mechner used rotoscoping of his brother leaping and running around to pull off the spellbinding animation – *Prince Of Persia* turned into a phenomenal success, and it's little wonder that so many gamers continue to love the Prince's exploits.

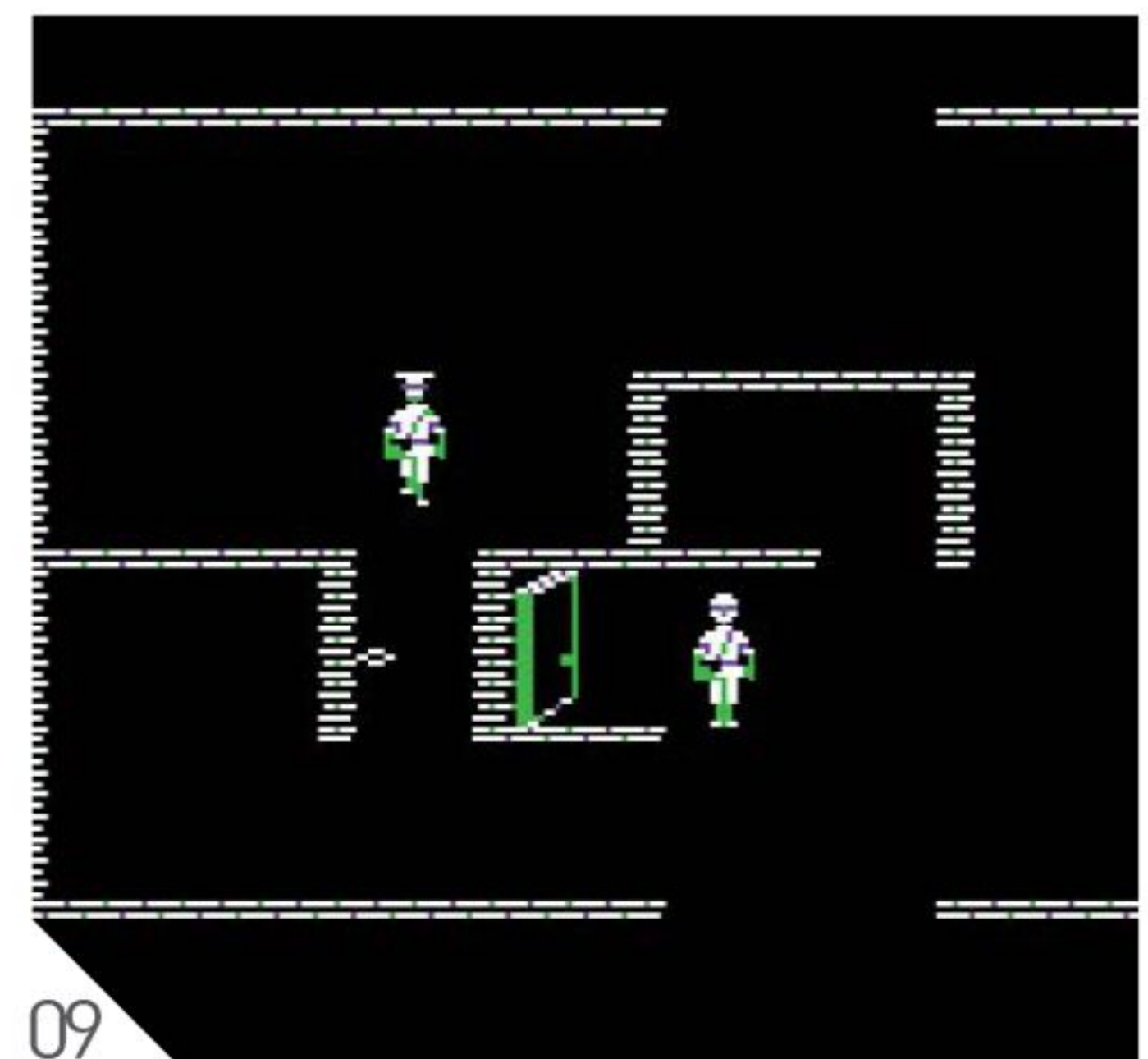

09

BEYOND CASTLE WOLFENSTEIN

- » RELEASE: 1984
- » PUBLISHER: MUSE SOFTWARE
- » BY THE SAME PUBLISHER: RESCUE SQUAD

09 Hideo Kojima is commonly recognised as creating the world's first video stealth game, but the kudos rightly belong to Apple II maestro Silas Warner. Released three years after *Castle Wolfenstein*, which itself predates *Metal Gear* by six years, Warner's sequel ups the stealthy gameplay by introducing plenty of new mechanics that greatly improve an already-excellent game. A knife can be used to pull off stealthy kills, while there is more focus on impersonating guards and using passes to progress deeper into Hitler's bunker.

Aurally it's also impressive – as you'd expect from the creator of *The Voice* – further deepening the atmosphere of exploring the large game world.

TAIPAN!

- » RELEASE: 1982
- » PUBLISHER: AVALANCHE PRODUCTIONS
- » BY THE SAME PUBLISHER: N/A

10 Not to be confused with either Ocean's venomous snake, *Taipan!* is an intriguing turn-based strategy game that offers a surprising amount of depth. Loosely based on James Clavell's novel *Tai-Pan*, Mega-Micro Computers' effort placed you in the shoes of a trader who must make his fortune via trading and piracy on the high seas. It's a truly enjoyable strategy title that's made all the better because you have so much choice when you're playing. Your ship can be upgraded, loans can be arranged, extortionists must be avoided, and there are seven distinct ports to trade with. A dazzling effort that remains highly enjoyable.



10



APPLE II

apple II

and the rest...

Text adventures, arcade conversions, platformers, flight simulators – the Apple II covered all these genres and more. Here are just a few of the many titles released for it.

- 01 BALLBLAZER
- 02 LEMONADE STAND
- 03 SIXGUN SHOOTOUT
- 04 DUNGEON
- 05 STAR TREK
- 06 FROGGER
- 07 HELICOPTER RESCUE
- 08 SPINDIZZY
- 09 ZAXXON
- 10 HACKER
- 11 SPACE VIKINGS
- 12 CRUSH, CRUMBLE AND CHOMPI
- 13 GAUNTLET
- 14 RAID OVER MOSCOW
- 15 VIPER
- 16 PANDEMONIUM
- 17 EPIDEMIC
- 18 IMPOSSIBLE MISSION
- 19 EVOLUTION
- 20 REPTON
- 21 TAPPER
- 22 KARATEKA
- 23 XEVIUS
- 24 SUPER HUEY
- 25 F15 STRIKE EAGLE
- 26 ROAD RALLY USA
- 27 DEATH SWORD
- 28 CHAMPIONSHIP LODGE RUNNER
- 29 SPY VS SPY
- 30 CASTLE OF DARKNESS
- 31 GOLF'S BEST
- 32 TITAN EMPIRE
- 33 JET PACK
- 34 RUN FOR IT
- 35 BEYOND CASTLE WOLFENSTEIN
- 36 SARACEN
- 37 THE HULK
- 38 ARCHON
- 39 PIPE DREAM
- 40 T-REX: THE DINOSAUR SURVIVAL ADVENTURE
- 41 ONE ON ONE
- 42 BATTLE OF HOTH
- 43 TRON
- 44 ALIEN TYPHOON
- 45 OGRE
- 46 ZORK I: THE GREAT UNDERGROUND EMPIRE
- 47 FIGHT NIGHT
- 48 THE BARD'S TALE
- 49 NIBBLER
- 50 FATHOMS FORTY
- 51 LAZER MAZE
- 52 OIL RIG
- 53 TROLLS AND TRIBULATIONS
- 54 CHOPLIFTER
- 55 ABM
- 56 KORONIS RIFT

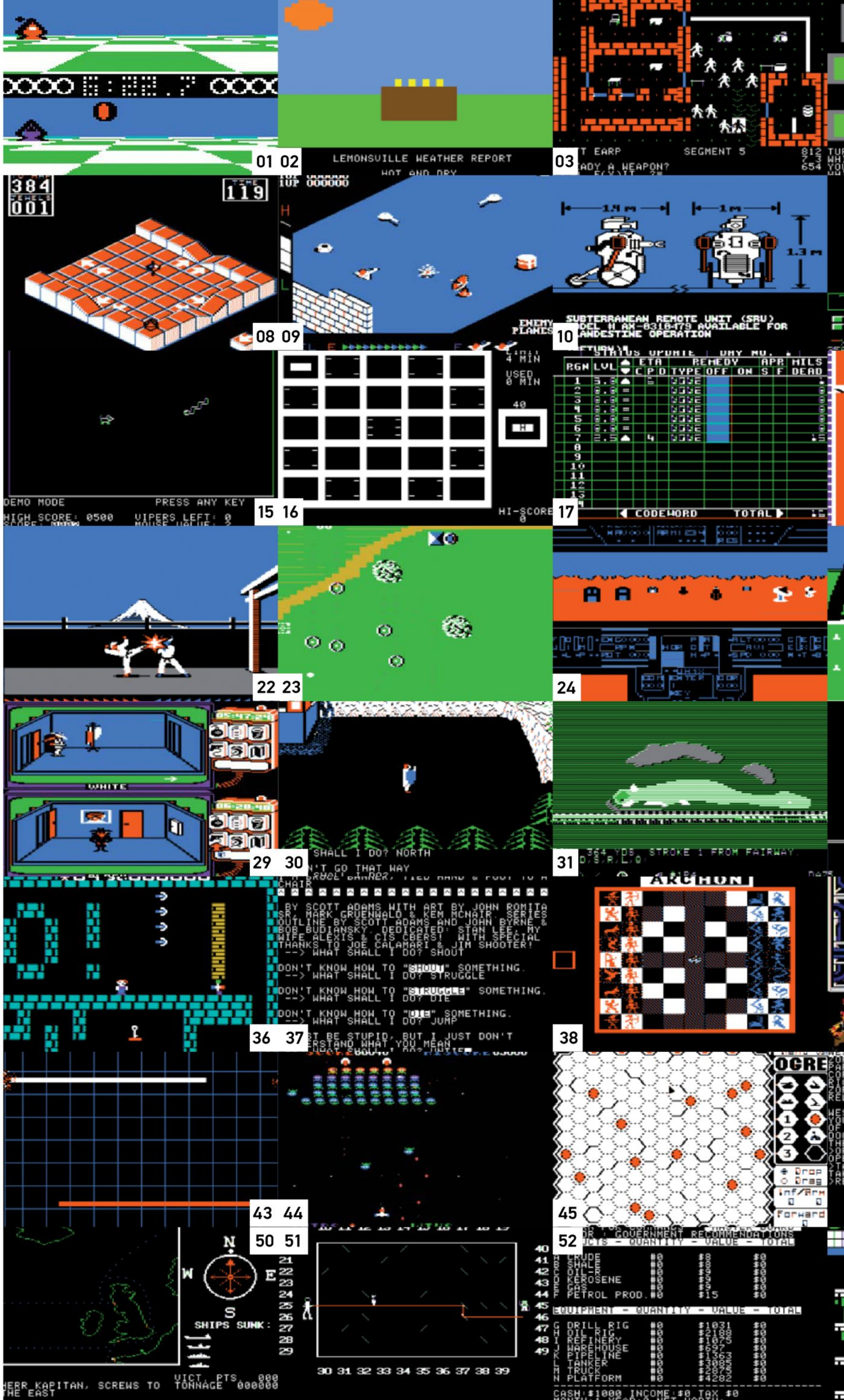

HERR KAPITAN, SCREWS TO THE EAST VICT PTS 000 TONNAGE 000000

CASH: \$1000 INCOME: \$0 TAX \$0



04 05



11 12



06



13



07



14



18 19



20



25 26



27



21



28

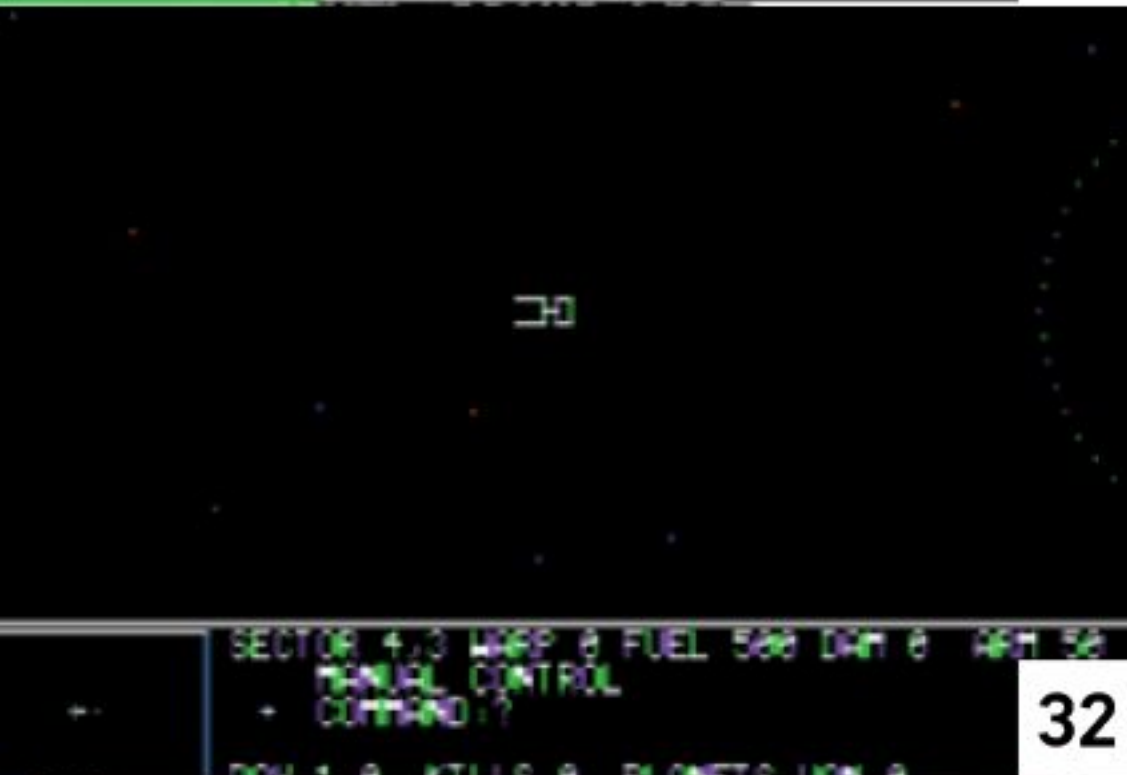

32 33



34



35



39 40

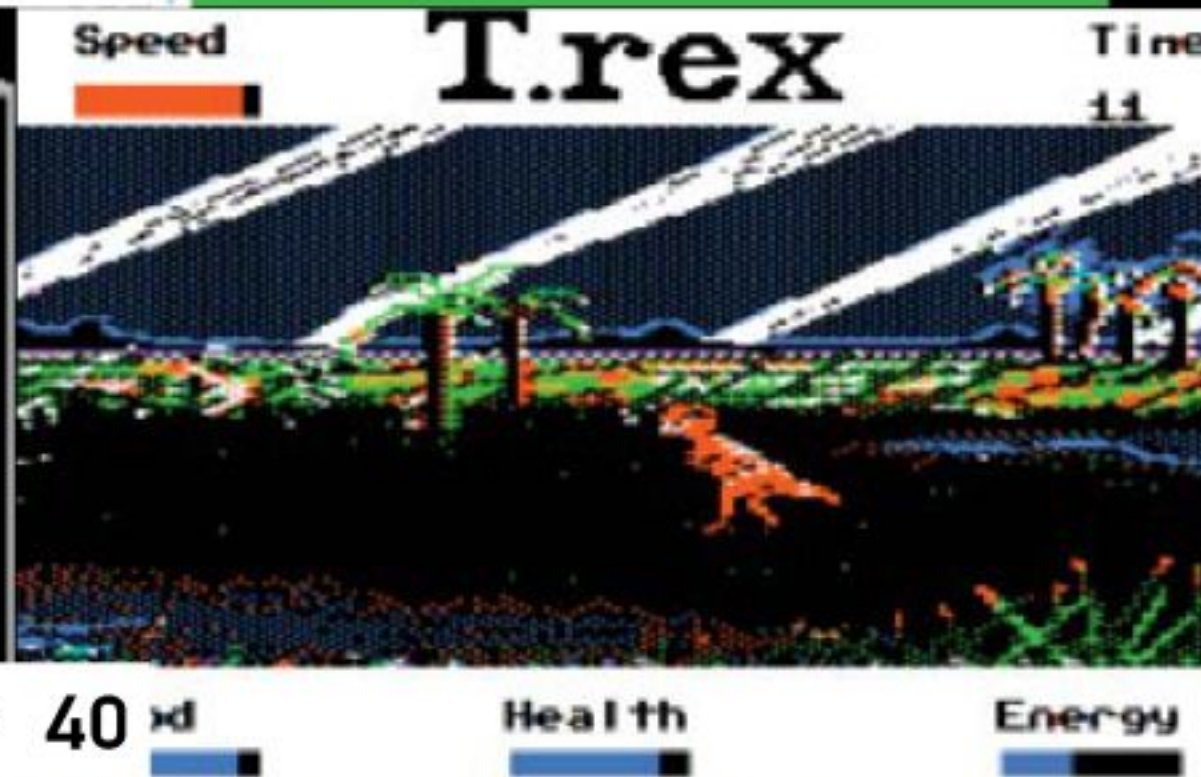

41



42

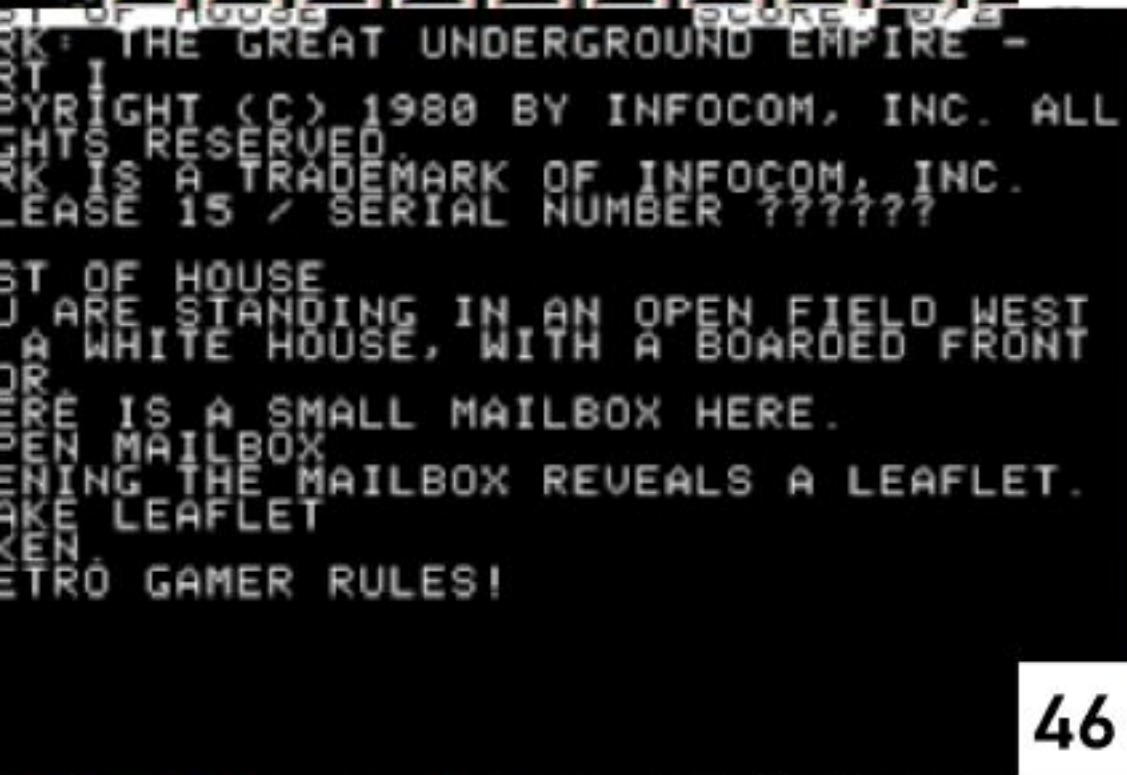

46 47



48



49



53 54

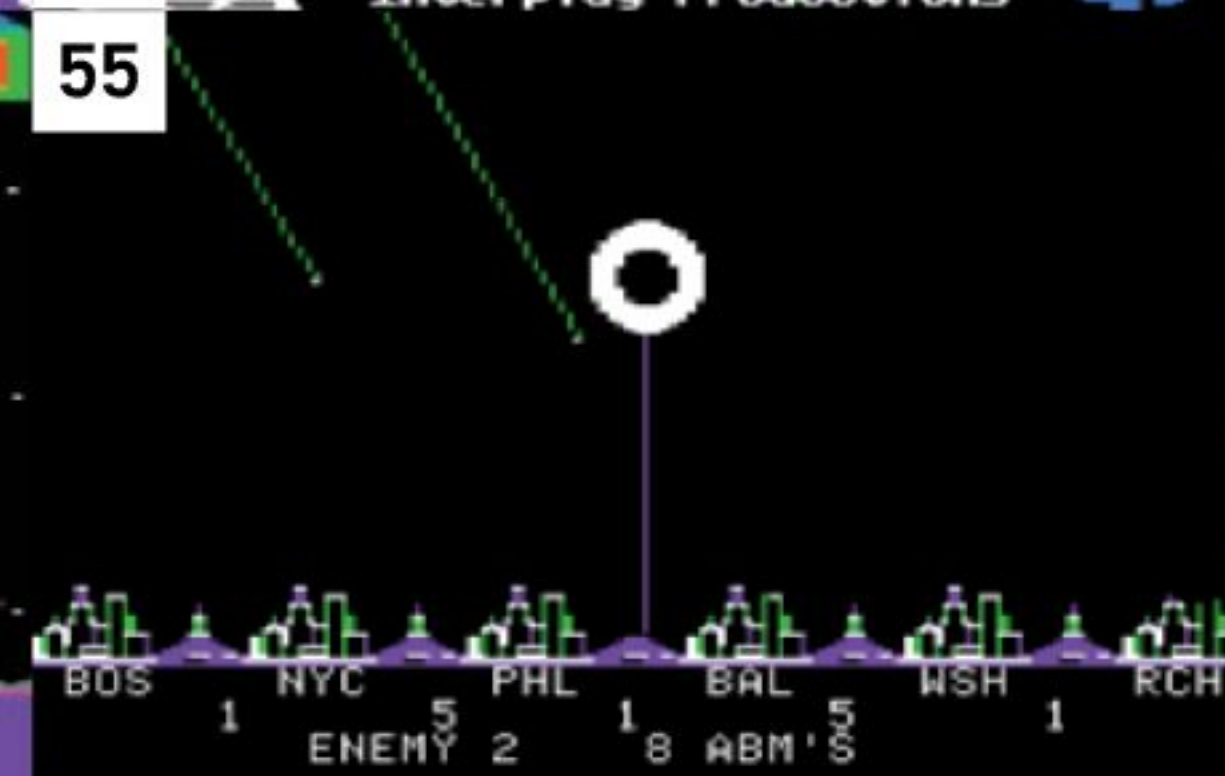

55



56



GAME BOY

It's been 25 years since the world first glimpsed the Game Boy, the creation of veteran designer Gunpei Yokoi and his team at Nintendo. To celebrate its birthday, we look back at that most modest of handhelds and find out what made it such a massive success

It's often said that there are no surprises in gaming anymore. In this connected age we now know everything, instantly. The days of walking into a shop and being blindsided by new gaming hardware and software are dead and gone.

But things haven't really changed that much. It was just less immediate in the past, with gamers having to rely on magazines drip-feeding information about exciting new products. This was certainly the case with the Game Boy, the Nintendo handheld that launched in Japan in April 1989 and the US shortly after but wouldn't arrive in Europe until September 1990. The long-running and respected UK magazine *Computer & Video Games* dropped the first details in its May 1989 issue, calling Nintendo's new machine a "micro-marvel". There was a product image too, allowing readers to scrutinise its key characteristics: the D-pad and button configuration, the grey-coloured shell, the yellowy-green screen. Displayed on the screen was a little something called *Super Mario Land*.

It wasn't possible to judge the size however. There were no hands gripping the Game Boy for comparison. All was revealed in the July 1989 issue of *C&VG* when

deputy editor Julian Rignall got his own hands on a Japanese Game Boy for an import review. "There's a new Nintendo console in town," wrote Jaz. "It fits comfortably in the palm of your hand, has its own tiny TV screen, and the games come on cartridges the size of a matchbox. Sounds too good to be true?"

Happily Jaz revealed that the Game Boy was not just real but rather quite brilliant. "The console fits in your hand perfectly," he remarked. "Playing games on it is a joy!" While he praised the sharpness of the graphics on the LCD screen, he did note blurry scrolling as a caveat. It was revealed that the handheld was powered by four AA batteries, but no mention of how many hours of play they offered (clearly Jaz wasn't changing them often enough for it to be regarded as an issue). Meanwhile, key Japanese launch title *Super Mario Land* was described as "unbelievably addictive". The review ended with some impressive sales claims from Japan – 500,000 units sold to date, with 300,000 snapped up at launch. Elsewhere in the issue the Game Boy was called "The future of handheld gaming". As Jaz's review was a UK exclusive you could forgive *C&VG* for laying it on thick, yet that statement would turn out to be beautifully prophetic. ▶





“I found the Game Boy to be a very simple and easy machine to code for”

R-Type II programmer Bob Pape

► When the Game Boy finally arrived in Europe, almost 18 months after its Japanese debut, there were just half-a-dozen games released alongside it. Of these, *Super Mario Land*, *Tennis* and *Golf* were the must-have titles. One title you didn't have to buy was the revelatory Game Boy version of *Tetris* as it came bundled with the console. This smart move had worked wonders for Nintendo in the US, leading to stellar sales (a reported million units were sold within weeks of its launch). European gamers could now dream of falling blocks too as *Tetris* fever took hold. It really was the perfect pack-in – the ultimate game on the go.

The success of the hardware quickly led to a flood of fresh software that identified the Game Boy as a diminutive yet capable contender that could punch above its weight (which was a lean 300g including batteries, if you were wondering). In its first couple of years the handheld was home to some fantastic original titles such as pinball sim *Revenge Of The 'Gator*, platform adventure *Gargoyle's Quest*, and the

Game Boy exclusive sequel *Metroid II: Return Of Samus*. There was also plenty of decent and undeniably attractive licensed fare like *Teenage Mutant Ninja Turtles*, *RoboCop* and *Batman*. Coin-ops were converted too with varying results, as you might expect, although *Double Dragon*, *Nemesis* and *R-Type* were all admirable attempts.

The Game Boy's custom processor, which was essentially a Z80 with some bits missing and others added, ensured that many programmers could move over to the machine with little problem. Bob Pape, who coded the celebrated Spectrum version of *R-Type*, went on to develop *R-Type II* for the handheld. “I found the Game Boy to be a very simple and easy machine to code for,” he says. “The hardware of course had limitations but then that was the same for all early 8-bit consoles and computers. Some people may have had problems dealing with the limited instruction set of the custom Sharp processor that the Game Boy used, compared to the Z80, but I think for those programmers who were used to having to scratch for every last

byte out of a 1K ZX81 or 48K Spectrum through tight coding then it was almost like coming home.”

In the past Nintendo has been accused of providing developers with vague or incomplete documentation, but in Bob's experience this wasn't too much of an issue as the hardware was pretty much an open book. “Well if you don't know what's missing then you can't say it's not there!” he comments. “It's more likely that certain coding techniques were kept quiet to

give companies an edge, things like how to multiplex the sprites or give the appearance of seven shades of grey. Other ways of programming the hardware were so obvious they didn't need documenting.”

Another Z80 developer who gladly moved over to the Game Boy was Ken Murfitt. “In many ways the Game Boy was easier to program than the other Z80 platforms,” says Ken, who came chiefly from an Amstrad CPC background and developed *Double Dragon 3* and *The Lawnmower Man* for the Game



» You won't get very far without using these.

MUSICAL INTERLUDE

Jonathan Dunn composed for many Game Boy titles, including the *RoboCop* theme used on that washing machine advert...



» Music man Jonathan Dunn.

What were your immediate thoughts on the Game Boy as a gaming platform?

When I first tried a Game Boy I thought it was a great little device. Of course the first thing I played was *Tetris* and I was hooked. I also remember that you could connect two Game Boys together and play two-player *Tetris*. That was the first time I'd seen anything like that.

How would you rate the Game Boy's audio capabilities?

The Game Boy had some interesting characteristics. It had a waveform that you could program yourself – 32 4-bit samples that you could define. I remember getting it to make some unusual noises. I also liked the fact that you had some control of stereo

» [Game Boy] *RoboCop*. Great game, superb soundtrack.



placement, though I wish I'd used that a bit more in the work I did. Quite often the stuff I did for the Game Boy was a port from another version so I didn't get to spend enough time experimenting with the possibilities.

Did you encounter any technical challenges at all?

I coded my own driver for the C64 and NES and SNES, but at the time didn't have enough knowledge of Z80 to do the audio driver that we needed. So Ocean's John Brandwood was roped in to convert the Spectrum driver, with a few modifications. I wasn't happy with the hardware volume envelopes, so I got John to add a more versatile software envelope system that gave me more accurate control. It had disadvantages as we effectively reduced the bit resolution of the volume, but it did allow me to sync the envelopes with other note-based events.

Your *RoboCop* title theme is still used and sampled to this day.

GAME BOY BOLT-ONS

Some of the not-so-silly accessories you could buy for your Game Boy

BATTERY PACK

■ Not the most exciting accessory, or most essential seeing as the Game Boy was the least power-hungry handheld. But when your AAs did finally give up, this add-on was good for up to ten hours of extra play. And if you were more likely to be found playing Game Boy at home, it also doubled as a handy AC adapter.



GAME LIGHT

■ The Game Boy was unplayable in low-light conditions so there was no shortage of third-party add-ons designed to brighten up the display. The Game Light from Nubi was one such solution that bolted on to the front of the screen. It required four AAs batteries so it was probably cheaper to find a decent light source instead.



AMPLIFIER

■ Another accessory from Nubi, this device plugged into the headphone socket at the bottom of the Game Boy and boosted the audio output. Sound was louder and also in stereo. With so many ridiculous-looking add-ons available for the Game Boy, this one deserved points for at least trying to match the Game Boy's style and form.



GB CAMERA

■ This quirky add-on was released in 1998 and turned the Game Boy into a compact digital camera (shortly before digital cameras became commonplace). In addition to snapping and reviewing photos, there were a number of built-in 'games' that would feature the player's grinning mug. They were borderline terrifying in all honesty.



GB PRINTER

■ If you had a burning desire to print the grainy, black and white photos you'd taken using the GB Camera then you clearly coveted this tiny thermal printer. Otherwise, a bunch of games supported the device, allowing you to print out high scores, screenshots and the like.



» Yes, the BoosterBoy is just as impractical to use as it looks.

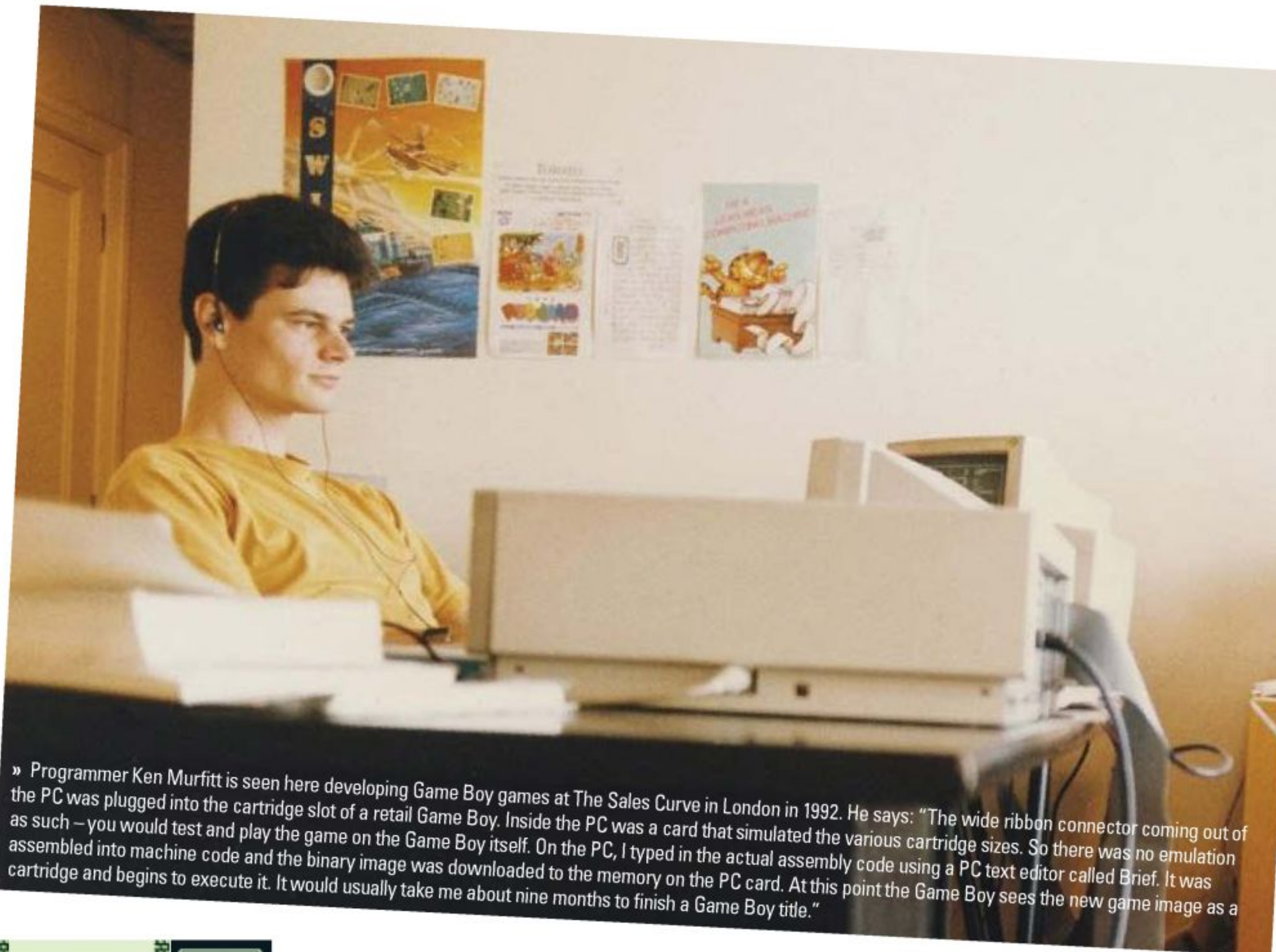

» Programmer Ken Murfitt is seen here developing Game Boy games at The Sales Curve in London in 1992. He says: "The wide ribbon connector coming out of the PC was plugged into the cartridge slot of a retail Game Boy. Inside the PC was a card that simulated the various cartridge sizes. So there was no emulation as such – you would test and play the game on the Game Boy itself. On the PC, I typed in the actual assembly code using a PC text editor called Brief. It was assembled into machine code and the binary image was downloaded to the memory on the PC card. At this point the Game Boy sees the new game image as a cartridge and begins to execute it. It would usually take me about nine months to finish a Game Boy title."



» [Game Boy] Tetris was the Game Boy's killer app. It was the perfect fit for the new handheld.

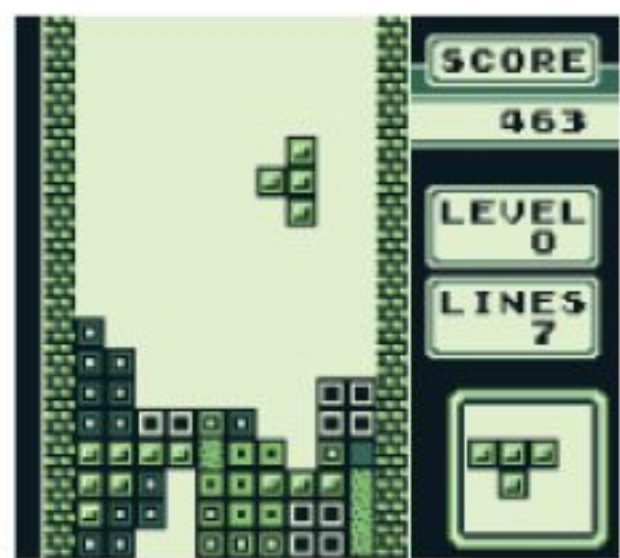

» [Game Boy] Tetris went on to sell millions, benefiting nicely from being a pack-in title.

Boy on behalf of The Sales Curve.

"It was exciting to use real sprite and background-scrolling hardware, after so many years of squeezing every last instruction out of platforms like the CPC and Spectrum. No more pre-shifted sprites that hog memory, sprite masking or the Z80 stack tricks required to perform background scrolling. You could just set up the sprite buffers one time and scrolling hardware registers once per frame and go. Obviously it was a step backwards in terms of colour count – there were four levels of grey against the Amstrad's palette of 27 colours. You could get in-between greys using flickering but it was visually distracting and so I preferred dithering."

So developing for the Game Boy wasn't particularly difficult for

seasoned programmers, but Ken notes there were a couple of unexpected considerations. "The first was battery life. The processor was put to sleep using the HALT or STOP command after processing had been completed for a frame, and this would minimise battery drain until the next vertical blank, 60 times per second. It was surprising to me at the time that the battery life could be extended by saving power during these tiny slices of CPU down time."

And then there was the odd entity known as 'Version Zero Game Boy'. Ken explains: "There were these early production Game Boys of which only a few thousand units existed in the world and Nintendo insisted that any submitted title must run perfectly

Does its continued popularity ever surprise you?

I don't think anyone could have guessed that the *RoboCop* theme would become so memorable. At the time it was just another game. It was the norm to produce stuff very quickly and there was always another project looming at Ocean, so you didn't really get time to think about it. If I look back at all the different versions of the same piece of music I had to do, I wonder how I did it. That tune in particular has been sampled a lot and it's great that it's still around.

Do you receive any payment when the *RoboCop* tune is used?

I now collect writer royalties whenever the track is used, though I didn't receive anything when it was used in the *Ariston* advert. I think Ocean thought it was just getting some free PR and marketing.

What are you up to these days?

For the last two years I've been living in Slovenia working as COO for a games company called IBZooT. I'm also the co-founder of Fatleg Games, a mobile games start-up. I still code, I still write music. It's fun to make small games for mobile. It feels a little like it did in the old days. You don't need massive teams to produce something fun.



» Not just any old Game Boy. This one, owned by our own Paul Drury, is signed by Alexey Pajitnov.

» [Game Boy] Hook was another game that benefited from Jonathan's music.



» [Game Boy] Capcom's *Gargoyle's Quest* was a fun spin-off from arcade hit *Ghosts 'N' Goblins*.



» [Game Boy] If there was a craze then it was all over the Game Boy. There were three *Turtles* games in total.

► on them. The difference was that the video memory was slightly slower in some respect and problems would be apparent with partially scrambled background tiles appearing in your game due to memory contention. It was a shame because it further restricted how many background blocks you could update during the video blank.

Due to the Game Boy's small screen and limited colour palette, it was the job of artists to ensure that the graphics, and in particular sprites, were as clear and defined as possible. It was a challenge that Elliot Curtis relished. Working for Tiertex Design Studios, he created Game Boy graphics for various Disney licences and *FIFA* entries. "To be offered the chance to make games on a console was a dream," he says. "Yes the Game Boy was limited but the

» If you want to play multiplayer games or use peripherals you'll need this port.



“ Nintendo created games that worked well on a small screen with no colour ”

Graphics artist Elliot Curtis

other consoles at the time were actually a bigger struggle to create graphics for. The first time you created a sprite and saw it running on a Game Boy screen was amazing. It always looked way better than it did in Deluxe Paint!”

The biggest headache occurred when creating full-screen images, such as title screens, due to display limitations. "A Game Boy screen is divided into an eight-by-eight grid and each square in that grid is a character," he explains. "When you create a full-screen picture you can actually only use about 21 unique characters. It was nowhere near enough. We had tools from the coder to highlight individual characters once we drew anything, and then we had to be creative by using flipped and rotated characters within the picture. It's always depressing butchering a nice picture but often it was required assets for a licence and there wasn't any scope for creativity. Publisher or licence

logos are boring enough to draw without spending all day editing them to make them actually work on the screen."

Elliot's later games were specially optimised for use with the Super Game Boy, the device that enabled Game Boy carts to be played on the Super Nintendo console, often with added colour. Explaining the process, Elliot says: "Colour would be designed into



» [Game Boy] Bob Pape's *R-Type II* conversion was an improvement over its already fantastic predecessor.

the graphics from the start. I would have four separate palettes of four colours each. I used to work on the Spectrum so the eight-by-eight character colour issues weren't new to me, but Super Game Boy graphics were a pain. The number of people who were ever going to actually see them was so small it seemed like a bit of a waste of time. I actually put a footballer in the border for *FIFA 98* in a Watford strip and got away with it!"

Super Game Boy games at least looked better in magazines – as anyone who tried to screen-grab original Game Boy titles will tell you. Nick Walkland worked on Europress's *GB Action*,



» [Game Boy] Street brawler *Double Dragon 3* supported cooperative play on the Game Boy.

MULTIPLAYER ON THE MOVE

You had a Game Boy. Your friends had Game Boys. Game on!

Two Game Boys could be connected together using the link cable that was initially bundled with the handheld. Conveniently, pack-in title *Tetris* included a fantastic two-player mode where players battled it out as Mario and Luigi. It was simple but genius and elevated *Tetris* to even greater heights.

As most Game Boy owners had a cable, lots of titles included two-player support. Sports titles like *Tennis* and *Golf* offered gentle competition while fighting games such as *Mortal Kombat* and *Killer Instinct* let you go toe-to-toe with a pal. The two *Double Dragon* sequels allowed you to team up with a friend and clean up the streets together.

» [Game Boy] 'Epic' is not a word you'd ever associate with Game Boy games, but *Link's Awakening* came pretty close.



the UK's first dedicated Game Boy magazine which debuted in 1992. "Game Boy games were a complete pain to screen-grab," says Nick. "We actually took photos because it was so tricky. The Game Boy was placed in this glorified cardboard box, with a black cloth around the entrance, which you put your head inside. Like a Victorian snapper but without the phosphorous flash. But there was always motion blur and when you tried to pause games they tended to come up with a pause screen. To make matters worse the Game Boy looked, well, awful. A bland greeny-grey, with shades in-between."

Nick is not alone in his lack of love for the Game Boy. "It was awful!" laughs Ed Magnin, a programmer who'd previously worked for MicroProse and Cinemaware on Apple II and IIGS software before moving onto the Game Boy at Virgin Games. "The processor was like a Z80 but it wasn't a complete one, and there were banks of memory and the memory had to be switched in and out. So if you had a piece of artwork it wasn't just a question of whether it would fit into the cartridge, but where you had a hole to put it where it wouldn't straddle banks. You know, up until the Nintendo DS, I've always said that it was our job as programmers on Nintendo platforms to make bad technology look better than it should have."

Despite his aversions, Ed was responsible for the fantastic and faithful Game Boy version of *Prince Of Persia*.

For this he also had to contend with Nintendo's famously dim view on videogame violence. "Nintendo had these policies where no-one ever died in a Nintendo game," he says. "So for *Prince Of Persia* the first thing we looked at was the slicer. We raised this and Nintendo said it was okay as long as we didn't show any blood. Even on the Game Boy they didn't want a big black puddle oozing out! The pop-up spikes on the floor were also a problem. Years later I found out that Nintendo didn't like what it called 'body deforming violence'. It was okay to get killed but not have the spikes popping out of your back."

For Ed and other developers, whether they were fans of the hardware or not, it was clear that Nintendo had devised a hugely popular platform. The Japanese firm had hit gold with the Game Boy. "It was my daughter who actually got me started on Nintendo," says Ed. "She was in kindergarten and I was out of work as the company I'd just finished a game for had gone out of business. It was hard to find a job and my daughter said 'Dad you should be doing Nintendo!'. And she was right. All of the kids had one!"



» Hear the Game Boy's music in all its glory. Or cover it with your hand.

» There's no back light on the original Game Boy, so adjusting the contrast is a must.

» The On button for the Game Boy also acts as a very handy cartridge lock. Not like they'd fall out...

Double Dragon 3 programmer Ken Murfitt reveals that developing co-op play was tough. "There were some interesting lessons," he says. "It required the efforts of myself and another programmer, Tom Prosser, to test the game – you couldn't flush out all of the synchronisation bugs by yourself. I learned about packets and timing issues. For example, no two Game Boys run at exactly 60Hz – one will be slightly slower. This may sound obvious now but you could not rely on only the vertical blank to synchronise your two-player game."

One of the most popular uses of the link cable was transferring Pokémon between the Red and Blue versions (if you were determined to catch 'em all then linking was mandatory). Battles could be staged between collectors too. A special four-player adapter was also available, although it was only supported by a small number of games. Notable titles included *F-1 Race* (with which the adapter was bundled), *Super RC Pro-Am* and *Gauntlet II*. A mention must also go to *Faceball 2000*, a Game Boy FPS that included support for up to 16 players!

"I WANNA BE THE VERY BEST" How the sales of two huge hits stacked up



The Game Boy quickly established itself as the world's number one handheld, and this was in the face of competition from rival machines that arrived shortly after. The Atari Lynx, Sega Game Gear and PC Engine GT (TurboExpress), with their colour screens and superior hardware, looked like a clear generational leap over the Game Boy. It really was men against boys, on paper at least. But the Game Boy subverted expectations and emerged as the clear winner.

The reasons for its success are fourfold. Firstly, the Game Boy was the fastest to market so it was the first portable to capture the interest and imagination of the public. And not only was it first but it was the least expensive too. Prices obviously varied from region to region, but in anyone's language the Game Boy undercut the competition significantly. Further discounting would push the Game Boy towards an impulse purchase price point. The third factor was battery life. Four AA batteries would power the Game Boy for up to 15 hours (and possibly longer if the speaker wasn't too troubled). Rival handhelds were much hungrier, requiring more batteries and exhausting them far sooner. Having to continually buy or recharge batteries was never ideal.

Finally, and crucially, there was the Game Boy's vast library of games. More than 700 titles were released over a period of ten years. Third-party production was plentiful and Nintendo itself continued to support the machine throughout its lifespan. Three *Super Mario Land* sequels appeared in 1992, 1994 and 1998, while the release of *The Legend Of Zelda: Link's Awakening* in 1993 showed that the Game Boy could deftly entertain sprawling adventure games. There was a brace from



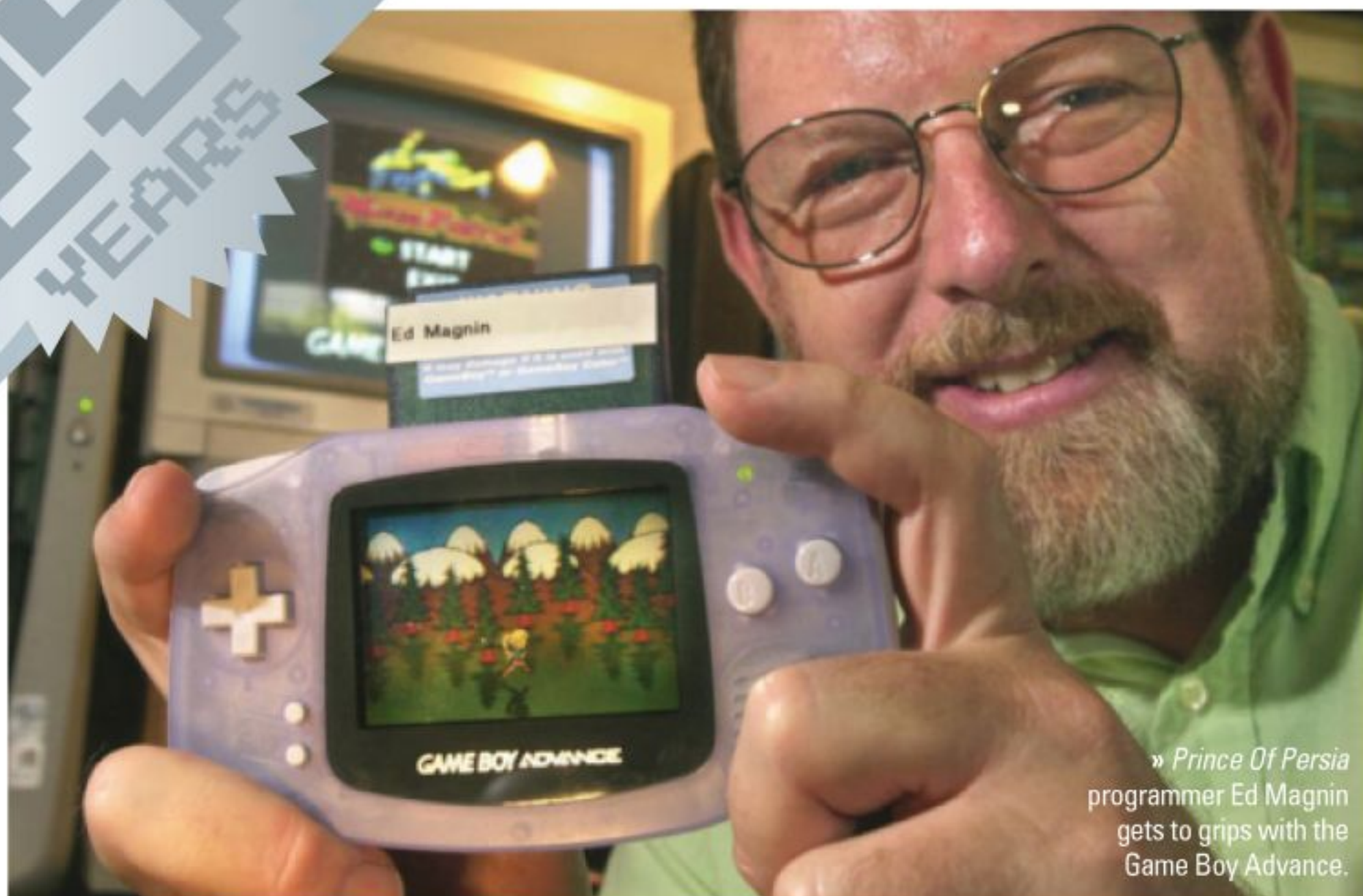

» Prince Of Persia programmer Ed Magnin gets to grips with the Game Boy Advance.

» Donkey Kong (1994) featured enhanced graphics and a retro border when played on the Super Game Boy.



» [Game Boy] In Gauntlet II, four players could work together – just like in the arcades.



► everyone's favourite gorilla too, with the arrival of *Donkey Kong* in 1994 and the first of Rare's *Donkey Kong Land* games in 1995. And just when the Game Boy was starting to look tired, along came *Pokémon* in 1996. The *Pocket Monsters* phenomenon ambled its way West over the next few years and gave the Game Boy a shot in the arm.

Nintendo would refresh the hardware too. The Game Boy Pocket arrived in 1996, sporting a sleek new form and clearer LCD screen. This was followed by the Game Boy Light in 1998, a Japanese exclusive that featured a backlit screen. The long anticipated colour screen Game Boy arrived later in the same year and effectively replaced the original model. Prior to the release of the Game Boy Color, Nintendo revealed that the original Game Boy had sold in excess of 64 million units worldwide.

For graphics artist Elliot Curtis, the key reason why the Game Boy was such a sales success in the face of 'superior' competition was down to its gaming library. "It was Nintendo so it had the best games," he says. "Obviously *Tetris* shifted the units in the first place, but



» Look away now Nintendo! The Prince attempts to pass a deadly slicer.

then you could also play *Mario*. Nintendo created games that worked well on a small screen with no colour. Everybody else seemed to be making versions of existing games that were inevitably inferior to the 'proper' version."

Programmer Ken Murfitt agrees: "Something that Nintendo understood well was that consumers enjoy straightforward products that are accessible, robust and low cost, but if I had to sum up the success of the Game Boy in one word it would be 'Tetris'."

Having experienced the Game Boy before most, Jaz Rignall is ideally placed to comment on how it held up over time. Despite the arrival of flashier

portables, his appreciation of the Game Boy did not diminish. "If anything, the more I played the competition the better Nintendo's little grey brick looked," he says. "Anything with a colour screen ate batteries as fast as you could shovel them in. The Game Boy was relatively frugal, making it much friendlier on the pocket, energy-wise. It was also nicely designed. These days it looks hefty, but you could hold it and play it for hours comfortably. It was also built like a tank. The Lynx and Game Gear were fragile by comparison. I never had any qualms about bunging it into a bag and taking it anywhere. I loved the PC Engine GT but it was expensive, and some of its games were unplayable because they'd been designed for a big screen. It was also one of the all-time greats for consuming batteries. Ultimately it's

about the games and not the tech, and the Game Boy proved that. It had a range of really fun carts – and *Tetris* was a killer app."

Jaz also notes the importance of handhelds to Nintendo's business

over the years – from the Game Boy through to the Game Boy Advance, DS and now 3DS. "Just one look at Nintendo's numbers show how much revenue handhelds have brought in. The importance of those numbers has varied from generation to generation, but when Nintendo's flagship console hasn't done so well, handheld success has been critical. The 3DS is a good example of that. Remove its figures from Nintendo's financials from last year and things would be looking pretty dismal."

So what now for Game Boy? When the DS was introduced in 2004, Nintendo made it clear that the Game Boy name was not being retired. Given the firm's current difficulties with the Wii U, there's a possibility we may see a new Game Boy at some point. Imagine a stripped-down handheld designed specifically for playing retro games – essentially a portable Virtual Console with access to not just Game Boy games, but titles from those rival handhelds that once tried to outmuscle the small but mighty Game Boy. That would be a nice surprise.

Special thanks to Warez, Bournemouth (retrowarez.co.uk) for its help with this feature



NINTENDO'S HANDHELD HERITAGE

An essential timeline to gaming on the go – Nintendo style

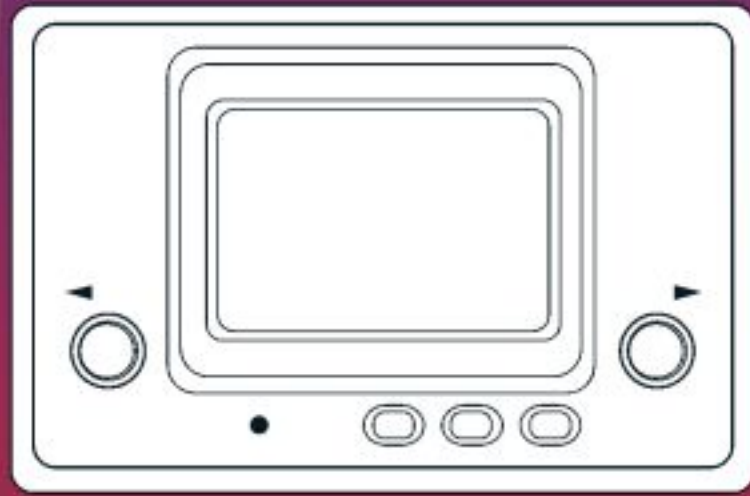

GAME & WATCH: 1980 ONWARDS

1989



GAME BOY

1998

1998

1996



GAME BOY COLOR



GAME BOY LIGHT

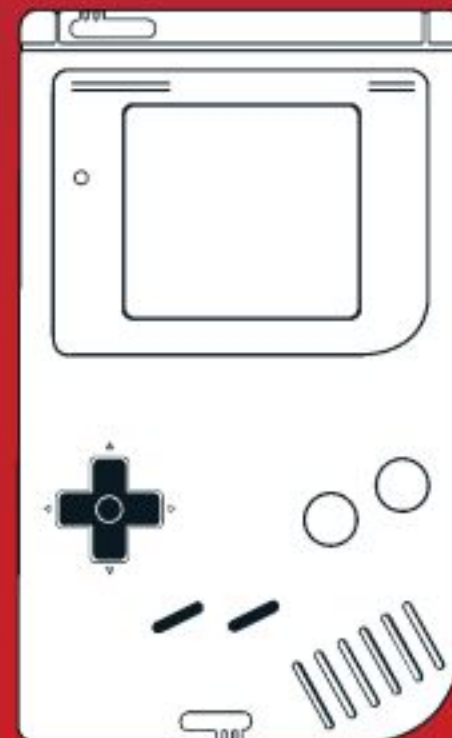

GAME BOY POCKET

“The more I played the competition the better Nintendo’s little grey brick looked”

Games journalist Jaz Rignall

GAME BOY ADVANCE

2001

2003

2005

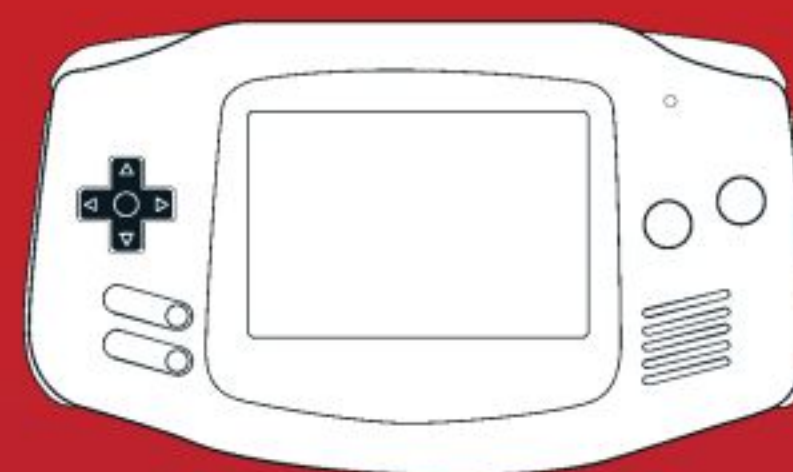

GAME BOY ADVANCE



GAME BOY ADVANCE SP



GAME BOY MICRO

NINTENDO DS

2004

2006

2008

2009

2011

2012

2013

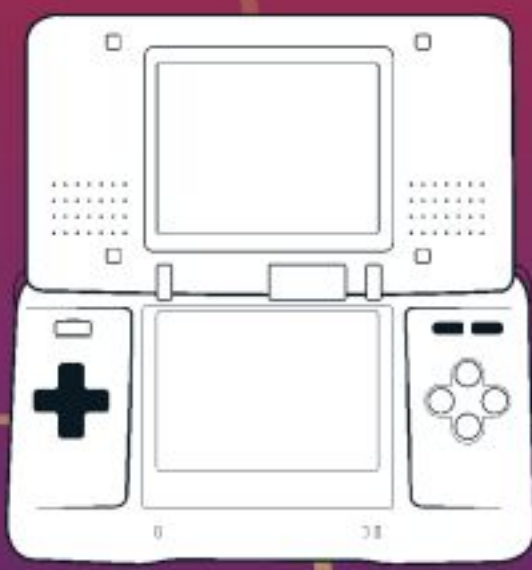

NINTENDO DS

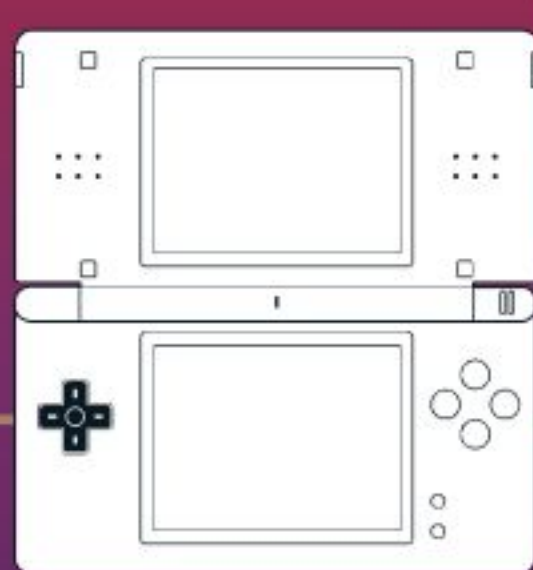

NINTENDO DS LITE



NINTENDO DSi

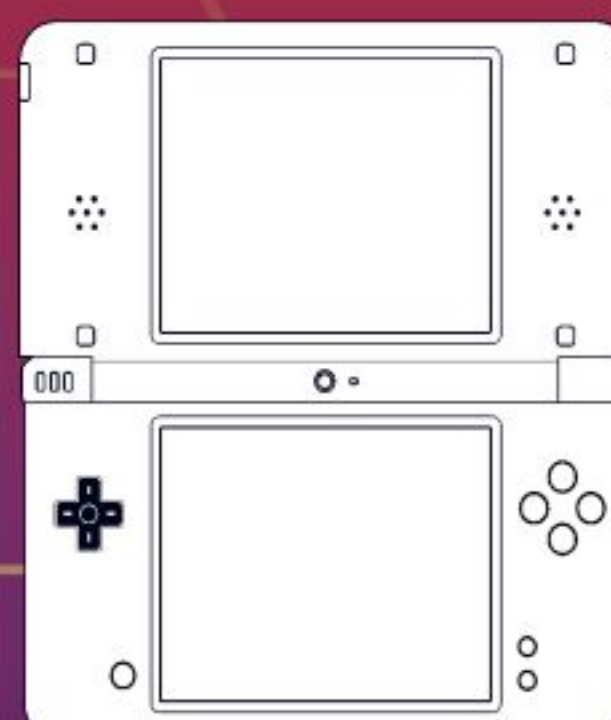

NINTENDO DSi XL



NINTENDO 3DS

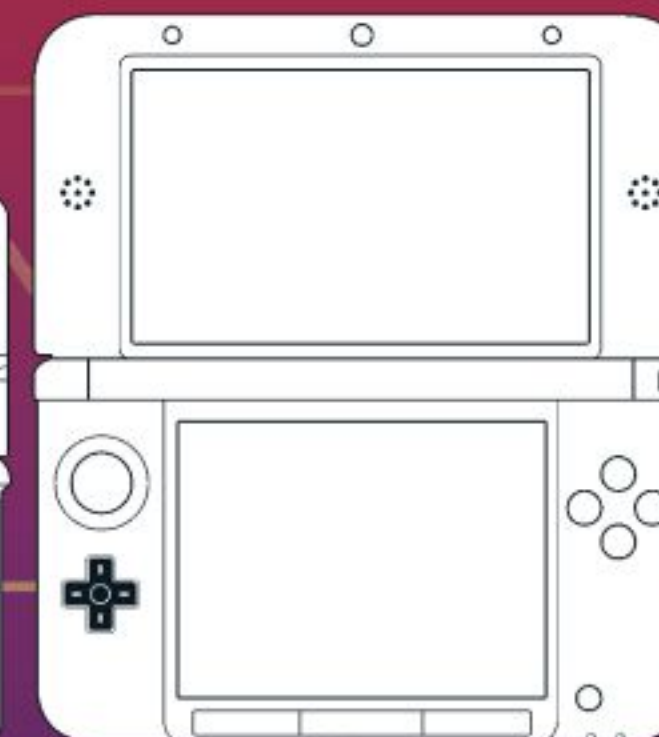

NINTENDO 3DS XL

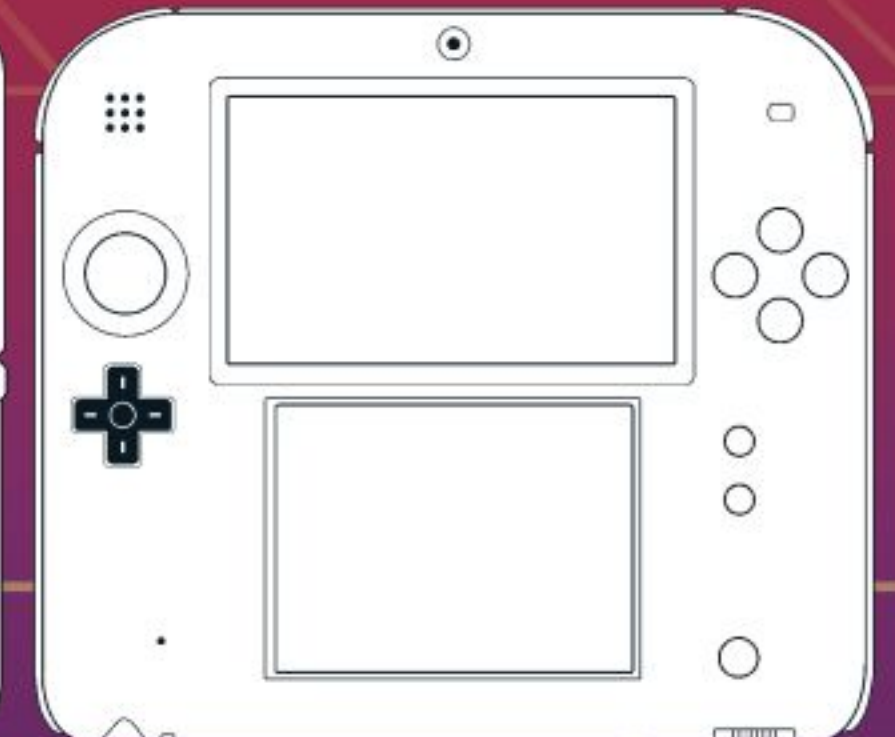

NINTENDO 2DS



simon

simon



» Ralph at his lab desk. Note the Simon Trickster in the foreground.



» "Now where's that Nolan Bushnell?" Ralph fires up the original console, the Brown Box.



» Nice suit, nice console...

» Ralph in his basement lab, where all the magic happens...

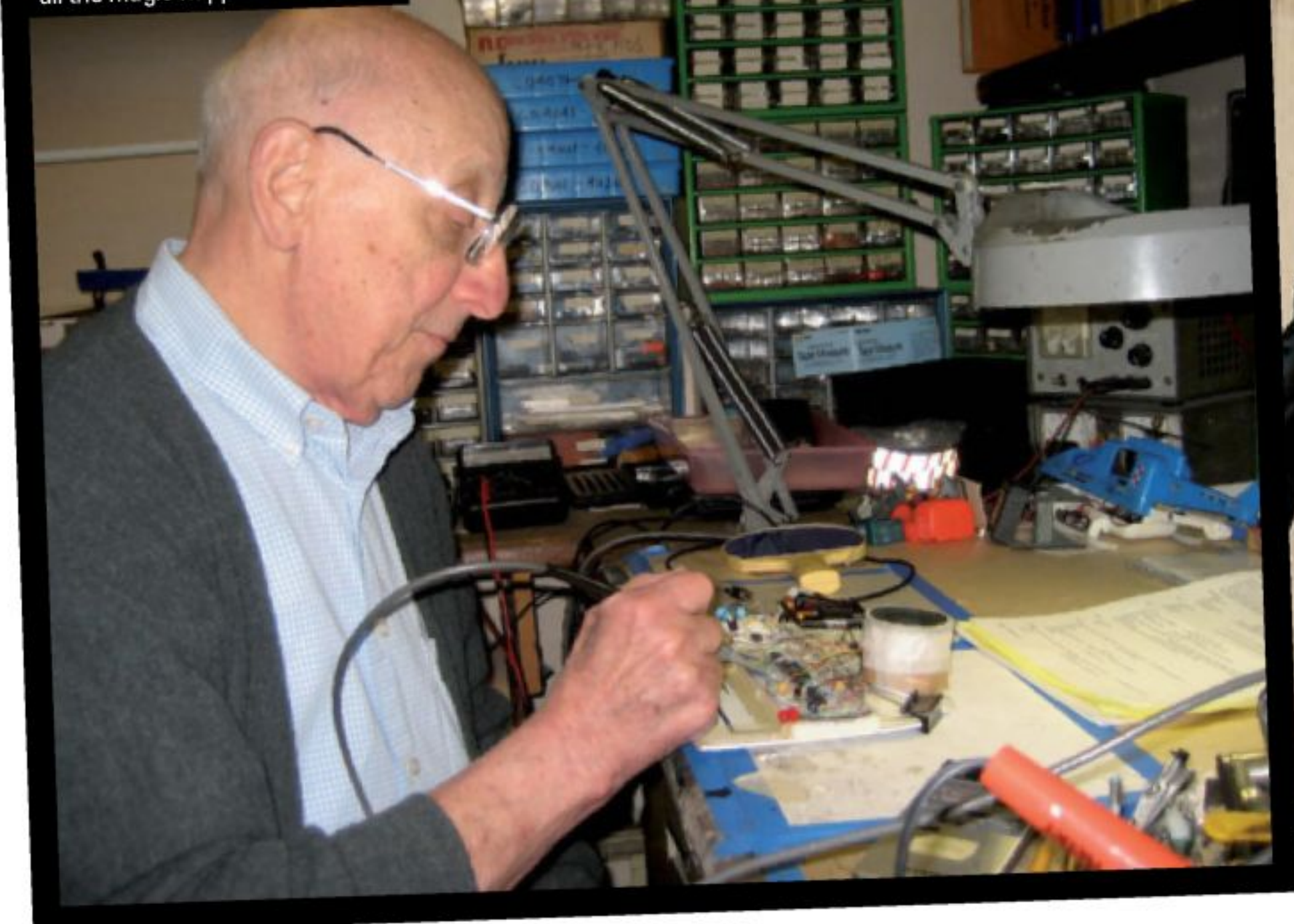

» Baer meets Bush. One of these men made the world a better place. The other...

FOLLOW THE LEADER

"Before *Simon* was even in production, Howard asked me, 'So what do we do for encores?'" says Ralph with a smile. "Lenny was so damn busy that I couldn't rely on him and had to grab a couple of other guys to work on *Amaze-A-Tron*. I remember I came up with the idea to use the corner segments to point to the person whose turn it was, which was pretty cute, I thought. Those little things make a game." Ralph worked on two further successful handheld games, *Computer Perfection* and *Maniac*, at the start of the Eighties and has since produced an incredible array of consumer electronics, ranging from interactive teddy bears to talking doormats, and he still spends much of his day tinkering away in his basement lab. "If I shut that off, what would I do? I've already written my autobiography – 500 pages with pictures and moving images that I hope will be published on the fourth generation of electronic books some day – and I was presented with the National Medal of Technology by President Bush in 2006. It doesn't get much better than that!"

Four colours, four sounds and an instantly understandable concept. Ralph Baer explains how he created the iconic memory-testing handheld game *Simon*. Paul Drury follows the leader

Ralph Baer is standing in the kitchen of his New Hampshire home, looking very sprightly for his 87 years. He's just made us eggs over easy for lunch and now he's telling us war stories.

"Yeah, I came to England for D-Day, zig-zagging across the ocean on a British freighter, part of a Royal Navy convoy. I had latrine duty all the way across," he grimaces. "I ended up in some English army barracks somewhere in the south of the country. The weather was abominable. It rained constantly. There was foot-deep mud all over the place. I ended up catching pneumonia and was taken to a field hospital, blood dripping from my nose. Shortly after that, the troops I'd left behind were shipped off to the Normandy beaches..."

So thanks to the miserable English weather, Private Baer was saved from the carnage of D-Day and when he returned to America he kindly invented videogames. Not straight away, of course, but even as early as 1951 he was fiddling with the innards of analogue televisions, mulling over how the patterns and colours he could create on screen might form some sort of interactive entertainment. By 1966, he was sketching out plans for how to play games on your TV set and two years later he had produced a working prototype, the 'Brown Box', that hosted a number of primitive videogames, including a compelling take on ping pong. Ideas and electronics were refined over the following years until, in 1972, Ralph's vision reached the mass market via the Magnavox Odyssey, the world's first home videogame console.

It's an epic tale of how Ralph, with the help of some valuable colleagues, laid the foundation for home videogames through ingenuity, determination and countless hours of soldering and experimenting with game logic. The full story is exhaustively recounted in his book, *Videogames: In The Beginning*. Today, though, we want to ask him about a single chapter of his

IN THE KNOW

- » PUBLISHER: MILTON BRADLEY
- » DEVELOPER: RALPH BAER/MARVIN GLASS AND ASSOCIATES
- » RELEASED: 1978
- » GENRE: PATTERN-MATCHING HANDHELD
- » EXPECT TO PAY: £25 FOR AN ORIGINAL MODEL

pioneering work. A simple four-note refrain that came after his rousing opening. This is the story of how the perennially popular handheld game *Simon* came to be.

In November 1976, Ralph was making what had become an annual trip to the AMOA show in Chicago, where the latest coin-ops were being showcased. "I went to these shows on behalf of Sanders and Magnavox to check on the presence of games that might be infringing our patents," explains Ralph. "I'd see who was doing a game that

has interaction between machine-controlled and manually controlled symbols, like a ping pong game. I don't care if it's a tank game with a shell bouncing around; it all comes under the same patent. I was looking at stuff, scribbling it down, and sending my notes to Magnavox to say, 'Hey, you wanna check how many units these guys are making and how much money they owe us!'"

As Ralph perused the aisles, he came across something of an oddity. *Touch-Me* was a dark brown, waist-high machine with no screen and just four large buttons on a sloping panel. These buttons would light up in a random sequence, accompanied by crude sounds, and the player was tasked with following the pattern. The game had actually debuted at the show two years earlier and Atari had produced "two or three thousand", according to its chief engineer at the time, Steve Bristow – a respectable number but certainly not aping the runaway success of *Pong* and *Tank*. "I thought it was kinda ugly and had these awful, raspy sounds," recalls Ralph. "But it was an interesting game. In fact, we bought one!"

He wasn't the only one to recognise the potential. Howard Morrison was a partner at Marvin Glass and Associates (MGA),





simon



“ I got a cheque for \$10,000 for Simon. Better than nothing, but peanuts compared to the \$30 million they must have made ”

Ralph on following the money...



» In the beginning was the Box, and Ralph said, 'Let there be dots of light...'



» Atari's Touch-Me coin-op, where the Simon story began.



» Ralph's first post-Simon project was Amaze-A-Tron for Coleco.



then the premier US independent toy and game design group. Ralph had recently become part of the team, splitting his time between working on new products at the company's Chicago offices and beaver away in his basement lab at his home in Manchester, New Hampshire. Howard had also played *Touch-Me* at the show and both men agreed that, though it was severely lacking in visual and aural appeal, the gameplay had a certain charm. Noting the recent release of *Football* by Mattel and other early handhelds from Milton Bradley, the pair began discussing the possibility of creating their own portable version.

"We thought it was worth a shot," says Ralph. "We outlined a brief spec and, in November and December, I built a hardwired breadboard system and designed a four-tone generator so that Howard could 'play' with it and get a feel for the game. He even demonstrated the game to one of MGA's managing partners, Jeffrey Breslow, by drawing four squares on a sheet of paper and imitating the sequence of lighting segments and sound. Jeffrey said: 'This is gonna work! Tell Baer to go ahead.'"

With the nod given to the project, which at this stage was known as '*Follow-Me*' or '*Tap-Me*', Ralph brought on board young software guru Lenny Cope. The pair had worked together on a programmable record player earlier that year, which had used the Texas Instruments TMS-1000 microprocessor, and they decided to build their game around this chip. Work began in earnest on 3 January 1977, but coding for the TMS-1000 was definitely not as straightforward as the gameplay they were trying to create.

"It was very crude and slow as molasses," chuckles Ralph. "Writing programs for it was a real chore. We had a Teletype terminal that Lenny used to communicate with a computer somewhere in Pennsylvania. Texas Instruments' program for the device was resident on that machine. Communicating at a couple of hundred baud per second took forever and the monthly telephone bills that ensued looked like the national debt! But Lenny was a smart guy and he coped."

Meanwhile, Ralph was busy designing and building the physical unit, containing a version of the TMS-1000 with external ROM, four light bulbs and push-button switches, and a loudspeaker. The sounds that were to come out of that speaker were still to be determined, a key decision considering the unpleasant audio of the original *Touch-Me* machine. Then, as he was flicking through his children's Compton's Encyclopedia, Ralph found an instrument that could play a variety of tunes using just four notes. "The bugle!" he laughs, taking that very book from his shelf and opening it at the page where he had his epiphany over 30 years ago. "Back when you're in your fifties, not eighties, a hell of a lot of things come together quickly in your head. I realised that if we programmed the beeps to be the notes G, C, E and G like the bugle, they would sound good played in any sequence. Perfect!"

The project, now entitled '*Feedback*', was definitely on song. A fully functioning square unit was presented to potential clients in the summer of 1978, and the first to see it, Milton Bradley, said yes. However, Ralph and Lenny still had one obstacle to overcome before the game reached the shops: Dorothy Wooster, PhD.

"She was a pain in the ass," says Ralph, shaking his head. "She was the daughter-in-law of the president of Milton Bradley. She was a psychologist and had to pass judgement on whether the kids would play with this little thing. She said, 'Yes they will, if you add this, change this,' and next thing I know, we've got two more switches, different difficulty levels, different versions and on it goes... All we got is 1K of friggin' memory and a 4-bit processor! How were we gonna do all this? The suitcase is kinda full! So we had to rearrange stuff, so to speak..."

SIMONSAYS

After the launch of the original Simon in 1978, many different models and variations followed. Here are four of our favourites

POCKET SIMON

Two revisions of the classic model appeared in 1980, the first being this charming pocket version. Remember, we all had bigger pockets in the Eighties. And bigger hair.

SUPER SIMON

This earned its 'Super' tag by introducing head-to-head and team play and doubling the number of buttons to eight. Try playing Fast Hands on maximum speed. Ouch.

SIMON GAME WATCH

You've always got time for a quick bit of pattern-matching, courtesy of this watch version from Nelsonic. See also the miniature key chain model.

SIMON: TRICKSTER

This modern update includes a classic mode alongside the colour-shifting *Simon Bounce* and the follow-me-backwards *Simon Rewind*. Still on sale today, over three decades after the original was launched.



The package was certainly bulging by the time it reached the market in 1978, but the colossal success of Ralph's pattern-matching plaything – a million sold that Christmas, 2 million the following year, and countless more in the subsequent decades – may have partly been due to some cosmetic changes made by a nameless employee before it went into production. "Some unsung genius changed the name to *Simon*, which made perfect sense, and made it round with pie-shaped segments that light up," explains Ralph. "It was just serendipity that when *Close Encounters Of The Third Kind* came out, the mothership was round and made sounds like *Simon*. When I saw the movie I said, 'Hey, it's *Simon* coming in!' I'm sure subliminally, it helped sales."

Equally otherworldly was the launch of *Simon* to the press. The flamboyant VP of Milton Bradley, George Dittomassi, organised a glitzy affair at the infamous Studio 54 nightclub in downtown New York. Ralph recalls the surreal scene well. "I was ferried to Studio 54 with some of the Marvin Glass partners by stretch limo from the Waldorf Astoria hotel, courtesy of Milton Bradley. I got a kick out of watching the crowds on the sidewalk part like the Red Sea did for Moses when we got out of that limo and entered the club. Maybe we looked like a bunch of Mafiosi to them. Inside, the noise was horrendous and there were all these flashing lights. Howard and I retreated upstairs and nothing happened until about two in the morning. Then, finally, they turned off the din coming from the DJ, everyone stopped dancing or whatever you call that stuff they were doing down there, and a four-foot diameter *Simon* floated through the air above the heads of all these zonked-out patrons..."

One can only speculate what those coked-up clubbers made of this particular strain of *Saturday Night Fever*, but *Simon* was undoubtedly a hit and made Marvin Glass and MB Games a fortune. Ralph received a cheque for \$10,000 – "better than nothing, but peanuts compared to the \$30 million they must have made," he quips – but the success of *Simon* actually gave him huge satisfaction for an entirely different reason. Back in May 1972, when Magnavox was promoting its revolutionary new TV game, the Odyssey, one Nolan Bushnell played on a machine at a dealer's open-house event in Burlingame, California. He went home and instructed one of his engineers, Al Alcorn, to work on a coin-op version of the Odyssey's ping pong game. The resulting *Pong* would not only launch Atari but kick-start the whole arcade business.

"It always annoyed me to hear Nolan referred to as the 'inventor' of videogames," says Ralph. "I think he's just a self-promoter. He's smart, he's smooth, he looks attractive, he's got all that, but he hasn't the courtesy to credit other people. Steve Mayer, who headed up the Grass Valley group at Atari that developed *Touch-Me*, says it was Nolan who first came up with the idea of some form of sound sequence game. We managed to make a success of it and so, unintentionally, I managed to upstage him for once."

With a broad smile, Ralph gives us a tour of his basement, where the amazing collection of all the games and gadgets he's invented over the years are proudly on show. We finish by playing a game of ping pong on an actual Brown Box, the grandfather of all the consoles currently sitting under your telly. He beats us soundly, mainly due to his masterly use of spin. "We call it 'adding some English' over here," he winks. How apt.



» Some of the wonderful creations that Ralph's had his hand in over the years



ATARI 5200

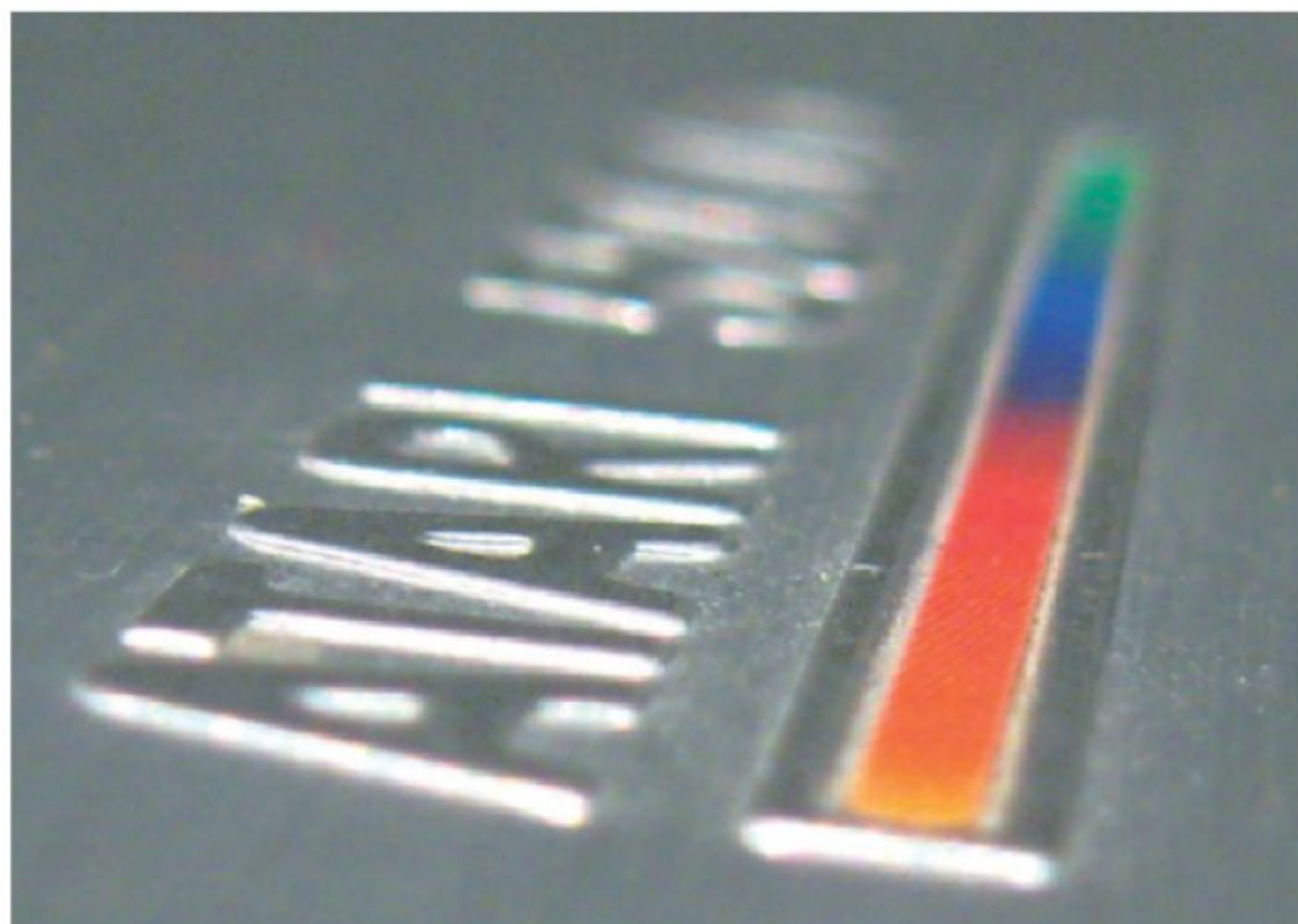

Launched in 1982 as Atari's high-end system to bring the full arcade experience to the home, the 5200 instead turned into Atari's two-year detour on the way to the release of the 7800. We reveal all

ATARI 5200

RELEASE INFO:

- Year released: 1982
- Original price: \$299.95
- Associated magazines: *Atari Age, Antic*
- Buy it now for: \$30-\$100

The Atari 5200 may be unfamiliar to UK gamers, as it never saw a PAL release. What should have been the system to bring Atari into the Eighties, had it been released when originally proposed in the late Seventies, instead became a long and winding path to missed opportunities and bad execution. Stepping into the 5200's internal design gives the key to its origins and sheds some light on the troubled path it took as a concept and design, before it was finally released to market in October of 1982. Internally, the 5200 is an Atari 400 PCS (Personal Computer System) – the lower-end machine of Atari's late Seventies/early Eighties computer line – which is not a random fact being thrown at you when you take into account how the 400 was initially proposed.

Codenamed 'Candy', the Atari 400 was initially meant to be a lower-end game console to complement the higher-end 'serious' computer, codenamed 'Colleen'. The vision of the design team leader, Jay Miner, the new game console was to replace the team's previous console, the Atari 2600. Miner's idea was to leverage the new custom sound and graphics chips that they were designing, for a console with a keyboard directly on it, the idea being that game programmers would be able to develop right on the console itself, rather than the then-arduous process of developing on 6502 simulators running on time-sharing mainframes and then burning the games to an EPROM to test on the real thing. As team member Joe Decuir recalled: "We knew we would need to leapfrog the 2600 before somebody else did. It had to support home computer character and bitmap graphics. We saw the Apple II, Commodore, and Radio Shack appliance machines coming."

The 2600's time being limited was echoed by the slow sales that 1978 Christmas season and the rallying cry of Atari

head at the time Nolan Bushnell. Bushnell thought that, much like Atari's previous plethora of *Pong* machines, the 2600's time on the market was limited to around two years before the company had to introduce a new console. It was the same gut instinct that he had gone on since the early coin-op days of Atari, when to stay ahead of the 'me too' competitors it had to continuously innovate and release new machines or fall behind. Unfortunately – or fortunately, depending on how you look at it – Atari was a Warner Communications company now and not a private game-engineering firm. Warner's vision was one of stability for its company, and getting better sales out of its products on the market at the time. It was a time when Atari itself was tanking, going from profits of \$40 million in 1977 to what would be just \$2.7 million in 1978. Bushnell being an absentee manager popping up with random directions and epiphanies didn't help, and in February 1978 Warner brought in a consultant to help make the company profitable again: Ray Kassar. Kassar and Bushnell spent the rest of 1978 butting heads, and Bushnell's stand at the Warner budget meeting that November would be his last. Getting in a shouting match with Warner's heads over drastically reducing the price of the 2600 to move it faster, they realised that he had to be completely taken out of the loop. After a feeble attempt to retain control of Atari by having a management meeting with Warner executives left out, the parent company decided to put Bushnell out to the corporate pasture, forcing him to retire.

By 1979, Kassar was in charge, and he put in place the idea to market the 2600 year-round, in direct opposition to Bushnell's plan – something executives at other videogame companies had been calling for since early in 1978. Atari also licensed the smash arcade hit *Space Invaders*, which, when released in 1980, gave the 2600 the shot in the arm it needed, and Atari was back up to \$80 million in profits for that year. Kassar also put into place his vision for Atari's new computer, and in the process axed the idea of a replacement for the 2600. Kassar's vision for Atari's computer line was coloured by his former position at the textile manufacturing

» This planned deluxe controller featured an arcade-style trackball, for the full experience in the home.



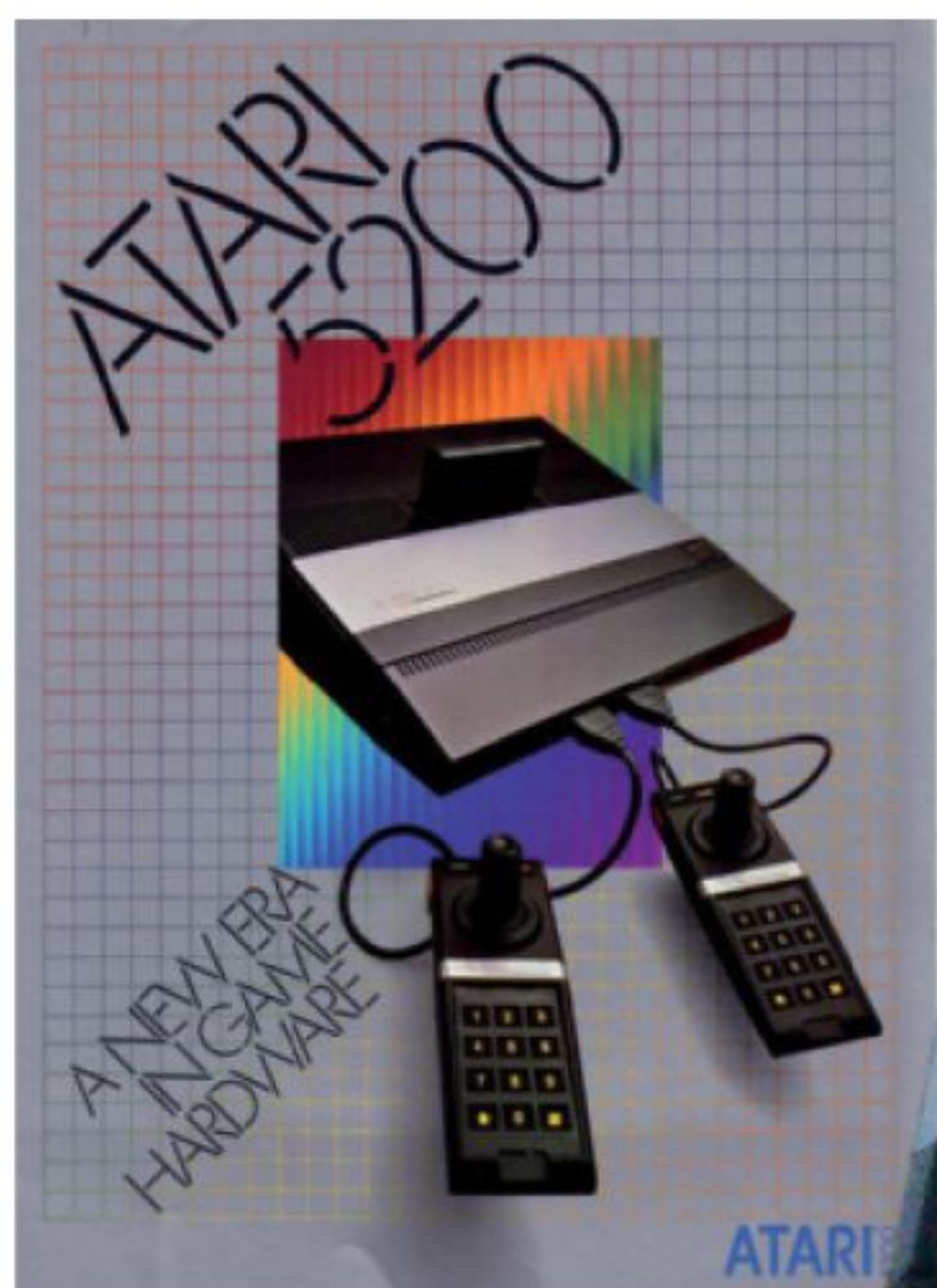

» The inclusion of the ageing and unimpressive *Super Breakout* as the console's pack-in raised eyebrows.

company Burlington Industries. Targeted towards mass consumer products like towels, carpets, and other woven products, Kassar felt his experience at Burlington gave him a keen sense of consumerism. He felt the computers should be developed and marketed as easy-to-use, consumer-oriented products in contrast to the overly technically inclined audience that home computer designers were then targeting. And although his suggestion during a meeting that the computers be marketed in different colours to attract housewives caused some Atari employees to quit on the spot, it turned out to foreshadow the way the market would go under Steve Jobs 20 years later with his coloured line of iMacs.

The problem was, with how right Kassar had been on everything, Bushnell was also right. By 1980 what would be the 2600's biggest competitor, Mattel's Intellivision, would be launched nationally, followed by a blitz of ads showing the Intellivision's more detailed sprites and the advantages of its 16-direction controllers, all summed up by a snooty and arrogant George Plimpton showing side-by-side comparisons. Combined with the rise of a third-party market of 2600 games thanks to the defection of some of Atari's game programmers to form Activision, Kassar knew that the company had to do something or lose its grip on the industry. And the rest of Atari knew that it now had no choice but to work on a direct answer to the Intellivision.

Steve Bristow and a team of engineers began working on an update to the 2600, codenamed 'Super Stella', 'Sylvia', the '3200', and even 'System X' at different times. They decided to bring the 2600's design more towards the new computer line by reproducing the format of the custom graphics chip team of GTIA and ANTIC. Keeping it backwards

compatible with the 2600 was imperative, and accomplished by substituting the GTIA with an advanced version of the 2600's TIA graphics and sound chip called Super TIA or STIA. Likewise, System X was to get its own version of the ANTIC called FRANTIC, and the addition of a Votrax voice synthesis chip. It would also get a memory upgrade from 128 bytes to a full 2K of memory, which was a big upgrade for 1980 and more in line with Intellivision's standards, if not more powerful when the ANTIC's display list technology was considered. The console and controllers would use a new advanced wedge shape design form by designer Roy Nishi, which he was also using for the in-

development remote control version of the 2600 called the Atari 2700. The controllers themselves featured side-mounted buttons and an eight-direction digital joystick with the look of a primordial Atari 5200 controller. Unfortunately, System X only got as far as full schematics and a black box development unit, along with case and controller mockups, before notice came down the line that it was scrapped. Apparently the guys in the Home Computer Division (HCD) were raising a ruckus over their technology

being marginalised if the Super TIA would have gone all the way through development. In a classic example of wasting time by running in circles, the push was made to use Atari's PCS technology after all.

Recycling the System X designation and some of the casing and controller work, in 1981 this new system's development started. This time, however, given the full support of Kassar and the Consumer Electronics Division (CED), all stops would be pulled to create a deluxe game system. In order to crush Intellivision, and in effect start the

“THE ATARI 5200 WAS CREATED FOR THOSE PLAYERS WHO DEMAND VIDEO GAME TECHNOLOGY”

— MICHAEL MOONE, PRESIDENT OF ATARI CONSUMER ELECTRONICS DIVISION





ATARI 5200



» The System X never made it past the early prototype stages before its designation was borrowed for what would eventually become the 5200.



next generation of 8-bit game consoles, they wanted to try to bring a full arcade experience to the home.

First, the team started moving the entire multiboard PCS architecture to a single board system that would fit in the wedge-shape case form factor. This included keeping the unique four controller ports, but moving to a novel hookup scheme by combining the power and antenna cord into a single cable that attached to a combined antenna/power box. A setup not seen since the RCA Studio II in 1977, Atari upped the ante by making it auto-switching – the very first console to do so.

Secondly, work was done to try to bring in controller features to compete against Intellivision's 16-direction keypad-driven controller, while providing the functionality for paddle-driven games that a digital controller simply could not support. The answer came in the form of a full analogue controller driven by two potentiometers, which when combined together would give a full 360-degree range of motion as well as provide accuracy for paddle games. It had the added benefit of being able to support velocity-tracking to control a character's speed of motion. The side-mounted buttons of the original System X's controllers were split into two A and B buttons on each side. Finally, a full keypad was added to the controller's empty space to allow the extra input control expected in the more advanced games on Atari's computer systems. Besides the start and reset buttons, both also found on the PCSs, a feature that gamers had been clamouring for was added as well: a pause button. This new controller was referred to as the 'Universal Game Controller', meant to imply that this was a deluxe controller – a luxury experience. To go with that experience, the team leveraged the now-cancelled Atari 2700's console-based controller storage area, complete with flip-up smoked plastic lid to complement anyone's early Eighties entertainment centre.

“NO! WE ARE NOT HCD! WE DON'T WANT THE 5200 TO BE A COMPUTER!”

– GEORGE KISS, DIRECTOR OF SOFTWARE, CONSUMER ELECTRONICS DIVISION

The case itself also was updated to co-ordinate with the HCD's pending update to its computer line, the 1200XL, to give a unified look across the entirety of Atari's 1982 product line. In came glossy and matte black plastic combined with a futuristic brushed metal inlay.

A bevy of peripherals were also planned. First and foremost was a keyboard expansion that was to plug in through a back expansion port, giving the 5200 some computer capabilities, including peripheral expansions. Second was a voice expansion module being designed by Milton Bradley for Atari, which would coincide with the version that it was designing for the 2600 as well. Third was a full four-voice, 48-octave musical keyboard with stereo output. Fourth was a full arcade-style 'Trak-Ball' controller, foreshadowing the type of in-home full-size arcade controllers used by MAME enthusiasts almost two decades later. Last was a 2600 compatibility module, which, contrary to popular myth, was planned from the beginning.

During much of the development, the system's internal name was changed to PAM (Personal Arcade Machine) before the final name was decided on prior to its public unveiling: the Atari 5200 Home Entertainment System. The move caused a change in the 2600's naming as well, just in time for its move to the all-black version affectionately known to collectors as the 'Darth Vader' model. Previously referred to as simply the Video Computer System, it now became the Atari 2600. Atari also updated the console and game boxes to go with the new launch, with boxes for both systems using a silver motif. Additionally, game boxes received futuristic hologram stickers, remnants of the shut-down Atari Cosmos tabletop game project.

Atari was also very careful in its pending marketing strategy for the system to explain that the 5200 was not a replacement for the 2600. At \$299.95, it was to be considered a high-end, state-of-the-art videogame system, with the 2600 and



Community



1. Atari Museum

www.atarimuseum.com

■ The Atari Museum, home of the Atari Historical Society, is the premier Atari archive. Run by noted Atari historian Curt Vendel, the site houses information and exclusive material not found anywhere else, thanks to Vendel's close ties to former Atari employees.



2. AtariAge

www.atariage.com

■ If you want to find the current fan base of the 5200, you'll find it at AtariAge's bustling online community. The de facto community site for the Atari scene, you'll also find a store that supports current 5200 homebrew authors with full packaged releases of their games.



3. Cafeman's Atari 5200

Supersystem Page

cafeman.www9.50megs.com/atari/atari5200.html

■ Ron Lloyd's shrine to the 5200 hasn't been updated in a while, but still remains a great source of information and commentary from some of the original Atari 5200 game developers.



4. Best Electronics

www.best-electronics-ca.com/cx52_j.htm

■ We've all heard about the problems with 5200 controllers breaking down. With 26 years in the business supplying replacement parts from Atari's original warehoused service stock, this is the place to go for every single part needed to repair your controllers.

5200 comprising "two home game systems in the same spirit in which an automobile manufacturer builds different models to suit different tastes".

With press first going out in May of 1982 and the big intro at the June CES with a view to an October launch, things were looking great for the console. Or so they thought.

In May, when Atari was announcing its next-generation system, another company thought to be long out of videogames surprised everyone. Coleco started announcing its own next-generation videogame system, the ColecoVision. Atari was caught completely off-guard and had to scramble to start a strategy against its new main competitor, once it was able to see the console at the June CES. Here it was, ready to kill Mattel and claim victory over the market by creating a new high-end niche while dominating the low end, and now the game had completely changed.

To make matters worse, during August and September focus groups were less than positive about the 5200's controllers. While many of the testers understood the possible advantages of learning to use the new controller format in the long run, most complained about the lack of resistance in the controllers, as well as the difficulty in playing four-direction precision games like *Pac-Man*. Also, in direct side-by-side focus tests with the ColecoVision, testers thought games on both systems looked equally great, with Atari's only advantage being that the system's case and controller styling were more appealing. Media reviews had a similar outlook, with the addition of complaints that the initial launch titles were the same old games already on the 2600, including the surprise inclusion of *Super Breakout* as the pack-in game instead of one of Atari's more high-profile licences like *Pac-Man*.

Likewise, many of the planned expansions and peripherals became like roadkill on the road to market survival. CED's pride and competition against HCD caused it to want to make sure the 5200 was nothing like the Atari 400, and that it would never be mistaken for a computer. Axed were the keyboard expansions by the October launch, which soon after also led to the cancellation of the voice expansion for both the 5200 and 2600, and an eventual lawsuit from Milton Bradley.

Atari worked to rectify many of these faults, however, and managed to release a good number of new titles for

the system over the coming year. It also managed to delay some games for its other platforms to make sure that the 5200 had a certain degree of exclusivity. By 1983, a revised two-controller-port model was released with sturdier parts on the controllers and a new pack-in game: *Pac-Man*. It also dropped the odd single power/television cord in favour of a more traditional two-cable separate switchbox setup. However, by that time sales were already seen as lacklustre, and the console's future was being questioned, both inside the company and by industry commentators. To make matters worse, the 2600 module was absent almost the entire time, giving Coleco the advantage of backwards compatibility with the 2600 via its own module. By the time it appeared for the two-port model, owners of the older four-port version found that they couldn't use it, save for the few that were lucky to get the last revision before the move to the newer model.



A final cost-reduced version was being worked on, codenamed the 5100, which cut the physical size of the console in half and included new CX-52L controllers – especially designed self-centring joysticks with spring-loaded side buttons – but it never made it to market. By February of 1982, production of the 5200 was secretly ended.

When Atari finally acknowledged it in May, it was ready to position the upcoming Atari 7800 as its replacement. As is well-known, however, Atari became a prominent victim of the North American videogame crash of 1982-1984, with the entire consumer division sold off to Jack Tramiel to form his Atari Corp. Unknown to many collectors, Tramiel actually re-released the four-port 5200 version in 1985 in an effort to sell off his sizeable inherited back stock of products. Featuring cost-reduced packaging and a return to the *Super Breakout* pack-in, he also re-released many of the previous games in similar packaging. Tramiel brought to market several previously finished but unreleased games that were thought victims of the crash: *Gremlins* and the groundbreaking Lucasfilm titles *Rescue On Fractalus!* and *Ballblazer*. Actually generating strong sales for several years during this era of the NES, Sega Master System and Atari 7800, support for the 5200 was finally dropped by 1991, closing the book on what was once to be Atari's flagship console.



► The design of the original System X 'Sylvia' hardware, sometimes known as the 3200, still holds retro appeal today.



ATARI 5200

PERFECTTEN GAMES



01

SINISTAR

- » RELEASE: 2010
- » PUBLISHER: ATARIAGE
- » BY THE SAME PUBLISHER: N/A

01 The first coin-op game to inspire fear in gamers with its boss's demonic-sounding digitized voice, Atari was working on a port for its 8-bit computers when the company cancelled it due to its severe financial problems. Almost completely finished save for some minor points, it remained a distant memory while passing through many hands over the years. That is until recently, when a 5200 homebrewer ported the game to the 5200 and AtariAge decided to make full productions complete with great label art. The game truly shows off the 5200's capabilities of reproducing early Eighties arcade titles, and the gameplay is great, successfully re-creating the franticness of the original.

MILLIPEDE

- » RELEASE: 2002
- » PUBLISHER: ATARIAGE
- » BY THE SAME PUBLISHER: N/A

02 Yet another victim of Atari's implosion, *Millipede* is a port of Atari's seminal follow-up to its monster 1980 hit, *Centipede*. Ready to go and even listed in the 1984 catalogue back in the day, its axing meant that gamers wanting to play *Centipede* would have to either purchase the 8-bit computer version or wind up having to suffer through a pretty terrible 2600 port. That is until AtariAge once again came to the rescue with a full re-production. *Millipede* is truly a joy to play with the 5200's Trak-Ball (yes, Atari spelled it with a "k"!) controller. The graphics and gameplay are spot on when compared to the original, with even the animated title screen re-created perfectly.



02

BALLBLAZER

- » RELEASE: 1986
- » PUBLISHER: ATARI
- » BY THE SAME PUBLISHER: JOUST

03 *Ballblazer* was one of Lucasfilm Games' first titles. Taking full advantage of the 8-bit computer and 5200's scrolling capabilities, Lucasfilm managed to create a beautiful futuristic 3D 'soccer' match complete with continuous fractalised music. Because the partnership was such a big deal, Atari wanted to hold off the computer release to give the 5200 and then the 7800 some exclusivity. Unfortunately it wound up backfiring, and the company imploded during the interim, leaving 5200 owners having to wait until Jack Tramiel revived 5200 sales in 1986.

MS. PAC-MAN

- » RELEASE: 1983
- » PUBLISHER: ATARI
- » BY THE SAME PUBLISHER: MISSILE COMMAND

04 What can be said about this bow-wearing beauty that hasn't already been said? Well how about that the 5200 port is an extremely solid re-creation of her arcade appearance complete with all the fun intermission animations and different levels? This Atari conversion is a massive step up from the earlier-released *Pac-Man* for the 5200, as this time around the programmers concentrated more on re-creating the overall faithfulness of the arcade game rather than just the speed of the original. A very solid conversion that's definitely worth tracking down if you are a fan of the arcade version.

ROBOTRON: 2084

- » RELEASE: 1983
- » PUBLISHER: ATARI
- » BY THE SAME PUBLISHER: SUPER BREAKOUT

05 What can get crazier than a session of Eugene Jarvis and Larry DeMar's classic in the arcade? How about a near-perfect port at home complete with dual joysticks? The 5200 version shipped with a special joystick coupler that enabled you to use both of the 5200's controllers to play the game as it was meant to be played. The looser feeling of the 5200's analogue sticks truly makes the fast multi-directional twitching a breeze to carry off. Some even like playing it on here better than the original. Another fantastic arcade conversion that 5200 collectors should immediately seek out.



03



04



05

Due to unfortunate timing, the Atari 5200 didn't have the largest of catalogues. Fortunately both Atari (and later the homebrew community) released some truly fantastic games for it

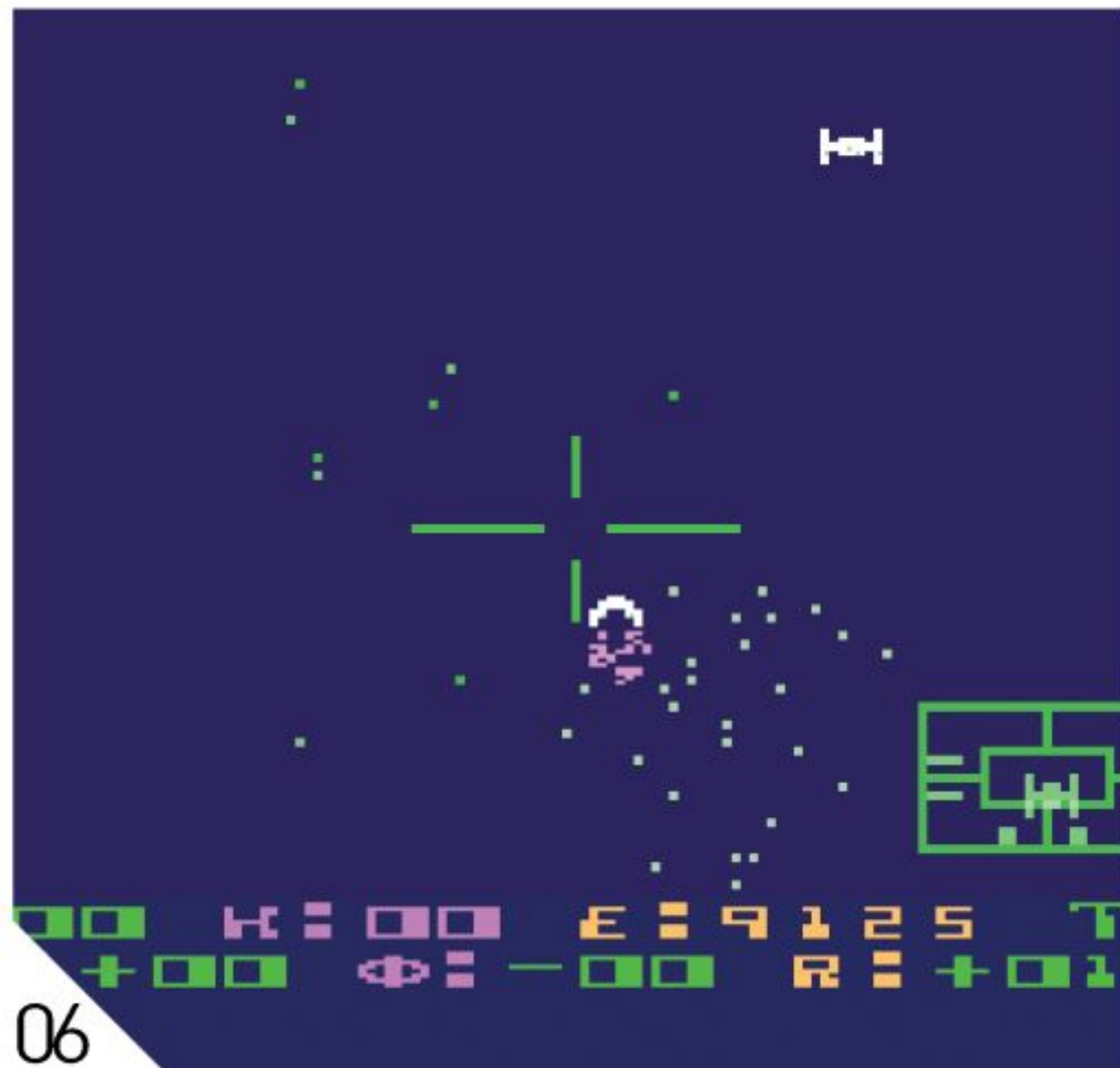

06

STAR RAIDERS

- » RELEASE: 1982
- » PUBLISHER: ATARI
- » BY THE SAME PUBLISHER: BATTLEZONE

06 You simply can't say you've experienced gaming on any Atari platform until you've spent time playing this classic. Designed for Atari's computer line in 1979 to show off their advanced capabilities, it was popular enough to later port to the Atari 2600, 5200, ST, and even inspire a graphic novel by DC comics. You're treated to a first-person view of a cockpit going through space, reminiscent of Exidy's Seventies classic *Star Fire*. With gameplay similar to the classic *Star Trek* text game, you go from sector to sector (via your trusty galactic chart) clearing each of those pesky Zylon ships.

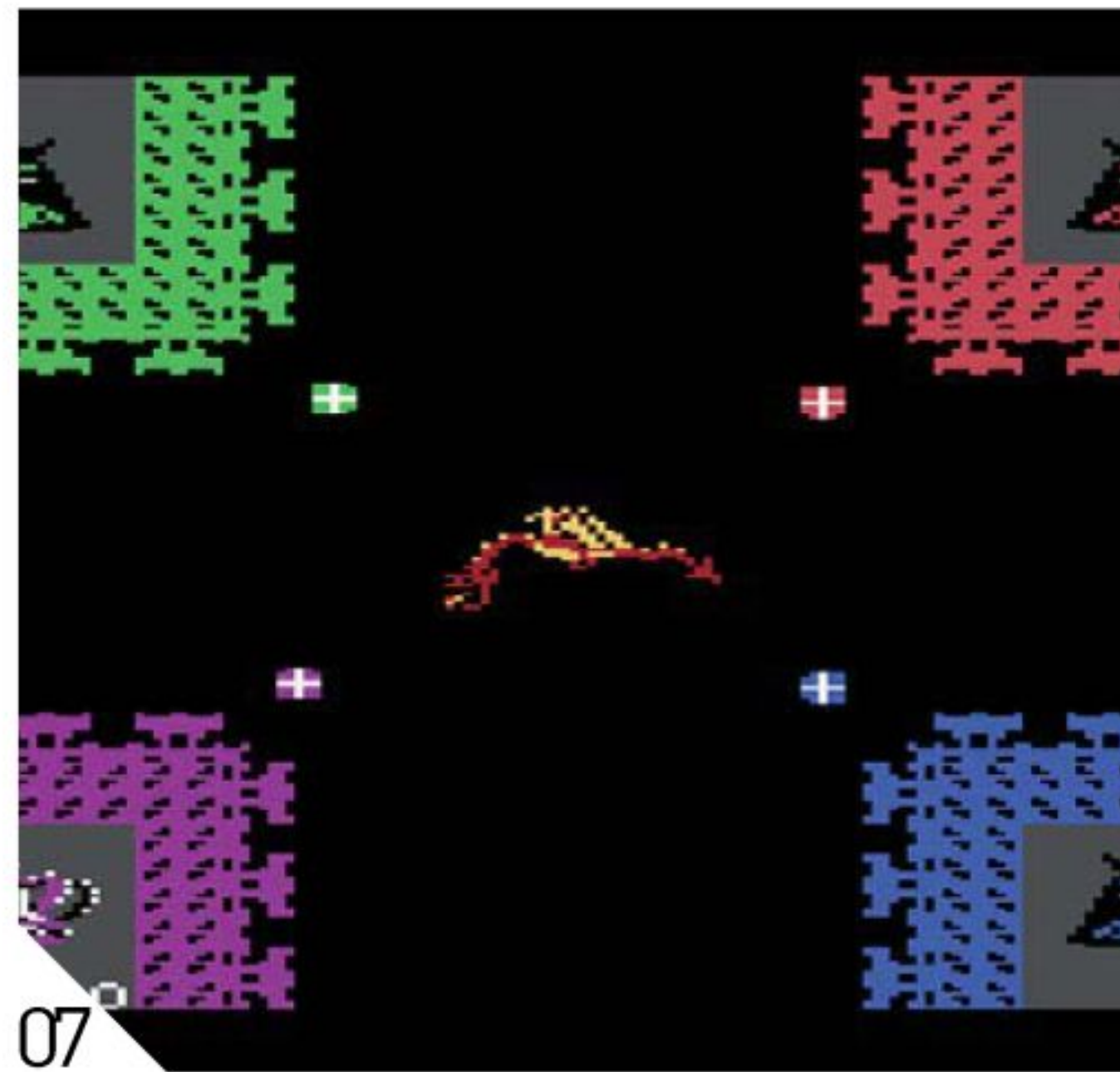

07

CASTLE CRISIS

- » RELEASE: 2004
- » PUBLISHER: SELF-PUBLISHED
- » BY THE SAME PUBLISHER: N/A

07 *Castle Crisis* is a homebrew game by veteran programmer Bryan Edewaard, and fans of the multiplayer coin-op favourite *Warlords* will be happy to learn this is a graphically arcade perfect port of that game, even though it doesn't share the same name. Which you would expect considering the arcade version ran on virtually identical hardware. The Atari 5200's analogue controllers are simply perfect for the precision needed to break out a pair of spinners, which is a problem that plagued many of the earlier ports of this game to other home consoles.



08

ADVENTURE II

- » RELEASE: 2007
- » PUBLISHER: SELF-PUBLISHED
- » BY THE SAME PUBLISHER: KOFFI: YELLOW KOPTER

08 No, this isn't like Dana Marschz's *Hamlet 2*. Atari 5200 homebrewer extraordinaire Ron Lloyd managed to create a legitimate follow-up to the hit 2600 classic, to the point of Atari giving its blessing in exchange for using it to create a scaled-down 2600 version for their Flashback 2 console. Keeping the fun gameplay of the original but vastly updating the graphics, *Adventure II* also includes plenty of new locations and foes to test you. It's worth it to pick it up for the beautiful graphics alone, but the additional updates and expansions make this a fantastic game for the 5200.



09

KOFFI: YELLOW KOPTER

- » RELEASE: 2002
- » PUBLISHER: SELF-PUBLISHED
- » BY THE SAME PUBLISHER: ADVENTURE II

09 Another homebrew classic by Ron Lloyd, this is a completely original game featuring a cartoonish yellow helicopter. Like a chopper version of Rudolph the Red Nosed Reindeer, Koffi is not allowed to go with the bigger rescue 'kopters' on missions. But when he learns of an insidious plan by Pyro the Storm Cloud to burn down the forests, Koffi flies into action to protect the woodland and the animals that live there.

In a take on US Games' 'Name This Game' contest for its 2600 game release in 1982, AtariAge forum members were allowed to enter a contest to design one of the animals appearing in the game.

BEEF DROP

- » RELEASE: 2004
- » PUBLISHER: SELF-PUBLISHED
- » BY THE SAME PUBLISHER: N/A

10 Mattel was responsible for porting Data East's coin-op classic *Burger Time* to the Intellivision (which is considered an excellent port), and its M-Network Publishing ported it to the Atari 2600, Apple II, and IBM PC. Unfortunately, the 5200 had zero chef love, which was a real shame. Thanks to Ken Siders, however, burger-loving 5200 owners can now build them all day long. Initially unveiled under the guise of an April Fool's joke surrounding a "found" prototype, Ken thankfully soon revealed that he had coded it up and was soon looking to publish it as the complete game. *Beef Drop* is the excellent end result.

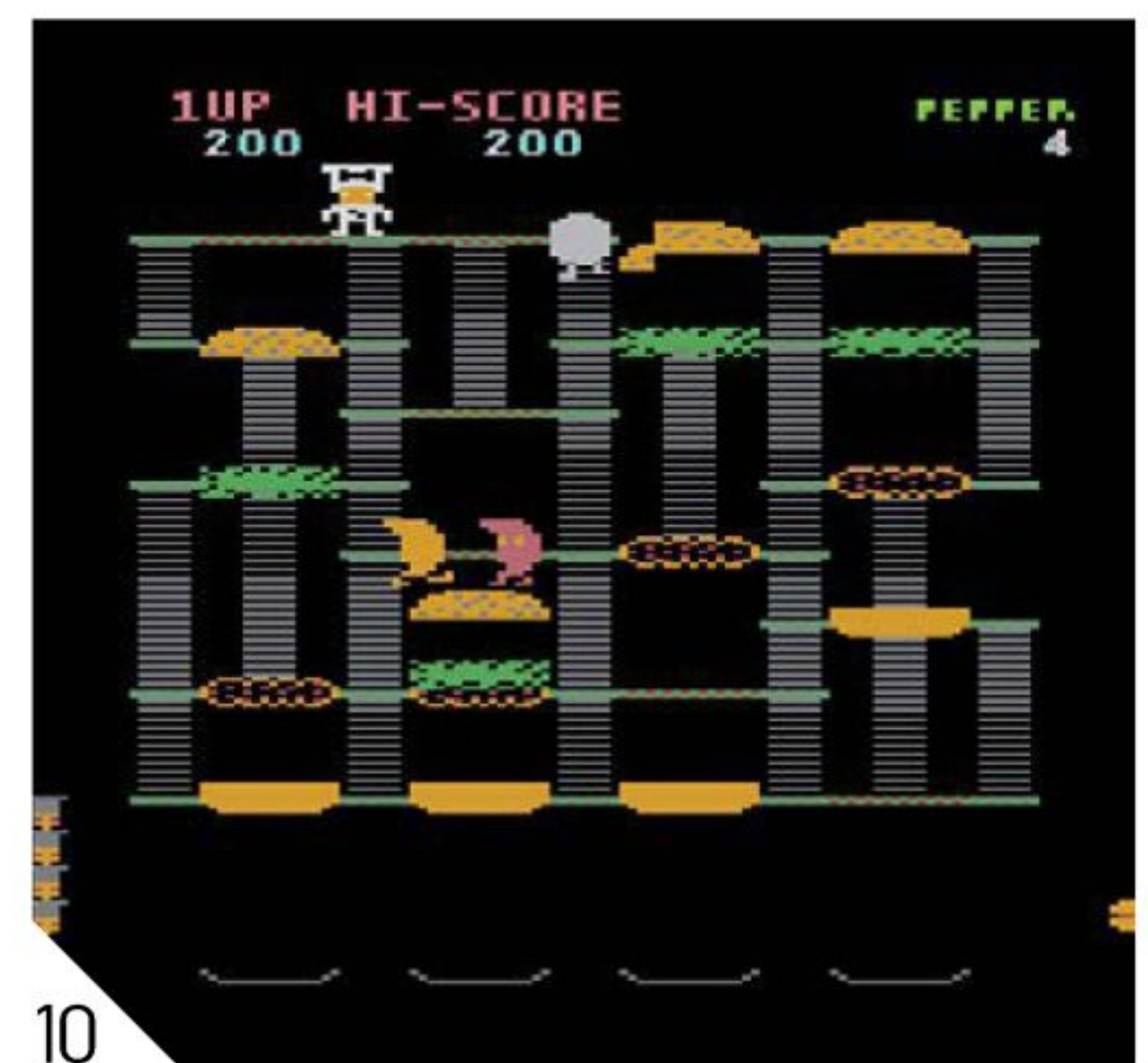

10



ATARI 5200

ATARI 5200

and the rest...

The Atari 5200's library of games may be small, but there are still plenty of great arcade conversions and original games to discover on it

- 01 CONGO BONGO
- 02 ROBOTRON: 2084
- 03 FROGGER II: THREEEEDPI!
- 04 LOONEY TUNES HOTEL
- 05 BERZERK
- 06 REALSPORTS BASKETBALL
- 07 ZAXXON
- 08 BALLBLAZER
- 09 CHOPLIFTER
- 10 JAMES BOND 007
- 11 MARIO BROS
- 12 DIG DUG
- 13 PENGU
- 14 TEMPEST
- 15 Q*BERT
- 16 ASTEROIDS
- 17 DECATHLON
- 18 KEYSTONE KAPERS
- 19 MONTEZUMA'S REVENGE
- 20 GORF
- 21 STARGATE
- 22 PITFALL II: THE LOST CAVERNS
- 23 COUNTERMEASURE
- 24 KABOOM!
- 25 RIVER RAID
- 26 SUPER BREAKOUT
- 27 VANGUARD
- 28 MEGAMANIA
- 29 ASTROCHASE
- 30 CENTIPEDE
- 31 H.E.R.O.
- 32 MISSILE COMMAND
- 33 FRISKY TOM
- 34 REALSPORTS BASEBALL
- 35 KANGAROO
- 36 SUPER PAC-MAN
- 37 POPEYE
- 38 DEFENDER
- 39 WIZARD OF WOR
- 40 MINIATURE GOLF
- 41 RESCUE ON FRACTALUS!
- 42 JOUST
- 43 QIX!
- 44 TRACK & FIELD
- 45 FINAL LEGACY
- 46 PAC-MAN
- 47 BLACK BELT
- 48 STAR WARS: THE ARCADE GAME
- 49 GALAXIAN
- 50 BATTLEZONE
- 51 SPACE INVADERS
- 52 MINER 2049ER
- 53 POLE POSITION
- 54 ZONE RANGER
- 55 BEAMRIDER
- 56 MR DO'S CASTLE

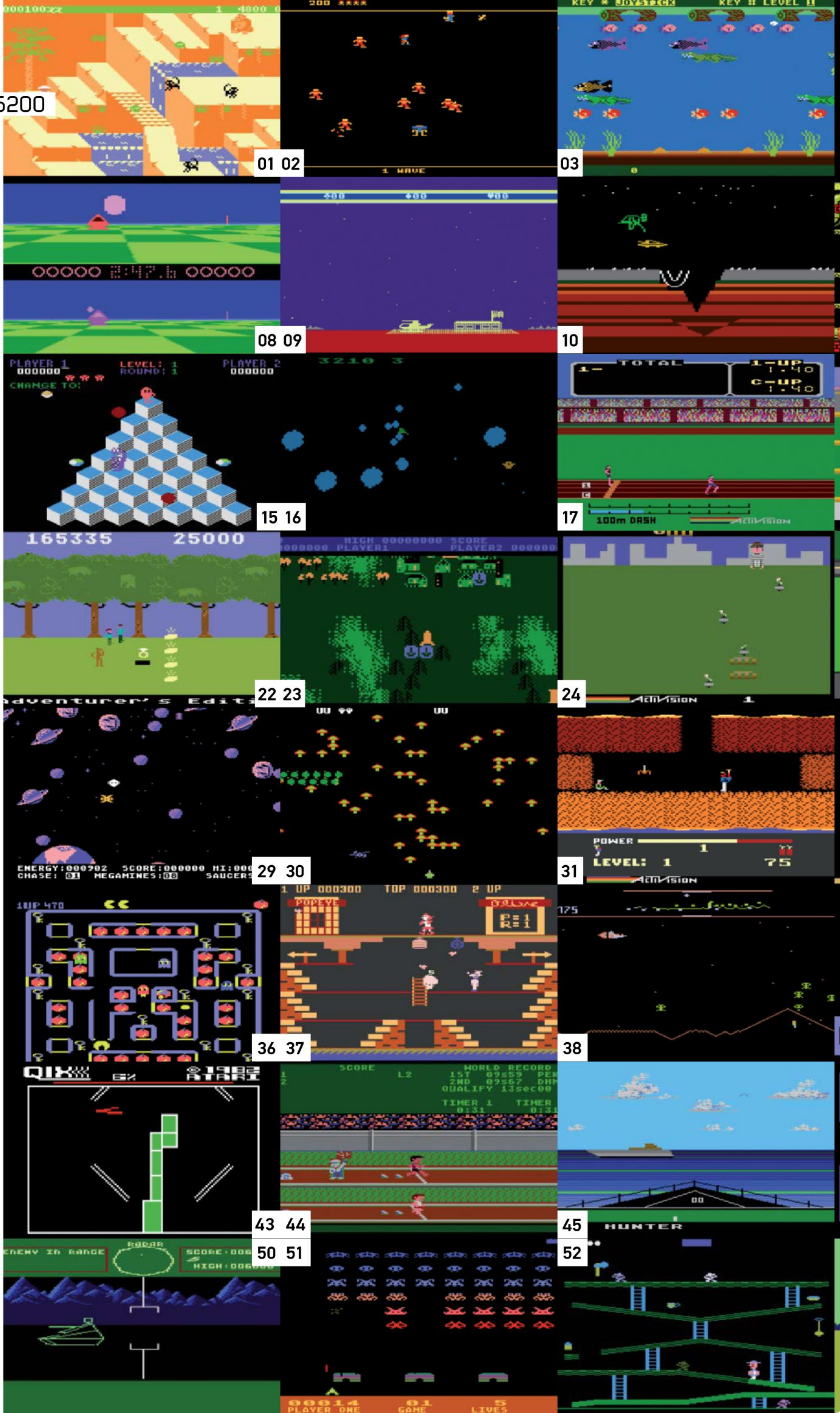



04 05



06



07



11 12



13



14



18 19



20



21



25 26

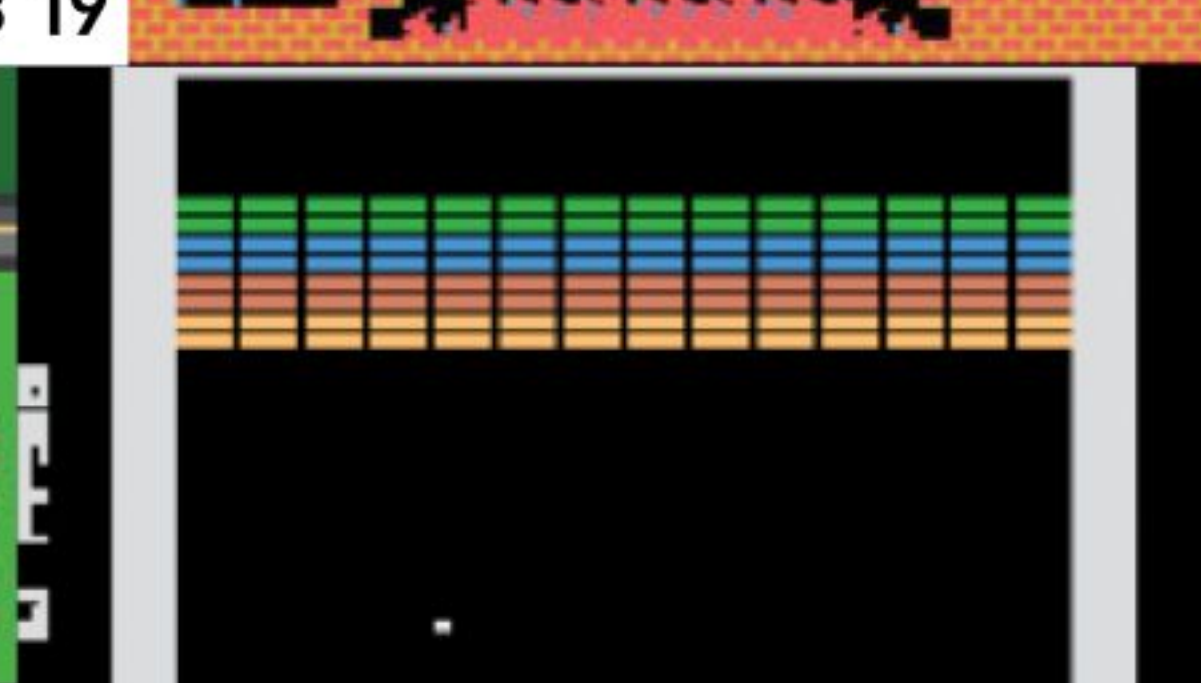

27



28



32 33

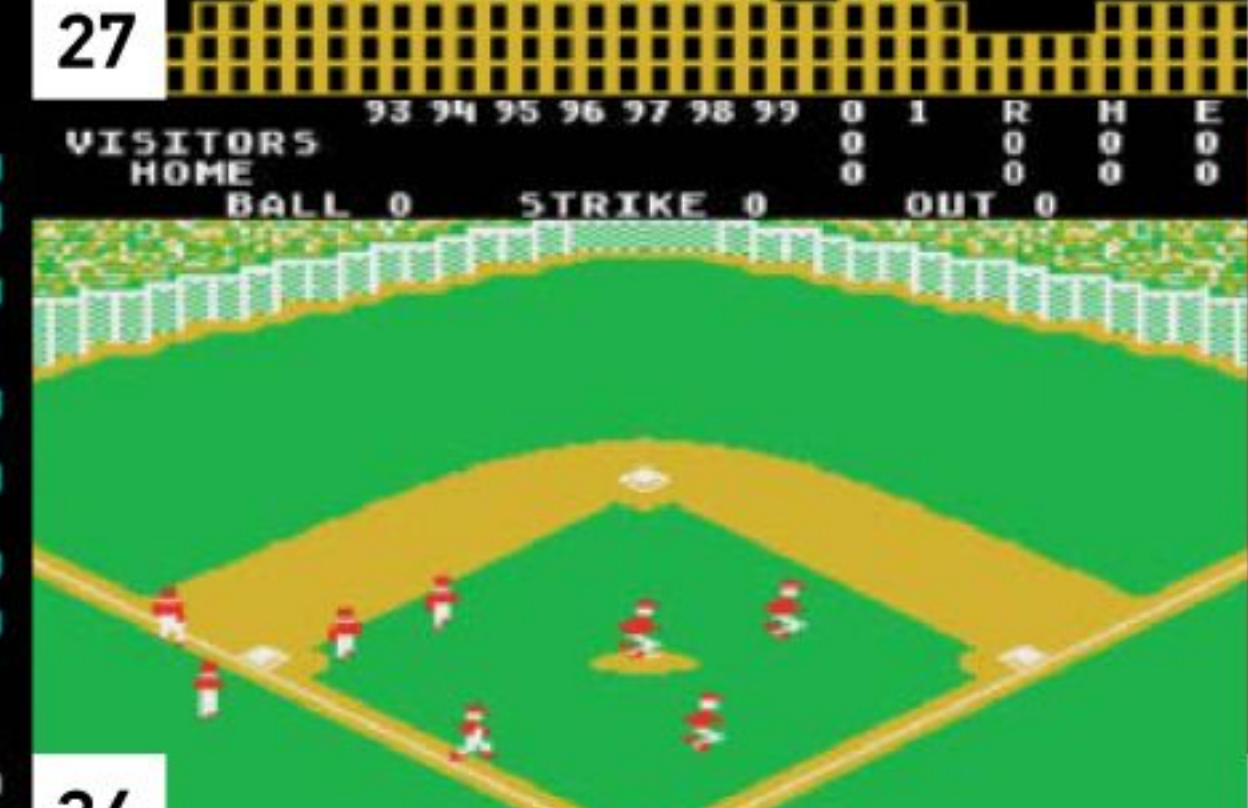

34



35



39 40

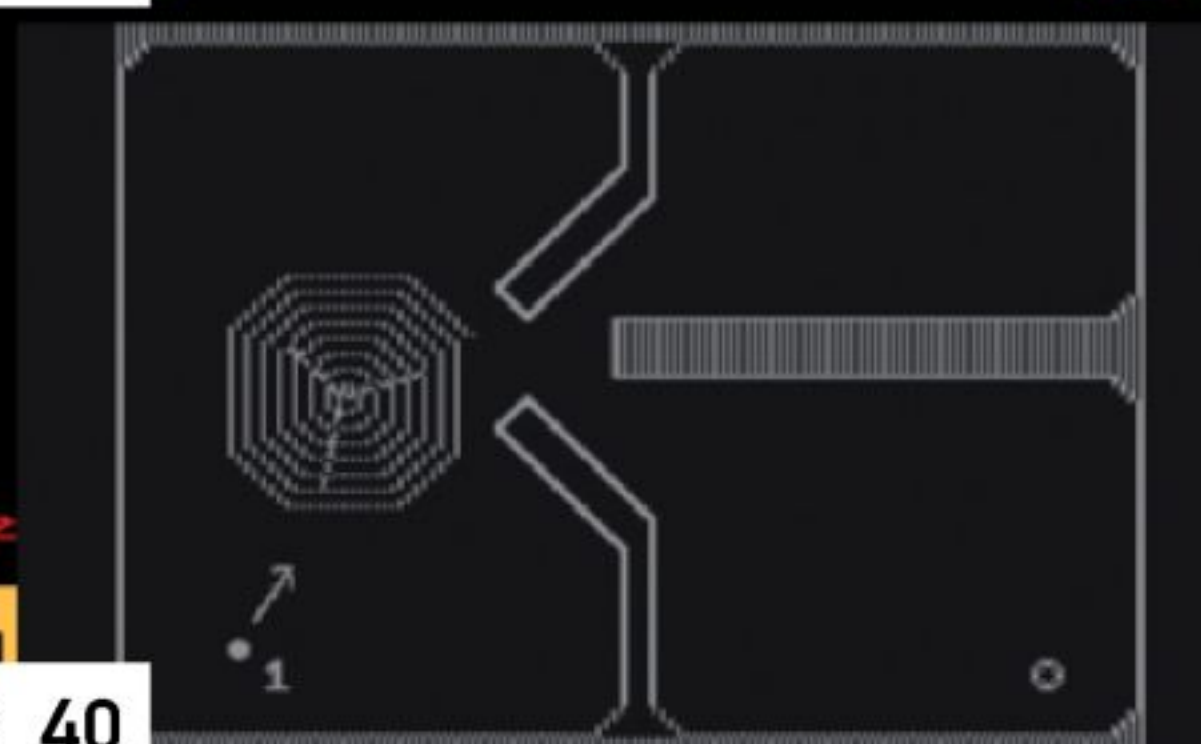

41



42



46 47



48



49



53 54



55



56



GT 65 Monitor

AMSTRAD

brightness contrast v-hold

power on off



MASTER COLOUR	
0 BLACK	9 GREEN
1 BLUE	10 CYAN
2 BRIGHT BLUE	11 SKY BLUE
3 RED	12 YELLOW
4 MAGENTA	13 WHITE
5 MALIVE	14 PASTEL BLUE
6 BRIGHT RED	15 ORANGE
7 PURPLE	16 PINK
8 BRIGHT MAGENTA	17 PASTEL MAGENTA
	18 LIGHT BLUE
	19 LIGHT GREEN
	20 LIGHT CYAN
	21 LIGHT MAGENTA
	22 PASTEL RED
	23 PASTEL BLUE
	24 BRIGHT PINK
	25 PASTEL YELLOW
	26 BRIGHT WHITE

CPC6128

AMSTRAD CPC 6128

WHEN THE AMSTRAD CPC 6128 WAS INTRODUCED IN 1985, SOME GAMERS DISMISSED IT AS A SERIOUS COMPUTER. BUT WHILE IT CERTAINLY LOOKED THE BUSINESS, BEHIND THE STRAIGHT-LACED EXTERIOR WAS A MACHINE WITH LOTS OF ADDED FUN

Year released: 1985

Original price: £299 (with green-screen monitor), £399 (with colour-screen monitor)

Buy it now for: £25+

Associated magazines: Amtix, Computing With The Amstrad (later known as CPC Computing), Amstrad Computer User (official publication), Amstrad Action, CPC Attack, fanzine WACCI

Why the CPC 6128 was great... It may not have been as cool as the Spectrum or as desirable as a Commodore 64, but the CPC 6128 was arguably the greatest 8-bit machine ever made. Adaptable (plug in a tape drive, fiddle endlessly with the volume control and you had a 464 with knobs on) and dependable, there was a mountain of games, a thriving community, and a real spirit of the underdog.

Sitting atop a chunky slab of plastic, the CPC 664's white and blue keys and the clumsy-looking addition of a disk drive exuded such ugliness that you couldn't help but feel sorry for the poor sods who bought it. It was a step up from Amstrad's iconic cassette-based 464 in the sense that it added a three-inch disk drive of the like seen in the Oric Atmos, some extra BASIC commands and both the AMSDOS and CP/M 2.2 operating systems. But while it sold around 10,000 units, within five months it was replaced by the 6128 – a machine which not only doubled the memory of its predecessor but looked far sleeker, too.

And so it was that the CPC 6128 came into being. It was launched in America in 1985 and it came to Europe shortly afterwards, making its UK debut at a glitzy press conference in London with BBC newsreader Richard Whitmore overseeing proceedings. Boasting the same three-inch drive, the only real features to distinguish the 6128

from the 664 were the 128K of RAM and a better, plain white, springier keyboard. The extra memory was an important addition, however, as it was used as a RAM disk or to store data such as gaming levels. In some cases, the 128K versions of CPC games would carry sound not heard in their 64K counterparts and all of this allowed developers to give their titles a little boost from time to time.

Before its unveiling, Mr Whitmore led the assembled journalists and dealers through a potted history of Amstrad. But it was Sir Alan Sugar himself who whipped the covers off the 6128 to show his new machine in all its glory. In doing so, he declared the 664 "well and truly dead" and he said the new arrival was due to "a leap in technology". He later stated that the 6128 was aimed at a more serious buyer,

although the decision to make the machine compatible with 464 and 664 software created an instant back catalogue of games for the new machine.

"There was a simple reason for launching the CPC 6128," says Cliff Lawson, who worked on the product launch of both the 6128 and 664. "It could be produced for the same money as the 664 so Amstrad decided it would be wise to go for the better product. It offered the punter more and it was, dare I say, much prettier, too."

The 6128 was one of two computers to be unveiled by Amstrad at the same time. The other was the PCW8256, pitched mainly at businesses. That machine came with a monochrome monitor, 256K of memory, a built-in disk drive, a printer and word-processing software, but it wasn't compatible with the CPC and there was no intention of opening its appeal to gamers. The PCW retailed at £460 and, as the trumpets blared for the 6128, the 464 was cut in price, bringing its cost down to £199 for the green-screen version and £299 for colour. In some sense, it meant that the 6128 was a halfway house – part business, part pleasure – bridging the gap between the PCW and the 464.

One of the first games to take advantage of the added capacity that the extra 64K of the 6128 offered was *Sorcery+*. Released in 1985, players of this disk-based joystick-only game saw many enhancements over the original *Sorcery*, including an extra 35 screens. Amstrad loved the lush look so much that it used screens of the game in its promotional literature and yet such enhancements didn't become the norm.

Although it was possible for both 464 and 664 owners to buy a 64K memory pack, which could be inserted into an expansion slot at the back of both computers (Datel Electronics would advertise Dk'tronics' 64K memory on a monthly basis), sales were not sufficiently high enough for all developers to put in the extra effort of creating additional enhancements. The gaming benefits of purchasing extra memory were not heavily pushed either, so whether or not a game carried the extra power depended on the whim of the developer or, in some cases, the near impossibility of making a game as impressive in 64K as it would be using double that memory.

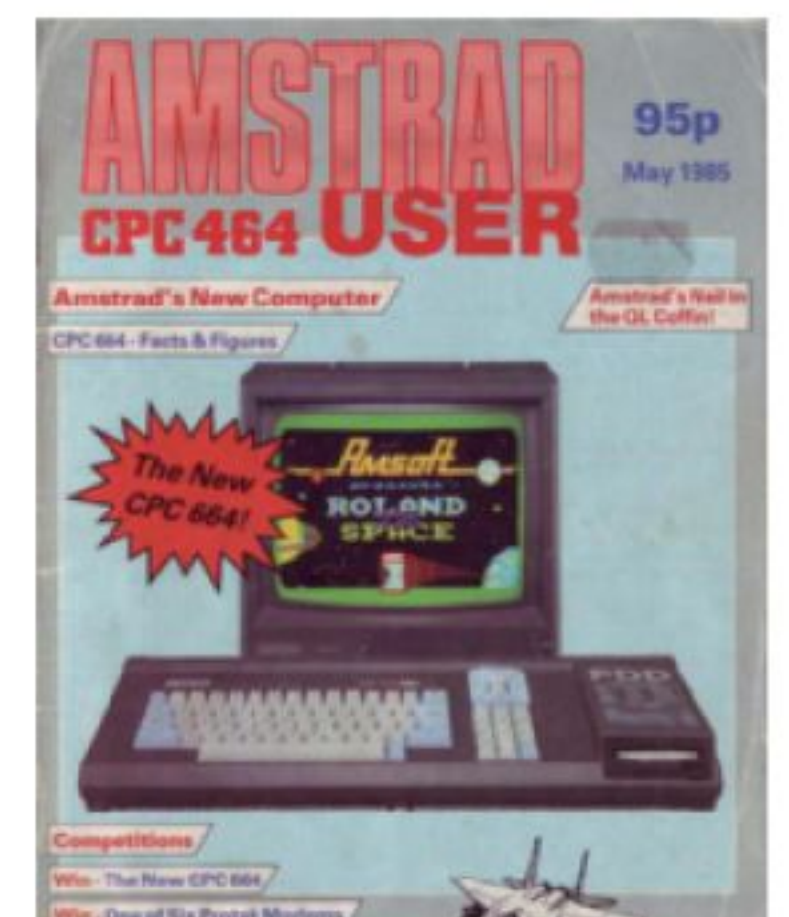

» Amstrad CPC 464 User magazine unveils the brand new – short-lived – 664.

INSTANT EXPERT

The Amstrad CPC 6128 was launched in 1985 as a successor to the short-lived CPC 664, adding 128K.

It cost £399 which made it more expensive than its monitor-less rivals, the Spectrum and C64. Amstrad wanted its machine to be an all-in-one solution powered with just one plug.

Although the internal drive accepted three-inch disks, it was possible to connect a second drive – either Amstrad's own three-incher, or one which accepted 3.5 or 5.25-inch disks.

The 6128 had 32K of ROM – and this contained the AMSDOS operating system and the Locomotive BASIC interpreter.

Amstrad marketed the 6128 as an all-rounder – good for programming and word processing, but equally at home with games. It was a perfect hook for kids to pester their parents.

Many 6128s therefore found themselves employed in businesses – and there was one sighting of it being used to operate a ride at Blackpool Pleasure Beach.

Educational software existed for the CPC 6128 but BBC computers dominated schools so it failed to make major inroads.

Many people hooked the 6128 to a tape deck and used the Multiface 2 to copy cassette games to disk.

As time went on, more games took advantage of the extra 64K and it came in handy for reducing loading times, too.

In 1990, the CPC 6128 was replaced by the 6128 Plus. It retained the three-inch drive but added a cartridge slot as part of a major redesign.

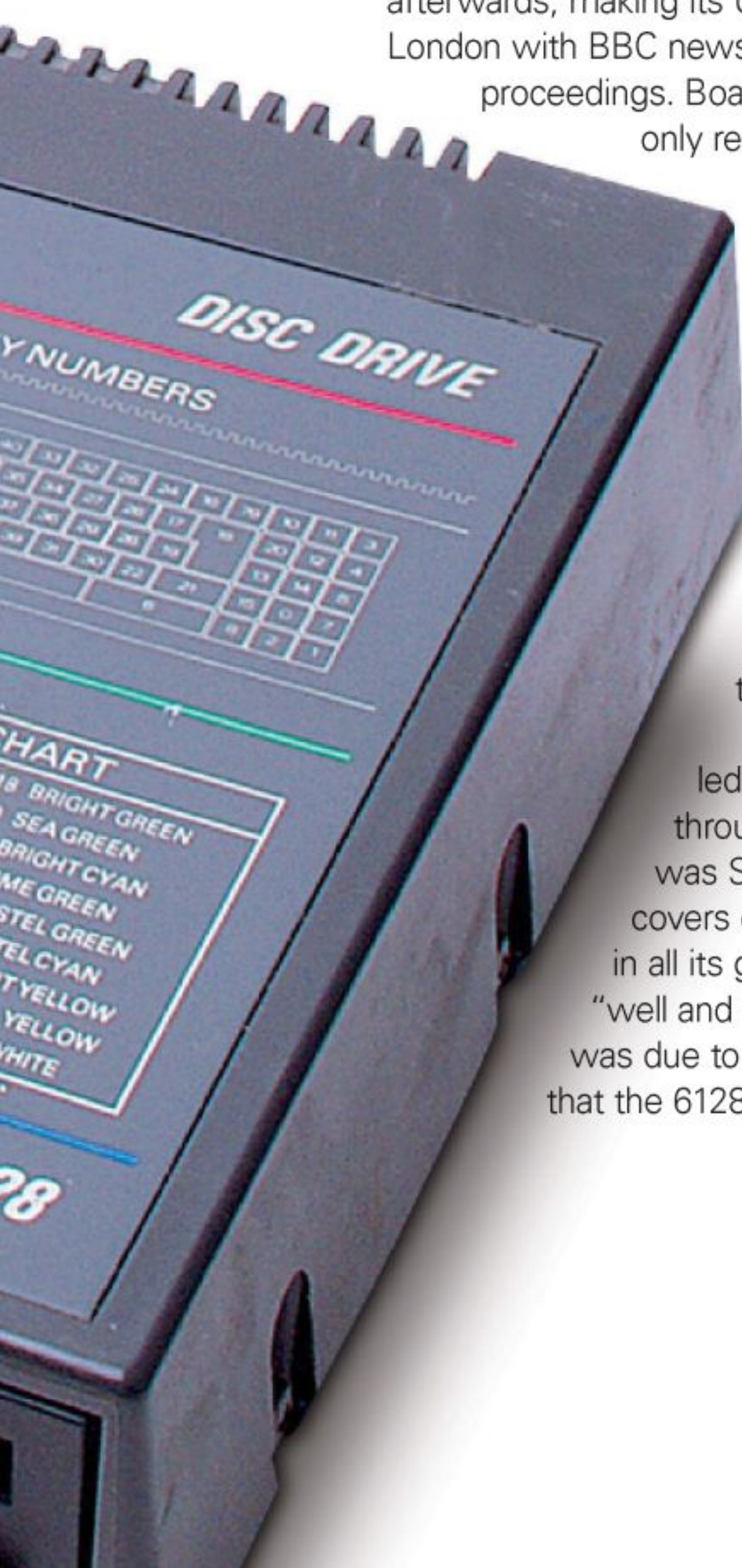



AMSTRAD CPC 6128

COMMUNITY CPC 6128 SITES TO WATCH

CPC Zone

www.cpczone.net

We've flagged up this website before, but if you want the full lowdown on anything CPC, then there is no better choice. Boasting a wonderful forum, scores of well-written reviews and lots of other goodies besides, Malc Jennings is doing a sterling job.



WinApe

www.winape.net

If you want to get back into CPC gaming or see what all the fuss is about, then you'll need to find a good emulator and there are few better than WinApe. Constantly updated, you can emulate all of the CPC models, including the 6128 and 6128 Plus.



SymbOS

www.symbos.de

For people more used to GUIs, the blue screen with yellow text that greets CPCers can be a little alien. SymbOS is a project that adds a Windows-style environment to the Amstrad and it even supports hard drives with capacity up to 128MB. Check it out.

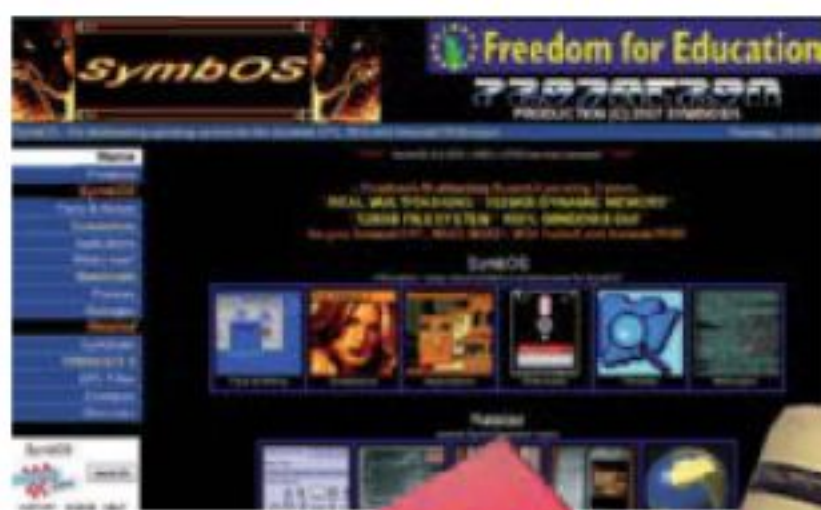

The Amstrad CPC Games Resource

<http://tacgr.emuunlim.com>

Once you've got your emulator going, you'll need some games. This website is full of retro delights and, as long as you already own copies of the games you download, you'll be on safe ground. It's a popular, well-run and resourced website.

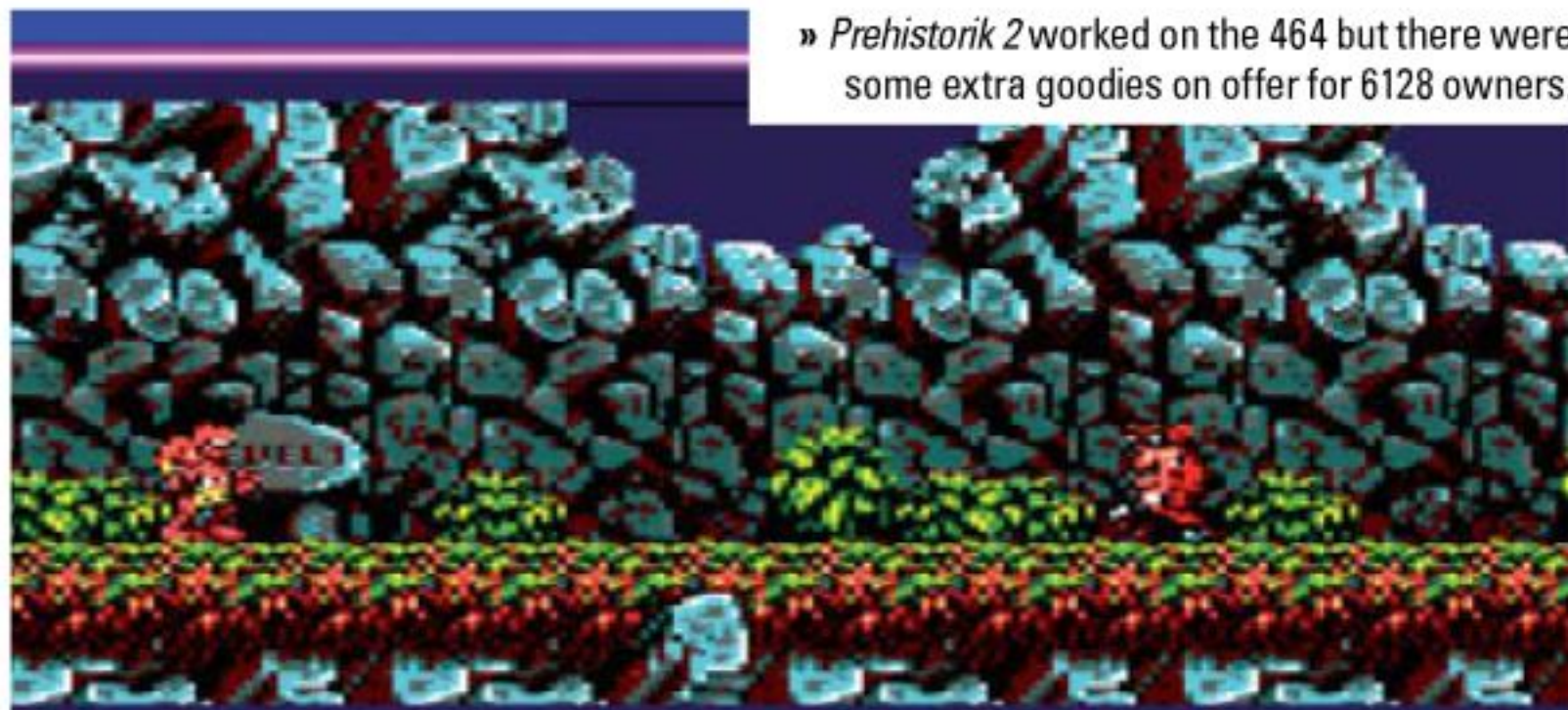

» Prehistorik 2 worked on the 464 but there were some extra goodies on offer for 6128 owners.



» Zap 'n' Balls took full advantage of the 6128's capabilities. It created the appearance of smoothly moving hardware sprites at full speed, but was accomplished with some technical wizardry, as explained by creator Elmar Krieger.



» The game box of Computer Scrabble De Luxe tells buyers the title is intended for the 6128.



TAPE AND DISK-BASED PLUS GAMES

The introduction of the three-inch disk drive with the 664 and 6128 proved to be a controversial decision at the time of its release. Amstrad seemed to adore the format, using it with its PCW range and with the Spectrum +3, despite the existence of the 5.25-inch and 3.5-inch disk formats. What annoyed people the most though was that 3.5-inch disks



held far more and became rapidly cheaper, so it was all the more surprising that Amstrad didn't scrap three-inch disks when making the move to the 6128 Plus in 1990.

"We looked at a number of storage systems including classic 5.25-inch floppy disks, three-inch floppy disks (like the 5.25-inch ones but smaller),



3.5-inch hard-case floppy disks and the three-inch hard-case disk," says Roland Perry. "At the time, the 3.5-inch disk wasn't 'IBM compatible' and it was a long time before the firm chose the format for the PS/2. So we decided to go for the three-inch disk as it was 'IBM compatible'. The three-inch disk also had the best price and performance, including our ability to commission custom-built units from an existing supplier."



Indeed, as the 6128 launched, some developers decided they wouldn't be sticking their neck out in support of the added extras of the new machine. Paula Byrne, of Melbourne House, said she would see how well the machine sold and Taskset's Paul Hodgson felt Amstrad missed an opportunity to enhance the graphics and sound chips and said he had no immediate plans to make games for it. But it wasn't all doom and gloom. Gremlin's Ian Stewart said it paved the way for better games and his company certainly made use of the new facilities on offer as the years went on.

"Amstrad didn't encourage 128K disk-based games to be produced," admits Cliff. "It wasn't particularly important since the extra memory was seen to have greater use with serious applications. The 64K games at the time worked well on the full range of Amstrad's CPC machines and it was in everyone's interest to ensure titles operated across the entire range and that the market wouldn't be split."

Around six months after launch, both the 6128 and the PCW were doing well. Amstrad announced £27.5 million half-yearly profits in April 2006 with sales in the six months to December 1985 increasing from £69 million to £128 million. The PCW8256 accounted for 20 per cent of the company's turnover, but the 6128 was becoming a market leader in France, as well as making major inroads into Germany and Spain.

Yet, for the average gamer, such corporate guff mattered little. They were more interested in enjoying some of the gems which were launched over the course of the 6128's life span. As time went on, more games arrived that could only be played with 128K of memory. They included Gremlin's *Nigel Mansell's World Championship*, one of the best Formula 1 games ever launched on the Amstrad and a title which deservedly won it much praise in the CPC gaming press.

Indeed, Gremlin, as we have discussed, liked to use the extra RAM to get the best out of its games. It produced 128K versions of *Space Crusade* and *Super Cars*. And titles such as *HeroQuest* and *Switchblade* contained music on the 6128, whereas, on an unexpanded 464, there were no tunes at all. Some differences were more subtle, however. "In *Lotus Esprit Turbo Challenge*," explains Nicholas Campbell, the CPC Games Review webmaster, "the only difference, as far as I am aware, is that the 'handbook' (the screens displaying the car's specifications) is loaded separately on the 64K version, whereas it is included with the main game in the 128K version."

There was more... Level 9's games, including *Gnome Ranger*, *Ingrid's Back*, *Knight Orc*, *Lancelot* and *Scapeghost*, did not contain graphics on a non-enhanced 464, but the 6128 proudly showed off a host of pictures. This was also the case with *The Famous Five* as well as all four of *Magnetic Scrolls'* adventures for the CPC (*The Pawn*, *The Guild Of Thieves*, *Jinxter* and *Corruption*), which were only playable if 128K was available.

Add to that little list less prestigious titles such as *European Superleague* and *Computer Scrabble De Luxe*, throw in the likes of *Final Fight* (this game came on a dual-format disk with the Spectrum version on the other side), tag on *Gauntlet III*, *G-LOC*, *Gunboat*, and most of Microïds' later releases – *Killerball*, *Sliders* and *Swap – No Exit*, *Pirates!*, then make space for all four of Silmarils' releases (*Windsurf Willy*, *Targhan*, *Xyphoes Fantasy* and *Bunny Bricks*), *SWIV* and *Times Of Lore* and you had a pretty good reason to go for Amstrad's best machine at the time. If nothing else, the extra vocal samples on *Chase H.Q.* were probably worth the price of an upgrade alone. Well, probably anyway.

And it wasn't just disk-based games that took advantage of the extra memory. It was possible to attach a cassette deck to the 6128 and most people did, enabling a huge library of cassette games to be played. Tape titles such as *Spellbound Dizzy* provided extra graphical effects on a 6128, such as animated Yolkfolk. It

was possible to see changes to the main character when he wore a snorkel and scrolls would appear in the 128K version. With some other games, including *Gryzor*, *Renegade*, *Operation Thunderbolt* and *Bad Dudes Vs Dragon Ninja*, the levels could be loaded in one go. They were stored in the additional bank of 64K.

What's more, using Romantic Robot's Multiface 2, tape-based games could be backed up to disk for easier loading and it became one of the most vital pieces of kit for the 6128, despite accusations of piracy. The device was also brilliant for those who liked to cheat. *Amstrad Action* was among the magazines to print Multiface 2 cheats that could help frustrated gamers through pretty much every title ever made.

Where the 6128 really came into its own, though, was in the final throes of its life. During the early-Nineties, programmers had truly got to grips with the CPC and there was a thriving homebrew and semi-commercial scene. Since cassettes took an age to duplicate and were more prone to error, most smaller devs released their games on disk and they also decided to make full use of the 128K available to the vast majority of CPC disk-based machines.

Games such as *Zap'T' Balls* would only work with 128K present – and those who didn't play this *Pang*-inspired jaunt were missing out on a belter. Creator Elmar Krieger explains: "In *Zap'T' Balls* the focus was on 100 per cent smooth 50fps software sprites, and this required page flipping, so two lots of 16K were needed as video memory," he says. "While the software sprites moved, the part of the background that became visible again had to be restored. Doing this fast enough required a complete third backup copy of the screen. So with 48K of 'video' memory, the remaining 16K was just not enough for music, games and so on. That's why *Zap'T' Balls* was 128K only."

Elmar also created *Prehistorik 2* and this also made extra use of the 6128's capacity, not least the addition of in-game music. "With *Prehistorik*, I was able to produce a 64K tape version for the 464 because it only used 16K of video memory, without page flipping, and the background was composed of tiles which ultimately meant there was no need for a backup of the entire screen," he says. "But I used the extra memory on the 6128 for extra effects. I went even further with the CPC+ version, creating additional parallax scrolling foreground and background graphics."

Although actual figures are not available, the 6128 was a solid seller. It fared particularly well in France, where *Iron Lord* and *B.A.T.* were produced to great fanfare. "The 6128 was a natural progression for the CPC range, especially for CP/M applications," says Roland Perry, who was Amstrad's group technical manager in 1985. "Customers demanded more RAM, even if they were not sure what it might enable them to do better."

The 6128 was only discontinued in 1990 because of the introduction of the superior 6128 Plus and yet the CPC 6128 story doesn't end at the turn of the decade. Many programmers cut their teeth on the machine, helped along, no doubt, by the brilliant 6128 manual, which didn't just show you how to turn the computer on and operate it, but also included a comprehensive guide to programming in BASIC with some handy gaming-related type-ins at the back. It's fair to say the legacy of the 6128 has continued to this very day.

"The instruction book for the 6128 was my favourite and that's not just because I wrote most of it," laughs Roland. "I had time to mature the book so that it became a 'learn how to programme' manual. The 6128 was a very stable platform for programmers and I bet we helped nurture many a games programming career. For me, that's a great legacy. I really do think that's something to be proud of."



SPECIFICATIONS

Processor: Z80A 8-bit processor (4MHz)

Memory: 128K RAM

Drive: Three-inch disk drive. Tape deck could be attached

Monitor: Green screen or colour monitor

Typical resolution: 160 x 200 pixels in 16 colour Mode 0 (out of a palette of 27)

Sound: General Instrument AY-3-8912 sound chip, providing three channels



» Roland Perry oversaw the introduction of the 464, 664 and 6128 range of CPCs.

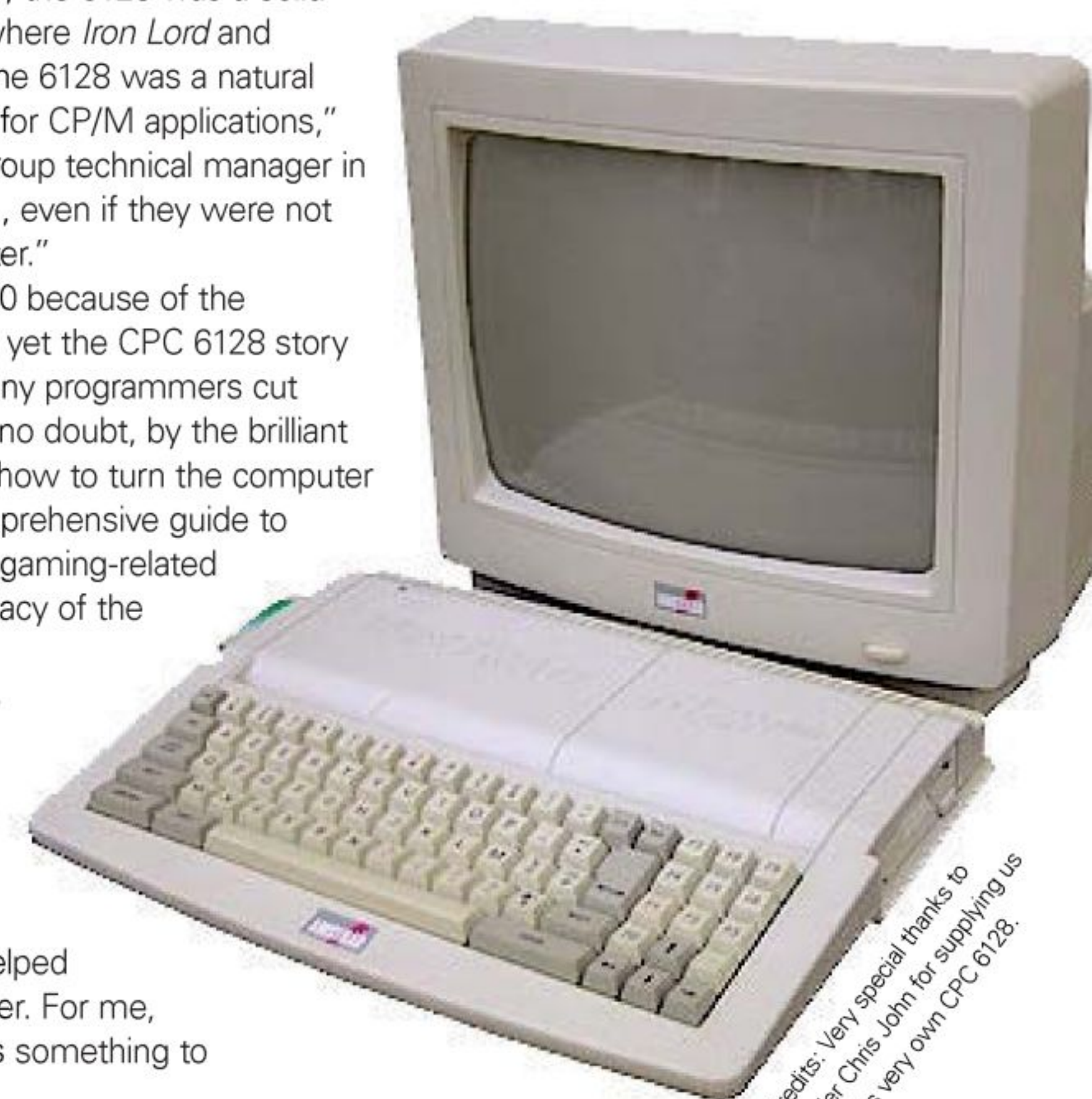

Credits: Very special thanks to reader Chris John for supplying us with his very own CPC 6128.



AMSTRAD CPC 6128

PERFECT TEN GAMES

Some games are poor. Some are great. And there are some which are wonderful and then made even better. Although the real joy came with a CPC 6128 exclusive, many games received a few tweaks here and there, improving them over their CPC 464 cousins. Here are our favourite ten CPC 6128 games...

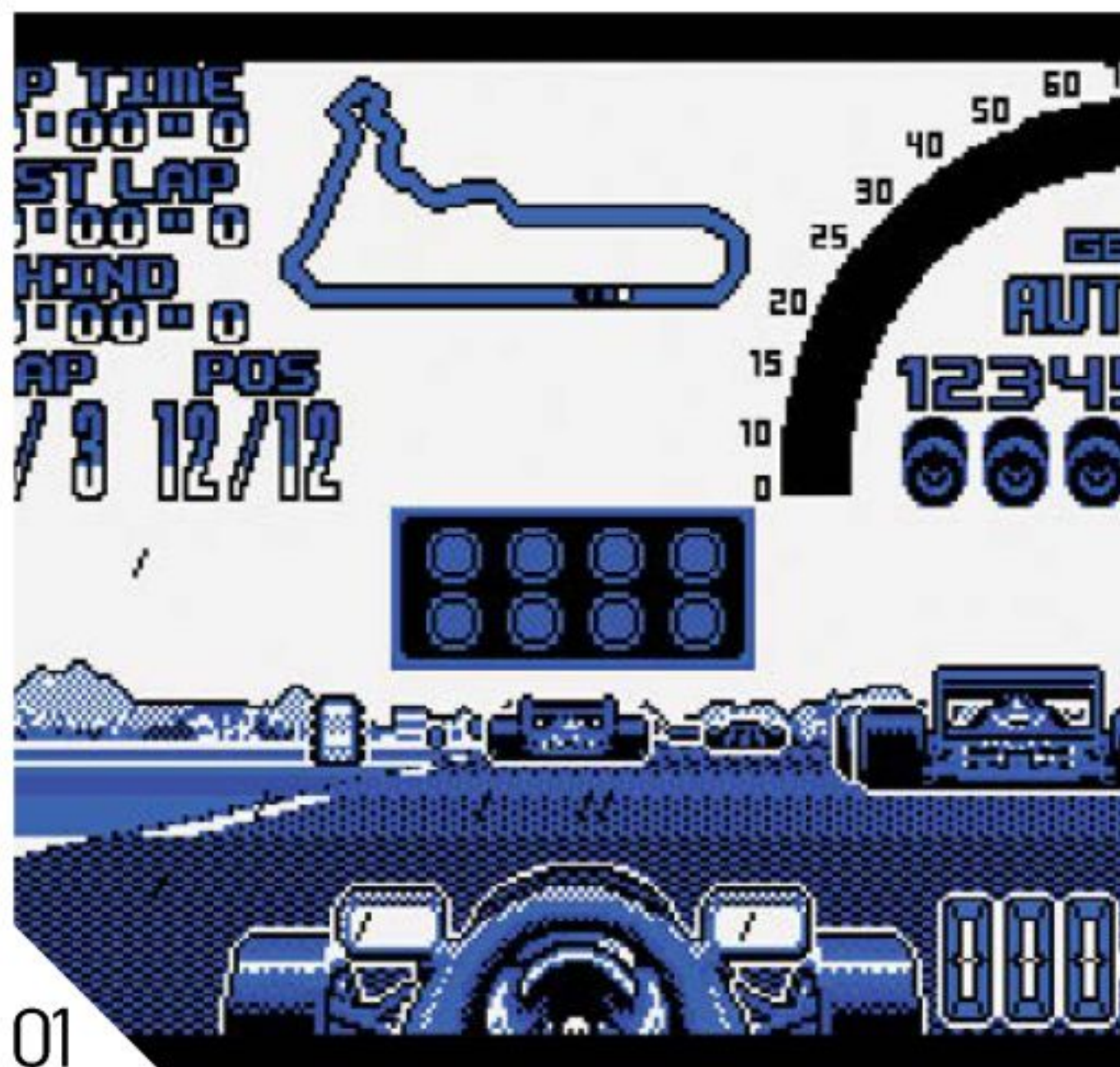

01

NIGEL MANSELL'S WORLD CHAMPIONSHIP

- » RELEASED: 1992
- » PUBLISHER: GREMLIN
- » CREATED BY: IN-HOUSE
- » BY THE SAME DEVELOPER: SWITCHBLADE

01 Owners of the 464 may have disagreed, but if there was ever a game that made perfect sense on disk, then Nigel Mansell's *World Championship* was it. It was a racing game Gremlin had clearly spent time on, packing it with as many features as it could possibly fit into 128K of memory. Much of that attention was lavished on the revved-up graphics – the spinning globe, the delicious icons, Nigel's turning hands on the steering wheel – and yet it still left time to spare to ensure this was a blisteringly fast game. It filled not one but both sides of a disk and that led to lots of – seemingly random – side swapping. But it was the best example of a racing game to have ever graced the Amstrad.

CHASE H.Q.

- » RELEASED: 1990
- » PUBLISHER: OCEAN
- » CREATED BY: IN-HOUSE
- » BY THE SAME DEVELOPER: TOTAL RECALL

02 If you ever heard the words 'Let's go, Mr Driver' coming out of the tinny speaker of your CPC, then chances are you were the proud owner of a 6128. The added 64K of memory was used to deliver some cool snippets of digitised speech – with another notable inclusion being the dreaded 'Your time's up' – and such utterances will surely continue to conjure up some truly magical memories to this day. But that's not the only reason that *Chase H.Q.* on the CPC 6128 rammed the CPC 464 version off the road. The tape version of the game was a multiload and while the loading time wasn't criminal, having the disk drive in the 6128 inevitably meant that the action came considerably faster.



02

SPELLBOUND DIZZY

- » RELEASED: 1991
- » PUBLISHER: CODEMASTERS
- » CREATED BY: BIG RED SOFTWARE
- » BY THE SAME DEVELOPER: PRINCE OF THE YOLKFOLK

03 *Spellbound Dizzy* was the largest *Dizzy* game ever, with its 105 rooms making it bigger than *Magiland* and *Fantasy World* put together. Critics said it was too big, and, given the *Dizzy* premise of finding objects to solve puzzles, having so many in one game did prove tiresome. However, for a *Dizzy* game not created by the Oliver Twins, it was full of interesting, fresh ideas. And although it came on cassette, the game made use of the 6128's extra 64K. So anyone with a 6128 and a tape drive could enjoy animated Yolkfolk, a sprite change for Dizzy when he donned a snorkel and the appearance of the scrolls.



02

B.A.T.

- » RELEASED: 1991
- » PUBLISHER: UBISOFT
- » CREATED BY: IN-HOUSE
- » BY THE SAME DEVELOPER: ZOMBI

04 Costing a whopping £24.99 when it first arrived exclusively on disk, *B.A.T.* was a French, Orwellian-inspired, icon-driven adventure masterpiece. A game of enormous scope and size and boasting some of the best visuals of any CPC game ever made, what it lacked in sound – there was not a peep – it more than made up for with its challenge. Little surprise then that the manual was so incredibly detailed. It was akin to a small novel and it lent the title great depth. To do this game justice meant Ubisoft simply had to utilise 128K and it had to go for a disk. Fortunately, disks were more popular in France, where this game really excelled.

ZAP'T'BALLS

- » RELEASED: 1992
- » PUBLISHER: CPCAMSTRAD INTERNATIONAL
- » CREATED BY: ELMSOFT
- » BY THE SAME DEVELOPER: PREHISTORIK 2

05 The main article has already discussed why *Zap'T'balls* wasn't released as a 64K, tape version. But even though it was made for the machine, not every 6128 owner could play it. Much of it depended on the type of CRTC chip in the computer. Elmar Krieger, who made the game exclusively for the CPC, said some disk drives had problems loading it too and he found the 6128 Plus appeared to run in to the most trouble. For those who got it to work, it was sparkling from the very moment the demo-inspired loading sequence sprung into action to the last pop of a balloon.



03



04



05



06

EVE OF SHADOWS

- » RELEASED: 1991
- » PUBLISHER: ADVENTURE PD
- » CREATED BY: ROB BUCKLEY
- » BY THE SAME DEVELOPER: FLUFF

06 Three things could put you off this game: it was written in BASIC, it only cost a quid or so to buy and it was never playtested. But the odd spelling mistake here and there and the preconception that cheap must equal bad, especially when combined with a rather primitive program language didn't hamper *Eve Of Shadows* one bit. It made full use of the 128K and drive of the 6128, loading the text and graphics straight from the disk, to free up the memory for the actual code. That made *Eve* a sizeable text adventure, but it was also one that oozed professionalism. Sending a quid, disk and SAE for this back in 1991 was a wise move.

PIRATES!

- » RELEASED: 1987
- » PUBLISHER: MICROPROSE
- » CREATED BY: IN-HOUSE
- » BY THE SAME DEVELOPER: GUNSHIP

09 Although a lot of 128K-only games would run on a 464 or 664 with a disk drive and 64K added, Sid Meier's *Pirates!* was a little bit different. It only worked with a straightforward 6128 and no amount of jiggery pokery would alter that. It was a shame for other CPC owners because it was such a brilliant game, but then it did come on both sides of the disk and with a lengthy manual inside the box packed full of information. While the graphics were chunky and the sound effects were poor, there was a quality to this MicroProse game that was rarely seen. Sure, at £19.95, it was rather expensive, especially when you think that it was released in 1987, but it was definitely one not to have been missed.



07

SORCERY+

- » RELEASED: 1985
- » PUBLISHER: VIRGIN
- » CREATED BY: IN-HOUSE
- » BY THE SAME DEVELOPER: DAN DARE

07 *Sorcery* was originally released on tape, but, to take advantage of the 6128, Virgin launched *Sorcery+*, adding an extra 35 screens to the 40 that were already on the cassette version. This was made possible via the fast loading of the screens from disk. It let the developer pack in lots of other extras, too – including scrolling messages and demo modes – and such was its success (*Amstrad Action* awarded it 91%, handing the original 90%), that it was seen as the start of a bright disk-based 128K future. It didn't quite work out like that since not all games made use of the extra 64K, but it was a noble effort, that's for sure.

HEROQUEST

- » RELEASED: 1991
- » PUBLISHER: GREMLIN
- » CREATED BY: IN-HOUSE
- » BY THE SAME DEVELOPER: LOTUS ESPRIT TURBO CHALLENGE

10 Sometimes it's the small things which make a difference. That was certainly the case with *HeroQuest*, a game that thrilled fans of role-playing games and which came in two distinct flavours: 64K and 128K. What marked the latter was its wonderful sound or music, to be exact. The medieval soundtrack was a joy to hear on the CPC 6128 and it brilliantly complemented the detailed, smooth visuals. It turned out to be one of the best games on the Amstrad in 1991, which is a massive compliment since it was something of a golden year for the machine. That it went down so well with critics and fans alike must have been music to Gremlin's ears.

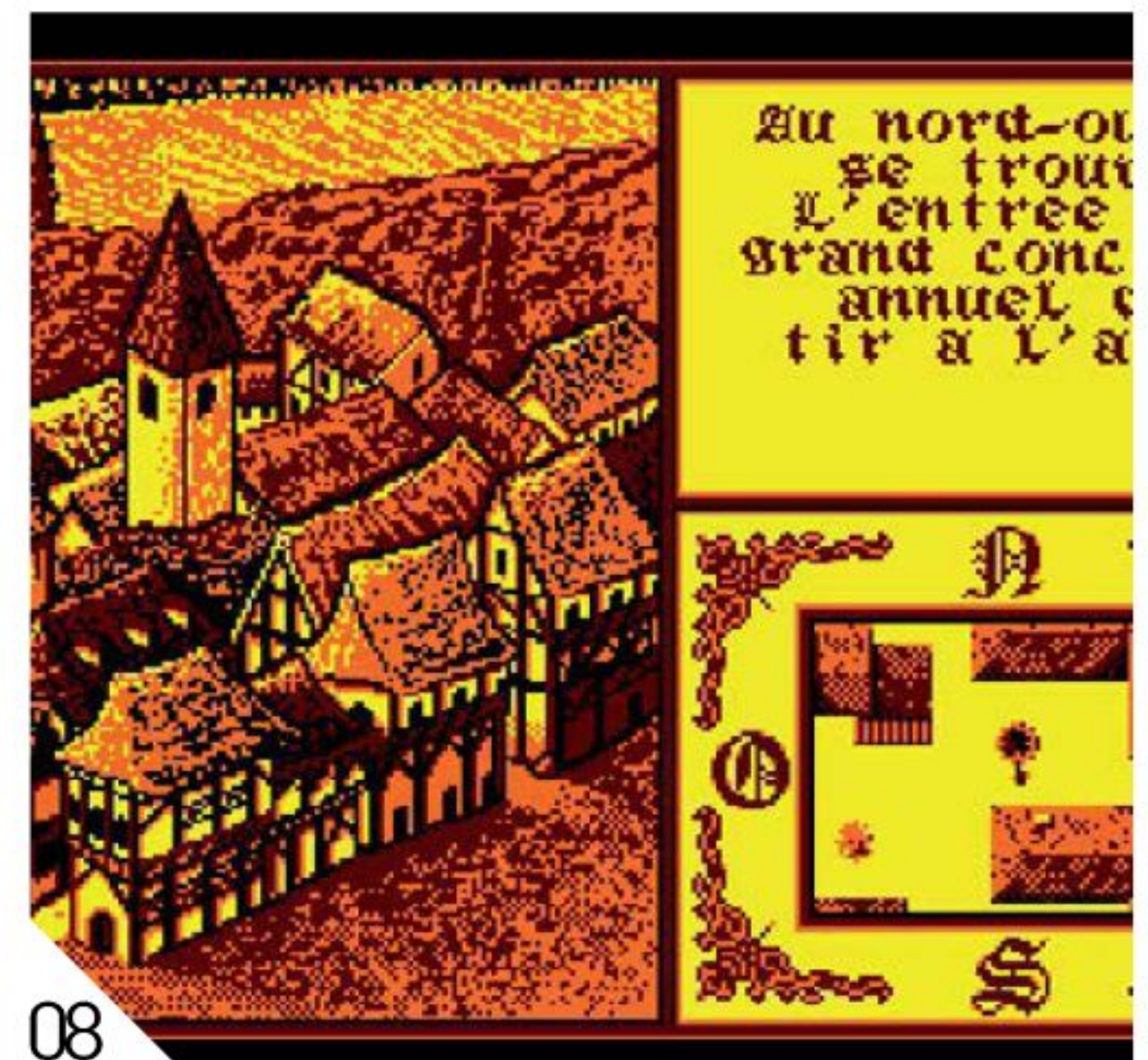

08

IRON LORD

- » RELEASED: 1990
- » PUBLISHER: UBISOFT
- » CREATED BY: IN-HOUSE
- » BY THE SAME DEVELOPER: EXIT

08 Ubisoft was a master of CPC design in the early-Nineties and, along with *B.A.T.*, *Iron Lord* was one of the undoubted classics from its French stable. Artistic in looks, *Iron Lord* became a firm and unique favourite of the swords-and-sorcery genre. It employed a multiple-choice interface and was joystick operated and that worked wonderfully in sucking players in. It was also chock-full with sub-plots. Like *B.A.T.*, *Iron Lord* was disk-only and expensive (£19.99), but for that price you could spend hours submerged in the game's involving quests and feasting your eyes on illustrations that could have come straight out of a children's storybook.



09

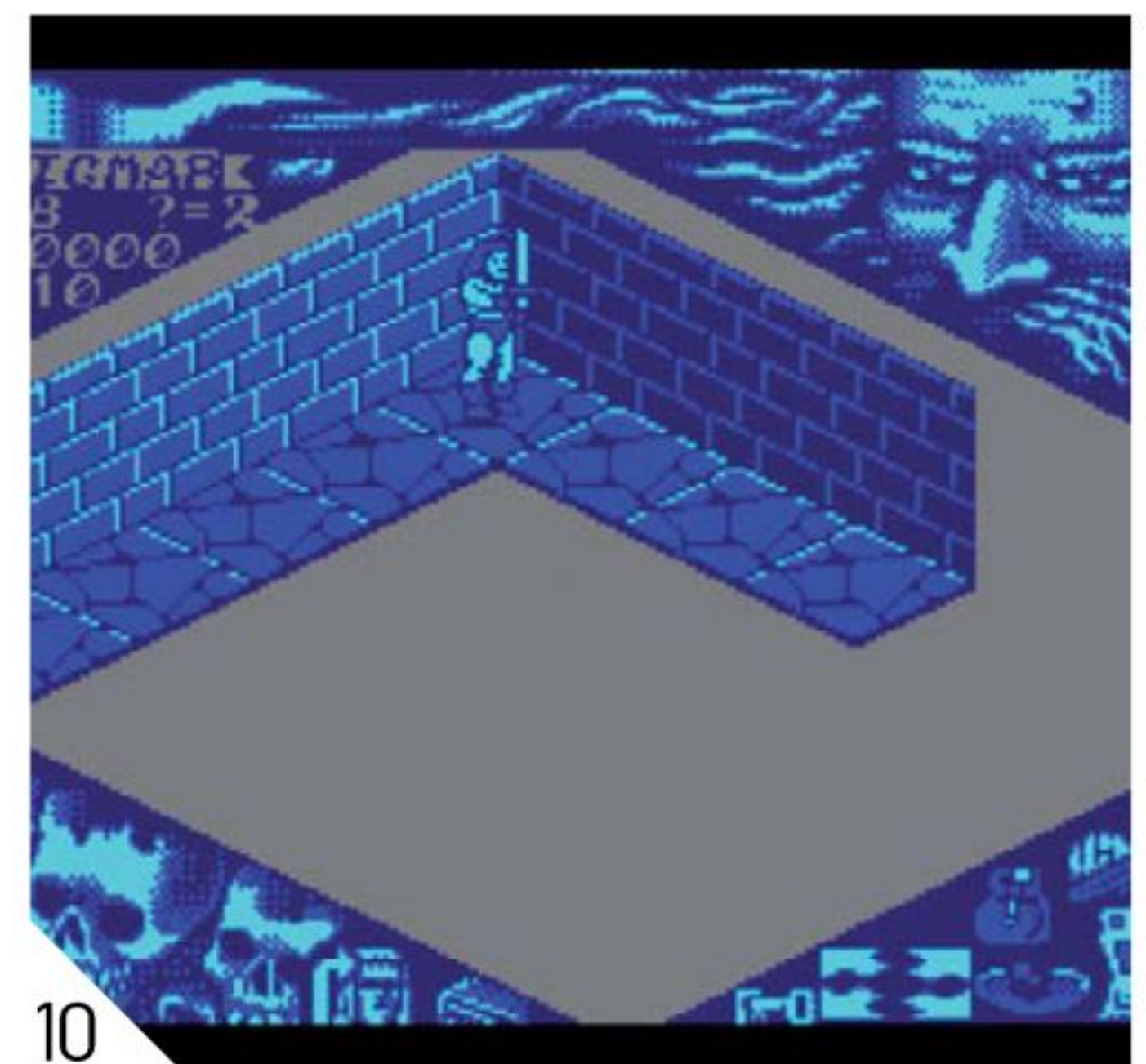

10



AMSTRAD CPC 6128

AMSTRAD CPC 6128 and the rest...

Sadly, the CPC 6128 didn't feature many games that took advantage of its more powerful technology. Good job it was backwards compatible with the CPC 464 back catalogue then. Here are a few of the highlights...

- 01 PRINCE OF PERSIA
- 01 1942
- 03 HEAD OVER HEELS
- 04 RAMBO: FIRST BLOOD PART II
- 05 BARBARIAN
- 06 POWER DRIFT
- 07 FEUD
- 08 TARGET: RENEGADE
- 09 IKARI WARRIORS
- 10 TOTAL ECLIPSE
- 11 ALIEN 8
- 12 GAME OVER
- 13 JET SET WILLY
- 14 SPACE HARRIER
- 15 BACTRON
- 16 DEATH WISH 3
- 17 KUNG-FU MASTER
- 18 SHOCKWAY RIDER
- 19 RICK DANGEROUS
- 20 KANE
- 21 WAY OF THE EXPLODING FIST
- 22 SPINDIZZY
- 23 GHOSTBUSTERS
- 24 KNIGHT LORE
- 25 STORMLORD
- 26 THUNDERCATS
- 27 THE SACRED ARMOUR OF ANTRIAD
- 28 CHASE H.Q.
- 29 DRILLER
- 30 FORGOTTEN WORLDS
- 31 INSIDE OUTING
- 32 NEBULUS
- 33 RAINBOW ISLANDS
- 34 CYBERNOID
- 35 GRYZOR
- 36 TEENAGE MUTANT HERO TURTLES
- 37 FREDDY HARVEST
- 38 RAMPAGE
- 39 WARLOCK
- 40 SORCERY+
- 41 GUNFRIGHT
- 42 PLATOON
- 43 STAR WARS
- 44 JACK THE NIPPER
- 45 ROBOCOP
- 46 IK+
- 47 SOLOMON'S KEY
- 48 BATMAN
- 49 OPERATION WOLF
- 50 CASTLE MASTER
- 51 KARNOV
- 52 VINDICATORS
- 53 PIPE MANIA
- 54 CAULDRON II
- 55 SAVAGE
- 56 GAUNTLET II



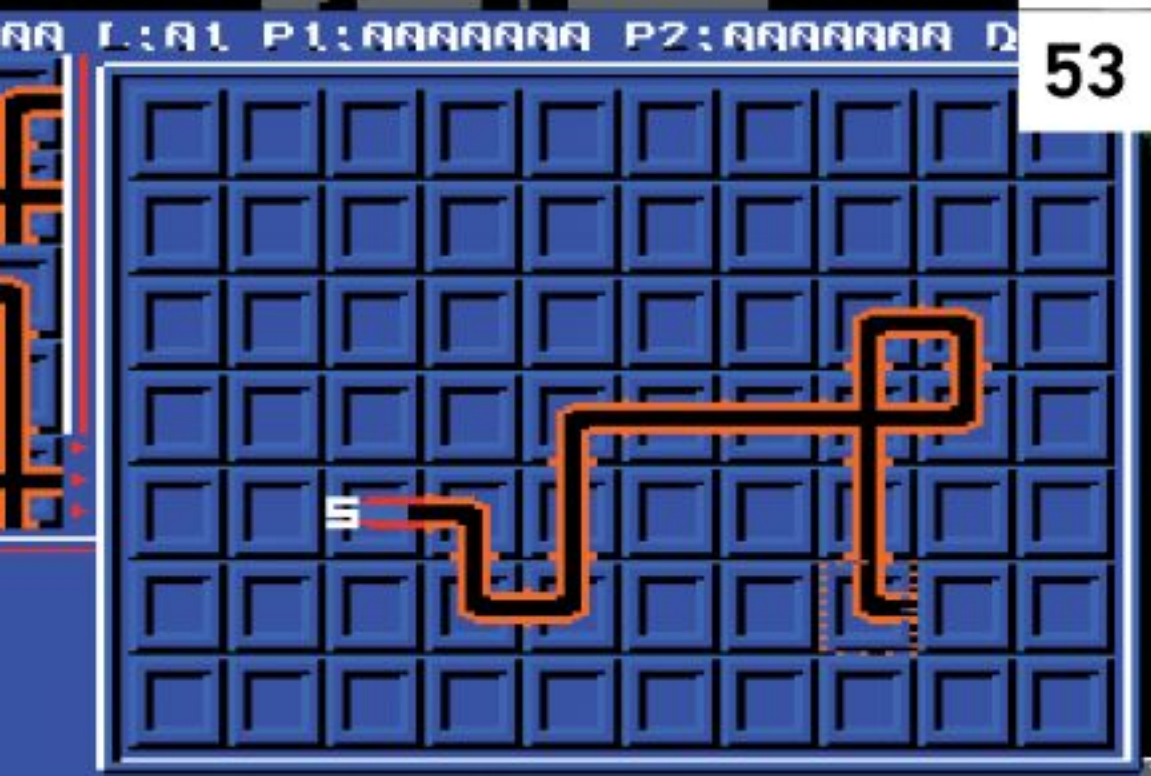
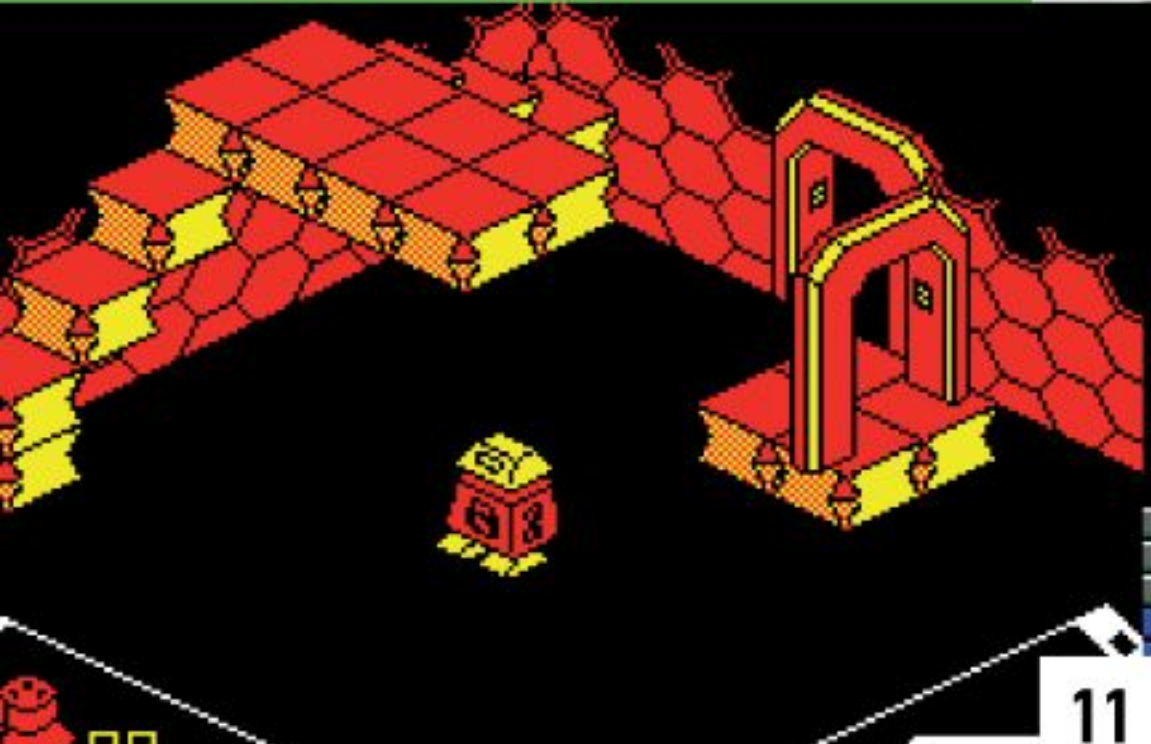



GAMATE



Specification

■ **Year released:** 1990 (Taiwan),
1991 (International)

■ **Original price:** £59.95 (UK)

■ **Associated magazines:** None

■ **Why the Gamate was great:** To be brutally honest, the Gamate was anything but great. However, for collectors it represents something of a Holy Grail as far as retro gaming is concerned: it's incredibly obscure, features a sizeable library of games and isn't currently emulated.

■ **Buy it now for:**
£25-£50+

Instant Expert

The UK distributor of the Gamate, Cheetah Marketing, was more famous for its range of joysticks, including the 125 and Mach 1.

In its native Taiwan, the Gamate was known as 'Chaoji Xiaozhi', which literally translates as 'Super Boy'.

Gamate games come in three types of packaging: International (English with other European languages via stickers), Italian and Taiwanese (in Chinese).

It's hard to be sure just how many games were actually released for the Gamate, but most collectors generally agree that the figure lies somewhere between 60 and 70, with many insisting that 71 games made it into production.

Battle Tank and Vindicators are listed as two different games in the Gamate library but they are, in fact, the same, just with different title screens. The same goes for *Enchanted Bricks* and *Brick Blaster*.

The curiously named *Dino Ball* is a pinball title for the Gamate, which contains no dinosaurs whatsoever.

Many of the Gamate software cases feature screenshots that vary from the actual game contained within, possibly due to them being taken from unfinished or prototype editions of the software.

Like the Game Boy that it tried so hard to emulate, the Gamate offers only mono sound through its single speaker but supports stereo via headphones.

UMC - which stands for United Microelectronics Corporation - is still in business today. The company's website can be found at www.umc.com.

Bit Corp was also known as Puzzy in its homeland.

GAMATE

You may consider your FM Towns Marty, MSX or WonderSwan to be off the beaten track as far as videogame hardware goes, but you haven't seen anything until you've witnessed the understated glory of the Gamate. We unearth the story behind this most obscure of handhelds

When Nintendo launched the original Game Boy to a rapturous reception in 1989, it was almost a foregone conclusion that other companies would follow suit and concoct their own portable systems. Arch-rival Sega quickly pushed the Game Gear onto store shelves, and industry veteran Atari contributed the tremendously powerful Lynx, but less famous pretenders to the throne also appeared, including the little-known Gamate, manufactured by a tiny Asian firm known as Bit Corp.

"Bit Corp was one of Taiwan's first videogame companies, active since at least the early Eighties," recounts Alex Evans, webmaster of gaming curio website NeoFuji and arguably the world's leading source of Gamate knowledge. "It developed a number of games for the Atari 2600, many of which saw release in Europe. With the rise of the Famicom in the mid-Eighties, Bit Corp moved onto that system with *Duck Maze* – the first Taiwanese-developed Famicom game – in 1987 and published at least four more titles in the following two years. Bit Corp also produced hardware, mostly clones of other popular consoles, but they tended to be a cut above the generic copies that their contemporaries were producing. Aside from the obligatory Atari 2600 and Famicom clones, it released two computers – the Bit-60 and Bit-90 – which were based on Atari 2600 and ColecoVision hardware respectively and maintained compatibility with each console's cartridges. Bit Corp also exploited

the similarity between the ColecoVision and Sega's SG-1000 to create a hybrid console called the Dina 2-in-1, which was sold as the Telegames Personal Arcade in the US."

Taking this history into account, it's clear that Bit Corp had a lot of experience with videogame hardware and was therefore perfectly positioned to capitalise on the new-found public appreciation for portable gaming. Unsurprisingly, given the company's penchant for plagiarising the work of other firms, the resultant Gamate shared many similarities with Nintendo's groundbreaking handheld. "While it's difficult to determine exactly what kind of CPU the Gamate has – it appears

to be a custom part, and the manual only states that it's 8-bit – the console has the same type of display, same amount of RAM, same control configuration and very similar graphical and audio capabilities to the Game Boy," explains Evans. "It even takes the same kind of AC adaptor. Clearly it was heavily inspired by Nintendo's machine, but I don't think it's an exact clone, as some have speculated – the screen resolution seems to be slightly different, for example."

One area where the Gamate differed from the Game Boy was the way in which its games were delivered, with Bit Corp favouring a card-style format similar to examples previously seen on the NEC PC-Engine and Sega Master System. "Much like NEC and Sega's cards, they're roughly credit-card sized, only somewhat thicker, and the majority of the card is actually solid plastic that only serves as a place for the label to go," says Evans. "The PCB is only about a third of the entire card's length, and consists of two small chips on a thin board, covered in epoxy and glued down. I'm not sure why this format was chosen – a more traditional Game Boy-style cartridge would have offered more space for larger ROM chips and extra features like a save battery, allowing the developers to create larger, more complex games – but it certainly stands out in people's minds as a pretty unique feature and it's always nice to be able to store your games in your wallet."

While Bit Corp clearly wished to emulate the performance of its more illustrious rival, the humble origins of the company resulted in a few corners being cut, the most obvious being the poor-quality screen. This shortcoming would have a dramatic effect on the public perception of the device. "The LCD display on the Gamate has the same problem as the original Game Boy, only about ten times worse: it suffers



» The Gamate was reviewed unfavourably in EMAP's *CVG* and *Complete Guide To Consoles* magazines.

from shocking motion blur," laments Evans. "This actually renders some games, such as the vertical shooter *Tornado*, nearly unplayable, because small, fast-moving objects like bullets become invisible. Some later models of the console feature a slightly improved screen, which goes some way towards alleviating this issue; it isn't perfect, but at least you can see everything. Bit Corp appear to have been using both the good and bad screens at the same time, so it may well have been a case of them using two different screen suppliers simultaneously for one reason or another, rather than making a conscious effort to fix the problem."

Given Bit Corp's diminutive stature and lack of budget, there was never any question of the company marketing the Gamate in territories outside its homeland. However, thanks to the success of the Game Boy and the sudden interest in portable gaming, Bit Corp was able to secure several distribution deals, which got the device into an impressive number of different countries, albeit with relatively low-key results.

"The Gamate appears to have been released in most major videogame markets, possibly excluding Japan," says Evans. "I know for sure it was sold in the UK, Italy, France, Germany, Switzerland, North America, Argentina, Uruguay, Taiwan and possibly mainland China, although units probably made their way into many more countries via local distributors." Joystick manufacturer Cheetah took on the UK distribution duties, clearly hoping that Game Boy fever would rub off on this plucky new challenger, and it certainly had a fighting chance: the unit itself launched at a very reasonable £59.95 – £10 less than Nintendo was selling its machine for – and software retailed for around £15. Sadly the critical reaction wasn't favourable, with EMAP's *Computer & Video Games* magazine highlighting the lack of big-name titles, poor screen and generally dire quality of software as being the main reasons to leave the console on the shelf. The Gamate never got off the ground in the United Kingdom and Cheetah eventually abandoned the format – although that didn't quite mark the end of the console's British aspirations. "Interestingly, it seems to have been released in the UK twice," reveals Evans. "First by Cheetah, then again by Maplin, though it looks like they had similar trouble shifting them. I've seen game boxes with 99p stickers on them – games that now go for £50 or more on eBay."

Elsewhere in Europe the Gamate found a somewhat warmer reception. "The Italian distributor of the machine, GiG, was actually quite a major player in the toy business," explains Evans. "They were the official distributor for the NES in the country, so presumably were able to use their marketing clout

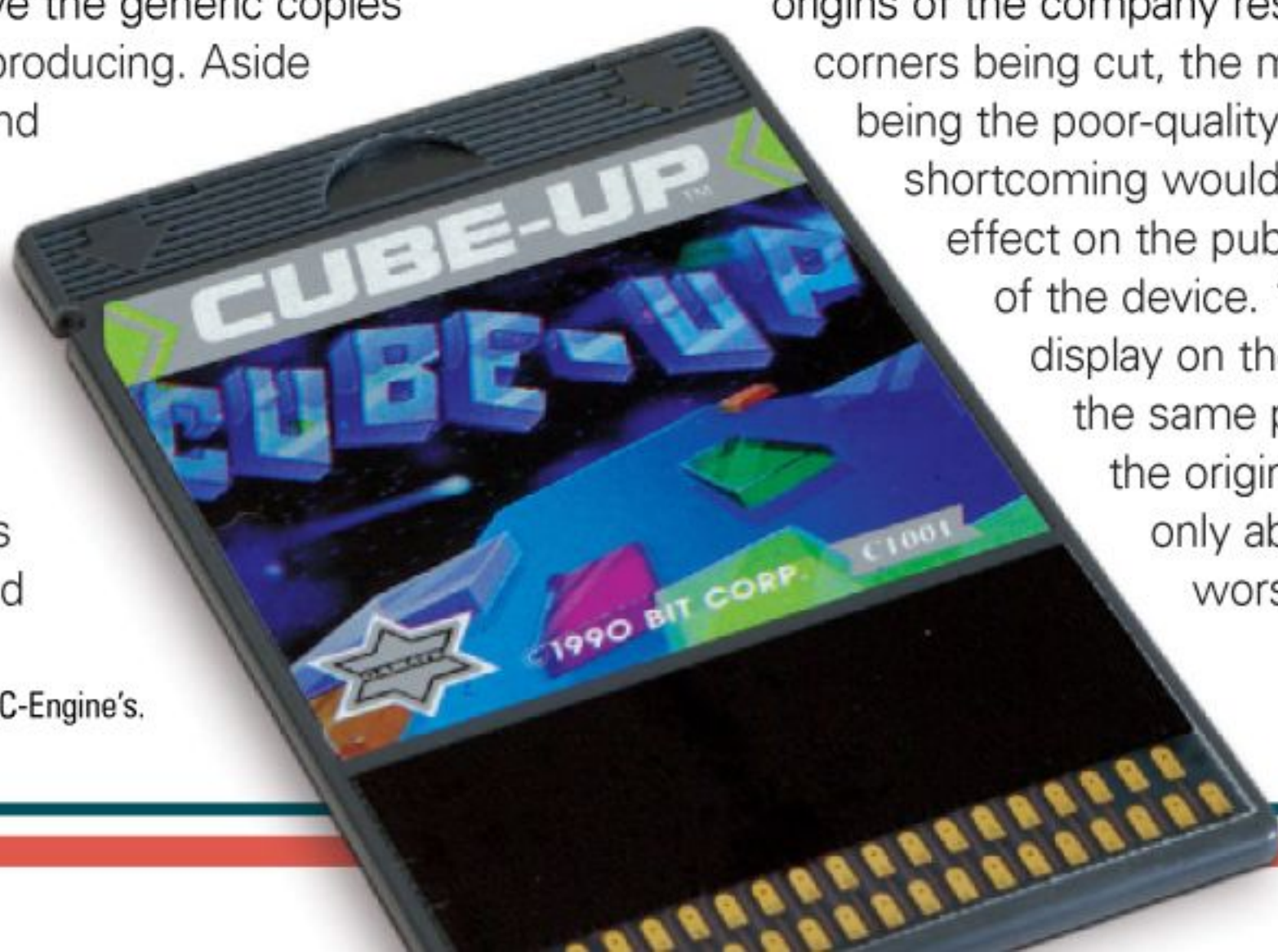



GAMATE

The Perfect Five

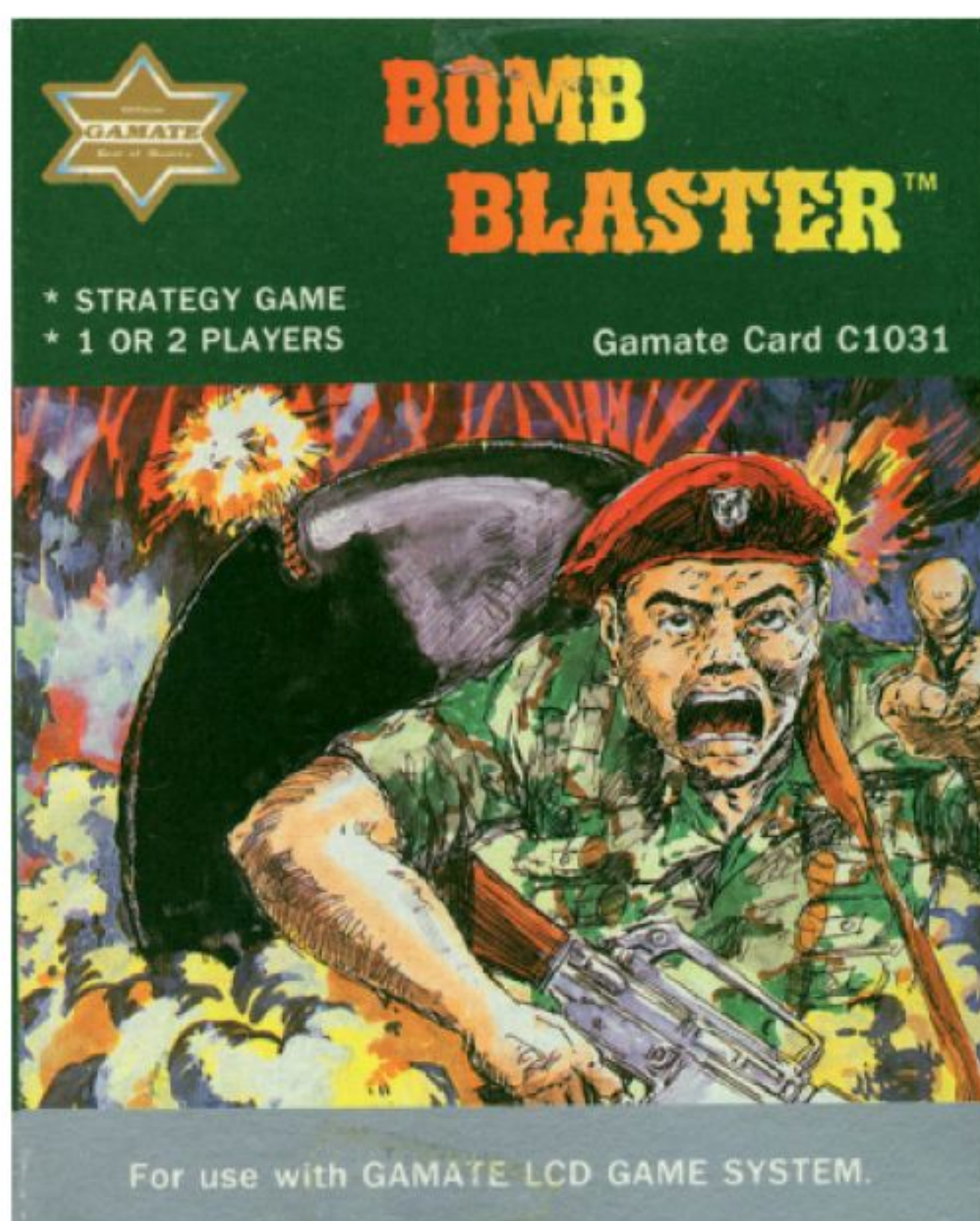

» *Bomb Blaster* was Bit Corp's take on Hudson's massively popular *Bombeman* series. It completely failed to capture any of the magic of its inspiration.

and sales network to get the console into far more homes than it managed elsewhere." Indeed, most of the Gamate titles currently changing hands on eBay are Italian variants, which suggests that the format experienced a modicum of success in that region.

One of the reasons that the Game Boy was so tremendously triumphant was because it enjoyed a surfeit of support from renowned third-party developers like Capcom, Konami, Taito and Electronic Arts. The Gamate, on the other hand, had to rely largely on internal development to create its modest library of titles, with Bit Corp's overworked and under-appreciated programmers handling most of this output. "There were no third-party publishers, but I know of at least two external developers working under contract with Bit Corp: Gamtec Corp, based in Taiwan, and Hengmao Electronics in mainland China," reveals Evans. "These relatively unknown companies managed to produce at least 71 games during the console's lifetime, which – in terms of quantity, at least – puts the Gamate ahead of every other minor player in the handheld market, including such far more well-known flops as the N-Gage, Game.com, Watara Supervision and Gizmondo." However, quantity doesn't always result in quality, as Evans freely admits: "The games themselves are a mixed bag, once you get past the console's audio-visual issues. They're not as uniformly terrible as some people make them out to be, but nor are they good enough to make the Gamate anything more than an interesting curiosity. Many show promise but were clearly rushed, which is a shame. *Myth Of Asamia* is a good example of this – it's an otherwise decent platformer ruined by shoddy jumping controls. Another game, *Flying Goblin*, was even released with the description to an entirely different game – *Mars Voyager* – on the back of the

"I've seen game boxes with 99p stickers on them going for £50 or more on eBay"

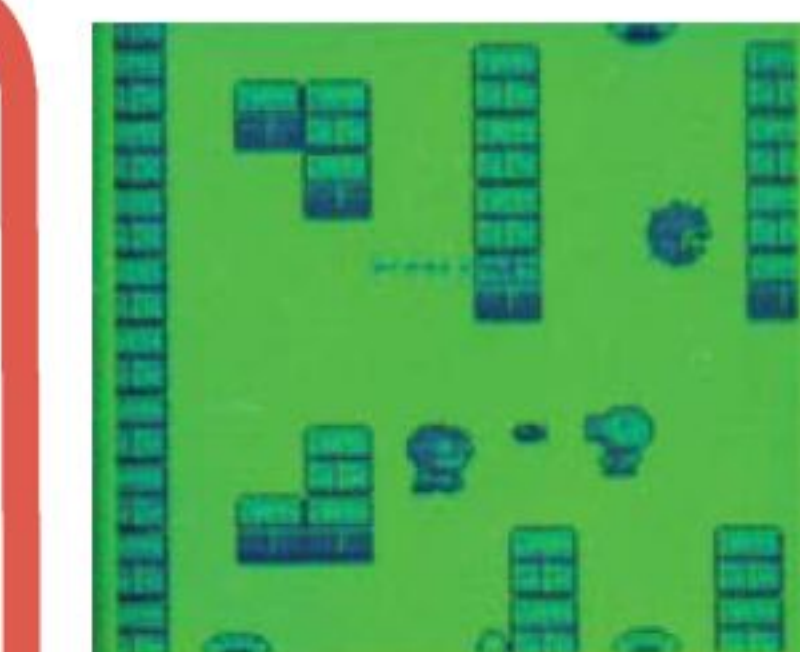

01 Snowman Legend 1991

■ Best described as a cross between *Snow Bros* and *Sokoban*, this charming title is one of the Gamate's better offerings. This is a definite must-have if you're serious about owning a Gamate. There's even a *Space Invaders* mini-game in there, too.

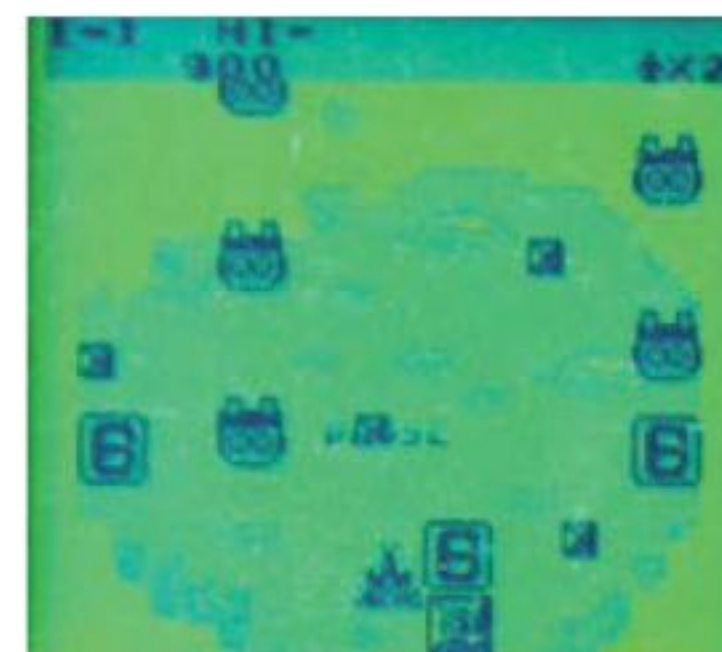

02 Tornado 1991

■ Despite the rather serious tone of the box art, this surprisingly enjoyable little shooter is actually closer to the likes of Konami's *Parodius* and *TwinBee* titles, boasting a bizarre range of cute and cuddly enemies to blow to pieces.

box. The developers weren't incompetent by any means, but they were clearly under pressure to get as much product out of the door as possible with limited time and resources to do so – after all, Bit Corp was a small company, with development support from a couple of even smaller companies, trying to take on a multinational behemoth with the world's biggest developers and publishers behind it."

In 1992, the strain of keeping the Gamate dream alive proved to be too much for Bit Corp. The company hit shaky financial ground but, astonishingly, the demise of its manufacturer didn't spell the end for the underdog console. "Gamate production was taken over by the semiconductor manufacturer UMC and its subsidiary Funtech, which was also known as Dunhuang Technology," says Evans.

This move was actually a smoother transition than you might otherwise expect, as UMC played a major part in the birth of the machine, albeit as a chip supplier rather than a creative force. "All Gamate consoles contain a UMC chip, but UMC chips were a fairly ubiquitous presence in all Taiwanese game consoles of the period – most early Famicom clones used UMC's copies of Nintendo chips, for example," explains Evans. "It may have been the case that UMC

initially just supplied chips to Bit Corp, before taking over the whole Gamate operation as its first foray into the videogame market after Bit Corp's demise."

Despite battling on under the arm of UMC and managing to carve out a modest niche in Italy, the Gamate eventually fell by the wayside in the face of the

Game Boy's unrelenting dominance and the gaming public's crushing indifference. A colour version of the console was mooted at one point, but Evans is unconvinced that it was anything more solid than an idle rumour intended to keep already slim hopes alive. "I've been unable to find any evidence of its existence," he admits. "Supposedly it was exhibited at CES and mentioned in a US game magazine, but I could never find the magazine in question, nor anything else more substantive than rumours about it being released in small quantities in Taiwan or entirely unlikely places like Mexico."

By the close of 1993 the Gamate was all but deceased, with only the most dedicated of fans mourning its demise. The lack of solid figures makes it hard to determine just how poorly it sold, but it's pretty obvious that it wasn't a commercial smash hit by any stretch of the imagination. "Judging by the scarcity of second-hand units it seems to have been a pretty spectacular flop – it was certainly in no danger



» The Gamate console was exported to many different countries. This Electrolab example was sold in Argentina, but instead of creating new packaging the distributor merely placed stickers over the English text.



Revision Provision

Despite its relatively short lifespan, the Gamate hardware underwent some subtle revisions, many of which are only obvious to those collectors who are savvy enough to spot the slight differences. "The main chipset appears to have been revised at some point during the production run, although this was presumably done for cost reasons as it doesn't seem to have any discernible effect on performance," states Evans. "I've also been in touch with a Taiwanese collector who owned a white machine, which they described as 'second-generation', but everything other than the colour appears to be identical. Internally, there are at least a couple more variations to be found – perhaps the most noticeable is the screen. Basically the Gamate seems to have had two different types of LCD screen used throughout its lifespan; one is somewhat better than the other, in as much as it actually allows you to see projectiles and such, although it still isn't great. The easiest way to tell which one you have is by turning the Gamate on without a game in: the 'bad' one displays horizontal lines while the 'good' one displays a slightly corrupted checkerboard pattern."

Evans explains how some iterations of the machine are incredibly rare and highly sought-after: "The very earliest versions of the Gamate featured a noticeably different case design, with different speaker holes, button recesses and D-pad, but this is considerably rarer than the standard version. I've seen one for sale on eBay, but none of the Gamate owners I've been in touch with actually have one."



03 Devil Castle 1991

■ The gothic setting and platforming action naturally inspire comparisons with Konami's legendary *Castlevania* series, and this has led to *Devil Castle* becoming one of the Gamate's most sought-after titles for collectors.

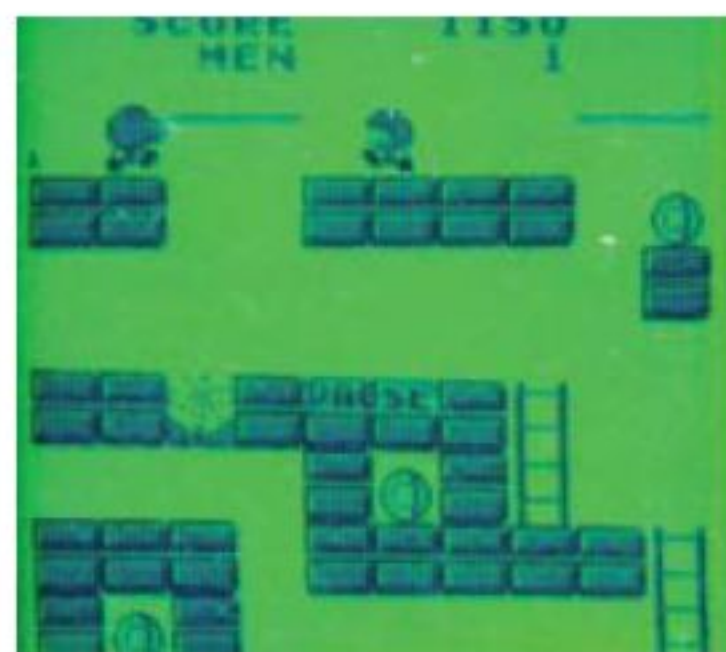

04 Treasure Hunter 1990

■ The Gamate was blessed with two *Lode Runner* clones between this and *Witty Apee*, but *Treasure Hunter* takes the crown as the best facsimile of Douglas E Smith's legendary title for the system.



05 Mini Golf 1991

■ Viewed from a top-down perspective, this unique golf simulation doesn't strive for realism but instead presents a refreshingly fast-paced take on the art of sinking balls into holes, with obstacles to negotiate and an unusual cursor-based control system.

Attack of the Clones

As was common practice in the age of the 8-bit micro computer, the Gamate's software library was packed full of shameless copies of existing hits, all of which Bit Corp had neither the inclination nor the funds to acquire and develop legitimately. Games cunningly replicated for the handheld include *Super Pang* (*Boom*), *Pitfall* (*Monster Pitfall*), *Bomberman* (*Bomb Blaster*), *Columns* (*Jewelriss*), *Lode Runner* (*Witty Apee* and *Treasure Hunter*), *Galaxian* (*Galaxy Invaders*), *Battle City* (*Mighty Tank*), *Breakout* (*Brick Blaster*), *Flipull* (*Flipuzzle*), *Lock 'N' Chase* (*Money Maze*) and *Tetris* (*Cube-Up*). *Pipe Mania* was also ported to the console under its original name, although it doesn't appear to be a licensed version. Finally we have *Mars Voyager*, which isn't a clone as such but bears more than a passing resemblance to Konami's *Gradius*, right down to a Moai statue featuring on the back of the box. Given Bit Corp's lack of cash and humble talent as a creator of games, it's almost forgivable that so many of the Gamate's titles were wholesale rip-offs, but sadly few – if any – of these copies managed to come anywhere near to the quality of the software they intended to emulate.

of bothering the Game Boy, Game Gear, or even the Lynx," states Evans.

Clearly, in the pantheon of gaming, the Gamate occupies a pretty lowly perch, and even hardcore fan Evans struggles to counter such a viewpoint. In purely business terms, the console can only be seen as a devastating disappointment. "Even in Italy, where it seems to have done comparatively well, it evidently didn't do quite well enough for its distributor to release the later games," he admits. "The only way to know for sure if it was truly a commercial failure is to find out whether Bit Corp and UMC actually made money on the project. It was never going to outsell the Game Boy but it may well have been a success by their own modest standards. The fact that Bit Corp went bust during the system's lifetime is hardly an encouraging sign, but UMC must have done decent enough business to not be put off the games industry completely – although it's worth noting that the firm's second console, the 16-bit Super A'Can, would lose UMC \$6 million and lead to the closure of its entire game division."

Ironically, the Gamate's humble standing in the world of portable entertainment has made it a highly sought-after system in retro collecting circles, with unboxed machines fetching anything from £25 to over £50 on the rare occasions that they actually turn up on eBay. "I'd say it's down to its extreme obscurity coupled with a fairly large software library," comments Evans when asked about this bizarre and almost frenzied demand for failed hardware. "It's quite unusual for a console that most people – even most retro enthusiasts – have never

heard of to have had over 70 games released for it. I suspect the fact that it has never been emulated is also a factor: the only way to play any of those games is to actually own them."

It would seem that the Gamate is destined to be considered a weird and wonderful collectable rather than a truly worthy gaming platform. Its abject failure and relatively unknown status appear to be the driving factors in its appeal to truly hardcore retro enthusiasts; certainly as a console it offered little in the way of mouthwatering features. "I have to admit it's pretty unacceptable that the vast majority of Gamate consoles are equipped with a screen that actually renders several of its games unplayable," Evans says. "The speaker is equally poor, too; some Gamate games have fairly good music, but you'd never notice without headphones. Having said that, there's nothing particularly wrong with the actual design of the machine; it was just let down by crap parts being used in the most obvious places. In a way, it's impressive they got as far as they did, but ultimately they took one too many short cuts and sacrificed too much quality for quantity when it came to software. Perhaps if they had cut the number of games by half and delayed the console's release to work out its hardware problems and give the developers more time to polish things up, they could have had a minor success on their hands. Unfortunately, it wasn't to be."



» Amusingly, the back of each Gamate card features a warning to avoid touching the "Golden Finger by hands". Sound advice indeed.

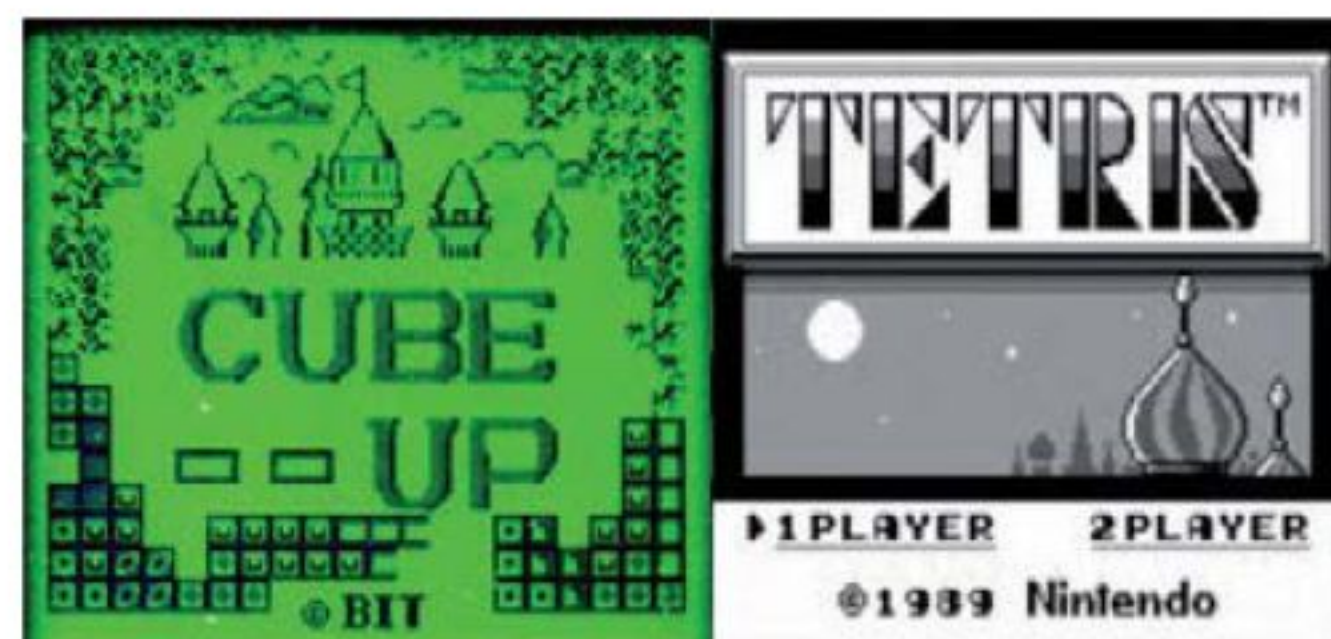

Thanks to Alex Evans for kindly supplying his Gamate console for the photography used in this feature. You can check out his site by visiting fuji.drillspirits.net.



» The cute little chap riding atop this Gamate doesn't have an official name, although there is speculation that he was intended to be a *Mario*-style mascot.



ATARI 800XL

ATARI 800XL

BROADLY CONSIDERED THE FINEST ALL-ROUNDER IN ATARI'S 8-BIT HOME COMPUTER RANGE, THE XL WAS ALSO THE BIGGEST SELLER IN GLOBAL TERMS. BUT DESPITE TOP-CALIBRE SOFTWARE SUPPORT FROM THE LIKES OF LUCASFILM, EA AND EPYX, IT NEVER PENETRATED THE COMPUTING MARKET TO THE EXTENT OF ITS NEAREST RIVAL, THE C64. WE TAKE A WELL-EARNED LOOK AT THE HISTORY OF ATARI'S UNDERACHIEVING 8-BIT WONDER

INSTANT EXPERT

The Atari 800XL was one of the third generation of Atari 8-bit home computers, and was preceded by the Atari 400, 800 and 1200XL. It is backwardly compatible with most software. It was Atari's bestselling 8-bit computer system worldwide.

Atari's home computers were the first to use special custom processors for graphics and device input/output, which freed up the main CPU for other tasks, a concept used by developers Jay Miner and Joe Decuir, on leaving Atari, for the design of the Amiga.

The Atari 8-bit computers were based on a 1.79MHz 6502 CPU, a considerably faster clock speed than its competitor, the C64, which had a 1MHz 6502 processor. As a result many maths-intensive titles, such as *Rescue On Fractalus!*, were faster on Atari machines than on the C64.

The 800XL had a little brother, the Atari 600XL, which was effectively the same machine but came equipped with 16K RAM, as opposed to the 800XL's 64K, and lacked the 800XL's composite video output.

The custom graphics chips in the 600XL/800XL computers were called ANTIC and GTIA, and offered sprite handling, advanced hardware scrolling and collision detection, and up to 256 colours (as opposed to the C64's 16-colour palette).

Four sound channels were available, originating from the Atari 800XL's custom POKEY chip, which also handled peripheral input/output. It was co-designed by *Star Raiders* creator Doug Neubauer.

A number of classic cross-platform 8-bit system games were initially programmed for Atari computers, including *Ballblazer*, *Rescue On Fractalus!*, *M.U.L.E.*, *Archon*, *Boulder Dash*, *Dropzone*, and *Miner 2049er*.

Doug Neubauer reveals that Atari originally intended its computer line to have the same sound processor as the 2600.

The marketing, and consequently overall success of Atari's home computer line was catastrophically affected by the failure of the 2600 (VCS) console in 1983. The company had \$400 million of unwanted console products in the pipeline in the face of a collapsing 2600 market, diverting corporate attention from the needs of the unfortunate Home Computer Division.

According to imdb.com, the repeated electronic beeping sound effect heard in the shuttle cockpit in the movie *Airplane II* is the sound of an Atari 8-bit computer's disc-drive booting up.

In the fifth issue of fondly remembered *C64* magazine *Zzap!64*, which hit newsstands in September 1985, Archer Maclean penned a tips guide for his classic shoot-'em-up *Dropzone*, which contained the oft-quoted (and misquoted) following comment. "The Atari, being the Porsche of home computers is capable of running *Dropzone* 2.5 times faster than the 64 and can handle any amount of blobs on screen. However, the 64 is still a respectable BMW 316 (S reg)." It was an unusual statement to find in a Commodore-oriented publication, and while *Retro Gamer* prefers to remain neutral in any debate regarding the technical superiority of either of the two competing machines, Archer may well have had a point.

Compared to the more popular home computers of the day, such as the ZX Spectrum and C64, Atari's computers were often regarded as high-end, and came equipped with an equally high-end price tag. In 1984, the newly released Atari 800XL, the computer designed to compete with the C64, was priced at around £250, considerably cheaper than its older sibling, the Atari 800, had been on launch in the US, but far more expensive than the Spectrum (£130) or C64 (£199). A higher price point than the more popular machines, and an over-reliance on the expensive cartridge format plagued Atari computer software. However, many classic games that originated on the Atari 8-bit computers, were faster and more refined than the now often better-known conversions on other contemporary platforms. But by the mid-Eighties, Atari had found to its cost that high-quality software, flashy technical specifications and above average build-quality simply wasn't enough to win in the fight for the hearts and minds of hobbyists and computer dealers whose main concern was competitive pricing.

In hindsight, Atari's relative failure with its 8-bit home computer range, at least in terms of longevity compared to its rivals, seems harsh when you consider that they were very much ahead of their time in conception. Work began on the company's first two home computer systems, the Atari 400 and 800, after the release of the 2600 console in 1977. "We knew we needed to leapfrog the 2600 before somebody else did," says Atari designer Joe Decuir. "We saw the Apple II, Commodore and Radio Shack machines coming, and we wanted to design a machine that would support home computer characters and bitmap graphics." Another member of the 400/800 dev team was Jay Miner, future 'Father of the Amiga', who headed design of the graphics display/output chips known as ANTIC and CTIA. A third custom chip (POKEY) handled peripheral input/output and sound, and these separate co-processors freed up the main CPU, improving performance. An industry first, the concept of separate dedicated chips to drive graphics and sound would be taken to its logical extreme when ex-Atari employees, including Jay, were hired by Commodore to produce its first 16-bit home computer.

Debuting in the US in autumn 1979, the Atari 400 and 800 computers sold for \$549 and \$999 respectively. The 400, with its membrane keyboard was geared towards the home hobbyist and games market and was intended to ship with 4K of RAM. The 800 was designed as a higher-end or business machine, and came equipped with 8K of memory. Both computers were capable pieces of hardware



Year released: 1983

Original price: US: \$299, UK £249

Buy it now for: £15+

Associated magazines: Atari User, Page 6 (UK), Antic, ANALOG (US)

Why the Atari 800XL was great... Of all of Atari's 8-bit home computers it was the most competitive all-round package, with a full 64K RAM, built-in BASIC, great audio/visual capabilities and a decent, compact casing and keyboard. Programmers loved the quirks and cutting-edge capabilities of Atari's hardware, and some of the games software it spawned was truly ground-breaking. Much of the technical know-how gained in the design of the Atari 8-bit line went on to be used in the Amiga, and even today's PCs.



“COMPARED TO THE MORE POPULAR HOME COMPUTERS OF THE DAY, SUCH AS THE ZX SPECTRUM AND COMMODORE 64, ATARI'S COMPUTERS WERE OFTEN REGARDED AS HIGH-END, AND CAME EQUIPPED WITH AN EQUALLY HIGH-END PRICE TAG”



ATARI 800XL

OTHER VERSIONS WHEN ONE MACHINE ISN'T ENOUGH

Atari 65XE

This replacement for the 800XL, launched in 1985, features sleeker styling, an updated version of Atari BASIC, and a new memory management chip called 'Freddie'. There's little to make it a better buy nowadays than its predecessor, although its very similar big brother, the 130XE, is notable for its 128K system RAM (double that of the 65XE and 800XL).



XE Game System

Released in answer to Nintendo's NES, this was a modified 65XE computer in console guise (more contemporary looking than the rather dated 5200 console). Add-on features included a detachable keyboard, which was a little 'mushy' in comparison to those of the computer line, and a light-gun. It came with *Missile Command* and Atari BASIC built-in.



Atari 800XE

The last 8-bit computer to be produced by Atari, the 800XE was almost identical to the 800XL, but with the slim-line casing of the 65XE/130XE computers. It has other similarities to the 65XE, such as the inclusion of the 'Freddie' chip. The 800XE had a short life span, and was sold for only a year. It was popular in Eastern European territories such as Germany and Poland.

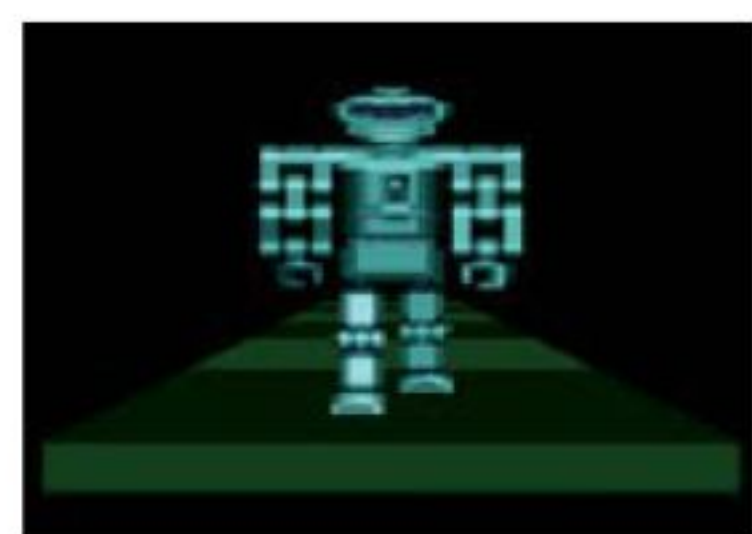

» The walking Atari Robot demo, which adorned many a computer shop window, demonstrating the impressive colour palette of the Atari computers.

for their time, sporting an unprecedented 128-colour palette, hardware sprites, four joystick ports, and cartridge, peripheral and memory expansion interfaces allowing unheard of levels of customisation. By the time of its launch, falling RAM prices allowed Atari to increase the 400's memory capacity to 8K. Eventually the 400/800 shipped with a standard 16K or 48K of RAM respectively.

Atari's marketing division made considerable efforts to publicise the advanced audio-visual features of its home computer systems, focusing on their unique custom architecture, fast full-colour graphic

capabilities and multi-channel sound. Atari CEO Ray Kassar's mandate to the company's design engineers had been that the systems should be invaluable for home and business use and have the capabilities to play exciting, cutting-edge games. Unfortunately, the company's reputation as a videogame manufacturer backfired on its Home Computer Division, as high-end consumers opted for the more business-like Apple II rather than the Atari 800, and gamers found the high cost of the 400 prohibitive compared to the cheaper VCS console. However, Atari did have one considerably powerful ace up its sleeve to lure gamers to its 8-bit computer line.

staggering when first experienced in 1979 as one of the launch titles for Atari's personal computers. It became one of the first examples of a home computer 'killer-app' with many customers purchasing a 400 or 800 and a *Star Raiders* cartridge just to enjoy Neubauer's creation, among them a youthful Archer Maclean. "I saw *Star Raiders* and it just blew me away," he says. "Something very special was happening. I made it my mission to find out what." Another fan, Jeff Minter, couldn't wait to play it. "You can keep your *Elites* and *Wing Commanders*, for me the original *Star Raiders* will always be the best. 8K of sheer 6502 code poetry," he eulogises. A further coup came in 1982, when LucasArts (then Lucasfilm) agreed to produce its first two hotly anticipated games, *Rescue On Fractalus!* and *Ballblazer*, exclusively for Atari machines. Both were developed on the Atari 800. "They wanted us to develop for the 2600 since it was their biggest installed base, but we were able to convince them we could do much more impressive games on the newer systems," says *Fractalus!* designer David Fox. "The target platform, initially, was the 5200. The other competing platforms at the time were the Apple II and C64," he continues. "The C64 didn't have much of an installed base then, but the Atari had a great set of chips, allowing us to squeeze a lot more out of the machine than we could on a computer like the Apple, which really had nothing like that." Ultimately, Lucasfilm's titles weren't enough to push Atari's computers into mainstream popularity, not being released until several years after the 5200 versions, and after the C64 had started to emerge as the 'it' machine for consumers. Lucasfilm eventually conceded and converted its games to the C64 and other platforms.

"ATARI'S REPUTATION AS A VIDEOGAME MANUFACTURER BACKFIRED ON ITS HOME COMPUTER DIVISION"

capabilities and multi-channel sound. Atari CEO Ray Kassar's mandate to the company's design engineers had been that the systems should be invaluable for home and business use and have the capabilities to play exciting, cutting-edge games. Unfortunately, the company's reputation as a videogame manufacturer backfired on its Home Computer Division, as high-end consumers opted for the more business-like Apple II rather than the Atari 800, and gamers found the high cost of the 400 prohibitive compared to the cheaper VCS console. However, Atari did have one considerably powerful ace up its sleeve to lure gamers to its 8-bit computer line.

Doug Neubauer, an Atari engineer and co-designer of the POKEY chip, had developed a game while working at Atari. Inspired by the generic '*Star Trek*' games he'd seen running on mainframe systems, Doug took advantage of the new Atari hardware, which he describes as "a quantum leap from the 2600" to update the game with a first-person 3D perspective. Not a huge logical progression by today's standards, except for one fact. No one had ever created a full free-roaming 3D game before. The result, *Star Raiders*, was

Around the time of the Lucasfilm deal, Atari was set to launch a successor to its 400/800 computers, with which it planned to phase out the older systems and boost flagging sales. Hitting shelves in January 1983, the Atari 1200 was intended as a more 'adult' computer system, and built on the successful 400/800 architecture, adding a professional-looking keyboard, 64K of RAM and improved peripheral support. The machine used a new graphics co-processor (GTIA) with an improved 256-colour palette. This had recently replaced the older CTIA chip in the 400/800 series and would be used in all future Atari 8-bit models. Designed to compete directly with the Apple II, the machine was unsuccessful in the competitive and soon-to-be-crowded market for business systems. There were also compatibility problems with some 400/800 software

PROJECT WIZARD

Atari's hard-working engineering department always strived for an experimental approach to design, although a number of ambitious and unusual research projects only ever reached prototype stage. One was Project Wizard, an incredibly strange concept that would have caused somewhat of a stir in the industry had it ever seen the light of day. "It was the first, and only game controller that used your mind," says research engineer Tim McGuinness. "It was created in 1982, and was one of my projects. It used three electrical sensors on the forehead to control right-left motion of the cursor, and was designed for games like *Breakout*. 1,000 pieces were manufactured under the Atari Wizard Controller name for the Home Computer & VCS lines, but were never released for sale. But it was so cool. You put on a headband with three sensors, and you willed the controller right and left – it took about 10 minutes for most people to get control. Some could control it with blinding speed. I think the main reason it didn't go on sale was the psychological stigma of a computer reading your mind. It actually worked using simple electrical signals, through the skin, but I believe that was the factor. Especially in those days, when the public had no idea of how limited the power of their computers was..."



» Atari's 1981 computer product-line-up, with the 400 and 800 personal computers taking pride of place in the centre of the picture.

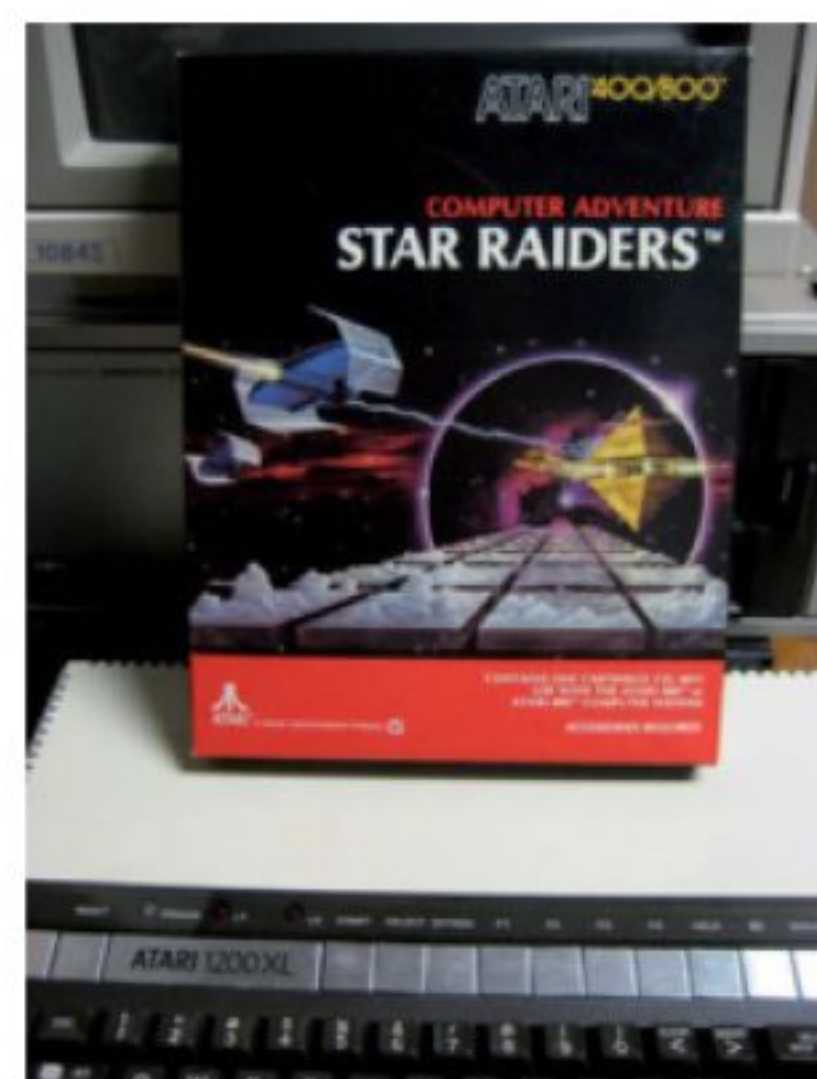

» Left: Atari's 'killer-app' *Star Raiders* perched atop the second-generation 1200XL. Right: A magazine advert for *Star Raiders* made a point of highlighting its pioneering first-person play-view.

COMMUNITY THE BEST ATARI WEBSITES

Atarimania

www.atarimania.com

A fabulous resource, in a similar vein to World of Spectrum and Lemon64, this site is a wonderful place to start for an overview of Atari 8-bit hardware and software. Atarimania has an enormous database of downloadable games and software, with screenshots and full-colour manual scans for many titles. It also features the occasional developer interview.



Atari Museum

www.atarimuseum.com

A massively impressive site, with a whole wealth of information covering Atari's 30-year history. Its archives are brimming with first-hand interviews with Atari staff, technical documents, Atari magazine scans, old adverts and press releases, and a bucket-load of other assorted resources. You name it and, if it's Atari-related, it will probably be here somewhere.



Back In Time

www.backintime.net

Another large Atari-oriented site with information and photos of pretty much every console and home computer model ever released by the famous company, along with features on official and third-party add-ons, and peripherals and unreleased prototype hardware. Check out the radio-show episodes featuring guests such as Sid Meier and Nolan Bushnell.



Atari Age

www.Atariage.com

Last but not least we have probably the most popular Atari website in existence, if its incredibly busy and extensive forums are anything to go by, that is. Admittedly, the main content does concentrate on Atari console hardware (particularly the VCS) but the 5200 section is useful, and as an Atari community it has, to our knowledge, no peers in all cyberspace.



titles due to the 1200XL's upgraded BIOS. The unpopularity of the 1200XL drove sales of the 800 as consumers raced to purchase the cheaper machine before it was discontinued. The system was an embarrassing flop for Atari, retailed for just four months before the plug was pulled on production. It was never sold outside the US.

Tim McGuinness, Atari's assistant director for corporate research engineering at this time, was a major player in the design of the 1200 and the later XL models. "Before the release of the 1200XL, Atari had VisiCalc, a few great databases, and a good word processor. In fact, many employees at the company used Atari 800 computers for all business work. But the early Ataris were marketed as home computers and by late 1982 we were months from the release of the IBM PC and first Compaq 'Lunchbox' PC." Despite the lack of consumer support for the system, Tim remains proud. "The 1200XL was the big step up from the 800/400 series," he says. "Later systems such as the 800XL were lesser progressions from an evolutionary standpoint." In fact, the machine may have been better received had Atari not been struggling financially. "The company was falling apart in the US, as the major corporate marketing engine was dealing with the collapse of the VCS console market. The home computers were a poor stepchild," says Tim.

In 1983, Atari went into direct competition at the lower end of the market. Squaring up against the C64, it launched the Atari 600XL and 800XL computers. Externally quite similar to the 1200XL, but abandoning the function keys and built-in demos, they were the first machines to include in-built Atari BASIC as standard. The 600XL/800XL came equipped with 16K or 64K RAM respectively and had two joystick ports. The Parallel Bus Interface

(PBI) was added, allowing the addition of advanced peripherals. The machines were very much scaled down versions of the 1200XL, and to reduce production costs further following Jack Tramiel's takeover of Atari in 1984, much of the manufacturing infrastructure was moved to Hong Kong. The price cutting was seen as an effort to directly undercut Commodore, who had forcibly ejected Tramiel earlier in the year. However, production delays had meant that most of Atari's stock of 600XL/800XL machines had hit retailers too late to compete against the C64 over the Christmas 1983 period, and Atari never managed to catch up with its rival from this point on. Coupled with the collapse of the 2600, Atari was on a slippery slope, and would never again scale the heights of its ascendancy under founder Nolan Bushnell. Despite these problems, the Atari 800XL remains the company's most successful 8-bit computer.

Atari soldiered on under Tramiel with some modifications to its 8-bit computers, such as the XE range and the XE Game System, released in 1987 as a competitor to the NES. In 1992, with its 16-bit ST home computer locking horns against Commodore's Amiga, Atari finally dropped all support of its 8-bit line, 15 years after the series' conception and long past the peak of its popularity. Brilliant and technically ahead of their time, Atari's 8-bits tried to be jack of all trades but fell short of winning the battle with Commodore or Apple. Perhaps their potential as a gaming platform was never quite realised. "Although the Apple II was the obvious target, we also conceived of the 800 as the next-generation gaming machine," says Joe Decuir. "In my opinion it had no peer until the NES came out five years later in Japan." Adds Tim McGuinness: "We still use Atari technology in today's PCs. Our MS DOS floppies use Atari DOS format. USB is the grandson of Atari Serial (the interface between Atari peripherals)." Now that's certainly something to think about.

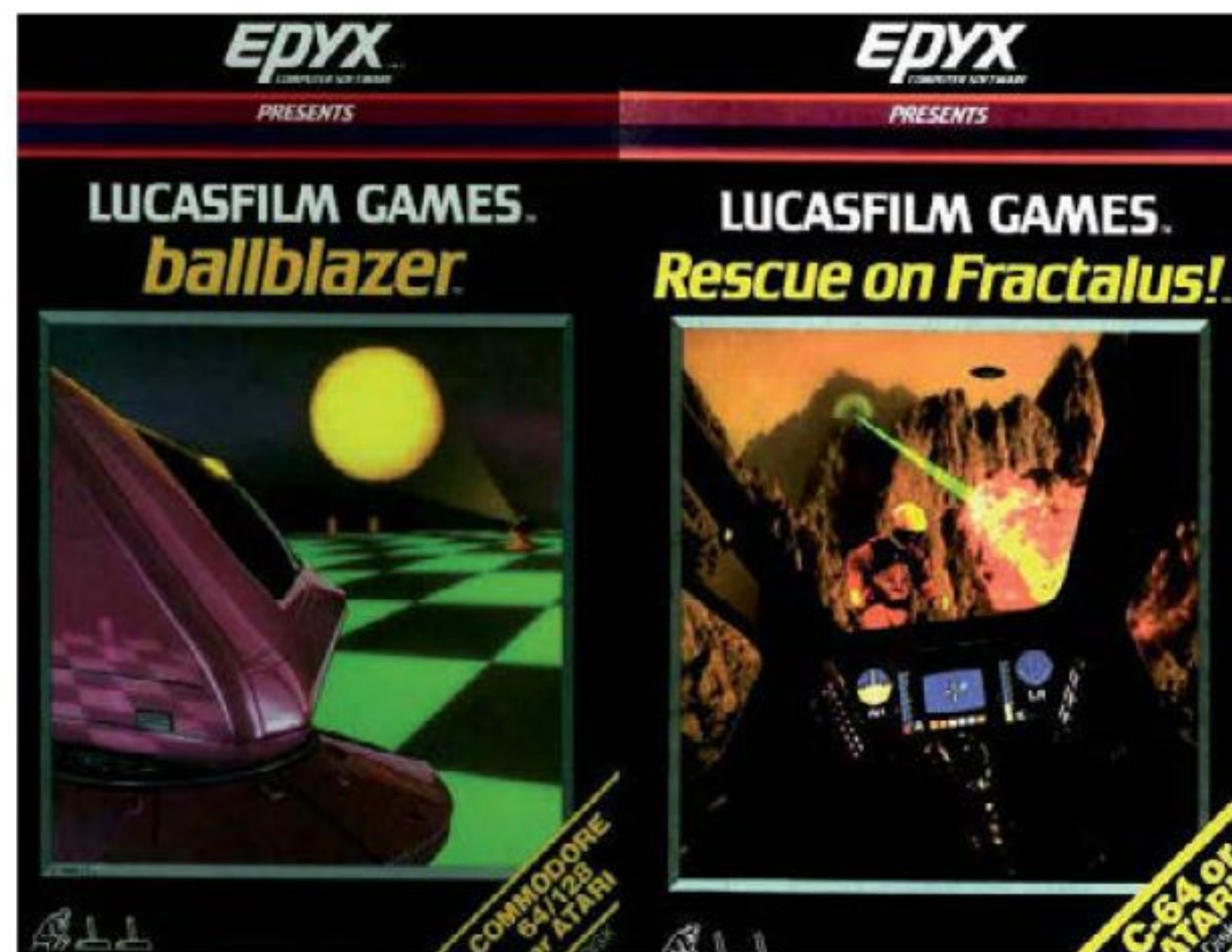

» Ballblazer and Rescue On Fractalus!. Two ground-breaking titles that were developed by Lucasfilm Games, on Atari 8-bit computers.



» Third-party support from publishers like Synapse, Epyx, Datasoft, First Star and Sierra was a great boost to the Atari home computer software catalogue.



DE RE ATARI

A long-held popular myth is that Atari deliberately held technical information on its 8-bit computers from third-party programmers, so that its internal developers would have an advantage. It's a rumour that ex-Atari software developer Chris Crawford (of Eastern Front fame) is eager to quash. "When the 400/800 were released, Atari executives assumed that the technical details of those machines would be kept secret, as they were with the VCS. Everybody in engineering knew that was absurd, but it took a while to convince them it would be better to encourage outside software developers. What did the trick was the early press reviews saying that the 400/800 were great machines but didn't have as much software as the Apple II. In December 1979, they issued a memo saying all technical documentation was now publishable. I had a number of friends in the software community and got on the phone to them. They wanted photocopies of the documentation, which I ran off myself and shipped to them. Thenceforth, all you had to do to get the documentation was to ask. We sent out exactly the same documents that we ourselves used. There was never any attempt to hold anything back after that. However, the documentation was not easy to understand. By December 1980 there were enough developers that I proposed a Software Development Support Group, to assist developers both inside and outside Atari. We wrote De Re Atari to make the documentation easier to understand." This legendary tome, published in 1982, was an invaluable aid to programmers like Archer Maclean, who likens reading it prior to creating Dropzone to a 'religious experience'. "If we'd started the Support Group sooner I think we could have beaten Apple to become the top 8-bit machine, and fended off the C64," says Chris. "But we didn't, which might be a good thing. If we'd beaten Apple, I might not be typing this on my Macintosh!"



» Two generations of Atari personal computers. The Atari 400 (top), Atari 800 (middle) and Atari 1200XL (bottom).





ATARI 800XL

PERFECT TEN GAMES

The Atari 8-bit personal computers were privy to some of the most impressive games of their time, and the Atari 800XL is still a great platform on which to experience them. Here's a selection of ten of the finest titles to whet your appetite. If we've managed to miss any of your favourites then feel free to let us know by visiting the forums at www.retrogamer.net/forum

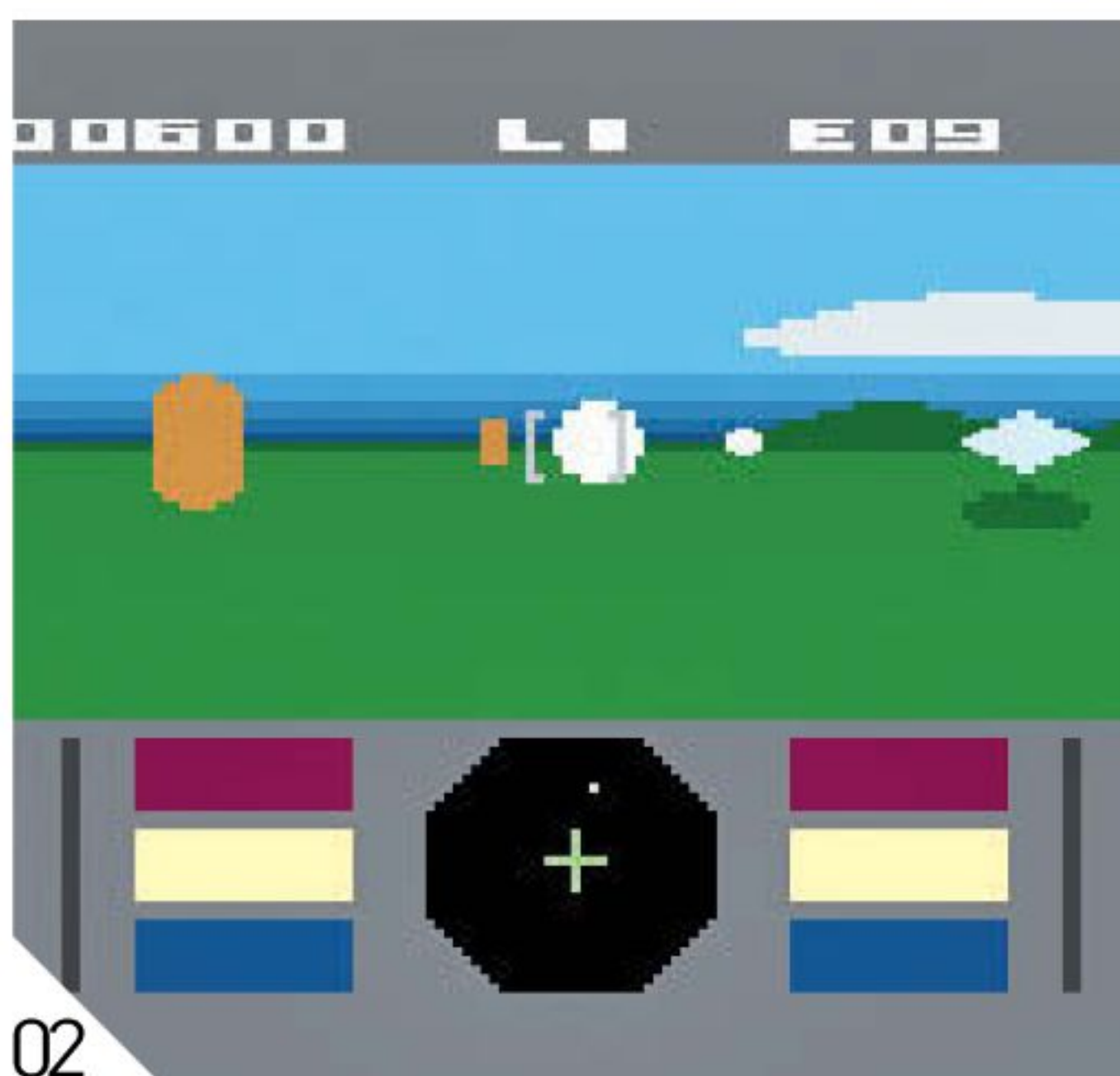
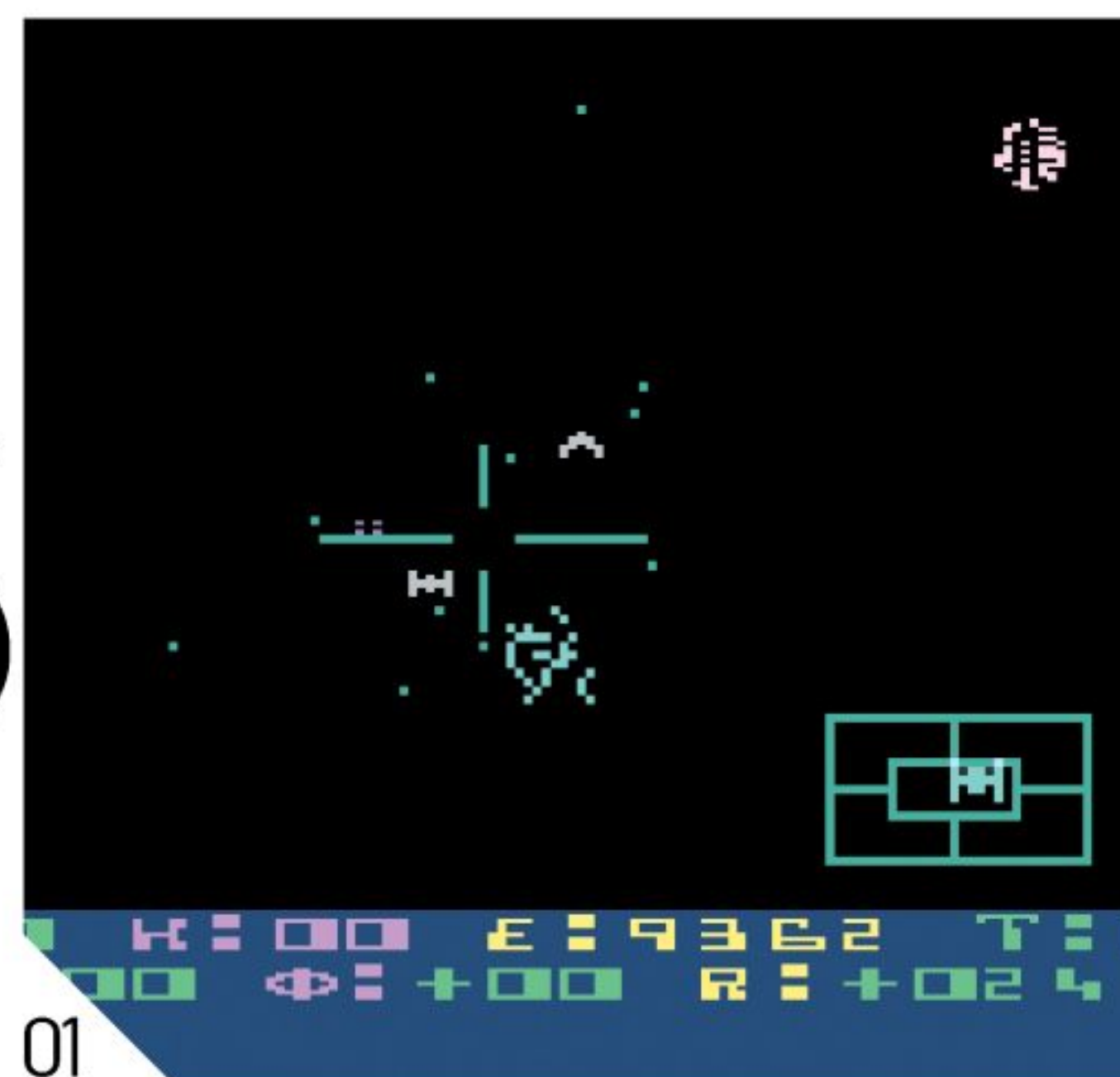

STAR RAIDERS

- » RELEASED: 1979
- » PUBLISHED BY: ATARI
- » CREATED BY: DOUG NEUBAUER
- » BY THE SAME PUBLISHER: QIX

01 Hugely influential to many of those that witnessed it on Atari's fledgling personal computers, *Star Raiders* was the title responsible for shifting more Atari 400/800 machines than any other. The granddaddy of the *Elite*-style 'space opera', it was also the world's first free-roaming first-person perspective game. Updating the generic 'Star Trek' games played by many a college student on mainframe systems, it was a striking mix of strategy and fast, immersive graphics that effortlessly sucked players into its universe. Criminally, the game's creator, Doug Neubauer, didn't make a single penny from *Star Raiders*, which he created in his spare time while he was employed as an Atari design-engineer.

ENCOUNTER!

- » RELEASED: 1983
- » PUBLISHED BY: NOVAGEN/SYNAPSE
- » CREATED BY: PAUL WOAKES
- » BY THE SAME PUBLISHER: MERCENARY: THE SECOND CITY

02 *Encounter!* was so good that when Jeff Minter first saw the game demoed at a computer trade show he hastily convinced author Paul Woakes to make it a full commercial product, giving birth to software house Novagen and paving the way for *Mercenary*. Playing out the mechanics of *Battlezone*, at what seems like around a thousand miles per hour, and with filled, solid objects zooming in and out of the screen, *Encounter!* was a technical marvel. And the impressively scary 'warp-sequence' between levels, which flings hundreds of enormous Ping-Pong balls at you while you struggle to avoid a collision, will still have you squirming in your seat like an Olympic rower with a scorpion in his pocket.

RAINBOW WALKER

- » RELEASED: 1983
- » PUBLISHED BY: SYNAPSE
- » CREATED BY: STEVE COLEMAN
- » BY THE SAME PUBLISHER: BRIMSTONE

03 *Rainbow Walker* is a unique and extremely playable title that is totally exclusive to the Atari 8-bit systems. Borrowing the colour-filling mechanics of *Q*Bert* and transposing them onto a chequered pseudo-3D scrolling play-field, its impressive z-axis scrolling utilises the Atari's unique graphic capabilities very nicely. Guiding our rotund hero Cedric across a series of aerial platforms fills in squares with a spectrum of colours, and moving up or down at either vertical extremity scrolls the patterned play-field towards or away from you. Enemy creatures can, and will, undo all of your hard work and must be avoided or 'pushed' off the rainbow by scrolling it until a gap appears beneath them. An attractive game and a really clever concept.

PASTFINDER

- » RELEASED: 1984
- » PUBLISHED BY: ACTIVISION
- » CREATED BY: DAVID LUBAR
- » BY THE SAME PUBLISHER: GHOSTBUSTERS

04 Despite a limited release by Activision (it remains one of the hardest titles to track down), *Pastfinder* is a great progressive shoot-'em-up which makes good use of the Atari's unique hardware. Helming a frog-like craft (the 'Leeper') your task is to explore a hostile planet while hunting down long-lost alien 'artefacts'. The scrolling forced-perspective terrain (resembling a top-down *Zaxxon*) is highly atmospheric, with great use of shadows, and the Leeper is a wonderfully charismatic creation with a superb control 'feel'. There's a huge *Star Raiders*-style strategy-grid to traverse in search of ancient loot, and guiding your 'space hopper' through the radioactive wasteland at breakneck speed is enormous fun.

BOULDER DASH

- » RELEASED: 1984
- » PUBLISHED BY: FIRST STAR SOFTWARE
- » CREATED BY: PETER LIEPA
- » BY THE SAME PUBLISHER: ASTRO CHASE

05 At the risk of being predictable we couldn't really leave *Boulder Dash* out of our Perfect Ten. Developed for the Atari 400/800 by Peter Liepa and Chris Gray, its beautiful gameplay (inspired by *The Pit*, an arcade game co-created by Andy Walker of Taskset fame) has been enthralling generations of gamers on various platforms for over 20 years, and its hero, Rockford, is a bona fide gaming icon. The dynamic physics, the predetermined 'rules' for enemy creatures, and the thought-provoking puzzle-like nature of the game were all masterstrokes. This then, the original creation in the lineage, is a must-play, with some outstanding and very challenging levels, which greatly deserve revisiting.

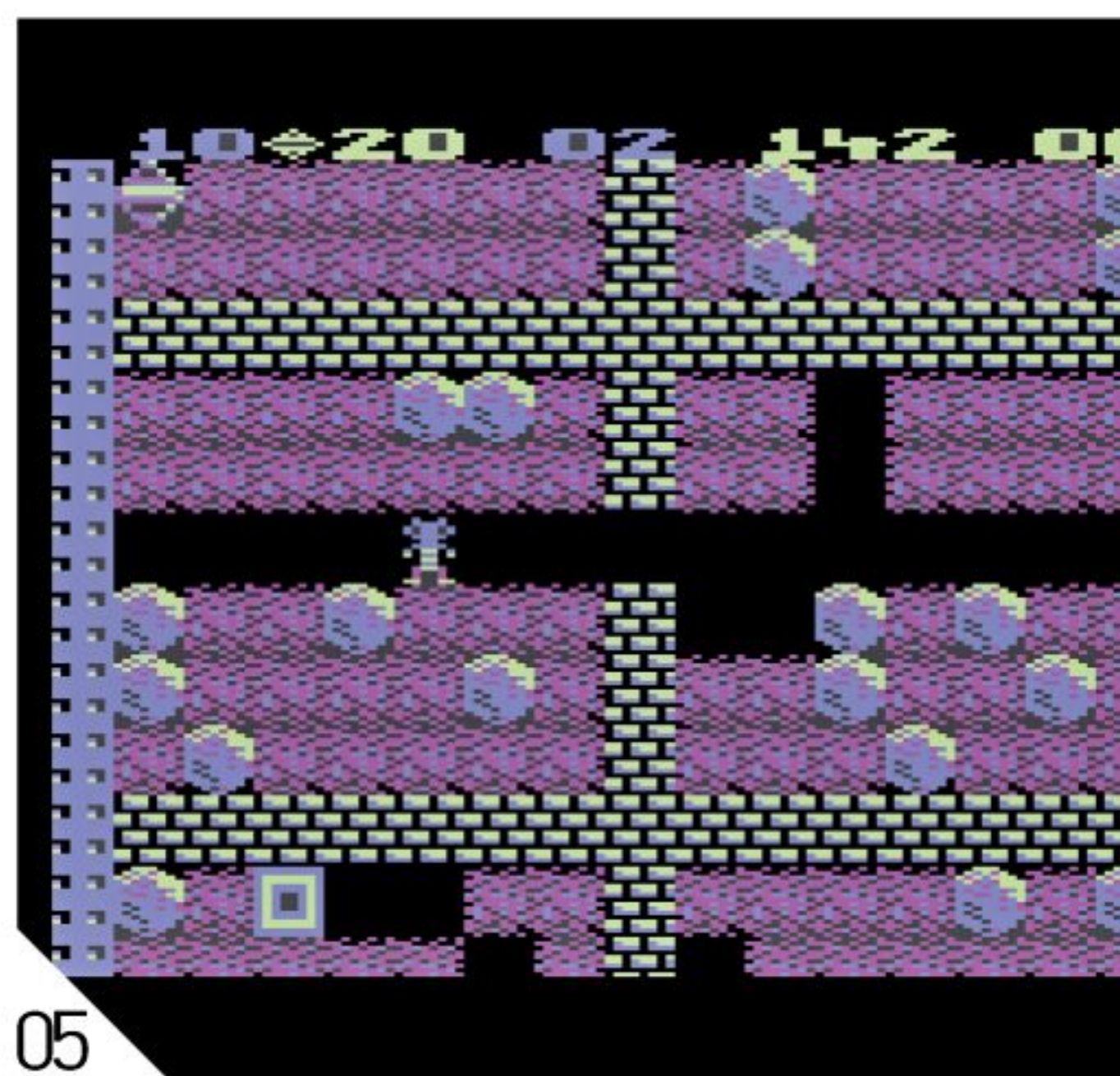

05



06

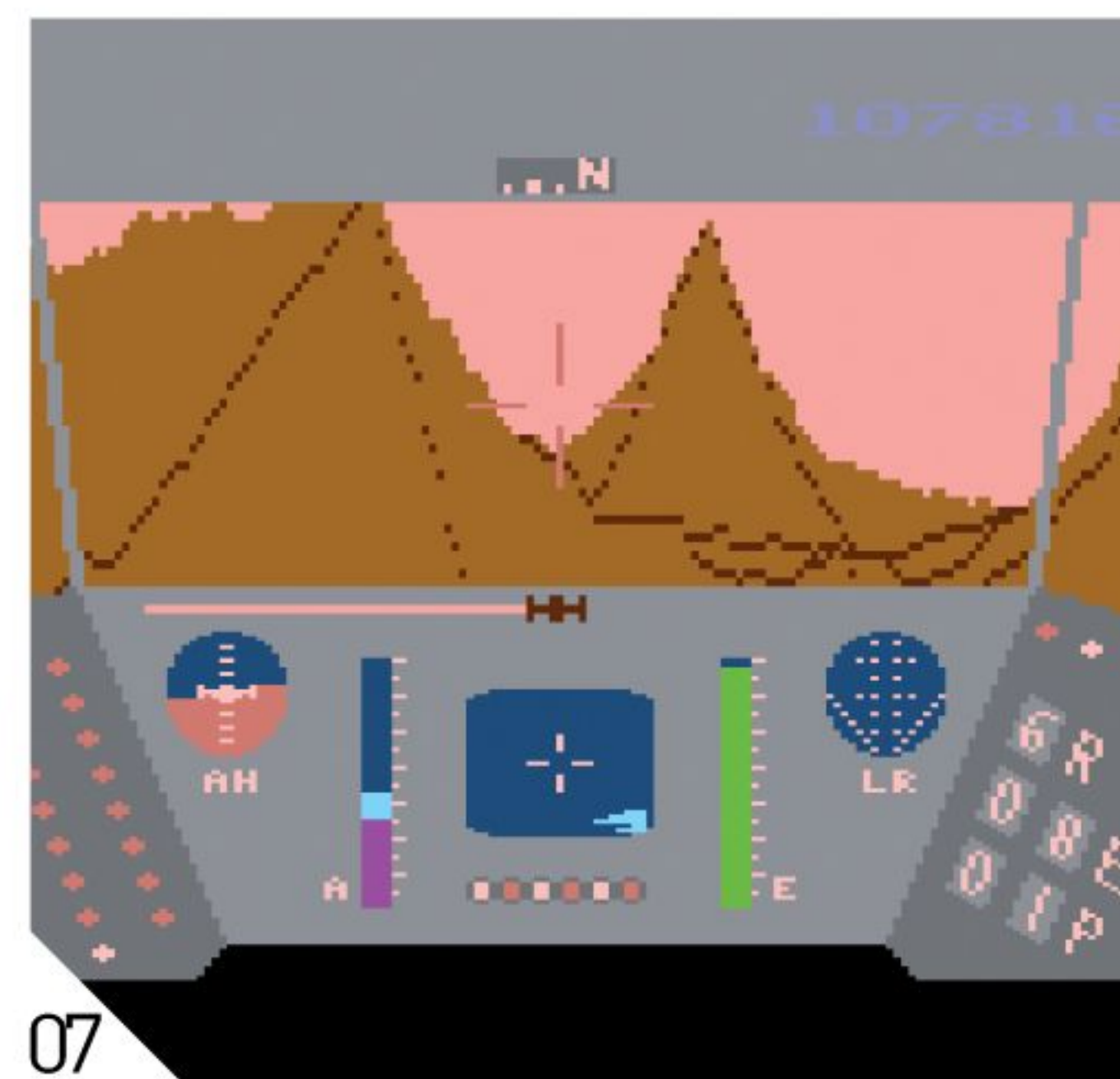

07



08



09



10

DROPZONE

- » RELEASED: 1984
- » PUBLISHED BY: US GOLD
- » CREATED BY: ARCHER MACLEAN
- » BY THE SAME PUBLISHER: OUTRUN

06 With *Dropzone*, a young Archer Maclean took a large helping of *Defender*, a sprinkling of *Jetpac*, and cooked up a brilliant and blisteringly paced Jarvis-esque mega blast. Like a fine wine, *Dropzone* has aged remarkably well, and the original Atari version is most definitely the finest vintage on offer. Considerably bettering Atari's already very decent *Defender* conversion, Archer's magnum opus displays an incredible eye for detail and pushes the Atari hardware to the limit with its incredibly rapid smooth-scrolling, pixel-perfect collision handling, incredible particle effects and fantastic playability. Even in death the game rewards the player's ineptitude with a spectacular on-screen firework display.

RESCUE ON FRACTALUS!

- » RELEASED: 1985
- » PUBLISHED BY: ACTIVISION/EPYX
- » CREATED BY: LUCASFILM GAMES
- » BY THE SAME PUBLISHER: PITFALL!

07 If *Star Raiders* managed to shoehorn a small but significantly impressive corridor of space into an 8K Atari cartridge, *Rescue On Fractalus!* went a step further by cramming a whole planet into a 48K computer. Lucasfilm's first-person fractal flight-sim delivered an incredibly immersive experience, which many thought impossible to achieve. Its release was a defining moment for the Atari 8-bit systems it was originally designed for, wowing gamers on their first exposure to its amazing real-time landscape. The Atari's faster processor means that this is the definitive version of the game, running around one-and-a-half times faster than the C64 conversion.

BOUNTY BOB STRIKES BACK

- » RELEASED: 1985
- » PUBLISHED BY: BIG FIVE SOFTWARE
- » CREATED BY: BILL HOGUE
- » BY THE SAME PUBLISHER: SCRAPER CAPER

08 Bill Hogue's excellent sequel to his classic *Miner 2049er* is an outstanding platform romp that improves on its predecessor by some distance. Bob's mine now has a satisfyingly solid isometric angled look, and there's a multitude of new contraptions to help (or hinder) our hero. With 25 stages (more than twice the number of the original), and some extremely devious screens with a proliferation of slides, pipes and teleports to scramble your brain, *Bounty Bob Strikes Back* will test your platforming skills to the max but have you coming back for more. And top players can glorify their achievements on one of the most polished and appealing high-score tables of all time.

THE EIDOLON

- » RELEASED: 1985
- » PUBLISHED BY: ACTIVISION/EPYX
- » CREATED BY: LUCASFILM GAMES
- » BY THE SAME PUBLISHER: TONY HAWK'S PROJECT 8

09 Probably the most ambitious, original and downright atmospheric title of Lucasfilm's fractal triptych, *The Eidolon* was scaring the nappy-filler out of gamer's many years before *Doom* or *Resident Evil* were. By cleverly inverting the fractal mountains from *Rescue On Fractalus!* and *Koronis Rift*, Charlie Kellner created an incredibly engrossing first-person subterranean adventure with strange revelations and fascinating beasties lurking around every corner. The creatures themselves are all great characters, from comical lowly minions to the game's famously impressive dragon guardians. And you don't even want to know what monstrosity awaits you at the end of the final level.

YOOMP!

- » RELEASED: 2007
- » PUBLISHED BY: N/A
- » CREATED BY: MARCIN ZUKOWSKI AND TEAM
- » BY THE SAME PUBLISHER: N/A

10 Imagine playing *S.T.U.N. Runner* (apparently we're not supposed to mention *Trailblazer*) with a bouncing ball in a psychedelic tubular playing field to a stonking soundtrack. Actually, imagine no more, just grab *Yoomp!* instead. This excellent title was created by a Polish programming team, and was inspired, according to its developers, by an old Bullfrog DOS game called *Tube*. Whatever its influences, however, this freeware masterpiece deserves to be experienced by as many players as possible, which is why we've included it here. Fire it up, grab a joystick, disengage your mind from the niggling background music of reality and prepare to enter the zone.



ATARI 800XL

ATARI 800XL and the rest...

With so many British gamers constantly harping on about the ZX Spectrum, CPC 464 and Commodore 64, it's easy to forget that there were plenty of other classic machines that were worth visiting, as this two-page 800XL spread proves

- 1 ACE OF ACES
- 2 EASTERN FRONT
- 3 REVENGE II
- 4 KORONIS RIFT
- 5 BOULDER DASH
- 6 DROPZONE
- 7 POLE POSITION
- 8 MERCENARY
- 9 SUMMER GAMES
- 10 ASTEROIDS
- 11 DEMON ATTACK
- 12 GHOSTBUSTERS
- 13 ATTACK OF THE MUTANT CAMELS
- 14 PASTFINDER
- 15 INTERNATIONAL KARATE
- 16 STAR RAIDERS
- 17 PAC-MAN
- 18 ARCHON II
- 19 BOUNTY BOB STRIKES BACK
- 20 M.U.L.E.
- 21 RAID OVER MOSCOW
- 22 CONAN
- 23 SPYHUNTER
- 24 NECROMANCER
- 25 GHOST CHASER
- 26 BC'S QUEST FOR TIRES
- 27 THE EIDOLON
- 28 MR DOI
- 29 SHAMUS II
- 30 ARCHON
- 31 ELEKTRA GLIDE
- 32 BALLBLAZER
- 33 SHAMUS
- 34 THE SEVEN CITIES OF GOLD
- 35 KARATEKA
- 36 DEFENDER
- 37 GREMLINS
- 38 PITFALL II: LOST CAVERNS
- 39 ASTRO CHASE
- 40 MINER 2049ER
- 41 ROBOTRON: 2084
- 42 GYRUSS
- 43 SOLO FLIGHT
- 44 STAR WARS
- 45 ZAXXON
- 46 FORT APOCALYPSE
- 47 ALTERNATE REALITY: THE CITY
- 48 ENCOUNTER!
- 49 SPINDIZZY
- 50 THRUST
- 51 BRUCE LEE
- 52 RESCUE ON FRACTALUS!
- 53 SPY VS SPY
- 54 THE GOONIES
- 55 MONTEZUMA'S REVENGE
- 56 TAPPER

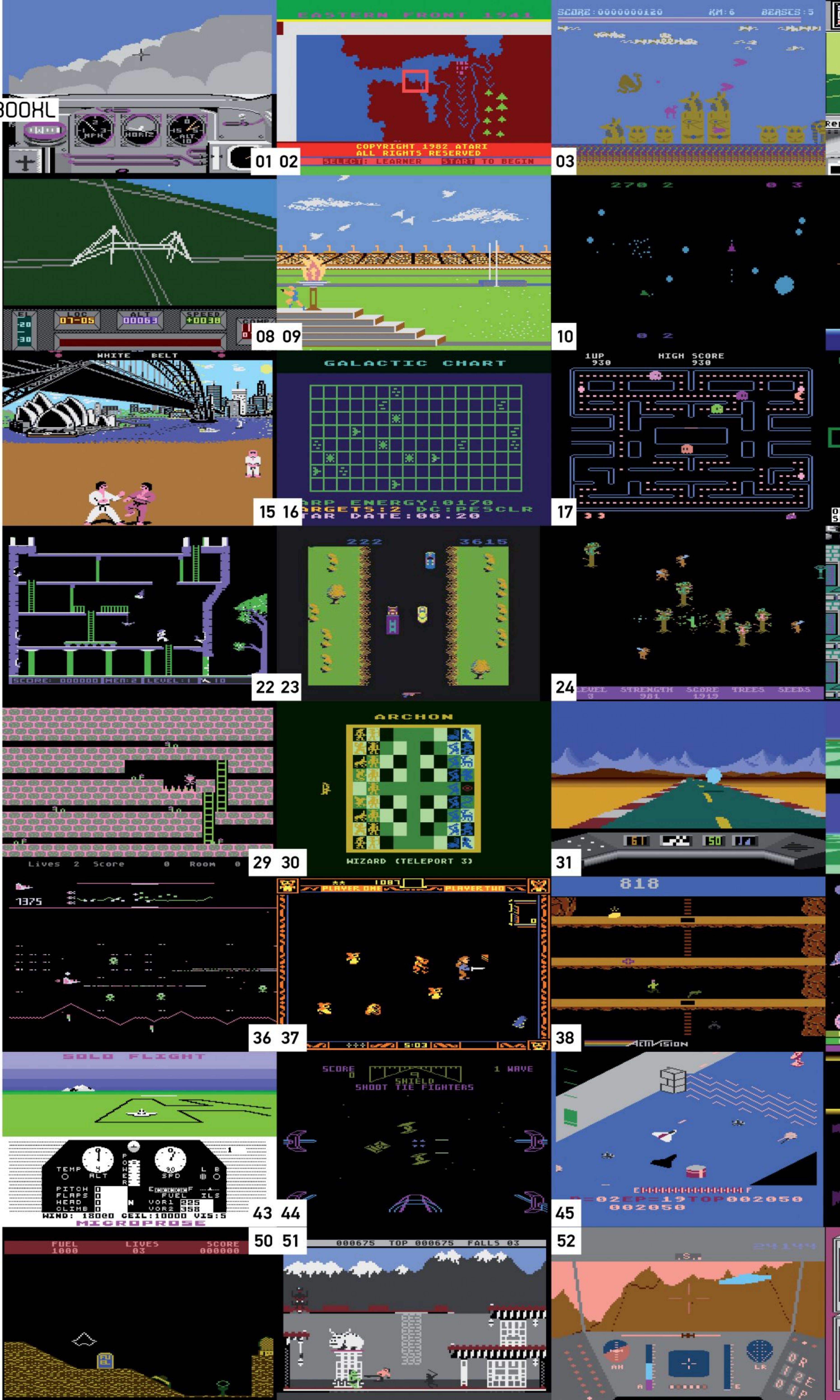



04 05



06



07



11 12

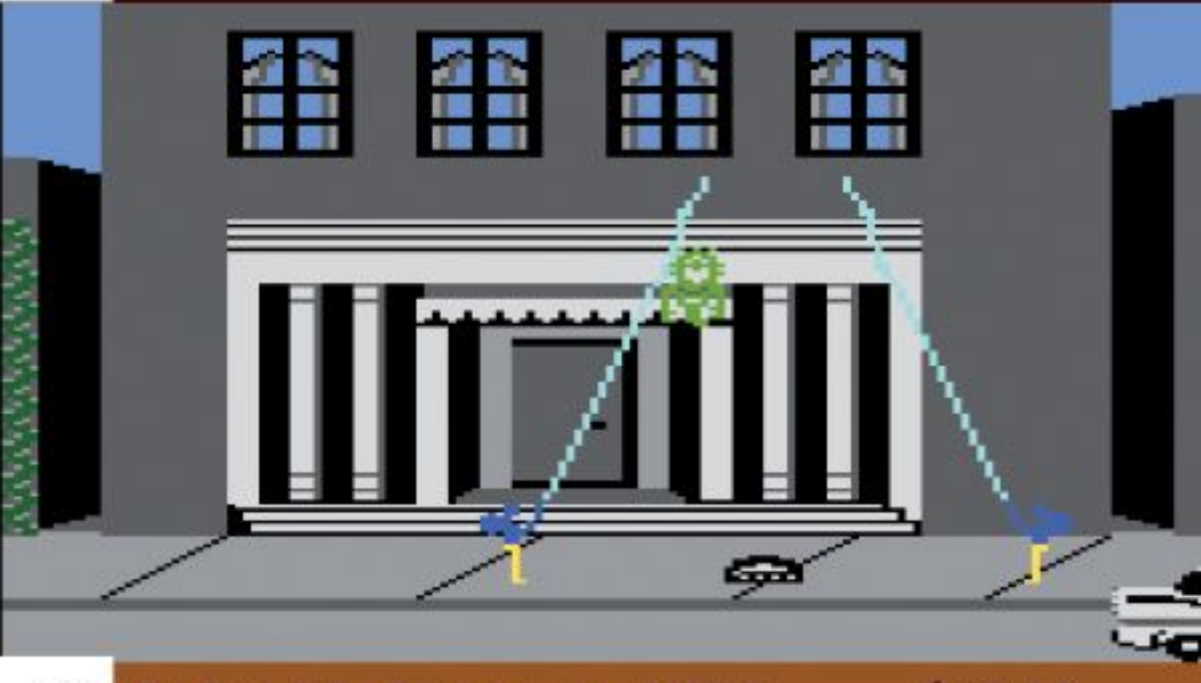

13



14



18 19



20



21



25 26



27



28

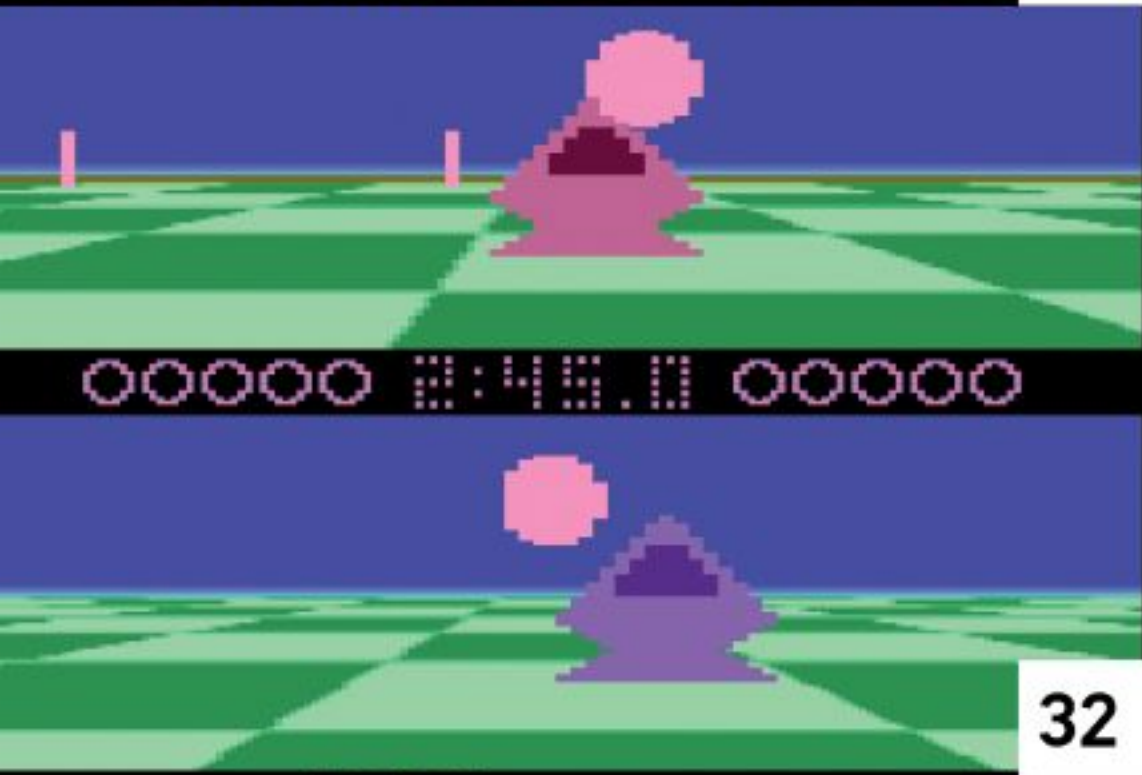

32 33



34



35



39 40



41



42



46 47



48



49

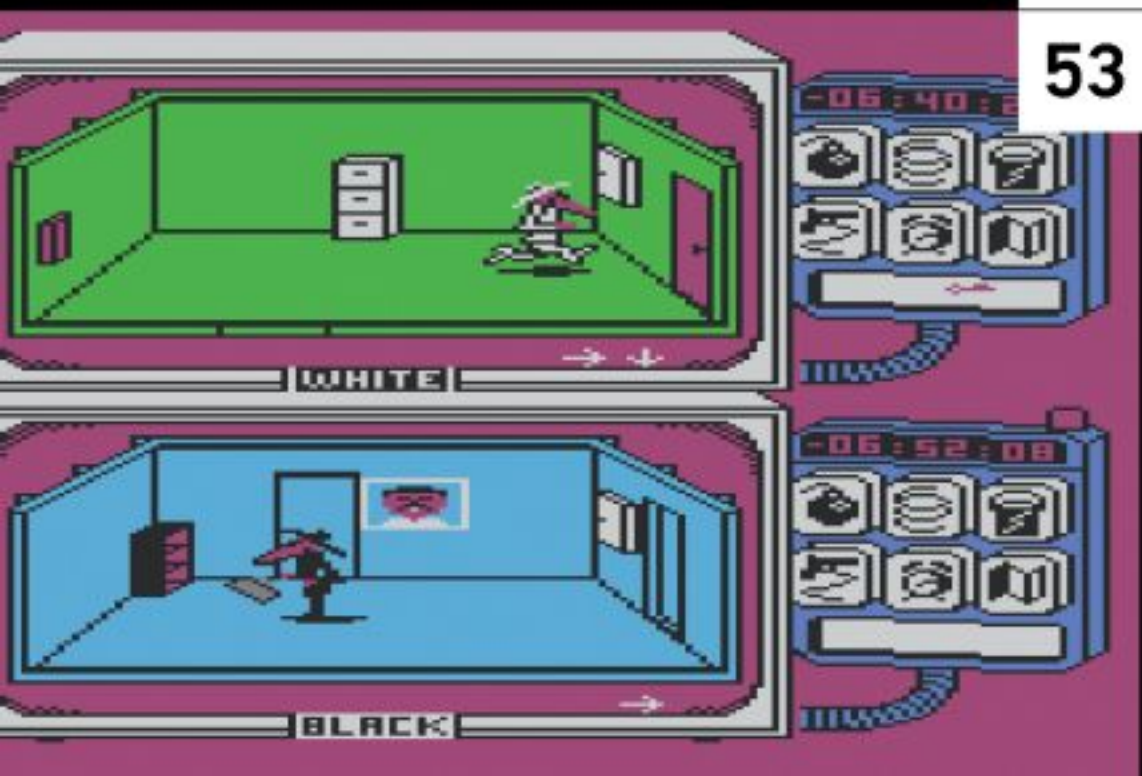
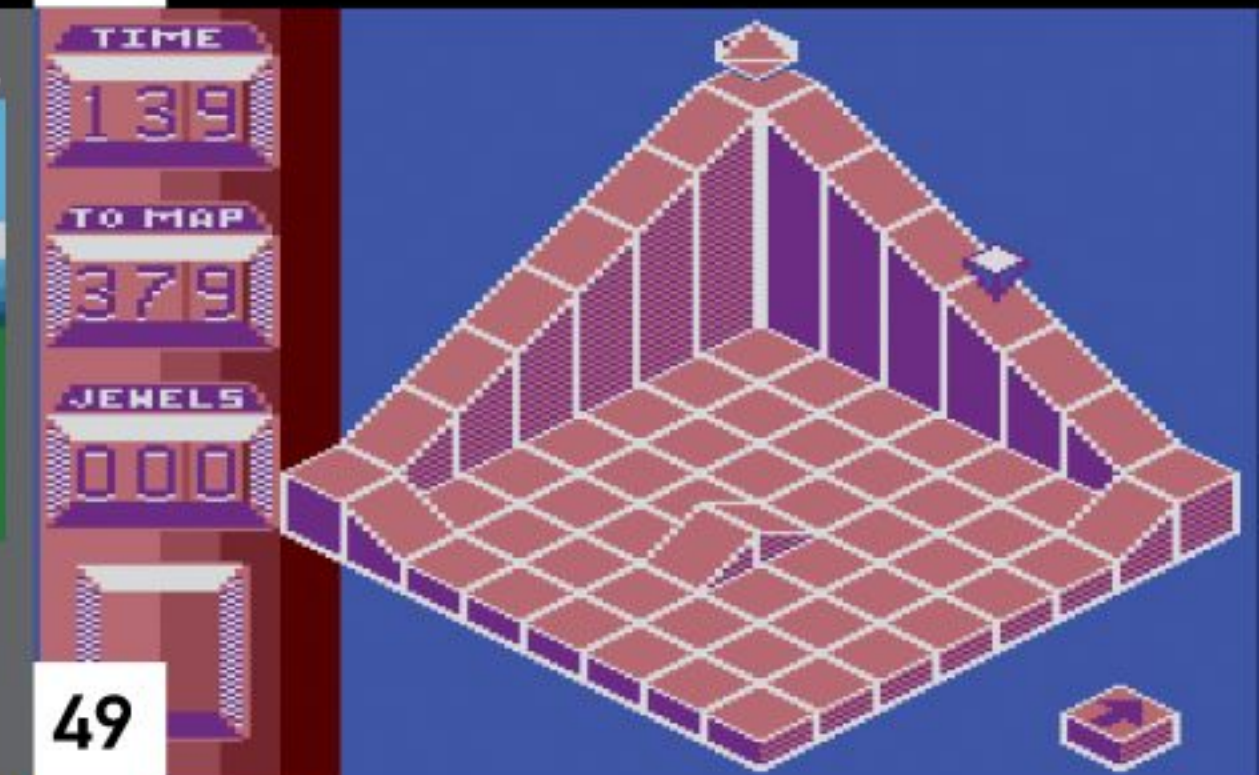

53 54



55



56





CONTROLLING HISTORY





Controlling History

From toggle switches to thin air, we attempt to chart the evolution of the game pad, and explain how it has driven the medium in more ways than you might think

While their looks and sounds have changed dramatically over the past three decades, the ways in which we play videogames have only recently started to evolve significantly by comparison. The joystick, the fire button, the paddle, and the quirky game peripheral have all been around since the dawn of the industry, and the innovative control methods to have emerged following the Seventies can pretty much be counted on one hand.

Developed by American physicist Willy Higinbotham, the quaintly titled 1958 game *Tennis For Two* was one of the first electronic games ever produced. Built in a New York research facility, the game was a simple recreation of tennis, viewed from a side-on perspective, and its graphics were displayed through an oscilloscope. Surprisingly, considering the game's age, *TFT* demonstrated an intelligent control scheme that suited the style of the game: played by two people, each player used an analogue control box that contained a fire button to strike the ball and a rotatable knob that could influence its trajectory.

Of course, *TFT* was a rare exception. Back then, many early



» The diminutive Cheetah Bug; its novelty looks belied great design and a small, responsive stick, making it an instant winner with gamers.





Tom Taylor

Ergonomics expert Tom Taylor, a teacher of product and graphical design, explains to us what features make a good game pad



RG: What do you think about early joypads like the 2600, ColecoVision and NES pads from an ergonomics point of view?

TT: The ergonomics of the Atari 2600 and NES game pad were truly appalling. I remember playing on them and having to stop every once in a while due to cramp. I believe that ergonomics did not enter into the design process. If you look at what Microsoft and Sony have achieved with the modern controllers, it's beyond belief why Nintendo thought that a rectangular design was going to be comfortable to hold.

RG: In your opinion, what makes a good joypad?

TT: To answer this I think you have to look at examples such as the early Microsoft

Sidewinder, Xbox and PSone controllers. Here we start to see the use of anthropometric data to help the designers create the modern controllers we have today. For me, what makes a good controller is something I can use for hours on end and feel no discomfort, but also something that my six-year-old son can pick up and use with no difficulties.

RG: How important has analogue control been for videogames?

TT: Hugely. Can you imagine trying to play *Call Of Duty* with a digital thumb stick? You would have no fine movement, and we would still be playing games like *Pong* and *Donkey Kong*. Both are great games even now, but for pure interactivity, an analogue controller is a must.

RG: Which company has a history of making the best, most ergonomic console pads, in your opinion?

TT: For me it has to be Nintendo. Okay, the NES joypad was a true horror to use. If you then look at the development they have put into game pads over the years, with the Super Nintendo joypad, N64 and finally the Wii Remote, for me they are a clear winner.

RG: What would you say was the best controller from the past?

TT: This is an easy one: the N64 due to its clever three-handed design – one for digital control and the other for analogue. The number of hours I spent using it to play *Mario Kart 64* in comfort is scary.

RG: What do you think is the best joypad currently on the market?

TT: Yet again, another easy one: the Xbox 360 controller. I can play for hours using it with no discomfort. And my six-year-old son can pick it up and use it with ease. It's a great example of anthropometric data being used to create an ergonomic design that can be used by people of all ages with different hand sizes.

RG: How important do you think motion-sensor controllers will become?

TT: I think they will always have their place in gaming, but for serious games I don't think they can replace the game pad. I don't see how they can build in the accuracy or range control that an analogue thumb stick is capable of.



» The Quickshot 130F featured an auto-fire button plus four input settings to allow Atari/Commodore, MSX, Amstrad or Sega machine functionality.

► games and control schemes were designed using whatever was available to engineers at the time. In the case of Steve Russell's seminal 1962 videogame *Spacewar!* – the world's first built-for-purpose videogame – the game ran on colossal PDP-1 mainframe hardware, and players used five toggle switches on the machine to operate the left and right rotation, thrust, firing and hyperspace controls of the game's two spaceships. However, realising that this control method proved cumbersome and awkward, engineers later created standalone control boxes, each containing two toggle switches and a single action button. Hooked up to the PDP-1 with a wire, these boxes would become the earliest examples of a dedicated game controller.

By 1971, the first wave of commercial coin-operated videogames were beginning to appear. First to be released was Bill Pits and Hugh Tuck's *Galaxy Game*. The game was a reprogrammed version of *Spacewar!* that ran from PDP-11/20 hardware but was mounted inside a fibreglass unit, giving it the appearance of an arcade machine. In the same year, Nolan Bushnell also released his revision of *Spacewar!*, *Computer Space*. However, instead of toggle switches, Bushnell further simplified the control scheme using buttons for input.

The early Seventies also saw the advent of the paddle controls. A variant of the rotatable knob controller first seen in *TFT*, the paddle, which works using a potentiometer to vary the output of the voltage levels to signal movement, was first used for a commercial videogame in Atari's *Pong*, in 1972. And like *TFT*, the simple control scheme – no buttons, no dials,

just a simple paddle used to move the game's in-game paddles up and down – went hand in hand with *Pong*'s simple gameplay, and allowed its cabinet to look sparse and uncluttered so as not to alienate potential customers who were green to videogames.

Designed by Ralph Bear, the Magnavox Odyssey (1972) is responsible for beginning the home videogame market. The first ever multi-game console, the machine worked in a similar way to the oscilloscope graphics of *Tennis For Two*: it basically projected light sources on screen that could be moved by players to play basic videogames, and used various overlays that rested on television screens to give its games colour and graphics. Replicating the strange space-age shape of the console itself, the Odyssey controller featured two analogue paddles positioned either side of its toaster-shaped design: one to allow vertical movement, and the other horizontal movement of one of two differing sized glowing light cursors that appeared on screen. A third dial, added to the crest of the horizontal paddle, allowed manipulation of a third light source that represented balls and torpedoes in some Odyssey games. Magnavox also released an unsettlingly realistic light gun for the Odyssey. Known as the Shooting Gallery – it came packed with a selection of shooting games, hence the name – it worked by detecting hits against light sources on the television and was the first commercial game peripheral released for any home console.

The most notable controller to come out following the Odyssey's release was the Fairchild Channel F's Hand-Controller in 1976. The Hand-Controller took the appearance of a short, baseless joystick

A Musical Interlude

PaRappa has a lot to answer for...

Drums

FIRST SEEN IN: **TAIKO: DRUM MASTER**
YEAR RELEASED: 2004

While many will remember angering the neighbours using the bongo drums that came packed with *Donkey Konga* (seen here), the drum peripheral was introduced by the popular Japanese rhythmic game series, *Taiko no Tatsujin* (*Taiko: Drum Master* in the West). Released on the PlayStation 2 in Japan and the US, the game came with a plastic replica drum called a TaTaCon, and players performed actions by striking its pressure-sensitive face panels using plastic drumsticks that resembled Cheestings.



Guitar Controllers

FIRST SEEN IN:
GUITARFREAKS
YEAR RELEASED: 1998

While popularised in recent years by *Guitar Hero* and *Rock Band*, it was Konami that introduced the world to the delights of plastic guitar-shaped controllers when it unleashed *GuitarFreaks* in 1998. Guitar controllers are essentially all very similar in their design: buttons on the neck to replicate the playing of strings and chords, and a fret lever to simulate the strumming of a real guitar. Later models also include a whammy bar, and a series of secondary buttons for solos.



Maracas

FIRST SEEN IN: **SAMBA DE AMIGO**
YEAR RELEASED: 1999

Debuting in arcades, before making its way into the home via the Dreamcast, *Samba De Amigo* was a colourful rhythm-action game that found players having to match on-screen hand gestures – shakes and poses – using replica maracas. While the arcade maracas worked using magnetic sensors to pick up movement, the home version operated using a sensor bar positioned just in front of the player's feet. It picks up movement using ultrasonic transmitters found on the wire of the maracas.



» Sega was one of the first manufacturers to consider ergonomics in controller design.

▷ that was bolted onto a long black hand grip. Predating Atari's VCS Stick by a year, it is one of the earliest examples of a joystick-style controller, and is also one of the first to be designed with ergonomics in mind. The Fairchild's short triangular-shaped stick could also be used like a traditional joystick, or rotated to work like a paddle. It was pressure-sensitive and could be pushed down to act like a fire button, and pulled up like a bottle opener to signal another input to the console.

But it was Atari that would really popularise the joystick controller. The Atari VCS stick (1977) remains

one of the most iconic game controllers ever designed. Comprising a dark black base housing a single digital red fire button and a cylindrical four-way joystick positioned in its centre, its simple design may not have been much to look at, but it hid its own benefits. Realising that the VCS would be the first time that many people would ever see a videogame, let alone actually pick one up and play one, Atari purposely packed the VCS with a simple control scheme that users could easily pick up and use.

Additionally, the VCS stick's all-purpose feel was designed to cope with the multitude of different games that would later appear on the console.

Atari's VCS console was also notable for having a wide range of control peripherals. In a bid to replicate an authentic arcade experience for the console's arcade ports, Atari later released the Paddle Controller for use with games such as *Pong*, *Breakout* and *Warlords*, and the Driving Controller

numerical pad, plus four additional action buttons positioned on its sides. The number pad made use of overlays that explained the function of each button for their respective games. Coleco Industries later imitated this style of controller for its ColecoVision console in 1982, but replaced the control disc with a short joystick. To compete with Atari, Coleco also released a number of peripherals for its machine, including a steering wheel controller; a trackball,

which came packaged with the games *Victory* and the *Centipede* clone *Slither*; and the Super Controller. Held like a pricing gun, and with finger triggers forming

“ Magnavox's unsettlingly realistic light gun for the Odyssey was the first game peripheral ”

– basically identical to the Paddle Controller, except it was sold individually rather than in pairs – for use with racing games *Indy 500* and *Race*. It also released the Keyboard Controller, for use with the programming software tool Basic Programming and a small number of educational software titles.

By the end of the Seventies, controller designs were becoming more complex. The Intellivision controller, for instance, featured a digital control disc with 16 directional positions and a 12-button

the fingery bit of the hand grip, the weighty Super Controller was produced specifically to play with the console's *Super Action* series of sport games.

By the early Eighties, the videogame industry was becoming flooded with game consoles and low-budget videogames as electronic manufacturers scrambled to capitalise on demand – one of the many contributing factors of its eventual collapse in 1983. And the glut of peripherals, add-ons and newfangled control schemes was only



Novelty Items

We reflect on some of the most barmy game controllers to ever find a release



Atari Track & Field Controller 1984

This button-basher's wet dream was released with the Atari 2600 port of *Track & Field*. Its arcade stylings featured three action buttons – two white 'run' buttons and a single red one to perform a jump or throw – and was compatible with other Atari games and machines, but control was obviously restricted to just left, right and shoot. The unit was also sold separately.

Arkanoid (Vaus) Controller 1987

Another peripheral designed to offer the authentic arcade experience, the *Arkanoid* Controller – or Vaus Controller, derived from the name of the ship in the game – was released by Taito to offer a precise paddle control system for the NES port of *Arkanoid*. Three variants were released, including one that allowed connection of another controller for multiplayer gaming.

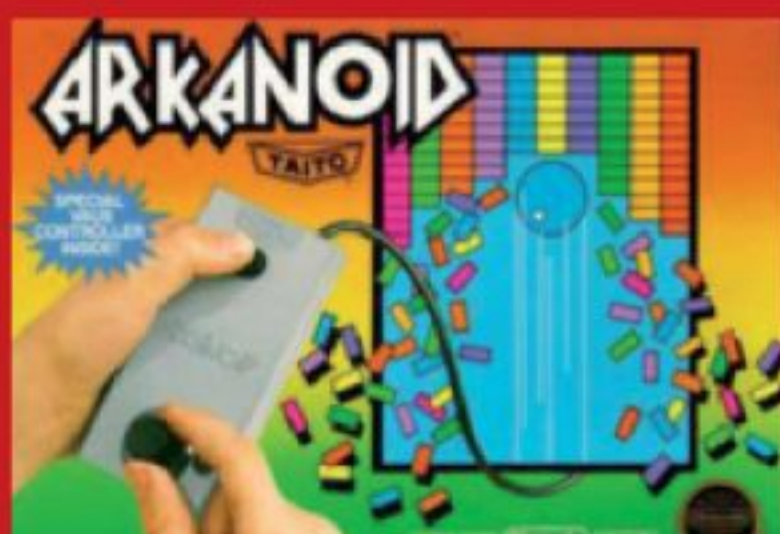

Namco neGcon 1994

Released for the PlayStation, Namco's twistable neGcon controller was designed specifically for racing games. The most notable aspect of the neGcon pad was that it featured two analogue face buttons – the standard PlayStation buttons are digital – and the two halves of the pad could be twisted to offer an analogue steering input, offering finer precision for handling, acceleration and braking.

Steel Battalion Controller 2002

With more buttons than the Hubble Space Telescope, the *Steel Battalion* Controller was released by Capcom for its simulator-style mech battle series. With over 40 buttons, twin control sticks and even pedal controls, this imposing beast was an essential purchase for fans of giant robots, but it didn't come cheap, retailing with the game at £140. It was also released in limited numbers.



Resident Evil 4 Chainsaw Controller 2005

Possibly the most pointless shaped controller ever released, this oddity by peripheral manufacturer Nuby Tech was likely to only hold appeal among die-hard *Resident Evil* loyalists. While a neat-looking collector's piece, as a control device it's unsurprisingly unwieldy and awkward. It was released for the GameCube and PlayStation 2.



▷ adding to its already-saturated state. It's here that we turn our attentions to a company called Nintendo, which, in 1985, would help resurrect the videogame industry in North America by stripping things right back and simplifying things again – including control schemes.

The origin of Nintendo's D-pad (or directional pad) can be traced right back to its Game & Watch electronic games – one of Nintendo's earliest forays in electronic entertainment. These cute, pocket-sized LCD games were designed to offer true portable gaming, but through their transportable design, they would also come to revolutionise the design of game controllers forever. Realising that incorporating a joystick into the design of the G&W would impede the pocket nature of his new product, Yokoi looked to a more portable control system and eventually settled on using tiny rubber buttons. Not only would buttons allow the Game & Watch to retain its portability, but they also offered a simple and responsive control method – pressing buttons requires less physical movement than moving a joystick – that suited the twitchy but simplistic nature of the G&W games. This control scheme was refined further in 1982 with the release of the G&W title *Donkey Kong Jr.* It featured four action buttons that were positioned in a cross position to visually correspond with the movements up, down, left and right, and the D-pad was born. Nintendo would patent this revolutionary and unique cross-shape button design, and

incorporate it into every one of its control pads from that moment on.

While often criticised for its angular look, the Famicom/NES joypad was actually very intelligent in its design. Borrowing the D-pad and simple control scheme of the Game & Watch games – two action buttons and Select and Start to toggle between game modes – the NES pad's simple layout, like Atari's VCS stick and *Pong's* paddle controls, would find appeal with those unfamiliar with videogames. They also suited the uncomplicated nature of those early Nintendo games, and by limiting the NES pad to just two action buttons, it meant that most developers were forced to make games for the NES easy to pick up and play. It was owing to the success of the NES that the game pad then became the preferred and adopted control method for console manufacturers, with many companies quickly submitting their own take on Nintendo's seminal D-pad controller. In 1986, Atari released a comparable controller for the 7800, featuring two action buttons and a cross-shape D-pad that had a hole in its centre to allow attachment of a small screw-in joystick, and Sega released a similar controller for its Sega Mark III/Sega Master System. The SMS pad featured two action buttons, and an eight-way D-pad. Known as the D-button as its square shape gave it the look of a button, early versions of the pad also allowed the attachment of a small joystick.

Finally, there was the PC-Engine controller (1987). The most comparable



» The six-button SNES pad is a seminal entry in the evolution of controller design.



» Atari released a variant of the Fairchild Channel F control stick for its VCS. Named the Video Command, it differed in that its stick wasn't rotatable and had a single fire button on its hand grip.

» The Atari VCS stick may have been stiff and clumsy, but it proved functional and accessible to green gamers.

▷ joypad to the NES controller in terms of look, it featured two action buttons, Select and Run buttons, and a circular D-pad. Later iterations, such as the controllers that came packed with the SuperGrafx and Turbo Duo, added three-way turbo switches for each of their action buttons.

Meanwhile, throughout Europe and parts of North America, thanks to the booming microcomputer and arcade industries, joysticks still had a strong following. Like Nintendo, many joystick manufacturers had realised that stripping things back was gainful, and produced basic but functional joysticks to suit the needs of gamers. Most of these designs were reminiscent of the early Atari VCS stick, and featured DE-9 connectors, digital sticks and two digital fire buttons for left or right-handed use. Movement in early digital joysticks

worked from leaf switches, where the joystick would register movement whenever the stick was pushed in the desired direction, causing two metal connectors to meet. Over time, though, these leaf connectors would bend, causing connections to fail unless the joystick was opened up and the

“ The Game & Watch would come to revolutionise the design of game controllers forever ”

connectors readjusted, understandably causing many headaches for arcade operators. The introduction of micro switch technology in joysticks would help solve this problem. Micro switches were more robust and, as they could be triggered with very little physical force, were also more responsive. As well as the change from leaf to micro switch technology in joysticks, the early Eighties

saw the first analogue joysticks emerge with the release of the Vectrex and Atari 5200 (both 1982) joystick controllers. Unlike digital joysticks, which registered movement whenever a connection between two connectors was made, analogue sticks worked using potentiometers, like the earlier paddles,

to offer a continual input of activity, and better precision.

In 1989, British peripheral manufacturer Konix, maker of the popular Konix Speed King stick,

planned to enter the console market with its innovative Konix Multisystem – a television-based console that took the shape of a controller. The console was designed with the assistance of Cambridge-based Flare Technologies, which would later have a hand in the development of the Atari Jaguar, with Konix coming up with the console's unique three-part design – the main



CONTROLLING HISTORY

» Many companies, such as Cheetah, imitated the Atari VCS stick in their joystick design.



▷ system could transform into a steering wheel, flight yoke or bike handlebars, and it also came with a gaming seat boasting surround sound and haptic feedback technology, predating Nintendo's N64 Rumble Pak peripheral by eight years – and Flare coming up with the processor and hardware. Despite boasting some impressive specs and support – it featured a 16-bit 8086 processor and 3D capabilities – plus planned third-party software from high-profile developers, including Llamasoft, EA, Ocean and Argonaut, Konix experienced trouble in trying to raise the money to get the console to market, forcing its release to be pushed back until it was eventually scrapped altogether.

Entering the Nineties, many console manufacturers finally started considering ergonomics in the design of their game pads. The Sega Mega Drive control pad (1988) not only slotted into hands better, thanks to its kidney shape, but also featured an ergonomic button layout. The pad had three action buttons, and Sega's decision to go with this setup was likely a result of its early arcade games. *Altered Beast*, *Golden Axe* and *Shinobi* all featured three action buttons on their arcade cabs, and they were positioned diagonally to follow the natural resting position of the right thumb: another defining moment in controller design that would quickly go on to become the standard. The Mega Drive controller also featured an improved version of the SMS D-button. More similar to the NES D-pad, the Mega Drive version added a cross-shape detail, affording more precision to the user, and was set slightly into the pad to provide a neat gully for left thumbs.

In 1990, Nintendo answered back by releasing one of the most popular and copied control pads ever made. A subtle tweak on its NES pad, the SNES



» The PlayStation pad is up there with the best ever designed, hence the design's longevity.

Wyn Holloway

We track down Wyn Holloway, founder of the British computer peripheral company Creative Devices Research, better known as Konix, and designer of the popular Speed King joystick



» The Konix Speed King revolutionised joysticks, and how we played *Daley Thompson's Decathlon*.

RG: You started out running your own computer shop, so why did you decide to move into joystick manufacturing?

WH: I used to run a computer shop in the Eighties, and the joysticks that were on the market were very cheap and cheerful. And our biggest problem was joystick returns – I remember the release of *Daley Thompson's Decathlon*, it was an absolute nightmare. I decided to do something about it.

RG: How did you come up with the handheld design of the Konix Speed King?

WH: I noticed the sticks used to have suckers on them. We used to have a 'try before you buy' section in the shop, and the kids could come in and try the computer or games before they purchased.

But instead of setting the joystick down on the top where we set it all up, the kids used to hold them, and they'd be bouncing around all over the shop.

RG: And what about the actual look of the Speed King?

WH: So I bought some Plasticine and moulded it into a handheld unit, and then I thought, 'Right, I've got to design something to fit inside that shape', and looked into micro switches and I approached a French company who used to supply them to the aviation industry. They were about £1.40 each, but I managed to get the price down to 40 pence by agreeing to place a significant order. Then I worked in my garage and got a prototype working and from that we had the tool made. That was it.

RG: What sort of reaction did you get when you showcased the joystick?

WH: Initial reaction wasn't all that promising. I attended the Consumer Electronics Show in London and had made 100 to take with me, but I didn't sell any. We found out this was down to the packaging. We didn't have much money and the boxes we made were rubbish, and customer perception was that if the packaging was rubbish then so was the product. So we ended up raising a bit of money, rethinking the packaging and sorting out a few problems with the moulding; we then did a distributor deal, managed to get the price to a competitive £12.99 – the same retail price as the cheaper joysticks, so they were competitive – including a two-year warranty.

From then we went to another show, and we set it up with *Daley Thompson's Decathlon*, and the kids loved it because of the accuracy. We then did a deal with a European group of distributors, which ensured our buying power was better, and they gave me an order for 500,000 units. We took on a little factory and expanded the company from there. Then we met Epyx at another show, went over to the States and met Toys R Us, Sears and Macy's, and Epyx gave us an order for 3 million units. In one year we went from unknown to one of the largest joystick manufacturers in the world.

RG: Were you ever worried that the Speed King would alienate left-handed gamers?

WH: Yes we were, and we ran a competition in a magazine for left-handed people, and over 80 per cent of left-handed people told us not to change it. What came back was that the triggers were brilliant for left hands, so what they would do is instead of moving the stick and holding the base, they'd move the base and hold the stick.



▷ controller was dog-bone shaped, compact, and its iconic design and clean button layout is still used in game pads today. As well as being more comfortable to hold, the controller featured a softer D-pad and four diagonally positioned face buttons that were complemented by two shoulder buttons placed at the top of the pad. A canny design choice by Nintendo, the two bumper buttons gave the controller a total of six buttons without it looking cluttered. Furthermore, having twice as many action buttons as the Mega Drive proved advantageous to the Super Nintendo in the wake of six-button games such as *Street Fighter II*.

The eventual return to the console market by Atari, with the Atari Jaguar in 1993, resulted in one of the most disastrous high-profile console releases in history. Citing that the machine was difficult to program for, Atari's 64-bit beast failed to gain support from third-party developers. And learning nothing from the boom and bust nature

» What a glorious sight. More sticks than you can shake a rod at.



“ The SNES pad’s iconic design and clean button layout is still used in game pads today ”

of the videogame industry following the crash of 1983, Atari did itself no favours by releasing its new machine at a time when the console market was once again looking saturated. But the problems didn't end there. The Jaguar also featured one of the most ill-conceived game controllers ever designed. Shaped like a haggis, the Jaguar controller was bulky, ugly and cumbersome, and its dark black case and red buttons, which gave it the aesthetic of the old Atari VCS stick, made it look old and dated from the outset. The Jaguar controller featured all the normal control elements that gamers had come to expect: a D-pad, two Start buttons and three diagonally positioned action buttons. However, owing to Atari's decision to add an interfering numerical pad to the design – the intention was to make use of instruction overlays much like the Intellivision and ColecoVision controllers – the direction and action buttons were pushed to the top of the controller, making its layout feel awkward and cumbersome.

By the mid-Nineties, 32-bit consoles and their respective controllers were appearing. For the Sega Saturn controller (1994), Sega would base the design on the six-button version of the Mega Drive controller, which it had packed with Mega Drive 2 consoles. As well as being thinner and shapelier, the Saturn pad featured two fantastically ergonomic shoulder buttons. In North America and Europe, however, the Saturn controller underwent a transformation. As well as a change in colour to tie in with the black look of the Saturn in these

territories, it was chunkier, featured a different, spikier D-pad, and those fantastic ergonomic shoulder buttons were planed off so as to tidily integrate them into the shape of the pad.

In 1994, a determined Sony finally entered the videogame hardware arena with the PlayStation. Given Sony's infamous past with Nintendo – Sony's contract to manufacture the SPC-700 sound chip for the Super Nintendo, the ill-fated SNES PlayStation project, and then Sony's humiliation following the bombshell that Nintendo was in cahoots with Philips to manufacture the SNES CD-ROM drive – it's little wonder that the PlayStation controller shared more than a passing resemblance to the SNES pad. Sony had invested a significant amount of cash into the SNES PlayStation project, even getting as far as the prototype stage, so it's little surprise that it mimicked Nintendo's popular SNES pad design. The PlayStation controller is essentially just a more ergonomic SNES pad, adding two additional shoulder buttons (L2 and R2) and incorporating two vertical hand grips into its design, offering more comfort and stability.

With the 32-bit generation came a growing trend for polygon-pushing 3D games. And while D-pads worked brilliantly in flat worlds, they weren't really equipped to handle the depth and precision required to steer avatars in 3D ones – remember how dire the controls were in *Resident Evil*. 1996 marks the year that all the big console manufacturers turned to analogue sticks for help. In this year, Nintendo released

» The multi-use N64 pad remains one of the most inventive controller designs ever released.





Jon Hare

Jon Hare reveals to us his favourite examples of good control in videogames, and why intuitive control is essential

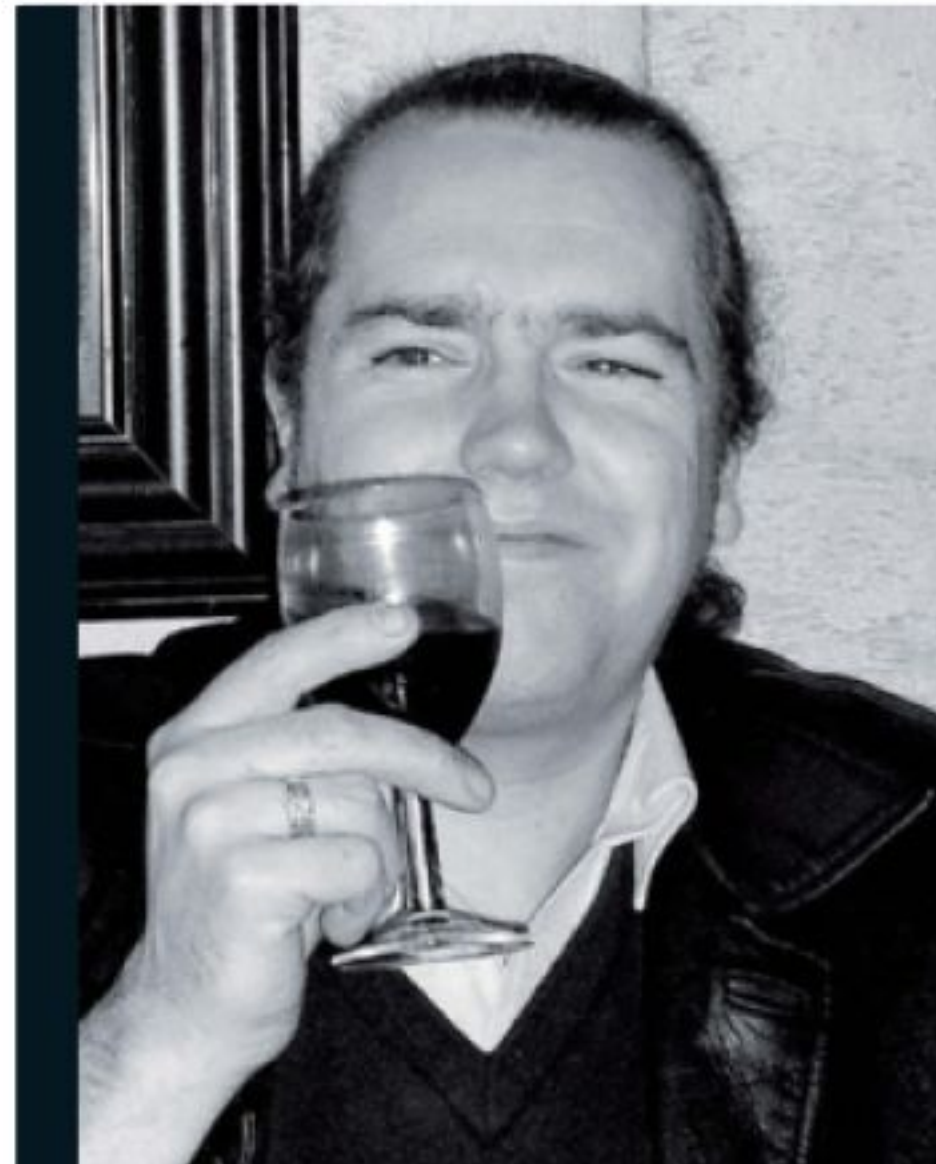

RG: Looking back over the years, what game controllers have impressed you most and why?

JH: Personally, I think certain peripherals suit different games better, so I would not say I have favourite controllers but more favourite applications of controllers. My number one favourite example of this is the archery in *Wii Sports Resort*. This, to me, is as perfect a simulation of a sport as you are ever likely to find. It does not have a lot of wow factor, but it is almost perfect in its execution. Second is the old *Centipede* arcade machine with the track ball; I loved that when I was 14. Third favourite is *WarioWare*. This game really utilises what the DS can do; a brilliant piece of design. Worst controller is the horrible Mac single-button mouse. I just don't get it at all.

RG: How significant a part do you think intelligent controls play in terms of good game design?

JH: Good controls play a massive part in game design. On all of our old C64 and Amiga games, we always did the controls first before everything else. It was only the world of writing design documents to justify getting paid that really changed this.

You must remember game controls are directly tied into on-screen feedback of events. Often, when moving a controller in a direction, it is unclear when you have reached your destination; it is only on-screen clues, sound effects and force feedback that will give you notification of successful or disastrous execution of controller manoeuvres. They also need to be managed and massaged into movement that is acceptable to the players. Too many green designers make the mistake of thinking realistic movement means accurate representation of the exact movements using the controller. However, this policy is flawed. If you want to emulate what really happens, you'd

get the player to walk, not push a little plastic stick forward. Also, to maximise other areas of the game, we sometimes need to be able to predict certain elements of the way characters move on screen. Controllers that give players apparent full control are great, but often it is an illusion. Being a great illusionist is all part of being a great games designer or programmer.

RG: All of your titles featured very simple controls. Was this something you always tried to rein in with your games?

JH: My philosophy to games is pretty simple: the game has to be easy to get, shouldn't need too much explaining, and be highly intuitive. Our games were designed to guess how the player was most likely to assume a certain control would work and then try to deliver what he expected. Nowadays people do this too, but in the main they do it by copying the control protocols of other games in similar genres. In Sensible's time, we were allowed to make up these new rules for control mechanisms without fear of alienating the players.

RG: What is your opinion on the current trend of motion-sensor technology? Do you feel that it has a bright future?

JH: Well, I have made two Wii games so far and I have seen Natal in action. The biggest gripes are sensitivity and speed. Certainly the [MotionPlus] for the Wii controller seems to make a bit of a difference now to certain types of spinning and aiming movements, but it is nothing more than it should have been in the first place. Natal also seems a little slow and woolly at present, although I am sure it will tighten up. Even once you overcome delay problems, though, you still have to overcome the bigger problem of foot movement and how to emulate it on a hands-only controller. You can use a stick to walk around, but it feels weird when you are mixing it with more realistic hand movements. I think the current set of movement-based controllers are a fad; however, I think the next phase of motion-based controllers could be much better, maybe in about four years.

RG: Do you think the industry will ever move away from hand-based control pads entirely?

JH: No, I don't think it can. The on/off precisely timed nature of the button click is too accurate and convenient to ever be ditched entirely. People must remember hands-free movement controls don't give us real-life controls; they give us another variant of interpreting movement of our bodies into instructions to change the next animation frame of objects drawn on computer screens. This is an inherently unnatural process whichever way you approach it.



» The Jaguar pad was a perfect example of poor controller design. It was cumbersome, crowded, and a little dated in the looks department.

▷ the N64 to the market, and it came with one of the most innovative controller designs ever seen. The pad's unique M shape allowed it to be held in three different ways, and its unique analogue stick – or 'Control Stick', as it was coined – offered a precise control method that was perfect for platform games such as *Super Mario 64*, and it's understood that Nintendo designed the N64 controller around this game, while its yellow C-buttons for controlling in-game cameras proved invaluable in games such as *GoldenEye* and *Zelda: Ocarina Of Time*. The N64 controller was also the first pad to feature haptic feedback through the attachment of a Rumble Pak peripheral. Launched in 1997 to coincide with the release of *Star Fox 64*, the Rumble Pak could be attached to the memory cartridge slot underneath the pad and exerted a physical output on the user to offer a heightened sense of immersion.

In 1996 Sega also released a custom analogue controller for its groundbreaking Saturn game *NiGHTS Into Dreams*. Its large, round design was carried over to the design of the Dreamcast controller, and it's the design that Microsoft would ostensibly base its original Xbox controller on. But Sony beat both Sega and Nintendo to the punch by releasing the Analog Joystick flight stick peripheral for the PlayStation. Sony followed this up with the PlayStation Dual Analog Controller a year later, which added two analogue nubs to the original PlayStation pad to offer precision control. The Dual Analog Controller's successor, the DualShock, then incorporated force-feedback through two motors that provided soft and strong vibrations, and rubber-textured analogue nubs that could be pressed down to actuate two additional inputs (L3 and R3). Sony

would later go on to release a total of three variants of the DualShock; one for each of its three games consoles. The PlayStation 3 variant, the DualShock 3, was a wireless controller that featured tilt-sensor technology. It was the successor to the PS3's Sixaxis Wireless Controller, a lightweight tilt-sensor pad without the vibration technology.

Until now, all of Nintendo's controller designs had brought something unique and innovative to the table. However, its next controller would memorably buck this trend. While well-constructed and ergonomically sound, the GameCube pad was essentially a Swiss Army knife in terms of controller design that tried to encompass all the control schemes that had come before it. As a result, trying to accommodate the myriad controls that gamers were familiar with meant the pad suffered by looking cluttered and unwieldy. Similar in design to the DualShock, the GameCube pad juggled eight buttons, two analogue sticks – one stick was a variant of the N64's C-buttons – a D-pad and a built-in rumble motor. And its derivative and overtly

» Some joystick designs, such as the QJ Superstar, based their look on arcade control panels.



It's been motion-able

Think arm-waving began with the Wii? Then think again



Mattel Power Glove

Released by toy company Mattel, the Power Glove was the first example of a game controller to use gestural recognition technology, making it a precursor to the Wii Remote. Criticised for being needlessly complex to work and its motion sensor technology feeling imprecise, despite big claims and finding endorsement in the movie *The Wizard*, the Power Glove failed to find appeal in the marketplace.

Brøderbund U-Force

Better known for its software output, Brøderbund also released this unusual motion-sensor peripheral for the NES. Using two perpendicular infrared sensors, it allowed NES owners to theoretically control games using hand gestures. In reality, though, trying to actuate simple movements like moving left or right with the device proved a real headache, and NES owners swiftly returned to their reliable D-pads.



Sega Activator

On paper, the Sega Activator sounded brain-meltingly brilliant. It was a beat-'em-up games peripheral spliced with what looks like a UFC play mat. The player placed

the octagon-shaped device on the ground and then stood inside it, punching and kicking the air and using infrared beams to register hits. Low hits registered a kick in the game, while high ones triggered a punch, and the player's actions were mimicked on screen... ish. Sadly, the Activator's beams were too sensitive and the software applications too limited to be deemed anything but a disappointing experiment.

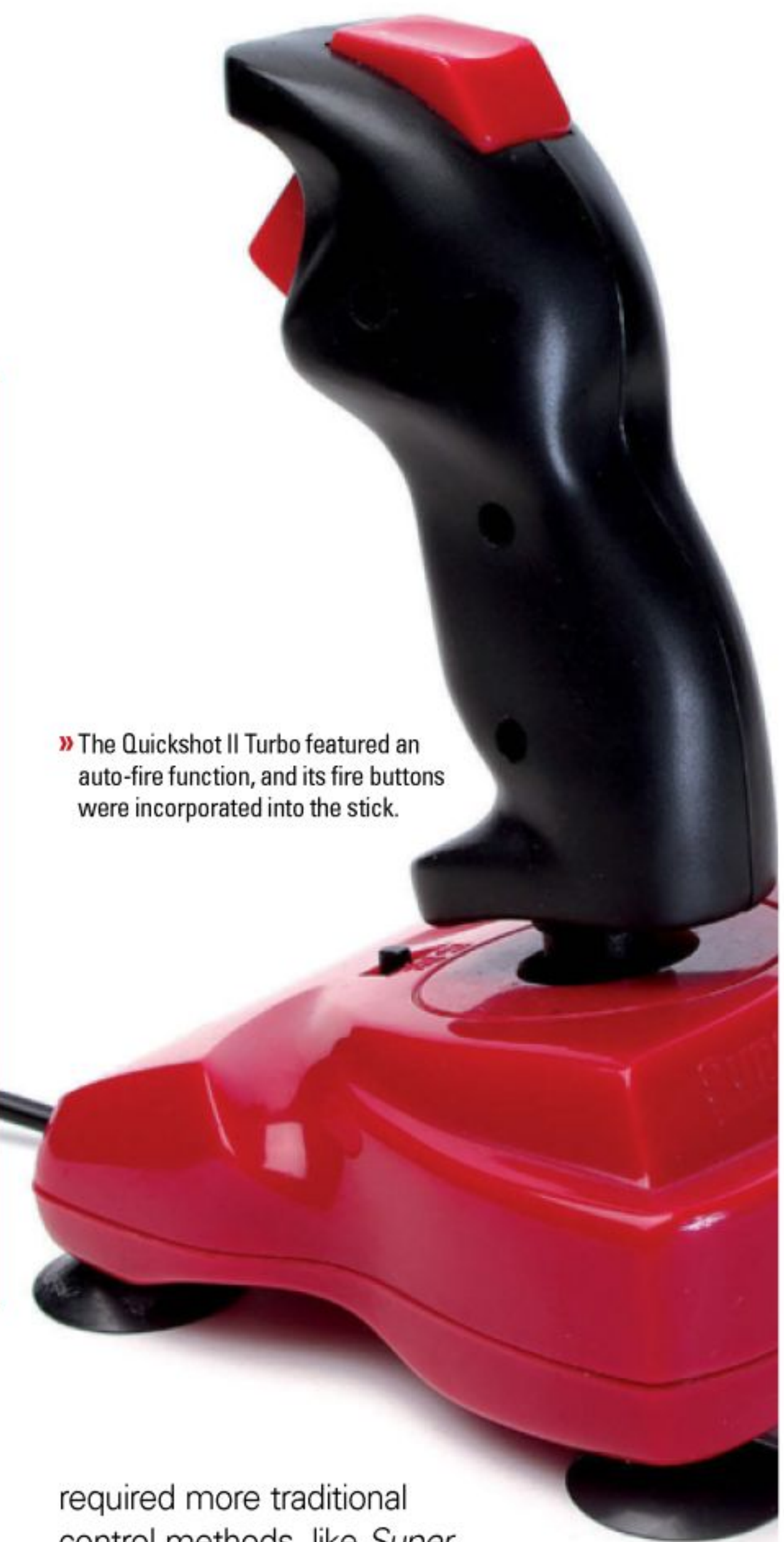

» The Quickshot II Turbo featured an auto-fire function, and its fire buttons were incorporated into the stick.

“ The Wii marked a watershed moment, and its ultimate influence is impossible to tell ”

▷ complex nature also went some way to scupper Nintendo's creative flair. Shigeru Miyamoto echoed this observation in an interview with *Famitsu* magazine in 2008.

“We made [the GameCube controller] as a culmination of everything leading up to it, but it really underwhelmed. This line of thinking doesn't give us anything else to shoot for, does it?” admitted Miyamoto. “The GameCube controller is a product of us feeling that, without this or that, people wouldn't be able to play the games we make. But then we realised that was a problem; that we were thinking based on that controller as the premise.”

But Nintendo of course returned with an innovative control scheme for its next console. Likely considering the popularity and success of computer vision and gesture-recognition technology seen at work with the Sony EyeToy, and having already tested the water with gesture recognition in games – unsuccessfully in the Eighties with half-baked NES peripherals such as Mattel's Power Glove and Brøderbund's U-Force, and far more successfully with the touch-screen and stylus controls on the DS – Nintendo decided that

a demand for this new immersive way of playing games existed, and knew that it had the means and know-how to apply this technology to its next games console, the Wii.

The Wii marked a watershed moment in controller design, and its ultimate influence is still impossible to predict. Its main wireless controller, the Wii Remote, looked like a television remote control, but, like the N64 pad, it could be held in different ways: either like a traditional NES controller, with control via a D-pad and two face buttons; or held like a baton to offer pointer functionality – a feature that it gets from containing multiple accelerometers that measure all directions of motion and communicating with a sensor bar that plugs into the Wii console and sits above the television. Nintendo also included a secondary analogue controller for the console that plugged into the Remote. Nicknamed the Nunchuk, it featured an analogue stick, two trigger buttons and an accelerometer to registered gestural movement, but offered no pointer functionality. Mimicking what it had done previously with *Super Mario 64* and the N64 pad, Nintendo released a series of simple games to show off the motion sensor control scheme (*Wii Sports*), and applied them intelligently to games that

required more traditional control methods, like *Super Mario Galaxy*, to demonstrate the versatility of its new machine.

In terms of time-honoured controllers, the Xbox 360 would succeed where the GameCube failed. Essentially a far better revision of the GameCube pad, proving that Nintendo actually came very close to getting it right once again, the 360 controller is a versatile, well-constructed and wonderfully comfortable controller, and is only equalled by Sony's lasting and similarly excellent DualShock.

Microsoft's announcement in 2009 that it was following Nintendo's lead through Project Natal – a control peripheral for the Xbox that negates the need for game controllers completely by using full-body 3D motion capture and face and voice-recognition technology – provides an ironic close to this brief overview of the evolution of game controllers. Although it's highly unlikely that the game controller will ever become entirely obsolete, the very thinking that by the end of this year we could be playing games without the need for control pads is a pretty sobering thought. The game pad has proven to be an integral armament to any console's success: make a good one and your console has a far better chance of latching onto the public; make a bad one and it might just struggle in the marketplace. Moreover, considering that controllers have also helped to simplify, enhance and drive the videogame since its inception, can they really hope to advance without them? We guess only time will tell.





AMIGA CD32



AMIGA CD 32

IT WAS COMMODORE'S FINAL HARDWARE DESIGN BEFORE THE COMPANY WENT BELLY UP AND IS ONE OF THE MOST DERIDED AMIGAS OF ALL TIME BUT IS THE CD32'S TERRIBLE REPUTATION SO DESERVED? WE ARGUE THE CASE FOR HISTORY'S MOST MISUNDERSTOOD CONSOLE

Backwards Compatible?

Oh yes. The beauty of the Amiga hardware under the hood of the CD32 meant that it was compatible with all previous Amiga software. Okay, there weren't many previous Amiga games on compact disc except, of course, for the CDTV, which the CD32 was 100 per cent compatible with. Although Commodore's previous CD-based console had played host to mostly dull edutainment titles, there were a couple of games worth holding on to. Old Amiga favourites *Sim City* and *Lemmings* were available and worked perfectly on a CD32 with an Amiga mouse. The best CDTV game, however, was *The Case Of The Cautious Condor*, a little-known adventure game, in which the player had 30 minutes to solve a murder by exploring a hand-drawn comic book world and eavesdropping on characters' CD audio conversations. For anyone with a CD-based Amiga, this unique adventure comes highly recommended.

A

lthough it launched in 1993, the story of the Amiga CD32 really begins in the late Eighties. Commodore dominated the home computer hardware market, with both the Commodore 64 and the Amiga 500, but were well aware that it had only cornered one half of the industry.

Its computers were primarily business machines, albeit with massive gaming potential, with high prices that only the wealthiest families could afford. Consequently console manufacturers had taken the opposite approach by pricing hardware as low as possible and making profit on the games themselves. The space beneath the family TV set was increasingly taken up by a dedicated games console and Commodore knew that it had to come up with something similar in order to compete. Furthermore, the respective storage mediums of cassette tape and floppy disk did nothing to facilitate profit for Commodore themselves; the standard storage devices were easy to come by, so Commodore could not enforce licensing fees and, worse still, piracy of such software was incredibly easy, even for the home user.

Two attempts to break into the console market soon followed, with the Amiga CDTV, an Amiga 500 powered set top box, and the cartridge-based Commodore 64GS, but neither had the desired impact. The C64GS quickly died out due to its underpowered hardware and lack of games, whilst the CDTV passed by unnoticed thanks to its £699 price tag and the fact that nobody really knew how to best make use of the fledgling CD-ROM format. Still, Commodore soldiered on with the console idea, eventually settling on the CD32, a piece of hardware that, at the very least, had the potential to get Commodore into that coveted spot underneath the TV once again. Having learnt from its past mistakes with the CDTV and C64GS, the CD32 got a number of things right straight away. The chipset inside the box was based on the Amiga 1200, which had been released

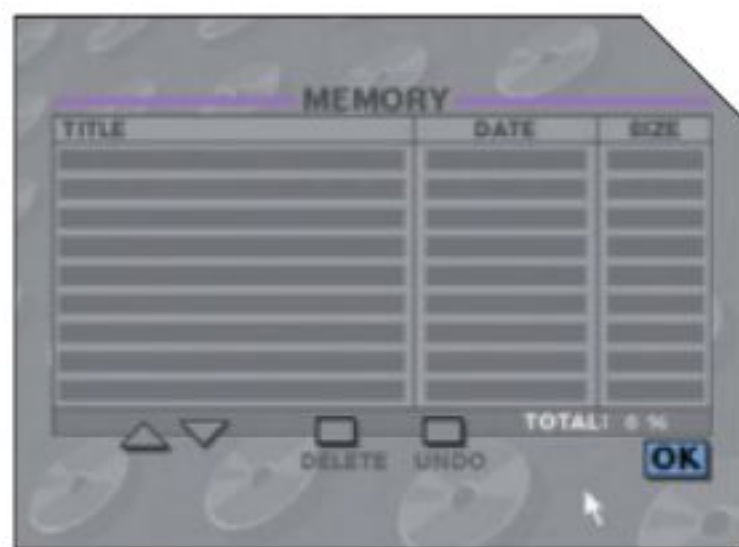

“HAVING LEARNT FROM ITS PAST MISTAKES WITH THE CDTV AND C64GS, THE CD32 GOT A NUMBER OF THINGS RIGHT STRAIGHT AWAY”



Year released: 1993

Original price: £250

Buy it now for: £25+

Associated magazines:

Amiga Power, Amiga Format, CU Amiga, CD32 Gamer, Amiga CD32 Magazine

Why the CD32 was great... Almost all of the Amiga's best games were available on the CD32, but without the hassle of disk-swapping, compatibility issues or decade-old joysticks. The CD32 was the Xbox of its day, bringing all the era's best computer games to your TV without all the nonsense that computer owners had to put up with. Better still, many of the games were significantly better than the original Amiga versions. It may have been the black sheep of the Amiga family but it was a sheep worth having. Erm...



AMIGA CD32



» Chris Evans and Commodore UK's David Pleasance at the CD32 launch event.



» *Diggers* was an original but uninspiring launch title.



» *Extractors* was a sequel to *Diggers* that was never released. The full game can be found on the 'net though.



» A bold American ad for the CD32. Too little, too late.

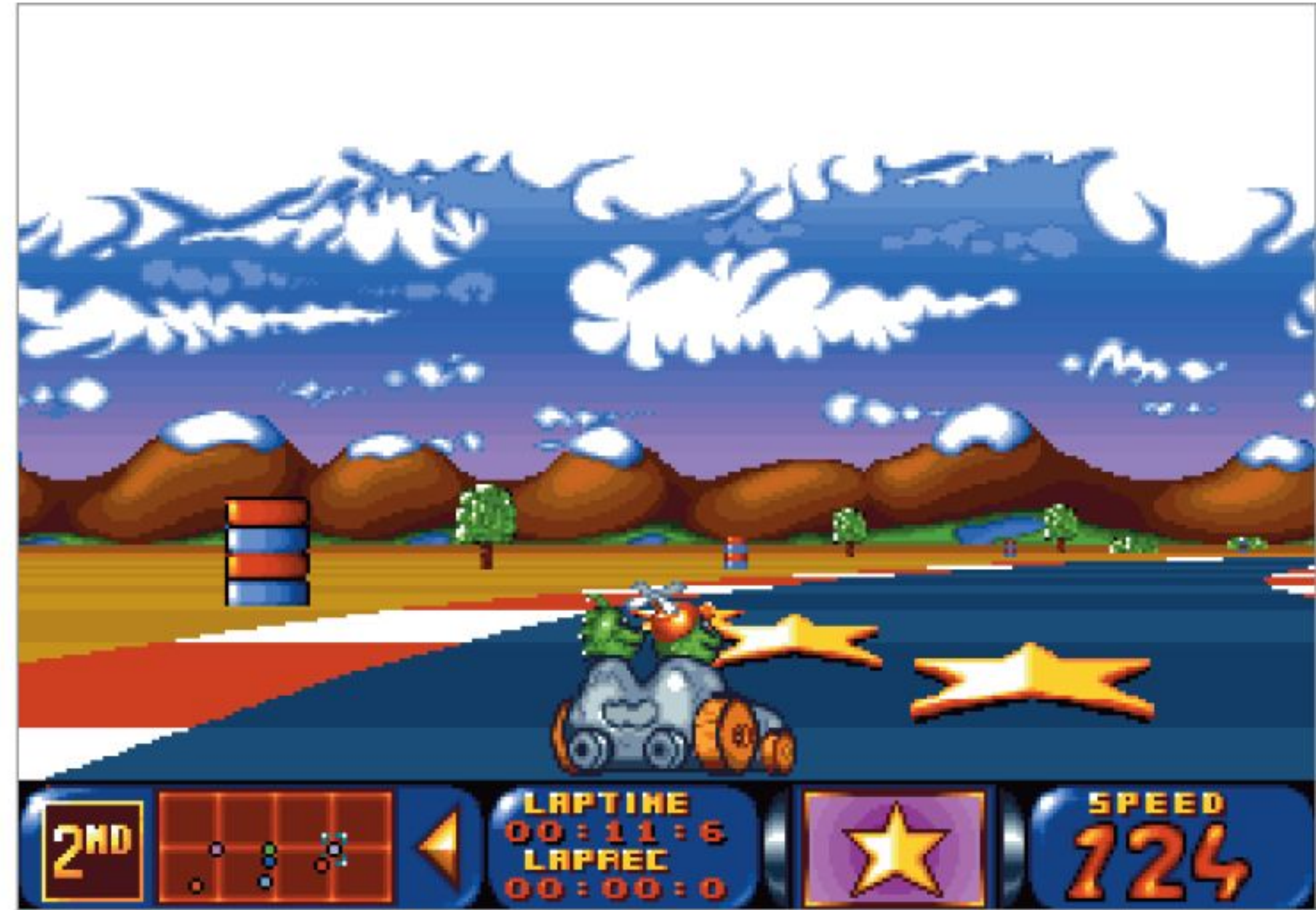

» The graphically impressive *Bump 'N' Burn* made good use of CD32's Akiko chip.

in the previous year, meaning that software would look bang up to date, while the machine itself also benefited from improved aesthetics. Jettisoning the confusing "set top box" look of the CDTV, Commodore designed the CD32 to look a lot more like a traditional games console so that consumers knew that the machine was a pure gaming device before they'd switched it on. Close comparison, in fact, reveals several visual similarities to Sega's Mega Drive – almost certainly a deliberate move to proudly show off the fact that the CD32 had twice as many "bits" as Sega's hardware. The console look was topped off with a custom control pad, made specifically for the CD32. In retrospect, the controller is one of the worst

ever designed as its D-pad was easily broken after extended play; however, at the time, good controllers were judged by how many buttons they had and with six action buttons to its name, the CD32 pad did not disappoint. Finally, the CD-ROM medium had now been around for a few more years, giving consumers, developers and publishers the opportunity to get to grips with the format's strengths and weaknesses whilst, fortunately for Commodore, the technology had not reached the point where software could easily be pirated.

As for the internal architecture itself, the CD32 was almost exactly the same as an Amiga 1200 except with the keyboard removed and the floppy drive replaced with a CD-ROM drive. A less obvious addition, however, was the addition of the Akiko chip to the 1200's custom chipset. To this day, the full capabilities of Akiko remain a mystery to all but the most tech-savvy, but we do know that its main purpose was to perform "Chunky to Planar" conversions on the hardware rather than waste valuable processor time. In plain English this means that 3D games would run much quicker on the CD32 than they would on an unexpanded A1200 and with several *Doom* clones just around the corner this would prove to be a usefully pre-emptive addition.

The CD-ROM drive itself, was designed to transfer data from disc at 300k per second, an abysmally slow speed by today's standards, but twice as fast as earlier CD-based hardware like the Fujitsu FM Towns and Commodore's own CDTV. More importantly, of course, the medium was much faster than floppy disks and would eliminate the pesky problem of disk-swapping that plagued fans of adventure games, which often took up more than ten floppies. The loss of a writeable format was countered with the inclusion of internal flash memory, which could be used to save game data, much as Sega's Saturn would the following year.

Externally the CD32 seemed like any other simple games console, but there were hidden depths. As well as the usual ports and sockets associated with such hardware, the CD32 featured an S-Video socket for improved picture quality that far exceeded the standard RF output of both the SNES and Mega Drive, whilst the two nine-pin joystick ports allowed any Amiga compatible controller to be plugged into the machine, meaning that mouse-driven games like *Cannon Fodder* and *Sim City* could be played just as they were meant to. Best of all, however, the back of the console featured a full expansion bay, which allowed for the attachment of an FMV module to play Video CDs (and even some of the Phillips CDi's videos) and, much more excitingly, the bay could be used in conjunction with a planned expansion card that would turn the CD32 into a fully functioning A1200, complete with disk drive ports, printer ports, extra RAM, faster processors and even a hard drive. An auxiliary port, on the left of the machine, allowed for an Amiga 4000 keyboard to be

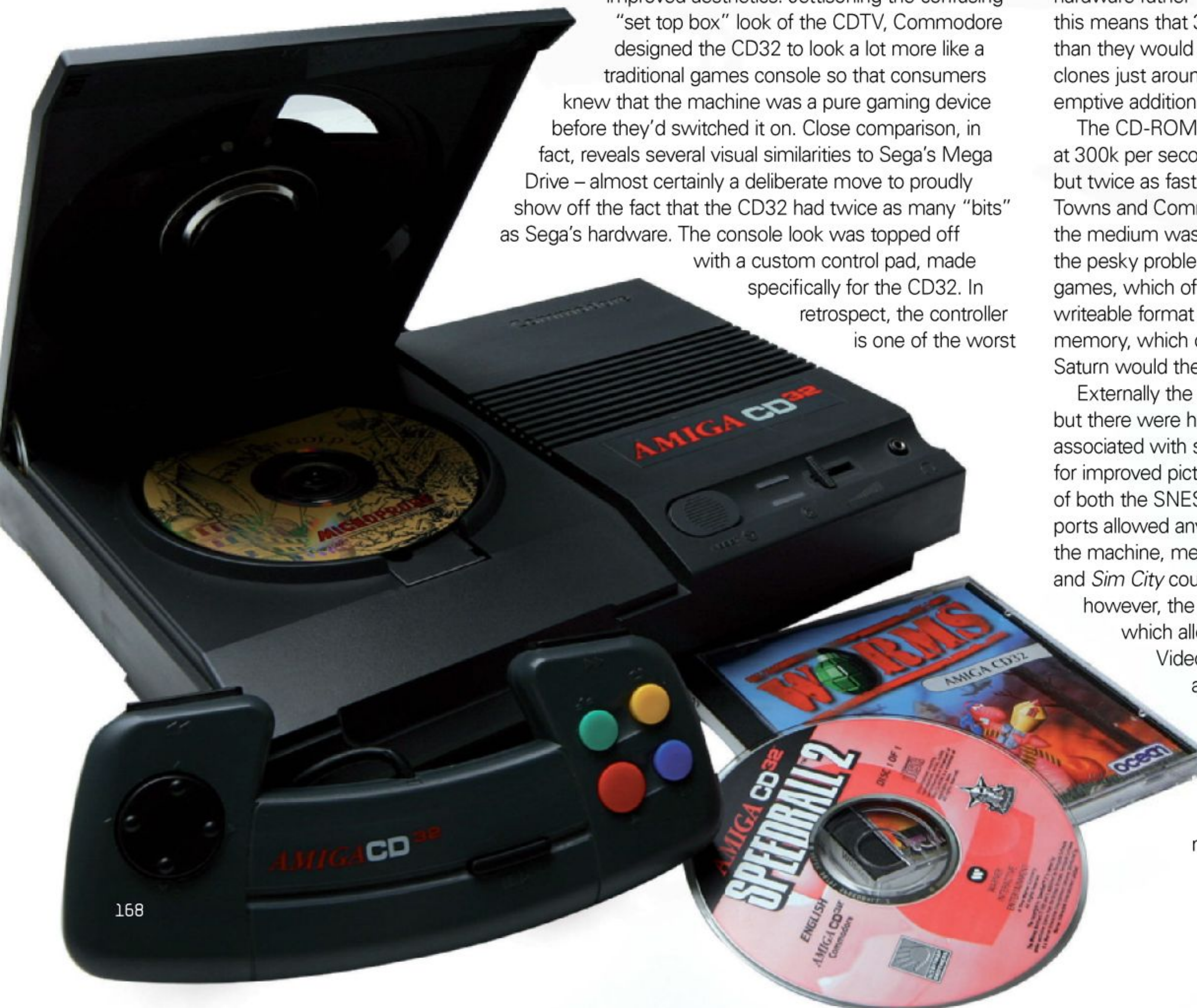

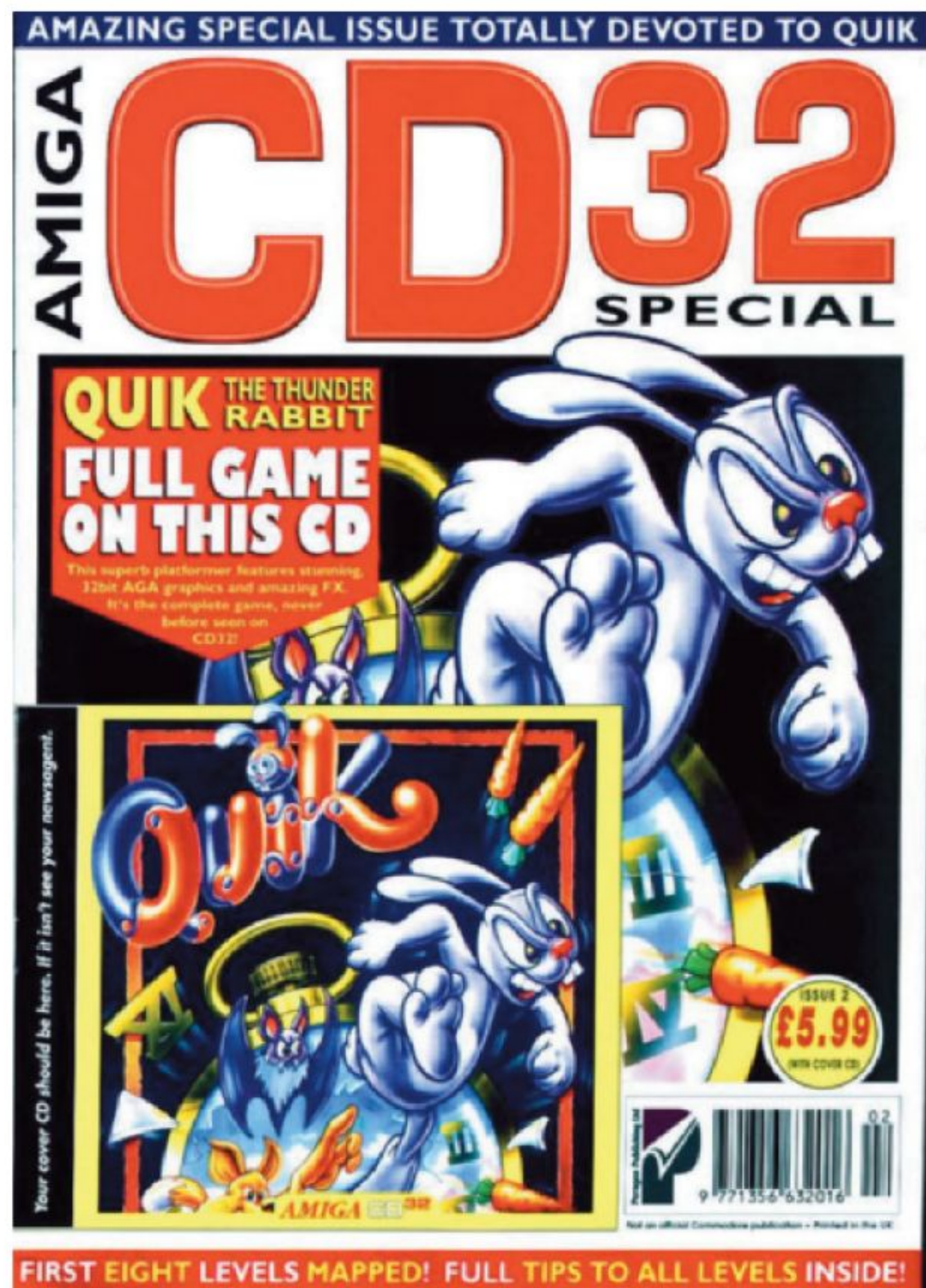

» Special issues of CD32 Gamer came with an entire free game.

plugged in, thus completing the CD32's potential to function as an Amiga computer.

In September 1993, the CD32 launched. As had become tradition with Amiga hardware, the console had limited appeal in its home country of America, but received a much warmer reception in Europe, most notably in Germany and the UK, where Commodore UK supported the console with a fierce marketing campaign. In the time-honoured Commodore tradition, a celebrity was roped in to endorse the console with "popular" TV presenter Chris Evans lending his visage to CD32 promos, just as William Shatner had endorsed the Vic 20 over a decade earlier. More aggressively, however, Commodore UK went straight for the throat of the Japanese console giants. A huge billboard advertisement was erected just outside Sega's UK headquarters and read "To be this good would take Sega

“THE CD32 WAS BOMBARDED WITH PORTS OF REGULAR AMIGA GAMES, WHICH WAS BAD NEWS FOR EXISTING AMIGA OWNERS BUT FOR THE THOUSANDS OF PEOPLE WHOSE ONLY AMIGA WAS A CD32, IT WASN'T ALL BAD”

ages”, whilst Commodore UK's boss, David Pleasance, took every opportunity to remind consumers that to buy into the CD32's nearest rival, the Mega CD, required them to buy a Mega Drive for it to work and would therefore cost far in excess of the CD32's price tag.

Somehow, Commodore UK's brutal tactics worked... to a degree. Though the CD32 did little to dent the armour of the SNES and Mega Drive, it was a relative success in the booming CD arena. Conventional wisdom dictates that the CD32 was a complete failure, but the truth is that in 1993, sales of CD32 software far exceeded those of any other CD-ROM medium, including the Mega CD and even PC-CD. Why? Well, price was an important factor. Mega CD games cost between £40 and £50 each, whilst PC-CD ROM games were much more expensive, reaching as high as £70 in the case of Virgin's *The 7th Guest*. CD32 titles on the other hand compared favourably with their floppy counterparts. The most expensive games were released at only £29.99 while some came in much lower or

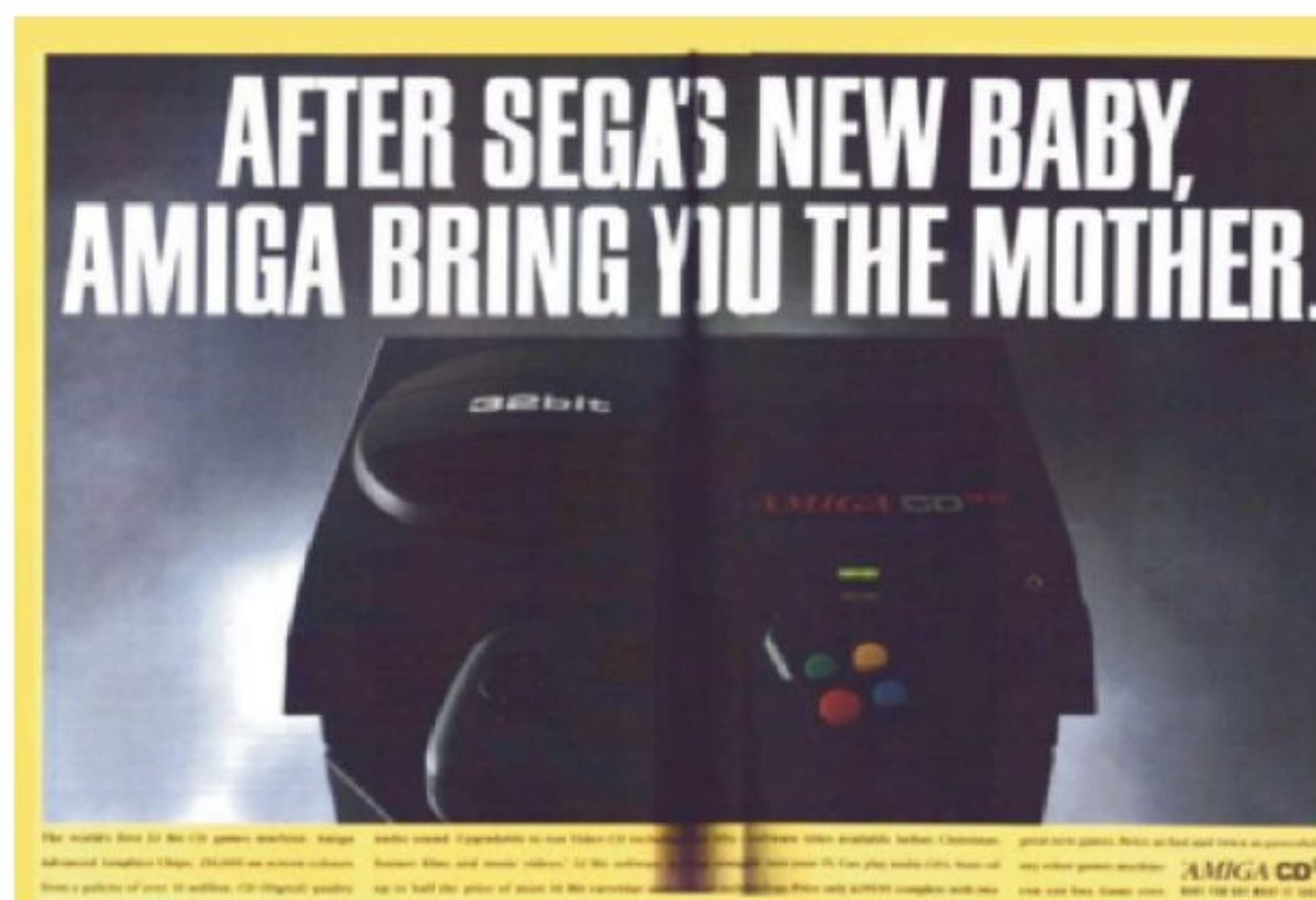

» An early CD32 ad, designed to attract potential Mega Drive buyers.



» *Simon The Sorcerer*: one of the best reasons to buy a CD32.

added value by compiling more than one game onto a disc and even adding playable demos, as was the case with Team 17's hugely popular double packs.

But what of the games? Sadly the CD32 was initially bombarded with ports of regular Amiga games, which was undoubtedly bad news for existing Amiga owners – but for the thousands of people whose only Amiga was a CD32, it wasn't all bad. Sure, many of the games that were ported directly from the A500 failed to take advantage of the new hardware, but then with games as good as *Speedball 2* and *Superfrog*, there was little reason to complain.

There were plenty of games that did take advantage of the CD32 though. Unfortunately, some were merely misdirected attempts to exploit the CD medium but, equally, there were original games that made the CD32 worth owning and even ports of existing Amiga games that used the new hardware to improve on the original.

Of those ports, nearly every game featured a CD-Audio soundtrack or animated intro, whilst a few others were boosted with extra levels, characters or something even better. Sadly, the launch software couldn't be counted amongst those that added anything new. The laughably poor *Oscar* was a terrible platform game, directly ported from the A1200, while the far more interesting *Diggers* was a good *Lemmings*-style puzzle game that, though very playable, hardly wowed prospective buyers. Aside from both games cohabiting the same CD, neither took advantage of the CD32's true potential. The first game to really do that came from Team 17 in the shape of *Ultimate Body Blows*. By combining characters from the original *Body*



» The most successful CD32 magazine lasted 21 issues, each of which came with a disc of demos and shareware.



» The first CD32 bundle came with the lacklustre *Microcosm*, among others.



» Another CD32 bundle that failed to pack in any killer apps.



» With games like *Cannon Fodder* and *Chaos Engine* this bundle was great but came a little too late to help.

Shareware Showdown

With the Amiga's massive shareware scene and the rise of Aminet, an Internet archive of free Amiga software, the CD32 was missing out on a wealth of brilliant games coded by enthusiastic Amiga hobbyists. It didn't take long for a few enterprising shareware distributors to begin producing CD32-compatible compilations, however. Early compilations like *Now That's What I Call Games* soon became available, whilst most Amiga magazines started to covermount CDs of the latest Public Domain games that would autorun on a CD32. Best of all the shareware compilations however, were undoubtedly *The Assassins* CDs: four compact discs jam-packed with many of the Amiga's best free games, presented through an expertly put together menu and at a reasonable price. Oddly enough, the four *Assassins* CDs are still available to buy, brand new, from their original manufacturer, who still operates through eBay. Track them down before it's too late.



AMIGA CD32



» **Above:** The FMV Module allowed Video CDs to be played, but was overpriced at £199. **Right:** Commodore's proposed CD1200 would have allowed the Amiga 1200 to play CD32 games, but was never released.



» **Above left:** These boards allowed developers to program games directly to the CD32 like a real Amiga. **Right:** The SX32 was one of a handful of devices to turn the CD32 into a full Amiga.

Blows and *Body Blows Galactic*, an epic roster of fighters was created that just would not have been possible on floppy disk. Several more expanded Amiga games soon followed: Team 17 struck again by releasing a double pack of *Alien Breed II* and *Alien Breed Tower Assault*, which was most notable for the specially filmed FMV intro that featured Team 17 staff spreading their Yorkshire accents deep into the far reaches of outer-space.

Codemasters took the easy route by using the massive storage space of the CD to bundle six *Dizzy* adventures together on a disk. Titled *The Big 6*, it was a cheap way of getting a title out, but the excellence of the *Dizzy* games made it an essential release. The CD32 version of *Worms* made more interesting use of the format: it allowed you to flip up the lid and pop in your own audio CDs, thereby allowing custom soundtracks eight years before the Xbox did.

Sound was, in fact, the one aspect of the CD medium that CD32 developers most made full use of; while most just included a musical score, some were daring enough to attempt CD speech. *Liberation* was one of the first; the voice acting wasn't great, but is fondly remembered for such classic (read: hideously embarrassing) lines as "Hey you, you wanna buy an animal? A real stuffed animal?". The aim was to create an immersive and realistic world, but was undone by the cheesy lines and soon became a parody of itself.

Adventure designers fared much better and, as history has proven, found that CD-speech and graphic adventures fitted together perfectly. Both arriving in 1994, *Beneath A Steel Sky* and *Simon The Sorcerer* broke new ground and shaped the way all adventure games are created today. Instead of having to read a line of dialogue that floated above the character's head, the speech would jump out of the TV set and into the gamer's world. When done well it brought added characterisation to everyone you met and allowed the listener to understand situations in a clearer way than was possible with text. Speech allowed characters to sound like they might be lying



» This CD32 magazine lasted only two issues.

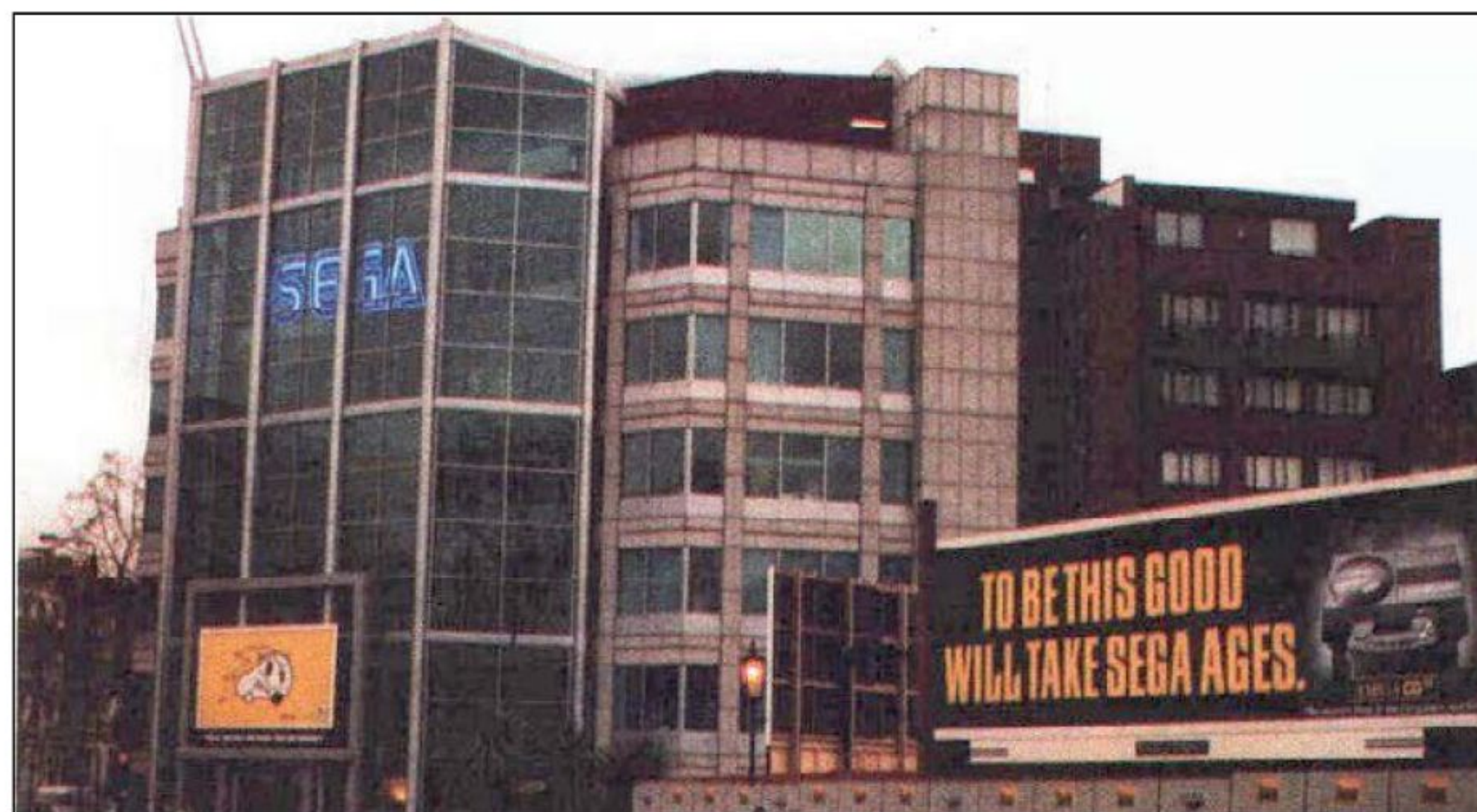

» Commodore's cheeky CD32 ads went straight for Sega's throat.



» *Flink* was a great CD32 platformer that also made it to the Mega CD.

or to show if they sympathised with the main protagonist or even if they were a possible danger. *Beneath A Steel Sky* far outstripped its floppy counterpart with a full-speech track voiced by members of the Royal Shakespeare Company, whilst the opening sequence featured a hand-drawn comic-style intro, exclusive to the CD. *Simon The Sorcerer's* production quality was similarly high: comedian Chris Barrie voiced Simon to an excellent standard, dropping his trademark wit and cynicism into every remark. The supporting cast did their best to match Barrie's excellent performance and ensured that the end product stood the test of time. *Simon The Sorcerer* stands out to this very day for its voice acting as well as its devilish puzzles, humorous plot and outstanding hand-drawn backgrounds.

Another voice-fuelled adventure game did appear on the CD32 but was, disappointingly, only available in Germany. *Inherit The Earth* introduced the player to a future Earth where humans had become extinct, and animals roamed the land on two feet and worshipped the long-dead humans as gods. As you may have already guessed, the voice acting was all in German so it is difficult to tell if it was any good. A text-only, English version did appear on the Amiga and PC though and is well worth checking out.

As well as the aforementioned conversions there were some CD32 exclusives. First up was *Bump 'N' Burn*, a cutesy cartoon racer by Grandslam. Though it failed to better *Mario Kart's* gameplay it did have a few graphical tricks up its sleeve that showed how the CD32 could have competed with the other consoles if it had been pushed properly. For a start the game ran in full-screen rather than the split-screen that *MK* players were used to. Secondly, it made great use of the Akiko chip to generate a track that climbed uphill, rolled down and banked at the corners. Finally, each race was preceded by a *Wacky Races* style introduction commentary in full CD audio.



» A shot from *Microcosm's* expensive FMV intro.



» Sixth Sense Investigations was the last known CD32 game to be released in 1998.



» Left: A CD32 advert from one of Commodore's biggest markets. Above: The extra disc space allowed for an unprecedented number of characters in Ultimate Body Blows.

Another CD-exclusive title that wowed Amiga owners was Psygnosis' *Misadventures Of Flink*. Most Amiga platform games paled in comparison to those on the SNES and Mega Drive, but *Flink* was refreshingly different. Graphically it soared well above the usual standard, with gorgeously colourful levels and screen-filling monsters; it used Akiko to generate sprite scaling and rotation effects and even had an unprecedented 60Hz mode!

There were certainly a few games that showed off the potential of Commodore's latest machine, but there were still signs that some developers didn't yet understand where the true capabilities of the medium lied. Despite creating magic with *Flink*, Psygnosis was one such developer to misjudge the CD format so dramatically. With its first CD32 game, *Microcosm*, the developer created a 3D shooter that used 34% of the CD for music and 62% for pre-rendered graphics, leaving only 4% for the actual game, which some might say they forgot to add at all. Still, *Microcosm* was something of an oddity on the CD32, which had far fewer FMV-driven games than on other formats, like the Mega CD for example.



» Liberation was the sequel to *Captive* and a very good CD32 RPG.

With its promising start, towards the end of 1993, it looked as if the CD32 might actually develop into Commodore's first decent console. After all, the ability to easily port Amiga software across meant that they had the support of the developers and the fair prices and general quality of the games meant that consumers favoured the console over its direct competitors; however, the CD32's future was already doomed. Commodore was falling apart at the seams, having milked profits dry and developed far too many hardware variations in a short space of time, and it was slowly becoming obvious to the public. Commodore Australia had already shut down, months earlier, and Commodore USA was next. Only seven months after the CD32's launch, Commodore's main office closed its doors for the last time. Commodore UK struggled on for a while, and even tried to buy the whole company at one point, but it was not to be. Commodore was dead and although the rights to both the Commodore name and the Amiga would be sold from company to company over the next three years, it became apparent that the brand would not return.

Developers continued to produce new CD32 games long after April 1994, however. No doubt encouraged by the Amiga's massive user base and the fact that third-party manufacturers had developed CD32 compatible CD-ROM drives for the A1200/A4000, the CD32 didn't truly find its best software until long after Commodore had perished. Great games like *Worms*, *Gloom* and *Alien Breed 3D* all made their CD32 debut in 1995 and beyond.

Even if Commodore hadn't passed on, however, it's doubtful that CD32 support would have lasted much longer than it did. By 1997, far superior consoles like the PlayStation and N64 were doing so much more than the CD32, essentially a product of the 2D era, could ever hope to achieve. There's no doubting that the console was a moderate success though and, had Commodore survived, it's possible that they would have built on that success to create the CD64 or CD128. Who knows where the Amiga CD might be today?

Yet, in many ways, the CD32 did live on. Amiga fans may have preferred the A1200 or A4000 back in '93, but with many having moved on to the PC (or Mac) since then, there's little room left on the desk for a second computer. It's the CD32, however, that retro Amiga lovers are increasingly turning to for their slice of Blitter-fuelled nostalgia. The compact design of the console and the speed and ease-of-use of the CD games make the CD32 the most convenient, hassle-free way to enjoy an old Amiga game. Sure, not all of the Amiga's games were ported across, but most of the best ones were and plenty were graced with enough significant improvements to make the console worthwhile. What's more, if you have an old Amiga game lying around, that wasn't available on CD, there are ways to get it to play (see boxout).

In short, the CD32 may not have been the best Amiga ever made, but it was certainly the most interesting and seemed to point the way for a possible bright future for the Amiga format before Commodore kicked the bucket and left us with what is essentially a more accessible Amiga 1200, with a couple of exclusive games, but one that's nowhere near as bad as some like to make out.

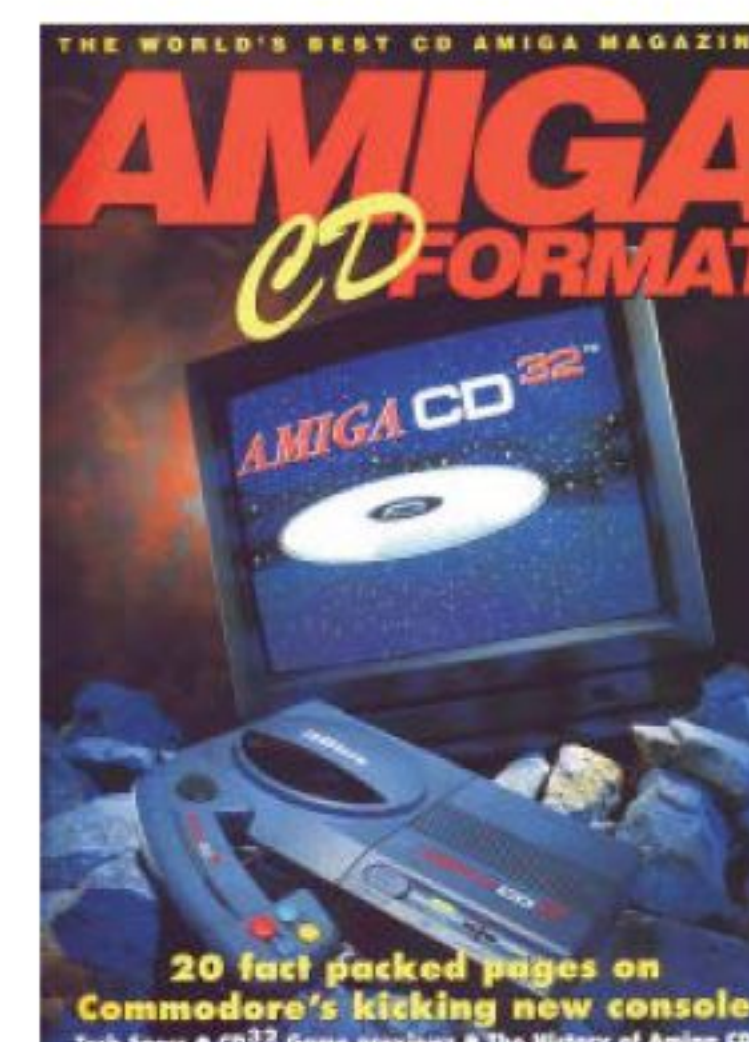

» A 6-page CD32 supplement given away free with Amiga Format in September 1993.

Unlocking the CD32's true potential

It is possible to add floppy disk drives, hard drives and a keyboard to the CD32 to turn the console into a fully-fledged Amiga computer. To do so requires an SX-1 or SX-32 expansion card, which are quite rare these days and very expensive. For those who want to play the floppy-based games, however, there is an easier way. For those who know exactly how, it is possible to copy the Amiga's floppy disks to a CD-ROM, add a CD32 boot-sequence and, just like that, the game will work on an unexpanded CD32. The more technically-minded are also able to store many floppy games on a single CD and load them from a menu. Please don't ask us how it's done though. Firstly, we don't know and secondly, it's a legally grey practice that, at the very least, requires you to own the original floppies.

Special thanks to www.amigahistory.co.uk for supplying all photographs.





AMIGA CD32

PERFECT TEN GAMES

We'd love to say that the CD32 was home to plenty of exclusive titles and not just 500 ports, but we'd be lying. Still, here's a selection of titles that you really shouldn't be without. Screenshots courtesy of www.lemonamiga.com



01



02



03



04

DIGGERS

- » RELEASED: 1993
- » PUBLISHED BY: COMMODORE
- » CREATED BY: MILLENNIUM INTERACTIVE
- » BY THE SAME DEVELOPER: JAMES POND2, ROBOCOD, GLOBAL EFFECT, VITAL LIGHT

01 One of the bundled launch titles for the star-crossed console, *Diggers* followed the antics of four mining concerns on the planet Zarg as they competed, with the help of the user, to rob the world of its resources. *Diggers* hasn't aged well, as it clearly attempted to mimic the success other strategy/management games had seen on the Amiga. The joypad provided a frustrating interface experience, but fortunately Millenium had the foresight to allow mouse control. Clean, if uninspired, graphics and chirpy tunes made it an enjoyable title for the right gamer, but was probably a bad choice for a bundled game. It pissed on its accompanying launch title (*Oscar*) from a great height, mind you.

WORMS

- » RELEASED: 1995
- » PUBLISHED BY: OCEAN
- » CREATED BY: TEAM 17
- » BY THE SAME DEVELOPER: ALIENBREED

02 *Worms* appears to have been released on practically every gaming platform known to man, so it should come as no surprise to learn that the CD32 received a version of its very own. It should also come as no surprise to learn that, like many other CD32 titles that have been mentioned on these two pages, *Worms* was pretty much identical to the original Amiga 500 version. Again though, it's a wonderful little title and the ability of the CD32's mouse meant that those pesky little annelids were just as easy to control on Amiga's console as they were on its home computer. Interestingly, a legal download of the CD32 version of *Worms* appears on the Dream17 website, so check it out at www.dream17.co.uk/softography.php?id=27&s=downloads.

FLINK

- » RELEASED: 1994
- » PUBLISHED BY: PSYGNOSIS
- » CREATED BY: PSYGNOSIS
- » BY THE SAME DEVELOPER: BENEFACTOR, MICROCOSM, LEMMINGS

03 One of the few dedicated CD32 games, from 16-bit legend Psygnosis. Also known as *The Misadventures Of Flink*, this game made full, unabashed use of the monumental storage space available on these new-fangled CD ROMs and greatly benefitted from it. The back story is pretty standard stuff (a wizard's apprentice putting paid to some evil dude's nefarious antics), but what's fascinating is the impressive number of cross-genre elements seamlessly blended into the gameplay. RPG, beat-'em-up, shmup, puzzle and adventure all intertwine in this impressive demonstration of what the CD32 was really capable of. The whole thing gets kicked in the nads by a crippling lack of a save option, however. Damn shame about that. Yes sir.

BANSHEE

- » RELEASED: 1994
- » PUBLISHED BY: CORE DESIGN
- » CREATED BY: CORE DESIGN
- » BY THE SAME DEVELOPER: TOMBRAIDER

04 It's rare to find a decent shmup on the Amiga and even rarer to discover one on the CD32, so when you discover one as good as *Banshee* you're not going to let it out of your sight. Obviously based on Capcom's 1942 series, *Banshee* is a tough as nails shooter that will have you gnashing your teeth in frustration as you gaze dumbstruck at its stunningly crisp visuals and hectic onscreen action. It may not be the most original of concepts but it has been put together with such flair and obvious skill that it really doesn't matter in the slightest. Fortunately for CD32 owners, *Banshee* plays perfectly fine with the machine's joypad and Core Design even saw fit to include an extra two levels to fight through. Those with a fetish for tough blasters would do well to track this down straight away.

GUARDIAN

- » RELEASED: 1994
- » PUBLISHED BY: ACID SOFTWARE
- » CREATED BY: ACID SOFTWARE
- » BY THE SAME DEVELOPER: SUPER SKIDMARKS, ROADKILL

05 It wouldn't be at all unreasonable to classify this unimaginatively titled game as 'Starfox for the Amiga generation'. A dynamic, playable and brightly coloured 3-D shmup that, for once, was actually better when using the CD32's nasty joypad thing. Many early 3-D fly-'em-ups descended into tedious simulations, rather than the zoom-around-blowing-stuff-up type games we really wanted, but *Guardian* shrewdly kept itself well within the "hit 'em hard, hit 'em fast" parameters. By keeping up the game speed and making the ship as controllable as possible, it elegantly camouflaged the somewhat limited gameplay and ticks all the right boxes for a proper console game, which, in retrospect, was exactly what the CD32 lacked and so desperately needed.

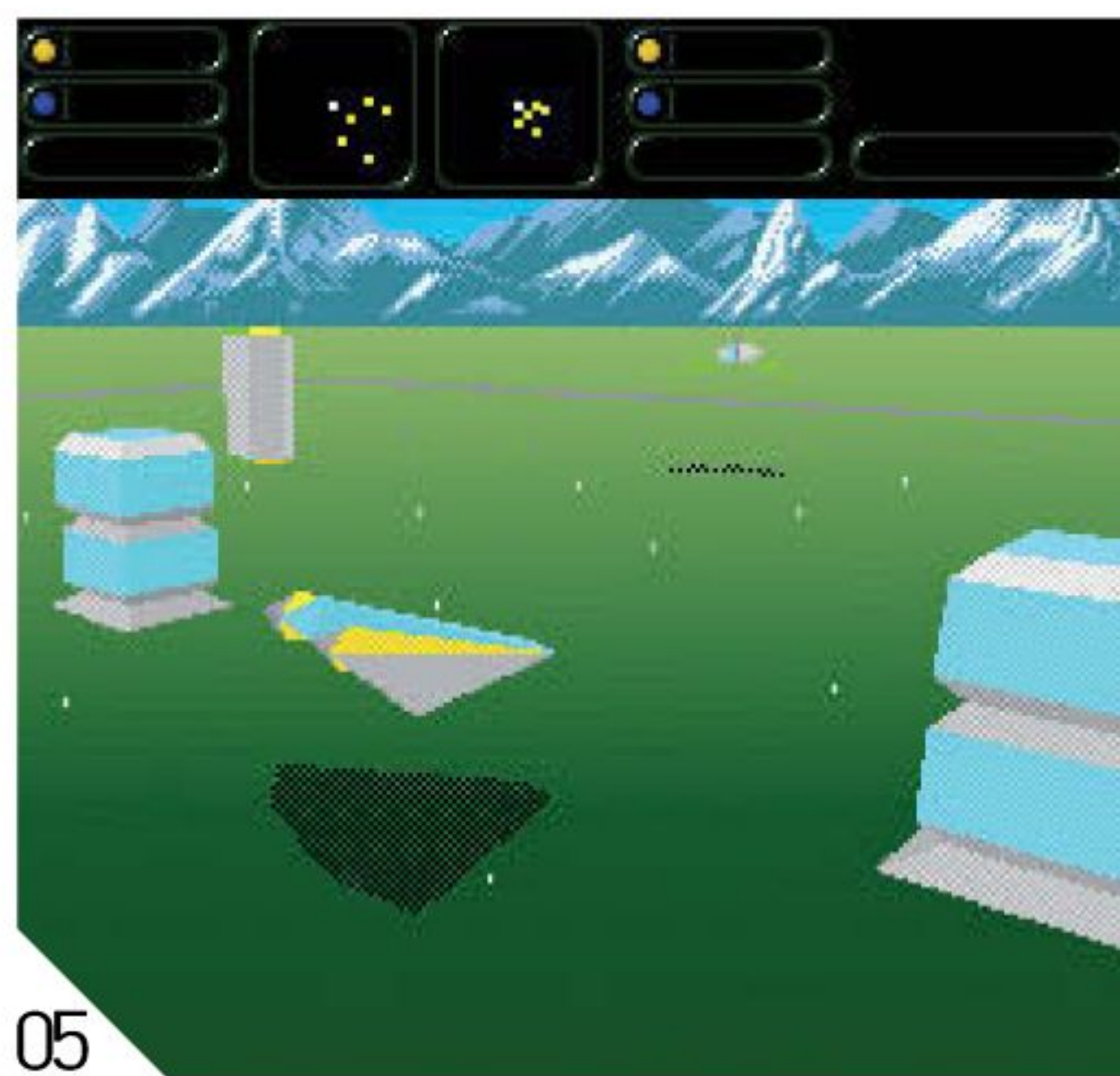

05



06



07



08



09

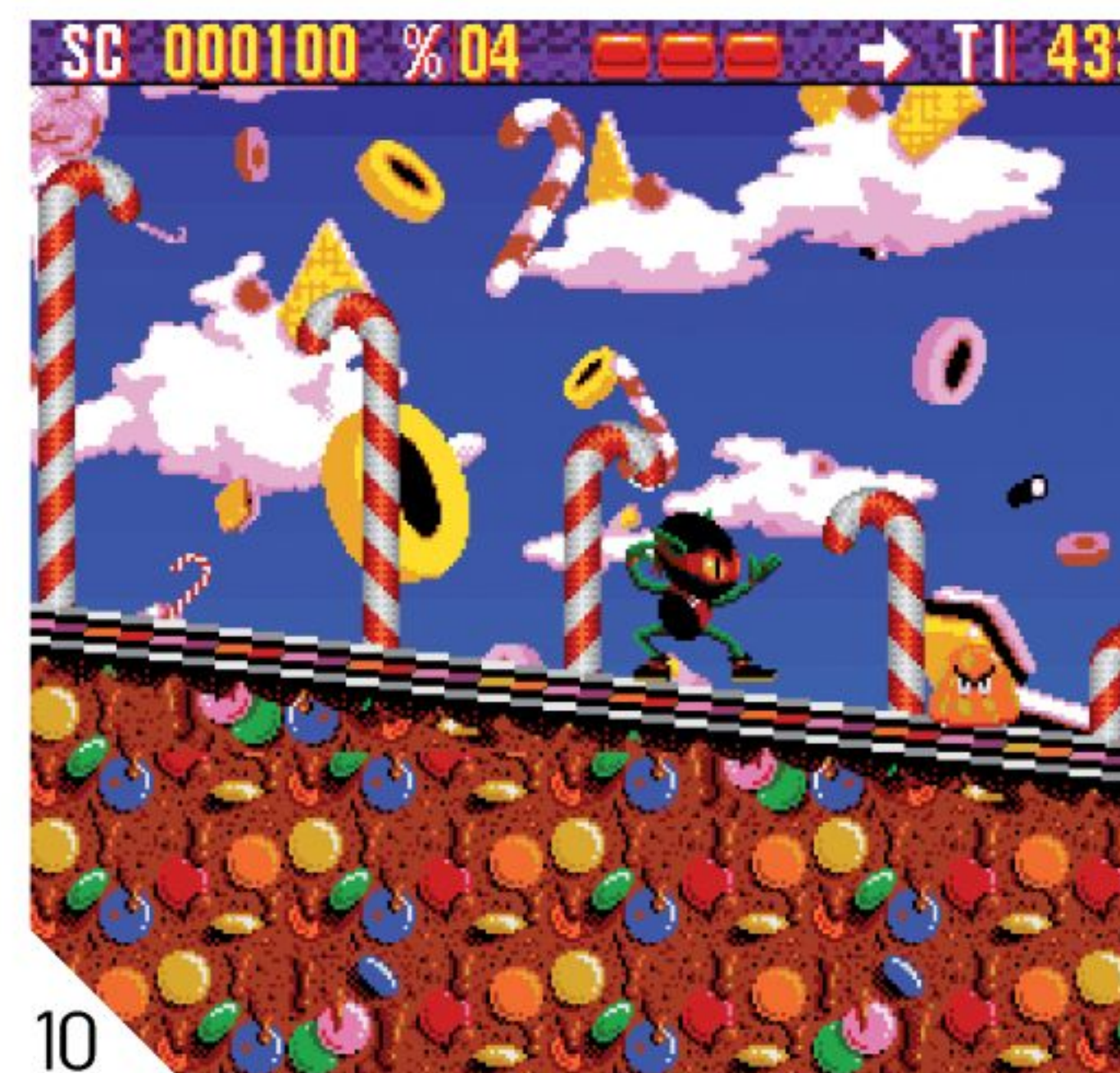

10

BENEATH A STEEL SKY

- » RELEASED: 1994
- » PUBLISHED BY: VIRGIN INTERACTIVE
- » CREATED BY: REVOLUTION SOFTWARE
- » BY THE SAME DEVELOPER: BROKEN SWORD

06 Along with *The Secret of Monkey Island* and *Indiana Jones & The Fate Of Atlantis*, Revolution's *Beneath A Steel Sky* is quite possibly one of the greatest Amiga point-and-click adventures ever made. Like many CD32 ports, *BASS* didn't push the console in any way other than offering superior music and greatly reduced loading times, but in a way this didn't matter. It certainly took a while to get used to the CD32's rather clunky pad, but play this with a mouse and everything became much more enjoyable. *Beneath A Steel Sky* may be little more than a basic port, but it's a basic port of one of the Amiga's greatest adventures, and owners of the machine rightly lapped it up.

ALIEN BREED: TOWER ASSAULT

- » RELEASED: 1994
- » PUBLISHED BY: TEAM 17
- » CREATED BY: TEAM 17
- » BY THE SAME DEVELOPER: PROJECT X

07 Team 17 was well known for going above and beyond the call of duty when it came to porting games across to the CD32, and the superb *Tower Assault* was no exception. Featuring an extremely lengthy intro, beautifully drawn sprites, a new retreat move that enabled you to walk backwards while firing, and plenty of over-the-top blasting action, *Tower Assault* was yet another excellent blaster from Team 17 and was perfectly suited to the CD32. Vastly superior to the PC version that appeared at the same time, *Tower Assault* was a stunning shooter that deserves to be in every CD32 owner's collection. If that wasn't enough, it also came with an AGA enhanced version of *Alien Breed II: The Horror Continues*.

D/GENERATION

- » RELEASED: 1993
- » PUBLISHED BY: MINDSCAPE
- » CREATED BY: ROBERT COOK
- » BY THE SAME DEVELOPER: FURY OF THE FURRIES, THEME PARK, SYNDICATE

08 A prime example of why the CD32 ultimately failed to grab the attention of seasoned gamers. *D/Generation* was already a fairly well respected game, so using it to acclimatise Amiga-philes to the new machine wasn't a bad idea. In principle. The decent isometric run-and-gun gameplay – interspersed with puzzler elements as the player infiltrates a building infested with out-of-control bio weapons – made zero use of the console's capabilities. The massive storage space of the CD was totally ignored, the joypad control was as effective as a one-legged man in an arse-kicking contest and the sparse graphics left players wondering why they didn't just stick with their Amiga 500. It's still a damn good game though...

SIMON THE SORCERER

- » RELEASED: 1994
- » PUBLISHED BY: BLITTERSOFT
- » CREATED BY: ADVENTURE SOFT
- » BY THE SAME DEVELOPER: WAXWORKS

09 Like *Beneath A Steel Sky*, *Simon The Sorcerer* was another classic 500 title that greatly benefited from the CD32's storage capacity. While there were no improvements in Simon's visuals, the new soundtrack and superb voice recordings greatly enhanced *Simon The Sorcerer's* atmosphere. Indeed, Chris Barrie's voiceover for Simon was a revelation and set high standards for other companies to follow. Sure, he had the deepest 12-year-old voice that you'd ever heard, but there was no denying that his acidic tongue perfectly suited Simon's many sarky one-liners. It may be little more than a port, but, with the greatly reduced loading times and superb voice acting, fans should snap it up straight away.

ZOOL

- » RELEASED: 1993
- » PUBLISHED BY: GREMLIN
- » CREATED BY: IN-HOUSE
- » BY THE SAME DEVELOPER: ACTUA SOCCER

10 *Zool*, is generally considered as one of the greatest Amiga platformers ever made – hardly surprising when it has no *Mario* or *Sonic* games – so it should come as no surprise to learn that the CD32 version was obviously the best incarnation of the bunch. Whilst a little too garish at times, *Zool's* cinematic opening, frenetic soundtrack and console styled nature means it's perfectly suited to the CD32, and best of all there's a brand new massive world to explore. Whilst *Zool* was never in the same league as the aforementioned platforming superstars (you can kid yourself otherwise but you know it's not true), it had no equal on the Amiga, so why not treat yourself to the definitive version of the game? Go on. You know it makes perfect sense.



AMIGA CD32



AMIGA CD 32

and the rest...

Looking over the following two pages you're probably thinking that the CD32 was home to Amiga 500 and 1200 ports and very little else, and to be honest you'd mainly be right. That's not to say they weren't good games though

- 01 SKELETON KREW
- 02 GUARDIAN
- 03 CHAMBERS OF SHAOLIN
- 04 ULTIMATE BODY BLOWS
- 05 MORPH
- 06 FLINK
- 07 PREMIERE
- 08 FRONTIER: ELITE II
- 09 BRUTAL: PAWS OF FURY
- 10 POWER DRIVE
- 11 TROLLS
- 12 JAMES POND II: ROBOCOD
- 13 CANNON FODDER
- 14 THE LOST VIKINGS
- 15 SEEK & DESTROY
- 16 PIRATES! GOLD
- 17 FIELDS OF GLORY
- 18 THE CHAOS ENGINE
- 19 MEAN ARENAS
- 20 RISE OF THE ROBOTS
- 21 FURY OF THE FURRIES
- 22 CHUCK ROCK
- 23 SHADOW FIGHTER
- 24 UNIVERSE
- 25 BATTLE CHESS
- 26 FIRE & ICE
- 27 LIBERATION
- 28 ALFRED CHICKEN
- 29 THE LABYRINTH OF TIME
- 30 SOCCER KID
- 31 JUNGLE STRIKE
- 32 D-GENERATION
- 33 BEAVERS
- 34 PINBALL FANTASIES
- 35 STAR CRUSADER
- 36 NAUGHTY ONES
- 37 DIGGERS
- 38 BRUTAL SPORTS SERIES FOOTBALL
- 39 MARVIN'S MARVELLOUS ADVENTURE
- 40 GLOOM
- 41 VITAL LIGHT
- 42 EXILE
- 43 GUNSHIP 2000
- 44 RYDER CUP: JOHNNIE WALKER
- 45 BENEATH A STEEL SKY
- 46 LEGENDS
- 47 AKIRA
- 48 DEEP CORE
- 49 PINBALL ILLUSIONS
- 50 ARABIAN NIGHTS
- 51 LAMBORGHINI AMERICAN CHALLENGE
- 52 MICROCOSM
- 53 ROADKILL
- 54 LITL' DIVIL
- 55 AMIGA CD FOOTBALL
- 56 SLEEPWALKER
- 57 WEMBLEY INTERNATIONAL SOCCER
- 58 DARKSEED
- 59 ARCADE POOL
- 60 SIMON THE SORCERER
- 61 GLOBAL EFFECT
- 62 ATR: ALL TERRAIN RACING
- 63 IK+
- 64 UFO: ENEMY UNKNOWN
- 65 ALIEN BREED 3D
- 66 THE SEVEN GATES OF JAMBALA
- 67 QUIK THE THUNDER RABBIT
- 68 SENSIBLE SOCCER V1.1
- 69 WHALES VOYAGE
- 70 CASTLES II: SIEGE & CONQUEST
- 71 ZOOL 2
- 72 MYTH: HISTORY IN THE MAKING
- 73 FEARS
- 74 TOP GEAR 2
- 75 DANGEROUS STREETS
- 76 SPEEDBALL 2: BRUTAL DELUXE
- 77 WILD CUP SOCCER
- 78 BANSHEE



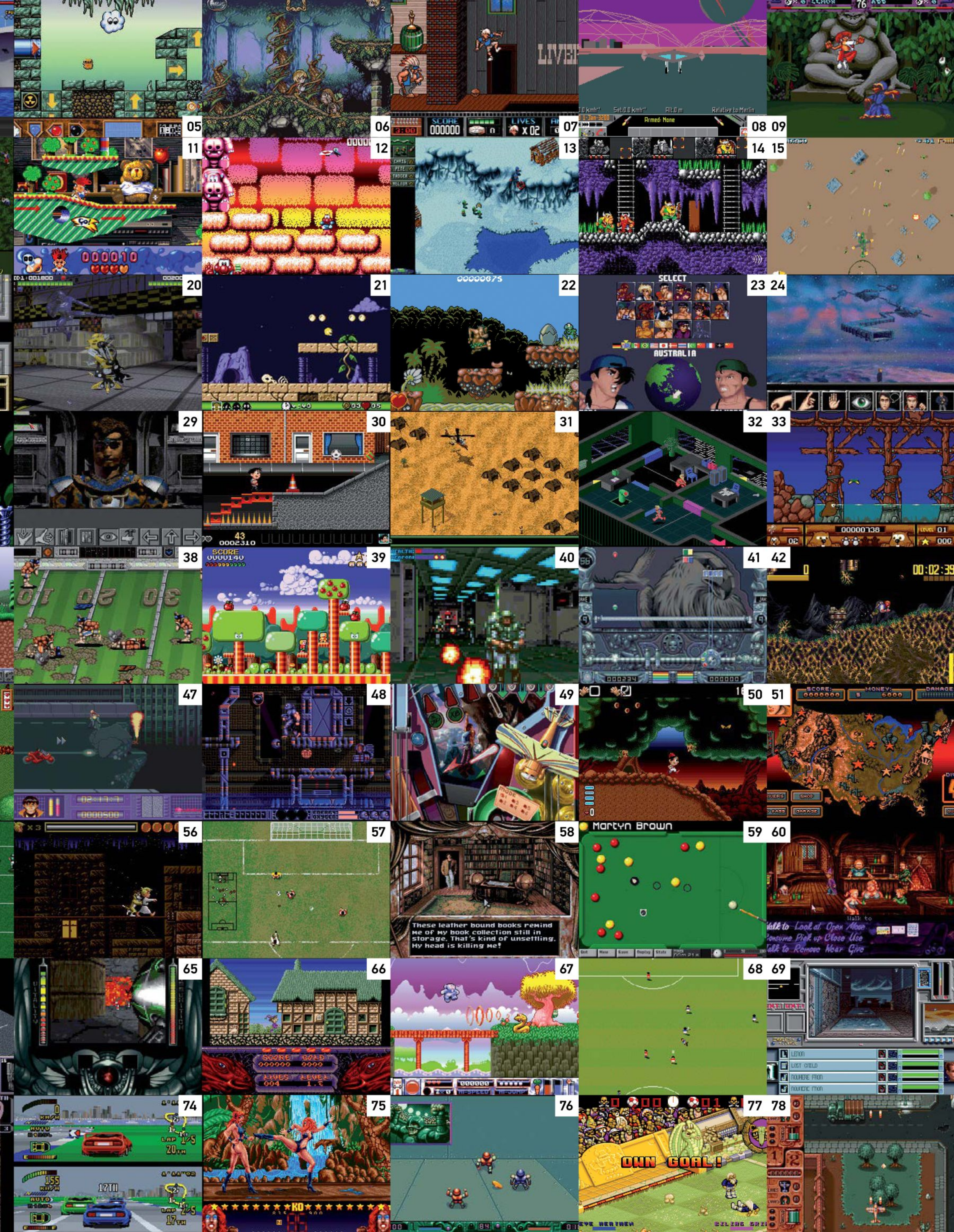

05

06

07

08 09

11

12

13

14 15

20

21

22

23 24

29

30

31

32 33

38

39

40

41 42

47

48

49

50 51

56

57

58

59 60

65

66

67

68 69

74

75

76

77 78



SINCLAIR QL



You're probably wondering why the Sinclair Quantum Leap deserves coverage. It was, after all, a business machine with bugger all games, right? Well that's where you'd be mistaken. Join us as we celebrate the last three decades of the Sinclair QL by lifting the lid on its best kept secret

SINCLAIR QL

When looking back at the QL, it's easy to get bogged down in the reasons why it was a commercial failure, so let's start by getting that out of the way. The QL wasn't a disaster of C5 proportions, but it barely made a dent in the business machine market when released in 1984. On paper, the QL looked like the perfect package. It was powered by a Motorola 68008 processor, came with 128KB of RAM, housed two internal microdrive storage devices, featured its own multitasking operating system (QDOS) and structured BASIC language (SuperBASIC), and came bundled with a complete office suite. The best bit? All this was yours for £399, at a time when a similar specced IBM PC would have set you back upwards of £2,000.

In order to undercut its rivals so severely and still turn a profit, Sinclair was forced to make crucial compromises to the machine's design. David Karlin was the QL's chief design engineer and he believes that economics compromised the project: "The price point prevented the inclusion of peripherals of an appropriate quality, an essential – and ultimately fatal – omission for the business market." Rather than the core 68000 processor, Sinclair opted for the cheaper 68008 version, which had a smaller address and data bus, limiting the performance of the chip. The biggest cutback, though, was the inclusion of

Sinclair's famously unreliable microdrives rather than a standard floppy disk system. "Overwhelmingly, the QL failed because of the microdrives," comments David. "I still think it's highly probable, and thought so at the time, that the QL would have made a much bigger mark had it dropped the microdrives and been bundled with a decent monitor, a floppy disk drive and a printer at, say, £799 instead of £399."

To compound matters, the QL was treated to a trademark Sinclair launch – everything went wrong. Punters waited months for their machines, and when the first models finally arrived they were plagued by software bugs and reliability issues. All of this was diligently reported by the computing press and Sinclair's once strong market image took a battering. Sir Clive predicted that 200,000 QLs would be sold in 1985 alone, yet by the middle of the year, the total sales figure stretching back to its launch in early 1984 stood at just 60,000. Sinclair took drastic action and in September 1985 the price of the QL was slashed in half in a bid to capitalise on pre-Christmas sales. At £199, it moved within easier reach of the hobbyist market and positioned itself as an upgrade option for Spectrum owners. And with that the demand for QL games grew.

Sinclair seemed to have a love/hate relationship with games. On one hand, the success of the Spectrum was fuelled by the abundance of low-cost gaming software available, while on the other, insider rumblings suggested that gaming

was seen to be beneath the dignity of the company. David disagrees with reports that gaming was a dirty word within Sinclair: "There were lots of people in the company who understood the gaming market very well and put plenty of work into ensuring that the Spectrum thrived in it, and the QL did its best. If anything, I swam against the tide within the company by focusing the QL resolutely on business." David's initial intention was to develop a pure business machine designed to be hooked up to a monitor, but his hand was forced as the project progressed. "Partway through development, I was told firmly not to alienate it so far from the Spectrum's market, at which point things like the TV interface and joystick ports were added. Retaining a tape port à la the Spectrum was discussed but discarded – the microdrives were supposed to be good enough."

Even with the compromised configuration, the QL wasn't built with gaming in mind, yet it had enough raw power under the hood to be a competent pixel pusher. The 68008 processor was clocked at 7.5MHz, and, despite being hamstrung by narrow buses, it could still carry out complex calculations across the full 32-bit instruction set. There were two generous video modes – 512x256 with four colours and 256x256 with eight colours – and unlike the Spectrum's rudimentary display, each pixel could be assigned its own colour value, which meant no ugly attribute clash. On the downside, the hi-res display occupied 32KB in memory, which was a meaty chunk of screen RAM to funnel around the QL's contended innards.

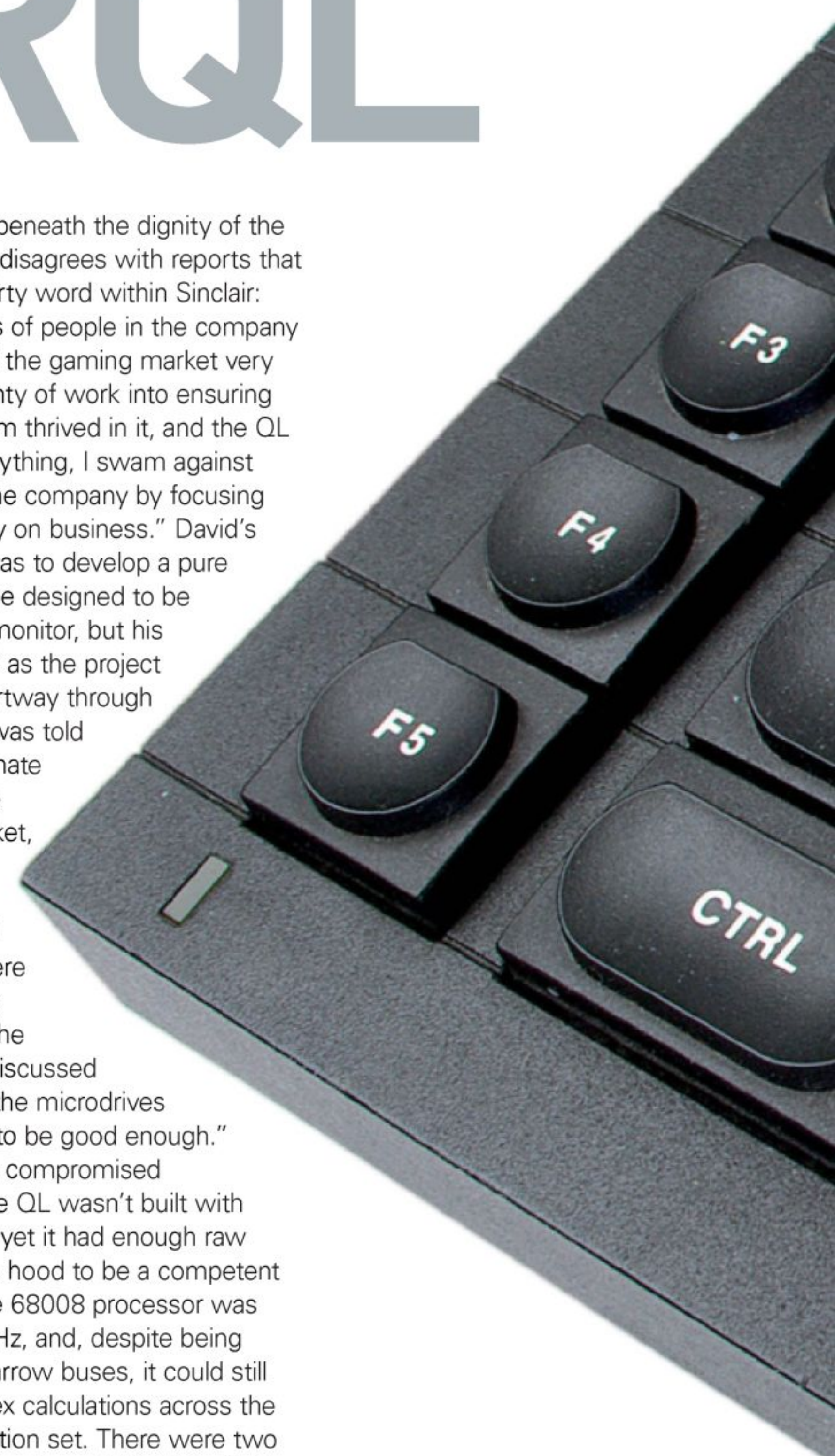

“ The QL wasn't built with gaming in mind, yet it had enough raw power to be competent ”



Year released: 1984

Original price: £399 at launch

Main Processor: Motorola 68008
(running at 7.5MHz)

Secondary Processor: Intel 8049
(running at 11MHz)

RAM: 128KB

ROM: 48KB

Operating system: QDOS

Onboard language: SuperBASIC

Internal storage: Twin microdrives

Display: 512x256 pixels (Mode 4);
256x256 pixels (Mode 8)

Colours: Black, white, red, green
(Mode 4); black, white, red, green,
yellow, blue, cyan, magenta (Mode 8)

Sound: Single channel oscillator

Associated magazines: *QL User*,
QL World, *QL Today*

Why the Sinclair QL was great...

The very fact that the QL was forged within Sinclair's hallowed halls ensures greatness alone. In all seriousness, the QL did not live up to its rather grand moniker, but its ambitions were admirable and any initial hardware shortcomings were soon sorted using updated chips and expansion boards. Regardless of its commercial fortunes, the QL remains an important Sinclair milestone alongside the ZX80, ZX81 and ZX Spectrum.



SINCLAIR QL

Different Versions



Sinclair never significantly developed the core QL design, but a collaboration project with ICL resulted in the One Per Desk, a desktop computer that borrowed the QL's hardware and bolted on a number of 'executive' additions; notably a modem and telephone handset. The machine was also marketed by British Telecom as the Merlin Tonto (pictured). In more recent years, enthusiasts have developed powerful QL clones based around the 68040 and 68060 processors.

Damon Chaplin Q&A

Damon was one of the most celebrated QL programmers back in the day, with a quintet of quality games to his name. He currently resides in the Lake District where he develops Linux software for a living.



■ **Retro Gamer: Can you describe your path to programming games on the QL?**

Damon Chaplin: My first computer was the ZX81, followed by the Spectrum and then the QL. I did some programming in BASIC on the ZX81 and Spectrum, and then ventured into assembly language. My aim had always been to write some games, so when I finally got a QL and an assembler that's what I did. And since *Pac-Man* was one of my favourite arcade games, I couldn't resist trying to emulate that. Hence *Spook* was born.

■ **RG: *Spook* was published by Eidersoft. How did that come about?**

DC: By a strange coincidence my parents bumped into Sir Clive Sinclair in a pub in Cambridge just after I'd finished *Spook*, and he was kind enough to give them Psion's phone number. I thought it was my lucky day, but unfortunately they weren't interested. So I skimmed through the adverts in the QL magazines and noticed that Eidersoft were based fairly close to us in Essex. We visited them and showed them the game, and that was that.

■ **RG: What was the main difficulty you encountered in programming for the QL?**

DC: For me, the graphics were the hardest part. I did get some help for *Spook* and *Deathstrike*, but the others were all my work. Sound was also a problem, due to the strange way that the sound chip was controlled. Each sound effect required a lot of experimentation.

■ **RG: How did you achieve full-screen scrolling in your games?**

DC: The MOVEM (Move Multiple Registers) assembly instruction was the key. You could move quite a few bytes in one go, fairly quickly. It took eight instructions per line of pixels, which wasn't too bad, although it didn't leave much time for the sprites and the rest of the code.

■ **RG: Do you look back on your QL days with fondness, and did your games open any doors for you in later life?**

DC: I was just a student at the time and did it mainly for fun. I never made much money out of any of it, but it helped me through university. The games did help a little when I applied for jobs, but I felt that some companies didn't take it seriously. I went for an interview at a large bank once and was asked to circle the errors on a trivial 30-line piece of C code. I'd written several published games in assembly language, for goodness' sake! Actually, I did miss half the errors, but that's beside the point!

“ It's estimated that as many as 100 commercial games were released for the QL ”

(In comparison, the Spectrum reserved just 7KB for the screen.) This pretty much ruled out fast, full-screen scrolling in games, so the majority of them were static-screen affairs.

“I thought being able to have full-colour graphics was critical based on the assumption that the user would want fully bitmapped pictures within documents,” says David about the display. “I wasn't so concerned about the speed of shifting things around the screen, which reflected my business versus gaming bias. If I had been designing a raw games machine, I would have worked very differently – no high-resolution mode, no co-processor, and a bit block transfer module in the video card, to name but a few. The QL core was basically fine for a business machine and not all that well suited to games.” But this didn't deter software houses from trying regardless, and although it's difficult to elicit an exact figure, it's estimated that as many as 100 commercial games were released for the QL.

The first game of note was *QL Chess*, published by Sinclair stalwart Psion in December 1984. At the time, chess was only going to be of interest to the bearded and the bespectacled, yet the QL version deserves special mention because its slick presentation pointed to what was possible on the machine. On boot up the game displayed the board and playing pieces in a typical plan view, just like Psion's earlier versions for the ZX81 and Spectrum, but by hitting a key you could switch to an impressive '3D' view, where the chunky pieces slid gracefully around the board. The sprite movement was fluid and flicker-free, and this boded well for Psion's second QL game, a

conversion of its popular Spectrum tennis title *Match Point*.

Match Point was famously fast on the Speccy, but the QL version was even quicker. The graphics were more detailed too, with multicoloured player sprites stepping in for the Spectrum's featureless silhouettes. The smooth sprite movement and impressive level of detail was possible because Psion opted to use the QL's four-colour mode for *QL Chess* and *Match Point* instead of the more common – for gaming, at least – eight-colour mode. The chief benefit of using four-colour mode was that the full resolution of 512x256 could be displayed, whereas eight-colour mode was restricted to 256x256. So the first job for any programmer was to weigh up the benefits of more detail against more colours. Most chose the latter.

The UK's biggest software labels showed no signs of supporting the QL and this allowed cheeky opportunists to release their own takes on popular titles. Early examples included *EVA*, a ropey *Jetpac* clone from Westway; and Microdeal's *Lands Of Havoc*, a vast, vaguely interesting *Sabre Wulf*-style maze game. Microdeal's Cuthbert character also made an appearance in *Cuthbert In Space*, another *Jetpac* rip-off, but the closest the QL got to its own mascot was BJ, star of three platform games beginning with *QL Caverns* and followed by *BJ The Return* and *BJ In 3D Land*.

Rather unsurprisingly, the vast majority of the QL games were arcade clones. Just for starters you had *Zapper (Galaxian)*, *Hopper (Frogger)*, *Knight Flight (Joust)*, *QL Meteor Storm (Asteroids)*, *QL Jabber (Centipede)* and *Hyperdrive (Pole Position)*. The quality of these wannabes was generally pretty good, with the standout effort being *Spook*, a faithful *Pac-Man* clone from Damon Chaplin. Damon went on to release a further four arcade games for the QL between 1987 and 1991 – *Deathstrike*, *Assault And Battery*, *Speedfreaks* and *Pudge* – and each one is a superb showcase for the QL's gaming capabilities. You can read an interview with Damon elsewhere in this feature.

One title that deserves a special mention is *Wanderer* from French software house Pyramide. This thoroughly bizarre space adventure featured 3D visuals – as in 'proper' 3D when viewed through coloured specs – and a crazy plot involving card-hustling man-cats – how very French! Yet it's notable because it demonstrates how deftly the QL could display vector-style graphics. Basically, when it came to



» Beyond the QL... Rick Dickinson's prototype design for the QL Plus, with built-in wafer drive and accompanying wafer stack. The design never progressed beyond this model.

INSTANT EXPERT

The Quantum Leap was known as the ZX83 during development. This was referenced in the names of its two custom chips: the ZX8301 and ZX8302.

It was the first mass-market computer to use a Motorola 68000-family processor, beating the Apple Macintosh to launch by just 12 days.

The first machines off the production line had just 32KB of ROM, which wasn't large enough to store all of the QL's operating software. As a quick workaround, an additional 16KB dongle, affectionately known as the 'kludge', was plugged in to the ROM port.

Using memory upgrades it was possible to boost the QL's RAM to 640KB. A third-party device known as the Trump Card later increased this further to 896KB.

The keyboard and case design were the work of Rick Dickinson, who designed all of Sinclair's computers. The subsequent Spectrum+ and 128 would go on to adopt the same styling.

Despite having more keys than the Spectrum, the QL did not have a dedicated 'delete' key. To remove characters you had to hold Ctrl and press the left and right cursor keys.

The QL was named 'Microcomputer of the Year' at the 1985 British Microcomputer Awards. Sir Clive was on hand to receive the trophy and received a standing ovation.

The QL's commercial life ended in April 1986 when Sinclair's computing arm was sold to Amstrad and the bearded one chose to axe the machine.

Linux creator Linus Torvalds owned a QL and originally learnt to program on it in his youth.

Legend has it that software developers received early QLs with power packs that were not properly earthed – with hilarious, often hair-raising consequences.

calculating the co-ordinates of wireframe 3D objects, the 68008 could eat 8-bit processors for breakfast. *Wanderer* was certainly no *Elite*, but it clearly signalled that Bell and Braben's masterpiece would have worked extremely well on the QL. In fact, *Elite* just might have been QL-bound at one point, as publisher Firebird announced in January 1986 that it would release software for the machine with an update of the classic budget game *Booty* as its debut title. *Booty* never appeared, however, and with that any prospects of QL *Elite* were presumably condemned to Witch Space.

So the QL may have missed out on *Elite*, but it did play host to another classic title from fledgling software house Magnetic Scrolls. *The Pawn*, surely one of the finest text adventures ever written, made a low-key, text-only debut on the QL in December 1985 as *QL Pawn* before going on to find great critical and commercial success on the Atari ST, Commodore Amiga and other platforms. Rather tellingly, the follow-up, *The Guild Of Thieves*, was denied a QL release as Magnetic Scrolls focused on more profitable platforms.

Such is the popularity of *The Pawn* that the QL version fetches £30-40 when the occasional complete copy surfaces on

COMMUNITY THE BEST QL RESOURCES ON THE WEB

RWAP Software
www.rwapsoftware.co.uk

Rich Mellor of RWAP Software has been supporting the QL since 1987 and his site should be your first port of call for information about QL software and hardware. Rich also has lots of items for sale and offers a repair service for faulty machines.



Dilwyn Jones Sinclair QL Pages
www.dilwyn.me.uk

Dilwyn's site is perhaps the most regularly updated QL resource and is definitely worth bookmarking. There's a wealth of software available to freely download, including games, plus a vast library of QL-related documentation and information.



QUANTA
www.quanta.org.uk

The independent QL user group QUANTA (The QL Users and Tinkerers Association) was formed prior to the machine's launch and is still going strong today with regular meetings and workshops organised around the UK. The group also publishes a bi-monthly magazine for its members.



Q-emuLator Homepage
terdina.net/ql/q-emulator.html

There are several QL emulators available, but if you're looking to run QL games on a PC or Mac then you should opt for Q-emuLator. The full version is shareware, but the free trial includes everything you need to run the vast majority of games.

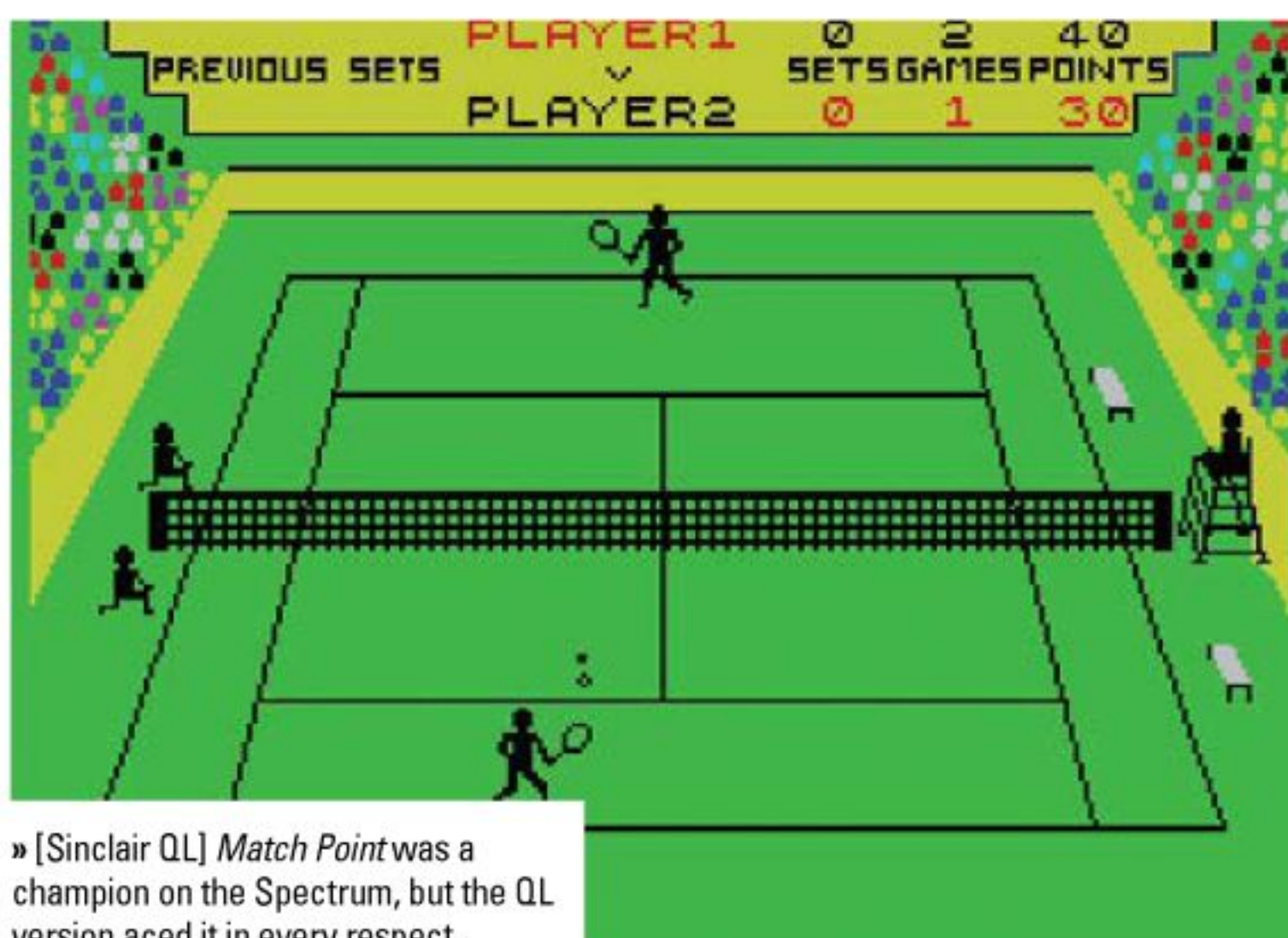

» [Sinclair QL] *Match Point* was a champion on the Spectrum, but the QL version aced it in every respect.



» Eidersoft published some decent QL software, including Damon Chaplin's first game, *Spook*, and the second and third *BJ* games.

eBay. This high price isn't just because of collectors wanting to own a piece of adventure gaming history: if you want to play *QL Pawn*, the only way is with an original copy. Due to clever copy protection methods included on the original release, which have yet to be cracked, there is no digital version available to use on a QL emulator. Thankfully, working dumps of many other games are available, but the problem then is that there's no repository of commercial QL software anywhere on the web. You can't just nip online and download a few games and fire them up under emulation. This is mainly due to the fact that those who have dumped the games and made them compatible with emulators do not wish to run the risk of distributing commercial titles, which are still copyrighted to the original publishers or authors. So, we're afraid the original hardware and software route is currently the only way to go.

That may sound off-putting if you've grown accustomed to using emulators to satisfy those pangs of retro gaming curiosity, but if you're a collector you'll know how rewarding it can be to get your hands on old kit. A quick check on eBay reveals that there are always three

or four QLs for sale at any one time, ranging from £40-50 loose to £100+ boxed. And if your QL develops a faulty keyboard (likely) or dodgy microdrive (highly likely), there's plenty of support out there to help you get it fixed (see the 'Community' boxout). Games turn up for sale less often, but they're certainly not uncommon and most titles – *QL Pawn* aside – can be picked up for only a few pounds each. So if you're a Sinclair enthusiast looking to kick-start a QL collection, turn the page to discover ten shining souvenirs of the QL's little-known gaming legacy.

Special thanks to Rich Mellor of RWAP Software (www.rwapsoftware.co.uk) for his help and generous assistance.

» Under the hood: the empty space on the left was an expansion bay for housing additional memory and peripherals.





SINCLAIR QL

PERFECT TEN GAMES

THE QL WAS NOT HOME TO A LARGE LIBRARY, BUT THERE'S ENOUGH QUALITY TO MAKE CHOOSING TEN OF THE BEST A TRICKY TASK. THE FOLLOWING TITLES ALL SHOWCASE ITS GAMING CAPABILITIES TO SOME DEGREE, BUT ABOVE ALL THEY'RE AN ABSOLUTE BLAST TO PLAY. IN NO PARTICULAR ORDER...



01

MATCH POINT

- » RELEASE: 1985
- » PUBLISHER: SINCLAIR RESEARCH
- » CREATOR: PSION
- » BY THE SAME DEVELOPER: QL CHESS

01 Such was the QL's low profile when it came to games, if you walked into a high-street chain store in 1985 looking to buy software, chances are you'd find no more than a couple of Sinclair-published games: *QL Chess* and *Match Point*. Luckily, both were fine titles, with *Match Point* standing out as probably the best game ever released for the machine. Great graphics and super-fast gameplay saw this power past other versions without breaking a sweat. If anything, it was perhaps too fast on the higher difficulty settings, making the use of a joystick essential. And no, you wouldn't find one of those for your QL in WH Smith or Boots either...

KARATE

- » RELEASE: 1986
- » PUBLISHER: EIDERSOFT
- » CREATOR: POINTBLANK
- » BY THE SAME DEVELOPER: N/A

02 If a game was a huge hit on other platforms, you could pretty much guarantee that an unofficial version would land on the QL at some point. And so here we have *Way Of The Exploding Fist*, complete with all the moves lifted straight from the Melbourne House masterpiece. But it's hard to criticise blatant copies when they're done with such aplomb. The use of the high-resolution four-colour mode allowed for detailed visuals and precise collision detection, and the all-important speed of the scrapping was sixth dan stuff. The only thing missing was a two-player versus mode, although on later stages you could face off against a couple of fighters.



02

JUNGLE EDDI

- » RELEASE: 1986
- » PUBLISHER: GRAFSOFT
- » CREATOR: STEFAN KUHNE
- » BY THE SAME DEVELOPER: THE LOST PHARAOH

03 Clones of *Ultimate* games were rife on the QL, and programmer Stefan Kuhne was one of the chief culprits. His earlier title *The Lost Pharaoh* borrowed wholesale from *Sabre Wulf*, while *Jungle Eddi* was his take on *Underworld*. The setting may have shifted from dark caverns to dense jungle, but the way your character leapt around the screen was drawn directly from Sabreman's second adventure. It was a lot of fun and made you wonder why Stefan didn't attempt a *Knight Lore* clone next. It also made you speculate what the Stampers themselves would have come up with if they'd supported the QL.

BJ IN 3D LAND

- » RELEASE: 1986
- » PUBLISHER: EIDERSOFT
- » CREATOR: JANKO MRSIC-FLOGEL
- » BY THE SAME DEVELOPER: QL CAVERN

04 The brilliantly named Janko Mrsic-Flogel achieved some press on the publication of his first game, *QL Cavern*, on account of him being just 16 years old at the time. He went on to become one of the machine's most prolific programmers and this second sequel to *QL Cavern* is his best. Unlike the previous two games in the series, *BJ In 3D Land* swapped the 2D approach for an isometric viewpoint and gameplay that was similar in style to Atari's *Crystal Castles*. It was also much more forgiving than the earlier *BJ* games in that you had an energy bar rather than a meagre and dwindling supply of lives.

QL QUBOIDS

- » RELEASE: 1986
- » PUBLISHER: SINCLAIR RESEARCH
- » CREATOR: AJS
- » BY THE SAME DEVELOPER: N/A

05 *QL Quboids* was one of the fresh new games that Sinclair put out as it renewed its efforts to support the QL following its price slash in late 1985. Talking its cue from *Lode Runner*, it was a platform and ladders affair where you had to dig holes to trap various enemies. The pleasingly chunky main character was reminiscent of the astronaut from Odin's *Yesod* games and sprite movement was fast and smooth. The only downside was that the game suffered from that peculiar Eighties ailment 'ladderitis', where your character would stubbornly refuse to budge from the ladder unless he was lined up perfectly with the platform. Damn ladderitis...

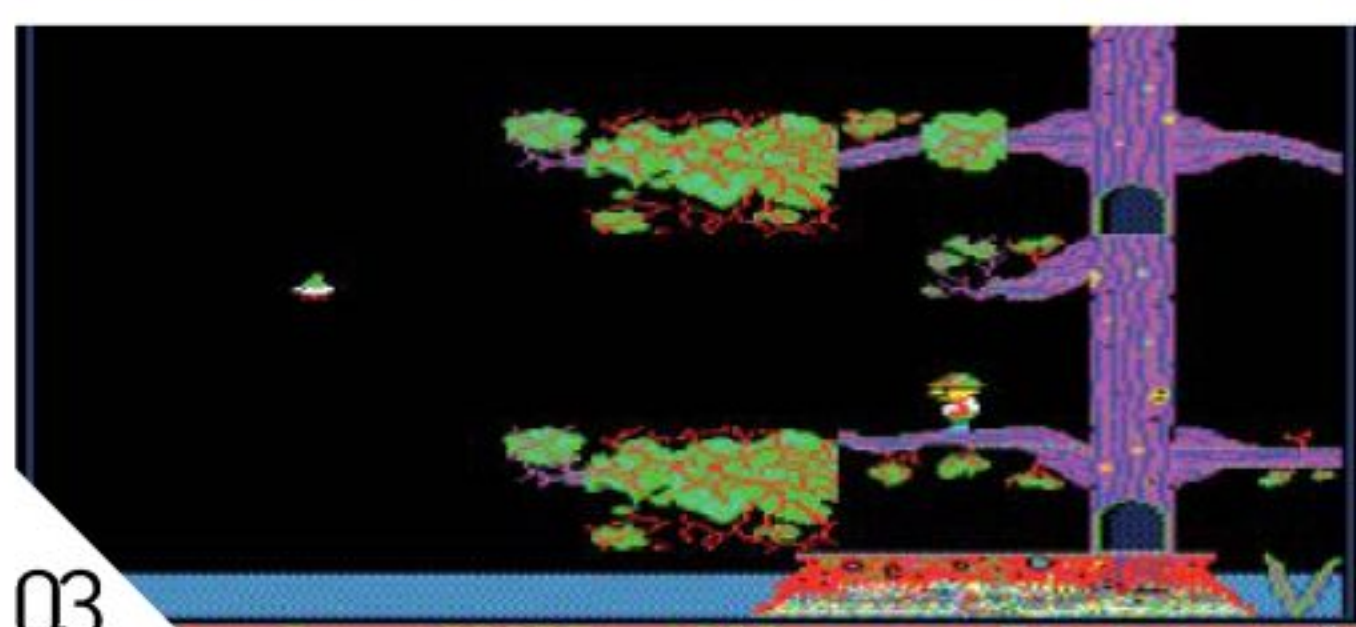
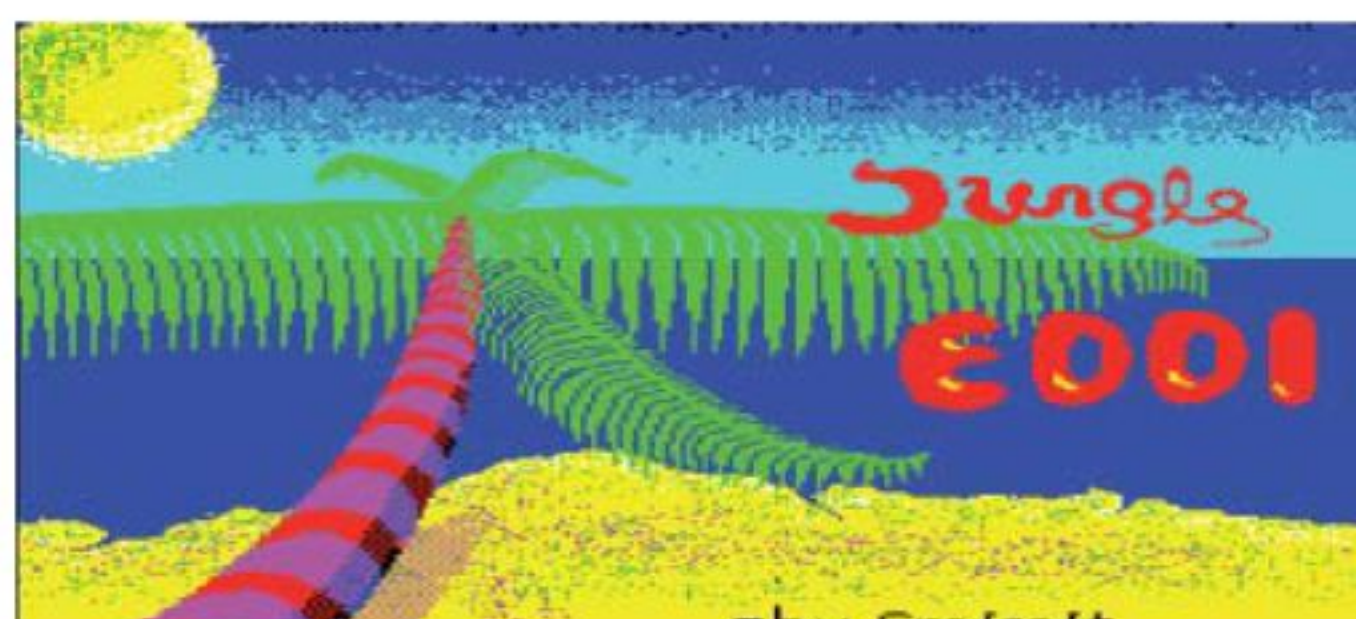

03

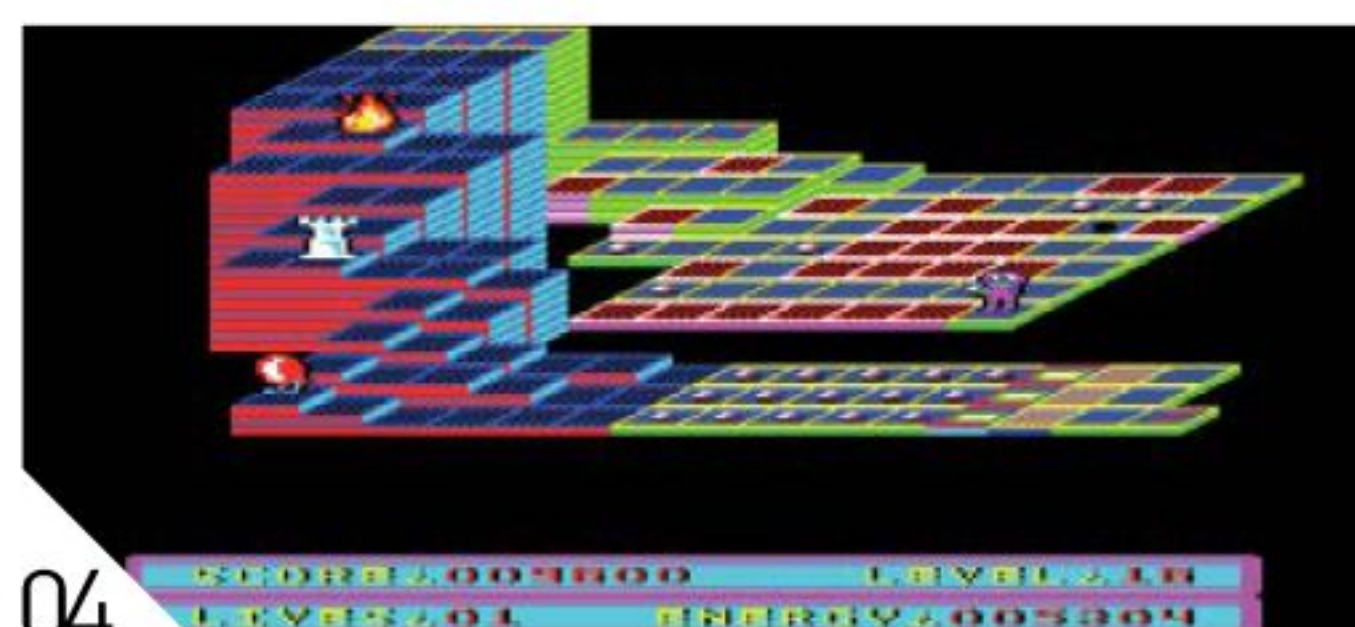
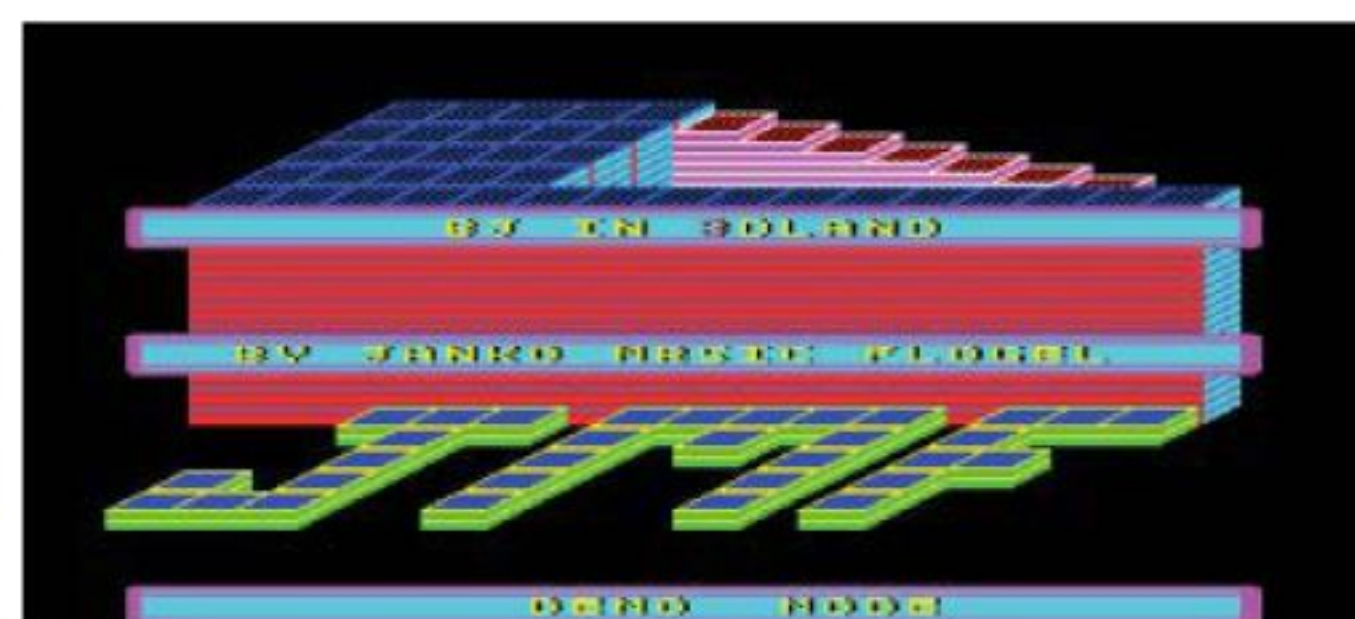

04



05



06



07

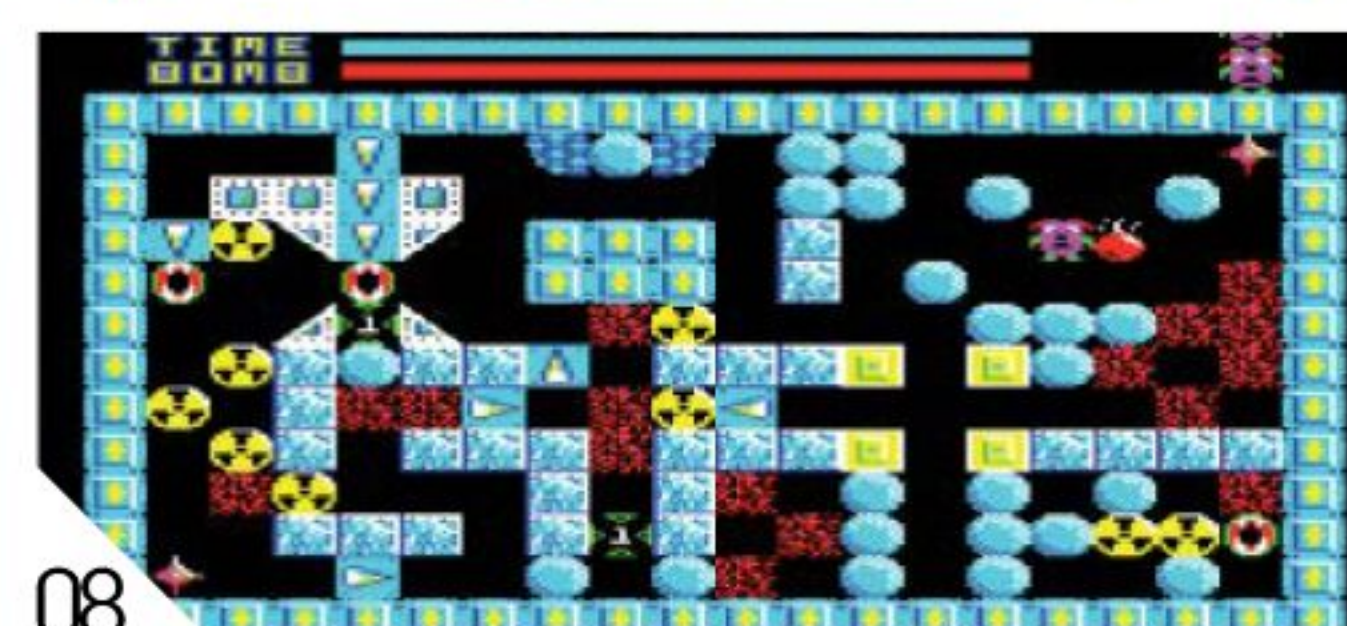

08

DEATHSTRIKE

- » RELEASE: 1987
- » PUBLISHER: TALENT COMPUTER SYSTEMS
- » CREATOR: DAMON CHAPLIN
- » BY THE SAME DEVELOPER: SPOOK

06 It was a long time coming, and sceptics said it wasn't possible, but *Deathstrike* was the first game to successfully implement full-screen scrolling on the QL. Okay, so the game in question was an unashamed *Scramble* clone, but it was a playable and faithful one, and certainly up to the standard of the arcade original. Navigating your ship through some of the tighter caverns was cruelly difficult, but the desire to push on and see the next stage ensured that you'd try again. Fans of vertical shooters would do well to check out another of Damon's games: the brilliant *Assault And Battery*.

SPEEDFREAKS

- » RELEASE: 1989
- » PUBLISHER: KAOS SOFTWARE
- » CREATOR: DAMON CHAPLIN
- » BY THE SAME DEVELOPER: ASSAULT AND BATTERY

07 *Spook was great* and *Deathstrike* was even better, but *Speedfreaks* was Damon's crowning achievement. This utterly fantastic *Super Sprint* clone featured eight challenging tracks and support for up to three players. With or without multiplayer, it was easily the most fun arcade game available for the QL. The cars were small but slickly animated and the controls were nice and tight. It was also one of the few games to make decent use of sound, even if the rumbling of the cars' engines sounded vaguely flatulent. This is a great little game that's still as playable now as when first released.

PUDGE

- » RELEASE: 1991
- » PUBLISHER: KAOS SOFTWARE
- » CREATOR: DAMON CHAPLIN
- » BY THE SAME DEVELOPER: DEATHSTRIKE

08 Another Damon Chaplin game in the top ten? That may seem slightly blinkered, but not if you spent a few minutes in the company of *Pudge*. Rather than a straightforward clone, *Pudge* takes a bit of *Boulder Dash*, stirs in some *Solomon's Key*, and cooks the whole thing up to create a tasty slice of puzzle pie. On each screen you had to first surround a ticking bomb with boulders, preventing it from exploding, then gather up the radioactive barrels and dispose of them. It's a real shame *Pudge* arrived so late in the day that only the QL's most stalwart supporters will have ever played it.



09

MORTVILLE MANOR

- » RELEASE: 1986
- » PUBLISHER: PYRAMIDE
- » CREATOR: KYILKHOR CREATION
- » BY THE SAME DEVELOPER: MAUPITI ISLAND

09 You may be familiar with this sumptuous adventure game from French publisher Pyramide, as it was also released on the PC, ST and Amiga. It made its debut on the QL, however, and while the original may not pack the visual clout of the later versions and is comparatively sluggish – you have to watch as each location image is painstakingly drawn on screen – it's still a very playable piece of interactive fiction. The game saw you exploring the creepy old dwelling of the title, finding objects and speaking to people in a bid to uncover a killer. All in all, it was a welcome change of pace from the QL's many arcade-style games.

QL PAWN

- » RELEASE: 1985
- » PUBLISHER: SINCLAIR RESEARCH
- » CREATOR: MAGNETIC SCROLLS
- » BY THE SAME DEVELOPER: THE GUILD OF THIEVES

10 With the QL having a wide display and being able to drag data quickly off microdrive cartridges, it was ideally suited to hosting text adventures. It was strange, then, that only a handful of titles were ever released for the machine. Still, it wouldn't be right to grumble when an adventure as groundbreaking as *The Pawn* was one of those available. If you're a fan of the genre then the game needs no introduction, and if you don't care for boring old text adventures, *The Pawn* might just change your mind. The QL version lacked the stunning location graphics of the later releases, but that shouldn't detract from what is a first-class adventure and a true QL original.



10



NEO GEO AES

NEO·GEO AES



SNK'S JET BLACK JUGGERNAUT LANDED IN 1991 WITH HUGE CARTRIDGES, BIGGER CONTROLLERS, AND A STRATOSPHERIC PRICE TAG. JOIN US AS WE CHRONICLE THE HISTORY OF THE LONGEST-LIVED HOME CONSOLE EVER, AND THE FIRST TO BRING TRUE ARCADE PERFECTION INTO YOUR LIVING ROOM – IF YOU COULD AFFORD IT...

If you weren't around in 1991, you might know the Neo Geo as something of a mythical beast of the gaming world. You may have heard rumours of games that cost hundreds, maybe even thousands of dollars. Perhaps you have seen its massive arcade-style joystick controllers, or stumbled into a Neo Geo internet forum, only to have your head virtually chewed off by the regulars. Or, maybe you are one of the lucky ones who has actually played a Neo Geo, and has joined the thousands of fans worldwide who regard the system as the crown jewel of a bygone era in gaming. These unfortunate souls are doomed to live with the sad knowledge that there will never be another system quite like the Neo Geo ever again. What is so special about this system that it can inspire such fervour in its fans? Read on...

Before the days of Neo Geo, its creator, SNK – also known as Shin Nihon Kikaku, or 'New Japan Company' – was a moderately successful Japanese arcade game developer responsible for such titles as *Vanguard*, *Alpha Mission* and *Ikari Warriors*. Thanks to its success in the late Eighties in the arcades and with various NES ports, SNK decided to experiment with new, unconventional ideas for expanding its presence in the arcade market. One such idea would lead to the birth of the Neo Geo arcade hardware – MVS, or Multi Video System – and, subsequently, the Neo Geo home console, the AES.

In the late Eighties, most new arcade games came on a single large circuit board and were sold complete with dedicated cabinets, at a significant cost. Arcade operators who wanted to have the latest games had to invest

considerable money and floor space while shouldering a great deal of risk as to whether their investment would actually pay off. SNK sought to change that with its new machine. The Neo Geo MVS was a single cabinet that could accommodate between one and six different titles in the same machine, depending on which model was purchased. Instead of new games being released as entire circuit boards containing the processing logic in addition to the game ROM, games would be sold as individual cartridges that contained only the game ROM data, leaving the logic integrated onto the MVS arcade board.

Luckily, SNK didn't skimp on the technical specs, and the MVS stood tall next to other arcade games of its era and proved to be extremely versatile as the years went on. The Neo Geo featured a fast 16-bit Motorola 68000 CPU, as well as a companion 8-bit Z80 CPU, hence the '24-bit' moniker. Multichannel stereo sound with digital audio capabilities was also integrated into the machine.

Perhaps the most striking aspect of the MVS, however, was its advanced graphics capabilities. The hardware allowed for 4,096 simultaneous colours on screen, a fact that SNK later touted in advertisements when advocating its technical superiority to the Sega Mega Drive and Super Nintendo. The Neo Geo was capable of displaying hundreds of massive, flicker-free sprites simultaneously, some of which could be larger than the entire screen. The cartridge format allowed the hardware to stream graphics from the game memory extremely rapidly, allowing for butter-smooth animation that would later prove a valuable asset for fighting games and pre-rendered 3D graphics.

That leads us to the home console counterpart to the MVS: the Neo Geo AES. It is important to remember that in the late Eighties and into the early Nineties, many of the most commercially successful console games were ports of the most popular arcade games of the time. High-quality arcade ports were viewed as system sellers. In



» Some 'dog tag'-style US-released Neo Geo cartridges, featuring the 'Bigger, Badder, Better' Neo Geo logo with the game title against a black background.



“ Fans worldwide regard the Neo Geo AES as the crown jewel of a bygone era in gaming ”

INSTANT EXPERT

■ **SNK actively supported** the Neo Geo AES with new releases from 1991 through 2004, making it the longest-lived home videogame console in history.

■ **Puzzled, aka Joy Joy Kid**, a launch title in Japan, was the smallest Neo Geo AES game, weighing in at just 22 megabits. The largest AES title was *The King Of Fighters 2003*, released in 2004, at 716 megabits.

■ **Of the 148** Neo Geo MVS titles officially released in the arcade, 117 had an AES home cartridge release in Japan. Of those, 93 had an official English-language counterpart.

■ **AES cartridges came** in three distinct types of packaging. The first-generation titles in Japan were released in easily damaged cardboard boxes. SNK quickly switched to a more durable, soft clamshell-type case, and eventually to a hard plastic snap case, beginning with the release of *Fatal Fury 3* in 1995 through the final release in 2004.

■ **All Neo Geo** games use identical ROM chips in the cartridges, regardless of region or format (AES or MVS). As a result, the mode and language in which a Neo Geo game plays is entirely dependent on the format and region of the system playing it.

■ **The Neo Geo AES 'Gold System'** was launched on 1 July 1991 in the United States and came with the console, two arcade-style joysticks, and *Magician Lord* as a pack-in. MSRP was \$649.99. The average MSRP for individual launch titles was \$199.99.

■ **Four-player gameplay** was possible on the AES. Certain titles, such as *League Bowling*, had a small 1/8" linkup port in the top of the game cartridge, allowing gamers to sync with another console running the same game. Only three games ever made use of the feature.

■ **Early MVS (arcade)** Neo Geo machines featured a memory card slot built in to the cabinet. That way, AES users with a memory card could continue games where they left off in the arcade.

■ **At some point** in the development cycle, each Neo Geo title was assigned a unique three-digit 'NGH' number, found within the game code itself. Because there are holes in the otherwise sequential known list of NGH numbers, it is believed that there were many Neo Geo games developed that never saw official release.

■ **'AES' is an acronym** for Advanced Entertainment System, another name for the Neo Geo home console. 'MVS' refers to the Neo Geo Multi Video System, the Neo Geo's arcade counterpart.



NEO GEO AES

▶ bringing arcade games home, game developers of the era were usually faced with the daunting task of reprogramming the games from the ground up for the less powerful home hardware, often with very mixed results. While some ports were able to capture the spirit of the arcade original, they were very rarely perfect, and purists were always quick to recognise omissions and compromises.

That was simply not good enough for SNK, and the idea of arcade perfection formed the foundation of the AES home console. SNK decided that its arcade

MVS games would also be made for its AES home system, and the games would be indistinguishable from their arcade counterparts. Therefore, the AES was manufactured to be technically identical to the arcade hardware. In fact, AES games actually used the exact same ROM chips as



» As with most collectables, counterfeit items can be a problem. These two AES cartridges look harmless enough but actually contain altered, fan-made case inserts in place of the SNK originals. Buy with caution!

the arcade cartridges, although the two cartridges were not interchangeable due to different pin connectors. Thus, gamers were guaranteed the same experience at home as they had in the arcade.

Shortly following the launch of the arcade hardware and after test-marketing the AES as a rental unit, SNK decided to sell the AES system worldwide and market directly to consumers. To assist in marketing the console in the US, SNK of America created a special position known as 'Game Lord'. This was a face gamers could associate with the system who would also be responsible for getting the word out to potential buyers. Longtime game industry veteran Chad Okada was selected for the task. "SNK originally created this position because the US branch was in need of a person who knew all the aspects of videogames," he recalls. "To market the product well, they needed to know the competition and they needed someone who knew videogames as a whole, from a strategic marketing standpoint and from a gamer standpoint."

» MVS to AES converters (two different models pictured) allow AES owners to play relatively cheap MVS games on their AES consoles in lieu of forking over hundreds of dollars for rare AES originals.

As with many things in life, perfection came at a price. The prices of the machine and its games are almost legendary in the history of gaming. Due to the advanced technology involved, the system's price was unprecedented at the time of release. The Neo Geo Gold System, which included one game, launched in the US in 1991 at \$649.99, with games averaging \$199.99 each.

The console itself had a sleek, elegant facade that was completely black, reinforcing its image as an 'elite' console. The game cartridges were larger than VCR tapes, had two edge connectors

underneath, and were packed with expensive high-capacity ROM chips – and they also smelled of solder; a sure-fire way to tell a 'fresh' cartridge! To highlight its arcade roots, the system also included two large four-button arcade-style joysticks, each of which was almost as large as the system

itself. At the time, the price of one AES cartridge was more than a brand new Sega Genesis console. More than one parent would lose sleep over the idea of keeping their kid happy with a fresh supply of games for this beastly unit.

Okada recognised the difficulties SNK faced in getting the console into gamers' hands, given the high price and retailers' reluctance to take a risk on the machine. "Early on, the strategy was to gain attention – not necessarily positive attention – and to market to a consumer that was older, richer, and could afford a premium-priced game system," he continues. "It was thought that we could only sell in places similar to a Sky Mall or Sharper Image. It was a difficult product to sell because of the price point."

As a result, SNK had to focus on the obvious technical superiority of the system while acknowledging the higher price tag. SNK had a very aggressive, adult-themed advertising campaign, and advertised in adult magazines in addition to the popular game magazines of the era. "It will always be known that SNK



» The mascot of the 'Bigger, Badder, Better' marketing campaign violently breaks off his leash to gnaw through the controller of your wimpy non-Neo game system in this classic ad.





» *Magician Lord* was a launch pack-in, and as such is very common on the used market.

COMMUNITY THE BEST NEO GEO AES RESOURCES ON THE WEB

neo-geo.com

■ This should be the first stop for anyone with even a fleeting interest in the Neo Geo. Home to the infamous Neo Geo forums and its community of rabid fans, the site also features price guides, master game lists, game reviews, cartridge photos, collection galleries, and the Neo Store, where high-end Neo goods are regularly stocked from sources worldwide.



neogeoforlife.com

■ Kazuya_UK's Neo Geo reviews site has long been one of the finest Neo Geo fan sites on the 'net. Here you can find in-depth reviews for nearly every Neo Geo title, including ports to other consoles and even SNK-developed games for other platforms. The site is loaded with screenshots and is the best place to get the lowdown on whether a title is worth your time.



unibios.free.fr

■ The Universe BIOS, created by community legend Razoola, is a handy console modification that unlocks the full potential of the game cartridges in both AES and MVS units. Gamers can access debug modes, cheats, hidden game data, and even play the games based upon different hardware configurations. Think of it as a Game Genie for your Neo Geo! Essential.



ngdevteam.com

■ NG Dev Team marketed and released *Last Hope*, a homebrew shooter, on the Neo Geo in 2006. The cartridge was priced at \$550 and was limited to 60 units produced. The fact that it sold out instantly is a testament to the dedication of Neo Geo fans and the continued interest in new releases. Who knows what the future holds for homebrew development?



» An exclusive photo of the two rarest and most valuable AES titles ever: English *Kizuna Encounter* and *The Ultimate 11*. Unlike most English AES titles, these are believed to have only been distributed in Europe and fetch thousands of dollars each in the rare event a copy surfaces for sale.

► tried to convince consumers that the Neo Geo [AES] was exactly the same as the \$4k machine in the arcades. And this was the truth," says Okada.

Fortunately for SNK, gamers quickly recognised the technical advances that the Neo represented. The AES launched alongside a host of software titles, and no popular genre was overlooked. There were action games (*Cyber-Lip*, *Magician Lord*, *The Super Spy*), sports games (*Top Player's Golf*, *Super Sidekicks*), shooters (*Ghost Pilots*, *Alpha Mission II*, *Last Resort*, *NAM-1975*), platformers (*Blue's Journey*), racers (*Thrash Rally*, *Riding Hero*), brawlers (*Burning Fight*, *Mutation Nation*), and even a pseudo-RPG known as *Crossed Swords* – obviously a difficult genre for the arcade. The vast majority of games all looked, sounded and played great, with many of the titles featuring high-quality speech that enhanced the home experience. Because many gamers had already played these titles in their local arcade, they salivated over the prospect of playing them at home.

"Gamers obviously went bonkers over it. They loved it. They all wanted it," recalls Okada about the launch. "When the Neo Geo was released, it was the most respected powerhouse game system out. It was a system that trounced everything out at the time and made everything else look like toys."

“ As gamers had played these titles in the arcade, they salivated over playing them at home ”

Nevertheless, retail sales for the machine continued to struggle. Then, suddenly, an event occurred that changed everything. 1991 saw the release of a little arcade title known as *Street Fighter II*, which, as everyone knows, shook the entire games industry to its core. Gamers packed arcades for their turn to go head to head against

friends and foes alike in the genre-defining 2D brawler. Suddenly, the platformers and shooters of old weren't quite as interesting. A new type of game was in town.

Luckily for SNK, the Neo Geo hardware happened to be perfect for the 2D fighting genre, thanks to its advanced

graphics, high memory capacity and four-button controller layout, which was unusual in the era of JAMMA-based arcade boards, which traditionally used only three buttons. It turns out that SNK was developing a fighting title contemporaneously with Capcom's effort, which later became known as *Fatal Fury*. Despite having only three

selectable characters and an admittedly inferior game engine, gamers jumped at the opportunity to play a decent alternative to *Street Fighter II*. *Fatal Fury* introduced many of SNK's most enduring and beloved characters, such as Terry Bogard and Geese Howard, as well as unique gameplay mechanics, including two-player co-operative gameplay and the 'line change' system. Plus, it looked and sounded great for its time. The fighting game frenzy was so intense that SNK quickly began producing additional new fighting franchises, such as *World Heroes* and *Art Of Fighting*. The games were so successful in the arcade that SNK couldn't release new sequels fast enough – barely nine months separated the release of *Fatal Fury 2* and *Fatal Fury Special* in 1993, for example.

In 1993, SNK released *Samurai Shodown*, a bloody weapons-based fighter set in feudal Japan. This incredible game proved that SNK was willing and able to challenge genre conventions and go toe to toe with Capcom in the fighting



NEO GEO AES



Samurai Shodown V Special: Neo Geo's final bow, complete with controversy

■ THE FINAL NEO Geo AES title, *Samurai Shodown V Special* (known as *Samurai Spirits Zero Special* in Japan), was released worldwide on 9 July 2004 at a retail price of ¥39,800 (\$359.99 in the US). Fans had clamoured for the release after seeing videos and screenshots revealing all-new violent fatalities for each of the beloved characters. When the AES cartridge finally arrived, fans were shocked to not only find bugs in the game's practice mode, but also that the fatalities had been removed. Fans could not understand the last-minute decision to censor the game in the age of *Grand Theft Auto* and were even more offended given the high price paid for the release. The uproar became so severe that SNK Playmore issued an unprecedented global recall of the Japanese and English AES cartridges, replacing a ROM chip inside the cartridges to allow for "toned-down" fatalities. Meanwhile, during the recall process, a talented Neo Geo fan developed a method to unlock the full fatalities in the game code of the original release using a specialised system BIOS (the 'Universe BIOS'). Of course, this disappointed fans that had purchased the game at release, only to ship it right back to SNK Playmore for what was supposedly a superior version.

As a result of the recall, there are now both 'fixed' and 'unfixed' versions of this AES release – SNK placed a small Neo Geo logo sticker on the cartridge shells to identify 'fixed' versions. Today, original 'unfixed' cartridges are very scarce and command a premium in the collectors' market, since that is the only version to contain the full fatalities hidden in the game code. Looking back, the episode serves to highlight a certain disconnect that SNK Playmore had with its loyal fans, who were certainly mature enough to handle a little blood and violence after forking over \$350+ for a game on a 14-year-old console.

At least it appears that SNK Playmore tried to send the Neo Geo off on the right note. The back of the game's English manual reads: "A FINAL FAREWELL: To all of our customers who have purchased NEOGEO ROM cartridges up till now. Thank you very much. We offer our most heartfelt gratitude for your loyal patronage over these 14 full years and hope for your continued support for our games on the many other platforms we will provide products for in the future. NEOGEO fans rule!"

game arena. The heated competition between the two companies would last through the decade and beyond as both companies tried to out-innovate each other with each new fighting game release. SNK's hugely successful *King Of Fighters* franchise, launched in 1994 and subsequently released in annual instalments through 2003, always went head to head with the hottest Capcom fighters of the day and remains a tournament favourite in Japan. Those who could afford the AES home console truly had access to cutting-edge titles, and this back-and-forth competition explains why almost half of all Neo Geo AES games are 2D fighters.

Thanks largely to the fighting genre and its cheap, modular cartridge-based design, the Neo Geo MVS was highly successful in establishing a foothold in arcades worldwide. Unfortunately, sales of the AES never really

took off, and by the mid-Nineties the system had practically vanished from store shelves. "Even with the amount of marketing we had out for the Neo Geo at the time, we couldn't get the product into big name chains," remembers Okada about the console's failure to break into the home market. Thus, AES fans were forced to source new releases from specialist game shops that could afford to advertise in game magazines, or directly from SNK via mail order. To make matters worse, the cost of new cartridges was slowly rising, and the media was beginning to give up on the console. SNK officially halted production of new Neo Geo AES consoles in Japan in 1996, although game production continued.

Ironically, it is during this time that the Neo Geo saw some of its most important releases. *Metal Slug*, developed by Nazca, was released in 1996 and gradually grew to be one of the Neo Geo's most beloved and enduring franchises. The game took the *Contra* formula and added smooth, cartoony animation, awesome music with voice effects, and a variety of outrageous weapons. The game spawned five sequels on the Neo hardware alone, and the series has been ported to nearly every system, from the Sega Saturn to the Xbox 360. *Bust-A-Move*, also known as *Puzzle Bobble*, is one of the most well-known and oft-imitated puzzle games outside *Tetris*, and has become a staple of arcades worldwide – although, for some inexplicable reason, this title never saw an official AES release.

The failure of the AES at retail did nothing to stop SNK from developing new Neo Geo games, because the MVS continued to thrive. And, because AES and MVS cartridges were produced in the same factories in Japan, SNK was able to easily produce AES versions of the latest arcade releases at minimal cost to satisfy the small legion of loyal fans that remained. This explains the longevity of the AES system: despite the fact that the system failed at dethroning Sega or Nintendo, the success of the MVS system meant there was little risk to SNK in releasing limited quantities on the AES format.

As it turns out, quantities in some cases were extremely limited. It is estimated that, outside of Japanese releases and popular *King Of Fighters* and *Metal Slug* entries, many post-1995 titles were produced in quantities numbering in the low

hundreds. For example, the AES version of *Metal Slug*, despite being one of the Neo's most successful arcade releases, is one of the most valuable videogames ever, commanding up to \$3,000 for a complete, authentic English cartridge. The rarest games are believed to be the English releases of *Kizuna Encounter* and *The Ultimate 11*, with only a handful of copies surfacing over the years. The price of other rare AES cartridges began dramatically increasing and hasn't stopped since, making the AES one of the most collectable videogame systems



» The first AES title, *NAM-1975* (NGH-001), released to retail on 1 July 1991, next to the final AES title, *Samurai Shodown V Special* (NGH-270), released 9 July 2004.



» SNK traditionally distributed flyers to arcade operators to promote the newest MVS releases. Toward the end, many were included as bonuses with new AES cartridge purchases.

» [Right] The final Japanese Neo Geo AES release, *Samurai Spirits Zero Special*. [Far Right] *Metal Slug X* was an improved remix of *Metal Slug 2*.



» *Neo Turf Masters* is a fantastic golf game by Nazca, the same team responsible for *Metal Slug*. Like many AES games released in 1996, an authentic cartridge will cost you plenty.



» A row of English-version home cartridge releases, illustrating the 'meg count' displays and game logos directly on the spines.

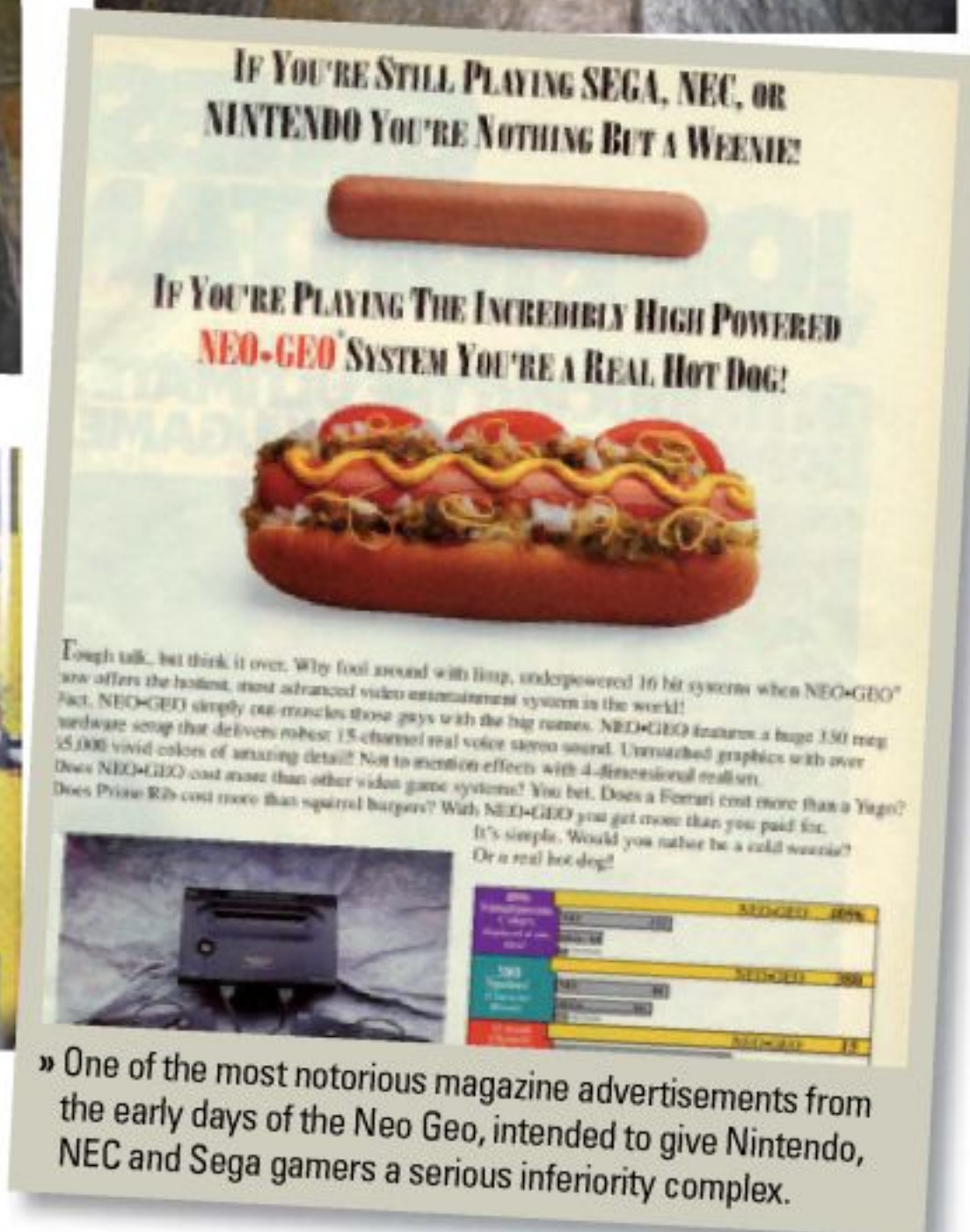
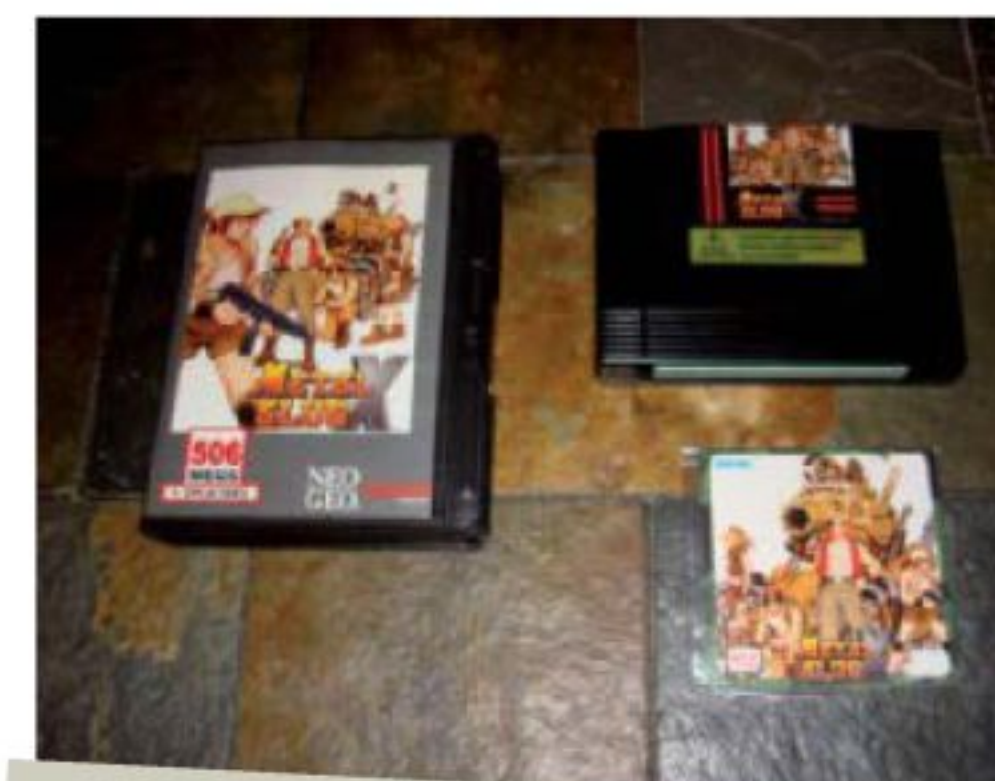

» One of the most notorious magazine advertisements from the early days of the Neo Geo, intended to give Nintendo, NEC and Sega gamers a serious inferiority complex.

► of all time. Many titles actually sell for more than their original MSRP on the used market, and a select few even fetch thousands of dollars in the rare event that a copy pops up for sale. This has led to an influx of counterfeit AES titles that can be nearly indistinguishable from SNK originals, so buyers should take care to buy only from trusted sellers. On the bright side, many of the early release titles had relatively large print runs, and brand new stock is frequently sold at reasonable prices for those interested in getting into the system.

As time went on, the games themselves continued to improve and astonish. SNK illustrated a new mastery of the ageing hardware with each new release, such as *Blazing Star* in 1998, a tour-de-force among horizontal shooters, or the sublime *Last Blade 2* in 1999, which proved SNK's mastery of the weapons-based fighter. Meanwhile, the evolution of the internet attracted new gamers to the console who longed for the 2D glory days as 3D polygonal graphics took hold of the games industry. Fans began snapping up cartridges to add to their collection as popular Neo websites began registering users by the thousands. Shawn McCleskey has owned and operated Neo-Geo.com, the most popular of all Neo-devoted websites, since 2000.

"Anyone can own a port or download the ROM, but to own these games in

their original form has enchanting appeal and is very rewarding," says McCleskey. "These games are art, from the packaging to the very game stored on the SNK boards, and to own Neo Geo home carts is to own a piece of hardcore 2D gaming history."

So how did the Neo Geo finally die? Even in 2004, after enduring the bankruptcy of SNK – later re-emerging as SNK Playmore – and spanning three different console generations, the hardware and games still proved popular in the arcades. The problem lay within the technology itself. When the Neo Geo was designed, piracy issues were simply not a major concern among the developers, mostly because the necessary ROM chips were so expensive to purchase. As a result, both the AES and MVS have no built-in copy protection. Over time, the price of ROM chips declined drastically, allowing pirates to manufacture bootleg cartridges in bulk for a tidy profit. To thwart the problem, SNK attempted to integrate various types of copy protection into some of the later releases, with little success. Toward the end of the system's life, a flood of illegitimate bootleg cartridges almost instantly followed each new MVS cartridge release. The problem eventually proved too great for SNK Playmore to overcome, and it was forced to move on to developing games for more modern hardware. Because MVS development ceased, so too did official support of the

Neo Geo AES. Many have speculated that if it weren't for the rampant piracy that plagued the MVS hardware in the 21st Century, SNK Playmore would still be manufacturing Neo Geo games today, thanks to the massive install base of the MVS hardware.

Today, over five years after its demise, the Neo Geo AES still has a massive legion of fans and hardcore collectors worldwide. The games continue to resonate with those who appreciate unmatched 2D graphics and animation combined with frantic, arcade-style gameplay. There is a certain charisma inherent in most Neo Geo games that sends one back to a time of fierce head-to-head arcade competition while reminding us what makes videogames fun in the first place. Chad Okada experienced the Neo's rabid fandom first-hand: "The fans were incredible. I have not, to this day, met any people as devoted to a videogame machine as the people who were fans of the Neo Geo."

McCleskey, whose website continues to thrive, agrees: "The fact that the Neo Geo [AES] home cartridge system is the longest-supported game system by a manufacturer in videogame history should speak loads about how dedicated the community has been. I have no doubt that there would be plenty of interest to buy, own and play any new official release from SNK Playmore if we were given the opportunity."





NEO GEO AES

PERFECT TEN GAMES



01

SAMURAI SHODOWN II

- » RELEASE: 1994
- » PUBLISHER: SNK
- » CREATOR: IN-HOUSE
- » EXPECT TO PAY: £20+

01 With its beautiful graphics, silky smooth animation and eclectic character roster, the second part of SNK's *Samurai Shodown* series is easily its best. The 202-meg cart featured new fighters, glorious backdrops and even slicker controls than the impressive original. A massive arcade success, *Samurai Shodown II* was a fantastic two-fingered salute to Capcom and proved that SNK's style and ambition knew no bounds. It certainly lacks the depth of later games in the series, but for sheer fun and accessibility *Samurai Shodown II* is without equal. A truly monumental fighter that still plays brilliantly today.

METAL SLUG

- » RELEASE: 1996
- » PUBLISHER: SNK
- » CREATOR: NAZCA CORPORATION
- » EXPECT TO PAY: £1,360+

02 Nazca's *Metal Slug* remains the definitive game in the series. Sure, we love X and 3, but the original just does everything right. The action is fast and furious and the pacing is superb, while the level design and variation remains impressive. Bosses are extremely satisfying to defeat, the tunes perfectly suit the action, and the tongue-in-cheek humour immediately makes it stand apart from other run-and-guns. It's the glorious animation and the amazingly balanced gameplay, though, that proves to be *Metal Slug's* trump card, not to mention that the titular tank is the cutest inanimate object we've ever seen.



02

THE LAST BLADE

- » RELEASE: 1997
- » PUBLISHER: SNK
- » CREATOR: IN-HOUSE
- » EXPECT TO PAY: £100+

03 Now here's a game that never seems to get enough love. Achingly beautiful – along with its sequel and *Garou*, it remains one of the Neo Geo's best-looking games – *The Last Blade's* deliberate pacing, outrageous depth and balanced characters have earned it an army of fans, and yet it's nowhere near as well-known as *Samurai Shodown*. Its alarmingly deep gameplay, over-the-top moves, ability to parry, and glorious aesthetics helped usher in a new era of Neo Geo gaming and proved just how versatile the hardware was.

BLAZING STAR

- » RELEASE: 1998
- » PUBLISHER: SNK
- » CREATOR: YUMEKOBO
- » EXPECT TO PAY: £510+

04 Sure, you can laugh at its fractured English, but play Yumekobo's stunning shooter and you'll be gobsmacked. With its mesmerising pre-rendered sprites, insane bosses, and outrageous power-ups, the 346-meg *Blazing Star* always justifies its high price tag, and along with *Pulstar*, it remains the Neo Geo's finest blaster. *Blazing Star* assaults the player with excited speech, intense alien waves, finely tuned gameplay mechanics and humongous mayors. The end result is an amazing rollercoaster of a ride that you'll never want to end.

KING OF FIGHTERS '98: THE SLUGFEST

- » RELEASE: 1998
- » PUBLISHER: SNK
- » CREATOR: IN-HOUSE
- » EXPECT TO PAY: £95+

05 It would have been all too easy to select several *King Of Fighters* for our top ten, but this is easily our favourite. Everything about *King Of Fighters '98* just screams, 'Look at me! I'm so much better than everything else!' The gameplay is instantly accessible but offers a satisfying layer of depth and its cartoony visuals still look sensational, while its many and varied backgrounds are some of the most detailed around. Add in its massive roster of excellent characters and it's another essential AES purchase.



03



04



05

With half the system's games being fighters, a fair few of them have made our Top 10. There are still some very classy – not to mention expensive – alternatives, though...



06

WINDJAMMERS

- » RELEASE: 1994
- » PUBLISHER: SNK
- » CREATOR: DATA EAST
- » EXPECT TO PAY: £95+

06 *Windjammers* proves that you don't need superlative visuals or complex fighting mechanics to become an essential AES release. Essentially nothing more than a tarted-up version of *Pong* – you fling a frisbee and use angles to slip it past your opponent – *Windjammers* is one of the finest multiplayer games on the system and combines slick controls and fast gameplay to create one of the most enjoyable games around. Like the best arcade games, it's easy to get into but includes enough nuances and techniques to ensure that you'll constantly return to it.



07

GAROU: MARK OF THE WOLVES

- » RELEASE: 1999
- » PUBLISHER: SNK
- » CREATOR: IN-HOUSE
- » EXPECT TO PAY: £340+

07 There can't be many Retro Gamer readers who aren't aware of this fantastic title, as we harp on about it every chance we get. Honestly, though, *Mark Of The Wolves* is basically the finest brawler on the AES and possibly the finest 2D fighter of all time. In addition to totally revitalising the *Fatal Fury* series, it boasts 11 new fighters, some of the best visuals to ever appear on the AES, and nigh-on perfect gameplay mechanics. It's expensive, but you could argue that you'd never need to buy another fighter.



08

NEO TURF MASTERS

- » RELEASE: 1996
- » PUBLISHER: SNK
- » CREATOR: NAZCA CORPORATION
- » EXPECT TO PAY: £1,000+

08 Extremely tough to get hold of – it currently has an 'extra extra rare' rating on Neo-Geo.com – this offering is still worth tracking down, providing you can afford it. While *Neo Turf Masters* (*Big Tournament Golf* in Japan) doesn't really bring anything innovative to the table, Nazca's superb offering plays an excellent version of the sport thanks to its slick presentation, tight controls and speedy pace. There are two modes to choose from, a variety of golfers, and some beautiful courses to play on. An excellent, surprisingly deep, game of golf.



09

FATAL FURY SPECIAL

- » RELEASE: 1993
- » PUBLISHER: SNK
- » CREATOR: IN-HOUSE
- » EXPECT TO PAY: £20+

09 Like *Garou* and *The King Of Fighters '98*, *Fatal Fury Special* is available on Live Arcade for just 800 Points. Purists may want to go for the original, and with a nice low price point it's definitely worth picking up. Essentially an updated version of *Fatal Fury 2*, improvements include a new combo system, speedier overall gameplay and a far larger roster of playable characters. Indeed, you now have access to all the bosses from *FF2*, as well as the return of several non-player characters from the original *Fatal Fury*, including Geese Howard and Duck King. It looks wonderful as well, with massive sprites and glorious backdrops.

PULSTAR

- » RELEASE: 1995
- » PUBLISHER: SNK
- » CREATOR: AICOM
- » EXPECT TO PAY: £340+

10 One day we'll confirm that *Pulstar* was created by former Irem employees, but for the time being you'll just have to be content to play one of the Neo Geo's toughest shooters. Unflinchingly difficult – our hats are doffed to anyone who has 1CCed it – it requires a hell of a lot of skill to make any sort of progress but is so fantastically designed that you'll want to keep persevering regardless, especially once you've managed to get to grips with its excellent charge system. Despite its difficulty, *Pulstar* remains a sensational addition to any Neo Geo collection and is highly recommended to all hardcore shmup fans.



10



NEO GEO AES

NEO-GEO AES

and the rest...

Undeniably expensive, the Neo Geo is host to some of the finest arcade conversions around, as the following two pages prove. How many have you played?

- 01 METAL SLUG
- 02 ART OF FIGHTING
- 03 2020 SUPER BASEBALL
- 04 VIEWPOINT
- 05 BLAZING STAR
- 06 NEO TURF MASTERS
- 07 SAMURAI SHODOWN II
- 08 FATAL FURY
- 09 NAM-1975
- 10 THE KING OF FIGHTERS '98: THE SLUGFEST
- 11 CROSSED SWORDS
- 12 ANDRO DUNOS
- 13 MAGICIAN LORD
- 14 DOUBLE DRAGON
- 15 METAL SLUG 3
- 16 EIGHT MAN
- 17 THE KING OF MONSTERS
- 18 PULSTAR
- 19 THE LAST BLADE
- 20 THRASH RALLY
- 21 ALPHA MISSION II
- 22 LAST RESORT
- 23 THE SUPER SPY
- 24 RIDING HERO
- 25 MUTATION NATION
- 26 SENGOKU
- 27 MAGICAL DROP II
- 28 SOCCER BRAWL
- 29 BASEBALL STARS 2
- 30 THE KING OF FIGHTERS '94
- 31 WORLD HEROES 2
- 32 WINDJAMMERS
- 33 GAROU: MARK OF THE WOLVES
- 34 NINJA MASTERS
- 35 STAKES WINNER 2
- 36 ART OF FIGHTING 3: THE PATH OF THE WARRIOR
- 37 BURNING FIGHT
- 38 KARNOV'S REVENGE
- 39 PUZZLE BOBBLE 2
- 40 REAL BOUT FATAL FURY SPECIAL
- 41 AERO FIGHTERS 2
- 42 SAMURAI SHODOWN IV: AMAKUSA'S REVENGE
- 43 CYBER-LIP
- 44 METAL SLUG X
- 45 SUPER SIDE KICKS
- 46 THE KING OF FIGHTERS '96
- 47 THE LAST BLADE 2
- 48 PREHISTORIC ISLE 2
- 49 TOP HUNTER: RODDY & CATHY
- 50 BREAKER'S REVENGE
- 51 NINJA COMMANDO
- 52 BLUE'S JOURNEY
- 53 PANIC BOMBER
- 54 GHOST PILOTS
- 55 FOOTBALL FRENZY
- 56 AERO FIGHTERS 3





04 05



06



07



11 12



13



14



18 19



20



21



25 26



27



28



32 33



34



35



39 40



41

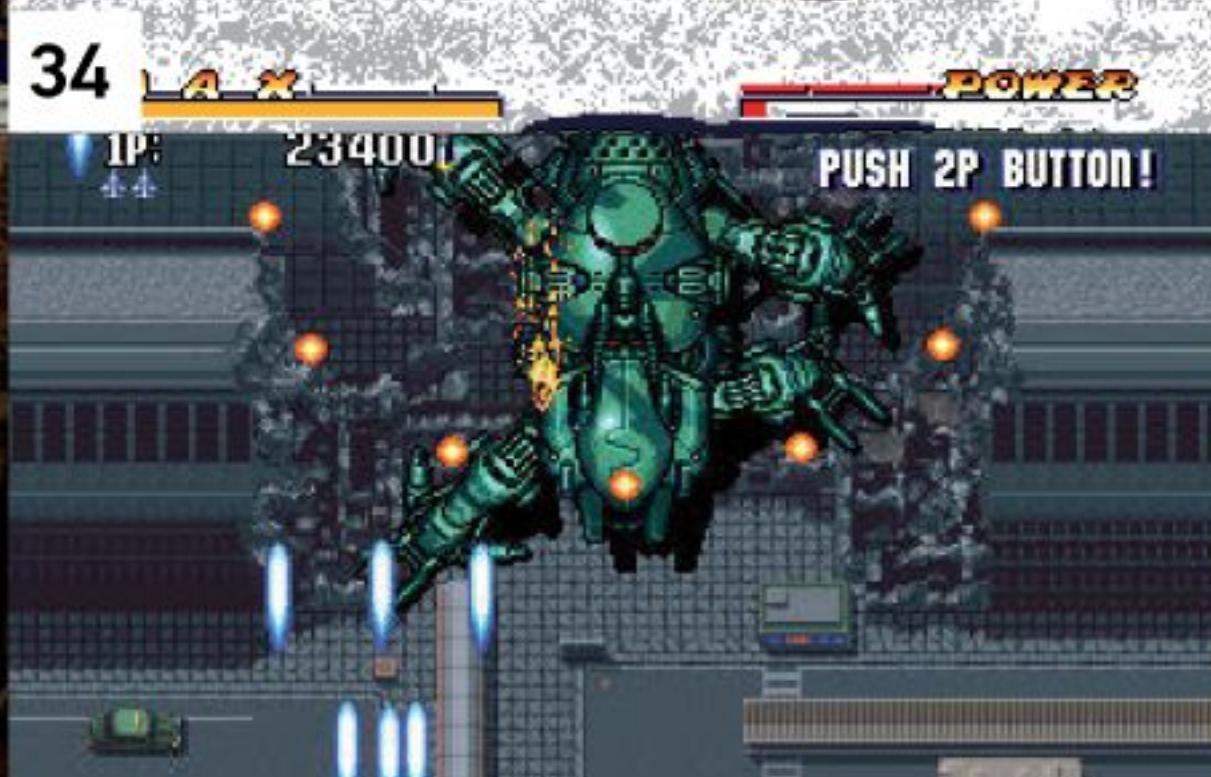

42



46 47



48



49



53 54



55



56





SAM COUPE

SAM coupé

Designed to bridge the gap between 8-bit computers and the 16-bit machines of the future, the SAM Coupé struggled and was swept away on a tide of apathy. We discover what went wrong

To call the Coupé a 'Super Spectrum' is tantamount to blasphemy in SAM circles. It's a lazy phrase, after all, based on the fact that one of the computer's four video modes mimicked the idiosyncratic output of the Sinclair machine, thereby allowing the SAM to run Spectrum software. Using the machine as a Spectrum emulator was a bit like showing it in first gear and gave no indication of the true power under the hood. The SAM's motor was a Z80B processor that ran at almost twice the speed of the Spectrum's Z80A, and it came with a minimum of 256KB memory, with 512KB quickly being standard. Audio was provided by a six-channel stereo sound chip, while the top-end graphics mode had a resolution of 256x192 and could display up to 16 colours from an available palette of 128. Its capabilities were more in line with the Atari ST than the creaky old Speccy, hence the fans' contempt for the 'Super Spectrum' moniker.

Yet the SAM's association with the Spectrum shouldn't really be sniffed at, as it was crucial in marketing the machine to potential owners. Four-page advertising features that appeared in magazines like *Crash* and *Your Sinclair* revealed just why you needed the new machine. "You've been building up your Spectrum software collection for years," ran the ad. "You want a computer with better sound, better graphics, more power – but you don't want to lose your software. The Coupé is the computer for you." It was a sound strategy. The SAM

launched in 1989 when the Spectrum hardware was seven years old and really beginning to show its age. All Amstrad had done since acquiring Sinclair was bolt a tape player and disk drive onto the existing 128K model in a bid to prolong the machine's life. It had worked up to a point, yet some publishers were starting to talk about dropping 8-bit support and focusing on the 16-bit formats instead. Spectrum owners looking to upgrade were naturally drawn to the Commodore Amiga, Atari ST or a PC-compatible, so the idea of a powerful new computer in the same league as the 16-bits, yet still able to play all the old Speccy games, was pretty damn persuasive. It also guaranteed that plenty of positive SAM editorial appeared in the Sinclair magazines.

However, there's more to the relationship between the two machines than just software compatibility. If you look closely at the SAM you'll see that the Spectrum's DNA runs right through it. The two men behind it, Alan Miles and Bruce Gordon, both worked for Sinclair Research before founding their own company, Miles Gordon Technology (MGT), in 1986. MGT specialised in designing neat peripherals for the Spectrum, such as the DISCiPLE floppy disk drive, which was presented as the professional alternative to Sinclair's flaky Microdrive storage system. Sales of the DISCiPLE, and its successor the +D, provided MGT with the funding to finance the SAM project.



» [Sam Coupé] The boot-up screen displayed a double rainbow of colours. That's supposed to be lucky, isn't it?

MILES GORDON TECHNOLOGY PLC
© 1990 SAM Coupé 512K

SPECIFICATIONS

Year released: December 1989

Original price: £169.95 at launch

Processor: Zilog Z80B
(running at 6MHz)

RAM: 256KB (expandable to
512KB internal / 4MB external)

ROM: 32KB

Onboard language: SAM BASIC

Internal storage: Two 3.5"
Ultraslim Citizen floppy
disk drives

Display: Maximum resolution
512x192 (Mode 3)

Colours: 128 available

Sound: Philips SAA1099
(six channels, eight octaves)

Associated magazines: *FRED*,
SAM Prime, *SAM Revival*

▶ When designing the SAM hardware, Bruce Gordon was clearly influenced by the work and principles of his former employer. Similar to the ZX81 and Spectrum, the SAM's innards incorporated several off-the-shelf chips and a custom ASIC (Application Specific Integrated Circuit). This design helped reduce the chip count and drive down manufacturing costs, thereby enabling MGT to undercut the competition by a considerable margin. And just as Sinclair Research had done with its computers, the SAM was to be launched in 'core' form, with the idea being that extra memory, storage solutions and other expansions could be bolted on as and when. "With the Coupé, your computer can grow with you," stated the advert. "There are

output ports for almost everything we can think of."

The machine's internal programming language could also be traced back to the Spectrum. SAM BASIC was an updated flavour of Beta BASIC, which in turn was an enhanced version of Sinclair BASIC developed by Dr Andrew Wright. Anyone who had learnt to program using Sinclair BASIC would feel immediately at home on the SAM, while the new features and functions ensured that more experienced coders would not be held back. The final link to the past was Flash, the art and animation package that was bundled with the SAM. Developed by Bo Jangeborg, Flash was an update to the popular Artist programs, which he'd written for the Spectrum. Besides introducing a bunch of new drawing tools, Flash was designed to demonstrate the SAM's visual prowess

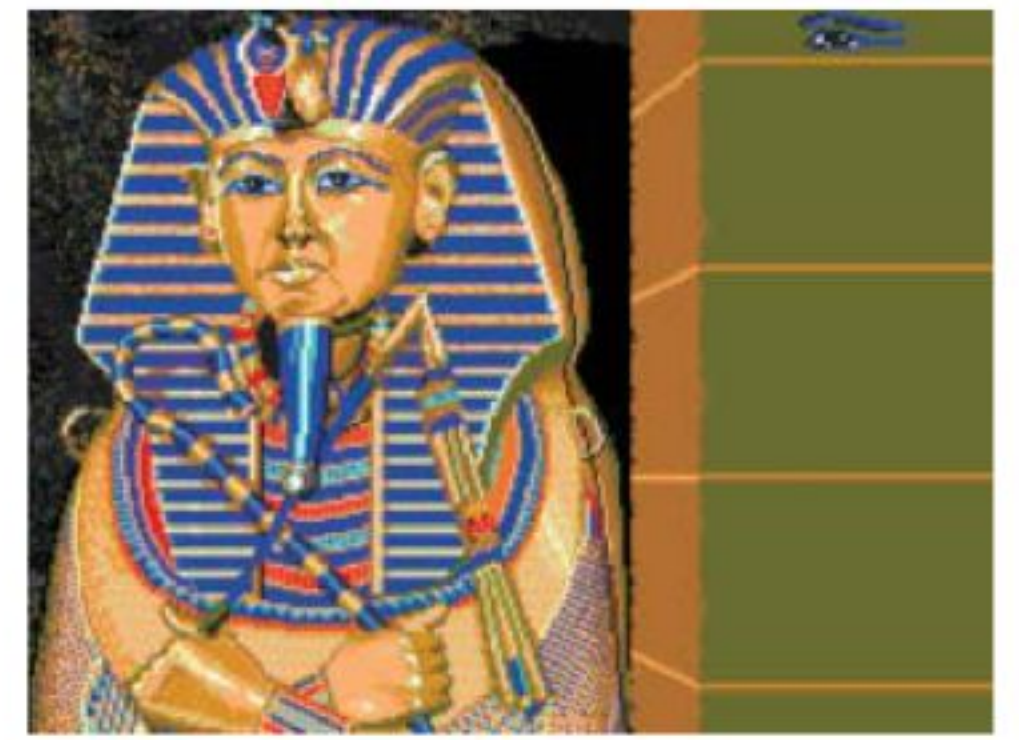

by enabling the user to create graphics in all four of the screen modes.

With the hardware and software in place, the SAM sped towards its launch date. In March 1989, *Your Sinclair* magazine revealed that the machine would be available in a couple of months time and would retail for just £150. That's right: the SAM would cost you half the price of a 520ST, and almost a third of the price of an Amiga 500. In terms of performance per pound, it looked to be unrivalled. What's more, it





SAM COUPE



BRUCE GORDON Q&A

The man who designed the SAM hardware is busy writing software for banks these days, but we managed to grab a few minutes with him to chat about his most famous creation.

■ **Retro Gamer:** How much bearing did the Sinclair computers have on the SAM design?

Bruce Gordon: It was in the design concept that we had compatibility with the Spectrum's software. However, it couldn't be another Spectrum, so we had four modes of operation, two of them being Spectrum-compatible. We promised a Spectrum-compatible machine and that's what we did.

■ **RG:** What element of the SAM Coupé hardware were you most pleased with?

BG: The ASIC chip. It had all the logic to service the needs of the processor, memory, sound chip, keyboard input and display output. So the hardware structure was simplified. I suppose it was inspired by the Spectrum design, although we put more into the ASIC than Sinclair.

■ **RG:** In hindsight, what would you have done differently?

BG: I would have gone to a bigger ASIC to accommodate more control of the display memory so that we could move the display pointers and counters. This would have enabled virtual movement of what the screen was showing relative to the memory.

■ **RG:** What were the main lessons you learnt from the whole SAM experience?

BG: It was too late in coming and we should have built a PC system with Spectrum compatibility.

■ **RG:** How do you feel about the SAM's legacy, and that there's still a dedicated community supporting the machine?

BG: When we designed the SAM, I put in as many hooks and as much connectivity as possible. I wanted it to be the type of computer that I would have wanted as a young inventor or designer. So I am very pleased and amazed at the fan following that it still has. I think from the outset it had a character of its own.



» [Sam Coupé] The Flash drawing package was the only piece of software initially bundled with the SAM.

▶ was still powered by a Z80, one of the most popular and widely known processors in existence, so there would be no shortage of software written for the machine – and, of course, it would hit the ground running with support for thousands of Spectrum titles. Surely the only way the SAM Coupé could fail was if everything that could possibly go wrong did go wrong. And that's more or less what happened.

The first problem that MGT ran into was a delay in the production of the SAM's custom ASIC by an external supplier. This pushed the launch back to December 1989 and only 200 machines were shipped out before the end of the year, meaning that MGT missed out on the lucrative pre-Christmas period. By the time the machine was available, the retail price had risen to £170. This increase didn't seem to bother the press, who were generally impressed by the SAM and the excellent value for money that it represented. However, it soon became apparent that there was a catch. If you wanted to bring the SAM up to the ST's spec, you'd need to double its memory by purchasing a 256KB upgrade for £40 and add a floppy drive for £90. This whacked up the cost to £300 – the same as an ST and within sight of the mighty Amiga and its £400 'Batman Pack' bundle.

To make matters worse, the add-on drives were delayed and they missed

“ If you look closely at the SAM, you'll see that the Spectrum's DNA runs right through it ”

the launch by several weeks. And when they did arrive, there was a bug in the DOS, which meant that the bootstrap code didn't automatically execute. Thankfully, the problem was soon patched. One problem that wouldn't go

away, however, was the poor compatibility rate with Spectrum software. MGT initially stated that 90 per cent of Spectrum tapes would load, and later reduced this to 75 per cent, while in many users' experience it was actually closer to 50-60 per cent. The main reason was that MGT didn't license

the official Spectrum ROM and so the bundled emulator used a rewritten 'skeleton ROM' instead, affecting compatibility.

Public domain emulators that used the proper Spectrum ROM and offered full compatibility would later appear, but at the time, the SAM pages in Sinclair magazines were filled with letters from disgruntled Spec-chums, listing all of the games that would and wouldn't load. To compound matters, users had to rely on the Spectrum back catalogue, as there was no sign of any dedicated SAM

software. At launch, Ocean, US Gold, Domark, MicroProse, Codemasters, Virgin and Activision all said that they would consider supporting the machine if it sold well and the demand was there. US Gold went further than the rest, famously claiming that porting games to the SAM was simply a case of mashing together Spectrum code and ST graphics. "We're getting a very experienced programmer at Tiertex called Chris Brunning to produce a SAM version of *Strider* for us," US Gold development manager David Baxter told *Your Sinclair*. "Supposedly it'll only take two weeks using our existing Speccy code and ST graphics."

Owners waited with bated breath, but *Strider* never leapt onto the SAM. In fact, it wouldn't be until June 1990, six months after launch, that the first commercial game would arrive in the shape of *Defenders Of The Earth* by Enigma Variations. The gameplay was identical to the Spectrum version, released earlier in the year, although the graphics were much more detailed and colourful. However, any celebrations were short-lived. The story goes that Enigma Variations phoned MGT to announce that the game was finished, only to be greeted by an answerphone message revealing that MGT had gone



COMMUNITY THE BEST SAM WEBSITES



World of SAM www.worldofsam.org

■ The first place to go for information about SAM Coupé hardware and software, as well as the people behind the products. The site is basically one big SAM wiki, which means that members of the community can contribute and add comments. It replaces the SAM Coupé Scrapbook, which first appeared online in 1994.



Quazar www.samcoupe.com

■ Visit Colin Piggot's Quazar site to buy software and hardware for the SAM, including his flagship Quazar Surround sound card and his new Trinity Ethernet Interface. You can also pick up his SAM games and utilities. The site is home to the *SAM Revival* magazine and you can review the contents of all 23 issues.



SimCoupé Homepage www.simcoupe.org

■ Go here to download the latest version of the fantastic SimCoupé emulator. It's available for a dozen different systems and provides close-to-perfect emulation of the SAM. Best of all, it's free to use and comes with everything you need to get it up and running straight away – and even includes some sample games.

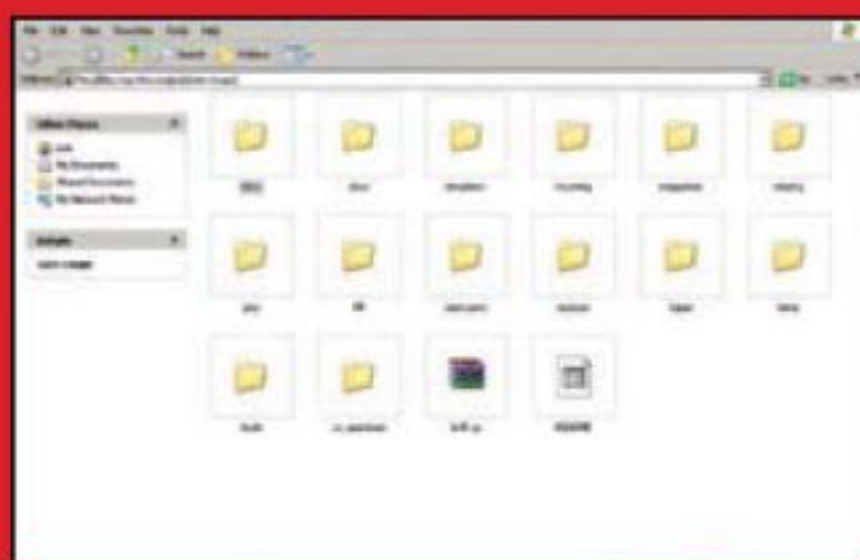

NVG FTP Site ftp.nvg.ntnu.no/pub/sam-coupe/

■ The web's original SAM resource is an absolute treasure trove if you have the time to dig deep into the various folders. Of particular interest are the magazine collections – including all 82 issues of *FRED* – and the archives of commercial and public domain software, which are available for you to download.



CHRIS WHITE Q&A We spoke to one of the SAM's most celebrated coders about converting *Prince Of Persia* and *Lemmings* to it.

■ **Retro Gamer: How hard was it to convert *Prince Of Persia*?**
Chris White: It was very difficult as there were no conversion tools, so I took screenshots of the PC version and converted them pixel by pixel to graph paper. I

then mapped the whole game by playing from start to finish. And yes, I still know the full route! It was a good experience on how to do it the hard way, but not a route I would choose again. It did show Domark that I was capable and led me into console development.

■ **RG: How did it sell?**
CW: I believe it was bought by almost every active SAM user. The accounting showed only a couple of hundred difference in SAM sales versus *Prince Of Persia* sales, which I was very happy about.

■ **RG: Was it difficult to make the *Lemmings* port authentic?**
CW: DMA gave me the graphic set for the ST version and a spec on

how the levels were made, so the SAM version looked the same. The SAM could read the disks directly so I wrote the tools to convert the images and the *Lemmings* into code format for my system.

■ **RG: How would you sum up the years working on the SAM?**
CW: It was very enjoyable. I met some very clever people and I enjoyed working against the odds and doing things above and beyond. I reckon 50 per cent of people who started on the SAM are still in software development. I know I would not be where I am now if I had not done the work on the SAM, so for that I owe Bruce Gordon and Alan Miles a huge thank you.

SAM COUPE

» This early picture shows the SAM's prototype logic array, which was painstakingly soldered by hand.

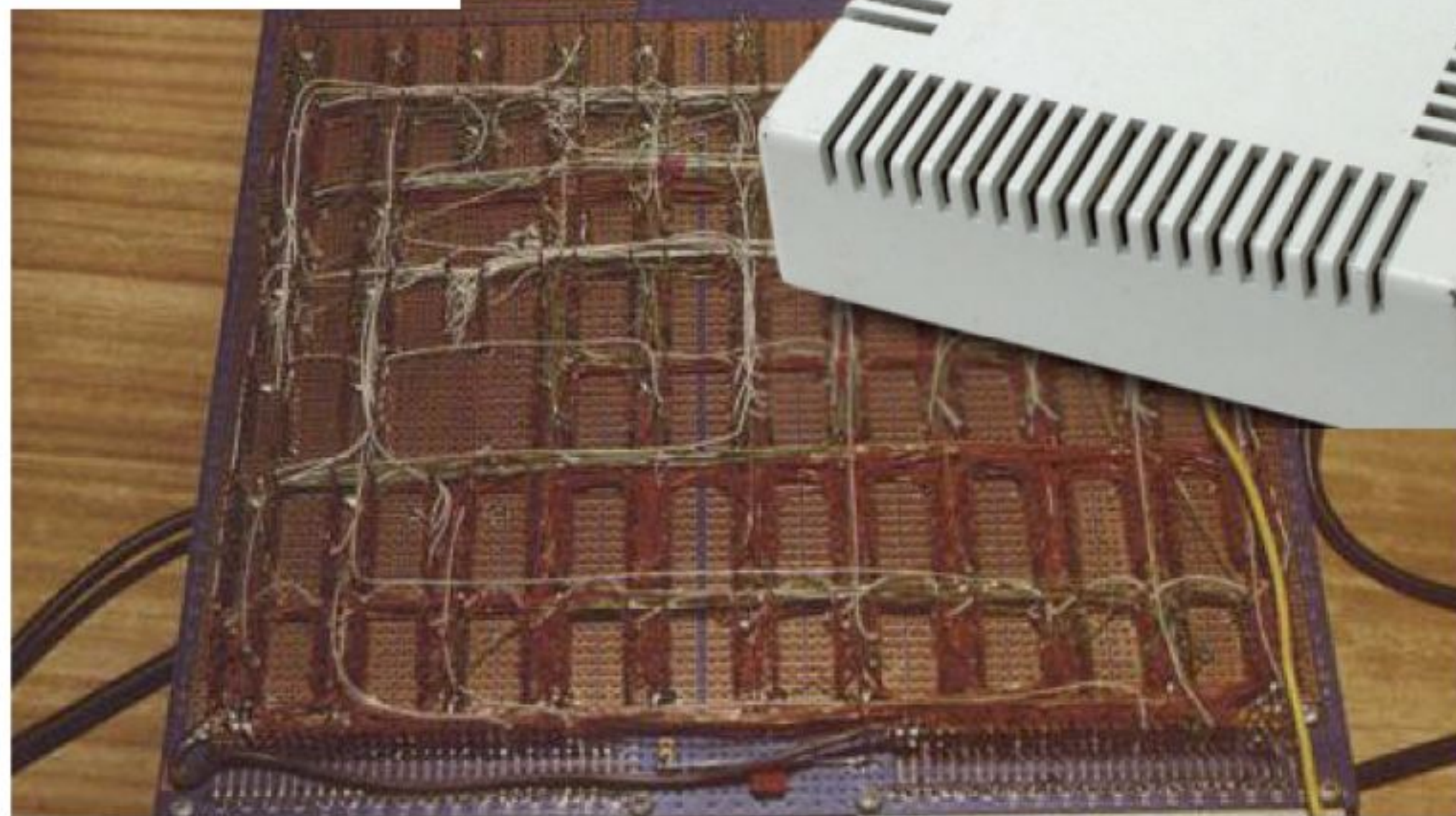

into receivership on 12 June 1990. The SAM had failed to sell in sufficient numbers and the company had simply run out of cash.

The initial hardware delay, the emulation problems, and the dearth of dedicated software all played their part in the SAM's stuttering performance. In addition, the Spectrum compatibility proved to be something of a double-edged sword – backwards compatibility meant backwards thinking to some, and the SAM was invariably linked to the Spectrum with no regard for its superior capabilities. Despite the public voting with their wallets, Miles and Gordon were confident that the machine could still be a success, though. On 6 August 1990, the pair announced the formation of SAM Computers Ltd, a new company that would continue to support their machine. SAMCo, as it was known, immediately attempted to reignite interest with two significant moves: it cut the price of the computer with one disk drive to £200 (a saving of £60), and launched its own software arm called Revelation. Under the Revelation banner, SAMCo would publish several top titles, including *Prince Of Persia*, *Manic Miner* and *Astroball*.

The SAM couldn't survive on first-party software alone, however, and while companies like Enigma Variations continued to support the machine, the user base was not large enough to attract the big hitters. This prevented potential owners from choosing the SAM over rival machines that were receiving wider and richer software support. It was a circle, and a vicious one at that. The failure of MGT probably didn't inspire consumer confidence in SAMCo either. On 15 July 1992,

after several months of inactivity, the company was liquidated.

This was not the end for the SAM as a commercial concern, however. An outfit called West Coast Computer acquired SAMCo stock and began selling it from 1993 onwards. It even released an updated model called the SAM Elite, which was basically a 512KB machine with a built-in parallel printer interface. By this point, the SAM had been embraced by enthusiasts, who prolonged its life by writing new software and building new hardware. Mainstream coverage of the computer died along with the Spectrum magazines, but dedicated disk-based magazines like *SAM Prime* and *FRED* kept the community up to date with new



developments. *FRED* became popular enough to publish its own games and managed to license *Lemmings* from Psygnosis. The scene really began to flourish, and demos that showcased the machine's graphic and sound capabilities were eagerly shared between users.

A key development occurred in 1996, when programmer Allan Skillman began work on a SAM emulator for Linux called X Coupé. Simon Owen then took on development duties and the emulator eventually became known as SimCoupé, and is currently available for Windows, OS X, Linux and many other systems.

It's estimated that just 12,000 SAMs were sold in total, but thanks to SimCoupé, anyone who overlooked the machine 20 years ago for whatever reason can now see for themselves what it really has to offer. The SAM certainly wasn't the most important 8-bit computer, and it probably wasn't the most innovative, but in many ways it was the most interesting.



SAM COUPE

PERFECT TEN GAMES



01

PRINCE OF PERSIA

- » RELEASE: 1991
- » PUBLISHER: DOMARK/REVELATION
- » DEVELOPER: CHRIS WHITE
- » BY THE SAME PUBLISHER: ELITE

01 This was the first real 'wow' game for the SAM. The preview screenshots looked amazing, yet there was always a worry that the platforming gameplay might be a little sluggish, or that the lifelike character animation might be missing a few too many frames. Thankfully the game lived up to its promise, and looked and played just like the 16-bit versions. As such, if you find playing *Prince of Persia* leads to hair-tearing frustration, the SAM version certainly won't change your mind. But back in 1991, when there were so few decent titles available for the machine, this was a must-have purchase and the closest thing it had to a killer app.

LEMMINGS

- » RELEASE: 1993
- » PUBLISHER: FRED PUBLISHING
- » DEVELOPER: CHRIS WHITE
- » BY THE SAME PUBLISHER: OH NO! MORE LEMMINGS

02 This was the conversion SAM fans had been waiting for. It was originally revealed in 1991 that the little green-haired critters would soon be marching onto the machine, and for a fleeting period it looked like a flood of quality games was on its way. This never happened though, and it would take another two years before *Lemmings* would eventually land on the SAM. By this point everyone else was playing the sequel, but all that mattered was that *Lemmings* had finally arrived! And it's a very good conversion too – a little slow, maybe, and with a slightly reduced screen size, but just as much panicked, frustrating fun as the original.



02

MANIC MINER

- » RELEASE: 1992
- » PUBLISHER: REVELATION
- » DEVELOPER: MATTHEW HOLT
- » BY THE SAME PUBLISHER: HUMPHREY

03 Most Miner Willy fans will remember talk of *Mattie Goes Mining*, the proposed, improved update of *Manic Miner* for the Commodore 64. It was sadly never released, but this sublime SAM version more than makes up for its absence. It features the original 20 levels, dressed up with colourful new graphics, plus a further 40 challenging caverns to explore. These 'lower levels' were designed by several people, but they all fit well into Willy's world and introduce some inventive challenges. SAM owners could have loaded up the original Spectrum version, but the additions made this worth the money.

ESCAPE FROM THE PLANET OF ROBOT MONSTERS

- » RELEASE: 1991
- » PUBLISHER: DOMARK
- » DEVELOPER: ENIGMA VARIATIONS
- » BY THE SAME PUBLISHER: DEFENDERS OF THE EARTH

04 Enigma Variations created *Pipe Mania*, *Klax* and this ace isometric shooter based on the Atari coin-op. Initial impressions were not good, as the intro story sequence was ripped straight from the Spectrum version. But as soon as the game started, brilliant Mode 4 graphics filled the screen and everything was fine. While the screen flipped rather than scrolling (like in the arcade and 16-bit versions), it showed that full-colour isometric games worked a treat on the SAM.

DEFENDER

- » RELEASE: 1998
- » PUBLISHER: PERSONA
- » DEVELOPER: CHRIS PILE
- » BY THE SAME PUBLISHER: PRO-DOS

05 There's an interesting story behind this version of the Williams arcade hit. Programmer Chris Pile prepared the game for Persona in 1998, but the publisher's boss died suddenly and it's thought that the game only received a very limited production run. Rather than leave the game stranded in deep space, Pile circulated the game for free and it quickly became a hit with SAM fans. Refreshingly, the game does not feature shiny new graphics and looks almost identical to the arcade original (it's so close that a few people assumed that Pile had actually emulated the coin-op code).



03



04



05

Some might say that there were no really great games for the SAM. But they'd be wrong...

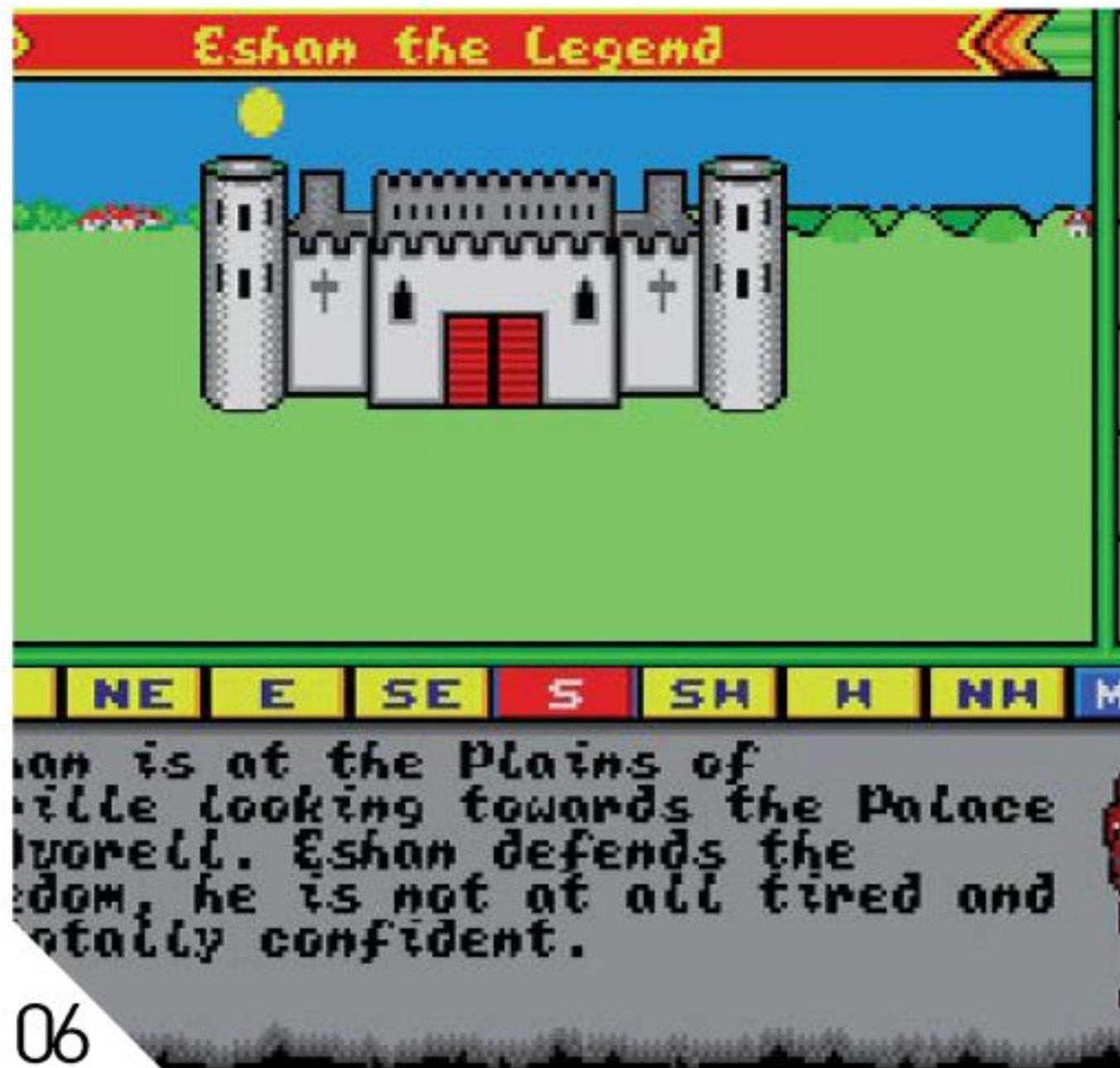

06

LEGEND OF ESHAN

- » RELEASE: 1994
- » PUBLISHER: REVELATION
- » DEVELOPER: JOHN EYRE
- » BY THE SAME PUBLISHER: SAM DICE

06 The small SAM userbase meant it wasn't profitable to license existing titles, which led to lots of clones and copies. Here's one example, which leans heavily on Mike Singleton's Spectrum classic *The Lords of Midnight*. The plot features all the usual babblings about Orcs and Witchkings and whatnot, but it's so polished that you can't help but get sucked in. There are 32,000 locations (each depicted with a pleasant Mode 4 screen) and everything is controlled through an excellent icon-driven interface (with mouse support). Those looking for adventure and strategy on the SAM will find plenty to enjoy here.



07

T'N'T

- » RELEASE: 1995
- » PUBLISHER: REVELATION
- » DEVELOPER: MATT ROUND
- » BY THE SAME PUBLISHER: RETROS

07 The SAM was home to a couple of popular creation tools – GamesMaster and SCADS – which opened the door to budding designers who weren't versed in the intricacies of Z80 coding. Matt Round used GamesMaster to create a number of quirky arcade games which appeared on the FRED disk magazine, yet *T'N'T* was so good that it was picked up as a commercial release. It's very similar to *Bomb Jack*, only with support for two players (Ted 'n' Tam, hence the title), and is vastly superior to the official *Bomb Jack* sequel that appeared on other 8-bits. This is a fun game that doesn't disappoint.

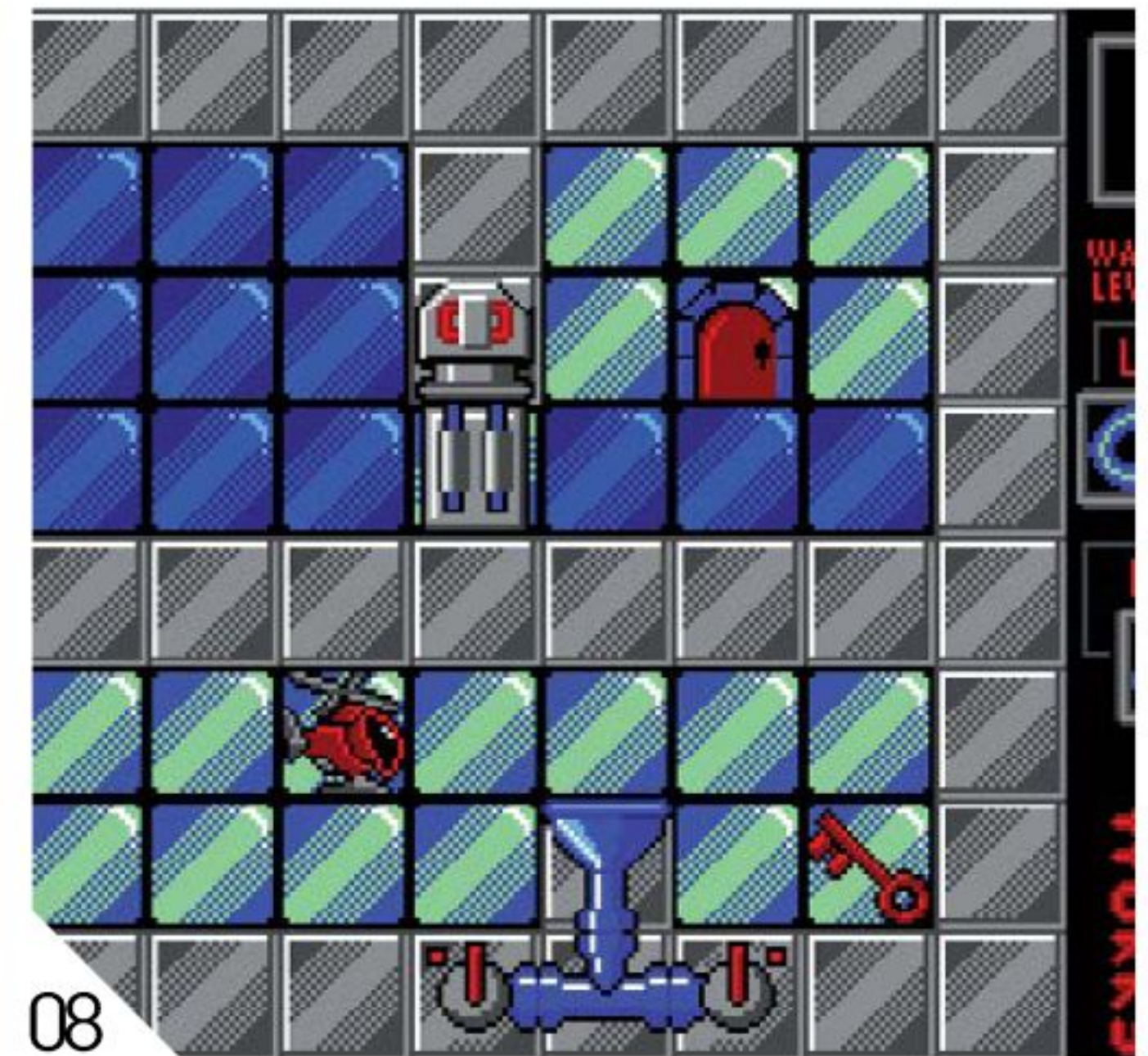

08

WATERWORKS

- » RELEASE: 1993
- » PUBLISHER: FRED PUBLISHING
- » DEVELOPER: MARTIN BELL
- » BY THE SAME PUBLISHER: WATERWORKS II

08 It was a running gag in *Your Sinclair* magazine that the SAM was home to far too many puzzle games. *Waterworks* was yet another one, and it arrived quite late in the day, so it was largely overlooked. Which is a shame, because it's a fantastic little game that at first glance looks a lot like *Pipe Mania*, yet with lots of individual touches that really set it apart. Water is both your aid and enemy, as you must use it to open doors and kill enemies, while avoiding drowning yourself. A sequel was released with several new features, but was too difficult to be enjoyable.



09

STRATOSPHERE

- » RELEASE: 1997
- » PUBLISHER: QUAZAR
- » DEVELOPER: COLIN PIGGOT
- » BY THE SAME PUBLISHER: MONEY BAGS

09 Quazar's Colin Piggot spent almost a year writing this four-disk SAM epic to show that the SAM was capable of producing a wire-frame 3D game. And it really works – the graphics move around with speed and smooth fluidity, with the only downside being that the display takes up almost half of the screen. The game plays a lot like *Battlezone* and the aim is to collect flags in each of the 40 levels while battling it out with enemy craft. *Stratosphere* includes support for the Quazar Surround soundcard, so it loses some of the intended effect when played under emulation. However, if you've got the Quazar kit, it's a must-have title.

INVASION II

- » RELEASE: 2004
- » PUBLISHER: QUAZAR
- » DEVELOPER: WARREN LEE
- » BY THE SAME PUBLISHER: SNIPER FIRE

10 The original *Invasion* was a simple shoot-'em-up written in GamesMaster that appeared on FRED (issue 58). Several years later, author Warren Lee fired up GamesMaster again and produced this top-quality sequel, which is a platformer rather than a shooter. Clearly inspired by games like *Impossible Mission* and *Flashback*, you have to infiltrate an enemy base while trying to keep your head (which seems to get removed from your shoulders all too often). The graphics are small but detailed, and the quality of the animation is generally excellent. If you fancy your chances against the alien threat, the game was featured exclusively on the coverdisk of SAM Revival issue 10.

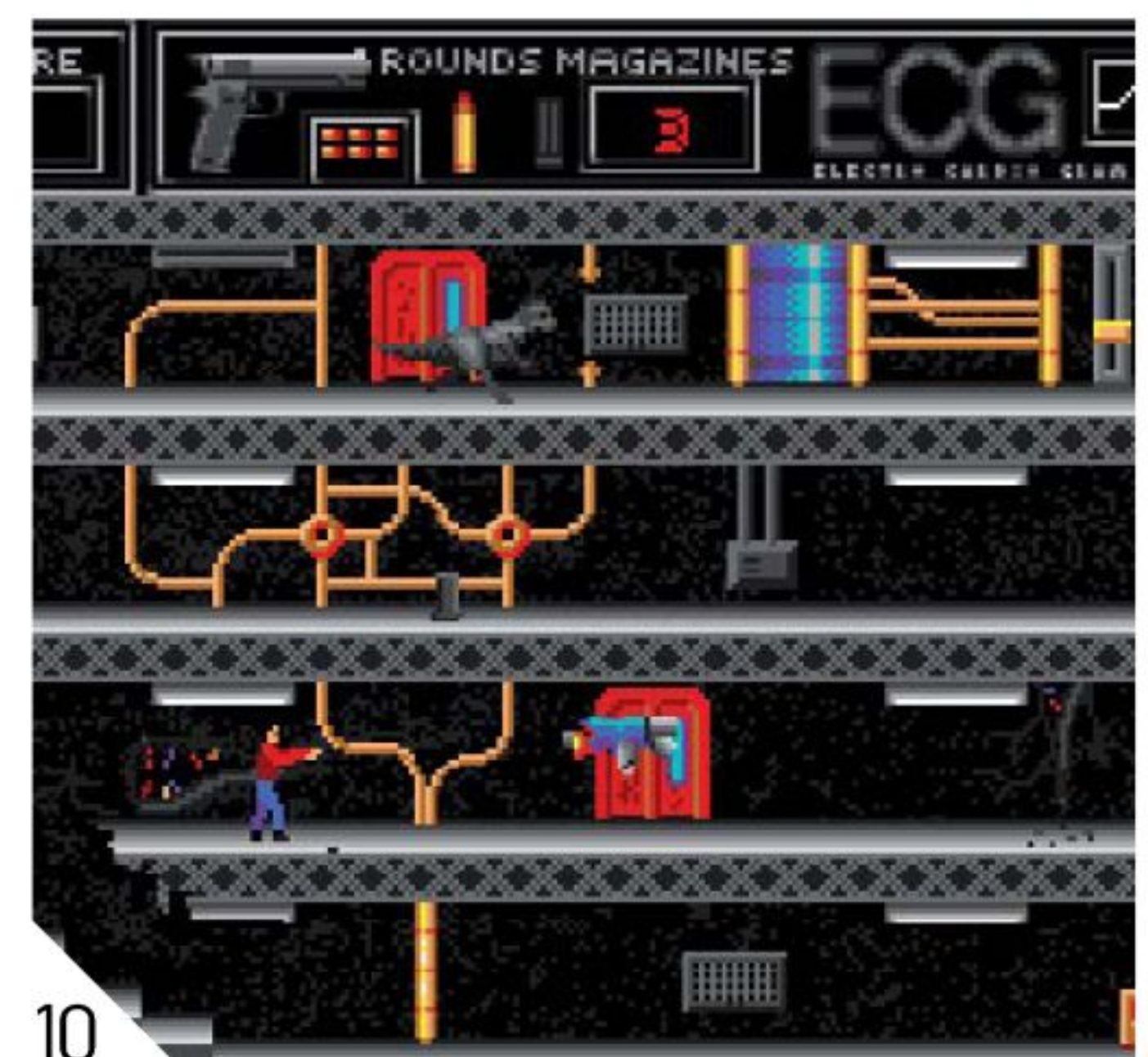

10

RETRO

Studio

The RCA Studio II, an obscure Seventies console long glossed over in the annals of video game history, finally sees its exclusive origin story come to light – you certainly will not want to miss it



II

The RCA Studio II has to be one of the more unique and interesting consoles for us to write about. Not just because it was only on the US market for about a year, sandwiched in between the Fairchild Channel F

and Atari Video Computer System, but because of the new found respect for this console that tracking down its origin history provided us, a history that has never been presented before, until now.

The origins of the Studio II present themselves in a time in history when there was a movement in the electronics industry towards pursuing the next big thing in computer technology. We're talking about the idea of shrinking the CPU of large mainframe and minicomputers down to a small IC chip called a microprocessor. It was being done out of the desire to pursue the next generation of computer driven devices for the consumer market, which included the march towards microcomputers. While it sounds like common sense, the notion of being able to shrink computers down to a size for the classroom, or even for the home, was revolutionary at the time.

Electronic component companies like Intel and Fairchild Semiconductor had started research in the late Sixties and were soon joined by the large consumer electronics companies that had research divisions such as RCA. RCA itself had been releasing mainframe computers since entering the field under the direction of RCA general manager, David Sarnoff, in the late Fifties. Becoming one of the 'big eight' manufacturers of computers during the Sixties, it was only natural that it joined in the electronics arms race for the miniaturization of the computer. RCA's high tech charge into the field was lead by Joseph Weisbecker.

Joseph Weisbecker had obtained his Bachelor Of Science in Electrical Engineering from Drexel University in 1956. Joseph was interested in computer technology for educational use from the beginning, designing things such as a *Tic-Tac-Toe* computer out of relays and several grade school educational aids using lights and switches. In 1956 he found himself in an internship with RCA installing its first commercial computer, the RCA BIZMAC (a large \$4 million computer composed of 25,000 vacuum tubes). Upon graduation he joined RCA and became a member ▶





INTERVIEW WITH *Forrest* *MacGregor*

We take a closer look at the creation of the RCA Studio II

How did you get involved at RCA?

In 1976, I graduated from Appalachian State University in Boone, NC with a degree in Industrial Arts and Computer Science. I had made a special study of microcontrollers, which were just emerging. As luck would have it, I applied at RCA Distributor and Special Products Division in Swannanoa, NC, and they were excited to find someone with formal training in micros. First job out of college for me, they promised that they would employ me in a videogame project, but it wasn't quite ready to start so for several months.

How was production done at RCA, considering it was the first videogame system it had created?

It was made on a human intensive assembly line of 125 or so mostly women. Chips were hand inserted, as were discrete components. Everything was wave soldered except a few wires. Board cleaning was in an ultrasonic degreaser using Freon TF. (I have a good memory.) Production rates were 1000 units a day on a single shift. Three or four adjustment/troubleshoot stations were in the line for rough testing of the RF components. We had a small cartridge with a test program for the console that put different patterns on the screen, tested the keys, beeper, expansion slot.

Considering its brief production, what were some of the signs on your side that the Studio II wasn't doing well and how did production wind down?

Units piled up in the warehouse and never did sell briskly. Competitive product from Fairchild and Atari were color, high resolution, sound-via-TV stuff with joysticks, so the monochrome block displays and keypad-only UI were outclassed from day 1. After 6-8 months, units were made available to employees at a discount. Eventually, RCA saw the writing on the wall, abandoned software development and the Studio 3, and shut it down. Inventory was sold to Radio Shack for 10 cents on the dollar.



» RCA Studio II team from left to right: Walt Stobbe, Dave Callaghan and Bill Stonaker.

► of the small team that developed RCA's first transistorised computer, the RCA 501, which he also coded a series of test and measurement programs for. Between the 501 and being co-architect of RCA's 601 system, Joseph had been gaining the foundation and experience he would put into good use for the design of his microprocessor years later. In fact, he was becoming a person who was able to predict coming trends, such as the time when he saw the move to mini-computers in the Sixties and proposed that RCA start planning its own, spec'ing out a system incorporating a low cost dot matrix serial printer, ROM subroutine storage, and combination projector-CRT display. RCA ignored his idea, and would continue to churn out large mainframe computers for the rest of the Sixties before exiting the market in 1971.

One area of Joseph's research RCA didn't ignore, though, was his research into the future applications of Large Scale Integration (the process of fitting thousands of transistors on a single chip) during the early Sixties, which was a time when the idea of integrated circuits was still very new, and the industry was still struggling to fit hundred of transistors on a single chip. It lead to him being a consultant on future products for RCA for much of the rest of the Sixties, besides designing unique I/O and storage systems for RCA's mainframe computers.

FRED (Flexible Recreational And Educational Device) is really what became the genesis of the RCA Studio II. Conceived in 1970 as a full microcomputer system based around a custom of the to be created microprocessor, encompassing all of Joseph's advanced LSI research, its first incarnation was the System 00 built in 1971. FRED/System 00 called for the FRED microprocessor, (8-bit single chip) along with 64K of RAM (DMA access), a cassette tape based storage system, a gravity card reader, small keyboard for input, and a standard TV set as a display for the output. As Joseph wrote in a 1972 memo, "FRED is an exciting new consumer product possibility. For the first time, a full power electronic

computer could be available at the price of a Hi-Fi system or color TV. Every home and classroom is a potential customer."

Joseph had a TTL (transistor-transistor logic, the same technology early video arcade games were based off of) based prototype of the microprocessor completed in 1971. Formally designated the COSMAC microprocessor in 1972, the full FRED prototype was completed that year, and its unique reduced instruction set architecture is considered the grandfather of today's RISC based microprocessors. Small changes include FRED's keyboard being realised as small 16-position keyboard, and a low-resolution black and white dot matrix TV display system that was chosen for both flexibility and low cost.

Work on software began that very year, too. Joseph's own vision for the software was for a complete computer suite including "a collection of programs that will demonstrate the power of [its] hardware in entertainment, education, and utility applications. Games, stimulants of artistic flair, simple drill-type learning programs, and calculator functions are included."

As 1973 rolled around, the tech world around Joseph seemed to be changing, and he seemed to find himself in direct odds with it at times. Joseph's vision was to make computer power available

for the masses by making it affordable. It was a vision not unlike the one Jack Tramiel would summarize over a decade later as, "computers for the masses not the classes." The problem was, the microprocessor 'arms race' had now begun and everyone was chasing more and more powerful chips against making microprocessors for a lower cost.

As Jack summarized in a later internal article at RCA, "There is no shortage of ideas for using computers, but there are no computers with a mass-market price tag. For widespread home and school use, the price of a free-standing, self-contained computer system should be well under \$500. This is the price level for colour TVs, quality audio systems, home-study courses, air hockey games, pool tables, one-week vacations, cheap electronic organs, and encyclopedias." He further illustrated, "Unfortunately, old habits are hard to break and we can also expect to see increased emphasis on [microprocessor] performance instead of cost."

The first fabrications of the low cost COSMAC had been completed towards the end of 1972 in a





IT'S NEW!! FROM RCA

INTRODUCING THE ADD-ON CARTRIDGE VIDEOGAME THAT KEEPS THE FUN COMING.

STUDIO II FROM RCA

Only at these RCA dealers:

- Darby Electric
- Darrel's TV
- Walla Walla
- Walters
- Tausick-Kauffman
- Western Auto
- Walla Walla
- Makin TV
- Walters
- Ferguson-Gagnon

GAMES, GAMES, GAMES

- TV GREETING CARD
- ELECTRONIC "ETCH A SKETCH"
- AUDIO-VISUAL DEMONSTRATOR
- TV ARITHMETIC DRILL
- WORD SPELLING DRILL
- WORD RECOGNITION TEST
- NUMBER BASE CONVERSION DRILL
- LOGICAL DEDUCTION TEST (21 QUESTIONS)
- NUMBER BASE CONVERSION DRILL
- TIC TAC TOE
- HEXAPAWN
- SLIDING BLOCK PUZZLES
- STATE CHANGE GAMES/ PUZZLES
- BOWLING
- MINIKRIEG
- TARGET SHOOT (OPTIONAL GUN)
- RACING
- ONE-ARMED BANDIT
- NETWORK GAMES
- TWENTY-ONE
- CELL MATCHING GAMES
- MAZE TRACING (INVISIBLE CHANGING)
- RACE GAMES (AGAINST TIME)
- SPACE WAR
- NIM GAMES
- LIFE

» We quite like the design of the RCA Studio II, even if it does look like some hi-tech telephone.

2-chip format that Joseph spent 1973 integrating into FRED as FRED2. Joseph and RCA set up a field test program with Random House, the New York based children's publisher and RCA subsidiary who at that time were the gold standard in elementary schools. Random House helped define the creation of programs for reading and mathematics, and the entire process lead to the creation of the RCA Microtutor (a stripped down version of the \$300 COSMAC based tutorial computer for learning the principles of microprocessors) the following year. In fact, most

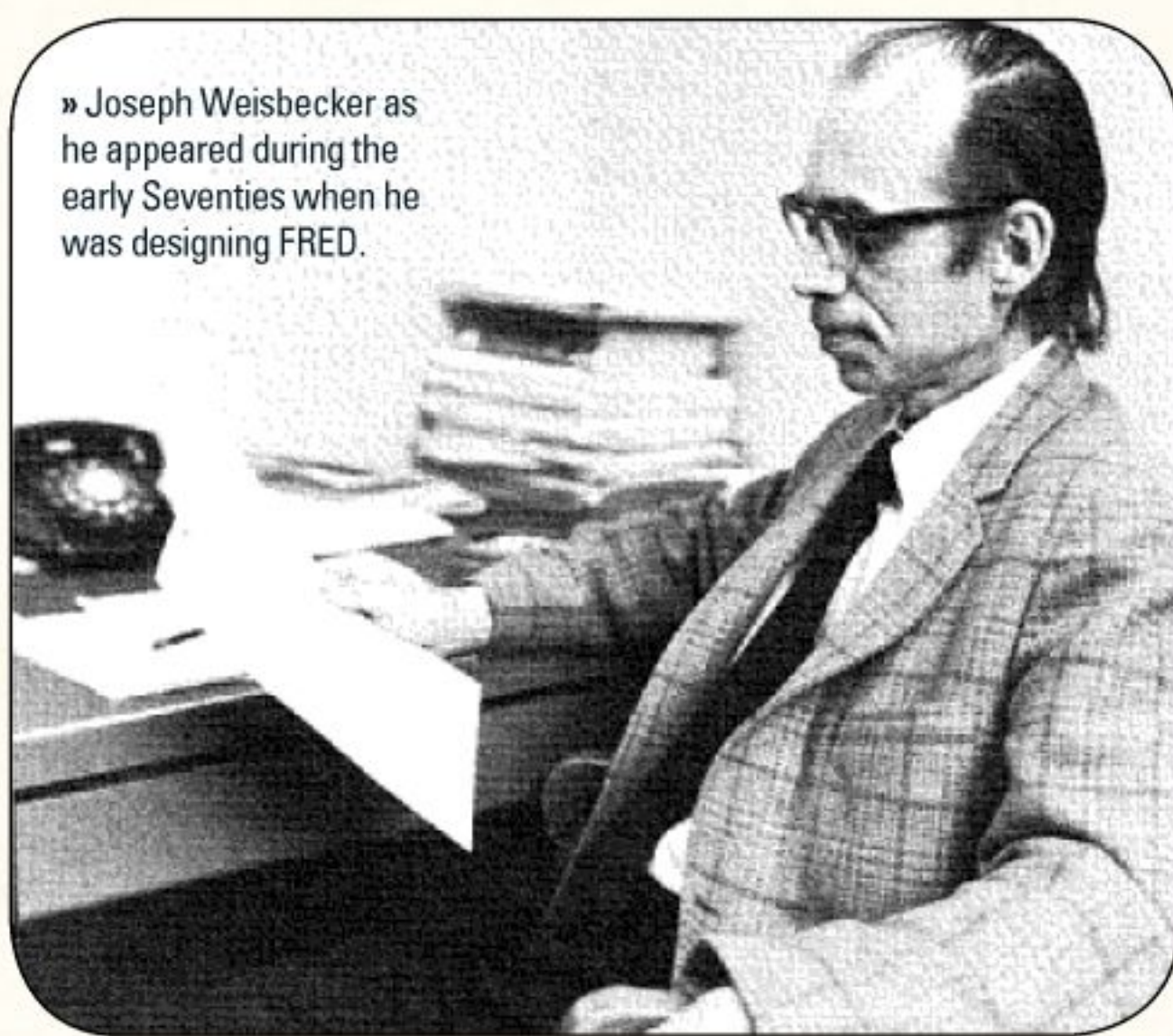

“Towards the end of 1974, RCA now wanted to see about leveraging FRED for coin hardware”

RCA becomes aware of the lucrative coin-op market

of the games and 'edutainment' software later available to the RCA Studio II were actually written during the 1973-1974 period. As Joseph noted at the time, "there has been no problem in motivating people to write game programs." At a time when home games consisted of basic Pong style play that needed two players, the games being designed for FRED2 such as Tic-Tac-Toe, Hexapawn, Twenty-one, and Space War were able to use the computer as the opponent with a rudimentary, yet adaptable AI. "The computer learns to play perfectly only after a number of games have been played," stated Joseph in 1974. The entire offerings of games, had they been released as a commercial product at that time or the following year, would have placed a home entertainment product on the market that was miles above the Magnavox Odyssey and the forthcoming onslaught of Pong derivative consoles. Joseph and P.K. Baltzer coded most of these titles, and even Joseph's daughter, Joyce, joined in to help with her father's work.

» Like many early systems, the RCA Studio II used cartridges for playing its games library.

With the increased popularity of arcade videogames, RCA wanted to consider entering into this market too. RCA had been flirting with the medium ever since it been approached in 1969 by Sanders Associates and Ralph Baer in order to license the technology around Baer's Brown Box prototype to create a videogame console. Contracts were drafted and upon their completion in March 1970, Sanders decided to walk away from the deal, with Ralph later saying that the deal had been too onerous. One of the RCA team members left to become VP of Marketing for Magnavox, scoring the console for Magnavox and its historical 1972 release.

Towards the end of 1974, RCA now wanted to see about leveraging FRED for coin hardware. There was one minor change, however, the games would be in removable ROM packs. The prototype would be completed in 1975 and moved to testing at several malls in the New Jersey area. Ultimately RCA decided not to get into the coin-op business or license it, but had it been released it would have provided switchable games almost a full six years before the Japanese DECO cassette based system was unveiled. The one positive thing to come out of those tests,

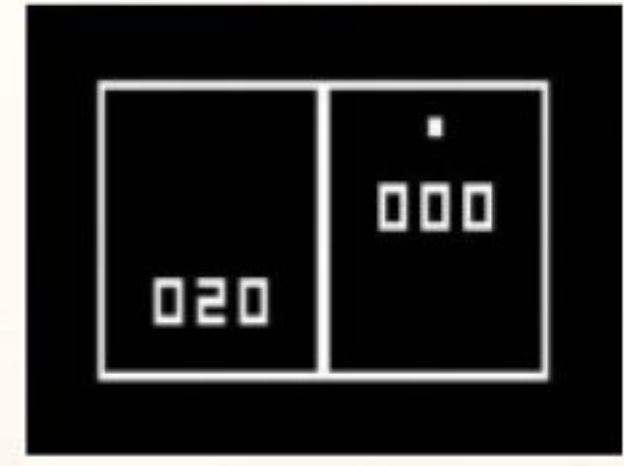
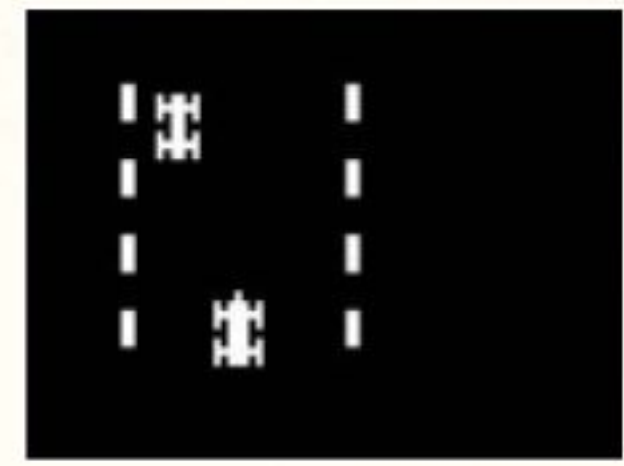
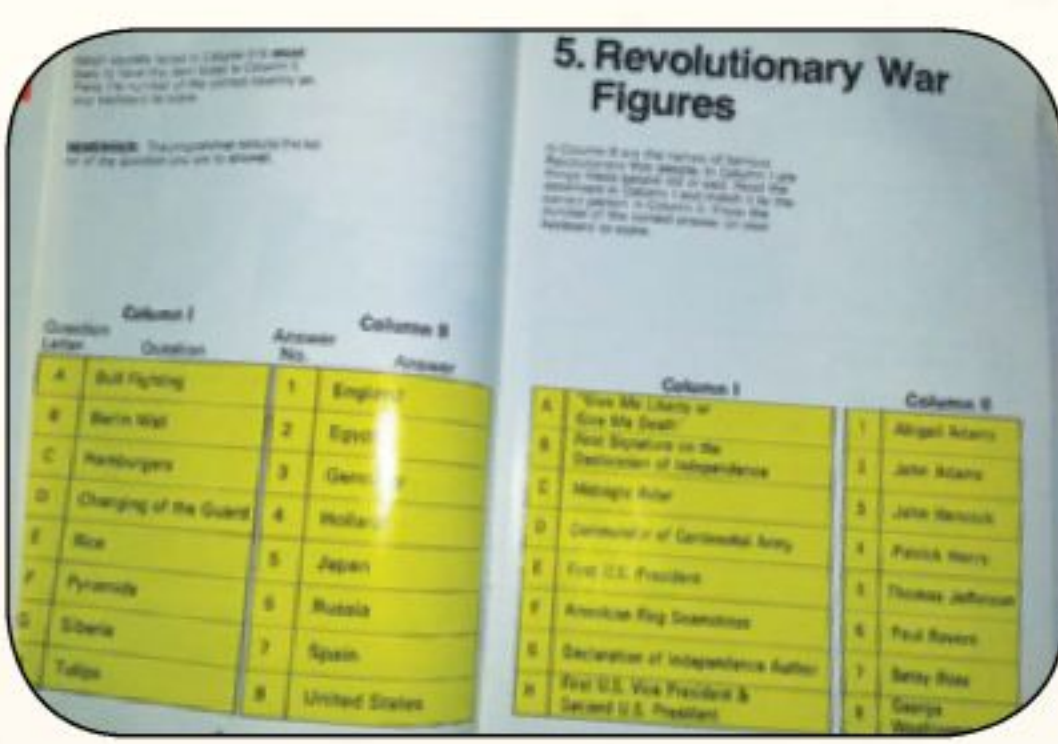
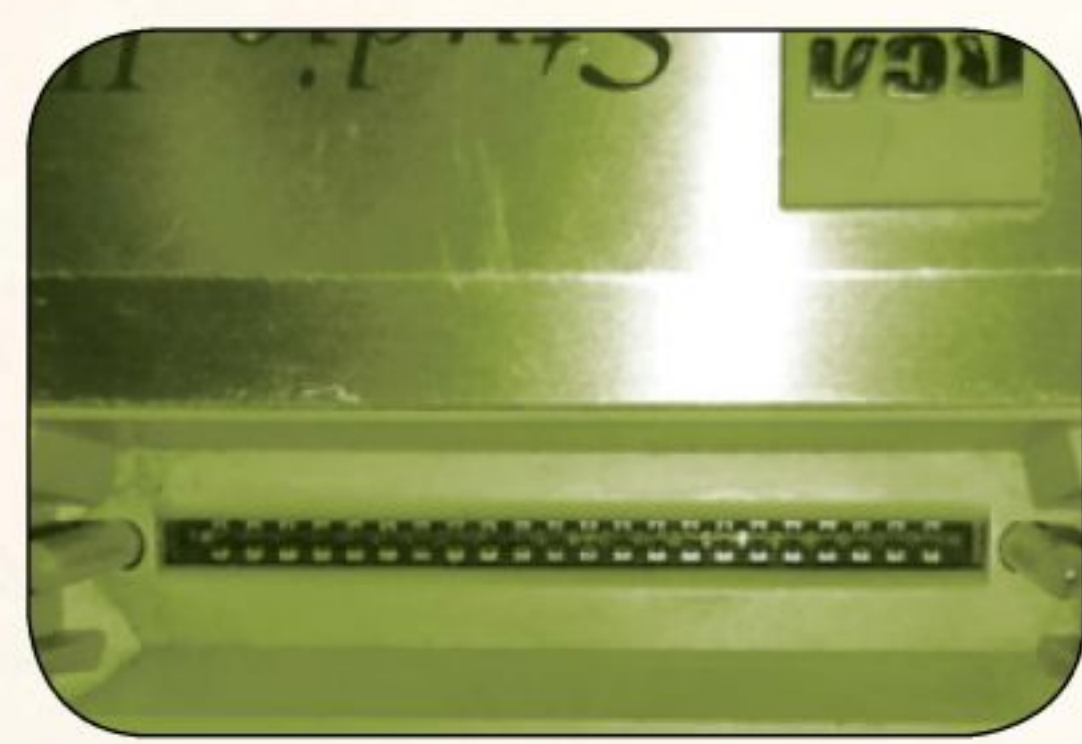



» Joyce Weisbecker and her sister operating the FRED2 computer. Joyce would also develop some of the early games.

► however, was that it became obvious that the FRED technology combined with the new removeable ROM technology could be scaled for a programmable home game console. During the second half of 1975, several prototype FRED-based consoles were built into attaché cases for demonstration and field testing. It did well enough that a console project is formally proposed to RCA's Engineering/Distributor and Special Products Division (D&SPD) to create a console with a planned targeted release in 1976.

The Studio II officially started development in January 1976, with the mandate of taking the modified FRED design and creating an actual product out of it. The vision for the console still aligned with Joseph's

original goals by bringing a programmable computer into the people's homes for a low cost. The team consisted of a talented and dedicated set of RCA engineers including Dave Callaghan, manager of engineering and responsible for all product development at D&SPD, including the Studio II, Bill Stonaker, who was responsible for the Studio II's digital circuit design, and Walt Stobbe, who was responsible for the Studio II's unique RF/power box.

The Studio II's design was timed just right to take advantage of the newly released single chip version of the COSMAC, the 1802, further lowering the cost

of the console. Ultimately, RCA divided its product into three areas needed for any console of the time: the main unit, the switch box and the power supply. A problem with most of the *Pong* consoles at the time was that the controls were directly on the console or in the vicinity of it. This meant either sitting up close to the television or leave a trail of chords (for power and RF) from behind the system to wherever the players were sitting.

The team came up with a unique method for cutting down on cables by having a single power/RF cable go from the console to the switchbox connected behind the TV. The power supply is in turn plugged into the this RF switch box, and the entire system is turned on by sliding the TV output selector on the switchbox. The unique setup would also be leveraged about five years later for Atari's 5200 system which also didn't find success.

The Studio II was designed with keypads for input, which were in turn developed specifically by RCA's Deptford mechanical engineering group and purposely arranged in a touch tone telephone format for familiarity. Why keypads? In keeping with the unique keyboard input of the FRED, and already created program base, the team needed to support both gameplay and numerical/character input. That planned usage is also why the Studio II was billed as the Home TV Programmer on its release. Rather than create a multitude of controls, RCA felt the built-in keypads would provide a quick plug and play setup, low cost, and stand up to the pressures of the high excitement gameplay situations we have come to experience.

The FREDs display circuitry and DMA memory circuitry were productized as the RCA CDP-1861 video display generator, a custom IC that provides the Studio II with a black and white 32 x 64 dot display matrix. And while the FRED used audio tape in its cassette player for sounds, the Studio II uses a 555 timer-oscillator circuit for generating its 'beep' sounds (which can also be shut off on the unit). Finally, five built in games were added: *Addition*, *Bowling*, *Doodle*, *Freeway*, and *Patterns*.

Completed by Fall 1976, the console went into manufacturing for a January 1977 limited release which was followed by a larger national release. With a list cost of \$149.95 and cartridges at \$14.95 each, it truly represented an affordable way for the consumer to enter into programmable consoles.



» An impressive closeup of the COSMAC Microtutor main unit. The main processing parts are on removable cards that dock in the empty slots shown.



» The COSMAC Microtutor kit, the first FRED-based product to reach the general public. Tested in schools by Random House, a 100 total were eventually produced.

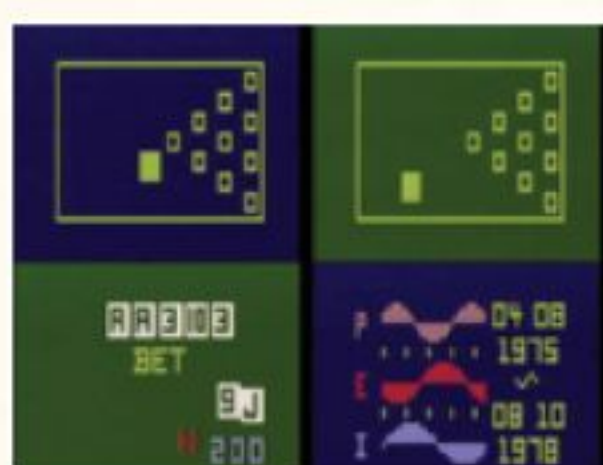

FROM THE ASHES

The technology behind the cancelled full-color RCA Studio III was licensed by RCA to several manufacturers around the globe who built their own version of the console much like 3DO would be marketed from its beginnings almost two decades later. Released in 1978 -1979, these versions include:

TOSHIBA VISICOM COM-100

■ Released in Japan, the Visicom includes a more computer like look and detachable joysticks. It also uses a different cartridge format than the other clones around at the time, and as such, it has its own series of games.



MUSTANG 9016 TELESPIEL COMPUTER

■ Released in Germany, this clone more directly resembles the Studio II in terms of visuals.

HANIMEX MPT-02 JEU TV

■ The French version of the console. The keypads are actually removable in this version of the system to allow easy holding in the hands. Hanimex also released several other programmable consoles in the MPT series.





“After a disappointing Christmas, RCA announced in the spring of 1978 it was cancelling the Studio II”

RCA's dream was sadly short-lived

use in Europe, Australia and Japan. Joseph's dream of low cost, affordable computing still lived on in the 1976 released COSMAC ELF, and 1977 released COSMAC VIP, and his work on FRED and its other variants would win several awards including the David Sarnoff Outstanding Achievement Award. Unfortunately, the RCA Studio II would sadly reach no such heights. The unfortunate console drifted off into relative obscurity it became an interesting footnote in video game history. The RCA Studio II was the only console of the period to start its life as a personal computer and then be scaled down to a console against the promise of upgrading to a full computer that the other late Seventies manufacturers were chasing at that point in time. *

» There are a number of multiplayer games available, but the playing area can make things feel crowded.

RCA was proud of its new console, trumpeting in late 1976 that the RCA Studio II “should offer the consumer a clear advantage over the subtle variations on the ‘ball going back and forth’ type of game that has been

available for the past year or so.” That wasn't exactly the case. You see, the problem was that it took so long for Joseph's technology to get to market that the console became sandwiched between the release of the two consoles that had essentially leapfrogged it in terms of technology: the Fairchild Channel F and the Atari Video Computer System.

After a disappointing Christmas, RCA announced in the spring of 1978 that it was cancelling the RCA Studio II. Work had immediately started on a full color version called the RCA Studio III which also included Joseph's new Chip 8 programming language, but the RCA Studio II's cancellation also put an end to this. However, the technology was licensed for

» The RCA Studio II catered for two sides of the market, offering fun games and educational ones.

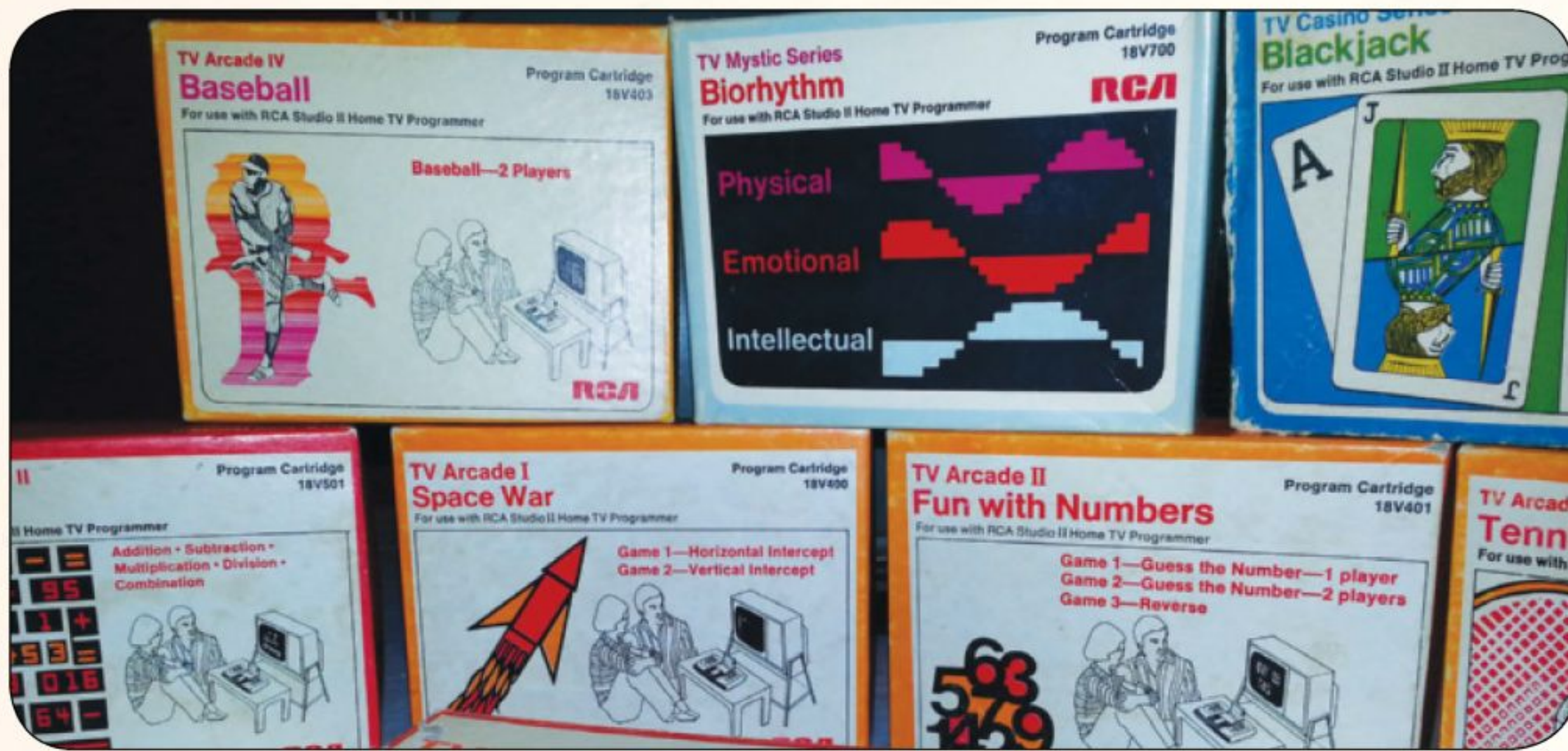

SOUNDIC MPT-02 VICTORY

■ Similar to the Hanimex model, the main difference is that it can use detachable joysticks similar to the type built into the Visicom.



SHEEN 1200 MICROPROCESSOR PROGRAMMABLE TV GAME

■ Also for the Australian market, this clone is basically the same as the Mustang.



CONIC M-1200 COLOUR

■ Produced for the European market by Conic, who released a series of pong consoles during the late 1970s. It again is derivative of the Mustang and Sheen versions.

A hand holding a stylized handheld console. The console is light gray with the words 'HANDS ON' written in large, bold, red letters. The hand is dark blue/black. The background is a light gray with various years (1979, 1981, 1983, 1985, 1987, 1989, 1991, 1993, 1995, 1997, 1999, 2001, 2003, 2005) scattered across it in a light gray font.

Gaming on the go – that has always been the defining intention of the handheld: a means to play our beloved videogames any time, any place, anywhere. Over the past 30 years we have seen many portable consoles impress and, frankly, bemuse. So join Retro Gamer as we load up on batteries, find some natural light and look back at the history of portable gaming

That things are getting smaller is a trend that is becoming increasingly more difficult to ignore. Phones, microprocessors, computers, televisions (well they're becoming thinner anyway) all seem to be a getting that little bit harder to locate around the house nowadays. Although the same cannot be said for our beloved games consoles (the first Xbox looks like it was designed in an episode of *Scrapheap Challenge*, and the PS3 is so heavy you actually have to bend your knees to pick it up), videogames have always been linked to compaction. Over the years, the application of portable gaming has evolved dramatically from what it once was. It's clear that today's handhelds are used more in and around the house than they are ever used out of it, and no company has been quicker to realise this curious trend than Nintendo. Through the DS, you can brush up on some classic fiction, become a culinary wizard, or even prep the brain for the *Sunday Times* crossword puzzle. Yet despite these new niches the DS is quickly discovering, the focus for most true handhelds has always been, first and foremost, for videogames. From as far back as 1979 electronic companies have been trying to drag videogames from the face of television sets and into the palms of your hands. Mobile gaming predates the NES, the Vectrex, the Spectrum and Sega's first entry into the home console market. And while you'd be forgiven for thinking that the medium originated with the advent of the Game & Watch, the first example was actually released a year earlier to Gunpei Yokoi's seminal creation, and it was designed by an American.

1979

Milton Bradley Microvision

• Released: 1979 • Number of Games: 12 • Games Developed Until: 1981

Milton Bradley is more commonly known for its tangible approach to game playing, with the US company building up a solid reputation in the West for its popular range of board games. But seeing the profits that videogames could potentially yield, the company dipped its playing pieces into the videogame market, with varying degrees of success. Milton Bradley most famously entered the videogame fray with the release of the Vectrex in 1982 – the world’s only videogame machine built entirely around vector technology. And while the Vectrex isn’t a handheld per se, it is a console that was designed with manoeuvrability in mind. Resembling a mobile arcade unit, the Vectrex display/machine setup comprised a wonderfully slim built-in monitor and a fold out control pad, which made the machine compact and easily mobile. It should come as no great surprise then that its creator, Jay Smith, can be traced back to being the true inventor of the first portable games machine with a device he released two years before Nintendo unveiled Game & Watch on the world. Smith, who started working for Mattel before establishing his own company, Smith Engineering/Western Technologies, set about working on an ambitious new device to allow kids to play electronic games on the go. The Microvision, as it was known, had a monochrome black and white 16 x 16 pixel LCD display that used overlay cards to give the illusion of colour in its games. With its small library of 12 titles, and each 2K sized game cart housing the CPU chip that ran the machine, isolated, the Microvision was simply an empty shell with an LCD display, on/off switch and contrast button. Even the fascia buttons (the number of which would vary depending on the game you were playing) were integrated into the game packs themselves. The Microvision was released in America and Europe, and was bundled with the *Breakout* clone called *Block Buster*. Software for the machine ceased in 1981.



» Smith’s Microvision marks the first page in the history of the handheld; it was unique in that its game cartridges each contained the CPU from which the machine ran.



1980

Nintendo Game & Watch

• Released: 1980 • Number of Games: 60 • Games Developed Until: 1991
 • Variants: Gold, Silver, Crystal, Multi-Screen, Widescreen, Panorama, Super Color, Micro Vs

» So Nintendo basically owes everything to the calculator then. Whoever said maths is boring, eh?

While Nintendo began its videogame tenure developing and manufacturing arcade machines, the big N’s first stab at videogame hardware for the home (and on the road) was the Game & Watch. After Nintendo technician Gunpei Yokoi spied a Japanese businessman tapping the buttons of his pocket calculator, Yokoi found the inspiration for the machine that would ultimately pave the way for Nintendo’s dominance in the pocket-sized gaming market. Released in 1980, and remaining on sale for a further ten years, the Game & Watch entered a market that was crammed to the hilt with LCD-style games. However, many were crudely made, uninspired and were surprisingly cumbersome, with many manufacturers choosing to adopt the tabletop arcade look of the Adventure Vision. Ironically, it was this saturated LCD market that proved beneficial to Yokoi’s creation. At the time, owing that LCD parts were in abundance, Yokoi could keep the production costs and the price of the Game & Watch units down to an affordable minimum. Slightly bigger than a credit card, the Game & Watch boasted a healthy battery life, was pocket-sized and amazingly durable; all qualities that helped it sit effortlessly in the hands of portable gaming. In fact, the design of the Game & Watch was so far ahead of its time that Yokoi would fuse many of its characteristics into the Game Boy, and Nintendo would use the ‘Multi-Screen’ look in the design of the DS. Furthermore, the handheld’s four-button controls would later be adapted into the cross-shaped D-pad that was incorporated into all Nintendo controllers. Owing to the success of the Game & Watch, Nintendo released an impressive 60 titles spread across the eight different variants of the machine. The first Game & Watch title was the juggling game *Ball*, and the final, which would pay homage to that first game, was *Mario Juggler*. It was released in 1991.

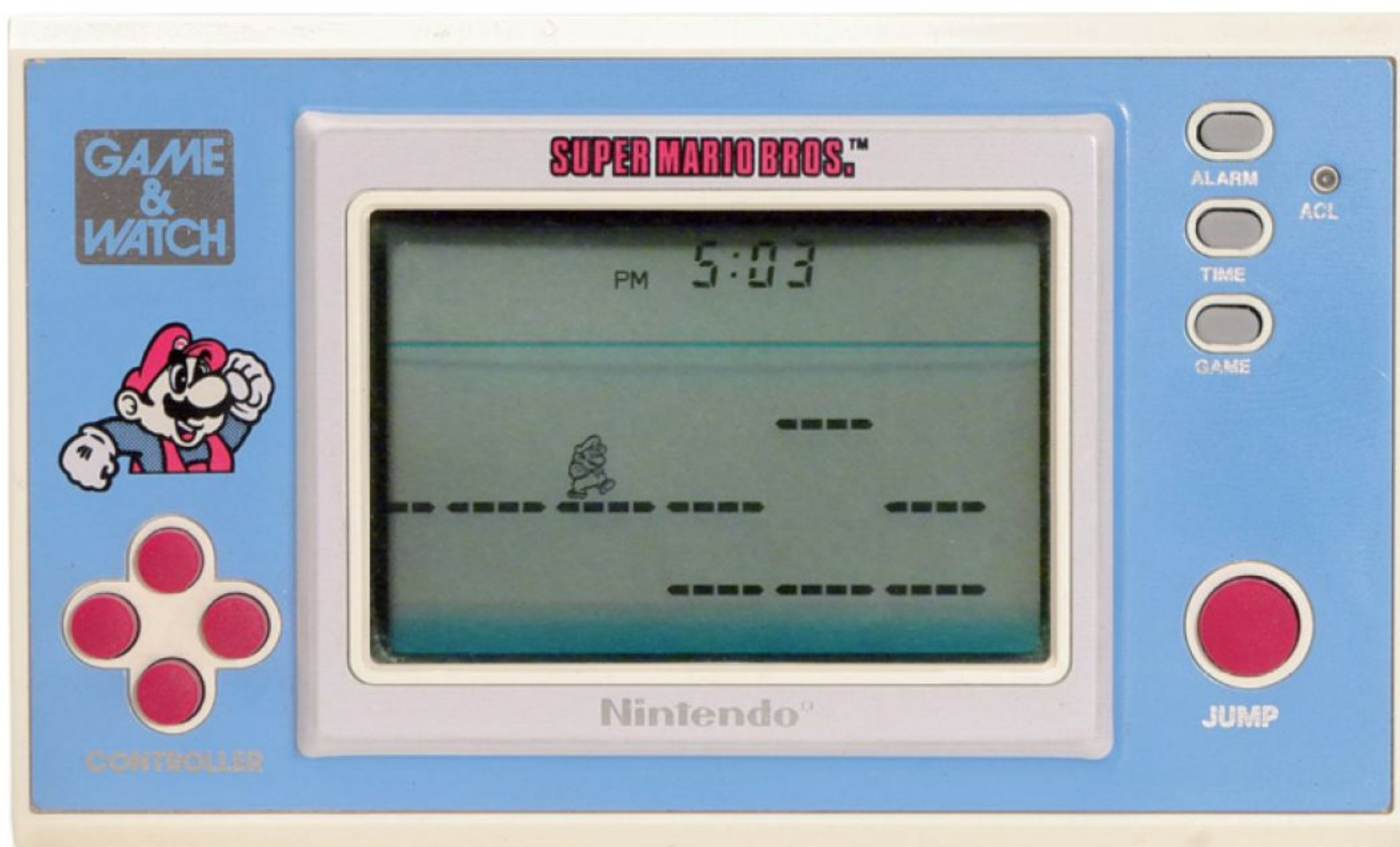



» The Adventure Vision may boast (if that's the right word) the smallest library of games on this list, but that hasn't stopped it from being popular with collectors.

1982

Entex Adventure Vision

• Released: 1982 • Number of Games: 4 • Games Developed Until: 1982

While not a direct sibling, this rare tabletop machine could serve as the spiritual stopgap between Smith's Microvision and Vectrex machines. Designed by Entex, then a well-established maker of portable LCD and LED games, the Adventure Vision took the appearance of a tabletop arcade and used interchangeable game cartridges that slotted tidily into its control dashboard. The games were controlled using a small silver joystick; either side of it sat two

clusters of four fascia buttons to ensure the machine was accessible to both left- and right-handed gamers. Like the Vectrex, the Adventure Vision is memorable for using an unusual method to project its games onto its screen. Whereas Smith's vector machine drew clean, striking white vector lines, Entex's visuals were made up of flickering red dots courtesy of a spinning mirror that would amplify a single strip of 40 red LED lights to a 150 x 40 resolution. With a library of just four games – including a port of the arcade classic *Defender* and the *Asteroids* clone *Space Force* – plus its distinct, deep red visuals, in some ways the style and ambition of the system shares many similarities with Nintendo's Virtual Boy.

1989

Nintendo Game Boy

• Released: 1989 • Number of Games: 1,200 • Games Developed Until: 2002
• Variants: Game Boy Color, Game Boy Pocket, Game Boy Light

At unit sales of 120 million, the Game Boy is the most successful videogame console in history. The Game Boy built wonderfully on what Nintendo and Yokoi had achieved with the Game & Watch. The look was chosen to be NES grey, while its controls mimicked the NES pad (the black four-point D-pad, A, B, Select and Start buttons) to ensure it looked and felt instantly familiar with Nintendo fans. Some gamers bemoaned the machine's dour yellowish visuals (actually comprising four shades of grey) and lack of a backlight (which meant a lot of fiddling around with the contrast button and trying to find nooks of natural light). However, its portability, fulsome selection of games, impressive battery life (up to ten hours from four AAs) and the Russian puzzle classic *Tetris*, which was bundled with the machine alongside a link-up capable to allow multiplayer gaming out the box, immediately ensured its success. And Game Boy's timing could not have been better. Nintendo became the first developer to quench the desire for portable gaming in the late Eighties. Titles such as *Super Mario Land* and the excellent *Link's Awakening* further strengthened the popularity of Nintendo's mighty mobile. However, it was in 1995 that the Game Boy's popularity would really catch a second wind. At the same time that Nintendo was gearing up for the release of the Game Boy Pocket – a smaller version of the handheld which came in a variety of bright colours – Nintendo, in partnership with the videogame developer Game Freak, unleashed *Pocket Monsters* (known in the West as *Pokémon*) onto an unsuspecting public, igniting a global craze that breathed new life into the machine. After the success of *Pokémon*, Nintendo continued to release more variants of its handheld. In 1998 it rolled out the Game Boy Color – a popular version of the machine that upped the Game Boy's display from four shades of grey to an impressive 56 colours. Slightly larger than the Pocket, the Color was supported by its own library of games, was backward compatible with Game Boy titles and could even breathe colour into them too. This was enough to convince consumers to make the upgrade, and the Game Boy Color was another success for Nintendo. Launched around the same time as the Game Boy Color in Japan, Nintendo also released the Game Boy Light. It was a marginally bigger, but lighter, version of the original Game Boy that was fitted with a backlight. With an astonishing 12 hours of battery life with its backlight on, and 20 hours without, the Light boasts the best consumption of all the Game Boy variants Nintendo released. But owing to a less than enthusiastic reaction to the machine from the East, it sadly never made it to Western shores.

Yeah... About those tabletop games

While we have paid special tribute to the Game & Watch and Adventurevision in this feature, as many handheld devotees know, there was a bevy of tabletop and cool portable games released during in the late '80s to early '90s (with certain LCD titles based on popular franchises like *High School Musical* appearing even now). Many were classic games in their own right, with the majority of well loved titles coming from the stables of electronic toy manufacturers, Tomy and Grandstand. Grandstand was responsible for giving us popular classics such as *Munchman*,

Astro Wars, *Krazy Kong* and *BMX Burner*, while Tomy brought us the Tomytronic range, and the delights of *Alien Attack*, *Space Turbo* and a bizarre little handheld that made thousands of kids raid their mum's pantries to rip the labels off tins of beans; the Barcode Battler. Sadly, we didn't have enough space this issue to take a detailed look at them all, but rest assured we're planning to

explore their history and contribution to portable gaming in a separate feature very soon. In the meantime here are a few images of some of our favourite tabletop games; do they ring any bells with you?



“ Tetris was bundled with the machine alongside a link-up cable to allow multiplayer gaming out of the box ”

» And here it is: the daddy, the big boy, the Game Boy. Chances are if you didn't own one, at least 20 of your friends did.

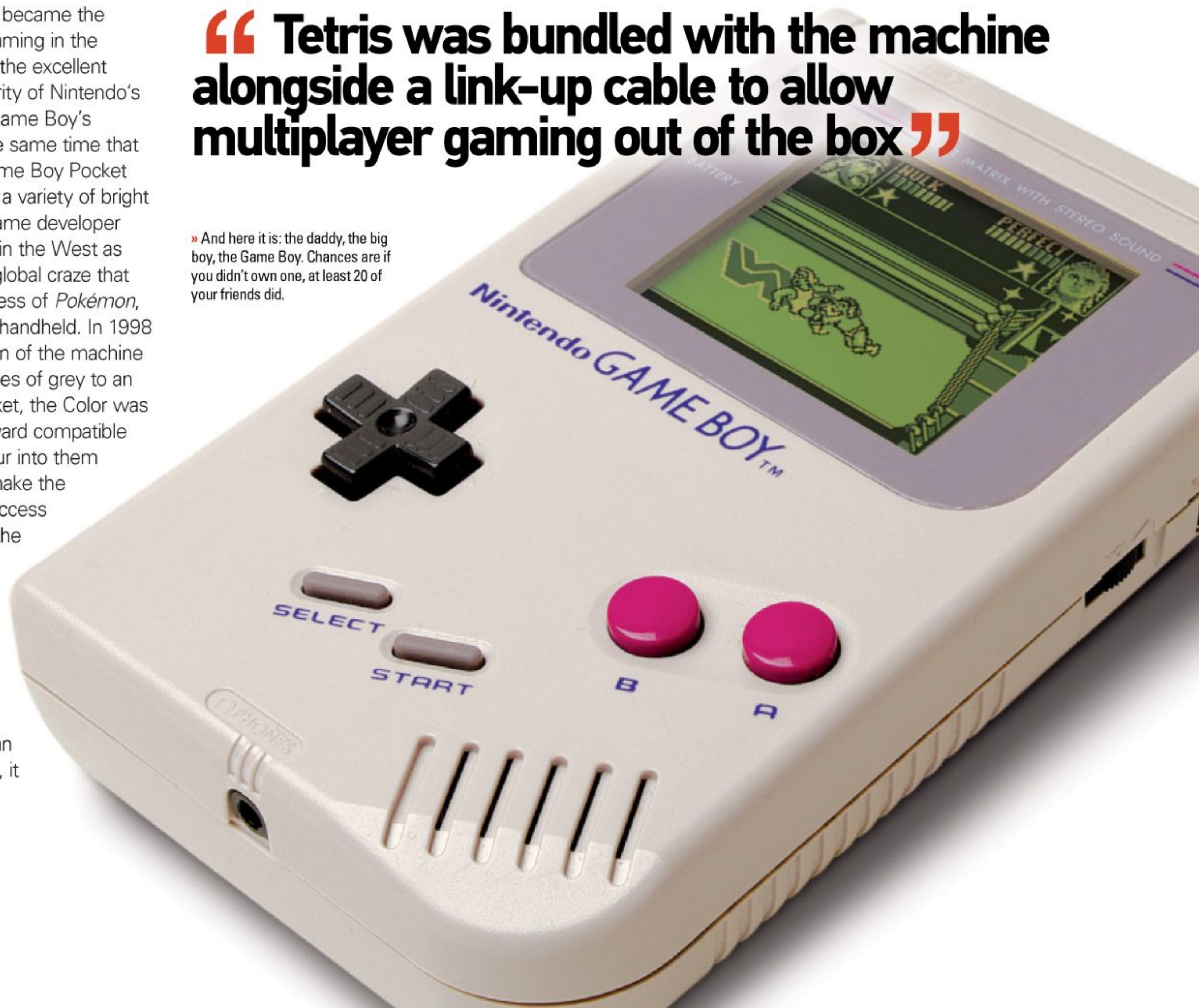

1990

Game Gear

• Released: 1990 • Number of Games: 300 • Games Developed Until: 1996

While Nintendo opted for mobility and lengthy battery life with the Game Boy, Sega hedged its bets on dazzling gamers with a 32-colour machine with a backlight. Of course, in those days such opulence came at a cost, and as a result the Game Gear was noticeably more expensive and larger than the Game Boy. However, while the Game Gear would mimic the Game Boy's two-button configuration, it did boast a more ergonomic directional pad – it was concave, allowing it to fit the thumb more comfortably. One important and oft overlooked difference between Sega and Nintendo's handhelds was the fact that the Game Gear was heavily based on home console technology: the Master System. The Game Boy, past design, shared few similarities with the NES mainly because the technology sitting inside the machines was so radically different. In fact, so similar are Sega's 8-bit machines (the most notable difference is that the Game Gear has a far greater colour palette), that Sega later capitalised on the fact by releasing a Master System converter for the Game Gear, which doubled its library of games. Yet, despite the clear relationship that existed between the Game Gear and Master System, it would turn out to be the Mega Drive that would prove the Game Gear's most valuable ally in the ensuing handheld war. The Game Gear shifted an impressive 30 million units in its lifetime, and that interest was no doubt sparked by both the Genesis's popularity in North America and the Game Gear's varied library of games which came courtesy of the many developer relationships Sega had established through Mega Drive/Genesis software licences. With titles such as *Mortal Kombat*, *John Madden* and *Shining Force* appearing on the Game Gear, Sega's handheld – like the Mega Drive – effortlessly found appeal with older gamers, with even its promotional adverts trying to separate it from the kiddie-focused feel of Nintendo's popular handheld.

» The Game Gear is essentially just a Sega Master System squeezed into a handheld. In fact, every one of Sega's portable machines was closely linked to its home consoles.



Atari Lynx

• Released: 1989 • Number of Games: 85 • Games Developed Until: 1994

Epyx was a big player in Amiga software development, but by the mid-Eighties the company was looking to break into the hardware market and assigned Dave Needle and RJ Mical from the Amiga development team to spearhead a new handheld project. Knowing that it couldn't bankroll the entire project itself, Epyx set about inviting various third-party hardware developers to come in with it on its machine. Following a disastrous meeting with Nintendo (the details of which you can read about in our full retroinspection of the Lynx back in issue 43), in 1988 Epyx eventually sold the idea to Atari and the Atari Lynx was born. The Lynx is notable for being both the first 16-bit and colour handheld to be released into the marketplace, but despite its impressive power it was far from perfect. As well as being almost twice the cost of the Game Boy, the Lynx (when not sharing a room with either a Virtual Boy or a Game Gear wearing an SMS converter plugged with an SMS game and donning a screen magnifier) was one of the largest handhelds released into the market. However, despite its chunkiness, poor battery life (you get a paltry four hours for six batteries) and weight – you need leg muscles and pockets like a kangaroo to ferry this beast around with you – it remains one of the finest examples of a portable arcade machine you can find. The Lynx was home to 30 of the most impressive arcade conversions ever seen on any handheld, with wonderfully faithful renditions of *Xenophobe*, *Rampage*, *Joust*, *APB*, *Xybots*, *Paperboy* and *Rygar* – not to mention some equally excellent titles in *Chip's Challenge*, *Blue Lightning* and a fantastic port of *Lemmings*. But while the Lynx was home to some classic games, sadly its prohibitive price, coupled with the impenetrable popularity of the Game Boy (which was released in the same year) and the arrival of the Game Gear, would quickly draw third-party developers away from the machine, and it was clear the Lynx was going to be muscled out of the market. While the Lynx is mainly criticised for its impractical size, rumour has it that its large size wasn't down to the cramming of cutting-edge technology but rather the misguided opinions of the world's worst focus group. Apparently, after being shown both small and large prototypes of the handheld, the panel preferred the bigger version. To later try to remedy the size issue, Atari released a revised version of the Lynx, called Lynx II, in 1991. The second generation was slightly smaller and lighter (although not by much), had a better directional pad, stereo headphone output and improved battery consumption. While its release did see a slight climb in Lynx sales, the combined marketing muscle of both Nintendo and Sega proved too overpowering for Atari, and the Lynx was gradually pushed out of the market.

» Before the Lynx became the Lynx it was known as the 'Handy'. Whilst visually impressive it drained batteries like there was no tomorrow. Its bulky design was also a hindrance for gamers on the go.

1989



1990 NEC PC Engine GT

• Released: 1990 • Number of Games: 320 • Games Developed Until: 1994

Proving that power comes at a cost, the NEC PC Engine GT (renamed the TurboExpress in the West), at a wallet-tearing \$299, was one of the most expensive handhelds to come to market. Its design is a clear mesh of Game Boy meets Game Gear – taking the Game Boy's portrait shape but spraying it with the mean dark look of Sega's handheld. The PC Engine GT is essentially just a mobile PC Engine, and as such was compatible with all the machine's HuCards – which lent themselves brilliantly to mobile gaming. That meant that when the PC Engine GT came to market it was instantly supported by an impressive array of varied software. However, and this is a warning to importers out there, the GT is one of the few handhelds – other examples being the Sega Nomad and DSi – that adhere to region lockout, seeing that (with the exception

» The PC Engine GT was targeted towards the more affluent gamer – like rich kids from Beverly Hills, not the likes of those earning a living by shovelling newspapers down the throats of letterboxes.



of the DSi) these handhelds were just portable versions of their territorial-adhering TV-based cousins. With its colourful active-matrix screen and large library of games, the PC Engine GT (from a technical and software standpoint) blew away the competition. But that impressiveness meant somewhere there had to be a catch, and sadly that snag was a hefty price tag and poor battery consumption (a pathetic two hours' play from six AA batteries). Quality control also proved to be a huge problem for the GT late on in life. While the GT Engine projected games in glorious rich colour, its display suffered from poor resolution and dead pixels, and the sound output was notably poor, doing nothing to help persuade consumers it was worth the lofty asking price. Ultimately it was the GT's price that really prevented it from penetrating the market, along with its risky software tie with the PC Engine; as the GT only fed from software developed for its big brother, when the PC Engine took a battering after the Super Nintendo's launch in North America, its slump in popularity took with it the hopes and ambitions of NEC's handheld.



» This weird-looking handheld from China tried to compete with the Game Boy and failed miserably.

1991 Wataru Supervision

• Released: 1989 • Number of Games: 40 • Games Developed Until: 1992

Released two years after Nintendo's million-selling handheld, the Supervision could almost be described as a Game Boy Picasso. All the right Game Boy fascia elements can be seen (four shades of grey LCD screen, contrast toggle, A, B, Select and Start buttons); they're just found in different places. The Supervision, which originated in China, was designed to be a cheap alternative to the Game Boy. Its odd open clamshell design featured two different-sized plastic cases that were connected by a swivelling rubber joint which tilted its 160 x 160 pixel LCD display but also prohibited the machine from folding into itself. This meant it was clunkier than its monochrome muse. Originally manufactured by the Asian company Wataru, the Supervision was licensed by several companies, including Audiosonic, Hartung and peripheral manufacturer Quickshot. But with sparse advertising, cumbersome looks and paltry software (only 40 titles were released for the machine), it drifted quickly into obscurity.

1995 Virtual Boy

• Released: 1995 • Number of Games: 22 • Games Developed Until: 1995

The 32-bit Virtual Boy marks a bridge too far for Nintendo. In a market it knew like the back of its hand, overreaching and rushed development would see the portable giant get its hands burnt. The brainchild of Gunpei Yokoi, the Virtual Boy was a bold handheld. The ditching of mobility for the benefit of 3D gaming caused huge confusion for Nintendo when trying to promote the Virtual Boy as a handheld, in a rush to try to capitalise on the growing Virtual Reality craze that was sweeping the globe. Predictably, the clunky headset design of the Virtual Boy was heavily criticised by many of the gaming press following the machine's unveiling at Space World in 1994, but you could understand Nintendo's thinking behind the quirky design. A headset was necessary to instil a keen sensation of an extra dimension and, to that end, the 3D technology that Nintendo had licensed, which worked through a combination of piling games with plenty of parallax scrolling and offsetting images to individual eyes, was functional but impractical for a handheld format. One interesting rumour about the Virtual Boy is that

the machine was believed to still be in its development stages when it was released, but an impatient Nintendo, wanting to focus its efforts and time on the launch of the N64, ordered Yokoi to rush it to market. Had Yokoi been given more time to refine his creation, there's a strong chance that the design and fate for the Virtual Boy could have been much different. Another criticism put to the Virtual Boy was the overbearing red colour of its games, which were courtesy of the red LED lights it used to display its games (red LEDs were used as they were cheaper). While gamers could handle the green-yellow tinge of the Game Boy's monochrome display, the dark and unwelcoming red worlds that the Virtual Boy painted proved a little too much for some eyes. Moreover, both the 3D visuals and red coloration of the graphics meant the Virtual Boy wasn't built for prolonged play. Gamers soon complained of eye strain and headaches, and as the unit had to be sat on a table and viewed like eye-test apparatus, it was criticised for being uncomfortable too. Not surprisingly, when the machine was launched in Japan and North America, consumers and software developers needed no further persuasion to strike the Virtual Boy down as a flawed gimmick, and the life of the machine was quickly over.



» The Virtual Boy marks a rather nasty red blip on an otherwise impeccable technological legacy for Yokoi, but was he really to blame?

1997

Tiger Game.Com

• Released: 1997 • Number of Games: 20 • Games Developed Until: 1999

Tiger was an arm of toy giant Hasbro that specialised in producing electronic LCD toys. Inspired by the success of the Game Boy, Tiger quickly set about developing a handheld that was years ahead of its time. Stumbling on a trend that wouldn't occur in the handheld market until almost ten years later, the Tiger Game.Com pushed the functionality of mobile gaming into bold new realms. Firstly, Tiger's machine was touch-screen and came packed with a stylus wand that slotted tidily into its casing. With the aid of an internet cartridge, it could access a text browser and e-mail facility. The Game.com's graphics were the same as Game Boy's four shades of grey, but its LCD screen was larger. Despite a keen price point (the original model sold for about \$60, while the second, Game.Com Pocket Pro, was a staggeringly cheap \$30) and gallant efforts by Tiger to secure such licenses as *Duke Nukem*, *Mortal Kombat* and *Virtua Fighter*, the machine struggled to attract enough third-party interest and was eventually dropped by Hasbro in 1999.



» The Game.Com was offering DS-like functions seven years before Nintendo's latest handheld, but it didn't have the marketing muscle to back it up.

We're Gonna Need Bigger Hands



SEGA NOMAD

Effectively a portable Mega Drive, this is the essence of flawed brilliance. Sadly, it's also region-encoded so will only play US Genesis titles (although rare adaptors are available). Priced at a staggering \$200 at launch, it allowed Sega to generate further revenue from the Genesis's popularity. With no titles made exclusively for the machine, awful battery consumption and an ill thought out second joystick port for multiplayer games, it failed to appeal and Sega was later forced to offload the handheld for half of the original retail price.



PC ENGINE LT

Released in 1991, The LT was a slight variation of the GT. With a clamshell design similar in look to the Advance SP, but bigger and heavier, and retailing at 100,000 yen, it was the most expensive PC Engine variant. To cushion the blow, the LT did boast a superior 5-inch display that helped remedy some of the resolution and pixel deaths plaguing GT screens. To eke further life from the handheld, NEC cleverly added a port that allowed the LT to be hooked up to the CD-ROM component, making it compatible with all TurboDuo games too.



MEGA JET

The Mega Jet was originally intended for use as in-flight entertainment for Japanese Airlines, hence its name, but later it found a commercial release in Japan. The Mega Jet is an all-encompassing Mega Drive/control pad unit similar to the Nomad handheld, but lacking a display. Without a screen, users had to hook the device to a TV to play it (which obviously harmed its 'handheld-ability'). Nonetheless, it did prove an easier way for Japanese gamers to play their Mega Drive collection on the road (or in the air).

1999

Neo Geo Pocket

• Released: 1999 • Number of Games: 80 • Games Developed Until: 2001

Given its long and rich history in the hardware market, it was inevitable that SNK would join the handheld fray at some point. The company's final console surprises by sharing little in common with its previous arcade-style consoles – the AES, MVS and Neo Geo CD. Released in Japan in 1998, the 16-bit Neo Geo Pocket stunned everyone with its simplicity. Rather than go down the PC Engine GT route and throw plenty of cutting-edge technology at the machine, SNK chose the more functional Game Boy approach, and not surprisingly the Pocket proved perfectly apt for portable gaming. A wonderful, sharp screen that display eight shades of grey crisp, and a responsive analogue nub to replace directional buttons, meant the handheld was well armed to take on the portable versions of SNK's popular arcade hits, particularly its many beat-'em-ups. With scaled-down versions of *Samurai Shodown*, *Fatal Fury*, *Metal Slug* and *The King Of Fighters* released on the machine, the

Pocket's commercial assault was heavily supported by SNK IP. However, shortly after the machine's launch in Japan, Bandai would throw a spanner in SNK's plans by unveiling the WonderSwan – a machine that looked and felt very similar to the Pocket. Thanks to Bandai's marketing muscle, and the fact the WonderSwan quickly found appeal among both boys and girls, it soon overtook SNK's handheld in the market, but by then both parties had another mutual threat to contend with: the Game Boy Color. In response, SNK quickly followed up its portable with the Pocket Color in 1999, which added a superior colour TFT display to compete with the Game Boy Color. The Pocket Color did find its way to this side of the Atlantic but, owing to the sheer popularity of the Game Boy Colour and a problematic launch (resulting from poor communication between SNK's East and West offices), it was slow to find interest from established developers and consumers. With SNK facing falling arcade, Neo Geo and eventually Pocket sales, the company was bought out and fragmented in 2000, later returning to our screens as SNK Playmore, and the Neo Geo Pocket was no more.



1999 Bandai WonderSwan

- Released: 1999 • Number of Games: 200 • Games Developed Until: 2003
- Variants: WonderSwan Color, WonderSwan Crystal

The story behind the WonderSwan is a tragic one. It marks the end of Gunpei Yokoi's handheld legacy before his premature death in a tragic motor accident, aged 56. Following the commercial flop of the Virtual Boy, Yokoi left Nintendo and went on to form his own company, Koto Laboratory. It was then that Yokoi was approached by the toy and television company Bandai – which had experience in the LCD market, producing electronic toys such as the popular Tamagotchi virtual pet – to help it enter the handheld videogames market. Seeing Yokoi and his company as the perfect partners to achieve this, Bandai gave him carte blanche when it came to designing the new machine. The WonderSwan was typical of Yokoi's previous handheld efforts: sleek, stylish and perfectly portable. Launched in a trio of attractive colours, affordable and christened with a name you'd not likely forget in a hurry, it immediately stood out, finding an almost instant appeal among gamers in Japan (most prominently girls) where it sold 1.55 million units. The console's monochrome screen, which was chosen to ensure greater battery life, belied impressive architecture and functionality. The WonderSwan ran from a 16-bit CPU, which was a huge step up from the 8-bit Sharp Z80 CPU found inside the Game Boy, and featured a novel dual control system that allowed the machine to be played either horizontally or vertically. While the first machine to offer this function was the Atari Lynx, the WonderSwan was the first handheld to really utilise the function to any noteworthy extent, allowing many of its games – including the machine's popular puzzle game *Gunpei EX* (developed and named after Yokoi himself) – to be played in portrait aspect. The icing on the cake came from the machine's impressive battery life, which offered a jaw-dropping 40 hours. To try to compete with the Game Boy Color, a year after the WonderSwan's launch Bandai released a successor which added a 2.9-inch, 241-colour display. The WonderSwan Color had its own range of titles and was backward compatible with older software, although it lacked the Game Boy Color's ingenious colour upscaling. The following year Bandai released its final WonderSwan variant; the WonderSwan Crystal featured a more robust case and a crisp TFT screen which solved some of the blurring issues that occurred in the older models. Despite the strong user base and inroads that the WonderSwan generated for Bandai, the company never again entered the handheld market and eventually pulled the plug on the machine in 2003.

» Sleek and powerful, the WonderSwan proved popular with Japanese gamers.



» The GBA went from being the one of the largest to the smallest handheld that Nintendo released.

2001 Game Boy Advance

- Released: 2001 • Number of Games: 800 • Games Developed Until: 2008
- Variants: Advance SP, GB Micro

Nintendo would again misfire with the original design of its next handheld. The Game Boy Advance (GBA) was launched in Japan 2001, and ditched the tall and slim portrait shape of the Game Boy for a fatter, Game Gear-esque shape and control configuration. The design proved a bad move for the new handheld, even with the impressive power it had under its hood. The GBA housed an impressive 32-bit RISC CPU, 32K of Memory and could display 526 colours on its crisp, blur-free TFT LCD screen. Two years after the machine's Japanese launch, Nintendo rolled out a clamshell variant – the Advance SP – into the marketplace. Nintendo shrunk down the look of the machine to make it more in keeping with the size and look of Game & Watch Multi-Screens, added a much-needed backlight and better battery consumption, and made it backward compatible with both Game Boy and Game Boy Color software – again making that decision to upgrade much easier for Game Boy users. In 2005 Nintendo would make one final change to the design of the GBA; it was a move that turned the originally quite bulky-looking machine into the smallest handheld ever released. While the tiny size of the Micro meant Nintendo was forced to drop the Game Boy and Color backward compatibility, the handheld did boast a wonderfully sharp backlight. But being released at the same time as the DS, it was the Micro handheld that struggled to continue Game Boy's popular heritage. While the GBA series failed to reach the same levels of success as previous Game Boy incarnations, it still managed to shift an impressive 30 million units in its lifetime and was a massive success for Nintendo.

2004



PSP

• Released: 2004 • Number of Games: Ongoing • Games Developed Until: Ongoing • Variants: PSP Slim & Lite

The brainchild of Ken 'the father of the PlayStation' Kutaragi, the PSP (Portable PlayStation) is the most powerful handheld on the market today. With a colossal 16:9 LCD display, capable of displaying over 16 million colours, and graphics comparable to that of the PS2, the machine is an impressive beast. While Sony was untested in the waters of portable gaming before the PSP's release, it was not entirely wet behind the ears when it came to the field of portable electronics. The electronics giant's Walkman range of

audio cassette, radio and CD players had been hugely successful, and Sony had also released products in the PDA market with its Clie series of pocket PCs. This fact wasn't lost on Kutaragi and his team, who were quick to promote the PSP as an all-encompassing media device. Through the PSP's new UMD storage format (a tiny disc), it was possible to watch movies (the first handheld to offer this function), download and store MP3s and firmware, and upload pictures. It was also possible to connect to other PSPs, PS3s and the internet via Wi-Fi. Despite slow sales initially, the PSP's popularity has been steady. It now stands as the bestselling non-Nintendo handheld ever released, and the release of the stylish PSP Slim & Lite, which ditched the heavy metal chassis to make the machine about 30% lighter, has only helped to further its portability and appeal.

» The PSP is the most technologically advanced handheld ever released. But it's not all rosy for Sony's handheld – shocking loading times, an unpopular movie format and far too many buttons.

Homebrew Heroes

Released in 2001, and developed by South Korean electronics developer GamePark, the GP32 was an open-source system designed to appeal to aspiring game programmers. However, it still found itself beleaguered by the Game Boy Advance and a lack of commercial software releases. Following the release of the GP32, GamePark was split into two separate companies, GamePark and GamePark Holdings, and in 2005 GamePark Holdings released a successor. The GP2X continued the GP32's open-source functionality by utilising a new Linux-based operating system and being compatible with emulators, yet the machine still struggled to gain any notable support from established software developers. GamePark Holdings is now rumoured to be gearing up the release of a successor to the GP2X, called the 'Wiz', later in the year. The machine should benefit from greater commercial software support.

» The DS may have taken some flak early on in its life, but from the wall of scepticism a true successor to Nintendo's Game Boy eventually emerged.

2004

DS

• Released: 2004 • Number of Games: Ongoing • Games Developed Until: Ongoing • Variants: DS Lite, DSi, 3DS

Leaving the Game Boy name behind was a risky move by Nintendo. The name had developed into a strong media brand, a stamp that had become synonymous with portable brilliance, so it was no surprise that the DS took its time to win over the sceptics. The DS's dual screens and the use of touch-screen technology immediately raised doubts as to the machine's functionality as a portable game console, and Nintendo didn't help matters by disassociating its latest handheld from the Game Boy, advocating the DS as a partner to the Game Boy rather than an out-and-out successor. This notion was clearly backed by Nintendo's decision to launch the GBA Micro – the smallest handheld Nintendo released – in the same year as the DS. So while many were trying to get their head around how stylus controls and dual screens would translate well into videogames, and where the DS would sit in Nintendo's long-term plans, Nintendo's new console geared up for its release. With wireless LAN and PictoChat software used for effortless multiplayer and data sharing, the DS had all bases covered, and quickly the machine's popularity gained momentum. Knowing it was on to a winner, Nintendo decided it was time to tackle the one area that the DS was clearly lacking: looks. Whereas the original DS was on the chunky side, the much sleeker DS Lite was a far more stylish machine. And Nintendo's fresh new revamp found the DS become the most successful Nintendo handheld after the Game Boy. As you read this, Nintendo will have just launched third iteration of the handheld in the UK. Launched in Japan last November, the DSi's new capabilities enable users to surf the web, chat online, listen to music and download applications (DSiWare) onto SD cards. And as well as offering internet browsing, the DSi features larger screens, a slimmer design and comes packed with two cameras – one found inside the inner hinge and the other embedded into its outer case. With the DSi's unparalleled functionality, it looks like Nintendo is further looking to revolutionise, redefine and shape the medium of portable gaming.





AMSTRAD GX4000

“GETTING OCEAN ON BOARD WAS ESSENTIAL. IT WAS ONE OF THE BIGGEST PUBLISHERS IN EUROPE, A POWERFUL SOFTWARE HOUSE THAT WOULD HELP SELL THE NEW CONSOLE”



AMSTRAD GX4000

FUTURISTIC STYLING, A BULLISH SIR ALAN SUGAR, A MAJOR DEVELOPER ON BOARD... WHEN AMSTRAD LAUNCHED ITS SPACESHIP-STYLED GX4000 CONSOLE, SURELY NOTHING COULD GO WRONG. BUT, AS WE REVEAL, IT MARKED THE END OF AMSTRAD'S GAMING AMBITIONS

Year released: 1990

Original price: £99

Buy it now for: £15+

Associated magazines: Amstrad Action, Amstrad Computer User, Mean Machines

Why the GX4000 was great... It's hard to give a valid reason for why the GX4000 was great because it wasn't. It was deeply flawed. Its poor quality controllers and paltry range of games led to terrible sales and there were nails in the coffin before it was even launched. But, although the console flopped, having cartridge capabilities in the Plus range of computers was a bonus. It allowed Amstrad to keep the CPC going for a few more years and it helped latter-day developers get more graphical power from their disk-based games.

Gary Bracey is sitting at a table. Around him are some of his colleagues from Ocean Software and sitting a few seats away is Alan Sugar, boss of Amstrad. Next to him is Malcolm Miller, Amstrad's chief executive and they are all gathered at the electronic giant's headquarters in Brentwood, Essex. It is 1990 and they are ready to do business. A product is about to be launched that promises to take on the world and cement Amstrad's power as a major force in computing.

Due to his immense success in electronics – the CPC, the PCW, the PC, the hi-fi and the Sky TV dishes – Sugar is confident. At stake is the future of the Amstrad CPC, a series of machines born with the 464 in 1984 and evolved with the short-lived 664 and the better received 6128. Not one to stand still, Sugar proposes to do away with the black rectangular machines that had proved so popular in France and Spain and that had allowed Amstrad to compete against the Commodore 64 and Spectrum in the UK. Riding into town to replace them, he told the Ocean contingent, were the shiny sheriffs – the Amiga-esque, white coloured new models that took the CPC, bolted on a cartridge port and enabled them to compete with anything else the market could throw at them in opposition.

But, more importantly, there was the standalone, keyboardless machine: the GX4000 gaming console, that dispensed with the tape and disk drives and monitors. This, Sugar explained, was the future of gaming, a system to beat Sega's Master System and the NES and so his abrasive manner was out in force. His new battalion was going to take no prisoners and he wanted everyone to know it.

"He had this bullish attitude," Gary recalls. "Although he was polite with the guys from Ocean – after all, he had called them together to ask them a favour – he was nevertheless straightforward in his approach and he was confident that the products he had were world-beaters. Actually, when I see him on *The Apprentice*, I think about how mellow he has become."

Following Sugar's introduction and the hard sell in which he made projections about how much money Ocean would make, Amstrad's technical gurus took over and continued to sell the console to Bracey and his gang. Getting the Manchester-based company on board was essential for Amstrad. It was one of the biggest publishers in Europe, a powerful software house that was hot on producing games based on film licences, the recognisable games, which would help to sell the new console.

"Alan Sugar was perfectly fine with us," says Gary, "since he was trying to get us to support him. It was important to him because he personally pitched the machine to us and asked to develop titles for it. The big thing he pushed was the fact that, because it was cartridge-based, piracy would be less of a problem. It was quite a meeting."

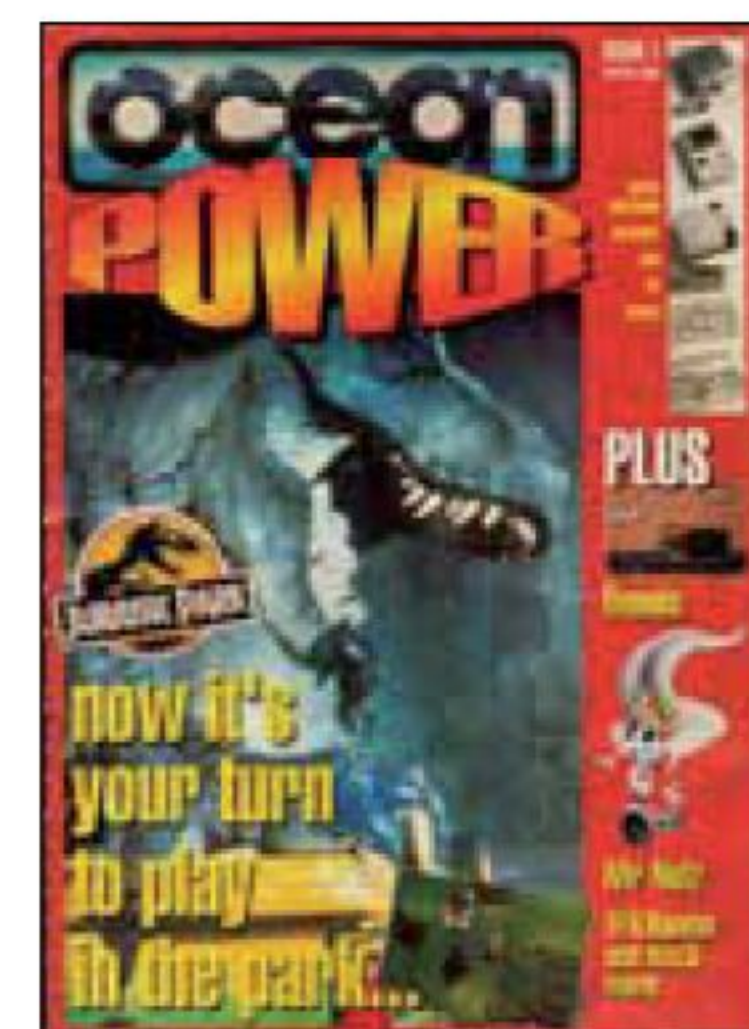

» Ocean produced a catalogue that showed off the range of games it was making at the time, including those for the GX4000.

INSTANT EXPERT

The GX4000 tried to build on the success of the 2.5 million-seller CPC range... but only 15,000 consoles were ever sold.

It was only the second UK-developed console to be released following the Grandstand console of the early Eighties.

GX4000 liked the number 16. There were 16 colours from a palette of 4,092 in low resolution, and 16 hardware sprites each measuring 16x16 and made up of 16 colours available effectively boosting number of on-screen colours to 32.

It was launched at the Hotel Meridien in Paris since the CPC range had done well in France. The CPC 464 had been launched at London's historic Westminster School.

The GX4000 came with Ocean's *Burnin' Rubber* on cartridge, two paddles, a power supply and manuals for the console and game.

Most of the £24.99 cartridge games were ports – some, unforgivably, of games available that sold for £3.99 on tape.

In some cases, games ported to the GX4000 had additional graphics. *Switchblade*, for example, had more splashes of colour.

The GX4000's cartridge capabilities were added to the Plus range of computers. Many homebrewers utilised this extra power... to create disk-based games. **It is understood** that around 35 games were made for the system but grabbing them all could be difficult. Only recently were some shown to exist, including *Chase HQ II*.

Mean Machines covered the GX4000. It was added at the last moment as a replacement for coverage of NEC's PC-Engine. Seven games were reviewed. Only *Pang* and *Switchblade* achieved more than 90 per cent.



AMSTRAD GX4000



TAPE AND DISK-BASED PLUS GAMES

Amstrad included the GX4000's capabilities in the CPC's Plus range of computers but they could only be accessed via games inserted into the cartridge port. This was implemented as an incentive for developers to produce games on cartridge that would then work on the GX4000 but it annoyed many people since it effectively barred disk and tape games from taking advantage of the increased capability.

Except it didn't. Despite Amstrad's claims, the extra features were not hardware locked so it was possible to produce software that allowed access to them. This paved the way for enhanced disk and tape games. Codemasters released the Plus-enabled *Stryker In The Crypts Of Trogon* on tape and games such as Radical Software's *Fluff*, Titus Software's *Prehistorik 2* and Ocean's *Space Gun* also took advantage. Many graphical demos made use of the Plus capabilities too as did a host of utilities. It made the Plus a much more desirable machine and it was one of the bonuses of an otherwise ill-fated adventure by the Brentwood electronics giant. If Amstrad had been quick to admit it was possible to use the Plus facilities via tape or disk soon after the GX4000 died and actively plugged that fact, the Plus machines may have fared much better.



» David Darling's Codemasters considered console games, but produced a cassette game that took advantage of the Plus capabilities instead.



» The Amstrad GX4000 television advert (pulled from an advertising break on Children's ITV in 1990, check it out at www.youtube.com/watch?v=0tMt0fqM9p8) was cheesier than cheddar. But was it enough to make you want to part with your cash? No way.

The GX4000 wasn't the only computer-based console being launched at the time. Commodore was producing the 64GS, essentially the C64 without the keyboard that also made use of cartridges. Both companies were keen to make an entry into the console market and for good reason – the home computers had been hugely successful in the Eighties and the Amiga was continuing that success in the 16-bit market. Yet Nintendo and Sega were making massive inroads. To sit back and watch as consoles took over the gaming industry was not an option.

"We came away having assured Alan Sugar of a small commitment to write some games – at least until it had proven commercially viable to increase," says Gary. "As a result, we got a bunch of prototype consoles and set to work porting some titles already in the works. But, if I'm honest, we were a little cynical about it. We weren't going to bet the firm on this new console and so we decided to concentrate on creating ports from other computers first of all and see how it went."

Over the next few months, Ocean cracked on, making the games that Sugar would unveil at the plush Hotel Meridien in Paris in September 1990. It was the official press conference during which the fine details of the machines were released. Not that it came as much of a surprise – news had leaked out about an imminent launch from Amstrad a couple of months before but the console and the fresh 464 Plus and 6128 Plus still caused great excitement.

In fact, the computing press jumped all over it, despite having reservations over Amstrad's decision to base the machine on 8-bit technology. Looking at the bundled game, *Burnin' Rubber*, gamers could be sure they were seeing a machine with superb 8-bit graphical capability and, because Amstrad had been successful with the CPC and the PCW and had a big clomping foot in the PC market, it was felt that it would do well.

With 4,096 colours from which to choose, 32 of which would be displayed on screen at once, and with built-in hardware sprites, and fast, smooth hardware-scrolling, games looked similar to 16-bit titles. The console plugged into a television via the aerial socket or SCART. It was also possible to wire it into an Amstrad monitor. There was a pause button, two ports for the poorly built game controllers, a port for an analogue joystick, a slot for a lightgun and, finally, a sound button. Turn the

machine on and the screen would be fuzzy. Insert the cartridge and the game would appear. For Amstrad users used to the long waits associated with tapes, it was pure joy and the line-up of games – which included *Fire And Forget II*, *Klax*, *Crazy Cars II*, *Kick Off 2* and *Batman: The Movie* – seemed impressive enough.

Sugar was confident he was on to another winner and he was pleased at having top developers on board. "We don't just see this as Amstrad fighting Nintendo and Sega, we see this as Amstrad, together with companies such as Ocean and others who want to make some money and who do not want to be dictated to, fighting against these people," he said, obviously pleased at having had Ocean's assurance that it would support the console.

Back in Manchester, the reality of this gung-ho, 'everyone together' stance was different. "Although we had agreed to work on the GX4000, there was no special software division created for the console or anything like that," says Bracey. "It was pretty much the same people who were working on the computer versions anyway. The console versions were 'adaptations' of the regular ones. Until the console proved to be more viable to commit specific resources then we weren't going to dedicate entire teams to it."

Ocean created some stunning games. It developed *Burnin' Rubber*, the fantastic *RoboCop 2* and the superb *Pang*. But it also ported games directly from the Amstrad CPC including *Operation Thunderbolt*. In some cases, it didn't make any enhancements and people became wary of buying a game on cartridge for £24.99 when it could be bought on tape for less than a tenner. "For us," says Gary, "it wasn't so much about the cost of dedicating teams specifically to the format, but rather the opportunity cost of taking them away from the more established computers."

The reason developers like Ocean, Gremlin and Loriciel didn't push the boat out with the GX4000 was simple. Sales were disappointing from the start. It didn't take long to realise that the GX4000 was not as good as the NES or Master System, nor did it represent an essential upgrade from the Spectrum, C64 or CPC. Gamers were buying Amigas and STs, tapping into the 16-bit market and, at the time, piracy was rife. Amstrad may have sold the console to developers on the fact that cartridges were expensive to produce but, faced with spending £24.99 on a game or grabbing some copied Amiga discs in the playground, then, rightly or wrongly, children were likely to do the latter. And where they were prepared to buy expensive games – for example with the NES or SMS – the range of games was far wider. It was clear there was a problem.

Even the in-store GX4000 demonstrators didn't help and the £20 million marketing budget, used to pay for television and magazine advertisements across Europe, failed to have an impact. "We





» This picture, taken by Gauthier Morand, shows the disk-based Plus-enhanced *Space Gun*.



» Best known for his role in *The Apprentice*, Sir Alan Sugar was even more bullish in 1990.

considered producing games for the GX4000," says David Darling, the former owner of budget label Codemasters. "But at that time we could see where the market was and it was lying with Nintendo and Sega. From a financial point of view, it was always going to be more worthwhile trying to produce games for those consoles."

The difference between producing for Nintendo and Sega and making games for Amstrad was one of control. Sugar didn't want to tie developers into exclusivity contracts nor create a licence system. Developers were free to produce whatever they wanted and they had complete freedom. As Codemasters later discovered, Nintendo was – and remains – fiercely protective over who could and couldn't produce games for its consoles.

The biggest problem, however, was the type of games released. There were some gems for the GX4000, but the remainder were fairly run-of-the-mill, the kind people were used to paying less for.

"Perhaps the manufacturing cost and therefore the sale cost of the cartridges were too high," says Roland Perry, Amstrad group technical manager when the GX4000 launched in 1990. "People could buy similar games on floppy disc for the home computer versions. A quick look at the price lists of games back then confirms this. Cartridges were, with the benefit of hindsight, too expensive."

Problems with manufacturing the cartridges didn't help. Shop supplies of games were low so even those who had bought the machine struggled to play anything on it. Rather tellingly, the main magazine, *Amstrad Action*, despite its gushing editorial at the time of launch, had very little coverage in subsequent issues. Few people upgraded from the CPC to the Plus and the magazine's writers decided to concentrate on their core readership.

In February 1991, mere months after launch, Dixons and Comet began to sell the GX4000 for £79 after Amstrad allowed them to keep more of the profits. Still, games were scarce and a few

months later there was some structural changes within Amstrad with 37 redundancies including Peter Roback, Amstrad's software and peripherals manager, one of the main men behind the GX4000 launch. The GX4000 was soon being flogged in independent stores for as little as £30. *Amstrad Action* even ran a contest, which asked readers to find the cheapest GX4000 in Britain.

Cliff Lawson, who was part of the team that launched the GX4000, said: "By the time we launched the new machines, there were computers like the Archimedes and ST which were showing what 16-bit CPUs could achieve. And we were still stuck in the 8-bit world. Admittedly, the GX4000 had hardware assistance, but the ST and Archimedes had powerful sound and graphic support chips."

Quite simply, Amstrad had waited too long to take the plunge. By deciding to capitalise on the success of its existing brand and technology, it was trying to nudge its way into the console market on reputation alone. It figured people would buy its consoles out of blind loyalty and familiarity and didn't see that people wanted 16-bit and that rival consoles were offering not only more but also something new. And even if it did offer something new, it didn't have the money to be able to spread the word effectively. While Sega and Nintendo bombarded gamers with cool, eye-catching advertising and word of mouth in the playgrounds spread, Amstrad was being left behind, eventually deciding to cash in its chips. Although it attempted to weld a Sega Mega Drive with a PC in 1992, Amstrad pulled out of the home computer and console market and proved that not everything Sugar touched was sweet.

VIVE LA FRANCE

The biggest market for the CPC was France and it is in this country that the Plus range and the GX4000 fared better. One of the most recent games for the Plus, produced in 2005 is the strangely named *Call & BD10'n'oeuf*, an arcade game created by French programmer and musician Fenyx Kell. He presented it at the Amstrad Expo 2005 in Coutances, France. The game is simple – you have to push an egg to the exit – but it makes use of the graphics of the Plus and it looks incredibly lush as a result.

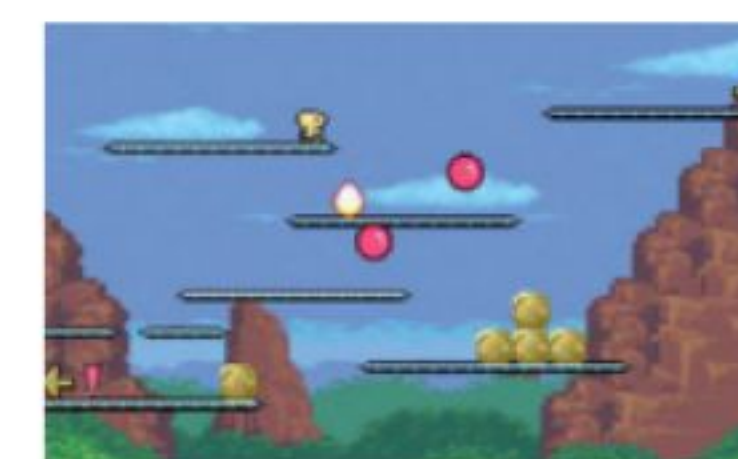

COMMUNITY GX4000 SITES TO WATCH

CPC Zone

www.cpczone.net

Run by Malc Jennings since 2000, CPC Zone is the top destination for all things GX4000/Plus. It has a host of game reviews thanks to its brilliant Gamebase, the latest news, covers and downloads. But best of all it has the finest CPC forum on the net.



The Amstrad CPC Games Resource

<http://tacgr.emuunlim.com>

With hundreds of downloads, this is the place to find virtually every single CPC game ever created. There are emulators too, some of them letting you play GX4000 titles.



CPC Wiki

www.cpcwiki.com

The CPC Wiki has lots of information not just on the GX4000 but also the entire CPC range. It's packed with information exploring every nook and cranny of the CPC scene to date, including the movers and shakers, the machines and the many publications.



CPC Game Reviews

www.cpcgamereviews.com

If you're looking to see whether a game is worth playing or compare your experience of a game with somebody else's, then this site is as comprehensive as they come listing hundreds of reviews, all in alphabetical order. It's an impressive collection.



» A selection of the GX4000's games, that just weren't enough to make it a success.





AMSTRAD GX4000

PERFECT TEN GAMES

With around 35 games created for the Amstrad GX4000, picking out ten 'perfect' titles should be a difficult task. In actual fact, though, it isn't. For while there were many straightforward lazy ports of CPC games, there were also some spectacular originals.



01

PRO TENNIS TOUR

- » RELEASED: 1990
- » PUBLISHED BY: UBISOFT
- » CREATED BY: BLUE BYTE
- » BY THE SAME DEVELOPER: THE SETTLERS

01 Fast, smooth and with realistic looking players, technically this was the best tennis game produced for the Amstrad. That it was available on the GX4000 gave people a reason to buy the console, especially as Ubisoft enhanced the graphics and tweaked the gameplay so that the way that you hit the ball had an effect on where it ended up. And that, looking back, was something of a bonus. There was a slickness to *Pro Tennis Tour* that makes it playable today. Although it is possible to hit a ball that has seemingly flown past you, the incredible attention to detail and the range of tournaments available, from Wimbledon to the French, Australian and US Opens, made it a welcome GX4000 addition.

ROBOCOP 2

- » RELEASED: 1991
- » PUBLISHED BY: OCEAN
- » CREATED BY: IN-HOUSE
- » BY THE SAME DEVELOPER: TOTAL RECALL

02 Time hasn't been particularly kind to *RoboCop 2*, the obstacles that are strewn before our hulking metal-clad, law-enforcing hero proving more frustrating than challenging when romped through today. Back in its Amstrad GX4000 day, however, this cartridge-only release was the console's shining light and, to be honest, there is more than enough in this platform game to make it well worth a full playthrough again, if only to experience the smooth scrolling, the great use of the hardware sprites and a beautiful blend of eye candy colours, all carefully drawn to make the screen ooze atmosphere. Can this compare to a 16-bit release? The answer would, graphically at least, have to be a positive.



02

BATMAN: THE MOVIE

- » RELEASED: 1990
- » PUBLISHED BY: OCEAN
- » CREATED BY: OCEAN/MIKE LAMB
- » BY THE SAME DEVELOPER: RENEGADE

03 When you play the first level of this Ocean licence – the third *Batman* game released by Ocean – you are instantly sucked in. Few can resist playing as the Caped Crusader, especially in a game based on the 1989 classic movie. Also, being inside a factory and aiming weapons at wave after wave of baddies in an iconic and most memorable first level was, 18 years ago, almost worth the £25 price tag alone. It didn't add anything new to the bog-standard CPC version, though, and the side-scrolling Batmobile level, the third/puzzle level and the change to fly the Batwing were ultimately disappointing.

BURNIN' RUBBER

- » RELEASED: 1990
- » PUBLISHED BY: OCEAN
- » CREATED BY: IN-HOUSE
- » BY THE SAME DEVELOPER: CHASEHQ

04 This was the game that got hearts racing and it was the first title that most, if not all, of the console's gamers played. In a lot of cases, it was also the last due to the lack of GX4000 games available, but its impressive graphics and the brilliant crash scenes showed the capability of Amstrad's offering and placed it in pole position when it came to finding the best 8-bit racing game of all time, in terms of visuals anyway. As long as you had the stamina to keep going without running out of time, you'd be awarded with engaging fun, the joy of seeing the sky change from day to night and some amazing crashes.

PANG

- » RELEASED: 1991
- » PUBLISHED BY: OCEAN
- » CREATED BY: IN-HOUSE
- » BY THE SAME DEVELOPER: PLOTTING

05 There were pangs of jealousy when this game was released as a cartridge-only GX4000/Plus game, mainly because it was a title that most CPC gamers wanted. The desire was so strong that indy developer Elmsoft – aka Elmar Krieger – produced his own version, *Zap T Balls* that, while not as good, at least gave CPCers something to get their teeth into. Popping balloons, seeing them split into two and trying to eradicate the lot was so much fun and it was made even better for the fact that the GX4000 enhanced it with graphics that took that jealousy to a whole new level.



03



04



05



06

KLAX

- » RELEASED: 1991
- » PUBLISHED BY: DOMARK
- » CREATED BY: ATARI GAMES
- » BY THE SAME DEVELOPER: GAUNTLET

06 One of the most ported falling-tiles games in history is – putting *Tetris* to one side – none other than *Klax*. And on the GX4000, a console that only had Ocean's *Plotting* as a rival, it was a must-have purchase. Having said that, it didn't come without some disappointment since it was identical to the standard game released on the CPC and it made very little use of the extra capability (much like *Plotting*). If *Klax* wasn't such a legendary, addictive game, it wouldn't actually warrant being in this Perfect Ten because of this lack of ambition. But there were so few games on the GX4000 that, if you take the game at face value, it's worthy of an inclusion.

SKEET SHOOT

- » RELEASED: 1991
- » PUBLISHED BY: TROJAN
- » CREATED BY: IN-HOUSE
- » BY THE SAME DEVELOPER: ENFORCER

09 Using the Amstrad GX4000's lightgun – and yes, there was one actually available for the princely sum of £30 – you could play *Skeet Shoot* (and pick up *Enforcer* later, had you some spare cash knocking around). Predictably, *Skeet Shoot* was a bloodless shooter in which you had to blast clay pigeons out of the sky. The geese that flew around the screen oozed liquid when they were hit, but that was about as gruesome as the game ever got. *Skeet Shoot* is one of the rarer games, mainly because to pick one up today you would have to find the lightgun that didn't sell all that well either. It's not a particularly wonderful game via an emulator (and neither, if you're asking, is the *Untouchables*-esque *Enforcer*).



07

NAVY SEALS

- » RELEASED: 1991
- » PUBLISHED BY: OCEAN
- » CREATED BY: IN-HOUSE
- » BY THE SAME DEVELOPER: ROBOCOP

07 With graphics as astounding as *RoboCop 2*'s, *Navy Seals* showed more than a hint of the capability of the GX4000. As a cartridge-only release, it made use of the console's extra features, boasting smooth scrolling and excellent animation. But the game was as hard as one of the five heroes you played, mainly because it wasn't a case of storming into the terrorists' HQ with all guns blazing. Instead, you had to take a more measured, stealthy approach as befitting a member of the prestigious Navy Seals. It's a shame the title was so difficult as it put many off venturing past the first level. With perseverance came great reward, however.

FIRE & FORGET II

- » RELEASED: 1990
- » PUBLISHED BY: TITUS
- » CREATED BY: IN-HOUSE
- » BY THE SAME DEVELOPER: CRAZY CARS

10 This sequel to *Fire & Forget*, a game that was released two years earlier, had three aims: kill, kill and... er... kill, basically. And as you scoot through the game's five levels in your Thunder Master II, you will be busting more terrorist butt than you could ever possibly imagine, firing missile after missile and taking to the air. The road is long – at times a little bit too long – and it can soon get rather tiring and somewhat repetitive, but driving you on is a deep down desire to keep taking pot shots at the enemy and it's certainly different to a regular run-of-the-mill shoot-em-up. With much excellent, if spartan, graphical elegance to feast your peepers on, *Fire & Forget II* is certainly one worth taking a run out with.



08

SWITCHBLADE

- » RELEASED: 1991
- » PUBLISHED BY: GREMLIN GRAPHICS
- » CREATED BY: GREMLIN/JEFF CALDER
- » BY THE SAME DEVELOPER: STRYKER IN THE CRYPTS OF TROGAN

08 Gremlin Graphics excelled itself with this platformer that some may argue was the best game on the console. It used the machine's Mode 1. Whereas the old CPCs were constrained to just four colours in that mode, (as opposed to the 16 that could be used in the lower-res Mode 0), the GX4000 could handle more. And so when you put the original CPC version next to the cartridge one, you can see the difference with extra colour and elegance. While that is the only real difference between the versions, it nevertheless showed that, had the GX4000 been successful, it was possible to push otherwise unheard of CPC boundaries.

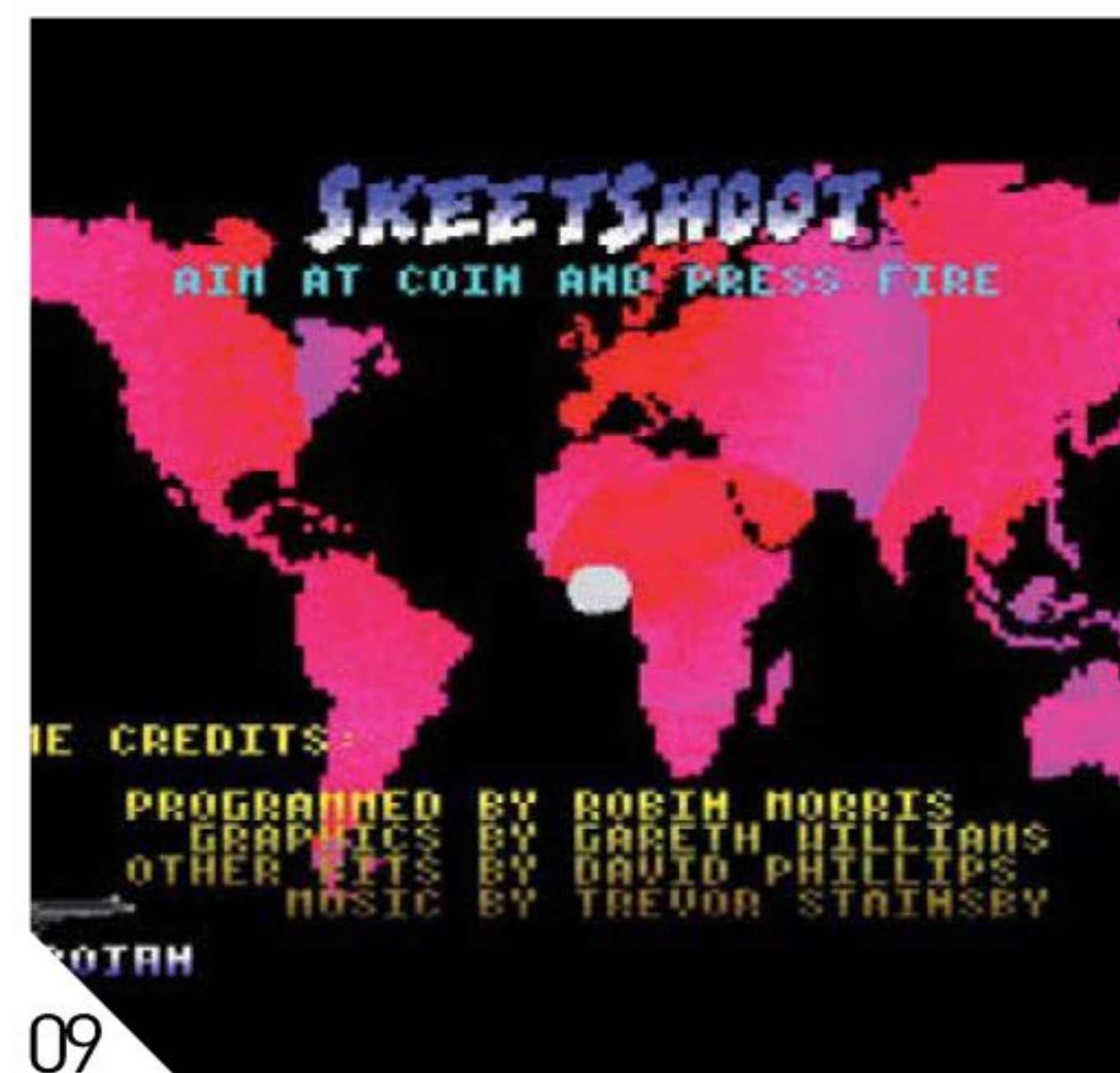

09



10



ACORN ARCHIMEDES



“ The engineers at Acorn took the courageous decision to design their own microprocessor chip ”

ACORN ARCHIMEDES

Produced between 1987 and 1999, the Acorn Archimedes featured a range of models to spark the interest of any vintage enthusiast. We reveal why we should never forget

Although it never achieved the same level of sales as home-console rivals Atari ST and Amiga, Acorn Computers' Archimedes still enjoyed an impressive library of exclusive games of which every fan of classic gaming should be aware. Thanks to its powerful CPU and colourful graphics, the Arc gave its owners their own mirror universe of games to enjoy, encompassing every genre.

By the mid-Eighties, British company Acorn Computers was riding the crest of a wave having secured a contract to produce an education-orientated computer, the BBC Micro. However, the ever-evolving nature of technology dictates that nothing ever stays the same for long, and by 1985 the 8-bit BBC Micro, which had put the company so prominently on the map in 1981, was beginning to look hopelessly old-fashioned when compared with such competition as Commodore's 16-bit Amiga. Following the success that it enjoyed in the education sector, and propped up by shareholder PC manufacturer Olivetti, Acorn began ploughing research funds into a successor to the Beeb. The first stage of the project that became the legendary Archimedes was under way.

Dissatisfied with the microprocessor chips that were in available at that time, the engineers at Acorn took the rather courageous decision to boldly design

their own using a fashionable new approach called the Reduced Instruction Set Computer (RISC). The RISC design methodology involves removing instructions that are infrequently used, in order to create a chip that is less complex. The result of Acorn's efforts, the Acorn RISC Machine (ARM) – which was later changed to the Advanced RISC Machine – chip, was one of the best performing chips of its generation, and about four times as fast as the 68000 that powered machines such as the Amiga. In fact, the performance of the finished chip surprised even Acorn engineer Sophie Wilson, who reveals that: "What we didn't expect was that a chip designed for 4MHz would run at 6MHz and, with some tweaking to critical paths, 8MHz."

The next surprise for the designers was that they had difficulty measuring the power usage of the first ARM as it drew so little. The ARM chip became the heart of Acorn's new machine, and thanks to its efficient design, it went on to become the lasting legacy of Acorn Computers. For example, the ARM is now the most common CPU found in embedded applications such as mobile phones.

And it didn't stop there, because Acorn also created a set of powerful custom chips to power the graphics, sound and input/output. The graphics architecture lacked some of the Amiga's more elaborate features – such as a blitter, copper chip and hardware sprites – but it was still capable of matching the Amiga's sprite-plotting prowess thanks to the far faster processor. The lack of a copper chip was apparent in some conversions of 16-colour games, such as *Gods* and *Twin World*, as they lacked the colourful graduated skylines of the Amiga versions.

Another limitation was the fixed palette in 256-colour modes, which gave games

a look that favoured primary colours. However, the most common gaming mode of 320x256 pixels with 256 colours still exceeded the baseline capabilities of most of the competition.

After a false start involving a US-based design team, Acorn Computers was left with a serious problem, because the hardware would be finished a long time before a potential operating system. The

INSTANT EXPERT

Like the BBC Micro before it, Archimedes' most common gaming keys were Z, X, ', /, and <return>.

All RISC OS-driven machines have a version of BASIC built into the ROM. Press F12, then type the word 'basic' to access it.

The Arc had eight-channel sound and each channel could be assigned to one of seven stereo positions.

RISC OS is still a commercial product that is being developed. For emulation purposes, you can buy a version of RISC OS 4 for £5 from the RISC OS Ltd website sales.riscos.com.

Most teachers wouldn't have approved, but many British youngsters got a sneaky first taste of 32-bit gaming on an Acorn machine at school.

The 1989 Acorn A3000 was the final machine in the range to have the words 'Archimedes' or 'BBC' on the case.

Nearly all Arcs lacked a digital joystick interface. Fortunately, third parties created add-on adaptors with software to simulate key presses.

The first-generation machines, with an 8MHz CPU and 1MB of RAM, became the baseline for most gaming, in the same way Amiga A500 and Atari 520ST did.

Most Arcs featured the famous red function keys, a signature livery that began with the BBC Micro. This tradition was phased out in favour of a more business-like look on the final workstations.

Eagle-eyed viewers of action show *24* may have spotted computer geek Edgar Stiles using RISC OS at CTU headquarters. Doubtless he installed it for trouble-free access to the best version of classic *Elite*.

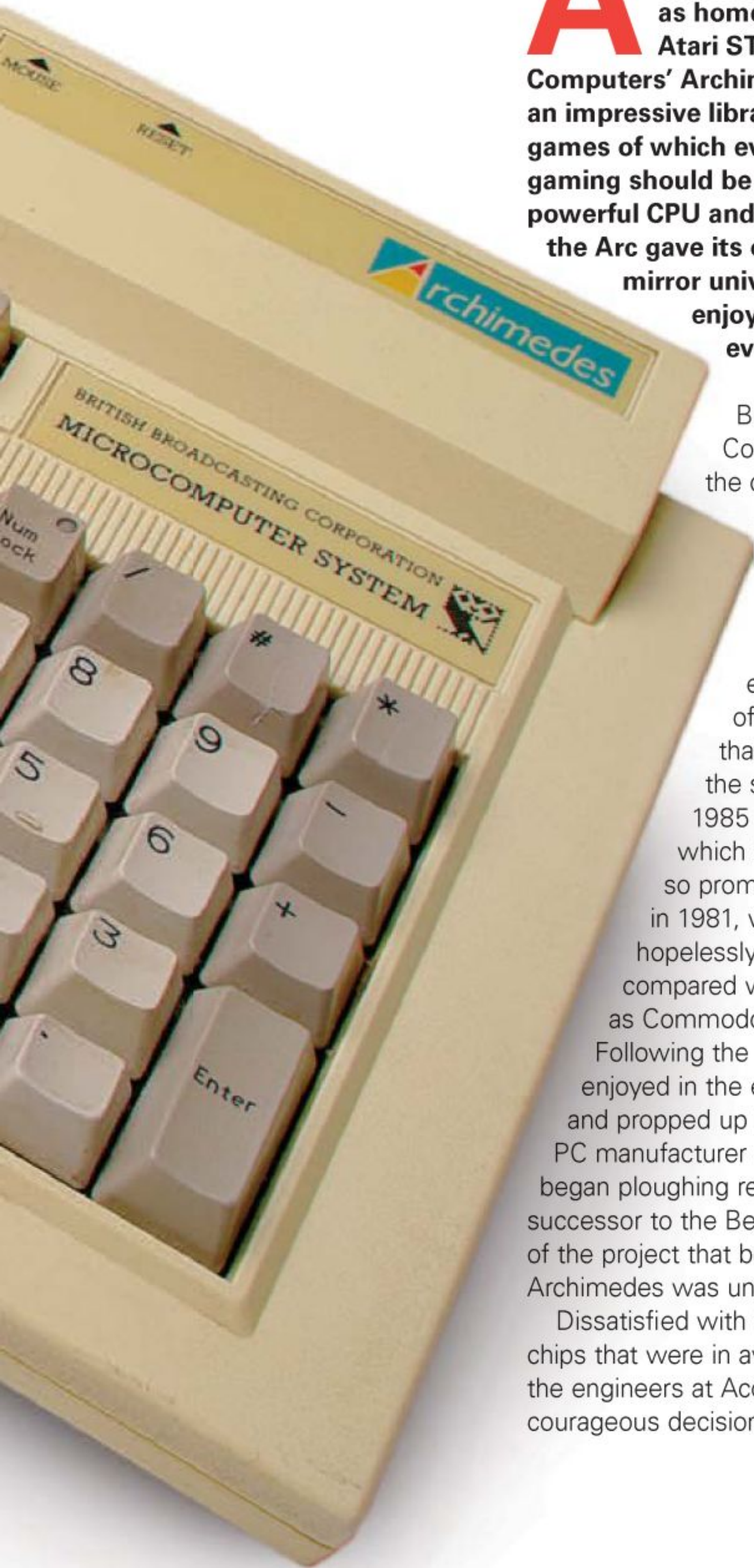



ACORN ARCHIMEDES

THE CURRENT SCENE

Like a lot of classic platforms, RISC OS has been kept alive by a strong community who run a combination of vintage computers and newer compatible hardware. We asked Chris Williams of drobe.co.uk about the current RISC OS scene and he was optimistic. "There's the usual stream of side developments and updates to keep things ticking over," he says. "From new versions of desktop software to a new graphics card designed to perk up some of the old hardware." Each year there are a couple of shows and some user group meet-ups. The biggest development seems set to come from the shared source branch of RISC OS. As Chris explains: "It's somewhat exciting at the moment in as far as things are actually happening that we didn't expect. The OS is being gradually ported to a new range of ARM-compatible processors found in swish netbooks and other gadgets so many more people will be able to use RISC OS on newer hardware." So, it seems that your next gadget purchase could involve not just an ARM processor, but also RISC OS as the operating system.

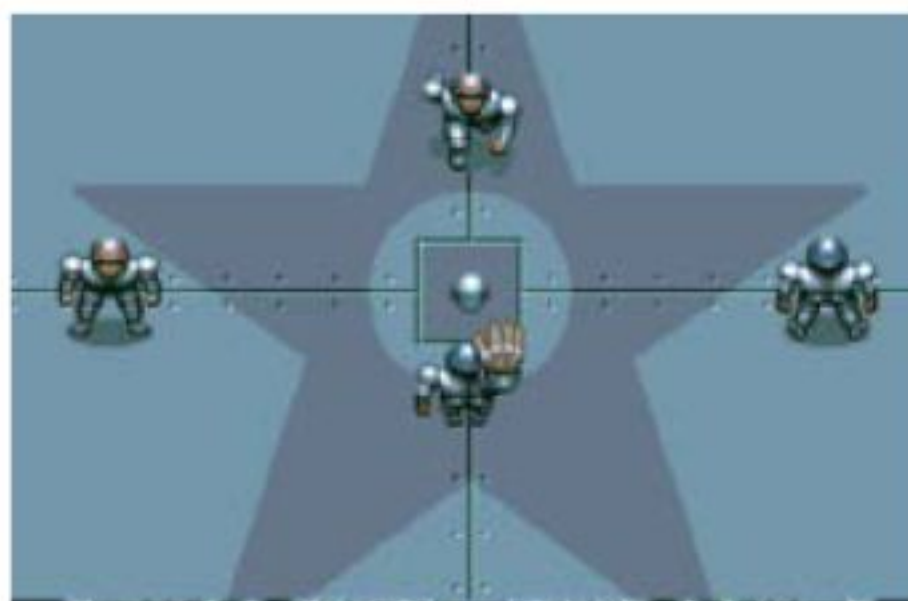
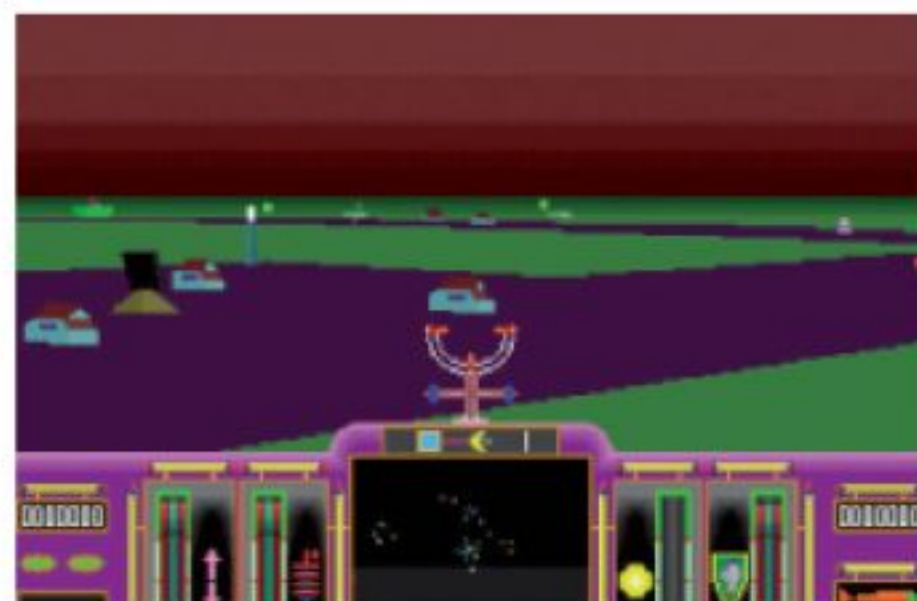

“ Archimedes could be used to teach page layout in one lesson and music composition in the next ”

engineers decided to develop a stopgap system based partially on the BBC Micro Operating System (MOS). The result, known as Arthur, allowed consumers and developers to get a glimpse of the amazing hardware in action, but compared to other operating systems of the time, it was a major disappointment. It didn't even offer multi-tasking. Backwards compatibility with BBC MOS gave existing developers a head-start in understanding the machine, but limited the architecture decisions that the designers could make. An additional problem was that any later OS would have to be backwards compatible with Arthur or else it would risk alienating developers.

In 1987, Acorn released the first Archimedes-branded workstations. The A310 was at the top of the range with an 8MHz processor and 1MB of RAM, while the somewhat cheaper A305 came with 512K. Although not massively more expensive than other high-end workstations of that time, the relatively inflated price did become an issue that dogged the platform throughout its life. The machines shipped with the Arthur operating system ROMs fitted internally, and the ROM-based operating system was a unique feature that made operation without a hard disk a much more reasonable proposition than it was on other workstations.

Selling a basically incomplete and fairly

expensive computer would have been an uphill struggle for most companies, but Acorn had several unique advantages. First, its monopoly in British education guaranteed thousands of sales from the beginning. Second, there already existed a network of user groups and high-street magazines that viewed the Archimedes as the natural successor to the BBC Micro. The reactions from the technology press were mostly positive as the machine was truly one of the fastest money could buy. The fact that it was a true 32-bit system was also a major selling point.

Most of the first commercial game releases were basic – in more ways than one, some of them were written in BASIC – but they began to demonstrate the viability of the Archimedes as a gaming platform. Alongside the first simple platformers and horizontal shooters, the first ports from other platforms began to appear. Ports were a good idea for the relatively small Archimedes market as the asset development, such as graphics, level data and even the packaging had already been completed. Archimedes owners were lucky enough to be able to play some of the big multiformat hits, but they also made the most of some good games that had been only low-key successes on their native platform.

Finally, about one year after the first hardware release, in 1988 Acorn brought out the successor to Arthur. RISC OS 2 was an operating system equivalent in quality to the hardware upon which it ran. Wilson confirmed that the relief felt among owners was shared by Acorn Computers. "The system really only became what we had desired with the release of RISC OS," she comments. Although RISC OS offered multi-tasking and advanced features such as scalable outline fonts, it was surprisingly efficient. The sheer speed at which the graphical interface operated was a benefit that was quite difficult to convey in pictures.

The combination of speedy hardware and a powerful operating system meant that Acorn's Archimedes was now an excellent all-rounder for serious applications. In a classroom environment, this meant that a basic Archimedes could be used to teach page layout in one lesson and then music composition or multimedia work in the next. PCs of the time were hampered by an extremely poor user interface, and an Apple Macintosh that could perform at the same level as an Archimedes would have been much more expensive.



COMMUNITY ACORN ARCHIMEDES SITES TO WATCH

Drobe

www.drobe.co.uk

Headed up by journalist Chris Williams, the Drobe team maintain an active news website that can be considered the nucleus of the modern Archimedes scene. Their site focuses on the most recent developments in the RISC OS world, rather than simply the vintage heritage of the machine.



Usenet: comp.sys.acorn.misc

<http://groups.google.co.uk/group/comp.sys.acorn.misc/>

Usenet provides the most active forum for discussion on the platform. If you have a question, this is the place to ask it. If you can't be bothered to set up a Usenet newsreader program, don't worry, because Google provides a front end.



The Icon Bar

www.iconbar.com/forums

Admittedly, the main news section of the Icon Bar website is rarely updated these days. However, the forum is still active. A lot of the participants were around 'back in the day', so they are more than likely to be able to answer any query about an old machine or piece of software. Give them a try at the address listed above.



riscos.info

www.riscos.info/index.php/RISC_OS

A hub for RISC OS software development, this site is the home of such projects as the Firefox port, Arc emulator RPCemu, and the GCC compiler. To find out about the modern face of software development on RISC OS, or the latest ported utilities, make this site your starting point.



VARIATIONS

Acorn Archimedes A310

Released: 1987

The A310 and its sister machine, the A305, were the first Archimedes hardware releases. They have a separate keyboard and the metal case was designed to carry a monitor. The later 400 series were cosmetically similar variants with different memory and hard drive options.

BBC A3000

Released: 1989

The wedge-shaped case with a built-in disk drive located around the side gave this model a look reminiscent of the Amiga A500 and the Atari 520ST. This machine became the baseline standard for gaming over most of the life of the series. Like most Archimedes, it requires a vintage monitor.

Acorn A4

Released: 1991

This was Acorn Computers' only attempt at a laptop. The case was actually taken from a standard PC laptop of the time, and the innards were repackaged to make the A5000 desktop computer. It lacked a built-in pointing device and featured a 16-scale greyscale screen, which was fairly standard back in 1991.

A5000

Released: 1991

The A5000 model was arguably one of the greatest machines that Acorn ever produced. This two-box design came with a faster processor and more memory RISC OS 3 as standard. On the downside, however, the graphics and sound hardware were more or less the same as the previous generation.

A3010

Released: 1992

Sporting distinctive green function keys, the A3010 was Acorn's final attempt to steal sales away from the Amiga and ST. Unusually for an Archimedes, it features both built-in TV modulator and joystick ports. The A3010 also benefits from a slight performance enhancement over the earlier machines.

RISC PC

Released: 1994

Once again, Acorn fans could hold their heads high as this 233MHz model was one of the most powerful workstations available. The graphics, sound and CPU capabilities were indeed competitive, but the software architecture was beginning to creak. You'll still find a number of people running these.

A9Home

Released: 2005

Advantage 6's A9Home comes with a 400MHz processor, 128MB of main system RAM, and 8 megs of VRAM. Because modern ARM chips aren't quite compatible with those used in vintage Arcs, the A9Home requires an extra piece of software to run legacy application. Recent apps run fine. Head over to www.advantage6.com.

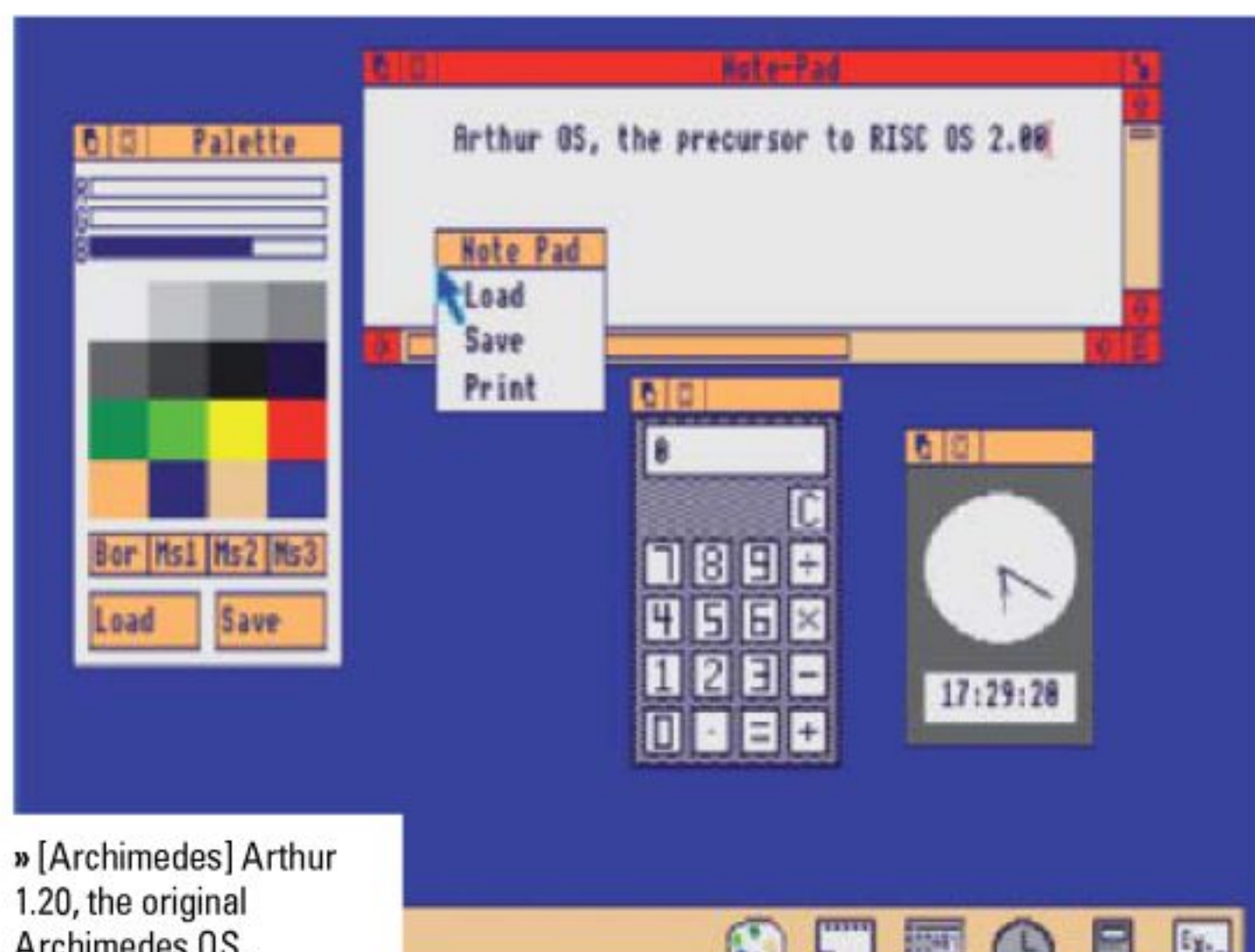

» [Archimedes] Arthur 1.20, the original Archimedes OS.



» [Archimedes] Games like *Ibix The Viking* started to push the Arc. A poke around on the disk reveals the game was written in BASIC.

» [Archimedes] *Top Banana's* gameplay was very reminiscent of Taito's *Rainbow Islands*.

As good as RISC OS was, it was not perfect. Some of the design decisions were somewhat curtailed by its backwards compatibility with Arthur, which had in turn been based on BBC MOS. For one thing, the multi-tasking of RISC OS was based on a co-operative model, much like contemporary versions of Mac OS and Microsoft Windows. In a co-operative system, the applications themselves have to manage some of the multi-tasking process. The net result is a system that isn't quite as smooth and crash resistant as it could be, because the whole system is at the mercy of a badly written or crashing application. Modern operating systems, such as Linux and all versions of Windows from Windows 95 onwards, use pre-emptive multi-tasking, a superior system. Even the Amiga OS of 1985 used pre-emption.

A myth seems to pervade within some retro gaming circles that the Acorn Archimedes didn't have many good games. It did. It just didn't have as many as the Amiga and the Atari ST. One of the main problems with gaming on the Archimedes was that, due to the shoestring budget upon which they were produced, many of the games

featured graphics that were drawn by the programmers. This approach, which was the way that most 8-bit videogames had been created, occurred at a time when Amiga titles were often created by a team of designers and artists. Visually speaking there were a couple of gems, but in practice users sometimes didn't get to see the full benefit of the amazing specs.

The classic period of Acorn Archimedes gaming existed between 1987 and about 1993. As with the Amiga, most videogames were designed to run on the basic, lowest-common-denominator hardware, although a number of the final games were capable of taking advantage of the extra facilities of later hardware.

Acorn Computers had enjoyed a massive lead over the competition upon the machine's release, but unfortunately, it didn't aggressively defend that lead. And the price was always slightly more than the competition in any given market. For example, in 1993 Acorn made a final attempt to secure some of the home gaming market with a single-box computer called the Acorn A3010. Unfortunately, the equivalent machine from Commodore, the

Amiga A1200, had far superior graphics, a great deal more software and was about £100 cheaper – quite a significant difference in that market. By the early-Nineties, the hardware releases were starting to become rather lacklustre. Models based around faster processors were periodically released, but the graphics system was hardly upgraded until the 1994 release of RISC PC, the final Archimedes workstation. To outside observers, it seemed the company was resting on its laurels, a mistake that Commodore would soon repeat. Losing ground on all sides, Acorn shut its workstation division in 1999.





ACORN ARCHIMEDES

PERFECT TEN GAMES

ACORN'S ARCHIMEDES PLAYED HOST TO A HUGE NUMBER OF WONDERFUL GAMES, SO TO SAVE YOU TIME, WE'VE LISTED THE TEN ARC GAMES YOU MUST PLAY BEFORE YOU DIE



01

ELITE

- » RELEASE: 1991
- » PUBLISHER: HYBRID TECHNOLOGY
- » CREATOR: WARREN BURCH AND CLIVE GRINGRAS
- » BY THE SAME DEVELOPER: NONE

01 Elite on the Archimedes is rightly regarded as the definitive version of this legendary game – a fitting honour as the title actually started out life on an earlier Acorn machine, the BBC Micro. The Archimedes rendition of the classic three-dimensional combat space trading game is faithful to the original but with a few clever refinements. In addition to the most impressive graphics of any version of *Elite*, this one also managed to take the player out of the centre of the game world to some extent. While it was strangely soothing to sit back and watch a miner going about his business in an asteroid field, it was exhilarating to watch police Vipers peel off to rescue a trader under attack by pirates.

CHOCKS AWAY

- » RELEASE: 1990
- » PUBLISHER: THE 4TH DIMENSION
- » CREATOR: ANDREW HUTCHINGS
- » BY THE SAME DEVELOPER:

02 The flight simulator trend of the era may have been moving towards detail and seriousness, but *Chocks Away* emphasised fun above all else. Like many classic retro games, it was very easy to pick up, but somewhat more tricky to master. "Come on, baby, hold it together," you'd whisper while nursing a battered plane back home for a challenging carrier landing. Well, we did. Most of the missions amounted to solo raids deep into enemy territory to destroy armament factories, barrage balloons, and other vital elements of the enemy war machine. Even better, you could team up with a mate for some split-screen or serial link-up action.

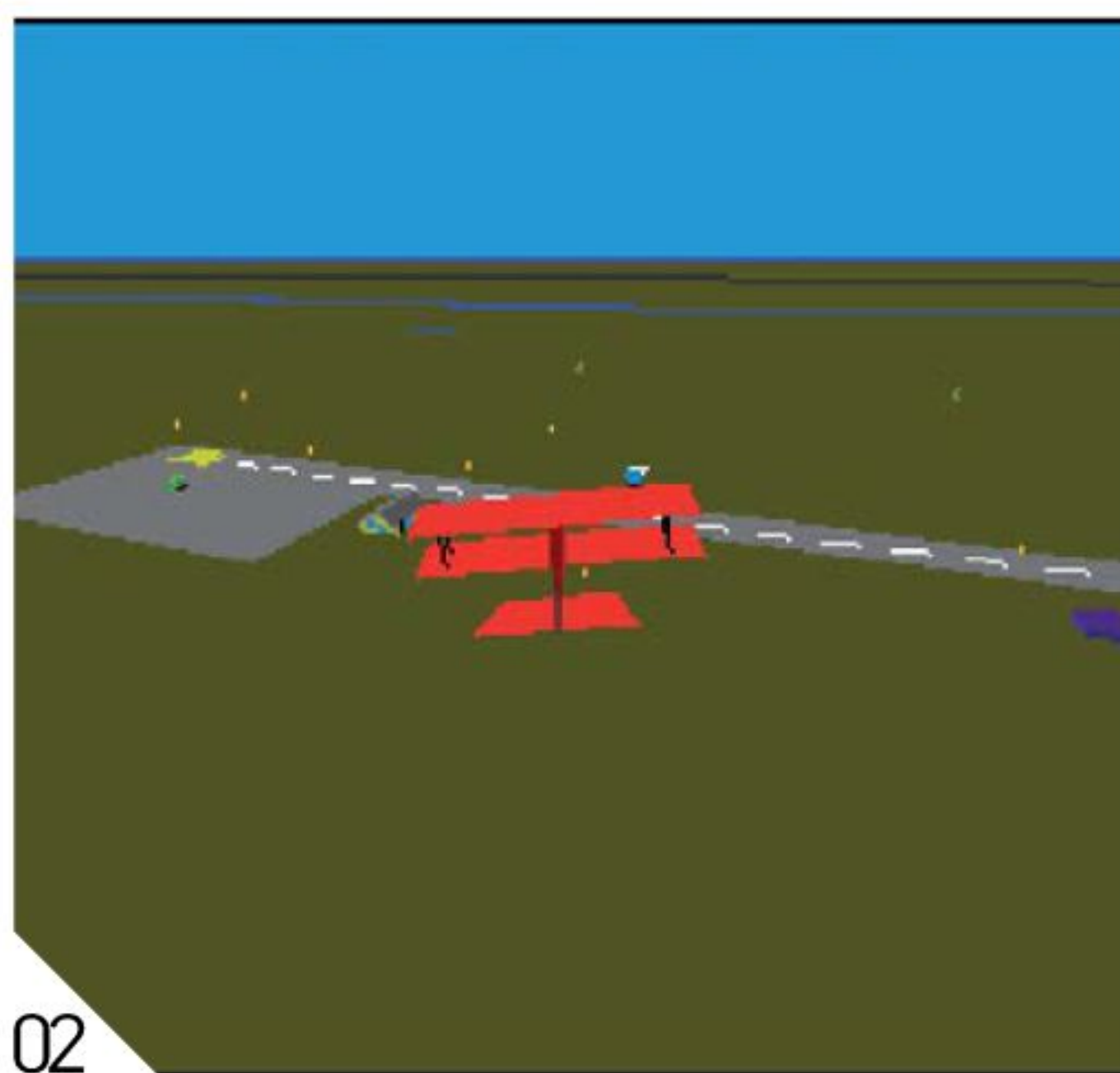

02

TWIN WORLD

- » RELEASE: 1990
- » PUBLISHER: CYGNUS SOFTWARE ENGINEERING
- » CREATOR: BLUE BYTE
- » BY THE SAME DEVELOPER: ZOOL (1992)

03 *Twin World* can boast the three essential components of a classic platformer: slick, responsive controls, just the right amount of variety, and a challenge that feels tough but fair. The control system, in particular, can make or break a platformer. The graphics, which looked a bit flat in an era of garish visuals, now look tastefully understated. The Arc version lacks the colourful skyline of the Amiga but features slightly tweaked sound and gameplay. The odd puzzle, a tricky but satisfying firing method, and excellent music round out a game that never received its due on home platforms but is rightly remembered as a classic.

TECHNODREAM

- » RELEASE: 1993
- » PUBLISHER: SUPERIOR SOFTWARE
- » CREATOR: GRAEME RICHARDSON
- » BY THE SAME DEVELOPER: THE REPTON SERIES (1985-PRESENT)

04 Like Graeme Richardson's earlier horizontally scrolling shooter *Nevryon* (incidentally a game well worth checking out), *Technodream* owed a great deal to *R-Type* and *Scramble*. All the classic elements are here: safe spots in the centre of a wave, pick-up weapon upgrades and end-of-section bosses with a secret weakness. At times, the Arc throws out up to 80 well-animated sprites. The difficulty is tough, but that's to be expected from a game of this sort. Great graphics and challenging gameplay were topped off with a two-player mode. *Blowpipe* is another extremely good game in a similar vein.

TEK 1608

- » RELEASE: 2002
- » PUBLISHER: ARTEX SOFTWARE
- » CREATOR: ARTEX SOFTWARE
- » BY THE SAME DEVELOPER: EXODUS (1997), A GALAXY-CONQUEST STRATITITLE

05 This RTS is notable as the final commercial game released on the platform. Acorn was involved in the development at one point as it was keen to have a good multiplayer game for one of its network computer projects. The finished game is probably one of the most advanced isometric-view RTSs ever released, with features such as the remote-view windows. The game was later ported to the Windows platform where it suffered for not being a true 3D game. Developer Artex had previously released galactic conquest game *Exodus*. The Arc also had a port of *Dune II*, the progenitor to most modern RTS games.



03



04



05



06 PICKUP TALK GIVE OPEN



07



08

ANKH

- » RELEASE: 1998
- » PUBLISHER: ARTEX SOFTWARE
- » CREATOR: ARTEX SOFTWARE
- » BY THE SAME DEVELOPER: BOT KILLER 2 (1999)

06 An Egyptian-themed title from Artex Software. Content creation for adventure games is very resource intensive, and the Arc didn't have many native examples. *Ankh's* gameplay is similar to other point-and-clicks such as *Simon The Sorcerer* and *Monkey Island*. It needs a late-era machine to run, thanks to the 640x400 32,000-colour graphics. *Ankh* was ported to PC, and 2008 saw the release of the latest game in the series, *Ankh: Curse Of The Scarab King* on Nintendo DS. The WIMP game was another native adventure game and a port of *Simon The Sorcerer* alongside Magnetic Scrolls games such as *Fish* and *Wonderland*.

TOWER OF BABEL

- » RELEASE: 1991
- » PUBLISHER: CYGNUS SOFTWARE ENGINEERING
- » CREATOR: PETER COOK (ORIG) JAMES BYRNE AND JAMES HARTSHORN (ARC)
- » BY THE SAME DEVELOPER: IRON LORD (1991)

07 With its improved graphics and sound, this 3D puzzler was another multiformat hit on Archimedes and yet it's criminally under-rated in general. In *Tower Of Babel*, the player takes remote control of three robots – a pusher, a zapper and a grabber – in a multi-level chequerboard environment complete with lifts and automatic guns. The puzzles start off fairly easy, but you're soon knee-deep in well thought-out stinkers. If you're a fan of games that make you go 'hang on' when the solution occurs to you the next day, this might just be the game for you.

STAR FIGHTER 3000

- » RELEASE: 1994
- » PUBLISHER: FEDNET SOFTWARE
- » CREATOR: FEDNET SOFTWARE
- » BY THE SAME DEVELOPER: STUNT RACER 2000 (1993)

08 *Star Fighter 3000* is quite possibly the ultimate Archimedes shooter. This three-dimensional game features a thrilling mixture of flat-shaded and texture-mapped graphics. It took full advantage of the faster processors of later machines and was also ported to the ARM-powered 3DO console among other platforms. Utilising a third-person behind-the-ship perspective, the player could fly around the map completing combat-heavy missions. Getting the balance right is essential when designing a mission-based shooter, and *Star Fighter 3000* is easy to fly, but contains tough challenges.



09

BUG HUNTER IN SPACE

- » RELEASE: 1990
- » PUBLISHER: MINERVA
- » CREATOR: IAN RICHARDSON
- » BY THE SAME DEVELOPER: IBIX THE VIKING (1988), PLATFORMER

09 The titular hero starred in not one, but two Archimedes videogames, and this one was definitely the best. *Bug Hunter In Space* is a logic-puzzle-driven platform game that is stuck in two eras at the same time. Similar videogames were all about the action, but the *Bug Hunter* series was a throwback to a previous era and a more considered pace. And that's perhaps the secret of its success: *Bug Hunter In Space* is not an evolution of the 8-bit platformer, it's an update. The basic but colourful graphics combine with the game's overall quality to produce a title not in quite the same universe as anything else in the vintage gaming world.

HAMSTERS

- » RELEASE: 1994
- » PUBLISHER: GAMESWARE
- » CREATOR: TOM COOPER
- » BY THE SAME DEVELOPER: DARKWOOD (1995), A THIRD-PERSON RPG

10 What do you get if you cross a hammer with a weird little main character and an army of furry enemies? Tom Cooper created a number of the final Archimedes games and this is one of his humorous psychedelic platformers. His creations are fondly remembered as consummate Archimedes games as they sum up the 'can do' attitude of the lone Acorn programmer. Guide our hero as he uses a large hammer to both move around the game world and do unspeakable things to furry animals. There's no getting around the fact that it's mad. Tom's other platform games include *Asylum*, *DinoSaw* and *Cycloids*. Yeah, they're mad too.



10



FAMICOM DISK SYSTEM

Famicom Disk System



VIRTUALLY UNKNOWN IN THE WEST BUT REVERED BY HARDCORE COLLECTORS WORLDWIDE, THE FAMICOM DISK SYSTEM IS A PIECE OF NINTENDO HISTORY. WE TAKE A LOOK AT THE MACHINE ON WHICH SUCH ESTEEMED NINTENDO FRANCHISES AS ZELDA AND METROID MADE THEIR FIRST APPEARANCES

Given what we now know about add-on hardware for games consoles, the very concept of the Famicom Disk System seems hopelessly flawed. Since this Japan-only system hit the market in 1986, we've seen the equally ill-fated Sega Mega-CD, Sega 32X and Nintendo 64DD all come and go without making any impression on the market. However, one should never underestimate the benefit of hindsight; back in 86 the rules were still being written, and certainly from Nintendo's perspective, the idea of expanding the potential of its bestselling Famicom home console – or NES, as it's better known in this part of the world – seemed like an eminently sensible move.

To get a better understanding of how the Famicom Disk System came to be, you need only survey the Japanese gaming industry back in the mid-Eighties. It's no exaggeration to say that Nintendo was the dominant force, effortlessly brushing aside rival companies and snapping up third-party support from all of the nation's finest code shops. By 1985 Nintendo was finding that gamers were so ravenous for new product that it was almost impossible to keep up with the intense demand; given this passionate interest in all things Famicom-related, it's easy to see why Nintendo started to investigate other avenues of making cash. Expanding the functionality of the millions of Famicoms already sitting in homes up and down Japan was the most logical course, so it was decided that the existing base unit should be augmented by a separate piece of hardware, permitting bigger and better games. With this objective in mind, Nintendo cast its gaze towards the home computing sector for inspiration.

"Floppy diskettes were quickly becoming the new standard for storage media on personal computers," explains avid Famicom collector Corbie Dillard. "Nintendo saw this technology as a viable solution for not only storing the games themselves, but also allowing game data to be saved directly to the diskette, so the company went ahead and created a proprietary diskette – dubbed 'Disk Card' – based upon Mitsumi's Quick Disk format."

Fellow enthusiast Laurent Kermel – who is employed at DreamWorks

Pictures as a 3D and CGI artist when he's not collecting rare Famicom items – explains just how much of a technological advancement these unassuming disks were: "Famicom disks represented a revolution. They offered twice the storage capacity of existing cartridges and were a lot cheaper to produce. Players could also save their game's progress without relying on cumbersome passwords; it has to be remembered that cartridges with save functionality using inbuilt batteries simply didn't exist at that time."

The most refreshing element of this increased storage was that it cost the end user less to purchase a Disk System game than a standard Famicom cartridge. "Because Disk Cards were cheaper to produce than cartridges, some of these savings were passed on to the consumer," says Dillard. "Disk System titles retailed for around ¥2,500-3,000 – quite a bit less than the ¥5,000-7,000 price tag for new cartridge titles at that time."

As well as offering increased capacity for larger games and the ability to record in-game progress, the Disk System promised a more compelling aural experience thanks to an additional audio channel for FM synthesis. "This allowed programmers to add yet another layer of sound to a game and was generally

» Nintendo's Disk Cards in all their glory. The format was derived from Mitsumi's Quick Disk floppy standard.

“ Back in '86 the rules were still being written, and the idea of expanding the Famicom seemed like a sensible move ”

Specifications

Year released: 1986

Original price: ¥15,000

Associated magazines:

Weekly Famitsu

Why the Famicom Disk System was great: With increased storage, the ability to save your game, and the introduction of an additional sound channel, the Famicom Disk System certainly felt like a step forward in '86.

While these features soon became irrelevant as cartridge technology progressed, the Disk System retains a sense of uniqueness; collecting for this format is possibly one of the most rewarding retro-gaming pastimes available.

Instant Expert

Famicom Disk System games were double-sided and could hold up to 112 kilobytes of data.

Nintendo continued to repair and support the Disk System right up until 2003.

During its lifespan 4.5 million Disk System units were sold – all in Japan, as the machine was never released anywhere else in the world.

The main menu music of the Nintendo GameCube console is actually the same tune used on the FDS start-up screen, only played at a slower speed.

Just like standard floppy software, FDS cards had tabs that could be removed to prevent the data being overwritten.

The Disk System launched with seven titles: *Baseball*, *Golf*, *Mahjong*, *Soccer*, *Super Mario Bros*, *Tennis* and *The Legend Of Zelda*.

All Night Nippon *Super Mario Bros* is one of the rarest titles available for the Disk System. A modified version of the original *SMB*, it featured graphics based on the popular Japanese radio show of the same name. It was given away on the show in 1986.

The Disk System mascot was known as 'Disk-kun' (meaning 'Mr Disk' or 'Disk Boy' in English) and has managed to outlive the machine itself – he features in *Super Smash Bros Melee* on the GameCube.

Just like its predecessor, *Legend Of Zelda 2: Link no Boken* (better known as *Zelda II: The Adventure Of Link* on the NES) was a Disk System exclusive in Japan.

Around 184 games were released for the Disk System. If you include the gold label re-releases that number rises to 212.





FAMICOM DISK SYSTEM

“ Nintendo maintained that the cream of the crop would be exclusive to the Disk System ”

used for percussion-type effects playing in the background, although it was sometimes used for creating additional individual sound effects as well,” explains Dillard.

The system was launched in February 1986 for the princely sum of ¥15,000, which represented quite an investment on the part of the customer. However, Nintendo maintained that from that point onwards the cream of the Famicom crop would be exclusive to the Disk System, and in the early years of the machine’s life, this was certainly the case. “The standard-bearers for the format are *Metroid* and *The Legend Of Zelda*,” explains Sean Corse of Famicom Dojo. These highly ambitious new games were coded with the Disk System in mind and were – in the beginning at least – exclusive to the new format. “Both were long adventures that required multiple gaming sessions to complete, facilitated by the Disk System’s save feature,” adds Corse. Other notable FDS ‘exclusives’ were *Hikari Shinwa: Parutena no Kagami* (*Kid Icarus*), *Akumajo Dracula* (*Castlevania*) and *Super Mario Bros 2* (known as *The Lost Levels* in the

for its time and could be considered a forerunner of more modern distribution methods. “Xbox Live Arcade, PlayStation Network and Steam provide essentially the same service, except the ‘disk’ is your console or computer hard drive and the ‘kiosk’ is a server you access over the internet,” argues Corse.

Another aspect of the system that was arguably ahead of its time was the ability to submit scores to Nintendo using specially produced ‘Disk Fax’ machines scattered throughout Japan. “From 1987, Nintendo organised contests where players from all over the country could send in their best scores for games such as *Golf Japan Course* or *F1 Race*,” reveals Kermel. “These scores would be sent to Nintendo headquarters using Disk Fax units.”

Specially produced ‘blue disk’ versions of games were manufactured for this very purpose, and the best players would be awarded prizes for their efforts. The entire notion is very similar to the online leaderboards that are so common in today’s internet-ready games.

While the fledgling format obviously had incredible advantages, it wasn’t all positive: “The disks were a lot more



» Nintendo’s decision to omit a protective shutter on the Disk Cards would prove to be a costly mistake.

fragile than cartridges and most of them didn’t come with a shutter to protect the magnetic film from fingerprints, dust or scratches,” laments Kermel. Instead of a protective shutter, Nintendo opted for the cheaper alternative of a wax sleeve, which the disk was stored in when not in use. Gamers who had spent the past few years treating their fairly rugged carts with disdain now had to handle Disk Cards with almost painstaking care; even placing a disk near a television was a no-no, because the magnets inside the TV’s speakers could demagnetise the data. Taking all of these points into account, it’s hardly surprising that many disks eventually become unplayable, plagued with random ‘bad sectors’, which led to numerous loading errors. While Nintendo was happy to exchange affected titles, the fragile nature of the medium made it seem like a poor second to the robust and seemingly indestructible cartridges that Famicom users were accustomed to.

Such quality software clearly had the desired effect: half a million FDS units were sold in the space of three months and that figure would eventually rise to an impressive 2 million by the time 1986 drew to a close. It seemed as if the Famicom’s almost uncontrollable popularity had ensured that the new format would be a rousing success almost by default.

However, possibly the most audacious part of Nintendo’s new scheme was the installation of ‘Disk Writer’ kiosks in retail outlets all over Japan. “These allowed Famicom owners to purchase a blank Disk Card for ¥2,000 and then insert it into the kiosk to have a game of their choice written to it for an additional ¥500,” explains Dillard. “Because the Disk Cards were rewritable, consumers could then bring their disk back to the kiosk to have a new game written over it when they’d finished their previous one.” This system was truly groundbreaking



» *Kid Icarus* is another beloved Nintendo franchise that started out as a Disk System release. Because the unit never came out in the West, it was ported to the NES in cart form.



Separated at birth



» This colourful comic was produced in order to educate Japanese youngsters about the strengths of the new format.



Such was the groundswell of anticipation surrounding the release of the FDS format that Nintendo even entered into a deal with electronics giant Sharp, which allowed the firm to produce an all-in-one Famicom and Disk System machine, dubbed the Twin Famicom. Launched shortly after the release of the standalone FDS module, this hybrid console remains a firm favourite with collectors even today. “It was a slick system that allowed A/V output rather than the RF that was standard on Famicoms of the era,” explains Kevin Tambornino of Famicom Dojo.

“The system comes in two flavours: a simple version and a redesigned edition with auto-fire controllers,” adds Laurent Kermel. “However, like the Famicom, the controllers are hard-wired into the unit, which is a real pain.”

Given Nintendo’s notoriously protective attitude towards its products, such a union is surprising but hardly unique. “Nintendo has often depended on electronics partners to create its gaming machines,” explains Sean Corse. “They partnered with Sony to develop the SNES sound chip and later infamously approached them – and eventually Philips – to create a CD-ROM add-on. More recently, Panasonic designed the Q, a version of the GameCube that can play DVDs.”

Community



Nintendo Life

www.nintendolife.com

■ One of the net's finest Nintendo-centric sites, Nintendo Life has a burgeoning retro section, which covers all elements of the company's history. By the time you read this, Corbie Dillard's excellent Famicom Collector's Guide should be live.



Famicom Dojo

www.famicomdojo.tv

■ Operated by Sean Corse and Kevin Tambornino, Famicom Dojo is a series of video segments focusing solely on the pastime of collecting Famicom games and hardware. Be sure to check out the episode with the ultra-rare FDS 'Disk Checker'.



Video Game Den

www.videogameden.com

■ The home of the insanely talented Laurent Kermel, Video Game Den has a massive section devoted to the Disk System. Kermel has even gone to the trouble of translating the massive comic-book manual, which came with the machine in Japan.



Famicom World

famicomworld.com

■ A repository for all things Famicom, this excellent site has a large section relating to the Famicom Disk System as well as handy user guides and an active forum, where you can trade rare games and hardware with like-minded collectors.



» [FDS] Gremlin's *Monty On The Run* was another British game to get the FDS treatment courtesy of Jaleco.



» Finding a second-hand Disk System in Japan is relatively easy, but finding one that actually works is another matter entirely.

Piracy was another issue that was exacerbated by the introduction of rewritable software. This is unsurprising when you consider that the disks were very similar to those used by home computers such as the Atari ST and Amiga, both of which suffered terribly from users copying software rather than actually buying it legitimately.

"Even with safeguards to modify the disk drive tech in a proprietary fashion, it couldn't stop those who were sufficiently determined," explains Corse. "There was quite a bit of money to be made in porting cartridge-only games to disk and selling them at insane profits. Nintendo went through several revisions of the FDS drives and introduced on-disk piracy prevention software, but these were cracked in a matter of months. Bootleggers were able to hook two units together and quickly copy disks, and programs like Disk Hacker allowed you to copy disks on a single machine with disk swapping. It's impossible to calculate how many sales were lost due to piracy, especially for the lower-profile third-party titles."

This aspect of the Disk System saga would have a long-lasting effect on the outlook of Nintendo itself. "Given how terribly Nintendo got burned by this massive downside to their own device, it's understandable how concerned they were with the possibilities when switching to CD and DVD formats later on," adds Corse.

While such rampant piracy was obviously a concern and would have put off many third parties from supporting the system, Nintendo's typically despotic attitude towards publishers arguably had a more significant effect. Nintendo already had many

companies under lock and key thanks to the excessive agreements relating to the licensing of Famicom cartridges, but when the company sensed that the Disk System could herald a new era of success, it went for the jugular. Nintendo wanted half of the copyright for every single FDS title published – a truly overwhelming demand, which basically meant that externally developed games would become, in part at least, Nintendo's own property. While many publishers were all too happy to sign on the dotted line to begin with, they were dissuaded when the FDS began to lose the technical lead it had over cartridges. "Soon after the release of the Disk System, cartridges reached the 128k mark and started to include inbuilt batteries," explains Kermel. With two of the key advantages of the format being removed so early in the game, the FDS struggled to remain a viable option.

"In the beginning, many companies jumped on the FDS bandwagon because it allowed them to make bigger and more innovative projects," says Kevin Tambornino of Famicom Dojo. "However, as chips and carts got cheaper, companies started having the option of bigger cartridges and battery backup memory for save games." Third parties preferred cartridges because they could be purchased by any

Famicom owner, not just those select few that had committed to the Disk System cause. While Nintendo was quick to point out that Disk System games were far less expensive than cartridge-based ones, publishers weren't so keen because the lower cost made it harder to turn a

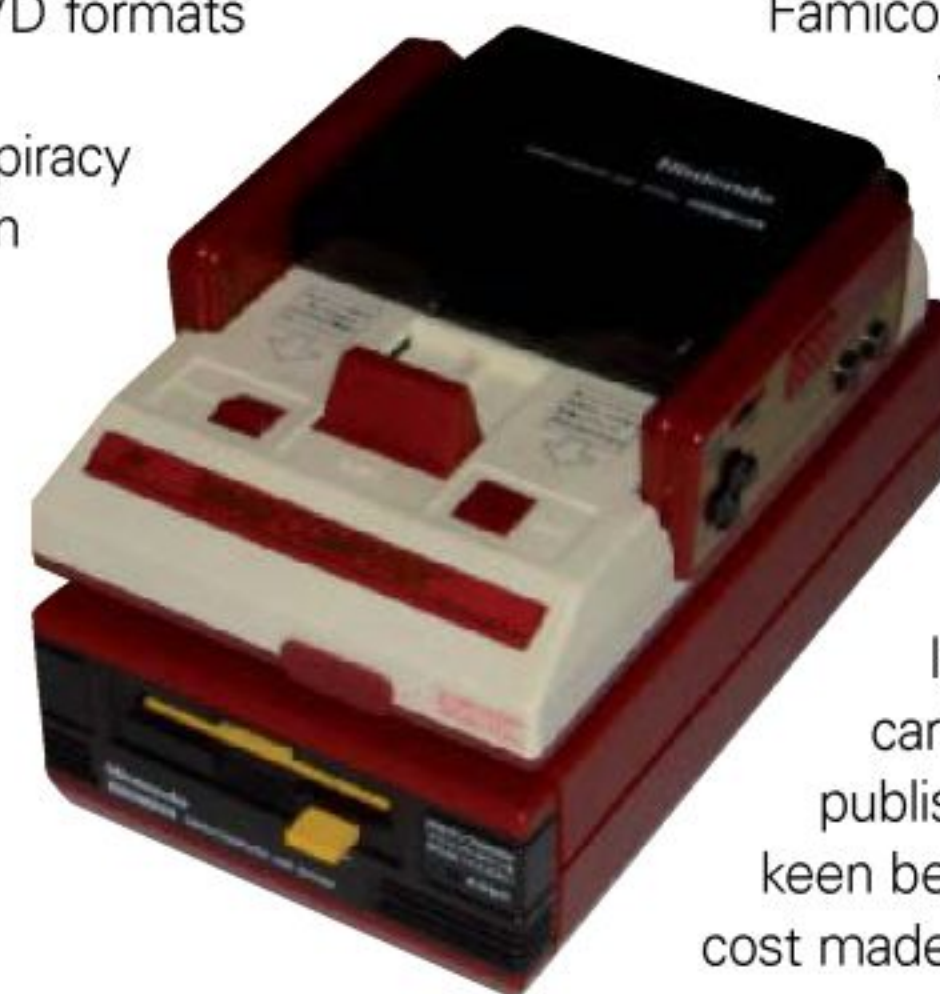



FAMICOM DISK SYSTEM

Perfect Five

TOBIDASE DAISAKUSEN

- » RELEASE: 1987
- » PUBLISHER: DOG
- » DEVELOPER: SQUARE
- » BY THE SAME PUBLISHER: JJ (FAMICOM)

01 This 3D shooter was very similar to *Space Harrier*, which had already hit arcades by the time this game made it to market. *Tobidase Daisakusen* was later released on the NES as *3-D WorldRunner*.



OTOCKY

- » RELEASE: 1987
- » PUBLISHER: ASCII CORP
- » DEVELOPER: SEDIC
- » BY THE SAME PUBLISHER: SOUND FANTASY (SNES)

02 Regarded by many as the forerunner to *Rez*, *Otocky* is a scrolling shooter where the player's on-screen performance influences the background music. Created by Japanese installation artist Toshio Iwai – who would later produce the sublime *Electroplankton* for the Nintendo DS – this truly unique piece of software sadly never saw release outside of its native Japan.



FALSION

- » RELEASE: 1987
- » PUBLISHER: KONAMI
- » DEVELOPER: IN-HOUSE
- » BY THE SAME PUBLISHER: ARUMANA NO KISEKI

03 This overlooked blaster is considered to be an off-shoot of the *Gradius* series and is one of the few titles to support Nintendo's 3D Goggles. If you've played the likes of *Starfox* or *Galaxy Force* then you'll know what to expect, but what sets this apart is the smooth scrolling and the well-animated enemies. *Gradius Gaiden's* Falchion Beta is based on the craft in this game.

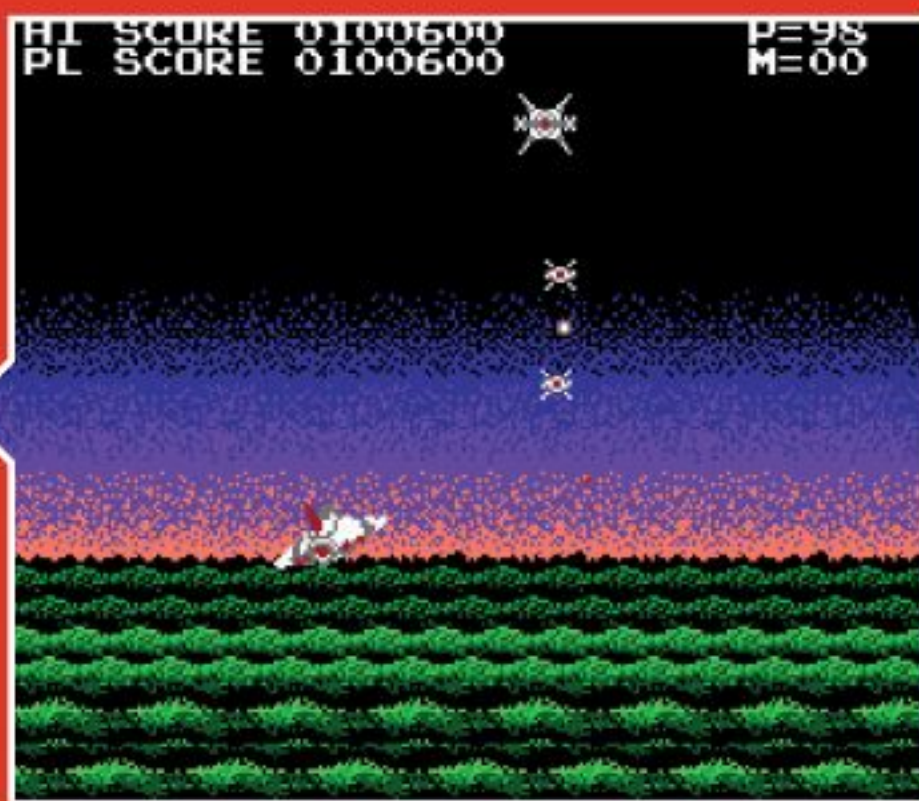

SUPER MARIO BROS 2

- » RELEASE: 1986
- » PUBLISHER: NINTENDO
- » DEVELOPER: NINTENDO EAD
- » BY THE SAME PUBLISHER: BASEBALL

04 Not to be confused with the Western *SMB2*, this Japan-only release is visually quite similar to its predecessor but the difficulty has been ramped up considerably. The two-player mode found in the first title is omitted and there are various minor tweaks to the gameplay, but this is essentially an extension of the original intended to challenge those players who consider themselves to be *Mario* masters.

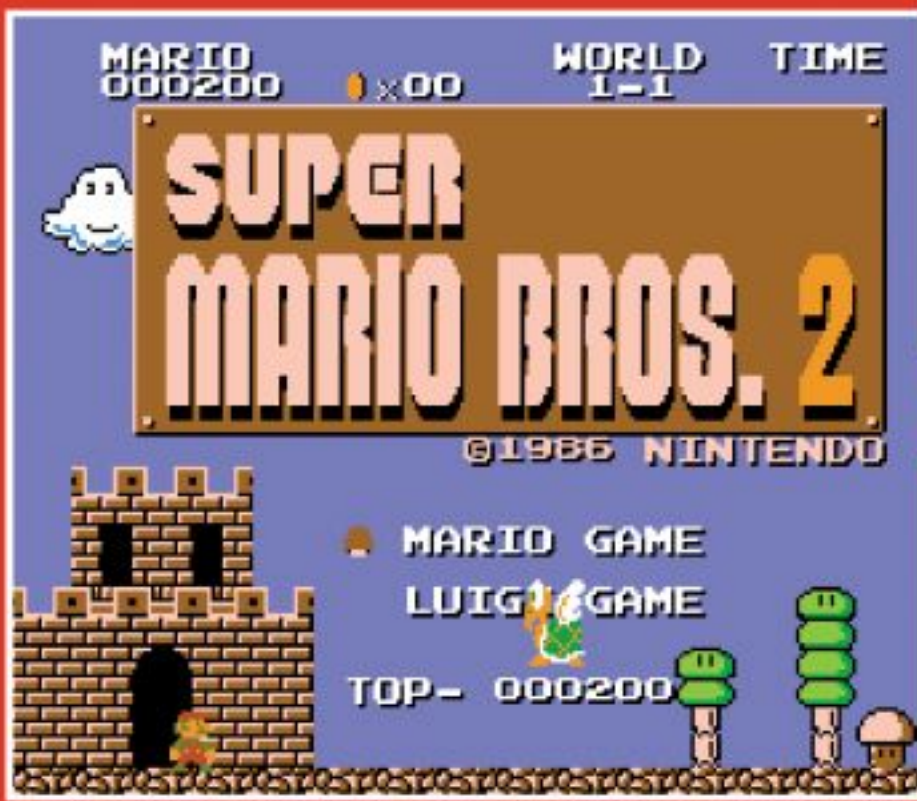

ZELDA NO DENSETSU

- » RELEASE: 1986
- » PUBLISHER: NINTENDO
- » DEVELOPER: NINTENDO R&D4
- » BY THE SAME PUBLISHER: ZELDA 2: LINK NO BOKEN

05 Regardless of how familiar you are with this game, it's worth finding in its FDS guise. At the time of release there was simply no way that the cartridge format could contain such an epic adventure, and the ability to save your progress was essential.



massive profit – something that they had been led to expect after years of growth with the standard Famicom system. The Disk Writer kiosks were an even bigger threat: offering new games for ¥500 didn't leave much room for anyone to make significant returns. Some companies even went as far as to shift entire development teams from working on FDS software to producing cartridge-based games. "*Final Fantasy* was originally a Disk System game but before it was released, Square shifted it to cartridge," reveals Tambornino. The ramifications of this switch could certainly be deemed incredibly significant, given the subsequent global success of the RPG franchise. "Had Square not switched formats, *Final Fantasy* would now be co-owned by Nintendo," he adds.

To make matters worse, the Disk System units themselves began to display worrying reliability issues. "It wasn't uncommon to be treated to a cryptic disk error that only displays a number without explanation," says Corse. These problems could be related to a number of factors, such as dust on the disk, demagnetisation, or issues with the reader head speed, but many users discovered that the rubber belts inside the machine, which controlled the spinning of the disks, were the ultimate cause of the fault. The bands would start to break over time, with some even melting during use. Nintendo's proclivity for proprietary components made replacing this everyday item more

complicated than it probably should have been. "Unfortunately, like the disks themselves, the drive band is not standard. An actual rubber band is not the correct elasticity," says Corse. The only option was to get in touch with Nintendo to obtain a replacement.

By the time 1989 arrived, many publishers had ditched the machine entirely and had returned to the more profitable Famicom cartridge format. Game stores began to complain that the now-ignored FDS kiosks were taking up valuable space, and even Nintendo itself began to abandon the system; much-hyped FDS exclusives were re-tooled for release on cartridge – a sure sign that the company had ultimately lost faith in the format. Although it was alluded to at the time, a Western launch was never really on the cards, much to the chagrin of many Nintendo fans.

"It was a bizarre decision, given that the NES hardware was designed with this particular expansion in mind," says Corse. "However, one can count many good reasons in the wake of the Disk System's release. Would North America accept a glitchy system when the NES 'toaster' hardware already had so many problems compared to the original Famicom? The piracy and unlicensed games were certainly an even greater issue and threatened to harm the 'Seal of Quality' branding that helped assure a sceptical public that the Atari apocalypse would never happen again."

While the FDS sold a fairly respectable 4.5 million units by the





Batteries not included

One of the most unique aspects of the Disk System hardware is the ability to power the unit using C-cell batteries. While this might lead you to assume that the device is portable, there's actually a more mundane reason for this option. "It certainly wasn't a portability issue, since the Famicom itself still had to be wired to the TV and the outlet," explains Famicom Dojo's Sean Corse. "But therein lay the answer: since both sockets would be used by the TV and Famicom, the battery solution reduced demand for a third socket. The batteries are actually a more economical solution, since the Disk System doesn't require continuous power during play. Besides, have you ever tried to hook up two AC power bricks to the same outlet? It's not pretty."



» The infamous 'Disk Error' screen – an all too common sight when using the FDS, sadly.

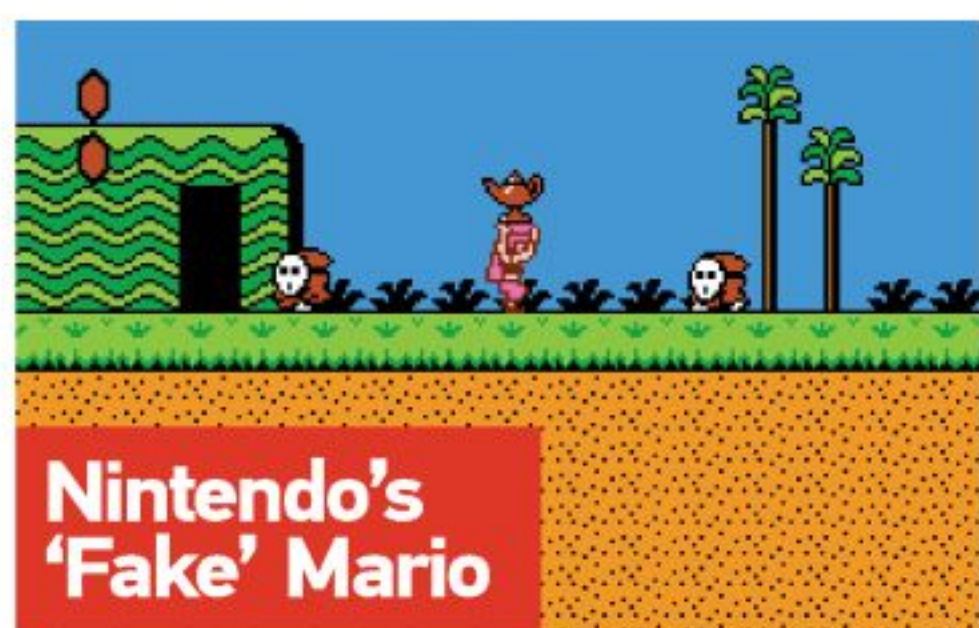

When Nintendo EAD produced the sequel to the bestselling *Super Mario Bros.*, it created a title that was incredibly similar to the original – it even had the same music and enemies. The Japanese team had intended the game to be a more challenging upgrade rather than a complete re-imagining, but Nintendo's American arm was less enthused; Nintendo of America president Howard Lincoln famously harboured an intense dislike for the game. He believed that the elevated level of difficulty coupled with the almost identical visuals would put off American gamers. Instead of releasing it in the US – where NOA believed that it would flop – it was decided that another Shigeru Miyamoto-created FDS title would be retooled in its place. *Yume Kōjo: Doki Doki Panic* went on to become Mario's second NES outing in the West, and the original Japanese sequel would later be released on the Super NES as part of the *Super Mario All-Stars* compilation. Because of its rather unique history, *Doki Doki Panic* is understandably popular with FDS collectors.



end of its lifespan, Nintendo had been banking on far more impressive figures. However, regardless of the various problems faced by the machine at the time, there's a compelling argument that the entire concept was flawed.

"As a general rule, gamers don't like to have to purchase additional add-ons for their game consoles," says Dillard. "When you start splitting your core audience like that, you're in for trouble." Had the Disk System offered something that the standard Famicom wasn't capable of then the story might have been different, but the rapid progression of technology quickly made it redundant.

"The Disk System was created to reduce production costs inherent in cartridges and to sustain game save states," says Corse. "Following Moore's Law, the technology for both cartridge production and battery backup saves for ROMs improved to the point where cost was not the issue it was in the early Eighties. This was put to the test when *The Legend Of Zelda* came out in 1987 on a battery backup cartridge; following this breakthrough, Nintendo didn't look back. The only benefit offered by the FDS in the end was superior sound, but who would miss what they hadn't experienced?" Ultimately, the FDS was overtaken by the standard cartridge format that it had sought to supplant; carts were more reliable, more robust, and offered publishers a better chance of turning a profit on their hard work.

Ironically, the system's dismal retail performance, shaky reliability, and issues with piracy have made it something of a darling with Nintendo enthusiasts. "It allows collectors to play lost games that were never available on cartridges,"



» The launch of the 64DD proved that Nintendo doesn't always learn from its mistakes.

replies Kermel when asked to explain the appeal of collecting for this system. "I myself rediscovered games such as *Zelda no Densetsu*, *Metroid* or *Akumajō Dracula* thanks to the enhanced sound chip. It is an amazing feeling to play *Zelda* as Japanese gamers did way back in 1986. Also, some Disk System games have incredible packaging; because the software was cheaper to produce, several publishers created fancier boxes and instruction manuals."

Tambornino was drawn to collecting not necessarily for the games but the exotic nature of the platform. "Like collecting LaserDiscs in a world that has DVDs, most FDS collectors do it for the feeling more than anything else," he explains. "Sure, there are some games that are exclusive for the format, but most of the good ones have been re-released on other systems. From a visual perspective, the disks have art, design and themes that represented that part of the Eighties. I remember reading about these games when I was a kid growing up; they seemed so exotic to me at the time and I never really saw myself owning them. Maybe I collect them now because I couldn't then."

However, collecting for the Disk System isn't as straightforward as it is with the traditional Famicom. For starters, finding a unit in working order is a considerable challenge due to its reliability issues. "A brand new Disk System bought at launch would usually last a good few years without a problem," explains Tambornino. "When buying one now you're likely to encounter all sorts of problems, from broken drive belts to gears out of alignment. If you buy a Disk System that

hasn't been opened up then chances are the drive belt inside will be broken – it's simply beyond its shelf life. The best systems to buy are mint condition units that have had the belt replaced."

It's not just hardware problems that make FDS collecting such a minefield: the delicate temperament of the Disk Cards themselves can make buying games tricky. "Any dust or scratches on the magnetic surface can make the disk completely inoperable," says Corse. This is, of course, assuming that the game you purchase is actually the game you thought you were getting: the rewriteable nature of the disks means that securing untampered software is equally difficult – but again, this can be part of the intrinsic appeal. "It's like a treasure hunt," says Tambornino. "In my experience what is on the label is only correct about 60 per cent of the time – you never know what you are going to get when you load a game. But on the other hand you might stumble across a hidden gem. For example, I once found the highly sought-after *All Night Nippon Super Mario Bros* on an unlabelled disk! If you buy disks from an import shop you might want to make sure they have been tested first, or you can take your chances. Frankly, that's half the fun."

Ultimately, though, such tribulations are unlikely to dissuade the hardcore collector. The FDS is beloved by such devoted individuals despite the problems of the machine, and it's easy to see the appeal. "Being able to play the game that became our *Super Mario Bros 2* with the original characters and the additional sound channel of the FDS is great for fans of the original US release," says Dillard. "It's also nice to be able to experience the amazing Disk System soundtracks of NES titles like *Metroid* and the *Legend Of Zelda* titles before they had their music altered for release on cartridge."

Indeed, for Nintendo completists the FDS is an essential purchase, and as the number of working units in the field slowly diminishes over time, it's only going to become more attractive for retro devotees with money to burn.



“The sprite handling was very impressive for the time. It can handle a ton of on-screen objects without any flicker”

Perry Thunte

ATARI 7800 PROSYSTEM

The Atari 7800 has to be the biggest ‘what if’ in the history of console gaming. From its turbulent early years to its homebrew renaissance, we find out why the ProSystem is still impressing after 30 years

In 1984 the console market in North America was in complete disarray, the US had suffered the infamous videogame crash with companies going out of business left right and centre. Even the industry’s biggest player, Atari, had been left battered, bloodied and bruised. It had lost over \$500 million and the failure of its newest console, the Atari 5200, had done nothing to help matters. It needed to come up with something fast if it was to turn round its fortunes and for the first time in the company’s history this help came from outside, in the form of the General Computer Corporation (GCC).

A few years earlier Atari had taken the fledgling company – started in 1981 by Doug Macrae, John Tylko and Kevin Curran – to court for making illegal mod-kits for a number of its arcade games. This lawsuit actually resulted in GCC working for Atari – it had clearly seen GCC’s talent and soon had it developing

arcade games such as *Food Fight* and *Quantum*, as well as converting a number of other coin-ops to both the 2600 and 5200 consoles. Atari was really impressed with GCC’s ability to not only turn out games quicker than everyone else but also deliver high-quality titles too. In fact Warner had nicknamed GCC “The Toaster” because of the way it was able to just pop games out.

Warner had been looking at ways to revive Atari’s fortunes and GCC looked like it might be able to provide the answer. Many projects had been looked at and considered, including the console that would become the Nintendo Entertainment System, but more on that later. Warner had also been conducting surveys to find out exactly what gamers wanted from a console. One of the key messages it got from the public was that they wanted to be able to play their old games on their new system. So GCC proposed a new





» Despite a lengthy delay Atari's console still managed sales of over 3 million. An impressive achievement considering.

► console to Warner that would not only provide powerful hardware capable of playing the latest games, it would also play all your old 2600 games. Atari even planned to make adapters to make your 5200 compatible with this new console too, so as not to abandon the users of its current machine. It seemed like the perfect plan.

Initially codenamed the 3600, the ProSystem would quickly become the sole focus of Atari. This upset a few people at Atari who were a bit miffed at Warner going outside of the company to find a new hardware solution. Art Ng, Steve Golson and several of GCC's chip architect designers, with assistance

from VLSI, would architect and design a revolutionary new graphics chip called MARIA. This name was chosen because the key custom chip in the 2600 was called TIA, thus completing the name of the popular liqueur Tia Maria. The MARIA would be the heart of the Atari 7800 ProSystem and the very first version of this chip was numbered GCC-1701 because GCC's engineers were big fans of *Star Trek*, the Starship Enterprise being NCC-1701. The only real flaw of the design was that it didn't include a new sound chip, relying on the old 2600 TIA chip to produce two-channel sound. It was intended that POKEY chips, or a new low-cost sound

chip called GUMBY, could be added to cartridges as an alternative option.

The finished console, now known as the Atari 7800 ProSystem, was announced in May 1984 with machines

shipping to stores for a test market release the month after. This would see it compete head to head with the similar test market for the Nintendo Entertainment System, the console Atari had turned down in favour of the 7800. A move that would prove extremely costly for the company...

13 games were announced for the system's launch, many of which were conversions of popular arcade games of the time. The press reaction to the 7800 was very positive too, seeing it as a much better bet than the NES. The console was praised for its backwards compatibility, high-quality graphics, sleek design, a return to standard controllers (after the much-maligned 5200 analogue sticks) and for the

inclusion of a BIOS that required a digital signature to be included in each game. This was specifically included to stop one of the key contributors to the North American videogame crash – unlicensed third-party software. Atari had big plans for the 7800, as well as announcing a stream of games it also planned to release a high score cartridge for saving your performance, a keyboard to turn it into a fully-fledged computer and even a Laser Disc player that could be hooked up to the expansion port.

Unfortunately for both the 7800 and the gaming public Atari's situation had worsened and Warner decided it wanted shot of the company. Atari was up for sale to the highest bidder and this would bring with it some very complicated issues for the new console. Eventually the consumer division of Atari was purchased by the Tramiels and the new Atari Corporation, as it was known, wanted to re-launch the 7800 across the whole of the US and go head to head with the NES and

“The way it was explained to me was that sports games were popular, ninjas were popular, so Ninja Golf. One can not help but be in awe of the thought process!”

David Dentt

TOP 5 EXCLUSIVES Classic games you can't get anywhere else



NINJA GOLF
 ■ ATARI ■ 1989
 The 7800's killer app, *Ninja Golf* is possibly the most mental idea for a game ever – a scrolling beat-'em-up where you also have to play golf! Believe it or not the concept works really well and the graphics and sound are particularly impressive, especially the *Shinobi*-esque boss fights as you reach the green. If you need to find a reason to own an Atari 7800 then *Ninja Golf* is most certainly it.



MIDNIGHT MUTANTS
 ■ ATARI ■ 1990
 Starring Grandpa from the cult TV show *The Munsters*, *Midnight Mutants* was one of the last games released for the 7800 and really shows that machine can more than hold its own with the NES and Master System. This isometric arcade adventure has a spooky Hallowe'en-based plot, which is told by an impressive animated intro, and a huge map that will have you playing right into the midnight hours.



SCRAPYARD DOG
 ■ ATARI ■ 1990
 We are cheating a bit here as this game also appeared on the Atari Lynx, but there enough differences between the games to make this inclusion warranted. *Scrapyard Dog* is clearly inspired by *Super Mario Bros*, a fact that becomes obvious as soon as you start playing it. It's an extremely solid platformer, perhaps the best on the machine, but it lacks the honed controls and the well-crafted level design of the game it's trying to emulate.



MELTDOWN
 ■ ATARI ■ 1990
 The 7800 lightgun might be hard to track down these days but it's well worth buying as some of the system's best games take advantage of it, including this underrated beauty. *Meltdown* might not look like much but the frantic shooting action will leave you sweating. The password feature is also an excellent edition, meaning you can return to where you left off. Don't underestimate this excellent title.



ALIEN BRIGADE
 ■ ATARI ■ 1990
 Another superb lightgun game for the 7800, *Alien Brigade* is basically *Operation Wolf* crossed with aliens. In fact one look at the screenshots will show more than a passing resemblance to the Taito gun game and the gameplay is just as similar. It's your mission to grab your XG-1 light gun and try to stop the alien invasion. *Alien Brigade* also features some rather swanky visuals too, making it well worth seeking out.



7800 VS NES VS SMS

How Atari's console and its competitors compared



PROCESSOR	ATARI SALLY 6502C @1.79 MHZ	RICOH 2A03 (6502 CORE) @1.79 MHZ	ZILOG Z80 @4MHZ
MEMORY	4K RAM, 4K ROM	2K RAM, 2K VRAM	8K
COLOURS	25	25	52
PALETTE	256	52	256
SPRITES	30+ PER LINE	8 PER LINE	16
RESOLUTION	320x240	256X224	259X192
SOUND	2 CHANNEL MONO	5 CHANNEL MONO	3 CHANNEL MONO



» Sadly the Atari 7800 doesn't have RGB support straight out of the box, which is something of a pity.

upcoming Sega Master System. The big problem was that GCC still hadn't been paid, and this caused a lengthy argument between Warner and the Tramiels over who should actually pay. Eventually Jack Tramiel handed over the cash to purchase the rights for the ProSystem from GCC, but then even more negotiations ensued to provide the software he desperately needed. Over a year after the initial purchase, Atari Corp had finally settled all matters regarding the 7800 and was ready to go into production with a full re-launch. Unfortunately for Atari the market for this new console wasn't what it was back in 1984. Not only had Nintendo swept in and aggressively taken hold of Atari's own marketplace, another new player from Japan was also set to enter the market, Sega with its Master System. The console market had been well and truly revived and Atari had a lot of ground to make up if its console was going to be the success story everybody had predicted at its original launch.

Due to Atari Corp's limited finances the 7800 was re-launched with limited advertising, a trickle of games, many of which now looked extremely dated, and very little investment into creating new ones. Atari also cancelled all the planned peripherals and removed the expansion

port in order to save money. This wasn't helped by Nintendo's new stranglehold on the market that had seen it block retailers from selling rival consoles, stop publishers making games for anything but the NES and spending big to tie up all the hottest licences. Despite Atari's lack of promotion and unwillingness to spend money supporting the 7800 it performed well in the marketplace, admittedly it was crushed by the NES juggernaut but did relatively well in a very distant second place. While the North American sales figure of 3.77 million (plus what was sold in the original test launch) pales in comparison to the 34 million Nintendo consoles it stands up well against the Master System, which sold less than 2 million in the US. So why wasn't it more successful? David Dentt, creator of *Ninja Golf*, offered the following insight. "There was a second-hand sense I got at the time that people believed it was doomed from the start. In the end, even if everything had been done perfectly, the 7800 never really had a chance because of *Mario*. Especially with the synergy between home and arcade. During my time on *Ninja Golf*, I was still working part-time in an arcade. People would learn things playing *Mario* at home, and then come play the arcade version to show off. A good deal for Nintendo. Just what the 7800 needed, but you

» A computer module was planned for the 7800 that included a professional keyboard.



» Like the Master System, the Atari 7800 had a pause button, making lengthy sessions far easier to manage.



25 YEARS



» The controller of the Atari 7800 looks very similar to the one found on the Nintendo Entertainment System.

► can't just come up with a killer game at will."

Initially there were no plans to release the 7800 in Europe, Atari decided to go with the XE Games System instead because this part of the world was dominated by home micros. That all changed when the popular UK magazine *Computer & Video Games* posted a public begging letter to Atari asking for the machine to be released in Europe. Penned by Tony Takoushi in his Hot Gossip section it saw the writer wax lyrical about the 7800 after having picked one up from the US. He bemoaned Atari's decision to go with the XE range and drooled over the 7800's graphical capabilities and ability to mimic popular arcade games. He also compared it to the rival NES and Master System, where he complained about the prices of the Sega and Nintendo products. Atari listened and a change of heart saw the PAL 7800 make its debut in 1987 with a new faceplate and simplified name. The 7800 went on to sell well in the UK and Europe and in a 1990 issue of *Raze* magazine it was reported that Atari currently had a 50 per cent share of the console market in the UK, taken from an independent Mintel report this was not to be sniffed at. We asked Atari UK marketing manager Darryl Still about the machine's performance, keen to know if it was as poorly placed in the market as many thought. "It was very well stocked by European retail," he reveals. "Although it never got the consumer traction that the 2600 did, I remember we used to sell a lot of units through mail order catalogues and in the less affluent areas."

So the question has to be asked about what the 7800 was like for the people who worked on it? Despite Atari not crediting people for their work on 7800 games, we managed to track down some people with first-hand experience of the console. David Dent is particularly notable as he was the programmer and designer of the console's 'killer app' – the seemingly ridiculous but ultimately brilliant *Ninja Golf*. The first question we had to ask him was just how he came up with the original concept.

"The idea actually came from someone at Atari," he explains.

"The way it was explained to me was that sports games were popular, ninjas were popular, so *Ninja Golf*. One can not help but be in awe of the thought process!" Wanting to know more we asked



» [Atari 7800] Curt Vendel released and manufactured reproductions of the planned 7800 High Score Cartridge.

AN INTERVIEW WITH CURT VENDEL

The curator of the Atari Museum discusses the 7800 XM



What prompted you to start developing the 7800 XM?

I have many original drawings and mechanical drawings from Atari, and one was for the original piggyback CPU design from April 1984 that Atari was considering for the computer expansion for the 7800 before going with the keyboard design. So I used that design. I went out and ask who would want to have a new case design done and such and then discussions started about adding things on, a POKEY chip, more memory... etc. then the dream

lists started to crop up, things were being tossed about and it got out of hand very fast. So, first things first – criteria: the system could only have technology that existed in 84-85 to keep it realistic.

Can you tell us more about your vision for the project?

I am hoping that it will open the door for bigger and more rich games, for older games to have original 2600 audio but then go to POKEY audio when it's sensed. The system has massive potential just in upgrading the audio on games, with the added memory, much more complex games could be achieved as well.

How do you feel about how Atari handled the 7800?

They should've kept some form of contract with GCC, they

were the guys who created it and wrote all of the games in the beginning, they could've put out many more great games for it. The advertising side is what hurt probably the most – people forget you if you're not in their face with ads and the Tramiels just didn't do that and that really hurt the image of Atari especially with Nintendo and Sega blasting ads every five minutes at kids.

What are the main strengths and weaknesses of the 7800 as a system?

Its graphics, handling of objects and manipulating data are really its strengths, its lack of a built-in POKEY chip is really its weakness. It can do everything a Nintendo and Sega Master System did and more. It is a far better system when compared to them.



» Atari's console features a universal port, meaning you can stick other controllers in it if you so wish to.

» [Atari 7800] *Bentley Bear's Crystal Quest* is the sequel that everyone has been waiting for.



» [Atari 7800] *Desert Falcon* is one of the most technically impressive games on the 7800.



“It was like stepping out of prison to go to this from the Atari XE. I was able to do some really great things with the 7800”

Chuck Peavey

him about how much of his own design went into the game. “Quite a bit actually. After being given the basic idea, we came up with most of it as we went along. There were two programmers, myself and the guy who did the XE version, and an artist. We would just sit around and throw ideas around. We also got some feedback from Atari.” David also programmed the 7800 conversion of *Klax* and he remembers the 7800 being great to work with on a technical level, providing some info on how he made *Ninja Golf*'s impressive visuals. “I remember that there were a limited number of colours available at any one time for display. So the game split the screen up into sections, and used different palettes for each section. This allowed more colours at a time on the screen as a whole, although any one section lived within its limits, this was very easy to do”.

Chuck Peavey was the programmer of *Chuck Norris: Missing In Action* for TNT Games and was also impressed by the 7800's MARIA graphics chip. “If you look at *Missing In Action*, you'll see there are a lot of colours. There was so much to work with. For example the waterfall in *MIA* was really cool because we cycled the colours to make it look like it was flowing. I do remember it was super easy to write levels and players. It was like stepping out of prison to go to this from the Atari XE. I was able to do some really great things with the 7800. In fact, it was one of my favourite platforms to work on”. Then Chuck laughs as he recalls his time with the 7800 and remembers an interesting story; one that he asks us to heavily edit in case he gets into trouble. “At the same time I was doing *Missing In Action*, Peter Adams was doing a game called *Grandpa's Attic*, starring Grandpa from the TV show *The Munsters*. Peter insisted on doing his own graphics,

something I'd given up on before I ever started coding professionally. *Grandpa's Attic* sucked, the gameplay was stilted, the graphics were horrible and it just wasn't that much fun. I didn't feel like I could say anything because Peter was my boss!” We were not surprised to find out that this game was never released.

The legacy of the 7800 today, much like the other Atari consoles actually, is in its bustling homebrew community.

No man has had a greater impact on the machine in recent years than Bob DeCrescenzo, who moved to the 7800 after first having released several hacks for the 2600 and 5200. We asked him what made him choose the 7800. “I noticed two things about the 7800,” he tells us. Firstly there was no *Pac-Man* at all for it (only *Ms Pac-Man*), and also there weren't many people creating homebrews for it. Those were the main two reasons I moved over to the 7800. I had starting hacking *Ms Pac-Man* into

» The original version of Atari's plug and play Flashback console was based on the 7800.



Pac-Man and Curt Vendel noticed this and was kind enough to let me see the actual source code for that game to make it easier to know what I was doing. Around that time, they had found the 'encryption code' needed to sign games to work on the NTSC version of the 7800, so I was able to make complete games as I got to know the system better. I enjoyed making/porting games to the 7800 so it just took off from there.”

So what makes the 7800 such a good console to code on? “Well its big strengths are handling of sprites, number of colours and backwards compatibility. But I really wish they would have gone with the POKEY as the standard sound chip.” Bob would certainly know, having produced excellent games like *Pac-Man Collection*, *Space Invaders*, *Moon Cresta*, *Scramble* and *Bentley Bear's Crystal Quest*. Does Bob still plan to support this greatly underappreciated console though? “Well, I had a good almost ten-year run making games for the 7800. I actually don't have anything planned for the 7800 currently, but with the release of 7800 BASIC, there are already some really good games coming to light.”

Perry Thuyente is another man making waves in the homebrew world, having just finished a new version of *Donkey Kong* for the machine that takes advantage of the new 7800 Expansion Module. This remake is arcade perfect in every way and arguably the best version for any 8-bit console. He's had a similar route to the 7800 as Bob having also not owned one as a child and has similar thoughts about the hardware's strengths. “The sprite handling was very impressive for the time,” he recalls. “It can handle a ton of on-screen objects without any flicker. The sound was definitely the primary weakness.” Perry remains embroiled in the console's bustling homebrew scene and remains happy to tinker away on new games. “I have a few projects I would like to work on,” he admits. “My first game to use the Yamaha chip in the XM will likely be an update to *Dig Dug*. I'm also interested in porting *Castle Crisis*, a *Warlords* clone, to the machine.”

The 7800 might not be as well remembered as its more illustrious rivals the Sega Master System and NES, which is a pity, as it really does deserve a place in your collection. It would be really interesting to imagine how things had played out if Warner had not sold Atari to the Tramiels, but the fact of the matter is that the 7800 was unfairly cut down before it had a chance to properly compete. And yet, Atari's system remains a great console that provided a number of innovations from out-the-box backwards compatibility to digital signatures. It has a solid library of games including some outstanding arcade ports and a vibrant homebrew scene that continues to push the machine to new limits. With the upcoming 7800 XM the future is very bright for the Atari 7800 as it enters its 30th year.

Special thanks to: David Dentt, Darryl Still, Chuck Peavey, Bob DeCrescenzo, Perry Thuyente, Curt Vendel and the Atari Museum.



TOP 10 ARCADE CONVERSIONS

Atari's 7800 has some superb coin-op ports. Here are our favourites



MS PAC-MAN

YEAR: 1987

Programmed by GCC itself, designer of both the 7800 and the *Ms Pac-Man* arcade game, this port is the best for any 8-bit machine. One of the machine's launch games it features all the fruit, all the mazes, all the intermissions and near perfect ghost AI too. It was only surpassed by the homebrew release of Bob DeCrescenzo's *Pac-Man Collection* that includes this game as well as many different versions of both this and the original *Pac-Man* arcade game. This was also the game that got Bob into programming the 7800, lucky us!



JOUST

YEAR: 1987

Williams' 1982 arcade game *Joust* was one of the very first to introduce the concept of cooperative two-player gameplay. It also has to feature one of the wackiest ideas of any arcade game as you control a knight riding a flying ostrich trying to progress through the levels by defeating groups of enemy knights riding buzzards and collecting the eggs. The 7800 version is easily the most impressive for any 8-bit machine and is nigh-on arcade perfect. This is also without doubt one of the best multiplayer experiences to be had on the machine.



COMMANDO

YEAR: 1989

Sculptured Software did an amazing job of porting the popular Capcom coin-op to the 7800 and this remains one of the best versions of the game on any platform of the time. As well as looking superb, Atari allowed the programmers to use a POKEY chip on the cartridge for enhanced sound. The arcade game's soundtrack has been replicated brilliantly using the four-channel chip and all the sound effects are provided by the native TIA. 7800 *Commando* is incredibly impressive and really shows what the 7800 is capable of in the right hands.



CENTIPEDE

YEAR: 1987

Don't be put off by the slightly rough looking graphics of this port, 7800 *Centipede* actually manages to improve upon its arcade parent. This is because Atari chose to include a fantastic two-player mode that allows you to team up with one of your friends to take out the hordes of insects, mushroom patches and the imposing centipede himself! Interestingly Atari also planned to release the sequel *Millipede* for the 7800 and despite it being rumoured that it was finished the game has never seen the light of day, still 7800 *Centipede* is more than fulfilling.



FOOD FIGHT

YEAR: 1987

The original *Food Fight* coin-op was designed and created by GCC, so it's no surprise to see this game on the 7800. It also won't be a surprise to learn that this is one of the best games on the machine! Just as you did in the 1983 arcade game you take the role of Charley Chuck as he runs around the screen throwing food at angry chefs and trying to eat the ice cream before it melts. *Food Fight* is insanely fun and we really do think it's criminal that this game was never converted to more home consoles. It gives us all a good reason to own a 7800 though!



XENOPHOBE

YEAR: 1989

■ We have always been huge fans of this 1987 Bally/Midway arcade game at **Retro Gamer**. A sprawling shoot-'em-up that takes heavy inspiration from the *Aliens* movie, the original coin-op was particularly notable for its split-screen three-player gameplay. While none of the home versions could replicate that many of them went for a split-screen two-player option instead, this version included. The Atari 7800 version of *Xenophobe* is massive and has some rather pretty visuals that make it far more impressive than its NES counterpart.



KUNG-FU MASTER

YEAR: 1989

■ Irem's 1984 arcade game *Kung-Fu Master* is widely credited as being the first ever scrolling beat-'em-up. It was converted to pretty much every system under the sun at the time but this 7800 port by Activision is one of the best. It features far more detailed graphics than the well-known NES port and also has some remarkably good TIA music too. The 7800 is actually well blessed for scrolling beat-'em-ups with the iconic *Ninja Golf* and a decent conversion of *Double Dragon* but *Kung-Fu Master* is still well worth checking out – you won't be disappointed!



DONKEY KONG

YEAR: 1988

■ It seems strange to many that the 7800 got ports of both *Donkey Kong* and *Donkey Kong Junior* when they were also launch games for the NES. This is because Nintendo had already licensed the games to Atari, which had released them for the Atari 8-bit computers, and so could not stop it releasing 7800 versions. Both *Donkey Kong* games stand up very well against the NES versions too. While this version is not arcade perfect that has now been rectified by the homebrew version of *Donkey Kong* that can be downloaded to try for free.



DIG DUG

YEAR: 1987

■ Namco's wacky 1982 arcade game *Dig Dug* was licensed for release in the West by Atari and despite its strange concept the game was one of the biggest hits of the 'golden age' of arcade games. This made it an easy choice for 7800 conversion and this version is one of the best out there. The rich and colourful graphics, impressive sound and addictive gameplay all add up to give you one of the best arcade experiences that can be had on the Atari 7800.



MARIO BROS

YEAR: 1988

■ One of three Nintendo games to appear on the 7800, it perhaps seems even stranger that *Mario Bros* is on an Atari machine than *Donkey Kong*. The 1983 arcade game was not only the first game to use the Mario name (he was previously known as Jumpman) but also the first one to introduce us to his brother Luigi and his career as a platforming plumber. Many of the attributes that made up the *Super Mario* games are seen in this early game and the simultaneous two-player action provides more than its fair share of fun!





SINCLAIR ZX80

SINCLAIR ZX80

SPECIFICATIONS

Year released: February 1980
Original price: £79.95 (kit), £99.95 (assembled)
Processor: Zilog Z80A (running at 3.5MHz)
RAM: 1KB (expandable to 16KB)
ROM: 4KB (expanded 8KB ROM later available)
Onboard language: Sinclair BASIC
Display: 32x25 characters
Associated magazines: *Sinclair User*, *ZX Computing*

IN THE BEGINNING THERE WAS THE ZX80. THEN THE ZX80 BEGAT THE ZX81, AND THE ZX81 BEGAT THE ZX SPECTRUM, AND SO BEGAN BRITAIN'S LOVE AFFAIR WITH THE HOME COMPUTER. WE LOOK BACK AT THE MODEST LITTLE MICRO THAT STARTED IT ALL

When people write about the Spectrum, it's almost mandatory to prefix the machine with the word 'humble'. As in the humble Speccy, with its limited colour palette, primitive 'beeper' sound, a maximum 48KB of memory, and its silly rubber keyboard. But when placed alongside its primitive forebear, the ZX80, the Spectrum looks more like that all-powerful WOPR thing out of *WarGames*.

In comparison, the ZX80 featured a monochrome display, no sound output, a measly 1KB of memory and an awkward membrane keyboard. To hamstring things further, the processor at the machine's heart was required to do everything, from reading keyboard inputs to updating the screen, and it obviously couldn't multitask, so the display would flick off when a key was pressed or the CPU was busy executing a program, which, to all intents and purposes, ruled out animated games. Only a couple of years separated the release of the ZX80 and the Spectrum, but there's almost a generation gap between the two machines – a clear sign of the speed at which the personal computer market was moving in the early Eighties. Component costs were tumbling, innovation was rocketing, and computers that were actually useful in an everyday sense were invading homes and businesses. The ZX80 may have been quickly superseded, yet it played a key role in demystifying and popularising the micro, particularly in the UK. It also provided Sinclair with the impetus to expand the ZX line. After all, we wouldn't even be banging on about the Spectrum were it not for the groundwork laid by the ZX80.

The development of the ZX80 can be traced back to 1978. In June that year, Clive Sinclair's micro-computing arm Science of Cambridge released the MK-14, a kit computer with a calculator keypad and an 8-digit LED display that retailed for £40. Although the assembled

kit was of little practical use, it was the perfect, low-cost training aid for students or hobbyists who wanted to learn about microprocessors. It's difficult to determine just how many kits were sold – reported figures vary from 10,000 to 50,000 – but it was successful enough to show Sinclair that computers were a market that could be tapped, even if it was just to raise funds for other ventures within his business.

In 1979, following Sinclair's resignation from his Radionics firm, of which the government's National Enterprise Board had taken a controlling interest, he focused his attention on Science of Cambridge and began to plan a successor to the MK-14. Looking to the US, he saw the big three machines – the Apple II, the Tandy TRS-80 and the Commodore PET – and while they were proper desktop computers designed for real-world application, they were also hugely expensive. The retail prices were even more prohibitive in



» The development of the ZX80 was very much a gamble that paid off handsomely for Sinclair

the UK, where import dealers would, in time-honoured tradition, simply swap the dollar sign for a pound sign and effectively double the price. Sinclair's notion of selling inexpensive consumer products certainly didn't embrace computers retailing at £1,000, nor even half that amount. In fact, he distanced himself from the Newbrain micro project while still at Radionics because its planned scope meant that he wouldn't be able to sell it cheap enough to attract a wide enough market. So he set about developing the ZX80 as a capable, low-cost computer that he could retail for that magic, consumer-pleasing price of £100.

It was a noble aim, but Sinclair was a businessman and he knew that any product still had to turn a tidy profit.

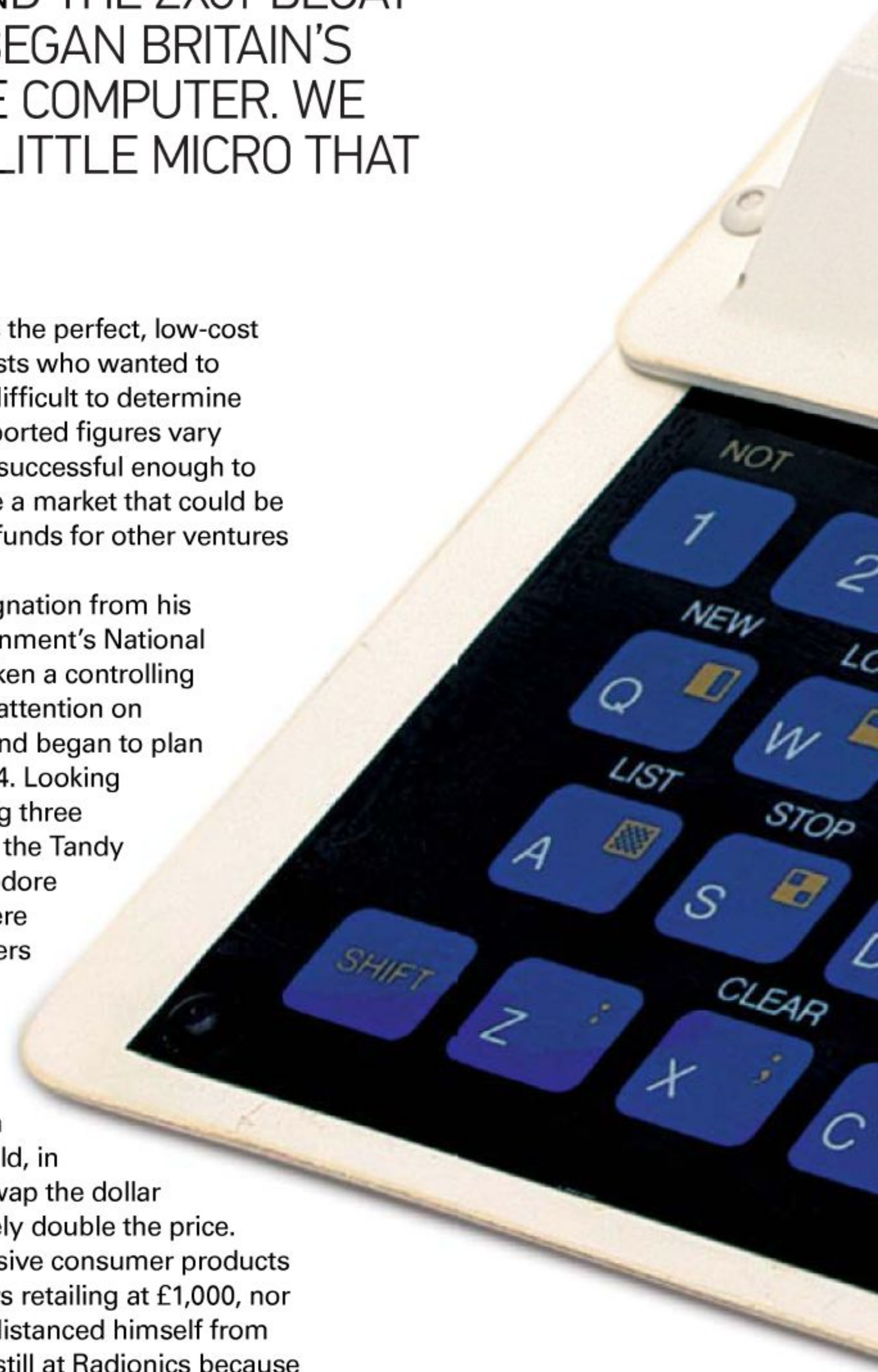



INSTANT EXPERT

- The processor inside most ZX80s was not actually a true Z80A, but rather a copy by NEC named the 780-C.
- John Grant, the creator of Sinclair BASIC, originally suggested that Forth might be a better choice of programming language for the ZX80. He was overruled. Sinclair later published a version of Forth for the ZX81.
- Rick Dickinson is often identified as the ZX80's industrial designer, but it was actually John Pemberton who designed the casing. Dickinson did design the RAM packs for the computer.
- Like a lot of Sinclair's most memorable products, it was a marvel of miniaturisation, measuring 208mm by 159mm – that's roughly half the size of the page you're currently reading.
- It was extremely light and portable, too, weighting just 340 grams.
- There were very few external connectors – a TV out to connect a standard television, ear and mic ports for a cassette recorder to save and load programs on tape and an edge connector for attaching memory packs and peripherals.
- The first ZX80s to be sold were assembled by an electronics outfit in St Ives, but when demand outstripped supply, production was moved to the Timex factory in Dundee.
- After launching in the UK, the ZX80 was exported to many countries around the world including the US, Germany, France, Australia and Japan.
- The expanded 8KB ROM essentially turned the ZX80 into a ZX81, with the exception of the NMI generator. However, third-parties offered their own hardware solutions, which blessed the ZX80 with SLOW mode.
- The ZX80 could use the black 16KB RAM packs designed for the ZX81. With the 8KB ROM, and an upgraded power supply, it could also power the ZX Printer.



SINCLAIR ZX80



▶ To keep the component budget down, long-standing Sinclair engineer Jim Westwood put together a simple hardware design based around the Z80A processor, which consisted entirely of off-the-shelf chips. It wasn't particularly innovative – and the aforementioned flickering display was an unfortunate flaw – but it was a considerable step on from the MK-14. The board and its 21 chips were housed inside a moulded plastic two-piece case designed in-house by John Pemberton. The most curious element of the ZX80's industrial design was the pressure-sensitive 'keyboard', which was basically a plastic sheet with 40 keys printed on it, and by prodding a key, contact would be made with the circuit board tracks beneath and the key press would be registered. It was cheap and not entirely cheerful, particularly after prolonged use.

Further compromises were made with the internal software. A 4KB ROM was provided to store the ZX80's system software, including BASIC, and the unenviable task of trying to cram so much onto such a tiny chip was handed to John Grant of Nine Tiles. Using the ANSI Minimal BASIC standard as reference, Grant spent the summer of 1979 creating the very first version of Sinclair BASIC. In order to meet the 4KB limit, some commands and functionality had to be dropped, with one of the main drawbacks being that the ZX80 could only deal with whole numbers. The dialect was aimed very much at beginners and introduced the one-touch keyword entry system that would become the hallmark of Sinclair BASIC. This idiosyncratic approach ensured that commands could not be mistyped, and to further reduce the chance of errors on code execution, the syntax of each line was checked for faults as it was entered. Considering the restrictions of the ROM chip, Grant's work was mightily impressive and must surely have helped establish BASIC as the language of choice for home micro manufacturers.

The ZX80 was officially launched at a London computer fair in February 1980 and made available to buy direct

from Science of Cambridge. Sinclair wanted to market the first ready-assembled computer to break the £100 threshold, and that's exactly what he did. An assembled ZX80 retailed for £99.95, and if you were handy with a soldering iron, you could buy the kit for £79.95. The first review appeared in the April 1980 issue of *Personal Computer World* magazine. "The ZX80 offers an ideal introduction to computing," wrote David Tebbutt. "It makes BASIC easy to learn, it's small enough for it not to be intimidating, and it's cheap enough that, should you

decide computing is not for you, you can give it away, sell it or whatever. The ZX80 appears to be a well thought out machine both in terms of hardware and software, leaving me very little to say except that I hope Mr Sinclair and his merry men of Cambridge can cope with the expected flood of orders." Perhaps Tebbutt had previous experience of Sinclair's haphazard mail order operation, because the orders did indeed flood in and, predictably, many customers had to wait months for their machines to arrive.

As the ZX80 wasn't sold through shops, actual sales data is hard to pin down. An article in *Practical Computing* magazine

from July 1982 claimed that Sinclair ordered enough component parts to make exactly 100,000 ZX80s – and sold all of them. In April 1983, Sinclair announced that his was the first company to sell more than 1 million home computers worldwide, and this figure included 130,000 ZX80s. More conservative reports estimate that sales were somewhere between 50,000 and 70,000. Even if sales reached the lower end of that estimation, it was still a considerable achievement. Its success was all the more startling because, even with a sub-£100 price tag, the ZX80 was far from an impulse purchase. What sealed the deal for many potential buyers, especially in the UK, was the reputation of Clive Sinclair himself. After all, computers were just the latest addition to his firm's range of innovative products, which included pocket calculators, digital watches and miniature TVs. Sinclair was Britain's favourite boffin, and general punters were far more likely to trust 'Uncle Clive' than some new start-up or some faceless computer conglomerate from across the Pond.

Despite impressive sales of the ZX80, Sinclair did not attempt to capitalise with a slew of upgrade options. At launch, an improved 8KB ROM was promised that would beef up the BASIC with improved mathematical and file-handling functions, but for the first 12 months of the ZX80's life, owners had to make do with official RAM packs. The first of these housed 1-3KB of RAM, with the full 3KB complement costing an eye-watering £60. One ZX80 owner who was not willing to fork out that much money was Nick Lambert of Southampton, who decided to build his own 3KB RAM pack instead. Seeing that it was possible to undercut Sinclair, he went on to start a business and sold his memory upgrades



▶ This unique ZX80 with clear plastic casing was a test created by the moulding company. It's currently part of Rick Dickinson's private collection.



COSTLY KIT

■ It's well-known that ZX80s are sought after these days, with boxed examples fetching upwards of £200, but one recent eBay auction eclipsed all others. On offer was a mint, unassembled ZX80 kit, and the winning bid was a head-spinning £1,500!

RG contacted the seller, Tim Starkie, and he told us that the transaction completed without a problem and the buyer, who was based in Poland, was happy with his purchase. But what's the story behind the kit itself? Tim says: "I bought the kit in 1981 when I was trying to get a job at Sinclair, to show some interest and enhance my application. This was sadly unsuccessful. I actually managed to join Sinclair in 1984 and worked on the design of the flat-screen TV and the Spectrum 128. It was due to the Sinclair exposure in the recent *Micro Men* TV programme that I decided to sell the ZX80 kit – I thought that the heightened awareness may increase the selling price. Was I in for a surprise! I never thought it would be worth that much. Several of the unsuccessful buyers have since contacted me to say they wished they had bought it. One of my work colleagues said that my future grandsons will say, 'Stupid granddad. He sold that kit for £1,500 in 2009 and now it's worth £10,000!'"





COMMUNITY THE BEST ZX80 RESOURCES ON THE WEB

Grant's ZX80 Site
tinyurl.com/gp7au

■ If you're a technically minded retro nutter then Grant Searle's ZX80 website is an absolute must. His hardware page provides a detailed guide to building your own ZX80 using off-the-shelf components that are readily available today. It even includes authentic keyboard overlays to print out and use.



Scot's ZX80 Site
tinyurl.com/yjwatdq

■ There's nothing unique about Scot's small site, but it serves to pull together all the interesting ZX80 information scattered around the web, including manuals, reviews, and adverts. It also includes the *Space Intruders* program that you can download and run in an emulator. No\$ZX81 is our recommended emulator.



ZX80/81 Forums
tinyurl.com/ykb8q9n

■ If you're looking for general information or specific technical advice, you can guarantee that the knowledgeable bunch on here will be able to help you out. The forum also includes sales and wanted sections where users can trade bits of kit. The admin is well-respected Sinclair enthusiast Rich Mellor.



ZX81 Stuff
tinyurl.com/ykgtqlh

■ This site really is the ZX81 equivalent of World of Spectrum, as it includes information on hundreds of games and provides the files for you to emulate them. The interest for ZX80 fans is that a number of 81 games also work on the 80, providing it had the 8KB ROM fitted, so you can uncover those here.

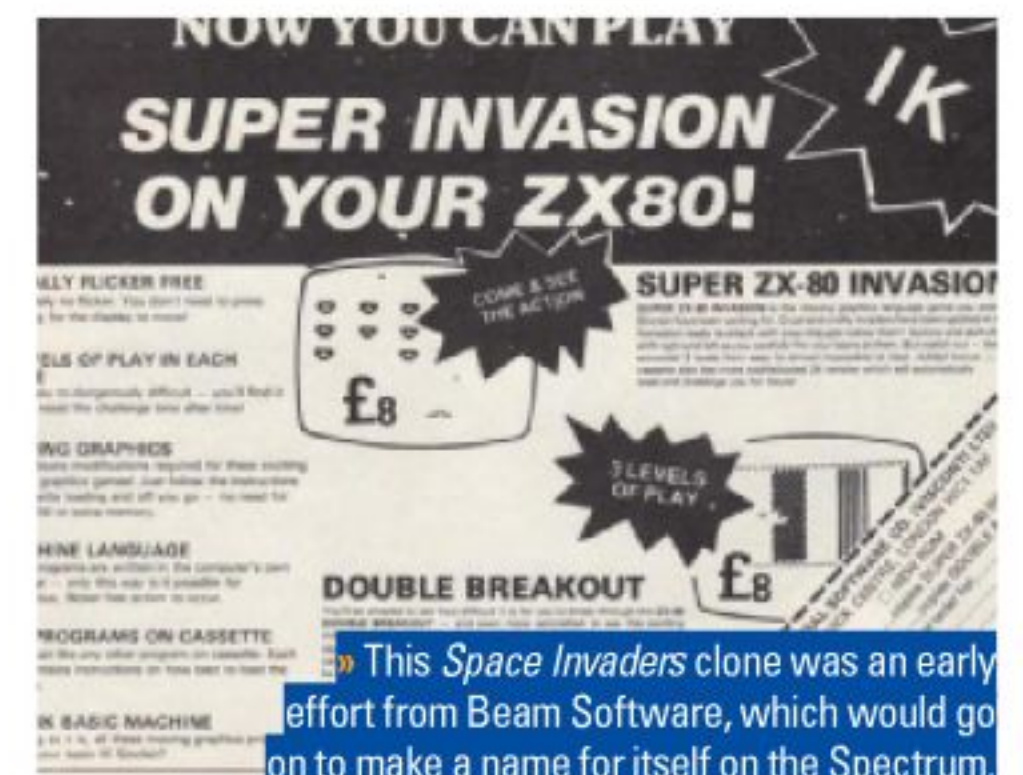

▶ via mail order for £40. Nick named his company Quicksilva and released a number of expansions for the ZX80, including a nifty sound board. He also began experimenting with games and programmed a version of the arcade hit *Defender* for the ZX80.

The general thinking was that animated games were not possible on the machine due to the flickering display, but ingenious coders worked out a way to overcome the problem. The breakthrough was made by Ken MacDonald of Macronics Systems, who wrote an interrupt routine. Basically, he realised that the CPU was only updating the display 80 per cent of the time due to the vertical blanking interval. During this period, when no picture information was being actively generated, code could be timed to run without affecting the display.

He named the routine Amazing Active Display and used it to create ZX80 games based on *Breakout* and *Space Invaders*. The program listing for the latter, titled *Space Intruders*, gained exposure after being published in the book *Making The Most Of Your ZX80* by Tim Hartnell.

Other programmers then used MacDonald's method to write their own smoothly animated games. If you picked up issues of *Personal Computer World* or *Practical Computing* in early



1981, you'd find a small number of ads for ZX80 games on cassette. They were mostly arcade clones or board games, with the two best-known developers being Quicksilva and Bug-Byte. The ZX software scene would soon flourish, though, with the unveiling of the ZX81 in March 1981.

The ZX81 was very much an updated ZX80 rather than a new computer – indeed, development titles for the machine included ZX80 II and ZX80 Series B. Screen flicker was overcome by the inclusion of a non-maskable interrupt generator, and it shipped with the long-awaited 8KB ROM, which was also sold separately as an upgrade for ZX80 owners. The main change, however, was the reduction of the number of internal chips from 21 in the ZX80 to a mere four in the ZX81. This redesign meant Sinclair could offer more features for less money – just £49.95 for the kit or £69.95 ready-built. The new price and spec saw ZX81 sales rocket past those of its predecessor, with 1 million units sold during its first two years.

It's often suggested that the ZX80 kick-started the home computing craze in the UK. However, in truth, the ZX81 deserves to take more credit, thanks mainly to the sheer numbers sold and the home-grown industry that sprang up to support it. But in its own right, the ZX80 was a plucky contender that perfectly realised Sinclair's aim of making computing accessible and affordable to the man on the street.

And just like that all-powerful WOPR thing out of *WarGames*, it too could play a perfect game of tic-tac-toe.



SEGA 32X

SEGA 32X



How do you take half a decade's worth of critical and commercial success and flush it down the toilet? Easy: you release a device like the Sega 32X. We dig around in the dirt for the truth regarding this most unfortunate of hardware releases

At the start of the Nineties, Sega was arguably at the height of its powers. The dawn of the decade saw the Western launch of the popular Mega Drive console, which managed to gain both commercial and critical acclaim – much to the annoyance of arch-rival Nintendo. Such success was not to last, however; in less than a decade, Sega's position would be far less dominant and the firm would be forced to limp meekly out of the hardware arena.

Why this disastrous fall from grace occurred is very much open to debate, but if you followed Sega's fortunes in the middle of the Nineties one thing is abundantly clear: the company took far too many risks when it came to videogame hardware. The forward-thinking but commercially disappointing Mega-CD represented the first indication that something was amiss, but industry experts point to the positively disastrous retail performance of the Mega Drive's 32X add-on as the real straw that broke the camel's back.

Like the Mega-CD before it, the 32X was a device that augmented the capabilities of the 16-bit Mega Drive, allowing it to perform the kind of 3D graphical tricks that would later become the mainstay of 32-bit consoles. However, by the time the machine was launched it was already being outgunned by Sega's own Saturn, and in less than 12 months it had been dropped from the company's plans altogether. From an outsider's perspective the failure of the 32X was almost a foregone conclusion, so why did Sega choose to sour its relationship with the gaming public just months before it intended to release the Saturn? Scot Bayless, senior producer at Sega of America from 1990 to 1994, is the ideal man to shed some light on this turbulent time because he was there the moment when Sega's American division got the telephone call from Sega of Japan CEO Hayao Nakayama that resulted in the birth of the machine.

"We were at CES '94 in Las Vegas, and Sega of America's head of R&D

Joe Miller asked a few of us to join him in his suite for a call he was expecting from Nakayama," remembers Bayless. "There had already been some discussion about an up-gunned Mega Drive with Hideki Sato and his Sega hardware team, but the essence of the call was that we needed to respond to Atari's Jaguar and we needed to do it right away. Joe said he was confident the US team could come up with a design that would do the job, so Nakayama said 'get it done' and we were off to the races. Marty Franz grabbed one of those little hotel notepads and drew a couple of Hitachi SH2 processors, each with its own frame buffer. That's pretty much where the 32X started."

The 32X – which at this juncture was known by the codename Mars – was actually one of two cartridge-based projects in development at the time; the other was known as Jupiter – as the more observant among you will no doubt have noticed by now, Sega had a habit of naming its hardware projects after planets in the solar system.

"Jupiter started as a ROM-based unit with theoretical specs a bit like the Saturn," explains Bayless. Although it was to be a more powerful machine on paper, the emergence of Project Mars meant that Jupiter was ultimately squeezed out of Sega's strategy. "I think Sato was really feeling the cost control heat, and the CD-based Saturn was hugely attractive from a cost perspective," he continues. "Therefore, Jupiter was officially put to bed and Mars was born."

From an engineering standpoint, the machine certainly had a lot of potential. "The design of the graphics subsystem was brilliantly simple; something of a coder's dream for the day," says Bayless. "It was built around two central processors feeding independent frame buffers with twice the depth per pixel of anything else out there. It was a wonderful platform for doing 3D in ways that nobody else was attempting outside the workstation market."

Despite Nakayama's keenness to square up to the Atari Jaguar, the decision to start work on the 32X

“The Mega-CD indicated that something was amiss, but the 32X was the straw that broke the camel's back



SEGA 32X

“ Frankly, the 32X just made us look greedy and dumb to consumers

was far from straightforward, and within the walls of Sega’s Japanese HQ there was much brow-furrowing over the project. This is largely due to the fact that in Japan the Mega Drive had finished in third position behind Nintendo’s Super Famicom and NEC’s PC Engine, and the consensus was that the company should plough all of its available resources into the 32-bit Saturn. However, Sega of Japan was savvy enough to realise that much of its current wellbeing was down to the incredible commercial performance of its 16-bit hardware in the West, and when Sega of America insisted that it was too early to pull the plug on this large market, Nakayama took notice.

“There was consensus at Sega of America that making an add-on for the Mega Drive was the right move,” Bayless explains. “To really understand the decision, though, you need to see it in context: the 32X call was made in early January and Nakayama’s mandate was to get to market by the end of the year. I think at the time he lacked confidence that the Saturn would make it to market within 1994.”

Although the Mars project was very much Sega of America’s baby, Bayless and his team were in constant contact with their Japanese counterparts. “The guys at Sega of Japan were great – especially Sato’s team,” he says. “We were all in super-double-secret-crunch mode and nerves were wearing pretty thin. I remember one of our technical

guys going completely ballistic over his dev kit losing one of its Hitachi SH2 CPU chips and then being told he’d have to wait two weeks to get a new part, but the guys in Japan were awesome. They worked their tails off to help us. We did, however, have a persistent problem with translations of manuals. Sega of Japan had a small localisation team in Tokyo, but those guys were completely slammed. So we started hiring translators in the Bay Area to help open up the technical translation bottleneck – with sometimes amusing results. The engineers in Sato’s group were literally sending us the docs as they wrote them and then we were handing them off to contract translators in San Francisco. Technical Japanese is something of a hybrid of English and non-standard uses of Japanese language, and orthodox translations can produce phraseology like: ‘The cracker of remembrance receives a tickle from the command of stern ancestor accounting.’ It was like a party whenever a new batch came in; we’d read them over lunch and howl.”

Although the 32X was meant to enhance the abilities of the Mega Drive hardware – which was half a decade old by this point – it actually shared several similarities with the Saturn. At the heart of both machines were the twin Hitachi SH2 processors, which were included to assist in the creation of complex 3D environments. However, despite sharing the same CPU setup,

the way in which the two devices utilised these chips was quite different.

“The Saturn was essentially a 2D system with the ability to move the four corners of a sprite in a way that could simulate projection in 3D space,” explains Bayless. “It had the advantage of doing the rendering in hardware, but the rendering scheme also tended to create a lot of problems, and the pixel overwrite rate was very high; much of the advantage of dedicated hardware was lost to memory access stalls. The 32X, on the other hand, did everything in software but gave two fast RISC chips tied to great big frame buffers and complete control to the programmer. To be honest, there’s a part of me that wishes the Saturn had adopted the 32X graphics strategy, but that ship had sailed long before the green light call from Nakayama.”

When you consider the state of the market at the start of 1994, it becomes a little easier to see why the 32X ever came to be. The 3DO and Atari’s aforementioned Jaguar were breaking through and garnering some nervous glances from established firms like Sega and Nintendo; 16-bit games were beginning to look terribly outdated and something was certainly needed to keep the momentum going. Sadly, almost from the start things didn’t go according to plan for the 32X: the aforementioned similarity between the machine and its sibling the Saturn caused numerous headaches.

Specifications

■ Year released: 1994 (US), 1995 (UK)

■ Original price: \$159.99 (US), £169.99 (UK)

■ Associated magazines: Mean Machines Sega, Official Sega Magazine, Sega Power, Mega Tech, MEGA, Sega Pro

■ Why the 32X was great:

It would be easier to list the reasons why this system was such a failure, but there are some positive things to mention: the increased power allowed for arcade-perfect conversions of *Space Harrier* and *After Burner*, and the 32X version of *Virtua Fighter* captured the essence of the coin-op edition brilliantly. If you didn’t have deep enough pockets to afford a Saturn then the 32X was a viable option; it’s just a shame that it sold so poorly because the potential was there for true greatness.



» Sega of America CEO Tom Kalinske fought the 16-bit war but even he couldn’t turn the 32X into a success.

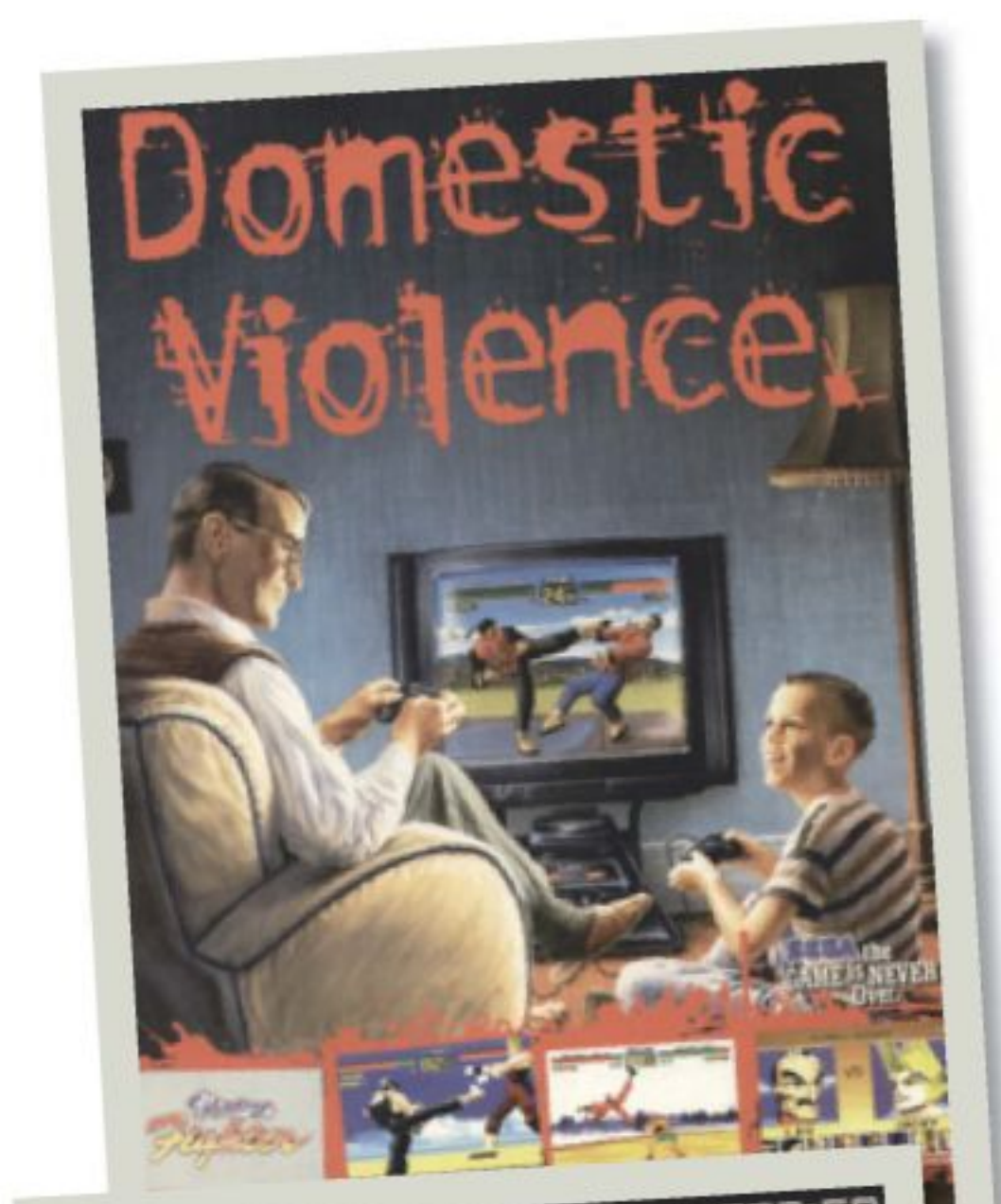

» It wasn’t long before Sega of Europe reduced the price of the 32X to under £100, along with fellow hardware casualty the Mega-CD.



"Early on, the Saturn launch date was uncertain," says Bayless. "There were a number of issues bearing on launch timing and, while Sega of America was making software for the Saturn, we weren't initially fixed on a launch date. Meanwhile, the 32X had to ramp up like a rocket just to hit its timing. So what happened is the two projects basically ran decoupled from each other, which is fine if there are no dependencies between the two; unfortunately there were tons. The systems used many of the same parts, so suddenly the 32X was facing shortages because chips were needed for the Saturn."

Bayless and his team were essentially attempting the impossible; they were trying to bring a hardware blueprint to life in less than a year and had to fight within Sega to get the resources to accomplish the task. To make matters significantly worse, Sega of Japan dropped a bombshell that essentially wrecked the 32X's chances of any kind of success: "The Saturn got its launch date: November of 1994 in Japan," remembers Bayless with a grimace. Rather than being the forerunner of the Saturn, the 32X now had to face the prospect of sharing the same release window as its 32-bit big brother. "Not surprisingly, word got out quickly in the West," he continues. "US and EU consumers immediately started asking the obvious question: 'Why should I buy a 32X when the Saturn is only a few months away?' Sadly, the best

answer Sega could come up with was that the 32X was a 'transitional device' – that it would form a bridge from Mega Drive to Saturn. Frankly, it just made us look greedy and dumb to consumers, something that a year earlier I couldn't have imagined people thinking about us. We were the cool kids."

The early launch of the Saturn had thrown all of Sega of America's already flimsy plans into complete and utter disarray, transforming the 32X from a life-saving blood transfusion for the Mega Drive into a poisonous tumour that would further erode the company's standing in the global marketplace. As Bayless is keen to point out, the timing was horrendous: "Sega of America had a devil of a time convincing anyone that the 32X made sense when the Saturn was just around the corner. Imagine how much harder that would be to sell to the public if the Saturn was already on store shelves."

Despite the obvious setbacks, the 32X experienced a reasonably successful launch in the West. It hit American stores shelves in November 1994, retailing for the substantial sum of \$159.99. Regardless of this hefty price tag, the machine shifted its initial shipment of 600,000 units with ease; it was even reported at the time that demand had far outstripped supply. A similar story can be told of the European release, which is unsurprising when you consider how much power Sega still held in PAL territories at the time.



Marty Franz

Sega vice president of technology (1993-1997)

Retro Gamer: Is it true that you were there the moment Joe Miller got the call from Sega of Japan to produce the 32X machine?

Marty Franz: Yes, I was present at that time. It wasn't really a call from what I remember; it was more like a summons. Joe Miller and Steve Payne flew to Japan and heard about the vision that Hayao Nakayama had. Joe and Steve returned and filled in the team and within a few weeks a small group of us are on an airplane to Japan to discuss the product.

RG: Is it true that Sega of America created the machine because, unlike Sega Japan, which had given up on the Genesis/Mega Drive following poor domestic sales, it believed that gamers still wanted to continue using their 16-bit machines?

MF: The Saturn was going to be slow to take off due to its price. The 32X was going to add additional life to the 16-bit Mega Drive market. This was good business for Sega since that was where it was earning the most income.

RG: What, in your opinion, made the 32X such a unique machine?

MF: We pushed really hard for the dual-SH2 architecture. We really liked the Hitachi SH2 CPUs

that the Saturn had and felt they were the star of the show. Putting two of them in a package with a good graphics buffer was a big advance at that time; it enabled software rendering tricks that were limited only by the imagination.

RG: Did the dual development of the 32X and Saturn create any friction within Sega?

MF: It might have in Japan, but I don't remember it causing any friction in the US. I remember the 32X as being a fast-paced development process with a great product produced at the end.

RG: What was it like working with Sega of Japan at the time?

MF: We had a great working relationship with Sega of Japan. All of us had worked at Sega long enough to know the personalities. We worked as a team even though we had a great deal of distance between us.

RG: Is it true that the 32X shared some technical similarities with the Saturn?

MF: Only the dual-CPU architecture was lifted from the Saturn. The rest was developed from scratch for the 32X. We had a short timeframe to develop the product and couldn't do much in the way of fixed function

hardware development. We had to keep it simple to make the development timeline. We pushed for everything we could imagine that would enable great games in the development timeline we had.

RG: The sound capabilities of the machine were improved over the Genesis but the games released didn't seem to show this enhancement. Why was this the case?

MF: Developing a new audio engine was probably deemed not worth the investment by developers. The 32X was destined to be a short lifespan product. The developers put the dollars to the screen and saved money by not enhancing the audio.

RG: Did you ever have much faith in the platform yourself? Even then it seemed like a fairly risky proposition.

MF: It was a neat product, but it was going to have a short shelf life no matter what. The next-generation consoles were going to take over at some point. Sega wanted to extend the life of the Mega Drive as long as it could.

RG: There was clearly potential in the machine but the opening batch of titles didn't really show off its power. Do you think programmers found it hard because of the complicated relationship between the Genesis and the 32X's processors?

MF: We had a very short development timeline for hardware and software – that didn't help. It also takes developers time to get used to a new platform. We see this with every generation that comes on the market. The developers need a few product cycles to really get their mojo down.

RG: What do you think killed the 32X in the end?

MF: The move to CD was inevitable. The 32X was destined to die because it didn't have a CD drive and was an add-on. An add-on device is never as well thought out as a built-from-scratch device.



SEGA 32X

PERFECT FIVE

SPACE HARRIER COMPLETE 01

» RELEASE: 1994 » PUBLISHER: SEGA » BY THE SAME DEVELOPER: VIRTUA RACING DELUXE



Back in 1995 it seemed like commercial suicide to launch a new piece of hardware with a crusty old arcade port from the late Eighties. While *Space Harrier Complete* is a fantastically faithful conversion, it simply wasn't a game that was going to

sell the system to gamers. Putting such concerns aside for a moment, this is a fantastic achievement that die-hard Sega fans won't want to miss – even if equally good versions are now available on more modern platforms.



02 KNUCKLES' CHAOTIX

» RELEASE: 1995
» PUBLISHER: SEGA
» BY THE SAME DEVELOPER: SONIC THE HEDGEHOG 3

Let's get one thing perfectly clear: this *Sonic The Hedgehog* spin-off (pun absolutely intended) isn't Sonic Team's finest hour, but having said that it's hardly the worst thing that the company has produced – the 2006 *Sonic The Hedgehog* arguably has that dubious honour. The concept of controlling two characters connected by an elastic band sounds more interesting than it actually is, but there are some neat ideas on display here regardless.



03 STELLAR ASSAULT

» RELEASE: 1995
» PUBLISHER: SEGA
» BY THE SAME DEVELOPER: ZAXXON'S MOTHERBASE 2000

A forgotten gem in the 32X library, this 3D space shooter (renamed *Shadow Squadron* in North America) takes inspiration from the likes of *Star Fox* and *X-Wing* to create a surprisingly playable space blaster. It's possibly not as complex as it could be and the visuals tend to look a little basic at times, but it's undeniably enjoyable. On a side note, a Saturn version was also released in Japan and is one of the rarest games in existence.



04 VIRTUA FIGHTER

» RELEASE: 1995
» PUBLISHER: SEGA
» BY THE SAME DEVELOPER: AFTER BURNER

Arguably the jewel in the 32X's crown, this coin-op conversion of Sega's legendary fighter was outclassed by its Saturn big brother but nevertheless succeeds in carrying across the same compelling gameplay that made the arcade version such a global hit. The sheer volume of moves and techniques on show is incredible, and because it's quite a common game it can be picked up fairly cheaply for aspiring collectors.



05 STAR WARS ARCADE

» RELEASE: 1994
» PUBLISHER: SEGA
» BY THE SAME DEVELOPER: STAR WARS TRILOGY ARCADE

Granted, the gameplay is as shallow as a puddle, but *Star Wars Arcade* is one of those games that actually managed to generate some degree of excitement when it was shown to prospective purchasers back in the mid-Nineties. The 3D visuals are fairly basic but the action zips along smoothly and it has enough of the *Star Wars* spirit to make it truly engaging. Just don't expect a deep or meaningful experience and you'll be fine and dandy.

However, despite this initial interest for the device on both sides of the Atlantic, demand quickly cratered thanks largely to a distinct lack of compelling software. Indeed, it could be argued that the 32X never really saw any games that could truly demonstrate its potential and give it a solid reason for existing.

"Not to be too harsh, but the launch mix for the 32X was horrible," laments Bayless. "Actually, it was non-existent. Some of the games were pretty good, but in context they needed to be amazing. Unfortunately for Sega, by the end of 1994 that context had become a whole lot more demanding. When the PlayStation launched in Japan, any argument in favour of the 32X just sounded ridiculous."

One possible argument is that developers struggled to co-ordinate the internal architecture of the Mega Drive and 32X correctly, which prevented them from pushing the console to its limits. "I don't think complexity was the problem," retorts Bayless. "By then experience with the Mega-CD had taught us orderly ways of spreading the workload across the various buses and chips in the combined system. I think the real issue was timing; the games in the queue were effectively jammed into a box as fast as possible, which meant massive cutting of corners in every conceivable way. Even from the outset, designs

of those games were deliberately conservative because of the time crunch. By the time they shipped they were even more conservative; they did nothing to show off what the hardware was capable of."

Taking this chain of events into account, it begs one fairly obvious question: did Bayless ever have any faith in the project at all? "I think the 32X was a great hypothesis," he replies. "But in execution it was disastrous."

Aside from the obviously murky marketing message that crippled it before it even launched, everything about the device was rushed. Nine months from a cold start is a ridiculous timeline for launching a new platform; everything about it was slammed together at breakneck speed and the result was exactly what you'd expect. The hardware was flaky, the industrial design questionable, and the

games were late or buggy – or both." Bayless is quick to point out that it wasn't for lack of trying, and he himself dedicated a considerable portion of his time to trying to make the 32X a viable product: "I spent weeks working with id Software's John Carmack, who literally camped out at the Sega of America building in Redwood City trying to get *Doom* ported. That guy worked his ass off and he still had to cut a third of the levels to get it done in time. What amazes me now is that with all that going on nobody at Sega was willing to say: 'Wait a minute, what are we





Firing Blanks

They say that lightning never strikes twice, but the 32X was just one of several ill-informed hardware ventures that Sega embarked on during the Nineties. The Mega-CD was launched in 1992 and, despite hosting some impressive titles such as *Sonic CD*, *Lunar: The Silver Star* and *Snatcher*, failed to catch on with the Sega faithful. The company also launched an expensive all-in-one Mega Drive and Mega-CD combo called the Multi-Mega. Around the size of a portable CD player, this machine was undeniably sexy but ended up being something of a non-starter. Finally, there was yet another revision of Sega's 16-bit hardware in the shape of the US-only Nomad. Essentially a portable Mega Drive, it was even larger than the already bulky Game Gear and sucked six AA batteries dry in around an hour – unsurprisingly, it didn't trouble the dominance of Nintendo's Game Boy. Ironically, the commercial failure of these platforms and the cachet of the Sega brand has resulted in steep price increases on the second-hand market; both the Multi-Mega and Nomad can sell for many times their original retail price when found boxed and in the right condition.



Three's a crowd

As well as boosting the performance of the Mega Drive, the 32X also had the ability to connect with the Mega-CD to create more impressive CD-ROM titles – that was the hype communicated at the time, at least. In reality, this hellish amalgamation of hardware didn't live up to the propaganda, and those games that were specially coded to take advantage of the setup were mainly poor FMV titles like *Corpse Killer* and *Supreme Warrior*. The controversial *Night Trap* also got a re-release, which featured better quality video, but the gameplay itself remained identical to the Mega-CD original. If the lack of decent games wasn't enough to convince you to disassemble the towering Mega Drive/Mega-CD/32X fusion then the fact that it required three separate power supplies in order to function – one for each component – most certainly was. Looking back, one can understand why Sega was so keen to create all-in-one consoles like the never-released Sega Neptune.

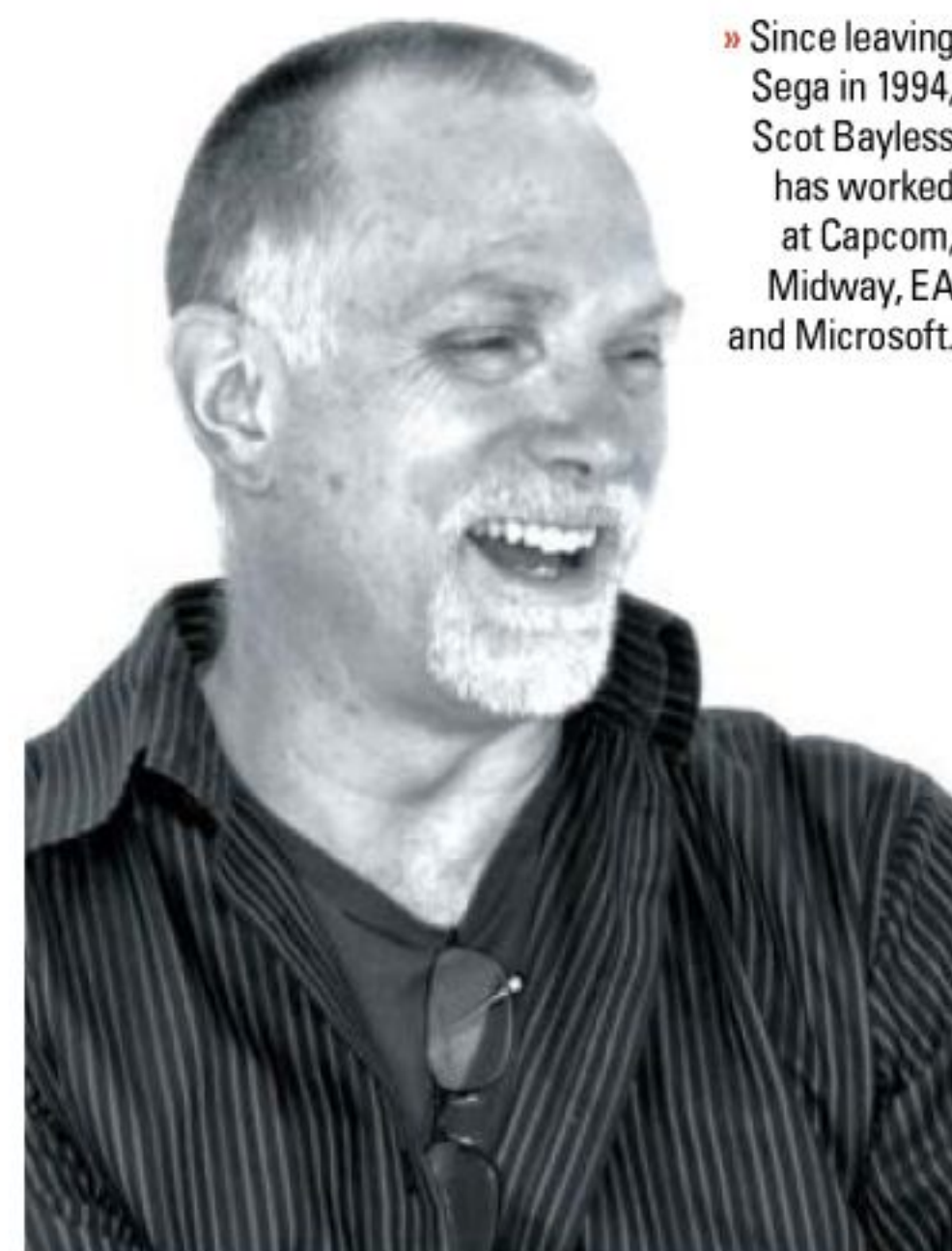

» Since leaving Sega in 1994, Scot Bayless has worked at Capcom, Midway, EA and Microsoft.



“ We stormed the hill and when we got to the top we realised it was the wrong damn hill



» North American ads were almost as bad as the UK ones, as this terrible effort proves.

doing? Why don't we just stop?' Sega should have killed the 32X in the spring of 1994, but we didn't. We stormed the hill and when we got to the top we realised it was the wrong damned hill. Looking back now I'd say that really was the beginning of the end for Sega's credibility as a hardware company.”

By the time 1995 arrived, the writing was on the wall for the 32X. Sega of America CEO Tom Kalinske remained bullish, insisting that better titles were on their way, but Bayless feels that he was making hollow claims: “We knew it was DOA. Everybody knew it but nobody would say it. It's a phenomenon that's all too familiar in big companies: people are afraid to speak out against the company's public posture. They're afraid of hurting their colleagues. They want to believe in what they're doing, so they remain silent – but we all knew. I've never spoken to Tom about what was in his head at that point but I suspect he knew as well. But what was he going to do? The chance to stop the 32X had long since come and gone. He had to make the best of the situation he was facing, and admitting publicly that the 32X was a mistake wasn't an option.”

Kalinske didn't have to make much of this bad situation for long: in 1995 he left the company. Bayless had already beaten him to it, handing in his notice at the end of 1994. He admits losing

faith in Sega as a whole, which is hard for him to disclose. “Even now I feel bad admitting it because I genuinely liked and respected some of the people making those decisions,” he explains. “When you look back at the hardware choices the company made between 1992 and 1995 it was like

watching the Hindenburg in slow motion. Just about every call the company made turned out to be the wrong one. Using cheap consumer drives in the Mega-CD, FMV games, positioning the 32X as an orphan system, designing the Saturn as a modified last-generation 2D system when clearly 3D was going to be the next big thing... Even Sega's peripherals were stupid. Remember the Activator? Sega VR? The company poured insane amounts of money into projects that didn't make sense, and consumers did what they always do: they voted with their wallets and stayed away.”

Ultimately, the 32X is a footnote in the history of the industry, but in the eyes of Bayless it represents an important lesson in how not to produce and position a piece of hardware. “The 32X is a great case study in two things,” he explains. “First, messaging: your number one job in marketing is to establish the value proposition. Even with all the rushed hardware and late software, if Sega had been able to convince people that the 32X was really worth having, it might have had a chance to succeed. But we never did that; we never managed to explain to anyone in any credible way what was so unique and worthy about the 32X. The result is exactly what you'd expect: Sony ate our lunch. Second: honesty; not in the legal sense, nor in the public

sense, but internally. I remember when I arrived at Microsoft in 1998 I attended an executive orientation briefing on my first day. The VP who met with us said: “The one thing we demand of every one of you guys is to say what you think.” That attitude was what kept Microsoft vibrant, healthy and successful for more than 20 years. Sega, by contrast, lacked that ruthless honesty. Nobody wanted to hurt anyone's feelings. Even when everybody knew the 32X and Saturn were way behind the power curve, nobody was willing to stand up and say so. And it wasn't just the hardware; during the same period, Sega published some of the oddest games it ever released. Games that were deeply flawed. Games that completely failed to connect. And all the while everyone was smiling and saying, ‘Gosh, aren't we great?’ I wasn't able to articulate all this at the time, but I know I felt it intuitively. I knew there was something wrong, that we were losing our way.”

The 32X is also a stark reminder that, while add-ons offer a way of extending the shelf life of consoles, they splinter the market. Bearing this in mind, what does Bayless think about the chances of Microsoft's Project Natal and Sony's PlayStation Move, both of which are due this year? “When I met with Microsoft in 2008 to look at Natal I asked: ‘When will you integrate this into the 360?’ Their response was: ‘We're probably going to wait and see on that.’ To which I said: ‘Then you're going to fail.’ Plays like this always fragment your market and the disincentive to developers is powerful; when I'm spending tens of millions on a game, the last thing I want to do is lose 90 per cent of my market.”

They say that those who ignore past mistakes are doomed to repeat them, and clearly Bayless is of the opinion that, rather than being an inconsequential footnote, the 32X should serve as a dire warning to any videogame manufacturer that starts to get ideas above its station.



ACORN ELECTRON



ACORN ELECTRON

IT'S BEEN OVER THREE DECADES SINCE THE INTRODUCTION OF THE ACORN ELECTRON, HERE WE REFLECT ON THE TALE OF THE BEIGE BOX THAT WENT FROM MUST-HAVE CHRISTMAS PRESENT TO THE 8-BIT OUTCAST THAT ALMOST SUNK ONE OF BRITAIN'S MOST BELOVED COMPUTER MANUFACTURERS

Year released: 1983

Original price: £199

Buy it now for: £10-£20

Associated magazines: Electron User, Micro User, Acorn User, A&B Computing, Acorn Programs

Why the Acorn Electron was great... The Electron offered the main functionality of the BBC B at half the size, and at a fraction of the cost. It had strong software backing, and boasted one of the best keyboards of any computer, with great feel and responsiveness, and a variety of shortcuts to common BASIC commands. And it was built to last, too.

After the roaring success of the BBC Microcomputer, Acorn was a company going places. It had conquered the schools market almost unchallenged, and with a cheaper, cut-down sibling to the Beeb designed for home use on the way, it was massively confident that it could dominate the marketplace. Four months ahead of the Electron's launch, joint managing director of the company Chris Curry was in bullish mood. "We are not placing any limits on the size we can grow to," he told *The Times*. "We see the Electron as a very powerful threat to the existing dominance by Sinclair and the Commodore VIC-20. We hope to get half the home computer market."

"It was absolutely manic – an insane time really," recalls Tom Hohenberg, Acorn's former marketing manager. "There were exhibitions going on all the time, and there'd be 50,000 to 60,000 people besieging the stands. The BBC Micro was selling like hot cakes – we couldn't make them quickly enough – so there were huge hopes for the Electron. Half the size, half the price, and the same sort of power. We were buzzing."

Lessons had clearly been learnt from the supply problems that had beset the BBC. Thankfully, due to the machine's tie-in with the broadcaster, the Beeb still went on to become very successful. Six months ahead of the Electron's launch, Curry told *The Guardian* that the new model would not even be advertised, let alone sold, until they were "completely confident that stocks are available". "More than almost anybody else we have suffered in the past from problems of lack of product when the demand is high," he said. "We are not going to let it happen again."

Launch day arrived on 23 August 1983, and anticipation was massive. The first review of the new machine was in, and so glowing that Acorn quoted it extensively on the full-page advertising it took out in the newspapers. "Compared to other micros in its price range, the likes of the Spectrum, Oric and VIC-20, the Electron wins on all counts," *What Micro?* magazine said. "It has better graphics, a better keyboard, and faster and more versatile BASIC. Acorn had better be ready for a rush, there's going to be one." If only Acorn had paid closer attention to that last line.

Acorn's strategy was to show parents that the Electron was a way of bringing their learning at school on the BBC into the home, and a £300,000 TV ad was commissioned to make the point. "It took three days to shoot, and was quite an epic production," says Hohenberg. "There were lots of kids and several sets. We

INSTANT EXPERT

The Acorn Electron was a cut-down version of the BBC Model B, retailing for half the price of its bigger brother. The Electron originally retailed for £199 from August 1983 to January 1985, before being cut to £129 and later to £99.

The Electron's size was based on a cardboard tissue box. It was roughly half the depth of the BBC Micro, although the Plus 1 and Plus 3 expansion boxes released for it increased its dimensions to approximately the same size.

Acorn spent £3.3 million on TV advertising to showcase the Electron in the months following its August 1983 launch. Prior to this campaign, its advertising budget was £1.5 million across the entire company.

300,000 Electrons were ordered following the machine's launch. Due to a problem with production of the computer's ULA chip, however, only one in ten worked, meaning that only 30,000 reached shops by Christmas 1983.

Like the original IBM PC and ZX Spectrum, the Electron features just one sound channel, cut down from the BBC's three melodic and one noise channels.

Most Electron titles run on the BBC, although due to the cut-down hardware, many BBC releases won't run on the Electron, and some of those that do run too fast to be playable.

At its peak in 1985, market research showed that the Electron was the UK's joint second bestselling computer, alongside the Commodore 64, but behind the Spectrum.

Somewhere between 1,200 and 1,500 games are estimated to have been created for the machine, as well as several hundred more educational titles.

Two dedicated emulators exist for the Electron – Tom Walker's Elkulator and Thomas Harte's ElectrEm.

Good condition second-hand models now sell for around £10-£20 on eBay. The official Acorn tape decks and Plus 1 and 3 expansion boxes are relatively rare in comparison and often fetch sums in the region of £20-£30 each.





ACORN ELECTRON

COMMUNITY ELECTRON SITES TO WATCH

Acorn Electron World

www.acornelectron.co.uk

The best resource for the Electron there is, with disk images, reviews, a vast PD archive, magazine scans (including every issue of *Electron User*), and the entire *EUG* back catalogue. Also, it's "Desperate to track down any games it hasn't got, and will pay good money!"



Stairway To Hell

www.stairwaytohell.com

Fantastic site dealing with the BBC and Electron, with massive archives of disk and tape images, articles, utilities, the excellent Lost And Found guide to rumoured and unreleased games, plus the most active 8-bit Acorn-related forum on the web.



Retro Software

www.retrossoftware.co.uk

Fast-rising software house, headed by Stairway To Hell founder Dave Moore alongside 'Samwise'. News on various works in progress including *Repton: The Lost Realms*, plus an active forum and various useful development tools for aspiring programmers.



The BBC Lives!

<http://bbc.nvg.org/>

It's gone without updates for years, and its front page boasts a 'site of the day' award from 1996! But this is still a fantastic resource for all 8-bit Acorn machines, featuring a staggering amount of documentation for anyone interested in contributing to the homebrew scene.



What Micro?

The Electron is bound to be compared to the BBC Micro. However, it would be better compared to other micros in its price range, the likes of the Spectrum, Oric and Vic 20. There is however no real comparison as the Electron wins on all counts - it has better graphics, a better keyboard, faster and more versatile Basic. We rate the Electron higher than any of its competition. Acorn had better be ready for a rush, there's going to be one. *What Micro? Sept '83*

This micro.

Today Acorn Computers would think their own home microcomputer called the Electron. And so you can see it has already got with official links to its first independent online distribution of high quality computer programmes. The company microcomputer is Acorn's own design for other Micros that own BBC Basic. (This was done in 1983, long before the year 2000 of the 21st century.)

» As well as his excellent *Galaxian* clone *Arcadians*, Orlando - under the name Delos D Harriman - also produced *Skimmish*, a superb version of *Joust*.



VERSIONS

BBC Model B

The big daddy of the Acorn range, this mainstay of the classroom, produced to tie in with BBC TV's Computer Literacy Project, boasted the same 32K as the Electron, but offered four-channel sound and improved graphics capabilities. Key additional features include support for Teletext and the low-cost networking system Econet. Later models included the short-lived B+ models, available in 64K and 128K flavours, although all the B range was eventually superseded by the BBC Master series.



Expanded Electron

Acorn's Plus 1 expansion box added two ROM cartridge slots, plus an analogue interface - often used for joysticks - and a parallel port to enable connectivity with a printer. The Plus 3 came complete with a 3.5-inch floppy disk drive. With both Plus 1 and 3 attached, the dimensions of the Electron became almost identical to the BBC Micro. Other third-party expansion boxes included the Slogger ROMbox and ROMbox Plus, and Millsgrade Ltd's Voxbox speech synthesizer.



BT Merlin M2105

A highly sought-after oddity for hardcore collectors of Acorn hardware, the Merlin consists of a debadged Electron attached to an expansion box, which incorporates a built-in modem and features a printer interface. The Merlin was used throughout all of the UK's Interflora shops from a pilot scheme in 1985 through to the mid-Nineties, and was used to transmit orders around the country. According to internet sources, a speech synthesizer is also apparently incorporated into the rear unit.





» Peter Johnson's *Overdrive* was for many years unchallenged as the best racer on the Electron, as it was thought impossible to create a game featuring corners for the machine. This was finally managed by Kevin Edwards' *Craze Rider* and Gordon Key's *E-Type*.



spent £3 million on airtime." The marketing of the machine was so successful that a reported 300,000 orders were received for the run-up to Christmas 1983.

Significantly reduced in size from its predecessor, but lacking some of the features and connectivity, the Electron's dimensions had in fact been based on a tissue box, after Acorn found itself unhappy with the case put forward by an industrial designer. "It will have been six to nine months to do the basic design, but then there were problems with the ULA," says former Acorn hardware designer Steve Furber. "We were geared up to produce 300,000," continues Hohenberg, "and then the ULA, the heart of the machine... only one in ten of them worked."

As a result, only 30,000 Electrons hit the shelves in this period. "All these families had promised the kids an Electron for Christmas, and it just wasn't obtainable," says Hohenberg. "We'd get a shipment in, then there'd be a stampede. People were fighting in Rumbelows." The Manchester branch of WHSmith reportedly received 1,500 phone enquiries in one week alone from people desperate to find one in time for Christmas.

Despite the production problems, support for the Electron steadily grew. Acorn's software arm – Acornsoft – led the charge, and its first batch of games included some superb conversions: *Snapper* (an excellent *Pac-Man* clone), *Meteors* (*Asteroids*) and *Monsters* (*Space Panic*), as well as Peter Irvin's fine space-based shooter *Starship Command*. "I sent it to several publishers who all wanted it," he explains. "But I decided to go with Acornsoft because, although their royalty rates were lower, I thought they were the better publisher."

The other main player on the Electron software scene in the early days was Leeds-based Micro Power. Fine conversions of *Frogger* and *Donkey Kong* – *Croaker* and *Killer Gorilla* – sold well, but the real gem was the outstanding maze-based shooter *Cybertron Mission*, heavily influenced by *Berzerk*. Alongside the early software players came the arrival of *Electron User*, the only magazine dedicated solely to the Electron. Launched in September 1983, it became vital to the machine's user base.

Late 1983 also saw the first Electron offerings from Superior Software, a company that would become the most important and long-lasting supporter of the machine. Already active on the BBC scene, Richard Hanson's company was wary of Acorn's supply problems, but dipped a toe into the market anyway. "Richard spent half the night reprogramming a one-armed bandit simulator," says ex-Superior man Steve Botterill. "Beeb sales were brilliant, but it took until the end of the year before Electron sales picked up. We had put about half-a-dozen titles together for it to see how it would go." After small numbers were initially picked up in the countdown to Christmas, Superior Software's big break for the Electron arrived. "In February, WHSmith ordered 1,000 each of seven Electron titles," Botterill recalls. "This marked the start of the Electron selling big numbers."

By February, a backlog of 200,000 orders for the Electron itself reportedly still remained. Acorn's production troubles soon eased, but the missed Christmas rush resulted in tens of thousands of machines arriving into the country with only a fraction of the demand for the machine remaining. "We had this warehouse in Wellingborough," Hohenberg recalls. "Before Christmas, the trucks were lining up at one end wanting to take the few Electrons we had away to stores, but now the trucks were all at the other end, delivering, and the market had completely dried up. Seeing Electrons piled floor to ceiling... it was very depressing."

And the company's troubles didn't end there. Shortly after the Electron's launch, Acorn had attempted to capitalise on its expected success by advertising 11.23 million shares for trading on the London Stock Exchange. The company's performance in the market was soon described in *The Times*, however, as "abysmal". Coupled with ill-fated attempts to set up operations in the USA and Germany, from a position of enormous financial strength, the company soon found itself in serious difficulty. Even Acorn's much-prized contract with the BBC was said to be under threat.

The software market for the Electron was gaining in strength, however. 1984 saw the arrival of Acornsoft's classic *Elite*. "The Electron version was more restricted than the BBC disk edition," says David Braben. "The video hardware on the Electron was very poor compared to the BBC, and we couldn't do some of the trickery we did on the BBC to save memory – this is why it was black and white on the Electron." Even in cut-down form, Electron *Elite* remains one of the finest technical achievements on the machine, and although Braben wasn't overly happy with the version, he and co-author Ian Bell have left one lucky user a present: "We never bought an Electron – one was loaned to us by Acorn, and when we finished, we attached a note to the inside of the case, saying 'Elite was written on this machine'," he says. "We both signed it, so somewhere, hopefully, it's still there in someone's machine."

Other 1984 arrivals included A&F's *Chuckie Egg*, as well as the evergreen (literally) *Repton*. This *Boulder Dash*-influenced series was Superior's biggest seller, and loomed over the 8-bit Acorn scene throughout the Electron's life. Acorn's popular Plus 1 and Plus 3 expansion boxes were launched too, between them adding joystick and disk-drive interfaces, as well as ROM cartridge slots.

Doubtless spurred on by the steadily increasing user base, Acorn seemingly rallied. The BBC contract was renewed, and by September sales of the Electron were said to be over 90,000. A stronger than expected Christmas saw this number double, with a Dixons spokesman expressing delight that the Electron was selling "four to five times as well as we had expected". This in spite of Acorn sticking to its £199 launch price, the same price as the heavily discounted C64, and vastly more expensive than the all-conquering £129.99 Spectrum 48K. In January 1985, however, Sir Clive Sinclair put the squeeze on still further, slashing the price of the Spectrum+ to £129.99. Acorn responded immediately, dropping the Electron



SPECIFICATIONS

CPU: Features a 6502A processor, running at a variable clock rate: 0.5897 MHz-2 MHz, Ferranti Semiconductor ULA coprocessor

Memory: 32K RAM, 32K ROM

Connectivity: General expansion port at the rear (for Plus 1, Plus 3 and so on), cassette player connector, TV connector (RF modulator), RGB monitor connector

Sound: One-channel sound

Video Resolution: 640x256 pixels (Mode 0)



» *Repton* arrived on the system in 1984, and went on to become the Electron's bestselling game.



ACORN ELECTRON

» Tynesoft's *Auf Wiedersehen Pat*, unbelievably released at full price, possibly the worst game on the Electron, which also had arguably the most uninspiring artwork.



by £70 to go head-to-head at that price point, but the new mark undoubtedly put further pressure on the company – the Electron was widely known to be costlier to produce than the Spectrum.

Despite strong Christmas sales, the company suspended share trading five weeks into the new year after its share price dropped to 28p, down from a high of 193p the previous year. Redundancies followed, and Olivetti stepped in to mop up a cut-price 49.3 per cent stake in the company, increased to a massive 79.8 per cent a few months later. After recording a £10.8 million profit in 1984, Acorn was now reeling from a £22.2 million loss. "That was grim," says Hohenberg. "We just felt like 'oh my god – we've sold out to big brother.'" Olivetti chairman Carlo De Benedetti criticised the company in an interview with *The Times*, observing that it'd tried to move into the US market "with forces totally inconsistent with their size, and their financial and managerial strength". A loss-making sub-£100 price tag was soon placed on the Electron, with the bulk of Acorn's warehoused stock 'distress sold' to Dixons. Profits were no longer an issue – Acorn needed cash, and fast.

Remarkably, however, the Electron went on to enjoy a successful year at its rock-bottom price. Figures released by market researchers AGB in May 1985 placed the machine as the joint number two bestselling computer in the UK, with a 15 per cent market share – way behind the Spectrum's 28 per cent, but the same as the C64. It was an unlikely showing for a machine all but written off in some quarters; even as early as September 1984, *Practical Computing* editor Jack Schofield described the Electron as "a crippled thing" and "poor value at any price".

With considerable software support now behind it, the Electron continued to sell well, and although it never got any closer to the Spectrum in the marketplace, its loyal users continued to demand games. One of the machine's main champions was Peter Scott. "I sort of felt all the 'proper' programmers worked exclusively on the BBC, shunning the Electron as it didn't have all the bells and whistles," he says. "It was half-speed in high-res or colourful modes and had single-channel sound that made porting games across from the BBC difficult. I always bore the differences in mind and tried to write games that worked fine on both. It did mean some of my games didn't push the BBC to the limit, but it meant the majority of players got a good game out of it, rather than one great version and one constrained conversion." Scott was renowned for his 'cute' sprites and puzzle-based adventures such as *Thunderstruck*, *Last Of The Free* and *Spycat*, but later became Superior Software's go-to guy for conversions. Ported titles included *The Last Ninja*, *Barbarian* and *Hostages*, but perhaps his finest hour was his outstanding version of *Sim City*. "I loved the challenge of fitting the massive disk-based C64 game into the Beeb," he says. "My proudest programming achievement, even if it didn't sell too well as the BBC and Electron market was in decline by then."

Another key Superior title was the huge space adventure *Exile*. While not as smooth as the BBC version, it was a considerable technical achievement. "The Electron version was the same basic

game, except it ran slower," says Irvin. "The video controller was limited in that it couldn't produce the reduced size display needed to make more RAM available for the game. The visible, random border was in fact part of the game program code." Particularly towards the late-Eighties and early-Nineties, as programmers tried to claw back additional memory to push the machine further, unsightly fragments of code were commonplace on screen features in Electron games – a performance-to-prettiness trade-off most gamers were happy to make to enjoy a string of excellent releases.

In 1989, Steve Botterill and his late brother Mark formed 4th Dimension, one of the last major players to emerge on the Electron software scene. Its first success was with Gordon Key's *Holed Out*, an excellent golf simulator. "It used literally every bit and byte, and we were very proud of it," says Botterill. "Gordon's one of the most brilliant programmers I have ever met." 4th Dimension's other acclaimed titles included *White Magic* and the fabulous *Inertia*, as well as a very creditable conversion of the *Archimedes* racer *E-Type*. With Acorn-related magazines beginning to struggle, however, the market was in serious decline. The demise of *Electron User* in June 1990 effectively marked the end of the active market for the machine, although Superior continued to release occasional compilations of popular favourites, coupled with the odd unreleased title, in its long-running *Play It Again Sam* series.

Although dimmed from its heyday, the Electron torch still flickers, thanks to the emulator scene – and the efforts of the Electron User Group (EUG). The Electron is served by two fine emulators – Tom Walker's Elkulator and Thomas Harte's ElectrEm, which allow users to run disk and tape images, as well as the excellent disk image-based *EUG* magazine, currently run by www.acornelectron.co.uk founder Dave Edwards. Now up to issue 68, this annual magazine includes games, demos, utilities and reviews. Also flying the flag is the recently launched Retro Software label, which promises new Electron releases soon. "The first wave of games are nearly all being developed for the BBC Micro," says site co-founder Dave Moore, also the brains behind www.stairwaytohell.com. "However, it's hoped that we'll be able to port most – if not all – to the Electron." Titles lined up for conversion are arcade adventures *Mountain Panic* and *The Two Towers*, but perhaps most intriguing is an incomplete, unreleased sequel to *Repton 4* subtitled *The Lost Realms*.

A quarter of a century on, opinion is still divided on the Electron. Many, particularly those who picked it up cheap, remember a well-built machine with excellent expansion capabilities and a sizeable catalogue of fine games. For those close to Acorn, however, thoughts are more rueful. "While I was happy enough with the look, performance and cost of the Electron," says Steve Furber, "it was a commercial disaster and contributed significantly to Acorn's downfall. So I wasn't very happy about that!" "We never had the critical mass," says Tom Hohenberg. "If we'd had 300,000 machines out there at the start, that would have created enormous demand for the software. But it missed its zeitgeist. If the bloody things had been there, it could have been a brilliant success."

» Andy Williams' Electron version of *Paperboy* was a slow and flickery conversion, but despite poor reviews it still became a huge hit for the machine.



» The quiz-based *You're Alan Partridge*, a PD title released in 2006, made use of Millsgrade's Voxbox to incorporate speech into the game.

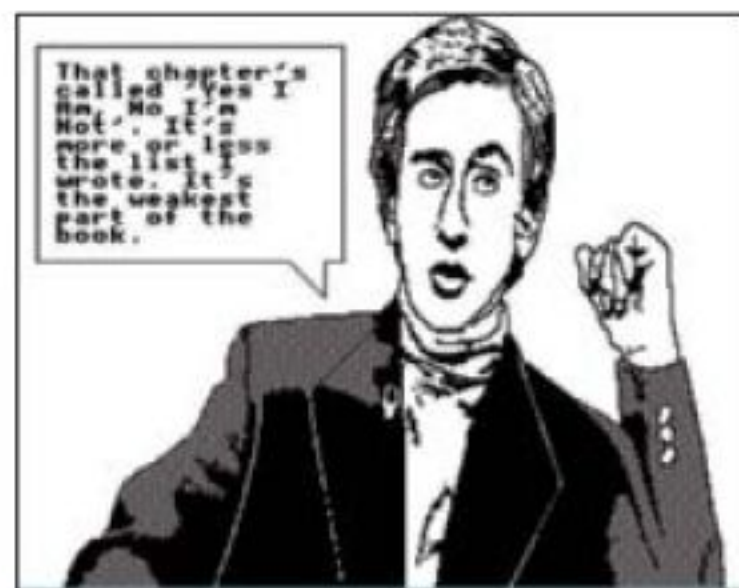



» Blue Ribbon's *Return Of R2* was a terrible attempt to capture the isometric magic of Ultimate's *Alien 8* and *Knight Lore* on the Electron, with this hopelessly crap vomiting monster just one cause of many frustrating deaths.

» Bug-Byte produced some fine titles at budget price, including the excellent maze-based shooter *Plan B*, which achieved ten out of ten in *Electron User*.

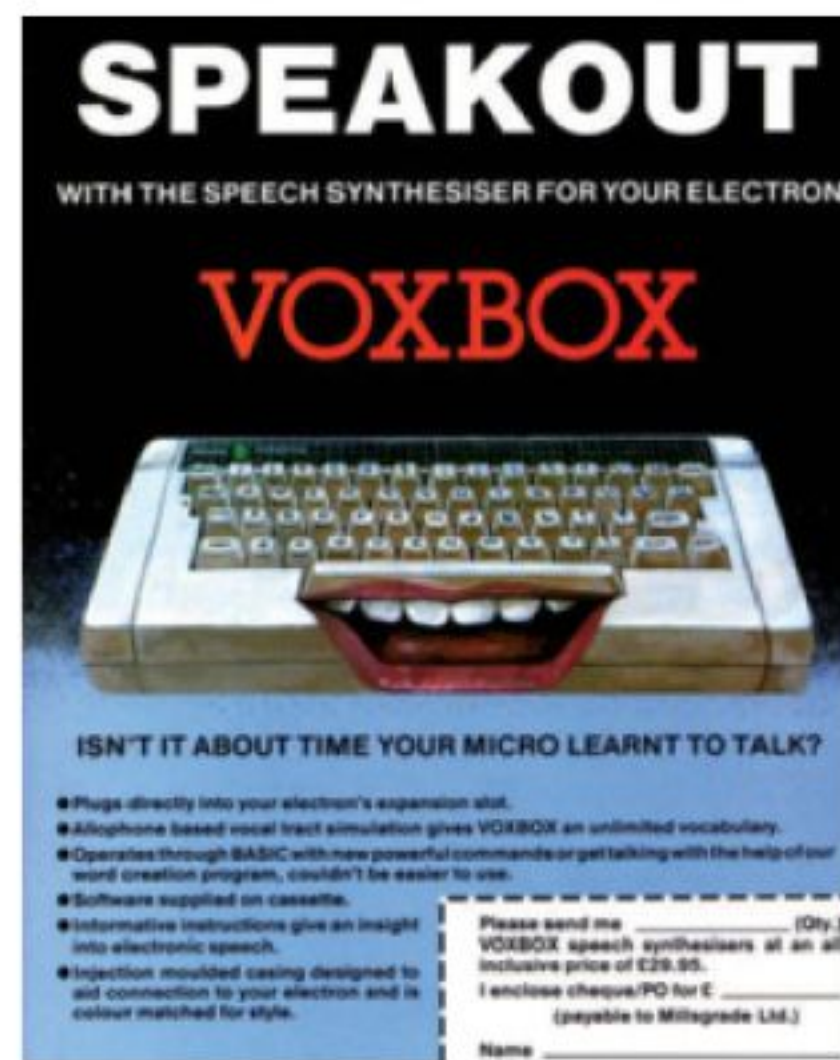
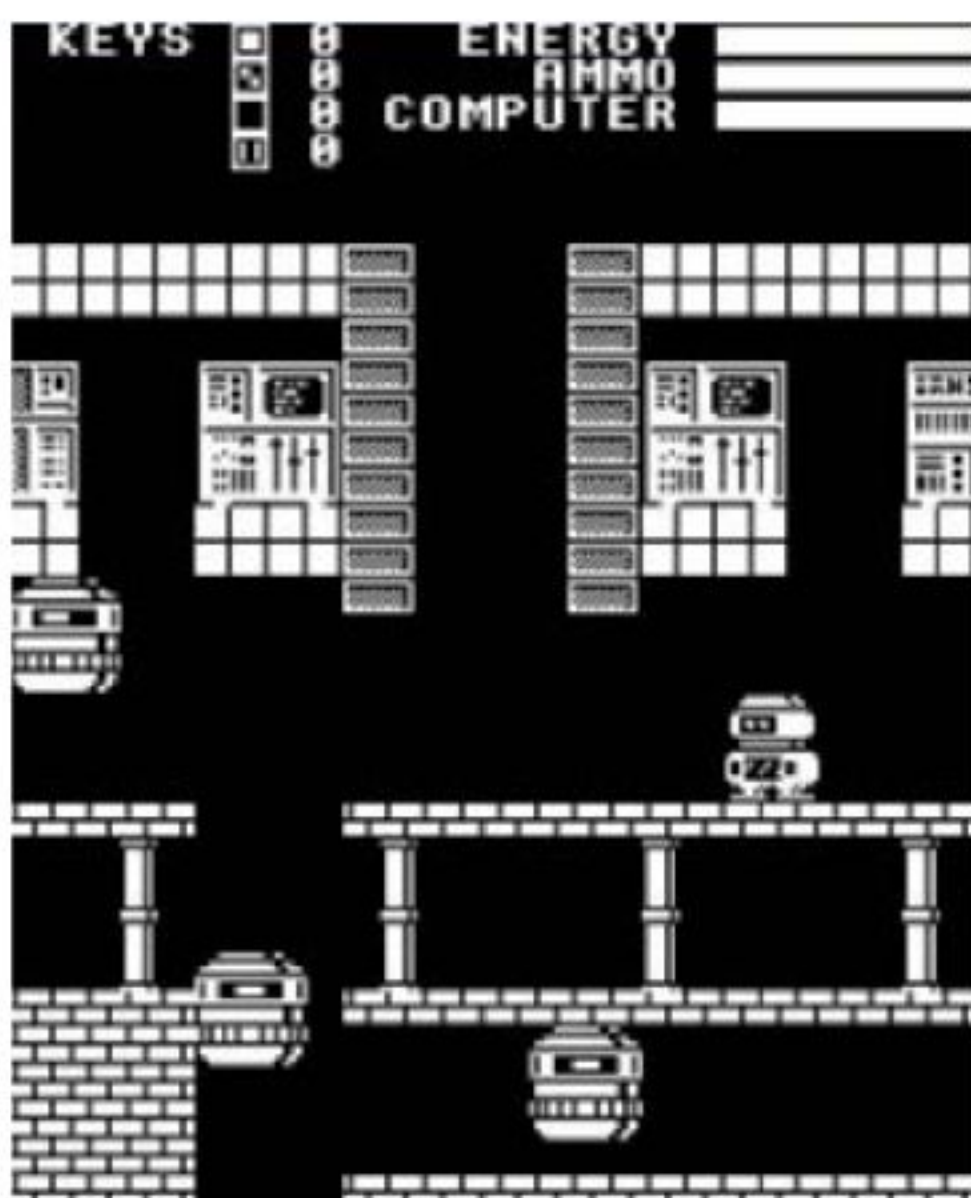

ELECTRON MAG-IC

In October 1983, Database Publications launched the first and only dedicated magazine for the Electron – *Electron User* – as a pull-out section in the Beeb-oriented *Micro User*, before it emerged as a standalone title in January 1984. Mixing news, reviews, type-in games, graphics demos and applications, it became hugely important to the future of the machine. “I guess it was a bit like *Web 2.0* today,” says former editor Roland Waddilove. “Most content was user-generated and I think this is one reason why it was so successful.” But what about those slow news months? “Sometimes we made it up. Yes, some of those stories about scout groups using Electrons to do their newsletters, accounts and memberships weren’t real.” While Acorn was struggling in 1985, the mag had an impressive 46 per cent rise in circulation, and survived well into the 16-bit era, eventually folding in June 1990.



LET'S TALK ABOUT TEXT



The text adventure scene was huge on the Electron, helped enormously by *Electron User's* adventure columnists Merlin (Paul Gardener) and Pendragon (Nic Outterside), who offered sage monthly advice to people stuck in those troublesome mazes. Key publishers included Robico, whose *Enthar Seven* and *The Rick Hanson*

Trilogy (apparently not named after the boss of Superior Software) were great sellers. Shards' *Woodbury End* was a popular favourite, as was Epic's *Kingdom Of Klein*, and all of regular *Electron User* correspondent Geoff Larsen's adventures for his own Larsoft label. Making use of Gilsoft's *The Quill*, Larsen's games – including *Puppet Man* and *Wychwood* – were highly imaginative examples of the genre, in spite of the limitations of the software used to create them. Finally, for laughs, Melbourne House's *Terrormolinos* and *Hampstead* mixed humour with a decent challenge, while Riverdale's TV soap-based *SUDS* games skittered mercilessly on the likes of *Coronation Street* and *Dallas*.



ACORN ELECTRON

PERFECT TEN GAMES

Just because the Acorn Electron was a cut-down version of the BBC Micro that didn't mean it didn't sport a host of great games. Granted, some of them appeared on both systems, but if you're a fan, you'll find the following ten titles essential. If we've missed out any classics why not submit them in the form of a profile at www.retrogamer.net...



01

CHUCKIE EGG

- » RELEASED: 1983
- » PUBLISHER: A&F SOFTWARE
- » CREATED BY: NIGEL ALDERTON
- » BY THE SAME DEVELOPER: CYLON ATTACK

01 In the tradition of *Donkey Kong* and *Miner 2049er*, *Chuckie Egg* was a simple, yet staggeringly addictive platformer featuring an everyman character in a very un-everyman situation. Nigel Alderton's golden egg collect-athon boasted a simple and solid control system, a protagonist who had the good sense to bend his knees when he landed from a fall, and wielded brilliantly that 'run and jump while collecting stuff' template. While many of our readers will no doubt have had dealings with the Speccy port, this version plays quite a bit differently. While it's a tad sluggish in comparison, the payoff is a game that feels slightly more solid, controls that feel less erratic, and, we think, on the whole just a fractionally better game.

CYBERTRON MISSION

- » RELEASED: 1984
- » PUBLISHER: MICRO POWER
- » CREATED BY: MATTHEW BATES
- » BY THE SAME DEVELOPER: BANDITS AT 3 O'CLOCK

02 *Cybertron Mission* is a neat *Berzerk* clone but with an emphasis on searching and destroying. Plonked inside one of the most dangerous environments we've seen in a game – a claustrophobic electrified maze, teeming with regenerating psychotic robots – it was your job to venture into the maze, gather a bunch of objects and then return them to a safe. Okay, so the plot could have done with some work but the action came fast and ferocious. Armed with a gun, and eight-directional aiming, the action could get pretty manic – especially at Level 3 when you had to face those annoying Cyberdroid enemies that bounced off walls. *Cybertron Mission* won't be to everyone's taste but there's nothing else quite like it on the Electron.

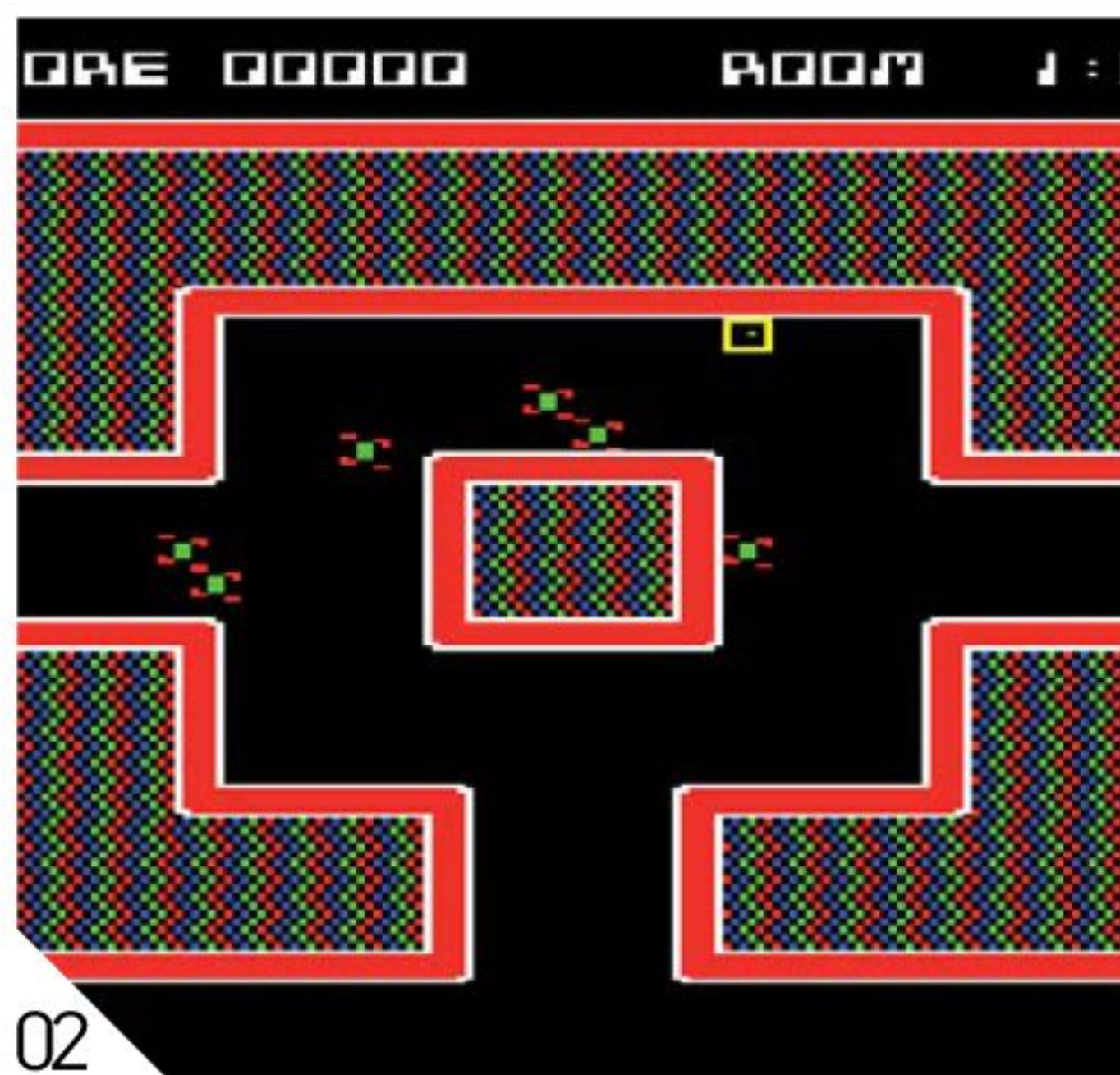

02

FRAK!

- » RELEASED: 1984
- » PUBLISHER: AARDVARK SOFTWARE
- » CREATED BY: ORLANDO AKA NICK PELLING
- » BY THE SAME DEVELOPER: BAGITMAN

03 At the other end of Chuckie Egg's limber-hero-spectrum sits *Frak!*, a platformer starring a caveman called Trogg who's suffering from acute osteogenesis imperfecta. While maddening there's something endearing about *Frak!*. The premise is simple: steer a fragile caveman through a level full of deathly statues and clean the screen of keys to advance. The game's level arrangements meant that clearing each level required lots of skill and patience. Incidentally, 'Frak' is said to be a bowdlerised version of the word 'F*ck', which is why Trogg spouts the word each time he dies – fracking potty mouth.

RANSACK!

- » RELEASED: 1987
- » PUBLISHER: AUDIOGENIC LTD
- » CREATED BY: PETER SCOTT
- » BY THE SAME DEVELOPER: GRAHAM GOOCH'S TEST CRICKET

04 Written by Peter Scott *Ransack!* was a shoot-'em-up with a difference. Your ship, Al, must fend off wave after wave of enemy droids, flying saucers and odd phallic *Flesh Gordon*-style spaceships, while ensuring he didn't fall through gaps, or get impaled on spikes, that appeared intermittently on the planet surface. *Ransack!* is solid, looks great and is very simple. And the neat bonus round that bookends its stages – which sees your character trying to blast a barrage of alien enemies while bouncing off a small and moving baking tray – offered a quirky break to the gameplay.

REPTON

- » RELEASED: 1985
- » PUBLISHER: SUPERIOR SOFTWARE
- » CREATED BY: TIM TYLER
- » BY THE SAME DEVELOPER: SIM CITY

05 Despite the similarities between *Boulder Dash*, *Tim Tyler* – *Repton*'s creator – has always remained resolute that he'd never played *Rising Stars* game. Regardless of whether it's a clone or not, *Repton* is a great game in its own right. Set across 12 stages, *Repton* finds you avoiding falling boulders and the deadly bites from spawning reptiles while trying to tidy the screen of diamonds cerebrally placed around the level. While it looked like *Boulder Dash*, if you boot both games up you'll notice there are some glaring differences between how they play. Basically, *Repton*'s puzzle action feels less chaotic than *BD*'s manic-panic gameplay.

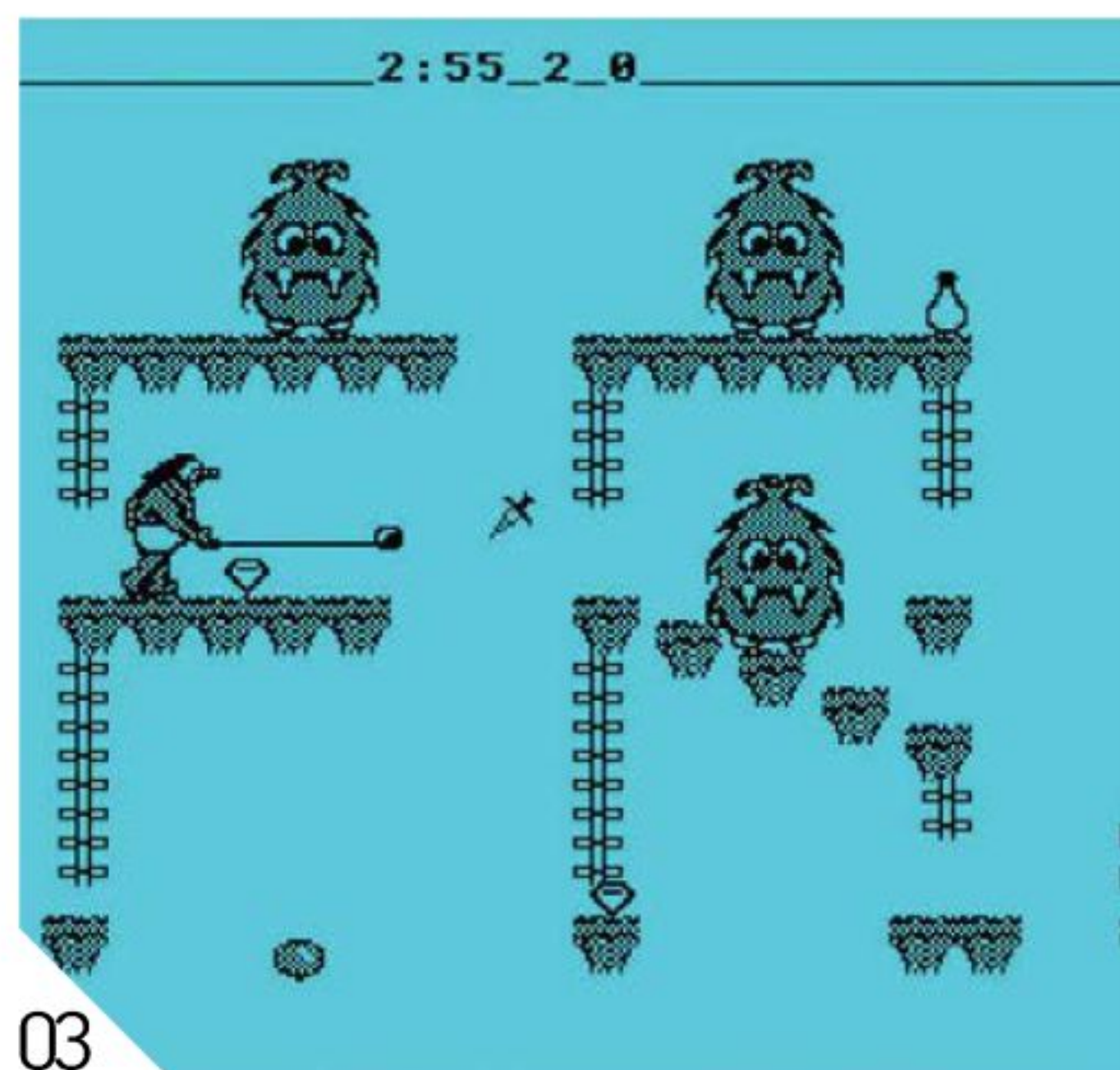

03

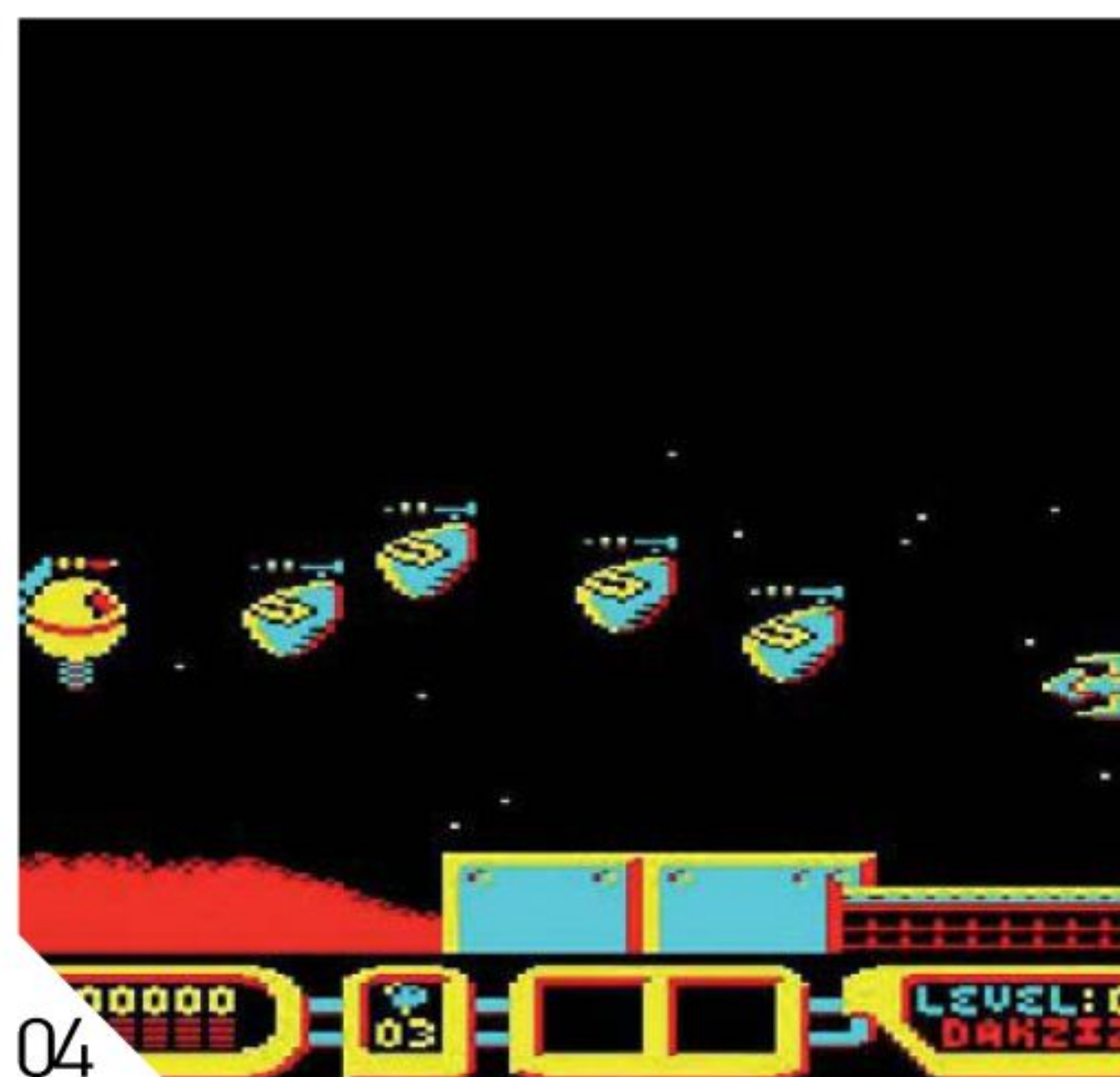

04



05

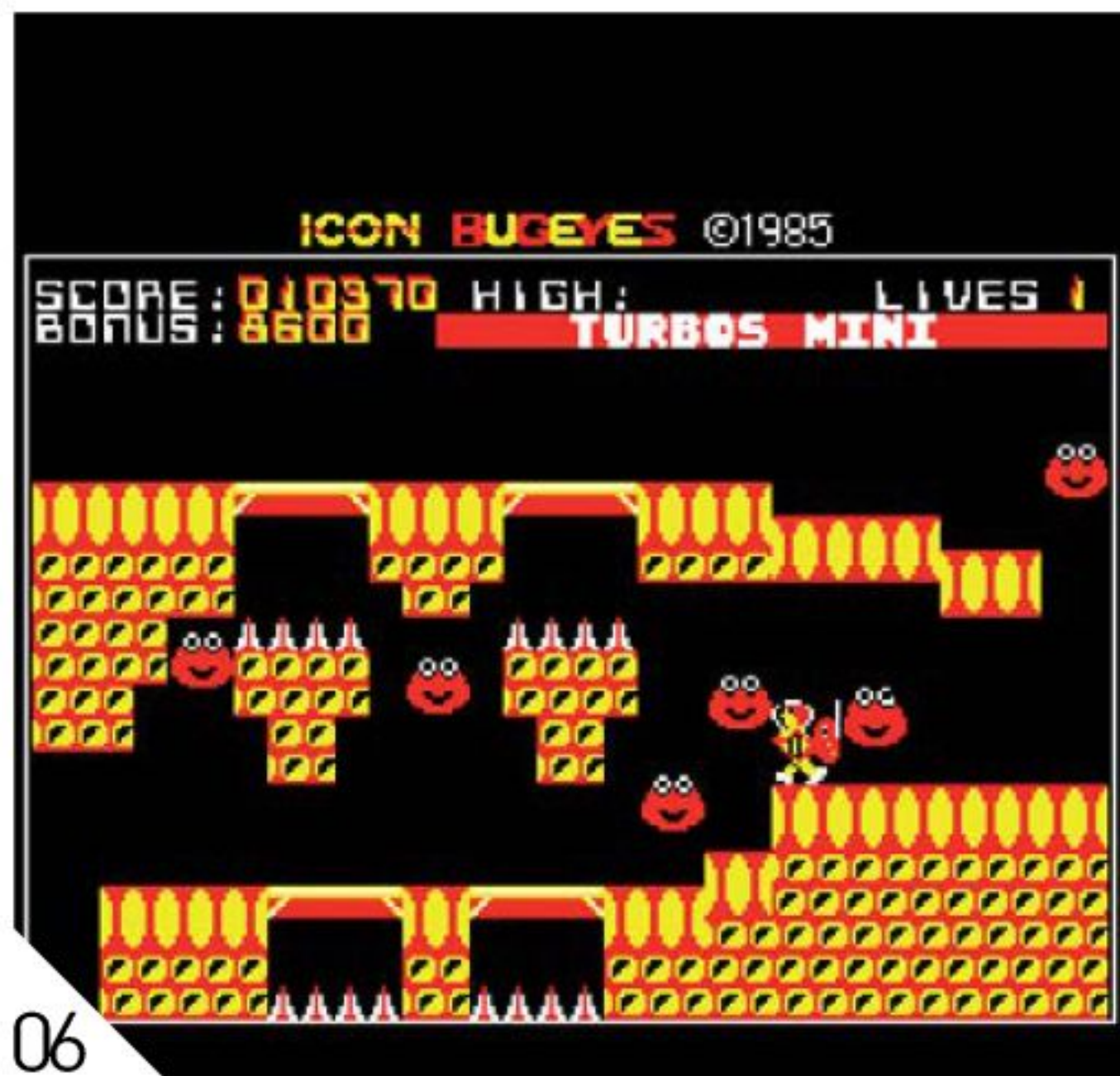

06

BUG EYES

- » RELEASED: 1985
- » PUBLISHER: ICON SOFTWARE
- » CREATED BY: PACKRAT AND BIT BRAIN
- » BY THE SAME DEVELOPER: DRAIN MANIA

06 *Bug Eyes* is a novel take on the platform genre that finds your hero's jumping ability vetoed, forcing him to negotiate each screen with only the power to walk left or right. Timing and precision is the order of the day here, and despite the lack of jumping power the game is still fiendishly challenging. The game is a neat take on analytical platformers like *Chuckie Egg* and *Manic Miner* by taking away the hassle of having to collect stuff. Your mission is to get from the top to the base of the screen without dying. Perhaps owing to its simplicity *Bug Eyes* is also annoyingly addictive, and an underappreciated Acorn classic.



07

THE LAST NINJA 2

- » RELEASED: 1988
- » PUBLISHER: SUPERIOR SOFTWARE
- » CREATED BY: PETER SCOTT
- » BY THE SAME DEVELOPER: RICOCHET

07 *The Last Ninja 2* really shows off Peter's talent of milking the very best out of the *Electron*. Boasting fluid animation and effusive visuals, this is a tour de force for the machine that doesn't shirk in any area. The game continues the series' brilliant isometric puzzle action-adventure recipe with aplomb, but this time supplants the faux-3D viewpoint from the swamps and gardens to a lovingly detailed New York locale. How Peter crammed this 500K C64 game into 35K still remains one of gaming's mysteries, but he did it, and along with his port of Will Wright's *Sim City*, *The Last Ninja 2* can stand tall as one of the best conversions on the machine.

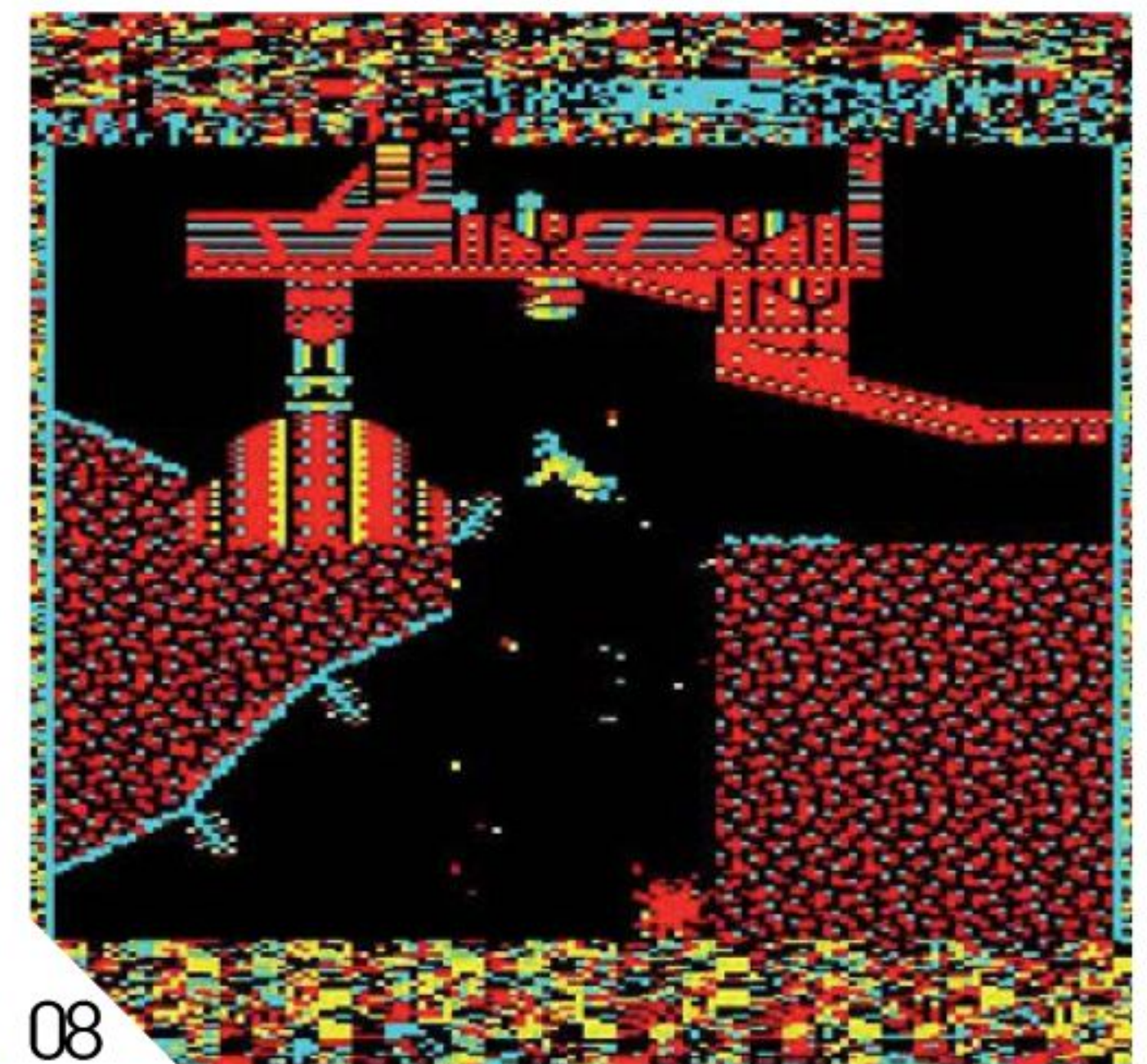

08

EXILE

- » RELEASED: 1988
- » PUBLISHER: SUPERIOR SOFTWARE
- » CREATED BY: PETER IRVIN / JEREMY C SMITH
- » BY THE SAME DEVELOPER: BARBARIAN II

08 You are Mike Finn, who, after finding himself stranded on a hostile alien planet, sets about venturing deep inside the sphere to find his team and confront a maniacal scientist. Peter Irvin's *Exile* is an atmospheric side-scrolling action/adventure game set on a colourful and sprawling world. It's by far the most technically impressive and immersive Acorn game. Owing to its enormity, open-ended gameplay and impressive physics it struck a chord with many *Electron* owners, and its success on the machine would help it to find its way across a throng of formats.



09

ARCADIANS

- » RELEASED: 1982
- » PUBLISHER: ACORNSOFT
- » CREATED BY: ORLANDO AKA NICK PELLING
- » BY THE SAME DEVELOPER: HOPPER

09 A tough choice this one, it was one we pondered for a while. The Acorn has three decent arcade conversions, and we only had room to put one of them in the top 10. It has a brilliant *Breakout/Arkanoid* clone called *Crack-Up*, a fair *Donkey Kong* clone – even if the controls are a wee bit fiddly – called *Killer Gorilla*, and this sublime *Galaxian* homage written by one of the machine's most respected coders. *Arcadians* is pretty slick but also very tricky – those pesky kamikaze aliens are unrelenting, but it's still great fun. It also looks spookily similar to the arcade game, down to the neat explosions that occur when the enemy insects get blasted to the way the front of your ship forms the weapon. It's just a great, great conversion.

ELITE

- » RELEASED: 1984
- » PUBLISHER: ACORNSOFT
- » CREATED BY: DAVID BRABEN AND IAN BELL
- » BY THE SAME DEVELOPER: FIREBUG

10 When David Braben and Ian Bell set about writing *Elite* on their Acorn *Electrons*, little did they know the impact their free-roaming space trading game would come to have on the industry. You simply can't talk about the Acorn, strategy or sandbox gaming without bringing Braben and Bell's interstellar opus to the fold. What makes *Elite* so special is that in many ways it's not just a game, it's a living, breathing, wonderfully realised universe – a virtual escape pod for you to go anywhere, do anything and explore to your heart's content. *Elite*'s virtual playground would capture the minds and imaginations of a generation, and is considered one of the most influential, innovative and immersive *Electron* games ever.

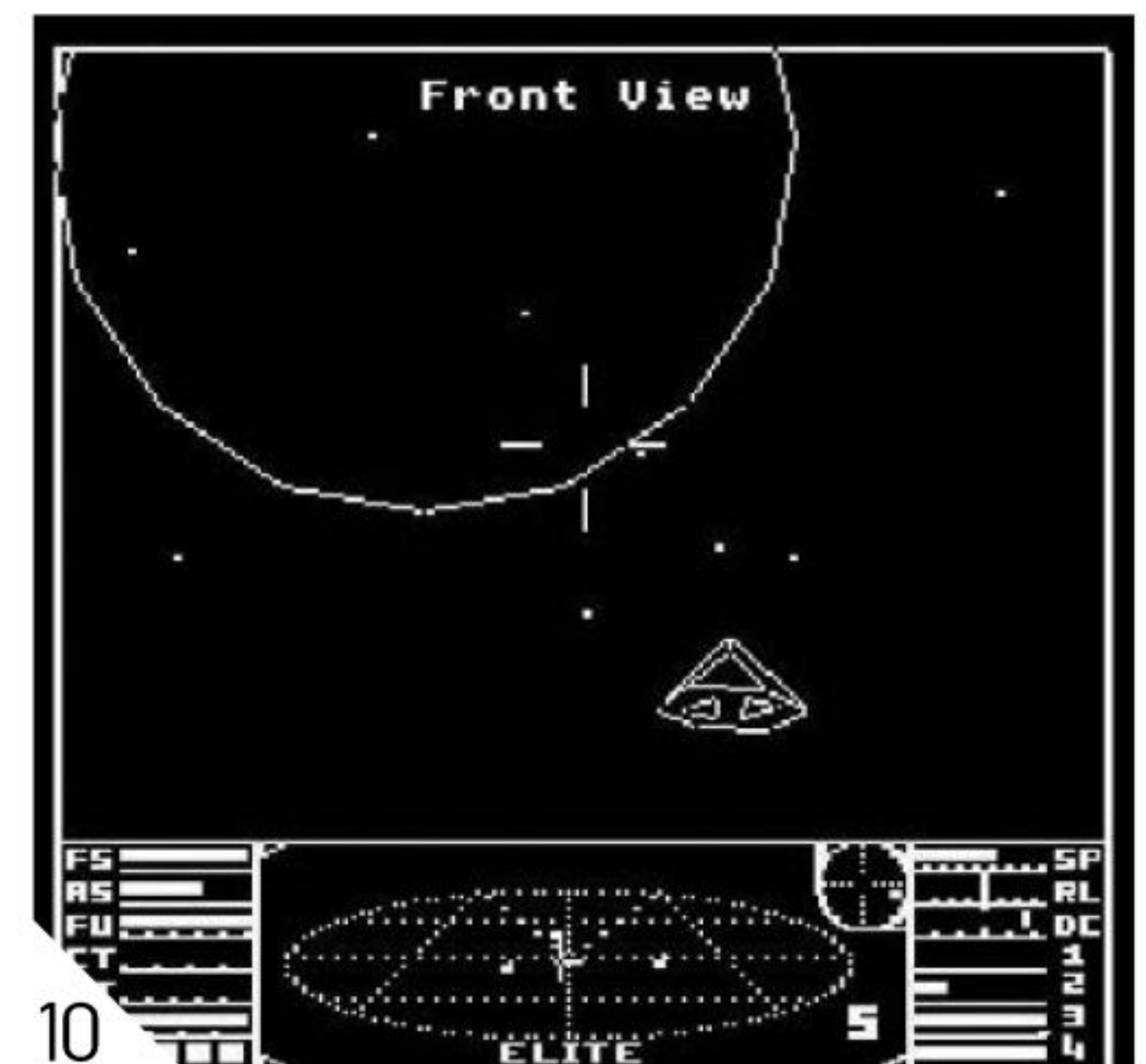

10

Special
trial offer

Enjoyed
this book?

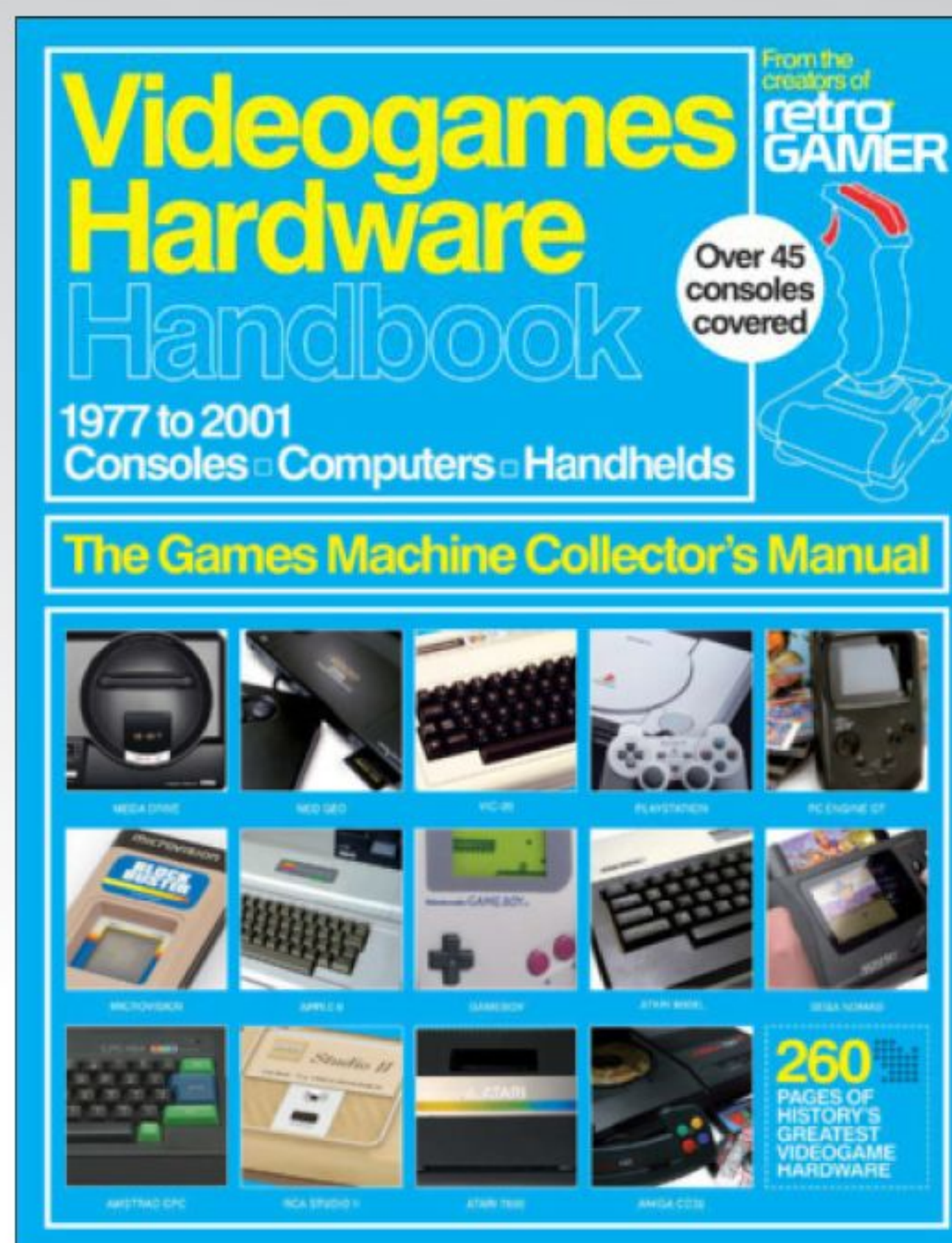

Exclusive offer for new



Try
3 issues
for just
£5*

* This offer entitles new UK direct debit subscribers to receive their first 3 issues for £5. After these issues, subscribers will then pay £22.50 every 6 issues. Subscribers can cancel this subscription at any time. New subscriptions will start from the next available issue. Offer code ZGGZIN must be quoted to receive this special subscriptions price. Direct debit guarantee available on request.

** This is a US subscription offer. The USA issue rate is based on an annual subscription price of £65 for 13 issues which is equivalent to \$102 at the time of writing compared with the newsstand price of \$9.99 for 13 issues being \$129.87. Your subscription will start from the next available issue.



The only UK magazine dedicated to retro games

Unmissable interviews

Every issue is full of one-on-one exclusive interviews with the original developers

In-depth articles

Exhaustive guides dedicated to all of the greatest gaming franchises

Nostalgia overload

Get those nostalgia glands going thanks to excellent articles that cover the good old days

subscribers to...

retro* GAMER

Try 3 issues for **£5 in the UK***
or just **\$7.85 per issue in the USA****
(saving 21% off the newsstand price)

For amazing offers please visit
www.imaginesubs.co.uk/ret

Quote code **ZGGZIN**

Or telephone UK 0844 848 8412 overseas 01795 592 872

+ Calls will cost 7p per minute plus your telephone company's access charge

Welcome back to the golden age



RETRO COLLECTIONS

Revisit the games, films, shows and hardware that defined entertainment for a generation

BUY YOUR COPY TODAY

Print edition available at www.imagineshop.co.uk

Digital edition available at www.greatdigitalmags.com

Available on the following platforms



 facebook.com/ImagineBookazines  twitter.com/Books_Imagine



retro*
GAMER Presents

The Essential Guide To Classic Videogame Hardware

* Back by popular demand, this new edition of the Videogames Hardware Handbook contains everything you need to know about even more classic videogame machines, from the most important to the most obscure



CLASSIC COMPUTERS

- Amstrad CPC
- Acorn Electron
- Apple II
- Oric-1
- Amiga 500
- Atari 800 XL
- Sinclair ZX80



VINTAGE CONSOLES

- PlayStation
- Neo Geo
- Colecovision
- Famicom Disk System
- Sega 32X
- Atari 7800
- Amiga CD32



RETRO HANDHELDS

- PC Engine GT
- Tiger game.com
- Microvision
- Gamate
- MB Simon
- Pokémon Mini
- Wataru Supervision