

# The Sinclair Story

Rodney Dale



Duckworth

Odense  
Universitetsbibliotek

First published in 1985 by  
Gerald Duckworth & Co Ltd  
The Old Piano Factory  
43, Gloucester Crescent, London NW1 7DL

© Rodney A M Dale 1985

All rights reserved. No part of this  
publication may be reproduced, stored in a  
retrieval system, or transmitted, in any  
form or by any means, electronic, mechanical,  
photocopying, recording or otherwise, without  
the prior permission of the publisher.

ISBN 0 7156 1901 2

**British Library Cataloguing in Publication Data**

Dale, Rodney

The Sinclair story.

1. Sinclair, Sir Clive      2. Businessmen—Great  
Britain—Biography      3. Electronic industries—

Great Britain—History

I. Title

338'.04'0924

HD9696.A3G7

ISBN 0-7156-1901-2

Design: Mark Rowden, Portfolio  
Artwork: Business Literature Services Ltd  
Typeset: Goodfellow & Egan Ltd, Cambridge  
Printed in Great Britain by Redwood Burn Ltd, Trowbridge

# Contents

Acknowledgements v

Introduction vii

- 1 Prelude 1
- 2 Sinclair the scribe 5
- 3 Sinclair Radionics 1962–1965 15
- 4 The Sinclair hi-fi boom 25
- 5 St Ives 33
- 6 The rise and fall of the pocket calculator 43
- 7 The picture in your briefcase;  
when time stood still 61
- 8 The NEB saga 77
- 9 Science of Cambridge and the MK14 89
- 10 Sinclair research and the BBC 95
- 11 The ZX82 109
- 12 Sinclair goes to the market 119
- 13 Question time 125
- 14 The ZX83 133
- 15 The picture in your pocket 143
- 16 The C5 conceived 151
- 17 The C5 built 161
- 18 Computers in decline 171
- 19 Private view 181

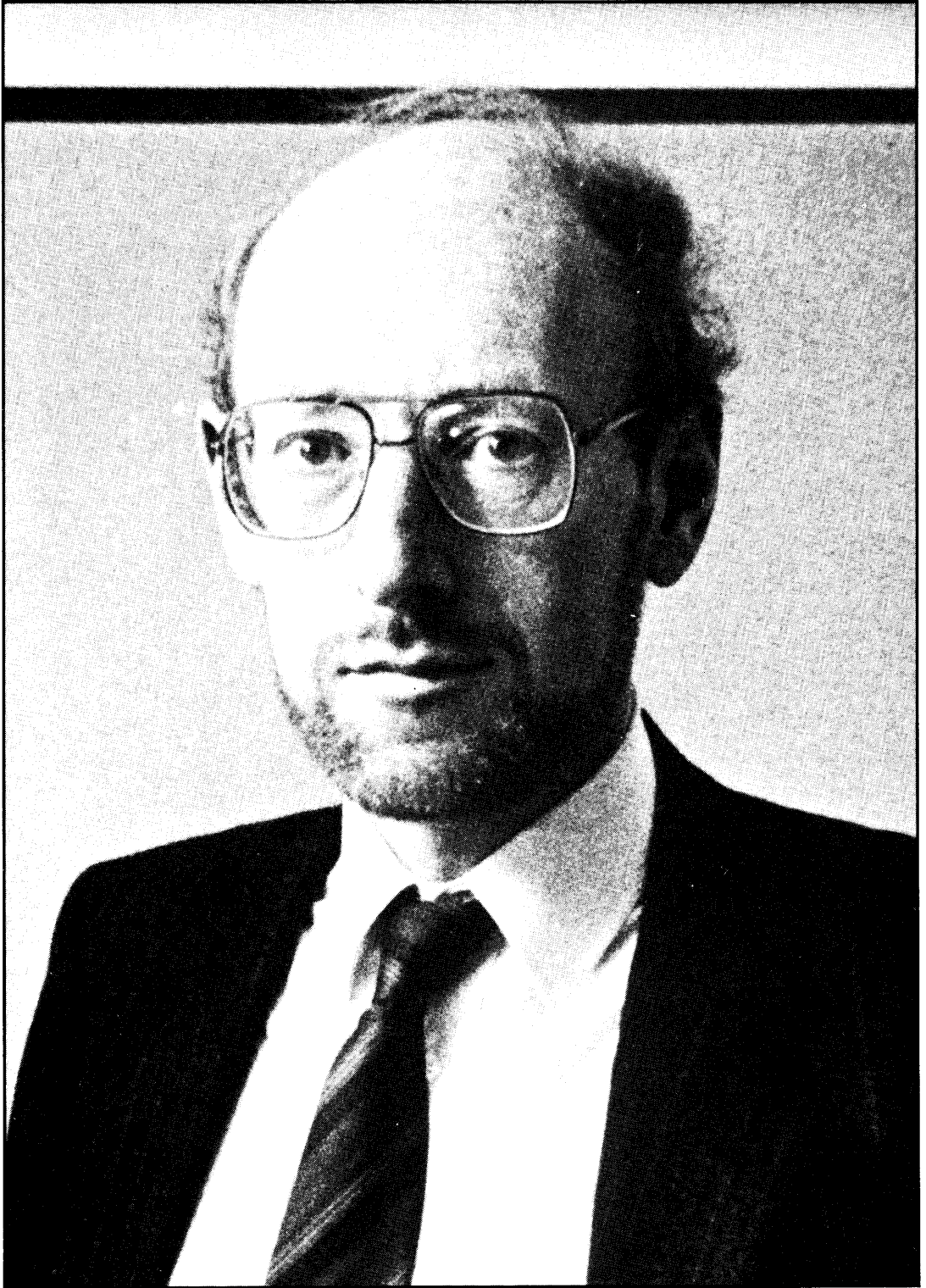

## Acknowledgements

I must start my list of thanks with Clive Sinclair himself, without whom there would have been nothing to write about. Then there are his colleagues past and present who have been kind enough to talk to me, each of whom has contributed pieces to my jigsaw, either unique or corroborative, and those who have put archive and illustrative material at my disposal, through whom our pages are the richer.

Particular thanks are due to Roy Atterbury, Michael Babani, Tracey Beale, Jane Boothroyd, Tom & Carole Bussmann, Robin Cameron, Peter Charman, Dave Chatten, Dee Cullingworth, Chris Curry, Richard Cutting, Rick Dickinson, Peter Drake, Tim Eiloart, Chris Fawkes, Julian Goldsmith, Bill Hardman, Tom Harrison, Mike & Elna Hoare, Michael Jeacock, Richard Jeans, Bill Jeffrey, David Jessop, David Karlin, Nigel Kember, Geoffrey King, Robin Kinnear, John Lawton, John Leigh, Duncan Leslie, Richard Longwill, Alison Maguire, Bill Matthews, Peter Maydew, Hugh & Pearl Metcalfe, Roger Morris, Bill Nichols, John Nicholls, Anna O'Connor, David Park, Molly Pearson, Paul Quade, Jeanne Razzell, Terry Reeve, Tony Wood Rogers, Nigel Searle, Mr & Mrs Bill Sinclair, Fiona Sinclair, Iain Sinclair, Brian Spooner, David Southward, Tony Starling, Tony Tebby, Steve Temple, Richard Torrens, Jim Westwood, Ian Williamson, and Barrie Wills. I apologise to anyone who has been overlooked.

I am particularly grateful to the team in my office who have worked so hard to keep me and my material in order. Tracy Stoten transcribed upwards of one million words of interviews, word processed numerous drafts, and prepared the discs for typesetting. Carina Mann and Margaret Ranken brought order from chaos where none was apparent, concatenating information from diverse

sources with great skill and sympathy, and Liz Yeo debugged it. Every author needs a firm editor, and Janet Whelan has kept me on the right lines with her dry comments on my initial obscurities; she has also directed artwork production. Any obscurities which remain are, as they say, entirely my responsibility.

Finally, I must thank my wife and family for sustaining me in my labours.

Rodney Dale  
September 1985

# Introduction

I started to write this introduction at the end of August 1985, as I was sitting in the atrium of the Willis Road premises of Sinclair Research. When I first entered this building two years ago it was a hive of activity; now it is more relaxed. True, many of the erstwhile inhabitants have moved to Milton Hall, but the atmosphere speaks eloquently of the limbo from which Sinclair Research has just emerged as it gathers energy for the promised leap ahead.

Beside me is a board on which the week's press news is displayed; to the left is a computer demonstration; ahead, a display of software. As I look around, I can count the word 'Sinclair' no fewer than 55 times. This word stands variously for Sir Clive Sinclair, founder of the enterprise, for the enterprise itself, and for the products, and this seems to me to epitomise the way in which the man and his deeds are intertwined.

I first met Clive Sinclair in the early 1960s, since when our paths have continued to cross both commercially and socially. It is no secret that he trusts more those he knows better, and I am grateful to him for trusting me to write this history; he has opened doors for me which might have been closed to others, and he has supported the venture without ever interfering with its course.

Without my prior knowledge of the Sinclair scene I could not have gleaned so much from my interviews, and I hope that the reader will forgive me if the story sometimes appears to take too personal a slant.

A far more serious problem has been deciding where to end the story. Writing history is easy, compared with the difficulty of writing an account of contemporary events which will be history by the time they are read. There is certainly no end to this story yet, and I look forward to recording the present – and the future – with

greater facility when they have become the past.

Thirty years ago, computers were very big, very expensive, and very few and far between – indeed in 1955 there were but thirty-three digital computers in the whole of the USA. Very few members of the general public knew that there was such a thing as a computer, let alone what it did. The last five years have seen one of the most concentrated changes ever in our daily lives; practically everybody knows what a computer is (even if they are somewhat hazy about it) and many people have had the opportunity of ‘hands-on experience’.

Clive Sinclair’s life, his driving force, is technology. In the UK at least, that driving force is largely responsible for our computer awareness. It is general computer awareness for which Sinclair would be remembered if he retired tomorrow; thus would he have made his mark on the history of technology.

But although our computer awareness may be his greatest achievement, there are other successes and failures for which Sinclair has become known. This book charts his course to date, describing the often troublesome, always exciting, path which has led to the name Sinclair becoming a household word – for a product, a company, and a man.



## Prelude

Clive Marles Sinclair was born near Richmond in Surrey on 30 July 1940. His father and grandfather were engineers; both had been apprentices at Vickers the shipbuilders. His grandfather – George Sinclair – was an innovative naval architect who had, amongst other achievements, managed to get the paravane (a mine-sweeping device) to work. He had also taken a major part in the refitting of the *Rurik*, an advanced armoured vessel, later described as ‘the only effective cruiser in the Russian Navy’. One of the comparatively few people in the West who could speak Russian at that time, George Sinclair, accompanied by his wife and three-year-old son Bill, led a party from Vickers to Kronstadt when the armaments of the *Rurik* were to be modified in 1913.

Later, Bill Sinclair tried to break the family mould of engineering by expressing a preference for going into the Church – or perhaps becoming a journalist. ‘Fine’, said his father, ‘but possibly unreliable; get a training as an engineer and when you’re 21 you can make your choice and you’ll have a skill behind you which will always get you work.’ So Bill Sinclair became a mechanical engineer and has been in the field ever since. At the outbreak of war in 1939 he was running his own machine tool business in London and naturally became involved in work for the Ministry of Supply.

When Clive was born the following summer, he and his mother left London to stay with an aunt in the comparative safety of Devon. One evening, Bill Sinclair had a very strong feeling that he should go down to see the family at Teignmouth straight away; that he should not wait until the morning. Against his better judgement he did; the following morning, a telegram arrived saying that the house in Richmond had been bombed. This forced

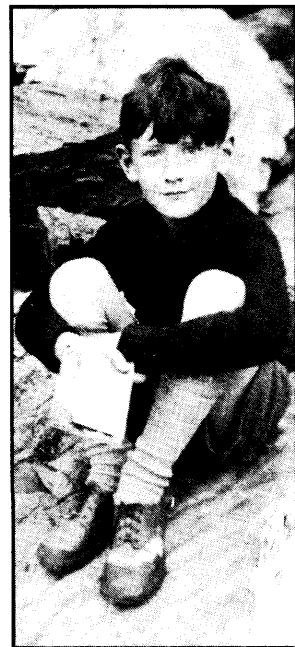



*Clive's mother*

a move; by another providential intervention, he quickly found a house at Bracknell in Berkshire, and there the family was reunited as the war continued its course.

Clive's brother Iain was born in 1943 and his sister Fiona in 1947. The Sinclair children remember a particularly idyllic childhood as many of us do; good solid houses in rural surroundings, summers of seemingly endless sunshine, and a lot of fun. There were visits to grandfather George in London and holidays with their mother's parents in Devon, days of great freedom to roam round the countryside and to explore. Clive came into his own in the holidays, for he loved swimming and boating and at an early age designed a submarine which owed as much to grandfather George's naval interests and Jules Verne as to the availability of government surplus fuel tanks.

Clive found the comparative freedom of holidays a necessary antidote to school; a time when he could pursue his own ideas and teach himself what he really wanted to know. A sensitive child with ways of thought and speech beyond his years, little interested in sports other than aquatic, he sometimes found himself out of joint with his schoolfellows, and xenophobia begets bullying. He preferred the company of adults, and there were few places other than with his family where he could feel intellectual companionship. To some, the Sinclairs seemed to be unconventional, a family who spoke directly, frankly, and often argumentatively to one another as a matter of course – because not only was it more fun that way, but also, as Clive now says: 'You get more out of people by disagreeing with them.' Those who could stand the pace found the Sinclairs refreshing to be with; they could make you feel welcome and important.

Clive went to Bóx Grove Preparatory School; he recalls it with affection, and was very upset when it was eventually closed and the site sold for building land. When he reached the age of ten, the school reported that it could teach him no more maths, and he moved on to the secondary phase of his education.

At about this time, his father suffered a severe financial setback. By now, he had branched out from machine tools and was planning to import miniature tractors from the US. Such machines were a novelty then but to Bill Sinclair their potential was quite clear. However, the exporters had designs on Bill Sinclair's business; they gave him credit to finance his expansion; he got the orders, and then found that they had been filled and invoiced directly to his customers. This forced him into an untenable financial position, and he had to give up his business. With Sinclair tenacity, he started from scratch – still in machine tools – and fought his way back in a remarkably short time. However, fighting one's way back is not without its effects on one's family, and Clive went to a number of different schools for

his secondary education, sometimes as a day boy, sometimes as a boarder, taking his O-levels at Highgate School in 1955, and S-levels (in physics, and pure and applied maths) at St George's College, Weybridge.

Mathematics – that perfect, concise language – had always interested him deeply, and he had barely become a teenager when he designed a calculating machine programmed by punch cards. Because he wanted to make the adding as simple as possible, he did it all with 0s and 1s. 'I thought that was a great idea. I was really amazed to discover that this was a known system; the binary system. That discovery disappointed me deeply; I thought I'd made my fortune . . . but I was very pleased with the idea.'

As a teenager, he also 'discovered' electronics, and when he wasn't occupied with mathematical puzzles and inventing mechanical calculating machines, he was designing and building electronic circuits. He had always been fascinated by things miniature, and he carried this interest into his 'electronic designs, seeking to produce ever more refined and elegant circuits, using smaller and smaller components. The state of his bedroom – a mass of wires – was a family joke, but from it came amplifiers and radios for his family and close friends, and an electrical communications system for their hideouts in the woods.

He worked hard at school, particularly on subjects he was keen on, reading and absorbing far beyond the required level. If he wanted to learn something, he did so very readily; he had – and still has – an incredible facility for assimilating information. The converse is true; at school he had little time for subjects which did not interest him. Nowadays, his planned forgetfulness is directed at information which he thinks he will not need again.

As Clive got older, he complemented his hard work with spare-time money-making activities and a hectic social life. At first, he earned money by mowing lawns and washing up, causing chaos in the cafe when the permanent staff found that he was getting 6d an hour more than they were. Later, he went for holiday jobs in electronic companies – it was at such a company, Solatron, where he first started to enquire of his mentors about the possibility of electrically-propelled personal vehicles. Mullard, however, missed an opportunity; Clive went there for a holiday job interview and took along one of his circuit designs. He hadn't built it – he didn't need to, because he knew that the theory on which it was based was sound. He was rejected for his theoretical precociousness. While still at school he wrote his first article for *Practical Wireless*; it was published; heady stuff.

As an antidote to working hard, Clive and his friends were wont to hold wild teenage parties. A friend of his from a strict Catholic family recalls that one Christmas Eve, after a few drinks, he said to Clive: "I'm off to church; I've got to go because I'm in



*Clive's father*

*A first lesson in hydraulics*





*Clive Sinclair at A-level time*

the choir” so Clive said he’d come along with me, and we staggered into the choir stalls and Clive just joined in with his fine bass voice. Not bad for an atheist!

When he left school just before his eighteenth birthday, there was no reason why he should not have gone to university – except that he didn’t want to. He knew from experience that what he wanted to learn he could find out for himself, and he was equally certain that there was no point in learning about things which didn’t interest him.

But never accuse Clive Sinclair of laziness; he has a capacious memory for anything that interests him and a very wide range of interests. His real ambition was to start his own business, and he knew exactly what he wanted to do: sell miniature electronic kits by mail order to the hobby market.

## Sinclair the scribe

# 2

C.M. Sinclair's Micro Kit Co was formalised in an exercise book dated 19 June 1958 – three weeks before the start of his A-levels. In this book we find a radio circuit, 'Model mark I' with a components list: 'cost/set 9:11d + coloured wire & solder/nuts & bolts + celluloid chassis (drilled) = 9/-'

The dimensions took on great importance:

### Dimensions

$$13\frac{1}{32}'' \times 12\frac{1}{32}'' \times 1\frac{1}{32}'' \approx 0.406'' \times 1.704'' \times 1.224'' \approx \frac{1}{2}'' \times 1\frac{3}{4}'' \times 1\frac{1}{4}''$$

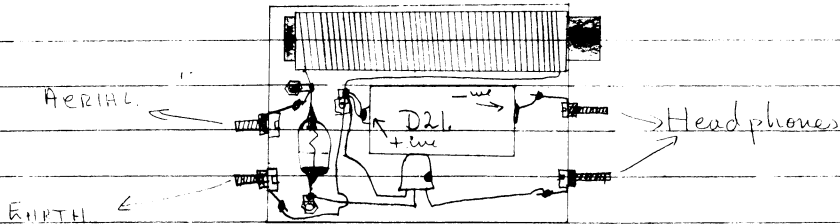

## Circuit of model mark I.

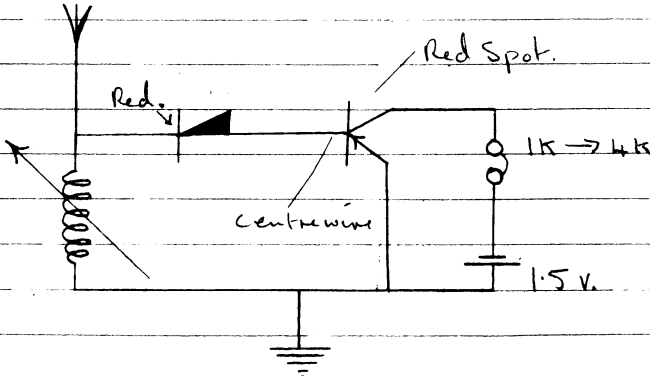
Components list.Price / dozen.

ferrite rod.

£: 5: 3 d:

wire.

1

crystal diode.

10

transistor.

£ 4

10

battery.

5

case.

4

post + package

6

Total.

£ 5 19 -

Cost/ret.

9: 11<sup>d</sup>. 7 ~~5~~

+ Coloured wire + solder / nuts + bolts.

+ Celluloid chassis (drilled).

= 9/-.

And here we find the advertising rates for *Radio Constructor* (9d/word minimum 6/-) and *Practical Wireless* (5/6 per line or part line). The Sinclair Micro Kit Co was theoretically ready to go. But the proprietor realised that he would have to think comparatively big: 'Initially production will be at the rate of 1,000 per month, this quantity being the smallest possible if an economic price is to be obtained for the components used. Orders will be placed with the companies supplying the components for 10,000 of each to be delivered at a call off rate of 1,000 per month.'

He had been delighted to find how cheap components were if bought in bulk, and that there were such things as call-off rates. He also realised that to sell big you had to look big, even if you weren't. Not for him ninepenny words and five-and-sixpenny lines; he would think in terms of half-page advertisements at the very least.

Half-page advertisements and components by the thousand . . . where was the money to come from? Why not write another article for *Practical Wireless*? It would help to while away the time as A-levels took their course. The article was accepted, although it was not published until the following November – no instant cash there. But then he saw *Practical Wireless* advertising for an editorial assistant; he applied for the job and got it. It was the start of the summer holidays, so he told his parents it was a holiday job: no objection. After a decent interval, he told them that *Practical Wireless* thought very highly of him and that there were tremendous prospects there and that he really ought to stay on – none of which was true.

But as it turned out there *were* tremendous prospects because the magazine was run by an incredibly tiny staff: editor, assistant editor, and editorial assistant (Clive). The editor had to retire through illness and the assistant editor stepped into his shoes. He soon collapsed under the strain, and there was Clive Sinclair, at the age of 18, running *Practical Wireless*. He says that it was not a difficult job; all he had to do was to take the material from the regular contributors, look through the articles which poured in from hopeful amateurs, select enough for a well-balanced magazine, and give them an editorial polish. The day a week that editing *PW* took gave him plenty of time for further reading and circuit design. *PW* readers could not always get his published designs to work, but a design which didn't work always resulted in a large postbag, and that reassured F.J. Camm that someone out there was reading his magazine.

F.J. Camm, brother of Sydney Camm the aircraft designer, was the founder and nominal editor of *Practical Wireless*. F.J. had been a prolific writer and editor and his *Practical Householder*, *Practical Mechanics*, *Practical Wireless* and *Practical Television* were eagerly awaited by hobbyists every month. Now he was



F. J. CAMM

advancing in years and somewhat short-tempered; most people were fearful of him, but Clive Sinclair used to chat to him and take an interest in his inventions – most of which had a delightful air of amateurishness about them and soon sank with very little trace.

There was the Cammpump, for example, which was mounted radially in a cycle wheel, attached to the valve, and inflated the tyre as you cycled along by means of a cam fixed to the central spindle. It needed careful handling, and the blow-off valve was capable of making an interesting noise. One particularly ingenious Camm invention was designed to combat the wear of the flint wheel of a cigarette lighter. Normally, this wheel was case hardened and the surface in contact with the flint rapidly wore through. Camm's idea was to put two thin wheels together so that there was a hard disc running through the middle. Clive Sinclair found this elegance particularly appealing.

A job which occupies an active mind for but a fraction of the time lacks satisfaction. The Silver Jubilee Radio Show opened at Earl's Court at the end of August 1958, and Sinclair was representing *PW*, on Stand 108, selling magazines and subscriptions, and still wondering how to launch his own business.

Opposite, on Stand 126, was Bernard's Publishing. Bernard Babani was an entrepreneur in the days before anyone had heard of the word. He had come to England in the 1930s; his poor eyesight had precluded him from serving in the war and he became an engineering inspector at Napiers. There were a large number of other engineers working there, allies who had escaped from the continent. They were familiar with the metric system, but had no idea how the Imperial system of measurement worked. And, of course, we're not just talking about feet and inches; there were all the gauges of thickness, numerous screw threads (BA, BSF, BSP, BSW . . . ), and so on to come to terms with, and it could take a lifetime to get the hang of it. Bernard Babani was the one who could explain it all, and he became so fed up answering questions that he made copies of his conversion tables and handed them out on request. However, this became more and more time-consuming, and in the end he got permission from Napiers to put all the tables into a little book and sell it, and that was how the *Engineer's and Machinist's Reference Table*, the first of his publications, came into being.

He founded Bernard's (Publishers) Ltd at the end of the war, when he realised that there was a dearth of books for radio constructors. As time went on, and the market became flooded with government surplus equipment, the need for such books grew and Bernard Babani was, perhaps, the first person to see that there were places other than bookshops to sell books. Pro-



# THE MICRO-MIDGET POCKET PORTABLE PRACTICAL **13** WIRELESS

NOVEMBER  
1958

EDITOR: F.J. CAMM

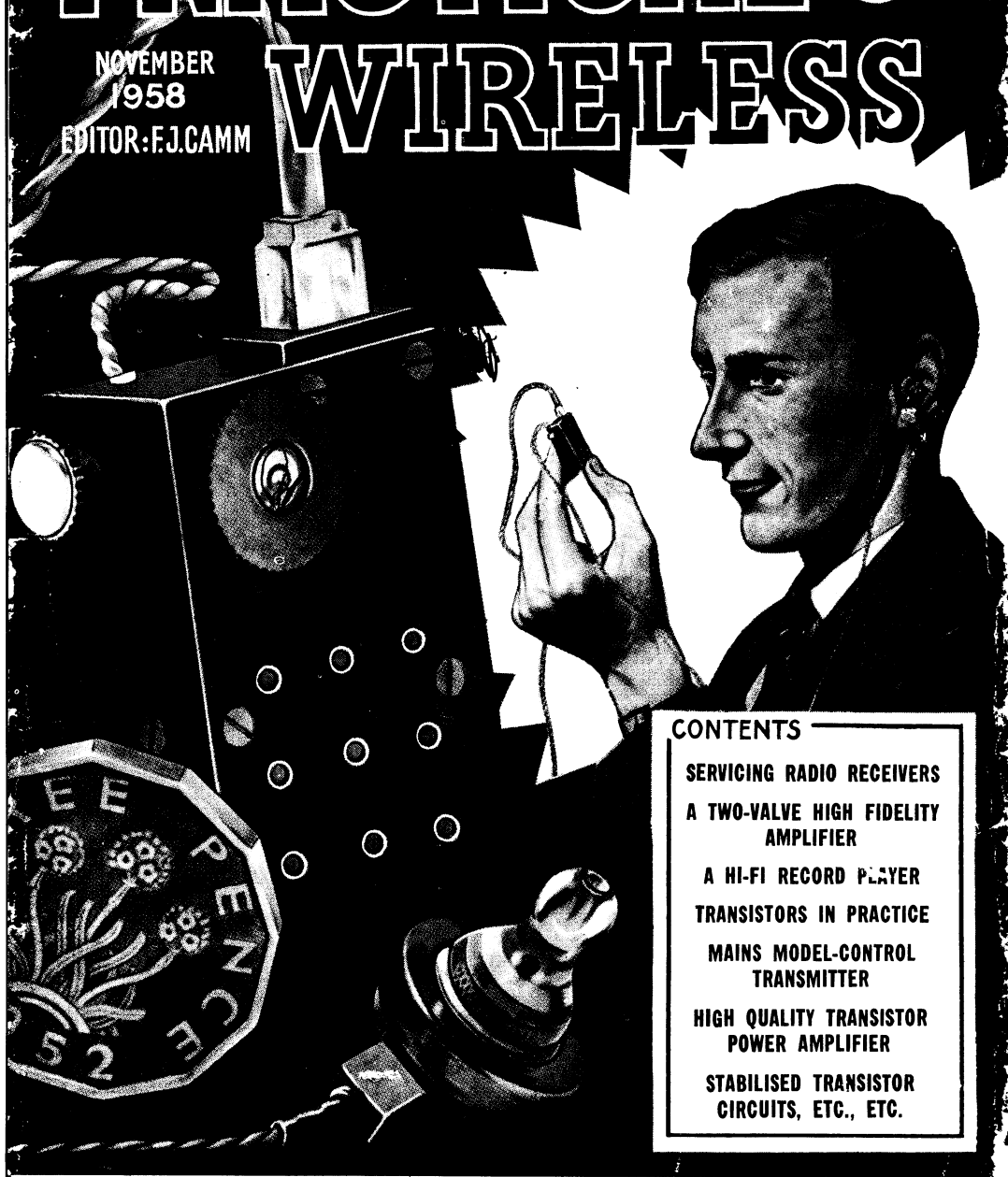

## CONTENTS

SERVICING RADIO RECEIVERS

A TWO-VALVE HIGH FIDELITY  
AMPLIFIER

A HI-FI RECORD PLAYER

TRANSISTORS IN PRACTICE

MAINS MODEL-CONTROL  
TRANSMITTER

HIGH QUALITY TRANSISTOR  
POWER AMPLIFIER

STABILISED TRANSISTOR  
CIRCUITS, ETC., ETC.

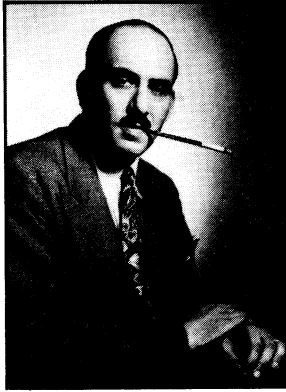

*Bernard Babani*

ducing the sorts of books that hobbyists wanted, at prices they could afford, and selling them in places where they could buy all the equipment and material to go with them, tapped a new and lucrative market. It upset the publishing and bookselling establishment at the time, but the practice is now so commonplace as to be unremarkable; it sells more books, so why not?

At the time of the Silver Jubilee Radio Show, Bernard Babani had some 150 titles on his list, and was always looking for more. As the 1950s drew to a close, constructors who had hitherto been steeped in the lore of the thermionic valve were beginning to appreciate that the transistor was a serious rival which could be here to stay. Sinclair understood transistors, and Bernard Babani was well aware of this. He realised that together he and Sinclair could develop a completely new market while others were still rubbing their eyes.

Sinclair recalls: 'There I was on the *Practical Wireless* stand, when all of a sudden an immense figure loomed up. It was Bernard Babani; out of the corner of his mouth, best gangster fashion, he said: "See you at the coffee stall in ten minutes."' At the coffee stall, Babani offered Sinclair £700 a year to run his publishing company. 'Maybe,' was the murmured reply, 'but I expect a rise after a short time.'

Sinclair could see that there was more future in writing books than in producing a monthly magazine which had already taken its toll of editors – besides, the salary would soon be twice as good and break the magic £1,000-a-year barrier.

When he arrived at Babani's Goldhawk Road premises at the end of 1958, he found a freedom that he had scarcely dared hope for. In his new office, he found a note on the desk:

'Get on with the job – BB'

– so he did.

Bernard's, run today by his son Michael, still occupies the same 1930s-modern block in Goldhawk Road as it did then, and the room where Sinclair and Mr Singh the draughtsman produced the books is now a storeroom. Clive Sinclair designed and sometimes built circuits, and Mr Singh did the drawings and prepared the artwork for printing the books. The secretary, Maggie, did everything else, including conducting worldwide correspondence in all languages. Sinclair's mother had been dubious about her son leaving the security of a monthly magazine to work for a publisher, but Bernard Babani said to her: 'Mrs Sinclair, your son's name will be on all the books we publish.' Many a true word; 25 years later, that storeroom which was Sinclair's office is stacked high with books about microcomputers – and you don't have to look hard for the name 'Sinclair' on the covers.

Sinclair's first book for Bernard's Publishing, *Practical Transis-*

for *Receivers Book 1*, appeared in January 1959. It was reprinted later that year, and no fewer than nine times subsequently. His *Practical Stereo Handbook* was first published in June 1959, and reprinted seven times over a period of fourteen years. A similar story is told in most of his subsequent titles, a tribute both to Sinclair's writing and Bernard Babani's publishing.

But Sinclair was doing more for Bernard Babani than writing books. Low-priced products from the Far East were beginning to trickle in to the country, and one of his jobs was to see if there was any future in incorporating foreign components into British products. At that time, Babani was concentrating on his associate company, Technical Supplies Ltd, also based at Goldhawk Road. Among other things, TSL sold a range of transistors 'by arrangement with one of Europe's leading manufacturers', and a range of speakers and other components advertised as 'particularly suitable for use with Sinclair designs'. The Sinclair designs were supporting TSL, and TSL supported the Sinclair designs.

The last book Sinclair wrote as an employee of Bernard's was *Modern Transistor Circuits for Beginners*, first published in May 1962. During the period that he worked for Bernard Babani, he had produced thirteen constructors' books – all commercially sound.

But his burning ambition was still to start his own business and in 1961 he had registered a company: Sinclair Radionics Ltd. His original choice had been Sinclair Electronics but this was already in existence; Sinclair Radio was acceptable to the registrar but didn't sound quite right to Sinclair; eventually Sinclair Radionics came into being on 25 July. He made two abortive attempts to raise the capital necessary for advertising and buying components; he designed some PCB kits (for which he was not paid), and he licensed some technology, as we would say nowadays (for which he was not paid either). Then he took his design for a miniature pocket transistor radio and spent some time seeking a backer for its production in kit form. Eventually he found someone who agreed to buy 55 per cent of his proposed company for £3,000. He gave in his notice to Babani, only to find that his backer had developed cold feet.

He needed another job to earn some money – both to live and to finance the business he was determined to start. He had little difficulty in finding one; he joined United Trade Press – based at 9 Gough Square, just off Fleet Street – as technical editor of the journal *Instrument Practice*. Transistors and other semiconductor devices were beginning to come into their own, and UTP realised that it was trying to serve two distinct market sectors: industry and the consumer. There seemed little point in competing with established professional journals such as *Wireless World*, or hobby

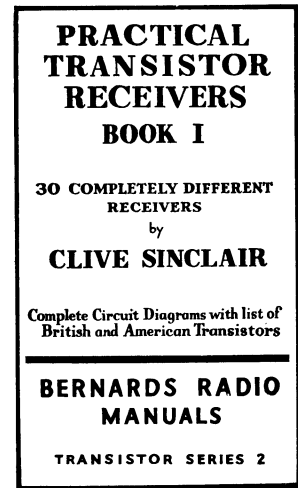

journals such as *Practical Wireless*. The market gap lay in industrial electronics; there were few journalists at that time who knew much about semiconductor devices, and it was in this field that Sinclair's expertise and creativity lay.

His name first appears in *Instrument Practice* as assistant editor in March 1962. He lost no time in getting to work, and 'Transistor DC Chopper Amplifiers' appears in two parts in May and June, followed by 'Silicon Planar Transistors in Hearing Aid Design' in July. In this article, he describes the method of making silicon planar transistors, their properties and applications, and expresses a hope that they may be available by the end of the year (1962). 'The Hughes Microseal package . . . is only 1.5 mm in diameter by 0.75 mm thick. Using these transistors and the smallest components now available it is possible to build a complete hearing-aid amplifier hardly larger than a single conventional hearing-aid transistor.'

Sinclair was obsessed with miniaturisation, so this topic was right up his street. And would not a microscopic amplifier be an initial product for his company with advantages over a microscopic radio in that it needed no tuning components and no case? Food for thought.

His next task for *Instrument Practice* was to undertake a comprehensive survey of semiconductor devices, which appeared in four sections between September 1962 and January 1963. Each section had a technical introduction, and covered 1 Transistors, 2 Negative Resistance Devices, 3 PNP Devices, and 4 Small Signal Diodes. He later published tables of P-N Junction Rectifiers and Zener Diodes. The whole survey was reprinted later in 1963, published by UTP and distributed by Bernard's.

His last appearance as assistant editor was in April 1963, but the year he had spent marrying UTP to the semiconductor industry was of great mutual benefit. As a journalist he could do what an enthusiastic circuit designer couldn't – he approached all the semiconductor manufacturers and was welcomed with open arms. The doors opened by UTP enabled him to reach the Ferrantis, the Mullards, the National Semiconductors, the SGS-Fairchild of this world and find himself privy to much of what was going on in the semiconductor industry. His tables list thousands of devices from 36 manufacturers. There is no question of the help that this entrée gave him – contacts and sample devices – and UTP had no objection; it was to everyone's benefit.

One of the companies he had contacted was Semiconductors Ltd, a company owned jointly by Plessey (51 per cent) and Philco (49 per cent). Plessey had provided capital, buildings and staff; Philco provided equipment and knowhow from the US parent company, and very advanced it was for that time. While other manufacturers were putting pellets of material into graphite jigs,

*'While on the subject of future developments, it might be interesting to consider the next advances to be made in the field of the ordinary broadcast band portables. The main possibility here is the further reduction in case size. Although the pocket radio is now being made very small, they are still too bulky to be carried in the pocket without a considerable bulge. Similar receivers, perhaps 3/4" thick, will certainly appear in the near future. Further reductions in size are held up only by the development of smaller speakers which are capable of reasonable performance. I have heard one Japanese set which uses a speaker only 1 3/4" in diameter and yet gave a very good performance. This little speaker had a cover area of about 2.4". A rectangular speaker could, therefore, be made with a similar performance which measures only 2" by 1.2". Such a speaker would make possible construction radios almost small enough to be worn on the wrist.'*

C.M. Sinclair,  
Transistor Superhet  
Receivers (1960)

pushing them through furnaces and hoping for the best, Semiconductors Ltd was using such techniques as electrochemical etching, infrared thickness monitoring, and automatic process transfer.

However, in spite of the advanced technology, the reject rate of the Semiconductors micro-alloy transistors (MATs) was still of the order of 70–80 per cent because they did not meet the specification. But Sinclair found that these ‘rejects’ were perfectly serviceable; all that was needed was a circuit design to take account of their characteristics. He soon produced a design for a miniature radio powered by a couple of hearing-aid cells; then he negotiated a deal with Semiconductors Ltd to buy their discarded MATs at 6d each in boxes of 10,000. He would then carry out his own quality control tests, and market his re-named MAT 100 & MAT 120 at 7/9d, and MAT 101 & 121 at 8/6d – highly competitive prices for transistors in those days. Again, everyone was happy; an ex-Semiconductors engineer recalls: ‘There were times when one of Sinclair’s orders was about the only one we got in a whole month – 10,000 transistors at 6d each – which paid my salary if nothing else!’

During his time with UTP, Sinclair had written two further books for Bernard’s, *Transistor Circuits Manual No 5*, and *22 Tested Circuits using Micro-alloy Transistors*. This last title was of course a marketing tool for the MATs, which he now had in such copious quantities; they, and the book, sold and sold for many years.

#### Bernard’s Radio Manuals by Clive Sinclair

No	Title	Date
148	<b>Practical Transistor Receivers Book 1</b>	1959
149	<b>Practical Stereo Handbook Book 1</b>	1959
151	<b>Transistor Superhet Receivers Book 2</b>	1960
163	<b>Transistor Circuits Manual No 2</b>	1960
164	<b>High Fidelity Tape Recorder for the Home Constructor</b>	1960
167	<b>Transistor Circuits Manual No 3</b>	1960
168	<b>Transistor Circuits Manual No 4</b>	1960
169	<b>High Fidelity Transistor FM Tuner for the Home Constructor</b>	1961
173	<b>Practical Transistor Audio Amplifiers for the Home Constructor</b>	1961
174	<b>Transistor Subminiature Receivers Handbook for the Home Constructor</b>	1961
175	<b>Transistorised Test Equipment and Semiconductors Manual</b>	1961
176	<b>Transistor Audio Amplifier Manual</b>	1962
177	<b>Modern Transistor Circuits for Beginners</b>	1962
179	<b>Transistor Circuits Manual No 5</b>	1963
181	<b>22 Tested Circuits using Micro-alloy Transistors</b>	1963

One of the facets of Sinclair's genius lay in his ability to reduce the size of his designs. Although he had a sound grounding in theory, he was also very practical; while others were saying that you couldn't use this or that component because its leakage current was too high, or its breakdown voltage was too low, he just got on and designed circuits which accepted such components. Having spent a lot of his time at UTP studying carefully what semiconductor manufacturers and product designers were doing, he knew that manufacturers were selecting components to meet their published specifications, which left them with 'rejects'. These 'rejects' would obviously meet *some* specification; the art was to determine what that specification was. Having done that, he could design circuits in which the components would perform perfectly well. Thus did he move from publishing to marketing.

# SINCLAIR RADIONICS LTD

Dept. C  
69 HISTON ROAD CAMBRIDGE  
TELEPHONE CAMBRIDGE 53965

## Build the Sinclair MICRO-AMPLIFIER

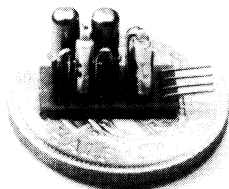

ACTUAL SIZE  
ONLY  $\frac{1}{4}$ " x  $\frac{3}{8}$ " x  $\frac{1}{2}$ "

This microscopic amplifier, **the smallest of its type in the world**, out-performs amplifiers 20 times as large.

Power Gain—**60dB (1,000,000 times)**.

Frequency Response—**30 c/s to 50 kc/s  $\pm$  1dB**.

Output Power—sufficient for any earpiece or small loudspeaker.

Simple to build using ordinary tools.

Uses brand new micro-miniature components and **micro-alloy transistors**.

Very low noise level. May be used as tape recorder pre-amplifier.

Free applications data supplied with every kit showing how to use the micro-amp in **micro-radios** and **transmitters**, and with high and low impedance pick-ups, microphones and stereo headphones.

**28/6** plus 1/6 postage and packing

Trade enquiries invited.

## Sinclair Radionics 1962–1965

The first intimation that the world had of the existence of Sinclair Radionics Ltd was the half-page advertisement which appeared in the hobby magazines in November 1962. This was for the Sinclair Micro-amplifier, ‘the smallest of its type in the world’, which ‘outperforms amplifiers twenty times as large’ – 28/6 + 1/6 p&p. There was a picture of the Micro-amplifier (overall size  $\frac{3}{4}'' \times \frac{3}{8}'' \times \frac{1}{2}''$ ) sitting on a halfcrown – (‘whatever that is’, smiled Sinclair – Gulbenkian-like – when I reminded him of it recently) reproduced ‘actual size’. In fact, it’s slightly below actual size, but no matter; it was very small.

Sinclair set up his research, development and marketing organisation in his office at Gough Square. His designs and products were still based on whatever cheap surplus materials were available, and the circuits in the books he had written for Bernard’s. However, the address given in the advertisements for Sinclair Radionics Ltd was 69 Histon Road, Cambridge; here is some background. In 1958, I started a design and printing company called Polyhedron Services, and two years later had moved to 69 Histon Road and become involved in the development of Cambridge Consultants Ltd, the first independent British contract research and development company. CCL was founded in 1960 by Tim Eiloart, a Cambridge chemical engineer. As a short-lived undergraduate, I had faced Tim across the bench in practical chemistry and had not lost touch with him; I was pleased to be invited to that historic lunch at which he unfolded his master plan for putting the fertile brains of the University at the disposal of industry, thus sowing the seeds of The Cambridge Phenomenon. When CCL wanted to set up a workshop, I let them the disused bakehouse at 69 Histon Road, and David Southward, another

*A rare, potted micro-amplifier*

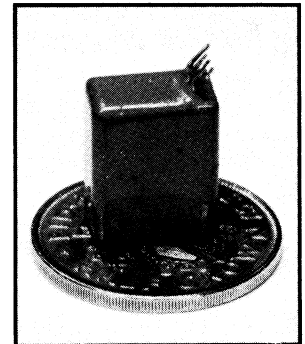

Cambridge contemporary, joined to develop it. By this time, Tim Eiloart had met Clive Sinclair; Tim and David needed more activity in CCL's new workshop; Clive had just set up Sinclair Radionics and needed an organisation to receive his mail, assemble sets of components into kits, and despatch them. It wasn't quite the high-tech work which CCL had envisaged but no matter; as the Sinclair advertisements appeared, CCL was ready with the servicing organisation.

We were but dimly aware of what was likely to happen. Nigel Kember joined us on 9 December 1962, and was immediately detailed to start packing components into little plastic bags ready for the avalanche of post. It was at about this time that I first met Clive; his brother Iain was working for me as a graphic designer, so there were several reasons why Polyhedron was invited to produce 1000 copies of the Micro-amplifier data sheet.

The half page Micro-amplifier advertisement was repeated in December 1962; and in January was expanded to a full page, the top half devoted to the Micro-amplifier and the bottom half to the micro-alloy transistors, with a big plug for Sinclair's *22 Tested Circuits* which had just been published by Bernard's. Not knowing what was going on, I was somewhat surprised when we were asked to print a second batch of 1000 data sheets. The idea of 'stack it high and sell it cheap' by mail order was one with which we at Cambridge Consultants and Polyhedron were unfamiliar. 'He's either going to become a millionaire or go broke' we muttered to one another as the piles of mail mounted and brightly-coloured postal orders were borne off to the bank daily.

The next thing we knew at Polyhedron was a request for 1000 cards regretting that, owing to an unprecedented demand, there might be some delay in despatching your Sinclair Slimline. This radio, the dream on which the original Sinclair Micro-Kit Co had been built, was announced in February 1963: 'the smallest receiver of them all, only  $2\frac{3}{4}'' \times 1\frac{5}{8}'' \times \frac{5}{8}''$ . Yet, in performance and design it far surpasses every other set on the market . . .'

Sinclair well understood the mind of the reader of the hobby magazines; browsing through the advertisements over and over again is as much a part of the excitement as reading the editorial

*Mensa Register, 1962*  
*Tim Eiloart's introduction*  
*to Clive Sinclair.*  
*'None' = religion*  
*'K' = special knowledge*  
*'C' = contacts welcomed*

Mr Clive SINCLAIR (s), 15 Langbourne Mansions, London N 6. Mountview 2985. None. London, 1940. General editor, publishers specialising in books on electronics; practising electronic consultant.

K: design of electronic equipment using semiconductors, technical writing. C: electronics; physics; writing; calculating machines; astronomy; English literature; telepathy.

Wide education (13 different schools, all types). Impatient, interested in just about everything.



matter and building and using the equipment itself. He saw the value of space – making the advertisements appear less tightly packed than other people's, easier to read, more enticing. He saw also the importance of a continually fresh appearance; while other advertisers used the same layout over and over again, he seldom used the same layout more than twice. The content varied little, developing slowly as the range of products increased, but it was sufficiently differently arranged to give the armchair enthusiast a new thrill every time he came across a Sinclair advertisement.

It was about this time (September 1963) that Jim Westwood, who for six months had been working at TSL, Babani's shop in Goldhawk Road, applied to Sinclair for a job. He knew all about Sinclair through the books he had written for Bernard's, and was familiar with the designs because he was selling parts and giving advice in the shop. Westwood had previously worked in Shepherd's Bush Market, and as a hobbyist had bought parts from TSL; this qualified him to ask Babani for a job – which he got at £300 a year. Now he thought that life at Sinclair Radionics would be a good deal more exciting, and offer a brighter future, than serving behind the counter. He was right. Sinclair immediately offered him £500 a year, and they have been together ever since.

Jim Westwood recalls the 8' × 10' office in Gough Square:

'a single room just off Chancery Lane above a bank, where all the development work was done. We spent an awful lot of time testing transistors and sticking labels on them. Clive and his wife tested half a million, and I tested half a million. Shortly after I joined, in September 1963, we bought our first oscilloscope – ex-army, £25.'

Sales were going from strength to strength; ideas for products were coming thick and fast. The CCL workshop was burgeoning, and the upper floor of the bakehouse was becoming somewhat overcrowded.

To cope with this expansion, we knocked down the baker's oven and some of the outbuildings and erected an asbestos-clad timber-framed building of peculiar shape because someone had read the wrong marks on the surveyor's tape. It was there that Nigel Kember moved in September 1963, just as the Sinclair product range was joined by the Sinclair Micro-injector 'fascinating to build'.

Sinclair was clearly aware of the value of using a name – his name – to identify all his products. In his first double-page advertisement, 'GO TRANSISTOR WITH SINCLAIR', the name Sinclair occurs no fewer than 16 times. From a design point of view, it is surprising to find that it is in 13 different typefaces.

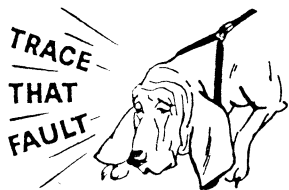

In April 1964 Sinclair Radionics (that is to say the offices and laboratories, as opposed to the mail order department) moved to Anchor House, 22 Duncan Terrace, Islington, just by *The Angel*. On the ground floor was an old friend Sean Hopkins, who manufactured adhesive labels as Ticket Services Ltd.

On the floor above TSL at Anchor House was a rag-trade sweatshop, Sinclair was above that, and at the very top lived an elderly couple whose house perhaps it was. The Sinclair floor had three rooms. The smallest served as a general office for Maisie, the general secretary, and of the two larger ones about 15' square, one was Clive's office and the other the laboratories.

It was here that Jim Westwood started work on the first miniature television (to which we will return), and the next generation of amplifier designs. Sinclair spent quite a lot of time in the labs; he would design circuits, draw them up neatly, and Jim Westwood would build them. But Sinclair could never resist the temptation to take part in the practical work – especially if he had a sudden bright idea, or if things weren't going according to plan. He also visited Cambridge quite often to keep tabs on the distribution, and of course took full responsibility for the advertising.

Considering that there was still no Sinclair house-style – except that there was an undoubted panache in the lack of it – the advertisements worked extremely well. Apart from the advertisement in *Wireless World*, April 1964 saw a number of other innovations. By far the most important was the laying of the

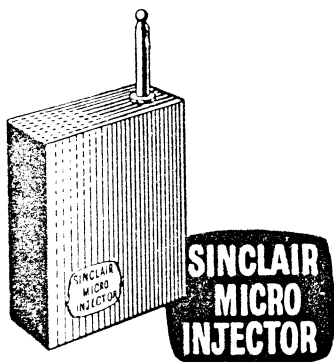

*Sinclair Radionics Ltd*  
rear of distribution  
department, 1963

foundation for the medium becoming the message: the now-famous Sinclair logo appeared. Not that it improved the coherence of the design; alongside the Sinclair logo in that first advertisement the name Sinclair still appeared in no fewer than six different typefaces.

The other innovation for April 1964 was a newsletter:



# NEWS

No. 1

APRIL/MAY, 1964

Sinclair News No 1 Headlined ‘This is what Sinclair service means to you’, we find Clive’s statement of the health of his 18-month-old company – or at least how he wanted it to seem to the outside world.

## WORLD LEADERSHIP

Within an amazingly short time, Sinclair Radionics has leapt forward to become a world-leader in its own specialised field of micro-electronic designs for the home constructor. The reasons for this are not hard to find, and even if, at first, they appear simple, they represent as much of a breakthrough in relations between customer and supplier as do the designs which we have introduced.

This was absolutely true; the use of the name Sinclair, and the constantly changing, action-packed advertisements must have ensured that all magazine-reading hobbyists had *heard* of Sinclair, even if they had never bought the products. And sooner or later they would have to buy the products, just to try for themselves that what they had read so often was true.

## SPECIALIST TEAMS

Our object is to produce micro-electronic transistor designs which are not simply interesting to build, but which are well ahead of anything offered by our competitors. They are also technically ahead of any available manufactured products. To achieve these standards, we employ our own highly qualified team of electronic engineers, and when they have contributed their share to a design we ‘marry’ it to the services of an industrial design group to ensure that our cases are both elegant and functionally right. Developments on these lines are going on all the time in the carefully planned Sinclair programme.

Looked at from one point of view, of course, this was pure bull. But what is ‘highly qualified’? Experience and designs which work count for everything. How big is a ‘team’? You can have a team of two, in this case Clive Sinclair and Jim Westwood – three if you count Maisie the secretary. Sinclair was doing what anybody else could have done, but nobody else *was* doing. As for the ‘carefully planned Sinclair programme’, the policy was to continue with development all the time, and to hope that the success of one product would finance the marketing of the next. And is that not what all companies, large and small, do?

### INSTRUCTIONS

Presentation of instructions is another Sinclair feature in which we naturally take pride. The experienced builder will readily recognise and appreciate the quality of the circuits shown in the Instructions. Equally important, however, is that *anyone* with or without technical knowledge can build a Sinclair design with 100% success from the word ‘Go’. With the Micro-6, for example, building is actually proving easier than even we believed at first, and already there are thousands in use.

Apart from Sinclair’s proven talents as a technical writer, he realised that since it costs no more to print good instructions than to print bad ones, it was good PR to produce good ones.

### SATISFYING THE CUSTOMER

How about you, the customer? We insist on your being completely satisfied in all your dealings with us. In fact, we have a special service department run solely to help and advise customers and to correct any errors in assembly which may have inadvertently been made. You need never feel that we will not be interested in your particular problem, no matter how slight it might appear to you. That we are genuinely willing and glad to be of help is something extra which even we cannot properly convey in the unique guarantee offered in our advertisements. We can only tell you of the hundreds of letters which we receive every week from all over the world praising both our service and our designs. *Full details of these appear on the following pages.*

*Sinclair News* also introduced ‘Mike Farrard, a rare character created for Sinclair Electronics (sic) by Ken Ward’.

*Sinclair News* No 2 May/June 1964, changed tack. It left the Sinclair philosophy, and turned to the products and testimonials that the company had received.

*Says Mike Farrard  
our favourite customer:  
‘He buries it in the garden if  
he doesn’t like the programme’*

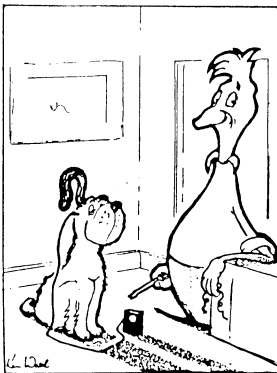

### THE FINEST LITTLE SET

Having been a transistor fiend for the last eight years, I must say it is the finest little set I have ever constructed. Please send me one more of these marvellous little instruments.

R.K, Preston

### MORE MICRO-6 DEVELOPMENTS

Because of the enormous interest in the Micro-6 we at Sinclair Radionics have been devoting much of our time to the development of accessories which add to its usefulness. The first of these, the TR750 Power Amplifier was introduced last month. This remarkably low-priced [39/6, ready-built and tested 45/-], high performance [frequency response within +1dB from 30 to 20,000Hz] design has, of course, a great many applications but in conjunction with the Micro-6 or the Slimline it can form a really powerful car, home or portable radio.

Sinclair News No 3, in June 1964, was back to matters of policy. Sinclair News No 4 appeared in July 1964.

### WE WILL PAY FOR YOUR PHOTOGRAPHS!

Completely built Micro-6 sets are understandably a rarity at head office which is why a couple of our secretaries slipped into the test room to listen for themselves and got caught in the act by the works manager who had his camera handy. If you have any amusing or interesting pictures of the Micro-6 in use, let us see them. 3 gns will be paid for each one published. All prints submitted will be returned.

Those who have followed the advertisements carefully will see evidence of a new writer at work here, though there is no record of a deluge of photographs.

This was the last *Sinclair News*; a pity: it was beginning to get interesting, and give us some insight into the company. However, it was now that Sinclair Radionics moved to Comberton. Nigel Kember had long been seceded from Cambridge Consultants to the Sinclair Radionics payroll, and with his wife Audrey had been coordinating outworkers responsible for putting the kits together ready for despatch. They lived at Comberton, just outside Cambridge, and it was thence, to the Village Hall rented from the WI, that the despatch end of Sinclair Radionics moved in July 1964. The change of address was announced in August 1964:

Demand for Sinclair products has grown so enormously that we have been obliged to move to bigger premises. With more space and staff, the delays experienced in the past by some customers will be no more. We offer them our apologies and assure them that Sinclair service is now back to its normal high level.

# THE SMALLEST SET IN THE WORLD

## SINCLAIR MICRO-6 SIX-STAGE RECEIVER

*Over 8,000 built and in use  
all over the world*

THE SINCLAIR MICRO-6 continues unchallenged as the most remarkable receiver of its kind ever made available to the public anywhere in the world. It has special 6-stage circuitry and is, at the same time, the smallest set on earth. Everything except the lightweight earpiece is contained in the smart, minute white, gold and black case which is appreciably smaller than a matchbox, as the illustration shows. With vernier-type tuning control, bandspread over the higher frequency end of the medium waveband and powerful A.G.C. to ensure fade-free reception of the most distant stations, the Micro-6 provides remarkable standards of performance. Quality of reproduction is outstandingly good and, again and again, the set is reported to give excellent results where other sets cannot be used at all. The Micro-6 cannot be too highly recommended, both as an intriguing design to build, and a most practical radio to use.

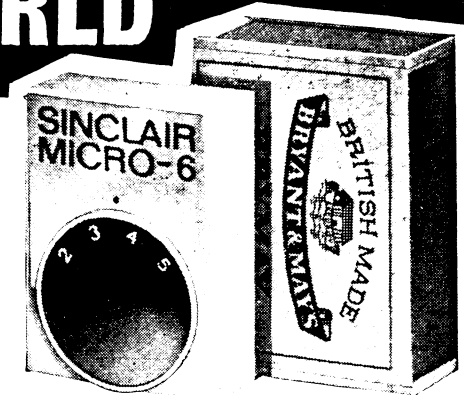

ACTUAL SIZE

$1\frac{1}{2}'' \times 1\frac{1}{8}'' \times \frac{1}{4}''$

• Weighs under 1oz.

• Tunes over M.W.

• Plays in cars, trains, buses, modern buildings.

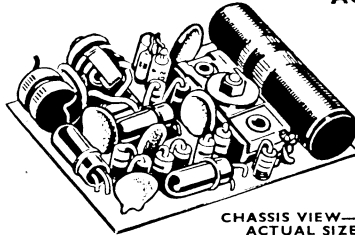

CHASSIS VIEW—  
ACTUAL SIZE

## SINCLAIR TR750 POWER AMPLIFIER

*Designed specially for use  
with the Sinclair Micro-6*

*With Built-in  
Volume Control  
and Switch*

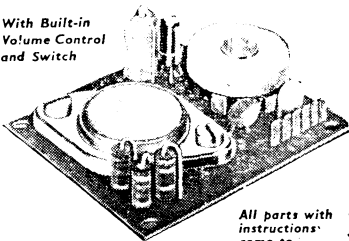

*All parts with  
instructions  
come to*

**39/6**

**READY BUILT  
AND TESTED  
with instructions**

**45/.**

THE TR750 (for building yourself or available ready built) measures only 2in. x 2in. It will provide powerful loudspeaker reproduction from the Micro-6 which can then be used as a car-radio, or domestic or portable loudspeaker set. The TR750 also has many other applications such as record reproducer, intercom or baby alarm. An output of 750 milliwatts for feeding into a standard 25-30Ω loudspeaker requires only a 10mV input into 2KΩ. Frequency response 30-20,000 c/s  $\pm$  1dB. Power required 9 to 12 volts.

*Easily built in a  
single evening*

Using components never before made available to the public, the Micro-6 is nevertheless easy to build. All parts including lightweight earpiece and 8 page instructions manual come to

# 59/6

"TRANSTRISA" black nylon strap for wearing the Micro-6 like a wrist-watch 7/6

MALLORY MERCURY CELL ZM312 (2 required), each 1/11

Handy pack of 6 cells, 10/6

# SINCLAIR

**SINCLAIR RADIONICS LTD  
COMBERTON, CAMBRIDGE**

Telephone: COMBERTON 682

## UNIQUE GUARANTEE

The following unconditional guarantee applies to everything you buy from Sinclair Radionics Ltd.:-

If you are not completely satisfied with your purchase (we are confident you will be delighted) your full purchase price will be refunded instantly and without question.

● FULL SERVICE FACILITIES AVAILABLE TO ALL SINCLAIR CUSTOMERS

In September the copywriting had taken another quantum leap forward, a prescient fusing of *Private Eye*'s Glenda Slag and Great Bores of Today:

HEY, MISTER, LOOK AT THIS! shouts a barmaid, pointing at something on the bar 'that is, if you can see it from there . . . ! *What is it?* It's a radio – a real, honest to goodness station-getting six stage British set so small that not even the Japanese, Americans or Germans have got anywhere near it. A gimmick did you say? Indeed not! If you're technical, you'll see on the pages which follow how this cute little Micro-6 works. All I can tell you is that it's loud, it's clear, and there seems no end to the stations you can tune in. You have to build it yourself of course, but they say that's half the fun. This one was given to me . . . makes a lovely present for someone doesn't it?  
It's the SINCLAIR MICRO-6 – the smallest set on earth!

Perhaps Sinclair felt that this style was somewhat removed from the image he was trying to build; thereafter, everything returned to deadpan seriousness.

On 1 January 1964, Gordon Edge joined Cambridge Consultants to build up the electronics side of the business. (He left six years later to set up the PA Technology Centre in Cambridge.) One of his CCL jobs was to design an audio amplifier for Sinclair which harnessed an emerging technique called 'pulse width modulation'. When this amplifier – the X-10 – hit the market in October 1964 it stirred up tremendous interest; never before had anything of similar size, performance and price been seen.



Unfortunately the debut of the X-10 was fraught with problems. The original circuit design had been delivered to Sinclair Radionics accompanied by a working 'bird's nest'; Jim Westwood took the bird's nest, engineered it into marketable form, and sent a drawing to the firm in Hampshire which manufactured Sinclair's printed circuit boards. They promised that the first batch of boards would be delivered within a few days, and the first advertisement for the X-10 was planned to coincide with promised deliveries.

The boards arrived dead on time. They looked first class, and Westwood set about building the first real X-10 amplifier. But shock! horror!! The board was a mirror image of what it should have been and the whole batch was useless. By the time a batch of correct boards had been made and an amplifier built and tested, the X-10 had been appearing in advertisements for some time.

# SINCLAIR X-10

## INTEGRATED 10 WATT HI FI AMPLIFIER AND PRE-AMP

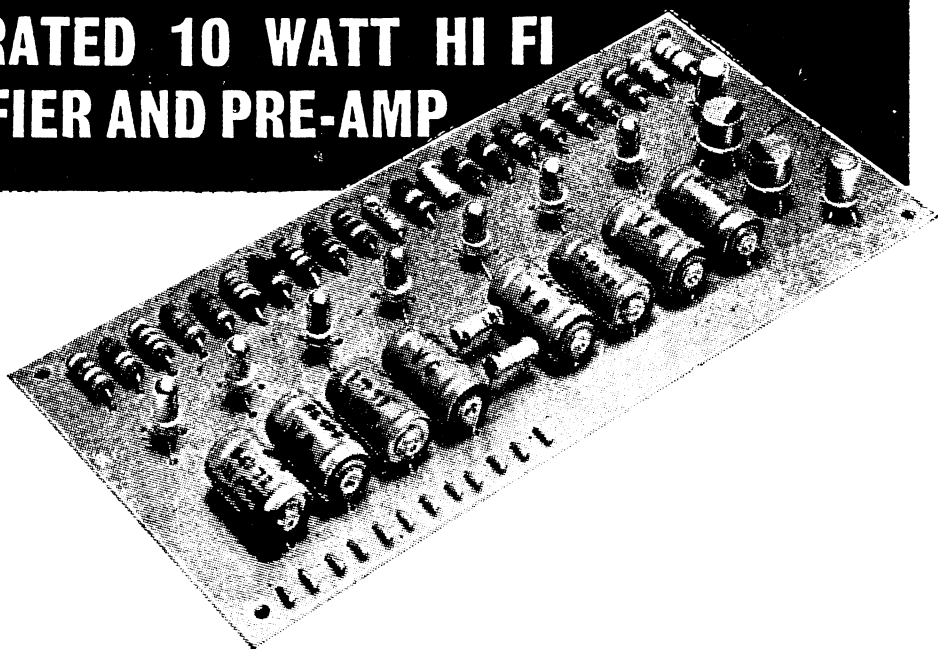



## The Sinclair hi-fi boom

On the strength of Sinclair Radionics' showing with the X-10, the company had won a contract to supply vibration test equipment to an aircraft equipment company; a high-powered amplifier which would drive a vibrator with power output up to 120 watts. Clive Sinclair was busy feeding ideas to Jim Westwood to try out. Richard Torrens was busy trying to solve some problem that had been encountered with the transistors which had been shipped to Hong Kong. Another engineer had to be found, since the Hong Kong problem needed someone's dedicated attention, and the deadline for the 120-watt amplifier contract was looming ever nearer.

So desperate was Sinclair that he nearly sent Torrens to Hong Kong . . . until he found Martin Wilcox.

Wilcox joined the company as chief engineer in February 1965. His first job was to sort out the 120-watt amplifier contract. After Sinclair had left for Hong Kong, Wilcox decided that the prototype amplifier couldn't possibly be ready in time for the client company's engineer who was visiting in a few days. He therefore set to and designed, built and tested a conventional 20-watt amplifier to demonstrate instead. At least there was something to show; he carried on and four months later the Z-120, as the larger amplifier was called, had been developed and tested. Built to a military specification to be acceptable to the aircraft industry, these eventually sold for £75 each.

The advertising of the X-10 was so ambitious that a new power rating had been proposed; amplifier power ratings in those days were even less clear than they are today, but four levels were in use: English Watts (RMS value); American Watts or Music Power (peak-to-peak); Squawk Power (indefinably higher than American

Watts); and Sinclair Watts (RMS Watts  $\times 2^n$ , ie, an unspecified number of doublings). Here's how Sinclair Watts came into being. CCL was designing an amplifier for 2½ watts RMS rating – the X-10 could give this level very clearly but Gordon Edge was talking about 5W peak rating. Sinclair thought that Edge was talking about 5W RMS rating, which would have meant 10W peak. He told the advertising agents it was 10 watts – and they added RMS! Thus the amplifier's performance had been improved by a factor of four and it now had a very good specification.

The X-20 was much better: it was putatively rated at 20 watts and it would indeed deliver 20 watts, but only with its dying breath, for the output transistors that arrived for manufacture were somehow never as good as the prototypes supplied for development. In any case, Sinclair already had a 10W amplifier: the new one obviously had to be better because it was more expensive! Apart from this, the X-20 was a good amplifier. There was none of the unpredictable performance of the X-10, no two of which ever behaved in quite the same way. Later – just about the time at which the X-20 was discontinued – larger output transistors became readily available. Some of these were tried in the X-20 and it gave 20 watts without the slightest troubles or sign of distress.

For those who are a bit dazed about watts, the idea is to have plenty of power in hand so that sound quality is maintained by using only part of what is available. It's the difference between the Mini and the Merc at 70 mph.

The X-20 continued to be the lead item in June and July advertisements, when a double-page spread trumpeted 'in step with the SPACE AGE!' in rather wobbly lettering backed by a drawing of the Post Office tower. Only a year old and 619 feet high, the tower symbolised London's step into the space age; not only did it handle satellite communications (indirectly); it had a revolving restaurant.

#### 'OUTDATES EVERY HI-FI AMPLIFIER TO DATE

The Sinclair X20 enables you to enjoy for the first time ever, the advantages of using a high power, high fidelity audio amplifier truly in step with today's space age electronics . . . and it is easier to build and install than any amplifier you have ever owned. Best of all it costs far less.'

Users said:

'The results were so remarkable that I purchased a further kit to replace my valve stereo system' S.M, Glemsford, Suffolk

'It is everything you claim it (X-10) to be, it is so good that I can hardly believe it is true. Thanks for a wonderful instrument.'  
K.D, Abbeymount, Edinburgh

Only five months later – in October – yet another new product appeared on the scene: the Micro FM. This was a miniature FM radio sold as a kit of parts which a year later received the dubious honour of being copied in the Far East. The copy was not a success.

The X-20 amplifier and the Micro-6 radio were selling quite well, but the more mature products, Tr750, Slimline, Micro-Amp, Micro-Injector, etc were beginning to come to the ends of their useful lives. The X-10 had failed – it was now widely known that it wouldn't deliver 10 watts – and was temperamental to boot. It was becoming quite an embarrassment and the company had to produce another amplifier of similar power to replace it.

Thus was the design of what was called the Z-12 finalised. Unlike the X-10 and X-20, the Z-12 was not going to be sold as a kit but fully made up. Its manufacture was subcontracted to one Harvey Hall who was running a factory in a Nonconformist chapel in Thetford, half way between Cambridge and Norwich. The factory had been started by Cathodeon in the 1950s, as part of the policy of the Pye Group of bringing employment to a wider area, and filling the houses of worship in a secular fashion; unkind commentators muttered phrases such as 'cheap labour'. Harvey Hall had been the production manager at Cathodeon, whose glass-to-metal seal outstation the factory was. Indeed, while I was working at Cathodeon, Harvey Hall offered to double my salary to £1200 pa (riches!) if I would go to manage that factory. I declined; he decided to do it himself, and later took the factory over completely, doing subcontract work such as assembling the Z-12.

Seduced by the joys of Cambridge – as seen through the rose-tinted eyes and enthusiastically brilliant conversation at *The Plough*, Fen Ditton, at lunch time on Saturdays, Sinclair had decided to move from London. What with the distribution operation at Comberton, the manufacturing at Thetford, and the development work in progress at Cambridge Consultants – not to mention a growing circle of friends – Cambridge seemed like the best place both for his business and his family. He found business premises at 22 Newmarket Road and a private house at 27 Maids' Causeway, a convenient walk for a non-car-owner. There was at last room for the whole of Sinclair Radionics – which by now numbered some two dozen people – to work in the same building, which greatly improved company morale. The move took place on 28 January 1966 just after the Z-12 amplifier was launched.

Turnover was now running at £100,000 pa and Sinclair Radionics had moved fairly and squarely into the stereo market – still aiming at the hobbyist, but producing major components of stereo systems, all ready-built on circuit boards; it was up to the purchaser to supply the casing and interconnect the modules so as to have a usable system. In the summer of 1966 the new lines were

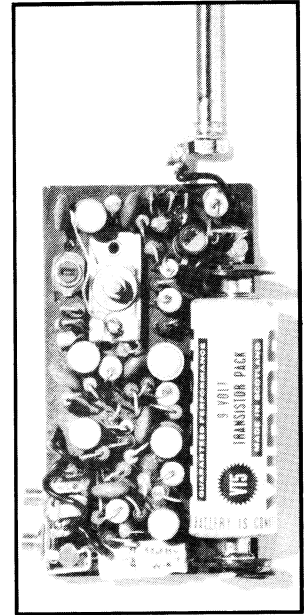

the power supply unit PZ-3, and the Sinclair Stereo 25 ‘de-luxe preamp and control unit’ providing volume balance and tone controls for the Z-12.

The Stereo 25 was supplied as a complete chassis and front panel, with knobs on, which needed mounting in a case – with the Z-12s and the PZ-3. It was designed by Iain Sinclair (Clive’s brother) and the unit itself cost £9 19s 6d; the ad went on to inform the reader that it was possible to build:

**‘A COMPLETE HIGH-FIDELITY STEREO ASSEMBLY FOR £22.18.0**

All you need is one Stereo 25 preamp Control Unit (£9/19/6), two Z12s (£8/19/–) and one PZ3 Mains Power Supply Unit (£3/19/6) to possess the finest hi-fi stereo installation. As a very desirable optional extra you could include the Micro FM (£5/19/6). The overall saving in cash will be staggering and you will have an installation second to none irrespective of price.’

The claim of completeness wouldn’t get past the Advertising Standards Authority nowadays; the advertisement omits to mention the necessity of adding at least a pair of speakers and a record turntable or a tape deck. Whenever Sinclair was subsequently censured by the ASA for overspecifying (or understating) the offending advertisement was usually out of date by the time the judgment had been handed down.

The six months between June 1966 and January 1967 were an exceptionally fertile period for Sinclair Radionics, during which no fewer than four new products were introduced.

It was also in the summer of 1966 that two new people joined the company; Lyndsey Lloyd said to Chris Curry: ‘I’m going for an interview at Sinclair Radionics – they’ve just moved to Newmarket Road.’ ‘Right,’ said Chris, ‘I’ll come along with you.’ Sinclair took them both on; here began the ambivalent Sinclair–Curry relationship which lasts to this day: Clive throwing things at Chris during the day (aiming, as he always did, to miss), and the two pursuing technical topics in the pub at night, the best of friends.

The ad in *Wireless World* in October 1966 devoted a whole column to listeners’ comments from around the world – Australia, Jamaica, New Zealand, Swaziland, South Africa and Uganda and went on to tell us that:

**‘35,000 CONSTRUCTORS CAN’T BE WRONG**

Something like thirty-five thousand micro kits have been bought and assembled by constructors ranging in experience from beginners to experts, for in size, design and performance there is just nothing like it in the world.’

In December another new product is introduced under the headline:

**SINCLAIR WORLD PACE-SETTER IN ELECTRONICS** hoping to exploit the more professional readers of *Wireless World* with the Sinclair Z-120 120-watt power amplifier, the one Martin Wilcox had designed.

The Z-120 was a pre-assembled unit mounted on a chassis, but without box or knobs, intended for inclusion in another piece of equipment 'Price per unit, supplied singly, £75' The most expensive product Sinclair had marketed to date. It was accompanied by a double-page spread on the rest of the Sinclair range which comprised the MICRO-6 and the MICRO-FM radios, the Z-12 amplifier with its power supply, and the Stereo 25.

A month later we had a new version of 'THE WORLD'S SMALLEST RADIO' with the word NEW! in letters two inches high behind a photograph of the SINCLAIR MICROMATIC being dwarfed by a wrist watch 'actual size', made to look larger by the cunning arrangement of its strap. It is a new medium wave radio  $1\frac{1}{5}'' \times 1\frac{3}{10}'' \times \frac{1}{2}''$  or exactly the same size as the MICRO-6 and in no way more automatic; '-MATIC' was an attempt to catch the mood of 1967 when automation was the in word.

Sinclair Radionics was growing fast; in April Clive Sinclair hired a new secretary via an ad in the *Cambridge Evening News*.

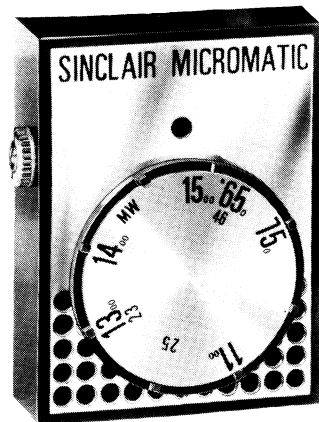

# sinclair

First Class  
Secretary  
required for the  
Managing Director of  
Sinclair Radionics Ltd

## Secretary

This is a most interesting job in excellent working conditions, for an experienced, attractive girl who must be able to work on her own initiative.

Please write or ring  
Sinclair Radionics Ltd  
22 Newmarket Rd  
Cambridge  
Tel 52996

In true Sinclair style it gave the feeling of a large and established company in which to be 'secretary to the managing director' would be a prestigious position. And indeed it soon would be – Sinclair was just a little ahead of himself.

A loudspeaker (the Q14) was added to the Sinclair range that autumn (1967), so that it was then possible to get a complete mail order stereo system from Sinclair, apart from a record player or the tape deck.

When Sinclair finally took an advertisement in *Hi-fi News* in September 1967, he certainly did it in style. He had already published the first-ever colour advertisement in a hi-fi magazine; now, in a normally black-and-white journal, he took a four-page colour supplement to launch the Neoteric 60 integrated stereo amplifier. The Neoteric was a top quality amplifier which was launched with a special trade reception at the Hi-fi Exhibition at the Hotel Russell in April 1968. It created tremendous interest, and Sinclair took a great many orders.

It was almost a year before the next explosion of new products; there was a lot going on in Newmarket Road in the meantime, in an effort to sort out all the problems with putatively existing products. The spring of 1968 was one of the worst periods the company had known. The Neoteric had proven impossible to build in quantity, so it needed a complete redesign. The 100,000 or so transistors which had been saved from the Hong Kong deal in 1964 had run out and it was not easy to find adequate replacements; the Micro-FM had therefore been dropped in 1967. Unfortunately, the Stereo 25 used those same transistors, and the dearth of supplies stopped production of this too. Manufacturers were having problems, and the supply of aerials for the Micromatic had dried up, and so had supplies of the power transistors used in the Z-12 and PZ-4; production on all these had therefore stopped as well.

However, Sinclair Radionics had reached a marketing agreement with Plessey on an audio integrated-circuit power amplifier, the IC-10. The first batch was scheduled for delivery on 1 June (1968) so the immediate future did not look quite so bleak. The advertising for the IC-10 duly appeared as a double-page spread in all the usual magazines. Deliveries of packaging material and instruction leaflets began on time, and all was set for a June launch.

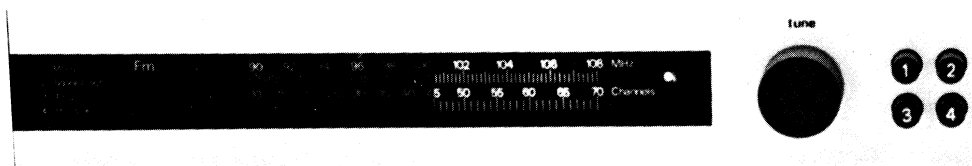

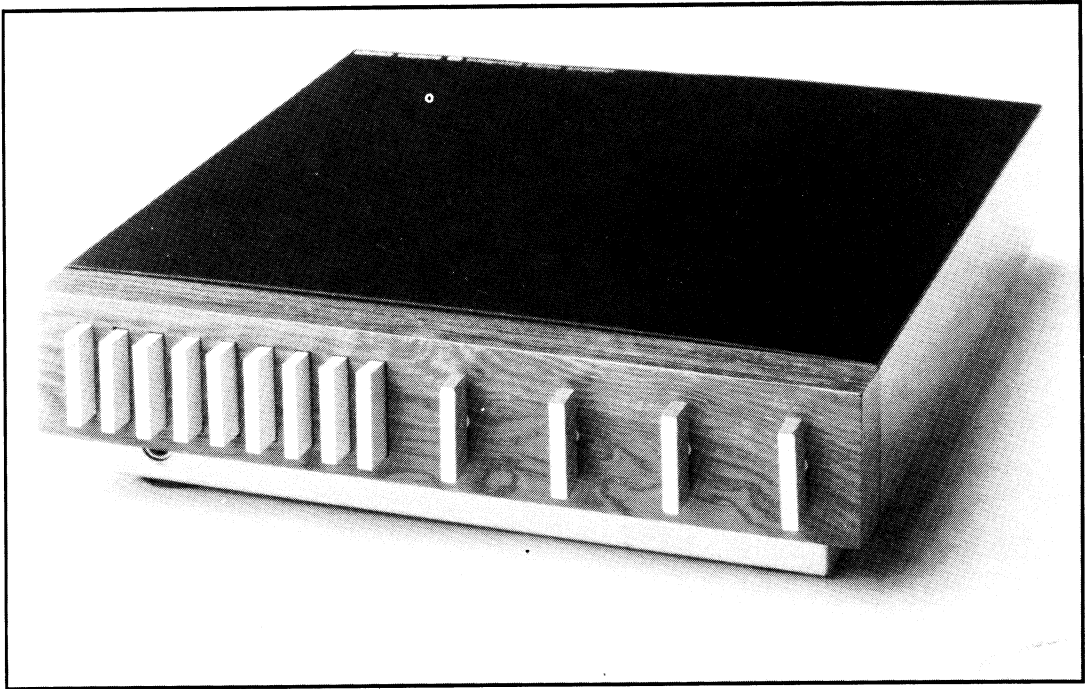

June arrived – but no ICs: there had been production problems. No – they didn't know how long these would take to sort out. No – Sinclair couldn't have even a small delivery immediately – not for an unspecified time.

*The Neoteric amplifier*

Since it takes about three months to change advertising, Sinclair decided not to modify the plans, for surely the devices would be available by the time the adverts changed? Eventually, it became apparent that the delay was going to be prolonged, but orders – and cash – were flowing in from customers. SRL had to write to tell them that there would be a delay: the delay was lengthy and all the customers' payments would certainly have to be refunded. Luckily, Chris Curry was working on the design of a minute FM radio which contained a small device – the IC-4 – which was wheeled out as a stop-gap alternative to the IC-10. Each customer who had ordered an IC-10 received an IC-4 as a free gift with an apology for the delay and a request to be patient, since the IC-10 was well worth waiting for.

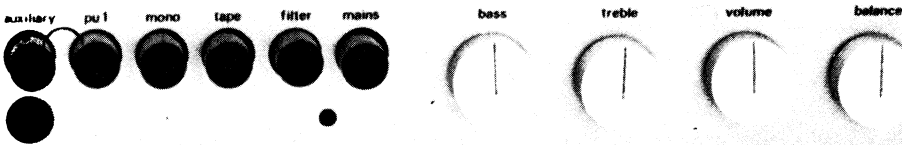

The delay in bringing out the IC-10 was very unfortunate, as it contributed to the slow rate of business at the beginning of 1968; it was obvious that the year had started poorly. Sinclair therefore decided that he needed a new product with a major market, and he and his brother Iain conceived the System 2000 – a matching hi-fi system with a stereo amplifier, tuner and speakers. All were housed in solid aluminium cases and were of a very simple and uncluttered design.

In parallel with the development of the amplifier, work started on a matching tuner, which was to use the same technique (pulse counting) as the Micro-FM; it was to be a mono tuner with an add-on stereo decoder. The mono version appeared in August, but there were technical problems in designing a decoder for use with this system, and the decoder didn't become available until November. Unfortunately, the alignment of the decoder was very critical, and so was that of the tuner; moreover, the tuner drifted. In the end, very few stereo tuners were produced and, although redesign work started early in 1970, the problems still hadn't been sorted out nearly two years later.

By now, Sinclair Radionics had moved into a different market, in that the products were not available solely by mail order. The ready-built stereo systems such as the Neoteric and the System 2000 could be bought from hi-fi dealers in the normal way. And all the big component suppliers familiar to the enthusiast, such as Lasky's, G. W. Smith and Henry's Radio, had a Sinclair section and would claim 'all Sinclair products in stock'; and of course they had an agreement not to undercut Sinclair, so wherever you bought anything it would always be the same price.

One of the last major products to be launched from Newmarket Road was the Project 60. It was a great success and was not superseded until four years later.

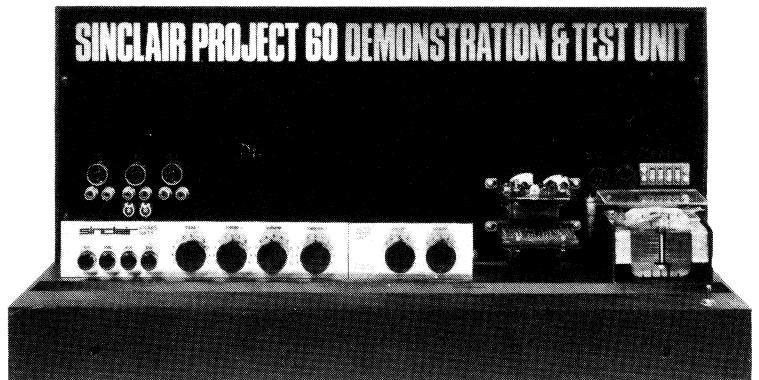



## 5

## St Ives

By 1970, the premises of Sinclair Radionics were bursting at the seams. Six months earlier the first sales rep, David Park, had been appointed, and his activities were paying off. Selling things that didn't exist was very hard work, but persuading the trade that it was worth their while to stock things which were at that time available only by mail order was even more of a challenge. Often retailers would be offered but 10 per cent discount, yet they would still take the products because the Sinclair name was synonymous with exciting innovation. However, this exciting innovation needed more room.

On the banks of the River Great Ouse at St Ives, then in Huntingdonshire, stands the seven-storey Enderby's Mill. It was modelled on the flour mills he had seen in Northern France by Potto Brown, a miller, who built it in 1854. Overlooking the river is a door per floor through which material would have been transferred to and from barges; overlooking the railway (long since gone, though the stanchions which bore its bridge still stand in the river) is another stack of doors through which material would have been transferred to and from a private siding.

For one reason or another, milling lost its profitability, and in 1902, the building was sold to Enderby & Co, a printing company set up by Chivers, the well-known local jam makers, to provide labels and packaging material – not to mention local employment. Over the years the business flourished and many single-storey buildings were added to the Mill, but the business declined and in 1959 Enderby & Co was taken over as a lossmaker by the St Ives Printing Group – which made its loss and moved to London in 1965.

For three years the Mill stood derelict until it was 'found' by Tim



*Tim Eiloart  
founder of  
Cambridge Consultants*

Eiloart for the AIM Group in 1968, thousands of square feet to let at 4/- per. AIM (which stood for Advanced Instrumentation Modules) had been set up as a manufacturing sister to Cambridge Consultants, with which there had been contact on and off ever since the very early days of Sinclair Radionics at a personal, if not a business, level. CCL had set up several other AIM companies, and in 1968 all became subsidiaries of a Group Company – AIM Cambridge Ltd. In spite of the grandiose dream, AIM couldn't possibly use all the space in the Mill, Sinclair Radionics was in dire need, so in 1970 AIM agreed that Sinclair should take over the seven-storey Mill and some of the single-storey workshop. The Sinclair service department (which had already overflowed from 22 Newmarket Road into AIM's previous premises at 71 Fitzroy Street, Cambridge) moved to the Mill at St Ives in October 1970, and the rest of Sinclair joined them at the end of the year.

But the Sinclair–AIM connection didn't end there. The AIM Group was running out of money, and a change of management was suggested; Tim Eiloart handed over the Chair to David Southward. Southward persuaded Robert Maxwell, head of Pergamon Press, who had long been an investor in the enterprise, to invest 'just a little more'; Maxwell said that he would do this only if he were given complete control – though he needed the job of chief executive 'like he needed a hole in the head' (the first time

*The Mill, St Ives  
viewed across the  
Great Ouse*



I'd heard that phrase). No one remembered to tell Tim Eiloart what was going on, and he was furious when he found out; Maxwell to his credit refused to proceed at a board meeting without Eiloart who, not at the board meeting, was casting about for alternative financial support. He suddenly thought of telephoning Clive Sinclair, who immediately offered £25,000 to keep AIM going, in return for which *he* would take complete control of the company. But things were too far gone; the receiver was called in on 8 September 1971, and Sinclair and AIM diverged again. CCL became a subsidiary of Arthur D. Little, the old-established consultancy based in Cambridge (Mass), and the other AIM companies were dispersed around the fens, some sinking, some swimming.

This diversion is not totally irrelevant – certainly less irrelevant than it might have seemed before 16 June 1985 when Robert Maxwell intervened in the financial plight of Sinclair Research Ltd. But there are other connections; David Southward joined Sinclair Radionics in 1977; Richard Cutting, who became managing director of Cambridge Consultants in 1970 (at the suggestion of Gordon Edge – novel, since Edge had already left the company!) joined Sinclair Research in 1983; other fractions of the disorganisation have subsequently contributed to the Sinclair story too.

Over the years that Sinclair Radionics occupied the Mill at St Ives they carried out vast improvements, not least the creation of Clive Sinclair's extensive corner office overlooking the river and the town in one direction and the river and the water-meadows in the other. It had an enormous sliding door which had to be craned in, and which was normally kept open; when it was shut you knew there was something going on – serious faces, raised voices, etc.

Well before snooker became fashionable, a table was installed for recreation – there was plenty of room. In the heyday of Sinclair Radionics, the Mill was a hive of activity, employing some 400 people, distributed throughout its six floors – the attic was left to the bats. There was TV tube research in the old boilerhouse; the single-storey attachments were devoted to production, service and despatch. In the Mill itself, every floor had its own characteristics and atmosphere – the research department, technical publications, industrial design, drawing office, accounts and so on. The stimulus of having all the company under one roof – and with plenty of space – was bound to be productive, and the Sinclair range began to expand again.

In June 1970, the Z-50 amplifier was added to the Project 60 range. The Z-30 was rated at 20 watts, so Sinclair decided to advertise the Z-50 as rated at 50 watts. Richard Torrens tested the amplifiers and found that they blew somewhere between 37 and 40

*Gordon Edge  
Cambridge Consultants'  
director of electronics*



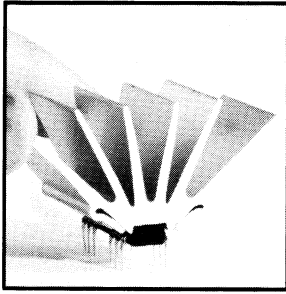

*Super IC12 with  
hedgehog heatsink*

watts, so he suggested 30 watts as a rating; the final compromise was 40 watts. The Z-50 needed a bigger power supply than the Z-30; by the time the range was complete, the Project 60 had quite a variety of power supplies to choose from. In November two new lines were announced: a stereo FM tuner supplied as a complete chassis and fascia which needed only to be put in a box, and the Q16, Wes Ruggles's speaker smartened up with a teak surround.

The tuner was launched at an audio exhibition at the Skyways Hotel at Heathrow. David Park remembers working frantically with Jim Westwood and Chris Curry for 28 hours non-stop to get the thing going, driving back to Heathrow through the night, the tuner finally working in time for the show. David adds: 'It only took 18 months to get it into the shops'.

It was not until June 1971 that another new product appeared on the scene, the 'Super IC-12 high fidelity monolithic integrated circuit amplifier'. This had a wondrous finned heat sink which made it look like some outlandish insect; it was affectionately known as the 'hedgehog'. For its advertisement, the Super IC-12 was photographed beside the recently-introduced 50 pence piece.

The next innovation was the Project 605

'The easy way to buy and build Project 60.

Project 605 is one pack containing one PZ5, two Z30s, one Stereo 60 and one Master Link. This new module contains all the input sockets and output components needed together with all necessary leads cut to length and fitted with neat little clips to plug straight on to the modules. Thus all soldering and hunting for the odd part is eliminated. You will be able to add further Project 60 modules as they become available adapted to the Project 605 method of connecting. Complete Project 605 pack with comprehensive manual, post free, £29.95. All you need for a superb 30 watt high fidelity stereo amplifier.'

This was about half the price of a comparable ready-made amplifier at the time. The applications of the Project 60 were listed as: simple battery record player, mains-powered record player, 20+20W stereo amplifier for most needs, 20+20W stereo amplifier with high performance speakers (this one needed a higher rated power supply), 40+40W RMS de-luxe stereo amplifier (this one used the Z50s), indoor public address system. A note at the foot of the advertisement stated that the FM stereo tuner (£25) and AFU filter unit (£5.98) may be added as required. And of course there was still the unique Sinclair guarantee.

The most important Sinclair event of 1972 was the announcement of the first pocket calculator; indeed, this was so important was that we will leave it until the next chapter.

The System 2000 was the beginning of Sinclair's attempt to break into the conventional hi-fi market. Advertisements continued to appear in lavish colour in all the hi-fi magazines, and the System 3000 40W amplifier was added to the range. System 3000 was in matt black; System 2000 in silver – both Sinclair favourite up-market finishes. The tuners in particular received a very positive response from the hi-fi world, because they were the first to use a system known as 'phaselock loop discrimination', which 'gives you lower distortion than any other tuner at any price'.

The hi-fi market was becoming more and more competitive, with a bewildering variety of systems available at an equally bewildering range of prices. But the Sinclair kits were very highly regarded in some quarters, and many magazines featured articles on their construction. The complete systems were very competitively priced at what retail psycho-linguisticians refer to as 'the budget end of the market'.

The Project 60, and its modification the Project 605 which needed no soldering, continued to be the most popular kit amplifiers, despite competition from the well-established Heathkit and others until the Project 80 was launched in November 1973.

The circular speakers which went with the System 2000 were not particularly successful and were dropped from the range, although the amplifier and tuner together with the System 3000 continued to be popular. An unusual 'planar' speaker, the Q30, was launched in the autumn of 1972. It used what is known as the 'infinite baffle technique'. It was given an extensive review in *Hi-fi Answers* and compared with the Goodman's Planax 2 although in fact they were

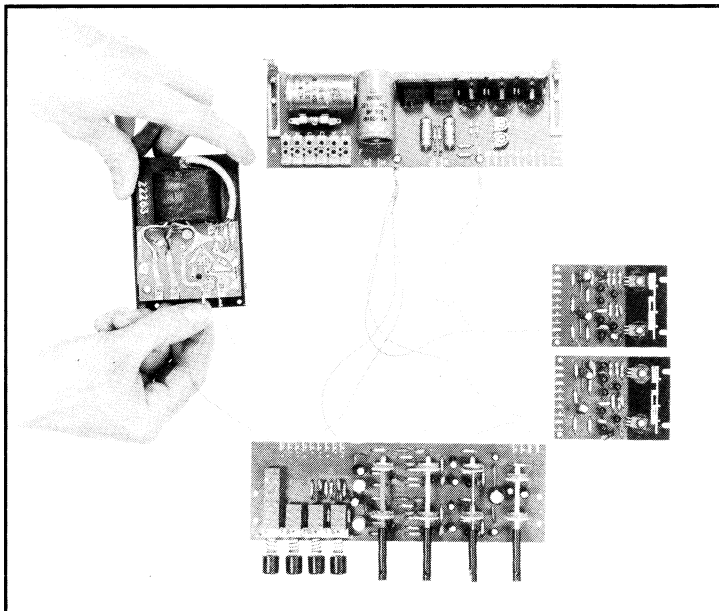
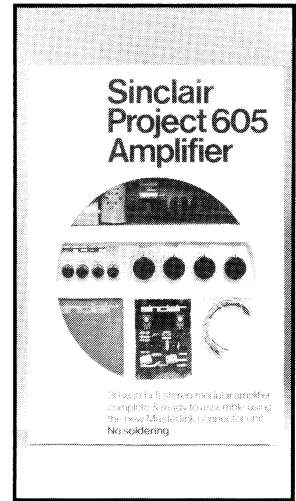

*Project 605 –  
so easy to assemble*

*Sinclair Project 80  
the ultra-modern non-  
obtrusive hi-fi*

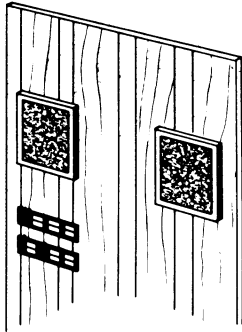
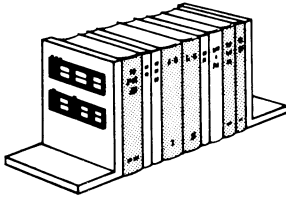
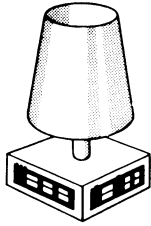
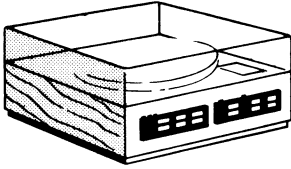

*When you have seen for yourself how fantastically slim and cleverly designed these modules are, further ways will suggest themselves in which they can become a pleasing part of your particular domestic environment.*

not technically comparable. Q30s were unusual eye-catching speakers which measured 3 1/2" wide by 2 1/2" high by 4" deep – a little inconvenient for anyone other than the hi-fi enthusiast or someone with a very large room.

Hi-fi enthusiasts usually overlooked the fact that the weakest link in the chain was the man-machine interface, ie, the room in which you sat to listen to the equipment. It is better to adopt the maxim 'If it sounds right, it *is* right' rather than be told by wavering needles or flashing lights what you *ought* to think. Not that a hi-fi enthusiast would ever give you much chance to listen to the music – there was always some mumble about rumble, flutter, wow, and hiss – for, like model railways, the enjoyment came from constantly modifying and rearranging the equipment, not from using it.

The System 4000 amplifier received a very favourable review in *Tape Magazine* of June 1974. It looked very like the System 3000, but the entire circuitry had been redesigned and:

'The test result table shows that, in almost every area, the amplifier exceeds its manufacturer's specification. At the time of testing it was mistakenly thought to be a 20 watt amplifier. None of the figures gave any reason to doubt this and only when checking the price with the manufacturers did it emerge that the rated output was only 17 watts rms power.'

For an amplifier intended to produce 20 watts per channel the results would be good; for one of 17 watts rating they are generally excellent.'

And the conclusion was:

'This is an amplifier that I would buy for myself if the manufacturers could sort out one or two minor problems with production. As it stands, the System 4000 is a triumph of engineering and design over production quality control.'

Now what exactly does that mean?

Sinclair had obviously taken to heart all the criticism levelled at the specifications of earlier models. The company was expanding its sales force and rationalising hi-fi sales by concentrating on major distributors; the aim was to capture 20% of the up-market hi-fi sector.

In December 1973 Sinclair took four pages of *Wireless World* to launch the Project 80.

The Project 80 offered all the same facilities as the Project 60 but with a black anodised aluminium fascia and sliders rather than knobs; it was designed by a Dutchman called Dirk who worked for

Sinclair Radionics for a while. Sliders were the in thing in 1973, before people discovered that they caused ear-splitting crackling when the dust got into them. The power outputs of the amplifiers had been slightly uprated and a whole page of line drawings showed how you could build the Project 80 system into a book end or the base of a lampshade or mount it on a false wall among other, slightly bizarre, ideas.

The Project 80 advertisement included a potted history of Sinclair Radionics:

1962 Micro-miniature power amp, small enough to stand on a 10p piece

Slimline pocket receiver smaller than a 20 cigarette pack

1963 Micro-6 receiver, smaller than a matchbox

1964 Pocket FM receiver; PWM amp (Z10)

1965 Z12 power amplifier modules; PZ3 power supply

1966 Stereo 25 pre-amp/control unit

1967 Micromatic: Q14 loudspeaker; the first Neoteric

1968 IC-10, the first ever integrated circuit for constructor's use

1969 Q16 – improved version of Q14: Systems 2000 and 3000:

Project 60 launched

1970 IC-12: Project 604

1971 Project 60 stereo FM tuner: Z50: PZ8

1972 Improvements to Project 60 with Z50 Mk 2 and PZ8 Mk 3: the Executive Calculator: Digital Multimeter: Q30 speaker

1973 Cambridge Calculator: PROJECT 80 LAUNCHED . . .  
NEXT?

What next indeed? In the world at large, Sinclair Radionics was perceived to be nearer the bottom end of the hi-fi market than the company would have wished. Not only was there growing competition in the field of hi-fi; the calculator market was consuming an increasing amount of Sinclair effort, and a profitable new line had been introduced – the digital multimeter.

At the time digital multimeters were rather novel and expensive laboratory equipment and Sinclair saw a market for them at a price that even hobbyists could afford. Moreover, the DM1 was a neat, small hand-held unit rather than the substantial bench-mounted versions available from other manufacturers. But there was one catch: its launch was accompanied by one of the familiar apologies. In huge capitals:

## SURPRISE!

And it went on to quote the specification. However, the DM1 read-out was displayed on the unpopular Nixie indicators, so that the initially enthusiastic response soon dropped off. In November

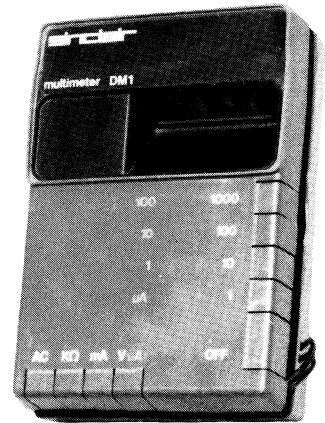

*Multimeter DM1*

## SURPRISE!

You surprised us with the overwhelming demand for our new DM1 digital multimeter—which far exceeded even our optimistic expectation.

## An Apology.

The result is that many of you who have placed orders have had to wait an unacceptably long time. For this we apologise.

All present orders will be fulfilled by the end of August and shortly after we hope to supply from stock.

To remind you that the Sinclair DM1 is worth waiting for here are its salient features.

Battery operated from a standard 9v throw away radio battery to give a service life of months—quite independent of mains supply.

Light in weight—only 1lb. 6oz. with battery. A compact transistorised truly portable instrument.

Robust with its tough and practical plastic case designed to put up with rough handling.

Accurate—basic accuracy of 0.4% of reading  $\pm$  0.2% of range on 1v DC.

Convenient to use with digital readout shielded within a recess to avoid the reflection of ambient light, brightness adjustment, and two clip probes.

Versatile—measuring AC and DC volts, AC and DC current, and resistance in a total of 23 ranges with push button selection.

Guaranteed for twelve months.  
All at a price of £49

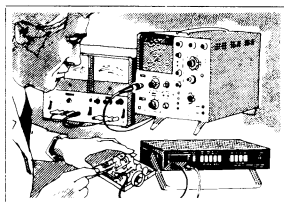

Use it in your laboratory. The DM2 sits rigidly on its combined carrying handle/stand.

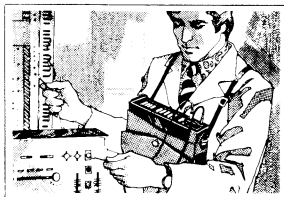

Use it on the move. Keep the DM2 in its carrying case - it's always ready for use.

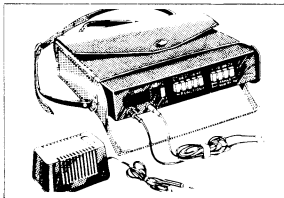

All you need to use the DM2... anywhere. Mains adaptor, carrying case, multimeter - you're ready for quick, efficient metering - whatever the situation.

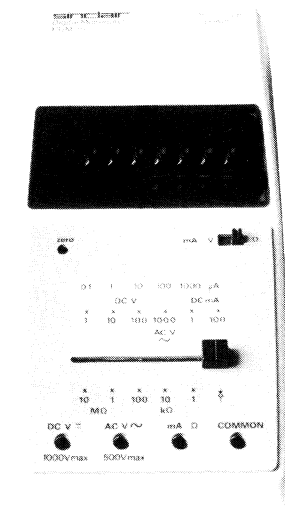

Multimeter PDM35

the price was reduced to £24.95 (plus VAT). It may be significant that the DM1 wasn't even mentioned in an historical account of Sinclair's entry into the multimeter business written in 1978.

Sinclair brought out the DM2 Multimeter in January 1975; it was much more successful than the DM1. *Electron* carried an article on its design written by Mike Pye. The DM-2 had been designed using a mixture of chips and discrete devices which were as far as possible components of other Sinclair products – except for one chip which was specially modified by General Instruments Microcircuits. The advantage of this was that Sinclair's bulk buying enabled the component cost – and hence the finished price – to be kept down. The meter was very quick to assemble and easy to test. It was built by Tek Electronics (Al Tekell – felicitous name – was the ex-AIM sales director) as subcontractors and tested at the Mill. Mike Pye concluded his article: 'Total time scale from inception to production was a little over six months. Two fine Sinclair engineers must take the credit. They are John Nicholls, project leader, who was responsible for the electronics and his assistant Keith Pauley who engineered the design for production. Another moral – first find competent, enthusiastic and fast-working engineers.'

Here was a rare example of a Sinclair design which considered production problems right from the beginning; it was a product with a very wide appeal and its launch was announced in a score of journals; scientific, hobby, retailing and education. And all the reviews were favourable. The *Practical Electronics* reviewer said: 'The old DM1 was not for me. But I'm now using the new DM2 very happily in my own workshop.'

The DM2 was such a success that two years later Sinclair launched a new digital multimeter, the PDM35 which – for a change – was announced in New York before it was announced in England: by now, Sinclair Radionics Inc was established at the Galleria, 115 East 57th Street, New York. This was a wholly-owned subsidiary responsible for selling and servicing Sinclair products in the USA. The DM2 was a 3.5 digit DMM of 1% accuracy selling at \$49.95 and aimed at the service and hobby markets. There were also plans for a 4.5 digit DMM aimed at the industrial market to cost around \$200 – the DM450.

By the end of 1978 the Sinclair instrument range comprised four multimeters and a portable oscilloscope, which used the tube from the miniature TV. The PDM35 was the smallest multimeter, the DM2 had been superseded by the higher specification DM235, although the original design had sold 30,000 units; 80% of them overseas. The next one up was the DM350 and top of the range was the DM450.

The portable dual-beam oscilloscope was another Sinclair innovation; designed by Bill Hardman, who had come from Neve



Electronics, it used the Telefunken TV tube in a DMM case. Hardman remembers Denis Taylor (one of the directors) asking him if there was a prize for getting it into such a small box. He had spent two concentrated weeks building a prototype for Clive Sinclair to take with him to the States on a sales trip. This little oscilloscope was a steady seller for many years.

As we shall see, the Sinclair range of instruments continued strongly to the end, and remain the one branch of Sinclair Radionics to live through SRL's successor Thandar; some of whose products are still updated versions of the original Sinclair designs.



*David Southward (right)  
showing Robert Maxwell  
a prototype*



## The other pocket calculators fit neatly into your briefcase.

The Sinclair Executive is the world's smallest and lightest electronic calculator.

How light? Just 2½ oz. Less than the bunch of keys you're probably carrying now.

And how small? It's 5½ inches long, 2¼ inches wide, and an incredible ¼ inch thick – same as a cigarette.

Yet this featherweight wafer of modern technology offers more than some desk-top models.

With its brilliant 8-digit display it adds and subtracts, of course. It multiplies and divides – and by a constant figure over and over again, if you want it to (to work out discounts for example, for currency conversions, or for percentages). It works to 2, 4 or 6 decimal places – or it allows the decimal point to float. It rounds off automatically to the nearest decimal place.

### The secret of the Sinclair Executive

The Executive's 'brain' is an electronic marvel – a 7,000-transistor integrated circuit (the largest ever produced for commercial use).

But the real genius lies in the circuitry linking the brain, the batteries, the keyboard and the display. Circuitry soaks up power, which is why other pocket calculators have to use large batteries – and that, in turn, makes them bulky.

In the Executive, the Sinclair flair for miniaturisation has developed circuitry which absorbs virtually no power. Tiny hearing-aid batteries take up the minimum space and, used from time to time during the day, will last for several weeks.

Yet small though it is, the Executive is far from frail. Every one is covered by a five-year guarantee.

**Smallest . . . lightest . . .  
exceptionally powerful . . .  
and easy to test for yourself!**

You'll find the Executive at all of the stores listed, and at other leading shops. Ask to handle one, and put it through any performance test you please. See how easily it slips into a pocket – and compare it with other 'pocket' calculators.

# sinclair

Kilroy Brothers Ltd,  
Shanower Road, Whitehall, Dublin 9  
Telephone: Dublin 379961

Distributors for the Republic of Ireland

## The rise and fall of the pocket calculator

# 6

In the mid-sixties, large calculators imported from the USA began to appear on the desktops of Britain. The first customers were senior executives who could afford – or whose companies could afford – to buy a machine. Whether they first bought them to play with, or as a status symbol, they soon found that they had instant numeracy at their finger tips.

The first pocket calculators were made by Bowmar in the United States. Bowmar had spent several years developing solid-state light-emitting diode (LED) displays for use in their aircraft instruments. Ed White, founder and president of Bowmar, realising that such displays would be applicable to calculators, made several trips to Japan, the country which dominated the calculator market at that time. The Japanese were not convinced, but it was on one of these trips that Ed White met the president of Texas Instruments whose company had developed a single integrated circuit containing no fewer than 7,000 transistors and capable of performing all the functions required from a general-purpose calculator.

Forgetting Japan, Bowmar started to make calculators of their own; the following year Texas Instruments entered the field. This shifted the calculator centre of the world from Japan to the United States, and set Bowmar on a path of rapid growth. These calculators had 8-digit displays, and were capable of performing only the four rules. Such basic machines – sometimes with the addition of constant, percentage and memory keys – continued to be the mainstay of the business. Simpler machines with a limited number of digits and no floating point (if they had a point at all) were false economy, and gave calculators a bad name. In the mid-1970s, more advanced calculators with scientific notation,

logs and trig functions, and then programmability began to appear until now – in 1985 – we can have in our pockets more calculator power than was available to the computer pioneers of the post-war years.

There was inevitably a steady increase in the number and variety of calculators on the market as the seventies dawned, but although they were becoming smaller and smaller they were still desktop machines, and a long way from being *pocket* calculators. The ever-reducing size was the result of advancing technology; manufacturers of silicon chips were packing more and more calculating ability into smaller and smaller areas.

Clive Sinclair had found the perfect challenge for his next piece of miniaturisation, and when he visited Texas Instruments he picked up a couple of chips with which to experiment. He returned to Newmarket Road and presented them to Chris Curry: ‘Get that going!’ For a moment, Chris was panic-stricken, not knowing quite what to do. The chip was the TI GLS 1802, and the calculating potential within it was, for those days, immense – ie it could perform addition, subtraction, multiplication and division. Westwood and Curry set to work and assembled a prototype with a keyboard made up of a cross matrix of wires (to feed data in) and set up drivers for a seven-segment LED display (to read data out). Panic gave way to wonder; the internal clock could be made to run slow or fast, and, running it slowly, you could see the chip calculating; watching it put one number in, then another and another, and seeing the results come up was astonishing: ‘Just one chip – it was like magic!’ Anyone would have thought so – there was no such thing as a pocket calculator in those days.

The prototype calculator was powered by three hearing-aid batteries, but consumed so much power that they didn’t last for very long. There was no other battery small enough; Jim Westwood and his team therefore set to work on the task of limiting the current drawn by the calculator. I remember another of those Saturday lunches at *The Plough*, Fen Ditton, when Clive explained the problem, and how, with a little planned serendipity, they had discovered that if they disconnected the power and reapplied it fairly quickly, the memory did not fade and the digits remained on the display. He was tickled pink.

The capacitors in the circuit would hold a charge for up to five seconds, so David Park designed and built a circuit which pulsed the power on and off, controlled by the ‘clock’ (which is built in to the chip in order to pace its operation). Before, the chip drew about 350 milliwatts of power; now it needed only 30 milliwatts. It was this power-saving technique that made the first truly pocketable calculator possible.

The case was made of injection-moulded polycarbonate (in black, of course); because it was flexible they had to find a flexible

glue to fasten the two parts of the case together.

The Sinclair Executive was launched in September 1972 – warts and all.

It weighed 2.5 oz and measured  $5\frac{1}{2}'' \times 2\frac{1}{4}'' \times \frac{3}{8}''$ . ‘One must always bear a packet of cigarettes in mind as the ideal size’, said a Sinclair executive, according to *The Financial Times*. Perhaps he said it with his tongue in his cheek. It was certainly a running joke at the time that Sinclair, who was then heavily into Capstan Full Strength (40+ per day), designed everything to come out at about the size of a packet of 20. The Executive had an eight-digit capacity and could add, subtract, multiply and divide. It had automatic squaring, reciprocals and a choice of fixed or floating decimal point. The circuit comprised the Texas Instruments GLS 1802 chip, 22 transistors, 50 resistors and 17 capacitors.

This first pocket calculator took the world by storm; everybody wanted one. It had a dramatic effect on Sinclair’s turnover and profitability; increased competition and a more discerning market had played havoc with hi-fi sales, the company needed a new product and the success of the Executive calculator exceeded their wildest expectations. The cost of the parts was close to £10, and with a price to the customer of nearly £80 it would have been difficult to go wrong. It was not so much the engineering of the Executive that astonished everyone, but the size. Even the engineers at Texas Instruments were stunned; the machine they had produced using the same chip – which after all was their design – was longer and wider and over three times as thick. It was also more expensive: the Sinclair Executive was selling for £79.95; no one else could come anywhere near the magic £100 barrier, let alone beat it.

It was a remarkable feat of engineering. Doug Thomas wrote in *The Financial Times*: ‘If there is one thing that miniaturisation forces upon engineers of all kinds it is a neatness of exterior design that often leads to greater efficiency in use.’ This certainly seemed true of the Executive. Richard Torrens was responsible for that neat exterior, which won the Executive a Design Council Award for Electronics in 1973.

Not only was the Executive small and cheap, it was also attractive. Until it appeared, nobody had tried to make a calculator that appealed to people just because of the way it looked. The *New Scientist* described it as ‘not so much a professional calculator – more a piece of personal jewellery’. An Executive calculator went on show at the Museum of Modern Art in New York – an event which has meant more to Clive Sinclair than many seemingly more important honours he has received since. David Rowlands wrote in *Design*: ‘It is at once a conversation piece, a rich man’s plaything and a functional business machine.’

This was all true. I remember travelling from Newcastle to

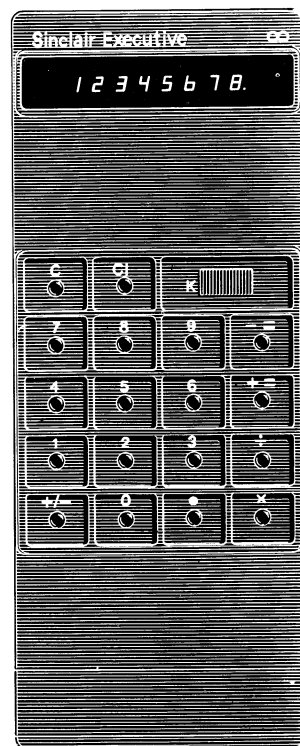

*The Executive*

London on the East Coast Main Line; at an adjacent table in the dining car was a group of Silks. One of them was extolling the virtues of his Sinclair Executive, explaining that he had been able to win his court case by his ability to perform rapid calculations time after time to the applause of the judge and the chagrin of his opponents. There was no doubt that it was at once a conversation piece, a rich man's plaything – and a functional business machine.

Until the Executive took off, Sinclair had never really considered employing someone to market his products; he had managed very well by himself. But this product was different; it needed something extra. He found – and hired – a young and vigorous London agency, Primary Contact.

Primary Contact was enthusiastic and eager but found that Sinclair was a somewhat unusual client. They were used to dealing with people who gave them them more or less clear briefings; people from whom they could at least elicit a brief by careful questioning. Sinclair was not like that; Richard Jeans – managing director of Primary Contact – remembers bewildering conversations:

Richard: 'What price do you want to sell it at?'

Clive: 'What price do you think people will pay?'

Richard: 'Who are you approaching?'

Clive: 'Who do you think would buy it?'

Richard: 'How do you think it should be distributed?'

Clive: 'Who do you think would stock it?'

Richard: 'How many can you make?'

Clive: 'How many can you sell?'

However, it would have been difficult for Sinclair to have found another agency at that time who would be excited about calculators, especially from a manufacturer who was not at that time terribly well-known except at the lower end of the hi-fi market.

Primary Contact was young and new and so was Clive Sinclair as far as the calculator market was concerned; they were both on the same learning curve. They were quick learners; bright and clever, but above all, enthusiastic.

As Richard Jeans says: 'We would have taken anything in those days. We had all spent our lives in straight business-to-business and, although the calculator was possibly office equipment, the opportunity to advertise in the colour supplements was in itself attractive. I don't know if Clive would have lived with it as a piece of office equipment, but that certainly was one of the options available: a desk or briefcase product which would have been sold to businessmen through the office equipment press. It was by no means clear at the time that it should be a stylish thing. We went through a long exercise, working out what it was going to be, and

we arrived at the statement that it should be considered as “a useful personal luxury for men who could either afford to buy it themselves, or would be able to claim it on expenses”.

‘The development of the calculator market is quite a story – how the price came down as extra functions such as a memory were added; how styling changed from black to white; how product life was prolonged by altering the features and revising the styling. The most significant thing in that sequence is the reduction in price, which set a pattern for quite some time with other products.

‘You set your initial price at a level where you have a fair chance both of recovering a good deal of your development money and of making some fairly swingeing price cuts once you have recovered it. By that time, your production cost will be relatively low, compared with the production cost when you first advertised. And so, if there is any competition, you are already ahead on product concept and styling, and you can with any luck recoup before the competition catches up. Then you can cut the price in such a way that you leave them stranded high and dry – and extend the life of your mature product because of the price cut . . . and by and large that happened throughout the range of the calculators.

‘When the price came down there was one problem: how to hold the image of the product. We were very lucky because we won a design award at about that time which enabled us to cut price and maintain image simultaneously. When the Executive moved into distribution, the advertising broadened and the product was allowed to retreat into the upmarket stores, so that the next product – the Cambridge – could take over where the Executive had left off. That was the cycle: recoup on development, cut the price to maintain the market share, go on getting some money out of a product that was now dying by pushing it off into distribution, and bring in the next product.’

Apart from the arrival of the calculator in the pockets of the public, the most obvious result of launching the Executive was to show that such a machine was technologically possible, which acted as a powerful spur to the competition. At first, there hadn’t been any competition; now the only way to stay ahead was through technical innovation, supported by that breathtaking policy of price adjustment.

In August 1973 the Sinclair Cambridge was launched. It measured  $4\frac{1}{2}'' \times 2'' \times \frac{1}{16}''$ , weighed less than 3.5 oz and sold (ex VAT) for £29.95 or, in kit form – make it in three hours – at £24.95. A ‘valuable book’ was supplied with the Cambridge to explain how to harness the full potential of this piece of electronic technology: as well as the four rules it could handle trigonometric functions, nth root extraction, compound interest and the like.

The Executive Memory was introduced in November 1973. It

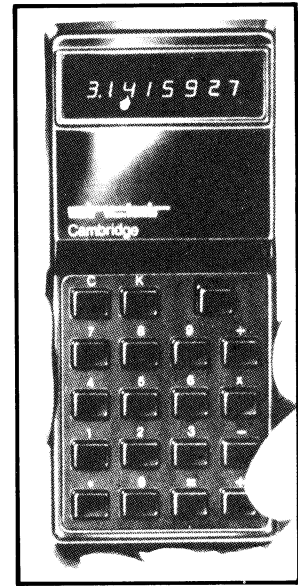

*The Cambridge*

used the same slimline casing as the Executive, and offered the same functions, but was now able to memorise subtotals from any number of chain calculations.

The concept of leading the field in technology in order to maintain a lead in the market had other repercussions. Sinclair believed that a company which designed, but did not manufacture, its own products, could be more responsive to market trends. Accordingly, he adopted the policy of subcontracting calculator manufacture and assembly. This was fine in principle, but unfortunately it created a certain amount of product unreliability. Clearly, every new idea had to be incorporated into the production design quickly. For example, the display on the Executive was changed several times in the pursuit of ever-lower power consumption. But continual changes cause both production and marketing problems. When you're aiming solely at your home market, unreliability is a nuisance; when you're exporting it becomes intolerable. Customers in Japan or the USA have no concept of sending a faulty machine to the Mill at St Ives for a replacement, no questions asked. As exports increased, Sinclair was forced to look more closely at the reliability of his product.

There were two reasons for his view of product reliability – or rather, his lack of view. The first was that he had so often produced theoretical designs which worked mathematically that he saw no point in testing them in practice. The second was that if things failed to satisfy he would replace the goods or refund the money without question. This was certainly cheaper than setting up a quality control department and was fine for hobby kits. But the calculator was a product whose potential and marketing were very different from anything Sinclair had come across before, for even the hi-fi was aimed at enthusiasts and constructors whose joy was to gather the bits and sort them out rather than at the plug-it-in-and-switch-it-on brigade.

Late in 1973, Sinclair finally admitted the necessity of setting up a quality control department. Incoming components were inspected before being packed into kits to be sent to the subcontract assemblers, and the calculators the assemblers sent back were also checked thoroughly. Records were kept and analysed so that eventually the engineering department was able to pick up and correct any recurring faults – in theory, at least.

Primary Contact found that they were always working at a frantic pace. Fortunately, refinements such as test marketing were unnecessary; Sinclair had a marvellous ability of knowing what the market would buy before the market even knew it existed!

At first the calculators were designed for the average businessman, but gradually they became more specific. Sinclair decided that he wanted to produce a calculator aimed at scientists,



engineers and statisticians; to move into the 'slide-rule' market. A scientific calculator had been launched by Hewlett-Packard in 1972 but, typically, Sinclair wanted to produce a smaller, cheaper model. He telephoned Richard Cutting, managing director of Cambridge Consultants Ltd, and asked if he had anyone who could help. Cutting at once thought of Nigel Searle.

Searle had a PhD in maths from Edinburgh and had applied to Tim Eiloart at Cambridge Consultants for a job and been taken on. He sold his house and moved to St Ives, only to be met with blank stares of the 'Nigel who? What job?' genre. What had happened was that although Eiloart had hired Searle he had forgotten why, and the letter that said: 'I've forgotten what we discussed. Were you going to set up an office for us in Edinburgh?' hadn't caught up with Searle until he was settled in to his flat in St Ives. For a short time (a few hours, perhaps) he and I worked together on an ambitious project – a partwork on industrial archaeology; gradually he was absorbed into the system; joined the CCL computing group and thus made use of his considerable talent. But Nigel Searle is restless, and he eventually decided to leave CCL and become an independent consultant. It was about this time that Clive Sinclair sought help from Richard Cutting, Cutting passed on the message, Searle contacted Sinclair, and soon he (Searle) and another independent consultant, David Postlethwaite, began work on a design for a single-chip for a scientific calculator. (His company was called Postlethwaite Electronic Associated Ltd, PEAL for short and his business cards were . . . bright orange.)

Nigel Searle had already met Sinclair through Tim Eiloart. Eiloart had set up a company called Cambridge Learning Enterprises to sell self-teaching texts on such subjects as digital electronics, and Searle had been involved in a discussion on advertising policy. He remembers being impressed with the masterful way Eiloart had picked up the phone and asked to speak to Clive Sinclair, more impressed with his saying 'Come up right now' and even more impressed with his panacea: 'There's only one way to do it – *Wireless World* is the magazine you want, and you must run a full page ad . . . I'll pay for the ad, and you pay me a pound for every book you sell.' Sinclair got about 130% return on his investment.

That was one sort of investment; trivial compared with the tens of thousands Sinclair Radionics was investing in developing new products, which was beginning to cause a severe shortage of cash. However, Sinclair had become friendly with Ed White, the President of Bowmar, the first company to manufacture pocket calculators in the States. White, as we saw earlier, was impressed by the work Sinclair was doing on the scientific calculator chip, so he agreed to buy rights in the single-chip calculator which Sinclair was designing, which agreement involved Sinclair Radionics

receiving a royalty when the calculator was finally manufactured. There were sighs of relief all round when the rights payment of some £30,000 came through from Bowmar, and the Sinclair employees received their pay cheques that month!

Development work continued until it was clear that the line of enquiry was fruitless; all that had been done had to be scrapped. But, as Nigel Searle says: 'A lot of people before then – and certainly since – have thought that all they had to do was to have access to Clive's ideas and – hey, presto! – they would be successful; it's not that simple because there's more to the Sinclair organisation than Clive's ideas.'

The Bowmar project having been abandoned, Searle visited Texas Instruments in Houston to see if they had a different kind of chip he could work on; his new idea was to take an existing calculator chip designed for non-scientific functions and reprogram it to perform scientific functions. After all, since a chip is a microcosm of a computer with data storage and a permanently-stored program, one should be able to alter the program during manufacture to make it perform different functions – so commonplace a concept now that it is a shock to realise what a breakthrough it was then. By December 1973, Searle had 'managed to shoehorn a scientific calculator into the TI chip'.

This project is typical of Clive's role in product concept and development. Relatively few people were involved; Searle as a consultant had no idea who else was working on the project – he was just looking after the chip. 'Sometimes it's very difficult to put one's finger on what exactly it is that Clive contributes', he says, 'but you know that you wouldn't have done what you did unless he had been there pushing, encouraging, exhorting, saying: "We must have it", and: "Don't worry about the money and the risk; it's my money and my risk; just get on with it."' He never puts it in those words, of course, but that's the impression he gives; he's the driving force and the facilitator; he enables people to do things they would not or could not do without such outside influence exerted upon them. Clive's contribution is not necessarily technical; he perceives the market need; then his familiarity with the available technology enables him to see how to meet that market need, and he encourages people to put the theory into practice, especially when it seems difficult or risky.'

But back to the scientific calculator. Searle, who had been working on a TI computer terminal in London linked to Houston, had a brainless calculator at the ready with a socket to take the new chip as soon as TI had made one. He went to the States at the beginning of December (1973) and sat waiting for a call. At last, on 20 December, the call came. He flew to Houston, got the chip, and plugged it in. It didn't work. He figured out why, fixed it, and it did work. Excitement! Although he was working for Sinclair

# Sinclair Scientific kit

## Britain's most original calculator now in kit form

The Sinclair Scientific is an amazing calculator.

It offers logs, trig, and true scientific notation over a 200-decade range — features normally found on calculators costing around £50 or more.

Yet even ready-built, it costs a mere £21.55 (including VAT).

And as a kit it costs under £15!

## Forget slide rules and four-figure tables

On the Scientific, you can handle *directly* all three trig functions, their inverses,  $\log_{10}$ ,  $\text{antilog}_{10}$ , giving quick access to  $x^y$  (including square and other roots).

plus, of course, the four arithmetic functions and any calculation based on them.

In fact, virtually all complex scientific or mathematical calculations can be handled with ease.



Now only  
**£14.95**  
(inc. VAT)

## So is the Scientific difficult to assemble?

No. Powerful though it is, the Sinclair Scientific is a model of tidy engineering.

All parts are supplied — all you need provide is a soldering iron and pair of cutters. Complete step-by-step instructions are provided, and our Service Department will back you throughout if you've any queries or problems.

Of course, we'll happily supply the Scientific or the Cambridge already built, if you prefer — they're still exceptional value. Use the order form.

## Features of the Scientific

- 12 functions on a simple keyboard
- Scientific notation
- 200-decade range
- Reverse Polish logic
- 25-hour battery life
- Genuinely pocketable

# Sinclair Cambridge kit

Now only  
**£9.95**  
(inc. VAT)

At its new low price, the Sinclair Cambridge kit remains unbeatable value.

The Cambridge is now Britain's most popular pocket calculator. And it's not surprising. Check the features — then ask yourself what other calculator offers such a powerful package at such a reasonable price.



## Features of the Cambridge

- Only  $4\frac{1}{2}'' \times 2'' \times \frac{1}{4}''$ . Weight  $3\frac{1}{2}$  oz.
- Fully-floating decimal point.
- Algebraic logic.
- Constant on all four functions (+ - × ÷).
- Constant and algebraic logic combine to act as limited memory.
  - Clear, bright 8-digit display.
  - Operates for weeks on 4 AAA batteries.

## Take advantage of this money-back no-risk offer today

The Sinclair Cambridge and Scientific kits are fully guaranteed. Return either kit within 10 days, and we'll refund your money without question. All parts are tested and checked before despatch — and we guarantee any correctly-assembled calculator for a year. This guarantee also applies to calculators supplied in built form.

Simply fill in the preferential order form below and post it — today!

To: Sinclair Radionics Ltd, FREEPOST, St Ives, Huntingdon, Cambs., PE17 4BR.

Please send me

Scientific kit — £14.95 inc. VAT  
Scientific built — £21.55 inc. VAT  
Cambridge kit — £9.95 inc. VAT  
Cambridge built — £13.99 inc. VAT

I enclose a cheque for \_\_\_\_\_ made out to Sinclair Radionics Ltd, crossed.  
 Please debit my  Access  Barclaycard account number: \_\_\_\_\_

Delete as required

Signed \_\_\_\_\_

Name \_\_\_\_\_

Address \_\_\_\_\_

Please print. FREEPOST — no stamp required

PS

Sinclair Radionics Ltd,  
London Road, St Ives, Huntingdon, Cambs., PE17 4JH. Tel: St Ives (0480) 64646  
Enquiries 099453 (England, VAT Reg. no. 213 017036)

**sinclair**

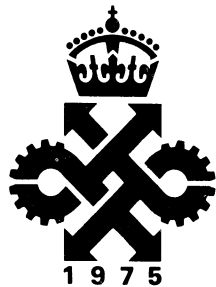

THE QUEEN'S AWARD  
TO INDUSTRY

Radionics as a consultant, he didn't know that Clive and Mike Pye were actually in Houston. Sinclair knew that Searle was somewhere in Houston, so he called his home in England (where it was 3 am) and found that they were all staying in the same hotel . . . so they went and had dinner.

Having seen the new calculator – the only working one-chip scientific in the world – Sinclair and Pye were naturally excited and suggested that Searle should accompany them to Boston. Searle, who had Houston clothes, hadn't realised how cold Christmas in Boston could be; nor did he have an hotel reservation, so he and Sinclair ended up sharing a room. The next morning – Saturday – they were to have an audience with Ed White of Bowmar. Should they or should they not show him the calculator? In the end they decided that they would. He would find out about it sooner or later, and he ought to know sooner, and face to face, that the rights he had bought were in a different machine, which had been abandoned, and that the present one was the result of a completely different approach. Ed White's reaction was one of bemused surprise, but he believed that Sinclair was telling the truth because it was even harder to believe that he was lying! 'Boy, I wish I was as clever as Clive', is Searle's reading of Ed White's acceptance of the way things were.

The meeting was over; the three made their way to the airport through a blizzard; Sinclair and Pye had first-class reservations – which shows how prosperous they felt – and Searle, who had been getting recorded messages from the airport all day, finally got a reservation which was not first class. It was then that Sinclair suggested that Searle should join Sinclair Radionics. Searle accepted, but he remained in the States and set up a sales office in New York while continuing to work on a chip for a programmable calculator.

The Cambridge Scientific calculator was finally launched in March 1974. It had an upper- and lower-case keyboard that gave twelve functions using only four keys. It incorporated logarithms to base 10, antilogarithms, and sine, cosine, tangent, arcsine, arc cosine and arc tangent.

The already tried and proven case and keyboard of the Sinclair Cambridge was used, but the Scientific was the first Sinclair calculator to incorporate an integrated circuit which was exclusive to the company. It sold for £49; the Hewlett-Packard equivalent cost £400.

The calculator market was rapidly expanding. Dozens of companies in the UK, the United States and Japan were entering the field. By 1974 the world production was 20 million annually and still climbing. Sinclair's turnover in 1972 had been £762,000. In 1974 it was £4,090,000. The same year Sinclair Radionics won

two Queen's Awards for Industry: one for Export Achievement and one for Technological Innovation – both for the Cambridge Scientific. This was on top of the Institute of Marketing's Award 1974 for the calculator marketing strategy, and the Design Council Award for 1973 – won by the Sinclair Executive.

Sinclair had a strong foothold in the overseas market. Early in 1974 \$1.5M worth of Sinclair Executive calculators were sold to Japan at six times the price of the Japanese calculators. David Wilson and Partners, a company specialising in selling technical and semi-technical products to Japan, laid the foundations. David Wilson found it very difficult to explain the capabilities of the Executive to the Japanese; they couldn't believe that it was so small!

However, an agent for a company called Van Jacket saw one in a window display in Austin Reed in London. He was very impressed and immediately approached Clive Sinclair. Soon a deal was signed. Once the Japanese were convinced, they came up with all sorts of selling ideas – department stores, boutiques, Diners Club, give-aways with car purchases and even in the Geisha houses in the Ginza in Tokyo: the idea was that a Geisha girl would produce an

*The Oxford range  
of calculators*



Executive calculator from under her kimono so that the host could add up the bill. He would then feel obliged to buy it and present it to his guest.

In 1974 sales of the Executive exceeded £2.5M and 100,000 Sinclair calculators were being produced each month, 55% of which were exported. During that time sales director David Park visited the Middle East on a Board of Trade trade mission. His wife presented the Sheikh of Qatar, Sheikh Isa Bin Sulman, with a gold-plated Executive. But something was amiss; it then transpired that the Sheikh thought that the working calculator was just a token; that the *real* gift would be one of the giant-size models used for exhibitions! It was a tricky moment, but the Sheikh understood and graciously accepted the smaller calculator.

In November 1974 Sinclair, among other companies, was asked to design a table-top calculator for Gillette to test-market in the United States. Gillette thought it was time to widen their product range by entering the consumer electronics market. Sinclair invested a lot of effort in this but, although the tests were successful, Gillette decide to wait before launching themselves into

*The Cambridge range  
of calculators*

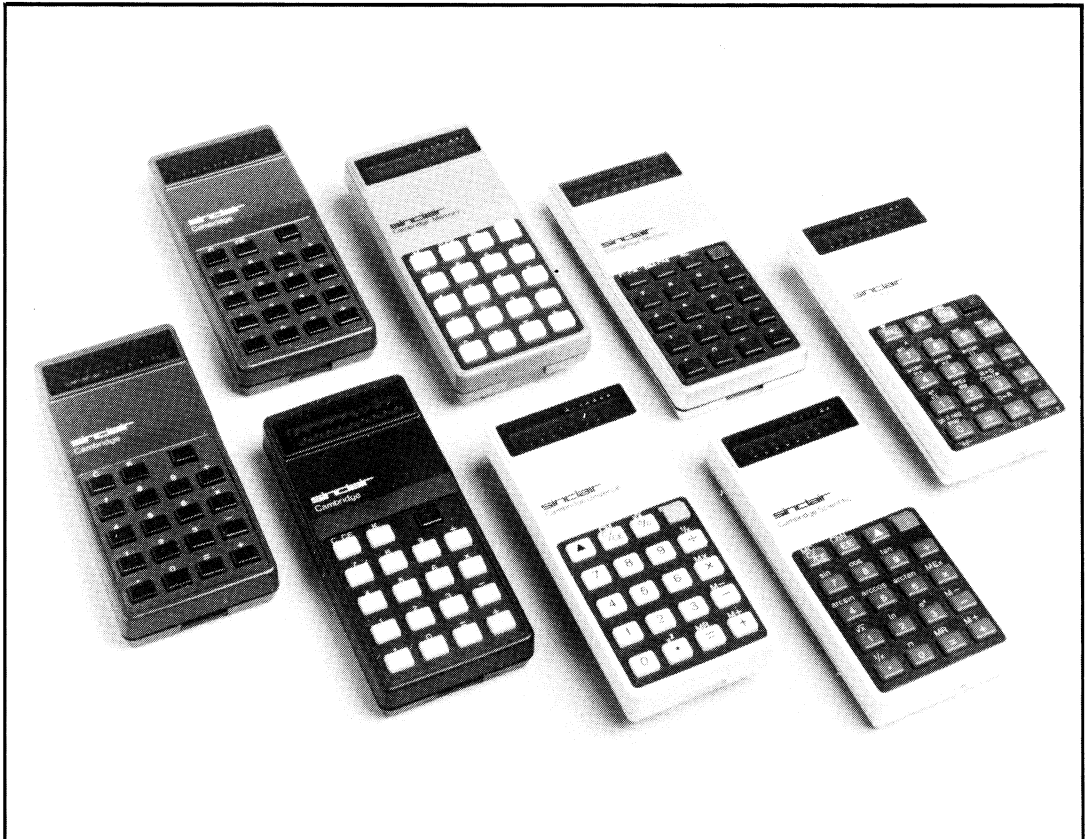

calculators; they were nervous about economic and pricing uncertainties.

However, the development work led to two things: Mike Pye (who had been working on the project at Sinclair) took a job with Gillette in the States, and the Sinclair Oxford range of calculators was launched in March 1975. The Oxford 100 was the calculator originally designed for Gillette, which used a chip bought from General Instrument Microelectronics but was fundamentally the same as that in the Cambridge. The Oxford 200 had the addition of a % key, as well as a full memory; the 300 was a scientific model, which at £29.95 set a new price level for this type of calculator. They were all desktop or 'briefcase' models and were aimed particularly at the overseas market.

Although sales were encouraging, production was having a few problems. Calculator users were becoming far more knowledgeable about the machines, and were demanding higher quality and reliability. The Japanese were now producing extremely reliable machines but Sinclair Radionics still hadn't managed to iron out some of the difficulties.

There were various problems. The Cambridge had given a great deal of trouble. The on/off switches were the major cause. Many materials, when exposed to the air, grow a thin oxide layer on their surfaces. When you're designing switch contacts, you either have to have a material which doesn't become oxidised (such as gold) or a material whose oxide is so soft that it breaks down when the contacts are closed. The original circuit board conductors were gold-flashed nickel, but in order to cut costs the coating was changed to tin-lead. This grew a soft oxide layer, with the result that after a switch had been slid backwards and forwards a few times the surface of the tin would smear across the insulation – so that the calculator could not be switched off. The Oxford range was criticised for draining the batteries very quickly – the peak current consumption was 40mA, while the batteries' recommended maximum was only 10mA. An article in *Computer Digest* added:

'There is an answer though – buy the PP9 battery. It's got the same connections on it and has a recommended range of 5–50mA. So you won't use it up in record time. The other point about the PP9 is that it's 6.6cm × 5.2cm × 8.1cm and weighs close on one pound. So it would have the added advantage of making the Oxfords into genuine desk calculators.'

The on/on switch nearly gave rise to an international incident. A telex came from Moscow: a Russian diplomat had been carrying a Sinclair Executive calculator in his breast pocket. Suddenly, the calculator exploded; the diplomat and his entourage were convinced that he was having a heart attack. On investigation, it

was found that his calculator had been switched on, and the current drain on the batteries was so high that they grew hotter and hotter, finally bursting. Fortunately, he had left it on by accident – there was no question of a faulty switch in this case.

In the space of a few years, calculators had become almost a necessity in every household. In the UK, the introduction of decimal coinage was introduced on 15 February 1971, followed by the financial complications which began in the early 1970s – floating exchange rates, rapidly changing interest rates, and inflation. The arrival of the pocket calculator was timely; as prices fell, engineers and scientists started to replace their slide rules and log tables with pocket calculators. Prices continued to drop, and by the mid-1970s about one third of calculators were bought by students, although some universities banned their use in examinations. When calculator prices were high, the ban was founded on the assumption that students who could afford them would have an unfair advantage in exams. As prices fell, the National Union of Students called for a free issue, but it was not long before most students were able to afford a calculator anyway.

The problem of calculators in schools was much more thorny, their use turning first on price, and then on morality. Secondary schools succumbed, as had the universities before them. But what of primary schools? It seems that learning tables by rote had started to fall out of favour before the arrival of the pocket calculator; the calculator came in as a substitute for mental arithmetic – heaven knows what would have happened to the country's numeracy had the calculator not arrived.

Ten years later, if proof be needed, any shopping trip will amply demonstrate that we are, by and large, a nation of innumerates whose world would collapse were it not plentifully blessed with electronic cash tills, not just to take the drudgery out of calculation, but to make it possible at all.

The prices of calculators plunged, as the growing competition encouraged companies to seek cheaper and cheaper means of producing more efficient machines. It was no longer a simple matter of demand exceeding supply and a small assembly shop being the only requirement to make a small fortune (or a larger shop to make a larger fortune).

At Sinclair Radionics, Tony Wood Rogers was put in charge of production after Wes Ruggles had his final difference of opinion and left; he remembers the tremendous rate of growth in the early seventies. 'One month in 1973 we made 500 calculators, a year later we made 5000 in the same month, and the year after that 50,000! And yet Sinclair's only production control system was a small form that summarised the products, work in progress, finished goods, and stock in the stores.'

One of the problems of production has always been erratic



demand; in this case due partly to the rapid development of technology, products becoming obsolete almost before the production lines were functioning properly. There was the added problem that during the first six months of a product's life Sinclair Radionics was unable to make enough units to satisfy demand; then, just as production was brought under control, orders would drop off. Occasionally the line would have to start producing something else – another model of the same calculator for example.

Component design and manufacturing altered radically during those years. When the Executive was launched it had about 130 separate components; two years later it had but three. Innovations included inserting the keys as a one-piece moulding into a grid already printed with numbers and symbols, and reducing the size of the eight-digit display and providing it with a built-in magnifier.

In 1976 Sinclair Radionics moved its production in house, which – though it helped enormously in improving quality while at the same time cutting overheads – was later to be a source of pain to Sinclair himself.

Meanwhile, the price war raged. The retail price of the first basic Sinclair calculator had been £80; just over a year later the cheapest Sinclair machine was selling for just £20. By January 1975 that price had halved again and in November 1976 the slightly improved version was £4.95. As we have seen, such price reductions were made possible by correspondingly reduced production costs resulting from rapidly advancing technology incorporated in the products.

Roger Helmer, then Sinclair's marketing manager, was quoted in 1974: 'The calculator market, like other innovative and high technology product categories, has a history of progressively reducing retail prices . . . Sinclair's ability to reduce prices is a reflection, not only of our superior technology but also of the economies of scale the company is able to achieve as production increases.'

It was becoming increasingly apparent that technical advances were being pushed to their limits in the humble calculator. Manufacturers of chips were so efficient and competitive that the price of a basic chip was now little greater than the batteries to operate the machine. Circuits of increasing complexity and greater memory capacity were being manufactured all the time, making the range of possible calculations ever wider. But manufacturers were not always sure what they could do with this low-cost computing power now that they'd got it. They had to examine the market closely to know where to go next.

An article in *The Financial Times* in 1974 discussed the problem: 'The margins on them [pocket calculators] even with basic circuit prices still falling or low-cost devices becoming more versatile, are contained by so many incompressible factors that it is preferable to

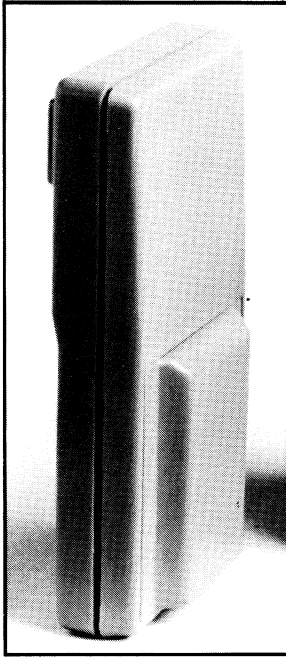

*The 'pregnant' Cambridge calculator*

concentrate on the potential of larger machines.'

In such a market it was obvious that companies who were – like Sinclair – in control of their own technology, were those most likely to succeed. They could provide for a few specialist markets, and develop quickly in any other direction that seemed appropriate.

Manufacturers began to see new outlets for their products, such as digital watches and TV games. The ordinary calculator, which had seemed such a marvel of human ingenuity only a few years before, was now unable to provide manufacturers with a living. However, Sinclair managed to stay ahead. Nigel Searle had moved to California in 1973 but he continued to work for Sinclair and spent some time developing a calculator with a company called AMI. The goal was a programmable calculator; once again the answer seemed to be to reprogram an existing chip, but it proved difficult to obtain all the desired functions and the idea fizzled out.

Finally, in August 1975, Sinclair launched the Cambridge Scientific Programmable. It could handle programs of up to 24 steps and was a major departure into advanced calculators. It cost £29.95. In the early part of 1977 a second Cambridge Scientific Programmable came on the market; a pocket-sized, single-chip machine powered either by a 9V battery or a mains adaptor. It sold for £17.22. As well as receiving a manual and twelve sample programs with the machine, the user could buy a four-volume library for £4.95, which gave an additional 294 programs. Each volume was devoted to a different use for the machine: finance and statistics, mathematics, physics and engineering, and electronics.

**NEW!**

**Sinclair Scientific Programmable.**

**For under £30!**

After four years of cut and thrust, the calculator market was pretty well spent as far as Sinclair was concerned – but not quite. Caught by the euphoria of the Silver Jubilee year of 1977, Sinclair produced the Sovereign, an attempt to escape from the bottom end of the maturing calculator market and re-enter at the top end. The Sovereign was one of the better engineered Sinclair calculators, and had a stunning visual impact. Designed by John Pemberton, it won a Design Council Award in 1977. It was available with a satin chrome finish or gold-plated; Aspreys even made two in solid gold! A great deal of effort went into its production but it was really too late to revive a dying market.

In a final bid for the market the PP3, or ‘pregnant’ Cambridge, was produced – so-called because of the bump in the back of the case which housed the battery. The PP3 was followed over the next two years by the Sinclair Enterprise, the Sinclair President and the Enterprise Programmable, but by the end of the 1970s Sinclair had lost its position in the calculator market.

There were several reasons for this. It was partly that technological development created cheaper and cheaper components which caused the price of calculators to sink rapidly. Eventually the margins were so narrow that it was impossible to make a profit, particularly in the UK. Heavy import duties were imposed on components – sometimes as much as 17.5% – while as little as 5% duty was levied on calculators imported from countries such as Japan or Hong Kong. The British manufacturers weren’t able to compete – such is the wisdom of the government.

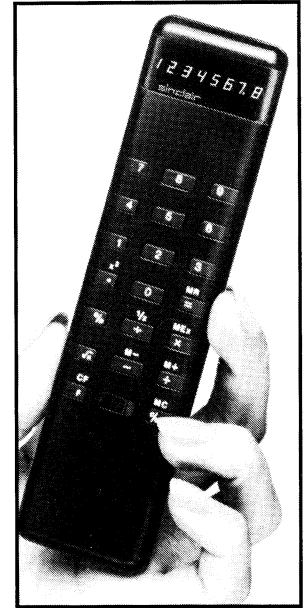

*The Sovereign*



*The President*

With hindsight, some people suggest that a Sinclair reputation for unreliable products had an adverse effect on the company's place in the calculator market. In fact, the reputation for unreliability was leavened by the no-quibble guarantee which kept people happy. I remember taking a calculator back to the Mill (anonymously) on more than one occasion; the surprise and delight I experienced on being handed a working replacement with a cheerful smile almost before I was through the door quite vanquished any memory of the feeling of annoyance at having to go there in the first place. But the Sinclair products were not up to competitors' standards and there were often delays in production and shipping, which did tarnish the Sinclair image a little.

The consensus is that it was the wrong choice of display technology which ultimately led to the demise of the Sinclair calculators. Although Sinclair had put some effort into developing LCDs (Liquid Crystal Displays) he eventually abandoned them in favour of LED (Light Emitting Diode) displays. LCDs would be more expensive because they had to be used with the new CMOS chips – which would have meant losing out to the cheaper Japanese models. The contrast ratios were not as good in LCDs either and LED displays (so their proponents rationalised) were more aesthetically pleasing. However, that wasn't quite the whole story; if the belief to which Sinclair clung – that people turned their calculators off between calculations – had been correct, LEDs might have remained in favour. But of course most people left their calculators on, and therefore needed to change their batteries far more frequently than they would have done using LCDs. Laziness was ever a hard taskmaster.



## The picture in your briefcase; when time stood still

# 7

From time to time in this narrative, like a faun a-peeping through the green, we have espied Sinclair's elusive shade, the miniature television. It is no surprise that, with his passion for the miniature, Sinclair should have turned his attention to television; what is surprising is that success eluded him for so long.

When he was working on *Instrument Practice*, finding out all he could about semiconductor devices, one of his topics of conversation was the possibility of building a miniature television set. One of my first jobs when I joined Cambridge Consultants full time at the end of 1963 was to search, on Clive's behalf, for a supplier of miniature television tubes with a screen 4cm × 3cm. I did obtain some sample glass 'envelopes' from Tony Krause of Twentieth Century Electronics, but as far as I know they were never equipped with any innards.

Whatever difficulties there were in producing an elegant circuit design were overshadowed by the difficulties of finding a miniature tube, and even miniature tubes still needed enormous power to run them compared with that needed by the rest of the set. Twenty years ago there was no low-power CMOS circuitry, and for continuous viewing batteries would have been needed which were larger than the machine itself. Typically, Sinclair's inventiveness lay far ahead of what was practicable. Not that this stopped him from pursuing the project; one of the first TVs they made used a sawn off bit of a Sony 5" tube with a home-made bit bolted on to it to produce a 2" diagonal picture. Sinclair went off to see what was happening in the Far East and returned to his designers with all sorts of interesting components and a number of the crucial cathode ray tubes from Hitachi. Jim Westwood, who had been concerned with the development right from the start, set to work, and by 1966 the team was ready to show a prototype Microvision, as the product was inevitably called. Sinclair Radionics booked a stand at the Radio and Television Show at Olympia and as the great day loomed nearer the team worked more and more frantically,

later and later into the night, to have a couple of sets ready.

Less than a week before the show was due to open – on the following Monday – some vital components still hadn't arrived. There's nothing you can do about exhibitions; like any other entertainment the show must go on, and many an exhibitor knows only too well the frantic preparation culminating in round-the-clock working and the final coat of paint even as the Minister of Technology is saying what a jolly good effort it all is, and cutting the ribbon.

This exhibition was no different; the vital components finally turned up on the Friday, and Jim Westwood went to work immediately. He worked throughout the weekend, hardly stopping to eat or sleep. But it was the first time that the various parts of the circuit had been put together and naturally there were some unpredictable incompatibilities to be ironed out before the sets would work. Sunday afternoon: still no pictures.

It was decided that Richard Torrens should set off for London on his own with the other products Sinclair Radionics was going to exhibit. Jim Westwood carried on working. At 3 o'clock on Monday morning he was ready to leave the lab; he called the taxi that was on standby and set off for Olympia. He had one Microvision working and another needing only slight adjustment.

The prototype Microvision was a 2" 405-line receiver which would handle all 13 channels in bands I to III. The speaker was a 2" piezoelectric transducer with an overall depth of less than 1/4". The set was powered by six pen light cells, and its total power consumption was less than 450mW, including less than 100mW for the tube heater. Its weight, including the battery, was 10½ oz. The cathode-ray tube was designed by Twentieth Century Electronics;

*Prototype Microvision*

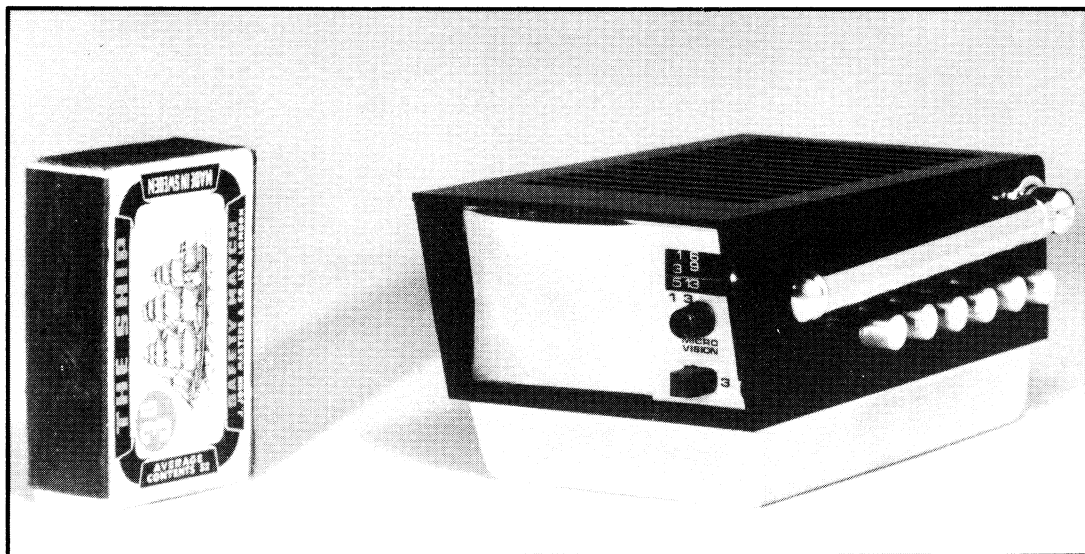

using magnetic deflection, it was just over three inches long, and there were some problems both in handling it and in assembling the set so that the spot would remain adequately focussed. Rather than using an integrated circuit, which would have been ruled out by the additional heavy investment needed – for had not Sinclair already invested heavily in the tube? – the Microvision contained 30 transistors and other discrete devices assembled together in a three-dimensional package. The packing density was incredible: components stood on end where there happened to be convenient holes, otherwise they lay down. Its design made the Microvision very difficult to test, service and repair.

And it had an interesting side-effect. Chris Curry saw an example of this marvel of compactness sitting on the bench, and, with natural curiosity, picked it up. OUCH! The set was switched off, but its EHT capacitors were charged up to 2,000 volts. Fearful of the consequences of dropping it, he tossed it into the air and caught it. OUCH! The process continued until all the capacitors were empty.

Despite its obvious shortcomings, the Microvision was the star of the 1966 Radio Show. Three girls, dressed all in silver – Clive's sister Fiona, his sister-in-law Carol, and Sally Willey – ensured that no one missed the Microvision, and would have distracted the attention of the visitors if the sets had packed up. They didn't pack up. A few orders were placed by the intrepid in the expectation that the set would be on the market the following year, priced at £57.45. But it was never really ready to be launched; the few orders were never fulfilled.

This was partly because of the difficulties in manufacturing the tube and partly because of a fundamental design change: silicon transistors had just become available and were obviously going to be cheaper and more stable than the germanium transistors used in the Microvision. It seemed eminently more sensible to carry out further development before going to the market-place again.

Throughout the early and middle seventies there were reports in the press that the design of the Sinclair television was nearly complete – and usually about a year from production. Rumours were rife; the TV became smaller and smaller, and one report even suggested that Sinclair was really working on an eye-level television that could be worn like a pair of spectacles!

The two overwhelming problems in developing a small television are the circuitry and the tube, which doesn't leave very much to achieve without effort. In 1973 Mike Pye left Texas Instruments – where he had been working on integrated circuits – to join Sinclair Radionics. He was to be research and development controller for new projects; new projects included a 2-inch screen portable television. Technology transfer: Pye knew about the right kind of integrated circuits so it was now a matter of finding the

*The coffin tube*

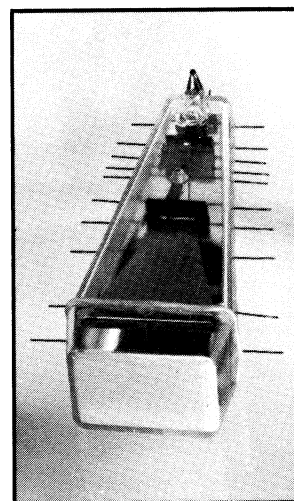

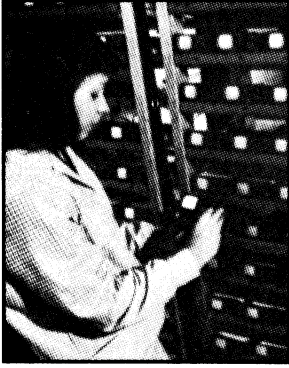

*Soak test for the daily batch of Microvisions*

right kind of tube. He rediscovered Tony Krause, who was by then Chief Engineer at Twentieth Century Electronics, and who had been developing a tube for a flat screen television.

Sinclair was impressed with Krause's work, and it wasn't long before he left Twentieth Century and joined Sinclair Radionics as a consultant. Tony Wood Rogers joined at about the same time, also to help develop the cathode-ray tube.

The first outcome of this collaboration was the 'coffin' tube, which was about 6 inches long and presented a picture about the same size as a 35mm slide. The glass envelope was formed from three pieces: the front cap, the top, and the bottom: in shape, it resembled a coffin.

It was a low-power electrostatic tube with the electrodes mounted on long wires held in place by a frame while the three glass mouldings were fused around them. Positioning the electrodes accurately needed the skill of the watchmaker. And when the tube had finally been assembled and pumped out, the components were mechanically very resonant; as you might imagine, if you tapped the tube the spot would swing all over the place.

Eventually Clive was forced to call it a day on the coffin tube. It was a fine design, but far too difficult to manufacture. In fact, apart from the prototypes, none was ever produced. However, as Sinclair has remarked: 'I have an appalling habit of believing I'm right, and once I decide where I'm going I'll get there, come what may, however much I'm drawn off course by circumstances.'

Where next to look for a tube? Sinclair found that ITT had been working on a TV project in the late 1960s, for which AEG Telefunken had been experimenting with low power consumption tubes. They had a number of interesting designs, and after some discussion agreed to help to develop a tube exclusively for Sinclair Radionics. Their investment in the development was eventually about £200,000, not to mention the £25,000 they paid Sinclair to help fund their part of the development. The outcome of this work was that the TV1A – the new Microvision – was launched in 1976, ten years after the original model had been shown at the 1966 Radio Show.

The TV1A was aimed at the international business market, mostly because of the price – £250 – while the up-market version, complete with power supply in a lined case was £650 from Harrods and Fortnum & Mason. The set was 4" wide, 6" deep, and 1.5" high. It operated either from rechargeable batteries or from the mains. The black-and-white picture could be viewed comfortably from about a foot away. It functioned on VHF and UHF bands and was the first-ever multi-standard receiver, which meant that it could be used in nearly every foreign country – as long as the



country used one of the three major TV standards. It weighed some 26 ounces.

The key component was the 2-inch tube manufactured by AEG Telefunken. The body of the tube was pressed glass made of two halves split longitudinally. There was no internal graphite coating; instead a metal shield was used to collect the beam current – the swinked electrons which in their prime had caused the screen to fluoresce.

The bulk of the electrical circuit was contained in five bipolar ICs, three of which were custom-designed for Sinclair Radionics. The TV1A was significant not only because of its size but also because Sinclair was no longer taking available component hardware and adapting it; he was now taking tricky design problems by the horns. The TV1A's integrated circuits, tuners and tube were nearly all designed from scratch. It augured well for British electronics.

By this time Sinclair Radionics had a large export market, primarily because of the calculators, so it was not long before the TV1A was being offered in Germany and the States. In fact Jim Westwood had taken an American version of the 1966 Microvision to the States in 1968, but it hadn't worked very well and the Americans had not been particularly impressed. However, there was no reason why the Americans should have remembered that Microvision, and once the TV1A had been launched in the UK, it was decided to display it at an exhibition in Chicago in January 1977. This event is photographically lined on the tablets of Jim's mind because no one in the company had appropriate export experience at this stage, and it was not until 15 December that he was told that to go on show in the US the TV would have to undergo tests for approval by the Federal Communications



*Daily Mirror 8 August 1977  
'Here comes the TV detector van, Arthur, you'll have to swallow it'*



*The new, UK-only  
Microvision*

Commission and the Department of Health, Education and Welfare in the US to ensure that no one would be X-rayed or suffer from electrical interference. Clearance normally took between three and six months! Luckily, the Electrical Research Association at Leatherhead agreed to test the Microvision just before Christmas, and Jim Westwood recalls stumbling around in heavy snow and failing light at an RAF test range; as the day merged into night, the tests were carried out with the help of car headlights and torches. But it was all worth while; approval was granted just in time for the exhibition.

The TV1A went on sale in the United States for \$400. Although orders began to come in, it was fairly obvious that to sell enough sets to cover development costs Sinclair would have to lower the price. As one magazine pointed out 'At nearly £10 an ounce it would be a third of the price in solid sterling silver'!

This time, the Americans were impressed. In *GADGET*, the newsletter for grown-up kids, 'A.G.' reported on the Microvision he had bought from Abercrombie & Fitch, New York City, for \$400.



## THE SET THAT STOLE THE SHOW

THE SINCLAIR MICROVISION POCKET TV RECEIVER provided a world wide sensation when shown for the first time at the recent 1966 Radio and TV Exhibition. This fantastic British set tunes over 13 channels on bands 1 and 3, operates from six self-contained "Penlite" batteries and measures only 4in. x 2½in. x 2in. Despite the minute proportions of this 30 transistor receiver, quality from the exclusively designed tube and loudspeaker is superb. This amazing Sinclair triumph will be available early in 1967 at a cost of 49 gns.

**SINCLAIR MICROVISION**  
The world's only pocket T.V.!

'I felt like a kid awaiting Christmas morning. Finally it came: the most exciting and ballyhooed new toy of 1977, the *Sinclair* pocket TV set. I rushed out to buy it the minute it became available in New York, even though \$432 (including sales tax) is a hefty price for a black and white television.

'The set is as revolutionary as all the advanced blurb indicated. But before the praise, let's first get its defects out of the way. My original unit broke after three days, when the tuning control jammed. Thankfully, *Abercrombie & Fitch* has one of the best return policies in Manhattan so the store gave me a brand new set on the spot rather than giving me the discount-store runaround by forcing me to wait for repairs.

'My replacement set is not without other flaws. For instance, in a car the picture is far from stable; it tends to roll around. (New York City's skyscrapers contribute to this, no doubt.) Also, the set has a 15-second warm-up period. Another irritation is that the tuning device is incredibly slow-moving. One final gripe: when the set is plugged in for recharging, there is no visible glow light to verify that recharging is taking place. But despite these nitpickings, any *GADGET* reader who doesn't buy a *Sinclair Microvision* simply cannot afford to.'

But A.G. – clearly an indefatigable gadgeteer – then sets out to extoll the virtues of his set:

' . . . Another great capability is that this is the only set that can receive throughout the world, wherever there is a television signal. According to the company, it is the only such multi-standard set available today.

'The best thing about the *Sinclair Microvision* for *GADGET* readers is that, in spite of its smallness, it's conspicuous. Wherever you are – buying a beer, having a cup of coffee, or simply sitting on a park bench – people will come over and ask questions about the set. It's like being the first kid on the block with the Captain Midnight Decoding Ring – you're the center of attention. After all, isn't that why you're a Gadgeteer?'

'On the more practical level, the *Sinclair* does plug you in to the world of not-to-be-missed TV shows. Sure, some of you *GADGET* readers have video equipment that can tape a show you would otherwise miss, but with the *Microvision* you can watch it as it's broadcast wherever you are. Ironically, I got my *Sinclair* one day after the New York City blackout in July. If I had had it earlier, I could have watched the goings on in the city while my electricity was out, since NBC and CBS continued broadcasting on emergency generators.'

And A.G.'s conclusion?

'Clive Sinclair, president of the company that makes the *Microvision* can be proud of his accomplishment. Although we cannot give this set unqualified praise, we still think it is an exciting contribution to our lifestyle, and we recommend it to *GADGET* readers. If you purchase your set from a top-notch store with a good record of replacing defective items, you will be thrilled to own this electronic miniature.'

'Hopefully, within the next two or three years, *Sinclair* will bring us a pocket set that will enhance viewer pleasure even more by including a color picture tube.'

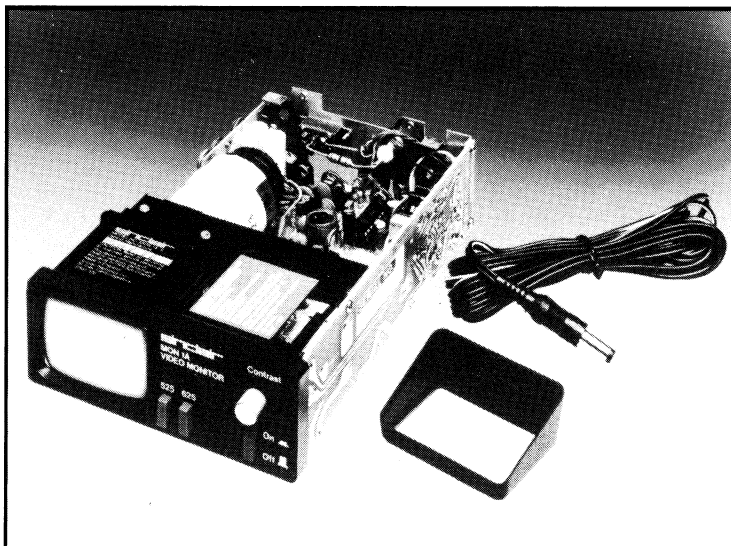

*The Sinclair Video Monitor  
MONIA*

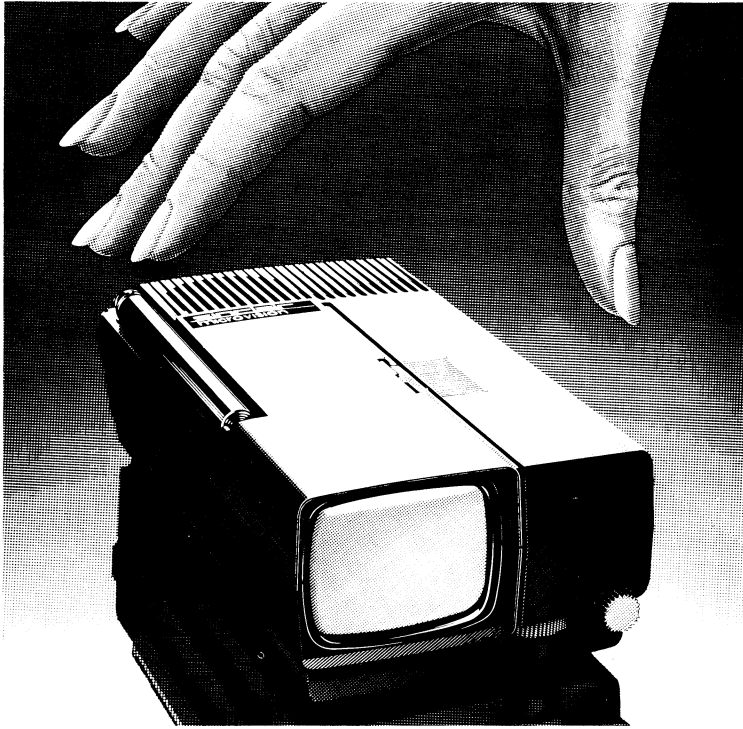

## Microvision – pocket television. From Sinclair for just £99<sup>95</sup>

There's television. There's portable television. And there's Microvision – *pocket* television, different from anything else in the world.

Microvision works on alkaline penlight batteries. It has its own aerial for all BBC and ITV stations, and a built-in loudspeaker. It has an adjustable stand, a plug-in ear-phone, a screen hood, and a carrying case.

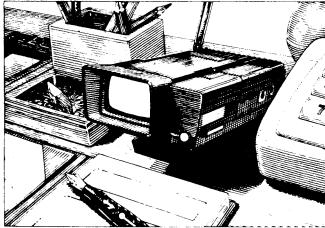

In the office, Microvision brings news, budgets and business programmes right where they're needed!

It's the simplest possible way to watch sport, news and entertainment; indoors, out of doors; at home, in the office, on holiday.

**The 2-inch screen that's as clear as a 21-inch screen.**

You watch your household TV from ten to fifteen feet away. You'll watch Microvision at normal reading distance. So, to your eyes, the two-inch screen is as big as a full-size screen. And the picture quality is unbelievably bright and sharp.

**Pocket TV—the idea that's here to stay.**

It's hard to imagine life without transistor radios, or pocket calculators. Yet only a few years ago, they were ideas as breathtaking as pocket television. Soon, Microvision will be just as much part of everyday life.

Yet this world first for Britain costs under £100 – very little for a concept which can transform the way you live.

**Microvision – for the first time, television the way you want it, wherever you want it.**

 **sinclair**  
World leaders in fingertip electronics

Sinclair Radionics Ltd. Tel: St Ives (0480) 67414

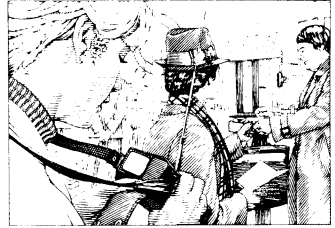

Take Microvision to the races, to football matches. Get a grandstand view, wherever you are!

See Microvision at: Boots Department Stores, Camping International, Currys, Dixons, Eurocaltel, Fortnum & Mason, Gailey Caravan Group, Harrods, Kendal Milne, Rackhams, Selfridges, Vallances, Wallace Heaton, also at selected branches of: Alders, Beatties, Binns, Chiesmans, Citer, The Co-op, Dingles, House of Fraser, NEEB, Owen Owen, RSC, SEB, Underwoods, and many local stockists.

Unfortunately, the price was governed by the cost of the special circuitry that enabled the set to work on several different transmission standards and consume less power, so there was no way of lowering the price on that particular model. There were also the inevitable production difficulties, although the sets that were sold generally worked perfectly. Sinclair had already learned the importance of quality control; a sample from each batch of televisions underwent rigorous tests before the batch was released.

There was soon an adaptation of the TV1A on the market: the monitor Mon1A. The principal user was a company called Bywood who used it as a tiny monitor with a display of 10 lines with 15 characters. It had an extremely rugged case, as used in police walkie/talkies. Sales of the Mon1A were small but consistent, and continued for a number of years.

Sinclair was determined to make the TV1A as small as possible because: 'This is a pocket portable; if you can't get it in your pocket it's not a pocket portable'; once again, the components were tightly squeezed into the space available, and this made it difficult to manufacture. There was a very small clearance between the PCBs – which sometimes carried quite a high voltage (up to 2kV EHT) – and the case. It was therefore necessary to put an insulating layer inside the case, but when it came to assembling sets there were problems in getting the case sleeve over the innards and, if the insulation ruptured, short circuits were inevitable. It was really only a matter of a fraction of an inch, but by the time anyone realised the difficulties it was too late.

However, the company managed to bring the output of the TV1A to about 4000 a month by the Christmas of 1977. There was now a labour force of 150 in the factory at St Ives, half working on TV1A; 75% of the output was exported, chiefly to the United States.

Meanwhile, development was pressing on with the next model, the TV1B. John Lawton, who designed its sound system, remembers: 'It was hell in the production department, I kept my nose out of there, there was too much going on. They had a flow-soldering machine which cooked the boards being used for the TV1A. These were very thin SRBP boards and someone would turn the temperature up too high occasionally, which warped the boards and made inserting them into the case even more difficult.'

The TV1B was known as the 'plastic box TV'. It was designed for automatic production and very low production costs. In the TV1A all the components were inserted manually into the five PCBs, using overhead projectors. In the TV1B the main circuit fitted on to a single PCB which was double-sided and through-hole plated. This more expensive technology, which was new for Sinclair, allowed a much higher component density and automatic

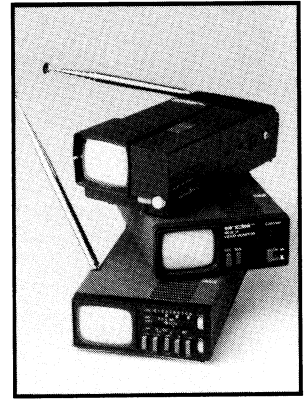

*Microvision in use – 1*



production. The other PCB was a new high-tech UHF stripline tuner. The prototypes were built in Radio Spares plastic boxes.

The first version was for the UK only because a VHF tuner, which was not available at the time, was not needed. It used the same video ICs as the TV1A but the sound system was reduced from two ICs to one. The speaker was made in Taiwan and was much smaller, and there was a new AEG high brightness tube. It had an automatic brightness control but produced an inferior picture because there was no black level clamping. The power consumption had been reduced so that the set would work on four calculator batteries (HP11s) which could be replaced or recharged. It would run for about eight hours per set of batteries, which meant that it cost 12p an hour to run.

The TV1A had had a metal sleeve case with plastic ends and this had caused some of the shorting problems; the TV1B slipped into a plastic box which, once tooling costs had been met, would be much cheaper to produce and could never cause short circuits.

*Microvision PCB assembly at  
St Ives Mill;  
Pam MacPherson (ex-AIM)  
stands on the right*

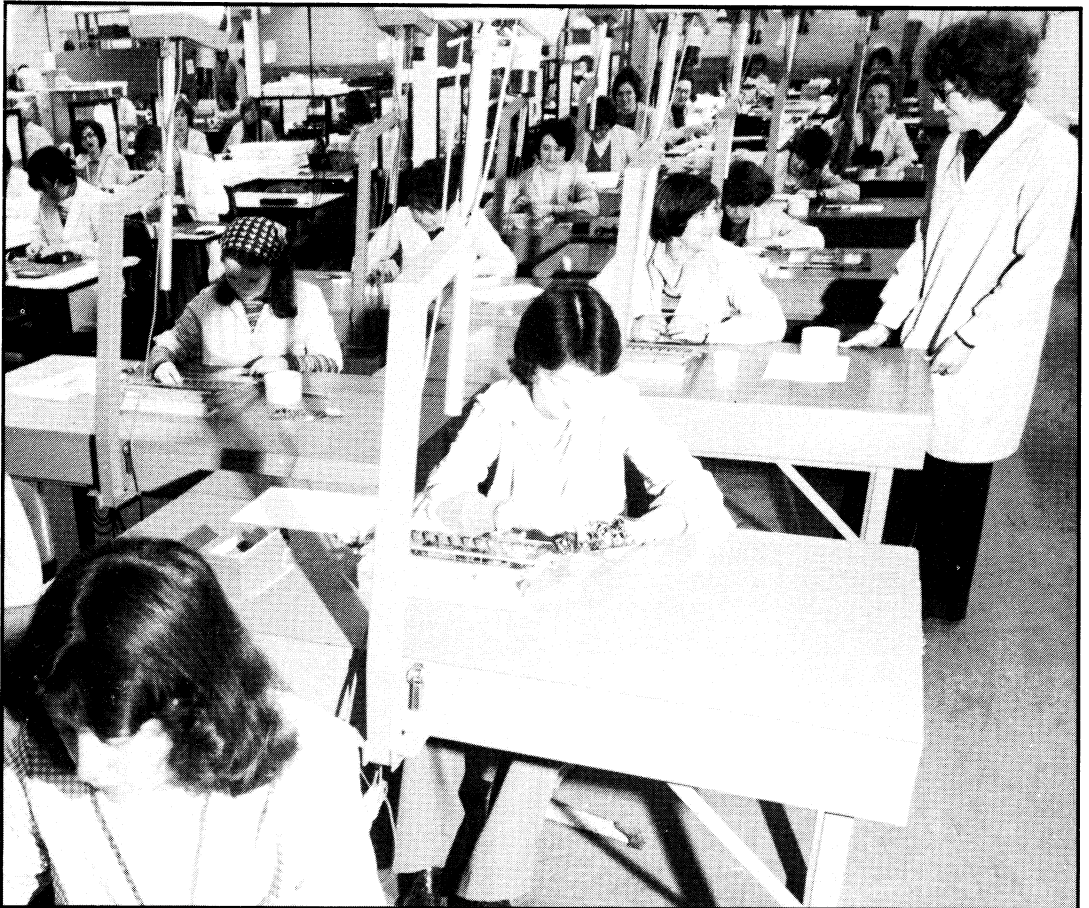

Both the TV1A and the TV1B used most of their power consumption for sound; the TV1A used about 100mW without sound which isn't all that much, though it could be used quite effectively as a torch. Although the TV1B had a one-inch speaker, it still used a lot of battery power for the sound; both sets were better if they were used with earphones.

The TV1B was finally launched in the autumn of 1978 at the Roof Garden of the Hilton in London. For the American market a VHF tuner was necessary; the one on the TV1A was insensitive so a new one was developed. This model went through its FCC tests and was called the TV1C. It went on sale in the US but not for long; for the TV to be a success a mass market was essential and this meant more than the UK or even the US, but Europe as well. In Europe there was a different sound frequency so the design of the TV1D was put in hand. Unfortunately, for reasons which we will come to later, the marketing effort was never sufficiently wholehearted for development costs to be recovered. Sinclair Radionics particularly needed the TV to be a success, because it was seen as the one product which had the potential to generate cash, for which Sinclair was now becoming increasingly desperate.

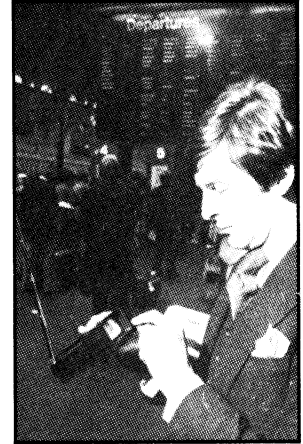

*Microvision in use – 2*

It was Saturday lunchtime at *The Plough*, Fen Ditton. 'Look at this', said Sinclair, prestidigitating a little case out of his pocket. There inside was something which looked like a black plastic watch without any face or hands. He pressed a button: it was 12.37. 'What do you call that?' we asked. 'Oh . . . The Black Watch, of course' he said. Everyone fell about.

And, indeed, Sinclair Radionics might have survived the losses accruing from the dying calculator market had it not been for that trendy-looking quartz digital chronometer which was wont to behave as though telling the time were not its prime purpose.

The company had high hopes that the profit on The Black Watch would outweigh the losses accruing from the calculator price-war . . . but announced in November 1975 with a major advertising campaign, The Black Watch seemed doomed from the start.

Certainly the original design was sound, and the market was there. The Black Watch was – for those days – an unconventional-looking timepiece, moulded in black plastic with a five-digit LED display. Inside it was a chip, a quartz crystal, a tantalum capacitor and a ceramic trimmer on a flexible printed circuit board – and the batteries. It had three buttons: one at the back for setting which, pressed in combination with one of the two buttons at the front, advanced the hours or the minutes. Used alone, the buttons on the front would display hours and minutes or minutes and seconds; the sleek, black appearance of the watch when its four LEDs were not draining its battery was a virtuous necessity.

Nothing like it had ever been seen before: Sinclair was even invited by the Swiss Horological Society to exhibit at the Royal Watch Fair – a first for any company outside Switzerland.

The watch went on the market for £25. There was also a kit version at under £15. But Sinclair was let down partly by problems of moulding the case and partly by the company who were supposed to be producing the chips. At first, it was Mullard, but they aborted the project without giving any reason for doing so from that day to this, although Sinclair thinks it was ‘a direction from above’. The next supplier was ITT Semiconductors who tried very hard, setting up a line dedicated to making the chips, but when they hit a series of production snags they forgot to tell Sinclair. If you know something is going wrong you can take steps to overcome it; if nobody tells you, you tend to assume that all is well.

When the chips finally started to come through, Sinclair had lost two years, and his place as potential world leader – there were now similar watches on the market at a similar price. For once he was not ahead of the competition – and there were still problems with the product. Nevertheless, Sinclair Radionics announced that they still expected to win 30 per cent of the UK digital watch market in 1976.

In June 1976 *Practical Wireless* published an article on assembling the Black Watch kit, which throws light both on the kit and on the sort of people who read *PW*:

‘For the temporary connection of batteries, Sinclair advise the use of a “Bulldog” clip, but it was very easy to short the batteries accidentally and almost impossible to hold two batteries, a flexible printed circuit and a Bulldog clip in the correct positions, all at the same time! This difficulty was aggravated by a tendency for one digit of the display to light up as soon as the batteries made contact. The instructions said that this might happen and that the remedy was to interrupt the battery supply. Then, of course, the clip, the batteries and the flexible printed circuit tended to part company once more! The problem of accidental short circuits was cured by using insulating tape on one jaw of the clip, but the operation remained very difficult to carry out.’

The idea of using two wooden clothes pegs (of the spring type), two drawing pins and a piece of insulated wire solved the problem. This enabled the batteries to be fitted one at a time and made the procedure comparatively easy. The adjustment of the watch took some four days to accomplish, but was not difficult, rather tedious through having to wait four days before being able to complete the watch.

Clothespegs aside, although the fundamental design was good the manufacture of the watch presented difficulties. Although the Sinclair Digital Multimeters were undergoing environmental



## The Black Watch. By Sinclair. £24.95.



### A new order of accuracy. A new level of elegance. How right you were to wait!

The Black Watch is a quartz controlled electronic digital watch. It works on a principle utterly and totally new in the history of time keeping.

Before it, the accuracy of a watch was controlled by the precision with which its mechanical parts could be made. The greater the precision, the greater the expense. A watch that offered the high accuracy was very expensive indeed.

True, there have been digital watches for years—watches which displayed figures, instead of moving hands. But they were mechanical.

True, there have been electric watches for years—watches which replaced a hand wound mechanism by a battery powered electric motor.

But none of them resembles the new electronic digital watch, which uses a quartz crystal and integrated circuit technology to control a light up digital display.

#### How the Black Watch works

Stimulated by the current from the batteries, the quartz vibrates and generates a very precise and even micro current of its own.

The integrated circuit—a piece of silicon just 3 mm square, carrying over 2,000 transistors—receives the frequency of this micro current to exactly 1 cycle per second. It uses this signal to count non-stop through seconds, minutes and hours.

If that sounds technical, think of the outcome: a watch with no moving parts, a watch with nothing to go wrong, a watch which gives an accuracy never achievable by the most precise mechanical engineering.

#### Why the Black Watch is unique

It's unique in the way it's built. The Black Watch is the only watch to use a single integrated circuit, a circuit designed by Sinclair, and exclusive to Sinclair. Using just one circuit dramatically increases reliability.

It's unique because Sinclair guarantees an accuracy within a second a day in normal use. Anything worse, and we replace your

watch free. (In fact, typical accuracy is far better, at around a second a week.)

And it's unique in its styling: a cool, black bar with no fussy knobs or buttons.

To tell the time, you simply touch the case and the display lights up to give you hours and minutes, or minutes and seconds.

It runs for up to a year on cheap batteries which you can easily replace yourself.

Like all Sinclair products, it's designed and built in Britain, and carries a 1 year no quibble guarantee.

Watches built on any other principle cannot match the accuracy of The Black Watch. And no watch in the world can match the elegance of the way it's styled.

**Touch and tell!**  
Touching the case of the Black Watch instantly gives you hours and minutes.



or minutes and seconds



No fussy, fussy knobs or buttons

### 10-day no-obligation offer.

The Black Watch is exclusive, though not expensive. The design is very advanced, and we believe that you should have every opportunity to see it and wear it without commitment.

You are therefore invited to try it on a 10-day money-back undertaking. It's not every day's watch, and we shall fully

understand if you eventually decide you would like something more conventional.

To try the Black Watch, simply fill in the FREEPOST order form below and send it with your cheque, or your Access, Barclaycard or American Express number. We'll send you a Black Watch direct. Or if you prefer, phone your credit card number to Ann Dent at St Ives (0480) 64646.



Sinclair Radiomics Ltd.  
London Road, St Ives, Huntingdon,  
Cams., PE17 4SH.  
Tel: St Ives (0480) 64646.

**sinclair**  
The picture in your briefcase; when time stood still

To: Sinclair Radiomics Ltd. FREEPOST, London Road, St Ives, Huntingdon, Cams., PE17 4BR

I am interested in trying the Black Watch

Please send me (only at £24.95 inc. VAT) with wear tested matt black strap

Please send me (only at £26.95 inc. VAT) with matt black stainless steel bracelet

I enclose cheque no

for £

\_\_\_\_\_

Address \_\_\_\_\_

\_\_\_\_\_

Signature \_\_\_\_\_

FREEPOST (no stamp needed)

Please debit my Access, Barclaycard or American Express account number

\_\_\_\_\_

\*Please enclose as application for a new or existing Access, Barclaycard or American Express number. Authorisation supplied by the issuer. Under no circumstances will we be responsible for any loss or damage to your card or account.

\_\_\_\_\_

\_\_\_\_\_

\_\_\_\_\_

The Black Watch is available from a few selected stores: Fortnum & Mason, Harrods, Selfridges. Also available from Greens, Henrys, Lindas, Laskys, Lewis's, M'Dermid, Pyram, Utterwinch.

testing, nobody seems to have thought of applying the same developmental rigorousness to The Black Watch. The chips had been tested during the winter, when the atmosphere was damp, but when the watch went into production in the summer it was found (eventually) that the slightest static affected the chip, making it stable rather than unstable. Instead of continually vibrating (as it should to jog the time along) the crystal froze; the display would show just one – extremely bright – digit, while the batteries drained and became hot – until sometimes they exploded. Fortunately, it seems that no Soviet dignitary ever had a Black Watch!

The batteries themselves were a problem. The first batteries were the same as those generally used in hearing-aids; they had a ludicrously short life span of the order of ten days, and it was hardly surprising that by the time customers received their watches the batteries were generally dead. So the watches came flooding back to Sinclair Radionics – often more than once which probably gave rise to the legend that the company received returns



far in excess of the number manufactured. It seemed that the only watches not returned were those thrown away in sheer frustration.

Apart from problems with the circuit and the batteries there were hitches in the design of the mechanism to switch from one function to another. Frequently it was impossible to change the function – or even to set the watch to the right time!

The plastic casing also caused difficulties. The original case was made of a plastic which turned out to be unglueable, so the parts were designed to clip together. The glue hadn't worked; the clips didn't work either. The subcontractor who was asked to solve this problem eventually sent Jim Westwood a small box on which was written 'We've solved the problem of The Black Watch!' Inside was a Black Watch with a half-inch coach bolt through it.

Gradually the difficulties were diagnosed and overcome. Silver oxide batteries replaced the previous mercury oxide batteries. Mike Pye and his engineering team devised a foil screen to protect the circuit from static. But *Practical Wireless* had this to say:

'Trying to fit the watch into the case was where the problems really started. The PCB assembly was too thick for the space available and there were two reasons for this. The impression was that the flexible copper screen had not been part of the original design; the instructions for the fitting of this screen were separate from the main assembly instructions. The two thicknesses of screen obviously reduced the front-to-back clearance between the PCB assembly and case. However, the main reason for the difficulty was that the soldered joints were protruding too far from the PCB. The importance of making very small solder joints had not been emphasised sufficiently in the instructions, which merely called for the use of a fine-tipped soldering iron, and "small wire cutters capable of cropping within ½mm of the PCB".

Sinclair have since stated that an improved IC is now being supplied which is free from any effects due to external static. The insulated copper screen is no longer necessary.'

Then another problem arose. It had been decided to manufacture the watch in-house. Hundreds and thousands had to be made to supply new orders and to replace the dud ones already sent out. Hundreds and thousands of returned watches had to be repaired. There were only about twenty people to do all this. Components flooded into St Ives and piled up.

David Park (then sales director) remembers one day delivering 5000 replacement Black Watches to somewhere in Scotland. The following day, another replacement order for 5000 watches had to be delivered in the South. None of these was making the company any money. Staff were working all hours; they just couldn't cope.

By the end of 1976 the watch was working, but by then the public didn't want to know. The Black Watch contributed to a Sinclair reputation that still lingers. Richard Brooks wrote in *The Sunday Times*: 'Is not Sinclair a company which has great ideas, which is smart, innovative, but is it not a company which fundamentally keeps producing great ideas and then fails to exploit them properly?' It's an observation with a disturbing amount of truth in it.

Eventually the problem of The Black Watch was solved by putting the single chip into a completely different case and marketing it as a slim and elegant car clock which sold very well – without doing much for the cash-flow problem at the time.

When I was researching this book I went through a Sinclair archive box with Jim Westwood. We found one of these clocks, pressed the button, and there was the time. It was still working perfectly after nearly ten years!

'Why', you may well ask, 'was The Black Watch released in so imperfect a state?' The problem was that it was a seemingly simple product (compared with the Microvision) on which Sinclair Radionics had pinned their hopes as the calculator market stagnated. One can sense the mounting panic with which orders for Black Watches must have been filled: 'Let's send them out quickly in case they're working when they arrive; anyway perhaps they won't be sent back . . . ' When a man knows he may go broke in a fortnight, his mind scoots off in all directions at once. Cash was flowing like anything, all in the wrong direction. Immense sums had been invested in the Microvision; further immense sums were likely to be needed to push it laboriously up to that corner just round which success always lies. Without further investment, the price of the television could never be brought down. Where was the money to come from?

*The Sinclair Microquartz  
timepiece*

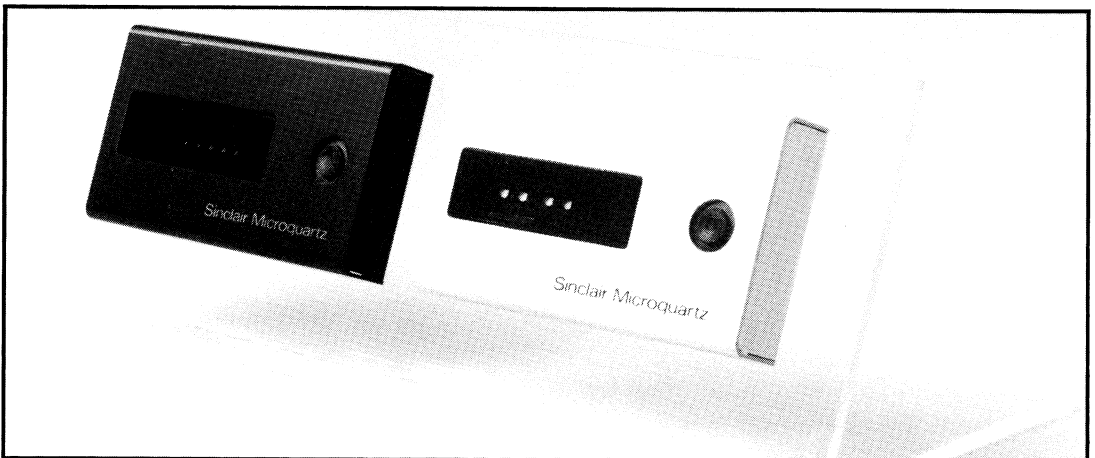

## 8

## The NEB saga

As 1976 drew to a close the feelings of panic at Sinclair Radionics were rising. The calculator market was inspissating, The Black Watch was more trouble than it was worth, the television needed more investment. Those in the know lived in constant fear of the receiver walking through the door and freezing the whole operation. Christopher Lorenz wrote in *The Financial Times* (24 November 1976), commenting on the fact that large US companies were also feeling the draught:

‘Clive Sinclair’s £6M company has been a David among several extremely hungry Goliaths, all of them competing hard for a slice of an extremely attractive cake – and ready to attack each other brutally in the process.’

Not a sentence which bears much analysis, but we see what he meant.

‘Mr Sinclair says he was prepared to postpone next year’s launch of the two-inch TV – though he and the company have worked on it for years, believing it to be a potential money-spinner.’

Sinclair prepared to postpone work on the TV? About as likely as Captain d’Ascoigne giving up command of his sinking ship. Perhaps the surprise is that the company continued as long as it did without outside assistance. It had a small capital base, an overdraft limit of only £250,000, a relatively narrow product range, and was still spending proportionally more on research than its better-cushioned opposition – a consequence of the force that drives Clive Sinclair.

At the year ending April 1976 Sinclair’s accounts showed a loss of £335,000. The TV1A was launched in an attempt to recoup



*Clive Sinclair*

*The portraits in this chapter are taken from an NEB report dated November 1978*



*John Nichols*  
technical director



*David Marshall*  
marketing director

some of those losses, but the price was too high to bring in the hoped-for profits. It was the well-known problem; with further development the price could have been brought down, but by this time the funds for such development were just not available.

But there were other problems. The company had grown very quickly – too quickly. There was no real management structure, and though Sinclair is the first to admit that management was – and is – his weak spot, self-flagellation is no solution to such a fundamental problem. He had not seen the need to reorganise the company as it grew, and if anyone else had the news, it had been kept secret. Sinclair knew little about managing people, production lines and stock control; he was trying to be in charge of everything himself: design, development, manufacturing and marketing. The company structure was not so much a squat pyramid as an inverted T.

‘If I couldn’t trust myself, how could I trust other people?’ Thus Sinclair ‘explains’ his inability, his failure, to delegate. He should have concentrated on what he excelled at – generating ideas and developing them – and given the responsibility of management to others; so easy to see in retrospect, this must have been less obvious at the time.

Development of the TV1A continued throughout the summer of 1976; by the autumn the choice was between scrapping the development programme – of a project which had been so close to Sinclair’s heart for so long – and seeking outside help. Given the choice, he was prepared to seek outside help in order to protect the hard-won technology, and enable it to be pursued.

The bank was not prepared to extend the company’s overdraft limit. There were two ways of remaining in business. The calculator and instrument side was still in good shape and it would have been possible to scrap the watches, television development programme (which for years had consumed most of the company’s R&D effort) and to sack about half the staff. Brian Turnbull, then financial director, had recommended this course, and it would have left the company profitable and with an instrument range offering great possibilities for expansion. The alternative was to continue with the TV development programme, recognising that this meant the company running at a loss, and to raise money by selling part of the equity. Sinclair found little excitement in the instrument range, and every hope in the TV. He began to approach sources of finance such as Charterhouse and TDC (Technical Development Capital – itself a part of what until recently was called ICFC – Industrial and Commercial Finance Corporation). Then, through Rothschilds, the merchant bankers, he was put in touch with Arnold Weinstock’s giant, General Electric Co – and the National Enterprise Board, a finance organisation set up by the government for the purpose of buying stakes in crucial areas of

British industry in order to fight off foreign competition.

Charterhouse was not a particularly good choice since their policy had always been to invest in companies with a record of consistent success – the Matthew effect.\* GEC also gave a negative answer. TDC management wanted to carry out a lengthy investigation before committing themselves; Sinclair did not have the time to wait. The NEB had been in operation for a relatively short time and Clive hoped that their freshness – and their mandate – would enable them to make the quick decision he so sorely needed.

By the time the NEB investigation started, the financial losses had reduced the nett book worth of the company, but the accounts placed no value on the company name, or – more importantly in Sinclair's view – on the potential of the television. In 'selling' Sinclair Radionics to the NEB, he was quick to point out that the TV project had involved state-of-the-art developments in several distinct technologies at the same time, and had been completed (totally successfully, he thought) after ten years of effort and at a cost of about £2M in real terms. 'We could sell it to an American company for several million pounds', levered Sinclair. 'However,' he continued, 'this would mean the project going abroad, and I'm most anxious to see it stay in England.'

At the end of their three-month investigation, to Sinclair's great relief, the NEB agreed to back the company with him remaining as chairman and chief executive. He called the senior managers to his office and explained what had happened; what was happening. Many people felt desperately sorry for Clive Sinclair; he had worked harder than anyone to keep the company – his company – afloat.

The NEB bought a 43 per cent interest in the company for £650,000, which valued it at £1.5M. Shortly afterwards, Sinclair concluded a separate agreement with the National Research Development Corporation (NRDC), who agreed to provide £1M over a period of some four years to develop the flat-screen television which Sinclair saw as the next jump in the TV market. The main funding was for the development of the flat-screen tube itself, so that it could be manufactured in Britain.

There were several reasons why the NEB decided to back Sinclair. The Board had been thinking about investing in companies such as Plessey and Ferranti; on the other hand Sinclair – the market leader in British calculators – could prove an invaluable weapon for fighting foreign competition.

But that was not all. At the time of the negotiations, Sir Leslie Murphy was chairman of the NEB; he had great faith in Sinclair, and believed that the future of the British television industry lay in the flat-screen tube. As Sinclair later put it, Murphy did not back

*\*'For whosoever hath, to him shall be given, and he shall have more abundance; but whosoever hath not, from him shall be taken away even that he hath.'* – Matt 13:12

SRL because of its products – more in spite of them, for it was the future rather than the present in which he was interested. It was largely because of his support that the NEB went ahead, though of course there is no question that the NEB believed that they would make a return on their investment. When Sir Leslie Murphy retired, Sinclair lost a powerful ally.

Unfortunately, the injection of NEB funds came too late. Sinclair Radionics could not make enough money to cover its costs, let alone make a profit. Only three months after the NEB invested, the market for calculators volatilised so dramatically that the company was once again in difficulty. Sinclair, which had opened the market for the low-priced pocket calculator for all, now found that market flooded with models at incredibly low prices – mostly from Japan. Profit margins became narrower and narrower, until they became losses.

Larger companies than Sinclair Radionics who were in the calculator market sustained heavy losses too; the difference was that they were better able to afford them. Nevertheless, the NEB made Sinclair the scapegoat for the behaviour of the market, and concluded that management of Sinclair Radionics should be taken out of his hands altogether. In July 1977 the NEB injected another £1,950,000 into the company, gaining a 73 per cent holding and, for the first time ever, Sinclair found himself with a minority interest. However, there were provisions that if certain financial targets were met he would retrieve part of the company.

The need to find a managing director was of paramount importance. No one knew better than Sinclair the difficulty of finding someone to play managing director to his chairman. Although he had already spoken to one or two whom he trusted, negotiations never got very far. Eventually, the man responsible for Sinclair Radionics at the NEB, Nicholas Barber, took on the job himself, and – Sinclair admits – did it superbly. Nick Barber listened carefully to everyone in the company, from the chauffeur and handyman to Sinclair himself; the result was approval to continue development of the television for a period of one year.

The Black Watch was scrapped totally (and about time, too); shedding that, in concert with the new cash injection and the guiding hand of Nick Barber would, it was thought, generate enough money from the remaining product range to allow the company to expand without needing any more external finance.

Although Barber was generally seen as a Good Thing, he brought a ‘management school’ style to Sinclair Radionics which didn’t go down well in all quarters.

Be that as it may, the two started to interview candidates for the permanent position of managing director. Sinclair was enthusiastic, because although he knew that Barber saw the new managing director reporting to him (Barber), Sinclair believed that an MD of



sufficient calibre would end up effectively reporting to him (Sinclair). Sinclair was only too pleased to be losing responsibility for the day-to-day management of the company which for long had prevented him from concentrating on research. He was also confident that an MD of high calibre would recognise that if Sinclair Radionics was to remain the exciting and dramatically successful business that it had been, it would have to be led by Clive Sinclair.

No one thought that finding an MD would be easy. 'Running any business employing several hundred people takes some ability, but a company that is growing at the rate of Sinclair – doubling in size every year – takes much more.' So wrote Clive, obviously behaving as though nothing momentous was happening: ' . . . and when that business is highly technical, at the forefront of the technologies it pursues, and sells in world markets against the best and most rapacious of competitors, then the job calls for a very rare individual indeed.'

One or two rare individuals were found, though none of them lasted very long – and not just because of personality clashes; they just weren't rare enough. Most sank without trace; the most notable was a gourmet who lived on a yacht and took all the senior management out to dinner, one by one, on expenses.

Sinclair had understood that he and the NEB would be jointly responsible for the appointment of a new MD. He was therefore not a little surprised when the NEB appointed Norman Hewett out of the blue for, although he came to like Hewett well enough, neither his experience nor his personality seemed to match the needs of the company. He had a background in heavy electrical engineering which is a very different kettle of fish from the world of fast-moving consumer electronics, manufactured in high volume, in a company run by ebullient youngsters.

The NEB's views of the incentive needed to run the company must have been different from Sinclair's for he was amazed to find that the NEB had given Hewett a shareholding equivalent to about a quarter of his. He did not resent what he saw as Hewett's good fortune, but he did regret that the NEB had handed out so lightly what Sinclair rightly thought he had won so very hard.

As for the product range, there was a significant shift in emphasis as the company moved away from calculators to instruments and television. At this time the television was said to account for 40 per cent of the turnover and the instruments 20 per cent; calculators made up the rest but were waning. In an attempt to improve product quality, most of the manufacturing was brought in-house instead of being sub-contracted.

But there were problems. The NEB was unfamiliar with companies such as Sinclair Radionics, but this in no way mitigated their obligation to obtain a reasonable return on their investment



*Norman Hewett  
managing director*

on behalf of the taxpayer. They were caught in a fork; they had to give the appearance of being able to run the company when everyone – including themselves – knew that they didn't really understand it. To say that it was a difficult time for all concerned is an understatement. The great silver door of Sinclair's office was often closed; voices were often raised in acrimony.

The NEB found it difficult to field the right advisers; people who could talk to the Sinclair team – never mind the right MD. For things to succeed, there would have to be the right balance of logical planning and operating freedom in the context of those intelligent and competent Sinclair employees who felt stifled by the perforce bureaucratic management system the NEB introduced. First distrust, then bad feeling, permeated the atmosphere; Sinclair's staff wanted to stand by him but felt that somehow they should curb what they now saw as his impulsiveness. Naturally, despite (or because of) the changes introduced by the NEB there was no dramatic change in Sinclair's personality.

Despite (or because of) Sinclair's lack of faith in Norman Hewett's experience and personality, he did his best to smooth his path as managing director. At first, he was prepared to make allowances for the differences in their management styles; but things never seemed to get any better. In spite of their differences, he always tried to support Hewett in front of the other directors. Even when Hewett was advocating policies which Sinclair considered to be grossly wrong, he tried to steer him gently in the 'correct' direction rather than disagree with him in public. At least, he thought he did; his impatience could scarcely have been totally disguised.

It was Hewett who became very excited about the possibility of opening a new factory to build Sinclair TVs at Bar Hill (a new village between Cambridge and St Ives) – and caused quite a lot of excitement in Bar Hill as well (I was Chairman of the Parish Council at the time). But this was just a manifestation of the if-only-I-had-another-filing-cabinet-I-could-be-tidy syndrome. Sinclair saw all too clearly that since they couldn't manage one factory properly, there was no way forward in opening another – even if they had needed it.

Relationships between Clive Sinclair and the NEB deteriorated. Norman Hewett would report to Nicholas Barber back at the NEB; Barber still had special responsibility for Sinclair Radionics. Often the internal Sinclair board would find out only by accident what was going on. By the end of May 1978, it was over six months since a 'proper' management meeting had been held and it was difficult to see how any company – let alone a company like Sinclair Radionics – could function properly like that.

Another action of Hewett's which puzzled Sinclair greatly was his hiring a firm of management consultants to advise on and help

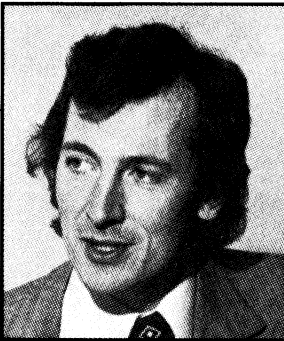

*Ray Wookey  
general sales & marketing  
manager*

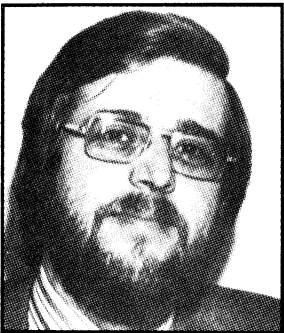

*Chris Childs  
instrument marketing manager*

instal systems. When the consultants had first appeared, Hewett had taken up their references and decided not to employ them. Three days later, he told Sinclair that he would like him to meet the consultants as he had appointed them! Not unnaturally, Sinclair wished that he and the other Sinclair directors *had* met the consultants; they were going to charge £100,000 for 13 weeks' work, and it was difficult to see how they could actually produce results worth that much in that time – not that Sinclair had much faith in management consultants anyway.

But one of the most irksome discoveries was that the NEB (dedicated, you remember, to keeping things British) was trying to sell off the television business – flat-tube package included – to whoever they could, including the Japanese. Apparently, they gave instructions to someone at the Department of Industry to conduct negotiations privily, and Sinclair was furious when he found out. He got hold of this unfortunate civil servant: 'You've no right to do this – it's beyond your remit . . . ' he thundered.

'Actually' Sinclair recalls ruefully 'I hadn't a clue whether or not it *was* beyond his remit . . . as a matter of fact, I wasn't entirely sure what a remit was, but it sounded pretty good.' They checked, and it was beyond his remit, and the NEB were not a little embarrassed that their dark deeds had come to light.

There were other clandestine negotiations to sell Sinclair technology to Finland, and via Finland to Russia, which was surely not on. Apart from the fact that there was no one at Sinclair Radionics with time to spare to train other people – let alone other nations – to make products, Sinclair was opposed to supplying technology to Russia. Moreover, the proposed deal was a very poor one, giving a small return for a great deal of effort.

Niggle, niggle; Sinclair thought that he'd have a look at the rate of recruitment, and found that the company was advertising for no fewer than twenty people, some essential, some less than so. He mentioned this to Hewett who then put a stop on all recruiting, regardless of the fact that there were some key people on the shopping list.

That was one side of the coin, but Sinclair had not abandoned his rose-tinted spectacles. He believed that the company could make a profit of between £50,000 and £100,000 per month if only the overhead costs were properly controlled. For his part, Hewett felt that he was 'running the company at a difficult time [an understatement] and that all would be well when TV1B comes onto the market'.

In the autumn of 1978 the new Microvision TV1B was finally launched, primarily as an alternative cash-generator to calculators and to release effort for development of the flat-screen television. Sales went quite well and there was a feeling of optimism in the air.

It was at that time that Norman Hewett resigned, saying that he

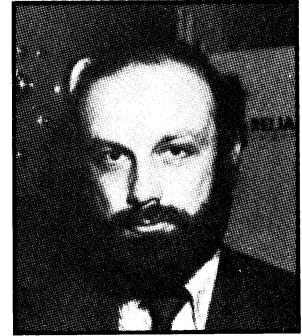

*Mick Giles*  
quality assurance manager

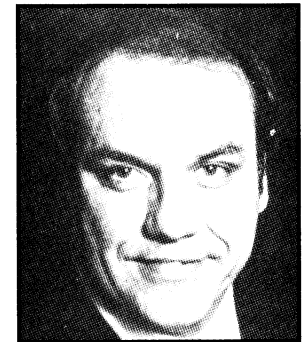

*Robert Gordon*  
vice president  
Sinclair Radionics Inc

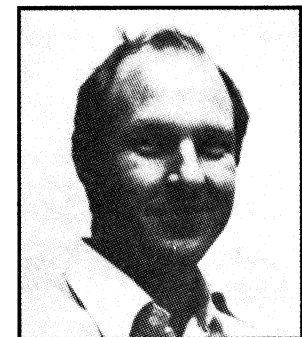

*Adrian Espin*  
engineering manager,  
television



*Michael Pye  
managing director*

couldn't work for more than one master. What was to be done? Mike Pye, Sinclair's erstwhile technical director, had now been at Gillette for two years. Gillette found that they could make much more profit – and in safety – by sticking to razors and shaving soap than by developing smoke detectors, hair care equipment and the like. Mike Pye was ready to come home so the call from the NEB was most timely. And Mike Pye was a good choice; he had an excellent knowledge of the products and the business, and he had a certain reputation for being able to stand up to Sinclair, based on a memorable up-the-stairs shouting match which had precipitated his resolve to seek a less-strenuous atmosphere.

Standing up to Sinclair wasn't easy – in better days you knew that he owned the company and that you didn't, and that any argument, discussion or disagreement started with the dice loaded in his favour. The difficulties he experienced in the transition from being a large majority to a small minority shareholder can well be imagined. Looking back, it is not surprising that the closely-knit group of hard-working individuals, fervently interested in the success of the company, led by a fiery inspiration called Clive Sinclair, was beginning to come apart at the seams. Now everyone was a little older and, surely wiser, and Pye could scarcely resist the call. So he re-joined Sinclair Radionics on the same day as Sinclair himself returned from a much-needed holiday.

The indications were now that the TV1B would sell in quite high volume. However, to be a real success it would have to do well both in Europe and in the United States. Unfortunately, the dollar began to fall and US sales dropped substantially. The NEB did not feel able to approve the necessary expenditure to market TV1B abroad.

For now the NEB were not only financing the development of the television, they were supporting the company while they waited for it to develop. As calculator prices collapsed there was no product ready to take over as a cash generator. Sir Leslie Murphy had retired from the NEB, and without his faith the Board began to lose confidence in the television and to look more closely at the instrument side of the business which, although small, had always been profitable. The Board was becoming increasingly unhappy about the amount of taxpayers' money that had poured into Sinclair Radionics. By this time they had invested £4.5M and had nothing to show for it except a loss of almost £2M in 1978 and the £1.3M deficit in the previous trading year.

Sinclair's frustration at the NEB's lack of faith in his flat-screen television project grew. When he had money of his own to invest in development, he invested it unstintingly. He could not understand why others did not share his faith. Something had to be done; the NEB needed to see a profit; money was needed on top of that for

development. The Sinclair management put their heads together and came up with a possible solution – why not develop a cheap microcomputer? Although this was a revolutionary thought for those days, it may not have been entirely out of the blue, as the next chapter will reveal. So work began on a microcomputer . . . but stopped again when it was found that the development cost would approach £500,000; moreover, there was no idea of what market existed for the product. One thing was certain: the chip on which the design was based would only become economic on a run of about 20,000 and the NEB was not prepared to fund yet another new product.

The first Sinclair microcomputer contained some interesting innovatory concepts, but the NEB decided to raise some much-needed cash by selling the design to Newbury Electronics. Newbury was an odd choice; they manufactured computer terminals, an art which would not automatically qualify anyone to make a success of building what (we now see) could have been the first home computer. When Newbury got hold of the product a lot of the Sinclair design flair was lost, and it became more expensive through development, rather than cheaper as it would have done in Sinclair's hands. When at last they launched the Newbrain it was two years too late. One might ask: 'Why Newbury?' Perhaps the NEB's link with Newbury had something to do with it.

While all this was going on, many of the senior management at Sinclair saw the writing on the wall and began to look round for other jobs. Looking back, one of them suggested that if they had at this stage pulled together more as a team, the company might still be functioning. But this can be naught but unadulterated nostalgia; the seeds of destruction must have been sown as soon as Sinclair became answerable to someone else.

Finally, Sinclair Radionics was given three months in which to find a commercial partner with the production and marketing strength necessary to support the development work being carried out on the television. Thorn-EMI and GEC were among the companies approached but three months grace was just not long enough. In March 1979, the NEB decided that it should no longer finance Sinclair Radionics Ltd as a whole, though it would retain and nurture the instrument side of the business. By now, the NEB had invested nearly £7M and still had a statutory obligation to make some return on it; doubtless the goings-on at Sinclair Radionics caused as near a feeling of panic as you can get in the corridors of power. NRDC had invested £¼M in the flat-tube project and was obviously anxious to see this work – in which they still faith – properly continued and concluded. It was clear that they would welcome the involvement of a suitable large company to continue with the project and give them some chance of a return.

Apart from the lease on the Mill at St Ives then, Sinclair



*Dennis Taylor*  
*non-executive director*

Radionics had a number of technical assets – the instrument business, TV1B, the flat-tube project, the computer project, and the Enterprise programmable calculator.

Sinclair set down his aims; he wanted to run a research business with associated small businesses making the products (shades of the ill-fated AIM Group). His research business would be funded by licence fees from these associated small businesses, and anyone else to whom he licensed technology. The reason for this was simple; he could see that, by itself, the research business might have difficulty persuading its potential customers that they should enter the new markets it would be offering. The need both to show the product and to prove the market would be fulfilled by the associated small businesses, which would show the way, and then hand over their activities to larger, established, companies.

Sinclair further stated that his areas of interests continued as computers, radio and television, timepieces [yes!], instruments – and electric vehicles. He then went on to suggest a means of deploying the various elements of the NEB's investment. First he would keep Sinclair Radionics Ltd as a legal entity so that it could be wound down gradually. He suggested that the NEB should form an entirely new company – called, for the sake of argument, Sinclair Instrument – which would buy the rights to the SRL instrument business. Sinclair Instrument, he suggested, should stay at the St Ives Mill to avoid disrupting production and staff. They would complete for sale the 15,000 or so TV1Bs which were in the pipeline. As the television work decreased so would the production of instruments increase. He suggested also that making and selling the Enterprise calculator was consistent with the instrument side of the business.

He further proposed to form a new company called, for example, Sinclair Research, dedicated solely to R&D with the emphasis on the R. This would take over the 'NRDC team' working on the flat-screen television, would be funded by NRDC, and Thorn would be offered the opportunity of continuing work on television development. Thorn would contribute a monthly fee for the privilege of staying in, which would eventually be replaced by royalty payments to make further NRDC funding unnecessary.

Sinclair proposed the formation of a third company to produce pocket televisions to be called, say, Sinclair Radio. This would take over TV1B, buying the components at cost price from SRL, and paying Sinclair Instrument to assemble them. He also wanted Sinclair Radio to take over the Sinclair Radionics tools and production equipment to transfer to a suitable subcontractor at a later date. Sinclair Radio would continue to sell the TV1B until the flat-screen television was ready. This way of working would be in keeping with his earlier suggestion in that Sinclair Radio would blaze the trail for the flat-screen television, subcontracting most of

the work with but a small permanent staff of its own, so that Thorn could come along later as the large company which would take over the market opened up by the small one.

He thought that framing a deal with Thorn was very important, since Thorn was potentially much the best customer for flat-screen technology. At that stage, Thorn no longer had a colour tube plant, and so was seen as the one company that might be willing to consider a radical approach to colour television. This was important – Sinclair warmed to his topic and changed into overdrive – ‘because the flat tube, while proven for pocket TV application, has an even more exciting future when used in the projection mode for large screen TV’. He foresaw the day when the man in the street could be offered a 50” wall-mounted flat-screen space-saving television at a cost less than today’s bulky 25” set. The viewer would have a much bigger picture, but the total set would take up less space in the room.

This flight of fancy seemed to forget that, if the 1” tube were to be viewed from a foot away, the 50” tube would have to be viewed from fifty feet away, and very few men in our street have living rooms that long. Sinclair the inventor then came to the fore:

‘ . . . while I cannot demonstrate a colour picture, I can, I believe, show the projection potential of the tube to Thorn on 20 April [1979] by showing a scaled-down black and white projector. Going to colour is then simply a matter of using three tubes instead of one as Thorn will appreciate. If they want to pursue this we can rapidly perfect a complete system now that we have tubes.’

Sinclair was keen to persuade the NEB to involve Thorn, since he thought that they would be willing to provide a substantial and continuing royalty – all based of course on his faith in the product.

He had cancelled a trip to Paris and worked through the weekend to produce this proposal, which was delivered to the NEB on Monday 2 April; he naturally assumed that Nicholas Barber would drop everything and discuss it with the Board. He didn’t. Sinclair’s colleagues wondered what was going on, and he felt that he had no alternative but to tell them. He thought there had been far too many secret discussions: ‘It may be proper – if ill-advised – for the NEB to act covertly; it would be improper and stupid for me to do the same with my own colleagues.’

Until 5 April he had believed that there was an excellent chance that the NEB would decide to keep Sinclair Radionics as one unit, as he had every confidence in the success of TV1B. He did not know that his plan had been accepted in principle the day after it was received, but that Barber in particular began to have second thoughts, and wrote suggesting a meeting for 10 April. More delay: Sinclair’s clear and forthright letter on Friday 6 April concluded:



*Derek Holley*  
*financial director*



*David Argent*  
*production director*

‘Time is now desperately short and if positive action is not taken in a few days, this entire organisation will be put in jeopardy. That you wish to cease supporting the television side of the business I regret but do not resent. If the NEB by its inaction causes this entire organisation to collapse, destroying the technical base and the jobs of all the senior people here who have worked so hard for so long, my wrath will be unappeasable.’

Three months later, the interests of Sinclair Radionics were split three ways. The television business was sold to a privately owned company – Binatone – who intended to mass produce the TV1B ‘shortly’. The NEB retained control of the instruments division, Sinclair Electronics Ltd, part of Sinclair Radionics Ltd. The instrument division started life as Heavepalm Ltd, a jolly off-the-shelf company name. Heavepalm was taken over by three ex-Sinclair men, Taylor, Holley AND ARgent, becoming THANDAR Electronics Ltd in 1981.

Sinclair left the Mill with a golden handshake and moved to King’s Parade in the very heart of Cambridge. He looked round his office at the Mill for the last time; the memories of the good times obliterated by the more recent traumata. Perhaps the view of King’s College Chapel – that universal symbol of Cambridge – was a fair swap for the river and the watermeadows. His eye fell on the telephone intercom on his desk. He had never liked it. He gave it a push. Gravity did the rest.



## Science of Cambridge and the MK14

# 9

Chris Curry never worked under the NEB. In the dark days leading up to the advent, he and Sinclair had spent more and more time discussing the future of the company, how they could set up an alternative operation, and what it should do.

Curry's position as Sinclair's confidant tended to irritate the senior managers, because he was somehow outside – possibly even above – the official hierarchy. He had thus been protected from the waves of redundancy which had begun to take place at the Mill and eventually, when things were becoming particularly nasty, he just sloped off – he never left Sinclair Radionics officially. He found a suite of offices at 6 King's Parade, Cambridge, and set up a 'lifeboat' company: Science of Cambridge. He borrowed £500 from his father to pay the first month's rent, and to buy basic office furniture.

The first Science of Cambridge product was a wrist calculator, which had been designed by John Pemberton, the Sinclair designer. It was a ghastly product, making use of redundant calculator chips and displays, mounted on a little PCB with half a dozen of the tiniest cells available to drive it. Curry advertised the wrist calculator and started to ship hundreds and hundreds of kits, by mail order, which resulted in a revenue in excess of £50,000. The calculator was very difficult to assemble but fortunately there were enough customers whose one joy was to fiddle about for hours trying to get things working.

There was a fundamental problem with tolerancing. If you were lucky enough to receive a kit of average parts, it would all fit together; if you received a kit of worst-case parts you had to do a lot of customising. Moreover there were two PCB suppliers; one made a working board and the other made a less working board. The

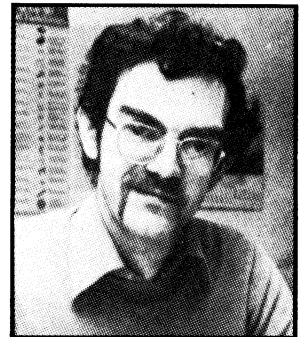

*John Pemberton*

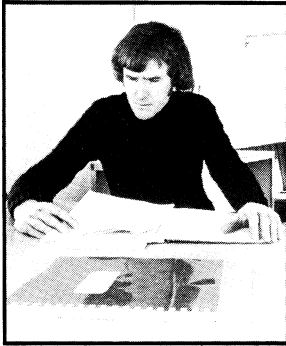

*Allen Boothroyd*

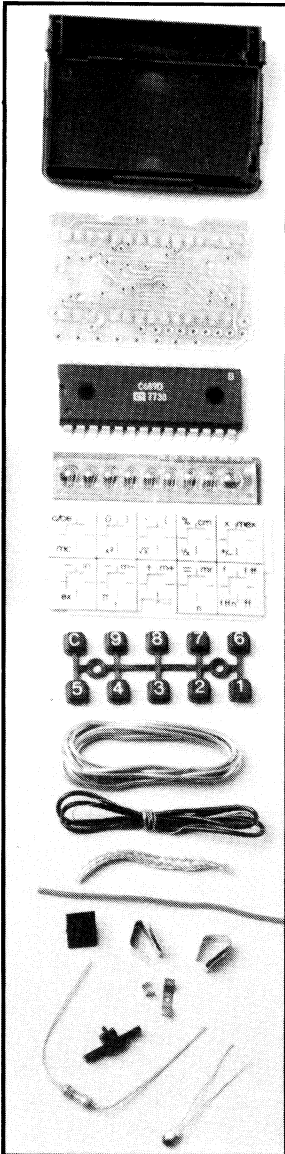

triumph of exporting 20,000 kits to the States turned into a double disaster when they all came back.

Another product – which never got off the ground – was a very smart watch designed by Allen Boothroyd at Cambridge Consultants. It was to be like a bracelet: a set of segments of which you pressed one to illuminate the display, which was another; I forget how you were supposed to know which segment was which. However, this elegance gave rise to great difficulties, so it was decided that there should be a button to press – and that made Sinclair very angry; he wanted no buttons to spoil the design. But he wasn't really very keen on the product; flexible PCBs were expensive, and the project died, strangled by its own complexity.

While Sinclair was so busy at the Mill, arguing, fighting, cajoling, wearing himself and everyone else to a shadow, he took surprisingly little interest in Science of Cambridge. The wrist calculators had made some money, and he trusted Curry to develop the company so that when he was finally forced to leave Sinclair Radionics – as he knew in his innermost heart he would eventually have to – there would be some sort of going concern for him to repair to.

The company was called Science of Cambridge because one of its objects was to pick up local ideas – particularly from the University – and turn them into products. There was some flirtation with telescopes and microscopes; indeed Curry found a very good microscope product but the inventor turned down a 20p per sale royalty in favour of a £1.30 per sale royalty from a large national company. What the inventor overlooked was that, whereas 500,000 units sold at £25 each (the Sinclair style) would have made him £100,000 in royalties, he would receive but £13,000 from 10,000 units sold at £70 each by the large national company. Since the large national company failed to produce the microscope anyway, nobody made anything except mistakes.

In mid-1977, a young electronics engineer at Cambridge Consultants, Ian Williamson, became interested in the advertisements in American science magazines for hobby kits designed to teach you about microprocessors. Microprocessors – of which everyone has heard even if their workings and purpose are but dimly understood – first appeared in 1971. As it became possible to pack more and more smaller and smaller electronics devices into a given space, we reached a point where it was possible to build a whole computer – what in the 1950s would have been a room full of racks of equipment with myriads of glowing valves – on one chip. True, it still needed a keyboard so that you could tell it what to do, and a display so that you could see what it had done, but so does a calculator.

Williamson's idea was to produce a hobby kit for the UK at a

very much lower cost than the kit imported from the USA which sold for £200. His idea was to use a calculator keyboard and its display (which you could buy for £5) connected to a microprocessor in such a way that you could learn how to program. He thought that it would be possible to put together a kit to sell for about £50 which would find a new market in hobby electronics.

He bought a Sinclair calculator and worked out how to bend the components to his will. He wrote a program, wired up the components on a circuit board and late one night – as is the nature of such projects – he got it all working in the lab.

The main problem with this arrangement was that using the calculator chip in this way the program had to be written in a low-level language – ie, one which the computer understands with ease but the human finds more difficult. (A high-level language is one which humans understand easily, but which the computer has to work out.) However, the Williamson setup enabled the enthusiast to find out a great deal about the way that chips work. He deliberately chose to limit the capabilities of the machine in order to keep the cost down. He had built it, tested it: it worked.

Suffering from latent entrepreneurial tendencies, he had been toying with the idea of selling his microprocessor training kit as a private venture. However, it was at about this time (September 1977) that he decided to take a job at Leyland Vehicles, and starting a sideline to develop and market kits at the same time as moving to a new and challenging job in a very different part of the country just wasn't on. He therefore offered his idea to various people, including Sinclair. It was obviously a Science of Cambridge idea; Sinclair contacted Chris Curry, and Chris Curry contacted Williamson who laid on a demonstration for him one evening. It was just what Curry thought Science of Cambridge were looking for; he knew that they ought to do something with microprocessors, but didn't know what. He became very interested and excited and turned up on Williamson's doorstep with an unbelievable pile of broken calculators saying: 'Don't worry about calculators, the Mill was built on them' (Curry's little joke). Williamson's next meeting was with Sinclair and Curry together; they discussed the kit and what products it might lead to. Shortly afterwards, Curry contacted Williamson again and said that they wanted to license the product from him. An agreement was drawn up, and there it all was in black and white, typed up and ready to sign – £5000 down payment plus royalties. The target was to sell at less than £50, and Williamson was to write the documentation to go with it. Late in September 1977 the agreement was ready to sign; it just had to be cleared with Sinclair.

But Williamson had made one mistake; being at that time more versed in prototypes than production, he hadn't thought properly about suppliers; the chips for his kit came from a number of

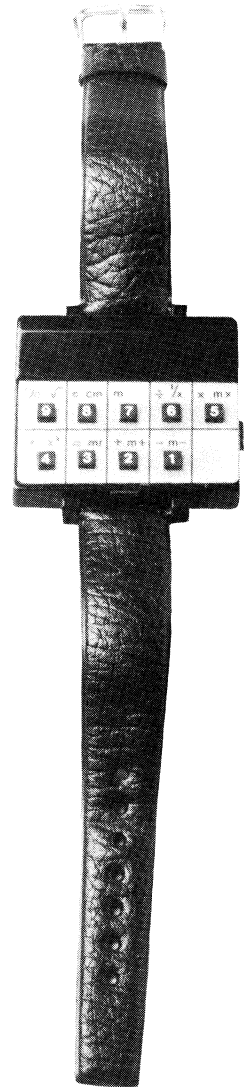

*DIY wrist calculator*

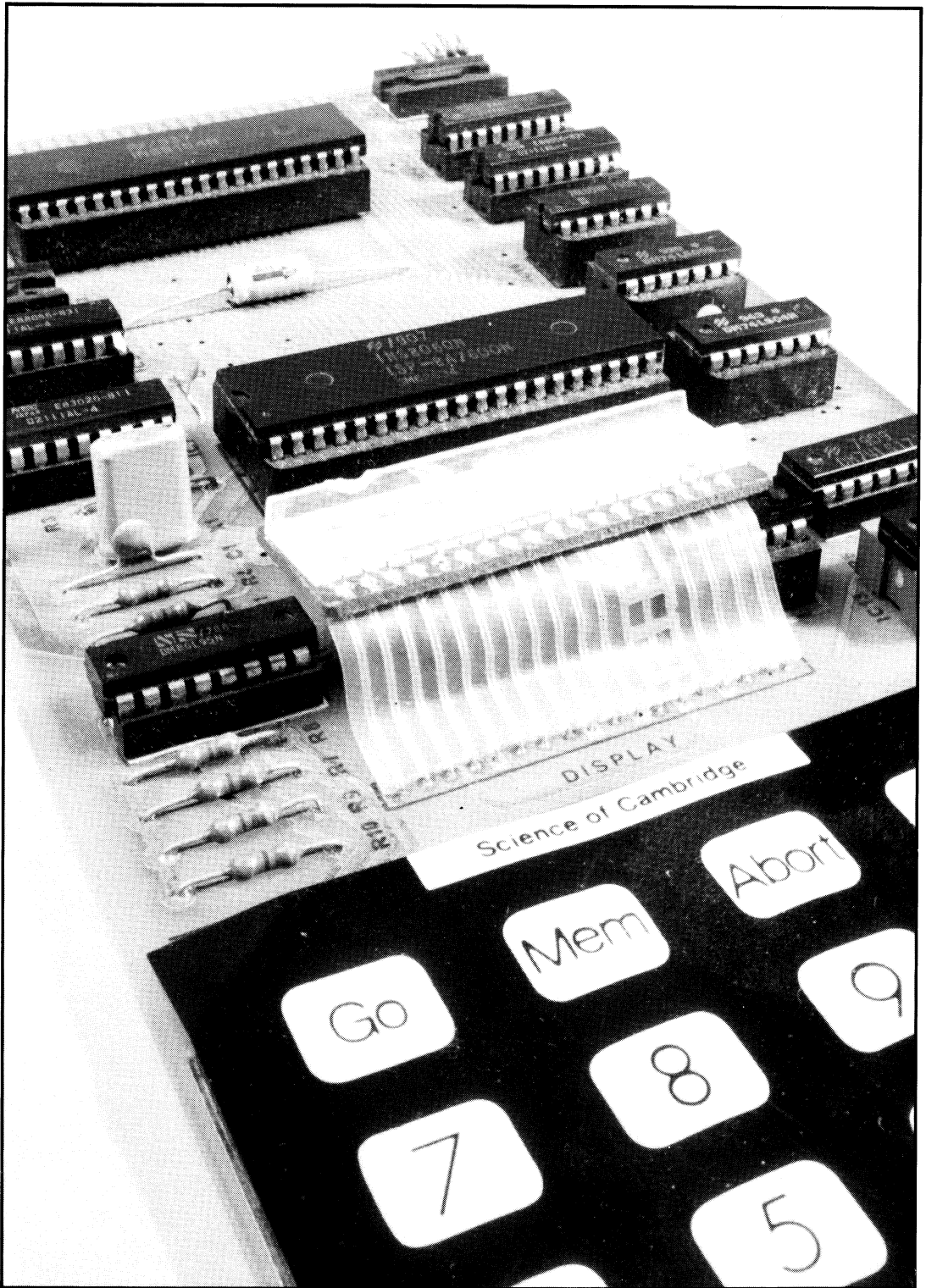

Layout of MK14

different sources. The following week Curry called him very apologetically and said that they had contacted National Semiconductor for supplies of one chip, and NS had offered to do a complete equivalent design using their chips throughout – free of charge, provided that they were awarded the contract to supply the microprocessors. The National Semiconductor design was put on the market as the MK (for Microprocessor Kit) 14; since it was demonstrably successful, it is worth a few moments fruitless speculation to wonder what would the course of history have been if Ian Williamson had not devised his demonstration?

If he had gone ahead and marketed his product, he would probably have sold his kit (component cost £20) for £50 or £60. The Science of Cambridge deal with National Semiconductor brought down the component cost and enabled the kit to be sold for £40, which resulted in 10,000 orders in just a few weeks. Where anyone else would have pitched the price at £60 and sold 1,000, Sinclair pitched it at £40 and sold 10,000 . . . though a lot of people had to wait a little while for their kits.

The interesting thing is that Clive Sinclair – according to Chris Curry – could see little future in the microcomputer kit. It was not until the MK14 started to sell that he saw the potential of its success . . . why, it could fund work on the miniature television! It was thus that Sinclair Radionics embarked on the development programme for the microcomputer which was subsequently chopped and sold to Newbury.

Chris Curry's perambulations round the University looking for ideas had brought him into contact with Hermann Hauser. Curry, not unnaturally, was feeling somewhat piqued at Sinclair's attitude towards the obvious next Science of Cambridge product, the successor to the MK14. He suddenly became big and strong and could see exactly what to do. He had had fourteen years of Sinclair breathing down his neck; throwing things about. He joined forces with Hauser, took premises in Market Hill (a stone's throw from King's Parade) . . . and in mid-1979 Clive Sinclair saw an advertisement for something called the Acorn System 75, Chris Curry's first product, in direct competition with the MK14.

As a gesture of thanks for the work Ian Williamson had done, Sinclair paid him for the book which he had written to accompany the kit. I edited this book; it got so far in production and then sank without trace. The next thing we knew was that it was published by Macmillan and sold out. *Practical Computing* said: 'The book is a model which other authors should follow. It is attractively laid out, easy to read, accurate and complete.' Blush, blush.

However, the MK14 could never do anything other than teach the idea of sequential, logical programming. In the introduction to *Understanding Microprocessors with the Science of Cambridge MK14*,

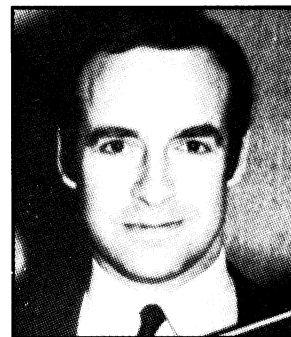

Chris Curry

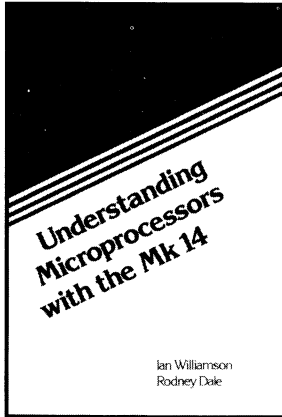

we pointed out that: ‘the MK14 is not a variety of pocket calculator.’ A very interesting comment; if the book were being written today, would we say ‘the MK14 is not a variety of microcomputer’?

For a year at least, the MK14 was a unique product and yet it was obviously sub-standard in the sense that it could not be properly expanded; you could do no more with it than use it as a teaching aid, and it had a cheap display and an even cheaper – and therefore somewhat temperamental – membrane keyboard. Nevertheless, it played its part in history: it proved to Clive Sinclair that microcomputers were a worthwhile product, and it provided a capital base for the next metamorphosis.

Sinclair had long since moved from 27 Maid’s Causeway to 18 Newton Road, a house fit for a rich man. This was a leasehold property, but the Leasehold Reform Act had enabled him to buy the freehold when the statutory period had elapsed. Now he sold it, bought The Stone House in Madingley Road at auction (‘I wanted that house more than I’ve wanted anything else in my life’), sold his Rolls Royce and absorbed a £10,000 golden handshake from the NEB. An admiring Scotsman called Ian Henry wrote to him out of the blue thinking that he might like some financial help, and invested to the tune of 6 per cent of the new company. Thus Clive Sinclair sloughed off the old, and Science of Cambridge became Sinclair Research.

## Sinclair Research and the BBC

# 10

It was on the question of quality that Sinclair and Curry diverged. The Acorn System 75, forerunner of the Acorn Atom – itself the forerunner of the BBC microcomputer – was little more than an MK14 with a proper keyboard.

Sinclair's success had always been based on being first with products, often aimed at a market that didn't know it existed. By 1979 there was a well established 'personal computer' market. Commodore had launched its £700 PET home computer the previous year. Olivetti was selling a £2,000 personal computer; Apple and Tandy were also well-known in the field. These machines were found variously in laboratories, and commercial and teaching establishments; not many people had a computer at home, for they were generally too expensive.

Sinclair decided that he would have to offer a product with all the essential features but at a greatly reduced price. In May 1979 *The Financial Times* predicted: 'Personal computers will become steadily cheaper and their price could drop to around £100 within five years.' Typically, Sinclair decided to do it in a few months!

The ZX80 – the world's smallest and cheapest computer – was launched at an exhibition in Wembley at the end of January 1980. It measured 9" × 7" and cost £99.95, or £79 in kit form.

In order to keep the price low the designers had to introduce some radical ideas to reduce vastly the number of components. The biggest saving was the use of a domestic television set as a screen and a cassette player as a program and data store. The machine had a Z80A microprocessor which was supplied by Nippon Electric; a large ROM, which contained a 4K-byte specially written BASIC interpreter – the software which enables the machine to under-

stand the instructions the operator types on the keyboard – the character set and monitor; and the interfacing circuitry.

There was a great deal of curiosity about who wrote the BASIC interpreter. David Tebbitt of *Personal Computer World* offered ‘a fiver to the first reader to identify this elusive gent’. A few days later he received a telephone call from a young person who informed him that the elusive gent was named John Grant (of Nine Tiles). David Tebbitt was slightly bothered by the fact that the informant was only ten years old, until he asked for the boy’s name: it was Crispin Sinclair!

The ZX80 was very much aimed at the person in the street wanting to know something about programming computers. Richard Jeans at Primary Contact remembers the nerve-racking period before the launch. Sinclair was convinced that people could be persuaded to buy the ZX80 but *how* to persuade them was the problem. The image of the computer at that time was somewhat Big Brother: clinical, air-conditioned surroundings; huge cabinets with reels of magnetic tape whirring to and fro. How would people relate such a frightening piece of equipment to the ZX80? Why would they want to buy it for the home? Why would they want to buy it at all? It was a very challenging marketing task.



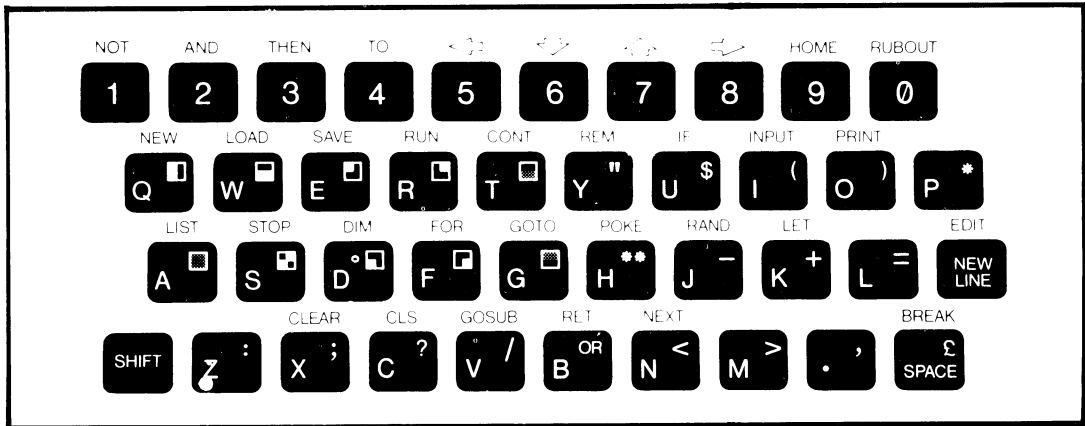

*ZX80 keyboard*

No one need have worried. The ZX80 was an immediate success; ten orders were placed at the exhibition in the first five minutes. The office in King's Parade was suddenly inundated with cheques; the switchboard was permanently jammed. Nobody had expected quite such a response and there was total chaos. Clive's immediate problem was to ensure that the company could cope efficiently both with the administration, and with the production of the ZX80.

The development of the flat-screen TV was taking up most of David Southward's time over at Durcam Hall – a self-contained building on the Mill site at St Ives; Jim Westwood was already working on the next model of computer, the ZX81. Sinclair called in various trusted allies to provide the assistance the company obviously needed if they were to cope.

Sinclair wanted to sell the ZX80 in the United States, although he did not expect to find an enormous market there because of the strength of the competition in the home computer field. However a few weeks before the launch of the ZX80 in the UK he took it to the Las Vegas Consumer Electronics Show and at the same time met Nigel Searle in Boston. Within a few days Searle had a new job, a new apartment and an office in Boston. He sold the ZX80 and later the ZX81 in the States from that office by mail order until early 1982.

Sinclair Research expanded rapidly; by September 1980, over 20,000 ZX80s had been sold. Clive Sinclair was determined to keep the company to a manageable size; he was all too aware of the need to try to learn from previous mistakes. Bringing manufacturing in-house in the days of Sinclair Radionics had seemed an excellent idea at the time, but the number of people they had had to make redundant had hurt him deeply.

By this time there were twelve employees at the King's Parade offices in Cambridge, six engineers still working at The Mill in St Ives, and Nigel Searle in Boston. To make sure that the company



*David Park  
marketing department*

didn't grow too fast Sinclair had subcontracted all manufacturing. To begin with, production was done locally in St Ives by Tek Electronics. Components were generally of a much higher standard than they had been during the Black Watch fiasco, so there was less reason to manufacture products in-house. Eventually, as more and more were produced, the computers were made by Timex in Dundee; it is a testimony to all concerned that the return rate on the ZX80 was only 1 per cent.

Although the machine was so popular and sold so well, this was largely because it had no competitors. In fact it did have some drawbacks, of which the company was well aware, such as the lack of floating point arithmetic, a capacity of only five digits and an inability to handle separate files on its cassettes. The touch-sensitive (or sometimes touch-insensitive) keyboard was unpopular with users too. But in spite of these shortcomings, the ZX80 had opened a new market sector which exceeded Sinclair's wildest dreams, so who was going to complain too loudly? In September 1980, the company launched a 16K RAMpack – that is to say, an extra plug-in memory – to attach to the edge-connector at the back of the machine. There will be many who remember the well-known RAMpack problem whereby a slight breeze could upset the connection and an evening's work would be lost. Thank heavens for Blu-Tack.

As Christmas 1980 approached, Sinclair discovered that the BBC was going to produce a television series aimed at teaching the elements of computer programming. As the largest producer of personal computers in Europe, Sinclair Research was extremely interested in this proposal. But there were some rumours flying around which they found alarming: it was understood that the BBC planned to sell a microcomputer under its own name and this, Sinclair thought, would provide an unfair advantage over those machines not being boosted by the BBC. In its wisdom, the BBC planned to obtain a suitable machine from Newbury, the Newbrain – Sinclair's design which the NEB had sold off. Newbury had announced its product in March, but had not yet built any. The rumour was that it would be well into 1981 before the Newbrain was produced; just how and why the BBC had decided to use a machine which did not exist is still a mystery.

Sinclair wrote to the BBC, pointing out that it was not easy to obtain the necessary level of reliability in large-volume production of computers; to the best of his knowledge, he said, there was no one outside the USA – apart from Sinclair – who had experience of large volume production; at that time, Sinclair was making 10,000 computers per month, 60 per cent of which were exported.

The other thing that worried Sinclair was which computer language would be used. One of the most widespread was BASIC

(Beginners' All-purpose Symbolic Instruction Code), a high-level language – ie, one which humans can understand reasonably easily – developed in the mid-1960s to make programming easier. BASIC was widely used by personal computer manufacturers, but now, some fifteen years after its introduction, it had several dialects, which meant that programs prepared on one machine would not necessarily run on another. True, the major American personal computer manufacturers all used the same version of Microsoft BASIC, but Sinclair Research had developed their own dialect because they felt that Microsoft BASIC, although a *de facto* standard, lacked many features necessary in a language.

Sinclair BASIC, of course, was highly praised both in the UK and in the States. Sinclair drew the attention of the BBC to this particularly, because he understood that they planned yet another version of BASIC which would, in his view, be a serious mistake. People who followed the BBC programmes would only be able to use the BBC computer which might not necessarily meet their needs.

Having unburdened his concerns in a letter to the BBC, Sinclair hoped that it would be possible to set up a meeting so that he could put Sinclair Research's case for being the obvious choice as the manufacturer of the BBC microcomputer, for was he not the 'onlie true begetter' of the British microcomputer industry?

Chris Curry was equally concerned at the BBC's plans to go into mail-order marketing of personal computers. He felt that this scheme would not be beneficial to the British microcomputer industry as a whole. Quite apart from whether or not the proposal transgressed the BBC's Charter, he strongly questioned the wisdom of the choice of the Newbury machine as the basis of the series. The choice, it appeared, had been made largely on the recommendation of one government department in favour of what

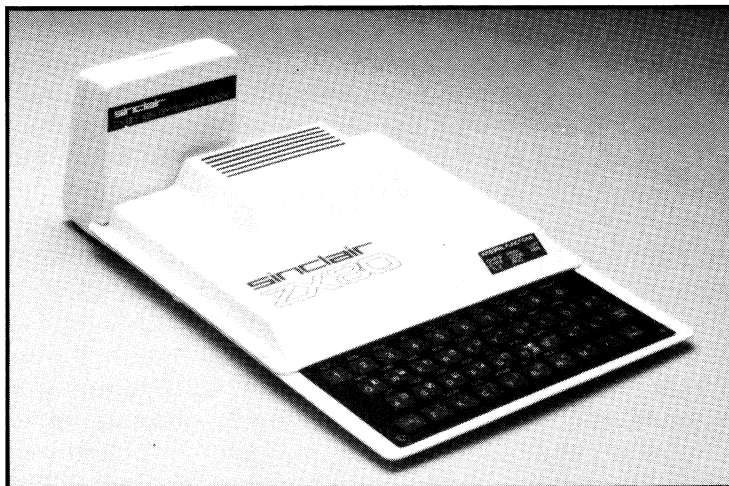

*ZX80 with RAMpack*

was effectively another government department – the NEB – which controlled Newbury. And, Chris Curry pointed out, the computer had been announced over nine months before and was not yet in production, let alone having been field tested.

He also approached the Department of Industry, saying that Acorn Computers, ‘along with one or two other British personal computer manufacturers’, had been striving with some success to reduce the dominance of American machines in the UK. It was therefore alarming to discover that all were to be faced with competition from what could possibly be considered the world’s greatest advertising medium, the BBC. Leaving aside questions such as whether the BBC should go into mail-order marketing, and whether it should deliberately compete with quite a successful sector of private industry, the inexcusable thing seemed to be that the choice of machine had been made without any approach to existing manufacturers who had tried-and-tested machines already on the market.

To choose – apparently behind closed doors – in favour of a machine which was highly unlikely to be bug-free, and had certainly not been field-tested, left other manufacturers wondering what vested interested were at work.

The BBC telephoned Sinclair as soon as they received his letter, and asked him to send details of his forward plans. He sent them details of the ZX80, explaining that some of its shortcomings would be met by a ROM which would be available the following February. He also disclosed, in confidence, that the ZX81 would be announced in three months’ time – a new version of the ZX80 which would be completely free from screen-flicker, enabling it to produce moving graphics, and in a very elegant case at just £79 – including power supply and an improved manual. The features and the economy of the new machine were made possible – in part at least – by one of the most complex bi-polar integrated circuits ever designed, a technical achievement which Sinclair felt only his company could have been capable of.

He made it clear that he applauded the concept of the proposed television series, and admired the BBC’s enterprise in undertaking it. Sinclair’s concern was, of course, that he and the other leading manufacturers in the industry should at least be consulted, but above all that the BBC should not lend its name and unparalleled credibility to any single machine, let alone to one of quite unproven merit.

The pressure from Chris Curry and Clive Sinclair seems to have done the trick; just before Christmas, the merchandising department of BBC Enterprises Ltd sent out a letter to announce to twelve British computer manufacturers what was now an open secret; that the BBC was in the process of producing a major television series in the field of computer literacy for first

transmission either in October 1981 or January 1982. The series would consist of ten television programmes, with linked written material.

‘Central to our thinking on the project is the need to provide our students with the opportunity of gaining “hands-on” experience on a microcomputer. The BBC has therefore decided to license a manufacturer to sell a machine in association with the project, and we are therefore writing to a number of manufacturers to assess which would be the most appropriate choice. The purpose of this letter is to enquire formally whether your company would be interested in producing such a machine, and on what terms.

The machine would be identified not by its existing trade name but as a “BBC Microcomputer”. . . We would need a minimum of 12,000 units of the microcomputer available during the first transmission of the television series . . . 3000 units would be required at the outset of the transmission period. It would be necessary to consider how further demand in excess of 12,000 units could be met.’

It seems that there was still some hope that the name of the manufacturer of the BBC Microcomputer might be kept confidential. The BBC said that a box number, together with the details of the machine and its availability, would be publicised by the BBC in association with the television series. The manufacturing company would be free to promote the ‘BBC Microcomputer’ separately, but would have to clear the terms of any such promotion with the BBC; ‘It would not be acceptable to link the trade name of the product with the BBC version.’ The BBC proposed to charge a licence fee of the order of 10 per cent on the basic price.

This letter was dated 23 December 1980, and one can hardly imagine that the BBC thought that it would arrive at its destinations – let alone gain much attention – before the new year was well under way. Notwithstanding this, they said that they hoped to complete their arrangements by 31 January. This meant that they would want to have documentation of any proposals from companies by 14 January, together with a machine for testing purposes. The letter was accompanied by a five-page ‘outline specification’.

Apart from the impossible time scale, Sinclair felt that there were still two serious defects in the BBC’s proposition. One was that labelling any computer ‘BBC’ would be bound to be seen by the public as authoritative, and therefore likely to detract from other machines, whoever made them; the other was that none of the leading UK microcomputer manufacturers had been consulted in producing the specification, so it lacked the benefit of their advice and experience. Sinclair wrote:

‘We are based in central Cambridge so that we can draw on the

massive accumulated expertise of the University. Professor Maurice Wilkes, who has just retired and left for the States, has been a consultant to us for several years. He built the world's first programmable computer and, until his retirement last year, headed the computer laboratory. With the benefit of his advice and that of his colleagues we believe we reached an optimum solution in taking the course we did. We respectfully doubt whether the BBC has had time and experience enough to do likewise.'

In fact, the BBC specification had been drawn up by John Coll of MUSE (Mini and Micro Users in Secondary Education) who later joined Acorn as an educational adviser. He knew a thing or two about the prospective market; Wilkes was one of the pioneers of computing in the UK, and used to a higher academic environment.

Sinclair was again disturbed to see that the proposed computer would use a Microsoft BASIC, since that was, in his view, inadequate – which was why Sinclair Research had taken the 'much thornier path' and developed Sinclair BASIC with its greater benefits. He still felt that there was an urgent need to set up a meeting to discuss the doubts which the BBC's course was raising in his mind.

There was little time to produce the documentation and the machine asked for by the BBC by 14 January; even they must have seen that the deadline was ludicrous. As it was, everyone had to be content with a meeting set for 23 January. By that time, Sinclair Research was producing and selling 9000 computers a month, making the ZX80 one of the most popular machines – if not *the* most popular machine – in the world. To the best of Sinclair's knowledge, no other manufacturer outside America had ever made more than 1000 units a month. This feat was relevant to the BBC's need for a minimum of 12,000 units: producing large quantities of computers to a high level of reliability is far from straightforward, but a skill which Sinclair Research had mastered. Sinclair was not aware of anyone else in the UK, or indeed in Europe, who could match it.

The long-awaited meeting took place at the BBC on the afternoon of Friday 23 January 1981. At that time, no official announcement had been made about the TV series, and a great deal of inaccurate information was going around. All that had been confirmed was that there was to be a computer linked to the project.

It was now known that the ten programmes would each run for twenty-five minutes, and that the series would be broadcast probably between January and March 1982, probably on Sunday mornings on BBC1, and repeated during the week for schools. There would be another late-night repeat between April and June

on BBC1, and the series would be supported by a book.

At that time, the BBC were still of a mind to look at different machines, and market one of their choice as 'The BBC Microcomputer'. Part of the purchase deal would therefore be that there would be no gratuitous advertising for the chosen manufacturer. They had approached many organisations for advice, and the Department of Industry had told them that they were doing something that would benefit the British computer industry.

Sinclair questioned this, since they had not approached Sinclair Research. He went on to explain again why the company had designed its own version of BASIC, and the technical achievements which made the (as yet unannounced) ZX81 possible.

He told them about the confidential talks he had been holding with representatives of W.H.Smith, Smiths' view of the ZX81, and their proposal to sell it in their stores. Smiths knew of the Sinclair-BBC discussions and expressed an interest in the proposed BBC series. The BBC was concerned about the keyboard of the ZX81 and asked the cost of a full-size 'professional' keyboard. They also felt that high-resolution graphics were very important, but Sinclair expressed doubts as to the relevance. The BBC also envisaged a simple machine which would get people started at minimum cost, but which could have a range of add-ons; he pointed out that a more flexible machine wouldn't automatically be more expensive. There were at that time already 40,000 users of the ZX80 in the field, and by the time the BBC programme was transmitted there would be 100,000 ZX81 users in the UK alone. He went on to discuss further plans for his 1982 computer, and the design of a compatible printer and storage medium.

There was still a great deal of discussion of the computer language. He pointed out that Sinclair BASIC was becoming the

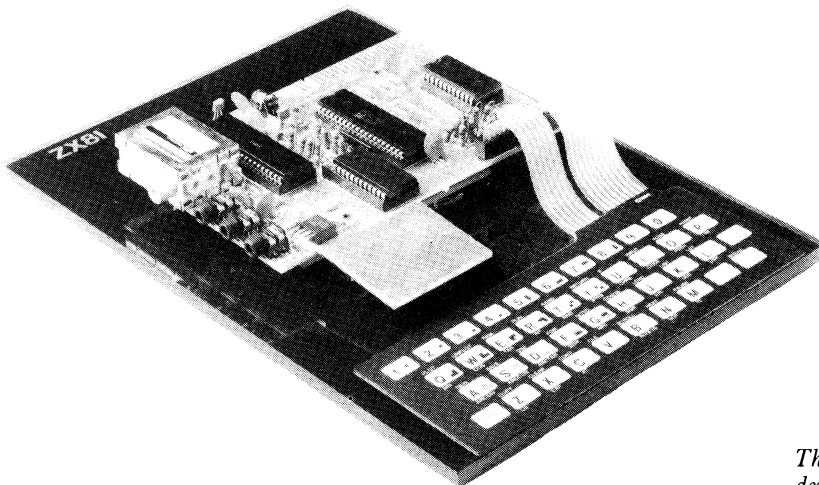

*The prototype ZX81  
demonstrated to the BBC*

standard if only because of the number of machines that Sinclair Research had sold. Jim Westwood pointed out that Microsoft BASIC had been written by amateurs and had then been taken over by Microsoft, 'and therefore had warts'. The BBC said that the BASIC used on an Acorn Atom was unacceptable, and Sinclair generously said that he would be happy to help Acorn, for example, if they wanted to use Sinclair BASIC. The BBC asked for a draft specification of the ZX81 to be left with them, and wanted to borrow a machine for a couple of days. It was agreed that one would be ready for them on Tuesday 27 January in Cambridge. Sinclair went on to say that there was no reason why Sinclair Research should not make a BBC machine with whatever features were required, but that it would have to use BBC BASIC. The 1982 machine, it was said, would have a 'proper' keyboard, built-in printer, and possibly a built-in micro floppy (Sinclair Research setting a standard again with a non-standard product – a floppy disc storage medium 100K smaller than 5"), and a 5" flat display screen (based on the new Sinclair television tube) built in. The meeting adjourned at 4.15pm, with the BBC asking for a draft working specification and price.

27 January came, and nearly went, before the men from the BBC arrived at 5.15pm. That put Sinclair Research at some disadvantage, since they had hoped to be able to demonstrate the new printer and the flat-screen display. The printer was a radically new mechanical design, the first to be able to produce graphics as well as symbols. The flat-screen tube was a major world breakthrough, and Sinclair was planning to spend £1.25M in 1981 on automated production plant for it.

The company also wanted to present the findings of market research, and demonstrate the packaging and presentation of the ZX81 – there hadn't been time for that either. Moreover, they were concerned that the men from the BBC seemed adamantly averse from the use of any language other than Microsoft BASIC (which Sinclair now described as 'an obsolete American standard'), or ABC ('a language which has not yet been implemented and offers little tangible benefits that we can see').

Clive Sinclair's specification for the BBC machine was as follows:

- Moving keyboard on a standard typewriter pitch with all the functions asked for by the BBC, capable of driving a TV screen
- RS232 compatibility
- Ring compatible
- Built-in speaker
- Viewdata and Teletext compatible
- High resolution graphics
- 16K bytes RAM



- 16K bytes ROM
- price: £110 inc VAT

‘We have left a little margin to cover unexpected items’, he wrote, ‘so the final price might be slightly less than that quoted.’ Hope springs eternal.

However altruistic Chris Curry and Clive Sinclair might have seemed in their approaches to the BBC, there is no doubt that each had his own interests very much at heart. When the BBC brought up the question of the MK14, Sinclair was quick to point out that it was not a ‘Sinclair’ product, but had been developed and sold by Science of Cambridge when that company was being run by Chris Curry (ouch!)

In the early stages of the BBC saga, Sinclair and Curry had exchanged selected copies of their correspondence with the BBC. Each thought he was monitoring the other’s moves until one day Sinclair telephoned Curry, only to be told (oops!) that he was at the BBC.

For one reason or another, the BBC eventually chose to use a machine which would be based on the Acorn Atom – a machine costing more than twice as much as the ZX80. Acorn expected to sell 25,000 BBC machines. This did not go down too well with Sinclair; he complained that Acorn were not going to be able to provide a printer – necessary for educational use – for as little as his proposed £50. He further complained that the BBC would be teaching a different BASIC, even though the National Computing Centre had called for some sort of standardisation of computer language. And did not Sinclair users outnumber those of any other home computer?

Sinclair put all his complaints in a letter to the Parliamentary Under-Secretary of State for Industry. But he was – perhaps understandably – not a favourite with the establishment. Although he was clearly rising again, and very rapidly, his stormy relationship with the NEB was still fresh in people’s memories. No one could deny the part he was playing in introducing microcomputers into the home – largely as a result of his having broken the magic £100 price barrier. But in doing so, whatever clever interior designs he had introduced were hidden; what the critic tasted first was the membrane keyboard. The ‘touch’ of the ZX80 keyboard compared with that of the Acorn must have been an eloquent speaker in the debate.

Was the BBC right in its choice? It depends on what it was trying to achieve. It doubtless saw the ‘serious user’ as one who would have a computer for business use: for stock control, accounting and so on; a computer with a conventional and reliable type of keyboard, in a firm and robust case, with reliable peripherals.

Sinclair concedes that the BBC micro is a perfectly good machine, but believes that its design is pedestrian in the extreme. But it is not, he thinks, commercially successful. Perhaps he was wrong to think that cheapness was the only criterion.

Shortly after the BBC contract went to Acorn, the government offered schools half the cost of a computer system if they bought one. However, the government-recommended list at that time included Research Machines of Oxford and Acorn – but not Sinclair Research.

The ZX81 was launched in March 1981. It contained a new chip, designed by Sinclair Research and manufactured by Ferranti – the world leader in uncommitted logic arrays (standard chips which can be adapted to a user's requirements at the last stage of production). The new chip replaced 18 chips in the ZX80 and the machine now retailed at £69.95 (or £49.95 in kit form). Sinclair also offered an add-on ROM to convert the ZX80 to the ZX81. The ZX81 had a floating decimal point and scientific functions. It came in a sturdy black case and, if you used a colour TV, would produce black characters on a restful green background. It was a vast improvement on the ZX80. Sinclair also announced that he would be launching a small printer to work with the ZX81 later in the year.

Now that he had an improved machine and the promise of a printer, Sinclair decided to fight back at the government's scheme by offering his own half-price deal. Schools could buy a package of a ZX81 and a 16K RAMpack for £60; and he further promised that they would be able to buy the ZX Printer at half price when it was launched. That made the total cost of a system £90, while under the

ZX81

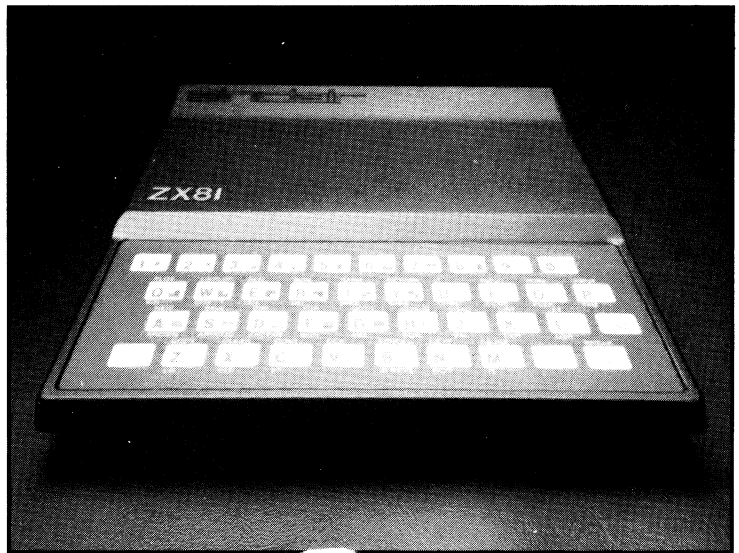

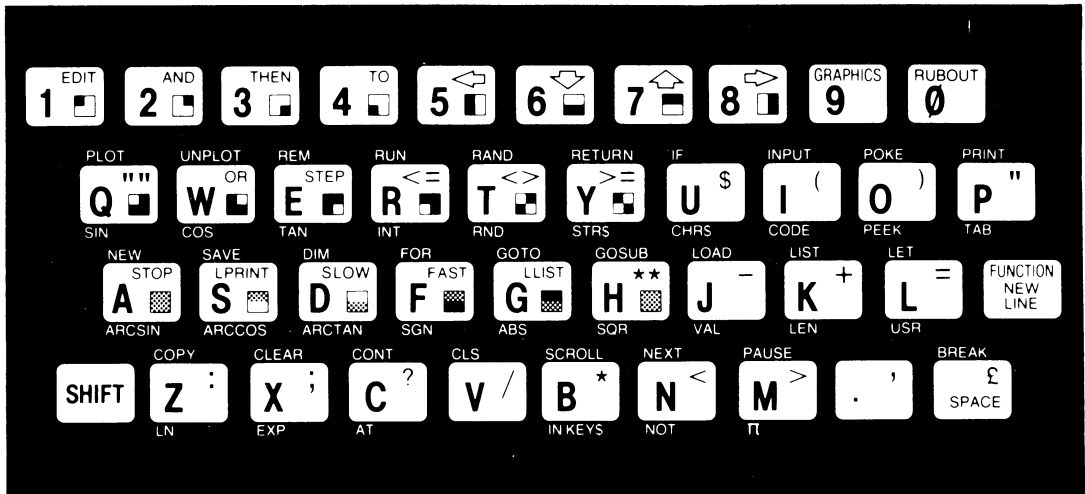

ZX81 keyboard

government scheme the minimum a school could pay if it bought an 'approved system' was £130. About 2300 schools purchased the Sinclair package.

The ZX81 received a very sympathetic review from David Tebbit in *Personal Computer World* in which he keeps referring to 'Uncle Clive'. On the other hand: 'Sinclair has been a bit cheeky in his advertisements. Under a column entitled "New, improved features", he proceeds to mention three things that were included in the ZX80 when it was launched over a year ago!'

The ZX Printer was eventually launched in November 1981 at £49.95. Designed for the ZX81, it could also be used with the ZX80 with an 8K ROM. It was a very compact little printer using a special metallised paper, and would print 32 characters to a line and nine lines to the inch. You plugged it in to the edge connector at the back of the computer using a stackable socket. It worked by pulsing current on to the paper via two styli that moved across on a moving belt at high speed; the current evaporated the aluminium coating so that the black backing would show through. The print was clear and readable; the ZX Printer sold well.

The market gradually expanded. In March 1981 Mitsui approached Sinclair Research and towards the end of the year was granted exclusive distribution rights for the ZX81 in Japan. Mitsui was one of Japan's main importers of British goods, the range including Jaguar cars and Burberry raincoats. They planned to market the ZX81 by mail order at about £90 and aimed at selling 20,000 computers during the first year; there were no competitors.

By the end of January 1982, 300,000 ZX81s had been sold worldwide. In the USA Sinclair was selling 15,000 personal computers a month by mail order; American Express were selling thousands to a potential ten million customers. Then Timex was granted a licence to market both current and future Sinclair

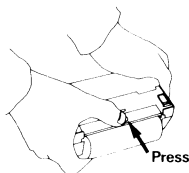

Press on the underneath of the reel carrier to disengage it from the printer

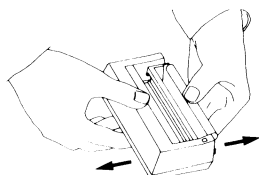

With the reel carrier pulled out of the printer, take out the empty cardboard tube but save the plastic hubs in the ends

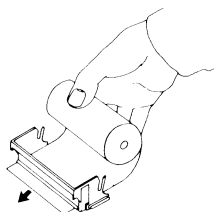

Thread the end of the new reel underneath the metal roller

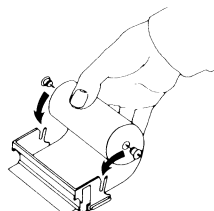

Push the hubs into the reel, and clip it into the carrier

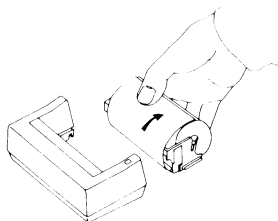

Pull some of the paper through, hold the carrier as shown and clip it back into the printer body

personal computer products in the US from mid-1982. They paid Sinclair a five per cent royalty for sales and bought the right to use the Sinclair name in the US.

In Britain, Sinclair signed an agreement to sell the ZX81 through the branching-out stationers and booksellers W.H. Smith. Today, when so many national stores – Boots, Dixons, John Lewis, and the rest – have sections devoted to matters computery, it is hard to remember what a breakthrough it was to be able to buy the ZX81 in the High Street. Not that other makers were far behind; the numerous retail outlets were just one of the ways in which the home computer created jobs. By February 1982 production of ZX81s was running at about half a million machines a year and the company had a turnover of £30M compared to £4.65M in the year ended March 1981!

One of the interesting side-effects of the ZX80 and ZX81 was the number of cottage industries that sprang up because of them, producing software, peripherals and publications. A ZX80 Users' Club had been formed before the ZX81 was launched; *SYNC Magazine* appeared in January 1981 to cater for ZX80 users; *Learning BASIC with your Sinclair ZX80* by Robin Norman, published by Newnes in early 1981, was one of the first books to develop BASIC programming techniques on the home computer.

In October 1981, Sinclair launched the ZX Learning Lab, a teach-yourself-programming package containing eight program tape cassettes. Six of them stored 20 programs to explain ZX81 programming and two were blank for practice. The pack cost £19.95 and was sold by mail order.

Hundreds of small operations started to sell programs, books, extra memory, printers, sound generators and add-on keyboards for use with the ZX81. In January 1982 one Mike Johnstone organised a fair for companies selling products for the Sinclair computers. Nearly 10,000 people turned up at Central Hall, Westminster, which has a capacity for only a few hundred; the police had to be called to control the crowds; seventy exhibitors took huge sums of money.

In April 1982 the special attraction at the Earl's Court Computer Fair was the ZX81 Village when some thirty companies demonstrated software and add-on hardware for the ZX81. It was this sort of spin-off business, which developed primarily because of Sinclair computers, that helped to support and prolong the sales of all personal computers worldwide.

Both the ZX80 and ZX81 had been produced as learning machines; for the person wanting to find out about computer programming. Once people knew what they were doing they wanted a more powerful machines, and at first they had to turn to manufacturers other than Sinclair Research to find them.

## The ZX82

Sinclair's philosophy – at least in retrospect – was to prepare the world for universal computer ownership in easy stages. Over 50,000 ZX80s had been sold, and more than six times as many ZX81s. As the market matured, the engineers were working away at the ZX82 (codename) which was launched as the ZX Spectrum in April 1982. The hardware was designed by Richard Altwasser, who later formed his own company, Cantab, and fell by the wayside in an attempt to market a computer called the Jupiter Ace. The software was written by Steve Vickers on contract from Nine Tiles Ltd – the company which had originally provided Sinclair BASIC.

Production of the Spectrum started at 20,000 a month and Sinclair expected to sell 300,000–400,000 during the first year. There were two versions: the 16K sold for £125 and the 48K for £175 (these Ks refer to the amount of memory available, and hence the amount of program and data which can be stored in the machine). For those who preferred to work up in easy stages, an extra pack to increase the memory of the cheaper machine was available for £60.

In many ways the Spectrum was altogether a 'better' machine than either the ZX80 or ZX81, although some said its predecessor the ZX81 was superior when it came to finding out how computers actually work. Its chief advantages over the ZX81 were 'eight-colour graphics capability, sound generator, high-resolution graphics [smaller dots on the screen] and many other features – including the facility to support separate data files.'

At last, Sinclair Research was notionally able to compete with the BBC Micro and other personal computers; the figures in the table published in the ZX Spectrum leaflet were impressive. The

ZX81 had been competing against the Acorn Atom; it could never have stood up against the BBC model A, the current Acorn competitor when the Spectrum came out. The Spectrum had a more versatile Sinclair BASIC than the previous two machines; an improved keyboard replaced the unpopular (though cheap) touch-sensitive keyboard; it was able to generate and display graphics using up to eight colours; and it could be linked to other Spectrums to create a communications network.

However, when Jim Lennox reviewed the new machine for the late lamented *Technology Week*, he was not impressed by the keyboard – which had been made to simulate moving keys by fitting a one-piece moulded rubber pad over a ZX81-type membrane keyboard, and which had a most peculiar feel to it. In fact this moulding combined the advantages of a membrane keyboard for home use with the feel (once you got used to it) of a proper keyboard encouraging you to undertake the extra typing you would surely want to do now that you had a much more powerful computer at your fingertips.

The Spectrum was the cheapest home computer to produce colour graphics but the reviewer complained of the lack of facilities and ‘found that the borders [between two colours] tend to wriggle in an irritating way’. It also had a small built-in loudspeaker which generated bleeps ‘acceptable for games, but not much more’. And that, to Sinclair’s disappointment, was about all the Spectrum was generally used for. The tone of the review was set in the first paragraph:

‘After using it, however, I find Sinclair’s claim that it is the most powerful computer under £500 unsustainable. Compared to more powerful machines, it is slow, its colour graphics are disappointing, its BASIC limited and its keyboard confusing.’

But never mind the reviewers; the Spectrum is without doubt the most commercially successful home computer ever. Sinclair Research was now so clearly in the personal computer market that the educational establishment had finally to look at its products in a more serious light. During 1982 the ZX81 and the Spectrum were demonstrated to the Department of Trade and Industry, who were proposing a second promotion of microcomputers in primary schools. The DTI was impressed; the Prime Minister, Margaret Thatcher, announced the scheme in July and in December the first order came in. Sinclair Research linked up with software manufacturers and gradually the company became more involved in the educational market. They still sell enormous numbers of microcomputers to that market overseas, although their share at home is still only of the order of two per cent.

It was after the launch of the Spectrum that computer fever

really took off; children were being introduced to computers at school and the very cheapness of the ZX80 and 81 meant that parents were prepared to buy them to give their children ‘a good start in life’. A friend of mine actually bought one, ostensibly for his little girl, when she was but six months old.

It seems quite clear in retrospect that just what sort of future needed a home computer to prepare its budding citizens for it, was, to say the least, hazy. There were several possibilities – everybody would need to know how to use computers, to program computers, to design computers. ‘Using computers’ was equated with knowing how to type, how to load programs, how to play games; ‘programming computers’ was equated with knowing how to load programs, how to type in programs, how to modify and debug programs; ‘designing computers’ was equated with writing programs, building a peripheral from a kit, mounting the whole set-up on a piece of hardboard with Blu-Tack. There was a great gulf between reality as it was and as many people thought it was. A proud parent of an earlier generation asked me if I thought his son should become an artist ‘because he does a lot of Spirograph work’. It’s the same sort of misconception.

The place of the computer in the home was reinforced by the meagre provision in schools, where there was often only one machine between 30 pupils and thus insufficient opportunity for everyone to practise. What better solution than a computer at home?

*ZX Spectrum keyboard*

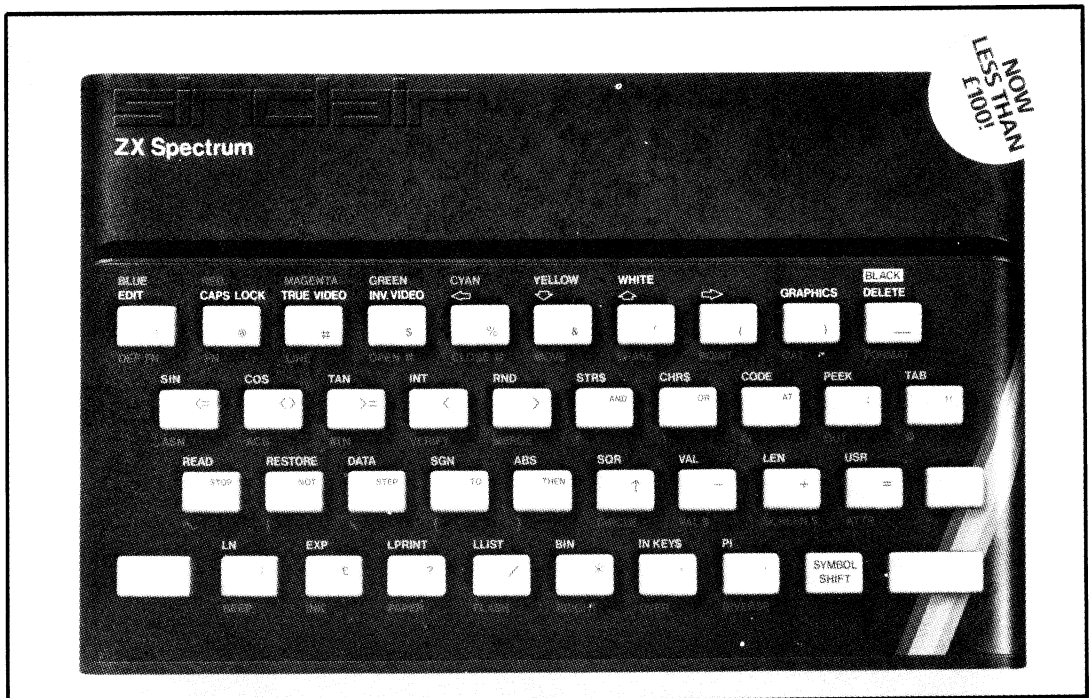



# Silicon Alley.

Many years ago, a Victorian entrepreneur established a business bottling water from a well in a Cambridge suburb. It's a typical Victorian use of a natural British resource, but alas, the mineral water business just didn't survive the less credulous, more stringent demands of the modern market place.

Today, there is no bottling at Willis Road.

There are no long production lines, no vast warehouses, no goods-in and goods-out. A building in a style between modernist and post-modernist is tucked away among some unassuming terrace houses. There's very little to tell you that this is a power-house of British industry.

Yet this is the home of Sinclair Research Ltd.

The site retains one direct link with its past. The old mineral water well, whether or not it was therapeutic, had one valuable characteristic: it maintains a constant temperature of 12°C, all the year round. Today, it's incorporated into a revolutionary heating system for the building, which helps reduce energy costs.

In every other way, this is a business of the future. And if its modest location is slightly surprising, just about everything else is very surprising indeed.

So far, the company has sold nearly two million home computers. *Two million*. It has generated a vigorous British home-computer industry. And it's made Britain one of the most computer-conscious countries in the world.

Yet the company employs only about 60 people, and makes nothing itself (apart from substantial profits, which are reinvested for the future).

The U.L.A. (uncommitted logic array) is made, to a Sinclair specification, by Ferranti. The touch-sensitive keyboard membrane by NFL Timex carry out the assembly in Scotland. Even the processing of orders and enquiries is sub-contracted, to GSI in Camberley.

Sinclair Research simply does what it's good at. It takes as its raw material something in which, Sinclair believes, Britain is particularly rich, original,

creative minds. It uses them to produce brilliant, marketable concepts. The rest is delegated to whoever's best at the job.

The computer age, unlike the mass-production age, offers tremendous opportunities to Britain. While British manufacturing industry has languished, British creative talent has flourished. If it doesn't fit into the old patterns, so much the worse for the patterns.

Sinclair Research is a modest model of the way in which original thinking can generate spectacular success. Our business is very different from our Victorian predecessor's. But the way in which we're using an inexhaustible natural resource indicates that we are worthy successors.

**sinclair**



But Sinclair observed another dimension: ‘The interesting thing is that as well as children being expert at programming, there is another expert group taking to it like ducks to water – retired people. The concept of it being peculiarly suitable to the young mind is perhaps wrong – it’s the mind that’s free of everyday burdens. The retired person with some time to spare can take to it wonderfully and it’s giving a lot of people a new interest in life.’

The first home computers had no software; to play a game on one you either had to make it up yourself or buy a magazine with a program in it – which was very good for the magazine industry – and type in the program before you could start to play. Now the Spectrum with its 48K memory was capable of playing very sophisticated games and there were companies starting up solely to produce them – often run by very young people who had learnt programming at school or from magazines.

In February 1983, W.H.Smith, who had been the Spectrum’s biggest distributors, were joined by Boots, Currys, Greens (Debenham’s in-store subsidiary) and John Menzies as Sinclair pioneered a change in the High Street. Many other stores such as John Lewis and the House of Fraser were supplied by Sinclair’s UK distributor, Prism Micros. 200,000 Spectrums had now been sold by mail order, and by Easter 12–15,000 Spectrums were being sold per week in the UK. The Spectrum had also been launched in more than 30 countries worldwide.

You couldn’t walk into W.H.Smith on a Saturday without being faced with shelves of software and mobiles and whizz-kids playing on the computers. What sort of computer you had become an important factor in playground status. The older generation were working hard to catch up – practising in secret when the children were in bed – for some adults find it humiliating to receive instruction from a twelve-year old although the twelve-year olds love it. When the twelve-year olds had at last gone to bed, and the machine was free, the adults would then take over, staying up far into the night, forgoing the snooker or the late movie.

And where has it all led? Computer awareness has been generally raised; the dust has settled, much of it on the home computers, leaving a hard core of enthusiasts. The market is saturated; the craze is over. The computer is settling into a serious niche comparable with ham radio; the days of the CB computer are surely over.

But 1983; heady days for Sinclair Research; the company sponsored the Cambridge Festival Half-Marathon to the tune of £5000 – both Clive Sinclair and Nigel Searle (to mention but two from Sinclair Research) ran in it. It was now a whole year since the Spectrum had been launched, and its price was reduced from £125 to £99.95 for the 16K version, and from £175 to £129.95 for the



*23 Motcomb Street  
London SW1*

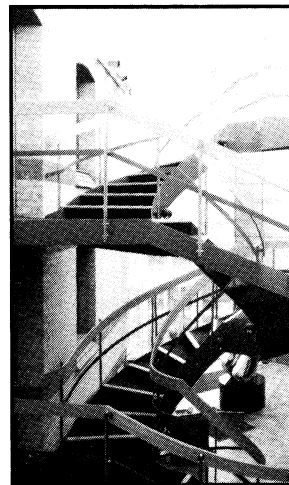

*The interior at Willis Road*

48K version. At the same time, the price of the ZX Printer was reduced from £59.95 to £39.95.

Sinclair Research had moved into new premises, both in Cambridge and in London. Sinclair had moved his own HQ to 23 Motcomb Street, SW1, tastefully decorated in Belgravian style.

Back in Cambridge, you will find tucked away in an inconspicuous corner between the Cambridgeshire College of Arts and Technology and the PO sorting office to which Nigel Kember had taken all those copies of *22 Tested Circuits*, what was once a rather dingy group of industrial buildings. These had started life as Barker and Wadsworth's spa water bottling plant; after various vicissitudes the property came into Sinclair's hands.

In January 1984 the Sinclair Research Computer Centre won an environmental award. The architects were Lyster, Grillet and Harding and the award was for 'combining Cambridge traditions with major innovations in architectural design, interior furnishing and environmental control systems'. The main L-shaped building had been restored to its original appearance and now contained offices and research laboratories. The former outhouses had been completely remodelled as a general office area with the exterior clad entirely in stainless steel. The yard between the building and the outhouses was transformed into an enclosed atrium (an LG&H speciality) and featured a 'fine bronze sculpture' by Helaine Blumenfield. Even the bicycle shed was fine art.

## ZX Microdrives!



The original mineral water well was used as the basis of an 'integrated environmental control system' because it supplied water all year round at a constant 12°C. 'A heat pump in this well and the solar gain in the atrium are used as a back-up to more conventional heating, with a microprocessor switching between them according as they are more efficient at any one time. The same system controls all the lights.' That's the theory of it anyway. It did take some time for the occupants to come to terms with the finer points of the heating and ventilating automation, for such systems usually throw a wobbly when unforeseen partitions are put up. Like any other hi-tech building, Sinclair Research at Willis Road is now well supplied with auxiliary fans for the summer and heaters for the winter.

In July 1983 the tape Microdrive, the loop memory which Sinclair Jim Westwood and David Southward had conceived the previous year, was finally launched. Until the advent of the Microdrive, there were but two means of permanent data storage for the microcomputer – the cassette tape and the floppy disc. The cassette tape is widely used, especially for home computers, and most software is sold in that form. It has the disadvantage that it can take a long time to wind through a tape to retrieve a particular program or set of data. The floppy disc is the more professional storage medium, but its cost is an order of magnitude greater than that of the cassette recorder. The ease with which programs or data can be retrieved from the floppy disc is analogous to the ease with which a particular track can be selected from a gramophone record; there is a similar analogy between the difficulty of selecting a program or track from a tape. Sinclair therefore developed the Microdrive for the Spectrum as an alternative storage medium to give rapid access to data at comparatively low cost. The Microdrive cartridge contains some 200 inches of tape (specially spliced from video tape for durability) with its ends joined to form a loop. The cartridge is plugged into the Microdrive itself; data is stored on the magnetic tape as it is wound past the tape head – and retrieved in the same way.

The Microdrive used a Ferranti chip custom-built to a Sinclair design, with a capacity of 85K bytes on a cartridge which retailed at £4.95. The Microdrive itself cost £49.95. It is essential for a computer to be able to tell its memory what information it requires from it, and how to store new material – hence the 'multi-purpose ZX Interface 1'. This is interposed between the Spectrum and up to eight microdrives. It also includes an RS232 interface to allow the Spectrum to be linked to other computers and peripherals (printers, for example), or to a local area network of up to 64 Spectrums so that they can play games with one another, or exchange messages. This was a big step forward for home computers!



*Jim Westwood*



*David Southward*

At the same time Nigel Searle announced the launch of the ZX Interface 2 which allowed the computer games enthusiast to use software and joysticks and ROM cartridges with the Spectrum. The ROM is a read only memory, a chip which contains a program telling the computer what to do. The Spectrum, for instance, has a built-in ROM which enables it to run Sinclair BASIC. The advantage of the ROM is that, being part of the computer, it can yield its information as needed very quickly. A game on ROM is that much more rapid and compact than a game on cassette tape. The ZX Interface 2 cost £19.95 and there were ten programs, each at £14.95 on ROM cartridge, with names such as Space Raiders, Planetoids, Hungry Horace, Horace and the Spiders, as well as the award-winning Chess and Backgammon (Nigel Searle's favourite). These were all being produced at the Thorn EMI Datatek factory while Timex in Dundee, where the Spectrum was manufactured, was being considered as a possible second source.

'Sinclair Research Limited has established a strict priority sales system for the ZX Microdrive. In sequence of purchase each Spectrum owner will be offered the opportunity to purchase ZX Microdrives at £49.95 each, including a free cartridge containing demonstration programs, and the ZX Interface 1 at £29.95.' Spectrum owners who bought their computers by mail order were sent information and – in the case of the earlier purchasers – order forms.

As the Microdrive was launched, there was a bargain offer on the ZX81 (of which more than 900,000 had been sold worldwide) called a 'low-cost introduction to the world of home computing'. At £45, it was described as a 'starter pack saving £30 on current retail prices', and comprised a ZX81 with a 16K RAM pack giving it maximum memory and one software cassette. It was one way of disposing of surplus stocks of a mature – not to say obsolete – product.

Sinclair was a long time starting in the software market; the company has never liked doing what others do, so any product – computer, printer, or microdrive – has to be much smaller or much cheaper than its competitors, or work on some arcane principle. For this reason, Sinclair initially felt that software was too simple, too trivial, and too ordinary to bother with – plenty of other people were producing it already. Thus several young men became rich in their teens by producing and selling computer software, and more and more demo tapes appeared in the Sinclair offices at Willis Road. Could there be something in it after all? We were in for a U-turn.

September 1983 Nigel Searle launched the first programs with the Sinclair imprint for the ZX81 and Spectrum; 'with the number of Spectrum owners now over half a million the demand for well-written applications is very high and software development is a

major priority at Sinclair.' In the summer Sinclair started working with Macmillan on educational software for five- to eleven-year olds. This was eventually launched by Sinclair and Macmillan in persons that November. There were five programs in the *Learn to Read* series derived from Macmillan's widely-used primary school reading course still entitled *Gay Way*. The four science *Horizon* programs explain key scientific ideas using graphic displays. 'Since my grandfather founded the business in Cambridge in the 1840s it has been our primary concern to ensure that the finest educational and instructional books and material are available to the young people of this country', said Macmillan. 'I am pleased that in my ninetieth year my family business continues this worthy tradition by joining Sir Clive Sinclair in this great technological advance.'

This educational software was a great boost for Sinclair when the Department of Education and Science (DES) launched its Micros in Primary Schools scheme. The three designs especially commended were the BBC Model B, the Research Machines 480Z – and the Sinclair ZX Spectrum.

Using computers in schools is a very different kettle of fish from using calculators. Calculators are now so standard that exam candidates not only use them, but are also advised to take in a second one – or at least spare batteries (which doesn't say much for

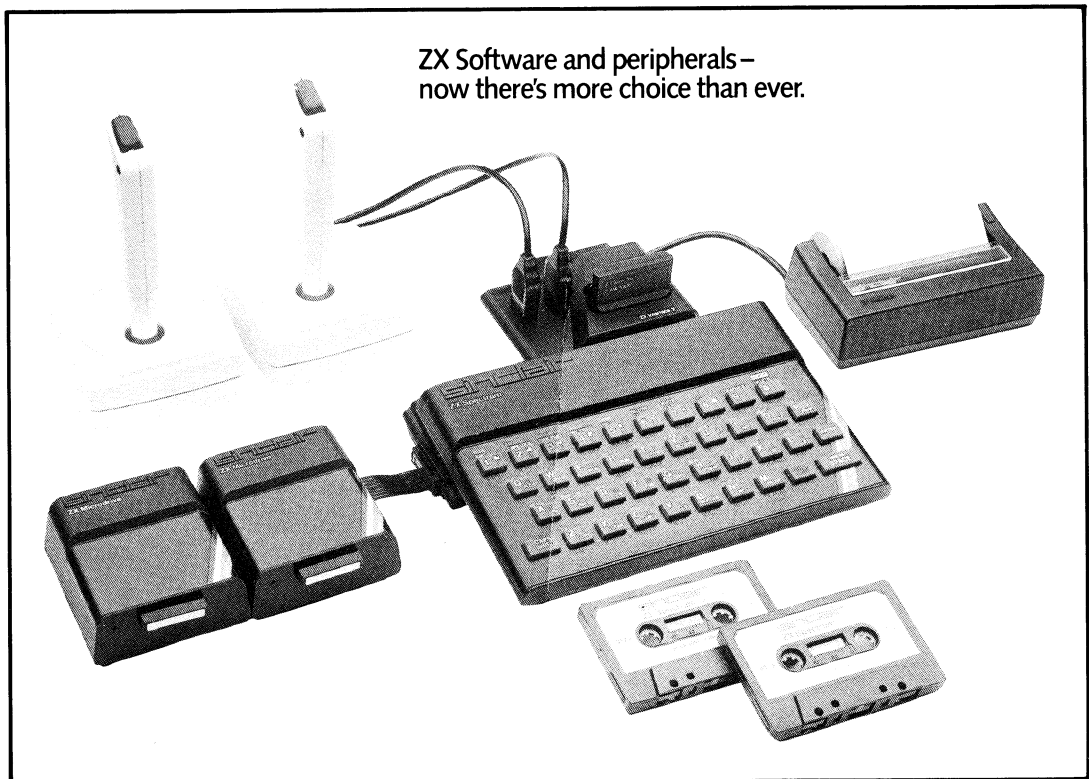

the examination boards' faith in the reliability of the modern calculator). The computer, on the other hand, is more akin to the language lab which was much in vogue ten years ago. The computer can actually help the teacher to teach, if he or she has sufficient ability to use it in that way. But computers are also expensive, and one for each child still seems a long way off; their use will be limited by lack of resources.

Sinclair's worldwide computer sales were now approaching two million and further expansion was still being planned. A new warehousing centre was opened for Sinclair Research by their sole UK distributor GSI (UK) Ltd whose staff had increased by 130 per cent over the year. Nigel Searle opened the centre; according to GSI's managing director Tony Kavandar: 'on a basic one-day shift GSI can now handle up to 250K hardware products, 300K phone calls, and 100K letters monthly.'

Sinclair educational software for the Spectrum was increasing steadily. Five-year olds could now use the Blackboard software spelling and punctuation programs for early learning. Languages for the Spectrum other than BASIC came to the fore, notably versions of micro-PROLOG (billed as the logical language for the fifth generation) and LOGO (with its turtle graphics – the one you usually see six-year olds bent over in television programmes about computing).

In September 1983 Clive Sinclair was presented with a special custom-made Spectrum at Timex of Dundee to mark the production of the one millionth unit. He was somewhat reluctant to go to this presentation; the idea was that he should follow the special millionth computer in its white case round the production line as it was being assembled. He came to the end; the Spectrum was being tested; all the cameras were there. There was a terrific atmosphere on the shop floor, all the girls on the production line gathered round, Barrie Lawson (the Timex director of manufacturing operations) said his few words and handed the computer to Sinclair, who suddenly changed into top gear, made a terrific speech about Timex, held the computer high for the cameras, and all the girls cheered . . . it was a tremendous performance.

The Spectrum continued to go from strength to strength. Sinclair Software now covered tax calculations as well as games, and a graphics package and Sinclair Research pre-tax profits for 1983–84 were declared as £14.28M with turnover up 42 per cent at £77.69M.

The ZX Spectrum was a resounding success and in 1984 was still on sale for just £100. A vast library of software is available and – perhaps most important of all – the Spectrum gained a reputation for excellent quality and reliability. It seemed that Sinclair Research had at last been able to allay the doubts that had ever surrounded Sinclair products.

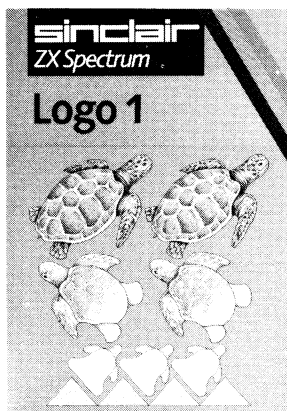

## Sinclair goes to the market

# 12

In the last decade or so the attitude of financiers to what we now call high-tech companies has changed radically. Within very living memory in the UK, only people with solid security could borrow money to finance their businesses. ('You've got to be a man of property to have an overdraft', my father once said to me proudly.) With the emergence of a climate in which the small high-tech company could flourish in the 1970s, there was an increasing need for people to be able to borrow money on the strength of their ideas rather than on the strength of property – because they tended to lack property.

The need was already well recognised and well catered for in the United States; now it became acceptable in Britain. Certain organisations that we have already met (such as the NRDC and the NEB) had been set up by governments to provide finance for development.\* The less-public sectors had been somewhat slower in coming forward, but the wind of change was blowing and has now found its way into the nooks and crannies of the High Street where your friendly local bank manager is more likely to be a trendy young graduate than his or her counterpart was twenty years ago, and is certainly likely to listen with helpful and well-disposed ears to a proposition which depends on an idea rather than on something more tangible.

In 1981, the Stock Exchange set up the unlisted securities market (USM) particularly to attract high-tech companies, most of which had some connection with electronics and computing, and at that time were small but fast-growing. Such companies were often run by an entrepreneurial whizz-kid, or sometimes two. The USM was a good idea; it allowed companies which were solid enough, and diligent enough, to find out how much they were 'worth' –



*Dee Cullingworth  
Clive Sinclair's secretary*

*\* What the fate of the NRDC would have been, had it not had an enormous income from royalties on the drug Cephalosporin and a lease on the Millbank tower is a matter for endless speculation.*



*Bill Nichols  
looked after Sinclair's PR  
before starting on his own*

always bearing in mind that nothing is worth anything other than what you can get for it.

For once, perhaps, everything was happening at the right time. With its rising turnover and profits, Sinclair Research was all set to 'go public'. Well, not quite. The bankers N.M. Rothschild and Sons Limited arranged a 'private placing' in January 1983 which meant that certain institutions (pension funds and the like) could have the privilege of buying a total of 400,000 25p ordinary shares in Sinclair Research at £34 each. The purpose of the placing was stated by Sinclair in his prospectus letter:

'Sinclair Research has conducted a limited amount of research into an electric vehicle project and this work has now reached a stage where significant funding is required for further research and development. The project is highly speculative and therefore I believe should not be funded by Sinclair Research. Accordingly, I have agreed to acquire, at cost, the rights to the research and development work carried out so far and intend to continue the project with funds provided from my share of the proceeds of the Placing.'

It was the time for 'computer millionaires'. Clive Sinclair had 3,704,391 shares in Sinclair Research of which he was going to sell 374,850. He would thus net some £12¾M and appear to be 'worth' well over £100M – fairly spectacular just two years after the ZX80 had been launched into the unknown.

According to *The Sunday Times* league table (4 March 1984), this assessment put Sinclair way in front of 'the unlisted, unsung heroes of the high-tech USM'; top of the list of six were Acorn's Hermann Hauser (£79.8M) and Chris Curry (£64.5M). Piers Harford, a stockbroker quoted in the article, said: 'Once [the computer millionaires] have met their immediate requirements to get a bit of money – perhaps £100,000, they become acutely aware that their millions will remain just so long as they stay and perform.' 'The high-tech millionaire', wrote Philip Beresford, 'knows that to sell would undermine market confidence in the company and leave him with a pile of worthless paper as reward for a decade's hard work, but he probably hasn't come to the market for personal wealth.'

Sinclair's placing exercise started in September 1982, as the success of the Spectrum was becoming clear to all. There was intense activity involving the merchant bankers, two firms of accountants, two firms of lawyers, and of course key people at Sinclair Research. The whole history of the company had to be laid out, including the background on Sinclair Radionics and why that hadn't been a success. The Sinclair condensed and laundered view was as follows:



'In 1961 I formed Sinclair Radionics Ltd, which initially marketed radios and amplifiers in kit form. This led to the development of a range of assembled hi-fi products. In 1972 Sinclair Radionics launched the Sinclair Executive calculator, the world's first true "pocket" calculator. The calculator business grew rapidly and in due course Sinclair Radionics withdrew from the hi-fi market. In 1974 Sinclair Radionics developed a complementary range of scientific calculators followed in 1976 by programmable calculators. In 1975 it commenced the marketing of a digital watch known as the "Black Watch", which was not commercially successful, largely because of an inability to obtain critical components manufactured to the standards and in the quantities required.

'During the early 1970s, Sinclair Radionics was developing a pocket television and by the mid-1970s development of a flat television tube had also commenced, with funding assistance from the National Research Development Corporation. However, by 1975, the funding of the pocket television and flat tube development programmes became difficult due to the Black Watch and the narrowing of margins in the calculator market. In 1976 the National Enterprise Board invested in Sinclair Radionics, enabling development work on the pocket television to continue and leading to the marketing of this television in 1977. Sinclair Radionics' range of electronic instruments, started in 1967, continued to be marketed. Following a number of years of profitability until April, 1975, Sinclair Radionics incurred trading losses of £2.2M in the next two years. In June, 1977, I ceased to have executive control of the business and trading losses totalling a further £2.8M were incurred in the period from May, 1977 until December, 1978. The National Enterprise Board took the view that there was no further role for Sinclair Radionics to play in consumer radionics but that the future of the business lay in electronic instrumentation. I believed strongly in the future of consumer electronics notwithstanding the losses and left in 1979, together with a number of colleagues, to develop the business of Sinclair Research, which I had owned since 1976 but in which I had previously played no executive role.'

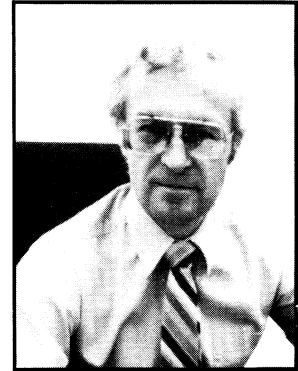

*Bill Matthews  
Cambridge-based finance  
director*

A lot of time was spent talking about the way to present that history, and the conclusion was that, if the NEB really had had faith in the idea of launching the computer, they might have pulled the company round. But they didn't, so Sinclair left and set up this new company which was now doing so well. In the year to 31 March 1981, it had made a pre-tax profit of just over £1M on a turnover of £4.6M. The following year, it had made a pre-tax profit of £9.8M on a turnover of £27.6M – better and better. In the first



*Bill Sinclair  
overseas marketing consultant*

seven months of the year in question, the pre-tax profit was £3.8M on £23.4M – not quite so good, though the forecast for the whole year was a pre-tax profit of £14M; a target which was achieved – just. It was an auspicious start for the flotation.

Whether Sinclair should have gone for the immediate USM quotation is difficult to say. Nobody wants to see anybody lose, though those who play the stock-market through avarice alone deserve all they get. Had Sinclair employees had the opportunity of buying into the company through a sense of mingled excitement and loyalty, it is doubtful whether they could have affected subsequent events which were really controlled – if control is the right word – by the marketplace, the City, and the financial journalists. Clive Sinclair needed a great deal of money (by anyone's standards) for his electric vehicle venture, and he raised it. At the time, it wasn't necessary to go ahead with the public quotation; the institutions were more than happy to get their share of the action provided the company was prepared to go for the USM later. Like many high-tech companies, Sinclair Research was in the anomalous position of having grown very fast, and perhaps not having a long enough track record for the USM – but then not many companies of that sort had!

The very fact that a company has external shareholders creates a pressure on it to organise itself and run itself in a more professional way. Sinclair Research had started in the conglomeration of pokey offices in King's Parade, and overflowed into other offices in Bridge Street somewhat more than a stone's throw away. Even when the fragments came together at the purpose-adapted high-tech building in Willis Road, the company was still not really under control. Having grown from nothing to a multi-million pound turnover in a very short space of time, those in command did not really know what had hit them – always supposing they realised they'd been hit at all. Working practices had hardly changed; everyone was as friendly as ever, highly dedicated to the work; chaos reigned.

But is it necessarily more efficient to have some great master plan, the traditional 'grey men' in command, the inevitable ossified hierarchy, people losing interest in their work and becoming clock-watchers? Why not maintain the friendly, bumbling, ebullient atmosphere where people work all hours because they happen to like the job and know that it has to be done? When everyone knows everyone else, shoulders several varied responsibilities, and has a lot of fun doing it? When the graded bonuses and hampers from Harrods spill through the hierarchy at Christmas?

Herein must lie the dilemma of the growing company. At one time, I used to subscribe to an *Animal Farm* leg-count view that small companies were good, and large companies were bad – or at least that there were small-company people and large-company

people, and never the twain shall meet. Now, I'm by no means convinced that things are as simple as that. Many a small company, started by a technological whizz-kid, has grown on its technology to a size where it needs other expertise – particularly in fields such as marketing and finance – to keep it going. And then when you're dealing with millions rather than thousands – and especially when it's other people's money – you find that controls just have to be stricter. An inordinate amount of time may be devoted to discussing the topic of how to maintain your free-and-easy company ethos; people who have been with a fast-growing company as little as a month or two will say that 'things aren't like they used to be in the old days'.

'Going public' should theoretically force a company to modify its ways of working and improve its management structure in such a way that it will become acceptable to those who are arranging the flotation. External shareholders expect certain standards, but because they are really only interested in the bottom line, they will be looking particularly at the company's *financial* controls – just as you can make a quick judgement of a school only by looking at its examination results.

One might have thought that a high-tech company – especially one making computers – would have its accounts on computer. Not so; until the prospect of flotation, the whole Sinclair system was manual in the extreme and consisted mainly of cash-in-cash-out transactions, with no regular financial accounts, no cash forecasting, no budgeting. The bank didn't worry, because Sinclair had no need of an overdraft. The system was in keeping with the view held by both Clive Sinclair and Nigel Searle that planning isn't really necessary. If you have successful products, more on the way, enough ideas to last beyond the end of the century, and cash flowing in, who needs to plan?

The company was successful, and that was that. Clive Sinclair was surely Britain's best-known millionaire, and was identified with 'the computer' in those domestic minds that knew about such things. He was the *Guardian* Young Businessman of the Year 1983, an honour to which he hardly felt entitled, thinking of himself neither as young (at 43), nor as a businessman. But he had made a significant contribution to British industry, and although it had long been predicted that he would receive some honour, he was genuinely dazed to receive a knighthood in the Queen's Birthday Honours List in 1983; it took him some time to come to terms with it. Just as he had had to dissuade people from calling him 'Mr Sinclair' when he wanted to be 'Clive', he found that he now had to dissuade them from calling him 'Sir Clive'.

'People start treating you differently when you're knighted. There are occasions when it works out quite nicely – when you

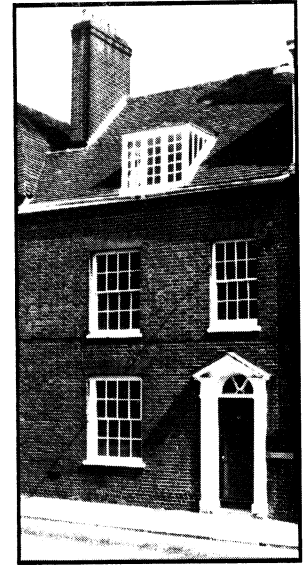

*Sinclair Research, Winchester*

sinclair  
↓ ↓ ↓ ↓ ↓ ↓ ↓ ↓  
sir clive



*Michael Pye  
guardian of the Winchester  
office  
having come up for the  
third time*

get a good table in a restaurant because people know who you are. Now that I've relaxed about it I can see the good side of it and that's OK. But for a long time I thought people resented it . . . I don't mean that I wasn't flattered by it – I was very flattered, very touched indeed, very proud that the Prime Minister thought of recommending me for it. But it does take some getting used to . . . '

The establishment had clearly come to terms with Sinclair's fall and rise; he had risen to an all-time high. Honours were showered upon him; he was appointed a Visiting Fellow by the newest Cambridge college, Robinson; in 1983 – apart from being *Guardian* Young Businessman of the Year – he received Honorary Doctorates of Science from the Universities of Bath, Warwick and Heriot-Watt; UMIST followed suit the following year, and Imperial College made him a Visiting Professor and Honorary Fellow. One of the awards he cherishes most is the 1984 Royal Society Mullard Medal, recognising his work in the field of electronics.

He began to become a television pundit, always with some refreshing way of looking at things. He was interviewed by Bernard Levin (who was obviously out of his depth and quite discomfited by the proceedings): 'If our world has a future, this man will have a big part to play in it . . . '

Which way was up?

## 13

## Question time

*I loved Question Time because you meet interesting people – it's great fun.*

I asked Sinclair why he'd been chosen for this weekly television panel of punditry, run by benign, no-nonsense chairman Robin Day. I had thought that the balance was the three political parties and one industrialist – Sinclair had been on the panel when the programme was broadcast from Scotland, with its Timex relevance.

*No, they get two people thinking from the left and two from the right. And usually one of the two on each side is a known politician, and the other is less obviously political . . . they think I think from the right.*

But in fact, one's opinions may vary from a set party line – I think it such a pity that affiliation to a political party appears to tie one's thinking to a set of national party standards whereas so many decisions should be made at a more domestic, local level.

*Exactly. You and I not being politicians are ill-suited to Question Time; I think it benefits the programme to have people who think for themselves, but the politicians are very vocal because they've thought out a stock answer for almost every subject, whereas I have to think up something on the spot because most subjects I haven't given any thought to.*

So sometimes Sinclair's answers sound a bit terse. But if you listen to a politician answering questions, you will often hear the automatic pilot being switched on, and the standard wording being fed out. Sometimes 'not answering the question' springs not from a desire to be evasive, but from an inability to switch off the programmed spiel. It happens to all of us; people tend to ask predictable questions, and we give our prepared answers.

Clive Sinclair's gramophone records currently embrace law and order, the nuclear tortoise, and – particularly – the fifth generation computer.

*Law and order*

Few can deny that over an observable period something seems to have changed in the general attitude to right and wrong; litter begets litter. Sinclair suggests first that rather than have a separate police, army, navy and air forces, there should be one combined organisation to protect the realm and fight to overcome crime. Second, to reduce the overcrowding in prisons and to maintain personal dignity, certain categories of prisoner should be allowed to go free provided that they can be monitored by means of a transmitter they would have to wear. The Romans branded thieves' foreheads FVR. Those who protest about human rights should be not less vociferous about human responsibilities.

*The nuclear tortoise*

Sinclair's argument here is that the logical stage after the visible and notionally interceptable inter-continental ballistic missile, and the slower, ground-hugging Cruise missile, is the nuclear tortoise which creeps slowly and inexorably across the countryside, travelling at night, hiding in hedgerows and ditches during the day, until it reaches its destination and does whatever it is programmed to do (such as exploding). Application of the *reductio ad absurdum* principle leads me to suppose that if the tortoises were immobile, staying where they are built, and either blowing themselves and their manufactory to smithereens or not as the case may be, they would effect rapid abandonment of nuclear weaponry . . . provided that both sides had them. It is akin to the spike in the centre of the steering wheel to make people drive carefully.

*The fifth generation*

The first generation of computers comprised the huge 'electronic brains' which swam into our ken in the early 1950s, reliant upon thermionic valves and useful for little other than number-crunching (ie, doing huge banausic sums) and allied tasks such as codebreaking. Since then we have seen the introduction of what became known as the transistor, not only smaller and more reliable than the thermionic valve but – by dint of the way it can be made in its hundreds on a silicon chip – a device of infinitely more potential. I doubt if anyone foresaw this when the transistor was invented. Be that as it may, the harnessing of the principle and the development of techniques of manufacture has enabled the computer to become smaller and smaller as it has become more and more powerful. 'Power' in a computer embraces several characteristics. Perhaps the most obvious is the size of its memory, though memory can theoretically be increased *ad infinitum*. However, according to the way in which you increase the memory, the computer may take

more or less time to access the part you want – and sometimes you may have to take part in the search by feeding the computer a disc or a tape. ‘Power’, then, may also be applied to the ease and rapidity with which data can be retrieved from storage. ‘Power’ may also refer to processing power, the variety of tasks which the computer can handle – not just doing sums (which to many people is what computers are for) but keeping accounts, typing letters, controlling plant, designing the shapes of car bodies, or whatever. On the other hand, this is a function of the programs that we give the computer, but the complexity of the tasks it will do for us, and the way it does it, comes back to processing power and memory.

What is all this computer power going to do for us?

*The fifth-generation machine is a design principally concerned with thoughts and ideas as opposed to numbers. What I’m interested in – what excites me – is making a machine which aids us as humans in the mental sphere in the same way as motors have aided us in the mechanical and the physical sphere. We’ve done very well there – right from the start of the industrial revolution we’ve been developing machines to aid us, and to take the burden off our muscles in every sense – machine tools, means of transport, domestic appliances, hand tools – that’s gone very well; now’s the time for doing the same thing for the intellect.*

*So far we’ve replaced human labour at the very lowest intellectual levels – no intellect’s needed for washing up and so on – and now we’re aiming at moving upwards and replacing intellect at the professional level. I think that what I’m doing is making a machine which will in due course sit in the home and replace – or supplement – the doctor, the solicitor, the teacher.*

I get the impression that you’re expecting Mr & Mrs Everybody to have a higher intellectual standard than I believe they actually have.

*Oh no, not a bit; I’m not expecting that. I don’t think that my machine will demand anything intellectually; it itself will have to have very great intellectual powers, but its users will have whatever intellectual powers they choose to have. The machine will be there, and it will advise them; they can ask it questions and it’ll give them answers – perhaps even tell them what to do. They can say: ‘What’s on television tonight?’ and they won’t have to worry about how it will get the information – it’ll decide that; it’ll ring up somebody or look it up in its memory banks, or find out by whatever means. Or they can say to it: ‘What’s the first train to London round about midday tomorrow?’ or: ‘I’ve got a pain in my right side and really haven’t been feeling too well’ – and it’ll recognise them; it’ll know who they are when they’re talking to it.*

TV programmes and trains to London – isn’t this covered by teletext – Ceefax and Oracle?

*Oh no, it's going to talk to you. If you go to teletext you've got to think: dial 100 or whatever – I meant it literally as I said it; you go to the machine and say: 'What's on TV tonight?' and it'll reply: 'What do you want to watch? Should I go right through the programmes, just tell you ITV . . . ?'*

I see. Will it actually tune itself to my intellectual level?

*Yes, certainly. It'll know the person; it'll deal with each person in the family as an individual. I hadn't thought of it as tuning to intellectual level but it's a nice way of putting it; that's what it will be doing.*

Well, in a sense it is. The way I ask my questions and the sorts of questions I can answer when it asks me will vary according to who I am. How does the machine find out about me?

*It's introduced to the family when it first arrives. You'll sit down and it'll say: 'Hello, tell me your name?' and you'll say: 'I'm Johnny' and it'll ask questions to find out all about you.*

But what then? Do you really foresee that everyone's going to be sitting at home talking to computers?

*I think it's a wonderful thing. I think it will remove a lot of loneliness for old people, and it'll improve the standards of education dramatically – because we'll be able to have individual tuition . . . whether it'll be done at home, or at school with each person sitting in front of one of these strange teachers, I don't know.*

*As I imagine it, you'd look at this machine and see a face there talking to you; it would have a personality. There wouldn't be a face; you'd just see one . . . I imagine that people would generate an image of the sort of face they'd like to see – it would certainly assume different personalities for different people.*

*Of course eventually you could pack it all into a body and make it into a robot . . .*

That's a different can of worms; how far away do you think this is?

*I think we can make a machine that does all this in the early 90s, but it'll be too expensive for domestic use until the turn of the century.*

We've already got a problem of non-standardisation – computers which don't communicate with one another because they use different languages or formats or media. What about standardisation for these machines which are orders of magnitude more powerful?

*Ah – this is a machine you talk to, so its language is natural.*

Interesting thought – machines from different manufacturers would have their own internal standards, but they could communicate with one another in plain English – or Japanese. You could shut a group of them in a room and listen to them having a conversation. But what about the standards for storing the information for what's on the telly or what time the trains are?

*It will refer to whatever systems are available, just as you do – or I do – now. It'll be so enormously intelligent that it will be able to cope with*



*all the different forms of information.*

It sounds like making a rod for your own back –

*The machine's got to relate to the world as it finds it.*

But if you have to alter the world . . .

*No, you're trying to alter the world to fit in with this machine that I haven't yet developed.*

So you'll need to have optical character recognition and something blinking over the times on the timetable?

*I think it'll need to be able to read the papers . . . I can see what you're saying and I don't deny that standards would help, but you've also got to be realistic. It probably won't happen to the extent that one might like – it would be nice if character fonts were standardised to make reading easier but that won't happen, so the machine's got to cope with that.*

What is it that you find so terribly exciting about this idea?

*I suppose it's because it'll be the first time that humans won't be the only known intelligence in the known universe. We don't have to wait for them to arrive from outer space; we can build them here.*

Why do you want that to happen?

*I don't particularly; I think it's exciting though!*

So you treat it as an intellectual challenge rather than as an end product that you think will be useful?

*On the contrary! I think it's a product which will be immensely useful. I think it will change mankind – create more wealth for mankind than any other development in history. I think that early in the next century we'll be able to make a robot with true intelligence and patience and all sorts of qualities; it will be able to walk into the Third World and advise them. These machines will be as the Greek slaves were to the Romans.*

One difference is that you're not actually creating a slave class from existing people. In the case of the Greeks and the Romans you had a means for soaking up those who were not employers of slaves.

*The people who employed the slaves were often the intellectual inferiors. The Greek slaves were superior to the Roman slave-owners. The Greek was often the intellectual – reading and writing letters, teaching the children and so on – that's why I'm using that particular analogy. So in that sense one doesn't see a need to mop up people.*

Aren't some of today's problems borne of the fact that there is a shortage of menial jobs – or perhaps that many people have been 'educated' to have expectations beyond what they can achieve?

*I don't know that they have been educated to believe that. I think there's a shortage of jobs at the moment because jobs have been shed from the manufacturing industry at such a rate that society can't adjust. Once that job-shedding ends, as it will, then I think society will adjust, and more and more people will be employed in service industries. I think this is happening in the States now. Even when we have robots people will prefer to be served by other human beings.*

I think my view of what is happening is different from yours. I think unemployment started with the industrial revolution; when we talk about unemployment there are people who *might* have been farm labourers, or people who *might* have been looking after the cab horses . . .

*In 1850 60 per cent of the population were either employed on the land or were servants, and it must have been unthinkable that those people could be elsewhere employed because they were the people who were thought of as only good for ploughing the land or scrubbing floors – how on earth could they be employed? But they were.*

That's what I mean about expectations. A servant who wanted to rise in the world could do so – well, theoretically. Most of them were content to do what they were doing and live from day to day in a simple fashion. They didn't think the world owed them a living. More benign employers and fewer potential employees with big ideas would work wonders for unemployment.

*I think we'll go back to full employment in the early 90s. And then I think that one day much further ahead the robots really will be able to do everything that humans can – with all human actions and so on – it may be that people will prefer to be served by robots than by humans . . . in which case there won't be any jobs, unless the robots decide they don't want to bother with us! However, we won't have to face the problem until the twenty-first century, and it will depend on what people actually want to do; we might change our views about unemployment. Macmillan said to me: 'I don't know why people keep complaining about not having any work; some of my best friends never work at all and look at them'. People will be brought up to that way of thinking.*

But they still have to have some means of support.

*They need wealth, but that wealth will be created in abundance by the robot slaves. Think about it – supposing you could economically make a certain number of robots. They could make many more, and they could make a larger number still – so suddenly you've got lots and lots of them. And they could all go out and work, generate all the wealth – do anything you like; they're as intelligent as we are. They don't tire. I'm not saying when – but one day.*

I think there's either a flaw in your argument or I'm not understanding it in the right way. I can't help wondering what on earth I shall do when robots are doing everything for me. I suppose they'll form their own bridge fours, and I can carry on as before. How far do you think the home computer has educated us for the future you describe?

*I think that we've done the first and second stages of the job – we've got millions of people out there now who play with computers, who're familiar with keyboards; the next stage is to make a machine that's useful to them. An awful lot of computers have been bought by people who wanted to learn about computers – which is the intention – and to play games on them. But an awful lot of other people have bought them*



*and found them inappropriate for their use. And we're really not winning if you still choose to use a pad to take your notes, rather than a computer. You can type, so if you had a machine which was sufficiently right for your needs you'd have it with you and put your notes straight into it.*

But then if I had a machine which was sufficient to my needs it would actually transcribe what we're saying wouldn't it?

*Oh yes, but the first sort of machine is just around the corner. It's not there yet, but it should be. It's what we've got to make; the opportunity is there. Instead of writing in your notebook, wouldn't you prefer to tell your machine where to file the data so you could retrieve it?*

It all depends what one is used to. I find that, admirable as your idea might be, spreading out all my papers and saying: 'I want this sentence from here, and that sentence from there, and this paragraph in here . . .' is something that you cannot do very well with a computer. Of course I know what you'll say about word processing, but I still need hard copy to be able to take a synoptic view of my material.

So you've tried to educate people, but they may have found that they can't do what they'd like to do with machines. Now, is there a danger that these people will go away sadly saying: 'Computers are not for us after all'? Do you really think you can take a second bite at the cherry; that you can come back with another machine and say: 'This will do what you had hoped'?

*I think the disillusionment is among a very few people. The market that I'm concerned with is the millions of young people who've played with computers and made them do just what they wanted them to. Now they're going to think – if we present the right machine to them: 'Ah yes, here's the next stage'.*

Yes. What tasks do you think young people want to do with computers that they can't do at the moment?

*I think that they can do all the tasks with the appropriate machine, but to do all the tasks well is perhaps too expensive – and portability is so vital. I think that the reason that we cling to paper is that it's so portable.*

Yes, and so fileable and so throw-awayable.

*Yes, but it's the portability that's still lacking with computers. You want a printout of the data so that you can take it with you – not because you want the paper. If the whole machine always goes with you without it being cumbersome, then you can do away with the paper.*

Even this small step needs a very great change in attitudes and methods of working. How much greater will be the problems of your new Periclean Athens?

*Manifold. I don't want to think about it!*

## The ZX83

Sinclair was working his purpose out; the Spectrum was a bestseller in the home computer market, and he was achieving his object – to familiarise the world at large with the joys of computing via the home computer.

Not that the process hadn't been a little back to front, for the advantages of the Spectrum over the ZX80 and ZX81 – either of which models might well have put Josephine Public off computing for life – were obvious to all who used it. For it was a much lamented fact that, hard as anyone tried – and there were liberated ladies out there trying as hard as anyone – the world of home computing was predominantly male. It was nicely summed up in the cover of *Practical Computing* showing the Mona Lisa holding a computer and saying: 'Very nice, dear, but what does it do?' Of course there is some advantage in the ladies understanding what it is to which the gentlemen of the family are devoting all their time . . . if only it weren't so difficult to satisfy feminine logic on such topics.

Be that as it may, the name Sinclair now meant computers, just as ten years before it had meant pocket calculators – more important, the word computer was beginning to mean Sinclair. Whatever machine a purchaser ended up buying, it is certain that the name Sinclair would have been on the shopping list.

Plans were laid for the next model, whose working name was the ZX83. It would be aimed at a specific gap in the now-educated market – the business user about to embark on computing. This was a market potentially ten times as big as that for home computing, so it was well worth pursuing. In 1984, a simple business installation cost at least £2000; more with a quality printer and a range of software. For many small businesses such a sum was

out of the question; for many others it was an unjustifiable expense, considering that all they really wanted was a computer to play with to see how -- or even if -- it could help them. Sinclair's aim was to bring down the price of a notionally comparable system so that a whole stratum of potentially interested users would be able to justify the expense.

How far could the price be brought down? When you're talking in thousands, a hundred or two either way is of little significance. But when you're trying to bring your products down into the hundreds region every saving is significant. So why not supply a machine without a monitor screen; the user could provide his own by connecting the machine to an ordinary domestic television set. The machine would be provided with 'two standard communications interfaces for peripherals such as printers and modems'. No big deal was made of printers, because a printer might cost as much again as the computer itself. Not having one -- however essential it turned out to be later -- would hardly prevent a user from experimenting with his system; thus was another initial saving possible. The really significant contribution towards cost-cutting (and, as we shall see, one of the contributory factors to the problems that were to occur) was the Microdrive.

The Microdrive had already been developed for the Spectrum, so it provided Sinclair Research with a ready-made, low-cost storage medium; the ZX83 would have two built-in Microdrives. One advantage cited for the Microdrive by Sinclair was its uniqueness. But uniqueness is a sword with many edges. On the one hand, it gives you a monopoly on the medium. Moreover, because it was a deliberate Sinclair policy to discourage software houses from writing games for the ZX83 there was an advantage in the monopoly -- in spite of the fun software which more-expensive established business computers provide, Sinclair felt that games would undermine the authority of the ZX83.

To emphasise the fact that it was a business machine, the ZX83 was to be supplied with four Microdrive cartridges carrying software specially developed by Psion for business use.

Originally known as a games software house, Psion had always wanted to enter the field of business applications, and the ZX83 gave them their chance. For fifteen months, the Psion development team toiled away producing Quill (the word processor), Abacus (the spreadsheet), Archive (the database) and Easel (the graphics program). Before embarking on this development, Psion had produced 300,000,000 games cassettes, and with a 1983 turnover approaching £10M could afford to devote almost all its programming resources to the ZX83 gamble. Not that it was that much of a gamble, for Psion retained the right to adapt the business suites for other purposes after Sinclair had had a period of exclusive use. However, the development did bring most of Psion's other

work to a grinding halt, indeed, during the fifteen months they produced only two new games – both for the Spectrum and both winners – *Scrabble* and *Chequered Flag*.

But to return to uniqueness, and its underlying philosophy. I asked Sinclair about standardisation – though in a different and more general context; whether he saw lack of standardisation as a drawback to development. ‘No, I don’t think so,’ he replied. ‘It has benefits, but it tends to curtail development, and when you’ve got fast-moving people that’s a nuisance.’ In other words, Sinclair tends to set standards and others may follow if they will.

Because the Microdrive is specially tailored to the needs of the ZX83, its average access time – the time it takes to reach a given part of the tape – is given as 3.5 seconds. However, although Spectrum and ZX83 cartridges are interchangeable, the information on them is not. But of course, neither is interchangeable with any other storage medium known to the world of computing. Not that that should worry us very much; computers are notoriously bad at running one another’s programs unless specifically set up to do so. Probably people just feel happier with the well-trying, reliable floppy disc than with the less-trying Microdrive. In the first place, the company saw the development of the Microdrive as another step towards improving computing power for everyone, and now the Microdrive (they thought) would come into its own as one of the decisive factors in bringing computing power to the businessman.

As 1983 drew to a close, work on the ZX83 (or would it be the ZX84?) became more and more frantic. Language proliferation caveats were thrown to the winds, and a new dialect of BASIC – SuperBASIC – was devised for the machine. Together Roy Atherton (who was writing the manual) and ‘Tony’ Tebby and Jan Jones who were writing the interpreter – the program which translates your instructions to the computer into a form which it can understand – pushed ahead with its development. At the beginning, Tebby was telling Atherton what the machine would do; as the project progressed, Atherton was telling Tebby what the manual said it would do.

What was the machine going to be called? Suggestions were invited from within the Sinclair organisation, perhaps the most memorable being, in honour of Sinclair’s favourite colour and recent honour, the Black Knight. One day my telephone rang; it was Alison Maguire, software manager:

‘We’ve got a name for the new computer.’

‘Yes, what?’

‘Hold on, I’ll just shut the door . . .

It’s Quantum Leap, QL for short.’



*Tony Tebby*  
systems designer

*Alison Maguire*  
software manager





*Rick Dickinson  
industrial designer*

There was very little I felt I could say. Looking back on it, one wonders why all the secrecy. And those two letters – QL – which seemed so novel then, now conjure up an image of a particular computer and all the surrounding controversy.

The launch date of the QL was fixed for 12 January 1984. That it was far too early a date is now well known, but just who realised that at the time when it was fixed is unclear. As we have said before, it was part of the Nigel Searle management technique never to prepare any sort of schedule showing who was going to do what and by when. Such an approach, he averred, leads people to take more time than they should. If you tell them the launch date, it gives everyone something to aim at. So Sinclair management ‘agreed’ the launch date with the engineers, with the proviso that the product would not be ready to ship in bulk until the end of February 1984: The launch date was decreed well before Christmas, and when you’re working at high pressure, two or three months ahead seems long enough to do anything in.

Another factor which no doubt played a part in the decision was the fact that industrial designer Rick Dickinson had already produced the elegantly styled case of the QL, since tooling for the mechanical parts of any model has to be put in hand sooner rather than later. Having such things to play with can give one a false sense of the proximity of the completion of any project.

But perhaps one of the most powerful reasons for making the announcement was that it seemed as though the competition were aiming at the same gap in the market (the low-priced business

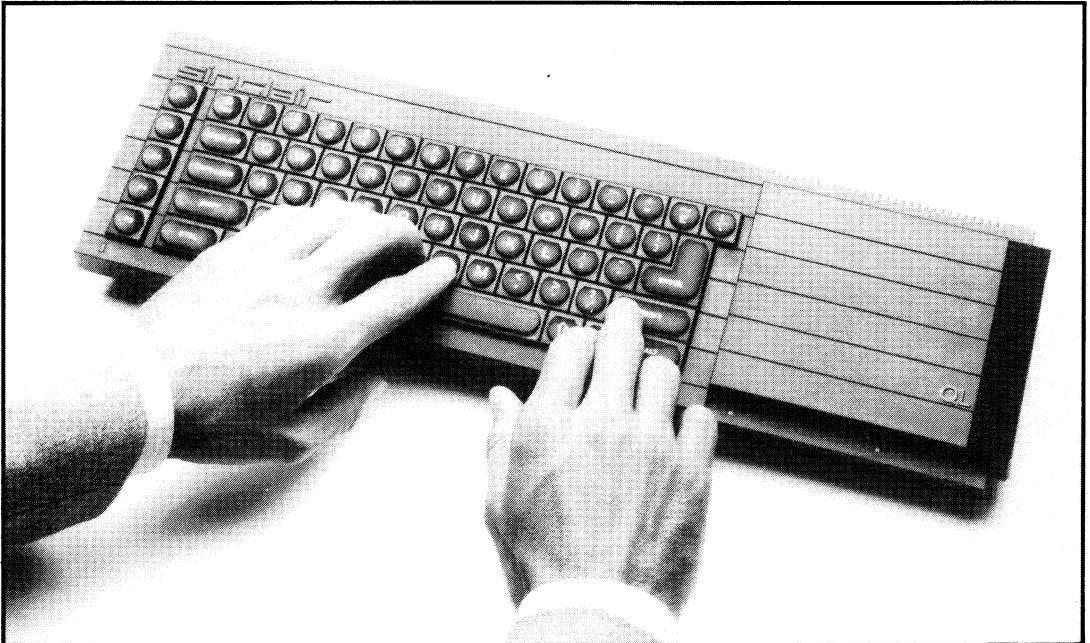



computer) – IBM with its PC, Apple with its Macintosh, Commodore with its 264 and, last but by no means least, Acorn with its Business Machine. Perhaps it would have been better to start rumours about the ZX84; there was, and never had been, any experience to show that the competition was likely to get a better machine out faster.

Sinclair Research was riding high on the Spectrum – the most successful single product in the company’s history, and the most successful home computer. Everything was going to take a quantum leap. The company commissioned designers Wolff Olins to produce a new typographic image; they specified a typeface called Syntax which, until that time, very few people had heard of. At least it would ensure that Sinclair advertisements and literature would have a ‘different’ look about them, even if readers couldn’t quite work out why.

The launch at the Inter-Continental Hotel, Hyde Park Corner, was spectacular: either the name of Sinclair, or the promise of breakfast, was such that some computer journals sent the entire staff to find out what was going on. By 10.30 everyone had trooped into the conference room and Nigel Searle introduced Clive Sinclair, who described how the QL had come into being, and unlocked the secret that QL meant quantum leap. ‘Many of its advanced capabilities, such as multi-tasking and multi-window display, are normally only available on machines costing several thousand pounds’ he said, perhaps it was the mad scramble to the phones which resulted in one journal quoting this as ‘£7000’. Sinclair in action at a press conference on a good day is a force to be reckoned with, and he received an almost standing ovation.

Nigel Searle then described the capabilities of the machine, and large screens around the hall echoed visually the content of his speech. A multicoloured picture of a room was built up, a picture frame appeared on the wall, the picture which appeared in the frame was a small version of what was already on the screen, another frame appeared, and so on. When the last dot – which we knew was the last picture only by analogy – appeared, snow started to fall past all the windows. A clever way of demonstrating the way in which the screen could be divided up into sections, each controlled independently.

Generally the questions from the floor showed that the press was well disposed towards the QL and the company producing it. ‘Where can I buy one?’ is always a good opener at a product launch. However, someone did suggest, to general murmurs of approval, that if you bought a machine at £399, the postage and packing (for any order over £390!) of £7.95 would bring the price above £400. Such pricing policies must be counter-productive.

We were also introduced to the QLUB (QL Users’ Bureau) which all QL users could join for a year for £35, thus becoming



*Nigel Searle  
managing director*

*David Karlin  
electronics designer*

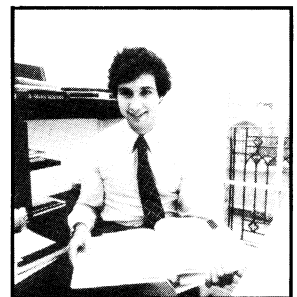

entitled to one free update of each of the four software programs, and six bi-monthly newsletters – generally thought to be a good idea.

When the formal part of the presentation was over, Buck's Fizz was handed round and David Potter (Psion's Managing Director) and his Psionists were on hand to run displays of the software and answer questions. Sinclair, Searle and especially David Karlin – who had been responsible for most of the electronics design and had been inside the machine pulling the strings – relaxed and mopped their brows. The launch was nothing if not lavish; everyone left the hotel clutching extremely glossy brochures and copies of the QL manual – almost as good as having a QL.

Generally rave reviews began to appear in the technical press. Soon, everyone had heard of the QL and orders began to pour in. Deliveries did not, however, begin to pour out. Even before the end of February, it was clear that the company would not be able to despatch QLs 'within 28 days' as promised.

At first, people were prepared to make allowances – Sinclair products were often a little slow off the mark, but when they arrived they were well worth waiting for. At the beginning of March Sinclair announced that deliveries of the QL would start in April. 'The delay has been caused by the final stages of development taking longer than planned', said a spokesman as if he had chanced on some cosmic truth. Sinclair's distributors, Prism Microproducts, were appointed to distribute the QL when sales began at some unspecified date (flash forward: within a year Prism appointed a receiver and manager, and the Sinclair agreement was terminated).

What a friend of the company described as 'a well-orchestrated anti-Sinclair campaign' began to be mounted. The delivery promises had now become something of a joke, and journalists sought ways of rubbing salt in the wounds. Of Sinclair's sponsorship of the Cambridge Half-Marathon, one suggested that the distance would be 'excellent training for people who run each day to the store to see if their QL has finally arrived'; of the Sinclair Prize for Fiction which he had set up another quipped that the winning title should be *Immediate Delivery of the QL*.

But the predicament of the QL was no joking matter. By the end of May, the company had received over £5M for 13,000 machines, but had only been able to deliver a few hundred. 'And what', people began to ask, 'is happening to the money that is being sent to Sinclair for QLs?' At first, the cheques were cashed, for there was no doubt in the company mind that the delivery promises would be met; in any case, this was not an unusual way of assisting cash flow and funding development.

As time went on, and it was clear that there would be a delay in

delivery, customers were offered the choice of their money back, or a free cable 'worth £15' when the machine was delivered. As disquiet grew, the company announced that it was paying would-be purchasers' money into a trust fund which would not be touched until machines were delivered. So the next question was what would happen to the interest on the money in the trust fund? Well, it would help to pay for those free cables.

In July, the company announced that the QL computer and flat-screen TV would go retail in September. It was put about that the machine which Clive Sinclair – with a fine sense of a good photograph – had been holding above his head at the press conference had been but an empty shell; why though need it have been anything else? – the demonstrations were real enough. It was 'revealed' that the screen shots which had illustrated the publicity matter had not been QL-generated. Why should they have been? It takes time to produce publicity material – especially glossy publicity material in full colour – and if the end is the same, the means is hardly relevant; it is not as though there were some intent to deceive. But in the growing atmosphere of disquiet these 'revelations' somehow took on a sinister note.

The machines that were slowly being delivered were still in effect under development, and contained gradually improving versions of the felicitously-named QDOS operating system (the system that orchestrates the computer's working). All of this was like wearing a coat with the tailor inside finishing it off. It turned out that QDOS was twice as big as the operating system on the Spectrum, and four times as complex, and that trying to produce QDOS in twelve months had been but a pious hope. As QDOS changed, so did Psion have to keep modifying its applications programs. Meanwhile, specialist journalists who had been lent a QL on the Pears Soap principle (that once you have used it you will use no other) discovered that the programs were not fully interchangeable, and that there were still bugs in the interpreter.

One of the oddities that people couldn't help noticing was the chip 'exposed to the elements sticking out of the back of the casing' which gave – not unnaturally – the impression that the machine was not properly finished. The reason for this extra chip, which became known in some circles as the kludge, could not be described in a sentence and the truth of the axiom 'never apologise, never explain' became apparent when people tried to. Here follows the story as told by Nigel Searle.

Originally, it had been expected that QDOS and the Super-BASIC interpreter would fit into 32K of read-only memory – ROM. There were therefore two ROM sockets inside the machine, each to take one 16K ROM chip. But it was later found to be impossible to pack everything into 32K, although 48K would be sufficient. Normally, the answer would have been to supply one

16K ROM chip and one 32K ROM chip ( $16+32=48$ ); however, this would have meant further delays as chips cannot go into production overnight. There was one way to get supplies moving: use electrically programmable ROMs – EPROMs. Although these cost 10 or 20 times as much as ROMs, they could be locally prepared, which saved a considerable amount of time. However, although 16K EPROMs were expensive, 32K EPROMs were unobtainable. The solution was therefore to use *three* 16K EPROMs which raised a new problem – where to put the third.

Searle reasons thus: suppose the third ROM had been mounted inside the machine on a flying extension lead; it would have looked like the afterthought and temporary expedient that it was, and when people opened the case (as they inevitably would) there would have been cause for even more adverse comment. The alternative was to put the EPROM into a little package and plug it into the external ROM cartridge slot which had been provided for applications software. Since none was yet available, this would have no adverse effect on the user, and the company would be absolved from any accusation of concealment. It was the ethical solution, and the one that they decided to adopt. When the proper ROMs became available, people would be invited to exchange them for the EPROMs. So now you know!

*Inserting a Microdrive cartridge*



Sinclair Research came in for a great deal of criticism for delivering the machine with 'a bit hanging out at the back', but it was a direct consequence of launching an unfinished product.

There was also a problem with the Microdrives. The QL used the same Microdrive cartridge as the Spectrum, but it was thought that the Microdrive was sufficiently well developed to run it 25 per cent faster in the QL. This gave rise to difficulties in the duplication processes because tape cleanliness became a problem at the higher speed; at the slower speed of the Spectrum, the signal was inherently easier to read, and tape cleanliness was not a crucial factor. Even tape temperature and microscopic amounts of wear on the drives could cause changes in performance. Because the Microdrive was built into the QL, there was also a possibility that the tape might be affected by electrical noise.

The cumulative effect of all these potential problems resulted in unpredictable incompatibility. Where did the problem lie? Again, Nigel Searle's view is that it could not be attributed solely to any one factor. For it manifested thus: a cartridge which would work with QL A would not work with QL B. A cartridge which would work with QL B would not work with QL A. Who was to say which was wrong – the cartridge or the machine? It is so easy to become charmed with the philosophical elegance of the question that the

*The interior of the QL*

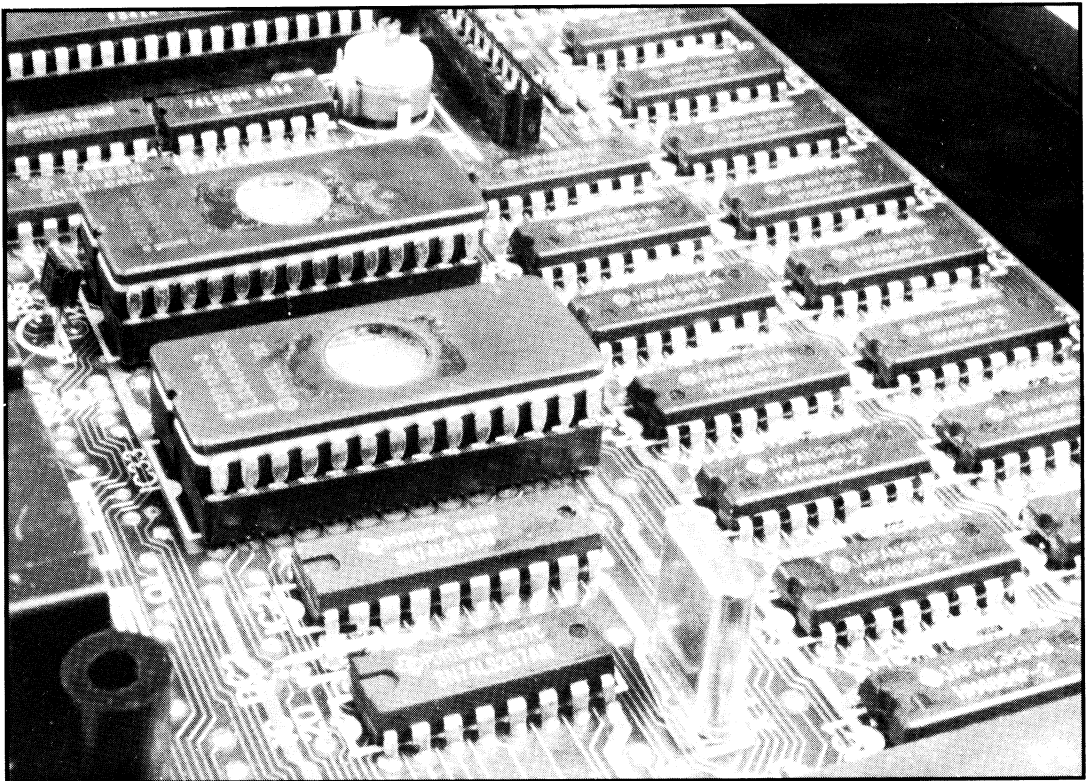

significance of its needing an answer pales. The fact is that it should have been discovered and eradicated before the QL was ever put into production; as it was, the Sinclair engineers were frantically trying to solve the problem, and the shipment of QLs was painfully slow, as each Microdrive cartridge was tested on its host machine to make sure that it worked properly.

The prolonged wait suffered by thousands of expectant customers, the temporary expedient with EPROMs, the changing versions of QDOS, the consequent modifications to software, and the multiple problems with the Microdrive all raised fundamental questions about Sinclair's design philosophy and marketing practice.

At the launch in January 1984, Clive spoke of QL production building up to 100,000 per month. In fact, fewer than 60,000 machines were sold in that first year.

Sinclair's adamant refusal to produce games software for the QL, on the mistaken principle that it would make it look like a games machine, must have played its part in dissuading potential customers. Even the lower-budget end of the business sector is likely to be looking for reasons – or excuses – to buy its first computer and the idea that it will appeal to all the family can be a powerful purse-opener. It is carrying one's principles to absurd lengths to say that it is better to sell an empty brain than one full of jokes and happiness, lest that should degrade its potential seriousness. It is difficult to believe that more QLs have been sold because there is no games software. But then Sinclair has always had an oblique view of software publishing.

## 15

## The picture in your pocket

The technique of the flat-screen television was developed in the 1950s by Dr Denis Gabor – who invented the hologram – at Imperial College, London. Various people had toyed with the idea on and off since then – without success – and the very fact that there was a Sinclair team gave rise to a certain amount of interested speculation. Gabor's idea had been to make a screen eight feet across; Sinclair had gone to the other extreme and was developing a two-inch flat screen for a miniature TV. *The Economist* pointed out that as far as TVs go, thinness sells. Customers want television sets that can be stored out of the way on shelves or in cupboards when not in use. The goal, elusive maybe, is a television set so thin that it can be hung from a picture rail (hands up if you have a picture rail); when the set is not in use, turn its face to the wall to display the work of art of your choice. *The Economist* also points out that as production wrinkles are ironed out semiconductor products tend to become cheaper – we are reminded of the pocket calculator and the digital watch – as if we could forget. The bulk of the cost of a television tube lies in making its complicated glass envelope so there is little chance of its price falling further. Unless, of course, it can be fundamentally redesigned to simplify its manufacture. The Japanese were busy working on 'exotic' new display technology – liquid crystals, thin films of transistors or electroluminescent panels. Sinclair, who as always wants to do things NOW, was using a traditional cathode ray tube. As *The Economist* put it:

Sinclair's trick is to squirt the electron beam creating the picture in from the side instead of the back of the set. The beam is focussed and steered in the normal way but instead of passing in a straight line through the tube, the beam is deflected through a

right angle by a powerful electric field to impinge on a phosphor screen placed on the side.

The viewer sees the picture exactly as it is beamed onto the phosphor screen. In today's conventional sets the picture is seen at one remove, as it is transmitted by the phosphor screen through the thick and specially coated glass screen of the ordinary tube. The advantage of the Sinclair system is a brighter picture. The tube is claimed to be three times brighter than an equivalent-size conventional television. It is also said to need less than a quarter of the power to drive it – which means longer battery life.

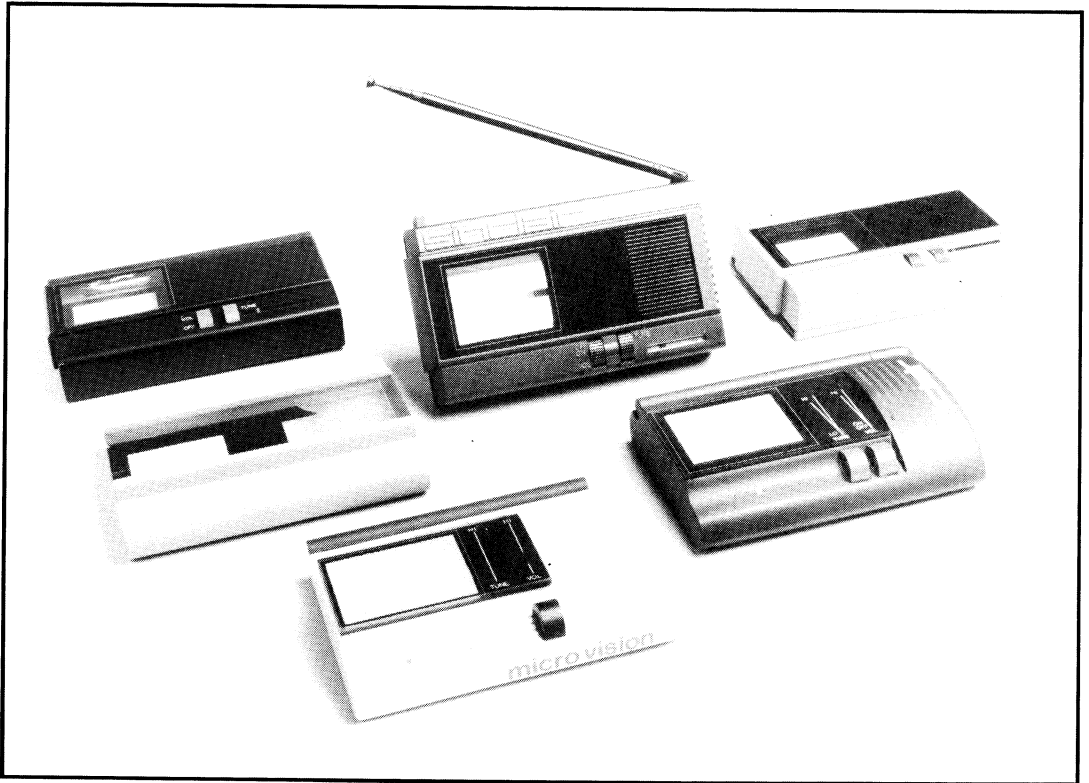

*TV prototype cases by  
Rick Dickinson*

For some reason it was thought that these tubes were going to be easier to manufacture than normal CRTs but *The Economist* said that none of the British manufacturers was likely to be able to produce them for less than \$100 each wholesale. As usual, Sinclair wanted to market the complete pocket-sized television for under \$200, which didn't leave much of a margin.

Sinclair may have been optimistic but it was only 20 months later in 1981 that we next heard about the flat-screen TV when *The Scotsman* told us that there was a £5M deal with Timex to build it and one thousand new jobs coming to Dunsinane by 1985.



According to Sinclair, Timex had been chosen 'for their renowned ability to design and make automatic production machinery and their eminence in precision engineering'. *New Scientist* told us that 'the flat-screen television would be on sale next year for around £50 incorporating an FM radio as well as a black-and-white television with a 7.5cm screen. It would work in almost any country in the world excluding France (France uses AM rather than FM sound for its television transmissions) and the Eastern bloc.

*New Scientist* was of the opinion that Sinclair was backing the wrong technology for the long term and that the matrix displays the Japanese were developing would have a greater potential; however, with these every little spot on the screen has to have its own individual 'address' which makes them prohibitively complicated for small volume production if one is to obtain any sort of picture clarity.

In order to reduce the TV's power consumption, the flat screen is wide but not very high, and a Fresnel lens mounted in front of it restores the picture to its normal size. This system puts less strain on the scanning circuits because they don't have to develop such high voltages. However, it causes some problems for the viewer as we shall see.

The demonstration set had a large box of electronics underneath it which, it was said, would subsequently be integrated to fit inside the case. This is not an unusual practice in prototype design, since often the easiest way to find out how a circuit performs is to build it from discrete devices, so that components can be changed as necessary to get the best result. When the circuit is working satisfactorily you then move on to the stage of integrating it into a silicon chip.

The Black Watch saga had still not been forgotten in Fleet Street but Sinclair announced that he had 'not been too proud to learn from the Japanese and to tighten quality control on components a thousandfold.' Of course, as *New Scientist* said, and as is still the case, the biggest question in most people's minds is whether there is actually a market for a miniature television even if it is small, flat and inexpensive. Most TV manufacturers see the project as merely a novelty and not contributing anything to the development of colour TV. 'Although some globe-trotting businessmen may buy tiny pocket TVs to impress their friends, they are more likely to watch large colour sets provided in hotels' . . . as if the only customers were globetrotting businessmen.

The more conservative journal *Electrical and Radio Trading* was not at all impressed. It points out that the problem with a small screen is to develop the scanning voltages required to deflect the beam, and the reviewer didn't like the Fresnel lens one little bit. You have to look at the picture from directly in front of the screen; viewing it from any sort of angle produced unacceptable distortion

(shades of the liquid-filled lens on the TV sets of the 1950s, with the family arranged like a human pyramid in its efforts to see the picture). The article ends:

It is difficult to regard this new project as anything other than a gadget that will appeal to many people initially in the continuous status race that afflicts us today. The proclaimed retail price of £50 for the first models in the middle of next year appears to be far too low for a pocket TV that will work on virtually any TV system in the world from a 9 volt PP3 battery – and with full coverage VHF/FM radio. Naturally the volume and the quality of the audio is a bit restricted by the necessarily small speakers possible in such a small space.

One can only wish Clive Sinclair good luck in his new project after all the work that has been put into it so far. At least no one else seems to have made a truly pocket TV yet. This may or may not be significant.

It is no surprise that the Sinclair flat-screen TV took another two years to reach the market place. Meanwhile, Sony had produced one of their own, using a squashed cathode ray tube, which went on sale in Japan in 1982 at £125 and was intended to be launched in the US at the end of the year. It was bigger than the one announced by Sinclair, which weighed in at 9½ oz was said to run for fifteen hours on its Polaroid-type batteries.

Sinclair's flat-screen television, the first to use a single chip (made by Ferranti) for its circuitry, was launched in September 1983 after a 'six-year, £4M development programme'. Just how accurate six years and £4M might be is difficult to assess. The set had been a Sinclair dream for so long that both the time and the investment might be thought to be underestimated – even if it isn't

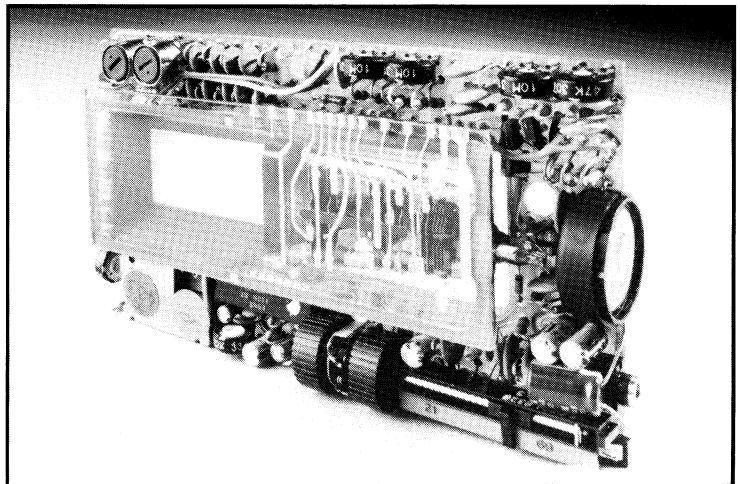

the 'same set' as originally conceived. However, now that this two-inch screen marvel was on the market, it cost £79.95, less than half the price of its nearest competitor. The advertising, as usual, was lavish. In the glossy folder which tells you all about the flat-screen pocket television from Sinclair, there it is photographed next to a passport, which is about the same size, and sitting on top of a briefcase. Here are floorboards (shades of the Neoteric); a cocktail shaker and some cocktail glasses; Sinclair has always known how to project an up-to-the-minute image.

The word 'revolutionary' was used quite liberally in the descriptions. 'Key elements of the set are revolutionary flat-screen cathode ray tubes'. This gave a three times brightness advantage but consumed a tenth of the power of a conventional tube. All the circuitry was incorporated into a single Sinclair-designed-from-scratch chip made possible by using a new Ferranti process (FAB2 CDI). 'Power is supplied by a revolutionary lithium power card.' Made by Polaroid, and supposed to provide an unchanging six volts to the end, power cards cost more than £3 a time.

Since the big question in everyone's mind is 'Why on earth do I want a pocket TV?' the advert devoted quite a lot of space to telling you – it's not for cynical sceptics.

This very portability produced its own problems. As MetaLab chief Richard Cutting said: 'The BBC guarantee that you can get a picture anywhere in the country if you put an aerial with umpteen elements on top of a 30-foot pole; all the pocket TV has got is 12 inches of telescopic aerial which is usually going to be five or six feet off the ground, and so you'll frequently be in a position where you'll need every bit of signal you can get – in Cambridge, for example, where TV reception isn't all that good anyway. In London, on the other hand, you'll hardly need to extend the aerial.'

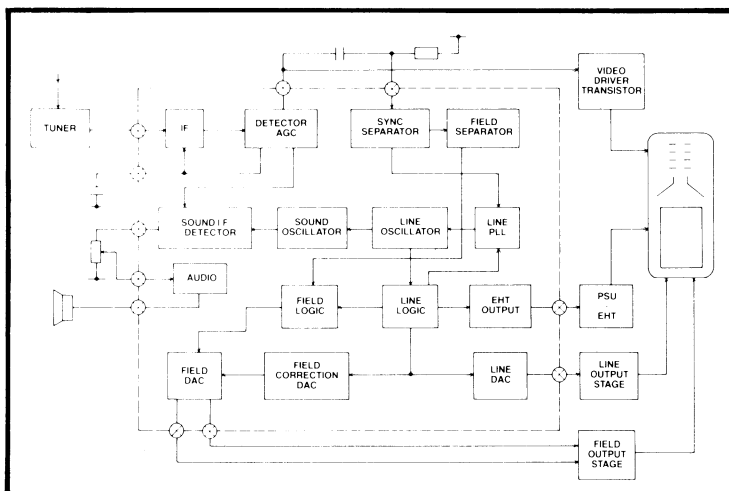

*TV block diagram showing integrated circuit and associated components*

# Sinclair flat-screen pocket TV. £79.95

(inc. p&amp;p)



## Now you can watch a little TV anywhere

This is the new Sinclair pocket TV. The first truly pocket sized television in the world. It's a stunning example of flat screen technology - a real 4 channel television smaller than a paperback book. But it's more than just a brilliant idea.

Sinclair pocket TV is a new and exciting way of looking at the world.

The 2" picture is absolutely pin sharp. Sound quality is excellent. And the price is pure Sinclair. Just £79.95.

### The world of pocket TV

The explosion in TV communications is happening now! Already we have 4 TV channels and 2 broadcast stations. Satellite TV is just over the horizon.

There's more to see and enjoy than ever before - if you have ready access to TV.

Sinclair pocket TV gives you that access. It's television you can watch anywhere. In bed or at the breakfast table, at the office or out of doors.

In fact, virtually anywhere you can take and read a paperback book, you can take and watch pocket TV.

It brings you news, current affairs and sport - as they happen.

It puts the world of TV entertainment in your pocket - ready for enjoy.

### Getting down to facts

#### The truly pocketable TV

The Sinclair pocket TV is just 5 1/2 inches wide, 4 1/2 inches tall and 1 1/4 inches slim. (So yes, our picture is a real size).

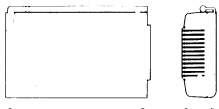

Compared to the average paperback book it's 2 1/2" smaller and weighs about a third less.

The set is so slim because of advanced flat screen technology. It eliminates the conventional vacuum tube that makes a domestic TV so bulky.

### The picture that thinks it's twelve times bigger

Screen size is just 2 inches, about a twentieth the size of the average domestic TV.

But you watch it from the same distance as you'd read a book - about 12 inches. The result is the same as watching your living room TV from your armchair. Except that the picture is brighter, often sharper too.

With flat screen technology, the picture is up to three times brighter than a conventional mono TV.

Of course, the only real way to appreciate the picture is to see it for yourself. Our 14 day money back option lets you do just that.

### The set you do not adjust

All the TV's routine functions are controlled by a single purpose made chip. Itly tunes a second channel, controls brightness and hold.

The only functions you control are the ones you need on off, volume and station choice.

As a result, the Sinclair TV is at least as reliable as the best conventional TV you can buy (if not more so).

### Everything you need for personal, pocketable TV viewing. For £79.95.

The Sinclair pocket TV comes complete with its own integral battery pack. You also get a built quality earphone for truly personal TV, and a smart carrying case.

Naturally, a battery is included - enough for 15 hours viewing. And for £79.95 you can add a mains adaptor to save battery power for when you're out and about.

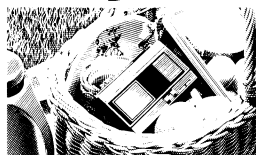

### Put Sinclair in your pocket

Small TV, great view, but pocket size. 3 1/2" screen. TV is compact, fit through.

The Sinclair pocket TV took 8 years to develop and cost £4 million. At £79.95, it really is a remarkably good value. And as you expect, there's a comprehensive 12 month guarantee. Order your TV today - and make sure you're among the first to own a world first!

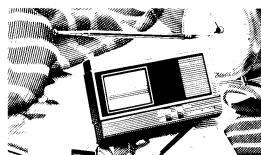

### How to order

Simply complete the coupon, enclosing the appropriate payment and post it to us.

Orders may be sent FREEPOST if no stamp needed. Access Railcard and Trustcard holders may also order by phone - simply call 02 222 7700, 24 hours a day.

There's a 14 day money back option of course. Please allow 28 days for delivery.

TV Division Sinclair Research Ltd, Stanbury Road, Camberley, Surrey, GU15 3BR. Tel: 02 222 7711

To: TV Division, Sinclair Research, FREEPOST, Camberley, Surrey, GU15 3BR			ORDER FORM	
Qty	Item	Code	Item Price	Total
	Sinclair Pocket TV	001	£79.95	
	Extra pack of three batteries	003	£9.95	
	Mains power adaptor	004	£7.95	
Please tick if you require a VAI receipt				Total £
I enclose a cheque/PO made payable to Readers Account Sinclair Research Ltd for £				
*Please enclose my Access Railcard and Trustcard*				
*Please delete - complete as applicable				
Signature				
Mr/Mrs/Miss				
Address				
All prices include VAT, postage, packing and insurance.				



The TV has got off to a slow start. Somewhere, over 10,000 of them have been sold but there have been a number of problems with making them in any quantity; and the Sinclair relationship with Thorn EMI, who assemble them at Enfield, has been long and rather frustrating. The problem is achieving the necessary cosmetic standards for something that is going to be studied so intensively. The user is looking at a tiny 2" square picture and holding the set very close, so the quality of finish must be correspondingly high. The alignment of the picture is critical because the viewer can readily spot whether it's even a little bit out; neither can the eye tolerate any kind of dirt or fluff trapped between the cathode ray tube and the plastic Fresnel lens on the front.

The printed circuit board has been laid out afresh so that most of the components can be inserted automatically – ‘a bit of a quart into a pint pot job’, as Richard Cutting put it. But now (mid-1985) the compression has been achieved; the circuit works extremely well. This version did not go into production until some time after the launch and problems are still being sorted out. At first, the picture seemed to drift around and drift off the screen very easily, until it was discovered that one of the very high value resistors had too low a temperature coefficient. Another initial problem was that manufacturers were not used to supplying several of the components in large quantities – and component manufacturers are not shielded from learning curves.

Early reviews complained that the volume of the set was too low, so the loudspeaker has been enlarged and the new version is more sensitive in low-signal areas. For once Sinclair is taking the time to get a new product right. As so often happens, this new product has given rise to legal argument: if you already have a TV licence then it's quite clear that you can also use a portable set, but it is unclear as to whether or not you need a licence for your Sinclair pocketable if you do not have a TV (and a licence).

The sets are now being made at a rate of over 1000 a week and are beginning to appear in the shops but it's taken a long time to achieve. More than 10,000 have been sold by direct mail and the really hopeful news from the sales front is that America has taken to the set very well. When American Express sent out a first mailshot they received 10,000 orders; Sinclair hopes that they can sell 10,000 a month and that the technology of this TV can be adapted to provide a miniature monitor for a portable computer. We can but look forward to the news that the Sinclair flat-screen TV has recouped its development costs and is funding whatever comes next.

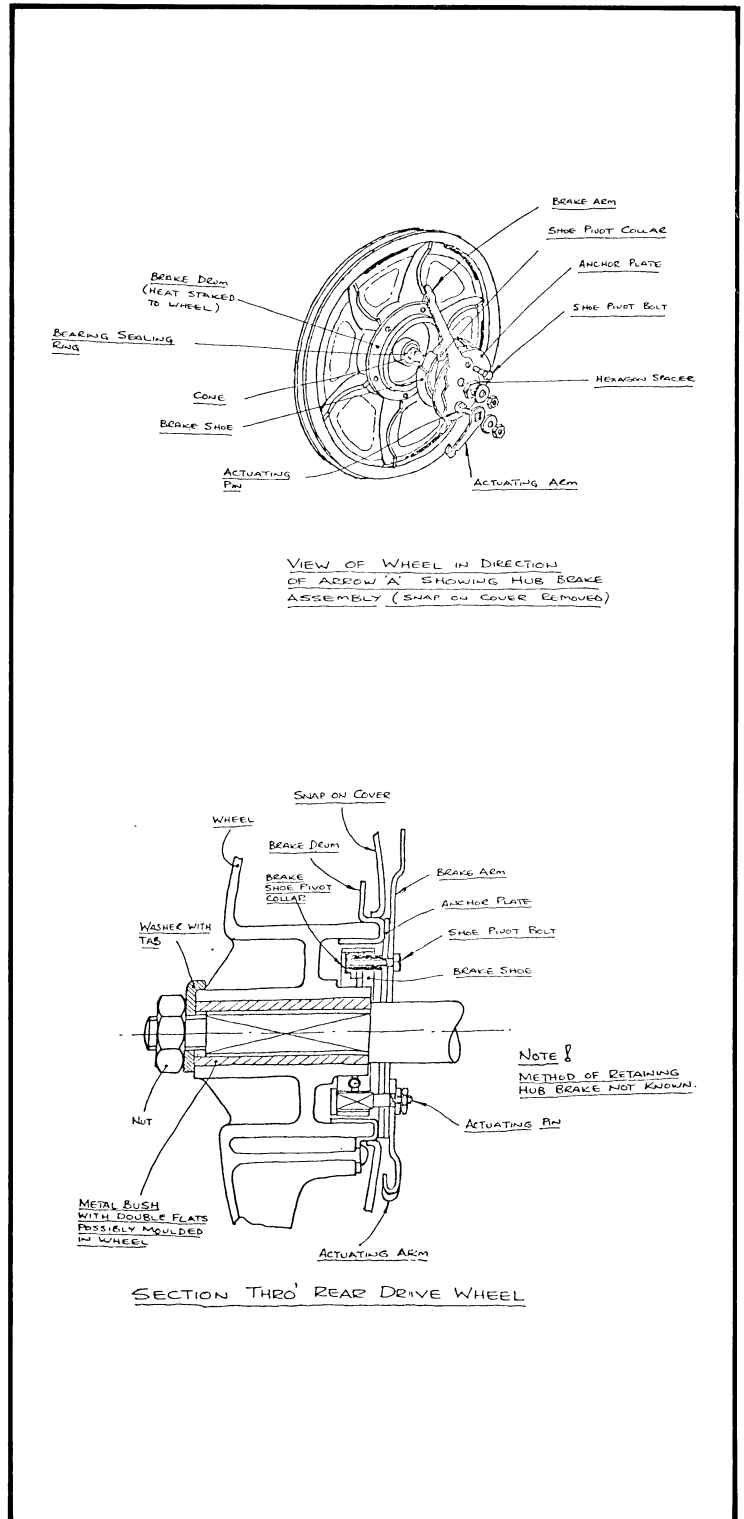

## The C5 conceived

# 16

Clive Sinclair recalls that it was as a teenager with a holiday job at the electronics instrument company Solatron that he first started to enquire into electric vehicles. They would be silent and pollution free, and he was fascinated with that possibility. However, the received wisdom was that electric vehicles were slow and cumbersome (because of all those batteries) – not to mention unreliable.

Early motor cars had generally emerged as an existing design of horse-drawn vehicle fitted with an internal combustion engine – and were they not called ‘horseless carriages’? Electric vehicle design was going the same way; now the internal combustion engine chassis was being used as a base, fitted with batteries and an electric motor. Sinclair thought that the proper approach must be to start from scratch (what we now call ground-up design – nothing to do with pulverising) rather than to tinker with an existing model (top-down design).

Sinclair pondered long on the personal electric vehicle, and in the early 1970s he had Chris Curry working on the problem at the St Ives Mill. At that time, he thought that it was the motor wherein the secret lay, and they worked on a wafer-thin model which was mounted on a scooter; if you stood on the platform with one foot, and pushed yourself off with the other as you pressed a button on the handlebars you could glide up and down the lab. However, it was at about this time that the pocket calculator became all-consuming, and although Sinclair continued to talk about electric vehicles, he sponsored no further work on them until the end of the 1970s.



*Tony Wood Rogers  
on prototype chassis*

In the 1970s, as the world became more conscious of the problems of pollution and the need to conserve energy, governments – and government bodies such as the Electricity Council in Britain – made funds available for sponsoring development work on electric vehicles. Some £5.5M was contributed in the decade, notably £2.3M to Lucas for the Lucas/Vauxhall delivery van, £1.9M to Chloride Silent Power for the sodium/sulphur battery and £0.5M to Lucas again for the nickel/zinc battery.

With the interest shown by the government in electrical vehicle research, it is not surprising that all those manufacturers who had been working on electric vehicles, Lucas prominent among them, found a sympathetic ear for their parliamentary lobbying; a working party was set up and eventually the electrically-assisted pedal cycle legislation was passed in August 1983. By that time, the companies in the automotive industry who had been pressing for the new laws had all felt a change for the worse in the industrial climate and were hardly in a position to pursue the topic.

It was about Christmas 1979 that Sinclair approached Tony Wood Rogers, with whom he had kept in touch since he had worked at Sinclair Radionics in the early 1970s. Rogers preferred to live in the West Country, and was now running the Exeter Academy. Sinclair asked him if he would like to act as a consultant on the electric vehicle project, and briefed him to ‘perform and present a preliminary investigation into a personal electric vehicle. The vehicle is assumed to carry one person (with a possible second small person only by squeezing), and is seen as a replacement for a moped and limited to urban use with a top speed of 30mph.’

They expected to launch the vehicle early in 1984, and were even then thinking in terms of 100,000 vehicles manufactured annually. A vehicle to this specification later became known as the C1. At the time, this was seen as the only way to get into the electric vehicle field; later, when Rogers tuned in to the new legislation, the specification changed to what we now know as the C5 (C for Clive and 5 for five).

Together, Sinclair and Rogers examined different vehicle layouts, and Rogers built prototypes to prove principles rather than to develop a product. During 1980, the specification of the vehicle became clearer. It was to carry the housewife, the urban commuter or the youngster; its advantages over the moped would be that it offered greater safety, weather protection, economy – and style – at a competitive target price of £500, based on the likely cost of such a vehicle vis-a-vis the competition: the moped and the second car. It would be designed to be easy to drive, easy to park, easy to get into and out of, and easy to load. It would need minimum maintenance and would provide maximum power efficiency for minimum battery size. For urban performance, it should have a minimum range of 30 miles on a fully charged



battery, which could be extended by means of an additional battery. Batteries would last for two years. It would be designed and engineered for simple, high-volume assembly using injection-moulded plastic components where possible and a polypropylene body.

On 26 March 1980, the government abolished motor tax for electric vehicles. Department of Transport figures for 1978 showed that there were 17.6M licensed vehicles in the UK, including 14M cars and 1.2M mopeds and motor cycles. 2.4M households had a second car.

There were 175,000 electric vehicles in use, of which 45,000 were road-going: 90 per cent of them milk floats. Then the very telling information – *93 per cent of all cars travel less than 60 miles per day; the average daily distance per car is 13 miles; virtually all journeys by pedal cycle and moped are less than 6 miles.*

The Transport and Road Research Laboratory (TRRL) gave comparative figures for primary energy consumption of vehicles in the following ratios – lead-acid electric vehicle (111): petrol car (100): diesel vehicle (55). However, continued the report, for urban driving the electric vehicle is twice as efficient as the petrol car, and better electric vehicles and batteries will further improve its efficiency.

There were clear advantages for electric vehicles. During the day they would provide an environmentally-acceptable method of transport, and when the batteries were being charged (normally during the night) they would be using off-peak power. We have

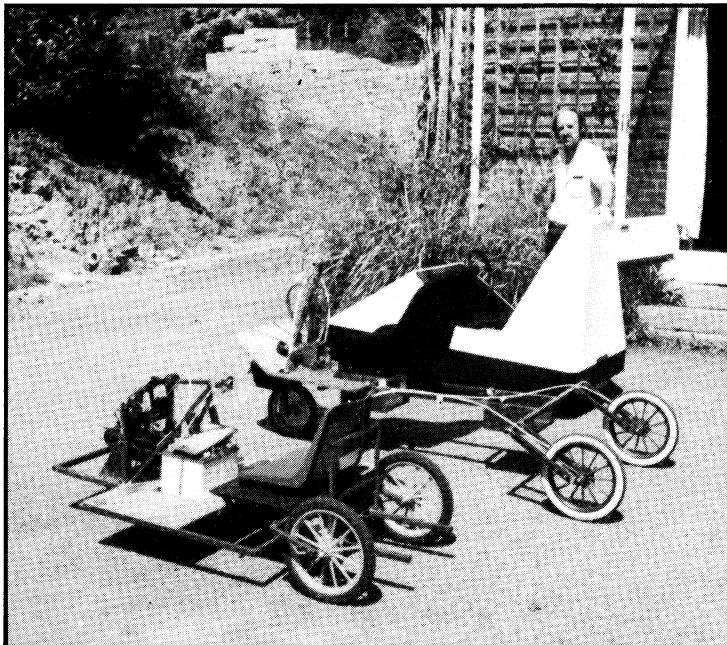

*Iain Sinclair  
with prototypes*

already seen that the British government sponsored £5.5M of electric vehicle research in the 10-year period ending in 1983; by contrast the US government allocated £71.5M for the 10-year period ending in 1986. Although there was a great deal of interest in promoting electric vehicles, the submissions to the government committees concentrated on public and commercial transport and made no mention of personal transport.

By March 1982 the first Sinclair vehicle, the C1, had reached quite an advanced stage. Innumerable calculations had been carried out on power efficiency, and the engineering of the battery motor and drive was largely complete. Tony Wood Rogers had built and tested a number of chassis, the later ones using components from preferred suppliers. One of the fundamental factors which had been realised from an early stage was the need to reduce the drag on the body as much as possible.

It is a widely-believed fallacy in the motor industry that below 20mph wind resistance doesn't matter. The truth is that wind resistance matters hugely, as any cyclist will tell you. It just seems to matter less with a car because there is so much rolling resistance at low speeds, but it is none the less significant if you are trying to conserve energy. If the rolling resistance of a motor car were as low as that of a bicycle, manufacturers would soon be putting their body shells into wind tunnels to study the effects of low-speed drag.

The body shape and basic layout of the C1 body was tested in the wind tunnel at Exeter University; Rogers made full-size fibreglass shells and fitted them to working chassis. He also surveyed all the regulations that might affect electric vehicles, paying particular attention to safety. Part of the ground-up approach was not to spend – as other investigators had done – enormous amounts trying to develop a more efficient battery, but to make use of the models already available. Sinclair's very sound reasoning was that a successful electric vehicle would provide the necessary push to battery manufacturers to pursue their own developments in the fullness of time; for him to sponsor this work would be misplacement of funds. There was, however, a need for a battery which would stand up well to the continuous charge–discharge cycle, and this he was obviously prepared to investigate.

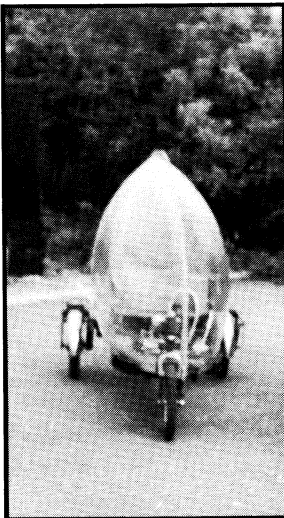

*An early embodiment*

So far, all this development work had been carried out under the umbrella of Sinclair Research Ltd, but when the project seemed to have a future, Sinclair saw that the cost of failure would be comparable with the reward of success. Moreover, he saw that it would need a very large sum to develop the vehicle, to tool up for production, and to launch it. He therefore decided to sell some of his shares in Sinclair Research in order to raise capital to invest in

the electric vehicle programme as a separate company – Sinclair Vehicles Ltd. The deal – described in Chapter 12 – was completed in March 1983, leaving him the richer by £12M.

Sinclair and Rogers now decided that the most important thing to do next was to have the vehicle body professionally styled, and the project was handed over to Ogle Design at Letchworth, well-known in the motor industry. For about a year, Ogle worked on the project considering not only the styling but also the production engineering. But although their methods of working were admirably suited to the car industry, they were not used to working with the likes of Clive Sinclair and Tony Wood Rogers. They spent a lot of time and money on aerodynamic tests, whereas Sinclair and Rogers preferred the quick estimate first and a detailed analysis later if it seemed to be profitable. Ogle did not appreciate that they were designing a personal electric vehicle rather than a car, and instead of building on the cycle technology and looking at ways of reducing the rolling resistance, they veered towards car design and increased the weight from less than 100kg to over 150kg. Sinclair and Rogers became increasingly worried.

Sinclair's search for someone to run Sinclair Vehicles finally led to his meeting Barrie Wills. Wills had taken part in building a factory for Leyland National in the late 1960s to manufacture the first bus to be built on car-assembly principles. He joined Reliant in 1972 when that company was at a crossroads investing a lot of money in a new product, again an almost green-field project. He was De Lorean's longest-serving employee and is saddened that the De Lorean will go down in history as a failure, when it was so nearly a phenomenal success.

In October 1982, a mutual friend asked Wills if he was interested in meeting Clive Sinclair to talk about his electric vehicle enterprise. He replied that of course he would like to meet Clive Sinclair, but that he was not in the slightest bit interested in electric cars; one thing that twenty-five years in the motor industry had taught him – he thought – was that there was never going to be an electric car. But when he met Sinclair and found that he was doing something entirely original, based on sound principles and the ground-up approach, he was immediately won over. This was the time that the crossroads had been reached with Ogle Design, and Wills took part in assessing their work. He had always believed – and Sinclair didn't need persuading – that there was little future in any personal electric vehicle which could not compete with the price of a second-hand car. It was lack of appreciation of this, he thought, that had so far bedevilled electric vehicle development.

By the time Wills joined Sinclair in March 1983, they had decided to put the Ogle programme on ice; it was somewhat ironic that the new managing director of Sinclair Vehicles should have been party to a decision which meant that he had joined the

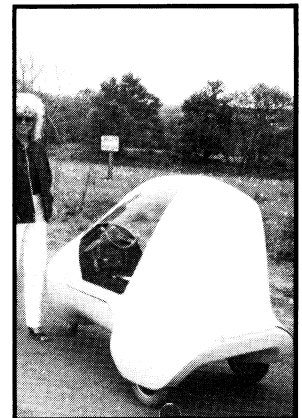

*The chassis clothed*

company without a product. But there was another factor which made the decision to freeze the Ogle work less painful. Sinclair and Rogers had now become aware of the impending legislation which would introduce a new category of vehicle – the electrically assisted pedal cycle. They saw that everything which had prevented the electric moped from competing with the conventional moped (the road tax, the insurance, the helmet, the driving licence) would be eradicated at a stroke: the only less-favourable aspect was the reduction of maximum legal speed to 15mph.

The closer they looked at the draft legislation, the more apparent it became that a tremendous amount of the development work that they had already done could be applied to a new vehicle: unique, exciting, attractive, stylish – and, they thought, marketable. They took as the basis of their new design the recumbent cycle with two wheels at the rear for stability, and thus was the C5 born.

Legislation had given Sinclair's electric vehicle development a new impetus; he could now see the C5 as his first shot at opening – once again – a market that did not exist. He would use the C5 to attune people to the idea of electric vehicles – to prove that they were a viable proposition – so that he could carry on 'to the end of the century and beyond' introducing more and more advanced models.

The new legislation had been written so that vehicle designers would have as much freedom as possible; notwithstanding this, the design that Sinclair Vehicles produced was a complete surprise to the Department of Transport. The regulations to be met by law are fairly short and simple. The cycle – as it's called technically – has to weigh no more than 60kg including the battery; as it was, the design of the C5 was so honed that it was possible to fit *two* batteries without exceeding the 60kg weight limit. The motor must not be rated at more than 250W. The vehicle has to meet British Standard regulations for cycle braking. It has to have an on/off switch biased towards off, it has to have a plate stating who the manufacturer is, and it has to be 'electrically assisted', so it must have pedals. It can be ridden (driven) by anyone over the age of 14, with no licence, no insurance, and no crash helmet.

It was about this time that Sinclair was looking very closely at Lotus cars, assisted by Wills who had known the company for fifteen years or so. For some time, they talked of the possibility of Sinclair buying into Lotus, but he eventually decided that it was not going to be the best way forward either for Lotus or for Sinclair Vehicles and the project was abandoned. But when Wills had been at Reliant he had developed a good relationship with Lotus; he and Sinclair therefore decided to place a development contract with Lotus to take the basic C5 design, finish the detailing, build the prototype and the test rigs, develop the vehicle, devise and execute the test programmes, and generally assist the project from its

design and development stages into production.

Brian Spooner was the project manager at Lotus. Initially, he was sceptical about the whole project; even seeing the model left him somewhat cold. However, when he got into it and drove it for the first time he began to warm to it, and once he'd started to look at the engineering he became excited about it very quickly.

This was the common pattern all the way through the project. Although the development work was kept extremely secret – and the fact that Lotus was involved never seemed to have leaked out until the launch of the C5 – a number of subcontractors and suppliers had to be shown the vehicle. And their reaction to it almost always followed the same course: first disinterest, then scepticism, and then – after a ride on a prototype – wild enthusiasm.

Lotus's first task was to examine the model and produce a package of proposals of what they would do. Down in Exeter, Rogers was doing some more work in the wind tunnel and further reduced the drag factor from 0.95 to 0.6. Throughout the project, the relative positions of seat, pedals and steering remained much the same; however, to avoid the need for an adjustable design – which would mean extra cost – they worked on a layout which would allow a range of people from a relatively slight 14-year-old girl to a notably tall man to sit in the machine and pedal it in comfort. This work was completed in 1983 and Lotus then went on to detailed design, development, and testing of the vehicle. A great deal – perhaps a quarter – of the work went into examining the legal and safety aspects; Lotus took all the British Standards that applied to cycles, and where they applied to the C5 ensured that it behaved as well as, if not better than, the stated requirements.

The C5 met the Ministry of Transport regulations in every way. The regulations were, of course, aimed at encouraging manufacturers to produce an electric vehicle, perhaps an unusually far-sighted approach. Those from the Ministry responsible for drafting the regulations went to look at the C5. They were incredibly impressed, but though they admitted that it wasn't quite what they had imagined, they were delighted and full of praise for both the vehicle and the team.

As the project progressed, further body designs were tested in the wind tunnel and full-size fibreglass shells were built. A number of people looked at the styling and, although they were not happy about it, could not pinpoint exactly what ought to be done.

It was at about this time that Sinclair Research took on Guy Desbarats, an engineer with a postgraduate training in industrial design. It was he who took a completely new look at the project; within a week or so he produced the revised styling on which the production C5 body was based. After a new clay model had been built, refinements such as the wheel trims and the luggage

compartment were added, and there was the finished body, more or less as it went into production.

In parallel with this was the mechanical design, crucial to which was the chassis. Again, the layout dictated the shape to some extent and the chassis emerged as two identical metal pressings, joined top and bottom with a closing plate at the rear. The design was subjected to a thorough stress analysis in order to produce a light structure which would have enough torsional flex to provide a suspension for the vehicle – there had never been any thought of a separate suspension system.

Tony Wood Rogers had been working on battery development, when out of the blue came a letter from one Joe Caine, an ex-Chloride man who wrote to Sinclair saying that he'd heard about the electric vehicle project, that he knew that the secret was to find a really good battery, and that he (Caine) knew all about batteries, and would like to help. Rogers went to meet Caine, took him on, and together they toured all the battery manufacturers to appraise the joys and woes of battery production. Soon, Caine was set up in a lab in Bolton with £10,000-worth of automatic battery testing machine, and in conjunction with Oldham developed a battery for the C5 whose life exceeded the 300 charge–discharge cycles specified. Rogers had also found a suitable motor – from Bosch – designed primarily to drive a truck cooling fan, which delivered the maximum 250W output. It was left to Lotus to design a gearbox for the C5 final drive.

The body of the C5 was made from two injection-moulded polypropylene shells; the upper shell being one of the largest – if not the largest – injection mouldings of its type in the UK: possibly even in the world. The two parts were to be bonded by placing a tape around the joint which can be heated with an electric current. They would be aligned on a jig and pressed together, the current passed, and – hey, presto! – a body shell. The process is used for manufacturing the Topper dinghy and the BL Maestro front and rear bumper assemblies. J.J. Harvey in Manchester – one of the UK's leading mould-makers – made the moulds, and Linpac, the UK's largest thermoplastic moulding company, supplied the shells. ICI, who supplied the raw material, took a great interest in the project, and ran computer programs relating to mouldflow. It was very much a team effort: a tremendous amount of know-how went into the development and manufacture of the C5 body after its shape had been determined. One mould set would produce up to 4,000 parts per week.

The original rear axle design was a tube with two stub axles welded to it; when Lotus examined it from a production engineering point of view they saw that they could draw on car steering column practice; the rear axle thus became a tube swaged

down at each end with rolled threads and splines – a very low-cost, handsome, elegant single-piece component.

Perran Newman of MetaLab, working at ‘arm’s length’, developed the circuitry which indicates, via green, amber and red LEDs, the state of the battery charge. As each segment is extinguished, you know that your battery is getting lower; at the last light, you know you have ten minutes of driving time left and then it will start flashing; if you don’t switch off it will switch itself off and you will have pedal power only. In the advanced model, another display acts as an ammeter with two green segments, an amber, and two red; red for when you’re pulling a high current, showing that you really ought to be pedal-assisting the motor. The idea is to try to keep the display green – the most economical running mode.

The vehicle has three systems for protecting the motor. The first is a stall system; if you draw too much current for too long (so that the motor heats up) the electronics will switch off and force you to wait half an hour before you can switch on again. The second system is a thermistor probe in the end of the motor armature which cuts off the current if the temperature rises above a certain level; it will reconnect when the temperature drops again. The third system, if the others fail, is a thermal trip built into the motor. The motor is therefore super-protected against all forms of idiocy.

The fact that Sinclair bought an option on the De Lorean assets in Northern Ireland led to some confusion in the press. Sinclair Vehicles had been set up to develop a range of models over a period of time, starting with the C5 as the most basic and leading on to others which would become more and more car-like. Now, one of the attractions of the De Lorean plant was that it had one of the most well-developed automated plastic body manufacturing facilities in Europe, or even in the world. This facility could have been of use in possible Sinclair Vehicles developments; the option was on some of the assets *within* the facility – indeed, Sinclair Vehicles would not have to use the factory at all; it could buy the assets and move them elsewhere if it wished. Talks lasted for about a year, but there was mounting pressure from the receiver wanting to dispose of De Lorean’s assets, so Sinclair relinquished the option and the plant went to auction.

From the very start of the project, Wills’s approach had been to document everything so that the reason for every decision was on file. On a cycle, the law calls for lights or a reflector – the C5 incorporates both; it has the normal lighting system built in, with an additional reflector which forms the top half of the lamp. There is reflective tape around the body and on the wheels. The rear light incorporates a central rear lamp and reflectors. The kit as originally

planned included a reflector pole to increase the height of the vehicle by two feet with a white reflector at the front and a red one at the rear – the decision to make increased visibility an extra would be one of the pieces in the jigsaw of the C5's disappointment. The vehicle was put through an extremely rigorous test schedule – the chains, the pedals, the effect of impact.

It would have been extremely adverse publicity if a fatal accident were to occur through the C5 not having been properly tested. Anyone who might conceivably have been concerned with safety was consulted, and Sinclair Vehicles 'took full note of all the recommendations which might improve the safety of the vehicle.'

At the beginning of Barrie Wills's association with Sinclair Vehicles, he was living in the Midlands while the company was based in Motcomb Street. He did not particularly want to move house, and in any case London is hardly the place to set up an automotive company – even a fringe automotive company. There was therefore a strong case for locating the business in the Midlands where there are likeminded people, the resources of the industry, the Motor Industry Research Association (MIRA), and a geographical centre of the motorways. There was no shortage of empty offices and factories in the West Midlands, mute testimony to the contraction of the automotive, machine tool, and aircraft industries. But a radically new product needs radically new thinking; where can you find space which can be expanded as you want it, so that you do not have to think too far ahead? How about a Science Park? Warwick seemed to be the most progressive with historical links with the motor industry, and it was on that science park – with all its flexibility – that Sinclair Vehicles' head office was established in 1984.



*Barrie Wills  
testing to destruction*



## The C5 built

# 17

In the spring of 1983, Hoover Ltd at Merthyr Tydfil was approached by the Welsh Development Agency (WDA) to see if they were interested in quoting for a project for Sinclair Research 'who are working on an electric car, and as a by-product of the research have designed an electrically-assisted bicycle. They are looking for a sub-contractor to whom they can entrust the assembly'. It so happened that Hoover had recently made a policy decision to look for sub-contract work, although they did not think that they were in the bicycle manufacturing business. However, when they heard that Sinclair envisaged sales of 200,000 a year, rising to 500,000 a year, and that the fabrication techniques would match their plant and experience, they naturally became very interested.

Of course, Barrie Wills was looking at possible manufacturers other than Hoover, but he was impressed at the speed with which they reacted, and particularly when he saw the sketches which Denis Roberts of Hoover had drawn of an assembly line for a product about which he knew virtually nothing. Wills saw that he was dealing with people who could understand what he needed very quickly – before he had told them even! – and arrangements went ahead for drawing up an agreement. The WDA balked when they discovered that the plastic moulding could not be done in Wales, but eventually an acceptable form of wording was found and Hoover at Merthyr Tydfil became the manufacturing base for the C5.

Building C5s was not quite what Hoover had envisaged when they were offering sub-contract facilities. They had thought that perhaps they would be offering a specialist service, such as porcelain enamelling, which was just one part of the process of



*One result of the leakage of the Sinclair–Hoover negotiations: Ron McTrusty in Computer News*

producing a washing machine. For the C5, they decided that they would have to set up a separate part of the factory with its own quality control, goods inwards, despatch, and so on. In April 1984, half a dozen people were chosen from the main factory, sworn to secrecy, and set on to manufacturing C5 parts. By the time that original team had outgrown its sealed room, Hoover had set up a proper assembly facility on the other side of the main Cardiff–Merthyr road, linked to the main factory by means of an (existing) underground tunnel. Hoover building MP7 was equipped with security locks and installation of the production line began. Altogether, Hoover spent something of the order of £100,000 providing the facility.

Goods are delivered through a roller shutter door, inspected, and stored for use in the various stages of production. Almic of High Wycombe built the body-welding equipment; the polypropylene shell is dropped on to a jig and the welding tape tacked into place with a telesonic gun. The main body is dropped over the top and clamped in position by means of an inflated band. Current passes through the tape and fuses the parts together; the jig is opened and the body taken out and hung on a conveyor track. The whole process takes about 70 seconds. At another point the assembly of the rolling chassis begins; tyres (from Taiwan) are fitted to rims (from Italy), axles are assembled, with bearings pressed on and fitted to the main chassis yoke; the steering assembly is fitted, and gradually the rolling chassis is built up. Meanwhile, the accessories such as lamps are fitted to the body shell, the wiring harness added; and soon body meets chassis for the first time to form a complete C5.

When the vehicle is complete, it moves along the conveyor on to the rolling-road test stand, which puts it through its paces and either passes it for finishing and despatch, or draws attention to any faults there may be. The rolling road test stand was developed at Hoover and, like a lot of the other C5 test equipment, was manufactured by Dancol of Feltham. The vehicle sits on the rolling road, an arm simulates the weight of a 12-stone person, and the brakes of the vehicle are tested under load. Each vehicle has its own manufacturing log going through with it. Hoover had already developed an advanced testing arrangement for washing machines which gives a computer printout on machine performance, and the plan was to interface the rolling-road tester to the inhouse Hoover computer.

Finished C5s are rolled into cardboard boxes on the conveyor belt which terminates in a special stacking mechanism so that they can be loaded straight on to the distribution lorries, stacked three high, three wide, and six deep. Both the packaging and the stacking conveyor were designed and built locally.

There is little provision for storage in the factory; the idea is that

C5 packs are loaded straight into the distribution lorries, which leave the site when they are full and travel to one of the three distribution centres; Hayes, Preston or Oxford. The plan was that there should be a stockpile of vehicles in time for the launch so that delivery could be made well within the statutory 28 days.

In the autumn of 1984, Hoover started assembling, disassembling, and re-assembling 100 C5s, both to find out what snags there would be in the process and to train the operators who would do the work. Two production lines were installed, each of which could produce 50 vehicles an hour. At the outset, there was no plan to work shifts, but by bringing both lines into play, and introducing shifts as necessary, up to 8,000 C5s could be produced every week.

It was a tremendous testimony to the integrity of everyone involved with the development of the C5 – and the sub-contractors and suppliers ran into hundreds – that the press was unable to get hold of anything like a true story concerning it. *The Engineer* published some inspired guesses but, having presumably overlooked the fact that the C5 might have been built to the electrically assisted pedal cycle regulations, multiplied its top speed by three. A non-professional (and, if it comes to it, an unprofessional) photographer produced a hazy photograph which was published in the *Mail on Sunday* in October 1984, but it was incredible that anyone who had managed to take a photograph of a vehicle – even a photographer that bad – could have got the accompanying story so wrong: could it, in fact, have been a sop to his conscience that the photograph was so poor and the detail so inaccurate? Following that publication, Sinclair Vehicles sent a letter to all contractors and suppliers who were in the know, assuring them that it had not been one of the ‘planned leaks’ for which the motor industry is known.

It is 10 January 1985; the snow on the ground is beginning to thaw as I trudge up the hill from Alexandra Palace station to the hall where the launch is to take place. While it is a relatively still and quiet winter’s day outside, the hall is buzzing with activity inside: people milling around collecting press packs from girls dressed in grey with touches of yellow, the theme colours of the occasion; many of the men are wearing pullovers in shades of grey and yellow as well. We troop into the arena, and take our places on tiered seating which puts me in mind of a dolphinarium. Even as we sit there, hardened journalists are subbing their press handouts. Sinclair Vehicles and Sinclair Research staff are moving about nervously; the atmosphere is awash with adrenalin.

Clive Sinclair speaks: ‘Good morning ladies and gentlemen; thank you very much for coming to this press conference today. It is of course a world first – the world’s first press conference held in a

*This official photograph shows that the driver of a C5 is higher up than the driver of a mini. Unofficially, the driver of the C5 is its stylist, Guy Desbarats, and the mini is a cardboard cut-out*



plastic bag . . . I'm going to start in a rather unusual fashion by telling you what we're *not* announcing today, because there have been some fairly confusing leaks. We're *not* announcing a conventional car. Sinclair Vehicles Ltd is dedicated to the development and production of a full range of electric cars, but today we have an electric vehicle, the first stage on the road to the electric car. . . There have been several reports that the vehicle is made of fibreglass; in fact it's not: the body is the world's largest, mass-produced injection moulding. It's astonishingly light, and astonishingly strong, moulded in the ICI wonder plastic polypropylene which has absolutely marvellous properties for a vehicle . . . enormously tough, enormously durable, obviously completely free from rust. The pigmentation is in the material itself, so no matter how scraped or scratched or bumped it gets it's never going to lose its colour, never going to deteriorate. . . Another fallacy is that the vehicle is powered by a washing machine motor. True, the Italian company that makes these motors does make washing machine motors – but they also make torpedo motors. This lightweight, highly efficient motor is specially developed for our vehicle. . . Another (very understandable) fallacy is that on a low-speed vehicle, wind resistance doesn't matter . . . the truth is that if you're designing a vehicle efficiently – and of course we are concerned with the ultimate in efficiency – wind resistance matters an enormous amount. A cyclist travelling at 20mph is using 90% of his energy overcoming wind resistance. The reason people have come to the conclusion that it doesn't matter up to 30mph in a car is that cars have such appalling road resistance. But the C5 doesn't; we've gone to tremendous lengths to get the road resistance very low, and having achieved that on an ordinary flat road, the wind resistance became dominant so we've put a great deal of effort into achieving a very low drag factor. . . Almost everything has been

designed and tooled from scratch for us – the lights, batteries, motors, electronic control system. Because of our work at Sinclair Research, the electronic control system is very advanced and we have a custom chip that monitors everything and controls everything – get into the vehicle and you don't have to think about it; it's all done for you. . .

We were very concerned right from the start with safety. For that reason we asked the Department of Transport who we should talk to and brought in all the best advice we could. We've gone to great lengths to make the vehicle very visible both in daylight and at night, and to make it tough. We're very much of the view that by encouraging people to be on three wheels rather than two we will be adding considerably to safety on the road. . .

Now, before I hand over to the managing director of Sinclair Vehicles, Barrie Wills, I'd just like to introduce the vehicles to you.'

Music which is deemed suitable for such occasions blares out. Further down the arena are six cardboard boxes in which something appears to be happening. The fronts of the boxes are covered with translucent paper, and six lights come on; then six C5s burst through, driven by six grey and yellow girls. They drive right round the arena and line up side by side on the finishing mark. It is a solemn moment.

Barrie Wills recounts his introduction to Clive Sinclair, his initial scepticism, and how he was won over to the electric vehicle.

Wills went on to explain the constitution of Sinclair Vehicles 'similar to Sinclair Research, a small, high-calibre team of people, principally product development and marketing oriented with a very heavy dependence on the resource and expertise of sub-contractors'.

'We're developing a family of traffic-compatible, quiet, economic and pollution-free vehicles for the end of the '90s. You're seeing the baby of the family today, the C5, a completely new form of

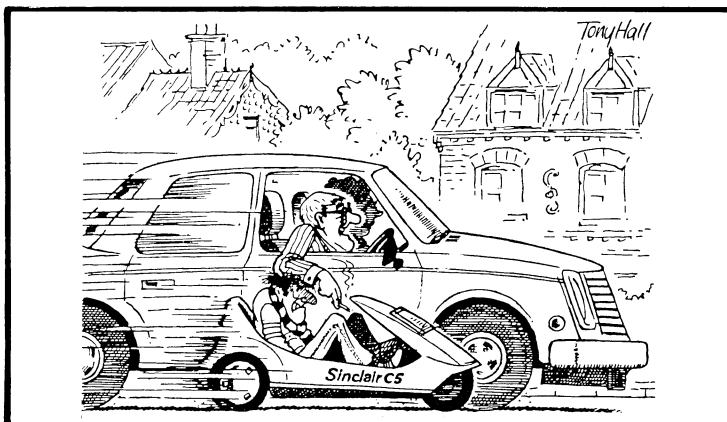

*'Apparently they're marvellous little vehicles – though I've yet actually to see one...' Seldom has a new product received such a wealth of attention from the cartoonists*

practical personal transport designed to meet the new legislation for electrically assisted cycles.’ Wills outlined the legislation as it applied to the development of the C5. ‘Using a package that was designed around the seating position of a Ford Capri, we developed it for production, laying down standards well in excess of the legislative requirement, imposing upon ourselves a system of testing based upon the United States automotive self-certification patent.’

Then came a video film which took us through the development, testing and manufacture of C5s. ‘The Prescott hill climb circuit was used to test both hill climbing performance and brake descent. Parts of the track were flooded and many of the tests were conducted in sleet and snow.’ Just like the weather outside that day. ‘Accessories to make the C5 an all-weather vehicle have been designed and are seen here . . . Waterproof side screens fit on front and rear wheel arches and are attached to the body shell by Velcro. The protective cape and hood is also attached by Velcro at the front and sides of the vehicles. Subsequent to this stage, a fashion designer has developed the cape principle into an attractive weathercheater, which is a cross between a ski-jacket and a mountaineering anorak. This includes a clever form of apron which encloses the cockpit area while allowing freedom of arm movement for signalling.’

Back to Barrie Wills: ‘. . . the last thing we needed to produce C5 was a vehicle manufacturer. The manufacture and assembly is far closer to that of a domestic appliance than it is to a vehicle, and after a very exhaustive review, we chose Hoover’s Merthyr Tydfil plant for the assembly. They have put together a dedicated assembly facility which was progressively equipped, manned and commissioned during 1984.’ He showed slides of the facility. ‘. . . Since 1 November 1984, an excess of 2,000 – and the count at 10.30 this morning was 2,507 – saleable vehicles have been built in preparation for the market launch today. We expect to produce well in excess of 100,000 units in 1985, creating some 200 new jobs at Warwick and at Merthyr Tydfil.

‘The C5 is the subject of a massive three-month, £3M mail order launch advertising campaign under the theme “A new power in personal transport”. The first press advertising will appear tomorrow, and the first TV commercial tonight. We’re going to show you that TV commercial now.’

Intimate, persuasive voice: ‘Imagine a vehicle that can drive you five miles for a penny; a vehicle that needs no petrol, just a battery; and that takes the press of a button to start, the squeeze of a lever to stop. That needs no licence, no road tax, and you can drive it whether you’re 14 or 40. A vehicle that costs just £399. The Sinclair C5 is a new power in personal transport. The Sinclair C5. £399.

Want to buy one? Want to see one? Or simply want to read all about it? Just dial 100 and ask for Freefone C5 – now.'

Barrie Wills continues: 'Mail order maximises initial quality awareness through the re-investment of higher sales margins directly into advertising. This provides the best possible platform for retail introduction, which we anticipate in the UK before the summer using retail chains such as white goods stores, supermarkets, do-it-yourself stores, and department stores. Our marketing plans are made possible by a series of major innovations in the after-market. These dispense with the need for a conventional car dealer and service workshop infrastructure. C5's servicing is franchised to Hoover: 19 Hoover service offices nationwide, employing over 400 service engineers, have been equipped to undertake vehicle maintenance on a door-to-door basis. 300 Sinclair battery centres have been established using Comet Group stores and service shops and selected Woolworth stores. These are already equipped to provide initial and replacement batteries, installation kits and additional battery chargers, and to handle any customer warranty problems on behalf of the battery manufacturer, Oldham. During the mail order phase, door-to-door delivery is being handled by United Parcels from three strategically located warehouses . . . C5 heralds a revolution in personal transport. We need now to pay tribute to all those who have contributed to making it all possible: Lotus Cars, Hoover plc, Oldham Batteries, Woolworth, ICI, the 80 suppliers of components, the suppliers of services and equipment, the Electricity Council, the Welsh Office, the Department of Transport, British Aerospace, Motor Services Research Association, the Transport and Road Research Laboratory, the Royal Society for the Prevention of Accidents and the UK Safety Organisation, and the University of Warwick. Above all my team at Sinclair Vehicles – the best team of people I've ever worked with. Together, we are also a new power in personal transport. Thank you.'

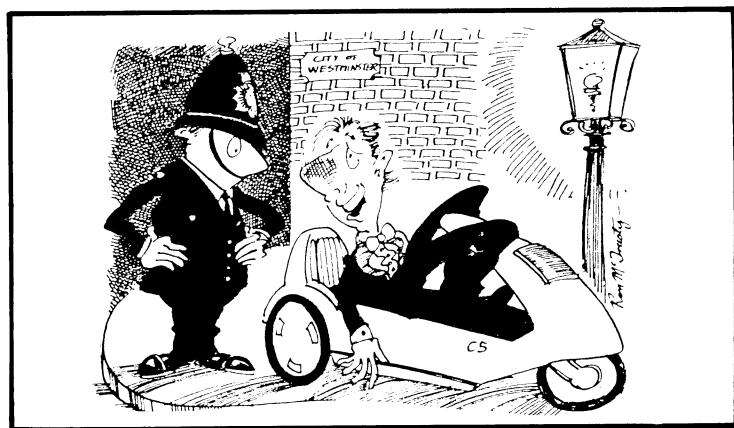

*'Of course I was riding on the pavement, oshifer! I don't think I'd have been safe on the main road, do you?'*  
Ron McTrusty at it again

There is going to be a chance to drive the vehicles later, but now it's question time: the first question from *The Times*: 'Can you tell me where I can buy one now; where is it on sale?' A benign opening question which sets the pattern for a generally friendly session – just like the QL. We disperse. Some people start to queue for their turn on the C5; others take a stroll round the side shows – C5 driver magazines, C5 driver hats, C5 driver pullovers, a C5 video game, C5 mugs, C5 bags, C5 carrier bags, C5 caps, C5 duster, keyrings, sun-visors, badges, tee-shirts; the specially developed garments. I queue up with Bill Sinclair for a ride on the C5; we are allowed one circuit of the arena, and compare notes, exhilarated and excited. Then the moment the lens boys have been waiting for: Clive Sinclair climbs into a C5 and press photographers crowd round. How will the press receive this? I pick someone at random: 'Have we seen history being made today?'

'Yes, but not in the way that Sinclair hope for. It's a shame that this vehicle could destroy credibility for the future when Sinclair comes up with real vehicles. They're so keen to come up with something, that they've had to come up with something that people really weren't expecting. And a lot of people are going to view it, I think, as a toy rather than a serious vehicle to use on the road. And I'm worried about the road safety aspect, and I think a lot of other people are.'

'But isn't this to introduce people to electric vehicles at an amazingly low price – just as the ZX80 opened the market for home computing?'

'Yes, I think that's probably the idea, but the ZX80 wasn't playing with lives. This is a gamble, you're playing with lives – young people out on the roads.'

'That's true, but surely an enormous amount of thought has been given to safety?'

'Obviously a lot of thought had to go into the safety aspect, but I still think that it's still too great a risk to allow 14-year-olds on the roads in one of these – I've got a 14-year-old son . . . imagine trying to cross lanes on a dual carriageway to turn right.'

Can it be that the new legislation has sown the seeds of the downfall of the C5? Would you let your 14-year-old out on the main road in one of these? Anyone who has suffered the nightly traumata of the 16-year-old out on the moped will know the answer.

Was launching the C5 in the bleak midwinter a calculated (or miscalculated) risk? The timing was such that production was under way, and the launch could hardly have been held up until the possibility of a bright spring day. Details were beginning to leak out to the press, and from that point of view it was right that the official story should be released as soon as possible lest the erroneous speculation should have done more harm than good.



And although Sinclair Research and the home computer market was quite separate from Sinclair Vehicles and the C5 market, the two did meet in Clive Sinclair, who knew that success with the C5 would reflect well on the home computer market which was beginning to run into problems.

Some said that Sinclair was at the peak of his success and the press was looking for an opportunity to degrade him. Some might, but generally I do not think that is a fair assessment, especially with hindsight. The C5 was welcomed in some quarters – on the cycle tracks of Stevenage, at Lowestoft, by the GLC: County Hall's chief traffic engineer Ken Huddart called it a positive step forward in road safety. There was some neutral reaction; in the House of Commons, parliamentary under-secretary of state for transport Lynda Chalker averred that the C5 was 'no more dangerous than a pedal-cycle'. One or two people who had lost their driving licences through a passion for alcohol made news by purchasing C5s so that they could once more become mobile menaces. In Glasgow, Stella Small said that since 1981 she had been successfully running a milk float which she had bought second-hand from the Co-op.

The vehicle was deliberately launched as the C5 in the hope and expectation that the public would find a name for it. As it was, names such as Doodle-Buggie, Hoover Hedgehog, Skinny-Mini and Voltswagen came and (mercifully) went. But generally, the reaction was adverse. The C5 was 'rapped' (as the journalists say) by insurance chiefs, road safety officers, and coroners. Dr Paul Knapman, Westminster coroner, predicted that one day a C5 driver would die in a crash. 'It's just a matter of time' he said. In those independent Isles, Man and Guernsey, the C5 was to be treated as a car – which effectively ruled out its use as it stood since it had neither speedometer nor horn.

Industrial unrest precluded the visit of the Prince and Princess of Wales to the Hoover C5 factory scheduled for 29 January. What this might or might not have done for the vehicle is worth another pause for thought. At about the same time, it was announced that plans for starting up the second C5 production line had been delayed, although sales in excess of 5,000 vehicles were claimed for the first month after launch.

At the beginning, Sinclair was inclined to blame James Tye of the British Safety Council for the adverse reaction; Tye had publicly stated that the launch should be called off, because the BSC was unhappy with the safety of the C5. To be fair, he had said: 'Bear in mind, it is a well-designed thing for what it is'; it was just that his eyes had been among the first to lose their scales. The other side of the safety coin was that RoSPA (the Royal Society for the Prevention of Accidents) had helped to compile a C5 safety booklet, which was handed out freely at the launch.

*From the RoSPA guide*

## STOPPING AND STARTING

With every new step you take on the road, you should be thinking of the other people around. Could you inconvenience or hurt them? Could they hurt you?

Every time you start off, or stop, or pass a road junction or a parked vehicle, or a school or playground, or go to turn left or right, make yourself aware of other road users. What are they expecting you to do? What are they going to do? Follow this system: THINK – LOOK – IS IT SAFE? – SIGNAL – MOVE.

The next few pages show some of the points to think about when you are out on the road.

### Stopping

If other traffic is not expecting you to stop suddenly, for example when you get to the end of your journey:

- Choose a suitable stopping place. Check that there is room for traffic to overtake you when you stop. Avoid stopping on a bend.
  - Look out for parked vehicles in the way or pedestrians about to cross.
  - Look behind. If traffic is very close it may be safer to continue to a better place.
  - If the road is clear, give a slowing-down signal to warn any vehicles behind, or pedestrians nearby.
  - Move well into the left, stop and get out on the pavement side. Park your C5 away from traffic.
- If you are stopping in traffic, for example at traffic lights:
- Don't stop too close to the vehicle in front.
  - Have your feet on the pedals, ready to start off quickly.
  - Try and stop where the driver in front can see you in his or her mirror.

### Starting

When you join the traffic stream from the kerb or out of a driveway other road users will not expect to see you, so take extra care. You will not normally need to signal when starting off, as you should not start while there is traffic coming. However, if you think the road is wide enough for you to start off alongside other traffic, you will need to signal to tell other road users what you are doing.

When turning left from a kerb or driveway:

- Stop at the kerb.
- Look all around for traffic coming on your side of the road.
- Wait until all traffic has passed before starting off. No signal is necessary unless you're starting on a wide road alongside other traffic.
- Move gradually out to your normal driving position.

All this was to no avail. The C5 had massive publicity, and had it been able to stand on its own merits, it doubtless would have done, whatever the critics said. As it was, that seductive exhilaration which won everyone over to the C5 on the test track quickly evaporated by the feeling of vulnerability among real traffic. A cost-cutting exercise to get the price down to the magical £399 (which in any case was pushed up to £428 when the delivery charge was taken into account) should not have been achieved at the expense of a single accessory such as the high-level plug-in reflector bar. For whatever reason, all those vehicles which were tried by the press – naturally out to test reliability and safety to the very limits – should never have failed.

Those who know what a tremendous amount of development work went into the C5 to make it reliable and safe cannot help but be saddened that the end product did not appear to carry those marks of Sinclair's £7M investment.

**WHO WILL SERVICE  
YOUR SINCLAIR C5?**

The amazing, innovative Sinclair C5 is being manufactured for Sinclair by Hoover at a brand new production line at their Merthyr Tydfil factory. Hoover, with 75 years experience of electrical engineering, were the ideal choice. Hoover were the natural choice, too, for Sinclair C5 servicing and spares. The nationwide network of Hoover Service Offices is already staffed with Service engineers specially trained to maintain Sinclair vehicles. And genuine Sinclair spares are available across the counter at all these offices.

Who better than Hoover to manufacture and service the Sinclair C5? After all, Hoover have been putting electrical power on wheels longer than anyone can remember.

**HOOVER®  
WHO BETTER?™**

## Computers in decline

It was towards the end of 1984 that the mumblings of discontent were first heard in the world of home computing. In the Christmas season of 1983, the chief stories of the home computer market had been of the shortage of machines available in the shops. Would-be purchasers were falling over one another; if they couldn't get what they wanted – and the Spectrum was top of many lists – they'd buy any other machine they could lay hands on; the manufacturers had been caught out. Nobody wanted to make the same mistake twice, and as early as July 1984 Sinclair Research announced a £4M Christmas advertising campaign, with a promise of the goods to meet the demand it would create.

However, it would be helpful to have a new product; it was clear that for one reason or another the expected potential of the QL market for the small business had not been realised. Perhaps Sinclair had overlooked the fact that many small businesses were already using Spectrums: there is so much software for the Spectrum – for accounts, spreadsheets and such specialised tasks as designing structural steelwork . . . and then by way of relaxation there is a satiety of games. In many ways, the reliability and popularity of the Spectrum with its range of software seemed preferable to the QL – with all its quirks and foibles – and its purposeful lack of software support.

The new product must be introduced stealthily; it must not detract from the QL. Sinclair had found that many would-be purchasers who otherwise liked the Spectrum were buying competitors' products for the sake of the keyboard. Here was a ready-made product: Sinclair could use the improved keyboard of the QL to give the Spectrum a new lease of life; thus was the ZX Spectrum+ born.

*Being part of the Cambridge scene, we are peculiarly attuned to the two local computer giants, Sinclair and Acorn. This accounts for our bias towards these two companies in this chapter – apart from the fact that one of them is our subject.*

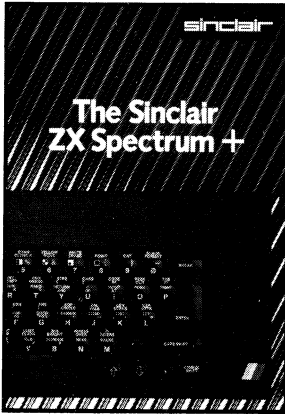

For once a Sinclair product was undelayed; the ZX Spectrum+ ‘with a 48K memory and a full typewriter action keyboard’ was available as it was announced – at £179.95 including six applications programs ‘worth over £50’.

To cater for status-conscious owners of original Spectrums there was an upgrade kit; if you sent your Spectrum to Sinclair you could have it hermit-crabbed into a Spectrum+ case for £50 – or you could buy a DIY kit for £30.

By the end of November, Sinclair was predicting record Christmas computer sales, and was prepared to ship more than 400,000 machines in the last quarter which would push its market share for the year up to 50 per cent. To some extent this was based on the naive view that history would repeat itself, though it is a fact that the Camberley distribution centre was working three shifts to despatch sufficient machines to UK retailers to meet the expected Christmas demand. One of the machines was the two millionth 48K Spectrum.

Desperate to increase its market share, Acorn had panicked. As early as October, Lasky’s ‘in London’s chip-ridden Tottenham Court Road’ (as *The Sunday Times* so aptly put it) had knocked £20 off the £399 price tag of the BBC Micro – and were throwing in a free tape recorder worth £29.90 and software worth £49.50. Not content with that, Acorn were starting to belittle the competition with knocking copy and Sinclair was not best pleased. In the season of Christmas cheer, a lot of Sinclair and Acorn people had gathered in a Cambridge pub, and it was not surprising when the principals met face to face that, in the heat of the moment, words and a much-publicised slap ensued. On Christmas Eve, by courtesy of Michael Jeacock, purveyor extraordinary of the news of Cambridge to the stews of Fleet Street, the whole world knew about the exchange between ‘the two men whose products will be in millions of stockings this Christmas.’

Personal Sinclair–Curry relations were restored within a week, but the business war continued. Sinclair withdrew the Spectrum from the home market and cut the price of the Spectrum+ from £179.95 to £129.95 in mid-January, a move which caused some anguish to those who had paid the higher price for their Christmas machines. Without alleviating that anguish, Sinclair justified the price cut: ‘The home computer market is currently entering a very vigorous phase and we anticipate strong competition from UK manufacturers in particular. Economies of scale in producing the Spectrum+ – production of which has now reached in excess of 200,000 per month – permit us to take a strong lead in reducing prices in this sector and further increase our market share in the UK beyond its present 44 per cent.’ By comparison, Commodore had 30 per cent of that market, and Acorn 10 per cent.

But all was not well. Whatever the manufacturers said – or did –

the truth was starkly evident to the computer retailers: there was a dearth of customers. Gloomier pundits suggested that the market had suddenly realised that home computers were little more than toys. The belief that they would be as common as TV sets had been abandoned – according to market research at the turn of the year which said that the British market was already ‘fully penetrated’. The report continued that 14 per cent of UK households had a computer, a figure which no other country could match. Half the families with teenage sons [!] had bought computers, some with serious intent, but most people used them only for playing games, if they used them at all.

In an attempt to find something buoyant, the report suggested that those who were serious about computing would soon be considering taking on a replacement machine – or perhaps a second one – as the older models curled up and died. In any case, as people’s computing ability increased they would need software and peripherals (printers, extra memories and so on) . . . and of course their computer awareness would spill from the home to the office and increase the potential market there.

Times were indeed hard, but the report suggested that Sinclair Research had ‘the potential to stay the distance as share prices and the more mature market found their level.’ It continued: ‘Sir Clive Sinclair’s company has been a very influential factor in the development of the UK home computer market. Innovative design coupled with volume production, if not always good quality control and aggressive pricing, has enabled Sinclair to create the mass market for home computers that exists in the UK today.’ The writers then proceeded to give their recipe for Sinclair’s continued success: continuing innovation (never a problem at Sinclair), improved quality (not exactly a new observation) and ‘management efforts’ concentrated on establishing the QL.

Improved quality . . . a study of the reliability of home computers had revealed that Acorn came out top with only 5 per cent of BBC Micros and 4 per cent of Electrons returned while Sinclair and Commodore – the top sellers – also had a top returns rate at 25.4 per cent in the case of the Spectrum. Clive Sinclair hotly disputed this, pointing out that returns are not the same as failures.

‘We have been accused of having a very high return rate on the Spectrum, but in fact that ought to be taken with a very large pinch of salt indeed . . . We have operated the most generous returns policy – far more generous than any of our competitors. Our competitors have a rule that you can exchange their computers over the counter 30 days from date of purchase. We have given people a whole year – not only that but we didn’t even monitor it; you could take your machine back after *more* than a

light on  
crash  
computers collapse  
micro market sh  
"At that time," Greenwood  
called last week. "per  
ing ridiculous."  
"I keep  
Acorn-  
crisis g  
suspension on Wednesday of  
e glamour stock, Acorn C  
-confirmed when news  
rs Lazards and sto  
JIM LEVI re  
be savan  
Chris C  
Curry: No  
year-end results  
lished in Septem  
"I keep gettin  
ings from our  
about not me  
ments about  
tion," he told  
"But I can  
want Chris Curry, head of  
last week scornfully dis-  
rumours of troubles in  
troubles with the BBC.  
bles with its share price.  
refused to give details of  
financial position, on the  
the company's  
-de that the company's

Imagine on  
bailiffs r  
obody here at Imagine,  
iffs have been in taking  
ure," said a confused  
operator at Imagine.  
has been  
raged. One game  
ready for launc  
sources say very  
other will

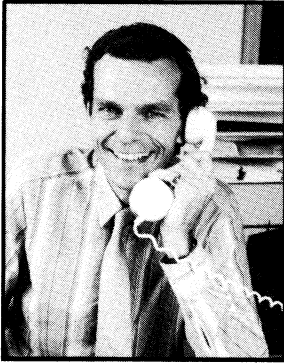

*Richard Cutting*  
director of MetaLab

year. Many of our customers, in fact the majority of them, are in the 14–15 year-old age bracket. These are characters who can destroy granite with one blow of their fist so a computer gets a pretty tough pounding over the course of the year – Coca-Cola spilt on it, this sort of thing – and they’ve been entitled to return that machine and swap it over the counter for a fresh one at any time during the year. So yes we get a lot back, but they aren’t faulty computers, they’re ones that have got damaged and so on. We are very proud of the quality of the machines that we build. We’ve been a little over-generous in the deal that we’ve offered our customers.’

One of the original advantages of the Spectrum keyboard had been trumpeted as its ability to withstand the ravages of Coca-Cola; perhaps the new formula from the Synthesists of Silver Springs had changed all that. The outcome was that the ‘one-year-or-more’ deal was reduced to the market norm of three months.

Kipling’s *If* is an inspiration to Sinclair, who can declaim it in full, and while all around were losing theirs he was busy unveiling the fact that he had brought in Robb Wilmot (chairman of ICL – remember the ICL One-Per-Desk personal computer incorporating the Sinclair Microdrive?) to lead his latest venture. For some time, Sinclair had been sponsoring work on wafer scale integration (WSI), the great silicon hope of the fifth generation computer. The fifth generation, you will recall from Chapter 13, is the realisation of Sinclair’s Periclean Athens, when every household will have its friendly factotum.

In 1984, Sinclair had set up his MetaLab which had, in those heady days, caught the public fancy in that it was generally believed to be an ideas factory wherein brilliant scientific minds would be given unlimited facilities to explore whatever technology buzzed beneath their bonnets. It was believed that all manner of world-shattering discoveries would emerge, just as Swift had described in the Voyage to Laputa in *Gulliver’s Travels*.

Richard Cutting had left the managing director’s chair at Cambridge Consultants to lead MetaLab and knew the reality; it was a commercial development organisation, very much a part of Sinclair Research, and would be pursuing projects in line with Sinclair’s products – flat-screen tubes and their applications, and computer developments of which WSI is an exciting part.

The first WSI product would be a 7-Megabyte memory built on a 4” wafer (high technology still works in Imperial measurements); seven megabytes is about 150 times as much memory as the 48K Spectrum has. No one else in the world was making memories that big, yet Sinclair proposed to produce them by the million within two years. Many companies had, of course, studied the problem of WSI, but had concluded for one reason or another that the world

was not ready for it.

Now here was Sinclair introducing respectability to his fifth generation project with Robb Wilmot as a figurehead seeking £50M to set up a WSI plant. As usual, it was a breathtaking move, especially as it was being pursued in parallel with a company cash shortage and it is unfortunate that it had to be abandoned as times become harder.

As January turned into February there was intense turmoil in the computer industry. All the problems seemed to come to light at once. Acorn shares were suspended because they had sacked their bankers – ‘an act of hari-kiri’. The same day, the Sinclair Board announced that they were postponing the USM flotation; taking the bull by the horns, they disclosed that Rothschilds had already advised against flotation: ‘This decision results from adverse stock market sentiment towards companies in the computer sector. Unaudited management accounts show that [Sinclair’s] sales and trading profit for the nine months ended 31 December 1984 were in excess of those for the corresponding period of the previous year.’

Amidst all this, Sinclair’s main distributor, Prism Microproducts, collapsed into receivership despite its auditors having forecast a profit for the year of £1.9M. Prism owed Sinclair upwards of £1M and when that news reached the City it did nothing to help matters. The fact that that £1M had such an effect when, one might have thought, it was relatively trivial in the Sinclair context, should surely have sounded more alarms than it seems to have done at the time.

The headlines were getting worse and worse. Acorn was now ‘under investigation’ by the Stock Exchange; Commodore, Sinclair’s main rivals, cut the price of their ‘top of the range’ model from £299 to £150 and there was talk of this price war extending to ‘up-market models like Sinclair’s QL, Amstrad’s CPC464 and new models from Japan’. The price of the ZX Spectrum+ had already been cut from £180 to £130; the QL held out until the end of August when its price was halved – from £399 to £199.95.

Sinclair was now having to refute allegations that his company was losing £1M per month, and it was not long before the headlines read: ‘City fears cash crisis at Sinclair Research’.

The newspapers were having a field day. Under the headline ‘Sinclair in debt fears’, we read: ‘Sinclair Research is talking to two international companies about selling licences to manufacture and market its flat-screen television. If successful, the resultant deals would go a long way to wiping out Sinclair’s overdraft – which, says Sir Clive Sinclair, the chairman, is “about £5M”.’ This statement followed the concern which Sinclair’s institutional shareholders had recently expressed, when it was revealed that stocks of



*When Nigel Searle returned to the States to run Sinclair's Boston Office (above), Dave Chatten (below) took over as MD of the computer division*



computers were of the order of £34M. Production was reduced, and subsequently hundreds of sub-contractors' staff were laid off.

However much anyone protested that Sinclair Research and Sinclair Vehicles were two independent companies, the problems which beset the C5 could scarcely turn the tide of ebbing confidence which was beaching the electronics business.

At the end of May it became known that Sinclair had a cash crisis; when it was announced that suppliers Thorn EMI and Timex had agreed to wait for payment; Sinclair took the reports 'with typical calm'.

Sinclair Research was now trying to raise between £10M and £15M for 'financial reconstruction'. The conventional method of raising this money would have been a rights issue of shares to the institutions who had already bought. But the City was so nervous, and share prices had tumbled so alarmingly, that the institutions had had to write down their investments, and were not likely to subscribe any more. Sinclair Research announced that it was looking for a new chief executive, in the folorn hope that this would woo City opinion; Clive Sinclair was quoted: 'I keep telling people that I am not a manager and don't pretend to be one'.

All Sinclair's creditors were going out of their way to be accommodating, because they hoped that the crisis would ease. There were plans to re-launch the QL in the UK, and to launch it in the USA by mail-order . . . as a home computer. The flat-screen television was said to be doing well in the States (but was still disappointing at home). A new Winchester disc drive (large memory) for the QL was on its way, as was a portable computer (codename Pandora). Sinclair Research had a rosy future, and while admitting that finance was 'tight' Sinclair appeared his usual cool self, averring: 'The view that the home computer business has come to an end in this country is completely erroneous.'

In June, it was disclosed that Thorn EMI and Timex had extended some £10M credit to Sinclair, and Timex believed that their contract allowed them to sell some of their stocks abroad. It was reported that a marketing firm in Manchester was disposing of 65,000 Spectrums overseas at a trade price of £71, £16 less than the Sinclair price. Although this was not helpful, neither was it unprecedented. A week later the situation had become: 'Sinclair seeks a rescue bid' as the company started seeking an industrial partner to buy a share in the business. The Bank of England chaired talks between Sinclair, its creditors, and any potential investors who came along; the institutional shareholders had yet to be approached to join the talks. Rothschilds said: 'Nothing can be decided until the accounts are available'.

However, in March Sinclair had announced pre-tax profits of £7.9M on a turnover of £89.5M (8.83 per cent) in the nine months to December 1984; this was in contrast to pre-tax profits of £14.3M



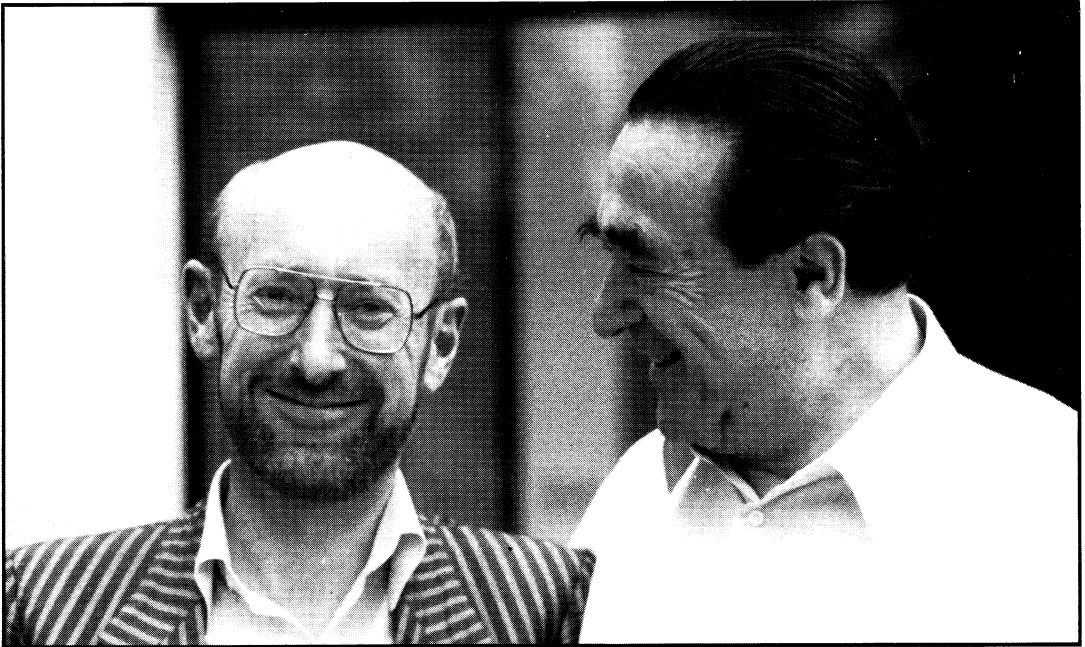

on a turnover of £77.7M (18.4 per cent) for the 1983-84 financial year, and £14M on £54.5M (25.7 per cent) for 1982-83.

The upper end of the computer industry was having a hard time, as IBM lowered its profit forecast, Sperry and Burroughs were negotiating a merger, and Apple was closing two plants and losing 1200 people – 20 per cent of its workforce.

What would happen? It was the evening of Sunday 16 June 1985; wondering what had been going on in the world I fortuitously turned to Ceefax and there, on page 113, I read:

*'Mirror* Publisher Mr Robert Maxwell has mounted a £12M rescue bid for Sir Clive Sinclair's troubled home computer company.

'Sinclair, like other home computer firms, was hard hit by a drop in sales last Christmas. Plans to offer shares to investors on the stock market this year were shelved.

'Mr Maxwell and Sir Clive talked for nine hours today. It was agreed that Hollis, a subsidiary of Mr Maxwell's company Pergamon, would take over a controlling stake in Sinclair for a nominal sum.'

The following morning, the *Daily Mirror* pictured the two together; the look of relief on Sinclair's face is remarkable. 'I'm tickled pink' he said to the *Cambridge Evening News*. Maxwell described Sinclair Research as 'one of Britain's great national assets' and said: 'I look forward to working with Sir Clive – a man of brilliant inventive genius'.

*A relieved Sir Clive with Robert Maxwell*

*Picture: Monte Fresco*

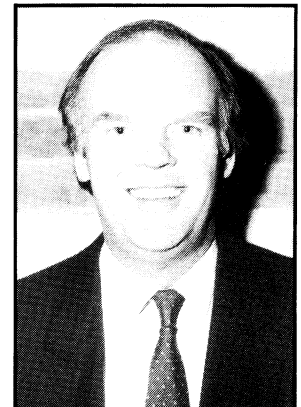

*Bill Jeffrey  
chief executive officer*

However, the popular image of Robert Maxwell pulling out his chequebook and scribbling a cheque for £12M was rather far removed from the processes which had to be gone through. At last accountants Coopers & Lybrand made their report, and at the beginning of August Hollis Brothers said: 'After advice by merchant bankers Hill Samuel, the board decided that on the basis of information available to it it could not recommend the acquisition to its shareholders.'

But all was not quite back to square one; Bill Jeffrey – who had joined Sinclair in March as MD of TV and Communications – became chief executive officer at the end of July. The possibility of the Maxwell deal had bought time, and time had brought a reported £10M deal with Dixon's, the high-street technochain. 'Over the past few days,' announced the company, 'it has become clear to all parties that as a result of recent sales successes the proposed refinancing of Sinclair Research is now no longer necessary.'

By the end of August, the company had reached an agreement with its bankers and main suppliers. Creditors were told that the company would be able to 'trade vigorously' in the immediate future. Thanks to the agreement, the company now had 'a good base from which to face with confidence the important Christmas selling period', and would be able to trade through its current financial year. And all the air a solemn stillness holds as we await the outcome.

Meanwhile, the state of computing continues to waver; forecasts are still being revised downwards. Stores which so recently reconstructed their displays to enlarge the amount of space devoted to computers are now reconstructing yet again to accommodate lines with more certain sale. A year ago, it was impossible to get close to the computer displays in these stores because of the youngsters demonstrating their considerable prowess; today, there is scarcely a youngster in sight; how those concerned for the state of the market would welcome those once-infuriating games-noises.

One cannot help feeling that the enthusiasm with which the computer was promoted – or even hyped – into education, for example, was one of the greatest triumphs of hope over experience that mankind has ever seen. This is not in any way to denigrate the excellent achievements of those who have made computing work, but rather to sympathise with those who haven't. In schools, the computer is possibly an adjunct to teaching amongst those who understand it; it is not a substitute for the teacher.

In the home, the computer is not going to solve your financial problems, ensure that your larder is always stocked to optimum levels for the recipes which you have programmed for months ahead, or print out lists of Christmas card addresses. It's not that it can't, it's just that it takes a great deal of effort, first to feed all the

**JANE** by John Burns and Ian Gammidge

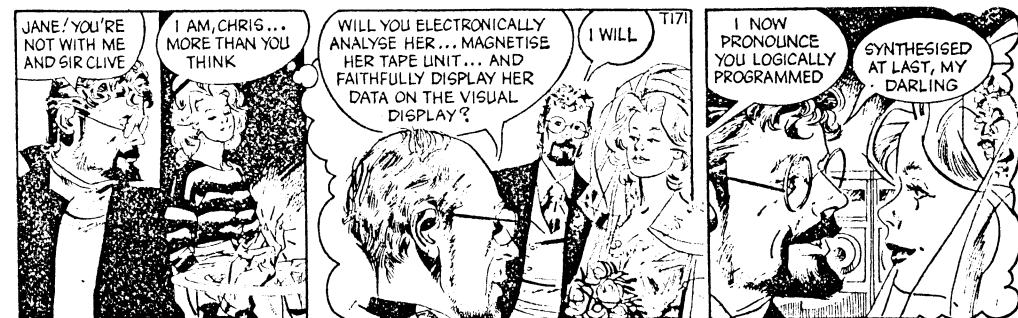
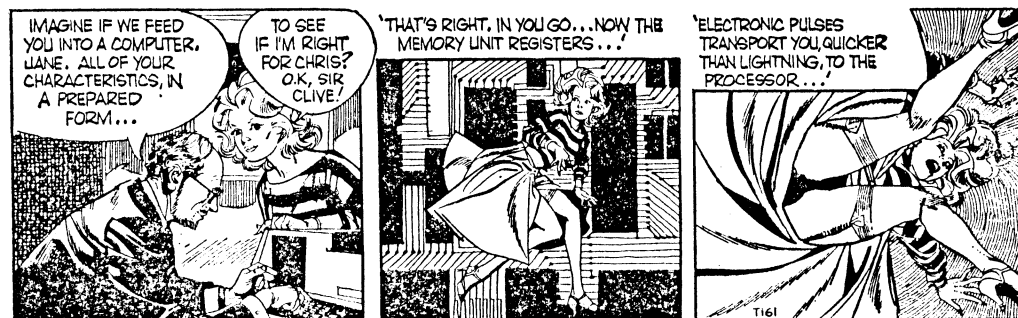

**THE MIRROR**

*During the Sinclair-Maxwell negotiations, Sir Clive appeared with the resurrected Jane. Did this set the tone of what might have been?*

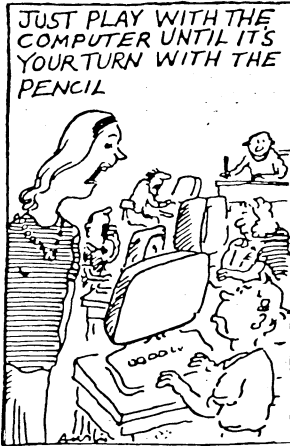

information into the computer, and then to keep it up to date. And I'm not being hostile towards computers or gloomy about human nature; it's just a fact of life until the robots of Periclean Athens arrive.

There is a world of difference between using a computer to play the inevitable games and understanding how those games are constructed. Those who are interested in learning how the games are constructed are comparatively few and far between and they may well be the computer engineers of tomorrow, just as many of the constructors of Sinclair's kits twenty years ago are the electronics engineers of today.

## 19

## Private view

It will not have passed unnoticed that Clive Sinclair has emerged from our pages through his deeds rather than through direct description. So what of the man himself?

We have seen that he can be as passionately interested in some topics as he is uninterested in others. This has led him to follow his own path ever since leaving school, supported by his tremendous ability to absorb knowledge. In technological jargon, he is a 'gatekeeper' par excellence – one who listens attentively (even if he sometimes doesn't seem to) and reads voraciously, storing what he harvests (the brain mountain?), cross-connecting information, and making use of it when the time is ripe.

He is fired by elegance; in technology, this can mean making one component do the job of several, thus reducing the number of components. This results in economy both of space and of cost, though it can lead to over-simplification with a consequent penalty in production difficulties and product reliability.

Sinclair's interests are not solely technological, for the elegance of economy applies to the arts as well as the sciences; the elegance and economy of sound in music, of words in poetry, of line and surface in art, and hence the circuit is complete back to mathematics, that most elegant of arts . . . or sciences.

Connecting what may seem to be disconnected is a characteristic not only of research and development, but also of humour and word-play, and word-play and argument are two of Sinclair's relaxations. Argument is not just as a method of gleaning information; it's also an intellectual exercise, and sometimes he will change sides with his opponent in mid-stream.

Clive Sinclair is a man of great kindness and compassion, and many people have been profoundly grateful to him for some help or

support he has given them in an hour of need. He is not a philanthropist on the grand scale, preferring to keep his works private, though he has supported the Cambridge Symphony Orchestra, the Cambridge Poetry Festival and the Cambridge Festival Half-Marathon, as well as the Sinclair Prize for Fiction – ‘awarded to the author of the best unpublished full-length novel which, in the opinion of the judges, is not only of great literary merit, but also of major social and political significance.’ He is Chairman of British Mensa – popularly described as ‘The High IQ Society’ – and has helped it to recognise itself for what it is: a social organisation.

Simplicity and elegance manifest themselves in the décor of his house with its predominant white and marble surfaces – reminiscent, perhaps, of his sun-drenched Periclean Athens – as near as I’ve seen to Le Corbusier’s ideal of ‘a machine for living in’. (When it became water-drenched as a result of a winter burst, he blamed it on ‘low technology’.)

He is not interested in money *per se*; his interest lies in its ability to allow him to pursue technology. Just before the launch of the C5 he said to me: ‘It’s a very nerve-racking time; I could lose all my money. I don’t mind not having any money, but it would be annoying in the sense that I couldn’t do what I want to do.’ And that’s what money is for – to do what you want to do, and in Sinclair’s case he wants to pursue technology.

Because his mind is quick, and he is often preoccupied with technothoughts, he can be exceedingly difficult to talk to, often giving an impression of shyness. But silence in conversation does not embarrass him as it does many people; he is more embarrassed by those who chatter about nothing to fill the silence. But he can burst into life when he is relaxed, or when he has something to say, or when he thinks that you might have some piece of information which would fit into the boundless jigsaw of his mind.

How does the course of Clive Sinclair’s business ventures reflect his personality? His impatience led him to abandon formal education after his A-levels; his single-mindedness and ability to learn for himself enabled him to find a niche in technical journalism which few others had explored. Here, Sinclair the technological gatekeeper came to the fore, and he saw how the knowledge he was gleaning from semiconductor manufacturers could be turned to good account.

He saw several other things as well: that high-volume production, rather than one-off design, was the way to make money; that to be big you had to start by looking big – hence the attention he paid to his advertisements; and that by selling by mail-order he would need the most basic distribution organisation. Right from the start, he recognised the importance of using his own name on

the products; Clive Sinclair is nothing if not honest, it was his company, and he was not afraid to be identified with what he was doing.

He succeeded in building up production, and in building his image, in spite of his lack of appreciation of the importance of quality and reliability. However, it is difficult to be sure that twice as much, say, attention paid to quality and reliability would have made him twice as successful; there has to be a cut-off point somewhere.

The pocket calculator alone could have been the contribution to mankind for which Sinclair has always sought, but he doesn't think it is. For the seeker, there is always another peak to climb; success is only something that we think other people have. But though Sinclair had a technological lead with the pocket calculator, and though he may have backed the wrong technology for its further development, a failure to appreciate the market was its final downfall.

The Black Watch is the quintessential example of poor quality and reliability. Sinclair had a clear lead in technology there (he puts it at two years) and, as subsequent events proved, a ready market. This disaster, combined not only with the money being absorbed by the Microvision and his stubborn refusal to drop it, but also with a lack of interest in the steady but mundane profitability of the instrument market, forced Sinclair to seek the outside finance finally provided by the NEB.

However, any arrangement which caused Sinclair to lose control of his own company must have been doomed from the start. He may well agree that he is not a manager, but this does not preclude his ability to drive and inspire his company – at which he is superb. He knew when the NEB came in that it might be impossible to work with them; he would give the arrangement a try, but he had to set up Science of Cambridge as a lifeboat.

Science of Cambridge turned to Sinclair Research; the first product was the ZX80 which broke the £100 price barrier; the ZX81 extended the market. With the Spectrum, Sinclair really got it right; by that time, Sinclair Research was sufficiently organised for quality and reliability to mean something; unfortunately, a great deal of the headway which had been made was thrown away when the QL was launched too early, and followed up so badly. Nevertheless, the lead which Sinclair took in home computing could again have been his contribution to mankind. But he was still driven on.

As for the C5, my considered opinion is that only the driving force of a Clive Sinclair could have produced it. Forget what happened after the launch; so much *was* right in the concept, the philosophy, and the development. A project of this nature needed a single visionary with enormous funds to back it. That it was a

flawed masterpiece is one of the great tragedies of the Sinclair Story.

And so to the maturing computer market. Market research was never a Sinclair forte; if the product's selling, what more is there to know? It seems incredible in retrospect that the signs which seem so clear now were so obscure then. But there is no doubt that Clive Sinclair's buoyant expression of his belief in his company and his product rubs off on all with whom he comes into contact. Perhaps a little more scepticism would have been good for all concerned; it could have averted a financial crisis.

Robert Maxwell might have saved the day, but had that deal gone through Sinclair would have lost control of his company once again and it is doubtful if this arrangement would have succeeded any better than the one with the NEB did. However, the Maxwell exercise bought time, and with it an alternative resolution of the mid-1985 crisis. If such crises can be resolved without Clive Sinclair losing control of his company, there is hope. We have yet to see what happens, but one thing is certain – and it is confirmed by many who know Clive Sinclair well – nothing will diminish his drive for running his own show in the pursuit of new technology.