

MACINTOSH II

REPAIR AND UPGRADE SECRETS

For Mac II, IIx, IIcx, IIfx, IIci, IIsi Computers,
and 12" Monochrome
and 13" Color RGB Apple Monitors

LARRY PINA

INCLUDES
COLOR TEST
PATTERN
GENERATOR

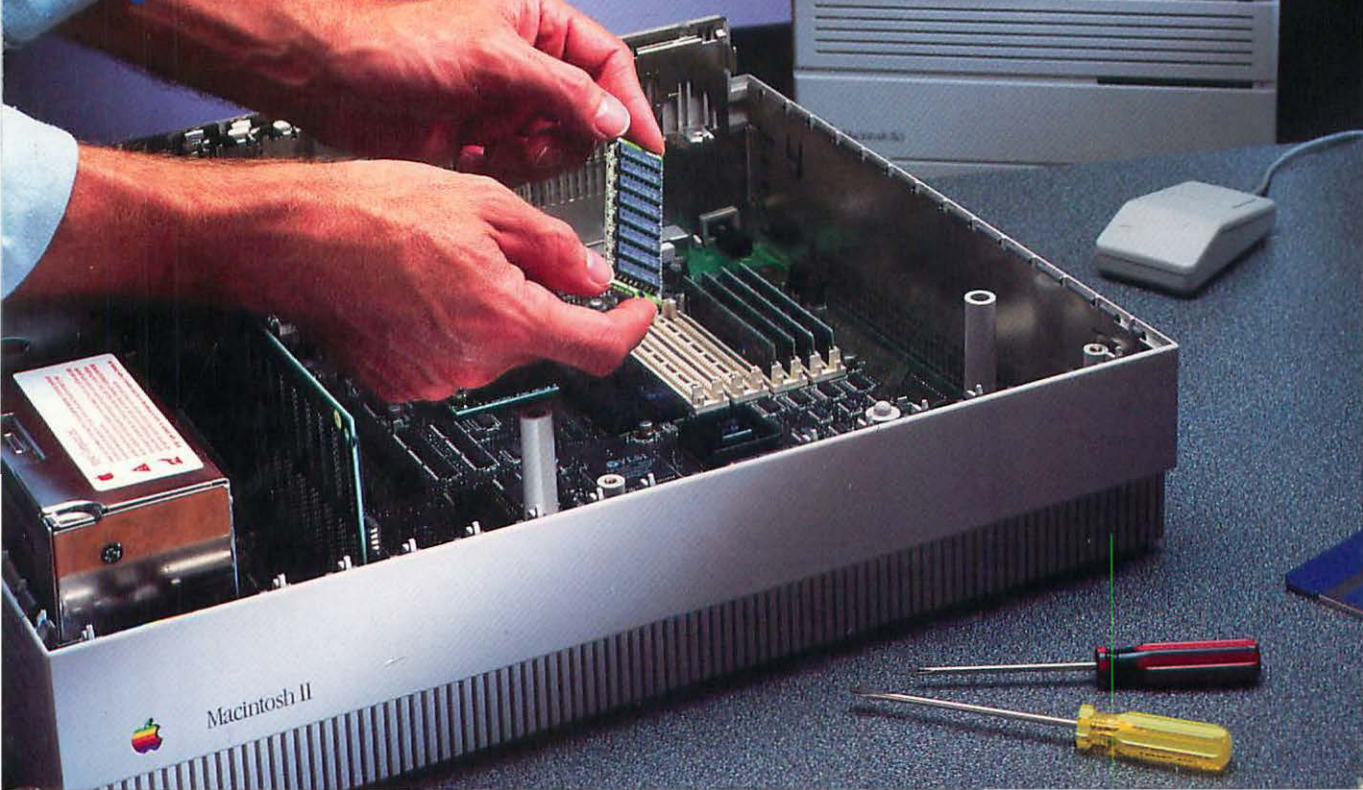

Macintosh II Repair and Upgrade Secrets

Larry Pina



Brady Publishing

New York London Toronto Sydney Tokyo Singapore

Copyright © 1991 by Larry Pina
All rights reserved,
including the right of reproduction
in whole or in part in any form.



Brady Publishing

Brady Publishing
A division of Simon & Schuster, Inc.
15 Columbus Circle
New York, NY 10023

Manufactured in the United States of America

10 9 8 7 6 5 4 3 2 1

Library of Congress Cataloging in Publication Data

Pina, Larry.

Macintosh II repair and upgrade secrets / Larry Pina.

p. cm

Includes index.

1. Macintosh II (Computer)—Maintenance and repair.
2. Microcomputers—Upgrading I. Title II. Title: Macintosh 2
repair and upgrade secrets.

TK7889.M33P55 1991

621.39'16—dc20

91-37576

CIP

ISBN 0-13-929530-5

Trademarks

All terms mentioned in this book that are known to be trademarks or service marks are listed below. In addition, terms suspected of being trademarks or service marks have been appropriately capitalized. Brady cannot attest to the accuracy of this information. Use of a term in this book should not be regarded as affecting the validity of any trademark or service mark.

Apple, ImageWriter, LaserWriter, Lisa, Mac, and Macintosh are registered trademarks of Apple Computer, Inc.

AppleTalk, HyperCard, and Finder are trademarks of Apple Computer, Inc.

Key Tronic and Key Tronic Professional Series are registered trademarks of Key Tronic Corporation.

MacGard is a trademark of Systems Control, a division of M.J. Electric.

MacTable is a registered trademark of ScanCo.

MacPro is a trademark of Key Tronic Corporation.

Microsoft and MS-DOS are registered trademarks of Microsoft Corporation.

Polaroid is a registered trademark of Polaroid Corporation.

PowerKey is a trademark of Sophisticated Circuits Incorporated.

Radio Shack is a registered trademark of Tandy Corporation.

Sony, MultiScan, and Trinitron are registered trademarks of Sony.

Limits of Liability and Disclaimer of Warranty

The author and publisher of this book have used their best efforts in preparing this book and the programs contained in it. These efforts include the development, research, and testing of the theories and programs to determine their effectiveness. The author and publisher make no warranty of any kind, expressed or implied, with regard to these programs or the documentation contained in this book. The author and publisher shall not be liable in any event for incidental or consequential damages in connection with, or arising out of, the furnishing, performance, or use of these programs.

Acknowledgments

Special thanks to my literary agent Bill Gladstone, of Waterside Productions, to Tracy Smith and Tom Dillon of Brady Publishing, and to the following trade professionals who helped in one way or another to make this a better book:

Terry Bell, Shreve Systems; Andy Bulgerin, Technology Works; Mari Byron-Abbott, Polaroid Polarizer Division; Mary Carlson, Systems Control; Christine Colburn, Creative Solutions; Bob Cook, Sun Remarketing; Frank Dexter, Educator's Newsletter; Luke Friendshuh, Ontrack Computer Systems; Richard Harold, Shreve Systems; Owen Hartnett, Ohm Software; Paul Johnson, Key Tronic; Mike McCord, MicroDoc; Jim McIntosh, GDT Softworks; Rosalind Preston, Nova International; Amar Singh, Sophisticated Circuits; Roger Smith, Sun Remarketing; Jean Sorensen, Soft Solutions; Soren Storm, ScanCo; Richard Tom, On-Time Mac Service; Anne Vershel, Ontrack Computer Systems; Dan Wright, John Fluke Manufacturing Company.

Contents

Introduction	xiii	
Color Test Pattern Generator (Color TPG)	xiii	
System Requirements	xiv	
Starting Color TPG	xiv	
Indicating a Screen Size	xvi	
Test Patterns	xvii	
Reference Menu Items	xviii	
Special Menu Items	xix	
Chapter 1	Safety Rules—Tools and Techniques	1
	Standard Safety Precautions	1
	Electrostatic Discharge Precautions	2
	Dealing with Static Electricity	3
	Step 1—Wear Natural Clothing	4
	Step 2—Choose a Suitable Work Area	4
	Step 3—Ground Yourself	5
	Step 4—Consider the Weather	8

Hand Tools	8	
Phillips-Head Screwdrivers	8	
Plastic TV Alignment Tools	9	
Chip Pullers	9	
Putty Knife	10	
Test Equipment	11	
Multimeters	11	
Using a Digital Multimeter	12	
Isolated AC Power Supplies	12	
Soldering Equipment	14	
Summary	15	
Chapter 2	Adjustments—Apple High-Resolution Monochrome Monitors	17
Definitions, Goals, and Objectives	18	
Periodic Adjustment Procedure	19	
Step 1—Remove the Control Cover Plate	20	
Step 2—Adjust the Width	20	
Step 3—Adjust the Height	24	
Step 4—Adjust the Focus	25	
Step 5—Replace the Control Cover Plate	26	
WYSIWYG Modifications	26	
Miscellaneous Adjustments	29	
Adjusting the Horizontal-Hold Control	29	
Adjusting the Vertical-Hold Control	30	
Adjusting the Cut-Off Control	31	
Monitor Accessories	33	
Chapter 3	Adjustments—AppleColor High-Resolution RGB Monitors	35
Definitions, Goals, and Objectives	35	
Subtractive versus Additive Color	37	
The Primary Subtractive Colors, Red, Yellow, and Blue	37	
How the ImageWriter II/LQ Makes Color	38	

The Primary Additive Colors—Red, Blue, and Green	39
How the AppleColor High-Resolution RGB Monitor Makes Color	39
Periodic Adjustment Procedure	40
Step 1—Remove the Control Cover Plate	41
Step 2—Adjust the Width	42
Step 3—Adjust the Height	45
Step 4—Center the Display	45
Step 5—Converge the Dots	46
Step 6—Adjust the Focus	48
Step 7—Replace the Control Cover Plate	50
WYSIWYG Modifications	51
Adjusting the Cut-Off Control	53
Adjusting the White-Balance Controls	54
Color Purity Adjustments	60
WYSIWYG Color Printing	62
Additional Convergence Adjustments	65
Adjusting the Linearity Controls	71
Component-Level Repairs	77
Ordering Replacement Parts	77
Monitor Accessories	78
Filters	78
Anti-glare Filters	79
Contrast Enhancement Filters	80
Anti-Radiation Filters	80
Stands	81
Swivel Bases	82
Chapter 4 CPU Maintenance—Logic Board Upgrades	85
Take-Apart Procedure for the Macintosh II/IIx/IIfx	86
Fan Controller Upgrades	89
Identifying Power Supplies—Which Model?	90

Installing Fan Controller Upgrades	91
Testing Fan Controller Upgrades	98
Mac II to IIx Logic Board Upgrades	99
Mac II/IIx to IIcx Logic Board Upgrades	101
Component-Level Repairs	102
Power-On Problems	102
Testing B2	103
Jumper Cables	104
Power Supply Service	104
Problems with the Real-Time Clock	106
SCSI Problems	106
ADB Problems	108
Other Problems	109
Take-Apart Procedure for the Macintosh IIcx/IIci	110
Macintosh IIcx to IIci Logic Board Upgrades	112
Component-Level Repairs	113
Power-On Problems	113
Problems with the Real-Time Clock	114
Take-Apart Procedure for the Macintosh IIsi	114
Error Sounds Common to All Models	117
Chapter 5	
VRAM—Video Card Upgrades	121
One-Bit Video	121
Four-Bit Video	122
Relative Brightness—Intensity	123
Color Saturation	123
Eight-Bit Video	124
24-Bit Video	129
Display Size Limitation	130
Benefits of 24-Bit Video	130
Near-Photographic Quality	130
Photographic Quality	131
True Grayscale and True Color	131

The Drawbacks of 24-bit Video	131
VRAM Upgrades	132
Identifying Video Cards—Which Model?	133
Installing Four-Bit to Eight-Bit Upgrades	135
Installing Eight-Bit to Twenty-Four-Bit Upgrades	137
Installing Thirty-Two-Bit QuickDraw Software	139
DRAM Upgrades	140
NTSC Compatibility Upgrades	142
Making an NTSC-Compatible Video Cable	142
Obtaining an Audio Cable	145
Installing (NTSC) Video Card Utility Software	145
Activating the (NTSC) Video Card Utility Software	145
Use with Original Macintosh II Video Cards	147
Use with Macintosh II Extended Video Cards	148
Use with Four-Bit Mac II High-Resolution Video Cards	148
Use with Eight-bit Mac II High-Resolution Video Cards	148
Deactivating the Video Card Utility Software	149
Configuring Macintosh Display Cards	149
Desktop Video Software	150
Troubleshooting Video Cards	151

Chapter 6 DRAM—Memory and Coprocessor Upgrades 153

Types of DRAM Chips	153
Memory Capacity	156
Power Requirements	156
Speed	157
Identifying Banks A and B	158
Configuring the Macintosh II/IIx/IIcx and Macintosh IIcx	158
Configuring the Macintosh IIfx	162
Configuring the Macintosh IIsi	162
Installing and Removing SIMMs	163
Troubleshooting SIMM Installations	165

	PMMU Upgrades for the Macintosh II	165
	Locating the HMMU	166
	Removing the HMMU	166
	Installing the PMMU	167
	Troubleshooting PMMU Upgrades	167
	Installing Virtual Memory Software	168
	Troubleshooting Virtual Memory	169
	FPU Upgrades for the Macintosh II	170
	Locating the FPU Socket	170
	Removing the Existing FPU	171
	Installing the MC68882 FPU	171
	FPU Upgrades for the Macintosh IIsi	172
Chapter 7	NuBus Expansion Card Upgrades	173
	Types of NuBus Cards	173
	Power Requirements	174
	Installing and Removing NuBus Cards	175
	Identifying Slots \$9 through \$E	177
	Working with Multiple Video Cards	178
	Working with Parallel Interface Cards	178
	Chooser Setup for Parallel Cards	180
	PrintLink Driver Options	180
	Troubleshooting Parallel Card Installations	182
	Working with Serial Interface Cards	182
	Communications Toolbox Upgrades for System 6.0.4, 6.0.5, and 6.0.7	183
	Chooser Setup for Serial Cards	184
	Troubleshooting Serial Card Installations	185
	Troubleshooting Other NuBus Card Installations	185
	Expansion Cards for the Macintosh IIsi	186
	Troubleshooting Macintosh IIsi Expansion Card Installations	186

Chapter 8	FDHD—Disk Drive Upgrades	189
	Types of Disk Drives	189
	400K Disk Drives	189
	800K Disk Drives	190
	1.4 MB Disk Drives	191
	Formatting Rules	191
	Building an External Disk Drive Adapter	193
	Construction Notes	194
	Installing the Adapter Cable	195
	Using the Adapter Cable	195
	Installing a Second Internal Disk Drive	196
	Installing an FDHD/ROM Upgrade into a Macintosh II	197
	Troubleshooting 800K Disk Drives	201
	Types of Cleaning Diskettes	203
Chapter 9	SCSI Hard Drive Upgrades	205
	Types of Hard Drives	205
	SCSI Interfaces	206
	Form Factor SCSI Drives	206
	Standard Hard Drives	207
	Setting the Bus ID	208
	Pin Header Locations	209
	Pin Header Labeling	210
	Checking Termination	211
	Terminator Orientation	212
	Terminator Filters	213
	SCSI—Hard Drive Upgrades	215
	SCSI Hard Drive Installation Kits	215
	Formatting Software	216
	SCSI Cables	216
	Mounting Brackets	216
	Installing a SCSI Hard Drive into a Macintosh II	218

Formatting the Drive	219
Putting Together an External Hard Drive	220
External Hard-Drive Enclosures	220
AC Power Cords	221
Metal versus Plastic Enclosures	221
Switching Power Supplies	222
Universal Mounting Brackets	222
Prewired 12V DC Fans	222
Data Cables	222
Terminating External Drives	223
Installing a SCSI Hard Drive into an External Enclosure	224
Troubleshooting External Hard Drives	224
Chapter 10 ADB—Keyboard and Mouse Repairs	227
Standard Safety Precautions	228
OEM Keyboard Disassembly	228
Servicing Intermittent Key Switches	230
Replacing Broken Key Switches	233
First Aid for Spills	234
MacPro Replacement Keyboards	235
MacPro Accessories	237
PowerKey Upgrades	237
Installing PowerKey	238
OEM Mouse Disassembly	240
Servicing Intermittent Cables	242
Replacing Broken Mouse Switches	243
Appendix A Acronym Glossary	245
Appendix B Dealer/Manufacturer Addresses	249
Larry P.'s Guide to Mail-Order Sanity	255
Index	257

Introduction

Macintosh II Repair and Upgrade Secrets covers the Apple High-Resolution Monochrome Monitor, the AppleColor High-Resolution RGB Monitor, the Macintosh II/IIx/IIfx, the Macintosh IIcx/ci, and the Macintosh IIsi. The focus of this book is practical maintenance. All you need to complete the upgrades and repairs described here is a digital multimeter, ordinary hand tools and minimal soldering equipment. You don't need to be an electrical engineer to benefit from the information in this book. The average person with average skills and ability should be able to complete all the repairs included in this book. You don't need any prior technical experience. If you use a Mac II at home or at work, the secrets revealed here could still save you hundreds of dollars.

Color Test Pattern Generator (Color TPG)

As a natural result of heat and old age, a large number of Macintosh II monitors have maladjusted displays. Instead of a normal-sized screen, there's a large black border all around. Instead of a well-focused screen, the corners are fuzzy. Color monitors may begin to exhibit red, green, or blue color shadows. All of these symptoms are very tough on the eyes.

Color Test Pattern Generator (*Color TPG*), the program included with this book, helps you to treat these problems. It creates precision alignment patterns just like the dot-bar generators used in color television repair. By analyzing the alignment patterns, you can determine which (if any) of the monitor controls need to be adjusted.

It's important to realize that simply running *Color TPG* does not fix your monitor! For that you need plastic alignment tools, a digital multimeter and detailed instructions. Vendors of plastic alignment tools and digital multimeters are listed in Appendix B. Detailed alignment instructions are in the chapters that follow.

System Requirements

To run this version of *Color TPG* in color, you need a Macintosh II with at least a 4-bit video card (or built-in video) and color monitor. To run this version of *Color TPG* in grayscale, you need a Macintosh II with at least a four-bit video card (or built-in video and grayscale monitor). *Color TPG* also works in black and white on the Macintosh Classic, the Macintosh SE and many older models.

The *Color TPG* program disk is supplied without System software. To use the 800K disk in a hard-drive computer, simply copy the program to your hard drive. To use the 800K disk in a two-drive computer, you have to start the computer with a System disk and run the program disk from the second drive. To use the program in a one-drive computer (with no hard drive), you must copy System software to the disk. Which version of the System software to copy varies according to your hardware configuration. Whatever you're using now to run your other programs should work fine. Refer to your computer's manual for more information on system software.

Before running *Color TPG* for the first time, it's very important to copy the program disk. The copy (generally called a workdisk) is for everyday use; the original disk (generally called a master disk) should be stored as a backup.

For maximum protection, the master disk should be stored in a safe place, preferably somewhere away from the workbench. In rough use, you have to expect disk casualties. If the master disk is stored safely elsewhere or unavailable, you'll always have something to fall back on.

Starting Color TPG

To start *Color TPG*, double-click the program icon, or simply select it and choose Open from the File menu. As shown in Figure I-1, the first thing you should see is a sign-on screen showing memory and ROM information.

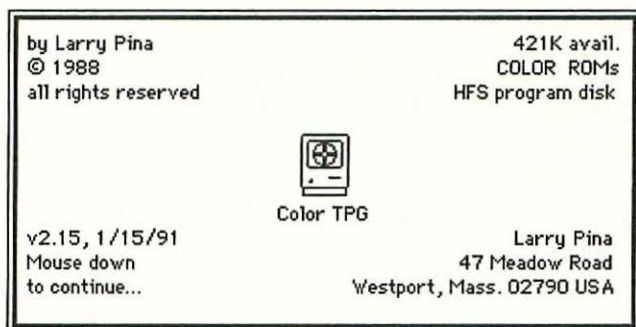

Figure I-1 The sign-on screen shows memory and ROM information.

To dismiss the sign-on screen, click and hold the mouse button down until the sign-on screen disappears, or just press the Return key. Assuming you're using a brand new copy of Color TPG that has never been run before, the next thing you should see is a list of general instructions, as shown in Figure I-2.

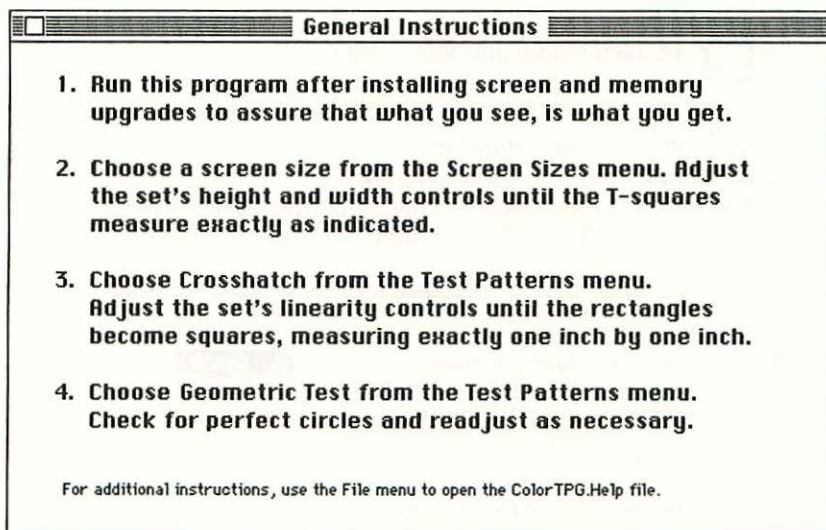

Figure I-2 The list of general instructions explains how to use the program.

After reading the instructions, you can close the window by clicking the close box, by choosing Close from the File menu, or by typing Command-W. You can refer to the list anytime you wish by rechoosing it from the Reference menu.

Indicating a Screen Size

Next, choose a screen size from the Screen Sizes menu. As shown in Figure I-3, this version of Color Test Pattern Generator directly supports the Apple High-Resolution Monochrome Monitor and the AppleColor High-Resolution RGB Monitor. As shown in Figure I-4, the Apple Macintosh Portrait Display, the Apple Two-Page Monochrome Monitor, and all other Apple Macintosh displays are supported by choosing Unlisted Mac Monitors.



Figure I-3 The Screen Sizes menu supports the Apple High-Resolution Monochrome Monitor and the AppleColor High-Resolution RGB Monitor.

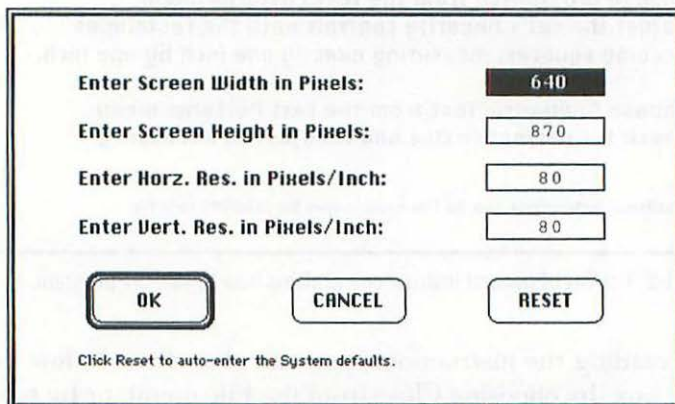

Figure I-4 The Unlisted Mac Monitor menu item supports the Apple Macintosh Portrait Display, the Apple Two-Page Monochrome Monitor, and all other Apple Macintosh displays.

Test Patterns

As shown in Figure I-5, the Test Patterns menu contains 13 items. Since all colors appear solid black (not as various shades of gray) on black-and-white models of the Macintosh, the color menu items can't be selected unless color ROMs are detected. Preventing all-black displays from appearing in place of color displays keeps inexperienced non-color Macintosh users from thinking that the program has failed, when in fact, they just don't have a color Macintosh.

To display colors (or shades of gray) correctly on color Macs, *Color TPG* requires that the monitors control panel device (CDEV) be set to 16 or higher. If the Monitors CDEV is set to 4 or to black-and-white and you select a color test pattern, *Color TPG* advises you as shown in Figure I-6. The point is, you can't get color when color is turned off. That's not a problem with *Color TPG*. That's just the way color Macs work.

Test Patterns	
Crosshatch	⌘G
Dot Hatch	⌘D
.....	
Center Cross	⌘≈
Center Circles	⌘R
.....	
Focusing Text	⌘F
Geometric Test	⌘T
.....	
Gray Bars	⌘π
Color Bars	⌘Ç
Red Raster	⌘Ⓞ
Green Raster	⌘Ⓢ
Blue Raster	⌘J
✓ White Raster	⌘Σ
Black Raster	⌘K

Figure I-5 The Test Patterns menu contains 13 alignment patterns.

To use the Monitors CDEV, choose Control Panels from the Apple Menu. If you are running System 6.0.7 or earlier, use the scroll bar in the Control Panels dialog to find an icon labeled Monitors, then click on it. Next, a window will appear that contains two sets of controls: Click

on the button labeled Colors: and choose any number equal to or higher than 16. If the window does not have a number equal to or higher than 16, then you cannot display color using Color TPG.

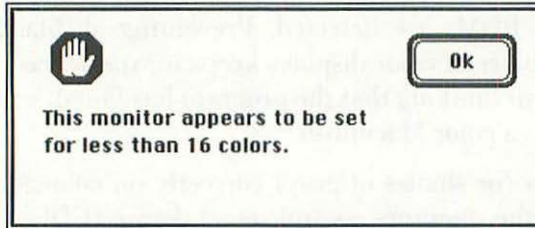

Figure I-6 If the color is turned off, Color TPG advises you prior to displaying a color test pattern.

Reference Menu Items

As shown in Figure I-7, Color TPG's Reference menu contains 12 on-line reference items. General Instructions is the list shown in Figure I-7. Monitor Specifications is the list shown in Figure I-8.

All of the Reference menu items use the Helvetica font. If you've removed the Helvetica font from your System, the Macintosh will default to the Geneva font and the text won't look as good.

Reference
General Instructions Monitor Specifications
Mac Take-apart Mac Audio Template Mac Video Alignment
Mac II Take-apart Mac II Video Alignment
Mac SE Take-apart Mac SE Video Alignment
Mac Classic Alignment
12-inch Mono Alignment 13-inch RGB Alignment

Figure I-7 The Reference menu contains 12 on-line reference items.

Monitor Specifications				
MAKE	MODEL	HWidth	VHeight	DPI
Apple Computer	Lisa 2/5; 2/10	720	364	90.0 x 60.0
Apple Computer	Macintosh 128K	512	342	72.0 x 72.0
Apple Computer	Macintosh 512K	512	342	72.0 x 72.0
Apple Computer	Macintosh 512K E	512	342	72.0 x 72.0
Apple Computer	Mac Classic	512	342	72.0 x 72.0
Apple Computer	Macintosh Plus	512	342	72.0 x 72.0
Apple Computer	Mac Portable	640	400	72.0 x 72.0
Apple Computer	Macintosh SE	512	342	72.0 x 72.0
Apple Computer	Macintosh SE 30	512	342	72.0 x 72.0
Apple Computer	Macintosh XL	720	364	90.0 x 60.0
Apple Computer	XL Screen Kit	608	431	72.0 x 72.0
Apple Computer	12-Inch HR Mono	640	480	76.0 x 76.0
Apple Computer	12-Inch Mono	640	480	76.0 x 76.0
Apple Computer	12-Inch RGB	512	384	64.0 x 64.0
Apple Computer	13-Inch HR RGB	640	480	69.0 x 69.0
Apple Computer	15-Inch Portrait	640	870	80.0 x 80.0
Apple Computer	21-Inch Two-Page	1152	870	77.0 x 77.0
PowerR	MacLarger	512	342	55.5 x 55.5
* Princeton	MAX-15 Autosynch	640	480	72.0 x 72.0
* Sony	1302 Multiscan	640	480	72.0 x 72.0

* Indicates Macintosh II equipped with Apple M5640 video card.

Figure I-8 Monitor specifications contains screen-size information for unlisted Mac monitors.

Special Menu Items

The Special menu, shown in Figure I-9, contains three special items. As shown in Figure I-10, choosing Set Startup. . . allows you to configure *Color TPG* for a specific monitor. You can select any of the listed screen sizes or you can enter a custom size.

As shown in Figure I-11, Switch Monitors. . . allows you to temporarily redirect the test patterns to a secondary monitor. This feature allows you to compare up to six monitors connected to the same Macintosh. To redirect a test pattern, drag the untitled window to the upper-left corner of the monitor that you wish to test. Adjust the window position so that there is a one-pixel space between the window outline and the display border.



Figure I-9 The Special menu contains three special items.

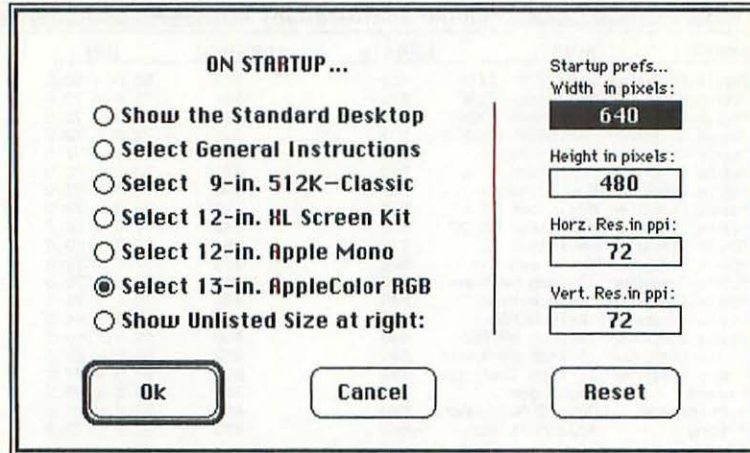

Figure I-10 Set Startup... allows you to configure Color TPG for a specific monitor.

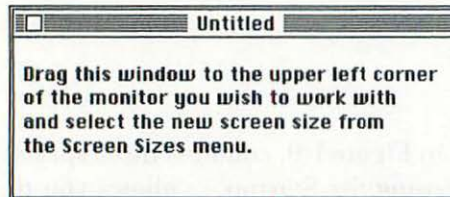

Figure 1-11 Switch Monitors... allows you to redirect the test patterns to a secondary monitor.

The Color TPG.Help file which is included on the program disk contains additional information on Test Pattern Generator. To read the help file, start *Color TPG*, dismiss the startup screen and choose Open... from the File menu. Like all current software, Color TPG is constantly being revised. If there are any new features or last-minute instructions, the Color TPG.Help file will bring you up to date on them.

1

Safety Rules—Tools and Techniques

This chapter contains an important discussion of safety rules, tools, and techniques. Please read this chapter for background information. Then, after you've gathered everything you need, please read it again, just before upgrading or repairing your Macintosh II computer.

Standard Safety Precautions

Upgrading and repairing any computer (not just Macintosh II computers) requires extraordinary presence of mind. Computers and computer monitors run on electricity. Electricity is inherently dangerous. Standard safety precautions must be taken at all times:

1. Whenever possible, disconnect the computer's power cord from the wall outlet. After that, disconnect it from the computer. Never work on live circuits unless you absolutely have to.
2. Avoid jewelry altogether. If a neck chain, a ring, or a wrist watch were to come in contact with live components, the resulting electric shock could be fatal.
3. Tie back long hair before working on electrical equipment. Remove neckties. Both tend to fall into your work, which is dangerous and distracting.

4. Never work with wet hands, wet hair or wet clothing. Water conducts electricity. Working on electrical equipment while you have wet hands, wet hair or wet clothing is *extremely* dangerous.
5. Don't allow children or pets in the work area. Their actions are both uncontrollable and unpredictable. Guaranteeing their safety is next to impossible.
6. Whenever you get stuck, stop! Seek further information or seek help from an expert.

To put point six in perspective, this book was written for average Macintosh II owners. With the benefit of this information, all Macintosh II owners will be able to perform some upgrades and repairs, some owners will be able to perform all upgrades and repairs, but not all owners will be able to perform every upgrade and repair.

Electrostatic Discharge Precautions

All Macintosh II computers use silicon chips. Silicon chip, or chip for short, is synonymous with integrated circuit (IC). As shown in Figure 1-1, chips come in all sizes and shapes, and they can be made of different materials.

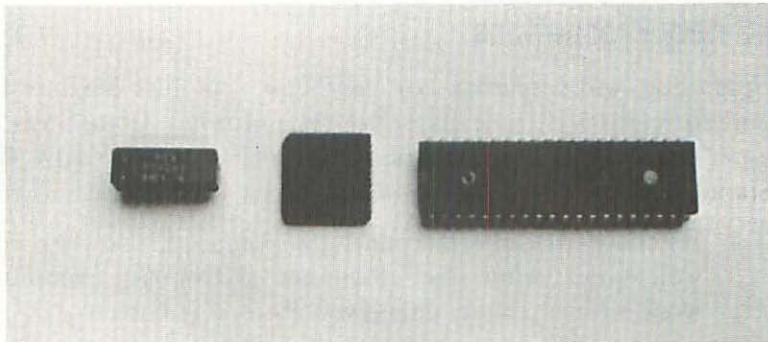

Figure 1-1 Chips come in all sizes and shapes.

Compared to earlier models of the Macintosh, the Macintosh II uses a higher percentage of complementary metal-oxide semiconductor (CMOS) chips. CMOS chips differ from older transistor-transistor logic (TTL) chips in that the insulating walls between their semiconductor

junctions are very thin. Like a torpedo fired from a submarine, even the slightest electrostatic discharge (ESD) can blow a hole in the wall large enough to sink the chip. This effect is shown in Figure 1-2.

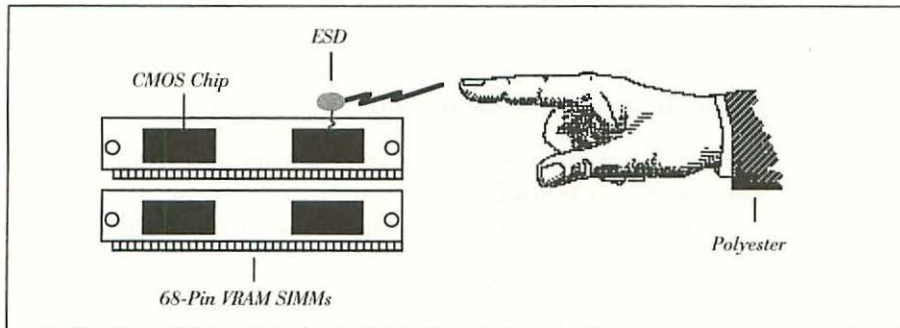

Figure 1-2 Like a torpedo fired from a submarine, electrostatic discharge can sink a CMOS chip.

As a result, most upgrade and repair instructions stress static electricity precautions. The precaution part of that warning is technically incorrect. To be absolutely safe, you must guard against electrostatic discharge during the entire time that you're working on the computer, because static electricity is an ever-present threat.

Dealing with Static Electricity

To understand why that is, consider the universe. The universe consists entirely of:

- Opposites (cold/hot, female/male, negative/positive)
- Which are constantly in motion
- Relative to each other.

We know from observation that opposites attract; each opposite is constantly moving toward the other. In addition, each opposite is potentially capable of becoming the other; so, the relative difference between opposites is called potential. Once you understand that potential is the difference between opposites, you can understand electricity.

When potential is neutralized, there is usually an explosion. When a cold front meets a warm front, there's a meteorological explosion (thunder and lightning). When members of the opposite sex connect, there's a biological explosion. When negative and positive charges collide, there's

an audible crack, and a lightning-like spark. To eliminate the spark, all you have to do is equalize the potential.

On this planet, electric potential is normally measured relative to earth ground. The word *ground* in the expression *ground wire* is a literal reference to the earth in your back yard. By definition, when ground wires are connected properly to a metal rod driven deep into the earth, they are held at the same potential as the planet.

Given a properly grounded electric outlet, the Macintosh II is normally held at earth potential by the ground wire in the AC power cord. Since people move about freely, our potential relative to the earth is constantly changing. We are not tethered to a ground wire like the computer, so the electrical charges that build as we move about have to be atmospherically dissipated. If it's hot and humid, the water in the air provides a grounding path to the water in the earth. Electric charges (created by dissimilar materials in motion) don't build, because they're constantly drained away. If it's cold and dry, there's no water in the air; there's no grounding path to the earth, and potential builds on our bodies.

Synthetic (nonabsorbent) clothing is largely responsible for that. Anyone can prove it. Wear 100% cotton (absorbant) clothing, with running shoes, and very little static builds. Wear a polyester suit with *leather shoes*, and you quickly become a walking capacitor.

A *capacitor* is an electronic component made from dissimilar materials separated by an insulator. As you move about separated from the earth by polyester insulation, you become positive; the earth remains negative. Potential builds. Touch anything grounded, and sparks fly; your potential is instantly neutralized.

Step 1—Wear Natural Clothing

The first line of defense against electrostatic buildup, then, is to wear natural clothing. With polyester clothing, even talking about electrostatic precautions is meaningless. Simple precautions are no help when you defy the laws of the universe.

Step 2—Choose a Suitable Work Area

Equally important is the work area. Standing on polyester blend wall-to-wall carpeting is just as bad as wearing polyester clothing. So is standing on waxed flooring. Wax repels moisture. Think of the last time you

waxed your car—the next morning, it was covered with beads of water. Those beads of water are analogous to electrostatic buildup. To prevent electrostatic buildup, wear natural clothing and stand on dull, moisture-absorbant flooring such as unpainted wood or cement.

Step 3—Ground Yourself

Given suitable clothing and a suitable work area, the next step is to ground yourself. Anything short of nudity allows a charge to build. Grounding yourself gets rid of it.

Most instruction manuals tell you to ground yourself by touching bare metal on the back of the computer. That's generally good advice, but it's only effective if the following three conditions have been met:

- The computer has to be plugged in.
- The ground wire in the AC power cord has to be connected.
- The ground wire in the electric outlet has to be connected.

More often than not, these conditions are not stated! In addition, the third condition must not be taken for granted. The fact that you have a three-wire cord plugged into a three-wire outlet is no guarantee that the third wire (the ground wire) is actually connected. Neither is a recently dated inspection sticker on your service entrance (breaker panel). Electricians make mistakes; inspectors don't see everything. If you want to be *sure* the outlet is wired properly, you have to check the connections for yourself. This is easily accomplished with an inexpensive three-wire circuit analyzer, as shown in Figure 1-3.

Assuming the ground wire connection tests well or shows that the outlet is correctly grounded, grounding yourself brings you to the same potential as the computer. But as soon as you disconnect the power cord and begin to move about, potential rebuilds. To prevent that, you could wear a wrist grounding strap.

For a wrist grounding strap to work, it also has to be grounded. Some straps terminate in an alligator clip. These are designed to clip onto external grounds such as cold water pipes (copper, not plastic), outlet cover screws (unpainted), and lightning rods. Other straps plug right into the same AC power cord you disconnect from the computer. Typical arrangements are shown in Figure 1-4.



Figure 1-3 Test the ground wire connection with a three-wire circuit analyzer.

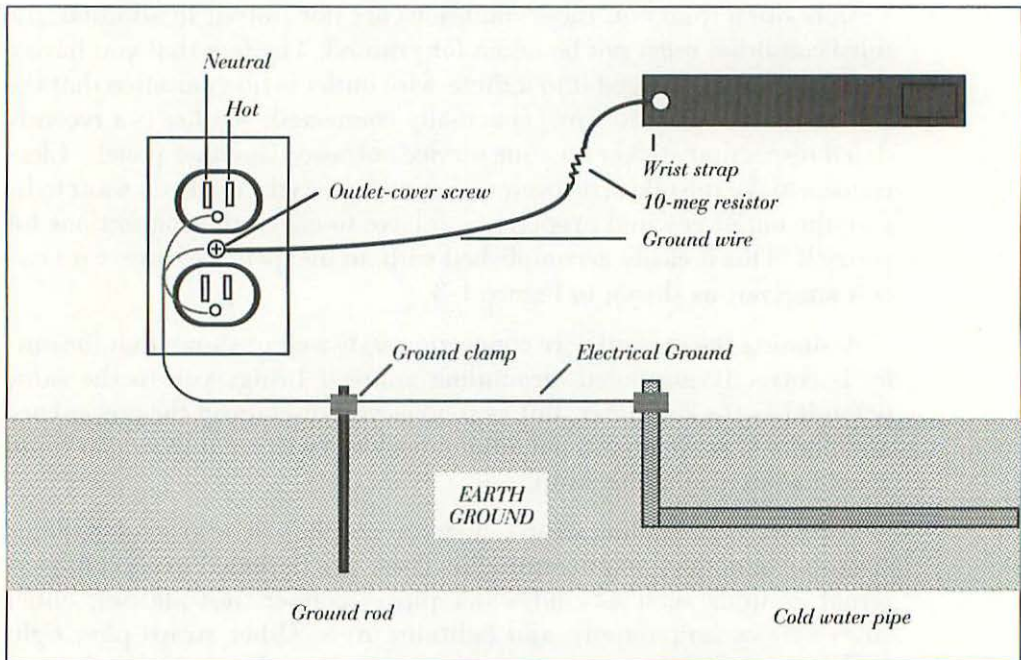

Figure 1-4 For a wrist grounding strap to work, it also has to be grounded.

On my own bench, I use both types of straps together with a MacGard™ multipurpose surge suppressor. This unique device performs three important functions:

- It continuously tests the ground wire connection in the electrical outlet.
- It provides a conductive pad for painless electrostatic discharge.
- It replaces the computer's power cord and provides two, 6-amp, surge-protected outlets.

A light-emitting diode (LED) on the MacGard continuously tests the electrical ground. If the ground wire is connected, the LED glows green, indicating *go/safe*. If the ground wire is disconnected, the LED does not glow, indicating *stop/dangerous*. With this unit, it's not necessary to use the circuit analyzer shown in Figure 1-3.

Assuming the LED glows green, the conductive pad provides a safe and convenient ground. Lacking the special setups shown in Figure 1-4, many sources advise clipping the strap to the ground trace on the circuit board. That keeps the wearer and the board at the same potential, but does not keep either at earth potential. If the board happens to knock against something that's grounded, say a solder station or another piece of equipment, it may cause a destructive discharge. Touching the conductive pad from time to time minimizes the chance of that happening. The MacGard unit is shown in Figure 1-5. When you're finished with the upgrade work, the MacGard can be attached to any size Macintosh.

Other sources recommend conductive place mats. These are similar to the conductive pad on the MacGard unit except that they are much larger, large enough to spread over the bench top. The problem with conductive mats, is that they must be taken up prior to servicing powered equipment. Otherwise, they're a shock hazard.

By definition, when a live wire contacts a properly grounded, conductive place mat, the result is a short circuit. To minimize the shock danger, conductive place mats (as well as wrist grounding straps) are usually wired in series with a 1-megohm current limiting resistor. We'll see how that works later on in this chapter. For now, the important point is that conductive mats should only be placed under unpowered boards; if you use them around live equipment, sooner or later sparks will fly and chips will be blown.



Figure 1-5 MacGard Multipurpose Surge Suppressor. *Courtesy of Systems Control, a division of M. J. Electric.*

Step 4—Consider the Weather

Even with all these precautions, it's advisable to consider the weather before attempting a static-sensitive procedure. If it's cold and dry, then sparks may fly, no matter what you do. Wait for a rainy day.

Hand Tools

In addition to wrist grounding straps and conductive mats, upgrading and repairing Macintosh II computers requires a certain amount of hand tools. Every job goes easier when you have the right tools. Everything is a hundred times harder when you don't.

Phillips-Head Screwdrivers

The Macintosh II is held together by #1 Phillips-head screws and plastic snaps. To avoid stripping the screw heads, it's important to remove the screws using a precision ground #1 Phillips-head screwdriver. Unfortunately, there's as much variation in tool sizes as there is in clothing sizes. Some brands run big; others run small. Get the wrong size, and instead of removing the screws, all you do is chew things up.

Sears is one of the very companies that sell both Phillips and Read-Prince screwdrivers. Both screwdriver tips look the same, but they grip differently. Most companies sell a combination tip under the Phillips name. That's the reason other tools may not work as well as the Craftsman 41053 WF. You think that you're buying a Phillips, but in fact, you're not.

Plastic TV Alignment Tools

Monitor adjustments require a set of plastic, color TV alignment tools. For all-around use, pick a set containing half a dozen sizes, as shown in Figure 1-6.

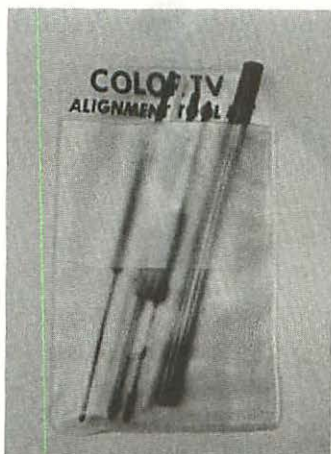

Figure 1-6 Color TV alignment tools.

The problem with most plastic tools is that they don't last very long. So, if you plan to use the tools often, choose a heavy-duty set. Whenever an individual tool wears out, replace it. Never substitute metal tools. Poking a conductive metal screwdriver into a live monitor circuit is just asking for trouble.

Chip Pullers

Coprocessor upgrades, Floppy Drive High Density (FDHD) upgrades, and Paged Memory Management Unit (PMMU) upgrades require that certain read-only memory (ROM) chips be replaced. To remove them

from their sockets, most shops use tong-like tools called *chip pullers*. Chip pullers come in various sizes. Good sets are expensive. Cheap sets don't work very well.

For occasional work, you can use an $\frac{1}{8}$ -inch screwdriver with no more than a 2-inch shaft to pry up 24-pin dual in-line package (DIP) ROMs, and a hardened set of steel jeweler's screwdrivers to pry up various-size plastic leadless chips (PLCs). The specified screwdrivers work fine provided that you're careful. Specifications and full removal details are in the appropriate chapters.

Putty Knife

The correct way to separate the power supply plug from the Macintosh II logic board is with a $\frac{1}{4}$ -inch, stiff-blade putty knife. A stiff-blade knife is shown in Figure 1-7.



Figure 1-7 Stiff-blade, $\frac{1}{4}$ -inch putty knife.

When shopping for this tool, be sure to specify a “stiff blade.” Something to that effect should be marked right on the package. Flexible-blade knives tend to twist and dig into the plastic. Chisel-blade knives are unnecessarily sharp.

Test Equipment

In addition to the hand tools described above, component-level troubleshooting requires a multimeter. For safety reasons, monitor service requires an isolated AC power supply.

Multimeters

Multimeters (alternately referred to as multitesters) can either be analog or digital. Analog models have a needle pointer and a scale. They're called analog meters because the needle position is analogous to a tiny number printed on the scale. Like old-fashioned slide rules, they're difficult to master, and accuracy varies, because you have to estimate the reading.

Digital models have a direct numerical readout. They're as easy to master as pocket calculators, and accuracy is consistent, because you never have to estimate the reading.

Digital multimeters (DMMs) can either be pocket or bench type. Pocket types generally cost less money, contain fewer features, and tend to be less accurate. Bench types generally cost more money, contain more features, and tend to be more accurate. Pocket types are OK for casual use, but a bench type DMM is recommended for serious work. A bench type DMM is shown in Figure 1-8.

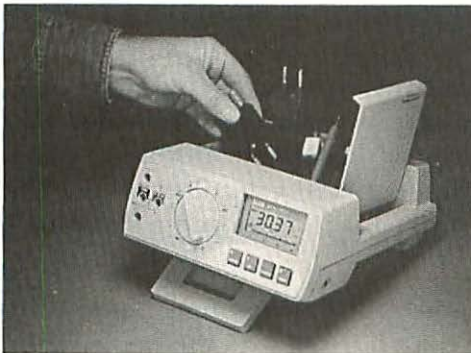

Figure 1-8 Digital multimeter. *Courtesy of John Fluke Manufacturing Company.*

Using a Digital Multimeter

DMMs are used to take voltage, current, and resistance readings. Understanding voltage, current, and resistance is easy. If the electric company were a municipal water works, voltage would be water pressure, current would refer to the flow of water, and resistance (to the flow of water) would vary with the faucet position. The more the faucet resists water pressure (voltage), the less water (current) flows. The less the faucet resists water pressure, the more water flows.

Electrically, this relationship is expressed as: *Voltage (V) = Current (I) × Resistance (R)*. With a little algebra, we begin to see what the one-megohm resistor in a wrist grounding strap does. Since the normal US line voltage (V) is 120, the one million-ohm resistor (R) wired in series with the ground wire limits current (I) to .00012 amps (120 Volts ÷ 1,000,000 ohms), a safe level.

Another useful expression is the wattage formula. Power (in watts) is expressed as: *Power (P) = Current (I) × Voltage (V)*. Should the wrist strap accidentally come in contact with the 1,800-watt (15 Amps × 120 Volts) power line, the resistor's low 1/8-watt rating causes it to quickly burn out, which opens the circuit and stops the current altogether.

Throughout this book we'll be talking about voltage, current, and resistance in context. If you've never used a meter before, just think water pressure, water flow, and faucet position, and you won't have any trouble following the instructions.

Isolated AC Power Supplies

Isolated AC power supplies (alternately referred to as isolation transformers) can either be variable or fixed. Variable models generally have a built-in volt meter (analog or digital) and an voltage control allowing you to vary the output from 0 to 150 volts alternating current (VAC). Fixed models generally have no volt meter and a standard 117 to 120 VAC output.

Some isolation transformers have three-prong power cords and two-conductor outlets. These can't be used with the Apple High-Resolution Monochrome Monitor or with the AppleColor High-Resolution RGB monitor, because both are equipped with three-prong power cords. Other isolation transformers have three-prong power cords *and* three-conductor outlets. That's the type to get.

The purpose of an isolation transformer is to minimize the risk of electric shock from improperly wired cords and outlets. When two-wire monitors are plugged into an electric outlet that's wired properly, the metal monitor chassis is held at earth-ground potential. Touching the metal chassis is exactly the same as touching the rich soil in your garden. But when the hot and neutral wires inside the electric outlet have been reversed, the metal monitor chassis is held 120-volts above ground. In that case the chassis is said to be hot or charged. Touch the charged chassis while in contact with the earth (or anything else in contact with the earth), and you become part of the circuit. It's the same as sticking your fingers into a live electric socket—call for paramedics!

An isolation transformer minimizes that hazard. As shown in Figure 1-9, the transformer plugs into the wall outlet, and the monitor plugs into the isolated electric outlet supplied by the transformer. The isolation function keeps the two (the wall and the monitor) electrically separated. Also, instead of 15 to 20 amps (the full capacity of the electric outlet), the maximum current on the outlet side is limited by the power rating of the transformer.

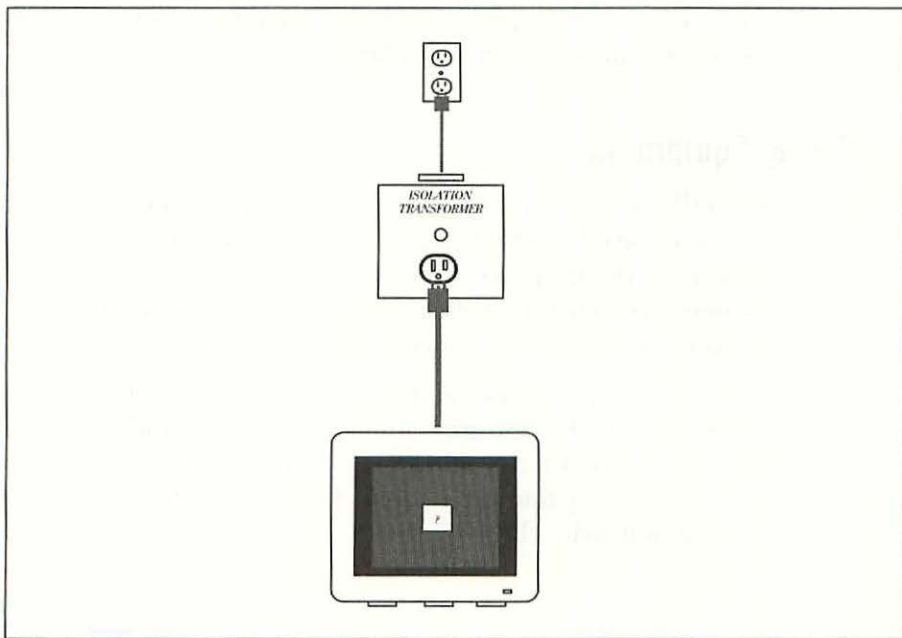

Figure 1-9 The isolation transformer plugs into the wall outlet, and the monitor plugs into the transformer.

Transformer power ratings (supply) are usually stated in volt amps (VA), while monitor power requirements (demand) are usually given in watts (W). That confuses a lot of people, but since amps are units of current (I) and since power (in watts) is expressed as: *Power* (P) = *Current* (I) \times *Voltage* (V), volt amps and watts actually refer to opposite sides of exactly the same thing. The term *volt amps* generally refers to the power supplied; the term *watts* generally refers to the power consumed.

To meet the power consumption demands of the Apple High-Resolution Monochrome Monitor and the AppleColor High-Resolution RGB Monitor, you need to know what their power requirements are. That information is printed on a sticker affixed to their respective cabinets. According to the stickers, the Apple High-Resolution Monochrome Monitor is rated at 100-240V~ 0.5A and the Apple High-Resolution RGB monitor is rated 100-240V~ 1.6A. (The ~ suggests a sine wave, which is the universal symbol for alternating current.) By plugging this information into the power formula ($P = I \times V$), we see that the Apple High-Resolution Monochrome Monitor requires 120 watts maximum (240V \times 0.5A) and that the AppleColor High-Resolution RGB monitor requires 384 watts maximum (240V \times 1.6A). Since it may be necessary to connect other equipment to the isolation transformer at the same time, it's best to choose a unit rated 500 VA or higher.

Soldering Equipment

Naturally, parts that test bad have to be desoldered and replaced. For that you'll need a roll of 60/40 rosin core solder, a set of soldering aids (similar to dental picks), a static-free vacuum desoldering tool, and a temperature-controlled, three-wire, 60-watt soldering station. A temperature-controlled soldering station is shown in Figure 1-10.

For occasional work, a three-wire, 15-watt soldering pencil (with stand) is also OK, but ungrounded (two-wire) soldering pencils should never be used. Ungrounded pencils are subject to high tip voltages. While innocently making a connection, the induced voltage could easily blow out a nearby chip.



Figure 1-10 Temperature-controlled soldering station.

Summary

Upgrading and repairing Macintosh II computers requires a small investment in hand tools and test equipment. For upgrade and nominal maintenance work, you need:

- A wrist grounding strap.
- A #1 Phillips-head screwdriver with a three-inch shaft.
- A set of plastic TV alignment tools.
- A set of jeweler's screwdrivers.
- A 1.25-inch wide, stiff-blade putty knife.

For troubleshooting and repair work, you also need:

- An isolation transformer.
- A digital multimeter.
- A vacuum desoldering tool.
- A grounded 15-watt soldering pencil (with stand).
- A roll of 60/40 rosin core solder.

Without these last items, you can still diagnose problems, but you're not going to be able to fix anything.

In addition, it's important to understand that there are risks involved. The Macintosh II runs on electricity. Electricity is inherently dangerous. Standard safety precautions must be taken at all times. Most important, whenever you get stuck, stop! Seek further information or seek an expert.

2

Adjustments—Apple High-Resolution Monochrome Monitors

This chapter shows how to adjust Apple High-Resolution Monochrome Monitors. High-Resolution Monochrome Monitors are identified from the front by the Apple trademark, and from the rear by model number M0400, as shown in Figure 2-1.

The instructions assume that you've made a Color TPG/System disk as described in the Introduction, and that you're familiar with the safety rules, tools, and techniques described in Chapter 1. If necessary, please review both sections before proceeding.

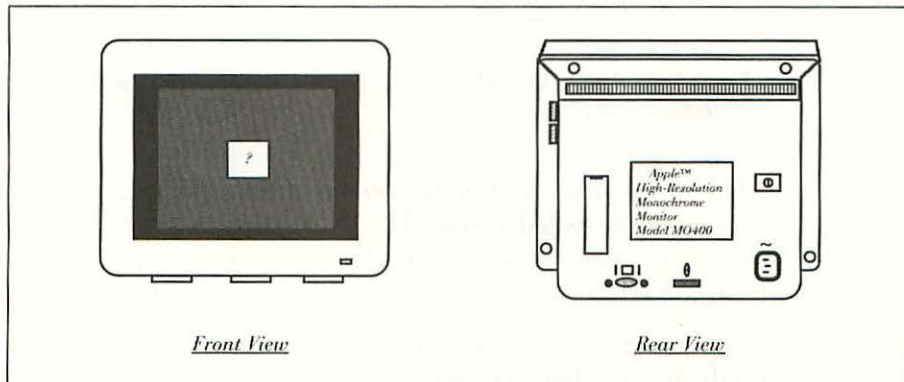

Figure 2-1 Model number M0400, the Apple High-Resolution Monochrome Monitor.

Definitions, Goals, and Objectives

The adjustments described in this chapter affect the computer display. As illustrated in Figure 2-2, the word *display* refers to the illuminated area of the screen. That which is displayed on the screen *is* the display.

The word *screen* refers to the face of the picture tube. On the Apple High-Resolution Monochrome Monitor, only the center portion is used for the display. Unlike a TV set, the edges of the screen are normally blanked out (they are not displayed).

The acronym *CRT* refers to the *cathode ray tube*, the whole picture tube—the front, the back, the anode well, the socket pins, and so on. None of the adjustments described in this chapter directly involve the CRT. All we're concerned with is the image displayed on the screen of the CRT.

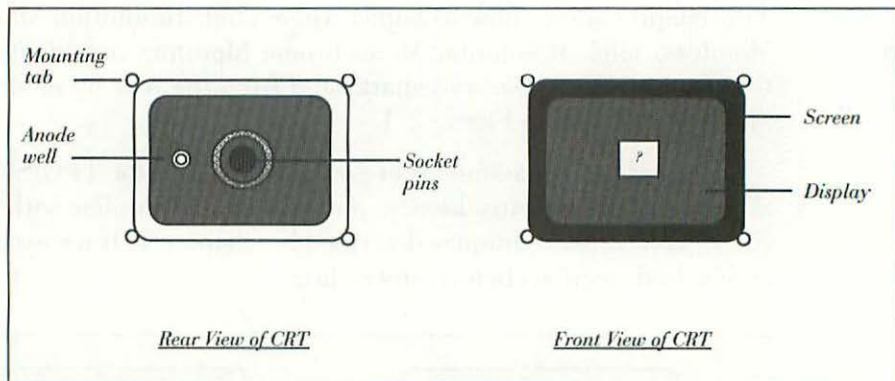

Figure 2-2 Parts of the CRT. The CRT is the whole thing. The screen is the front. The display is what's shown on the screen.

The image displayed on the screen of the CRT is made up of 307,200 luminous dots called *pixels*. The word *pixel* is a contraction of picture element. Pixels are to a display what pieces are to a jig-saw puzzle—they are the smallest individual pieces of a much larger picture.

According to published original equipment manufacturer (OEM) specifications, there are 640 pixels across the display and 480 pixels from the top to the bottom. (640×480 equals 307,200 total pixels.) The specifications also state that each pixel is factory adjusted to measure $\frac{1}{76}$ of an inch square, so when the monitor is adjusted properly, 76 pixels

should measure one inch square. To determine the unstated width specification in inches, divide the 640 pixels across the display by 76 pixels per inch: The result (rounded to two decimal places) is 8.42 inches. To determine the unstated display height, divide the 480 pixels from the top to the bottom of the display by 76 pixels per inch: The result (rounded to two decimal places) is 6.32 inches. Other width and height combinations are possible, but any combination other than 8.42 inches \times 6.32 inches is contrary to OEM specifications.

To confirm whether a particular monitor currently meets OEM specifications, the display has to be measured with a tape measure. Since hundredths of an inch are not generally marked on an English tape measure, some people find it easier to use a metric tape measure. Either type of cloth or vinyl tape measure is fine. Given that there are 2.54 centimeters to the inch, the correct metric specifications for model M0400 are 21.39-centimeters wide \times 16.04-centimeters high.

When the monitor is adjusted according to OEM specifications, circles are always round and squares are perfectly square. When the monitor is out of adjustment, objects may appear distorted: squares may resemble rectangles and circles may resemble ovals. In addition, maladjusted displays may be darker than they should be, and they may be difficult to focus. That's tough on the eyes.

Since aging inevitably causes all monitors to drift out of adjustment, all monitors should be periodically readjusted. The object of the periodic adjustment procedure is to restore the display to its original operating condition.

Periodic Adjustment Procedure

In addition to a working Mac II and a copy of *Color TPG*, the only tools needed to adjust an Apple High-Resolution Monochrome Monitor are an $\frac{1}{8}$ -inch slotted screwdriver (or a metal nail file), a plastic TV alignment tool, and a cloth (or vinyl) tape measure. The complete procedure involves just five simple steps:

1. Remove the control cover plate.
2. Adjust the width.
3. Adjust the height.
4. Adjust the focus.
5. Replace the control cover plate.

Plan on spending about half an hour to work through this material for the first time. Once you've mastered the technique, subsequent adjustments should only take about five minutes.

Step 1—Remove the Control Cover Plate

As shown in Figure 2-3, the display adjustment controls are located under a cover plate on the left side of the back cabinet. To pry off the cover plate, insert a small screwdriver (or a metal nail file) into the screwdriver slot at the top of the cover plate and push the screwdriver handle away from you (toward the monitor). With very little effort, the cover plate should pop right off. No other disassembly is required. It's *not* necessary to loosen any screws. It's *not* necessary to remove the cabinet back.

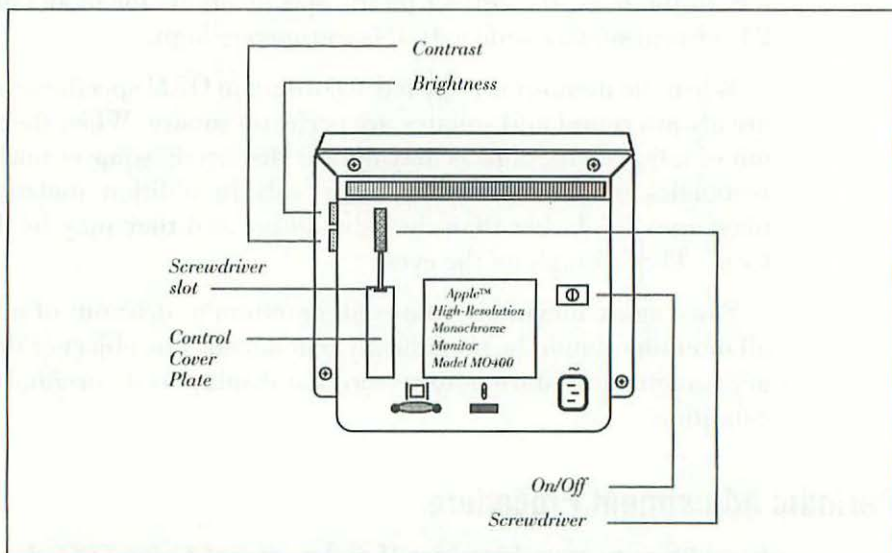

Figure 2-3 The display adjustment controls are located under a cover plate on the left side of the back cabinet.

Step 2—Adjust the Width

Prior to adjusting the width, locate the brightness and contrast controls on the right side of the cabinet. The center position of the brightness control (the upper control) is identified by a click stop. Verify that the brightness control is centered in the click stop and that the contrast control (the lower control) is turned all the way up (fully clockwise).

When the brightness control is centered and the contrast control is turned all the way up, start *Color TPG*, dismiss the startup screen and General Instructions window (if necessary), and choose 12-inch Apple Monochrome (Command-N) from the Screen Sizes menu. As soon as you release the mouse button, *Color TPG* displays standard T-squares, as shown in Figure 2-4.

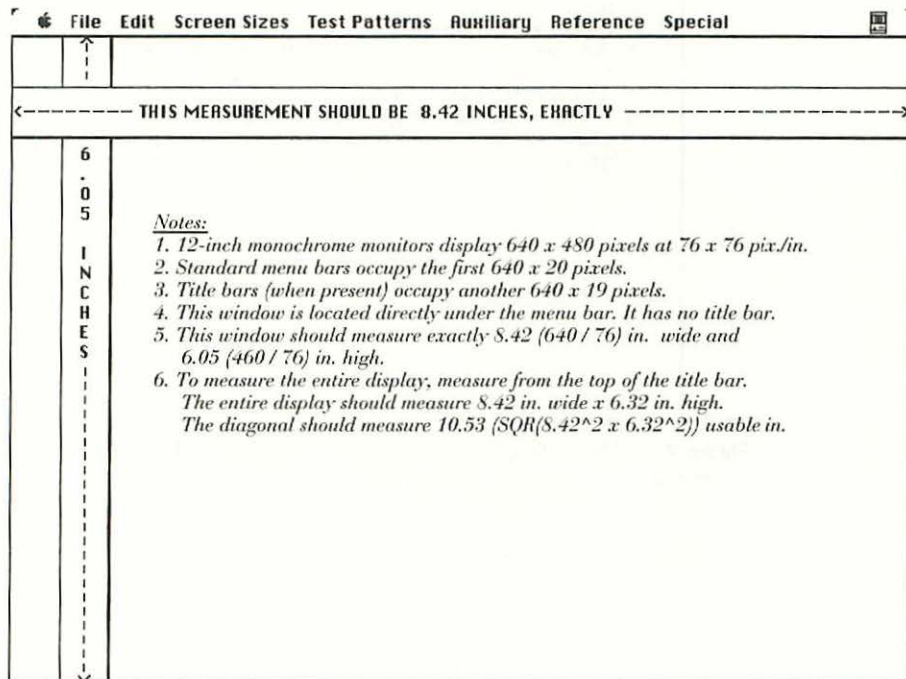

Figure 2-4 Standard T-squares for Apple High-Resolution Monochrome Monitors specify height and width values in inches.

The standard T-squares specify height and width values in inches. To specify height and width values in centimeters, hold down the option key while choosing 12-inch Apple Monochrome. As soon as you release the mouse button, *Color TPG* recalculates and displays metric T-squares, as shown in Figure 2-5.

Neither of the T-squares displays actual width measurements. They merely state what the width measurements should be. Actual width measurements have to be taken with a cloth (or vinyl) tape measure as shown in Figure 2-6.

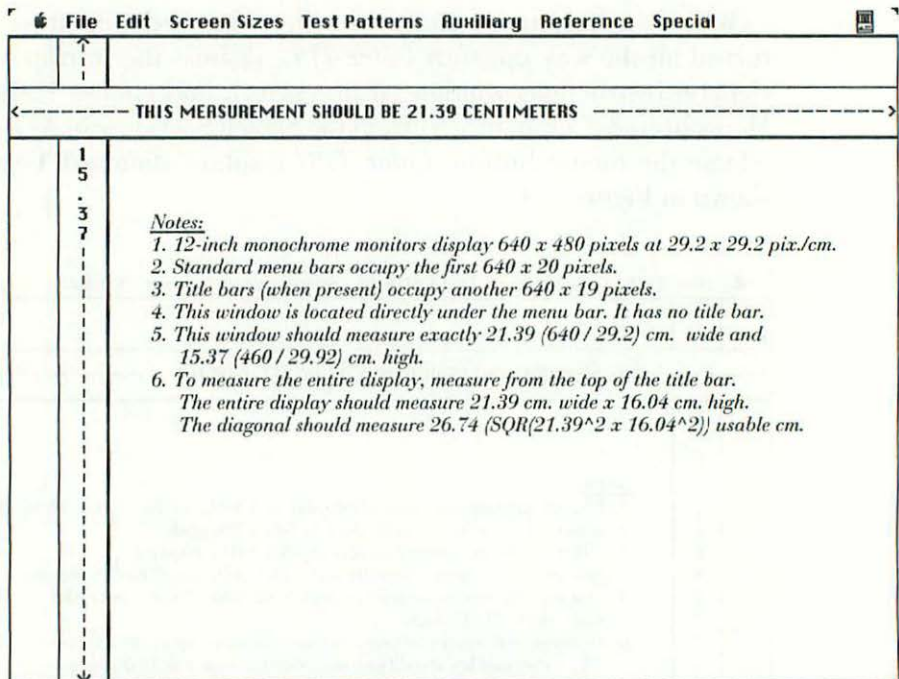

Figure 2-5 Metric T-squares for Apple High-Resolution Monochrome Monitors specify height and width values in centimeters.

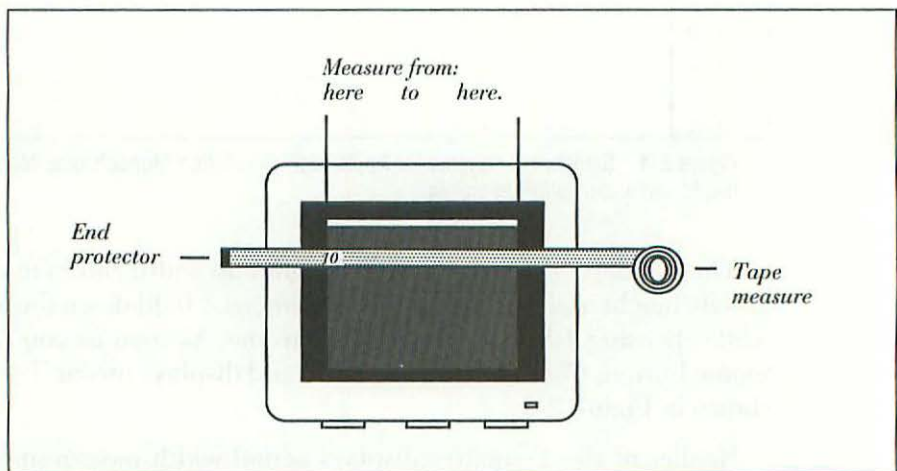

Figure 2-6 The actual width measurements have to be taken with a cloth (or vinyl) tape measure.

When using a cloth (or vinyl) tape measure, it's important to disregard the first few inches (or centimeters) on the ruler. Most of the cheap tape measures sold today have metal or plastic protectors haphazardly cemented to their ends. Not only can their sharp edges scratch the screen, but their first and last inches are usually inaccurate. For accuracy, start from the 10-inch mark and drop the first digit (11 inches becomes 1 inch, 12 inches becomes 2 inches, 13 inches becomes 3 inches, etc.).

To compensate for the screen curvature, hold your eye so that it's perpendicular to the left side of the display, and line up the 10-inch (or 10-centimeter) mark on the ruler with the left edge of the T-squares. Hold the tape in place at that spot. Now hold your eye perpendicular to the opposite side of the display and compare the right edge of the T-squares to the 18.42-inch (31.39-centimeter) mark on the ruler. Is the actual display narrower or wider than specified? If so, refer to Figure 2-7.

The width control is identified symbolically by a horizontal line with arrows at either end. On this particular monitor, it's the sixth control down (not the fifth control down). To correct the width, insert the screwdriver end of a plastic TV alignment tool (not a metal screwdriver) into the width control and turn it slowly until the actual display width measures 8.42 inches (approximately $18\frac{7}{16}$ - 10) or 21.39-centimeters (31.39 - 10.00).

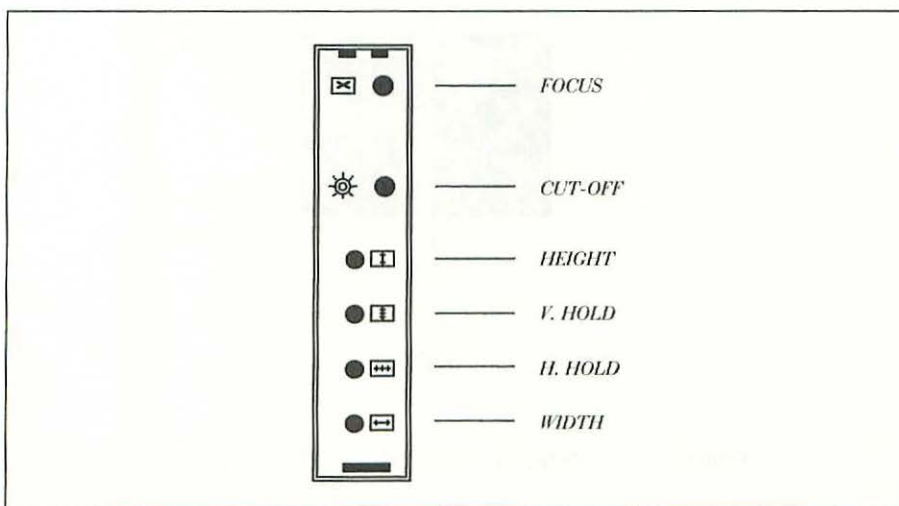

Figure 2-7 Control identification for Apple High-Resolution Monochrome Monitors.

When adjusting the width (or any of the display controls), grip the alignment tool lightly. The width control is not a screw. It's not supposed to be tightened down, and it's not designed to go around and around. A little turn, one way or the other, is generally all you need to do.

Step 3—Adjust the Height

When the width measures exactly 8.42 inches or 21.39 centimeters, rotate the tape measure and check the height as shown in Figure 2-8. To avoid confusion between window height and display height, refer to notes 4, 5, and 6 on the T-squares display. Is the actual display height taller or shorter than specified? If so, refer to Figure 2-7. The height control is symbolically identified as a vertical line with arrows at either end. On this particular monitor, it's also the third control down (not the fourth control down). To correct the height, insert the screwdriver end of a plastic TV alignment tool (not a metal screwdriver) into the height control and turn it slowly until the actual display height measures 6.32 inches (approximately $16\frac{1}{3}$ - 10) or 16.04 (26.04 - 10.00) centimeters.

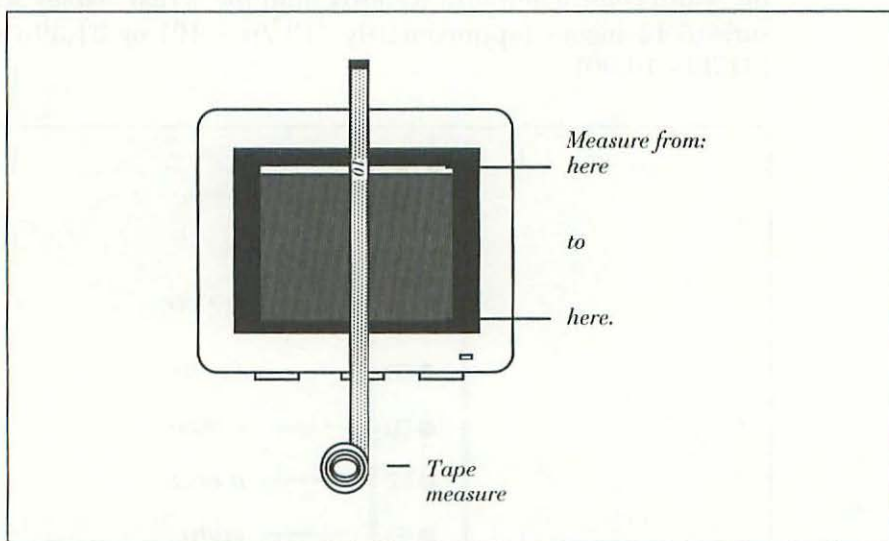

Figure 2-8 Rotate the tape measure to check the height measurement.

Step 4—Adjust the Focus

When the width and height measurements are exactly according to specifications, it's time to check the focus. Begin by wiping the screen with a damp paper towel. If the screen is covered with finger prints or if it's cigarette-smoke stained, the evaluation will be invalid. Certain areas may appear to be out of focus, when in reality they might only be covered with dirt.

When you're satisfied that the screen is clean, choose Focusing Text (Command-F) from the Test Patterns menu. This test fills the display with 9-point Monaco characters. To fill the display with 12-point Monaco characters, hold down the Option key while choosing Focusing Text. If 12-point Monaco is installed in your system file, the display will fill with 12-point text. If 12-point Monaco has been removed, or if it was never installed, 9-point text will appear in either case, as shown in Figure 2-9.

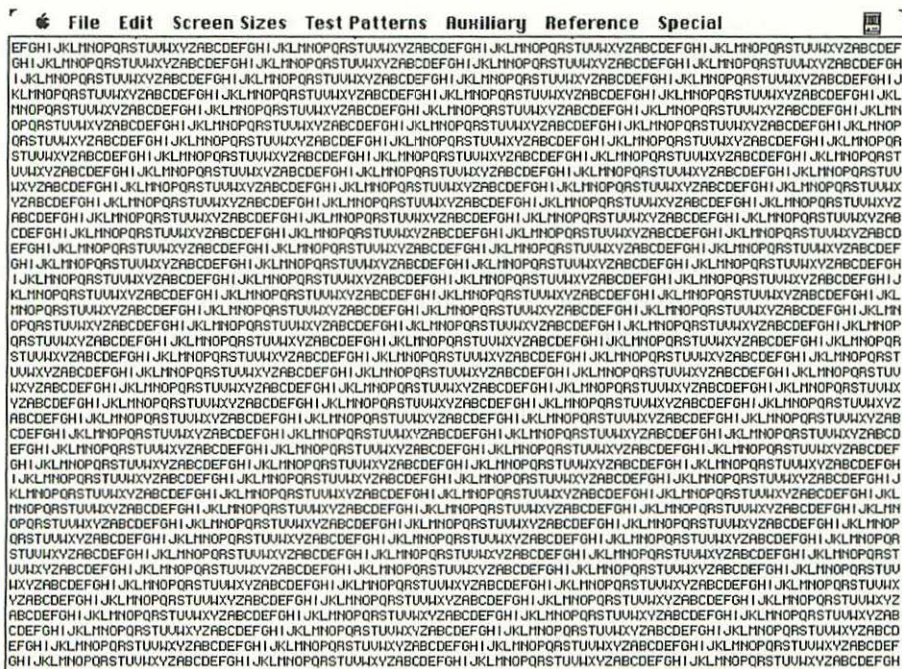

Figure 2-9 Focusing Text fills the display with 9-point Monaco text.

The ripple pattern of 9-point Monaco characters creates a distinct barber-pole effect. The barber pole runs diagonally, from top right to bottom left. If the diagonals appear to be equally sharp, the focus is set correctly. If the diagonals appear to alternate between sharp and fuzzy, then the focus may be out of adjustment. The older the set is, the more likely it is that there will be a problem.

As shown in Figure 2-7, the focus control is symbolically identified by an x. On this particular monitor, it's also the control at the top of the panel. To adjust the focus, insert the screwdriver end of a plastic TV alignment tool (not a metal screwdriver) into the focus control and turn it slowly until all of the diagonals appear to be equally sharp.

The ripple pattern of 12-point Monaco characters creates a vertical-bar effect. The bar effect is less obvious. Sometimes it's easier to use the 12-point pattern; sometimes it's easier to use the 9-point pattern. For best results, try switching between them.

When you're satisfied that the focus is as good as you're going to get it, slowly turn the contrast control (the lower control on the right side of the monitor) counterclockwise until you reach a point where the focusing text is as black as it can be and the glare of background is minimized.

Step 5—Replace the Control Cover Plate

Once the width, the height, the focus, and the contrast are adjusted, it's time to replace the control cover plate. Insert the nib at the bottom of the plate into the slot at the bottom of the control panel and push the plate toward the monitor, as shown in Figure 2-10. With very little effort, the cover plate should snap right into place. That's all there is to it. This procedure is so simple that there is no reason to suffer with a maladjusted monitor. It's easy. Try it for yourself and see. You won't believe the difference this makes!

WYSIWYG Modifications

WYSIWYG is an acronym for "What you see is what you get." It's commonly believed that what you see on the Macintosh display is exactly what you get on paper. Nevertheless, when the Apple High-Resolution Monochrome Monitor is adjusted exactly according to OEM specifications, what you see on the screen is physically smaller than what you get on paper.

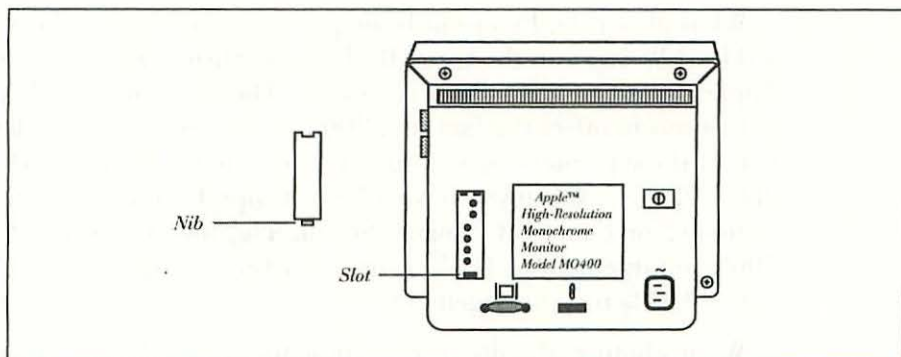

Figure 2-10 Cover plate reinstatement details.

As shown in Figure 2-11, the Macintosh operating system presumes a display device adjusted for 72×72 pixels per inch (ppi). Since the Apple High-Resolution Monochrome Monitor is adjusted for 76×76 pixels per inch, printout is actually enlarged to 106% ($76 \text{ ppi} \div 72 \text{ ppi} = 1.06$ enlargement).

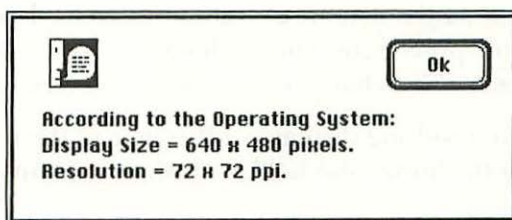

Figure 2-11 The Macintosh operating system presumes a display device adjusted for 72×72 pixels per inch.

To verify the 72×72 -ppi presumption on your own computer, run *Color TPG* and choose *Get Info. . .* from the File menu. With the exception of stock configuration Lisas and Mac XLs which report 90×60 , the *Get Info. . .* dialog box invariably reports 72×72 ppi. Since the Apple High-Resolution Monochrome Monitor is adjusted for 76×76 ppi, and since $72 \text{ ppi} \div 76 \text{ ppi} = 0.95$, the only way to ensure that what you see on the screen is really what you get is to print 95% reductions. If the chosen printer resource doesn't support 95% reduction, either directly or via a special effect (an option in the *Page Setup. . .* dialog box), then what you get on paper is always going to be 6% larger than what you see on the screen.

What about the Precision Bitmaps? option offered by Hewlett Packard DeskWriter and the Exact Bit Images (Shrink 4%) option offered by Apple LaserWriter II printer resources? These options merely print 96% reductions to offset the fact that 300 dots per inch (the standard resolution of these printers) is not directly divisible by 72 ($300 \times 0.96 = 288$, $288 \div 72 = 4$). When you have a 76×76 -ppi display, choosing Precision Bitmaps? or Exact Bit Images (Shrink 4%) merely reduces the normal 106% enlargement to 101% ($106\% \text{ existing enlargement} \times 0.96 \text{ reduction} = 101\% \text{ total enlargement}$).

What about realigning the monitor for 72×72 ppi? Other than the fact that it contradicts the OEM specifications, that makes *perfectly* good sense! To have *Color TPG* figure the display size for you, choose Unlisted Mac Monitors. . . (apple + U) from the Screen Sizes menu. For English measurements, click the OK button as shown in Figure 2-12. For metric measurements, hold down the option key when you click the OK button. At 72×72 ppi, line 6 of the resulting T-squares display will indicate that the display size should be 8.89×6.67 inches, or 22.58×16.93 centimeters.

Readjust the height, width and focus as described in the periodic adjustment procedure, and without having to do anything special, what you see *will be* what you get, each and every time you print.

If the resulting display is off center to the right, you can fix it by adjusting the horizontal hold control, as explained in the next section.

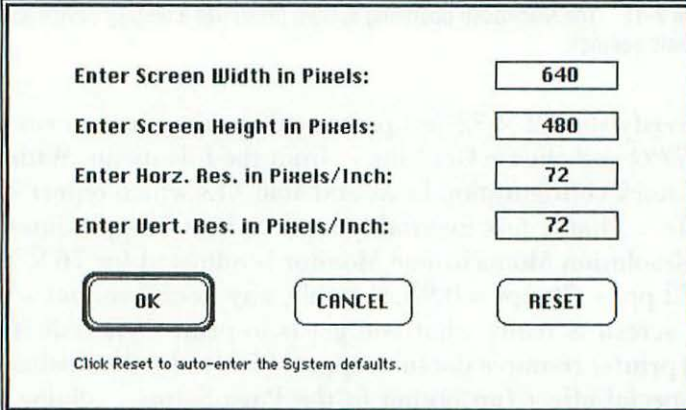

The image shows a dialog box with a double-line border. It contains four rows of text labels followed by input fields. The first row is 'Enter Screen Width in Pixels:' followed by a field containing '640'. The second row is 'Enter Screen Height in Pixels:' followed by a field containing '480'. The third row is 'Enter Horz. Res. in Pixels/Inch:' followed by a field containing '72'. The fourth row is 'Enter Vert. Res. in Pixels/Inch:' followed by a field containing '72'. Below these fields are three buttons: 'OK', 'CANCEL', and 'RESET'. At the bottom of the dialog box, there is a small line of text: 'Click Reset to auto-enter the System defaults.'

Figure 2-12 To have *Color TPG* calculate the width and height for you at 72 ppi, choose Unlisted Mac Monitors. . . (apple+U) from the Screen Sizes menu.

Miscellaneous Adjustments

This section explains how to adjust the three remaining monitor controls, the horizontal hold, the vertical hold, and the cut off.

Adjusting the Horizontal-Hold Control

When the horizontal-hold control is out of adjustment, the top of the display may fold to the left, as shown in Figure 2-13, or the display may be off center to the right, as shown in Figure 2-14.

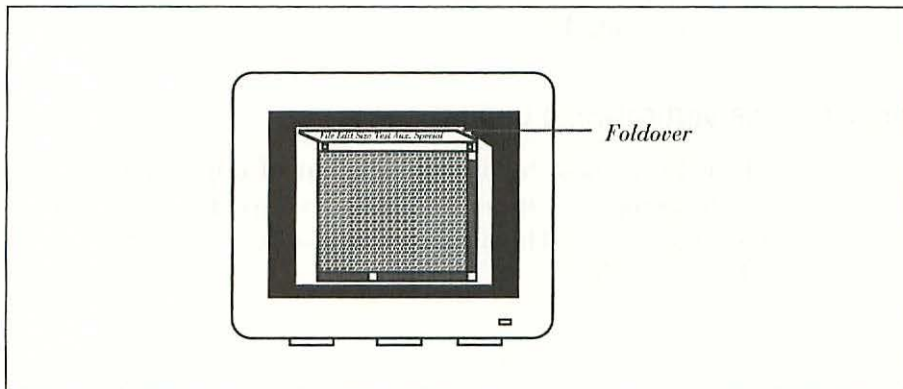

Figure 2-13 When the horizontal-hold control is out of adjustment, the top of the display may fold to the left.

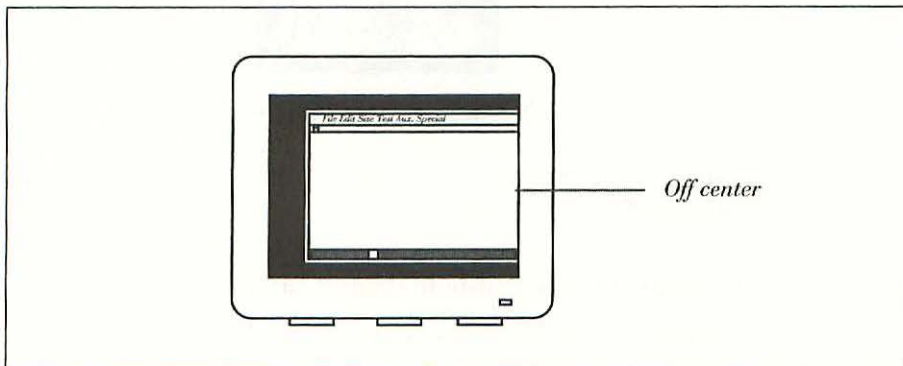

Figure 2-14 When the horizontal-hold control is out of adjustment, the entire display may be off center to the right.

To adjust the horizontal hold control (and fix the problem):

1. Remove the control cover plate, as shown in Figure 2-3.
2. Locate the horizontal-hold control. The horizontal-hold control is identified by a horizontal line with a dot in the middle and an arrow at either end. On this particular monitor, it's also the fifth control from the top, as shown in Figure 2-7.
3. Insert the screwdriver end of a plastic TV alignment tool (not a metal screwdriver) into the horizontal-hold control and slowly turn it one way or the other until the problem disappears.
4. Replace the control cover plate, as shown in Figure 2-10, and you're all done.

Adjusting the Vertical-Hold Control

When the vertical-hold control is out of adjustment, the display rolls over from top to bottom (or bottom to top). The rolling rate can be very slow or very fast. The display may also stabilize between rolls as shown in Figure 2-15.

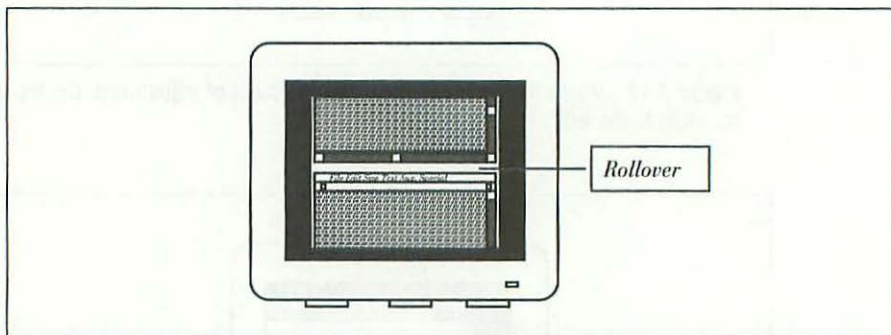

Figure 2-15 When the vertical-hold control is out of adjustment, the display rolls over from top to bottom.

To adjust the vertical-hold control (and fix the problem):

1. Remove the control cover plate, as shown in Figure 2-3.
2. Locate the vertical-hold control. The vertical-hold control is identified by a vertical line with a dot in the middle and an arrow at either end. On this particular monitor, it's also the fourth control from the top, as shown in Figure 2-7.

3. The control has slightly more than a 180° range. The minimum setting can be thought of as 11 o'clock and the maximum setting can be thought of as 7 o'clock. Insert the screwdriver end of a plastic TV alignment tool (not a metal screwdriver) into the vertical hold control and slowly turn it one way or the other until the display stops rolling. Note the position of the control. Continue the turning until the display starts rolling the other way. Finalize the setting mid-way between those points. On a new monitor, the mid-way setting is approximately 3 o'clock.
4. Replace the control cover plate, as shown in Figure 2-10, and you're all done.

Adjusting the Cut-Off Control

When the display intermittently goes dark, you're not running a screen saver, and the only way to get the display back is to turn off the monitor and wait a while before turning it back on, then the cut-off setting is probably too high. To check the cut-off setting:

1. Start *Color TPG*, dismiss the start-up screen and General Instructions window (if necessary), and choose 12-inch Apple Monochrome (Command-N) from the Screen Sizes menu.
2. Locate the brightness and contrast controls on the right side of the monitor. Turn the brightness and contrast controls all the way up (fully clockwise).
3. Choose Black Raster (Command-K) from the Test Patterns menu. This test turns the display solid black.
4. Dim the room lights and compare the shade of the screen border to the shade of the black-raster test pattern. If the cut-off setting is correct, there shouldn't be any difference. If the cut-off setting is too high, then the black-raster test pattern will be somewhat lighter than the screen border (dark gray, instead of black) as shown in Figure 2-16. If the cut-off setting is way too high, then the shade of the black-raster test pattern will be light gray.

Whether it's dark gray or light gray, if the shade of the black-raster test pattern does not match the shade of the screen border, then the cut-off setting is too high. To adjust the cut-off control:

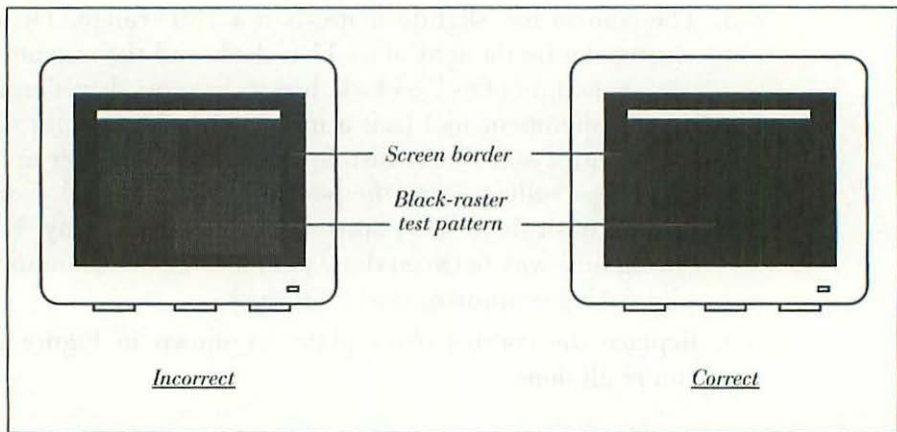

Figure 2-16 If the cut-off setting is too high, then the black-raster test pattern will be lighter than the screen border.

1. Remove the control cover plate, as shown in Figure 2-3.
2. As shown in Figure 2-7, the cut-off control is identified by a star. On this particular monitor, it's also the second control from the top. Insert the screwdriver end of a plastic TV alignment tool (not a metal screwdriver) into the cut-off control and slowly turn it counterclockwise until the black raster just fades into screen border. Stop when they're exactly the same shade. Don't overadjust (or the display will lack brightness).
3. When you're satisfied that the black raster and screen border are exactly the same shade, choose White Raster from the Test Patterns menu, then choose Focusing Text from the Test Patterns menu. This combination sets up black text on a white background.
4. Slowly turn the brightness control (the upper control on the right side of the monitor) counterclockwise until it's centered in the click stop.
5. Slowly turn the contrast control (the lower control on the right side of the monitor) counterclockwise until you reach a point where the focusing text is as black as it can be and the glare of white background is minimized.
6. Replace the control cover plate as shown in Figure 2-10, and you're all done.

Monitor Accessories

In the Monitor Accessories section at the end of Chapter 3, *Adjustments—AppleColor High-Resolution RGB Monitors*, we look at model MO403, the Apple Universal Monitor Stand. This stand fits the Apple High-Resolution Monochrome Monitor as well. We also look at contrast-enhancement and anti-glare filters in that section, and explain what to look for when purchasing a filter for either monitor. So, even if you don't own an AppleColor High-Resolution RGB Monitor, be sure to check the Monitor Accessories section at the end of the next chapter before moving on to Chapter 4, *CPU Maintenance—Fan Controller Upgrades*.

3

Adjustments—AppleColor High-Resolution RGB Monitors

This chapter shows how to adjust AppleColor High-Resolution RGB Monitors. High-Resolution RGB Monitors are identified from the front by the Apple trademark, and from the rear by model number M0401, as shown in Figure 3-1. A unique characteristic of the Apple RGB color monitor is the appearance of a very light gray line in the lower one-third of the image display. This is said to be caused by a wire inside the cathode ray tube that is used to hold up the mask. You have to look very hard to notice it. After you've owned your monitor for a while, you tend to forget about it, but new owners sometimes think they have a defective monitor when actually it is a design implementation. The line is part of the usual operation of the monitor and does not affect its performance.

The instructions assume that you've made a Color TPG/System disk as described in the Introduction, and that you're familiar with the safety rules, tools, and techniques described in Chapter 1. If necessary, please review both sections before proceeding.

Definitions, Goals, and Objectives

The adjustments described in this chapter affect the computer display. As illustrated in Chapter 2, Figure 2-2, the word *display* refers to the illuminated area of the screen. That which is displayed on the screen *is* the display.

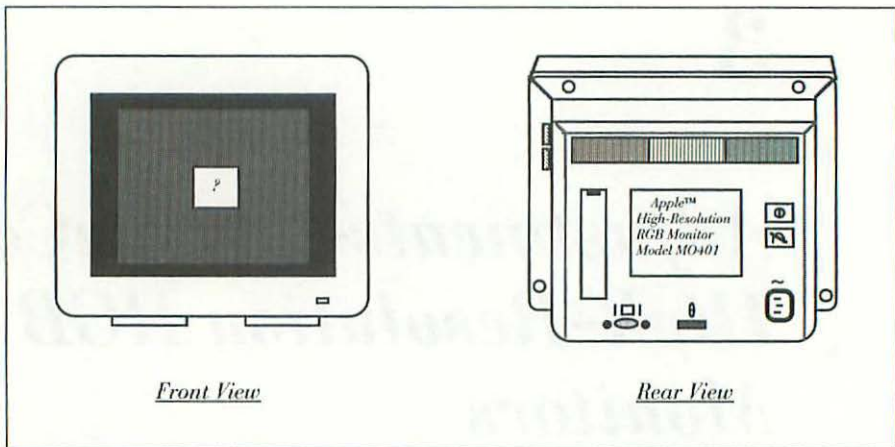

Figure 3-1 Model number M0401, the AppleColor High-Resolution RGB Monitor.

The word *screen* refers to the face of the picture tube. On AppleColor High-Resolution RGB Monitors, only the center portion is used for the display. Unlike a TV set, the edges of the screen are normally blanked out (They are not displayed).

The acronym *CRT* refers to the cathode ray tube, that is, the whole picture tube—the front, the back, the anode well, the socket pins, and so on. None of the adjustments described in this chapter directly involve the CRT. All we're concerned with is the image displayed on the screen of the CRT.

The image displayed on the screen of the CRT is made up of 307,200 luminous dots called *pixels*. The word *pixel* is a contraction of picture element. Pixels are to a display what pieces are to a jigsaw puzzle—they are the smallest individual pieces of a much larger picture.

According to published OEM specifications, there are 640 pixels across the display, and 480 pixels from the top to the bottom. (640 × 480 equals 307,200 total pixels.) The specifications also state that each pixel is factory adjusted to measure $\frac{1}{69}$ of an inch square, so when the monitor is adjusted properly, 69 pixels should measure 1-inch square. To determine the unstated width specification in inches, divide the 640 pixels across the display by 69 pixels per inch: The result (rounded to two decimal places) is 9.28 inches. To determine the unstated display

height, divide the 480 pixels from the top to the bottom of the display by 69 pixels per inch: The result (rounded to two decimal places) is 6.96 inches. Other width and height combinations are possible, but any combination other than 9.28 inches \times 6.96 inches is contrary to the OEM specifications.

To confirm whether a particular monitor currently meets OEM specifications, the display has to be measured with a tape measure. Since hundredths of an inch are not generally marked on an English tape measure, some people find it easier to use a metric tape measure. Either type of cloth or vinyl tape measure is fine. Given that there are 2.54 centimeters to the inch, the correct metric specifications for model MO401 are 23.56-centimeters wide \times 17.67-centimeters high.

When the monitor is adjusted according to OEM specifications, circles are always round and squares are perfectly square. When the monitor is out of adjustment, objects may appear distorted: squares may resemble rectangles and circles may resemble ovals.

In addition, RGB displays tend to exhibit three-dimensional colored shadows. That makes them difficult to focus and *much* harder to adjust than monochrome monitors.

Subtractive vs. Additive Color

When addressing color-specific problems, it helps to remember the difference between *subtractive color* and *additive color*. Subtractive color has to do with paint; additive color has to do with light. One has to do with printers, and one has to do with monitors.

The Primary Subtractive Colors, Red, Yellow, and Blue

Most people learn about subtractive color with water paints. It's a grammar-school lesson that's tough to forget. As shown in Figure 3-2, everyone is taught that the primary colors are red, yellow, and blue. Adjacent primary colors are said to be complementary. Mixing the complementary colors makes the secondary subtractive colors, which are orange, green, and purple. Mixing the primary colors in equal proportions makes black.

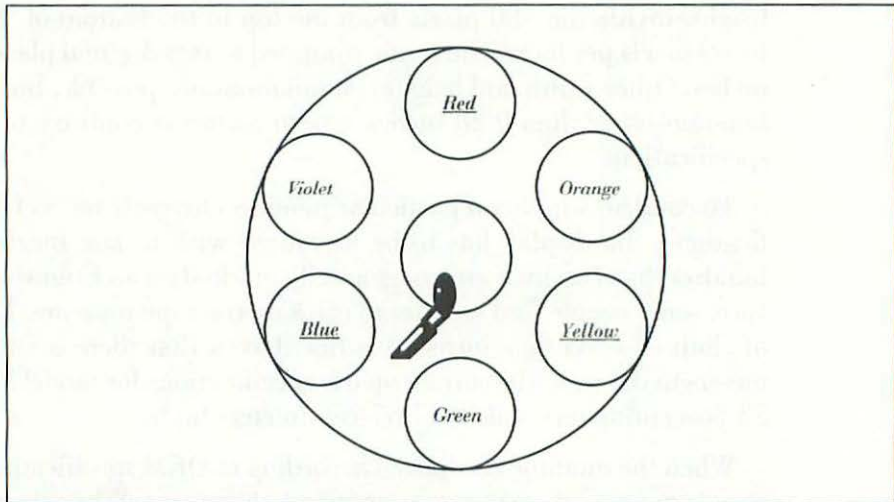

Figure 3-2 The primary subtractive colors are red, yellow, and blue.

How the ImageWriter II/LQ Makes Color

That's how color ImageWriter printers work. In addition to black, color ImageWriter ribbons have separate magenta (red), yellow, and cyan (light blue) bands. Printing any of the primary colors (magenta, yellow, cyan) is just as fast as printing black, but printing any of the three secondary colors (orange, green, or purple) takes twice as long because the printer has to make two passes. When printing green, for example, the first pass prints yellow. The second pass prints cyan (light blue) on top of the yellow—making green. When you consider the black band and the natural whiteness of the paper, you can print reasonably fast eight-color documents (provided you count black and white as colors) using a four-band ribbon. Colors that require more than two passes take that much longer to print, and final color is not that good. This information is summarized in Table 3-1.

On ImageWriter II and ImageWriter LQ ribbons, the logical order of the color bands is YMCK (yellow, magenta, cyan, and black). The yellow band is at the top, the magenta band is second from the top, the cyan band is third from the top, and the black band is on the bottom. Nevertheless, color printers in general are called CMYK printers, without regard to the order of the color bands. So whenever you see CMYK, think subtractive color. Next we'll see how the CMYK (subtractive) color process differs from RGB (additive) color generation.

Table 3-1. ImageWriter II/LQ Color Subtraction

Color	1st Pass	2nd Pass
Yellow	Yellow	Unnecessary
Magenta	Magenta	Unnecessary
Cyan	Cyan	Unnecessary
Black	Black	Unnecessary
Orange	Yellow	Magenta
Purple	Magenta	Cyan
Green	Yellow	Cyan
White	Unnecessary	Unnecessary

The Primary Additive Colors—Red, Blue and Green

In high school, science students learn about additive color with prisms. As shown in Figure 3-3, the primary additive colors are red, green (not yellow!), and blue. When red, green, and blue light is mixed in equal proportions, the result is pure white light.

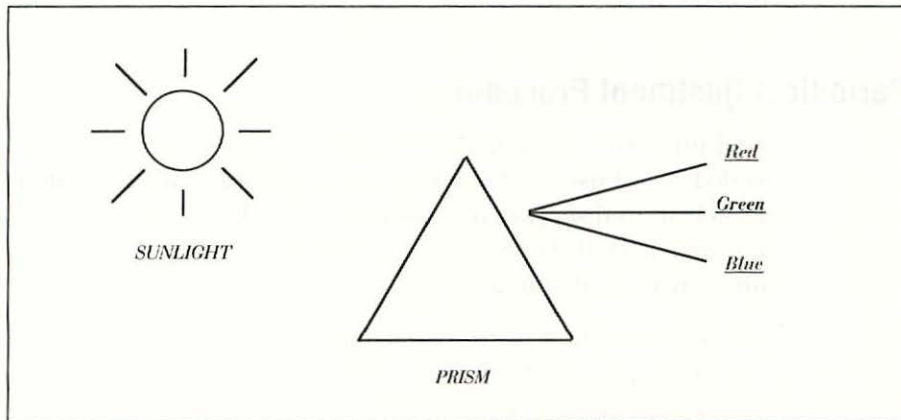
**Figure 3-3** The primary additive colors are red, green and blue.

How the AppleColor High-Resolution RGB Monitor Makes Color

That's how AppleColor High-Resolution RGB monitors work. Instead of the single electron beam used in monochrome CRTs, color CRTs have three separate electron beams (one for the red phosphor stripe, one for

the green phosphor stripe, and one for the blue phosphor stripe). Secondary colors are made by varying the intensity of the three electron beams. Provided that all three beams are aimed properly and adjusted equally, the monitor can display any color that occurs in nature, with exactly the same speed as the three primary colors. (Exactly how that works is the subject of Chapter 4.)

Convergence problems occur when the beams are not aimed properly. In that case, the monitor displays three-dimensional (3-D) color shadows. Left untreated, the display becomes unwatchable. The effect is like trying to read a 3-D comic book without the special glasses. It's very bad for the eyes.

White balance problems occur when one electron beam is driven higher than the others. In that case, all of the other colors are tinted with the higher-driven color. The monitor is perfectly watchable, but the color you see on the screen is not even close to what you get on paper.

Since aging inevitably causes all monitors to drift out of adjustment, all monitors should be periodically readjusted. The object of the periodic adjustment procedure is to restore the display—particularly the height, the width, the convergence, and the focus—to original operating condition.

Periodic Adjustment Procedure

In addition to a working Mac II and a copy of *Color TPG*, the only tools needed to adjust an AppleColor High-Resolution RGB Monitor are an 1/8-inch slotted screwdriver (or a metal nail file), a plastic TV alignment tool, and a cloth (or vinyl) tape measure. The complete procedure involves just seven simple steps:

1. Remove the control cover plate.
2. Adjust the width.
3. Adjust the height.
4. Center the display.
5. Converge the dots.
6. Adjust the focus.
7. Replace the control cover plate.

Plan on spending about one hour to work through this material for the first time. Once you've mastered the technique, subsequent adjustments should only take about 10 minutes.

Step 1—Remove the Control Cover Plate

As shown in Figure 3-4, the display adjustment controls are located under a cover plate on the left side of the back cabinet. To pry off the cover plate, insert a small screwdriver (or a metal nail file) into the screwdriver slot at the top of the cover plate and push the screwdriver handle away from you (toward the monitor). With very little effort, the cover plate should pop right off. No other disassembly is required. It's *not* necessary to loosen any screws. It's *not* necessary to remove the cabinet back.

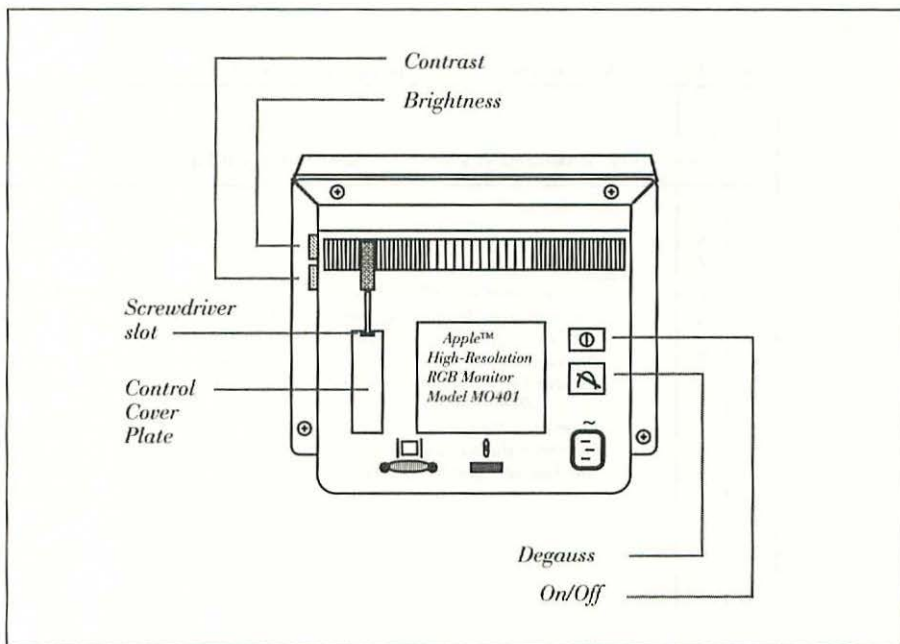

Figure 3-4 The display adjustment controls are located under a cover plate on the left side of the back cabinet.

Since the display on an RGB color monitor changes during the warm-up period, turn on the monitor (if necessary) and wait at least 20 minutes before proceeding to step 2.

Step 2—Adjust the Width

After the monitor has been on for at least 20 minutes, locate the brightness and contrast controls on the right side of the cabinet. The center position of the brightness control (the upper control) is identified by a click stop. Verify that the brightness control is centered in the click stop and that the contrast control (the lower control) is turned all the way up (fully clockwise).

When the brightness control is centered and the contrast control is turned all the way up, start *Color TPG*, dismiss the start-up screen and General Instructions window (if necessary), and choose 13-inch AppleColor RGB (Apple-B) from the Screen Sizes menu. As soon as you release the mouse button, *Color TPG* displays standard T-squares, as shown in Figure 3-5.

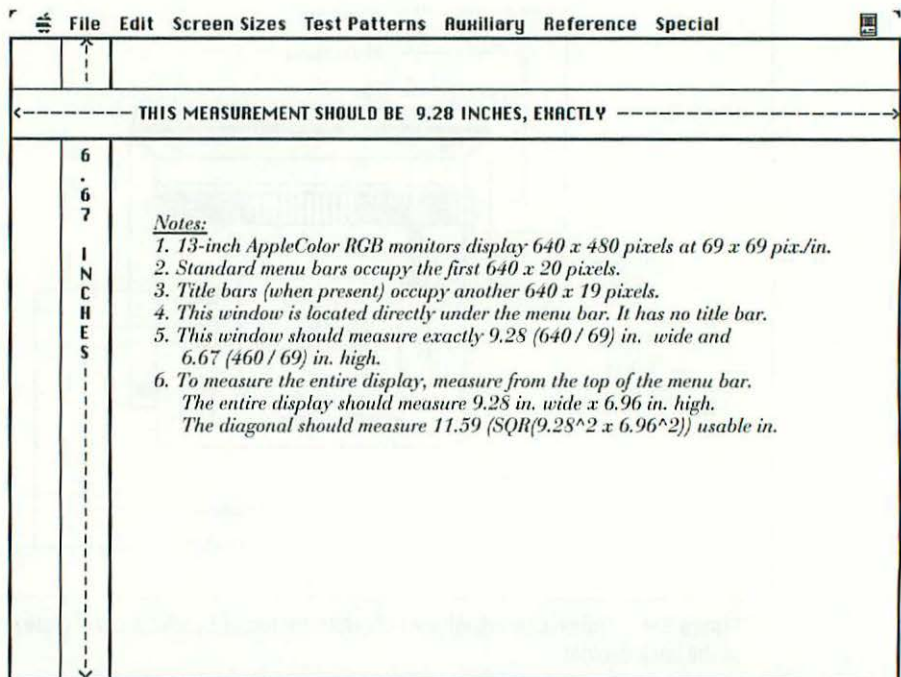

Figure 3-5 Standard T-squares for AppleColor High-Resolution RGB monitors specify height and width values in inches.

The standard T-squares specify height and width values in inches. To specify height and width values in centimeters, hold down the option key while choosing 13-inch AppleColor RGB. As soon as you release the mouse button, *Color TPG* recalculates and displays metric T-squares, as shown in Figure 3-6.

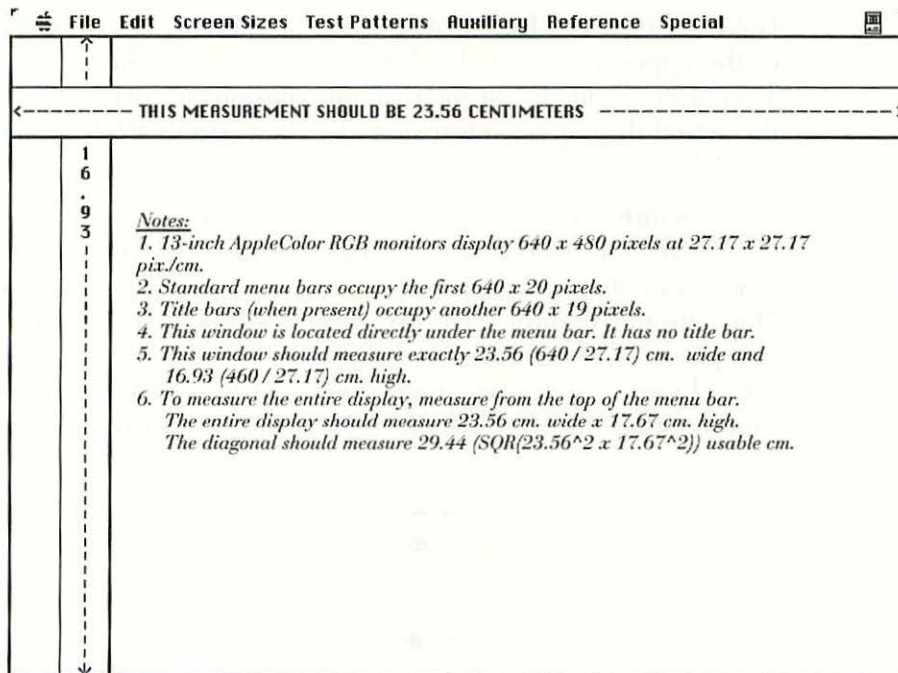

Figure 3-6 Metric T-squares for AppleColor High-Resolution RGB monitors specify height and width values in centimeters.

Neither of the T-squares displays actual width measurements. They merely state what the width measurements should be. Actual width measurements have to be taken with a cloth (or vinyl) tape measure, as shown in Chapter 2, Figure 2-6.

When using a cloth (or vinyl) tape measure, it's important to disregard the first few inches (or centimeters) on the ruler. Most of the cheap tape measures sold today have metal or plastic protectors haphazardly cemented to their ends. Not only can their sharp edges scratch the screen, but their first and last inches are usually inaccurate. For

accuracy, start from the 10-inch mark and drop the first digit (11 inches becomes 1 inch, 12 inches becomes 2 inches, 13 inches becomes 3 inches, etc.).

To compensate for the screen curvature, hold your eye so that it's perpendicular to the left side of the display, and line up the 10-inch (or 10-centimeter) mark on the ruler with the left edge of the T-squares. Hold the tape in place at that spot. Now hold your eye perpendicular to the opposite side of the display and compare the right edge of the T-squares to the 19.28-inch (33.56-centimeter) mark on the ruler. Is the actual display narrower or wider than specified? If so, refer to Figure 3-7.

The width control is identified symbolically by a horizontal line with arrows at either end. On this particular monitor, it's the third control down (not the sixth control down as on the Apple High-Resolution Monochrome Monitor). To correct the width, insert the screwdriver end of a plastic TV alignment tool (not a metal screwdriver) into the width control and turn it slowly until the actual display width measures 9.28 (approximately $19 \frac{1}{4} - 10$) inches or 23.56-centimeters ($33.56 - 10.00$).

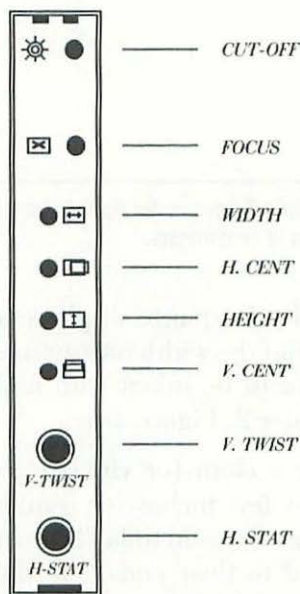

Figure 3-7 Control identification for AppleColor High-Resolution RGB Monitors.

When adjusting the width (or any of the display controls), grip the alignment tool lightly. The width control is not a screw. It's not supposed to be tightened down, and it's not designed to go around and around. A little turn, one way or the other, is generally all you need to do.

Step 3—Adjust the Height

When the width measures exactly 9.28 inches or 23.56 centimeters, rotate the tape measure and check the height, as shown in Chapter 2, Figure 2-8. To avoid confusion between window height and display height, refer to notes 4, 5, and 6 on the T-squares display. Is the actual display height taller or shorter than specified? If so, refer to Figure 3-7. The height control is symbolically identified as a vertical line with arrows at either end. On this particular monitor, it's also the fifth control down (not the third control down as on the Apple High-Resolution Monochrome Monitor). To correct the height, insert the screwdriver end of a plastic TV alignment tool (not a metal screwdriver) into the height control and turn it slowly until the actual display height measures 6.96 (approximately 17 - 10) inches or 17.67 (27.67 - 10.00) centimeters.

Step 4—Center the Display

When the height and the width measure exactly as specified, hold down the Option key and choose Center Cross (Apple + Option + X) from the Test Patterns menu. As shown in Figure 3-8, the optional Center Cross test pattern quarters the display.

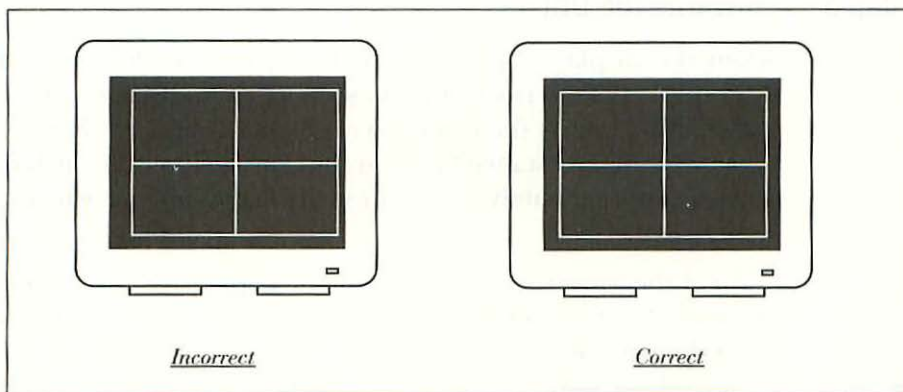

Figure 3-8 The optional Center Cross test pattern quarters the display.

To confirm the horizontal centering, measure the distance from the left side of the test pattern to the left edge of the screen and compare it to the distance from the right side of the test pattern to the right edge of the screen. Are they the same? If not, refer to Figure 3-7. The horizontal centering control is symbolically identified as a box within a box. The smaller box is offset to the right. On this particular monitor, the horizontal centering control is also the fourth control down (not the fifth control down as on the Apple High-Resolution Monochrome Monitor). To correct the horizontal centering, insert the screwdriver end of a plastic TV alignment tool (not a metal screwdriver) into the horizontal centering control and turn it slowly until left and right borders of the test pattern are both approximately $\frac{1}{2}$ of an inch or 1.27 centimeters from the left and right edges of the screen.

To confirm the vertical centering, measure the distance from the top of the test pattern to the top edge of the screen and compare it to the distance from the bottom of the test pattern to the bottom edge of the screen. Are they the same? If not, refer to Figure 3-7. The vertical centering control is symbolically identified as a box within a box. The smaller box is offset to the top. On this particular monitor, the vertical centering control is also the sixth control down. To correct the vertical centering, insert the screwdriver end of a plastic TV alignment tool (not a metal screwdriver) into the vertical centering control and turn it slowly until the top and bottom borders of the test pattern are both approximately $\frac{3}{8}$ of an inch or 0.95 centimeters from the top and bottom edges of the screen.

Step 5—Converge the Dots

When the display is perfectly centered, choose Dot Hatch (Apple-D) from the Test Patterns menu. As soon as you release the mouse button, *Color TPG* hatches the display with regularly spaced dots, as shown in Figure 3-9. The distance between the dots is either one inch or one centimeter (approximately $\frac{7}{16}$ of an inch) depending on which measuring system is in effect.

All of the convergence dots should be perfectly white. There shouldn't be the slightest hint of color. If the three electron beams have been aimed properly, you shouldn't see any red, green or blue shadows. Examine the display closely. Are the white dots in the corners of the display just as white as the dots in the center? If not, refer to Figure 3-7. The static

convergence controls are the seventh and eighth controls down. On this particular monitor the vertical convergence control is marked V-TWIST and the horizontal convergence control is marked H-STAT. (Other makes and models may be marked differently.) To begin the static convergence procedure, turn both the V-TWIST and the H-STAT controls fully clockwise (not fully counterclockwise). Every white dot in the test pattern should separate into distinct red, green, and blue dots, as shown in Figure 3-10.

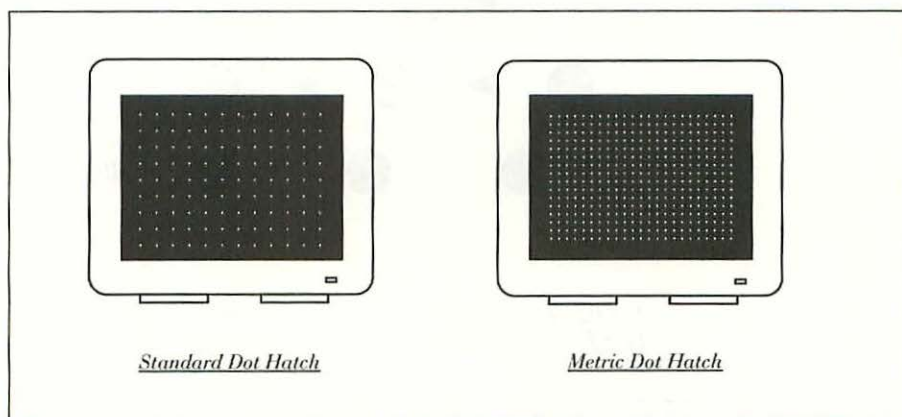

Figure 3-9 The Dot Hatch test pattern hatches the display with regularly spaced dots.

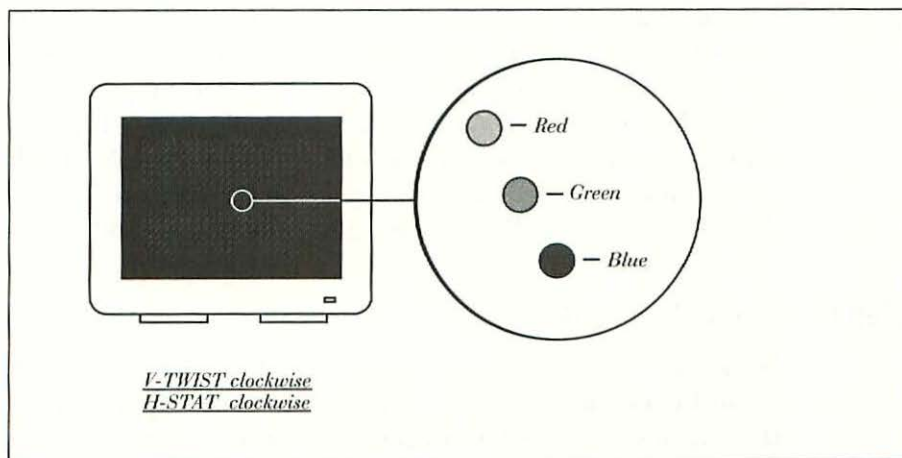

Figure 3-10 When both the V-TWIST and H-STAT controls are fully clockwise, every white dot in the test pattern should separate into distinct red, green, and blue dots.

Next, observe the center of the display and turn the H-STAT control counterclockwise until the red, green, and blue dots are directly above one another. When the V-TWIST control is fully clockwise and the H-STAT control is adjusted properly, each of the three-dot patterns should resemble a tiny stop light, as shown in Figure 3-11.

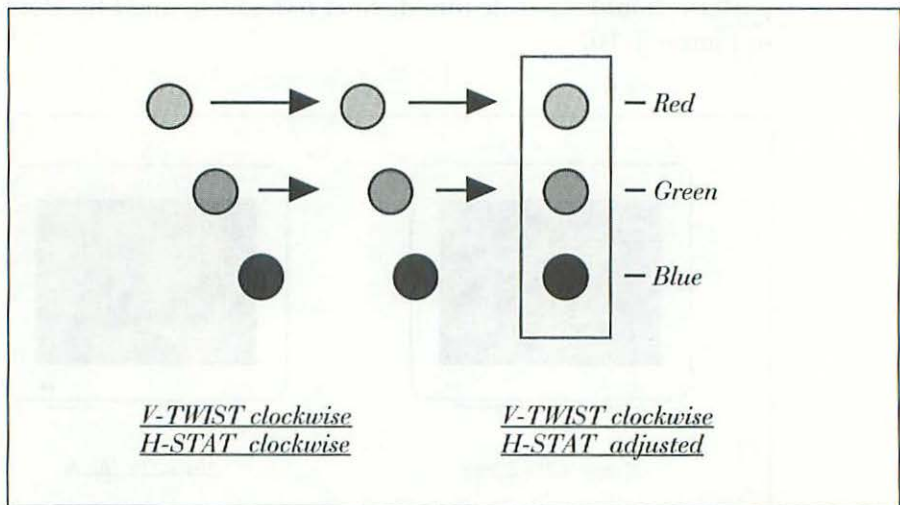

Figure 3-11 When the V-TWIST control is fully clockwise and the H-STAT control is adjusted properly, each of the three-dot patterns should resemble a tiny stop light.

Now, continue to observe the center of the display and turn the V-TWIST control slowly counterclockwise until the separate red, green, and blue dots converge into a single white dot. Stop as soon as you see white. Try not to turn the control past that point. When the V-TWIST control is adjusted properly, each of three-dot patterns should have *just* merged into a single white dot, as shown in Figure 3-12. If you go past that point, the overall results are generally not as good.

Step 6—Adjust the Focus

Once the convergence has been adjusted, it's time to check the focus. Begin by wiping the screen with a damp (not dripping) paper towel. If the screen is covered with finger prints or if it's cigarette-smoke stained, the evaluation will be invalid. Certain areas may appear to be out of focus, when in reality, they might only be covered with dirt.

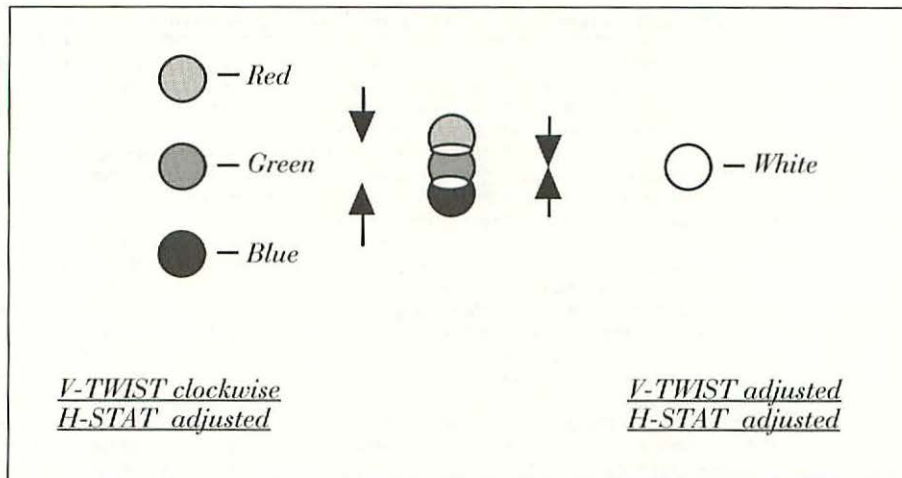

Figure 3-12 When the V-TWIST control is adjusted properly, each of the three-dot patterns should have just merged into a single white dot.

When you're satisfied that the screen is clean, choose Focusing Text (Apple-F) from the Test Patterns menu. This test fills the display with 9-point Monaco characters. To fill the display with 12-point Monaco characters, hold down the Option key while choosing Focusing Text. If 12-point Monaco is installed in your system file, the display will fill with 12-point text, as shown in Figure 3-13. If 12-point Monaco has been removed, or if it was never installed, 9-point text will appear in either case, as shown in Chapter 2, Figure 2-9.

The ripple pattern of 9-point Monaco characters creates a distinct barber-pole effect. The barber pole runs diagonally, from top right to bottom left. If the focus is set correctly, then alternating diagonals should be equally sharp. This pattern works best on Apple High-Resolution Monochrome Monitors. On AppleColor High-Resolution RGB Monitors, it's generally easier to use 12-point Monaco characters.

The ripple pattern of 12-point Monaco characters creates a less obvious vertical bar effect. If the focus is set correctly, bars at the sides of the display should be just as sharp as bars in the center. If the bars appear to alternate between sharp and fuzzy, or if one side appears to be sharper than the other, then the focus may need adjustment. The older the set is, the more likely that there will be a problem.



Figure 3-13 Holding down the Option key while choosing Focusing Text fills the display with 12-point Monaco text.

As shown in Figure 3-7, the focus control is symbolically identified by an x. On this particular monitor, it's also the second control down (not the top control as on the Apple High-Resolution Monochrome Monitor). To adjust the focus, insert the screwdriver end of a plastic TV alignment tool (not a metal screwdriver) into the focus control and turn it slowly until all of the text bars appear to be equally sharp.

When you're satisfied that the focus is as good as you're going to get it, slowly turn the contrast control (the lower control on the right side of the monitor) counterclockwise until you reach a point where the focusing text is as black as it can be and the glare of background is minimized.

Step 7—Replace the Control Cover Plate

Once the width, the height, the focus, and the contrast are adjusted, it's time to replace the control cover plate. Insert the nib at the bottom of the plate into the slot at the bottom of the control panel and push the plate toward the monitor as shown in Figure 3-14. With very little effort, the

cover plate should snap right into place. That's all there is to it. This procedure is so simple that there is no reason to suffer with a maladjusted monitor. It's easy. Try it for yourself and see. You won't believe the difference it makes!

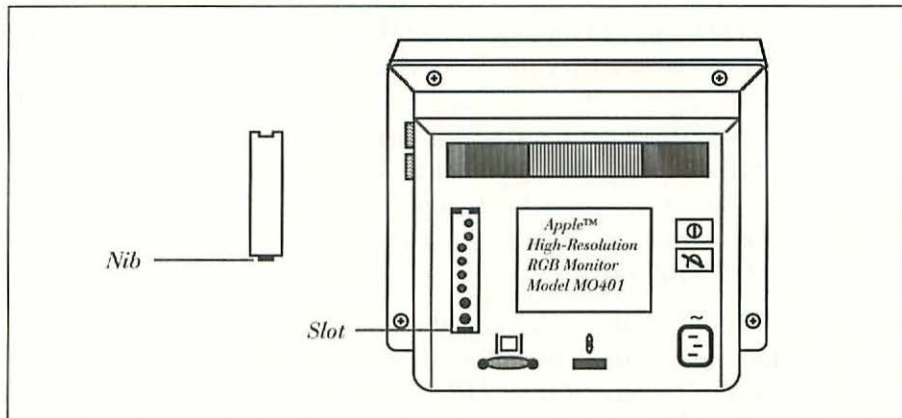

Figure 3-14 Control cover plate reinstallation details.

WYSIWYG Modifications

WYSIWYG is an acronym for “What you see is what you get.” It’s commonly believed that what you see on the Macintosh display is exactly what you get on paper. Nevertheless, when the AppleColor High-Resolution RGB Monitor is adjusted exactly according to OEM specifications, what you see on the screen is physically larger than what you get on paper.

As shown in Chapter 2, Figure 2-11, the Macintosh operating system presumes a display device adjusted for 72×72 pixels per inch (ppi). Since the AppleColor High-Resolution RGB monitor is adjusted for 69×69 pixels per inch, printout is actually reduced to 96% ($69 \text{ ppi} \div 72 \text{ ppi} = 0.96$ reduction).

To verify the 72×72 -ppi presumption on your own computer, run *Color TPG* and choose Get Info... from the File menu. With the exception of stock configuration Lisas and Mac XLs which report 90×60 , the Get Info... dialog box invariably reports 72×72 ppi. Since the AppleColor High-Resolution RGB Monitor is adjusted for 69×69 ppi, and since $72 \text{ ppi} \div 69 \text{ ppi} = 1.04$, the only way to ensure that what you see on the screen is really what you get is to print 104% enlargements. If

the chosen printer resource doesn't support 104% enlargement, either directly or via a special effect (an option in the Page Setup... dialog box), then what you get on paper is always going to be 4% smaller than what you see on the screen.

What about the Precision Bitmaps? option offered by Hewlett Packard DeskWriter and the Exact Bit Images (Shrink 4%) option offered by Apple LaserWriter II printer resources? These options merely print 96% reductions to offset the fact that 300 dots per inch (the standard resolution of these printers) is not directly divisible by 72 ($300 \times 0.96 = 288$, $288 \div 72 = 4$). When you have a 69×69 -ppi display, choosing Precision Bitmaps? or Exact Bit Images (Shrink 4%) merely reduces the normal 96% reduction to 92% (96% existing reduction \times 0.96 further reduction = 92% total reduction).

What about realigning the monitor for 72×72 ppi? Other than the fact that it contradicts the OEM specifications, that makes *perfectly* good sense! To have *Color TPG* figure the display size for you, choose Unlisted Mac Monitors... (Apple-U) from the Screen Sizes menu. For English measurements, click the OK button, as shown in Figure 3-15. For metric measurements, hold down the option key when you click the OK button. At 72×72 ppi, line 6 of the resulting T-squares display will indicate that the display size should be 8.89×6.67 inches, or 22.58×16.93 centimeters.

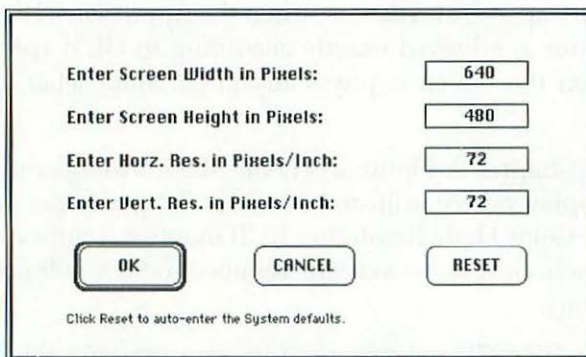

Enter Screen Width in Pixels: 640

Enter Screen Height in Pixels: 480

Enter Horz. Res. in Pixels/Inch: 72

Enter Vert. Res. in Pixels/Inch: 72

OK CANCEL RESET

Click Reset to auto-enter the System defaults.

Figure 3-15 To have *Color TPG* calculate the width and height for you at 72 ppi, choose Unlisted Mac Monitors... (Apple-U) from the Screen Sizes menu.

Readjust the height, width, centering, convergence, and focus as described in the periodic adjustment procedure, and without having to do anything special, what you see *will be* what you get, each and every time

you print. The only drawbacks are that the display will be 4% smaller than before, and the black border surrounding the display will be 1/4-inch larger all around.

Adjusting the Cut-Off Control

The cut-off control at the top of the panel is not mentioned in the periodic adjustment procedure, because it does not require periodic adjustment. But when the display intermittently goes dark, you're not running a screen saver, and the only way to get the display back is to turn off the monitor and wait a while before turning it back on, an incorrect cut-off setting may be responsible. To check the cut-off setting:

1. Start *Color TPG*, dismiss the start-up screen and General Instructions window (if necessary), and choose 13-inch AppleColor RGB (Apple-B) from the Screen Sizes menu.
2. Locate the brightness and contrast controls on the right side of the monitor. Turn the brightness and contrast controls all the way up (fully clockwise).
3. Choose Black Raster (Apple-K) from the Test Patterns menu. This test turns the display solid black.
4. Dim the room lights and compare the shade of the screen border to the shade of the black-raster test pattern. If the cut-off setting is correct (or too low), there shouldn't be any difference. If the cut-off setting is too high, then the black-raster test pattern will be somewhat lighter than the screen border (dark gray, instead of black), as shown in Chapter 2, Figure 2-16.

If the cut-off setting is correct (or possibly on the low side) it should not be tampered with. Turn it up, and you'll only compound the problem. But if the shade of the black-raster test pattern does not match the shade of the screen border, then the cut-off setting is too high and should be reduced. Reduction should solve the problem. To adjust the cut-off control:

1. Remove the control cover plate, as shown in Figure 3-3.
2. As shown in Figure 3-7, the cut-off control is identified by a star. On this particular monitor, it's also the first control at the top of the panel. Insert the screwdriver end of a plastic TV alignment tool (not a metal screwdriver) into the cut-off control and slowly turn it counterclockwise until the black raster just fades into the screen

- border. Stop when they're exactly the same shade. Don't over-adjust (or the display will lack brightness).
3. When you're satisfied that the black raster and the screen border are exactly the same shade, choose White Raster from the Test Patterns menu, then choose Focusing Text from the Test Patterns menu. This combination sets up black text on a white background.
 4. Slowly turn the brightness control (the upper control on the right side of the monitor) counterclockwise until it's centered in the click stop.
 5. Slowly turn the contrast control (the lower control on the right side of the monitor) counterclockwise until you reach a point where the focusing text is as black as it can be and the glare of white background is minimized.
 6. Replace the control cover plate, as shown in Figure 3-14, and you're all done.

While working on this chapter, I saw three instances of maladjusted cut-off controls. Despite the dead giveaway of the intermittent-display symptom, the first person had been given a "whole new logic board." The second person had been sold a "whole new power supply." The third person had been advised that he needed "a whole new logic board" and possibly a "new high voltage resistor" (HVR). All three of these people had spent a lot of time and money chasing down the problem. None of the items they'd been sold or been told that they needed had anything to do with the solution. When the display intermittently goes dark, and you're not running a screen saver, and the only way to get the display back is to turn off the monitor and wait a while before turning it back on again, then you'll probably find that the cut-off has been tampered with, or that it's simply drifted too high. Check it as described here, readjust it if necessary, and everything should be fine. If not, you'll need a service manual to go further. See component-level repairs at the end of this chapter.

Adjusting the White-Balance Controls

If your monitor has never been opened since the day you got it, then the periodic adjustment procedure (described earlier in this chapter) should be all you need to do. Upon completion, the display should look as good as the day you bought it. But if your monitor has ever been board swapped, then chances are that it's going to need considerably more work.

When the monitor has a distinct red, green, or blue tint, the white balance is out of adjustment. That's not going to hurt anything, but the display may be unpleasant to view, and the colors you see on the screen won't even come close to the colors you get on paper. To check the white balance setting:

1. Start *Color TPG*, dismiss the start up screen and General Instructions window (if necessary), and choose 13-inch AppleColor RGB (Apple-B) from the Screen Sizes menu.
2. Verify the settings of the brightness and contrast controls. Both should be adjusted for normal viewing (not turned to maximum).
3. Choose Gray Bars (Apple-Option-P) from the Test Patterns menu. As shown in Figure 3-16, this test displays eight system patterns, in ascending order from white-to-gray-to-black. If the white balance is adjusted properly, there shouldn't be the slightest hint of color; you shouldn't see any red, green, or blue shades in any of the bars.

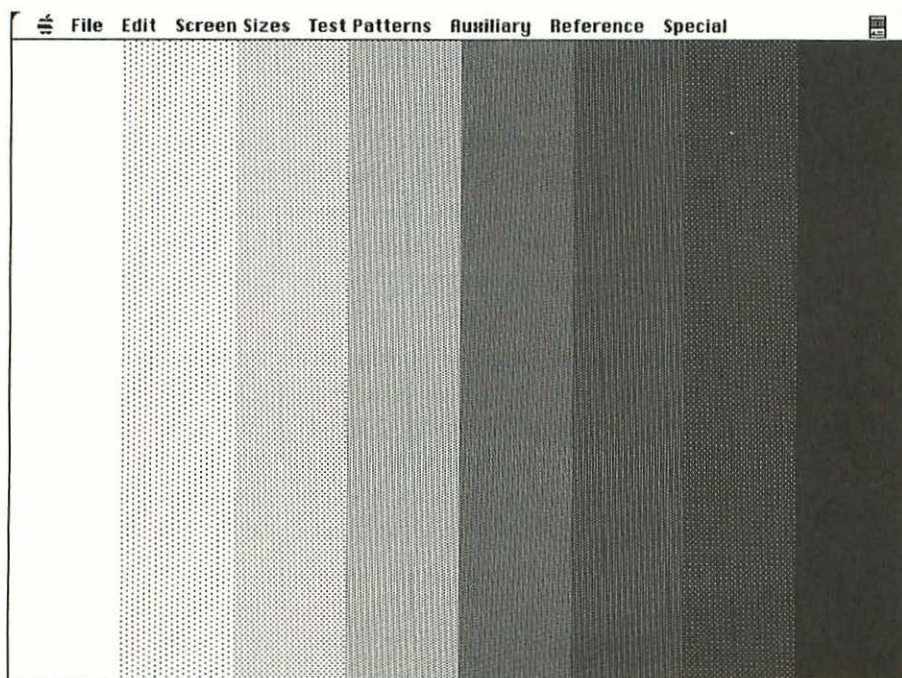

Figure 3-16 The Gray Bars test pattern displays eight system patterns, in ascending order from white-to-gray-to-black.

In practice, the bars are usually tinted light blue. Light blue, provided it's a very light blue, is acceptable (cool looking, good for hot climates), so is a very light red (warm looking, good for cold climates), but green tints (OK on a monochrome monitor, but sick looking on an RGB monitor) are generally unacceptable.

On the AppleColor High-Resolution RGB monitor, the white balance controls are inside the cabinet. To reach the controls, the cabinet back has to be removed. That exposes you to dangerous high voltage and the possibility of electric shock. As explained in Chapter 1, an isolation transformer must be used to minimize the shock hazard. With the understanding that the following information is only for qualified radio/TV-repair technicians working in fully equipped shops, here's the white-balance adjustment procedure:

1. Remove all rings, watches, and other jewelry. Review the safety rules given in Chapter 1.
2. Turn off the Macintosh II and the monitor, wait 30 seconds, and then unplug the power and video cables from the back of the monitor.
3. Unplug the other end of the monitor's AC power cable.
4. Set up a container for holding small parts. As shown in Figure 3-17, the back cabinet of the AppleColor High-Resolution RGB Monitor is held by four Phillips-head screws. One screw is located in each corner. Lay the monitor face down on a soft towel and remove the screws using a #1 Phillips-head screwdriver. Place the screws in the parts container. Lift away the cabinet back and put it aside.
5. While taking care not to touch any exposed connections, stand up the monitor, and place it on top of a soft towel. Do not place it on top of a static discharge pad! If you touch any exposed connections, or if you place the monitor on a static discharge pad, you may get an electric shock (severe enough to cause you to drop the monitor), even though the power cord is disconnected.
6. As shown in Figure 3-18, an aluminium-colored electromagnetic interference (EMI) shield is press-fit over the "B" and "C" boards at the back of the monitor. There are two dimples at the bottom of the shield and two clips at the top. The screws just below the dimples and just above the clips *do not* have to be removed. Without removing the screws, gently pull off the shield and put it aside.

Removing the EMI shield exposes the “B” and “C” boards as shown in Figure 3-19. Note that the “B” and “C” labels are not arbitrary. That’s the way the boards are marked!

7. For safety, verify that both ends of the monitor’s AC power cable are disconnected. While taking care not to touch any exposed solder joints, reconnect the power and video cables to the back of the monitor. Do not reconnect the other end of the power cable, just yet.

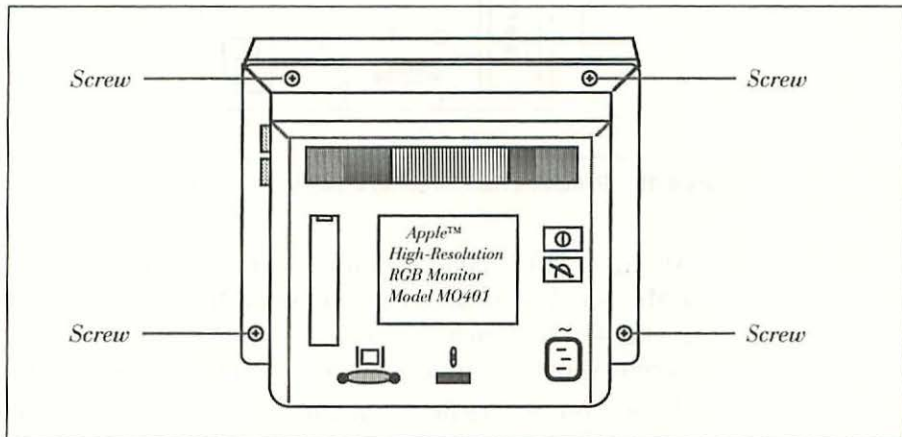

Figure 3-17 The back cabinet of the AppleColor High-Resolution RGB Monitor is held by four Phillips-head screws.

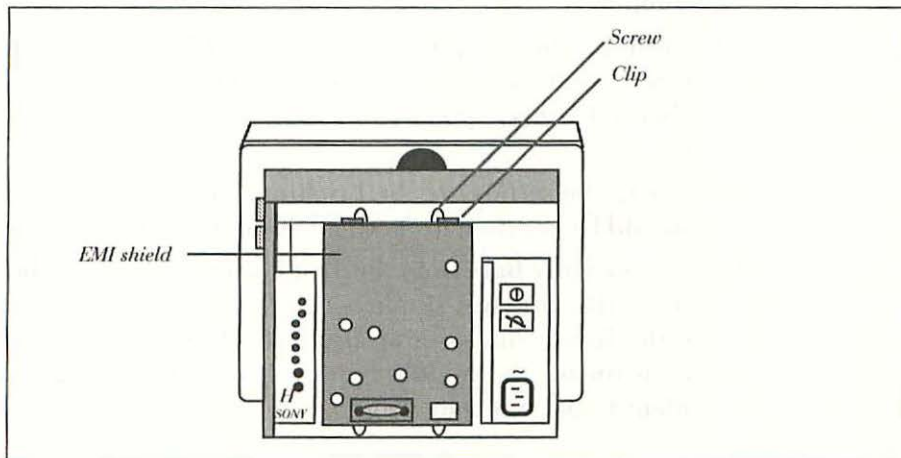

Figure 3-18 An aluminium-colored EMI shield is press-fit over the “B” board at the back of the monitor.

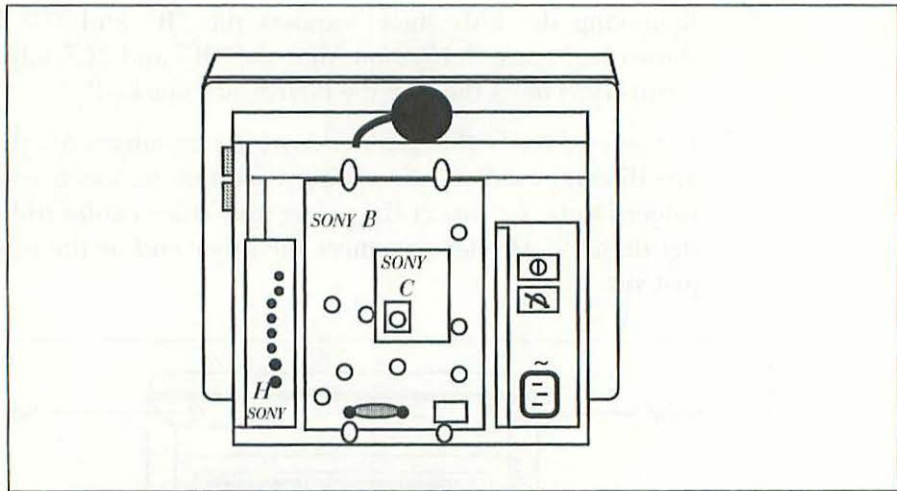

Figure 3-19 Removing the EMI shield exposes the “B” and “C” boards.

8. At this point, make absolutely sure that the aluminum-colored EMI shield is a safe distance away from the work area. If any metal objects touch the exposed connections, there will be a dangerous short circuit as soon as you turn on the power.
9. When you're satisfied that the work area is safe, reconnect the monitor's power cord to an isolation transformer. *Do not attempt this procedure without the benefit of an isolation transformer!* Connect the isolation transformer to 120VAC and turn on the computer.
10. Turn on the computer, start *Color TPG*, dismiss the start-up screen and General Instructions window (if necessary), and choose 13-inch AppleColor RGB (Apple-B) from the Screen Sizes menu.
11. Verify the settings of the brightness and contrast controls. Both should be adjusted for normal viewing (not turned to maximum).
12. Choose Gray Bars from the Test Patterns menu. As shown in Figure 3-16, this test displays eight system patterns, in ascending order from white-to-gray-to-black. If the white balance is out of adjustment, the middle bars will be tinted red, green, or blue. Identify the tint color.

13. As shown in Figure 3-20, the three white-balance controls, RV731 blue background, RV721 green background, and RV711 red background are on the “B” board. Locate the background control (not the screen control) associated with the tint color.

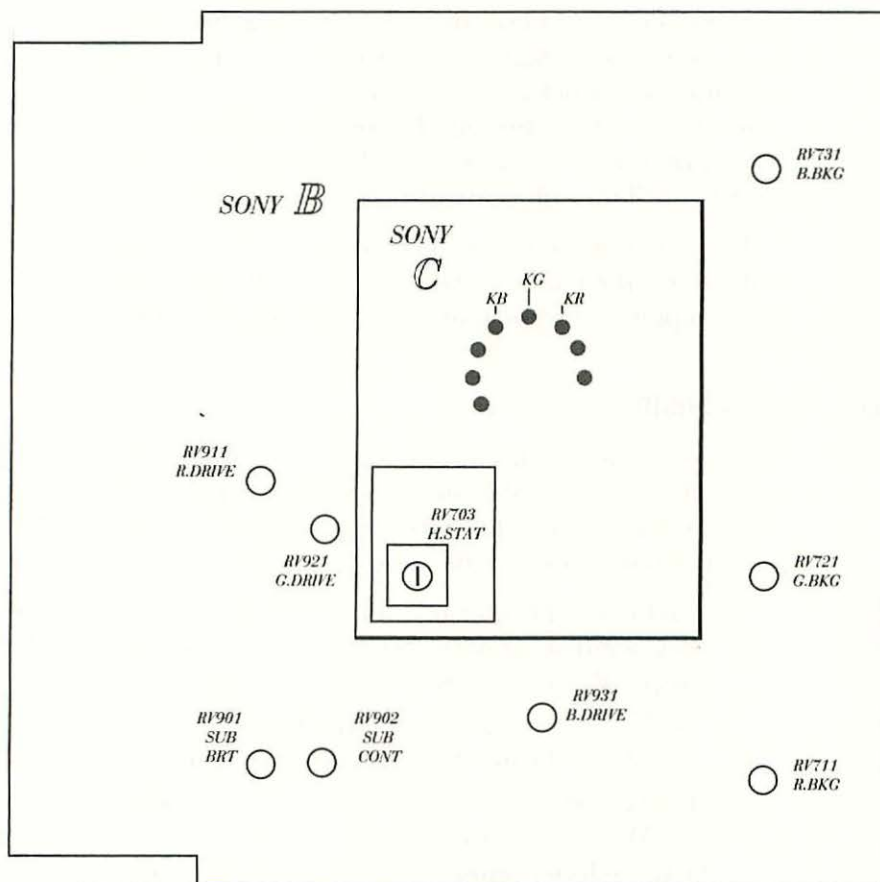

Figure 3-20 The three white-balance controls, RV731 or blue background, RV721 or green background, and RV711 or red background are on the “B” board.

14. Insert the screwdriver end of a plastic TV alignment tool (not a metal screwdriver) into the background control associated with the tint color and *slowly* turn it clockwise until the pattern-bar color fades to gray. Stop *as soon as* you see gray. Don't overadjust or you'll just cause one of the other colors to predominate.
15. That's generally all there is to it. Reverse steps 10 to 1 and you're all done.

If turning clockwise the background control associated with the tint color *does not* fix the problem, then chances are that other controls on the “B” board have been tampered with. (Tampering is defined as turning adjustments without the benefit of knowledge or instructions.) In that case, you may be able to restore the white balance by turning down all three background controls, then turning them up one at a time. First, turn up the red background control until the bars have adequate brightness and a distinct red tint. About midrange on the control is a good place to start. Next, turn up the green background control until the green color just starts to affect the red. Then turn up the blue background control until the color mix just starts to turn gray.

If that doesn’t work, then chances are that someone has really done a number on the monitor. You’ll need a full service manual to correct it. See component-level repairs at the end of this chapter.

Color Purity Adjustments

If the gray bars are uniformly tinted, then the white balance procedure generally takes care of it. But if irregularly sized color blotches appear in the gray bars, then color purity adjustments may be in order. To check the color purity on your monitor:

1. Start *Color TPG*, dismiss the start-up screen and General Instructions window (if necessary), and choose 13-inch AppleColor RGB (Apple-B) from the Screen Sizes menu.
2. Verify the settings of the brightness and contrast controls. Both should be adjusted for normal viewing (not turned to maximum).
3. If necessary, choose Control Panel from the Apple menu and use the Monitors control device (CDEV) to set the Characteristics of the selected monitor to 16 (or more) colors, as shown in Figure 3-21. Set it to the highest number available.
4. Choose Red Raster (Apple-Option-R) from the Test Patterns menu. As illustrated in Figure 3-22, this test turns the display solid red. If the purity is adjusted properly, there shouldn’t be the slightest hint of green or blue in the test pattern.
5. Alternately, choose Blue Raster (Apple-Option-B) from the Test Patterns menu. This test turns the display solid blue. If the purity is adjusted properly, there shouldn’t be the slightest hint of red or green in the test pattern.

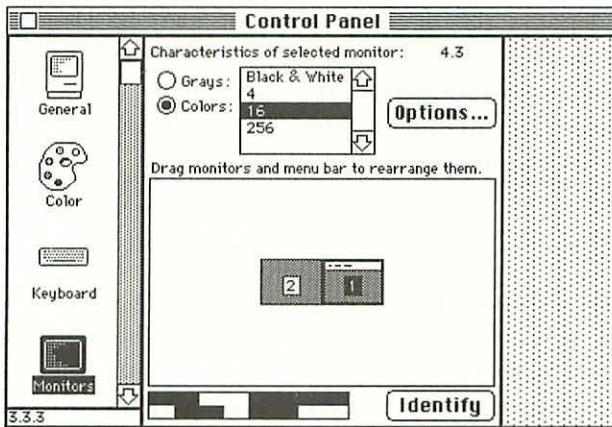

Figure 3-21 Use the Monitors control device (CDEV) to set the Characteristics of selected monitor to 16 (or more) colors.

6. Alternately, choose Green Raster (Apple-Option-G) from the Test Patterns menu. This test turns the display solid green. If the purity is adjusted properly, there shouldn't be the slightest hint of red or blue in the test pattern.

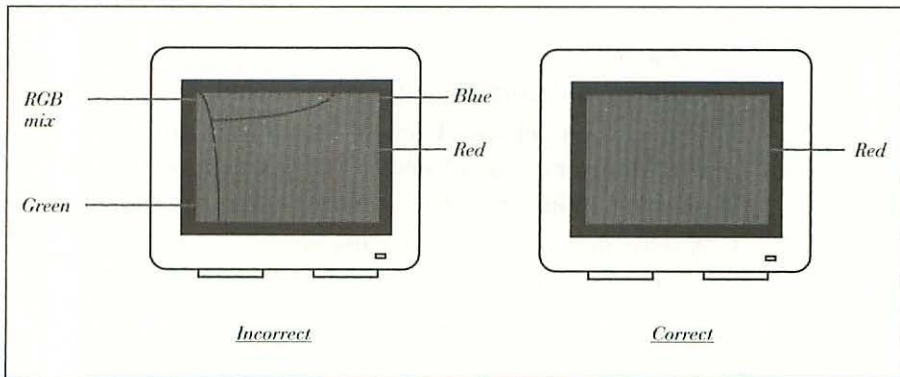

Figure 3-22 The Red Raster test pattern turns the display solid red. If the purity is adjusted properly, there shouldn't be the slightest hint of green or blue in the test pattern.

Minor color purity problems (those caused by stray magnetic fields, not those caused by yoke misalignment) can usually be corrected by pressing the degauss (pronounced dee-gouse) switch. As shown in Figure 3-4, the degauss switch (named after 19th century German physicist Karl Friedrich Gauss) is just below the power switch on the back of the

monitor. To degauss the display, press the switch! Degaussing takes about eight seconds, causes the monitor to flicker, and ends with a distinct click. If the impurities persist, then the yoke is probably misaligned. You'll need the service manual to correct it. See component level repairs at the end of this chapter.

WYSIWYG Color Printing

If the colors that you see on the computer display are not the same as the colors that you get on paper, especially after the white balance and the color purity have been set properly, then you could be selecting the wrong display colors, or using the wrong shade of paper. As explained earlier in this chapter (and illustrated in Figures 3-2 and 3-3), printers rely on subtractive color; monitors rely on additive color. The two processes are completely different. To see which colors match and which do not:

1. Verify that the color printer is connected to the computer, turned on and loaded with the paper that you *normally* use (not scrap paper). Note whether the color printer is connected to the printer port or the modem port.
2. Select the Chooser desk accessory (DA) from the Apple menu. As shown in Figure 3-23, verify that the correct printer (the color printer) and port are currently selected.
3. If necessary, choose Control Panel from the Apple menu and use the Monitors control device (CDEV) to set the Characteristics of selected monitor to 16 (or more) colors, as shown in Figure 3-21.
4. Verify the settings of the brightness and contrast controls. Both should be adjusted for normal viewing (not turned to maximum).
5. Start *Color TPG*, dismiss the start-up screen and General Instructions window (if necessary), and choose 9-inch 512K—Classic (Apple-M) from the Screen Sizes menu. Alternately, you can choose 13-inch AppleColor RGB (Apple-B) from the Screen Sizes menu, but this size prints an unnecessarily large color sample, which takes longer and wastes more of the printer ribbon.
6. Choose Color Bars (Apple-Option-C) from the Test Patterns menu. As shown in Figure 3-24, this test displays eight standard color bars in the usual order: white, yellow, cyan, green, magenta, red, blue, and black.

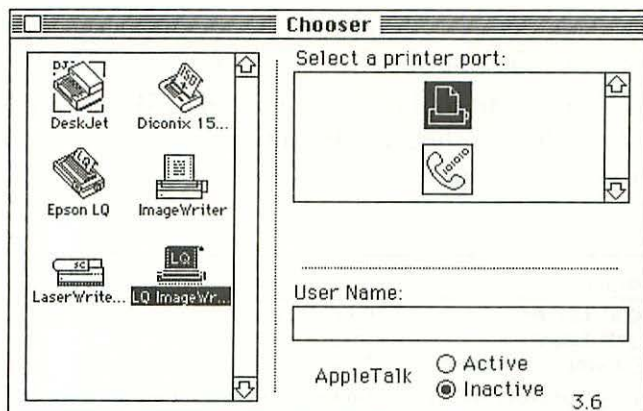

Figure 3-23 Use the Chooser DA to verify that the correct printer and port are currently selected.

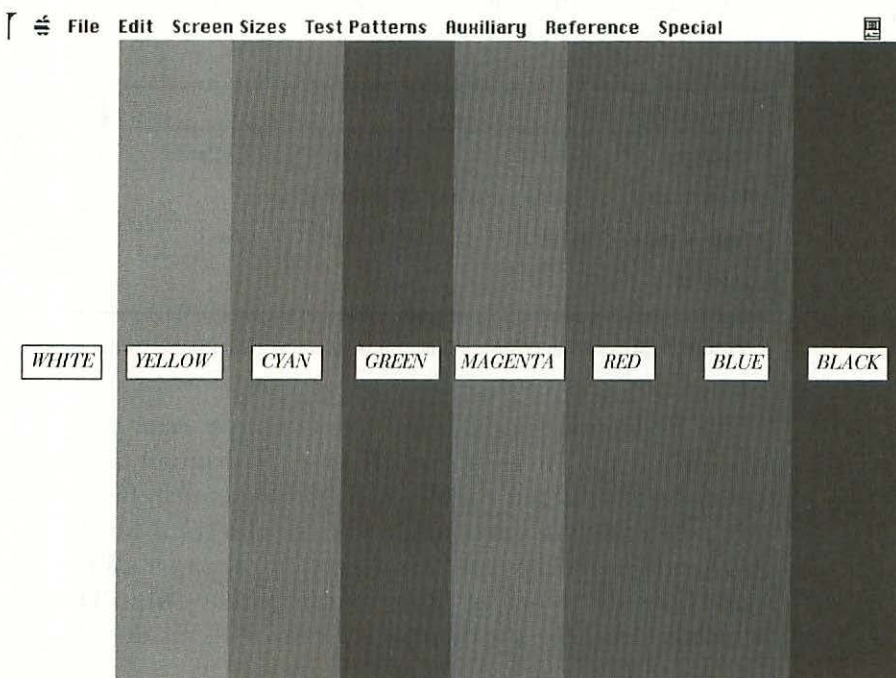

Figure 3-24 The Color Bars test pattern displays eight standard color bars in the usual order: white, yellow, cyan, green, magenta, red, blue, and black.

7. Choose Page Setup... from the File menu. Select the Reduction special effect (50% or less), as shown in Figure 3-25.
8. Choose Print... from the File menu. Select Best quality as shown in Figure 3-26 and click the OK button (or press the return key) to print the color sample.

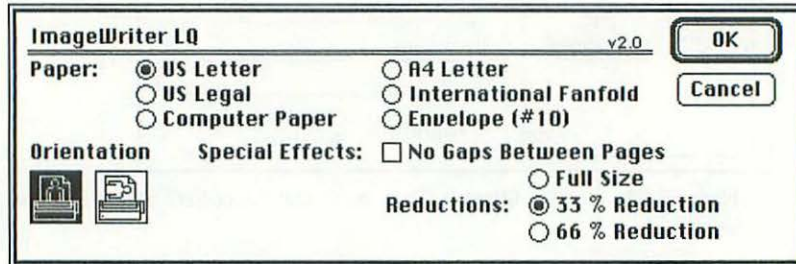

Figure 3-25 Use the Page Setup... dialog box to select the Reduction special effect.

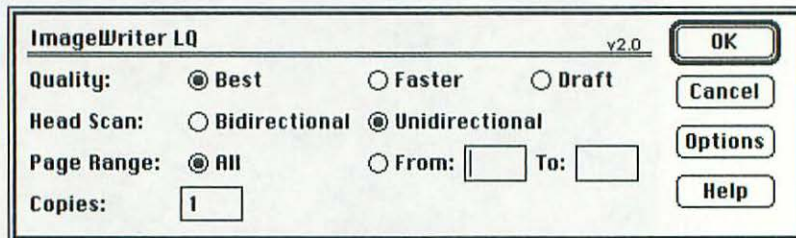

Figure 3-26 Use the Print... dialog box to select Best quality printing.

The Reduction special effect allows you to print tiny color bar samples. When the ImageWriter (II or LQ) printout is compared to the screen display, all but the blue color should match. Because of the difference between subtractive and additive color, blue on the computer display tends to look purple when printed on paper. What's to be done? Avoid blue altogether, or print on transparency film. Transparency film (which is clear, like the monitor screen) yields results which are closer to the computer display. Another solution is to use a different shade of paper. Still another solution is to set the Characteristics of the selected monitor to a different number of colors.

Minor discrepancies in the other seven colors printed in the test pattern can usually be corrected by turning down the contrast control or switching to a different brand of ribbon.

Additional Convergence Adjustments

When you can't converge the dot hatch test pattern simply by adjusting the H-STAT and V-TWIST controls at the back of the monitor, it's usually because the "C" or "D" boards inside the cabinet have been swapped. In that case, controls on the replacement board (or boards) will have to be adjusted as well.

To reach the controls, the cabinet back has to be removed. That exposes you to dangerous high voltage and the possibility of electric shock. As explained in Chapter 1, an isolation transformer must be used to minimize the shock hazard. With the understanding that the following information is only for qualified radio/TV-repair technicians working in fully equipped shops, here's the additional convergence procedure:

1. Remove all rings, watches and other jewelry. Review the safety rules given in Chapter 1.
2. Turn off the Macintosh II and the monitor, wait 30 seconds, and then unplug the power and video cables from the back of the monitor.
3. Unplug the other end of the monitor's AC power cable.
4. Set up a container for holding small parts. As shown in Figure 3-17, the back cabinet of the AppleColor High-Resolution RGB Monitor is held by four Phillips-head screws. One screw is located in each corner. Lay the monitor face down on a soft towel and remove the screws using a #1 Phillips-head screwdriver. Place the screws in the parts container. Lift away the cabinet back and put it aside.
5. While taking care not to touch any exposed connections, stand up the monitor, and place it on top of a soft towel. Do not place it on top of a static discharge pad! If you touch any exposed connections, or if you place the monitor on a static discharge pad, you may get an electric shock (severe enough to cause you to drop the monitor), even though the power cord is disconnected.
6. As shown in Figure 3-27, the monitor's EMI shield is held by five Phillips-head screws and loosely clipped to the anode (high voltage) wire. One screw is located on the lower right side of the monitor, the remaining four are located on top. Remove the screws using a #1 Phillips-head screwdriver. Place the screws in the parts container. Do not remove the EMI shield just yet.

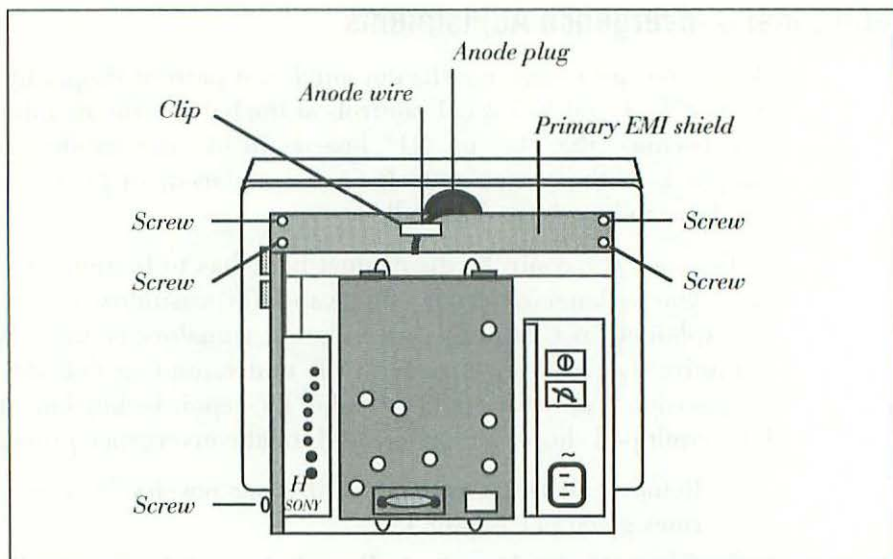

Figure 3-27 The monitor's primary EMI shield is held by five Phillips-head screws and loosely clipped to the anode (high voltage) wire.

7. While observing the anode-wire clip on the EMI shield, carefully lift the shield and gently twist it free of the anode wire. Do not grip the clip or hold the anode wire with your hands! Do not touch the anode well or any other part of the CRT. When the twisting motion separates the anode wire from the clip on the EMI shield, lift the EMI shield away and put it aside.

Removing the EMI shield exposes the "D" board, as shown in Figure 3-28. Note that the "D" label is not arbitrary. That's the way the board is marked!

8. As shown in Figure 3-18, a secondary electromagnetic interference shield is press fit over the "B" and "C" boards at the back of the monitor. There are two dimples at the bottom of the shield and two clips at the top. The screws just below the dimples and just above the clips *do not* have to be removed. Without removing the screws, gently pull off the shield and put it aside.
9. For safety, verify that both ends of the monitor's AC power cable are disconnected. While taking care not to touch any exposed solder joints, reconnect the power and video cables to the back of the monitor. Do not reconnect the other end of the power cable just yet.

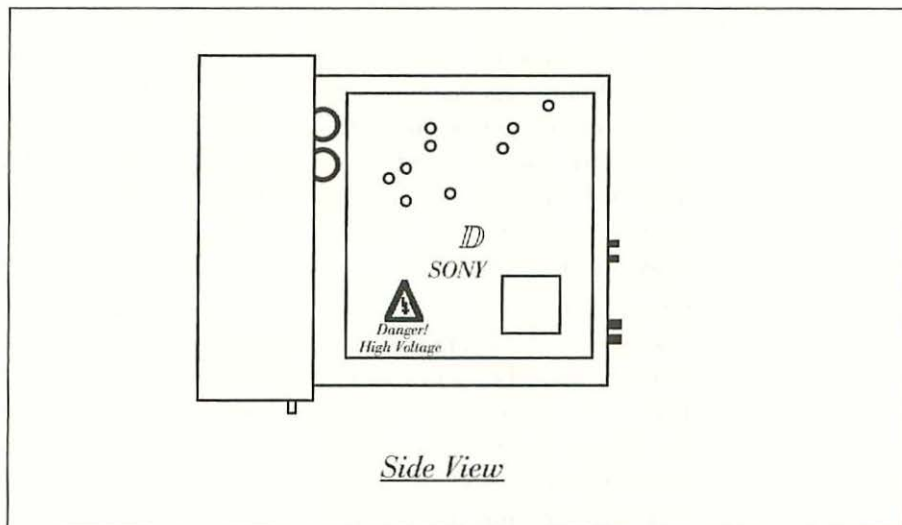

Figure 3-28 Removing the EMI shield exposes the "D" board.

10. At this point, make absolutely sure that the two metal EMI shields are a safe distance away from the work area. If any metal objects touch the exposed solder joints, there will be a dangerous short circuit as soon as you turn on the power.
11. When you're satisfied that the work area is safe, reconnect the monitor's power cord to an isolation transformer. *Do not attempt this procedure without the benefit of an isolation transformer!* Connect the isolation transformer to 120VAC and turn on the monitor.
12. Turn on the computer, start *Color TPG*, dismiss the start-up screen and General Instructions window (if necessary), and choose 13-inch AppleColor RGB (Apple-B) from the Screen Sizes menu. Holding down the Option key while choosing 13-inch AppleColor RGB engages the metric system, which ultimately spots more dots.
13. Choose Dot Hatch (Apple-D) from the Test Patterns menu. As shown in Figure 3-9, this test hatches the display with regularly spaced white dots. The distance between the dots is either one inch or one centimeter (approximately $\frac{7}{16}$ of an inch) depending on which measuring system is in effect.

14. Refer to Figure 3-7. The static convergence controls are the seventh and eighth controls down. On this particular monitor the vertical convergence control is marked V-TWIST and the horizontal convergence control is marked H-STAT. Turn both the V-TWIST and the H-STAT controls on the "H" board *fully clockwise* (not fully counterclockwise). Every white dot in the test pattern should separate into distinct red, green, and blue dots, as shown in Figure 3-10.
15. Observe the angle of the dot axis. Now turn the H-STAT control (but not the V-TWIST control) fully clockwise. The clockwise dot pattern should be a mirror image of the counterclockwise pattern. If the two angles are not mirror images, as shown in Figure 3-29, locate the "C" board shown in Figures 3-19 and 3-20. Insert the screwdriver end of a plastic TV alignment tool (not a metal screwdriver) into RV703, the H.STAT control on the "C" board, and turn it until the angles are the same.

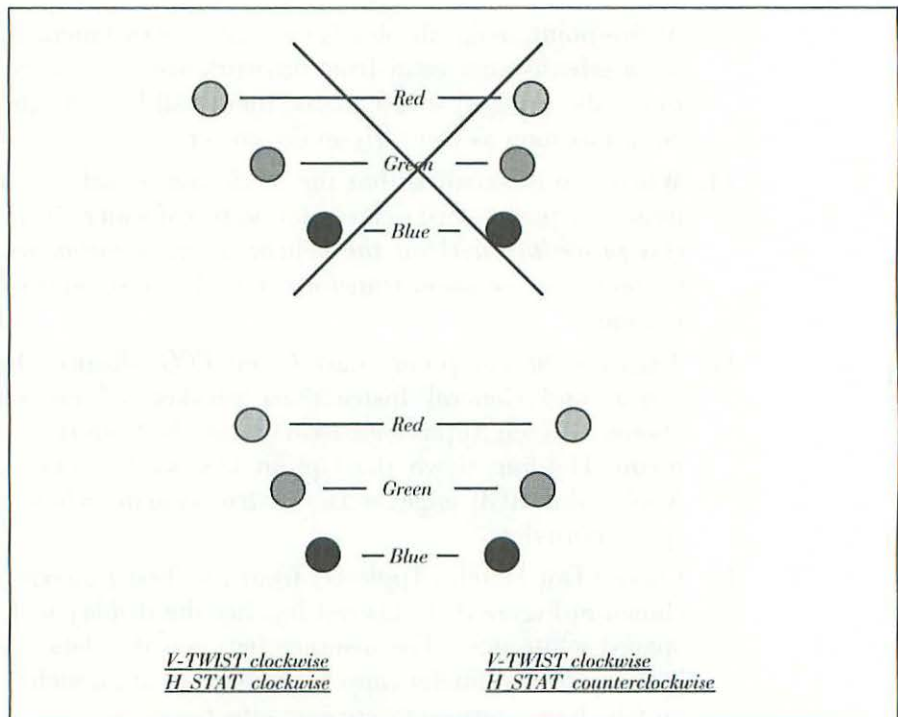

Figure 3-29 When RV703, the H.STAT control on the "C" board, is adjusted properly, the clockwise dot pattern should be a mirror image of the counterclockwise pattern.

16. When you're satisfied that the angles are the same, observe the center of the display and turn the H-STAT control until the red, green, and blue dots are directly above one another. When H-STAT control is adjusted properly, each of the three-dot patterns should resemble a tiny stop light, as shown in Figure 3-11.
17. As shown in Figure 3-30, two additional convergence controls, RV518, V.TOP, and RV517, V.BOTTOM, are on the "D" board. Compare the dot patterns at the top and bottom of the display to the dot patterns in the middle. When the V.TOP and V.BOTTOM, controls are adjusted properly, the spacing between the dots should be the same, as shown in Figure 3-31.

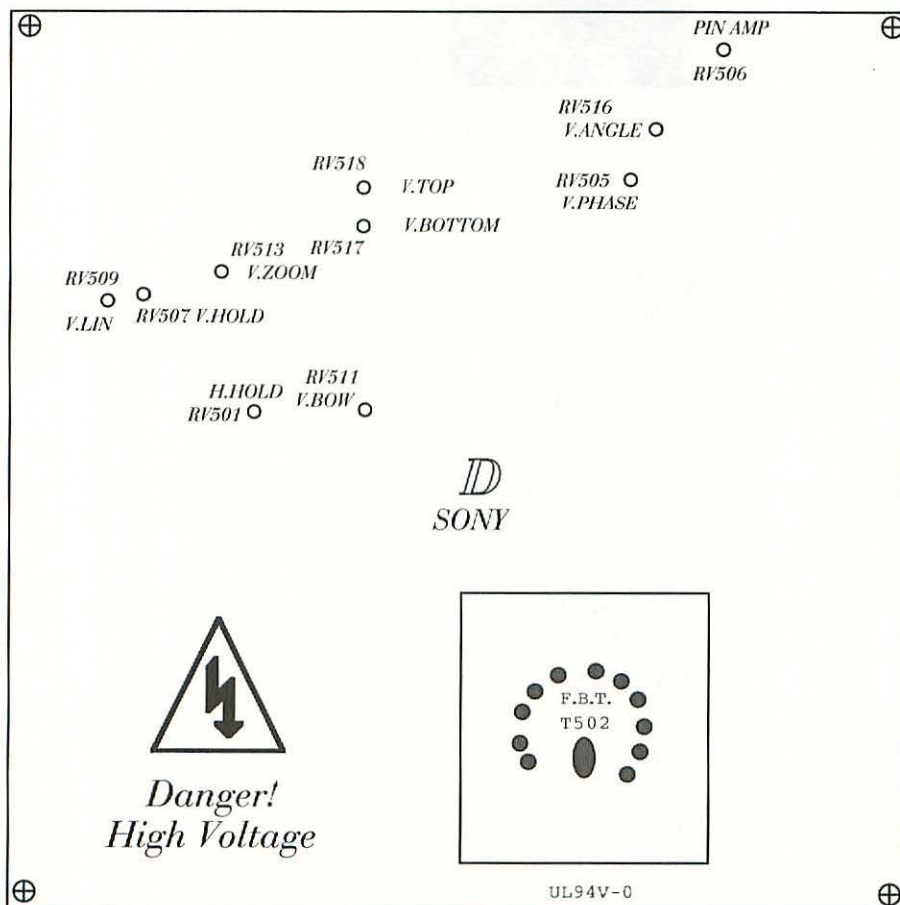

Figure 3-30 Two additional convergence controls, RV518, V.TOP and RV517, V.BOTTOM, are on the "D" board.

Note: The “Danger! High Voltage” warning symbol has been added to Figure 3-30 as a safety reminder. It does not actually appear on the “D” board. Nevertheless, “D” boards are dangerous. Use extreme caution when working in this area.

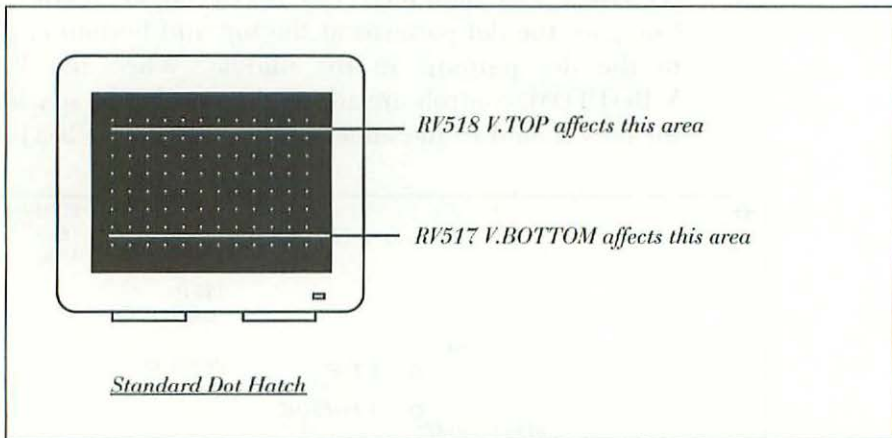

Figure 3-31 When the V.TOP and V.BOTTOM controls are adjusted properly, the spacing between the dots should be the same.

18. If the dot patterns at the bottom of the display are more tightly spaced than the dots at the middle of display, insert the screwdriver end of a plastic TV alignment tool (not a metal screwdriver) into RV517, the V.BOTTOM control on the “D” board, and turn it until the problem is corrected.
19. If the dot patterns at the top of the display are more tightly spaced than the dots at the middle of the display, insert the screwdriver end of a plastic TV alignment tool (not a metal screwdriver) into RV518, the V.TOP control on the “D” board, and turn it until the problem is corrected.
20. When you’re satisfied that the spacing between the dots is as good as you’re going to get it, concentrate on the middle of the display and turn the V-TWIST control (on the “H” board at the back of the monitor) slowly counterclockwise until the separate red, green, and blue dots converge into a single white dot. Stop as soon as you see white. Try not to turn the control past that point. When

the V-TWIST control is adjusted properly, each of three-dot patterns should have *just* merged into a single white dot, as shown in Figure 3-12. If you go past that point, the overall results are generally not as good.

21. That's generally all there is to it. Reverse steps 12 to 1 and you're all done.

Note to eyeglass wearers: If you suffer from astigmatism and wear lightweight polycarb lenses, then you may be bothered by three-dimensional red/yellow colored shadows (on horizontal lines at the top and bottom of the display) that no one else can see. In that case, adjusting the convergence controls won't accomplish anything, because the problem is not in your monitor! It's caused by the high refraction index of the polycarb lenses. To eliminate the phantom red/yellow shadows, switch to contact lenses, or to a heavier pair of eyeglasses.

Adjusting the Linearity Controls

When the height and width measurements are correct but the monitor displays one or more of the linearity problems illustrated in Figure 3-33, it's usually because the "D" board inside the cabinet has been swapped. In that case, various controls on the replacement board will have to be adjusted as well. To reach the controls, the back cabinet has to be removed. That exposes you to dangerous high voltage and the possibility of electric shock. As explained in Chapter 1, an isolation transformer must be used to minimize the shock hazard. With the understanding that the following information is only for qualified radio/TV-repair technicians working in fully equipped shops, here's the general linearity adjustment procedure:

1. Remove all rings, watches, and other jewelry. Review the safety rules given in Chapter 1.
2. Turn off the Macintosh II and the monitor, wait 30 seconds, and then unplug the power and video cables from the back of the monitor.

3. Unplug the other end of the monitor's AC power cable.
4. Set up a container for holding small parts. As shown in Figure 3-17, the back cabinet of the AppleColor High-Resolution RGB Monitor is held by four Phillips-head screws. One screw is located in each corner. Lay the monitor face down on a soft towel and remove the screws using a #1 Phillips-head screwdriver. Place the screws in the parts container. Lift away the cabinet back and put it aside.
5. While taking care not to touch any exposed connections, stand up the monitor, and place it on top of a soft towel. Do not place it on top of a static discharge pad! If you touch any exposed connections, or if you place the monitor on a static discharge pad, you may get an electric shock (severe enough to cause you to drop the monitor), even though the power cord is disconnected.
6. As shown in Figure 3-27, the monitor's primary EMI shield is held by five Phillips-head screws, and loosely clipped to the anode (high voltage) wire. One screw is located on the lower right side of the monitor, the remaining four are located on top. Remove the screws using a #1 Phillips-head screwdriver. Place the screws in the parts container. Do not remove the EMI shield just yet.
7. While observing the anode-wire clip on the EMI shield, carefully lift the shield and gently twist it free of the anode wire. Do not grip the clip or hold the anode wire with your hands! Do not touch the anode well or any other part of the CRT. When the twisting motion separates the anode wire from the clip on the EMI shield, lift the EMI shield away and put it aside.

Removing the EMI shield exposes the "D" board, as shown in Figures 3-28 and 3-30. Note that the "D" label is not arbitrary. That's the way the board is marked!

8. For safety, verify that both ends of the monitor's AC power cable are disconnected. While taking care not to touch any exposed solder joints, reconnect the power and video cables to the back of the monitor. Do not reconnect the other end of the power cable just yet.

Note: The “Danger! High Voltage” warning symbol has been added to Figure 3-30 as a safety reminder. It does not actually appear on the “D” board. Nevertheless, “D” boards are dangerous. Use extreme caution when working in this area.

9. At this point, make absolutely sure that the metal EMI shield is a safe distance away from the work area. If any metal objects touch the exposed solder joints, there will be a dangerous short circuit as soon as you turn on the power.
10. When you're satisfied that the work area is safe, reconnect the monitor's power cord to an isolation transformer. *Do not attempt this procedure without the benefit of an isolation transformer!* Connect the isolation transformer to 120VAC and turn on the monitor.
11. Turn on the computer, start *Color TPG*, dismiss the start-up screen and General Instructions window (if necessary), and choose 13-inch AppleColor RGB (Apple-B) from the Screen Sizes menu.
12. Choose Cross Hatch (Apple-G) from the Test Patterns menu. As shown in Figure 3-32, this test hatches the display with regularly spaced grid blocks. The distance between the blocks is 1 inch or 1 centimeter (approximately $\frac{7}{16}$ of an inch) depending on which measuring system is in effect. If the linearity is adjusted properly, all of the grid lines should be straight. The display should be perfectly square. Blocks at the top of the screen should be exactly the same size as blocks at the bottom of the screen. Typical linearity problems are shown in Figure 3-33.
13. If the test pattern has a trapezoidal shape, insert the screwdriver end of a plastic TV alignment tool (not a metal screwdriver) into RV505, the V.PHASE control on the “D” board, and turn it slowly until the problem is corrected.
14. If the test pattern has a concave or a convex (pin cushion) shape, insert the screwdriver end of a plastic TV alignment tool (not a metal screwdriver) into RV506, the PIN AMP control on the “D” board, and turn it slowly until the problem is corrected.

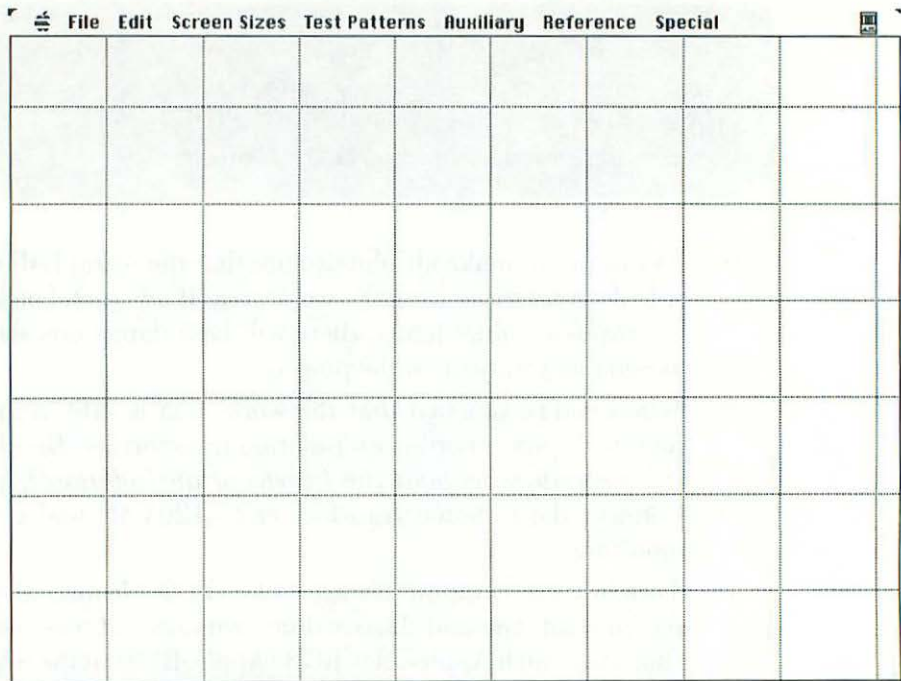

Figure 3-32 The Cross Hatch test pattern hatches the display with regularly spaced grid blocks.

15. If the blocks at the top of the test pattern are not exactly the same size as the blocks at the bottom of the test pattern, insert the screwdriver end of a plastic TV alignment tool (not a metal screwdriver) into RV509, the V.LIN control on the “D” board, and turn it slowly until the problem is corrected.
16. If the test pattern display is bowed or curved, insert the screwdriver end of a plastic TV alignment tool (not a metal screwdriver) into RV511, the V.BOW control on the “D” board, and turn it slowly until the problem is corrected.
17. If the test pattern has a parallelogram shape, insert the screwdriver end of a plastic TV alignment tool (not a metal screwdriver) into RV516, the V.ANGLE control on the “D” board, and turn it slowly until the problem is corrected.

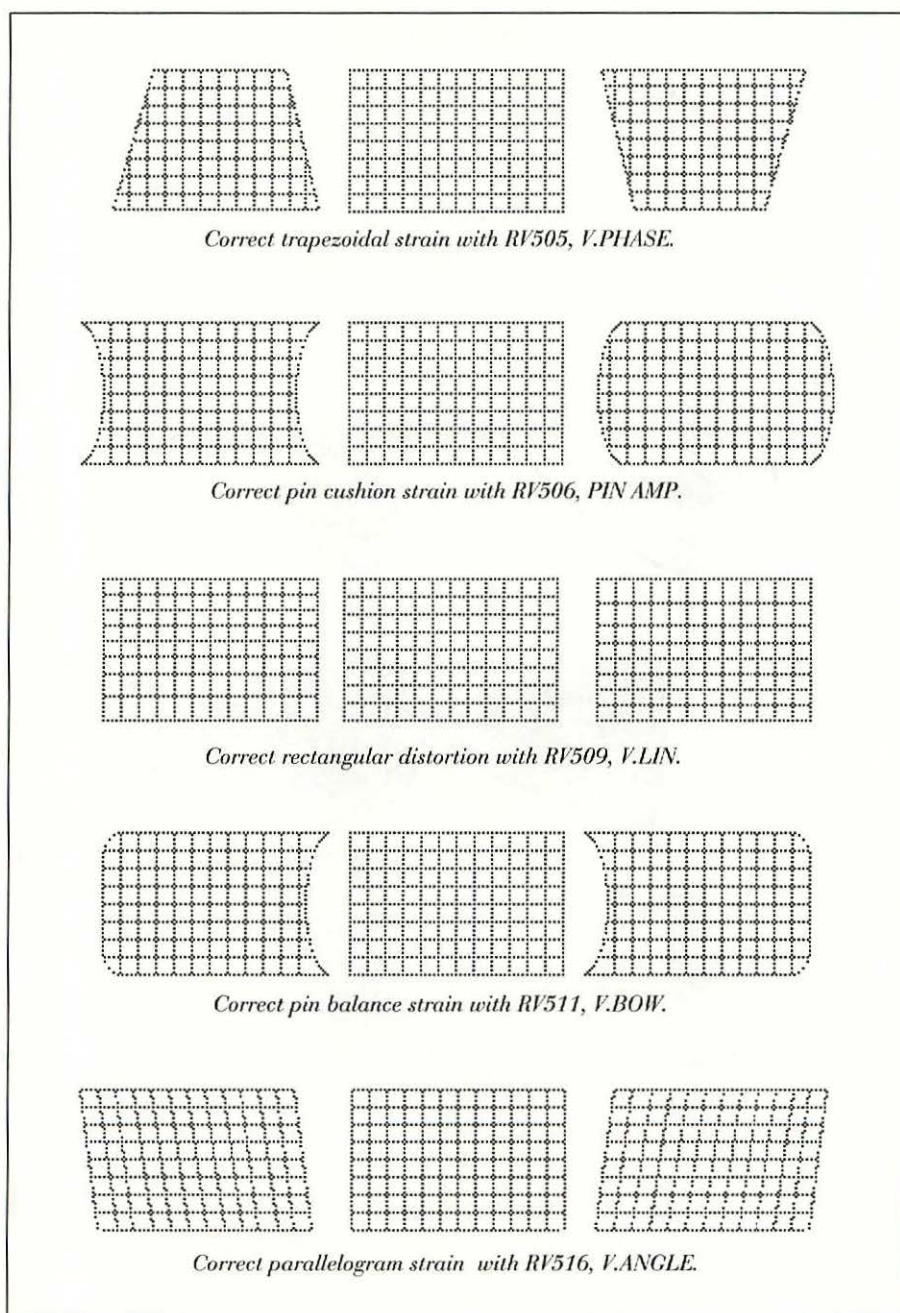

Figure 3-33 Typical linearity problems.

18. When you're satisfied that the linearity is as good as you're going to get it, hold down the Option key and choose Geometric Test (Apple-T) from the Test Patterns menu. As shown in Figure 3-34, the Geometric test pattern draws five circular patterns on top of the cross hatch.

Each of the circular test patterns should be perfectly round. The four smaller test patterns should be exactly the same size. If significant distortion persists, you'll need the service manual to go further. See component level repairs at the end of this chapter.

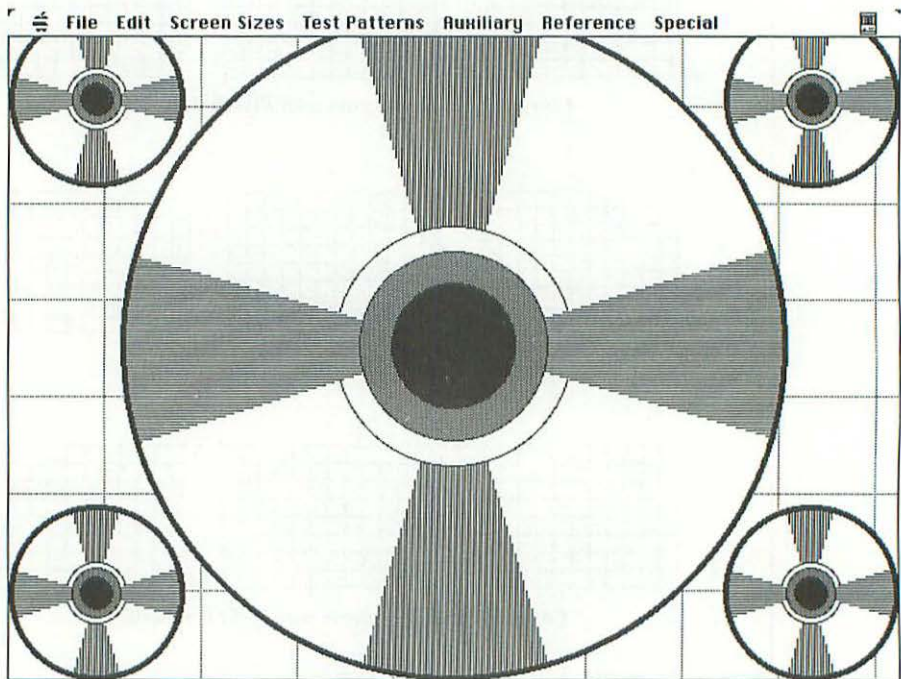

Figure 3-34 The Geometric Test draws five circular patterns on top of the cross hatch.

19. Normally, that's all there is to it. At this point, the monitor should look spectacular—as good as the day you got it. Reverse steps 12 to 1 and you're all done.

Component-Level Repairs

Many people think that Apple Computer Corporation builds its own monitors completely within the United States. In fact, the AppleColor High-Resolution RGB monitor is manufactured by Sony Corporation of Japan. It's merely imported by Apple Computer.

Other Macintosh II-compatible RGB monitors that are built on similar frames include the Sony CPD-1302 and Sony CPD-1304. Model CPD-1302 is similar to the AppleColor High-Resolution RGB monitor. Model CPD-1304 is similar to non-Apple Trinitron monitors.

Comparing Sony-built monitors (regardless of whose name is on the cabinet) is like comparing Chrysler Corporation cars. When you compare Dodge cars to Plymouths and Chryslers (all built by Chrysler Corporation), you find that the bodies (cabinet parts) are different, but major mechanical parts are interchangeable.

With that in mind, Table 3-2 provides an interchangeable parts cross-reference guide. For a complete list of interchangeable OEM parts, compare the circuit drawings in the Sony CPD-1302 Service Manual to the actual boards in an AppleColor High-Resolution RGB monitor.

Table 3-2. Interchangeable Parts Cross-Reference Guide

AppleColor H-R RGB	Sony CPD-1302	Description
Service Manual	9-963-637-01	S/M CPD-1302 1986 US/CAN
Q508 2SD1887	8-729-805-07	2SD1887-CA Horizontal-output transistor
T502 F.T.B.	1-437-164-11	Flyback transformer
HVC	1-230-666-12	High-voltage resistor

Symptoms of HVC failure are a failure for the monitor to operate at all, or of the monitor blanking out after short use. If this part fails, you can order a replacement much cheaper by going through the Sony parts distributor than through the usual repair channels. See the Sony CPD-1302 service manual for replacement details.

Ordering Replacement Parts

Once you understand that the AppleColor RGB High-Resolution Monitor is a Sony television set, you can proceed to service it like any other Sony television set:

1. If you don't already know the telephone number of your regional Sony TV parts distributor, you can get it from the national Sony TV Service Group. The telephone number for the national Sony TV Service Group is given in Appendix B.
2. Next, call the regional Sony TV parts distributor and order the service manual you need. The part number for Sony CPD-1302 service manual is given in Table 3-2.
3. Once you get the Sony CPD-1302 service manual, you can order additional OEM repair parts by number from the same regional parts Sony TV parts distributor.
4. If the part you want is not in the CPD-1302 service manual, you can still try to order it. Just use the Sony number printed on the part. If asked, tell them it's for a Sony-built private label monitor and leave it at that.

Remember that the Sony CPD-1302 service manual is written for trained TV-repair technicians. It assumes that you have a fully equipped shop (DMM, frequency counter, isolation transformer, luminance meter, oscilloscope) and that you know how to use the equipment. There's a great deal of information in the manual but there's very little hand holding.

Remember also that the Sony CPD-1302 is similar to, but not identical to, the AppleColor High-Resolution RGB monitor. In addition, ongoing board revisions mean that some are more similar than others. In each case, it's up to the TV technician to figure out which parts are the same, and which are not. The point is that anyone who can fix a Sony Trinitron TV can fix an AppleColor RGB, provided that he has a Macintosh II to connect it to and a copy of *Color TPG*.

Monitor Accessories

Accessories for the AppleColor High-Resolution RGB Monitor fall into three general categories: filters, stands, and swivel bases.

Filters

Anyone who's ever used the AppleColor High-Resolution RGB Monitor knows that the screen glares. Anyone who's ever used the CPD-1302 and/or CPD-1304 monitors knows that the screens on comparable Sony monitors do not.

The reason has to do with the CRT. The Trinitron CRT used in the AppleColor High-Resolution RGB Monitor bears Sony part number M34JNQ10X. The nonglare Trinitron CRT used in the Sony CPD-1302/1304 monitors bears Sony part number M34JNQ15X. Although both are made by the exact same company (Sony), they are not identical.

To eliminate the glare, you can either change the CRT or add a screen filter. The first option is not cost effective. Trinitron CRTs are expensive and there's quite a bit of labor involved. Unless your CRT otherwise needs replacement, the only cost-effective way to eliminate glare is with a screen filter.

Anti-glare Filters

Screen filters come in two types: anti-glare and contrast enhancement. The best anti-glare types use circular polarizing (CP) filters made of optical-quality glass. These eliminate glare just like Polaroid sunglasses. Laminated triacetate CP filters work equally well, but are more easily scratched.

Table 3-3 lists Polaroid filter products for the AppleColor High-Resolution RGB Monitor. Since the same filters also fit dozens of other monitors, this information will help you to order from mail-order catalogs that don't normally include Apple products in their cross references.

Relatively heavy glass CP filters hang from the top of the monitor. Relatively lightweight triacetate CP filters stick to the monitor's front bezel with adhesive pads. An adapter kit for triacetate filters (sold separately) helps to contour the flat filter frame to curved monitor bezels. The adapter kit is not needed with glass CP filters because they mount from the top. Both types of filters are shown in Figure 3-35.

Table 3-3. Polaroid Filter Products Appropriate to the AppleColor High-Resolution RGB Monitor

Model No.	Part No.	Description	Filter Size
CP50	607012	Laminated triacetate anti-glare filter	11 ⁵ / ₈ × 8 ⁷ / ₈
CP50SC	611589	Laminated triacetate anti-glare anti-VLF/ELF filter with grounding clip	11 ⁵ / ₈ × 8 ⁷ / ₈
CP90	615327	Glass anti-glare anti-VLF/ELF filter with grounding clip	10 ¹ / ₈ × 13 ¹ / ₈
Adapt Kit	612148	Curved bezel adapters for triacetate filters	
PolaClear	615202	Nonstreaking cleaner for triacetate and glass filters	

**Figure 3-35** Circular Polarizing Filters. *Courtesy of Polaroid Corporation, Polarizer Division.*

Contrast Enhancement Filters

Other anti-glare filters work like regular sunglasses. They merely enhance contrast by darkening the screen. When used on AppleColor High-Resolution RGB monitors, they're usually counter-productive. To compensate for the darkened screen, many users respond by turning the brightness control to maximum. That has a negative effect on focus. Other users compensate by turning up the cut-off control. That causes the monitor to intermittently shut itself down, which usually results in costly and completely unnecessary board swaps.

Anti-Radiation Filters

A third type of filter helps to reduce extremely low frequency (ELF) and very low frequency (VLF) radiation emitted from the CRT. These generally contain an extra lens coating and an electrostatic discharge (ESD) clip. To see how they work, hold a piece of paper next to the face of the CRT. On an unprotected AppleColor High-Resolution RGB monitor, the paper will stick to the screen. With a radiation filter in place, the paper will fall away.

Stands

Another way to deal with VLF radiation is to reposition the monitor. Experts disagree on whether exposure to VLF has harmful effects, but everyone agrees that VLF is real. Furthermore, every study made to date states that VLF radiation drops to insignificant levels once you get two feet away from the monitor. That being the case, what's the point of arguing? You can easily protect yourself by using a full-size computer table and positioning the AppleColor High-Resolution RGB monitor two feet away from your chest. A typical setup is shown in Figure 3-36. ScanCo's MacTable is shown in Figure 3-37.

Other safe arrangements might incorporate a swivel arm, or a CRT float, anything to push the monitor back and away. The important point is that the AppleColor High-Resolution RGB Monitor should not be placed on top of a Macintosh II CPU the way it's shown in the OEM literature. Due to the confines of a normal-sized desk, that puts you within VLF range, approximately 18 inches from the screen.

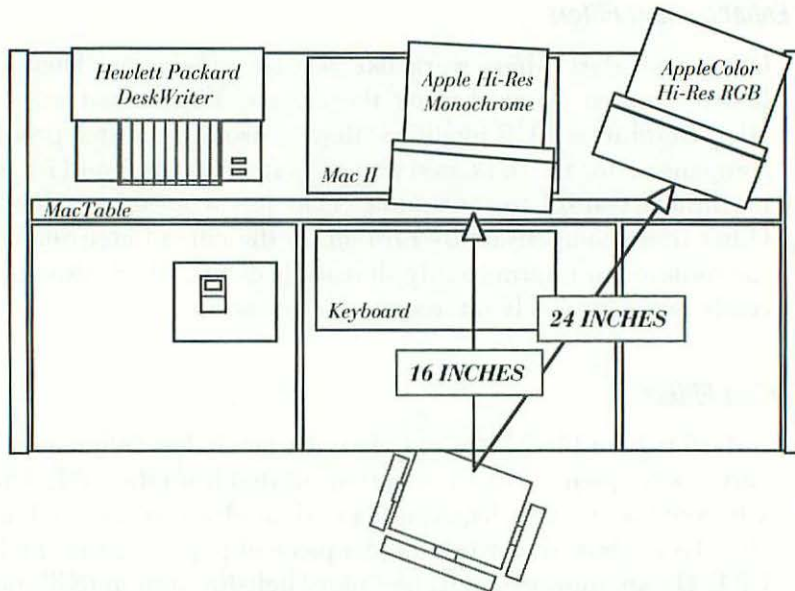

Figure 3-36 To protect yourself from VLF radiation, use a full-size computer table and position the AppleColor High-Resolution RGB Monitor at least two feet away from your chest.



Figure 3-37 MacTable. *Courtesy of ScanCo.*

Swivel Bases

Another difference between the Sony CPD-1302 and the AppleColor High-Resolution RGB Monitor is that the Sony monitor is usually equipped with a swivel base while the AppleColor monitor is not. The solution is to install model number MO403, the Apple Universal Monitor Stand. This stand fits the Apple High-Resolution Monochrome Monitor as well. Here's the installation procedure:

1. Turn off the Macintosh II and the monitor, wait 30 seconds, and then unplug the power and video cables from the back of the monitor.
2. Place the monitor upside down on a soft towel.
3. Unscrew the hole plug using a Phillips-head screwdriver as shown in Figure 3-38.

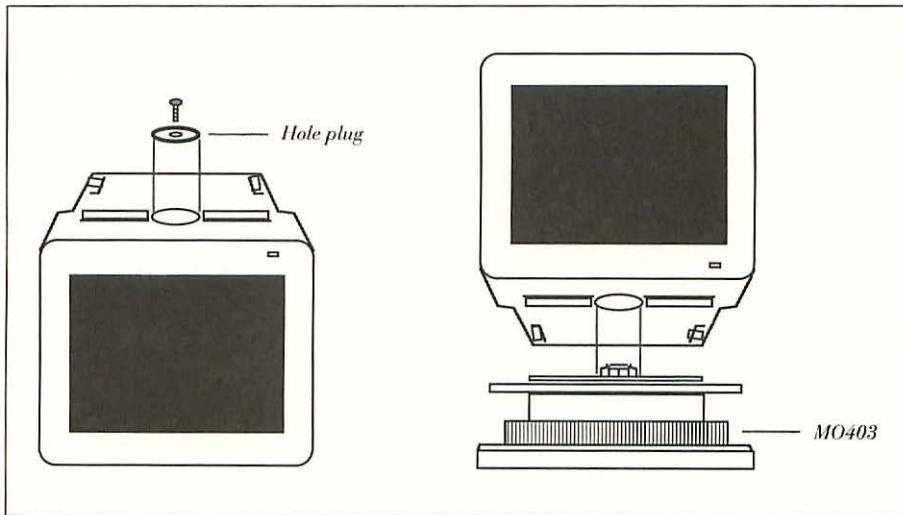

Figure 3-38 To prepare an Apple monitor for use with an Apple Universal Monitor Stand (MO403), unscrew the hole plug using a Phillips-head screwdriver.

4. The area capped by the hole plug mates with a protrusion on the swivel base. Position the Universal Monitor Stand to the left or right of the CPU as shown in Figure 3-36, stand up the monitor and set it on top of the swivel base. When the two units come together, the fit should be perfect.

5. Reconnect the power and video cables to the back of the monitor and you're all done.

That's it for AppleColor High-Resolution RGB Monitors. Next we'll take a look at the Macintosh II CPU.

4

CPU Maintenance— Logic Board Upgrades

“A rose is a rose is a rose” or so the saying goes, but to date there have been 16 different models of the Macintosh II. This chapter outlines the various take-apart procedures, shows how to install logic board upgrades, and covers common repairs at the component level.

Table 4-1 gives model number identification information for the various Macintosh II central processing units (CPUs).

Table 4-1. CPU Model Number Information

Model Number	Description
M5333	Macintosh II CPU
M5430	Macintosh II Hard Disk 40 CPU
M5410	Macintosh II HD40/4 CPU
M5820	Macintosh IIx CPU
M5830	Macintosh IIx Hard Disk 80 CPU
M5660	Macintosh IIcx CPU
M5610	Macintosh IIcx 1/40 CPU
M5680	Macintosh IIcx 4/80 CPU
M5710LL/A	Macintosh IIci CPU
M5715LL/A	Macintosh IIci 1/40 CPU

(continued)

Model Number	Description	<i>(continued)</i>
M5740LL/A	Macintosh IIci 4/80 CPU	
M5510LL/A	Macintosh IIx CPU	
M5515LL/A	Macintosh IIx 4/80 CPU	
M5520LL/A	Macintosh IIx 4/160 CPU	
M0363LL/A	Macintosh IIsi 2/40 CPU	
M0364LL/A	Macintosh IIsi 5/80 CPU	

In order to cover every model of the Macintosh II, this chapter is divided into sections. The first section covers the Macintosh II/IIx/IIfx. The second section covers the Macintosh IIcx/ci. The third and last section covers the Macintosh IIsi.

Take-Apart Procedure for the Macintosh II/IIx/IIfx

Always start the Macintosh II/IIx/IIfx take-apart procedure by grounding yourself. To ground yourself, verify that the computer is turned off but plugged in, then touch any unpainted piece of metal at the back of the computer.

Next, disconnect the AC power cable from the wall outlet and from the computer. Safety requires that both ends of the power cable be disconnected. Simply choosing Shut Down (from the Special menu) is not enough.

Next, disconnect the keyboard, monitor, mouse, printer, and all other peripheral cables. Remove any disks that might be partially inserted in the disk drives.

When the disk drives are empty and all of the cables are disconnected, reach for a #1 Phillips-head screwdriver, and set up a container for holding small parts.

The lid of the Macintosh II/IIx/IIfx CPU is fastened by a single #1 Phillips-head screw. As shown in Figure 4-1, the screw is located at the top center of the real panel. Remove the screw, and put it in the parts container.

The back edge of the top cover or lid is further secured by two lid latches, as shown in Figure 4-2.

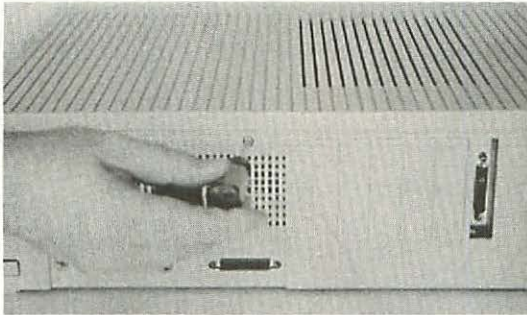

Figure 4-1 The lid of the Macintosh II/IIx/IIfx CPU is fastened by a single #1 Phillips-head screw.

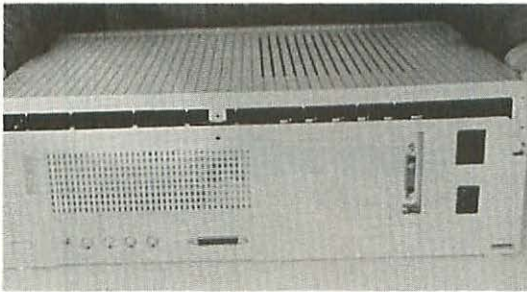

Figure 4-2 The back edge of the top cover or lid is further secured by two lid latches.

Pushing the latches releases the back edge of the lid, but not the front edge. The front edge of the lid is hinged. To release the hinges, carefully rotate the lid, pull back, and push out, as shown in Figure 4-3. Be careful not to rotate the lid a full 90°. The lid hinges are made of plastic and are easily broken.

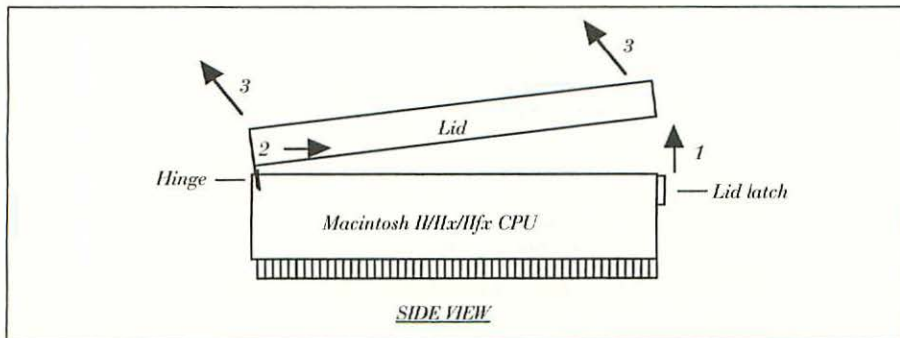

Figure 4-3 To release the hinges, carefully rotate the lid, pull back, and push out.

When the hinges are fully separated, the top cover can be lifted away. Figure 4-4 identifies the various subassemblies inside the Macintosh II/IIx/IIfx.

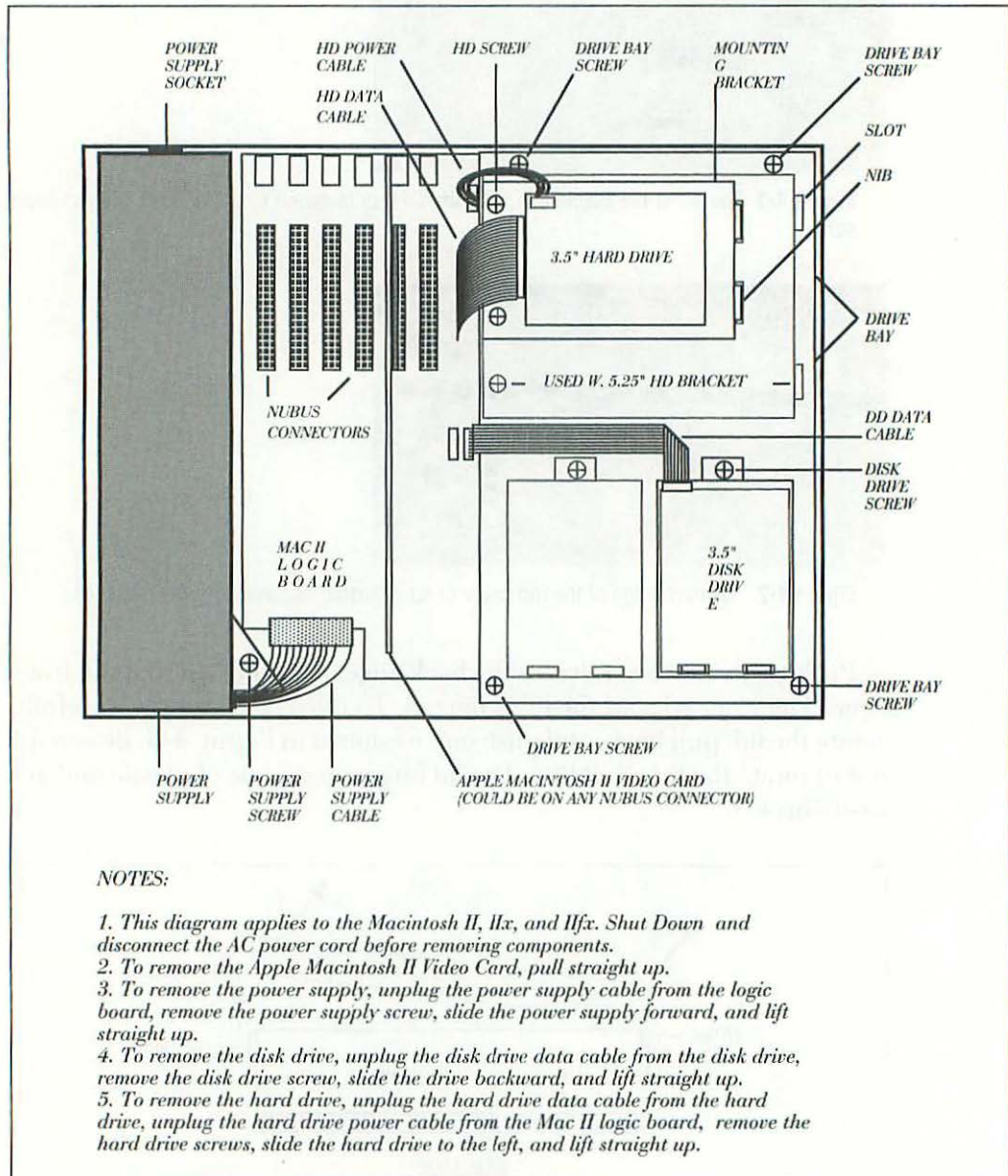

Figure 4-4 Inside the Macintosh II/IIx/IIfx.

Additional disassembly instructions are given in context in the next two sections. Take-apart instructions for the Macintosh IIx/ci and IIsi are given later in this chapter.

Fan Controller Upgrades

The original Macintosh II and the Macintosh IIx contain one-speed power supply fans which run at high speed all of the time. The original fans are *very loud*.

The Macintosh IIfx, IIcx, IIci, and IIsi contain thermostatically controlled power supply fans. As shown in Figure 4-5, thermostatically controlled fans run at variable speed in response to temperature. Under normal operating conditions, thermostatically controlled fans are *much* quieter.

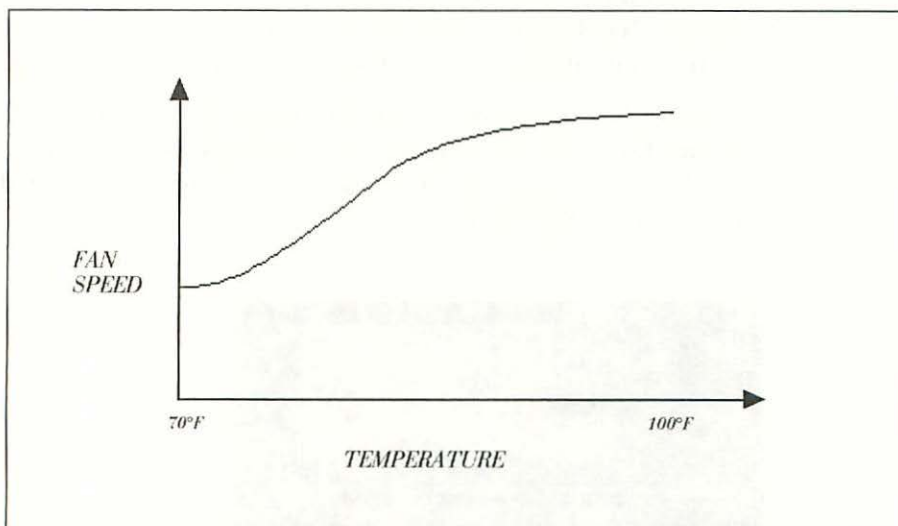

Figure 4-5 Thermostatically controlled fans run at variable speed in response to temperature.

The fan controller upgrade involves adding a thermostat to the Macintosh II/IIx power supply. With this upgrade the original Macintosh II/IIx fan becomes just as efficient and just as quiet as the variable-speed fans supplied with the latest Macintosh IIfx CPUs. A fan controller upgrade kit is shown in Figure 4-6.



Figure 4-6 Nova Fan Controller. *Courtesy of Nova International.*

Identifying Power Supplies—Which Model?

Apple Computer uses two power supplies in the Macintosh II and the Macintosh IIx. One is made by Astec and the other is made by Sony. Nova International makes a different fan controller for each.

To identify which power supply is inside your Macintosh II/IIx, open the lid and read the brand name printed on the side of the power supply. Typical labeling is shown in Figure 4-7. Component-level differences can be seen in Figure 4-8.

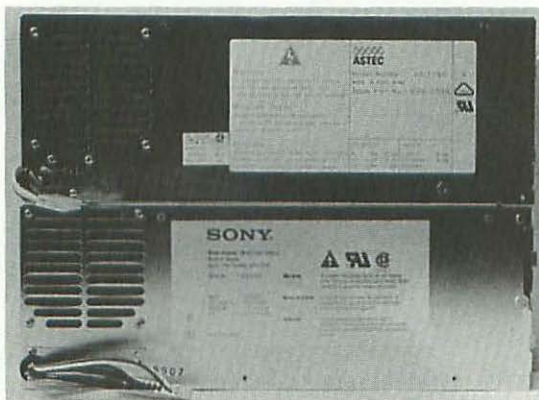

Figure 4-7 Apple Computer uses two power supplies in the Macintosh II and the Macintosh IIx.

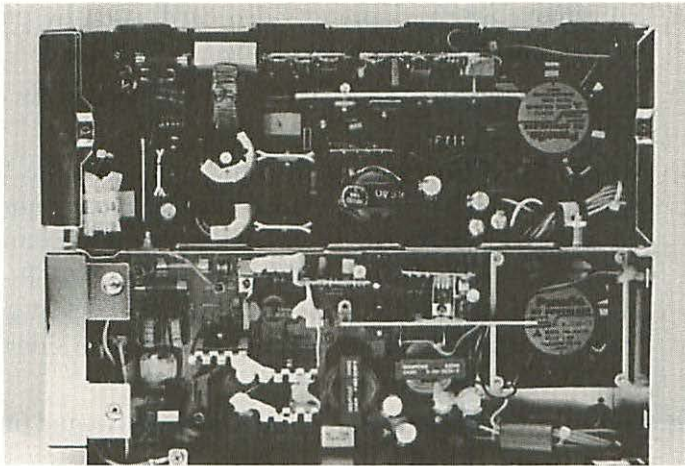

Figure 4-8 The upper supply is made by Astec. The lower supply is made by Sony.

Note: The OEM number of the Astec supply is AA13780 (Made in Hong Kong). The OEM number of the Sony supply is CR-45S (Made in Taiwan). The Apple part number for either supply is 699-0389.

Installing Fan Controller Upgrades

Electrically, the two supplies are equivalent but physically, they are quite different. Consequently the fan controllers are different and the installation procedure is slightly different. With that in mind, here's the complete installation procedure:

1. Shut down the Macintosh II/IIx (if necessary), and wait 20 seconds.
2. Disconnect the AC power cable from the back of the computer.
3. Remove the computer's lid as shown in Figures 4-1 and 4-2. If necessary, refer to the take-apart procedure for the Macintosh II/IIx/IIfx given at the beginning of this chapter.
4. Identify the power supply screw and power supply cable shown in Figure 4-4. If the currently installed video card (or any other Nu-Bus card) overlaps this area, the card will have to be removed:

- 4a. To remove an overlapping video card, start by putting on a wrist-grounding strap as explained in Chapter 1.
- 4b. Next, unscrew the video cable from the back of the Macintosh II/IIx.
- 4c. When the video cable is disconnected, grip the bare metal bracket at the back of the video card with one hand, and grip the other side of the video card with your other hand. Pull the overlapping video card straight up and out, as shown in Figure 4-9. If the card appears to be stuck, rock it gently from front to back. Don't rock the card from side to side or you may break the NuBus connector.
- 4d. Once the card is out, place it on a conductive mat or on a clean sheet of aluminum foil.

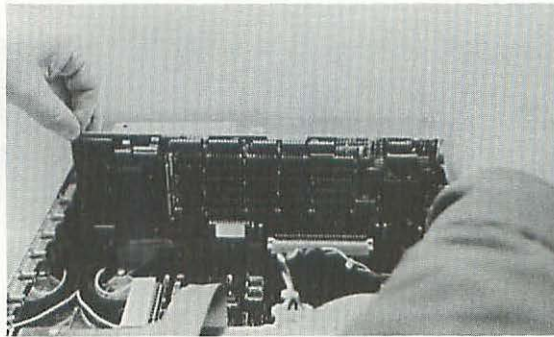

Figure 4-9 Pull overlapping video cards straight up and out.

5. The power supply is fastened by a single #1 Phillips-head screw. As shown in Figure 4-10, the screw is located in the left front corner of the CPU. Remove the power-supply screw, and put it in the parts container.
6. The end of the power supply cable is tightly connected to the Macintosh II/IIx logic board. As shown in Figure 4-11, separate the connector using a 1.25-inch wide, stiff-blade putty knife.
7. The AC power socket on the back of the power supply is loosely fit through the back of the CPU cabinet and the bottom of the power supply is loosely hooked into the bottom of the CPU cabinet. To remove the power supply, slide it forward as far as it can go, then lift it straight up and out, as shown in Figure 4-12.

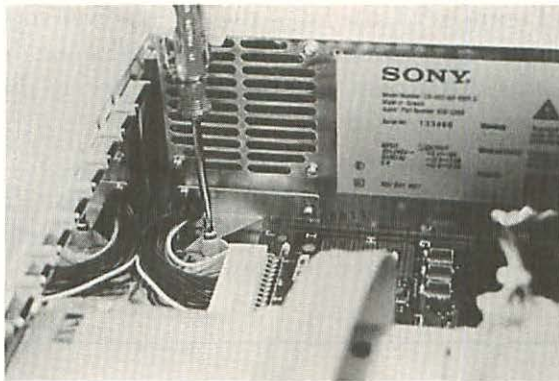

Figure 4-10 The power supply is fastened by a single #1 Phillips-head screw.

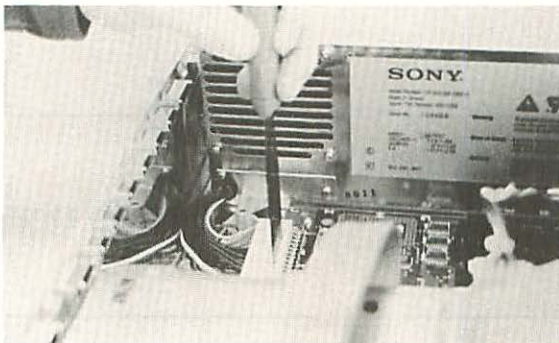

Figure 4-11 Separate the power supply connector using a 1.25-inch wide, stiff-blade putty knife.



Figure 4-12 Remove the power supply by sliding it forward and lifting straight up.

8. As shown in Figure 4-13, the lid of the Astec power supply is held on each end by a single Phillips-head screw, and along the edges by tight-fitting nibs. After removing the screws, pry up the Astec lid with a small slotted screwdriver.

As shown in Figure 4-14, the lid of the Sony power supply is held on one end by two Phillips-head screws, in the middle by tight-fitting nibs, and on the opposite end by two hidden hinges. After removing the screws, pry up the Sony lid and rotate it toward the hinges.

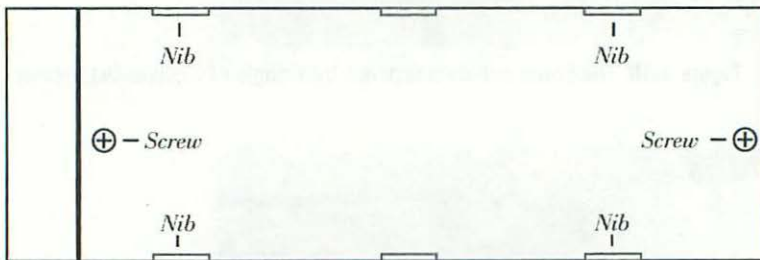

ASTECC AA13780 Power Supply

Figure 4-13 The lid of the Astec power supply is held on each end by a single Phillips-head screw and along the edges by tight-fitting nibs.

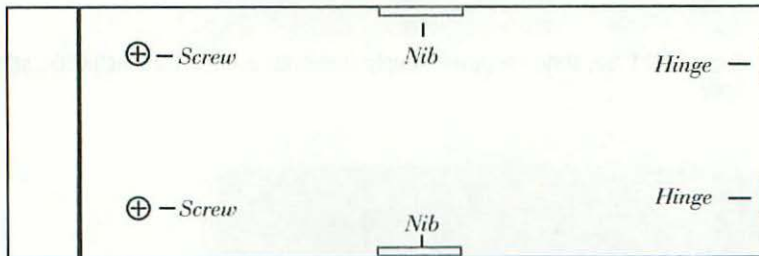

SONY CR-45S Power Supply

Figure 4-14 The lid of the Sony power supply is held on one end by two Phillips-head screws, in the middle by tight-fitting nibs, and on the opposite end by two hidden hinges.

9. If you've had your Mac for very long, the power supply and the CPU cabinet may be packed with dust. Dust should be removed with a hairdryer, as shown in Figure 4-15. It's best to do this outside. Cleaning the cabinets can make a sizeable dust cloud.

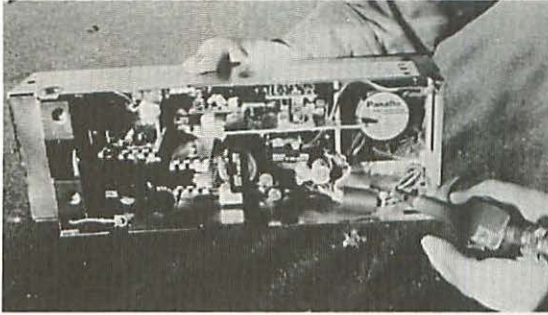

Figure 4-15 Dust inside the power supply can be removed with compressed air.

10. The two fan wires in the Astec power supply plug into a printed circuit board (PCB) connector marked “FAN.” The two fan wires in the Sony power supply plug into a PCB connector marked “CN204.” The physical locations of the connectors are different. Locate the correct connector by following the fan wires to the PCB. Disconnect the fan wires from the PCB connector by pulling straight, up as shown in Figure 4-16.

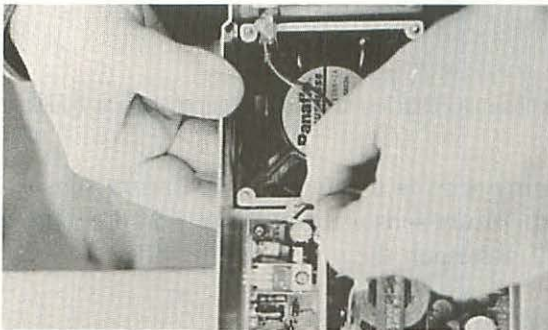

Figure 4-16 Disconnect the fan wires from the PCB connector by pulling straight up.

11. Conceptually, the fan controller goes between the fan wires and the PCB. Plug the fan wires into the controller, as shown in Figure 4-17, then plug the controller wires into the PCB.
12. The fan controller attaches to the power supply lid with double-sided tape, as shown in Figure 4-18. The mounting location is slightly different for each power supply. Clean the power supply lid, and mount the controller so that it doesn't hit the fan. Attach a tie wrap to the controller for extra strength.



Figure 4-17 Plug the fan wires into the controller, then plug the controller wires into the PCB.

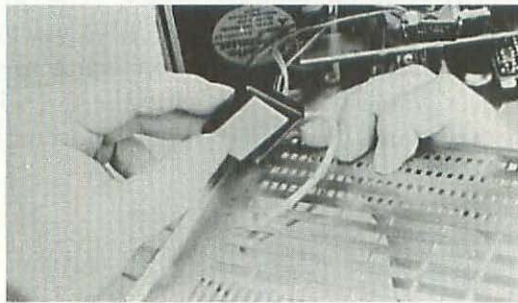

Figure 4-18 The fan controller attaches to the power supply lid with double-sided tape.

13. The remaining wire is a remote temperature sensor. Snake the remote temperature sensor through the grid opening, as shown in Figure 4-19. Reattach the power supply lid.

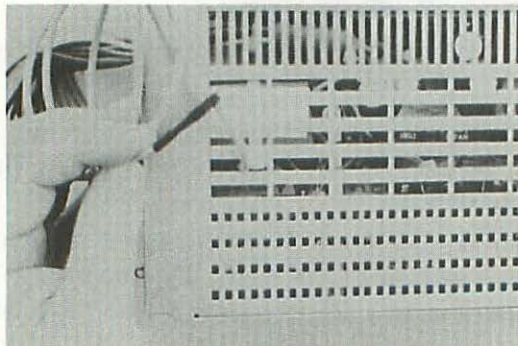

Figure 4-19 The remaining wire is a remote temperature sensor.

14. To reinstall the power supply, place it down as close to the front of the CPU cabinet as you can and slide it back into position. If you put it down in the middle of the CPU cabinet, the hooks underneath the power supply won't grab the eyes on the bottom of the cabinet and it won't seat properly.
15. Reconnect the power supply screw and the power supply cable.
16. Figure 4-20 shows the video card mounting position illustrated in the AppleColor High-Resolution RGB Monitor manual. Note that this position muffles the fan, which unnecessarily increases the internal operating temperature of the CPU and generally defeats the purpose of a fan controller. Positioning the Mac II video card further away from the power supply, as shown in Figure 4-21, allows the fan's air to circulate.

To reinstall the card further away from the power supply, select an empty NuBus slot, pull up the slot's metal expansion cover shield, and push out the slot's plastic hole plug. Install the metal expansion cover shield and the plastic hole plug behind the old slot. Install the video card in the newly selected slot. Reconnect the video cable to the video card.

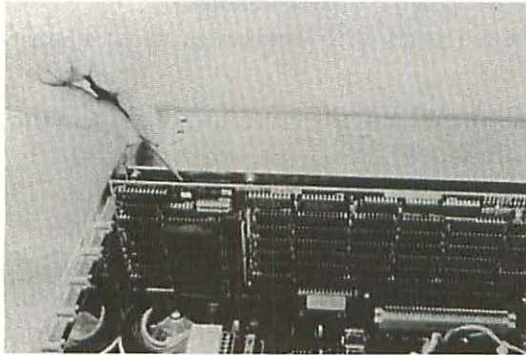

Figure 4-20 The video card mounting position illustrated in the AppleColor High-Resolution RGB Monitor manual muffles the power supply fan, which unnecessarily increases the internal operating temperature of the CPU.

17. Position the thermostat wire between the disk drive and the hard drive, as shown in Figure 4-22. Hard drives tend to run hot. This area is also directly above the single in-line memory modules (SIMMs) which also tend to run hot. Fasten the thermostat wire with tape and tie wraps.

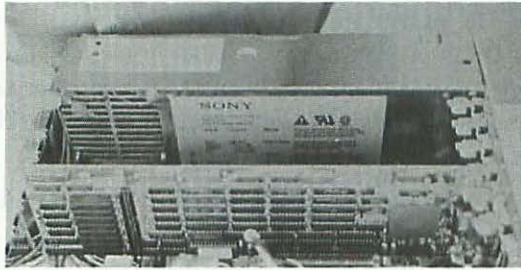

Figure 4-21 Positioning the video card further away from the power supply allows the fan's air to circulate.

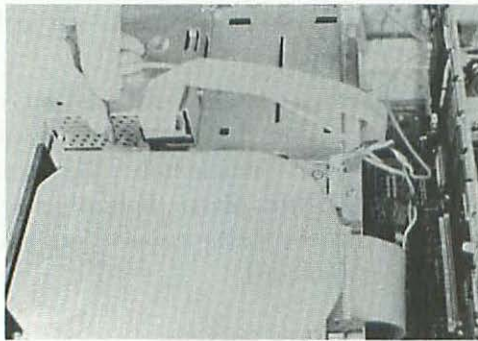

Figure 4-22 Position the thermostat wire between the disk drive and the hard drive.

18. Reinstall the lid and the lid screw, reconnect the power cable, and you're all done!

Testing Fan Controller Upgrades

With the fan controller installed, it's difficult to hear the fan spin over the noise of a hard drive. Under normal room temperature conditions of 70°F, you may have to hold your hand near the air intake (over the left front side of the CPU cabinet) to prove that it's working. If it is working, you'll feel the air movement.

As the temperature inside the CPU cabinet increases, the fan spins faster and the noise gets louder. In heat wave conditions of 95 to 100°F, the fan noise is quite noticeable. In chilly conditions below 55°F, the fan won't spin at all until the temperature inside the CPU cabinet rises.

Mac II to IIX Logic Board Upgrades

An original Macintosh II is upgraded to an official Macintosh IIX by changing the logic board and adding a 1.4 MB disk drive. Here's the board-swap procedure:

1. Shut down, disconnect the AC power cord from the wall outlet, and remove the computer's lid. Follow the take-apart procedure for the Macintosh II/IIX/IIfx given earlier in this chapter.
2. Remove all NuBus cards and remove the power supply as documented in the section on fan-controller upgrades.
3. Unplug the drive cables. As indicated in Figure 4-4, unplug the disk drive data cable(s) from the logic board. Unplug the hard drive data and power cables from the hard drive.
4. Remove the drive bay. As indicated in Figure 4-4, unscrew four Phillips-head screws and lift straight up.
5. Disconnect the remaining cables. As indicated in Figure 4-23, disconnect the hard drive data (J9) and power cables (J8) from the logic board. Disconnect the disk drive cable(s) (J16—17) from the logic board. Disconnect the speaker plug (J30) from the right front corner of the logic board.

The jack (Jn) references illustrated in Figure 4-23 are correct for Apple part number 820-0288-A, which is a late-model Macintosh II logic board. Earlier models of the Macintosh II logic board are marked with different jack references, although the jacks are in exactly the same spots, as shown in Figure 4-24.

6. If necessary, blow out the dust with compressed air.
7. Remove the single inline memory modules (SIMMs) from the logic board. Refer to Chapter 6, if necessary, for SIMM removal details.
8. Remove the logic board. As indicated in Figure 4-23, unscrew the two Phillips-head screws at board references B9 and B13 then, starting from the front of the logic board, use your thumbs to release the nine plastic snaps which secure the board to the CPU cabinet. Don't use a screwdriver on the snaps! If the tool slips, it will dig into the board and may cut nearby traces.
9. Remove the knob from the on/off switch.
10. Reverse steps 9 to 1 to install the Macintosh IIX logic board.

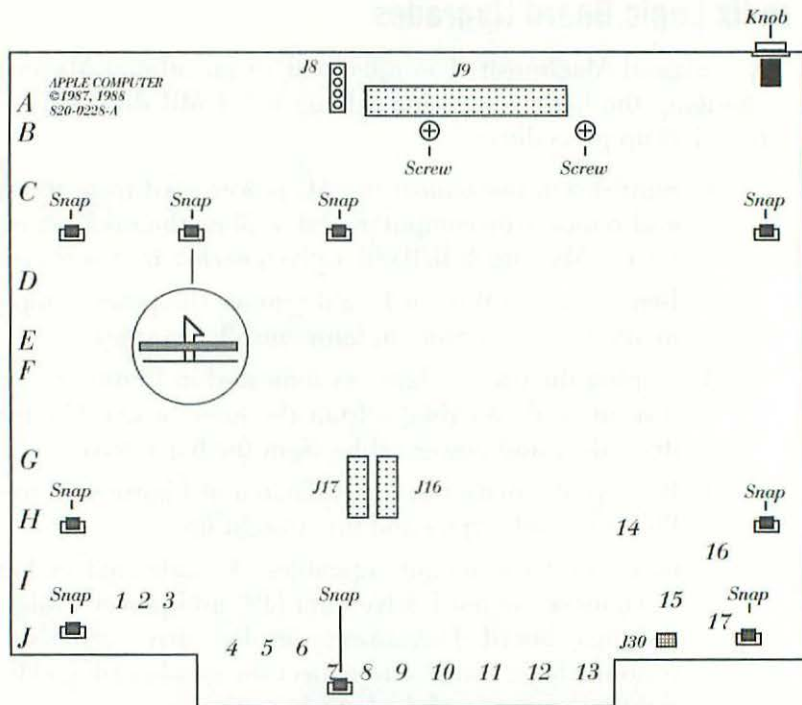

Figure 4-23 All Macintosh II/IIx logic boards are held by two Phillips-head screws and nine plastic snaps. The jack references illustrated here are correct for Apple part number 820-0228-A, which is a late-model Mac II logic board.

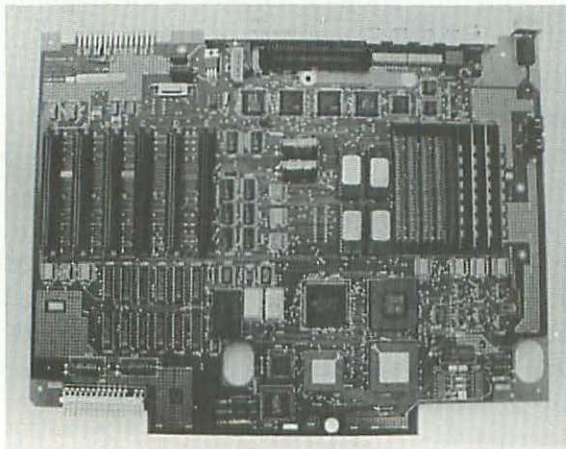

Figure 4-24 Earlier models of the Macintosh II logic board are marked with different jack references, although the jacks are in exactly the same spots. This photo shows Apple part number 820-0163-03.

The Macintosh IIx logic board upgrade includes a faster MC68030 CPU with built-in paged memory management unit (PMMU), a faster MC68882 floating-point processing unit (FPU), 256K of read-only memory (ROM) on a SIMM, and a super-integrated Wozniak machine (SWIM) disk-controller chip with built-in support for 1.4 MB high-density floppy drives (FDHDs). To complete the II-to-IIx upgrade, at least one 1.4 MB floppy drive must be added to the computer as well. Disk drive upgrades are covered in Chapter 8.

An alternative to swapping the whole logic board is to add a MC68851-RC16A PMMU, and a MC68882 FPU to your existing logic board. Chip-level upgrades are covered in Chapter 6. New ROMs and a SWIM chip can be added to an existing logic board, as well. FDHD upgrades are covered in Chapter 8.

Since all Macintosh IIx computers were factory equipped with 4 MB of random-access memory (RAM), II-to-IIx upgrades for original 1 MB Mac IIs should also include at least 4 MB of memory. Memory upgrades are covered in Chapter 6.

Mac II/IIx to IIfx Logic Board Upgrades

An official Macintosh IIx is upgraded to a Macintosh IIfx by changing the logic board, adding new 64-pin SIMMs, and installing a variable-speed fan controller into the power supply. Other than the fact that existing 62-pin IIx SIMMs cannot be transferred to the new logic board, the upgrade procedures are exactly the same as described in previous sections.

An original Macintosh II is upgraded to a Macintosh IIfx by changing the logic board, adding new 64-pin SIMMs, and installing a variable speed fan controller and a 1.4-MB disk drive. It's not necessary to go from a II to a IIx before upgrading to a IIfx. The II-to-IIx step can be skipped altogether.

The Macintosh II/IIx-to-IIfx logic board upgrade includes a faster MC68040 CPU with built-in PMMU, a 32 kilobyte static RAM cache, a faster 40 MHz MC68882 floating-point processing unit (FPU), a super-integrated Wozniak machine (SWIM) chip with built-in support for 1.4 MB high-density floppy drives (FDHDs), and 512K of ROM on a SIMM. The 512K ROM SIMM suggests that future Mac ROMs may contain a different operating system (OS). If so, upgrading to the new OS would simply be a matter of plugging in a new SIMM.

Component-Level Repairs

A lot of people buy Macintosh II/IIx-to-IIfx logic board upgrades when their original logic boards malfunction. That's great if you've been lusting for a IIfx upgrade anyway, but a more reasonable alternative is to fix the logic board you've already got. This section describes common failures and suggests things that you can do (or arrange to have done) to save thousands of dollars over the cost of a complete board swap.

Power-On Problems

When a Macintosh II/IIx/IIfx fails to power up from the keyboard, and the power-on/power-off switch on the back of the computer doesn't work either, then the trouble is most likely with B2, one of two lithium cells inside the computer. On the original Macintosh II and on early models of the Macintosh IIx, B2 (marked Varta, lithium 3V, ER 1/2 AA) has pigtail leads and is soldered to the logic board (like any other component), as shown in Figure 4-25.

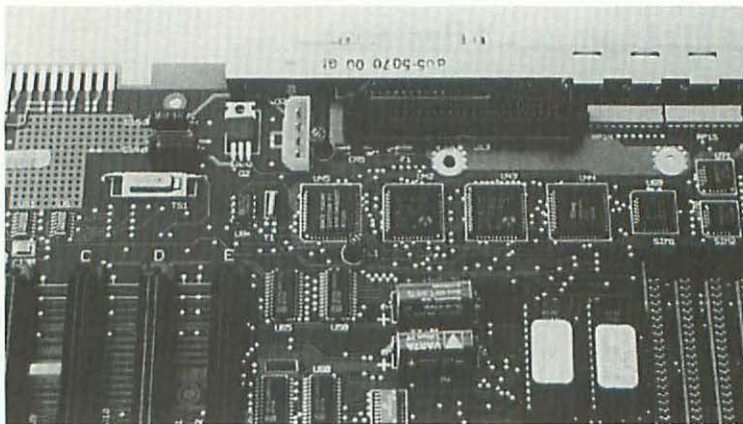

Figure 4-25 When a Macintosh II/IIx/IIfx fails to power up from the keyboard, and the power-on/power-off switch on the back of the computer doesn't work either, then the trouble is most likely with B2, one of two lithium cells inside the computer.

On later models of the Macintosh IIx, the two lithium cells (marked TL-5112 1/2AA, Tadiran 3.6V, lithium, inorganic) snap into a small battery box mounted in exactly the same spot. Note that the snap-in cells are rated 0.6 volts higher than the solder-in type.

On the latest Macintosh IIx, the cells (also marked TL-5112 1/2AA, Tadiran 3.6V, lithium, inorganic) snap into separate battery boxes, mounted further to the right.

Testing B2

To test B2, shut down and turn off the computer. Remove the lid and the drive bay as described in previous sections. Turn on your digital multimeter (DMM) and set it to read direct-current volts (VDC). Touch the red probe to the positive (+) side of the cell and touch the black probe to the negative (-) side of the cell. As shown in Figure 4-26, good cells read 3.2 to 3.85 volts. Weak cells read 2.3 to 3.1 volts. Any cell below 2.3 volts is considered dead.

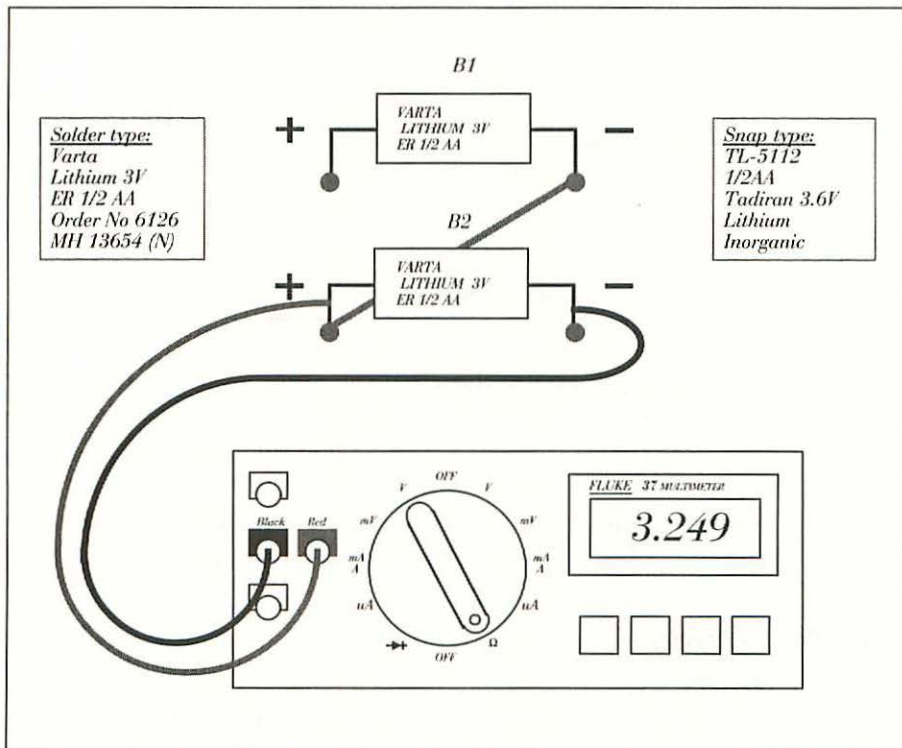

Figure 4-26 Good lithium cells read 3.2 to 3.85 volts.

It's very important to replace weak cells without delay. If the cell should leak, the battery acid could seriously damage the logic board. Instead of an easy repair, you'll be faced with quite a mess. The shelf life of a lithium cell is much longer than the in-service life, so spares can be kept on hand. Vendors of exact replacement lithium cells are listed in Appendix B.

Jumper Cables

So your Macintosh II/IIx/IIfx is down, you don't have any lithium cells on hand, and whatever you've got to do, had to be done yesterday. No problem. In an emergency, you can jump start the computer the same way you jump start a car. Figure 4-27 shows exactly how to do it. Table 4-2 provides a parts list. Everything you need can be purchased for just a few dollars at the local Radio Shack.

Table 4-2. Parts List for Figure 4-27

Quantity	Description	Radio Shack	1991 Catalog Price
2	AA cells	23-468	0.29 ea
1	Battery box	270-382	1.19 ea.
1	Battery snap	270-325	1.19 pkg/5
1	Jumper cables	278-1157	3.99 pkg/8

The bent paper clip shown in the diagram is not absolutely necessary, but the extension it provides makes it easier to work in tight quarters. Also, note that it's not necessary to clip the red jumper cable to pin 15 on the power supply connector. All you have to do is tap pin 15. Once the computer starts, (and it should start immediately) you can remove the jumper cables altogether, the same as when jumping a car battery.

Power Supply Service

The only exception to that is when bench servicing the power supply. To run either power supply (part number 699-0389, Astec or Sony), apart from the computer, the AC power cord has to be plugged in and the jumper cables have to remain connected. Table 4-3 provides pinouts, signal descriptions, and actual supply voltages. Both supplies are rated 156 watts, peak load.

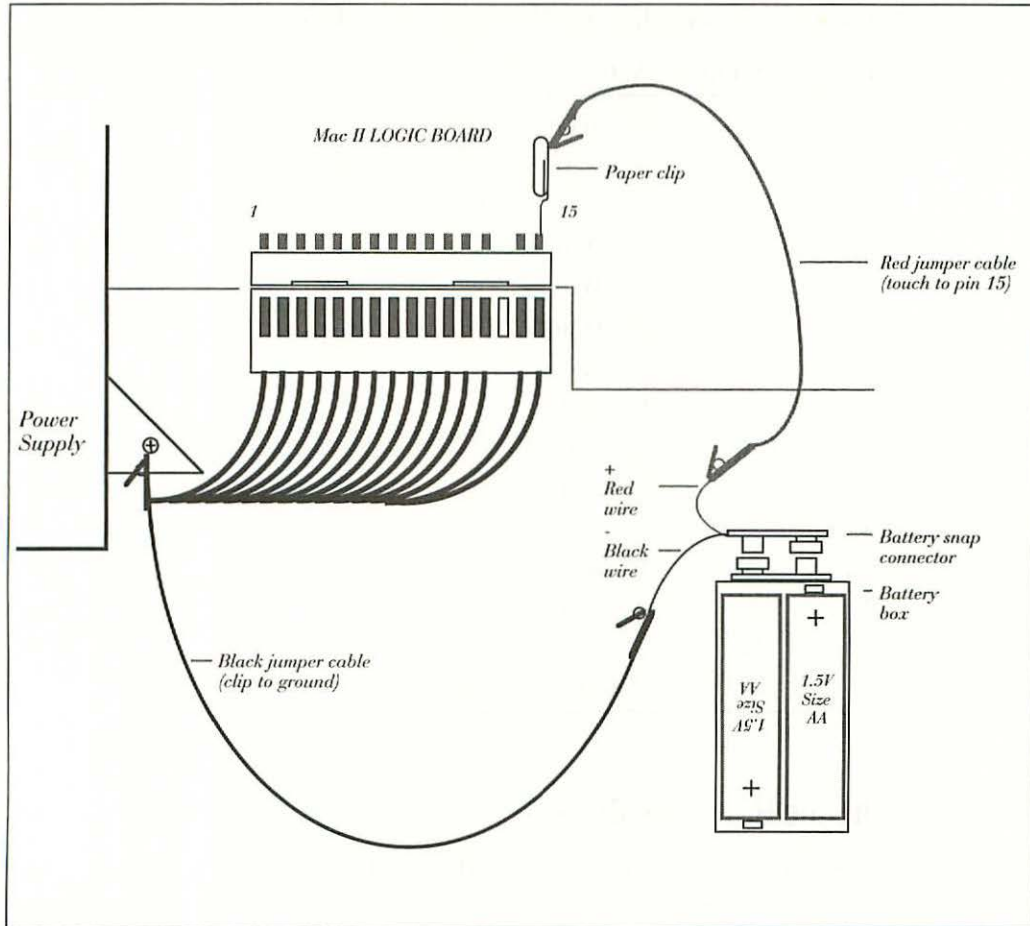

Figure 4-27 In an emergency, you can jump start a Macintosh II/IIx/IIfx the same way you jump start a car with a dead battery.

To test the supply, turn on your DMM and set it to read direct-current volts (VDC). Clip the black probe (-) to the power supply cabinet, and touch the red probe (+) to each of the pins on the power supply connector, one at a time. If any of the voltages given in Table 4-3 are missing or way out of range, then the supply is at fault. Sending it out for repair will save you approximately 50% over the cost of a power supply swap. Check Appendix B for a list of service providers that specialize in power supply repairs.

Table 4-3. Macintosh II/IIx/IIfx Power Supply Voltages

Pin	Signal	Actual
1	+12V	11.50V to 12.80V
2	+5V	4.90V to 5.20V
3	+5V	4.90V to 5.20V
4	+5V	4.90V to 5.20V
5	+5V	4.90V to 5.20V
6	+5V	4.90V to 5.20V
7	GND	Ground
8	GND	Ground
9	GND	Ground
10	GND	Ground
11	GND	Ground
12	GND	Ground
13	NC	No connection
14	-12V	-13.40V to -10.80V
15	/PFW	Power failure warning

Problems with the Real-Time Clock

The second cell in the lithium battery, B1, powers the real-time clock chip and the parameter random access memory (PRAM) chip, where control panel settings are stored. The load on B1 is less than the load on B2, so provided that the two cells are always changed in pairs, and provided that both replacement cells are equally fresh, B2 should always fail before B1. To test and replace B2, follow the procedure given above for B1. If either cell (B1 or B2) tests weak or bad, then replace them both.

SCSI Problems

When an original Macintosh II fails to recognize any small computer system interface (SCSI) device attached to the external SCSI port, and the devices in question are known to be in good working order because they work fine on other Macs and the SCSI bus is correctly terminated, then

the trouble is most likely with fuse F1 (1A, subminiature, fast acting), which is located next to the internal hard drive connectors, as shown in Figure 4-28.

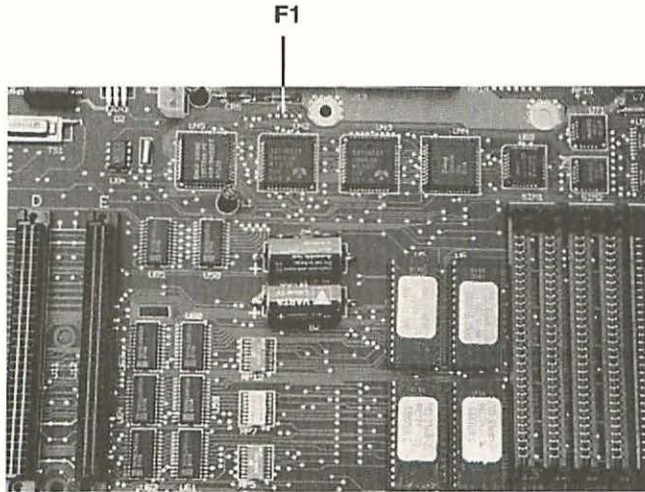

Figure 4-28 When an original Macintosh II fails to recognize any small computer system interface (SCSI) device attached to the external SCSI port, and the devices in question are known to be in good working order because they work fine on other Macs, then the trouble is most likely with fuse F1.

To test F1, shut down and turn off the computer. Remove the lid and the drive bay, as described in previous sections. Turn on your digital multimeter (DMM) and set it to the kilo-ohms ($k\Omega$) scale. Touch the red probe to one side of the fuse and touch the black probe to the other side of the fuse. A good fuse will read 0.00 to 0.01 Ω , depending on the sensitivity of the meter and the resistance of the test probes, as shown in Figure 4-29. Bad fuses generally read 0.L (overload) or give a very high reading.

If the fuse is bad, replace it (or have it replaced) and everything should be fine. Whether you do the work yourself or have it done by someone else, you'll still save big money over the cost of a board swap. Service providers and vendors of exact replacement fuses are listed in Appendix B.

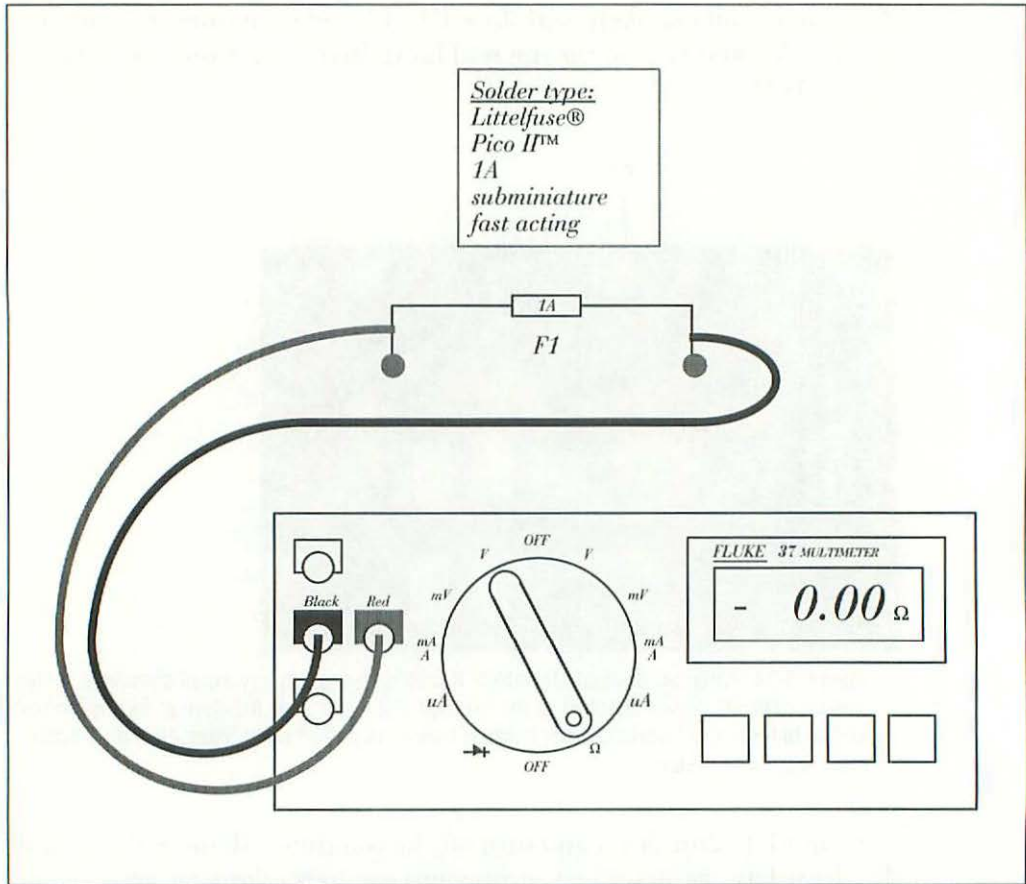

Figure 4-29 A good fuse will read 0.00 to 0.01 Ω , depending on the sensitivity of the meter and the resistance of the test probes.

ADB Problems

When an original Macintosh II fails to recognize any Apple desktop bus (ADB) device attached to the external ADB ports, and the devices in question are known to be in good working order because they work fine on other Macs, then the trouble is most likely with fuse F2 (1A, subminiature, fast acting), which is located behind the ADB connectors, as shown in Figure 4-30.

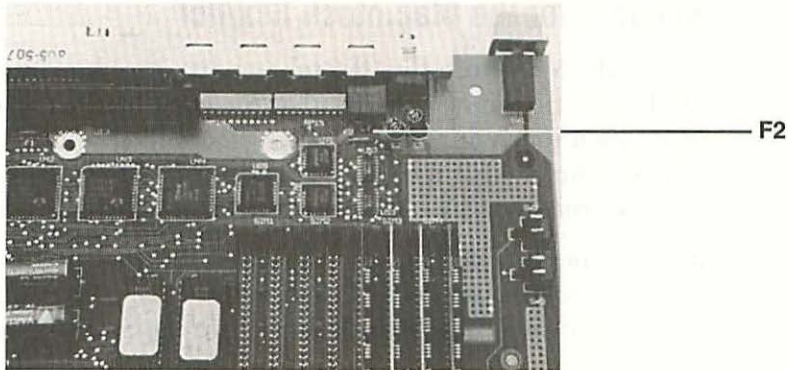

Figure 4-30 When an original Macintosh II fails to recognize any ADB device attached to the external ADB ports, and the devices in question are known to be in good working order because they work fine on other Macs, then the trouble is most likely with fuse F2.

To test F2, shut down and turn off the computer. Remove the lid and the drive bay, as described in previous sections. Turn on your digital multimeter (DMM) and set it to the kilo-ohms ($k\Omega$) scale. Touch the red probe to one side of the fuse and touch the black probe to the other side of the fuse. A good fuse will read 0.00 to 0.01 Ω , depending on the sensitivity of the meter and the resistance of the test probes, as shown in Figure 4-29. Bad fuses generally read 0.L (overload) or give a very high reading.

If the fuse is bad, replace it (or have it replaced) and everything should be fine. Whether you do the work yourself or have it done by someone else, you'll save big money over the cost of a board swap. Service providers and vendors of exact replacement fuses are listed in Appendix B.

Other Problems

Although blown fuses and weak batteries are the most common problems, filter networks, gate arrays, integrated circuits (ICs), and surface mount devices (SMDs) fail as well. The cost and complexity of the equipment needed to diagnose and service these failures far exceeds the cost of professional repairs. If blown fuses and weak batteries are not your problem, then you can still save big money by sending your board out for service. The shops listed in Appendix B have the experience, the tools, and the service literature needed to do the job. Regardless of what the problem may be, there's no need to shell out big bucks for a board swap, unless that's what *you* want to do.

Take-Apart Procedure for the Macintosh IIcx/IIci

Always start the Macintosh IIcx/IIci take-apart procedure by grounding yourself. To ground yourself, verify that the computer is turned off but plugged in, then touch any unpainted piece of metal at the back of the computer. On this model, the shiny metal shells of the disk drive, hard drive, and external monitor connectors are all suitable grounding spots.

Next, disconnect the AC power cable from the wall outlet, and from the computer. Safety requires that both ends of the power cable be disconnected. Simply choosing Shut Down (from the Special menu) is not enough.

Next, disconnect the keyboard, monitor, mouse, printer, and all other peripheral cables. When all of the cables are disconnected, reach for a #1 Phillips-head screwdriver, and set up a container for holding small parts.

The lid of the Macintosh IIcx/IIci CPU is fastened by a single #1 Phillips-head screw. As suggested in Figure 4-31, the screw is located at the top center of the rear panel. Remove the screw, and put it in the parts container.

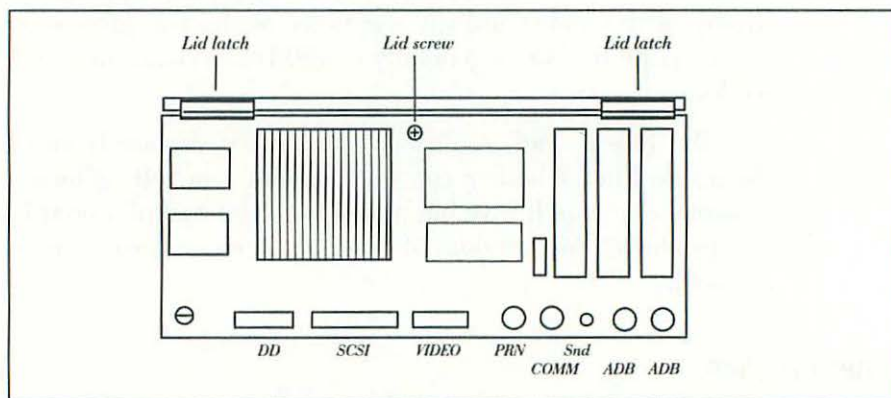

Figure 4-31 The lid of the Macintosh IIcx/IIci CPU is fastened by a single #1 Phillips-head screw.

The back edge of the top cover or lid is further secured by two lid latches. Pulling (not pushing) the latches releases the back edge of the lid, but not the front edge. To release the front edge, carefully rotate the lid about 15° and then lift the lid up and away.

Figure 4-32 Identifies the various subassemblies inside the Macintosh IIcx/ci.

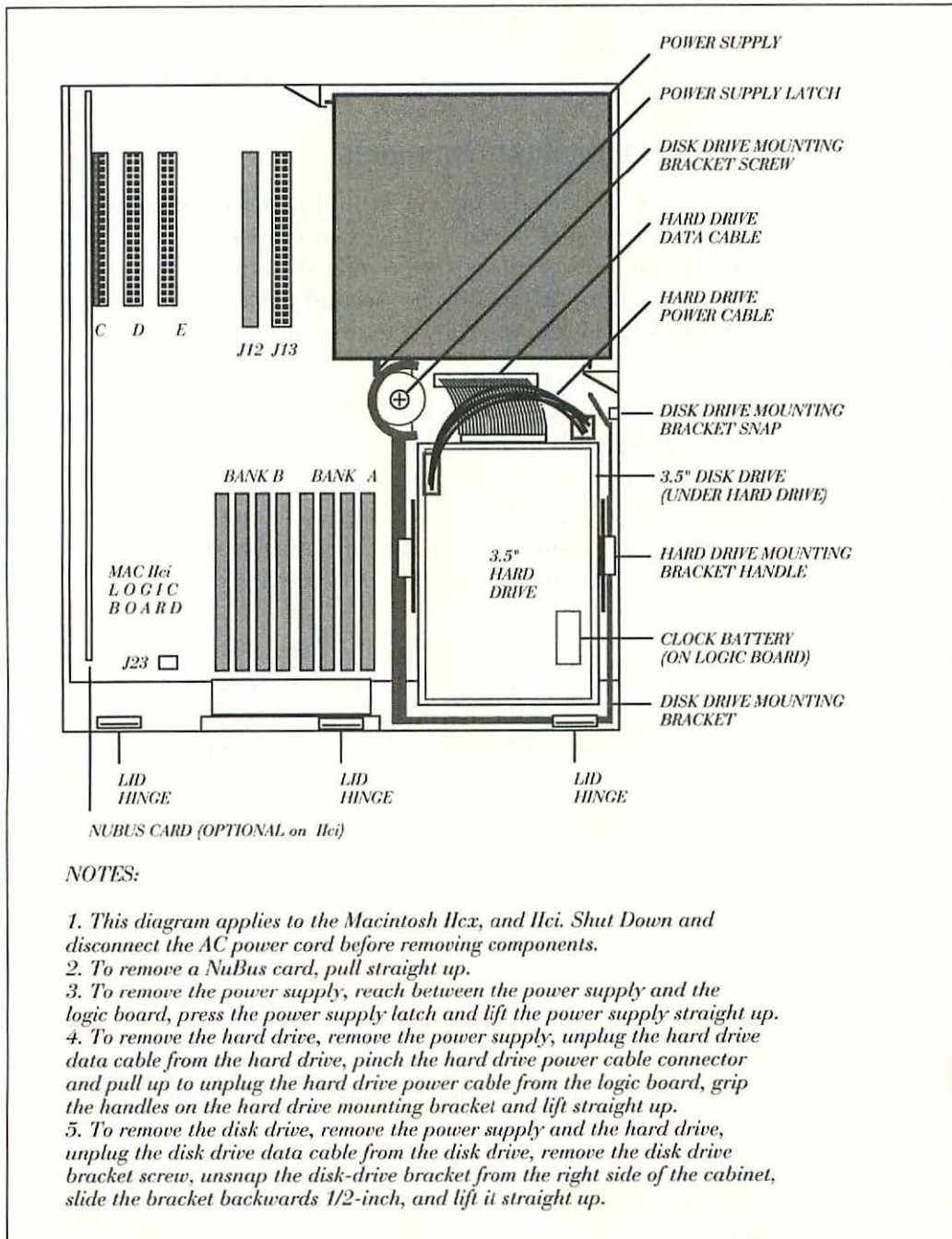

Figure 4-32 Inside the Macintosh IIcx/IIci.

Additional disassembly instructions are given in context, in the sections and chapters that follow. Take-apart instructions for the Macintosh IIsi are given later in this chapter.

Macintosh IIcx-to-IIci Logic Board Upgrades

A Macintosh IIcx-to-IIci upgrade consists of a IIci logic board pre-installed into a IIci cabinet bottom. The existing disk drive, hard drive, power supply and NuBus card(s) are removed from the IIcx and transferred to the new unit. Faster 80-nanosecond SIMMs must be installed into the IIci as well. Here's the complete procedure:

1. Shut down, disconnect the AC power cord from the wall outlet and remove the computer's lid. Follow the take-apart procedure for the Macintosh IIcx/IIci given earlier in this chapter.
2. Remove the power supply. Reach between the power supply and the logic board, press the power supply latch toward the front of the IIcx cabinet and lift the power supply straight up. Note that it slides out on two metal rails. Transfer the power supply to the IIci cabinet.
3. Remove the hard drive. Unplug the hard drive data cable from the logic board. Pinch the hard drive power cable connector and pull up to unplug the hard drive power cable from the logic board. Grip the handles on the hard drive mounting bracket and lift the hard drive straight up. Put the hard drive aside.
4. Remove the disk drive. Unplug the disk drive data cable from the logic board. Remove the disk drive bracket screw. Unsnap the disk drive bracket from the right side of the cabinet, slide the bracket backward one-half inch, and lift it straight up. Transfer the disk drive to the IIci.
5. Transfer the hard drive to the IIci.
6. Transfer any NuBus cards to the IIci.
7. Install 80-nanosecond (or faster) SIMMs into the IIci logic board. For the IIci's built-in video to work, install 80-nanosecond (or faster) SIMMs in bank A.
8. Transfer the lid and the lid screw to the IIci.
9. Transfer the monitor, keyboard, mouse, printer, and modem to the IIci.
10. Plug everything in, then transfer the AC power cord to the IIci.

The Macintosh IIcx-to-IIci logic board upgrade includes a faster 25 MHz MC68030 CPU, a faster 25 MHz MC68882 floating-point processing unit (FPU), and a 120-pin connector to accommodate high-speed random access memory (RAM) cache cards. It should be noted that the original IIci cache cards haven't worked out very well. The current problems may or may not be worked out over a period of time.

The IIci logic board also includes 512K of read only memory (ROM) installed on a single inline memory module (SIMM). The IIcx has 256K of ROM soldered to the logic board and empty SIMM socket for ROM expansion. The SIMM sockets suggest that future Mac ROMs may contain a different operating system. If so, upgrading to the new operating system would simply be a matter of plugging in a new SIMM.

Component-Level Repairs

Some people might be inclined to buy Macintosh IIcx-to-IIci logic board upgrades when their original logic board malfunctions. That's great if you've been lusting for a IIci upgrade anyway, but a more reasonable alternative is to fix the logic board you've already got. This section describes common failures and suggests things that you can do (or arrange to have done) to save thousands of dollars over the cost of a complete board swap.

Power-On Problems

Apple Computer uses two power supplies in the Macintosh IIcx and the Macintosh IIci. One is made by Astec and the other is made by General Electric. The Apple part number for either supply is 661-0467. Both are rated 108 watts, peak load. Table 4-4 provides pinouts, signal descriptions, and actual supply voltages.

Unlike the Macintosh II/IIx/IIfx, voltage for the power-on circuit is provided by the +5V.TRKL line (pin 10). The lithium cell on the IIcx/IIci logic board runs the clock. Consequently, power-on problems are usually related to built-in protection circuits. If the inrush current on power up exceeds 108 watts, the power supply kicks off. The usual fix is to remove one or more power-hungry NuBus cards, install lower-power CMOS SIMMs, and/or install a lower-power hard drive. Another alternative is to replace the 108-watt OEM power supply with an after-market 150-watt model. Check Appendix B for a list of vendors who sell after-market power supplies.

Table 4-4. Macintosh IIcx/IIci Power Supply Voltages

Pin	Signal	Actual
1	+12V	11.5V to 12.8V
2	+5V	4.9V to 5.2V
3	+5V	4.9V to 5.2V
4	+5V	4.9V to 5.2V
5	GND	Ground
6	GND	Ground
7	GND	Ground
8	-12V	-13.2V to -10.8V
9	/PFW	Power failure warning
10	+5V.TRKL	Plus five-volt trickle

The cause of a less common power-on problem remains somewhat of a mystery. In cases where stock configuration (not heavily loaded) IIcx/IIci computers, particularly those equipped with Astec power supplies, fail to start, removing and reseating the supply will often solve the problem. Disconnecting the AC power cord and letting the computer sit for a while also seems to work.

Problems with the Real-Time Clock

As shown in Figure 4-32, the clock battery on a IIcx/ci is mounted on the logic board under the drive area. To get at the battery box, the power supply, the disk drive, and the hard drive all have to be removed. Details are given in the IIcx-to-IIci upgrade section. The cell inside the battery box is marked TL 5112, 1/2 AA, Tadiran 3.6V, lithium, inorganic. To test the cell, refer to Figure 4-26 and follow the procedure given earlier for testing B2 on the Macintosh II/IIx/IIfx. Replacement cells can be ordered from the vendors listed in Appendix B.

Take-Apart Procedure for the Macintosh IIsi

Always start the Macintosh IIsi take-apart procedure by grounding yourself. To ground yourself, verify that the computer is turned off but plugged in, then touch any unpainted piece of metal at the back of the computer. On this model, the shiny metal shells of the disk drive, hard drive, and external monitor connectors are all suitable grounding spots.

Next, disconnect the AC power cable from the wall outlet and from the computer. Safety requires that both ends of the power cable be disconnected. Simply choosing Shut Down (from the Special menu) is not enough.

Next, disconnect the keyboard, microphone, monitor, mouse, printer, and all other peripheral cables. When all of the cables are disconnected, reach for a #1 Phillips-head screwdriver, and set up a container for holding small parts.

The lid or cabinet top of the Macintosh IIx CPU is fastened by a single #1 Phillips-head screw. As suggested in Figure 4-33, the screw is located at the top left of the rear panel. Remove the screw, and put it in the parts container.

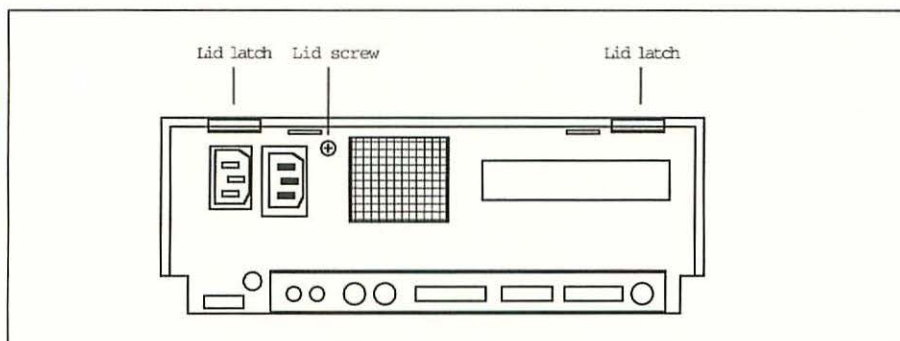

Figure 4-33 The lid or cabinet top of the Macintosh IIx CPU is fastened by a single #1 Phillips-head screw.

The cabinet top is further secured along the left and right sides by a tongue-and-groove design. To remove the lid, place your thumbs on the thumb rests built into the rear panel and pry up the lid latches with bent index fingers. Lifting the latches releases the back edge of the lid, but not the front edge. To release the front edge, grip the sides and lift straight up.

To remove the power supply, pull on the power supply latch, lift the front of the power supply just enough to clear the latch, then press in the two power supply springs at the back of the power supply and continue lifting. When the latch and the two springs are released, the power supply will lift right out.

Figure 4-34 Identifies the various subassemblies inside the Macintosh IIx.

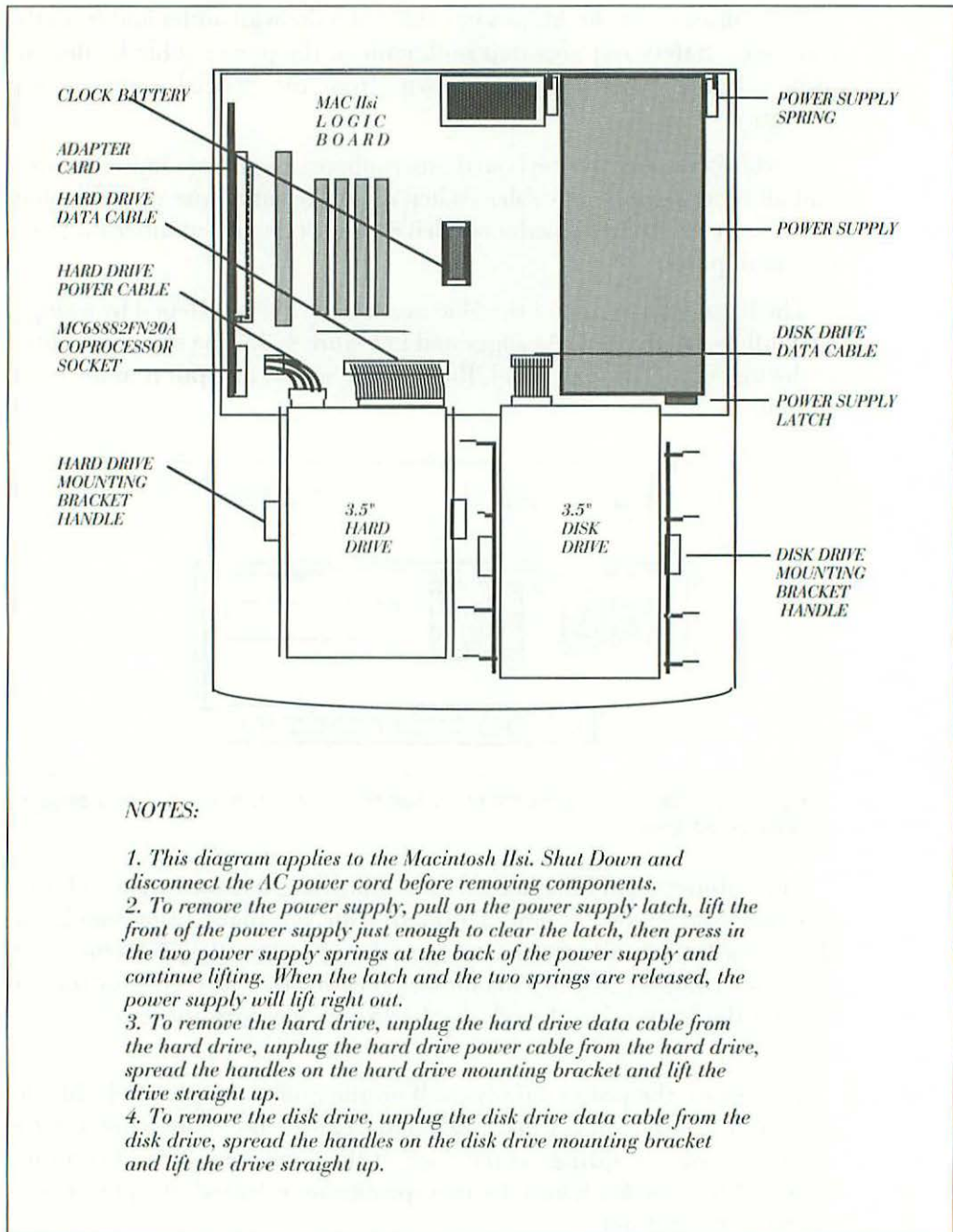

Figure 4-34 Inside the Macintosh IIsi.

To remove the hard drive, unplug the hard drive data cable from the hard drive, unplug the hard drive power cable from the hard drive, spread the handles on the hard drive mounting bracket, and lift the drive straight up.

To remove the disk drive, unplug the disk drive data cable from the disk drive, spread the handles on the disk drive mounting bracket, and lift the drive straight up.

Additional disassembly instructions are given in context, in the sections and chapters that follow.

Error Sounds Common to All Models

All models of the Macintosh II make a distinct chiming sound on startup. The chime indicates that the power/on signal has been received. Immediately after chiming, the computer runs several diagnostic tests contained in read-only memory (ROM). If all tests pass, raster comes up on the monitor, and a floppy-disk icon with a blinking question mark is displayed. Immediately after that, the computer looks for a start-up disk. First it checks for a start-up disk in the floppy drive(s). If no start-up floppy disk is found, then it looks for a hard drive on the SCSI bus with identification number zero (ID = 0). If none is found or if the hard drive fails to contain system software, then it looks for a SCSI hard drive with identification number six. If none is found or if the hard drive fails to contain system software, then it looks for a SCSI hard drive with identification number five. The process continues until SCSI ID = 4, ID = 3, ID = 2, and ID = 1 have all been checked, in descending order.

As soon as a suitable start-up disk is found, the computer runs the Finder and/or the program(s) previously selected in the Finder's Set Startup dialog box. (The Set Startup dialog box is chosen from Special menu.) If no start-up disk is found, the computer continues to poll the disk drives and continues to display the floppy disk icon with a blinking question mark (suggesting "Got a disk for me?"). If you insert anything other than a start-up disk, the disk is immediately kicked out, and the blinking question mark is momentarily replaced by an "X" (suggesting incorrect).

When the diagnostic tests fail, the start-up chime is followed by additional chimes called error sounds. There are generally three parts to the error sound. The first part is always the start-up chime. The second part

is either a chord, a high-pitched note, or the same high-pitched note followed by an even higher-pitched note. The third part is usually a do-do-da-da melody. Table 4-5 summarizes the error sounds and shows what they mean.

Table 4-5. Error-Sound Information

1st Part	2nd Part	3rd Part	Problem found in:
Startup chime	none	none	no problem found
Startup chime	chord or none	do do da da	Initial check
Startup chime	high	do do da da	RAM 1 (Bank A)
Startup chime	high higher	do do da da	RAM 2 (Bank B)

Initial check sequence errors are often caused by tape backup drives and older SCSI hard drives. Some drives need to be on, even when they are not being used, or they drag the whole bus down: “chime, chord (or none), do do da da,” no raster. The solution is to switch on the drive and restart the computer. If the drive is already on, it may have gone bad. Unplug the computer’s power cord from the wall outlet, disconnect the external SCSI cable from the back of the CPU, reconnect the computer’s power cord, and try again. If the computer restarts, the problem is in one of the external SCSI devices. Check Chapter 9 for further information. If the computer still doesn’t start, then the problem may be in the internal hard drive. Unplug the computer’s power cord from the wall outlet, open the computer’s lid, disconnect the hard drive’s power and data cables, close the lid, reconnect the computer’s power cord and try again. If you get the normal startup chime and see the floppy disk icon with a blinking question mark, the problem is definitely related to the internal hard drive. Check Chapter 9 for further information.

RAM 1 errors indicate a problem with the SIMMs in Bank A. RAM 2 errors indicate a problem with the SIMMs in Bank B. Sometimes the cause is a faulty SIMM, or due to incorrectly installed SIMMs. SIMM upgrades are covered in Chapter 6.

Other times the cause is an intermittent SIMM socket. The white SIMM sockets used in newer models of the Macintosh II have been more troublesome than black SIMM sockets used in older models. To correct the problem, try swapping and/or reseating the SIMMs. If that doesn’t work, remove the SIMMs and look inside the sockets for contacts that

may be spread further apart than the others. Tighten any that you find. If that doesn't work, the suspected socket or sockets will have to be replaced. Check Appendix B for a list of service providers that specialize in logic board repairs. Replacing bad sockets is a lot cheaper than replacing the whole board—almost a whole board cheaper!

That's it for CPU maintenance. Next we'll look at Macintosh II Video Cards and video RAM upgrades.

5

VRAM—Video Card Upgrades

This chapter shows how to upgrade the original Macintosh II Video Cards from 4 bits to 8 bits and shows how to upgrade the latest Macintosh Display Cards from 8 bits to 24 bits. Connector pinouts and cable diagrams are given, including pinouts for making a video cable compatible with standards set by the National Television Standards Committee (NTSC). With this cable and readily available Video Card Utility software, you can connect a Macintosh II directly to most video cassette recorders (VCRs), and view the computer display on a standard (US) television set.

One-Bit Video

Older models of the Macintosh (128K, Lisa, XL, 512K, 512Ke, Plus, SE, SE/30, and Classic), have built-in one-binary digit (one-bit) video circuitry. One-bit video means that each pixel on the computer display is controlled by a single binary digit. The prefix “bi” implies two objects which are generally opposites. By definition, bi-nary digits can only be 1s or 0s. They can’t be anything else.

When the binary digit assigned to a certain screen coordinate is an 0, the corresponding pixel is illuminated. When the binary digit assigned to that same coordinate is a 1, the corresponding pixel is not illuminated. With a white-phosphor CRT, that allows only two color choices, black or white, as shown in Table 5-1.

Table 5-1. One-Bit Video

1-Bit Binary Number	Color Number
0	0 (White)
1	1 (Black)

Since the classic nine-inch display measures 512×342 pixels (175,104 total pixels), 175,104 bits are required to store the video information. With eight bits to the byte, that works out to 21,888 bytes of random access memory (RAM) or roughly 21K ($21,888 \div 1024$). On the 128K, 512K, 512Ke, Plus, SE, SE/30, and Mac Classic, that amount has to be subtracted from the total available memory, leaving that much less for application software.

Four-Bit Video

The Macintosh II, IIx, IIcx, and IIfx do not have built-in video circuitry. Instead, they require a NuBus-compatible video card. Without one, you can't connect a monitor! Model number M0211, the original Apple Macintosh II Video Card, is a four-bit model. Four bits per pixel allows up to 16 color or 16 gray choices, as shown in Table 5-2.

Table 5-2. Four-Bit Video

4-Bit Number	Color/Gray Number
0000	0
0001	1
0010	2
0011	3
0100	4
0101	5

(continued)

4-Bit Number	Color/Gray Number	(continued)
0110	6	
0111	7	
1000	8	
1001	9	
1010	10	
1011	11	
1100	12	
1101	13	
1110	14	
1111	15	

Since the standard Mac II display measures 640×480 pixels (307,200 total pixels), $307,200 \times 4$ bits per pixel (1,228,800 total bits) are required to store the four-bit video information. With eight bits to the byte, that works out to 153,600 bytes of random-access memory (RAM) or roughly 149K ($153,600 \div 1024$)—21K more than the total memory available on the 128K Macintosh. To supply it, eight D41264C dual-ported video random-access memory (VRAM) chips totalling 256K are soldered right on the Macintosh II Video Card. In addition, eight empty chip sockets are provided for further expansion. Expanding the card is covered later in this chapter.

Relative Brightness—Intensity

Part of the extra VRAM ($256\text{K} - 149\text{K} = 107\text{K}$) on the Macintosh II Video Card stores relative brightness or intensity information. With one-bit video, pixels can only be 100% on or 100% off. With four-bit video, individual pixels can also be dimmed and brightened. The brightness level of each pixel in the display is stored in part of the extra VRAM.

Color Saturation

Another part of the extra VRAM ($256\text{K} - 149\text{K} = 107\text{K}$) on the Macintosh II Video Card stores color-saturation information. With one-bit video, pixels are always 100% white or 100% black. Gray patterns can

be simulated by alternating black and white pixels over an area (a process called dithering), but individual gray pixels are not supported. For an example of one-bit gray patterns view Color TPG's Gray Bars test pattern through a magnifying glass.

With four-bit video, color pixels can also be lightened and darkened relative to each other. As explained in Chapter 3, each color pixel is illuminated by three separate electron beams—one for the red phosphor, one for the green phosphor, and one for blue phosphor. A light-green pixel is less saturated with color than a dark-green pixel.

Gray pixels are lightened and darkened in similar fashion. So not only does four-bit video allow 16 colors (hues) or 16 gray scales, but it also allows for different pixel intensities and for different color (or gray) saturations.

Eight-Bit Video

Model number M5640, the Apple Macintosh II Extended Video Card, has sixteen D41264C VRAM chips soldered on the card. Sixteen VRAM chips provide 512K of video memory—equal to the total memory available on the 512K Macintosh. With 512K of video memory, eight bits are assigned per pixel, allowing up to 256 color or 256 gray choices (one or the other, not both at the same time), as shown in Table 5-3.

Table 5-3. Eight-Bit Video

8-Bit Number	Color/Gray Number	8-Bit Number	Color/Gray Number
0	0	10000000	128
1	1	10000001	129
10	2	10000010	130
11	3	10000011	131
100	4	10000100	132
101	5	10000101	133
110	6	10000110	134
111	7	10000111	135
1000	8	10001000	136

(continued)

(continued)

8-Bit Number	Color/Gray Number	8-Bit Number	Color/Gray Number
1001	9	10001001	137
1010	10	10001010	138
1011	11	10001011	139
1100	12	10001100	140
1101	13	10001101	141
1110	14	10001110	142
1111	15	10001111	143
10000	16	10010000	144
10001	17	10010001	145
10010	18	10010010	146
10011	19	10010011	147
10100	20	10010100	148
10101	21	10010101	149
10110	22	10010110	150
10111	23	10010111	151
11000	24	10011000	152
11001	25	10011001	153
11010	26	10011010	154
11011	27	10011011	155
11100	28	10011100	156
11101	29	10011101	157
11110	30	10011110	158
11111	31	10011111	159
100000	32	10100000	160
100001	33	10100001	161
100010	34	10100010	162
100011	35	10100011	163
100100	36	10100100	164
100101	37	10100101	165
100110	38	10100110	166

(continued)

(continued)

8-Bit Number	Color/Gray Number	8-Bit Number	Color/Gray Number
100111	39	10100111	167
101000	40	10101000	168
101001	41	10101001	169
101010	42	10101010	170
101011	43	10101011	171
101100	44	10101100	172
101101	45	10101101	173
101110	46	10101110	174
101111	47	10101111	175
110000	48	10110000	176
110001	49	10110001	177
110010	50	10110010	178
110011	51	10110011	179
110100	52	10110100	180
110101	53	10110101	181
110110	54	10110110	182
110111	55	10110111	183
111000	56	10111000	184
111001	57	10111001	185
111010	58	10111010	186
111011	59	10111011	187
111100	60	10111100	188
111101	61	10111101	189
111110	62	10111110	190
111111	63	10111111	191
1000000	64	11000000	192
1000001	65	11000001	193
1000010	66	11000010	194
1000011	67	11000011	195
1000100	68	11000100	196

(continued)

(continued)

8-Bit Number	Color/Gray Number	8-Bit Number	Color/Gray Number
1000101	69	11000101	197
1000110	70	11000110	198
1000111	71	11000111	199
1001000	72	11001000	200
1001001	73	11001001	201
1001010	74	11001010	202
1001011	75	11001011	203
1001100	76	11001100	204
1001101	77	11001101	205
1001110	78	11001110	206
1001111	79	11001111	207
1010000	80	11010000	208
1010001	81	11010001	209
1010010	82	11010010	210
1010011	83	11010011	211
1010100	84	11010100	212
1010101	85	11010101	213
1010110	86	11010110	214
1010111	87	11010111	215
1011000	88	11011000	216
1011001	89	11011001	217
1011010	90	11011010	218
1011011	91	11011011	219
1011100	92	11011100	220
1011101	93	11011101	221
1011110	94	11011110	222
1011111	95	11011111	223
1100000	96	11100000	224
1100001	97	11100001	225
1100010	98	11100010	226

(continued)

(continued)

8-Bit Number	Color/Gray Number	8-Bit Number	Color/Gray Number
1100011	99	11100011	227
1100100	100	11100100	228
1100101	101	11100101	229
1100110	102	11100110	230
1100111	103	11100111	231
1101000	104	11101000	232
1101001	105	11101001	233
1101010	106	11101010	234
1101011	107	11101011	235
1101100	108	11101100	236
1101101	109	11101101	237
1101110	110	11101110	238
1101111	111	11101111	239
1110000	112	11110000	240
1110001	113	11110001	241
1110010	114	11110010	242
1110011	115	11110011	243
1110100	116	11110100	244
1110101	117	11110101	245
1110110	118	11110110	246
1110111	119	11110111	247
1111000	120	11111000	248
1111001	121	11111001	249
1111010	122	11111010	250
1111011	123	11111011	251
1111100	124	11111100	252
1111101	125	11111101	253
1111110	126	11111110	254
1111111	127	11111111	255

24-Bit Video

Tables 5-1 to 5-3 indicate that the number of bits is exponentially related to the number of colors: 1 bit = 2 colors, 4 bits = 16 colors, 8 bits = 256 colors, etc. Mathematically this relationship is expressed as: $2^{\text{number of bits}} = \text{number of colors}$. So how many color choices does a 24-bit Macintosh Display Card offer? The answer, is 16,777,216 (2 to the 24th power) or over 16.7 million choices, as indicated in Table 5-4.

Table 5-4. 24-Bit Video

24-Bit Number	Color/Gray Number
000000000000000000000000	0
000000000000000000000001	1
000000000000000000000010	2
000000000000000000000011	3
000000000000000000000100	4
000000000000000000000101	5
000000000000000000000110	6
000000000000000000000111	7
000000000000000000001000	8
...	...
1111111111111111111111000	16,777,208
1111111111111111111111001	16,777,219
1111111111111111111111010	16,777,210
1111111111111111111111011	16,777,211
1111111111111111111111100	16,777,212
1111111111111111111111101	16,777,213
1111111111111111111111110	16,777,214
1111111111111111111111111	16,777,215

Exercise: At two lines per minute, how long would it take for a human typist to complete Table 5-4? Answer: Assuming 40-hour work weeks and no vacations, it would take over 67 years!

Display Size Limitations

It's important to note that while 24-bit video allows 16,777,216 color choices, it's generally not possible to display all 16,777,216 colors at the same time. Under present technology, there can only be one color to a pixel. At one color to a pixel, you would need a display measuring at least 4096×4096 pixels (16,777,216 square pixels) to display all 16.7 million colors. At 72 pixels per inch, that works out to 56.88×56.88 inches, or something measuring roughly 4.75 feet wide \times 4.75 feet high. Try fitting that on your desk!

The Benefits of 24-Bit Video

So if you can't see all 16,777,216 colors at one time, what good is 24-bit video? To answer that question, consider the sky. Really look at it. The sky is not blue. It's a thousand subtly different blues. At the same time, you seldom see green in the sky. Even in something as spectacular as a sunset, it's doubtful that anything near 16,777,216 different colors can be seen. The ability to see 16.7 million colors at one time, no matter how often it's claimed in product literature and repeated in magazine reviews, is a completely meaningless criteria.

Near-Photographic Quality

What is important is the ability to display exactly the same hues and shades of blue that are seen in the sky. To do that, you need a huge number of hues and shades to choose from. With 16.7 million colors in the palette, enough hues and shades are available that skylscapes can be displayed with near-photographic quality.

With only 256 colors in the palette, the jumps between hues and shades are gross, rather than subtle. Instead of a seamless transition from one blue to the next, changes are marked by clearly visible lines. This effect is called *banding*.

With only 16 colors in the palette, skylscapes resemble cheap oil paintings. They look okay from far away, but from up close you can see where black pixels have been interspaced with the blue to simulate darker hues and shades, a process called dithering.

Photographic Quality

So what's it going to take to get photographic quality? Thirty-two-bit video cards and 4.29 billion (2^{32}) color choices? No. What's more important is smaller pixels. At 72 ppi, color swatches displayed on the screen can't be any smaller than $1/72 \times 1/72$ -inch square. The silver-halide crystals (the smallest elements) used in high-speed camera film are much smaller. For photographic quality (comparable to 35mm prints), we need pixels that are just as small as silver-halide crystals. For lifelike quality, we need pixels that are infinitely small, the same size as the smallest color changes that occur in nature. For now, infinitely small pixels pose a formidable technological challenge.

True Grayscale and True Color

To continue with the blue-sky example, the sky is not only blue, but it also has puffy white clouds shadowed with light gray and dark gray and black. Eight-bit video cards allow 256 grays, or all of the grays that can be seen by human eyes (called true grayscale), or 256 colors (some of which could be grays), but eight-bit cards don't allow 256 colors and 256 grays to be chosen at the same time. As a result, eight-bit skylscapes look very good, but they're not breathtaking.

Twenty-four-bit video cards allow 16.7-million colors, or all of the colors that can be seen by human eyes (called true color), and true grayscale (all 256 grays) to be chosen simultaneously. In reproducing something as complex as a skyscape, the ability to choose from the entire visible spectrum of grays and colors makes a noticeable difference. The 24-bit skyscape looks more like a 35mm slide projection than an eight-bit computer graphic.

The Drawbacks of 24-bit Video

The triple drawbacks of 24-bit video are cost, speed, and storage requirements. At the present time, 24-bit cards are considerably more expensive than 8-bit cards. Prices are expected to come down over a period of time.

Twenty-four bit video is also much slower than eight-bit video. Just as it takes longer for you and me to read aloud the 24-bit entries in Table 5-4, than it does to read aloud the 8-bit entries in Table 5-3, it takes longer for a Macintosh II to process 24-bit data than it does to

process 8-bit data. How much longer varies from program to program and from computer to computer, but it's generally quite noticeable. Without a graphics coprocessor, redrawing a 24-bit display can take several seconds.

Twenty-four bit video files are also much larger than eight-bit files. The storage requirements are greater, but file-compression algorithms and the availability of increasingly larger hard drives at reasonable prices makes this less of a problem.

VRAM Upgrades

VRAM is an acronym for video random-access memory. In order to upgrade VRAM, you need three pieces of information:

- The model number of the video card to be upgraded,
- The amount of VRAM currently installed on the card and
- The maximum amount of VRAM that can be installed on the card.

Table 5-5 lists the various Apple-brand video cards and video card upgrades by model number. Once you determine that the card you own can hold extra memory, it's relatively simple to install the parts.

Table 5-5. Video Card Model Number Information

Model Number	Description
M0211	Macintosh II (4-Bit) Video Card
M0213	Macintosh II Video Card Expansion Kit
M5640	Macintosh II Extended (8-Bit) Video Card
M0322	Macintosh II (4-Bit) High-Resolution Video Card
M0324	Macintosh II Extended (8-Bit) High-Res. Video Card
M0504	Macintosh II 1-Bit Monochrome Video Card
M0119	Macintosh II Portrait Display Video Card
M0260	Macintosh II Two-Page Monochrome Video Card
M0121PA/A	Macintosh (8-Bit) Display Card 4.8
M0412LL/A	Macintosh Display Card VRAM Kit
M0507PA/A	Macintosh (24-Bit) Display Card 8.24
M0122	Macintosh (24-Bit) Display Card 8.24GC
M0505LL/A	Macintosh Display Card DRAM Kit

Identifying Video Cards—Which Model?

The easiest way to determine how much VRAM is installed on the video card installed in your Mac is to choose the Control Panel desk accessory (DA) from the Apple menu and select the Monitors Control Panel device (CDEV). This process is shown in Figures 5-1 and 5-2.



Figure 5-1 Choose the Control Panel DA from the Apple menu.

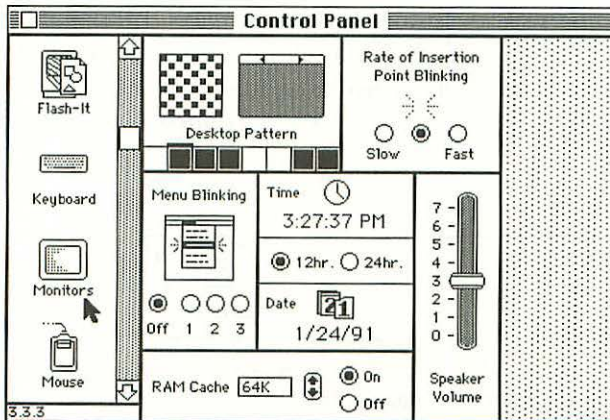

Figure 5-2 Select the Monitors CDEV from the Control Panel.

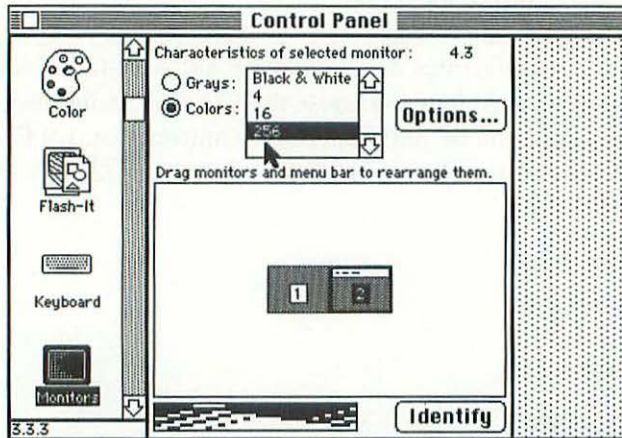

Figure 5-3 The highest entry listed under “Characteristics of selected monitor:” reveals how much VRAM is installed.

As shown in Figure 5-3, the highest entry listed under “Characteristics of selected monitor:” reveals how much VRAM is installed. If the highest entry is “Millions,” then you have a 24-bit card. If the highest entry is “256,” then you have an 8-bit card. If the highest entry is “16,” then you have a 4-bit card. If the only entry is “Black & White,” then you have a 1-bit card.

Not all cards can be upgraded! One-bit cards can’t be upgraded at all—not even to four bits. Four-bit cards can only be upgraded to eight bits. Newer 8-bit cards can be upgraded to 24 bits but older 8-bit models cannot. To identify which type video card is currently installed in your Macintosh II, open the Monitors CDEV (version 4.0 or later) as shown in Figures 5-2 to 5-4 and click the Options . . . button. With Monitors CDEV version 4.0 or later, video card model identification is printed in the upper-left corner of the Options . . . dialog box as shown in Figure 5-4.

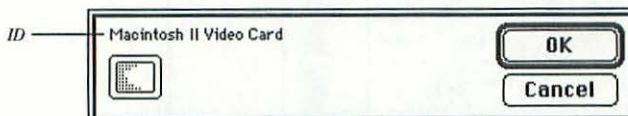

Figure 5-4 With Monitors CDEV version 4.0 or later, video card identification is given in the upper-left corner of the Options . . . dialog box.

“Macintosh II Video Card” indicates an original model. If the highest entry listed under “Characteristics of selected monitor:” is 16, then the card can easily be upgraded from four bits to eight bits. Complete details are given in the next section. If the highest entry listed under “Characteristics of selected monitor:” is 256, then the card has already been upgraded, or it was originally sold as an eight-bit “Macintosh II Extended Video Card.” Either way, no further component-level upgrades from 8 bits to 24 bits are possible.

“Mac II High-Resolution Video Card” indicates an improved model. The improvements have to do with monitor identification and NTSC compatibility. For the purposes of VRAM upgrades, “Mac II High-Resolution Video Cards” are upgraded the same as original “Macintosh II Video Cards.” If the highest entry listed under “Characteristics of selected monitor:” is 16, then the card can easily be upgraded from four bits to eight bits. Complete details are given in the next section. If the highest entry listed under “Characteristics of selected monitor:” is 256, then the card has already been upgraded, or it was originally sold as an eight-bit “Macintosh II Extended High-Resolution Video Card.” No further component-level upgrades from 8 bits to 24 bits are possible.

“Macintosh Display Card” indicates yet another model. If the highest entry listed under “Characteristics of selected monitor:” is 256, then the card can easily be upgraded from 8 bits to 24 bits. Complete details are given following the next section. If the highest entry listed under “Characteristics of selected monitor:” is “Millions,” then the card has already been upgraded. No further component-level upgrades are possible.

Note that it’s not necessary to remove the card to determine what type it is and how much memory it has.

Installing 4-Bit to 8-Bit Upgrades

On the original (four-bit) Macintosh II Video Card, and on later (four-bit) Mac II High Resolution Video Cards, eight D41264C VRAM chips are soldered right on the printed circuit board (PCB) and eight 24-pin chip sockets are provided for expansion. To upgrade the card from four bits to eight bits, all you have to do is plug in another eight D41264C VRAM chips. To meet OEM specifications, the additional chips must be rated 150 nanoseconds or faster.

The official Apple Macintosh II Video Card Expansion Kit bears part number M0213, but generic D41264C VRAM chips can also be used. These work equally well, and usually cost less money. Check Appendix B for a list of vendors.

In addition, you need a #1 Phillips-head screwdriver to remove the computer's lid and a wrist grounding strap to prevent ESD. The use of a wrist grounding strap is covered in Chapter 1. With the assumption that you've read the ESD precautions given in Chapter 1, here's the complete four-bit to eight-bit upgrade procedure:

1. Shut down the Macintosh II (if necessary), and wait 20 seconds.
2. Unscrew the video cable from the back of the Macintosh II.
3. Verify that the disk drives are empty. Unscrew the lid of the Macintosh II, press the lid latches and carefully lift the lid up, back and away as explained in Chapter 4. Do not rotate the lid a full 90°, or you may break the snaps.
4. To prevent electrostatic discharge, put on a wrist-grounding strap, as explained in Chapter 1. If you proceed without a wrist strap, naturally occurring static electricity may damage the video card and/or destroy the upgrade.
5. Grip the bare metal bracket at the back of the video card with one hand and grip the other side of the video card with your other hand. Pull the card straight up and out. If the card appears to be stuck, rock it gently from front to back (on the long axis). Do not rock the card from side to side (on the short axis) or you may break the NuBus connector. Once the card is out, place it on a conductive mat or on a sheet of aluminum foil.
6. As shown in Figure 5-5, the printed circuit board (PCB) used on the original Macintosh II Video Card is marked like a grid map. The numbers 1 to 8 are marked across the top of the PCB, and the letters A to H are marked along the left edge of the PCB. The empty chip sockets are at grid locations B1, C1, D1, E1, F1-G1, H1, G2 and H2. Note that one end of each chip socket is notched. The notch indicates the front of the socket.
7. Note that each of the eight new chips is also notched. The notch indicates the front of the chip. Insert the eight chips into the empty sockets one-at-a-time, taking care to point the notch on each chip in the same direction as the matching notch on the socket.

8. That's all there is to it. Reverse steps 5 to 1 and you're all done. The whole procedure barely takes 10 minutes!

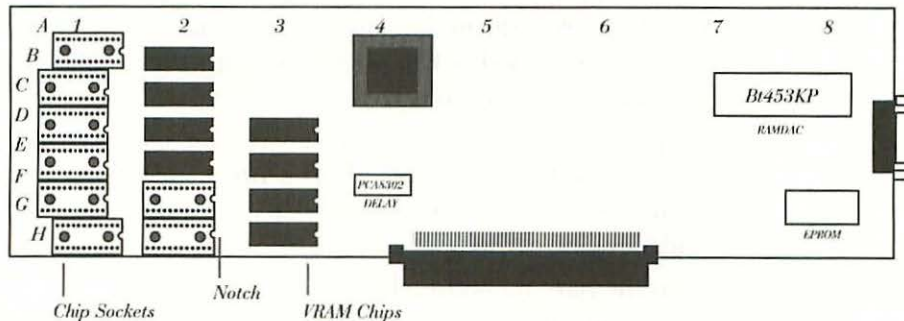

Figure 5-5 The PCB used on the original Macintosh II Video Card is marked like a grid map. The empty chip sockets are at grid locations B1, C1, D1, E1, F1-G1, H1, G2, and H2.

Note: The component layout on Mac II High-Resolution Video Cards is somewhat different from the component layout on original Macintosh II Video Cards. Otherwise, the upgrade procedure is exactly the same.

Installing 8-Bit to 24-Bit Upgrades

On the Macintosh II (eight-bit) Display Card 4.8, four TC528128AJ-10 VRAM chips (totalling 512K) are soldered on the PCB and two 68-pin single SIMM sockets are provided for expansion. To upgrade the card from 8 bits to 24 bits, all you have to do is plug in two 256K VRAM SIMMs, rated 100 nanoseconds or faster.

The official Apple Macintosh Display Card VRAM Kit bears part number M0412II/A, but generic 68-pin VRAM SIMMs can also be used. Generic SIMMs (when available) work equally well and usually cost less money. Check Appendix B for a list of vendors.

In addition, you need a #1 Phillips-head screwdriver to remove the computer's lid and a wrist grounding strap to prevent ESD. The use of a wrist grounding strap is covered in Chapter 1. With the assumption that you've read the ESD precautions given in Chapter 1, here's the complete 8-bit to 24-bit upgrade procedure:

1. Shut down the Macintosh II (if necessary), and wait 20 seconds.
2. Unscrew the video cable from the back of the Macintosh II.
3. Verify that the disk drives are empty. Unscrew the lid of the Macintosh II, press the lid latches and carefully lift the lid up, back and away as explained in Chapter 4. Do not rotate the lid a full 90°, or you may break the snaps.
4. To prevent electrostatic discharge, put on a wrist-grounding strap as explained in Chapter 1. If you proceed without a wrist strap, naturally occurring static electricity may damage the video card and/or destroy the upgrade.
5. Grip the bare metal bracket at the back of the video card with one hand, and grip the other side of the video card with your other hand. Pull the card straight up and out. If the card appears to be stuck, rock it gently from front to back (on the long axis). Do not rock the card from side to side (on the short axis) or you may break the NuBus connector. Once the card is out, place it on a conductive mat or on a sheet of aluminum foil.
6. As shown in Figure 5-6, the printed circuit board (PCB) used on the Macintosh II Display Card 4.8 is also marked like a grid map. The numbers 1 to 12 are marked across the top of the PCB and the letters A to E are marked along the left edge of the PCB. The empty SIMM sockets are at grid locations D1-6 and E1-6.

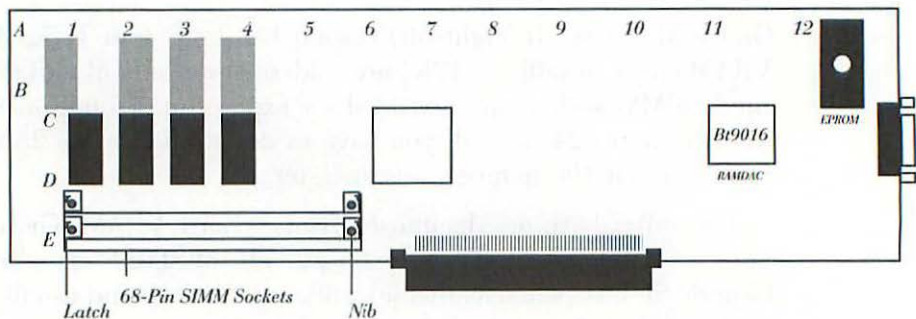

Figure 5-6 The printed circuit board (PCB) used on the Macintosh II Display Card 4.8 is also marked like a grid map. The empty SIMM sockets are at grid locations D1-6 and E1-6.

- Note that each VRAM SIMM has two mounting holes. Note also that each SIMM socket has two mounting nibs. Insert the SIMMs vertically into the sockets until the mounting holes line up with the nibs, and push back 45° until the latches snap into place.
- That's all there is to it. Reverse steps 5 to 1 and you're all done. The whole procedure barely takes 10 minutes!

Installing 32-Bit QuickDraw Software

In addition to a 24-bit display card, 24-bit video requires System Software Version 6.0.5 or later, 2 megabytes of random access memory (RAM) and 32-Bit QuickDraw. Thirty-two bit QuickDraw is part of the 512K read-only memory (ROM) built into the Macintosh IIci, IIx, and IIsi, but on the Macintosh II, IIx, and IIcx which have less powerful 256K ROMs, a 32-bit QuickDraw INIT has to be added to the System software. On 800K disks for System 6.0.7, the color folder is on the Printing Tools disk. Make sure you're using Version 1.2 or later of 32-bit QuickDraw.

To install the 32-Bit QuickDraw INIT which is supplied with System 6.0.7, open the Apple Color folder on the System Additions disk, as shown in Figure 5-7, and drag the 32-Bit QuickDraw icon into the System Folder of your start-up disk. Restart the computer and 32-Bit QuickDraw will install automatically, just as if it were part of the ROM.

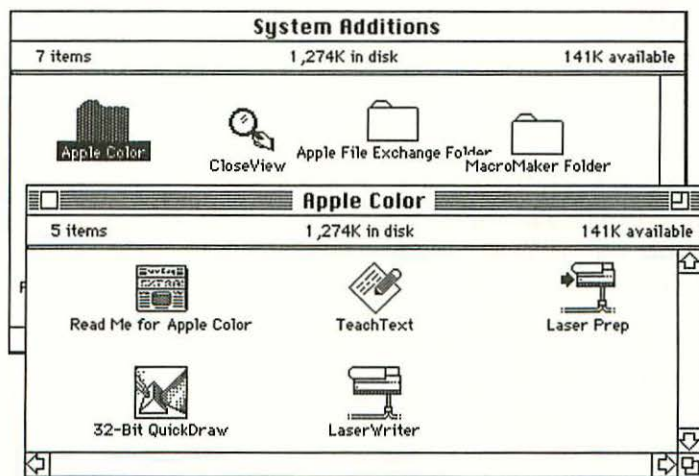

Figure 5-7 The 32-Bit QuickDraw INIT supplied with System 6.0.7 is in Apple Color folder on the System Additions disk.

The 32-bit QuickDraw INIT even works with 8-bit cards, allowing them to display documents containing more than 256 colors. It also allows halftone images to be printed on monochrome LaserWriters and adds NTSC-video compatibility to original Macintosh II Video Cards. NTSC upgrades are described in the next section.

Note: Despite the 32-bit name, only the first 24 bits of 32-bit QuickDraw are currently used. The last 8 bits are reserved for future expansion.

DRAM Upgrades

On the Macintosh II (24-bit) Display Card 4.8 GC (graphics coprocessor), eight MCM6295J25 VRAM chips (totalling 1 MB) and sixteen 524258AJ-10 dynamic random-access memory (DRAM) chips (totalling 2 MB) are soldered on the printed circuit board (PCB), and two SIMM sockets are provided for DRAM expansion. Applications written to take advantage of the expanded DRAM can redraw the display faster.

To upgrade the card, all you have to do is plug in two double-sided DRAM SIMMs. The official Apple Macintosh Display Card DRAM Kit (two 1-MB SIMMs) bears part number M0505LLA/A, but generic DRAM SIMMs can also be used. Generic SIMMs work equally well, and usually cost less money. Check Appendix B for a list of vendors.

In addition, you need a #1 Phillips-head screwdriver to remove the computer's lid, and a wrist grounding strap to prevent electrostatic discharge (ESD). The use of a wrist grounding strap is covered in Chapter 1. With the assumption that you've read the ESD precautions in Chapter 1, here's the complete 2 MB to 4 MB DRAM upgrade procedure:

1. Shut down the Macintosh II (if necessary) and wait 20 seconds.
2. Unscrew the video cable from the back of the Macintosh II.
3. Verify that the disk drives are empty. Unscrew the lid of the Macintosh II, press the lid latches, and carefully lift the lid up, back and, away, as explained in Chapter 4. Do not rotate the lid a full 90°, or you may break the snaps.

4. To prevent electrostatic discharge, put on a wrist grounding strap as explained in Chapter 1. If you proceed without a wrist strap, naturally occurring static electricity may damage the video card and/or destroy the upgrade.
5. Grip the bare metal bracket at the back of the video card with one hand, and grip the other side of the video card with your other hand. Pull the card straight up and out. If the card appears to be stuck, rock it gently from front to back (on the long axis). Do not rock the card from side to side (on the short axis) or you may break the NuBus connector. Once the card is out, place it on a conductive mat or on a sheet of aluminum foil.
6. As shown in Figure 5-8, the PCB used on the Macintosh II Display Card 8.24 GC is marked like a grid map. The numbers 1 to 16 are marked across the top of the PCB, and the letters A to K are marked along the left edge of the PCB. The empty SIMM sockets are at grid locations A5-12 and B5-12.

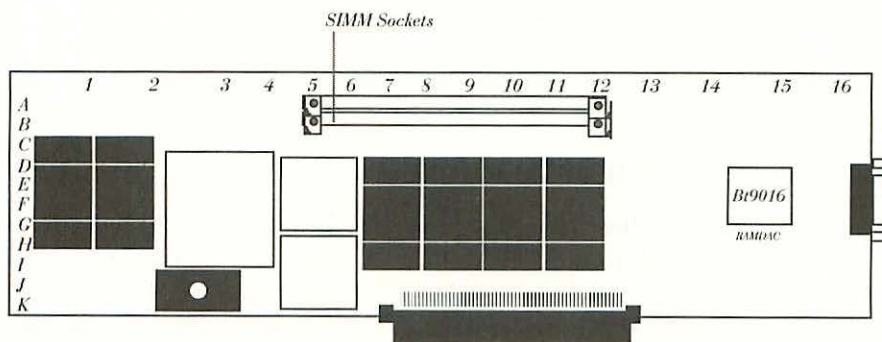

Figure 5-8 The PCB used on the Macintosh II Display Card 4.8 GC is marked like a grid map. The empty SIMM sockets are at grid locations A5-12 and B5-12.

7. Note that each DRAM SIMM has two mounting holes. Note also that each SIMM socket has two mounting nibs. Insert the SIMMs vertically into the sockets until the mounting holes line up with the nibs, and push back 45° until the latches snap into place.
8. That's all there is to it. Reverse steps 5 to 1 and you're all done. The whole procedure barely takes 10 minutes!

NTSC Compatibility Upgrades

NTSC is an acronym for National Television Standards Committee. In the United States (but not in Europe and Asia), all Beta and VHS video cassette recorders (VCRs), all of the monitors equipped with standard Radio Corporation of America (RCA) video-in/video out jacks designed to work with VCRs, all camcorders, and all of the composite monitors designed to work with Apple II, II+, III, IIe, and IIGS computers are NTSC-compatible. So are Commodore Amiga computers. That adds up to a lot of equipment.

To transfer NTSC-compatible computer images (such as titles, charts, and graphs) to video tape, all you have to do is connect the video output of the computer to the video input of the tape recorder. It's as simple as dubbing from one tape deck to another and quite useful.

Although it's not well-documented, all models of the Macintosh II Video Card (Original, Extended, and High-Resolution) and all models of the Macintosh Display Card (4.8, 8.24, and 8.24GC) are also NTSC-compatible. The earlier cards generally require three items: a custom-built cable, 32-Bit QuickDraw, and Video Card (NTSC) Utility software. The latest Macintosh Display Cards simply require a custom-built cable.

Making an NTSC-Compatible Video Cable

Table 5-6 lists the Macintosh II (DB15S) Video Card to AppleColor High-Resolution RGB Monitor signals. The cable (part number 590-0161-A) used to connect Macintosh II Video Cards and Macintosh Display Cards to AppleColor High-Resolution RGB Monitors has a DB-15P connector on each end. All 15 wires inside the cable are connected straight through, as shown in Figure 5-9. The same cable is used to connect Apple High-Resolution Monochrome Monitors.

Table 5-6. Macintosh II (DB-15) Video Signals

Pin	Macintosh II Video Card	AppleColor High-Res. RGB
1	Red Ground	Red Ground
2	Red Video	Red Video
3	Composite Synch	Composite Synch
4	Monitor ID, Bit 1	Composite Synch Ground

(continued)

(continued)

Pin	Macintosh II Video Card	AppleColor High-Res. RGB
5	Green Video	Green Video
6	Green Ground	Green Ground
7	Monitor ID, Bit 2	Not Used
8	Not Used	Not Used
9	Blue Video	Blue Video
10	Monitor ID, Bit 3	Not Used
11	Composite Synch Ground/ Vertical Synch Ground	Not Used
12	Vertical Synch	Not Used
13	Blue Ground	Blue Ground
14	Horizontal Synch Ground	Not Used
15	Horizontal Synch	Not Used
Shell	Chassis Ground	Shield Ground

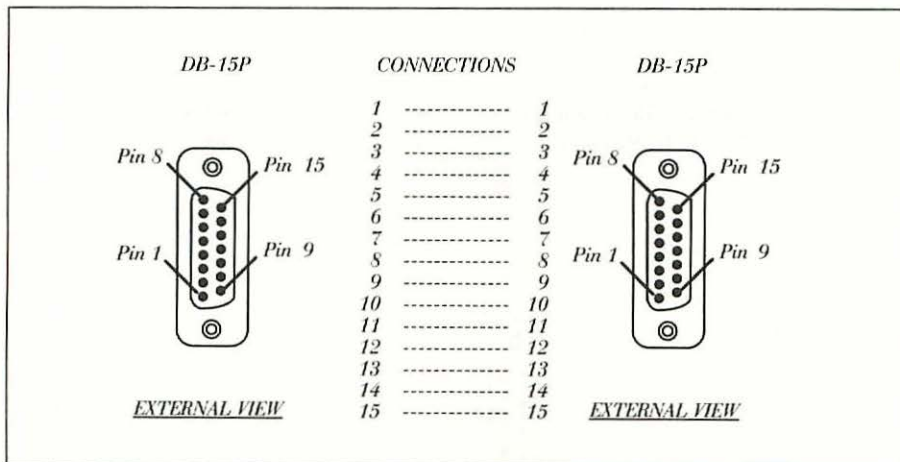

Figure 5-9 Wiring diagram for OEM part number 590-0161-A, Macintosh II Video Card to AppleColor High-Resolution RGB Monitor cable.

To connect Macintosh II Video Cards (Original, Extended, or High-Resolution) to NTSC-compatible equipment (composite monitors and VCRs) you need a cable with a DB-15P connector on one end and an RCA phono plug on the other end. Pin 5 on the DB-15P, green video, is

connected to the tip of the RCA phono plug, and pin 6 on the DB-15P, green ground, is connected to the shell of the RCA phono plug. The wiring diagram for this cable is shown in Figure 5-10.

To connect Macintosh Display Cards (4.8, 8.24, 8.24GC) to NTSC-compatible equipment, pin 5 on the DB-15P is connected to the tip of the RCA phono plug, pin 6 on the DB-15P is connected to the shell of the RCA phono plug, and pins 4, 7, and 11 on the DB-15P connector are jumpered together, as shown in Figure 5-11.

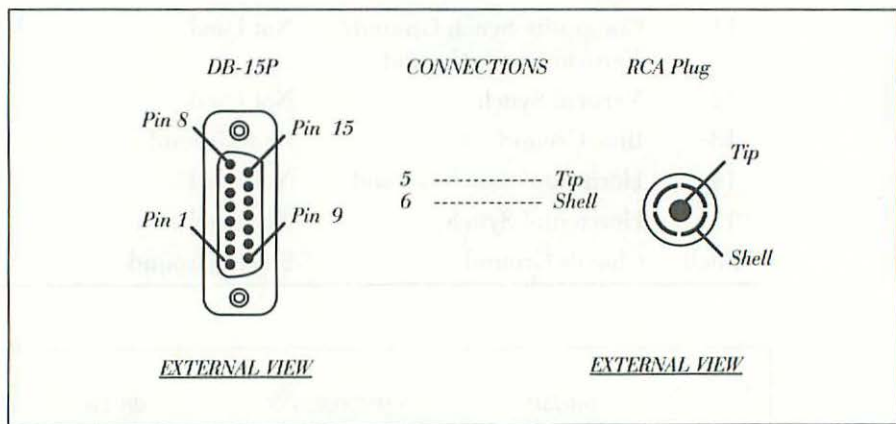

Figure 5-10 Wiring diagram for Macintosh II Video Card (Original, Extended, High-Resolution) to NTSC-compatible (composite monitor/VCR) cable.

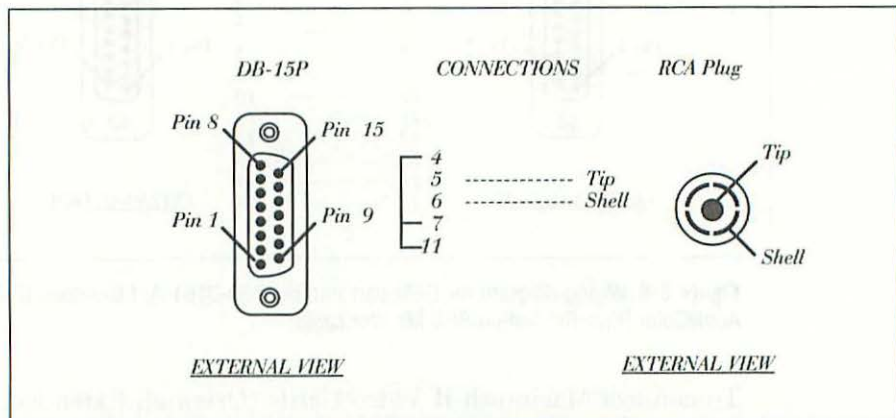

Figure 5-11 Wiring diagram for Macintosh Display Card (4.8, 8.24, 8.24GC) to NTSC-compatible (composite monitor/VCR) cable.

Think twice before you experiment with cables other than those diagramed in Figures 5-10 and 5-11. Video equipment is easily damaged by incorrect wiring. Repairs can be costly!

Obtaining an Audio Cable

All sound effects created on the Macintosh II are normally reproduced by the computer's built-in speaker. To transfer sound effects to video tape without having to use a microphone, you need a direct-connect audio cable with a stereo 1/8-inch mini plug on one end and two RCA phono plugs on the other end. This same cable is also used to connect personal portable stereos and compact disc players to high-fidelity stereo component systems. You can buy one ready-made at Radio Shack.

Connections are made by plugging the stereo 1/8-inch mini plug into the speaker jack on the back of the Macintosh II, and by plugging the two RCA phono plugs into the left and right audio input jacks on the VCR.

Installing (NTSC) Video Card Utility Software

Older Macintosh II Video Cards (Original, Extended, and High-Resolution) generally require System Software Version 6.0.3 or later, Monitors CDEV 4.0 or later, 32-Bit QuickDraw, and Apple Video Card Utility software. The utility software (a startup INIT) is not available at retail. Instead, it's distributed by user groups and authorized on-line services. Check Appendix B for sources.

To install the Video Card Utility, drag its icon into the System Folder of your startup disk. If necessary, drag 32-Bit QuickDraw and Monitors CDEV 4.0 or later into the System Folder as well. When you restart the computer, the Video Card Utility icon will be drawn at the bottom of the screen along with your other INITs. An "X" drawn through the Video Card Utility icon on startup indicates that it's installed, but currently deactivated, as shown in Figure 5-12.

Activating the NTSC Video Card Utility Software

The Video Card Utility INIT is accessed by clicking the Options button in the Monitors CDEV. To activate the software:

1. Choose the Control Panel desk accessory (DA) from the Apple menu, as shown in Figure 5-1.
2. Select the Monitors Control Panel device (CDEV), as shown in Figure 5-2.
3. Select Grays and set the “Characteristics of selected monitor:” to Black & White.
4. Click the Options button. As shown in Figure 5-13, the Video Card Utility adds several new options to the Monitors CDEV.

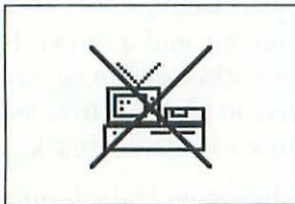
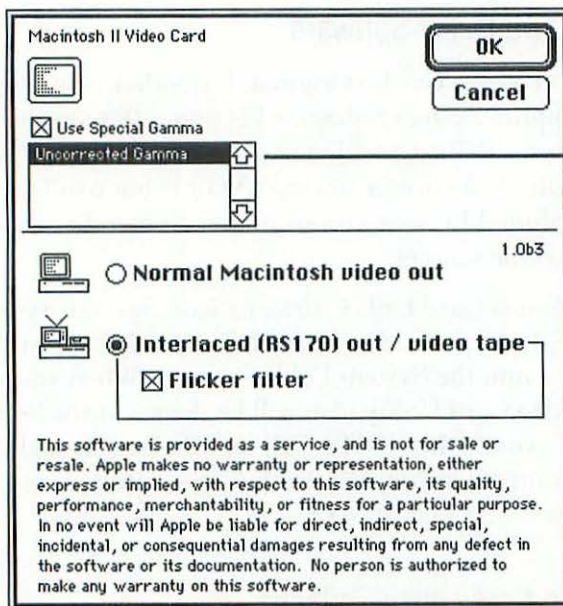

Figure 5-12 An “X” drawn through the Video Card Utility icon on startup indicates that it’s installed, but currently deactivated.



NOTE:
Gamma options pertain to System 6.0.7 They don't appear when earlier system software is run. They don't appear in system 7.0

Figure 5-13 The Video Card Utility (used with older Macintosh II Video cards) adds “RS 170 out / video tape” options to the Monitors CDEV.

5. Select “Interlaced (RS170) out / video tape”.
6. Select Flicker filter. Note that Flicker filter is only available when the “Characteristics of selected monitor:” are set to Black & White, as instructed in step 3. If Flicker filter can’t be selected, click the Cancel button and repeat steps 3 to 6.
7. Click the OK button and click the Close Box on the Control Panel.
8. Shut down the computer, wait 20 seconds, and replace the standard video cable with the correct NTSC-compatible cable.
9. To record sound effects as well, plug the correct audio cable into the stereo speaker jack on the back of the Macintosh II.
10. Connect the NTSC-compatible equipment, turn the equipment on and restart the computer.

A typical arrangement looks just like the video card utility icon—the Macintosh II is connected to a VCR which is connected to a television set. Alternately, you can skip the VCR and connect directly to an NTSC-compatible monitor, the type with RCA video input jacks. For the first 15 to 45 seconds (depending on the speed of the start-up drive) diagonal lines accompanied by an unfamiliar noise give the impression that the vertical hold will need adjustment, but as soon as the Video Card Utility loads, the vertical signal stabilizes and usual display appears on the television screen. To record it, just press the record button on your VCR, the same as if you were recording a TV show. Other use depends on whether the video card is an original, Extended, or High-Resolution model. High-Resolution models have more features.

Use with Original Macintosh II Video Cards

With the Flicker filter on (underscan), the desktop size is reduced to 512 × 342 pixels, the same as on a Macintosh Classic. The mouse moves much slower than usual, but the display is rock solid. The “Characteristics of selected monitor:” are fixed at Black & White.

With the Flicker filter off (overscan), the desktop size is enlarged to 640 × 480 pixels, the same as on the Apple High-Resolution Monochrome and AppleColor High-Resolution RGB Monitors. The menu bar is drawn slightly above the top of the display. The mouse moves as usual, but thin, 1-pixel high horizontal lines flicker. The “Characteristics of selected monitor:” can be varied. If 16 grays is selected, the NTSC equipment records and/or displays 16 shades of gray. If 16 colors is selected,

the NTSC equipment records and/or displays the green component of all 16 colors. In that respect, results are similar to using an Apple High-Resolution Monochrome Monitor. Even though color characteristics are supported, and even though you're connected to a color VCR and a color television set, you don't actually get color.

Use with Macintosh II Extended Video Cards

Use with Macintosh II Extended Video Cards is exactly the same as described for original Macintosh II Video cards, except that the "Characteristics of selected monitor:" are increased to 256 grays or 256 colors.

Use with Four-Bit Mac II High-Resolution Video Cards

With the Flicker filter on, the desktop size can either be 512×384 pixels, slightly larger than on a Macintosh Classic, or 640×480 pixels, the same as on the Apple High-Resolution Monochrome and AppleColor High-Resolution RGB Monitors. The mouse moves much slower than usual, but the display is rock solid. The "Characteristics of selected monitor:" are fixed at Black & White.

With the Flicker filter off, the mouse moves as usual, but thin horizontal lines flicker. The "Characteristics of selected monitor:" are fixed at 16 grays or colors. Black and white and two-bit video (4 grays or colors) are not supported.

If 16 grays is selected, the NTSC equipment records and/or displays 16 shades of gray. If 16 colors is selected, the NTSC equipment records and/or displays the green component of all 16 colors. In that respect, results are similar to using an Apple High-Resolution Monochrome Monitor. Even though color characteristics are supported, and even though you're connected to a color VCR and a color television set, you don't actually get color.

Use With Eight-Bit Mac II High-Resolution Video Cards

Use with eight-bit Mac II High-Resolution Video Cards is exactly the same as described for four-bit Mac II High-Resolution Video Cards, except that the "Characteristics of selected monitor:" also supports 256 grays or 256 colors.

Deactivating the Video Card Utility Software

To deactivate the Video Card Utility software, follow this procedure:

1. Choose the Control Panel desk accessory (DA) from the Apple menu, as shown in Figure 5-1.
2. Select the Monitors Control Panel device (CDEV), as shown in Figure 5-2.
3. Select Grays or Colors and set the “Characteristics of selected monitor:” to its usual position.
4. Click the Options button.
5. Select “Normal Macintosh video out”.
6. Click the OK button and click the Close Box on the Control Panel.
7. Shut down the computer, wait 20 seconds, and replace the NTSC-compatible cable with the standard video cable.
8. Disconnect the audio cable from the stereo speaker jack on the back of the Macintosh II.
9. Reconnect the standard monitor, turn the monitor’s power switch on, and restart the computer.

Configuring Macintosh Display Cards

The purpose of the Macintosh II Video Utility is to tell the older Macintosh II Video Cards (Original and Extended) that they’re connected to NTSC-compatible video equipment (not normal Macintosh video equipment). The newer Macintosh Display Cards (4.8, 8.24, and 8.24GC) get that information from pins 4, 7, and 10 on the DB-15P end of the Mac-to-NTSC video cable. When pins 4 and 7 are shorted to pin 11, Vertical Synch Ground, Display Cards automatically switch from RS-343 timing (Mac) to RS-170 timing (NTSC). As shown in Figure 5-14, interlaced displays are internally supported. Video Card Utility software is not needed.

Macintosh II Display Cards (8.24 and 8.24GC) also have built-in Apple Convolution. This logic allows flicker-free eight-bit interlaced video in real time. Even when the “Characteristics of selected monitor:” are set to 256 grays or 256 colors (green component only), there is no flicker and the mouse does not slow down.

NOTE:

Gamma options pertain to System 6.0.7 They don't appear when earlier system software is run. They don't appear in system 7.0

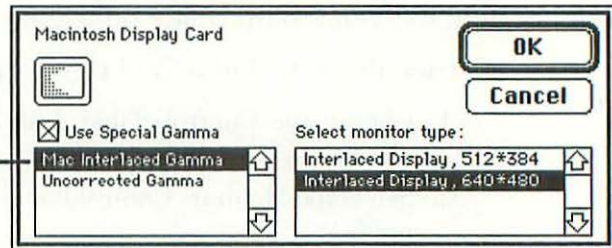

Figure 5-14 Macintosh II Display Cards (8.24 and 8.24GC) have built-in RS 170 / video tape options. Interlaced displays are internally supported. Video Card Utility software is not needed.

As indicated in Figure 5-15, NTSC-compatible video is interlaced. Interlaced means that even-numbered (horizontal) lines in the computer display are refreshed on even-numbered (vertical) sweeps and odd-numbered (horizontal) lines in the computer display are refreshed on odd-numbered (vertical) sweeps (or vice versa). If you think of the vertical-refresh signal as food, then interlacing forces each horizontal line to skip every other meal. With thin objects that are only one-pixel tall, the constant on/off action causes the object to flicker. Thicker objects that are two or more pixels tall don't seem to flicker as much, because at least some part of the object is getting fed. This effect is shown in Figure 5-15.

Apple Convolution is a mathematical formula that averages each line in the display with the lines directly above and below it. Based on the convoluted average, the card continuously adjusts the video signal (up and down) which causes a slight blurring sensation, but stops thin horizontal objects from noticeably blinking on and off.

Desktop Video Software

In addition to HyperCard, other presentation programs which are well suited for desktop video use are Microsoft PowerPoint and Symantec's More. Both hide the menu bar (important when you've only got one video card) and both allow slides to be cycled manually or automatically. When you get your credits just the way you like them, you can set them to music, switch on the NTSC equipment and record the whole thing.

Admittedly, you won't get professional quality, but if all you want to do is create slides and titles for family home videos, the stuff you already own may be all the stuff you need.

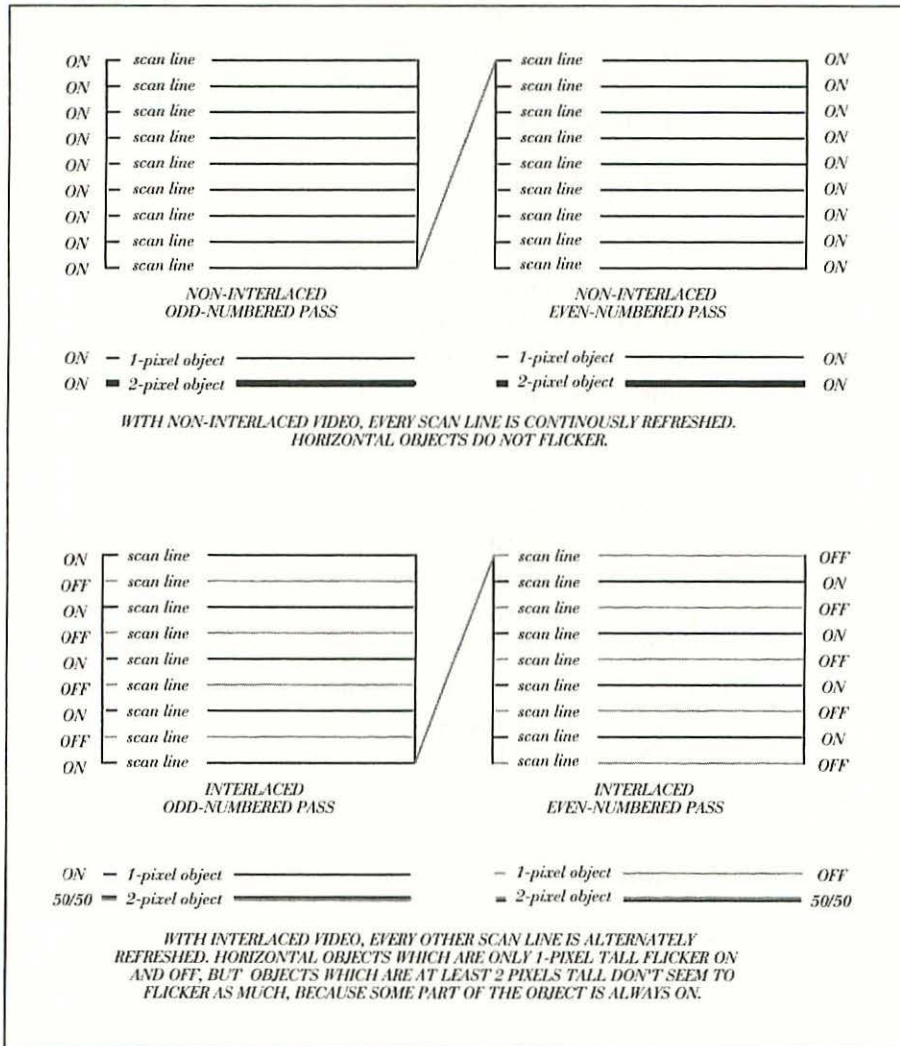

Figure 5-15 If you think of the vertical-refresh signal as food, then interlacing forces each horizontal line to skip every other meal.

Troubleshooting Video Cards

All Macintosh II Video Cards (original, Extended, and High-Resolution) are built on layered, printed circuit boards (PCBs). Through-hole components are soldered on both sides of the PCB. Some cards contain single outline J-lead (SOJ) surface mount devices (SMDs) which are very difficult to replace. Compared to servicing Macintosh Plus analog-boards, a

much higher degree of soldering skill is required to successfully repair video cards. With the understanding that the information in this section is for trained technicians working in fully-equipped radio/TV repair shops only, here's a list of common symptoms and solutions:

1. Completely dead cards are usually associated with the PCA 14-pin EP8302 delay line.
2. Color blotches that have been isolated to the card (not due to color purity problems on a particular monitor) are usually associated with the Bt453KP (triple 8-bit 66-MHz) RAMDAC. Original and Extended Macintosh II Video Cards use a 40-pin plastic dual-inline package (DIP) with 0.6-inch spacing between pin centers. Macintosh II High-Resolution Video Cards use a surface-mount 44-pin plastic J-lead package.
3. Static that has been isolated to the card is usually associated with one or more of the D41264C-12 VRAM chips. Replacement chips that were originally soldered should be socketed to facilitate future repairs. The correct socket to use is a 24-pin solder tail DIP with 0.4-inch (not 0.3-inch) spacing between pin centers.

Compared to the cost of “a whole new video card,” you can generally save big money by getting your old video card repaired. Some firms specialize in Macintosh II Video Card repairs. Others carry replacement parts. Check Appendix B for a list of vendors.

That's it for Macintosh II Video Cards. Next, we'll look at DRAM—memory and coprocessor upgrades.

6

DRAM—Memory and Coprocessor Upgrades

This chapter shows you how to add memory and coprocessor upgrades to a Macintosh II. All models are covered, through and including the Macintosh IIsx. The instructions assume that you're familiar with ESD and that you know how to take your Macintosh apart. If necessary, please read Chapter 1 for ESD-prevention information and Chapter 4 for take-apart information before proceeding.

Types of DRAM Chips

The expression *dynamic random access memory* (DRAM) generally refers to a single memory chip or to a bank of memory chips. On the Macintosh II, banks of DRAM chips are soldered to small printed circuit boards (PCBs) called single inline memory modules (SIMMs).

Each module contains a set of two to nine DRAM chips. Each module plugs into a matching SIMM socket on the Macintosh II logic board. To fit the SIMM sockets, each module is manufactured to a standard width but the height of the module varies according to the type of DRAM chip used. Common types of DRAM chips include dual inline package (DIP), plastic leadless chip carrier (PLCC), and single outline J-lead (SOJ).

As shown in Figure 6-1, 256K DIP SIMM refers to a through-hole memory module with 16-pin DIP chips. The chip leads extend through holes drilled in the PCB, and all connections are soldered on the back side of the board. Each 256K DIP SIMM may have two or eight chips, depending on the density of the DRAM chips used. In general, 256K DIP SIMMs are physically larger and consume more power than other types.

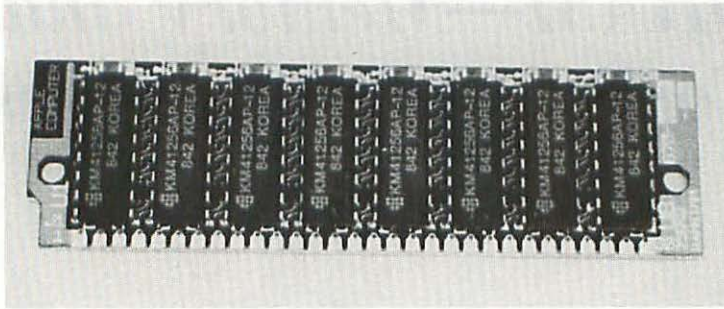

Figure 6-1 DIP SIMM refers to a through-hole memory module with 16-pin DIP chips.

PLCC SIMM refers to a solid memory module with 18-pin surface-mount chips. As shown in Figure 6-2, two sides of the chip have five leads each. The other two sides have four leads each. All 18 leads are soldered on the front side of the module.

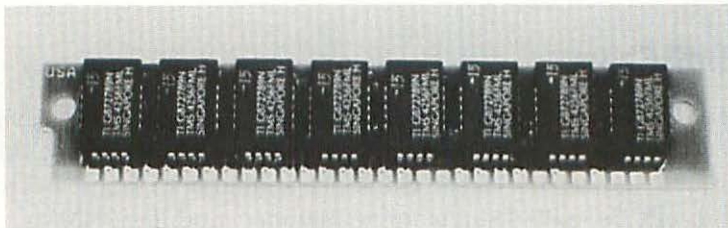

Figure 6-2 PLCC SIMM refers to a solid memory module with 18-pin surface mount chips.

SOJ SIMM refers to a solid memory module with 20-pin surface mount chips. As shown in Figures 6-3 and 6-4, each SOJ SIMM can have either two or eight chips, depending on the capacity of the DRAM chips used. As shown in Figure 6-5, PCB layouts vary from manufacturer to manufacturer.

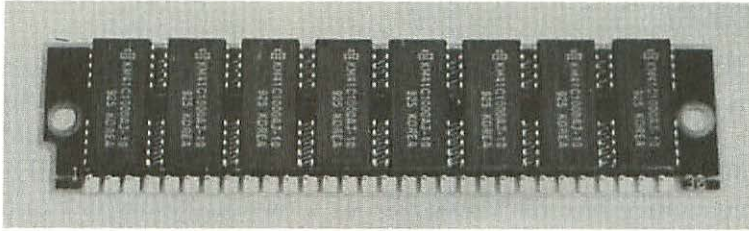

Figure 6-3 SOJ SIMM refers to a solid memory module with 20-pin surface mount chips.

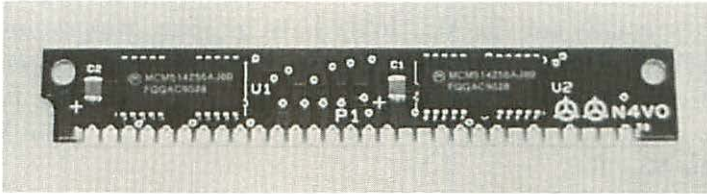

Figure 6-4 SOJ SIMMs can have either two or eight chips, depending on the capacity of the DRAM chips used.

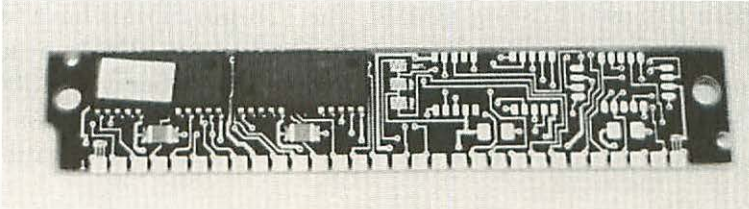

Figure 6-5 SOJ SIMM PCB layouts vary from manufacturer to manufacturer.

Some manufacturers use a combination of PLCC and SOJ DRAM chips, as shown in Figure 6-6. The important point is, that while they look different, and while their power requirements are different, the memory capacity (256K) of each of the SIMMs shown in Figures 6-1 to 6-6 is identical.

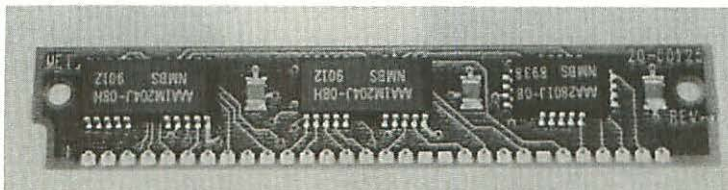

Figure 6-6 Some manufacturers use a combination of PLCC and SOJ DRAM chips.

Memory Capacity

SIMMs also differ in their memory capacity, power requirements, and speed. Memory capacity refers to the density of the DRAM chips used on the SIMM. The original Macintosh II can accept 256K SIMMs, 1 MB SIMMs, and special 4 MB SIMMs. One-megabyte and 4 MB SIMMs look pretty much like the 256K SIMMs shown in Figure 6-1 to 6-6, except that the part numbers on the chips are different. Chips marked 41256 indicate a 256K SIMM. Chips marked 511000 indicate a 1 MB SIMM. Chips marked 514100 indicate a 4 MB SIMM. Four megabyte SIMMs made especially for the Mac II/IIx have an extra programmable array logic (PAL) chip on them. Four megabyte SIMMs made especially for the Mac IIcx/ci and Mac IIsi don't have the extra chip. The former type works in all five models. The latter type only works in the Mac IIcx/ci and the Mac IIsi.

Electrical configurations also differ. The Macintosh II/IIx, IIcx/IIci, and IIsi use 60-pin SIMMs. As shown in Figures 6-1 to 6-6, 60-pin SIMMs have 30 electrical contacts on each side of the module. The Macintosh IIfx uses 128-pin SIMMs. The 128-pin SIMMs have 64 electrical contacts on each side of the module. The 128-pin SIMMs are also 1/4-inch longer than the 60-pin type. The point to remember is that 80NS, 60-pin SIMMs taken from a Macintosh II/IIx, IIcx/IIci, or IIsi won't fit into a Macintosh IIfx and vice-versa. They're physically incompatible.

Power Requirements

Chips marked with a "C" (as in 511000C) are made from complementary metal-oxide semiconductor (CMOS) material. CMOS SIMMs consume less power than other types. That leaves more power for hard drives and NuBus cards.

It's very important to install CMOS SIMMs in the Mac IIcx/ci, because their power supplies (rated 108W) are 50% weaker ($108 \times 150\% = 162$) than the 156W power supplies used in the Macintosh II/IIx/IIfx. Although other types of SIMMs can be used in the IIcx/IIci, the IIcx/IIci power supply may shut down (or refuse to run) if a big hard drive and a full complement of NuBus cards are added later on.

On the IIsi, where the power supplies (rated 44W) are 350% weaker ($44 \times 350\% = 154$) than the 156W power supplies used in the Macintosh II/IIx/IIfx, and 250% weaker ($44 \times 250\% = 110$) than the 108W power supplies used in the IIcx/ci, CMOS SIMMs are considered a necessity.

Speed

Speed is measured in billionths of a second (nanoseconds or ns). Speed ratings are like golf scores. The lower the number, the faster the speed. SIMMs rated 120ns are faster than SIMMs rated 150NS. SIMMs rated 100NS are faster than SIMMs rated 120NS, and so on.

Speed ratings are indicated by two digits marked on the SIMM. In Figures 6-1 and 6-5, the “-12” indicates 120 nanoseconds. In Figure 6-2, the “-15” indicates 150 nanoseconds. Relatively slow 150ns (-15) SIMMs are fine for use in a Macintosh Plus or a Macintosh SE, but 150ns SIMMs usually cause system errors in a Macintosh II/IIx or IIcx. Sometimes, they won’t work at all.

In Figure 6-3, the “-10” indicates 100 nanoseconds. One hundred ns SIMMs are faster than 120ns SIMMs, but they’re the slowest SIMMs that can be used in a Macintosh IIsi. One hundred twenty ns SIMMs which work perfectly in a Macintosh II/IIx/IIcx don’t work properly in a IIsi!

In Figures 6-4 and 6-6, the last two numbers are “80” indicating 80 ns. Eighty ns SIMMs are even faster than 100ns SIMMs, but they’re the slowest SIMMs that can be used in a Macintosh IIfx. One hundred ns SIMMs which work perfectly in a Macintosh II/IIx/IIcx/IIsi don’t work properly in a IIfx!

System errors pertaining to one particular machine may also be the result of mixing speeds. Although most other sources say that it’s perfectly OK to do that, it’s been my experience when SIMM speeds are mixed, mystery problems occur. Replacing the oddball SIMMs so that the entire complement of four or eight SIMMs are all the same speed (preferably the faster speed), usually cures the problem. This information is summarized in Table 6-1.

Table 6-1. Macintosh II SIMM Specifications

Model	Min.Speed	Contacts
Mac II/IIx/IIcx	120 NS	60
Mac IIfx	80 NS	128
Mac IIsi	100 NS	60

Identifying Banks A and B

As shown in Chapter 4, Figures 4-32 and 4-34, there are eight DRAM SIMM sockets in the Macintosh IIcx/IIci but only four DRAM SIMM sockets in the Macintosh IIsi. The SIMMs are arranged in banks of four, generally referred to as Bank A and Bank B. This causes a lot of confusion, because “Bank A” and “Bank B” are not always labeled (so which is which?), and various revisions of the Mac II/IIx/IIfx logic board are all marked differently.

As shown in Figure 6-7, the SIMM sockets on the original Macintosh II logic board are marked in ascending order from SIM1 to SIM4. Note that SIM is spelled with only one “M” and that “Bank A” and “Bank B” are not marked. In addition, the left-to-right orientation of the SIM1-to-SIM4 labels gives the impression that Bank A might be the sockets marked SIM1 and SIM2 while Bank B might be the sockets marked SIM3 and SIM4. Not so!

As shown in Figure 6-8, the SIMM sockets on later Macintosh II logic boards are marked in descending order from SIM4 to SIM1! Bank B is actually on the left (SIM4 and SIM3). Bank A is actually on the right (SIM2 and SIM1). This right-to-left arrangement is exactly the opposite of earlier Mac II boards! Right-to-left is also consistent with the IIx and the IIcx/IIci, but the IIfx is arranged a third way.

As shown in Figure 6-9, the SIMM sockets on a IIfx are rotated 180° and marked in staggered order from J31 to J38. Bank A refers to the four sockets closest to the back of the computer. Bank B refers to the four sockets closest to the front of the computer. The point is that the various Mac II logic boards are all marked differently. The labels on some Macintosh II logic boards are exactly the reverse of others. The fact that they’re all marked differently is not always made clear when you buy SIMMs. That makes it easy to misunderstand the directions.

Configuring the Macintosh II/IIx/IIfx and Macintosh IIcx

The original Macintosh II shipped with four 256K SIMMs totalling 1 MB (4 × 256K) of memory. As shown in Figure 6-10, the SIMMs were installed in the four sockets closest to the right side of the computer. The four sockets closest to the left side of the computer were empty. All eight sockets are directly below the drive bay. To get at them, the drive bay has to be removed, as illustrated in Chapter 4, Figure 4-4.

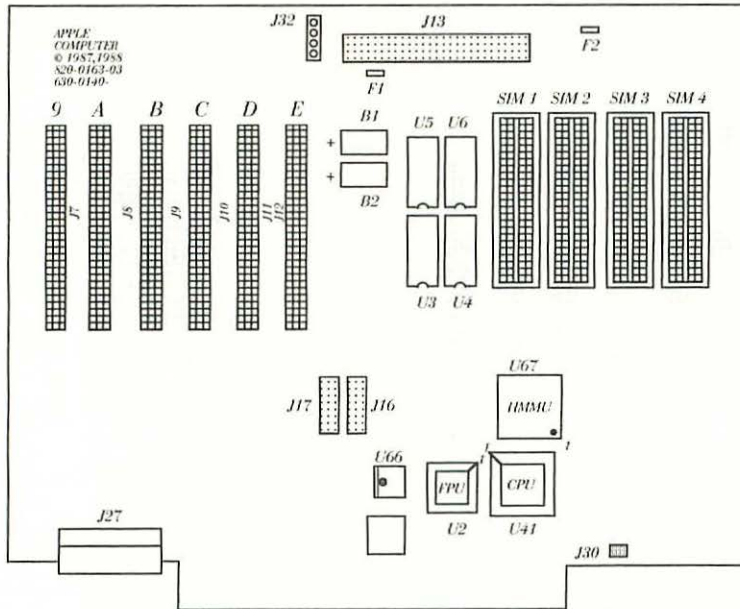

Figure 6-7 The SIMM sockets on the original Macintosh II logic board are marked in ascending order from SIM1 to SIM4.

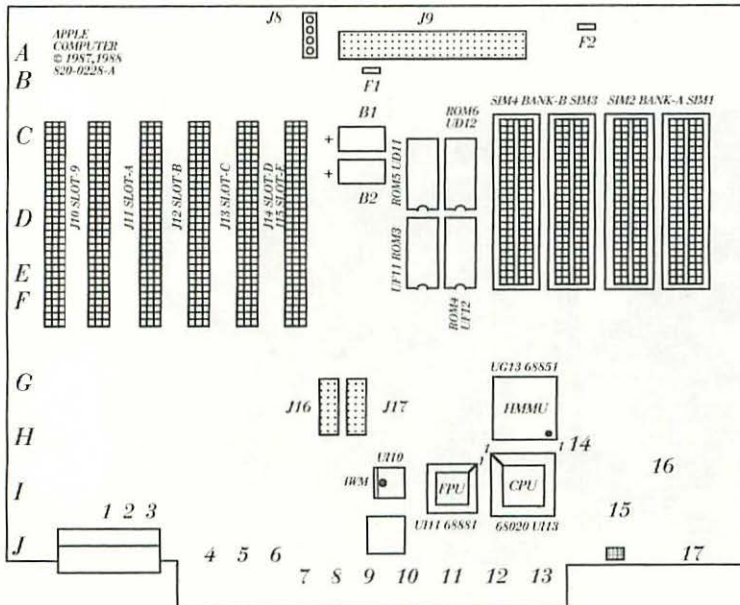

Figure 6-8 The SIMM sockets on the later Macintosh II logic board are marked in descending order from SIM4 to SIM1.

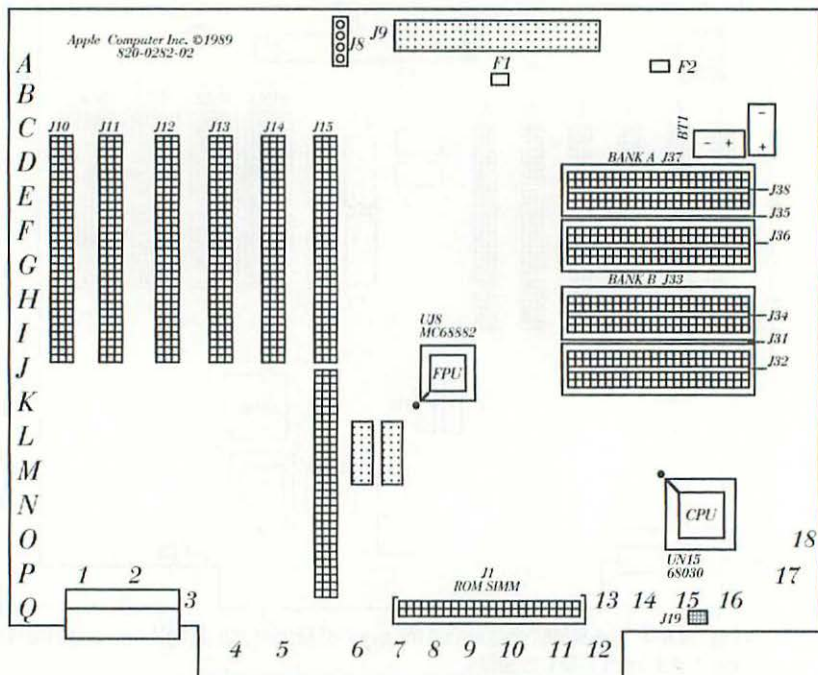

Figure 6-9 The SIMM sockets on the Macintosh IIx logic board are marked in a staggered order from J31 to J38.

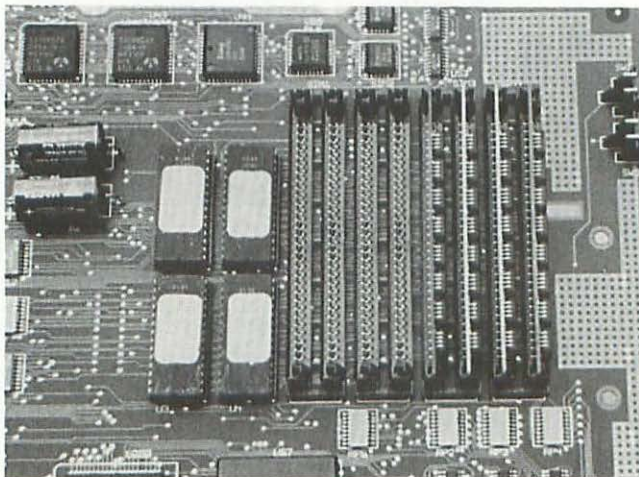

Figure 6-10 The original Macintosh II shipped with four 256K SIMMs totalling 1 MB (4 × 256K) of memory.

One-to-two megabyte upgrades simply involve plugging four 256K SIMMs into the empty sockets, but 1 MB-to-5 MB upgrades are handled differently: The 256K SIMMs are removed, the 1 MB SIMMs are installed in their place, and the 256K SIMMs are installed in the previously empty sockets. That's not obvious.

Obvious or not, the Mac II/IIx/IIfx and Mac IICx rule is that the highest-capacity SIMMs always go in Bank A. If you leave the 256K SIMMs in their factory locations and plug four 1 MB SIMMs into the empty sockets (Bank B), then 1 MB-to-5 MB upgrades won't work. Depending on the revision number of the logic board, you'll either get an error sound, or 3 of the 5 MB will not be recognized.

A second rule applicable to all models of the Macintosh II is that SIMMs are always added and/or removed in sets of four. Banks A and B must either be full or empty. The total number of SIMMs must always be divisible by four. That allows 15 different SIMM configurations, of which only 9 are permitted, as summarized in Table 6-2. Other configurations (where the total number of SIMMs is not divisible by 4) stop the computer from working and result in an error tone.

Table 6-2. SIMM Configurations for Mac II/IIx/IIfx/IICx

Total Memory	Bank B	Bank A
1 MB	empty	all 256K
2 MB	all 256K	all 256K
4 MB	empty	all 1 MB
5 MB	all 256K	all 1 MB
8 MB	all 1 MB	all 1 MB
16 MB*	empty	all 4 MB**
17 MB*	all 256K	all 4 MB**
20 MB*	all 1 MB	all 4 MB**
32 MB*	all 4 MB	all 4 MB**
error	all 256K	empty
error	all 1 MB	empty
error	all 1 MB	all 256K
error	all 4 MB	empty
error	all 4 MB	all 256K
error	all 4 MB	all 1 MB

* Configurations greater than 8 MB require System 7.

** Mac II/IIx require FDHD ROMs and PAL SIMMs.

Configuring the Macintosh IIci

The Mac IIci differs from the Mac II/IIx/IIfx and the Mac IIcx in that it doesn't matter where you put the SIMMs. All 15 configurations work, but only 12 support the IIci's built-in RAM-based video. Since refreshing the video takes time, you can speed things up on a IIci by installing a Macintosh II Video Card or a Macintosh Display Card into a NuBus slot and putting all (or most) of the RAM in Bank B. This information is summarized in Table 6-3. Other configurations (where the total number of SIMMs is not divisible by 4) stop the computer from working and result in an error tone.

Table 6-3. SIMM Configurations for Mac IIci

Total Memory	Bank B	Bank A	Built-in Video
1 MB	empty	all 256K	Yes
2 MB	all 256K	all 256K	Yes
4 MB	empty	all 1 MB	Yes
5 MB	all 256K	all 1 MB	Yes
8 MB	all 1 MB	all 1 MB	Yes
16 MB*	empty	all 4 MB	Yes
17 MB*	all 256K	all 4 MB	Yes
20 MB*	all 1 MB	all 4 MB	Yes
32 MB*	all 4 MB	all 4 MB	Yes
1 MB	all 256K	empty	No
4 MB	all 1 MB	empty	No
5 MB	all 1 MB	all 256K	Yes
16 MB*	all 4 MB	empty	No
17 MB*	all 4 MB	all 256K	Yes
20 MB*	all 4 MB	all 1 MB	Yes

* Configurations greater than 8 MB require System 7.

Configuring the Macintosh IIsi

The Macintosh IIsi differs from the Macintosh II/IIx/IIfx and the Macintosh IIcx/ci in that only four SIMM sockets (instead of eight) are provided. One megabyte of DRAM is permanently soldered to the logic

board. The IIsi also works with 2 MB SIMMs. This allows five configurations, all of which support the built-in RAM based video, as summarized in Table 6-4. Installing less than four SIMMs stops the computer from working and results in an error tone.

Table 6-4. SIMM Configurations for Mac IIsi

Total Memory	Expansion Bank	Built-in Video
1 MB	empty	Yes
2 MB	all 256K	Yes
5 MB	all 1 MB	Yes
9 MB*	all 2 MB	Yes
17 MB*	all 4 MB	Yes

* Configurations greater than 8 MB require System 7.

Installing and Removing SIMMs

SIMMs are easy enough to install and remove, but people who've previously installed SIMMs into a Macintosh Plus or a Macintosh SE may have trouble. As shown in Figure 6-11, the installation angles are exactly reversed! Mac Plus SIMMs go in straight, then lie at an angle, but Mac II SIMMs go in at an angle then straighten up! If you're not aware of that and you try to put the SIMMs in backwards (correct for a Macintosh Plus) you may break the sockets.

Replacing a single SIMM socket involves removing the whole logic board, and desoldering/resoldering 120 contacts (60×2). That's time consuming. It also requires expert soldering skills. Most shops charge accordingly.

To avoid unnecessary repairs, study Figures 6-10 and 6-11 very carefully. Notice in Figure 6-10 that the chips face Bank A. The smooth backs of the modules face Bank B. This orientation is correct for all models of the Macintosh II, through and including the IIsi, whether Banks A and B are labeled or not. It's also true for the Macintosh IIfx and for the SE30.

As each SIMM is inserted, it's important to latch the bails. At the top of the bails are tiny hooks which hold the PCBs in place. As shown in Figure 6-12, the bail hooks resemble half arrows. If one of the half arrows is off to the side rather than securely on top of the SIMM, the upgrade may not work.

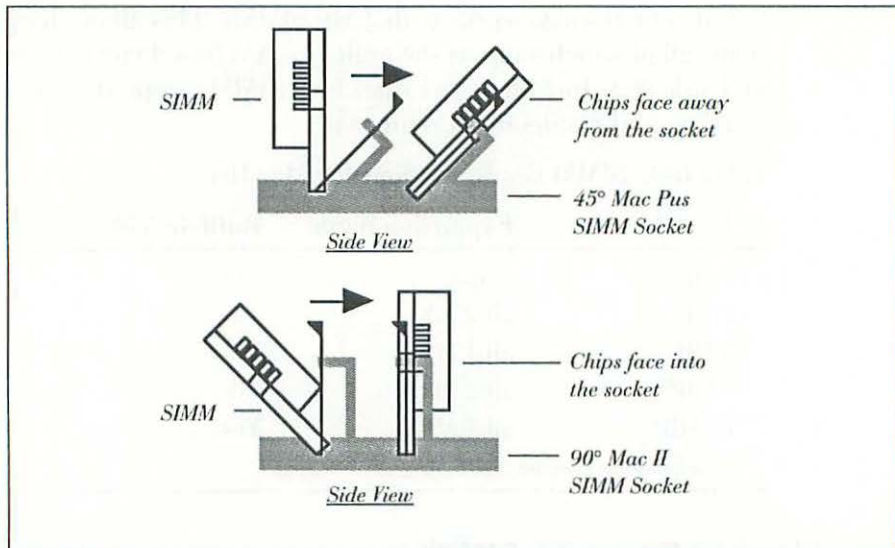

Figure 6-11 Mac Plus SIMMs go in straight then lie at an angle, but Mac II SIMMs go in at an angle then straighten up!

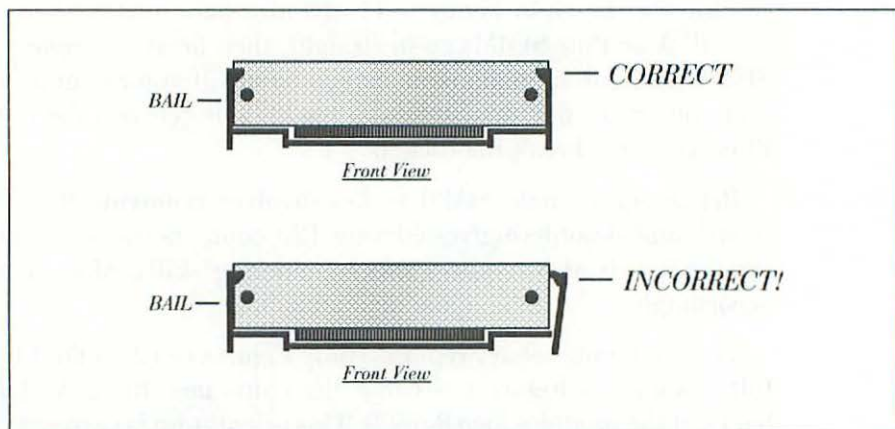

Figure 6-12 As each SIMM is inserted, it's important to latch the bails.

There are two types of SIMM sockets. The older sockets (used in original Mac IIs) were black. The newer sockets (used in the latest models) are white. The white sockets are much harder to work with. Consequently, they give more trouble. Be especially careful when working with them.

Troubleshooting SIMM Installations

When a SIMM upgrade doesn't work, and you get an error tone, it's usually because:

- The SIMMs have been installed in the wrong sockets.
- The SIMM speed is too slow for this Mac II.
- Someone tried to install the SIMMs backwards and bent or broke the sockets.
- The bail hooks are not latched.

When a SIMM upgrade doesn't work, and the computer hangs on "Welcome to Macintosh" or at some other point during the start-up sequence (when it worked perfectly prior to the upgrade), it's usually because of an INIT conflict. How can that be when all you did was add SIMMs, not new INITs? Some INITs behave differently when you have more memory.

To correct the problem, start up from a known-good (preferably INIT-free) system disk, and remove all the INITs from the System folder of your normal start-up disk. Restart the computer. If the normal start-up disk works now, you'll know that INIT conflicts were causing the problem. Replace each INIT, one at a time, shut down and restart until the problem reoccurs. When it does, the last INIT you installed is the one responsible.

PMMU Upgrades for the Macintosh II

Another way to add more memory to an original Macintosh II is to replace the OEM address memory management unit (AMU), alternately known as a Hochsprung memory management unit (HMMU), with a Motorola MC68851RC16A paged memory management unit (PMMU). Provided that you're running System 7 and that you have a large enough hard drive, a PMMU upgrade turns 2 MB machines into much more useful 15 MB machines. Not bad for a single chip.

PMMUs are not needed on the Macintosh IIx/IIfx, IIcx/IIci, and IIsi because paged memory management is built into the MC68030 processor.

Locating the HMMU

As shown in Figures 6-7 and 6-13, the OEM HMMU on early Mac II logic boards is located at board reference U67. As shown in Figure 6-8, the OEM HMMU on later Mac II logic boards is located at grid reference UG13 (U at G-13). Other board revisions may be labeled differently. The general location is directly beneath the drive bay toward the front of the computer.

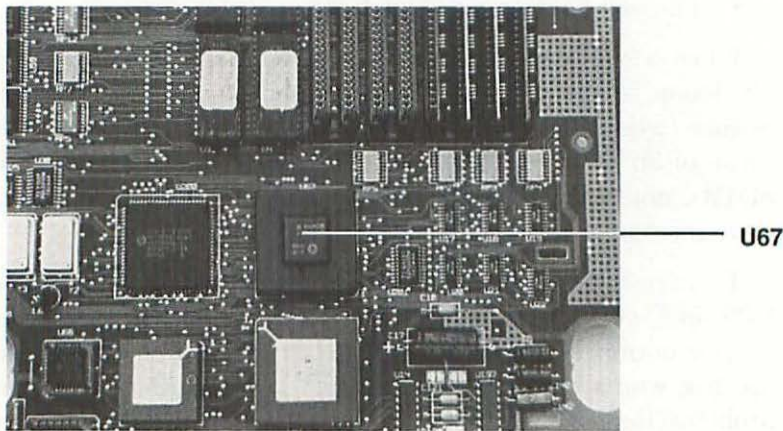

Figure 6-13 The OEM HMMU on early Mac II logic boards is located at board reference U67.

Removing the HMMU

Notice the dot in the lower right corner of the HMMU chip. The dot indicates pin one and points to a “1” printed on the logic board. The Motorola MC68851RC16A PMMU chip is marked with a gold-colored stripe, just like the nearby MC68020RC16B CPU and the nearby MC68881RC16A FPU. When the PMMU chip is installed, the gold-colored stripe on the chip must point toward the “1” on the logic board. It’s important to note that relationship now, so that you don’t absent-mindedly insert the PMMU incorrectly.

To remove the HMMU, carefully pry between the HMMU socket and the HMMU chip with a small flat-head screwdriver. Note that the chip is very thin. The socket is several times thicker than the chip. Be sure to insert the screwdriver between the chip and the socket, not between the chip and the logic board. If you try to pry the socket loose, it’s not going to work, and you may break the PCB.

The HMMU is a 70-pin device. Each pin is deeply rooted into the socket. You can't pull this chip like a two-penny nail. Instead, take tiny bites and keep the tool moving. As my grandparents used to say: "*Não é a força, mas é o jeito.*" (It's not the force, it's the technique.) Once or twice around the perimeter (10 to 12 small prys), and the HMMU should lift right off.

Installing the PMMU

Orient the PMMU such that the stripe on the chip points toward the "1" printed on the logic board. Align the pins with the socket and carefully press the chip home. Don't pound on the PMMU, or you may break the PCB.

When the chip is fully seated, a slight space will remain between the chip and the chip socket. How large a space? About the same as the space between the nearby CPU and FPU chips and their sockets.

Troubleshooting PMMU Upgrades

When there's no raster on restart immediately after a PMMU upgrade, the problem may be a defective socket. To work with a PMMU, the socket must have a 13×13 pin grid array (PGA) with 150 contacts. Some Mac IIs contain HMMU-specific sockets with only 70 unevenly spaced contacts. These can't be identified from the top of the logic board.

To verify that the socket is at fault, remove the logic board, as described in Chapter 4, and examine the solder work underneath the HMMU socket. As shown in Figure 6-14, the HMMU socket on early Mac II logic boards is bordered by C191, C30, C190, and C129. A good socket has 150 symmetrically spaced solder joints, all connected by traces, exactly as shown. A defective socket has 70 unevenly spaced solder joints, just enough for the HMMU. If the solder work on your board does not resemble Figure 6-14, reinstall the HMMU and forget about a PMMU upgrade. Other than replacing the logic board, there's no way to make it work.

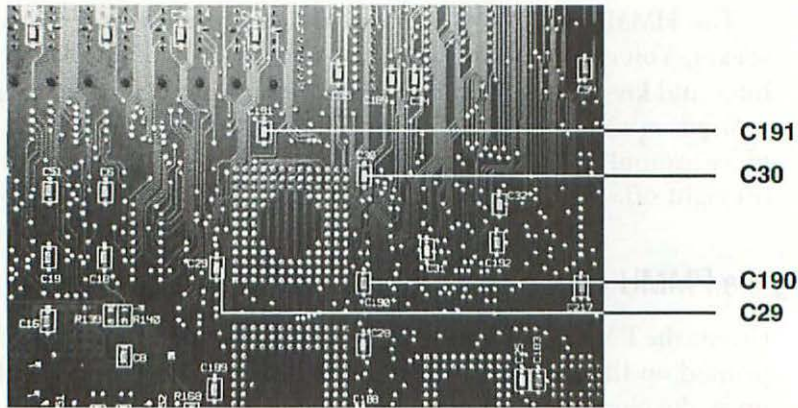

Figure 6-14 The HMMU socket on early Mac II logic boards is bordered by C191, C30, C190, and C29.

Installing Virtual Memory Software

To turn on the virtual memory software, choose Control Panels from the Apple menu (System 7 or greater), and double click the Memory CDEV. Select a hard disk with ample storage space, use the lower set of double arrows to set the total memory amount and click the Virtual-Memory On button.

In order to give maximum memory size when using 24-bit virtual memory, you must install NuBus cards in contiguous slots. On the IIcx, fill from the lowest numbered slot (\$9) up. On the IIfx, start from the highest numbered slot (\$E) when not using RAM-based video. Other Macs start from either end. Note that this is only for 24-bit virtual memory; 32-bit virtual memory does not have this restriction. Installing cards in this fashion may obstruct the flow of air through the fan, so the user must weigh the benefits of 24-bit virtual memory versus the risk of damage from overheating.

To check the installation, restart the computer and choose About This Macintosh from the Apple menu. When run on an original Mac II, the software recognizes 14 MB of gross memory ($14 \times 1024 = 14,336$), then subtracts 1 MB (1,024) for every installed NuBus card. The HD-40 shown in Figure 6-16 shares a Mac II with twin video cards, so the total memory shown is 12 MB ($14,336 - 2048 = 12,288$ K).

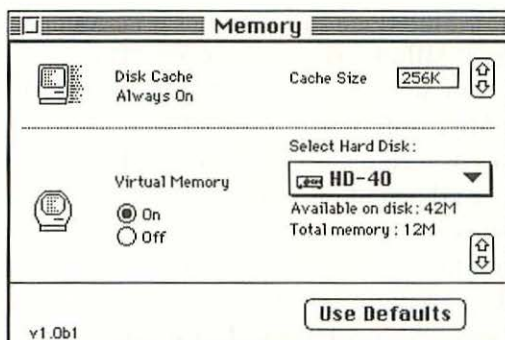

Figure 6-15 To turn on the virtual memory software, choose Control Panels from the Apple menu (System 7 or greater), and double click the Memory CDEV.

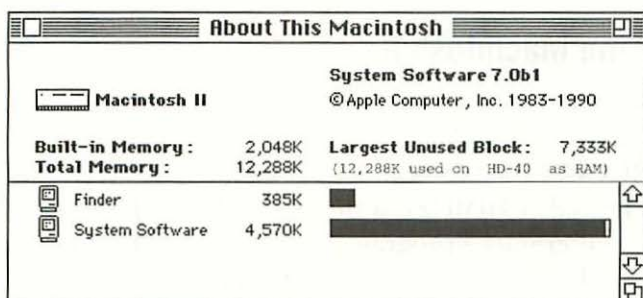

Figure 6-16 To check the installation, restart the computer and choose About This Macintosh from the Apple menu.

Troubleshooting Virtual Memory

If you have a 2 MB Mac II, Virtual lets you get real work done under MultiFinder but some things aren't compatible. Versions of Tops networking software (made for System 6), crash the computer on startup if more than 8 MB is available. Early versions of Microsoft Mail crash if more than 8 MB is available. Early versions of the Macintosh Display Card 8.24GC (graphics accelerator) don't work unless the accelerator is disabled. Direct-connect HP-DeskWriter printers which communicate at 57,600 baud produce "Datacomm buffer overrun—no DTR handshaking" errors but HP-DeskJet printers (original, DeskJet Plus, and DeskJet 500) which communicate at 9,600 or 19,200 baud all work fine.

Printer spoolers slow down the computer so much that they become useless. Software that runs in the background can make the mouse jump. Otherwise, a Mac II running virtual memory handles about the same as a

Macintosh Plus. Is a slow Mac II useful? You bet it is. A good part of this book was written under 8 MB of virtual memory (using an Apple CDEV designed for System 6) on an original Mac II with only 2 MB of DRAM (eight 256K SIMMs). Microsoft Word 4.0b, Microsoft Works 2.0a enhanced by Lundeen and Associates WorksPlus, Spell 2.0a6, MultiFinder 6.0.7, SuperPaint 2.0a, and just about everything else I use regularly ran perfectly. Switching between open applications was much slower than I'm used to, and sometimes that tried my patience, but every time I switched Virtual off, I quickly turned it back on. So what's the bottom line? Virtual may not be as fast as DRAM, but it does work, it is useful, and provided you buy the PMMU right, you just can't beat the cost per megabyte.

FPU Upgrades for the Macintosh II

Another way to enhance an original Macintosh II is to replace the factory installed MC68881RC16A floating point coprocessor unit (FPU) with an MC68882RC16A FPU (the same as on a Macintosh IIx). Both chips are externally clocked at 16MHz but the MC68882 is much faster internally. Object-oriented graphics programs, scientific applications, and spreadsheets all benefit from the extra speed. Depending on the application, performance improvements of 40% to 100% can be expected. The difference is definitely noticeable.

MC68881-to-MC68882 FPU upgrades are not needed on the Macintosh IIx/IIfx and IIcx/IIci because these machines are factory equipped with an MC68882.

Locating the FPU Socket

As shown in Figures 6-7 and 6-13, the '881 FPU on early Mac II logic boards is located at board reference U2. As shown in Figure 6-8, the '881 FPU on later Mac II logic boards is located at grid reference UI11 (U at I-11). Other board revisions may be labeled differently. The general location is directly beneath the drive bay toward the front of the computer.

Removing the Existing FPU

Notice the gold-colored stripe on the existing FPU chip. The stripe indicates pin one and points to a “1” printed on the logic board. The Motorola MC68882RC16A FPU chip is also marked with a stripe, just like the nearby MC68020RC16B CPU. When the new FPU chip is installed, the stripe on the new chip must also point toward the “1” on the logic board. It’s important to note that relationship now, so that you don’t absentmindedly insert the new FPU incorrectly.

To remove the existing FPU, carefully pry between the FPU socket and the FPU chip with a small flat-head screwdriver. Note that the chip is very thin. The socket is several times thicker than the chip. Be sure to insert the screwdriver between the chip and the socket, not between the chip and the logic board. If you try to pry the socket loose, it’s not going to work, and you may break the PCB.

The FPU is a 64-pin device. Each pin is deeply rooted into the socket. You can’t pull this chip like a two-penny nail. Instead, take tiny bites and keep the tool moving. As my grandparents used to say: “*Não é a força, mas é o jeito.*” (It’s not the force, it’s the technique.) Once or twice around the perimeter (10 to 12 small prys), and the FPU should lift right off.

Installing the MC68882 FPU

Orient the ‘882 such that the gold-colored stripe on the chip points toward the “1” printed on the logic board. Align the pins with the socket and carefully press the chip home. Don’t pound on the ‘882, or you may break the PCB.

When the chip is fully seated, a slight space will remain between the chip and the chip socket. How large a space? About the same as the space between the CPU (located just to the right) and its socket.

By installing an MC68851 PMMU, an MC68882 FPU, and a 1.4 MB FDHD SuperDrive Upgrade (described in Chapter 8), you can turn an original Macintosh II into the functional equivalent of a Macintosh IIx for a small fraction of the official upgrade cost.

FPU Upgrades for the Macintosh IIsi

While the original Macintosh II has a MC68881 FPU, and the Macintosh IIx/IIfx and IIcx/IIci all have MC68882 FPUs, the Macintosh IIsi has no FPU. The Macintosh IIsi is not even supplied with an FPU socket!

FPU upgrades require an expansion card. As shown in Chapter 4, Figure 4-34, the FPU socket is supplied on the card; an '882 plugs into the socket and the card plugs into the IIsi's expansion slot. The cards offer other features as well. We'll have more to say about them in Chapter 7—NuBus Expansion Card Upgrades.

7

NuBus Expansion Card Upgrades

This chapter shows how to add NuBus expansion cards to a Macintosh II. All models are covered, through and including the Macintosh IIsx. The instructions given here assume that you're thoroughly familiar with ESD and that you know how to take your Macintosh apart. If necessary, please read Chapter 1 for ESD-prevention information and Chapter 4 for take-apart information before proceeding.

Types of NuBus Cards

When the Macintosh was introduced in 1984, people criticized it for its closed architecture. What you bought was what you got. There were no expansion slots. There was no way to upgrade. Today, you can add almost anything you want to the Macintosh II/IIsx/IIfx and IIsx/IIsi because these models are equipped with NuBus expansion slots. Compatible cache cards, coprocessor cards, modem cards, networking cards, parallel interface cards, printer cards, serial interface cards, and all types of video cards are readily available.

Only two restrictions apply to NuBus expansion-card upgrades. First, you can only add as many NuBus cards as you have slots. Full-size Macintosh II/IIsx/IIfx computers have 6 NuBus slots. Compact Macintosh IIsx/IIsi computers have 3 NuBus slots. The Macintosh IIsx has no NuBus slots—a single NuBus slot is optional.

Power Requirements

Second, the cumulative power requirements (expressed in watts) of the total number of NuBus cards installed in any computer must not exceed the number of NuBus slots \times 13.9. For a Macintosh II/IIx/IIfx, that means no more than 83.4 watts (6 slots \times 13.9 watts per slot) of NuBus cards. For a Macintosh IIcx/IIci, that means no more than 41.7 watts (3 slots \times 13.9 watts per slot) of NuBus cards.

The second rule poses more of a problem for compact Macs than it does for full-size models. Three 20W cards (3 \times 20 = 60W) leave 23.4 watts to spare (83.4 - 60 = 23.4W) in a Mac II/IIx/IIfx, but overload a Mac IIcx/ci by 18.3 watts (41.7 - 60 = -18.3W). So, just because three cards work in a Mac II/IIx/IIfx, doesn't necessarily mean that the same three cards are going to work in a Mac IIcx/ci. If their combined power requirements are 41.7 watts or less, they will work. If their combined power requirements are greater than 41.7 watts, they probably won't. Just one 20W card will stop a fully-loaded Macintosh IIsi (equipped with optional slot adapter) from working.

Unfortunately, NuBus card power requirements are not always listed in product literature. In addition, some vendors are very reluctant to reveal that information. For reference, the power requirements of various Apple-brand NuBus cards are listed in Table 7-1.

Table 7-1. NuBus Card Power Requirements

Model No.	Description	Watts
MO410LL/A	Apple EtherTalk NB Card	10.1
M0261	Apple Coax/Twinax Card	10
M0264	Apple Serial NB Card	12.5
M0237	Apple TokenTalk NB Card	15
M0211	Macintosh II Video Card	10
M5640	Macintosh II Extended Video Card	?
M0322	Macintosh II High-Resolution Video Card	10
M0324	Macintosh II Extended High-Res. Video Card	?
M0504	Macintosh II 1-Bit Monochrome Video Card	5
M0119	Macintosh II Portrait Display Video Card	?
M0260	Macintosh II Two-Page Monochrome Video Card	?
M0121PA/A	Macintosh Display Card 4.8	7
M0507PA/A	Macintosh Display Card 8.24	?
M0122	Macintosh Display Card 8.24GC	20

Installing and Removing NuBus Cards

The installation and removal of NuBus cards is pretty well covered with text and graphics in Chapters 4 and 5. Here's a quick summary of the installation procedure:

1. Follow the take-apart procedure for your specific computer as given in Chapter 4.
2. Inside the CPU cabinet, each NuBus slot is fitted with a 96-pin Euro-DIN connector. As shown in Figure 7-1, original Macintosh II computers contain six 96-pin Euro-DIN connectors labeled "9 A B C D E." Macintosh IIcx/ci computers contain three 96-pin Euro-DIN connectors marked "9 A B" or "C D E." Select an empty 96-pin Euro-DIN (NuBus) connector.
3. As shown in Figure 7-2, empty NuBus slots are capped by metal expansion cover shields, which are in turn covered by plastic hole plugs. From the top edge of the CPU cabinet, gently pull up the slot's metal expansion cover shield. Notice how the shield connects to the CPU cabinet. The expansion card is going to connect exactly the same way. Practice inserting and removing the expansion cover shield until you see how it works.
4. From the inside of the computer, push out the slot's plastic hole plug. Use your fingers to push out the plug. Don't use a screwdriver or any other metal tool.

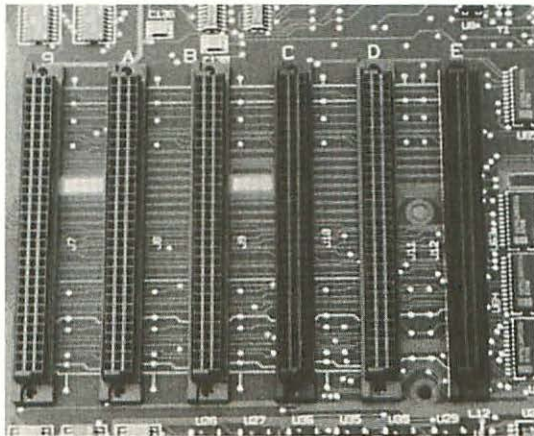

Figure 7-1 Original Macintosh II computers contain six 96-pin Euro-DIN connectors labeled "9 A B C D E."

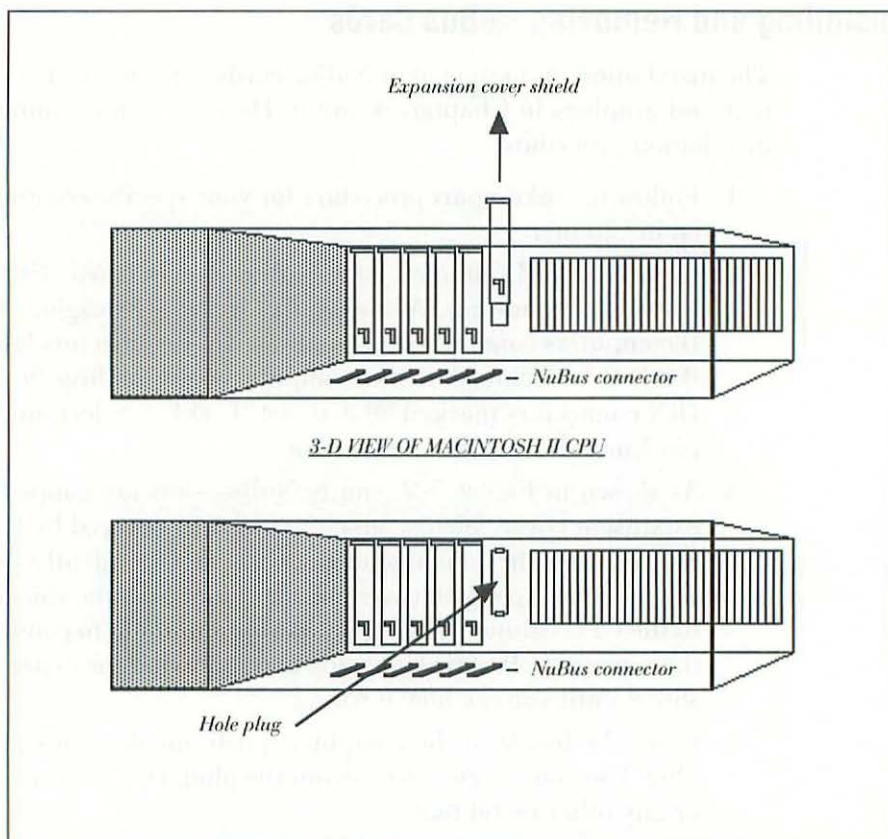

Figure 7-2 Empty NuBus slots are capped by metal expansion cover shields, which are in turn covered by plastic hole plugs.

5. When no cards are installed, the back of the Mac II/IIx/IIfx CPU cabinet tends to bow outward. While paying special attention to the card's built-in expansion cover shield, insert the card into the slot. If necessary push in on the back of CPU cabinet until it lines up with the card's expansion cover shield.
6. Reverse the take-apart procedure to complete the installation.

Allow about 15 minutes to complete the NuBus-card installation procedure the first time you try it. After that, subsequent installations should only take about five minutes.

Identifying Slots \$9 through \$E

A common problem having to do with NuBus card installations has to do with NuBus slot identification. As shown in Table 7-2, every revision of the Macintosh II logic board is marked differently. In addition, the board references are written in hexadecimal (base 16). To someone unfamiliar with the hexadecimal numbering system, that's not obvious.

In the hexadecimal numbering system the numbers 1 to 9 are written the same as in the decimal (base 10) numbering system, but the numbers 10 through 15 are written as A, B, C, D, E, and F. Sometimes, hexadecimal numbers are preceded by a dollar-sign symbol (as in \$A, \$B, \$C, \$D, \$E, and \$F). Other times hexadecimal numbers are not preceded by dollar signs.

Another problem has to do with translations. Hexadecimal numbers tend to be translated into decimal on-the-fly (as a matter of course), the same way bilingual people intermix words and expressions. Hence references to slot 1 (logical decimal position as read from left to right), slot A (hexadecimal as marked) and slot 10 (hexadecimal as translated into decimal) are all references to the exact same slot!

There's no way of predicting what the instruction manual accompanying any particular card might read. The important point to remember is that Mac II logic boards are all marked differently. If the person who wrote the NuBus card installation instructions is not aware of that, his references to slot IDs may not match those marked on your Macintosh II logic board.

Table 7-2. NuBus Slot Identification

Model	Slot1	Slot2	Slot3	Slot4	Slot5	Slot6
Mac II	9/J7	A/J8	B/J9	C/J10	D/J11	E/J12
Mac IIx	J10/9	J11/A	J12/B	J13/C	J14/D	J15/E
Mac IIfx	J10	J11	J12	J13	J14	J15
Mac IIcx	\$9	\$A	\$B			
Mac IIci	\$C	\$D	\$E			
Mac IIsi	The IIsi does not have a built-in NuBus slot					

Working with Multiple Video Cards

Since there are six NuBus slots in a Macintosh II/IIx/IIIfx, up to six video cards can be installed in the CPU cabinet. Each card displays more of the Macintosh desktop. It's not necessary to connect a monitor to every card, but as far as the computer is concerned, installed means used. If there's a card in a NuBus slot, the startup sequence assumes that a monitor is connected to the card, whether that's the case or not.

That assumption is the reason that most manuals show a video card in slot 9 (even though it blocks the power supply fan). On startup, the computer checks the NuBus slots in ascending numerical order. Unless otherwise instructed by the Monitors CDEV, menu bar information is directed to the video card with the lowest slot number. If there's no monitor connected to that video card, then the menu bar is not displayed *on any monitor* and the computer appears to be broken.

The general rule then, is that the main monitor in a multiple-monitor setup should always be connected to the video card with the lowest slot number. Since the cards are read from left to right, the main monitor should also be positioned to the left of the other monitors. Unused video cards should be always be installed in slots with higher numbers.

If you ignore these rules, then every time you update the System software or start up from a standard System disk or install 32-bit QuickDraw software in your System Folder, the menu bar will switch to the monitor connected to the card with the lowest slot number. To switch the menu bar back to where it was, you'll have to reset the Monitors CDEV and then restart the computer. That's no big deal, but it's inconvenient. For details on resetting the Monitors CDEV, refer to Chapter 5, Figures 5-1 to 5-4.

Working with Parallel Interface Cards

Many people still believe that you can't use a PC-compatible (parallel-interface) printer on a Macintosh. That's not true. Configuring a Macintosh II for use with a parallel printer is no more difficult than configuring a PC-compatible computer for use with a parallel printer. Whether it's a PC or a Mac, the requirements are exactly the same. All you need are:

- A Centronics parallel interface (CPI) card.
- A compatible printer driver.

Figure 7-3 shows a Hurdler CPI card from Creative Solutions. It installs like any other NuBus card. To use it, just connect up a parallel printer (the same as you would on a PC) and install the appropriate printer driver software in your System folder.

Figure 7-4 shows the Print Link Collection Driver disk from GDT Softworks. This disk includes drivers for Epson FX, Epson LQ, Hewlett-Packard ThinkJet, Kodak-Diconix 150, and Toshiba P351 printers. Since most parallel printers are Epson-compatible, the total number of printers supported by this one disk is more than 500!

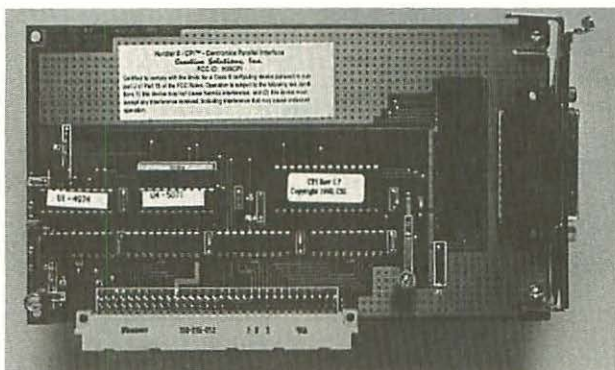

Figure 7-3 Hurdler-CPI card. *Courtesy of Creative Solutions*

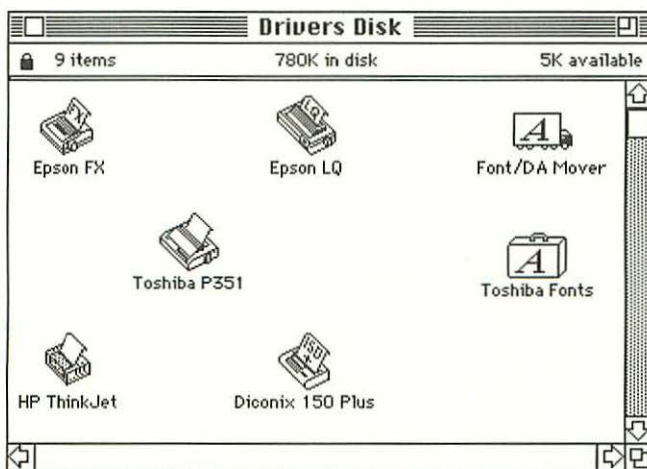

Figure 7-4 The PrintLink Collection includes drivers for Epson FX, Epson LQ, Hewlett-Packard ThinkJet, Kodak-Diconix 150, and Toshiba P351 printers.

Chooser Setup for Parallel Cards

Once a Hurdler-CPI card is installed in a NuBus slot, it makes itself available to all compatible printer drivers. To see it, pull out the Chooser DA, select a parallel-printer driver, and scroll to the bottom of the “Select a printer port:” list box. As shown in Figure 7-5, selecting a parallel port via a PrintLink driver is no more difficult than selecting one of the built-in serial ports via an ImageWriter driver.

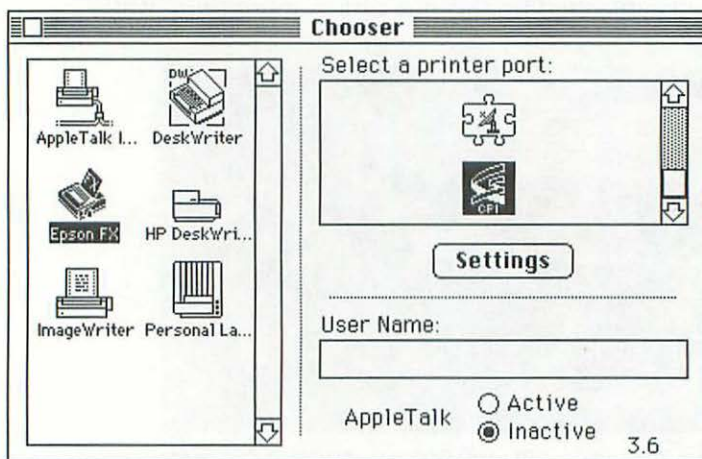

Figure 7-5 Selecting a parallel port via a PrintLink driver is no more difficult than selecting one of the built-in serial ports via an ImageWriter driver.

PrintLink Driver Options

Clicking the Settings button (added to the Chooser by the PrintLink driver) returns the dialog box shown in Figure 7-6. This dialog box allows you to select many advanced features, including fractional widths and outline fonts. With these features, even the cheapest Epson-compatible printers are able to outperform Apple ImageWriters.

As shown in Figures 7-7 to 7-9, PrintLink’s Page Setup dialog box allows reductions and enlargements from 25% to 400%, just like Hewlett-Packard DeskWriter and Apple LaserWriter drivers. Additional page setup options allow you to adjust the top margin, flip, and even invert the image. The maximum resolution supported in the Print dialog box is 360 × 360 dots per inch. That’s even denser than a LaserWriter!

Many people buy letter-quality printers for use with PC-compatibles because they're affordable and they work well. The important point is that with a parallel interface card and compatible printer driver, letter quality printers work just as well on a Macintosh II.

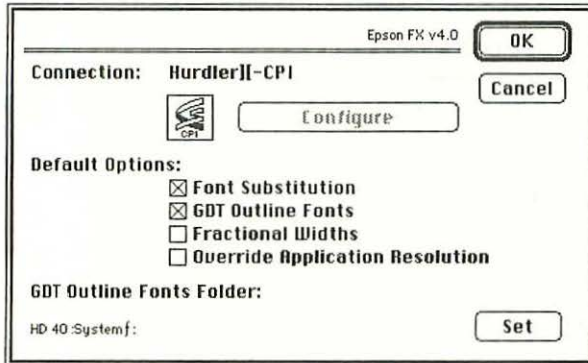

Figure 7-6 Clicking the Settings button (added to the Chooser by the PrintLink driver) allows you to select many advanced features, including fractional widths and outline fonts.

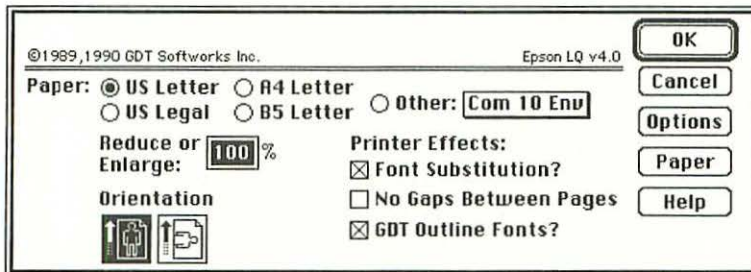

Figure 7-7 PrintLink's Page Setup dialog box allows reductions and enlargements from 25% to 400%.

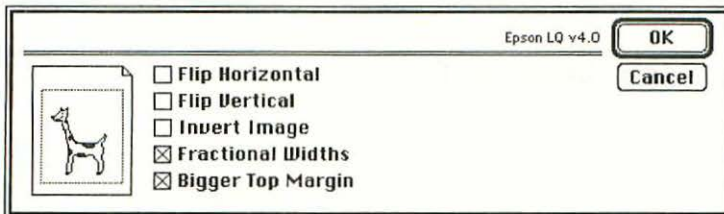

Figure 7-8 PrintLink's Page Setup options allow you to adjust the top margin, and flip and even invert the image.

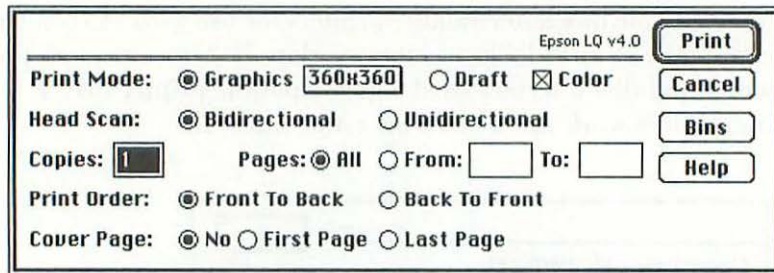

Figure 7-9 PrintLink's Print dialog box supports resolutions up to 360 × 360 dots per inch.

Troubleshooting Parallel Card Installations

The Hurdler CPI card works equally well with System 6 and System 7. It's pretty much plug and go. The only problem you're likely to have is finding a suitable parallel cable.

First, you need a parallel cable with a slim DB25-P connector. Cables with bulging DB25-P connectors won't fit through the openings at the back of a Mac II CPU cabinet. To work on a Macintosh II, the DB25-P end of the cable can't be any wider than $\frac{9}{16}$ of an inch. Typical parallel cables with $\frac{11}{16}$ -inch wide DB25-P connectors are simply too fat to fit.

Second, some parallel cables (that work fine on PCs) are incompatible with the Hurdler-CPI card. Since nothing happens when you try to print, you may conclude that the Hurdler-CPI card and/or the printer driver software is defective, when the problem is really an incompatible cable. This problem is particularly frustrating because cable wiring is almost never printed on cable packaging, and identical cables, bearing identical part numbers, purchased from the same vendor, may be wired differently from lot to lot. It all depends on which OEM supplied the cable. If you run into trouble, try another brand of cable before you condemn the Hurdler-CPI card and/or the printer driver software.

Working with Serial Interface Cards

All Macintosh computers have two built-in serial ports, referred to as COMM 1 (modem) and COMM 2 (printer). Beyond that, many people still believe that you can't add COMM 3 and COMM 4 to a Macintosh. That's not true. Starting with System 7, configuring a Macintosh II for

use with dual-port (or quad-port) serial interface cards is no more difficult than configuring a PC-compatible computer for use with dual-port serial cards. Whether it's a PC or a Mac, the requirements are exactly the same. All you need are:

- A dual-port (or a quad-port) serial interface card.
- System software to register the extra serial ports as COMM 3, COMM4, COMM 5, and COMM 6.

Figure 7-10 shows a Hurdler-HQS (Hurdler quad serial) card from Creative Solutions. It installs like any other NuBus card. To use it, just connect up a serial device (the same as you would on a PC) and install the "Register HxS" INIT in your System folder.

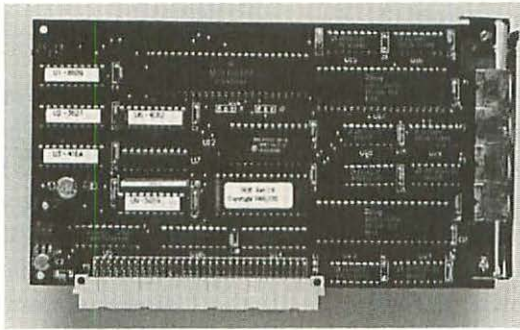

Figure 7-10 Hurdler-HQS card. *Courtesy of Creative Solutions*

The INIT, "Register HxS," registers Hurdler serial cards with the Macintosh Communications Toolbox (CTB) at startup. After that, the extra serial ports are automatically available to any program compatible with the Communications Toolbox feature of System 7.

Communications Toolbox Upgrades for System 6.0.4, 6.0.5, and 6.0.7

If you have a Macintosh II computer with only 1 MB of memory, then you can't run System 7, but you can still use the Hurdler-HQS card by installing the CTB into Systems 6.0.4, 6.0.5, or 6.0.7. This is accomplished by running the Apple Installer program (supplied with the Hurdler-HQS card) as suggested in Figure 7-11 and copying the "Communications Folder" from CSI's "Comm ToolBox Demo" disk into the System Folder of your startup disk. These two actions give Systems 6.0.4, 6.0.5, and 6.0.7 the Communications Toolbox equivalent of System 7.



Figure 7-11 Use the Communications Toolbox Installer to add the CTB to Systems 6.0.4, 6.0.5, and 6.0.7.

Chooser Setup for Serial Cards

Once a Hurdler-HQS card is installed in a NuBus slot, it makes itself available to all CTB-compatible printer drivers. To see it, pull out the Chooser DA, select an appropriate printer driver, and scroll to the bottom of the “Select a printer port:” list box. As shown in Figure 7-5, the icon for the Communications Toolbox resembles a jig-saw puzzle piece of a communications satellite dish. Select that icon, then click the Settings button. As shown in Figure 7-12, the Communications Settings dialog box allows you to set baud rate, parity, data bits, and so on (just like a telecommunications program). To select one of the Hurdler-HQS ports, click the appropriate icon.

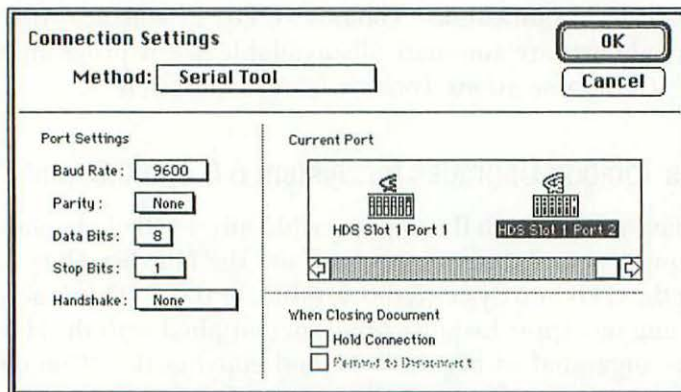

Figure 7-12 The Communications Settings dialog box allows you to set baud rate, parity, data bits, and so on, just like a telecommunications program.

Troubleshooting Serial Card Installations

The Hurdler-HQS card works equally well with System 6 and System 7, but unlike the Hurdler-CPI card, it's CommToolbox dependent. If a printer driver doesn't support the CommToolbox, the satellite-dish icon doesn't show up in the Chooser, and you can't access the extra serial ports. Through System 7.0, none of the Apple-brand printer drivers (ImageWriter II, LQ ImageWriter) support CommToolbox! The same is true of many telecommunications programs. In other words, it's not enough to simply add Hurdler-HQS hardware. If your communications software doesn't support CommToolbox, the extra ports are not going to be readily accessible.

Second, early versions of the Hurdler-HQS card only support baud rates of 300 to 38,400. They don't support high-speed 57,600 baud communications. They don't work with HP-DeskWriter printers, not even under System 7 with a JetLink Express printer driver from GDT Softworks. Instead, the DeskWriter prints: "Datacomm Error - please check baudrate". (Right or wrong, there's no period after "Datacomm" and "baudrate" is spelled as one word.)

Troubleshooting Other NuBus Card Installations

The ROM chips supplied with the original Macintosh II limit each NuBus card to 1 MB of on-board memory. Laser printer cards and 32-bit video cards containing more than 1 MB of on-board memory don't work on these machines.

The fix involves a ROM upgrade. Installing revision B ROMs eliminates the problem. Installing revision C ROMs which are included with the floppy drive high density (FDHD) upgrades (described in Chapter 8) also eliminates the problem. To find out which ROMs are in your original Macintosh II, refer to Chapter 6, Figures 6-7 and 6-8 for exact chip locations, and refer to Table 7-3 for ROM version information.

Table 7-3. Macintosh II ROM Identification

U3/UF11	U4/UF12	U5/UD11	U6/UD12	Revision
3 STOOGES LLv1.366	3 STOOGES MLv1.366	MACH ROM MHv1.3	THREE STOOGES HHv1.3B6	Original?
342-0108A	342-0107A	342-0106A	342-0105A	A
342-0108B	342-0107B	342-0106B	342-0105B	B (Fixes NuBus)
342-0642B	342-0641B	342-0640B	342-0639B	B (adds FDHD)
342-0642C	342-0641B	342-0640B	342-0639C	C (later FDHD)

Expansion Cards for the Macintosh IIsi

Unlike the Macintosh II/IIx/IIfx and the Macintosh IIfx/IIfci, the Macintosh IIsi *does not* contain a NuBus-compatible expansion slot. The single expansion slot that it does contain is designed for one of two optional adapter cards which add *either* a NuBus slot compatible with other Macintosh II computers, or an MC68030 (‘030) processor-direct slot (PDS) compatible with the Macintosh Se30. Both cards also provide an MC68882RC20A floating point unit (FPU), also known as a math coprocessor.

Figure 7-13 shows an adapter card which adds an ‘030 slot. The empty slot is at the top of the adapter card. Actual ‘030 cards plug into this slot, span the top of the CPU cabinet, and rest on a plastic support shelf attached to the power supply. The support shelf is included with the adapter card, not with the ‘030 (or NuBus) card. Note also that while adapter cards mount vertically (up and down), expansion cards mount horizontally (across the top of the CPU cabinet), as suggested in Figure 7-14. Since heat rises, any expansion card in a Macintosh IIsi tends to run hot.

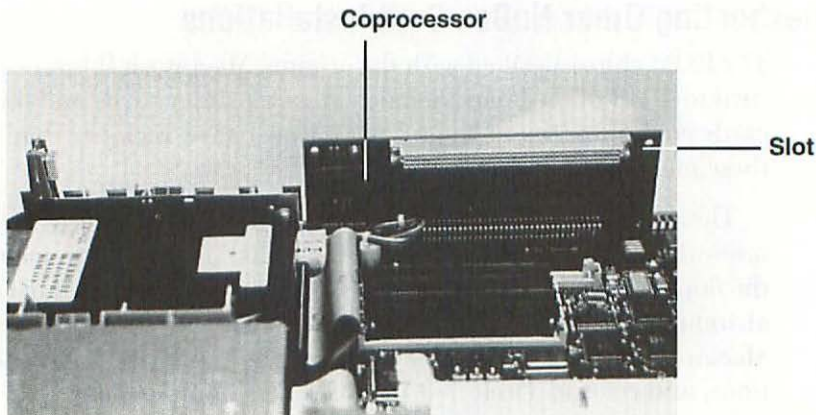

Figure 7-13 Optional adapter cards for the Macintosh IIsi include an MC68882RC20A math coprocessor and either a NuBus expansion slot or an MC68030 processor-direct expansion slot.

Troubleshooting Macintosh IIx Expansion Card Installations

Due to power supply limitations, NuBus cards requiring over 15 watts and PDS cards requiring over 7 watts may not work in a fully configured Macintosh IIx. The stock Mac IIx power supply is only rated for 44 watts. With 17 MB of RAM and an 80 MB hard drive, there's not much power left over for expansion cards. Under such circumstances, a 20-watt Macintosh Display Card 8.24 GC may prevent the computer from turning on. The fix is to remove the offending expansion card and replace it with one that consumes less power.

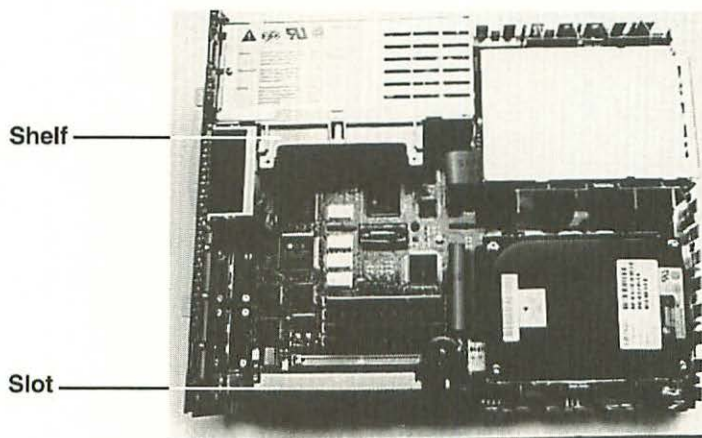

Figure 7-14 Actual '030 expansion cards plug into the processor-direct slot at the top of the card and rest on a plastic support shelf that attaches to the power supply.

A second problem has to do with the number of expansion slots. A IIx adapter card adds only one expansion slot (either '030 or NuBus). PC-compatible coprocessors and graphics accelerators which require more than one NuBus expansion slot are physically incompatible.

That's it for expansion card upgrades. Next, we'll look at disk drives.

8

FDHD—Disk Drive Upgrades

This chapter shows how to add a second disk drive to the Macintosh II/IIx/IIfx. Internal and external drives are covered, including floppy-disk high-density 1.4 MB drives. The instructions given here assume that you're thoroughly familiar with ESD and that you know how to take your Macintosh apart. If necessary, please read Chapter 1 for ESD-prevention information and Chapter 4 for take-apart information before proceeding.

Types of Disk Drives

Macintosh disks can either be single-sided double-density (SSDD), double-sided double-density (DSDD), or double-sided high-density (DSHD). SSDD disks work with 400K disk drives. DSDD disks work with 800K disk drives. DSHD disks work with 1.4 MB disk drives. Apple-brand 1.4 MB disk drives are officially known as floppy disk high density (FDHD) drives and also referred to as *super drives*.

400K Disk Drives

The 400K disk drive used in the original 128K Macintosh, 512K Macintosh, Lisa 2, and Macintosh XL is a single-sided, group code recording (GCR) model. *Single-sided* means that the drive has one head (a lower head) and consequently the drive only writes to the lower side of the disk. The upper side of the disk is not used.

Group code recording means that the speed of the drive's spinner motor is varied. Since sectors near the diskette hub spin slower than sectors near the diskette rim, slowing down the drive's spinner motor when the read/write head is over the outer sectors increases a disk's storage capacity. When the same SSDD disk is formatted under constant-speed modified frequency modulation on a PC-compatible computer, it holds only 360K of data, 10% less than when formatted on a Macintosh.

On the 128K/512K/512Ke and the Macintosh Plus, speed regulation for the 400K disk drive is provided by an ASG PAL on the logic board. Macintosh SE logic boards also provide speed regulation for 400K disk drives. Other Macintosh logic boards including all Macintosh II logic boards do not. If you try to use a 400K disk drive on an SE 30 or a Macintosh II, it won't hurt anything, but the drive won't work (not even as a 360K drive). When you insert a 400K disk, the drive spins briefly at constant speed, then, lacking the external speed control signal, it comes to an abrupt stop, and ejects the disk. Please note that this doesn't mean you can't use 400K disks in a Macintosh II series computer, only that you can't attach (or install) an old 400K disk drive to a Macintosh II.

800K Disk Drives

The 800K disk drive used in the 512K enhanced Macintosh, the Macintosh Plus, the original Macintosh SE, and the original Macintosh II is a double-sided, GCR model. *Double-sided* means that the drive has two heads (upper and lower) and consequently the drive writes to both sides of the disk.

Unlike 400K drives, the motor speed on 800K drives is self-regulating. In order to use an 800K disk drive in a Macintosh that also provides regulation, lines 9 and 20 of the disk drive data cable have to be cut. If lines 9 and 20 are not cut, the drive pulses incessantly and doesn't work.

1.4 MB Disk Drives

The 1.4 MB floppy disk high density (FDHD) super drive used in the Macintosh SE FDHD/SE30 and the Macintosh IIx/IIfx, IIcx/ci, IIsi, and LC is a double-sided model that supports both GCR *and* modified frequency modulation (MFM).

Under Macintosh Finder software, SSDD disks can be formatted to 400K, DSDD disks can be formatted to 800K, and DSHD disks can be formatted to 1.4 MB, using GCR data encoding. The Macintosh allows both SSDD and DSDD disks to be formatted to 800K or 400K. DSHD disks can only be formatted to 1.4 MB when using a FDHD drive.

Under Apple File Exchange software (version 1.1 or greater), DSDD disks can also be formatted to 720K and DSHD disks can be formatted to 1.4 MB, using MFM data encoding. Generic text and graphics files can then be copied to these disks and the disks can be read in PC-compatible computers under Microsoft Disk Operating System (MS-DOS). Formatting a disk with Apple File Exchange is illustrated in Figure 8-1.

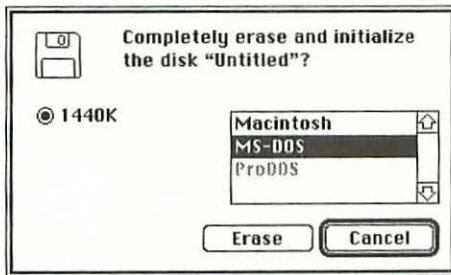

Figure 8-1 Under Apple File Exchange software (version 1.1 or greater) DSHD disks can be formatted to 1.4 MB, using MFM data encoding for use in PC-compatible computers.

Apple File Exchange software is the official way for Macintosh IIx/IIcx, Macintosh IIcx/ci, and Macintosh IIsi computers to share disks with PC-compatible computers, but MS-DOS formatting doesn't work on original Mac IIs equipped only with 800K drives. To make full use of Apple File Exchange software on an original Mac II, you have to add a 1.4 MB super drive *and* install an FDHD/ROM upgrade.

Formatting Rules

Brand new, brand-name SSDD disks can often be formatted to 800K with no problem whatsoever. The reason used brand-name disks give problems has to do with the pressure pad used (in place of an upper head) on 400K disk drives. Over a period of time, the cotton-like pressure pad accumulates grit which gradually sands away the upper side of the disk (like a disc sander). The more the disk has been used, the more the upper side has been sanded, the less reliable it becomes.

For unrelated reasons, DSDD disks that become unusable may also have problems on the upper side. If that's the case, they can usually be formatted to 400K, where they will continue to give good service in single-sided disk drives. This salvage method is guaranteed to work at least 50% of the time.

Some firms sell disk notchers that allow you to format DSDD disks to 1.4 MB. In general, disk notchers only work reliably with the best brand-name disks. With other brands, only about 50% of the DSDD disks you notch will actually format to 1.4 MB. Afterwards, a full 50% of those will prove to be unreliable.

In general, floppy disks should only be formatted in their native disk drives. DSHD disks have thinner magnetic particles than DSDD disks. Thinner magnetic particles require weaker magnetic signals and vice versa. The biggest problem occurs when high-density disks are formatted to 800K in a high-density drive. Under certain circumstances when the disk is subsequently used in an 800K drive (which has a stronger head), the data may become scrambled.

Another problem arises when someone has taken a DSHD disk and formatted it in an 800K drive. The 800K drive doesn't know about DSHD disks and formats it as an 800K disk. When someone takes that disk and inserts it into a 1.4 MB DSHD drive, the drive realizes it's an DSHD disk, but doesn't understand the 800K formatting (because you're not supposed to format DSHD disks to 800K). Thus, the Macintosh thinks that the disk is not readable and asks you to initialize the disk. In order to read a DSHD disk formatted to 800K in a FDHD drive, cover the opening on the opposite side of the disk lock notch with a small piece of opaque tape.

(It should be noted that PC-compatible computers have similar problems. 360K DSDD 5¼-inch disks formatted in a 1.2 MB DSHD drive cannot be read reliably in 360K drives.)

Ideally then, at least until such time as 800K disks are no longer used, it makes sense to have both 800K and 1.4 MB disk drives. The Macintosh IIx/ci and the Macintosh IIsi are factory equipped with one internal 1.4 MB drive and one external disk drive connector. To add an external 800K disk drive, all you have to do is plug one in.

On the Macintosh II/IIx/IIfx, adding a second disk drive is somewhat more complicated. These computers are not equipped with external disk drive connectors. In the next section, we'll see how to add one.

Building an External Disk Drive Adapter

As shown in Chapter 4, Figure 4-4, the Macintosh II/IIx/IIfx can hold two internal disk drives. The disk drive data cables plug into 20-pin plug connectors on the logic board. The plug connectors, shown in Chapter 6, Figures 6-7, 6-8, and 6-9, are generally marked J16 and J17. The board references (J16 and J17) may read from left to right, from right to left (J17 and J16) or they may be unmarked (? and ?). Regardless of how they are marked, the plug connector on the right is for the right side drive, and the plug connector on the left is for the left side drive. If the Macintosh II does not have a second internal disk drive, then the other plug connector can be fitted with an adapter cable, routed through the back of the computer and used to connect an external disk drive. Figure 8-2 provides wiring details for making your own cable. Table 8-1 provides a parts list.

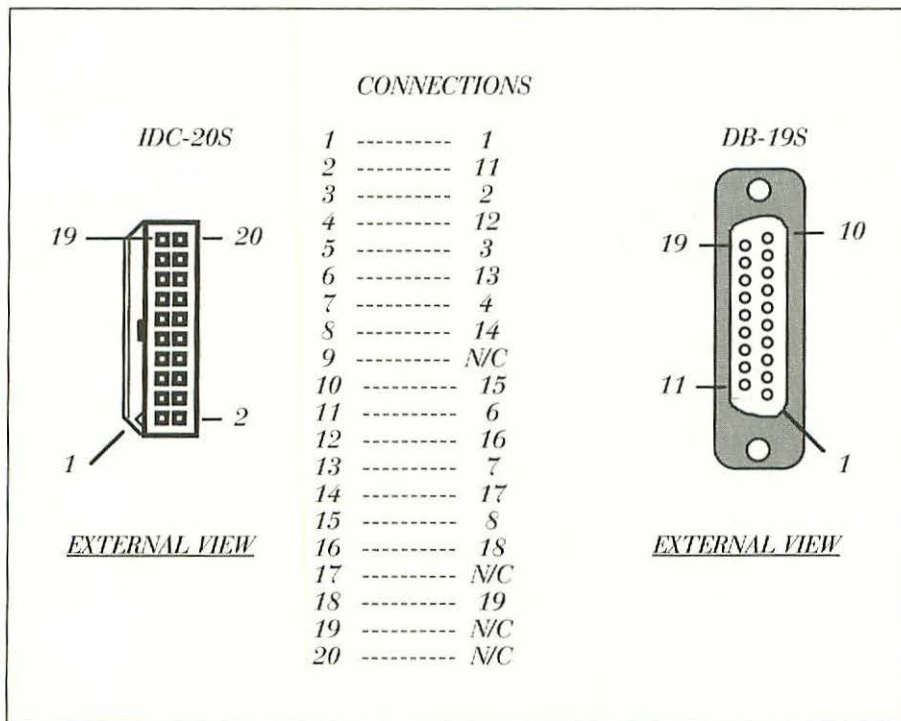

Figure 8-2 Wiring instructions for Mac II/IIx/IIfx to external disk drive adapter.

Table 8-1. Parts List for External Disk Drive Adapter Cable

Quantity	Description
1	DB19-S (socket)
1	DB19-H (hood)
2	feet of 20-conductor ribbon cable
1	IDC-S20 (socket for 20-conductor ribbon cable)

Construction Notes

Socket number one on the insulation displacement connector (IDC) is indicated by an arrow etched into the plastic housing. Wire number one in the 20-conductor ribbon cable is indicated by a red stripe. Start by finding the arrow etched into the plastic housing. Align the red stripe on the 20-conductor ribbon cable with the arrow on the housing, insert the cable, and squeeze the two halves of the IDC together. You can buy a special tool (called an IDC crimper) for squeezing IDCs, but an ordinary shop vise works fine. In either case, you only get one shot, so line up the connector very carefully before you squeeze.

To prepare the other end of the cable, lay it on a flat board and separate the wires using a sharp razor knife. Make each strand about 1/2 inches in length. Strip 1/16-inch of insulation from each strand.

Next, tin the stripped ends with a tiny amount of solder. When that's done, secure the DB-19S in a small shop vise, and tin each of the solder cups. Once the stripped ends and the solder cups are tinned, put the solder away. Using a 15- to 25-watt (low-wattage) soldering pencil with a very fine point, touch the tinned wires to the tinned solder cups and melt the joints without adding any more solder.

When soldering the ribbon cable to the DB-19S, bear in mind that the socket numbers will be reversed. On the solder side of the DB-19S, the numbers go the opposite way. They read from left to right, not right to left.

A small shop vise or a helping hands tool (a set of alligator clips attached to a weighted stand) makes the solder work go much faster. Without something to keep the DB-19S from moving, soldering the wires is very difficult.

If you've never made this type of cable before, allow yourself an hour to finish the job. Otherwise, assuming a well-equipped work shop, you'll need about 15 minutes.

Installing the Adapter Cable

Once you build the cable, it's a simple matter to install it. Here's the general procedure:

1. Follow the take-apart procedure given in Chapter 4 for the Macintosh II/IIx/IIfx. Remove the lid of the CPU as shown in Figures 4-1 to 4-4.
2. Select an unused NuBus slot, remove its expansion cover shield and push out its hole plug as shown in Chapter 7, Figure 7-2.
3. Starting from the outside (not the inside) of the CPU cabinet, route the IDC socket connector through the expansion cover opening.
4. Plug the IDC-20S socket connector into an unused disk-drive plug connector on the Macintosh II logic board. As shown in Chapter 6, Figures 6-7 and 6-8, the unused disk-drive connector is generally marked J16 or J17. The two connectors are keyed. There is only one way to fit them together. There is no way to fit them together backwards.
5. Adjust the ribbon cable so that the DB19-S dangles conveniently out the back of the CPU cabinet. Taking care not to pinch the ribbon cable any more than necessary, carefully reinstall the expansion cover shield and the hole plug.
6. Reattach the lid of the CPU.

Using the Adapter Cable

Just like the external disk drive connector on a Macintosh IIcx/ci and the Macintosh IIsi, the adapter cable only works with self-regulating disk drives. If you try to use an externally regulated drive (400K or non-Apple 800K) on the adapter cable, it won't hurt anything, but the drive won't work. Whenever you insert a disk, the motor will spin briefly, then, lacking the external speed control signal, it will come to an abrupt stop and eject the disk. As mentioned previously, there's nothing to be done about externally regulated disk drives. They were designed for use on the 128K/512K/Mac Plus and Mac SE, not for use on a Macintosh II.

On the original Macintosh II, adapter cable use is also limited to self-regulating 800K external disk drives. Self-regulating 1.4 MB drives do work, but until you upgrade the read-only memory chips (ROMs) and the integrated Wozniak machine (IWM) on the Macintosh II CPU board, they only work as 800K drives and not as well as the real thing.

On the Macintosh IIx/IIfx, the adapter cable works with both self-regulating 800K and 1.4 MB disk drives. Since both the Macintosh IIx and IIfx are factory equipped with internal 1.4 MB disk drives, the adapter cable is a great way to make use of external Apple-brand 800K drives that you already own.

Installing a Second Internal Disk Drive

Alternately you can install an second internal disk drive in a Macintosh II/IIx/IIfx. Sources for low-cost 800K drives include dual-drive Macintosh SEs that have received internal hard drive upgrades and/or dual-drive Macintosh SEs that have received FDHD super drive upgrades. Macintosh SE disk drives and Macintosh II disk drives are 100% interchangeable right down to the mounting hardware. A second 1.4 MB drive can also be added to a Macintosh II/IIx/IIfx, but until such time as 800K disks are no longer used, this makes less sense. Regardless of what drive you choose to install, the installation procedure is the same:

1. Follow the take-apart procedure given in Chapter 4 for the Macintosh II/IIx/IIfx. Remove the lid of the CPU as shown in Figures 4-1 to 4-4.
2. Unplug the data cable from the plug connector on the back of the new disk drive.
3. Plug the data cable into the empty disk-drive connector on the Macintosh II logic board. As shown in Chapter 6, Figures 6-7 and 6-8, the disk drive connectors are generally marked J16 or J17. The one located on the right is for the original (right side) drive. The one located on the left is for the additional (left side) drive.
4. Underneath the front of the disk drive mounting bracket are two metal prongs that fit into slots cut into the drive bay. Insert the prongs into the slots and slide the disk drive all the way forward.
5. Secure the back of the disk drive mounting bracket to the drive bay with a single 3.5 × 8-millimeter Phillips-head screw.

6. Plug the data cable into the pin header at the back of the disk drive.
7. Reattach the lid of the CPU.

When installing 1.4 MB drives into original Macintosh II CPUs, bear in mind that unless you upgrade the ROMs and the integrated Wozniak machine (IWM) on the Macintosh II logic board, they'll only work as 800K drives, and not as well as the real thing.

Installing an FDHD/ROM Upgrade into a Macintosh II

The official Apple FDHD Macintosh II Upgrade Kit, part number M0244, provides the five chips you need to get a 1.4 MB super drive working in an original Macintosh II. Table 8-2 provides a parts list with board references for various revisions of the Macintosh II logic board. Figure 8-3 shows the general area where the five chips are located.

Table 8-2. Parts List for Apple FDHD™ Macintosh II Upgrade Kit, part number M0244

Quantity	Part Number	Description	Board References
1	342-0640B	Medium high ROM	U5 ROM5 UD11
1	342-0639C	High ROM	U6 ROM6 UD12
1	342-0642C	Low ROM	U3 ROM3 UF11
1	343-0641B	Medium low ROM	U4 ROM4 UF12
1	344S0062-01	SWIM GCR/MFM FDHD controller	U66 IWM UI10

In addition to the Apple FDHD Macintosh II Upgrade Kit, part number M0244, you need an FDHD drive mechanism, part number 661-0474, a disk drive data cable, part number 590-0188, and System software version 6.0.2 or later. Earlier System software versions don't support 1.4 MB drives, not even when an FDHD upgrade kit is installed. These items are shown in Figure 8-4, superimposed on a Mac II logic board for clarity.

It should be noted that System software version 6.0.2 is the minimum FDHD requirement. System software 6.0.4 is preferred for stock CPUs with 1 MB of DRAM. System 7 and beyond is preferred for upgraded CPUs with at least 2 MB of DRAM.

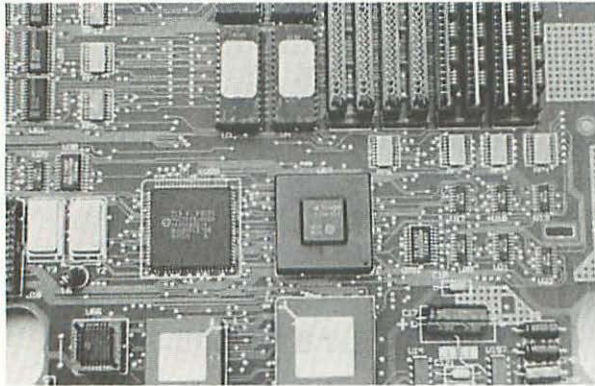

Figure 8-3 On the original Macintosh II logic board, the ROMs are at board references U5, U6, U3, and U4. The IWM is at board reference U66.

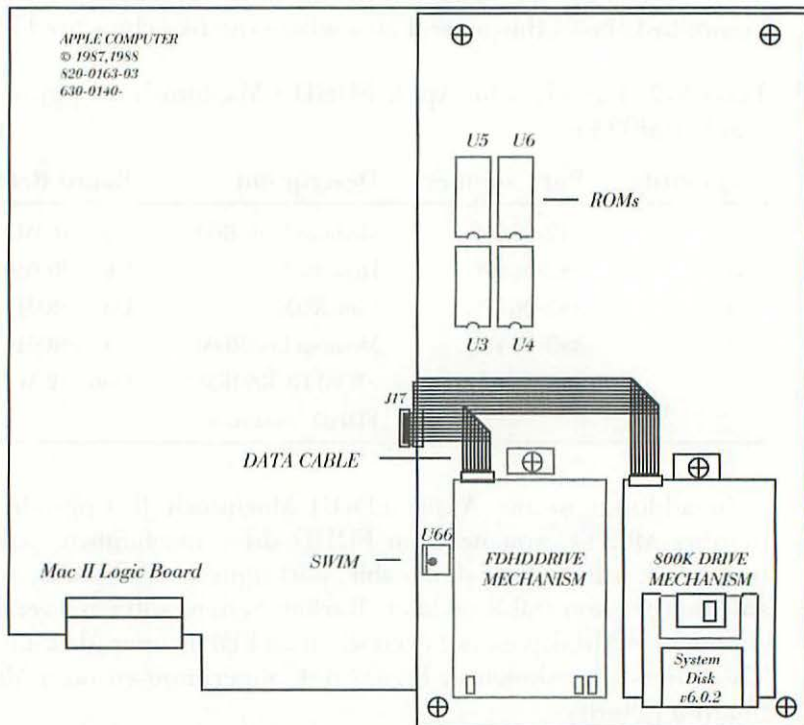

Figure 8-4 In addition to the Apple FDHD Macintosh II Upgrade Kit, part number M0244 which includes 4 ROMs and a Super Wozniak Integrated Machine (SWIM), you need an FDHD drive mechanism, part number 661-0474, a disk drive data cable, part number 590-0188, and System software version 6.0.2 or later. Parts are superimposed on a Mac II logic board for clarity.

Once you gather the FDHD upgrade parts, it's a simple matter to install them. Here's the general procedure:

1. Follow the take-apart procedure given in Chapter 4 for the Macintosh II/IIx/IIfx. Remove the lid of the CPU as shown in Figures 4-1 to 4-4.
2. Unplug the drive cables. As indicated in Figure 4-4, unplug the disk drive data cable(s) from the logic board. Unplug the hard drive data and power cables from the hard drive.
3. Remove the drive bay. As indicated in Figure 4-4, unscrew four Phillips-head screws and lift straight up.
4. Inspect the logic board. If necessary, blow out accumulated dust with compressed air.
5. Locate the IWM socket. On early logic boards, as shown in Chapter 6, Figure 6-6, the IWM socket is at board reference U66. On later logic boards, as shown in Chapter 6, Figure 6-7, the IWM socket is at board reference UI10. Note that the IWM is a 28-pin plastic leadless chip (PLC).
6. Observe the existing chip orientation. As shown in Figure 8-3, the left side of the PLC is beveled. A dot printed on top of the PLC faces the power supply. It's very important to note the orientation details now, before you remove the existing IWM, so that there is no confusion when it comes time to insert the replacement chip.
7. Remove the IWM. As shown in Figure 8-3, the upper-left and lower-right corners of the IWM socket are slotted. The easiest way to remove the chip is with a PLC removal tool, but you can also pry it out (very carefully) using a #2 jeweler's screwdriver. Insert the screwdriver tip into one of the slots (between the chip and the PLC socket, not between the socket and the logic board) and pry gently. Take tiny bites. Move the tool back and forth from slot to slot. Don't try to pop the chip entirely from one slot. Brute force doesn't work. As with all delicate work: "*Não é a força, mas é o jeito.*" (It's not the force, it's the technique.) If you don't use *jeito*, (if you don't take tiny bites and move the tool back and forth from slot to slot) you may snap the tool, or you may break the PLC socket.
8. Install the SWIM. Point the dot on top of the SWIM toward the power supply and gently press the chip into the PLC socket. Press gently. If you pound the chip with your fist, you may break the logic board.

9. Locate the ROM sockets. On early logic boards, as shown in Chapter 6, Figure 6-6, the ROM sockets are at board references U5, U6, U3, and U4. On later logic boards, as shown in Chapter 6, Figure 6-7, the ROM sockets are at board references UD11, UD12, UF11, and UF12. Note that the ROMs are 28-pin plastic dual inline package (DIP) chips.
10. Observe the existing chip orientation. As shown in Figure 8-3, one end of each ROM chip is notched. Each notch faces the front of the CPU cabinet. It's very important to note the orientation details now, before you remove the existing ROMs, so that there will be no confusion when it comes time to insert the replacement ROMs.
11. Remove the ROMs. The easiest way to remove them is with a DIP IC removal tool, but you can also pry them out (very carefully) using a small screwdriver. Insert the screwdriver tip between the chip and the socket (not between the socket and the logic board) and use an alternating lever technique. Don't try to pop a chip entirely from one side of its socket. Brute force doesn't work. If you don't use *jeito*, (technique) you'll bend the pins on the old ROMs and your dealer may refuse to take them in trade.
12. Install the replacement ROMs. Refer to Table 8-2 for part number to board reference information. Be sure to point the notches toward the front of the CPU cabinet. The easiest way to insert the ROMs is with a DIP IC insertion tool but you can also insert them (very carefully) by hand. The "*jeito*" here is to get all the pins started simultaneously.
13. Inspect the ROMs. Make sure that they are oriented correctly, seated firmly, and that none of the pins are bent under or sticking out from the sockets.
14. Reinstall the drive bay. As indicated in Figure 4-4, attach the drive bay with four 3.5 × 8-millimeter Phillips-head screws.
15. Install the 1.4 MB drive mechanism. Underneath the front of the disk drive mounting bracket are two metal prongs that fit into slots cut into the drive bay. Insert the prongs into the slots and slide the disk drive all the way forward. Secure the bracket to the drive bay with one 3.5 × 8-millimeter Phillips-head screw.

16. Reconnect the drive cables. As indicated in Figure 4-4, plug the hard drive data and power cables into the hard drive. Plug the new data cable into the connector at the back of the 1.4 MB disk drive. As shown in Chapter 6, Figures 6-7 and 6-8, the disk drive connectors on the Macintosh II logic board are generally marked J16 or J17. The one located on the right is for the original (right side) drive. The one located on the left is for the new (left side) drive.
17. Reattach the lid of the CPU.

To test the FDHD upgrade, format a blank DSHD disk in the new drive. Under Finder versions supplied with System 6.0.2, 6.0.3, 6.0.4, 6.0.5, and 6.0.7, the formatted DSHD disk window should show 12K in disk and 1,404K available. Under Finder versions supplied with System 7.0b, the formatted DSHD disk window should show 12K in disk and 1.3 MB available.

DSDD disks can also be formatted in high-density drives, although it's not a good idea. Nevertheless, you may want to try it, just to make sure everything is working okay. Under Finder versions supplied with System 6.0.2, 6.0.3, 6.0.4, 6.0.5, and 6.0.7, the formatted DSDD disk window should show 7K in disk and 779K available. Under Finder versions supplied with System 7.0b, the formatted DSDD disk window should show 1K in disk and 785K available.

Troubleshooting 800K Disk Drives

Problems with 800K drives are invariably related to the loading rails and the eject mechanism. Over a period of time dust clogs the mechanism. Eventually, the grease dries up. Sooner or later the eject mechanism jams, and disks become stuck in the rails, especially disks with three or more labels affixed to them. At that point, the problem would be easy enough to repair, except that frustrated users, invariably armed with needle nose pliers, tend to forcibly extract the disk. Forcible extraction bends the eject levers and damages the upper read/write head. Typical head damage is illustrated in Figure 8-5.

When the upper head is bent, every 800K disk you insert returns a dialog box stating: "This disk is unreadable. Do you want to initialize it?" When you click the OK button and select "two-sided," the initialization fails. To verify that problem is related to the upper read/write head

(not something else), insert a blank disk and try initializing it as “one-sided.” If the disk formats to 400K, then you know that a bent upper head is definitely the problem.

Replacing the head assembly is easy enough. Aligning it properly is not. To do the job right, you need an alignment disk, exerciser software, and an oscilloscope. All cost more than a professional repair, so for most people, the only cost-effective option is to send out the drive. For a list of repair shops that specialize in disk drive work, refer to Appendix B.

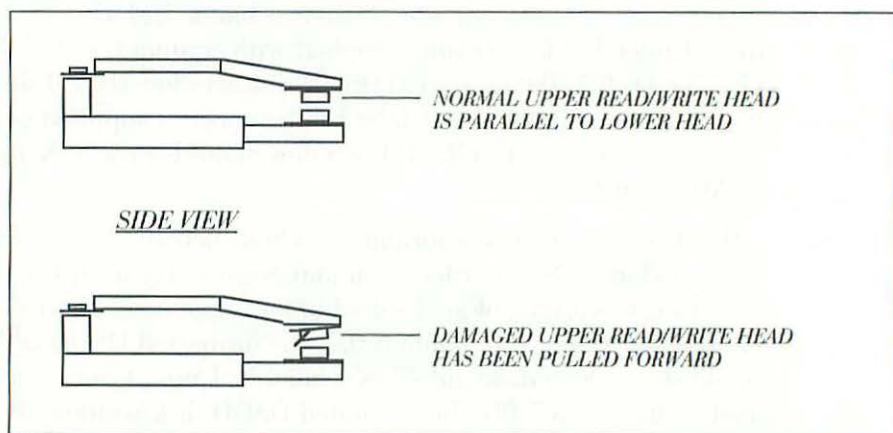

Figure 8-5 Forcible extraction bends the eject levers and damages the upper read/write head.

Sometimes, every 800K disk you insert returns a dialog box, stating: “This disk is unreadable. Do you want to initialize it?” even when you haven’t experienced eject problems. In that case, the problem may have been caused by airborne pollutants. Humid air carries cigarette smoke, pollen, sea salt, and other contaminants into the drive. All this mixes with disk dust to make mortar. The mortar eventually dries (usually on the heads) and disk drives that worked perfectly yesterday suddenly stop working.

To verify that the problem is related to airborne pollutants and not something else, insert a premoistened cleaning diskette, wait the prescribed time (usually a few minutes) and try inserting a disk. If everything works now, the head was just dirty. Don’t worry about it.

Types of Cleaning Diskettes

Cleaning diskettes come in two types. One uses a premoistened polyester pad. When this type is inserted, the head pulls back to track zero, the pad spins for a few seconds (like a floppy disk) and then you get a “This disk is unreadable. Do you want to initialize it?” dialog box. At that point, cleaning is finished. To eject the cleaning diskette, click the eject button.

A second type uses soft pile brushes. When this type is inserted, the head is methodically stepped across the brushes under software control. The brushes do a much better job, but without diagnostic software, this type does not work. A brush-type cleaning system complete with diagnostic software is shown in Figure 8-6, courtesy of Trackmate America.

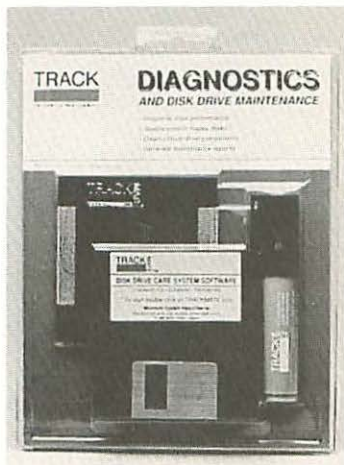

Figure 8-6 Trackmate Generation 3.0. *Courtesy of Trackmate America.*

With either type of cleaner, the “This disk is unreadable...” problem can suddenly recur. Sometimes recurrence is caused by using a single bad disk. Some disks make more disk dust than others. Disk dust and hot, humid air make head mortar. If the problem recurs, clean the drive again, retire the suspect disk(s) and try another brand.

That’s it for FDHD upgrades. Next, we’ll look at SCSI hard drives.

9

SCSI Hard Drive Upgrades

This chapter explains the difference between internal and external SCSI hard drives, shows how to install hard drives into a Macintosh II, and shows how to install hard drives into external enclosures. The instructions given here assume that you're thoroughly familiar with ESD and that you know how to take your Macintosh apart. If necessary, please read Chapter 1 for ESD-prevention information and Chapter 4 for take-apart information before proceeding.

Types of Hard Drives

Many people are under the impression that internal and external SCSI hard drives are completely different. They're not. The main difference between an internal hard drive and an external hard drive is that the former is mounted inside a Macintosh II CPU cabinet and the latter is mounted inside an external enclosure. As suggested in Figure 9-1, you can take any hard drive out of a Macintosh II and put it inside of an external enclosure. Conversely, with the exception of the Macintosh IIsi, you can take any 3.5-inch form-factor SCSI hard drive out of an external enclosure and put it inside of a Macintosh II CPU cabinet.

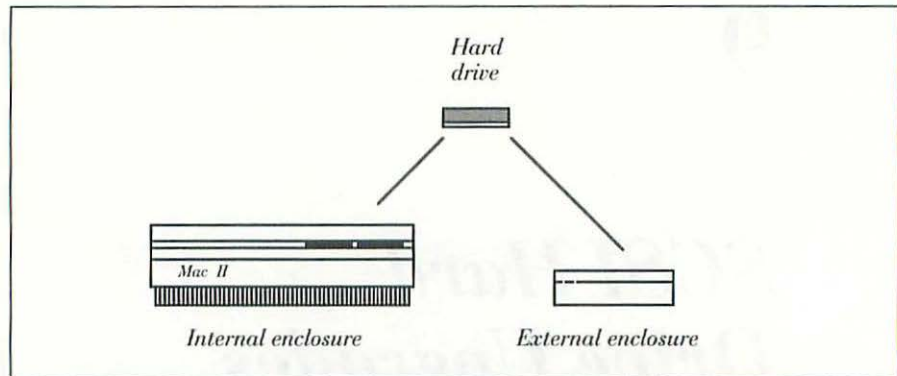

Figure 9-1 The main difference between an internal hard drive and an external hard drive is that the former is mounted inside a Macintosh II CPU cabinet and the latter is mounted inside an external enclosure.

The important point is that any given hard drive is a constant. Only the mounting hardware varies.

SCSI Interfaces

SCSI refers to the *small computer system interface* (an NCR 53C80 chip) built into every Macintosh from the Macintosh Plus on up. A lot of people have trouble understanding what an interface does. If computers were human beings, then the logic board would be the brain, the hard drive would be the stomach, and the personal biological system interface (PBSI) would be the mouth and digestive organs. Data would be like food. Food has to be routed through the PBSI to your stomach, before it can be drawn upon by the brain. This analogy is not perfect, but it gets the idea across. No interface—no digestion.

Form Factor SCSI Drives

Form-factor half-height SCSI hard drives are made of three separate pieces. As shown in Figure 9-2, the SCSI controller card (1) is joined to the drive mechanism (2) by a metal frame (3). The diameter of the drive mechanism can measure either 3½ inches or 5¼ inches. The height of a half-height drive mechanism measures approximately 1½ inches. Since earlier hard drive mechanisms measure approximately 3 inches high, drives measuring only half as much (1½-inches high) are known as ½-height drives.

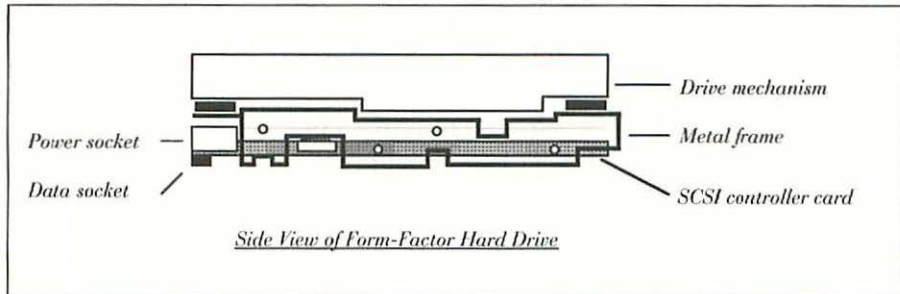

Figure 9-2 Form-factor SCSI hard drives are made of three separate pieces. The SCSI controller card (1) is joined to the drive mechanism (2) by a metal frame (3).

As shown in Chapter 4, Figures 4-4 and 4-32, the drive bay in a Macintosh II/IIx/IIfx is large enough to fit either the 5.25-inch size or the 3.5-inch size, but the drive bracket in a Macintosh IIcx/IIci can *only* handle the 3.5-inch size. Due primarily to power-supply limitations, the Macintosh IIsi can only handle an even smaller one-third height, 3.5-inch size. Although it is possible to get a low-power half height, 3.5-inch drive to work in a IIsi, the extra drive height precludes the use of a full-size NuBus card so it's not recommended. This information is summarized in Table 9-1.

Table 9-1. Macintosh II Hard Drive Capabilities

Model	1/2-height 5 1/4-inch	1/2-height 3 1/2-inch	1/3 height 3 1/2-inch
Mac II	Yes	Yes	Yes
Mac IIx	Yes	Yes	Yes
Mac IIfx	Yes	Yes	Yes
Mac IIcx	No	Yes	Yes
Mac IIci	No	Yes	Yes
Mac IIsi	No	Not Recommended	Yes

Standard Hard Drives

Form-factor drives differ from standard hard drives in that both the drive and the controller are supplied by the original equipment manufacturer. Private-label vendors sell the prepackaged drive exactly the way they get it.

Standard hard drives are manufactured without embedded controllers. Assemblers of hard drive subsystems (SCSI hard drives mounted in an external enclosure) have to provide the controller separately. As shown in Figure 9-3, that requires a bigger box, additional cabling, more cooling, and a bigger power supply.

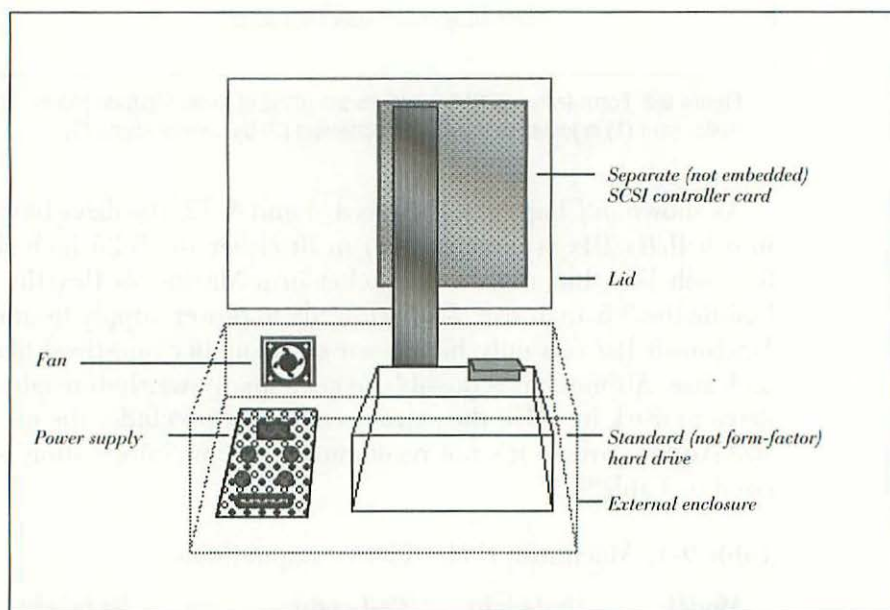

Figure 9-3 Standard hard drives with separate controllers require a bigger box, a bigger power supply, more cooling, and additional cabling.

Unlike form-factor drives, standard hard drives can't easily be transferred to a Macintosh II, because there's no provision for mounting the separate controller card.

Setting the Bus ID

Every hard drive, laser printer, scanner, etc., on the SCSI bus must be assigned a unique identification (ID) number. The Macintosh II CPU is factory set at ID = 7. By convention, internal hard drives are assigned ID = 0. External devices are assigned ID = 1, ID = 2, ID = 3, ID = 4, ID = 5, and ID = 6.

Each ID number is assigned by jumping pin headers (generally 0.025-inch square posts on 0.100-inch centers) on the device's SCSI controller card. Assorted shorting blocks (used to jump the pin headers) are shown in Figure 9-4.

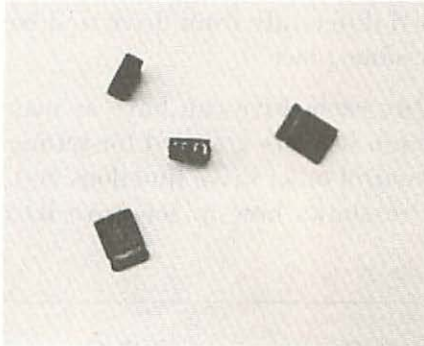

Figure 9-4 Assorted shorting blocks (pin header jumpers).

Pin Header Locations

Pin header location varies from controller card to controller card. As shown in Figure 9-5, the SCSI ID pins on the Quantum QA250 (the original 40 MB SCSI drive used in the Macintosh II/4-40) stick up (at a right angle) from the middle of the controller card. On other drives, the ID pins may stick out from (be parallel to) the edge of the controller card.

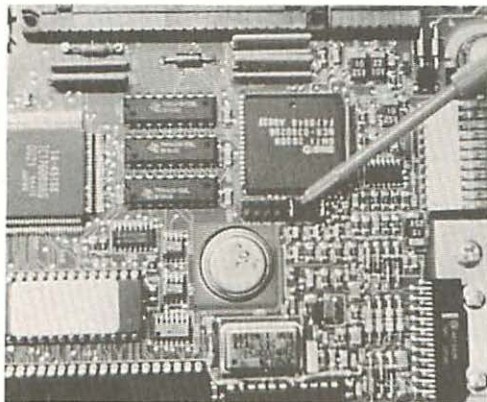

Figure 9-5 The SCSI ID pins on the Quantum QA250 stick up (at a right angle) from the middle of the controller card.

Pin Header Labeling

Pin header labeling also varies from controller card to controller card. The SCSI ID pins on the Quantum QA250 are labeled A0, A1, and A2. On other drives, the same pins are labeled W1, W2, and W3. Sometimes, they're not labeled at all. The important points to remember are that SCSI ID pins are often labeled differently from drive to drive, and they are not always located in the same place.

As illustrated in Figure 9-6, each drive can have as many as 8 pin headers. Only the first three pin headers are used for setting drive IDs. The remaining pin headers control other drive functions and should not be tampered with. Figure 9-6 shows how to set drive ID numbers 0 through 6.

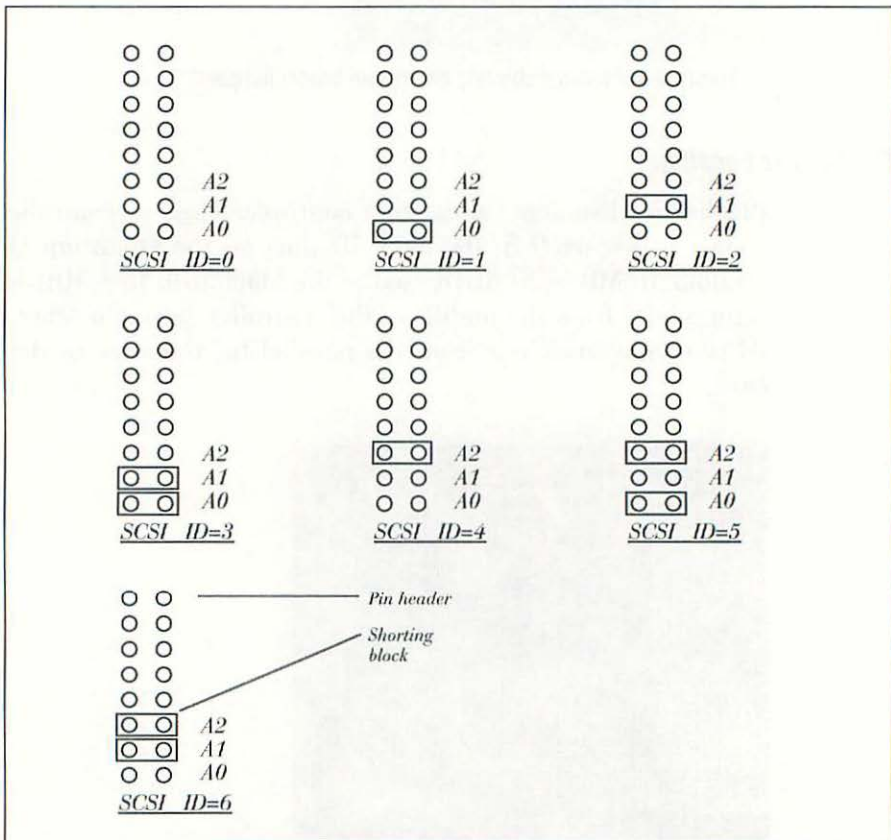

Figure 9-6 Drive ID numbers 0 through 6 are assigned by placing two-pin shorting blocks over pin headers on the embedded controller card.

Checking Termination

As a general rule, the first and last devices on a SCSI chain must be terminated. Internal drives with ID = 0 (considered the first device) are usually terminated with three 220/330-ohm, eight-pin, single inline package dual-terminating resistor networks (SIP terminators). A set of SIP terminators is shown in Figure 9-7.

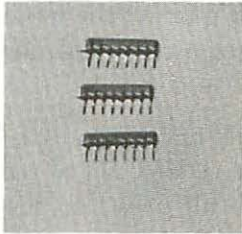

Figure 9-7 SIP terminators.

The 220/330-ohm SIP terminators plug into machine-tooled sockets next to the 50-pin cable connector at the back of the drive. As shown in Figure 9-8, the terminator sockets on the Quantum QA250 (the original 40 MB SCSI drive used in the Macintosh II/4-40) are labeled U31, U32, and U38. Other resistor networks at the back of the drive are soldered in place. The soldered resistor networks serve other purposes and should not be tampered with.

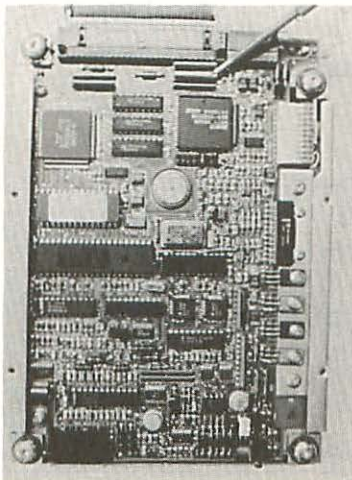

Figure 9-8 The terminator sockets on the Quantum QA250 (the original 40 MB SCSI drive used in the Macintosh II/4-40) are labeled U31, U32, and U38.

Terminator Orientation

The schematic of a typical eight-pin SIP 220/330 dual-terminating resistor network is shown in Figure 9-9. Note that pin 1, which is indicated by a dot or a stripe printed on the part's outer case, is electrically different from pin 8. Pin 1 connects to chassis ground. Pin 8 does not. When installing dual-terminating resistor networks, it's important to orient the dot or the stripe on the outer case such that pin number 1 plugs into socket number 1 (chassis ground). If one or more of the terminators are backwards, you may not be able to format the drive or you may get read/write ("This file could not be written and was skipped.") disk errors.

In most cases socket number 1 is labeled. If not, you can easily identify socket number 1 with a digital multimeter (DMM) set to read K-ohms ($K\Omega$). Here's the general procedure: With all power to the drive off, touch the red probe to one side of the terminator socket and touch the black probe to the drive chassis. As shown in Figure 9-10, and suggested by the ground symbol in Figure 9-9, socket 1 will read 0.00 ohms. Socket 8 will typically read 100 ohms to 2,000,000 ohms, depending on whether or not SIP terminators are installed when you make the test.

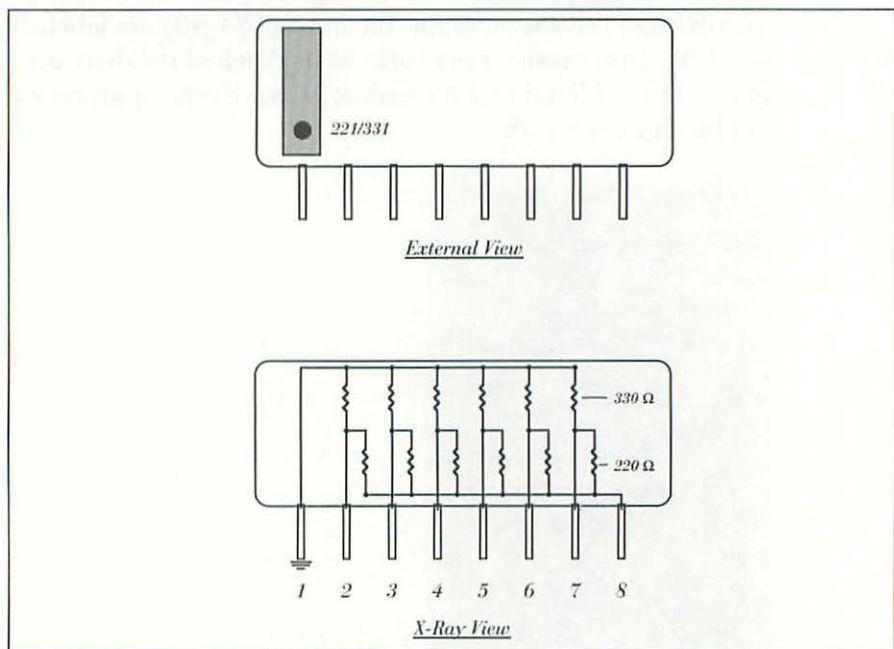

Figure 9-9 The schematic of a typical eight-pin SIP 220/330 dual-terminating resistor network.

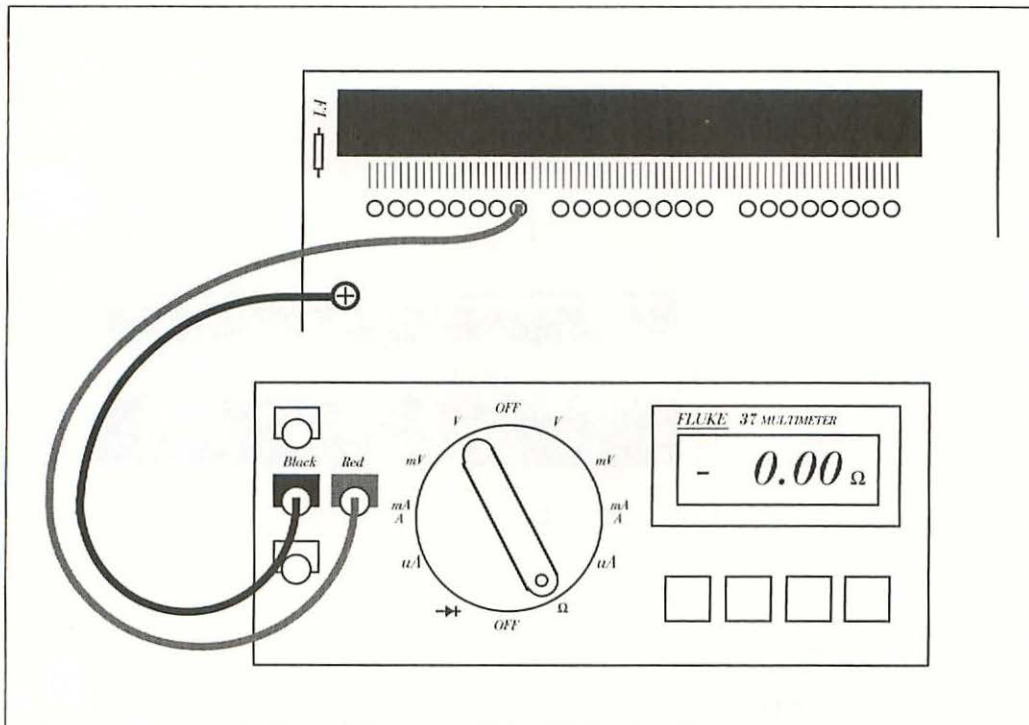

Figure 9-10 Terminator socket number 1 reads 0.00 ohms. Socket 8 will typically read 100 ohms to 2,000,000 ohms, depending on whether or not SIP terminators are installed when you make the test.

Terminator Filters

Most internal SCSI drives installed in a Macintosh IIfx and some internal SCSI drives used in a Macintosh IIci require a SCSI filter to suppress line noise. The SCSI filter plugs into the 50-pin socket at the back of the SCSI drive. The 50-pin data cable that normally plugs into the socket plugs into the filter. This arrangement is shown in Figure 9-11.

Terminator filters can also be used on other models of the Macintosh II, but with the exception of the Macintosh IIfx and the IIci, they're generally not necessary. The filter adds two capacitors (2.2 mfd and 0.01 mfd ceramic) to the terminator schematic, as shown in Figure 9-12.

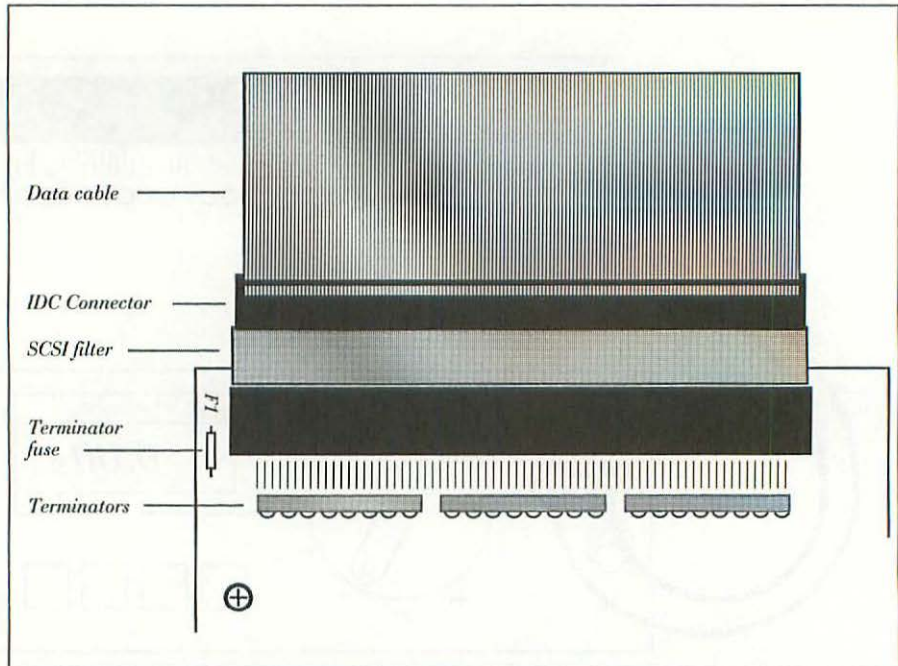

Figure 9-11 A SCSI filter plugs into the 50-pin socket at the back of a SCSI drive.

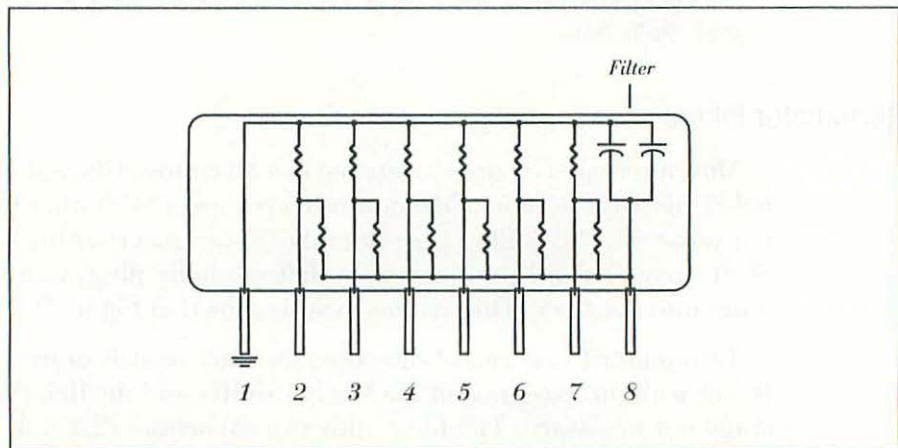

Figure 9-12 The schematic of an 8-pin SIP terminator with built-in SCSI filter.

SCSI—Hard Drive Upgrades

Anyone can install a SCSI hard drive upgrade into a Macintosh II. It's equally easy to replace an existing SCSI drive. There's really nothing to it. All you need are:

1. A form-factor SCSI hard drive that fits your model of Macintosh II. For details refer to Table 9-1.
2. A SCSI hard-drive installation kit that fits your model of Macintosh II.
3. A Phillips-head screwdriver.

SCSI Hard Drive Installation Kits

As shown in Figure 9-13, SCSI hard-drive installation kits typically include at least four items:

- A Macintosh disk with SCSI formatting software.
- A 50-pin SCSI data cable.
- A four-wire SCSI power cable that fits your model of Macintosh II.
- A mounting bracket that fits your model of Macintosh II.



Figure 9-13 SCSI hard drive installation kit. *Courtesy of ONTRACK Computer Systems.*

To replace an existing drive, all you need (other than the new drive) is SCSI formatting software. The mounting hardware from the old drive (the 50-pin SCSI data cable, the 4-wire SCSI power cable, and the mounting bracket) can generally be reused.

Formatting Software

Formatting software is used to set up the drive for Macintosh use. To set up the same drive for Amiga, Apple IIGS, or PC-compatible use, you would need different formatting software. Since the OEM has no way of knowing what type of computer you own, formatting is generally up to you.

Don't take formatting software for granted. Quality and functionality varies from publisher to publisher. Some programs, particularly Disk Manager Mac from ONTRACK Computer Systems, work exceptionally well and support a variety of drives. Other programs, like HD SC Setup from Apple, work only marginally well and support relatively few drives. In general, Apple-brand drives that are reformatted with Disk Manager Mac tend to run faster and have more usable space on them. Disk Manager Mac can also fix some broken Apple-brand drives (Quantum and Seagate) that Apple's HD SC Setup considers unsuitable. There's really no comparison between the two programs. Disk Manager Mac is much better than HD SC Setup. Next to the hard drive, good formatting software is the most important part of the installation.

SCSI Cables

Fifty-pin SCSI data cables (socket-to-socket ribbon cables) are pretty much standard and they're keyed, so there's no way you can put them in backwards, but four-wire power cables vary from Macintosh model to Macintosh model. Power cables for the original Macintosh II, the Macintosh IIx, and the Macintosh IIcx have identical rectangular connectors on both ends. Power cables for the Macintosh IIcx/IIci and Macintosh IIsi have a rectangular connector on one end and square connector on the other end. The various cables are illustrated in Figure 9-14.

Mounting Brackets

Mounting brackets also vary. Brackets for 5¼-inch drives are physically larger than mounting brackets for 3½-inch drives. Mounting brackets designed for the Macintosh II/IIx/IIcx do not fit the Macintosh IIcx/IIci and vice versa. Mounting brackets for the Macintosh IIsi are a third type. Mounting brackets for the Macintosh IIsi only fit the IIsi.

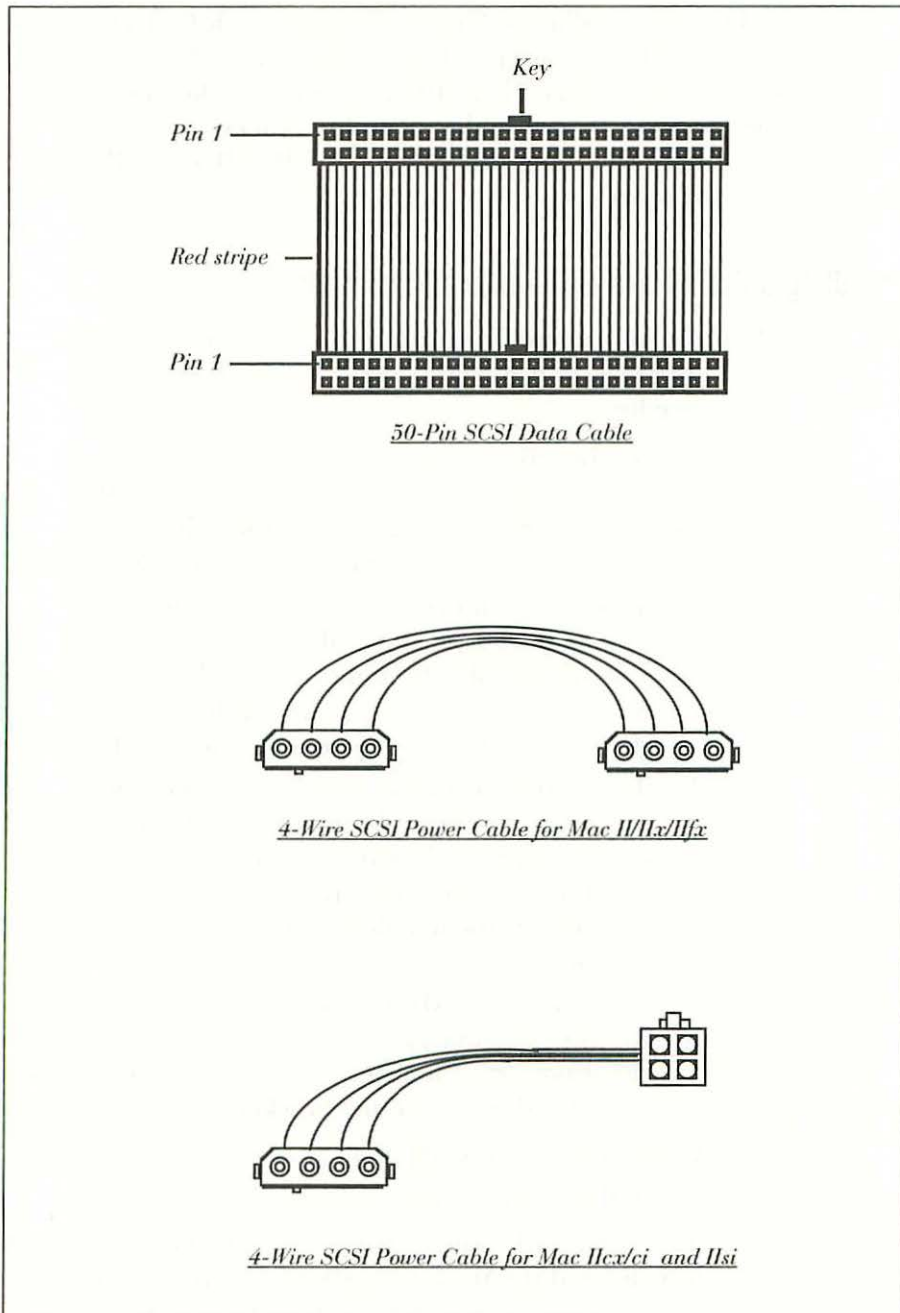

Figure 9-14 Fifty-pin SCSI data cables are pretty much standard, but power cables vary from Macintosh model to Macintosh model.

Finally, installation kits for the Macintosh II/IIx/IIfx should contain screws and lock washers. It takes four $\frac{6}{32} \times \frac{1}{4}$ -inch screws to secure a hard drive to a Mac II/IIx/IIfx mounting bracket and two 3.5×8 -millimeter screws to secure the mounting bracket to a Macintosh II/IIx/IIfx drive bay. Mounting brackets for the IIcx/IIci and IIsi snap into place without screws.

Installing a SCSI Hard Drive into a Macintosh II

Once you've gathered the materials that are correct for your particular model of Macintosh II, you're ready to install the drive. Here's the general procedure:

1. Follow the take-apart procedure for your specific computer as given in Chapter 4. Refer to Figure 4-4 for Mac II/IIx/IIfx information. Refer to Figure 4-32 for Macintosh IIcx/IIci information. Refer to Figure 4-34 for Macintosh IIsi information.
 - 2a. To remove an existing hard drive from Macintosh II/IIx/IIfx, unplug the 50-pin data cable from the old drive, unplug the 4-wire power cable from the Macintosh logic board, unscrew the hard drive/hard-drive mounting bracket assembly from the drive bay, slide the bracket to the left, and lift straight up.
 - 2b. To remove an existing hard drive on Macintosh IIcx/ci, remove the power supply, unplug the 50-pin data cable from the old drive, pinch the hard drive power cable connector, pull up to unplug the hard drive power cable from the Macintosh logic board, grip the handles on the hard drive mounting bracket, and lift straight up.
 - 2c. To remove an existing hard drive on Macintosh IIsi, unplug the 50-pin data cable from the old drive, unplug the hard drive power cable from the old drive, spread the handles on the hard drive mounting bracket, and lift straight up.
3. Verify that the SCSI ID number of the new drive = 0 (zero).
4. Verify that the new drive is terminated.
5. If necessary (Macintosh IIfx), plug a SCSI filter into the back of the new drive. If the Macintosh IIfx was not previously equipped with a hard drive, unplug the SCSI termination block from the 50-pin SCSI connector on the Macintosh IIfx logic board.

6. If necessary (because you don't have a new bracket), unscrew the old hard drive from the existing mounting bracket.
7. Attach the new drive to the mounting bracket. When replacing identical-size drives, the old bracket should work fine. But when the replacement drive is a different size, or if it comes from a different model of Macintosh II, then you may need a new bracket.

To replace a 5¹/₄-inch drive in a Macintosh II/IIx/IIfx with a 3¹/₂-inch drive, you'll need a smaller bracket. To replace a 3¹/₂-inch drive in a Macintosh II/IIx/IIfx with a 5¹/₄-inch drive, you'll need a larger bracket.

Mounting brackets are also machine-specific. Brackets from the Macintosh II/IIx/IIfx don't fit the IIcx/IIci or the IIsi. Brackets from the IIcx/IIci don't fit the II/IIx/IIfx or the IIsi. Brackets from the IIsi don't fit the II/IIx/IIfx or the IIcx/IIci. So if you're moving a hard drive from one model of Macintosh II to another, and the target Macintosh II doesn't already have a hard drive, then you will also need a new bracket.

8. When the replacement or new hard drive is screwed into the bracket, reverse step 2 to install the drive. If you're replacing an existing drive (say pulling out an older 40 MB drive and replacing it with a larger, faster 100 MB model), then the old 4-wire power and 50-pin data cables can be reused.
9. Reverse step 1 to reassemble your Macintosh II computer system.

Formatting the Drive

Apple-brand SCSI drives generally come preformatted (for Macintosh or Apple IIGS use), but OEM SCSI drives generally do not. In that case, you'll need something other than Apple's HD SC Setup program to format the drive for Macintosh use. Here's the general procedure:

1. Start your Mac from a floppy disk containing recent System software and the formatting program that you plan to use.
2. Double click the formatting program.
3. Figure 9-15 shows Disk Manager Mac version 2.24. SCSI ID = 0 is preselected, because it's the only drive connected to the computer. Note that the status of the new drive is unformatted. To format the drive, click the Auto-Install button.

4. When the format operation is complete, quit Disk Manager Mac and use the Apple Installer program which came with your Macintosh II (or with a recent System software update) to put fresh System software on the drive.

That's it. When you restart the computer, the new drive will mount. Copy your applications to it and you're back in business!

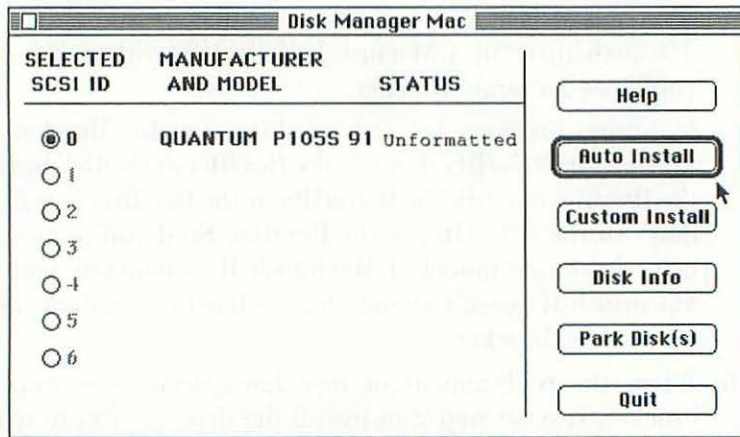

Figure 9-15 Disk Manager Mac Version 2.24.

Putting Together an External Hard Drive

Assuming that the drive you just replaced is in good working condition (just too small or too slow for everyday use), you can still use it (for miscellaneous storage or as a backup drive or as a main drive on another computer) by installing it in an external enclosure.

External Hard-Drive Enclosures

As shown in Figure 9-16, external hard-drive enclosure kits typically include at least nine items:

- An alternating current (AC) power cord.
- A metal or plastic enclosure, also called a case or chassis.
- A prewired switching power supply with +5V and +12V direct current (DC) outputs.
- A prewired +12V DC fan.

- A universal four-wire power cable.
- A universal mounting bracket with miscellaneous hardware.
- An integral data cable.
- An external Mac-to-SCSI hard-drive cable.
- An integral drive LED, with prewired cable.

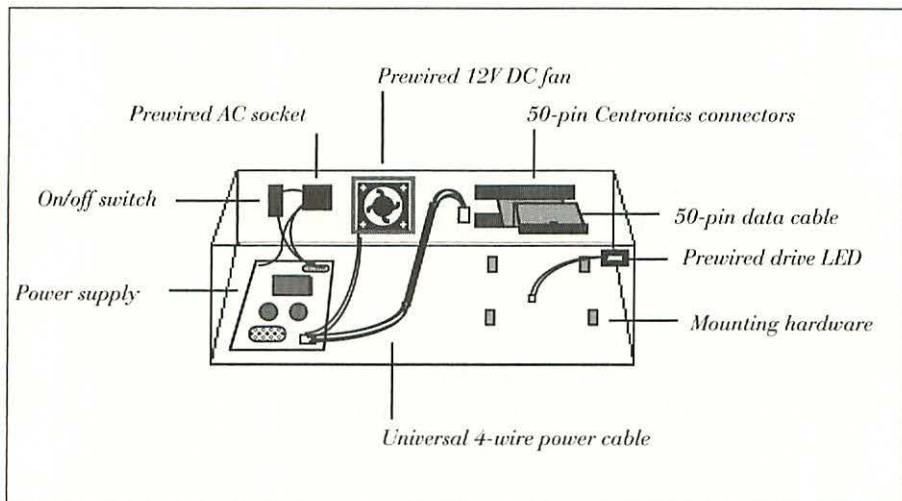

Figure 9-16 External hard-drive enclosure.

AC Power Cords

Computer power cords are pretty much standard. Most hard-drive enclosures use the same type of power cords used on a Macintosh II, a LaserWriter, an ImageWriter, etc. Except for jacket color and plug angles, they're generally all the same. In a pinch, you can generally substitute one Mac-related power cord for the other.

Metal vs. Plastic Enclosures

Metal enclosures are better than plastic. A drive that's perfectly well-behaved in a metal enclosure can cause video interference in a plastic enclosure. Generally, people blame this problem on their monitors or their CPU power supplies. The repairman never finds the problem, because all the time their monitors and their CPUs are in the repair shop (miles away from the offending enclosure), they work perfectly.

Switching Power Supplies

Switching power supplies are all different. To use a 40-watt Quantum QA250 (the original 40 MB SCSI drive used in the Macintosh II/4-40) in an external enclosure, you need at least a 40-watt power supply. Many enclosures are regularly equipped with less than 30-watt power supplies. These won't power a Quantum QA250, at least not for long. In general, the bigger the power supply, the better the enclosure.

Universal Mounting Brackets

Whether or not to get an enclosure with universal (5 1/4-inch/3 1/2-inch) mounting hardware depends on your circumstances. Universal enclosures tend to come with bigger power supplies and that's good. They also tend to be physically larger and somewhat less attractive. That's generally not so good.

If you're trying to find a home for a 5 1/4-inch Apple HD 40 (Quantum QA250), then you have no choice. You need the larger, universal type. But, if you've just pulled a 3 1/2-inch Apple HD 40 (Seagate ST157 or Sony SRD2040A) out of your Macintosh II, then a smaller external enclosure designed strictly for 3 1/2-inch drives will be fine.

Prewired 12V DC Fans

The bigger the power supply, the bigger the fan should be. DC brushless fans are much better than the universal type with brush motors. Motor brushes eventually cause static, which invariably shows up as interference on your monitor display.

Ball-bearing fans tend to make much less noise than fans with sleeve bearings. Air intakes should be filtered. Otherwise, dust (which acts as thermal insulation) accumulates around sensitive components and invariably causes them to run hot and burn out.

Data Cables

External hard-drive enclosures come with two types of internal data cables. This type uses 50-wire ribbon cable and has two 50-pin female Centronics connectors on the external-cable end. The preferred type accepts standard 50-pin male Centronics SCSI connectors.

External hard-drive enclosures that use 25-wire ribbon cables should be avoided. This type has two DB25-S (socket) connectors on the external-cable end. These are a nuisance to connect in the middle of a SCSI chain. They're also more susceptible to noise problems than the fully wired 50-pin type. Until and unless Apple switches over to this type, DB25-S SCSI connectors on an external Macintosh device make no sense at all.

Terminating External Drives

To terminate an external drive or not to terminate it, that is the question. As mentioned previously, the general rule is that the first and last devices on a SCSI chain must be terminated. If the external enclosure is going in the middle of a SCSI chain (because you already have at least one other external SCSI device), then the drive's internal SIP terminators have to be removed. To use the same drive on the end of a SCSI chain later, you can either put the drive's internal SIP terminators back in or fit the drive with an external terminator. An external terminator is a short male-to-female (M-F) 50-pin Centronics adapter that plugs into the back of the drive. The male end of the 50-pin external SCSI cable can either plug into the female end of the terminator, or it can plug into the unused Centronics connector on the back of the drive. Generally, it makes no difference.

If the drive is going on the end of a SCSI chain (because you don't have any other external SCSI devices), then the internal SIP terminators can stay. Official sources would have you remove the internal SIP terminators and use an external terminator regardless of where the drive is going, but with the possible exception of a Macintosh IIx which comes with a special external terminator (equipped with a built-in SCSI noise filter), that doesn't make any sense.

Even if you have to buy SIP terminators separately, a set of three generally costs less than \$1. An external terminator generally costs \$30 to \$40! If you received a special external terminator/filter with your computer (Macintosh IIx), then use it. If your Macintosh II CPU requires an add-on SCSI noise filter, then add one. Otherwise (Macintosh II/IIx, Macintosh IIcx) why spend the extra money?

Installing a SCSI Hard Drive into an External Enclosure.

Once you've obtained a suitable external enclosure, you're ready to install the SCSI drive. Here's the general procedure:

1. Remove the lid of the enclosure.
2. To remove an existing hard drive from the enclosure, unplug the 50-pin data cable from the old drive, unplug the four-wire power cable from the old drive, and unscrew the hard drive from its mounting bracket.
3. Refer to Figure 9-6. Verify that the ID number of the new drive is a unique number between 1 and 6.
4. Install and/or remove internal terminators as necessary.
5. Refer to Figure 9-11. If necessary (Macintosh IIx), plug a SCSI filter into the back of the new drive.
6. Plug the 50-pin data cable into the drive.
7. Plug the four-wire power cable into the drive.
8. Plug the two-wire drive LED cable into the drive.
9. Screw the hard drive into its mounting bracket.
10. Reattach the enclosure lid.
11. If the drive has no internal SIP terminators and is at the end of a SCSI chain, plug in an external terminator. If the drive has no internal SIP terminators, no internal SCSI filter and is at the end of a Macintosh IIx SCSI chain, plug in the special external terminator (with built-in SCSI noise filter) that came with the Macintosh IIx CPU.
12. Connect the external SCSI cable. If an external terminator is present, the external cable can either be attached to the back of the terminator, or to an unused 50-pin connector at the back of the drive. It makes no difference.

Brand new drives may have to be formatted as described above and they may need system software. Working drives taken from a CPU cabinet should be ready to go.

Troubleshooting External Hard Drives

If the CPU fails to boot when the external drive is connected but powered down, try turning on the external drive. If the CPU boots now, but the external drive doesn't show up, choose Restart from the Special menu. If

the external drive shows up now, then you'll have to turn on the external drive before turning on the CPU. In some cases, mostly when using older standard hard drives with separate controller cards, you may have to let the external drive come up to full speed before turning on the CPU. That problem is in the drive's controller card, and generally, there's nothing to be done about it. Either live with it, or move the drive to a Mac Plus where it will be used as an only drive.

If seven internal hard drives show up when you boot the computer but no external hard drive appears, you have a SCSI ID conflict. Generally, it means both drives are set to ID = 0. Change the ID of the external drive and everything should be fine.

If the external drive works fine, but the drive LED doesn't come on, then the LED connector is probably upside down. Turn off power to the drive, unplug the LED connector, rotate it 180°, plug it back in, and everything should be fine.

If the external drive never shows up and your SCSI formatting software reports "broken bus" or "bus not terminated" then either the terminators are not in, or the terminator fuse on line 26 (marked F1 in Figure 9-10) is blown. Check the fuse with a digital multimeter as indicated in Chapter 4, Figure 4-29. If the fuse reads infinity or overrange, replace it.

If the external hard drive never shows up and your SCSI formatting software reports "error during inquiry command" or something to that effect, then you have a bad data cable. Usually it means one or more lines on the internal 50-pin ribbon cable is open. These usually occur at the ends, right under the insulation displacement connectors (IDCs). Breaks in external cables are less common.

If you get read/write ("This file couldn't be copied and was skipped.") errors that you never got before, one or more SIP terminators may be in backwards. Refer to Figure 9-10 to check them out. Similar problems may be related to excessive cable length—19½ feet (three 6-foot external cables plus three 6-inch internal ribbon cables) is the maximum.

Usually, none of these problems occur. In most cases the external drive comes up just fine the very first time you try it.

10

ADB—Keyboard and Mouse Repairs

This chapter covers six items (three keyboards, two mice, and one accessory) that plug into the Apple Desktop Bus (ADB):

- The Apple Standard Keyboard—Part# MO116
- The Apple Extended Keyboard—Part# MO115
- The Key Tronic MacPro keyboard
- The Sophisticated Circuits PowerKey
- The Apple Desktop Bus Mouse—Part# A9M0331
- The Apple ADB Mouse—Part# 65431

The first half of this chapter deals with ADB keyboards. It shows how to take them apart, tells how to fix intermittent key switches, and shows how to replace broken key switches.

The second half of this chapter deals with ADB mice. It covers routine mouse cleaning, tells how to fix intermittent mouse cables, and shows how to replace broken mouse switches.

Standard Safety Precautions

For the benefit of someone who's just turned to this page and hasn't read Chapters 1 and 4, yet. . .

To prevent almost certain damage to the Mac II logic board and to minimize the possibility of electric shock, always switch off the power and physically disconnect the ADB cable from the computer before beginning repairs. Switching off the power before disconnecting a mouse or keyboard cable is very important. Live disconnects may result in the total failure of the desktop bus. In that case, it may seem that both the mouse and keyboard are broken, when the damage is actually on the logic board. To avoid the complications discussed in Chapter 4, switch off the power before disconnecting cables!

OEM Keyboard Disassembly

Keyswitches are somewhat delicate, so always begin the disassembly procedure by spreading out a soft towel. Next, flip the keyboard upside down and loosen the screws in the bottom cover with a #1 Phillips-head screwdriver. As shown in Figure 10-1, the Apple Standard Keyboard has three screws. As shown in Figure 10-2, the Apple Extended Keyboard has four screws.

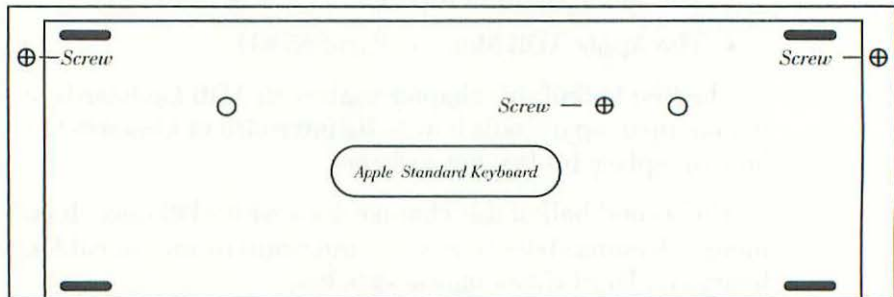

Figure 10-1 Screw locations for Apple Standard Keyboard.

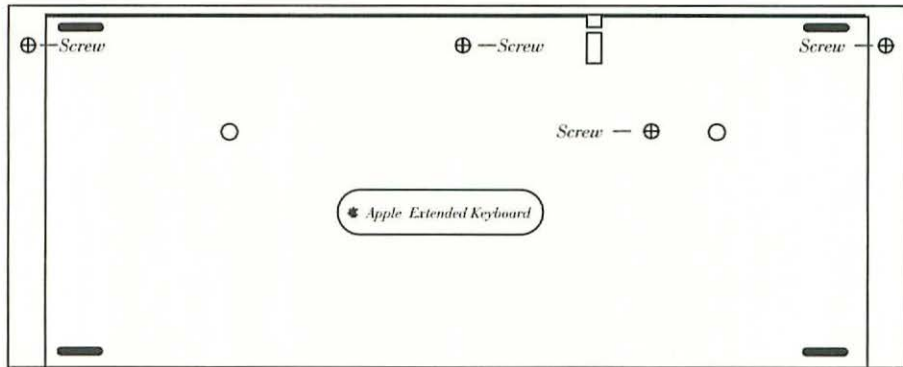

Figure 10-2 Screw locations for Apple Extended Keyboard.

Once the screws are loose, flip the keyboard right side up and gently shake out the screws. They should land on the towel. Pick up the screws and place them in a parts container. Plastic food tubs make good parts containers. Otherwise, use something made of unbreakable material, with a lid and a low center of gravity.

If one or more screws does not fall out, flip the keyboard upside down, loosen the remaining screws, and try again. When all of the screws are safely in the parts container, place the keyboard right side up and gently rotate the top cover towards the space bar. As shown in Figure 10-3, the front edges of both covers are fastened by thin plastic hooks. These stubborn hooks are easily broken, so study the diagram and be very careful.

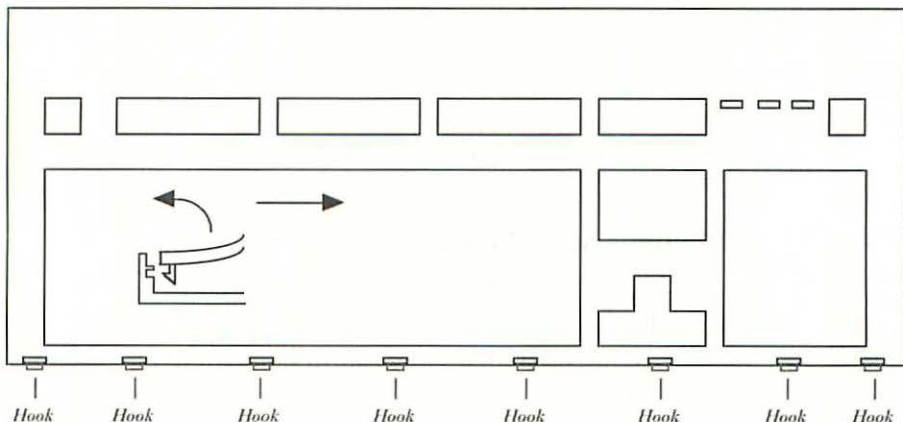

Figure 10-3 Fastener details for OEM ADB keyboard covers.

When the top cover is at a 45° angle to the bottom cover, push it backwards a bit, then carefully lift the top cover up and away. Don't try to force the covers apart! If you break the hooks, the covers will never fit back together again.

Once the covers are separated, note that the keyboard assembly consists of three printed circuit boards (PCBs). As shown in Figure 10-4, tiny ADB boards located in each of the rear corners connect to the larger key matrix PCB by ribbon cables. To remove the larger PCB, first free the ADB boards from their plastic retainers, then lift the key matrix PCB straight up. Don't force anything. The entire assembly is fragile and easily broken.

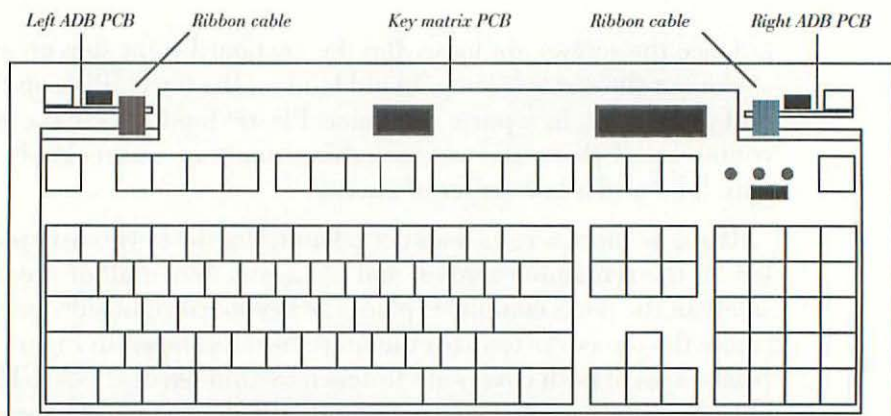

Figure 10-4 Board locations for Apple Extended Keyboard.

Now, slide the key matrix PCB backwards a bit, then lift the keyboard assembly away from the bottom cover. Put the three or four screws, the top cover, and the bottom cover aside. There are more screws on the key matrix PCB, but these need not be removed.

Servicing Intermittent Key Switches

If you've had the keyboard for very long, especially if you've kept it uncovered, you might be surprised by a thick layer of dust. This layer should be removed with an air compressor. If no air compressor is available, blow the dust out with the exhaust end of a vacuum cleaner. Don't try to vacuum the dust. The key stems are delicate. You could easily damage them with stiff vacuum cleaner tools.

The easiest way to remove the key cap from the affected switch is with a key-cap puller. As shown in Figure 10-5, press the wire whisks over the key cap, twist the handle, and lift straight up.

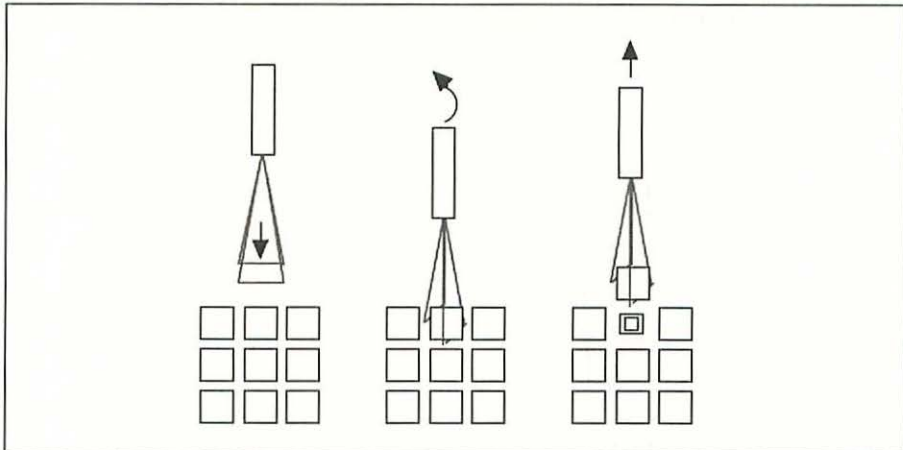

Figure 10-5 The easiest way to remove the key cap from the affected switch is with a key-cap puller.

Key-cap pullers can either be store-bought or homemade. A store-bought key-cap puller is shown in Figure 10-6. A do-it-yourself key-cap puller, made from a six-inch kitchen whisk, is shown in Figure 10-7.

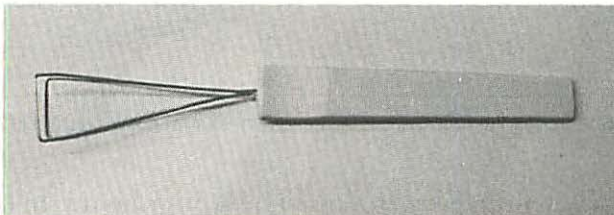

Figure 10-6 Store bought key-cap puller.

Kitchen whisks are sold in the housewares section (alongside can openers and measuring spoons) in most supermarkets. You can buy about 15 kitchen whisks for the price of one key-cap puller! To make it work as well as the real thing, remove one of the three wire loops, reposition the other two loops, and flatten the ends, as shown in Figure 10-8.



Figure 10-7 Homemade key-cap puller.

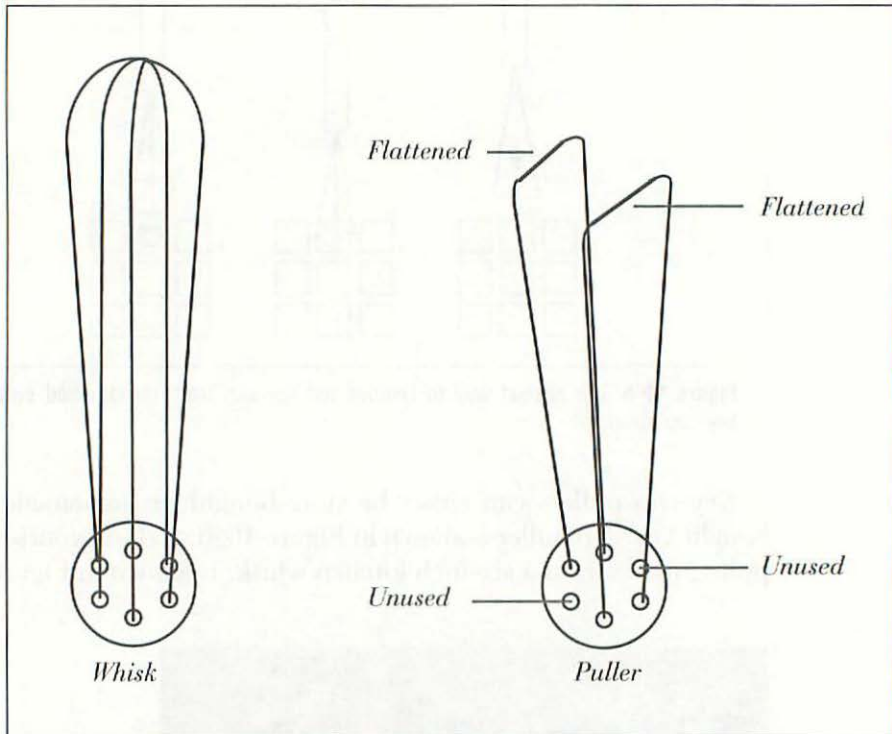

Figure 10-8 Modification details turning a kitchen whisk into a key-cap puller.

If the key switch problem was caused by a prior liquid spill, spray the affected area with WD-40 lubricant to loosen the dried residue. Mop up the mess with cotton swabs as best as you can. Work some lubricant into the key switch by pressing the key stem up and down. In most cases, a tiny squirt is all it takes. WD-40 drives out moisture, lubricates, and generally dissolves corrosion. To test your work, replace the keyboard covers, attach the keyboard cable, and switch on the computer. If the key switch works now, shut down, replace the key cap, reattach the cover screws, and you're all done. If the key switch is still intermittent, proceed to the next section.

When reattaching the cover screws, bear in mind that the covers are made of breakable plastic. To avoid snapping the plastic, always hold the screwdriver between your thumb and index finger. Bear down just enough to snug the screws.

Replacing Broken Key Switches

WD-40 will almost always fix intermittent contacts but it can't mend broken plastic. For that you'll need an identical replacement Alps-brand key switch. In a pinch, you can replace a broken switch with a seldom used key switch from another part of the keyboard. With the exception of the Caps Lock key, all of the key switches on both OEM keyboards (Standard and Extended) are exactly the same.

Begin by desoldering the defective switch. As shown in Figure 10-9, use a low-wattage, grounded soldering pencil and a vacuum desoldering tool. Be sure to discharge the waste solder into a 13-ounce (coffee) can each time you recharge the tool, otherwise the waste will just spit onto the circuit board.

Next, check the desoldered switch tails with a small screwdriver or a soldering aid. They should break away from the circuit board easily and/or move freely. If they offer much resistance, reheat the joint, add a little fresh solder, and vacuum it again (with the desoldering tool) until you can wiggle the switch tails. If the switch tail still doesn't move, check for remaining solder, as shown in Figure 10-10.

When you can wiggle both switch tails, turn the keyboard right side up and pull the key stem upward. A completely desoldered key switch should lift out with little resistance.

Note that the solder tail holes in the keyboard PCB are slightly off-center. Line up the replacement key switch so that the switch tails line up with the holes and snap it into place. Replace the key cap, turn the keyboard upside down again, solder the tails to the circuit board, and that's it.

To test your work, replace the keyboard covers, attach the keyboard cable, and switch on the computer. If the replacement key switch works, shut down, reattach the cover screws (remember not to tighten very hard), and you're all done.

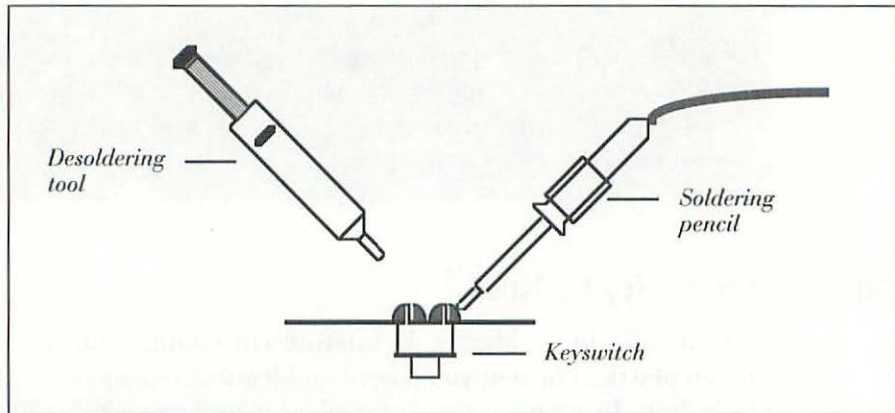

Figure 10-9 Desolder the defective switch with a low-wattage, grounded soldering pencil and a vacuum desoldering tool.

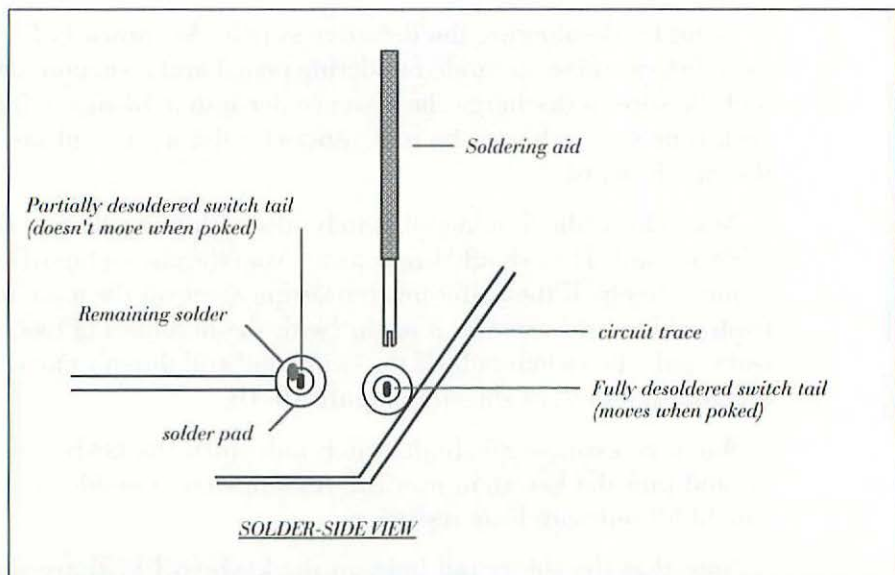

Figure 10-10 The desoldered switch tails should move freely when poked with a soldering aid.

First Aid for Spills

In the event of a liquid spill, reach for a towel and turn the keyboard upside down so the liquid can drain out. Don't leave the keyboard right-side up one second longer than you have to!

When the keyboard is completely dry, pull off all of the key caps and soak them in a sink with mild soap and water. Scrub them with a soft tooth brush. Rinse each key cap, and allow them to air dry. Clean up any residue inside the keyboard with WD-40 and cotton swabs. Wipe down the keyboard covers with mild soap and water. When you're ready to replace the key caps, refer to Figures 10-11 and 10-12 for key cap positioning information. If you're lucky, there won't be any permanent damage, and the keyboard will work just as well as it did prior to the spill.

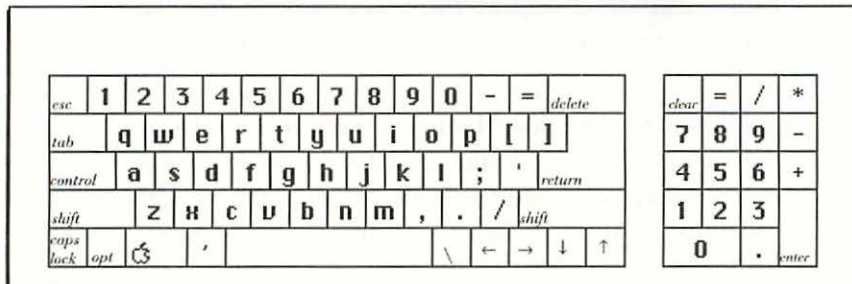

Figure 10-11 Key cap positioning for Apple Standard Keyboard.

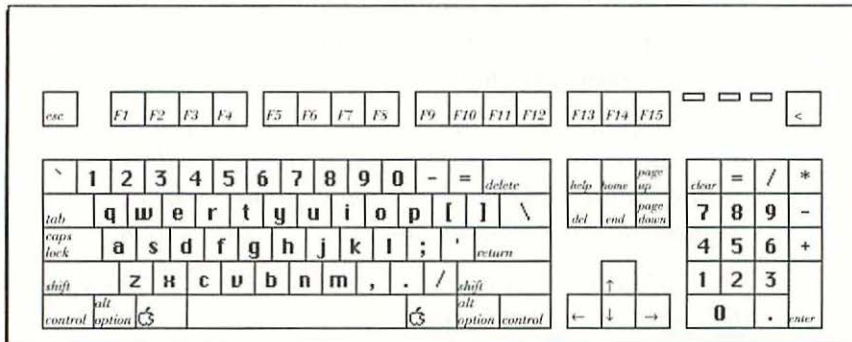

Figure 10-12 Key cap positioning for Apple Extended Keyboard.

MacPro Replacement Keyboards

If you're not lucky, or if whoever spilled the liquid didn't think to turn the keyboard over, so many key switches could be damaged that the OEM keyboard may not be worth repairing. If you can't find an authorized dealer to sell you new key switches at a reasonable price, look into the MacPro replacement keyboard shown in Figure 10-13.



Figure 10-13 MacPro Keyboard. *Courtesy of Key Tronic Corporation*

Why a Key Tronic MacPro keyboard and not another OEM model? Because Key Tronic makes great keyboards, and if a Key Tronic product ever breaks, you're less likely to have a problem getting parts. The following is quoted directly from the Key Tronic MacPro Accessories Catalog:

“Technical support and assistance is just a phone call away with Key Tronic’s toll-free line, 1-800-262-6006. In Washington State, call (509) 927-5515. Product support specialists can be reached at these numbers for both technical questions and repair information for Key Tronic products.

For repair service, be sure to call this number to ensure quick handling and response. The support staff will give you a return authorization (RA) number and shipping instructions at that time to guarantee acceptance into our receiving system.

In addition to Key Tronic’s technical support, you may also order spare parts and hard to find items such as cables, key tops, key switches and EPROMS for your Professional Series® keyboard. These items can be ordered by calling our Key Tronic Accessories Department from 7 AM to 4 PM (Pacific Time), Monday through Thursday and from 7 AM to 12:00 Noon (Pacific Time) on Fridays.

Our reputation for quality and complete service stands behind every Key Tronic product. Please feel free to give us a call if we can be of further service to you.”

That's good enough for me. I'll take a repairable Key Tronic keyboard over a disposable OEM keyboard any time.

MacPro Accessories

Key Tronic offers a unique accessory kit which allows you to modify the touch of any MacPro key switch simply by changing a rubber dome underneath the key cap. The accessory kit contains two sets of domes which act like springs. Installing the stiff domes gives the keyboard a firm touch. Installing the soft domes gives the keyboard a lighter touch. The stock domes that originally come with a keyboard give it a medium touch.

A key-cap puller is provided with each kit. To try out a new dome, pull the key cap, pick up the existing dome, and plop down the new one. Replace the key cap and you're all done.

If you have to use both Macs and PCs and the difference in the feel of the two keyboards bothers you, or if you just have trouble hitting certain keys, try changing the domes. Once you've equalized the two keyboards (especially if you run Microsoft Word, Works, and Excel), you'll hardly notice that you're on another computer.

Note: The Key Tronic dome kit is only for Key Tronic Professional series keyboards. It doesn't work with the Apple Standard Keyboard or with the Apple Extended Keyboard.

PowerKey Upgrades

All ADB keyboards contain a power-on key. Its function is to turn on the Macintosh II computer. When an external monitor is plugged into the Macintosh II power supply, it turns on the monitor as well. That's great, but what about second monitors, external hard drives, scanners, and printers? You can either turn them on one at a time, or all-at-once from a power strip. Either way, it's inconvenient.

Normal power strips don't always work very well with external hard drives. If you turn on the power strip too late, the hard drive may not show up on the desktop unless you restart.

PowerKey, from Sophisticated Circuits, is an *ADB-compatible* power strip. It monitors the power-on signal generated from the keyboard. Whenever the power-on key is pressed, PowerKey *automatically* turns on up to four additional devices.

PowerKey also monitors the power-off signal generated from the Finder. Whenever Shut Down is chosen from the Special menu, PowerKey *automatically* turns off the additional devices.

If you think about it, PowerKey multiplies the functionality of the stock power-on key by 300%. Where previously only two AC devices could be controlled, now you can control six. A PowerKey unit is shown in Figure 10-14. The ADB cable is on the right. PowerKey's four AC outlets (which are not shown) are on the ends.



Figure 10-14 PowerKey, from Sophisticated Circuits, multiplies the functionality of the stock power-on key by 300%.

Installing PowerKey

Installing PowerKey is a simple, five-step process:

1. Shut down the computer. Plug the straight end of the supplied ADB cable into PowerKey and plug the L-shaped end into one of the two ADB sockets on the back of the CPU. The L-shaped end provides an extra ADB socket. If both of the ADB sockets (on the back of the CPU) are taken, disconnect an existing ADB cable from the back of the CPU and plug it into the extra socket on the L-shaped end of the PowerKey cable.
2. Plug the peripheral equipment into PowerKey and plug PowerKey into an AC outlet. Switch the peripheral equipment on. Even though the switches are on, the peripheral equipment won't power up yet.

3. Turn on the computer and copy the PowerKey control device (CDEV) to the System folder of your startup disk.
4. Choose Shut Down from the Special menu.
5. Wait 10 to 15 seconds, then press the power-on key on your keyboard. Everything should turn on. To continue testing, choose Shut Down from the Special menu. Everything should turn off.

In addition to monitoring the power-on signal, the PowerKey CDEV lets you program timed on/off events. At a time and date that you select (say 4:00 A.M.), PowerKey can turn on the computer and execute a command keystroke. Whatever macro you assign to that keystroke (using a macro program) will then be executed. The macro could go on line, download messages, and go off line. A few minutes later, PowerKey could execute another macro that would turn off the computer by choosing Shut Down from the Special menu. A typical sequence of timed events is shown in Figure 10-15.

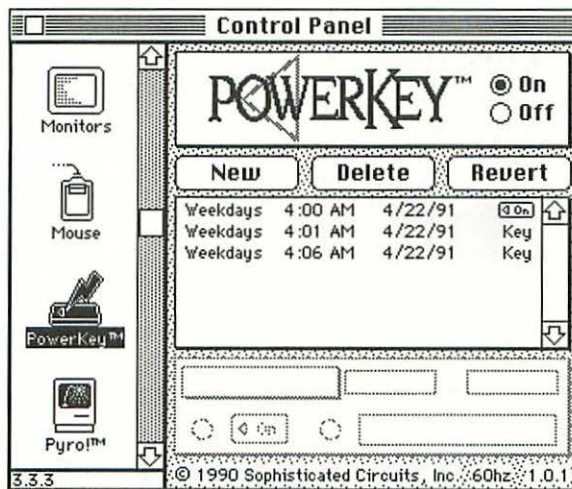

Figure 10-15 In addition to monitoring the power-on signal, the PowerKey CDEV lets you program timed on/off events.

A modem is optional. Although there are less expensive ways to do it, PowerKey could just as well turn on the sprinklers, wake you up to music, make coffee, etc. If you're out of town, PowerKey could switch on lights, play the radio, give your home or apartment that lived-in look while you're away. So, in addition to extending the power-on key, it offers the basic features of a limited home-control system.

OEM Mouse Disassembly

When the mouse pointer is erratic, and consistently hesitates in one or more directions, a thorough cleaning will almost always solve the problem. Begin by spreading out a soft towel. Next, shut down the computer, wait 10 to 15 seconds, then disconnect the mouse cable from the back of the CPU. Flip the mouse upside down. As shown in Figure 10-16, the bottom of the mouse case is imprinted just above the retaining ring with an L (for locked) and an O (for open). In normal use, the marker on the ring points to the L (for locked).

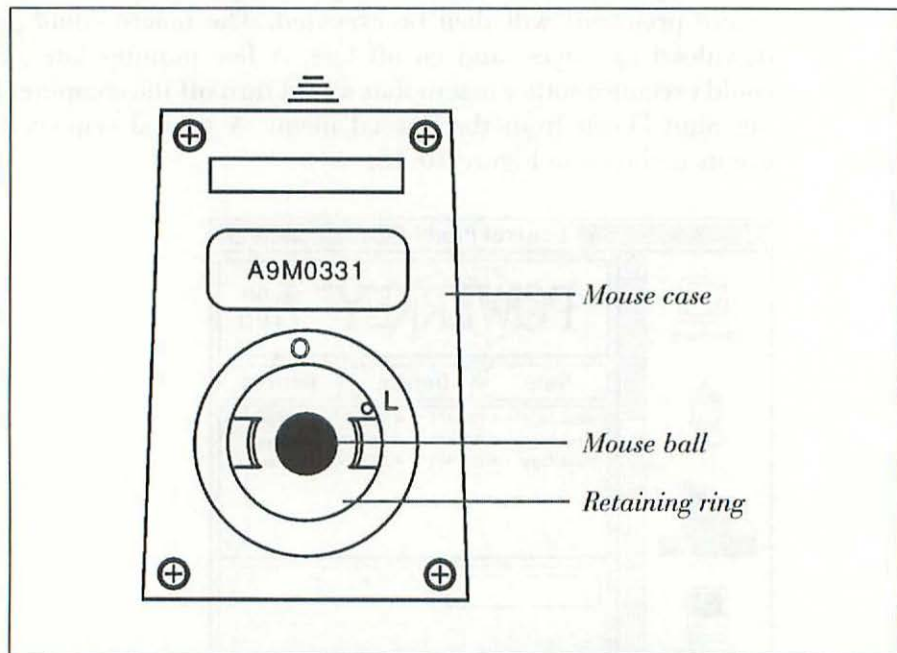

Figure 10-16 The bottom of the mouse case is imprinted just above the retaining ring with an L (for locked) and an O (for open).

To remove the mouse ball, grip the mouse with two hands, press down on the retaining ring with your thumbs, and turn it counterclockwise until the marker points to the O (for open). Flip the mouse right side up and both parts (the retaining ring and the mouse ball) will slip right into your hand. Put the mouse ball and the retaining ring in a parts container. Plastic food tubs make good parts containers. Otherwise, use something made of unbreakable material, with a lid and a low center of gravity.

Next, loosen the four screws in the bottom cover with a #1 Phillips-head screwdriver. After loosening the screws, flip the mouse right side up and shake the loose screws into your hand. If the screws are loose enough, they should fall right out. If not, loosen the screws some more, and try again. Put the four screws in the parts container. Carefully separate the top and bottom covers.

As indicated in Figures 10-17 and 10-18, there are various types of ADB mice. Some have 25.44 mm diameter mouse balls. Others have 21.9 mm mouse balls. In addition, completely different mice often bear the same model number. That makes it very difficult to order parts or discuss repairs. Just as with software, hardware is continually revised.

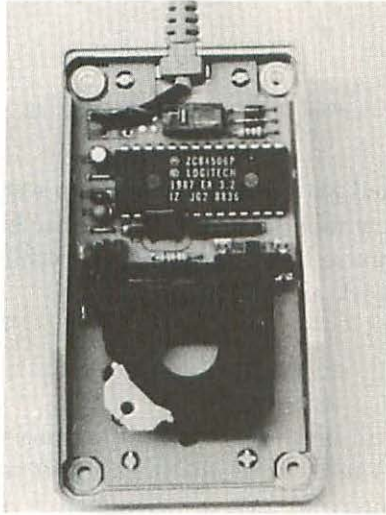

Figure 10-17 Model number A9M0331, the Apple Desktop Bus Mouse.

If you've been diligently cleaning your mouse according to the official instructions in the owner's manual, you may be surprised by the mass of dust, human hair, and pet fur that's accumulated around the capstans, underneath the top cover. When you only remove the mouse ball retaining ring, you never see this stuff. Pick out as much of the foreign matter as you can with a pair of tweezers. Blow out the rest with an air compressor or with the exhaust end of a vacuum cleaner. Continue disassembly as necessary, but don't try to vacuum the dust. The various mouse mechanisms are delicate. You could easily snap something with a stiff vacuum cleaner brush.

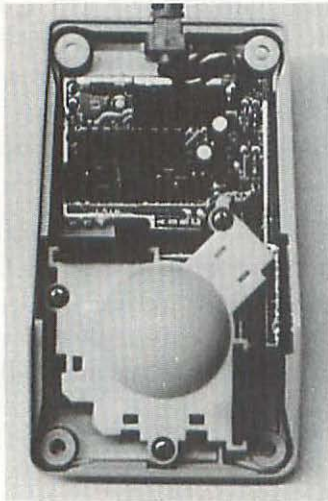

Figure 10-18 Model number A9M0331, another type of Apple Desktop Bus Mouse.

The mouse ball can be cleaned with mild soap and tap water. Rinse it well, and let it air dry. If you try to wipe it dry, the mouse ball will just pick up towel lint. Once the mouse ball is dry, put everything back together and the mouse should work as good as new.

Servicing Intermittent Cables

When you intermittently lose all or some mouse functions (no pointer movement, no button response) and you're sure it's not software-related, the chances are you've got an intermittently or permanently open wire in the mouse cable. If so, you should be able to make this problem come and go by wiggling the ends of the cable. If you can't make this problem come and go by wiggling the cable, try substituting a known good mouse before attempting repairs. It's not that cable repairs are difficult. It's just that more often than not, frozen pointers indicate buggy software. If the substitute mouse fails as well, that proves the software is at fault. All the cable repairs in the world aren't going to do you any good.

If by wiggling the wire you're able to establish that there's a break at the mouse end of the cable, the fix involves cutting the cable ahead of the break, stripping the wires, and soldering them back to the mouse printed circuit board (PCB).

As shown Figure 10-19, there are only three wires in the cable. Color codes are generally printed directly on the mouse PCB.

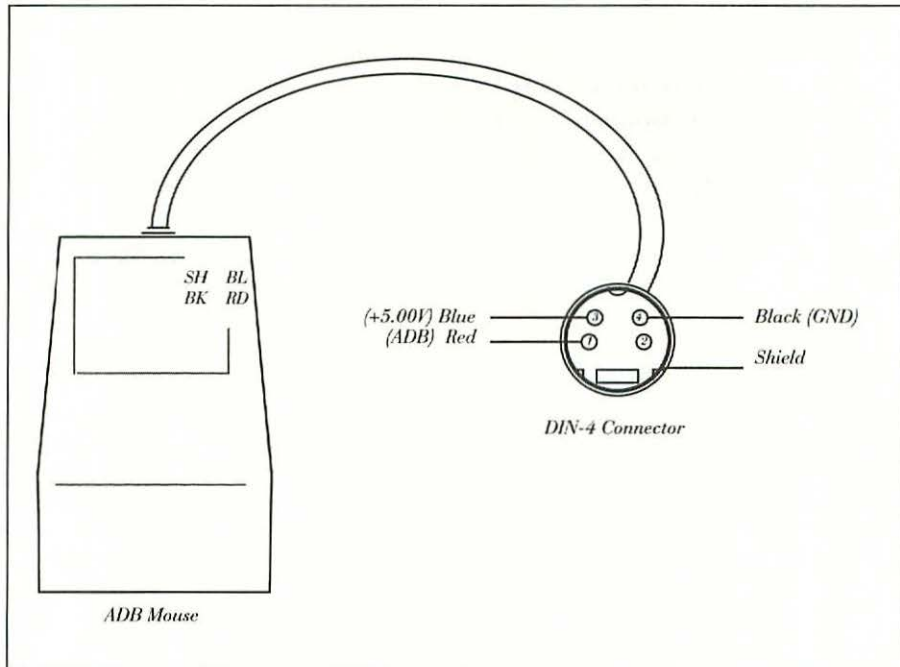

Figure 10-19 Wiring diagram for ADB mouse cable.

When the intermittent wire is at the CPU end of the cable, not the mouse end, it's best to replace the whole cable. Vendors of replacement cables are listed in Appendix B.

Replacing Broken Mouse Switches

If the mouse pointer moves, but the mouse button has no effect, then the microswitch under the mouse button is probably broken. Test for continuity with a digital multimeter set to the K-ohms scale. When the mouse button is up, the meter should read 0.L, infinity, or over range. When the mouse button is down, the meter should read 0.00 to 1.00 ohms, depending on meter sensitivity. Intermittent switches typically fluctuate between 0.00 to 500 or 5000 ohms. The usual problem is a

broken switch mount. The only way to fix it is to replace the micro-switch. Suitable replacements can sometimes be found at Radio Shack for under \$2. Vendors of exact replacement micro switches are listed in Appendix B.

That's it for *Upgrading and Repairing Macintosh II Computers*. For information on the Macintosh Classic, the Macintosh LC, the Macintosh 12-inch Monochrome Display, and the Macintosh 12-inch RGB Display, ask for the next book in this series, *Upgrading and Repairing the Low-Cost Macs*.

A

Acronym Glossary

- AC—Alternating current
- ADB—Apple desktop bus
- AMU—Address memory unit
- CDEV—Control device
- CMOS—Complementary metal-oxide semiconductor
- CMYK—Cyan, magenta, yellow, black
- COMM—Communications
- CP—Circular polarizing
- CPI—Centronics parallel interface
- CPU—Central processing unit
- CRT—Cathode ray tube
- DA—Desk accessory
- DC—Direct current
- DIP—Dual inline package

DMM—Digital multimeter
DPI—Dots per inch
DRAM—Dynamic random-access memory
DSDD—Double-sided, double-density
DSHD—Double-sided, high-density
ELF—Extremely low frequency
EMI—Electro-magnetic interference
ESD—Electrostatic discharge
FDHD—Floppy disk high density
FPU—Floating-point processing unit
GCR—Group code recording
H-STAT—Horizontal static convergence
HMMU—Hochsprung memory management unit
HVR—High voltage resistor
IC—Integrated circuit
IDC—Insulation displacement connector
IWM—Integrated Wozniak machine
KB—Kilobyte
LED—Light-emitting diode
LQ—Letter quality
MB—Megabyte
mfd—Microfarad
MFM—Modified frequency modulation
MHz—Megahertz
MS-DOS—Microsoft Disk Operating System
NS—Nanosecond
NTSC—National television standards committee

OEM—Original equipment manufacturer
OS—Operating System
PAL—Programmable logic array
PCB—Printed circuit board
PLC—Plastic leadless chip
PLCC—Plastic leadless chip carrier
PMMU—Paged memory management unit
PPI—Pixels per inch
PRAM—Parameter random-access memory
RAM—Random-access memory
RAMDAC—Random-access memory digital-to-analog converter
RCA—Radio Corporation of America
RFI—Radio frequency interference
RGB—Red, green, blue
ROM—Read-only memory
SCSI—Small computer system interface
SIMM—Single inline memory module
SIP—Single inline package
SMD—Surface mount device
SOJ—Single outline J lead
SSDD—Single-sided, double-density
SWIM—Super Wozniak integrated machine
TPG—Test Pattern Generator
TTL—Transistor-transistor logic
V-TWIST—Vertical twist
VA—Volts [x] amps
VAC—Volts (alternating current)

VCR—Video cassette recorder

VDC—Volts (direct current)

VHS—Video home system

VLF—Very low frequency

VRAM—Video random-access memory

WYSIWYG—What you see is what you get

B

Dealer/Manufacturer Addresses

American Educational Services

(Component-level repairs on 800K disk drives, OEM replacement head assemblies for 800K disk drives)

7611 Allman Drive
Annandale, Virginia 22003
(703) 256-5315

Brooktree Corporation

(Original equipment manufacturer of Bt453KP and Bt9016 RAMDACs used on Macintosh II video cards and Macintosh Display Cards)

9950 Barnes Canyon Road
San Diego, California 92121-2790
(619) 452-7580

Creative Solutions

(NuBus-compatible Centronics parallel interface cards for Mac II expansion slots, NuBus compatible two-to-four port serial cards for Mac II expansion slots)

4701 Randolph Road, Suite 12
Rockville, Maryland 20852
(301) 984-0262

Conner Peripherals

(Original equipment manufacturer of CP3040A hard drives used in the Macintosh IIsi)

3081 Zanker Road
San Jose, California 95134
(408) 456-4500

Digi-Key

(1A/125V Pico fuses, 2-pin shorting blocks, 8-pin SIP 220/330 dual terminators, 24-pin machine tooled DIP sockets with 0.4-inch spacing, micro switches—call for a catalog)

701 Brooks Avenue South
Post Office Box 677
Thief River Falls, Minnesota 56701-0677
(800) 344-4539

Fordham Radio

(Isolation transformers, test equipment—call for a catalog)

260 Motor Parkway
Hauppauge, New York 11788-5134
(516) 435-8080

GDT Softworks

(Communications-toolbox-compatible Macintosh-to-Epson printer drivers, Communications-toolbox-compatible Macintosh-to-Kodak/Diconix printer drivers, Communications-toolbox-compatible Macintosh-to-Hewlett Packard printer drivers, universal serial-to-parallel interface converters)

Suite 188 4664 Lougheed Highway
Burnaby, British Columbia
Canada V5C 6B7
(604) 291-9121

Globe Manufacturing Sales, Inc.

(Expansion cover shields and I/O brackets for Mac II NuBus slots—call for a catalog)

1159 Route 22
Mountainside, New Jersey 07092
(908) 232-7301

JDR Microdevices

(2-pin shorting blocks, 3.6 v lithium batteries for Mac II/IIx/IIfx, IDC connectors, DB15 connectors, DB19 connectors, Mac-II keyboard/power/video cable extension sets, miscellaneous OEM parts, soldering equipment, test equipment—call for a catalog)

2233 Samaritan Drive
San Jose, California 95124
(408) 559-1200

John Fluke Manufacturing Company

(Digital multimeters, cases, test leads, probes, and clips—call for a catalog)

P.O. Box 9090
Everett, Washington 98206
(800) 443-5853

Key Tronic

(MacPro ADB keyboards, repair parts, rubber dome kits—call for nearest dealer)

Post Office Box 14687
Spokane, Washington 99214
(509) 927-5251

Marshall Industries

(Bt453KP video chips for Mac II video card)

9320 Telstar Avenue
Elmonte, California 91731
(800) 522-0084

MCM Electronics

(2SD 1887 horizontal output transistors, isolation transformers, miscellaneous OEM parts, soldering equipment, test equipment—call for a catalog)

650 East Congress Park Drive
Centerville, Ohio 45459-4072
(800) 543-4330

Motorola, Semiconductor Products Sector

(Original equipment manufacturer of MC68851RC16A PMMUs and MC68882-16 FPUs used in original Macintosh IIs)

Post Office Box 20924
Phoenix, Arizona 85036
(800) 521-6274

NCR Micro Electronics, Logic Products Group

(Original equipment manufacturer of 53C80-40 44PL SCSI chip used in original Macintosh IIs)

1635 Eroplaza
Colorado Springs, Colorado 80916
(800) 334-5454

Nova International

(Fan controllers for Mac II/IIx power supplies—call for nearest dealer)

11700 9th Avenue N.W.
Seattle, Washington 98177
(206) 361-2208

On-Time Mac Service

(Component-level repairs on Apple 4-bit video cards, Apple 8-bit video cards, and AppleColor RGB monitors; component-level repairs on Mac II logic boards; component-level repairs on Mac II power supplies)

830 Woodside Road
Redwood City, California 94061
(415) 367-6263

Ontrack Computer Systems

(Do-it-yourself internal hard disk installation kits—brackets, cables, Disk Manager Mac formatting software)

6321 Bury Drive, Suites 15-19
Eden Prairie, Minnesota 55346
(800) 752-1333

Polaroid Corporation, Polarizer Division

(Circular polarizing filters for AppleColor High-Resolution RGB Monitors—call for nearest computer or office-supply dealer)

1 Upland Road N2
Norwood, Massachusetts 02062
(800) 225-2770

Quadamation

(External SCSI hard-drive enclosures, internal SCSI hard drive mounting kits, replacement 150-watt power supplies for Macintosh IIx/ci)

1120 Stewart Court, Suite L
Sunnyvale, California 94086
(408) 733-5557

Radio Shack

(3-wire circuit analyzers, audio cables for Mac-to-VCR connections [same as CD-to-stereo system], chip pullers, color-TV alignment tools, micro switches, miscellaneous OEM parts, soldering equipment, test equipment)

over 700 stores coast to coast

listed in the yellow pages phone book under:
“Electronic Equipment & Supplies”

Shreve Systems

(Used Mac IIs, keyboards, monitors, parts, etc.—call for a catalog)

3804 Karen Lane
Bossier City, Louisiana 71112
(800) 227-3971

Soft Solutions

(Component-level repairs on Mac II logic boards, component-level repairs on Mac II power supplies, fan-controller upgrades for Mac II/IIx power supplies)

907 River Road, Suite 98
Eugene, Oregon 97404
(503) 461-1136

Sony Service Company, Parts Division, Publications Department
(Service manuals for Sony CPD-1302 and CPD-1304 monitors, OEM parts for Sony monitors—call for regional parts distributor)
8281 N.W. 107th Terrace
Kansas City, Missouri 64153
(816) 891-7550

Sophisticated Circuits
(Install-it-yourself SIMM upgrades for the Macintosh II, PowerKey ADB-compatible 4-outlet power strip)
19017 120th Avenue North East, Suite 106
Bothell, Washington 98011
(206) 547-4779

Sun Remarketing
(Used Mac IIs, keyboards, monitors, parts, etc.—call for a catalog)
Post Office Box 4059
Logan, Utah 84321
(800) 821-3221

Systems Control, a division of M.J. Electric
(Dual-outlet surge suppressor with integral anti-static touch pad)
Post Office Box 788E
Iron Mountain, Michigan 49801
(800) 451-6866

Technology Works
(1 Meg SIMMs, 4 Meg SIMMs, NanoDISK RAM Disking Software)
4030 Braker Lane West, Suite #350
Austin, Texas 78759
(512) 794-8533

The Chip Merchant
(1 Meg SIMMs, 41264K dual-ported VRAM chips, install-it-yourself 4-to-8 bit upgrades for 4-bit Macintosh II Video Cards, install-it-yourself 4-to-8 bit upgrades for 4-bit Mac II High-Resolution Video Cards)
9541 Ridgehaven Court, Suite A
San Diego, California 92123
(619) 268-4774

Trackmate America

(Trackmate diagnostics and disk drive maintenance systems)

14577 South Bascom Avenue
Los Gatos, California 95032
(408) 356-0795

True Value Hardware

(1.25-inch stiff-blade putty knives, 3-wire circuit analyzers, WD-40)
Hundreds of stores coast to coast

listed in the yellow pages phone book under:
“Hardware-Retail”

Tulin Corporation

(External SCSI hard-drive enclosures, internal and external SCSI hard-drive subsystems, miscellaneous cables and parts for external SCSI hard-drive enclosures, replacement power supplies for external SCSI hard-drive enclosures)

2156H O’Toole Avenue
San Jose, California 95131
(408) 432-9025

Larry P.’s Guide to Mail-order Sanity:

- If there’s no address and/or no phone number in a magazine advertisement, it means the company positively does not want to talk to you. Don’t waste your time. Shop elsewhere!
- Avoid ordering from any catalog with a misplaced index. Locating misplaced indexes is a hassle. If management misplaced their own index, imagine what they’re going to do with your order!
- Avoid ordering from any catalog printed on high glare paper. If the printed presentation glares, you can bet the personal service will glare even more.
- Don’t discuss. Don’t ask. Know what you want before you pick up the phone.
- Observing these failure-avoidance strategies will steer you away from incompetent mail order firms, but you could still receive unsatisfactory goods. In that case, please call the company that filled your order. This address list is not an endorsement. The author cannot guarantee your satisfaction.

Index

A

AC power cords, 221
ADB (Apple desktop bus) problems, 108–9
additive colors, primary, 39–40
address memory management unit (AMU). *See* HMMU (Hochsprung memory management unit)
anti-glare filters, 79–80
anti-radiation filters, 81
Apple Convolution, 149
Apple Desktop Bus (ADB), 227
Apple File Exchange software, 191
audio cables, 145

B

B1 lithium cell, 106
B2 lithium cell, power-on problems and, 102–4
banding, 130
battery, clock, Macintosh IIcx/IIci, 114
board-swap procedure. *See* logic board upgrades
brightness, relative, 123
brightness control, 20

C

cables
 audio, 145
 for external SCSI hard drives, 222–23
 jumper, 104
 mouse, intermittent, 242–43
 NTSC-compatible, 142–45
 SCSI, 216
capacitor, 4

centering the display on AppleColor High-Resolution RGB Monitors, 45–46
central processing unit (CPU). *See also* logic board upgrades
 model number information, 85–86
 take-apart procedure Macintosh II/IIx/IIfx, 86–89
Centronics parallel interface (CPI) card, 178–79
chiming sounds, 117
chip pullers, 9–10
circular polarizing (CP) filters, 79
cleaning diskettes, 203
clock, real-time
 Macintosh IIcx/IIci, 114
 problems with, 106
clothing, static electricity and, 4
CMOS SIMMs, 2–3, 156
CMYK printers, 38
color printing, WYSIWYG, 62–64
color purity adjustments, 60–62
colors
 additive, 39–40
 subtractive, 37–39
color saturation, four-bit video and, 123–24
Color TPG (Color Test Pattern Generator), xiii–xx
 indicating a screen size in, xvi
 Reference menu, xviii
 Special menu items, xix–xx
 starting, xiv–xv
 system requirements, xiv
 Test Patterns in, xvii–xviii

Communications Toolbox (CTB),
 upgrades for System 6.0.4, 6.0.5, and
 6.0.7, 183–85

contrast control, 20

contrast enhancement filters, 81

convergence, 40
 adjustments, 65–71
 on AppleColor High-Resolution RGB
 Monitors, 46–48

CP filters, 79

CPU. *See* central processing unit

CRT (cathode ray tube), 18

cut-off control
 on AppleColor High-Resolution RGB
 Monitors, 53–54
 on Apple High-Resolution
 Monochrome Monitors, 31–32

D

degauss switch, 61–62

desktop video software, 150

diagnostic tests, error sounds and,
 117–19

Digital multimeters (DMMs), 11–12

DIP SIMMs, 153–55

disk drives
 800K, troubleshooting, 201–2
 types of, 189–91

disk drive upgrades, 189–203
 external disk drive adapter, 193–96
 FDHD/ROM upgrades for Macintosh
 II, 197–201
 second internal disk drive, 196–97

diskettes
 cleaning, 203
 formatting rules, 191–92
 types of disk drives and, 189–91

Disk Manager Mac, 216

display, definition of, 18

display cards. *See* video cards

dissassembly. *See* take-apart procedure

DRAM upgrades, 140–41, 153–65. *See*
also SIMMs

E

eight-bit video, 124–28
 upgradeability of, 134
 upgrade from four-bit video, 135–37
 upgrade to 24-bit video, 137–39

electricity
 safety precautions for working with,
 1–8

electrostatic discharge precautions, 2–8

error sounds, 117–19

Exact Bit Images (Shrink 4%) option
 Apple LaserWriter II, 28, 52

expansion cards. *See also* NuBus
 expansion cards
 for the Macintosh II, 186–87

external disk drive adapter, 193–96

extremely low frequency (ELF) radiation,
 81

eyeglass wearers, convergence problems
 and, 71

F

fan controller upgrades, 89–98
 installing, 91–98
 power supplies and, 90–91
 testing, 98

FDHD (floppy disk high density) super
 drive, 190–91. *See also* disk drive
 upgrades

File Exchange software, 191

filters, monitor, 79–81

floating point coprocessor unit. *See* FPU
 (floating point unit) upgrades

focus adjustments
 on AppleColor High-Resolution RGB
 Monitors, 48–50
 on Apple High-Resolution
 Monochrome Monitors, 25–26

formatting diskettes, 191–92
 formatting software, for SCSI hard drives,
 216
 four-bit video, 122–24
 upgradeability of, 134
 upgrade to eight-bit video, 135–37
 FPU (floating point unit) upgrades
 for the Macintosh II, 170–71
 for the Macintosh IIsi, 172
 fuse F2, 108–9

G

glare, eliminating, 79–80
 grayscale, true, 131
 ground(ing), 4–7
 ground wire, 4

H

hand tools, 8–10
 height adjustments
 on AppleColor High-Resolution RGB
 Monitors, 45
 on Apple High-Resolution
 Monochrome Monitors, 24
 HMMU (Hochsprung memory
 management unit), 165
 locating the, 166
 removing the, 166–67
 horizontal centering control, on
 AppleColor High-Resolution RGB
 Monitors, 46
 horizontal-hold control, on Apple
 High-Resolution Monochrome Monitors,
 29–30
 HP-DeskJet printers, 169
 HP-DeskWriter printers, 169
 H-STAT control, 47, 48
 Hurdler CPI card, 179
 Hurdler-HQS (Hurdler quad serial) card,
 183–85

I

ImageWriter II/LQ printers, how color is
 made by, 38–39
 isolated AC power supplies (isolation
 transformers), 12–14

J

jumper cables, 104

K

keyboards, 228–37
 disassembly of, 228–30
 first aid for spills on, 234–35
 MacPro, 235–36
 replacing broken key switches, 233–34
 servicing intermittent key switches,
 230–33
 Key Tronic MacPro keyboard, 235–37

L

linearity controls, 71–76
 lithium cells, power-on problems and,
 Macintosh II/IIx/IIfx, 102–4
 logic board upgrades
 Macintosh IIcx-to-IIci, 112–13
 Macintosh II/IIx to IIfx, 101
 Macintosh II to IIx, 99–101

M

MacGard multipurpose surge suppressor,
 7
 Macintosh Display Card, meaning of
 designation, 135
 Macintosh Display Card VRAM Kit, 137
 Macintosh II Display Cards, configuring,
 149–50
 Macintosh II Extended High-Resolution
 Video Card, meaning of designation,
 135

- Macintosh II Extended Video Card,
 - meaning of designation, 135
 - Macintosh II Video Card. *See also* video cards
 - meaning of designation, 135
 - NTSC-compatible cables for, 142
 - Macintosh II Video Card Expansion Kit, 136
 - MacPro replacement keyboards, 235–37
 - MacTable, 81
 - Mac II High-Resolution Video Card,
 - meaning of designation, 135
 - MC68030 (‘030) processor-direct slot (PDS), 186
 - MC68882RC16A FPU (floating point unit), 170–72
 - MC68882RC20A FPU (floating point unit), 186
 - memory. *See also* PMMU (paged memory management unit) upgrades; SIMMs
 - virtual, 169
 - Microsoft Mail, 169
 - monitors. *See also* Monochrome Monitors, Apple High-Resolution; RGB Monitors, AppleColor High-Resolution
 - interchangeable parts cross-reference guide, 77
 - isolated AC power supplies (isolation transformers) for working on, 12–14
 - Monochrome Monitors, Apple High-Resolution
 - accessories, 33
 - adjustments to, 17–33
 - cut-off control, 31–32
 - definitions, goals and objectives, 18–19
 - focus adjustments, 25–26
 - height adjustments, 24
 - horizontal-hold control, 29–30
 - periodic adjustment procedure, 19–26
 - removing the control cover plate, 20
 - replacing the control cover plate, 26
 - vertical-hold control, 30–31
 - width adjustments, 20–24
 - WYSIWYG modifications, 26–28
 - isolation transformer for working on, 14
 - measuring the display, 19, 21–23
 - More, 150
 - mounting brackets, SCSI hard drive, 216
 - external SCSI hard drives, 222
 - mouse, 240–44
 - multimeters, 11–12
- N**
- near-photographic quality, 24-bit video, 130
 - NTSC compatibility, 140
 - Macintosh II Display Cards, 149–50
 - upgrades for, 142–151
 - audio cables, 145
 - cables, 142–45
 - video card utility software and
 - activating the software, 145–47
 - deactivating the software, 149
 - with eight-bit Mac II High-Resolution Video Cards, 148
 - with four-bit Mac II High-Resolution Video Cards, 148
 - with Macintosh II Extended Video Cards, 148
 - with original Macintosh II Video Cards, 147–48
 - NuBus expansion cards
 - identifying slots \$9 through \$E, 177
 - installing and removing, 175–79
 - multiple video cards and, 178
 - parallel interface cards and, 178–82
 - power requirements of, 174
 - types of, 173

O

one-bit video, 121–22
 one-bit video cards, upgradeability of, 134

P

PAL chips, 156
 parallel interface cards, 178–82
 Chooser setup for, 180
 Phillips-head screwdriver, 8–9
 pixels, 18–19
 photographic quality and, 131
 PLCC SIMMs, 153–55
 PMMU (paged memory management unit) upgrades, 165–70
 installing, 167
 installing virtual memory software, 168–69
 locating the, 166
 removing the HMMU and, 166–67
 troubleshooting, 167
 troubleshooting virtual memory and, 169–70
 Polaroid filter products, 79–80
 polyester clothing, 4
 potential, static electricity, 3–4
 PowerKey, 237–39
 power-on problems
 Macintosh IIcx and IIci, 113–14
 Macintosh II/IIx/IIfx, 102–6
 PowerPoint, 150
 power requirements, of NuBus expansion cards, 174
 power strips, PowerKey, 237–39
 power supplies
 after-market, 113
 bench servicing, 104–6
 CMOS SIMMs and, 156
 for external SCSI hard drives, 222
 fan controller upgrades and, 90–91
 fans, upgrading, 89–98

 isolated AC, 12–14
 putty knife for removing, 10
 PRAM (parameter random access memory) chip, 106
 Precision Bitmaps? option, Hewlett Packard Desk Writer, 28, 52
 presentation programs, 150
 primary colors
 additive, 39–40
 subtractive, 37–39
 printers, parallel, 178–82
 printer spoolers, 169
 printing, color WYSIWYG, 62–64
 PrintLink Collection Driver, 179–82
 putty knife, 10

Q

QuickDraw, 139–40

R

radiation filters, 81
 RAM (random access memory) 1 errors, 118
 real-time clock, problems with
 Macintosh IIcx/IIci, 114
 Macintosh II/IIx/IIfx, 106
 Reference menu, Color TPG's, xviii
 resistance, 12
 RGB Monitors, AppleColor High-Resolution
 accessories, 78–84
 filters, 79–81
 stands, 81–82
 swivel bases, 83–84
 additive colors and, 39–40
 adjustments to, 35–84
 centering the display, 45–46
 color purity adjustments, 60–62
 convergence adjustments, 46–48, 65–71
 cut-off control, 53–54

- definitions, goals and objectives, 35–37
 - focus adjustments, 48–50
 - height adjustments, 45
 - linearity controls, 71–76
 - periodic adjustment procedure, 40–51
 - removing the control cover plate, 41
 - replacing the control cover plate, 50–51
 - white-balance controls, 54–64
 - width adjustments, 42–45
 - WYSIWYG modifications, 51–53
 - convergence problems, 40
 - how color is made by, 39–40
 - interchangeable parts cross-reference guide, 77
 - isolation transformer for working on, 14
 - replacement parts for, ordering, 78
 - subtractive colors and, 37–39
 - white balance problems, 40
 - ROM upgrades, 185
- S**
- safety precautions, 1–8
 - screen, definition of, 18
 - screwdrivers, 8–9
 - SCSI (Small Computer System Interface), 206
 - Macintosh II/IIx/IIfx problems with, 106–8
 - SCSI cables, 216
 - SCSI hard drives, 205–25
 - data cables, 222–23
 - error sounds and, 117–18
 - external, 220–23
 - enclosures, 220–23
 - external enclosure, installing into, 224
 - fans, 222
 - switching power supplies, 222
 - terminating, 223
 - troubleshooting, 224–25
 - universal mounting brackets, 222
 - form-factor half-height, 206–7
 - identification (ID) number for, 208–10
 - installing
 - cables for, 216
 - formatting software, 216
 - formatting the drive, 219–20
 - installation kits, 215–18
 - Macintosh II, 218–19
 - mounting brackets, 216
 - screws and lock washers, 218
 - pin header labeling, 210
 - pin header locations, 209
 - standard, 207–8
 - termination of, 211–13
 - terminator filters, 213–14
 - types of, 205–8
 - serial interface cards, 182–85
 - setup for, 184
 - troubleshooting, 185
 - silicon chips. *See* chips; and specific types of chips
 - SIMMs (single inline memory module), 153–65
 - DIP, 153–55
 - DRAM, 140–41
 - electrical configurations, 156
 - identifying Banks A and B and configuring, 158–63
 - Macintosh IIfx, 162
 - Macintosh II/IIx/IIfx and IIcx, 158–61
 - Macintosh IIsi, 162–63
 - installing and removing, 163–64
 - memory capacity of, 156
 - PLCC, 153–55
 - power requirements of, 156
 - SOJ, 153–55

speed of, 157
 troubleshooting installations, 165
 VRAM, 137-39
 SIMM sockets, intermittent, error sounds
 caused by, 118-19
 SIP terminators, 211-13
 for external SCSI hard drives, 223
 SOJ SIMMs, 153-55
 Sony-built monitors, interchangeable
 parts cross-reference guide, 77
 sounds, error, 117-19
 stands, monitor, 81-82
 start-up chime, 117
 static electricity, 3-8
 subtractive colors, primary, 37-39
 surge suppressor, MacGard, 7
 swivel bases, monitor, 83-84

T

take-apart procedure
 Macintosh II/IIx/IIfx, 86-89
 Macintosh IIcx/IIci, 110-12
 Macintosh IIsx, 114-17
 terminator filters, 213-14
 terminators, SIP, 211-13
 for external SCSI hard drives, 223
 test equipment, 11-14
 Test Patterns, in Color TPG, xvii-xviii
 32-bit QuickDraw, 139-40
 three-wire circuit analyzer, 5
 tools and equipment
 hand tools, 8-10
 soldering equipment, 14
 test equipment, 11-14
 Tops networking software, 169
 transformers, isolation, 12-14
 true color, 131
 true grayscale, 131
 TTL chips, 2-3
 TV alignment tools, 9

24-bit video, 129-32
 benefits of, 130-31
 drawbacks of, 131-32
 near-photographic quality, 130
 photographic quality, 131
 size limitations, 130
 upgrade from eight-bit video, 137-39

U

universal mounting brackets, for external
 SCSI hard drives, 222

V

vertical centering control, on AppleColor
 High-Resolution RGB Monitors, 46
 vertical-hold control, on Apple
 High-Resolution Monochrome Monitors,
 30-31
 very low frequency (VLF) radiation, 81
 video cable, NTSC-compatible, 142-45
 video cards. *See also* VRAM upgrades
 color-saturation information and,
 123-24
 DRAM upgrades, 140-1
 eight-bit, 124-28
 four-bit, 122-24
 identifying, 133-35
 multiple, 178
 NTSC-compatible. *See* NTSC
 compatibility
 one-bit, 134
 relative brightness or intensity and,
 123
 32-bit video, 131
 troubleshooting, 151-52
 24-bit, 129-32
 benefits of, 130-31
 drawbacks of, 131-32
 near-photographic quality, 131
 photographic quality, 131

- upgrade from eight-bit video, 137-39
- utility software for NTSC compatibility
 - activating the software, 145-47
 - deactivating the software, 149
 - with eight-bit Mac II High-Resolution Video Cards, 148
 - with four-bit Mac II High-Resolution Video Cards, 148
 - with Macintosh II Extended Video Cards, 148
 - with original Macintosh II Video Cards, 147-48
- virtual memory, troubleshooting, 169-70
- virtual memory software, installing, 168-69
- voltage, 12
- VRAM upgrades, 132-40
 - 32-bit QuickDraw software, 139-40
 - four-bit to eight-bit, 135-37
 - information needed for, 132-33
- V-TWIST control, 47, 48

W

- wattage formula, 12
- white-balance controls, 54-64
- width adjustments
 - on AppleColor High-Resolution RGB Monitors, 42-45
 - on Apple High-Resolution Monochrome Monitors, 20-26
- width control, on Apple High-Resolution Monochrome Monitors, 23
- work area, static electricity and, 4-5
- wrist grounding strap, 5
- WYSIWYG
 - AppleColor High-Resolution RGB Monitors and, 51-53
 - Apple High-Resolution Monochrome Monitors and, 26-28
 - color printing, 62-64

About the Author

Larry Pina is a software developer and technical writer living in Westport, Massachusetts. He has been involved with electronic sales and service since 1971. He is the author of *Macintosh Repair and Upgrade Secrets* and *Upgrade Secrets*, *Macintosh Printer Secrets*, and *The Dead Mac Scrolls*.



Macintosh II Repair and Upgrade Secrets Color TPG

REPLACEMENT ORDER FORM

Please use this form when ordering a 3.5-inch disk or a replacement for a defective diskette.

A. If ordering within thirty days of purchase

If a diskette is reported defective within thirty days of purchase, a replacement diskette will be provided free of charge. *The back of this card must be totally filled out and accompanied by the defective diskette and a copy of the dated sales receipt.* In addition, please complete and return the Limited Warranty Registration Card.

B. If ordering after thirty Days of purchase but within one year

If a diskette is reported defective after thirty days, but within one year of purchase and the Warranty Registration Card has been properly filed, a replacement diskette will be provided to you for a nominal fee of \$5.00 (send check or money order only). *The back of this card must be totally filled out and accompanied by the defective diskette, a copy of the dated sales receipt, and a \$5.00 check or money order made payable to Simon & Schuster, Inc.*

Macintosh II Repair and Upgrade Secrets/Color TPG LIMITED WARRANTY REGISTRATION CARD

In order to preserve your rights as provided in the limited warranty, this card must be on file with Simon & Schuster within thirty days of purchase.

Please fill in the information requested:

NAME _____ PHONE NUMBER () _____

ADDRESS _____

CITY _____ STATE _____ ZIP _____

COMPUTER BRAND & MODEL _____ DOS VERSION _____ MEMORY _____ K

Where did you purchase this product?

DEALER NAME? _____ PHONE NUMBER () _____

ADDRESS _____

CITY _____ STATE _____ ZIP _____

PURCHASE DATE _____ PURCHASE PRICE _____

How did you learn about this product? (Check as many as applicable.)

STORE DISPLAY _____ SALESPERSON _____ MAGAZINE ARTICLE _____ ADVERTISEMENT _____

OTHER (Please explain) _____

How long have you owned or used this computer?

LESS THAN 30 DAYS _____ LESS THAN 6 MONTHS _____ 6 MONTHS TO A YEAR _____ OVER 1 YEAR _____

What is your primary use for the computer?

BUSINESS _____ PERSONAL _____ EDUCATION _____ OTHER (Please explain) _____

Where is your computer located?

HOME _____ OFFICE _____ SCHOOL _____ OTHER (Please explain) _____

70-92953

Get the Spark. Get *BradyLine*.

Published quarterly. Free exclusively to our customers.

Check here to begin your subscription.

Macintosh II Repair and Upgrade Secrets Color TPG

Please fill out the information below and return it to the address listed with your *original* 3.5-inch diskette. Please print clearly.

- I am ordering a replacement diskette within 30 days. I have enclosed my original diskette and a copy of the dated sales receipt. ISBN 0-13-929530-5
- I am ordering a replacement diskette after 30 days but within one year. I have enclosed my original diskette, a copy of the dated sales receipt, and check or money order for \$5.00 made out to Simon & Schuster, Inc. ISBN 0-13-929530-5

NAME _____ PHONE NUMBER () _____
ADDRESS _____
CITY _____ STATE _____ ZIP _____

Please mail this request to: MICROSERVICES, 200 Old Tappan Road, Old Tappan, NJ 07675.
For more information, call (201) 767-5054.

PUT
FIRST
CLASS
STAMP
HERE

College Marketing Group
50 Cross Street
Winchester, MA 01890

ATTN: CHERYL READ



Macintosh/Hardware

“Larry Pina remains the undisputed champion of do-it-yourself Macintosh repairs. His books provide information unknown even to authorized repair centers.”

— OWEN HARTNETT
Dir. Macintosh Technical Group
Boston Computer Society

Tired of paying *outrageous* prices for unnecessary Macintosh II repairs? Here's the book you've been waiting for! *Macintosh II Repair and Upgrade Secrets* shows you how to open the box to the entire family of Macintosh II computers and fully reveals their inner workings. With this hands-on book you'll learn to fix 95% of the most common problems—from circuit boards to disk drives—with simple, step-by-step instructions. No specialized tools or expertise required, so stop paying for those expensive repairs and let this essential guide show you:



How to diagnose symptoms quickly and replace component-level parts safely



How to adjust and upgrade disk drives, logic boards, keyboards, mice, monitors, NUBUSs, PMMUS, SCSIs, SIMMS, video cards, and more!



Where to find repair, tool, and part vendors



Includes the latest color version of popular test pattern generator software with a value equal to test equipment costing over \$300.00!

ISBN 0-13-929530-5



9 780139 295300

BRADY PUBLISHING ★ SIMON & SCHUSTER ★ NEW YORK

\$39.95