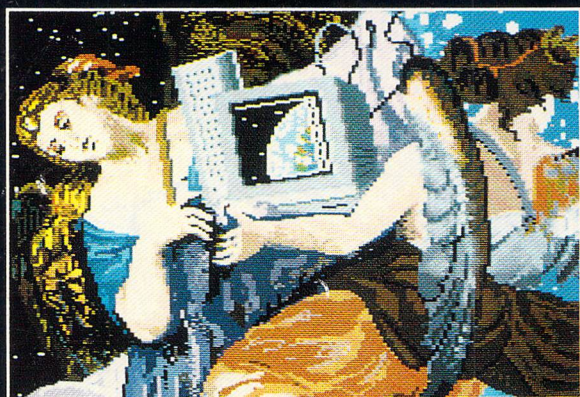
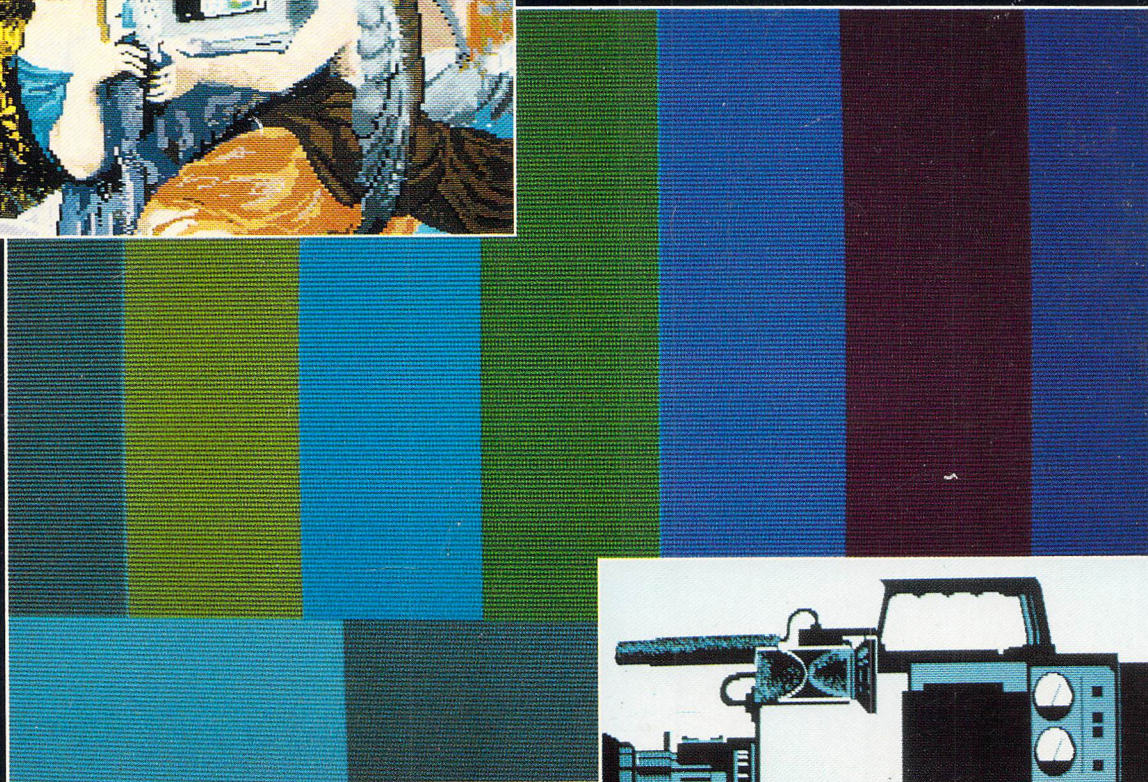


AMIGA DESKTOP VIDEO

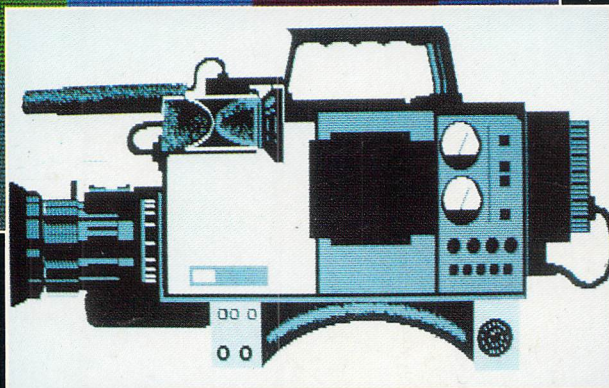
Create your own videos through step-by-step instructions and tutorials.



STEVEN ANZOVIN



COMPUTE! Books



Amiga Desktop Video

Steven Anzovin

COMPUTE! Books

Radnor, Pennsylvania

Other Books by Steven Anzovin:

COMPUTE!'s Using Deluxe Paint
COMPUTE!'s Quick and Easy Guide to HyperCard
COMPUTE!'s Exploring HyperCard
Speeches of the American Presidents
Facts About the States
It Hurts: A Parent's Guide to Children's Needs

Editor: Pam Williams

Copyright 1989, Steven Anzovin. All rights reserved.

Reproduction or translation of any part of this work beyond that permitted by Sections 107 and 108 of the United States Copyright Act without the permission of the copyright owner is unlawful.

Printed in the United States of America

10 9 8 7 6 5 4 3 2 1

Anzovin, Steven.

Amiga desktop video / Steven Anzovin.

p. cm.

Includes index.

ISBN 0-87455-171-4

1. Video tape recorders and recording 2. Amiga (Computer)

3. Video recordings—Production and direction. I. Title.

TK6655.V5A59 1989

621.388'33—dc20

88-63203

CIP

The author and publisher have made every effort in the preparation of this book to insure the accuracy of the information. However, the information in this book is sold without warranty, either express or implied. Neither the author nor COMPUTE! Publications, Inc. will be liable for any damages caused or alleged to be caused directly, indirectly, incidentally, or consequentially by the information in this book.

The opinions expressed in this book are solely those of the author and are not necessarily those of COMPUTE! Publications, Inc.

COMPUTE! Publications, Inc., Post Office Box 5406, Greensboro, NC 27403, (919) 275-9809, is part of ABC Consumer Magazines, Inc., one of the ABC Publishing Companies, and is not associated with any manufacturer of personal computers. Amiga, Amiga 1000, Amiga 500, Amiga 2000, Amiga 2500, and Kickstart are trademarks of Commodore Business Machines, Inc. *Deluxe Paint*, *Deluxe Paint II*, *Deluxe Paint III*, *Deluxe Photo Lab*, *Deluxe Print II*, *Deluxe Productions*, *Deluxe Video Construction Set*, *Deluxe Music Construction Set*, and *Instant Music* are trademarks of Electronic Arts. *Sculpt 3D*, *Animate 3D*, *Sculpt-Animate 3D*, and *Sculpt-Animate 4D* are trademarks of Byte by Byte Corp. *Animator*, *Images*, *VideoScape 3-D*, *Video Titler*, *Draw Plus*, *Draw 2000*, *Lights*, *Camera*, *Action!*, *Modeler 3-D*, *AudioMaster II*, and *Sonix* are trademarks of Aegis Development Corp. SuperGen is a trademark of Digital Creations, Inc. Digi-View, Digi-Paint, and Video Toaster are trademarks of NewTek, Inc. *Photon Paint*, *Photon Cel Animator*, and *Photon Transport Controller* are trademarks of Microillusions, Inc. Betamax, Betacam, and U-Matic are trademarks of Sony Corp. VHS is a trademark of JVC.

*To Janet
Companion, partner, love.*

Contents

Foreword *vii*

Acknowledgments *ix*

Introduction *xi*

- 1. Hollywood on Your Desktop** **1**
Enter Desktop Video • Advantages of DTV • Creating with DTV • Uses for DTV • Beginning Your Exploration
- 2. Inside Video and Amiga Graphics** **12**
How Video Works • The Camera Head • The Viewfinder • The VCR • The Video Signal • From Analog to Digital • The Amiga • Basic Amiga Graphics • Amiga Color • Interfacing the Amiga with Video
- 3. The DTV Studio** **40**
Ask These Questions • Amiga Hardware • DTV Hardware • VCRs • 1-inch • $\frac{3}{4}$ -inch • $\frac{1}{2}$ -inch • 8mm • Choosing a VCR • Cameras and Camcorders • Choosing a Camera • Choosing a Camcorder • Video Displays • Choosing a Color Display • Other Video Components • Amiga-Specific DTV Hardware • DTV Software • Setting Up the Studio
- 4. DTV Production** **75**
The Stages of Production • Pre-Production • Production • Basic Camera • Shooting for Continuity and Narrative • Lighting • Working with Talent • Expect the Unexpected

5. DTV Post-Production	104
Using a Genlock for Post • Titles and Character Generation • Using a Digitizer • Editing • The Editing Process • Cutting for Continuity • Pacing • Transitions	
6. DTV Graphic Design	127
Elements of Video Design • Composition • Color • Using Color • Titling • Graphics Software •	
7. Animation	154
Animation Basics • Amiga Animation • Using a Page- Flipper Program • Animating an Atom • Three- Dimensional Animation • Object Building • Scene Editing • Rendering Techniques • Object Movement • Sharing Objects and Animations Among Programs • Getting Animation on Tape	
8. Audio for DTV	179
Basic Audio Equipment • Recording Sound in Production • Audio in Post-Production • Making Amiga Music • Amazing MIDI • Tips on DTV Scoring	
9. Stepping Up to Broadcast	203
What Broadcast-Quality Really Means • The Amiga and Broadcast • Amiga Graphics for Broadcast • Broadcast Production • SMPTE Time Code • Broadcast Post- Production • Breaking into the Big Time • Conclusion	
Appendices	
A. Desktop Video Resources 220	
B. Desktop Video Glossary 247	
C. Countries That Use NTSC Video 259	
Index 261	

Foreword

Filled with practical examples, helpful advice, and full-color examples, *Amiga Desktop Video* is your guide to the fundamentals of pairing your VCR and Amiga to achieve amazing results. For the first time, a book tells how this fast-growing field of computer video can be brought into your own home.

Whether you're a beginner or advanced artist, *Amiga Desktop Video* explores the ins and outs of combining computer graphics with your own home or professional video. Inside, you'll find technical information and production techniques along with suggested applications in the business, education, and creative realms. Then, once you have the basics, you'll move on to the more advanced aspects like creating animation and 3-D graphics.

After an introduction to desktop video and how it works, you'll learn about the DTV studio—choosing a VCR, a camcorder, and a computer, and how to set up your own studio. You'll then delve into the world of DTV production, with explanations for everything from lighting, to working with talent, to expecting the unexpected—before getting a full lesson in post-production that includes digitizing, editing, and creating continuity.

Chapter 6 is your introduction to graphic design with helpful advice on what to avoid and how to best present your projects. You'll find hints on composition, color, and titling, and with this lesson behind you, you'll be ready to move on to animation, and then combine pictures with audio—all in your own studio.

Once these basics are covered, the book explores broadcasting—everything from what it means, to breaking into the Big

Foreword

Time. Then, the appendices provide a glossary of desktop video terms and an up-to-date list of DTV resources, including software and hardware manufacturers, books on the subject, and more.

This is your complete guide to desktop video—the book that will have you turning out videos you never dreamed possible.

Acknowledgments

One of the pleasures of writing a book is thanking those who have helped in its conception. First of all, I owe my interest in video to Doreen Hyman, one of NBC's great editors, who taught me the basics and showed me how much fun it could be. Producer and director Sian Evans has been a constant support through the last nine years; she provided many tips on how the pros make video productions succeed despite the odds. At Electronic Arts, Diane Flynn, Stewart Bonn, Dale Weideman, Tom Casey, Rachel Famighette, and Charlotte Taylor gave generously of their time and resources. Scott Peterson of Byte-by-Byte deserves thanks for information on the "big picture" in 3-D animation. Aegis Development's Michelle Mehterian and David Hopkins were also enthusiastic about this project and supplied needed materials on short notice. Several members of New York's AMUSE Amiga users' group came up with useful tips, notably Steve Jacobs of AmiEXPO. COMPUTE!'s Stephen Levy supplied his usual expert editorial guidance. Of course, any errors in this book are mine alone.

Steven Anzovin
September 1989

Introduction

On your desk sits a computer. In your living room is a VCR. For years, they've been like neighbors who never talk to each other. Until now, that is. Suddenly, your TV and computer are finding they have a lot more in common than they thought, and they're spending a lot of time together. The romance of video and computers is called *desktop video* (DTV), the burgeoning practice of interfacing low-cost computers with consumer and industrial level video systems, and it is arguably the hottest development in computing and video since desktop publishing and the camcorder.

Since 1985 the desktop video computer of choice has been the Amiga. Amateurs and professionals immediately recognized that the Amiga, with its superlative graphics, animation, sound, and video compatibility, was the only low-cost computer capable of fueling the DTV revolution. Today, despite competition from IBM and Apple, the Amiga is still in the vanguard.

However, few people, even few videomakers or computer users, know what DTV is and what can (and can't) be done with it in the creative, educational, and business realms. In part this is because people in the video and computer worlds rarely talk to one another—for the most part, they don't even speak the same technical language—so there are few sources of reliable information on how computers can work with video systems to create new kinds of programming.

About This Book

Amiga Desktop Video is intended to fill that gap. This book is meant for any Amiga owner who can also use a VCR. Previous video production experience is not really required; you'll pick up

what you need as you go along. But experienced video producers entering the DTV world for the first time should find material of value here, too. Included is information on

- interfacing video and computer graphics
- setting up a DTV studio
- the wide range of DTV hardware and software
- production techniques for DTV
- graphics, titling, and animation
- getting broadcast-quality video out of your Amiga
- using DTV for business, education, and entertainment programming

Chapter 1 is an introduction to what desktop video is all about. Chapter 2 covers the theory behind video and Amiga graphics. A description of the available hardware and software is the subject of Chapter 3, followed by a chapter on planning and shooting a production. Chapter 5 covers DTV post-production. DTV design, titling, animation, and sound are discussed in Chapters 6, 7, and 8. Finally, Chapter 9 shows how to tailor your Amiga DTV productions to the world of broadcast television. Appendices include a complete glossary of terms, an up-to-date list of manufacturers and products, and a list of countries adhering to the same video standards as the United States.

Throughout the book, tutorials make use of popular DTV programs and hardware, but the emphasis is on basic technical information and production techniques that apply no matter what brand of hardware or software you're using. Mention of a particular product in this book is not meant as an endorsement; with the wide variety of products available, you may find another that better suits your needs. The illustrations, all created with Amiga graphics programs, provide examples of DTV graphic techniques.

Video Wizard Not Required

One thing that's *not* taken for granted in *Amiga Desktop Video* is that you are a skilled computer artist or videographer. The best part about DTV is that just about anyone can get flashy results with a minimum of knowhow. Of course, that doesn't mean you can fly completely blind, either. If you're a new Amiga owner, be sure you're familiar with your computer's basic operations before you read further in this book. You should know your way around

the Workbench (the Amiga's graphic interface); have at least a nodding acquaintance with the CLI, the Amiga's Command Line Interface; and understand disk and file handling. Carefully read the Amiga operations manual that comes with your computer. Likewise, you should be comfortable with using consumer-level video equipment—recording and playing tapes, hooking up one component to another, and handling a video camera or camcorder.

Once you've mastered the DTV basics and want to study further, you have the best teaching tool right in your own home: your television. Don't just passively absorb what's on the tube—really look at how programs and commercials are staged and edited, how animation is used, how sound pulls it all together. You may decide you can do better—and, given the homogenized nature of much television programming these days, you probably can. Video is ripe for a creative mass revolution; this book will help you get that revolution started.



Chapter 1

Hollywood on Your Desktop

Imagine two scenes:

- A television studio, New York City, late 1950s. You and your crew are taping and editing the latest episode of “The Dinah Shore Show.” Along with a couple of dozen technicians and studio personnel, you’re using three massive television cameras; a video switcher to mix the video coming from each camera into a single signal; a brand-new Ampex videotape recorder, one of the few of its kind; a machine the size of a washer-dryer unit that uses tape two inches wide; and the latest videotape editing system—a marker pen, a splicing knife, a magnifying glass, and some sticky tape. The farthest thing from your mind, as you struggle to get your fragile machines to work smoothly together, is that television production technology might ever be available to John Q. Public. And, though you’re working at the cutting edge of electronics, you’ve never seen a computer. Total production time: one week.
- Your desktop, 1989. You have four hours to create a flashy color video presentation for tomorrow’s meeting. On hand is the tape you shot earlier at the plant with your camcorder. On your desk is the camcorder, an editing VCR (Video Cassette Recorder), and linking them together, an Amiga computer. Running a simple animation program on the Amiga, you whip up two moving bar charts and a video slideshow showing shop floor innovations; you then insert them quickly into the footage of the plant. A titling program lets you add explanatory notes and credits right over the moving video. Finally, you add an

original synthesized soundtrack you composed just by moving the Amiga's mouse. Total production time: 3 hours, 20 minutes.

Three decades have brought a mass revolution in video technology. It was just over a decade ago that video equipment aimed at consumers first appeared on the market. Now, nearly half of American households have VCRs, and a sizable proportion has camcorders, too; a whole new hobby, home video recording, has supplanted the home movie industry. A parallel revolution has taken place in the computer industry. In 1978, nearly all computers were refrigerator-sized boxes serviced by white-coated technicians in the inner sanctums of corporations and governments; the personal computer was the way-out hobby of a few dedicated hackers. Today almost 20 million PCs are in use worldwide, and big computers may be a dying breed.

Enter Desktop Video

Today the two revolutions are coming together in a new field called *desktop video* (DTV), the practice of linking low-cost video equipment and computers to generate sophisticated video programming for home, business, educational, and creative use. Current DTV products let you mix live video and computer effects, add titles and text over video, turn video images into computer pictures, create computer slideshows, and even craft amazingly detailed three-dimensional animations. And desktop video is hot—many observers think it will have as big an impact on the world of the personal computer as desktop publishing did two years ago.

You can see DTV in use everywhere, from home videophiles putting titles on their family videos to TV pros needing quick computer graphics for high-budget network programs, including "Amazing Stories" and "Max Headroom." Like desktop publishing, desktop video brings a formerly difficult, exclusive, and expensive medium of communication within reach of anyone with the will to learn. In fact, the rise of desktop video amounts to a democratization of video programming technology—Hollywood (or maybe just Burbank) on your desktop. Given the rapid evolution of consumer video and personal computers, it's likely that the multimillion-dollar video production studio of today will be obsolete in five or ten years, replaced by flexible, creative individuals and small groups using DTV technology to create top-quality video on a shoestring.

Now, you may not be out to overturn the entire television industry, and that's fine. One of the best things about DTV is that it doesn't require a massive investment in time or money. You can start small in your own home or office with equipment you already own—your computer and VCR—and a few software packages. Even starting from scratch, an investment of \$3000 to \$5000 will get you up and running with a system that boasts color graphics, three-dimensional animation, fancy titles, sound effects, and music.

The one thing you need is a sophisticated computer that can work seamlessly with video, and for that there's only one real choice, the Commodore Amiga. The Amiga line of computers was designed from the ground up with graphics and video in mind, and offers unique, built-in video capabilities. That's why, since its introduction in 1985, the Amiga has been the platform of choice for DTV producers, videographers, artists, and animators, and why it boasts the widest range of DTV hardware and software products of any current personal computer. And that's why this book deals solely with the Amiga.

Advantages of DTV

As a medium of mass communication, video has no peer. For good or ill, most Americans have grown up with TV; the majority of us watch it every day, sometimes for several hours a day. A slim two or three percent of American homes are without a TV. We look to TV for entertainment, information, relaxation, company, and can't imagine life without it. The primacy of television as the mass communications medium par excellence was demonstrated once again in the recent presidential elections. Both parties spent hundreds of thousands of dollars on print ads but tens of millions of dollars on TV commercials, with one side winning the election in part because of a few devastatingly effective ads.

In short, information communicated through video has a ready-made, accepting audience that often can't be reached in other ways. And, given video's high density of transmitted information—music, sound, color, motion, text, photographic imagery, graphics, and narrative, available all at once—it's ideal for conveying any complex idea that can be shown or told. You only have to look at the proliferation of "how-to" videos to see that publishers have caught on to that. Businesses are increasingly using video for training, presentations, and corporate communications. Many schools play educational tapes every day.

The disadvantage to video programming is that it has been expensive to produce, leaving it in the hands of producers who can raise the bucks but who may not have the greatest grasp of the subject or the most powerful imaginations. As noted above, that's where DTV comes in. DTV makes sophisticated but inexpensive video production possible. With DTV a lot more people will be able to tap into the part of our brains that has been trained by television, and perhaps shake things up a bit. DTV should make possible new kinds of small-scale programming that meets our needs but that no commercial producer would ever touch.

DTV also touches our feelings about computers. Here, the relationship is less passive, more active and productive. You *watch* TV, but you *use* computers. DTV offers the possibility of truly interactive video—that is, television programming that the watcher can modify and control, with the computer making the interaction possible. This is perhaps the most subversive aspect of DTV, and the most exciting.

Creating with DTV

How does desktop video work? Conceptually, it's fairly simple (although the details can be quite complex, as you'll see in later chapters). A typical DTV system is, as you might expect, compact enough to sit on a desktop. It requires a camcorder or video camera, an Amiga computer, a separate device for bringing video into and out of the computer, software for graphics, and a VCR. Footage shot on the video camera or camcorder is fed into the computer, where it's mixed with computer graphics, titles, animation, or whatever images you like. The mix is then output from the Amiga and input into a VCR, which records it to tape. The tape can then be played back on any compatible VCR at any location. Chapter 2 provides a much more detailed picture of this process, but the core of DTV is just a flow of imagery from input to output, with you altering the pictures along the way with the Amiga.

There are innumerable variations on this basic setup. You can dispense with the camcorder, for example, and just create programming in the Amiga for recording on the VCR. Or you can capture video images as computer pictures and save them on disk to display only on the Amiga, not on tape. Scores of software packages and hardware devices provide a dazzling range of capabilities, from the simple to the elaborate, the amateur to the thoroughly professional. In Chapter 3 you'll find descriptions of each

type of DTV peripheral and program, along with guidelines for setting up a variety of systems tailored to various tasks. Appendix A lists manufacturers and publishers for the major available Amiga DTV products.

What DTV can't do—in fact, what no device or system can do—is determine the type or quality of the programming created with it. As the DTV director, that's your job. And like any director, you'll need to

- Know what you want to communicate.
- Identify your audience.
- Choose the best way to present your ideas.
- Organize your information.
- Create a coherent video and audio design.
- Analyze your production needs.
- Assemble the required hardware, software, and other materials.
- Manage a team of co-creators.
- Translate idea into finished product on time and within budget.

The conceptual work of planning and preparing, assembling material, and setting up the production is the hard stuff, and that's where you'll probably expend most of your creative effort. Playing with the equipment and programs is, by comparison, easy. Chapter 4 helps you to prepare for any DTV production, talking you through the various stages of planning and production. DTV post-production, editing, and more are covered in Chapter 5.

Of course, not all desktop videos require the organizational skills of a Cecil B. DeMille. Many DTV projects will be rather simple—the creation of a simple video logo or set of titles, for example—calling for minimal effort in planning and production analysis. Other projects will be more elaborate but still primarily functional, with well-defined goals. You might have to create a presentation for the production V.P. using such-and-such data for the big project, for example; or the tape of the rock band's new music video needs some added effects, and you've only got so many hours and so much money to accomplish the task. In such cases, creative issues tend to fall in line behind the imperatives of message, money, and time, making it easier to see what choices you have to make.

Then there are DTV projects that are purely creative in intent, such as art animations or "guerrilla video." A creative DTV

director needs to keep in mind all of the requirements listed above, plus the overarching imperative of being true to the vision of the piece. A talent for striking visual design; a sensitivity to narrative rhythm; a good sense of drama, comedy, or satire; an ear for sound and music; and the need to strive for perfection are all traits that will help the creative DTV director. (Or, at least, having the ability to recognize these traits in others, and to get those people to work with you, certainly helps). In chapters 6, 7, and 8 you'll find discussions of graphics, animation, and sound techniques that will make DTV creation easier and more successful, as well as some hints on the aesthetic dimension of DTV, but the creative impulse is yours to supply.

Uses for DTV

You now have a general sense of what DTV is all about, but what, specifically, can you do with it? Here are a few suggestions:

Home Video. Home videophiles can use DTV tools to add titles and graphics to tapes of special events—weddings, vacations, birthday parties, and so on—to give them a professional look. For example, you can add titles to a family tape that state the date and location of the event, the age of each child, and the names of distant relatives—a real boon when you look at those tapes 20 years from now (in whatever information format we'll be using then!). Consider making a record of your house and possessions for insurance; the tape can contain a complete audio description of each visual, plus text and explanatory graphics. Another related use for DTV is to document collections of coins, stamps, antiques, art, baseball cards, and other valuables, complete with titles describing each item and the ability to print out a picture for distribution at any time.

Many home videophiles use their equipment for taping sports events—Little League games, for example. With DTV you can add names, statistics, graphics, and sound effects to your tapes, and then show them to the team. One golf enthusiast I know uses the Amiga to analyze his golf game. He hits the ball while videotaping himself from different angles; he then digitizes the pictures and uses Amiga graphics software to eliminate everything but the outlines of his movements. These simplified pictures make it easier to see how to improve his stroke. He even uses a computer-aided design program to measure the angles of the club and the bends in his arms and knees.

Business Video. Businesspeople can create desktop videos for presentations, training, demonstrations, documentation, point-of-sale programming, advertising comps, product development, video catalogues, and even commercials for broadcast. It's child's play to create animated graphs and charts, as in the example at the beginning of this chapter, to impress the V.P.'s at the sales meeting. (See chapters 6 and 7 for more on business graphics.) Several studies show that well-designed animated graphics are an effective way to communicate complex processes, such as market behavior. Graphics married to video can be even more effective. With a greater investment in effort and equipment, businesses can produce creative in-house programming that rivals anything aired by the local cable channel.

Business television is one of the newest corporate buzzwords; it refers to the fast-growing practice of using video as a management communications tool. Businesses that produce their own video have greater control over the end product, and pay off the higher initial capital costs of setting up a television facility by lower per-program production costs and cheaper distribution. Also, certain kinds of information are more easily digested by modern CEOs and managers in video form than in printed materials or live presentations. Among the advanced uses for business TV are video conferences (also called teleconferences), corporate news reports, special events broadcasts aimed at the press, and *narrowcasting*, the creation and broadcast of programs aimed at selected audiences, including customers, vendors, and stakeholders.

Business TV programs are usually produced in a corporate studio, then either broadcast live via satellite link to branch offices, sent via cable hookup to regional markets, or distributed on tape. The Amiga and other DTV tools make it possible to add sophisticated effects to business TV programs that might not otherwise be possible for even a well-equipped corporate studio.

Education. Educators will find many uses for DTV in presenting difficult technical concepts, especially in the sciences, math, and geography. Since DTV productions are entirely under your control, programming can exactly match your lesson plan. Students can also create their own DTV programming, learning computer, video, communicative, and cooperative skills at the same time. Most schools already have VCRs and other A/V equipment, so only a modest additional investment is needed. Commodore offers a school-purchase program.

Interactive DTV can be a wonderful adjunct to books, slide-shows, and ordinary video programs. In this case, interactive means the student can partially direct the course of the video. Of course, students can progress through a DTV lesson at their own pace, absorbing information in screen-size packets. But the program itself can monitor student responses and tailor the lesson to suit student strengths and weaknesses. For example, you can program the lesson so a student who enters a wrong answer is immediately shown a new Amiga graphic that discusses the problem in more depth. *Deluxe Video* (Electronic Arts) is one DTV application that makes it easy to set up a branching program structure that can be directed by the student. With a little more sophistication, you can create your own video programming and use an Amiga database to provide random access to the material—see Chapter 5.

Architecture and Engineering. Architectural and engineering DTV simulations are increasingly being used to test ideas and concepts. Amiga 3-D modeling and animation programs are perfect for building structures and objects with extreme realism. These can then be mixed with video to create convincing scenes.

For example, an architect can draw up plans with an Amiga computer-aided design program, such as Aegis Draw 2000, and then load the plans into a compatible modeling program for conversion into three dimensions. The model can then be superimposed onto a digitized photo or video of the building site, and then recorded onto tape to show the client. With this process, three integrated levels of information are available—two-dimensional plans to guide the actual construction, three-dimensional models to check the “gestalt” of the design, and video for client or management presentations.

Research. Researchers and medical professionals can use DTV for documenting experiments and examinations, adding titles, explanatory graphics, and digitized images as necessary. DTV hardware can record time-lapse video images and convert them directly to computer graphics for analysis with *image processing* software (discussed in Chapter 6). DTV can also be invaluable for putting together technical presentations on short notice and within grant budgets, as well as for creating complex animated simulations that would take days to create with other computers.

Medical researchers are using the Amiga and video to study the nonlinear behavior of cardiac fibrillation; to create 3-D images

of bone prostheses; and to animate image slices taken with CAT and MRI scanners. The Amiga is also being used to process and analyze video images in astronomy, materials science, and robot vision research. NASA recently commissioned a complex 3-D simulation of the proposed space station—created entirely with the Amiga.

Video Art. Video artists are already finding unlimited new uses for the technology. The relative low cost of DTV production puts it within reach of artists and students who could never have afforded to work in video only five years ago. Hundreds of young Spielbergs are working to stretch the creative boundaries of video and performance art, animation, music videos, and social documentaries.

One example: Among the many young artists working with Amiga DTV is New York-based Steve Jacobs, a genial, bearded descendent of the “guerrilla video” artists of the mid-1970s. Jacobs had been working with low-cost video and electronic music for several years before he discovered desktop video on the Amiga. Just as the early video artists let enthusiasm about the revolutionary possibilities of low-budget video shape their work, Jacobs is interested in the potential of the new medium of DTV to create videos with a sharp social consciousness. A current project is to mix together video images of street beggars in India and New York City—“the two places are getting more and more alike,” says Jacobs—and enhance the footage with Amiga effects and sounds. Jacobs now organizes an Amiga art and video competition that attracts hundreds of entries.

Amiga DTV is already sparking a renaissance in low-cost animation. With the most sophisticated video animation tools available for any personal computer, animation on the Amiga may result in a flowering of the art to match that of the 1930s and 1940s, animation’s first golden era. Certainly the tools of animation have never been made so available, and so easy to master. You can see 3-D Amiga animation in MTV music videos and in Saturday-morning kids’ TV. Chapter 7 discusses Amiga animation in detail.

There are new opportunities for software entrepreneurs as well, especially in the computer and video game markets; imagine an adventure game running on a combined computer-VCR system that mixes graphics, animation, video, and hi-fi sound, and you get a sense of where the entertainment software industry is headed.

Audio for Video. The Amiga can generate a wide variety of sounds, from bizarre computer sound effects to artificial voices, and fully professional scores for video dramas. As more musicians turn on to the advantages of electronic music—versatility, speed of composition, and low cost—they are discovering the Amiga. When audio must be synchronized to video or animation, the Amiga is the obvious choice for a computer synthesizer, because you can output both video and stereo audio from the computer at the same time. For more on audio for video, see Chapter 8.

Professional DTV. Anyone who turns on the TV is bombarded by sophisticated computer video graphics. Network spots are filled with flying text in every imaginable material, from bronze to glass to marble. Computer-generated footballs of simulated pigskin sail through computerized end zones before every NFL game. Elaborate animated maps accompany every local TV weatherperson. The recent Summer Olympics saw the greatest blitz of computer graphics ever offered on American TV; the dazzling effects, far more imaginative than the live coverage of events, were so ubiquitous that we took them for granted.

Yet, common as flashy computer graphics have become on TV, they are incredibly expensive and time-consuming to create—well out of the financial reach even of most professional producers. It's the rare industrial production or TV commercial that can budget several thousand dollars per *second* for broadcast computer graphics. A few post-production houses with millions of dollars in equipment supply video effects to the networks and top producers; individuals without six-figure budgets have had to do without. That's why video professionals are increasingly looking to DTV to provide video graphic pizzazz that would otherwise be unaffordable.

Here's one real-world case history: Sian Evans, a producer of commercials for broadcast, needed computer animation for a piece on Morgan Grenfell, the British investment firm. "Our budget was tight, and the clients were very picky. They wanted real animated charts and graphs with lots of color and movement, but time on a Cubicomp [a high-end computer graphics animation workstation found in many video post-production studios] costs thousands of dollars per second of finished work." With only a week to come up with the necessary footage, Evans approached a graphic artist who had an Amiga 1000. "Although he had never

done animation professionally, he agreed to try, using a two-dimensional color animation package called Animator [from Aegis Development].” Required sequences involved two charts with growing bars and a graph with a line that drew itself, along with assorted titles. Backgrounds and colors were to be bright and detailed. The finished graphics were then overlaid on taped video of Morgan Grenfell employees. “We had some difficulty getting the quality of video we needed directly from the Amiga—this was before you could get an Amiga genlock—so finally, the tape had to be processed through a proc amp [a broadcast signal amplifier and corrector] at a commercial editing suite. And the clients weren’t sure about the low-resolution Amiga image, which made the titles look a little blockier than they expected. But they liked the bright colors and the design, and when it became obvious that the Amiga animation would cost less than a tenth of Cubi-comp work, they went for it. Now I always give clients the option of Amiga graphics, because they mostly want to save money.”

While DTV is not right for every professional situation—there will always be clients who need the ultimate in image quality, and have the money to pay for it—it can be a budget and schedule saver for the video pro who is short on time and money, conditions most producers must cope with on every project. And even quality-conscious clients are increasingly ready to accept the low-resolution “look” of desktop video as it shows up in more and more broadcast material, just as people are beginning to accept laser-printed books and magazines even though they don’t have the quality look of typeset publications. Chapter 9 covers the basics of using DTV in the broadcast arena.

Beginning Your Exploration

In this book, you’ll find the basic information you need to hone your skills with the new DTV tools. As with all explorations into uncharted territory, you’ll have to adopt an adventurous outlook to get the most from the experience. This book will guide you through the world of desktop video, but don’t hesitate to experiment for yourself—DTV has creative potential that can only be realized by you. There’s nothing to stop you from making your mark as one of the new breed of desktop movie moguls.

Chapter 2

Inside Video and Amiga Graphics

NTSC. RS-170A. Subcarrier phase. Horizontal and vertical sync. The jargon of video is likely to make a computer enthusiast's head swim. Video comes out of the world of analog electronics, where the nice, simple, digital rules that make computers so easy to understand (aren't they?) just don't apply. By the same token, videographers aren't comfortable with the digital world of bytes and bitplanes, buses and DMA. Most people in the video world ignore the world of computers, and vice versa; this is easy to do since they don't even talk the same language.

To be a successful DTV creator, you have to give up some of the bliss of ignorance. A basic grounding in both video and computer concepts as they apply to DTV and the Amiga is really a prerequisite for success, especially if you plan to enter DTV in any professional capacity. This knowledge will help you arrange hardware in any configuration you need, cope with strange set-ups when you have to use them, and recognize the sources of technical problems when they arise. Just as important, you'll be able to converse with the real videoheads and computer graphics nerds without feeling too embarrassed at your own ignorance.

This doesn't mean you have to turn into a tech yourself. What follows is not by any means an exhaustive discussion of the technical side of video and computers—that would fill several volumes—but just enough to get you started. To help you get your bearings, here's a much-simplified explanation of how video works. Later we'll look at the operation of the Amiga and how it generates graphics.

How Video Works

Video is a method of transmitting and displaying sound and visual images. A scene and ambient sound is converted by a video camera and microphone to an electrical signal that carries the video information. The signal is broadcast with a transmitter or carried along a cable to a television receiver, which recreates the scene and sound, or to a video tape recorder, which records the signal on magnetic tape for later replay.

Think of video as a little like plumbing—the signal flows like water from one component to another as long as electrical power is supplied to the system and the right “valves” are open (that is, the right components are attached in the right way). Figure 2-1 is a block diagram of the flow of video in a typical video system.

The signal won't flow and be useful without the proper components. The three main components are the video monitor, the video camera, and the VCR. Let's look at how each of these works, as well as examine the video signal in more detail. As an example, we'll use the typical camcorder, which combines all three basic video components (Figure 2-2).

Figure 2-1. Video System

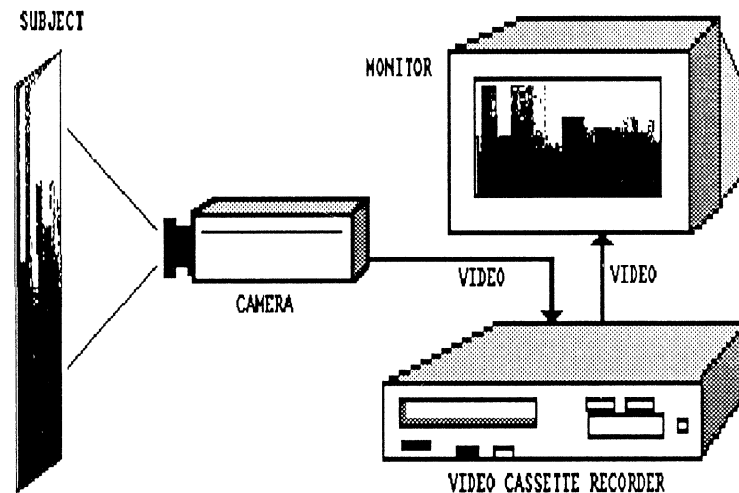
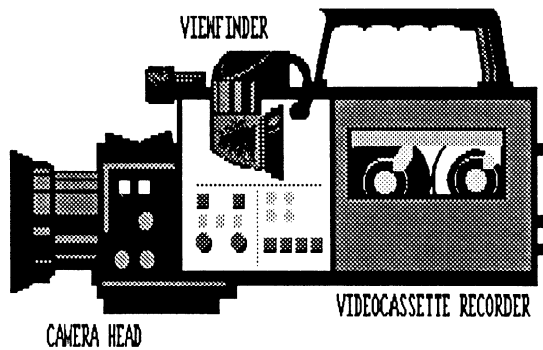
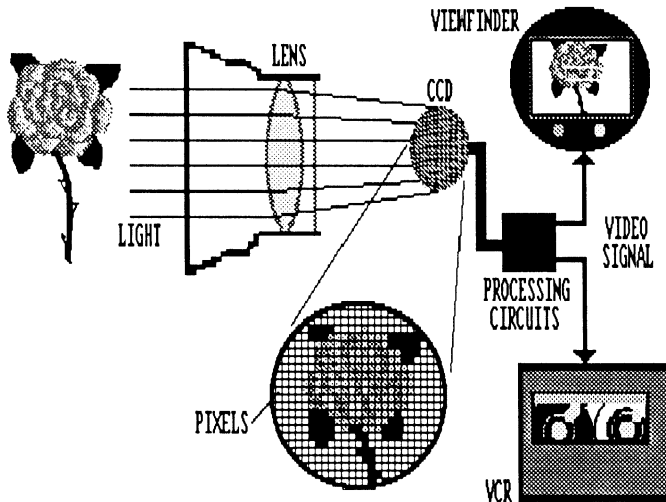


Figure 2-2. Camcorder Components

The Camera Head

The camera is the pickup device that first converts the image of a scene into a video signal. In most modern camcorders a lens focuses light from the scene—for the purposes of this discussion, let's say the camera is focused on a red rose—onto a light-sensitive plate, called a *CCD* (*Charge-Coupled Device*). The CCD is divided up into small elements called *pixels* (picture elements); each pixel generates an electrical current based on the amount and color of the light falling on it. Circuitry in the camera combines the outputs of all the pixels into one analog video signal that contains all the information about the scene that the camera could re-

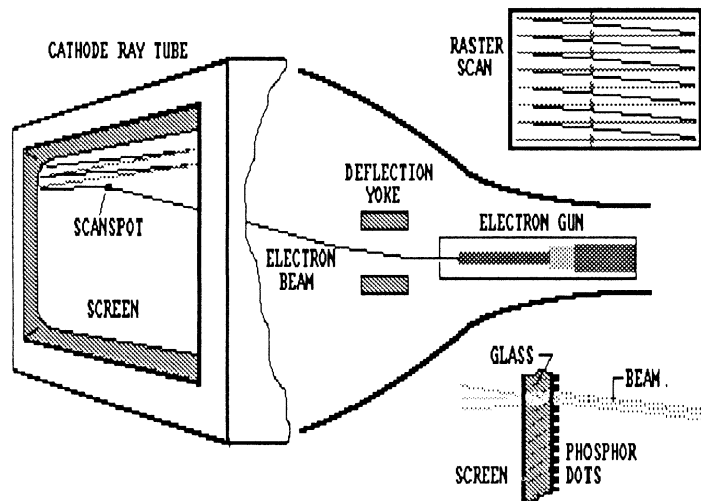
Figure 2-3. Camera Head

solve. With the CCD pickup system, the amount of scene detail the camera can “see” is limited by the number of pixels on the CCD plate: the more pixels, the more detail (see below for more on picture resolution.) Figure 2-3 outlines how this works. At the same time, a microphone in the camera is picking up ambient sounds and converting them to an audio signal. The video signal from the camera is routed to the *viewfinder*, a small monitor on top of the camcorder, and audio plus video goes to the VCR part of the camcorder.

The Viewfinder

The camera image is displayed in the viewfinder. If the viewfinder is the electronic type—the kind possessed by most better camcorders—it’s essentially a tiny black-and-white monitor. (If your camcorder has an optical viewfinder, refer to your TV or video monitor instead.) Inside the viewfinder is a picture tube or CRT (cathode ray tube) containing a gun that scans a beam of electrons across a field of tiny phosphor dots on the back of the monitor screen. The dots glow when hit by the scanspot of the beam. The signal from the camera head contains the information necessary to vary the intensity of the electron beam so it activates only those phosphor dots that create the image on the screen. The beam scans back and forth 15,750 times a second, creating the image out of individual lines of activated phosphors as it zips

Figure 2-4. Scanning



left to right while moving top to bottom. This happens so fast that, at a reasonable viewing distance, your eye reads the image as a solid picture. Up close to the screen, though, you can see the individual lines. Figure 2-4 illustrates the process. The video screen image, composed of the scanlines created by the electron beam, is called a *raster*.

The complete raster has 525 horizontal lines (of which only about 490 are visible on the screen), but not all are written at once. Actually, two partial images, called *video fields*, are created, one every 1/60 of a second. The beam writes one set of lines for the first field, skipping every even line (that's $262\frac{1}{2}$ lines per field), then returns to the top of the raster to write the second field, which includes all the odd lines skipped in the field before. (See Figure 2-5 for an illustration.) The alternate writing of video lines is called *interlacing*, a term you'll see again later when we discuss Amiga screen formats. The complete video image created by two fields is a *video frame*; there are 30 frames every second.

Color video is electronically similar as far as scanning goes, but mechanically more complex. The back of the monitor screen is coated with three colors of phosphors—red, green, and blue, the primary colors of video—grouped in threes, with one of each color in every group. Many video monitors have three electron guns, with the beam of each gun targeted for phosphors of only one color. A *shadow mask* located right behind the screen has

Figure 2-5. Interlacing

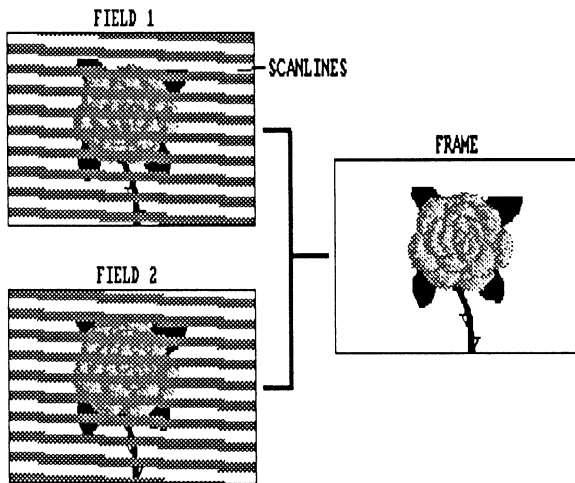
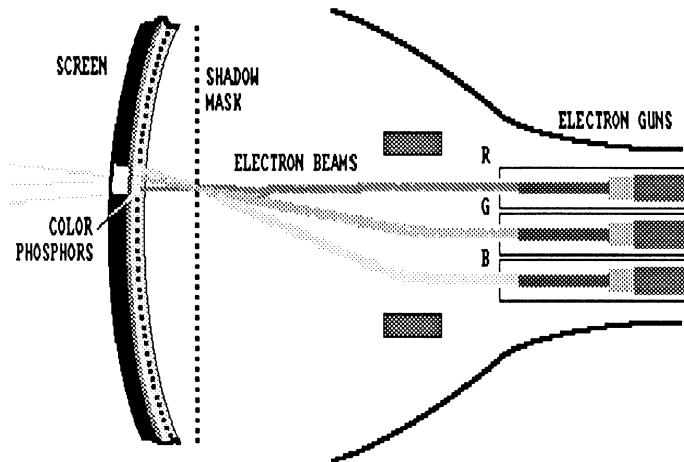
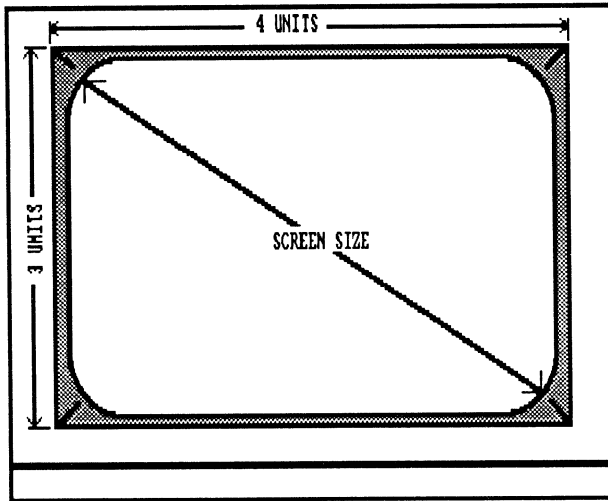


Figure 2-6. Color Picture Tube

thousands of tiny holes aligned with the phosphor groups; the beams shoot through the holes at slightly different angles, so the beam from the “blue” gun hits only the blue phosphors, the “red” gun hits the red phosphors, and the “green” gun hits the green phosphors. Figure 2-6 shows how this works. In the picture of the rose, for example, the beams will activate mostly red phosphors and few green phosphors to recreate an image of the petals, but mostly green and few red phosphors to recreate the leaves.

As you’ve probably noticed, all video displays, including the viewfinder, have the same *aspect ratio*, or proportion between width and height of the screen. This ratio is 3×4 units, or 3:4, as in Figure 2-7, and applies to any size screen. Uniform display proportions are necessary so a broadcast video signal, containing instructions that rigidly control the scanning process and location of the scanspot, will send the scanspot to the right locations on any TV or monitor that receives the signal. Measurements of screen size are usually given in inches across the diagonal of the screen; a 20-inch monitor measures 20 inches from the upper left to the lower right of the screen.

An audio signal, either mono or stereo, is sent to the typical monitor along with, but separate from, the video signal. Sound is recreated with an audio amplifier and speaker or speakers in the monitor. The typical viewfinder has no speaker attached (although at least one model of camcorder does offer this); the audio

Figure 2-7. Video Screen Aspect Ratio and Screen Size

signal is routed to a headphone jack instead for use with standard audio headphones.

The VCR

The video and audio signals are also routed to the video cassette recorder in the camcorder. The VCR records the signal onto recording tape in a cassette so it can be regenerated for display at any time. The tape is composed of a plastic substrate coated with ferrous particles that are sensitive to the magnetic fields created by the VCR recording heads. Figure 2-8 shows a cross-section of the structure of videotape.

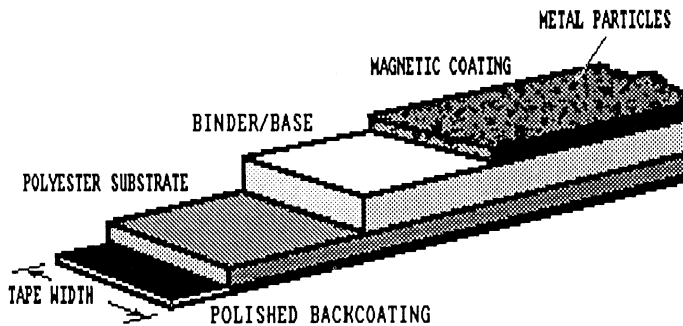
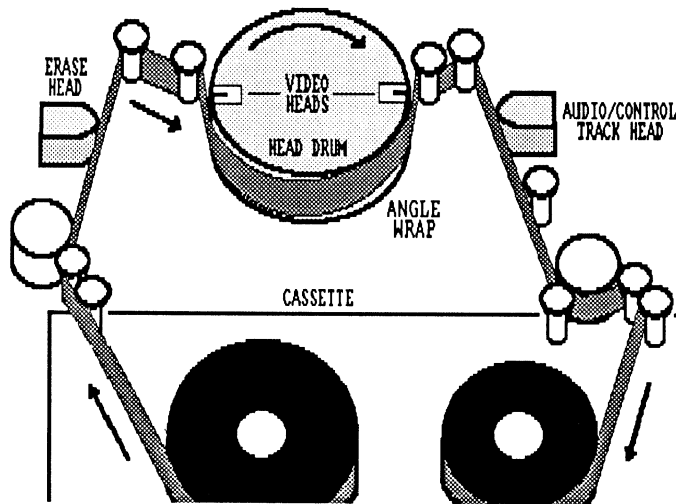
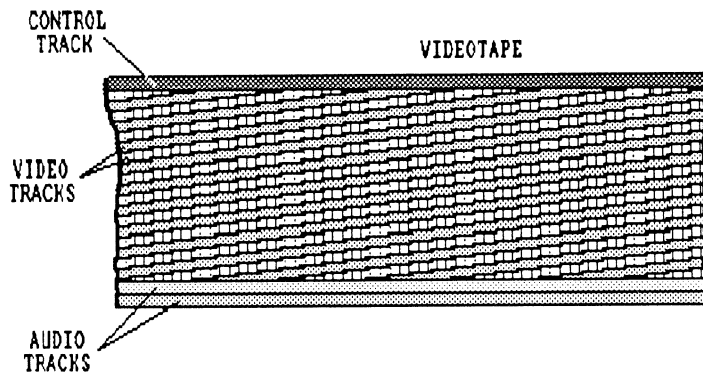
Figure 2-8. Videotape Cross-Section

Figure 2-9. Tape Wrapping and Recording Heads

Inside the VCR are two or more rotating *video heads*—small electromagnets—inside a *head drum*. When the tape is loaded it wraps around the head drum in one of several possible configurations, depending on the tape format and type of VCR. Figure 2-9 shows a typical tape wrap for a VHS camcorder. No matter which wrap format you use, all modern VCRs wrap the tape at a slight angle around the head drum, as Figure 2-9 shows. This angle is important because it enables the heads to record more video information on tape.

Tape and video heads move at the same time. In VHS camcorders running at the SP speed, the video heads spin at 2700 rpm, and the tape moves at 1.32 inches per second in the reverse direction from the spin of the heads. The faster the tape moves, the better the image quality of the recording. This may seem counterintuitive, but it's true; the slowest VHS speed—extended play, or EP, at .45 inches per second—yields the poorest picture, as any VHS user knows. That's also the reason for spinning the heads—to create the fastest possible relative speed of tape to recording head without having to move the tape so fast it breaks. A slower tape speed does have the advantage of allowing longer recordings to fit on a tape. You can record a standard two hours of programming on a T-120 VHS tape running at the SP speed, but six hours at the EP speed.

Figure 2-10. Tape Tracks

When recording, a portion of the incoming signal is sent to each video head, which turns the voltage into a small magnetic field. Each video head in turn sends out a magnetic pulse to the passing tape that lays down a *track* slantwise across the tape, as in Figure 2-10. Each track contains the information for one video field. A separate head or heads lays down one or more audio tracks and a *control track*, a separate signal that controls tape motion in playback. The control track contains pulses that demarcate each frame to provide information about frame timing. An *erase head* blanks the tape. In some VCRs, the erase head spins inside the head drum and can erase individual tracks, a necessary feature for videotape editing (see Chapters 3 and 5).

In playback, the video heads read rather than write information—the magnetic field in the tape induces a current in the heads that's amplified to output a standard video signal, which can then be displayed on a monitor or recorded to another VCR. For display on older TVs that lack direct video jacks, most VCRs (but few camcorders) also output video in the form of AM radio waves (called *RF*) that can be led by cable directly to the antenna leads of the TV.

The Video Signal

What's in the color video signal that enables the monitor to recreate an image of the scene, and the VCR to record it? The signal is a series of small voltages, expressed as pulses and sine waves, that encode information about each line of the picture and tell the electron beam how and when to scan.

The part of the video signal that actually creates the picture includes information about:

- *Luminance*, the brightness of the image; also called the Y part of the signal. It's the black-and-white part of the signal.
- *Color saturation*, the intensity of the image colors.
- *Hue*, the percentage of red, blue, or green in each part of the image. Together, hue and saturation are called *chrominance*, also called the C part of the signal. Color video components can display or record the chrominance part of the signal, while monochrome components (a black-and-white TV, for example), ignore it, displaying only the luminance part of the signal.

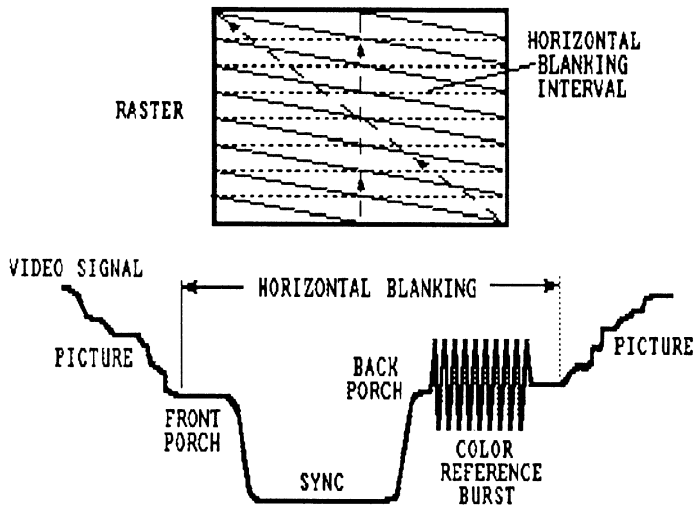
Two reference waves make sure each line is always set to the proper color and amplitude:

- *Color reference burst* or color burst, a reference wave for measuring hue and saturation
- *Reference black level*, or *pedestal*, a reference for total picture brightness

Also included in the signal is *synchronizing* information that controls the timing and location of the scanspot, making sure that each element of the video signal occurs in lockstep with the others. All components in a video system must be *in sync* with the others, that is, abide by the synchronization commands of the video signal, or video won't travel from one component to the next. The sync part of the signal includes:

- *Horizontal line synchronizing pulses*, to control the transition from the end of one horizontal scanline to the beginning of the next. The part of the signal from one line to the next is the *horizontal blanking interval*, so called because the picture information in each line has to be blanked-out and reset before the next line can be written. Figure 2-11 is a diagram of the waveform of the horizontal blanking interval.
- *Vertical synchronizing pulses*, to control the transition from the last horizontal line of one field to the first horizontal line of the next field. These pulses are contained in the *vertical blanking interval*, so called because the screen is blanked out while the

Figure 2-11. Horizontal Blanking Interval



scanspot moves back to the top of the raster to begin the next field. Figure 2-12 is a diagram of the waveform of the vertical blanking interval.

Waveforms and Vectors. You'll want to have an idea of how these waveforms look should you ever enter a professional editing studio. There you'll find machines that constantly display the

Figure 2-12. Vertical Blanking Interval

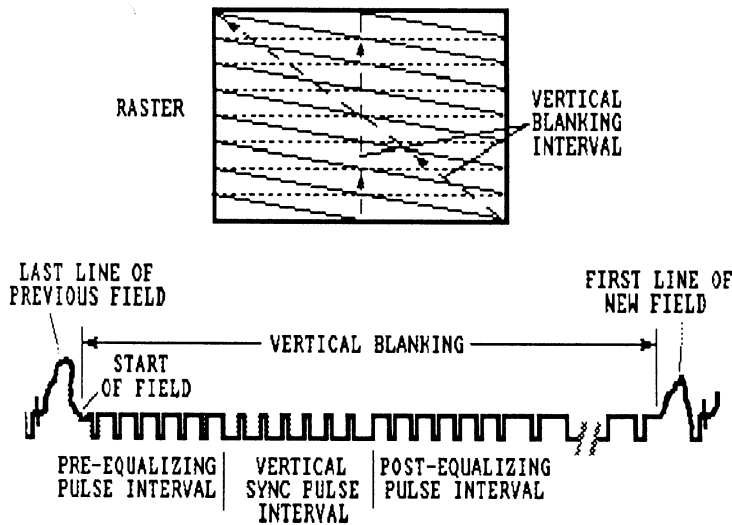
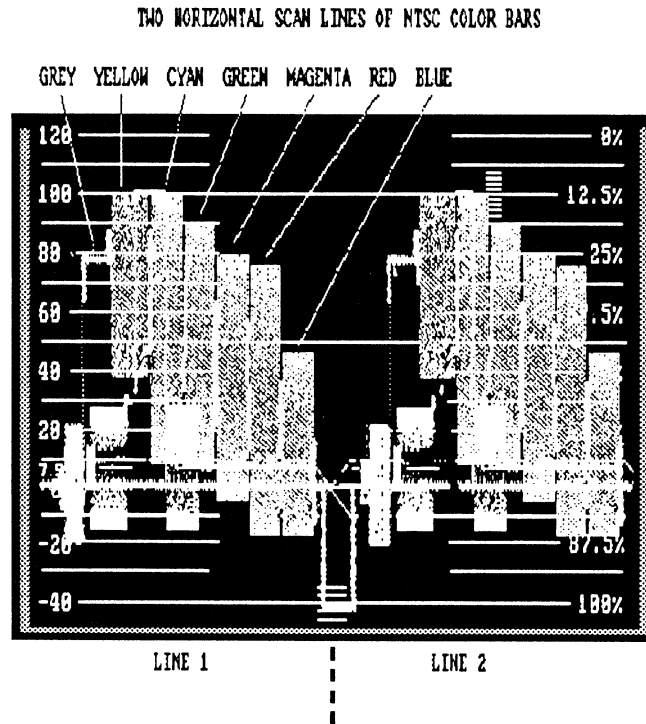
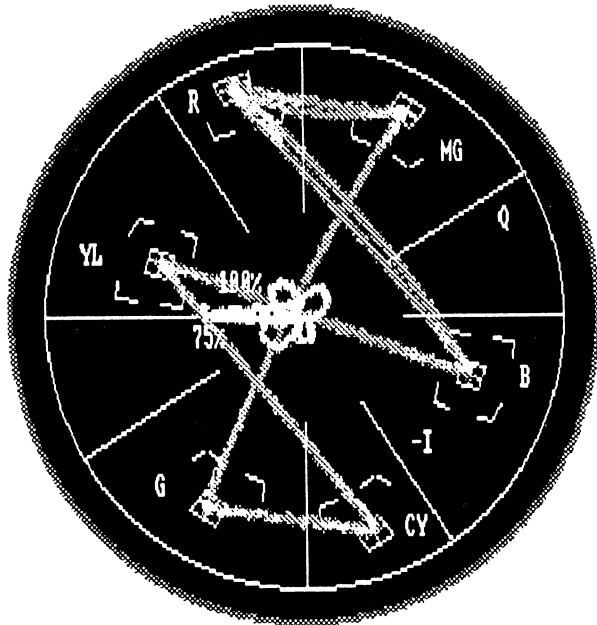


Figure 2-13. Color Bars on Waveform Monitor


signal and provide a way to tell if it meets specifications. A *waveform monitor* and a *vectorscope* are the most common signal measuring devices. Figure 2-13 shows how one line of video generated by the image of *color bars* (a standard color test pattern) appears on a waveform monitor. Figure 2-14 shows how color bars appear on a vectorscope, which displays the phase and amplitude of the color subcarrier.

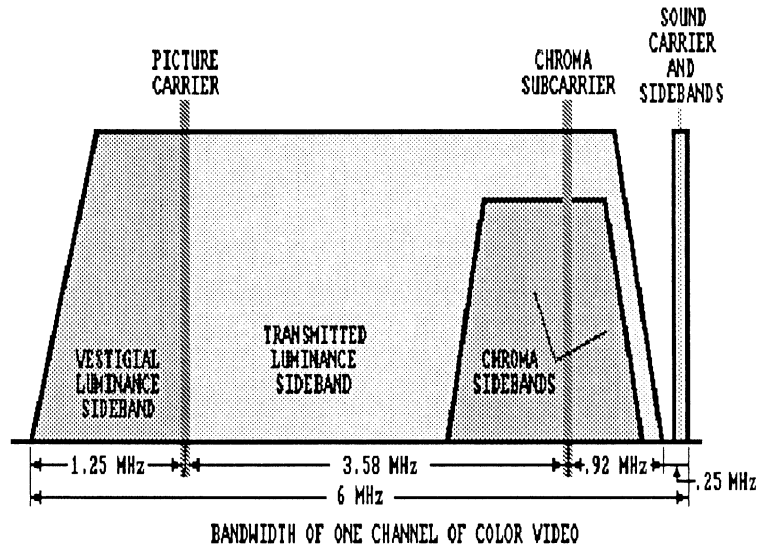
Bandwidth. The amount of information a video signal can carry is in part determined by its *bandwidth*. The bandwidth is the maximum frequency range—from the peak white level, requiring the maximum voltage, to the blackest black, requiring the least—of the luminance part of the transmitted signal, measured in cycles per second, or *hertz*. Think of the bandwidth as the hole that sand pours through in an hourglass. A wide hole lets a lot of sand through. A small hole only lets a small amount of sand through. It's the same with the signal—a wide bandwidth can carry more luminance information than a narrow one. Video re-

Figure 2-14. Color Bars on Vectorscope

quires a wide bandwidth to carry all the luminance information, about 4.5 MHz (MHz, millions of cycles), and 6 MHz when you include audio and sidebands. Figure 2-15 diagrams the color video bandwidth divisions. You can gather some useful information about video components, especially VCRs, if you know the bandwidth they can transmit or record, as you'll see later.

Composite Video. The mixed video signal, including all color and synchronizing information, is called *composite video*, and it's the signal type used by all consumer and nearly all professional video equipment. (It is not the type of video produced by most Amigas, as you'll see below.) To yield acceptable quality, a composite video signal to be used in the U.S. and some other countries must meet a technical standard set by the National Television Standards Committee (NTSC) known as RS-170A. Casual references by videoheads to "composite video," "NTSC video," or "RS-170A video" mean essentially the same thing—good quality TV-type video. Discussions and diagrams in this book will deal with NTSC video. Other television standards include PAL, widely used in Europe and Latin America; and SECAM, used in France, the USSR, and many African countries, among other

Figure 2-15. Video Bandwidth



places. These TV standards use different scanning rates and a different number of lines in the raster.

Component Video. An increasingly popular alternative to composite video is *component video*, in which the color parts of the signal are kept separate to prevent them from partially interfering with one another, as happens in composite video (see Figure 2-15, which shows the overlapping *sidebands* around the main parts of the channel bandwidth). The Super-VHS tape format, for example, uses a component video scheme in which the luminance information is separated from the chrominance information, not combined into one signal, yielding a higher-quality picture. (The next chapter has more on tape formats.) Computers and some professional video equipment use another component system in which the red, green, and blue elements of the picture are transmitted separately. Composite and component video schemes are electronically and mechanically incompatible, requiring some kind of converter device to translate component into composite video.

From Analog to Digital

Up to now we've been talking about analog electronics—waveforms and so on, where information is carried by the amplitude and frequency of a continuously varying small electrical current.

You might think of the analog waveform as being an analogy of the scene—carrying a kind of representation of the scene in the shape of the wave itself—and in fact you can tell something about the appearance of the scene by looking at the waveform on a waveform monitor. On the other hand, computers, at least in their internal operations, use *digital* electronics, in which information is carried as a string of discrete pulses that are in one of two possible states—on or off, 1 or 0. In digital video, the scene is converted into a series of binary numbers that, if you were to look at them, would convey no information at all to the human eye. The computer understands the numbers, however, and can reconstitute the scene perfectly every time.

The two methods of encoding information are electronically incompatible—digital signals look like random noise to analog equipment, and analog signals are completely incomprehensible to computers. A device called an *analog-to-digital encoder* (or an *A/D device*) is needed to convert video information to digital format; a *digital-to-analog encoder (D/A)* converts the signal from digital back to analog. Such encoders are at the heart of computer-video systems, and are what make DTV possible.

Each time an analog signal is processed through a component, the quality of the signal is degraded. For example, a top-quality camera can output an image with 525 lines of picture information, the maximum the NTSC video signal can carry. But a typical home VCR can record only a fraction of the incoming information. The amount of information a VCR can record is measured in *resolution lines*, which can be calculated by multiplying the luminance signal bandwidth the VCR can output by 80. The more resolution lines a component offers, the better, as far as picture quality is concerned. A standard VHS VCR has a luminance bandwidth of 2.92 MHz, and thus a resolution of approximately 234 lines. In essence that means that about half the incoming luminance (black-and-white) information from a pure broadcast-quality signal is actually getting on tape. Whatever fraction of the information does get on tape has to be averaged among 525 lines of output, since that's what NTSC video requires, so the recorded picture is considerably degraded compared to the original. Signal is even lost anytime it's carried over a cable; that's why every piece of video equipment contains several amplifiers to boost and reconstitute the signal. To top it off, the FCC requires that video broadcasts be limited to 330 lines of resolution to keep the trans-

mission bandwidth within the channel width allotted to each broadcaster.

It follows that analog video is also degraded when you copy it from tape to tape. A good analogy is the process of copying a picture on a photocopier machine. Take a picture and copy it. This is the first generation copy. Then take the copy and copy that to create a second generation copy. The first-generation copy has less detail than the original, and the second-generation copy has less detail than the first. The more you continue this process, the less information is in each succeeding generation, until you finally get a copy that's completely unrecognizable, with no useful information. The same thing happens in video, as anyone knows who has copied a tape down several generations. This is just a fact of life of the analog world. You might say that entropy is always trying to reduce the analog signal to random noise.

But in the digital world, the numbers are forever. As long as the numbers are transmitted correctly, you get the same picture every time, no matter how many times you copy it, view it, or transmit it. Computer users know, for example, that they can copy a file as many times as they like, down as many generations as they like, and have exactly the same information in each file. Software compares the contents of a file and its next-generation copy and tells you immediately whether the versions are identical or not. If the information in one file is somehow corrupted, chances are the file won't copy at all.

Video users, who currently have to struggle to copy their first-generation videotapes down as few generations as possible to produce completed programming, can look forward to the eventual replacement of analog video with digital video. The invasion of the analog world by the digital world is proceeding rapidly. Almost all video special effects are now produced with computers, then output in analog form. Video editing systems use computers to control machines and record the list of editing decisions. The first practical digital VCRs are now appearing. The latest model camcorders even offer some digital effects, like perfect still-frame. But for now, the analog and digital worlds have to work together.

That's enough video theory to get you started—and possibly more than you ever wanted to hear. If you need an expanded discussion of the video signal and basic video technology, a good place to start is the excellent series of articles in the *Encyclopedia Britannica*. Or you can look at one of the books listed in Appendix

A, “DTV Resources.” Chapter 9 has more on such arcana as broadcast video, time code, sync, and control tracks, if you want it.

The Amiga

With these basics under your belt, you’re ready for the computer side of things, beginning with a quick description of the Amiga. If you come from the video world and you’re new to computers, make sure you master the basic computer vocabulary—hardware, software, disks, drives, RAM, and kilobytes—before you read further.

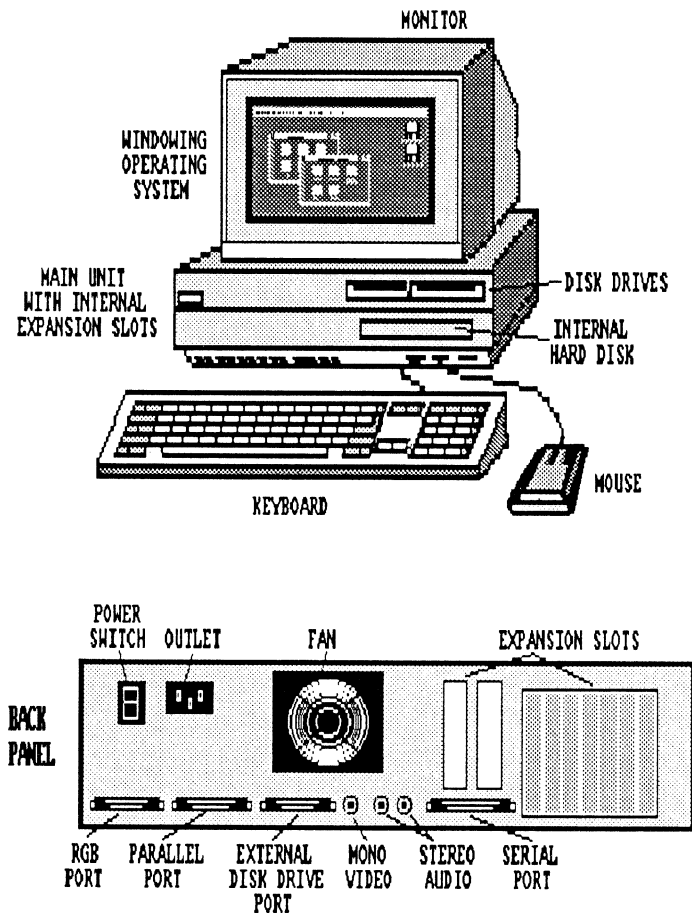
The Amiga is a general-purpose computer based on the Motorola 68000 microprocessor (which runs at 7.16 MHz). Currently the Amiga comes in four flavors, the original A1000, introduced in 1985 but no longer manufactured by Commodore; the A500, a low-priced, entry-level machine; the A2000, the pro-level Amiga with expansion slots and a detached keyboard; and a new Amiga model, the A2500, a 68020-based machine with additional memory and a hard disk, which has been available since mid-1989. The Amigas can access up to 9 megabytes of random-access memory; they use 3½-inch floppy disks formatted to hold 880 kilobytes of data (the format is not compatible with any of the IBM or Macintosh disk formats), and utilize a proprietary disk operating system called AmigaDOS. Underlying the Amiga screen display is a set of libraries and graphics routines called Intuition.

Amiga users are presented with a choice of two different ways to control their Amiga world—the *Workbench*, a graphical user interface resembling the Macintosh interface, and the *CLI*, a command-line interface similar to the one offered by MS-DOS on IBM-PC and compatible computers. Special Amiga chips handle animation and sound, making the Amiga the choice for DTV and games applications. But perhaps the most unusual aspect of these machines is that they are currently the only low-cost computers to offer true *multitasking*—that is, the ability to run several programs at a time and switch effortlessly between them.

On the back panel of the Amiga 500, 2000, and 2500 are output jacks for RGB video (see below), monochrome video, and stereo sound, as well as the parallel, serial, and floppy disk ports you would expect to find on a computer. Around the front are two mouse ports, one of which is usually occupied by the mouse

that comes with the Amiga and which is essential for controlling the Workbench and using nearly all Amiga programs. The A2000 and A2500 have 8 internal expansion slots, some configured for IBM-PC-type plug-in cards and some for Amiga-specific *Zorro* cards, as well as a slot designed especially for video cards. These cards can add new capabilities to your computer, including the ability to mix video right in the machine. The A1000 has no internal slots and different parallel and serial connectors, but it does offer a color composite video output jack and an expansion connector on the right side that can accept extra memory or other devices. Figure 2-16 shows the typical configuration of an Amiga 2000 system.

Figure 2-16. Amiga 2000 System



Amiga Memory. The Amiga's random access memory is organized in a way that has some relevance to video applications, and to Amiga graphics in general. There are two kinds of Amiga memory: *chip RAM*, memory that can hold picture information, and *fast RAM*, memory that can hold any kind of programs and data *except* picture information. Current Amigas can address more than 8 megabytes of fast RAM but only 512 kilobytes of chip RAM, putting an upper limit on the amount of picture information your Amiga can deal with at any one time. In practical terms, that means a limit to the detail and colors in the display. (Next-generation Amigas will be able to access at least 2 megabytes of chip RAM, allowing better-looking pictures with more colors—see the discussion of Amiga graphics below.) Well-designed DTV programs move as much as possible of the program operations into fast RAM, reserving chip RAM for picture information only.

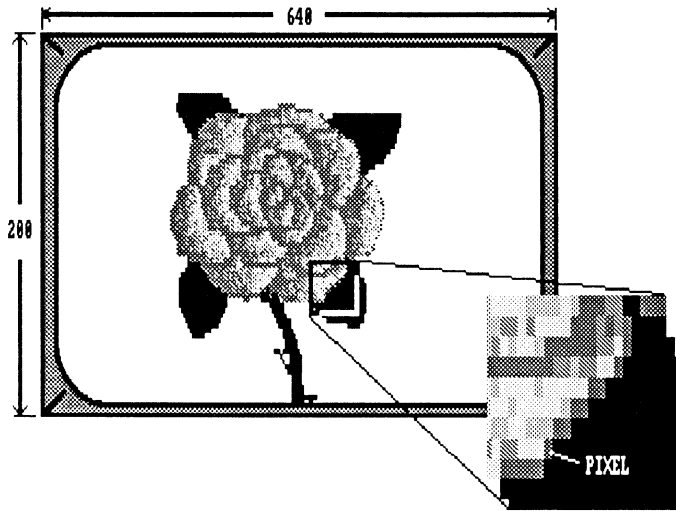
Basic Amiga Graphics

To gain a better understanding of the kinds of images your Amiga can create, let's start by looking at how your computer makes pictures.

All computer displays—screen images—are composed of *pixels*. The pixel is the smallest possible dot the computer can display—the fundamental particle of computer graphics. On the screen, pixels are arrayed in a grid, usually specified as a number of pixels across by a number of pixels down. Figure 2-17 shows a screen composed of 640×200 pixels. The computer can make each pixel black, white, or any of various available colors in between. Computer images are no more than fields of pixels—often referred to as *bitmaps*, after the area in computer memory where the image is stored—shaded to look like some object. On the most basic level, when you create graphics on the screen, you're painting with pixels.

The fewer pixels on the screen, the grainier and less detailed the image. The more pixels on the screen, the less grainy and more detailed the image. To take an example, a 340×400 screen format has twice as many pixels as a 320×200 screen format, and so can yield images with twice the detail. The Amiga's hi-res mode (640×400) has four times as many pixels as the lo-res mode, yielding four times the detail. In computer graphics, the graininess of a screen or picture is called its *resolution*. Resolution is defined by the size and shape of the smallest pixel that can be

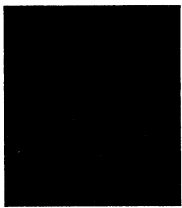



Figure 2-17. Pixels



generated by the computer. In Figure 2-18, you can see the various relative pixel sizes and shapes available on the Amiga.

The unaided human eye cannot resolve picture elements smaller than about .05 millimeter. Anything smaller than that can't be picked out as an individual object by the eye (except in certain circumstances, as when a tiny, white speck can be easily seen on a solid black background). The graininess of ordinary

Figure 2-18. Pixel Sizes

	LO-RES	HI-RES
NON-INTERLACED	320 X 200 	640 X 200 
INTERLACED	320 X 400 	640 X 400 

video is a bit coarser than this, but viewed from a distance, the TV picture looks smooth and realistic (but not as sharp as a frame of modern 35mm film, which has almost imperceptible grain). In numerical terms, the Amiga can produce an overall screen resolution that exceeds the quality of video in some measures, but not in others. At the maximum picture height (768 pixels, see over-scan, below), the Amiga offers more than 550 lines of horizontal resolution, better than any VCR. But Amiga images still look course and blocky compared to the typical video image—more so in the Amiga's lower resolution screen formats (see below), but still quite noticeable in the higher ones. Diagonals and curves are particularly jagged, as you can see in Figure 2-19. This phenomenon is known as *staircasing*, *aliasing*, or simply *the jaggies*. This is what gives the computer images that familiar digitized look. Mainly, the jaggies are the result of the limited number of colors available on the Amiga screen (see below for more on color): video's millions of colors give it a smoother, more lifelike appearance.

Another method of measuring video resolution is the *nanosecond measurement*. This expresses resolution as the amount of time needed to display a pixel, in nanoseconds (billionths of a second). The smaller the measure, the finer the resolution. For example, you'll see dedicated character generators offering 35 nanosecond

Figure 2-19. Jaggies



Table 2-1. NTSC Amiga Screen Formats

Format	Pixels	Onscreen Colors
Lo-Res	320 × 200	2,4,8,16, or 32
Interlace	320 × 400*	2,4,8,16, or 32
Med-Res	640 × 200	2,4,8, or 16
Hi-Res Interlace	640 × 400*	2,4,8, or 16
Extra-Halfbright	320 × 200	4,8,16,32, or 64
	320 × 400*	4,8,16,32, or 64
Hold and Modify (HAM)	320 × 200	4096
	320 × 400*	4096
Overscan (extreme) (works with HAM and Extra-Halfbright)	384 × 240*	2,4,8,16, or 32
	384 × 480*	2,4,8,16, or 32
	768 × 240*	2,4,8, or 16
	768 × 480*	2,4,8, or 16

*Preferred for video

(35ns) resolution. This is about twice as good as the Amiga can offer. (But that doesn't make the Amiga a bad titling engine.)

Screen Formats. Just to make things complicated, the Amiga offers a multiplicity of built-in *screen formats*. Each format or display mode is characterized by a predetermined number of pixels, a certain pixel size, and a maximum number of onscreen colors. Table 2-1 lists all the currently available Amiga screen formats.

As you can see from the table, there are four main screen formats—*lo-res*, *interlace*, *med-res*, and *hi-res*—with a variety of colors available in each format. The lo-res format creates the coarsest, most digitized look. In hi-res, there are four times as many pixels on the screen as in lo-res, and the pixels are one-quarter the size, yielding the greatest resolution and the finest grain. In both of these formats, the pixels are roughly square in shape. Interlace and med-res put the same number of pixels on the screen, but the pixels are shaped differently—squat and wide in interlace, high and narrow in med-res. Note that a rectangular pixel can lead to odd distortions in pictures—all things being equal, square pixels are best.

Interlace. That's not all you need to know about screen formats, though. You need to consider the matter of interlacing. As you saw above, composite video consists of two interlaced fields. The Amiga offers interlaced screen formats as well—interlace and hi-res—and these are the ones you should use when creating graphics for DTV, as they are more compatible with NTSC stan-

dard video. Workbench 1.2 and 1.3 include an option in Preferences to turn on Workbench interlace. Public domain programs such as *SetLace* do the same thing. In addition, most DTV programs allow you to work directly in the 320×400 or 640×400 interlaced screen format. In general, it makes sense to use the 320×400 interlaced format rather than the 640×400 hi-res format because you can use more colors—up to 64 onscreen at the same time. (See below for more on color.) A number of recent programs even display any screen format, not just interlace or hi-res, in an interlaced mode. In essence, these programs send each line of pixels to the screen twice, meaning you can use the format of your choice for DTV and get good results.

One problem with the interlaced formats is that they generate a noticeable flicker on the Amiga's monitor, especially along horizontal lines, that many people find irritating. This flicker is not visible on videotaped Amiga graphics, though, so it's no problem for DTV applications. The flicker can be masked with an inexpensive mesh that fits over the monitor screen, or by a plug-in card (see Appendix B) that doubles the interlace refresh rate and generates a flickerless picture on multisynchronous monitors. Those programs that can generate an interlaced picture in lo-res and med-res, however, offer a better-than-standard picture. Because each line is sent to the screen twice, the thin, dark spaces between the lines are filled, yielding a clearer, sharper picture with more saturated colors.

Extra-Halfbright. Three screen formats need additional explanation. *Extra-halfbright* adds up to 32 additional colors; these colors are derived by the Amiga from base colors in the color palette, but are half as bright as those colors. This mode works only with Amigas containing the extra-halfbright chip, which excludes some early-model Amiga 1000s.

HAM. *Hold-and-modify (HAM)* can display all the Amiga colors on the screen at once, yielding stunning images, but there's a catch. In HAM, pixel color is dependent on the color of adjacent pixels; it can take up to three pixels to get from a color to its complement, so sharp color transitions are often impossible. That's not a terrible problem with video images, however, since sharp, contrasting color borders will just crawl and otherwise look bad on the typical TV anyway. HAM pictures do take up more memory and more disk storage space, as well as loading and sav-

ing more slowly. There's more on using HAM paint programs in Chapter 6.

Overscan. The last Amiga mode you need to know about is *overscan*. Most Amiga graphics, as you'll notice, leave a thick black border around the image area. For example, a 640×400 hi-res image leaves unused more than 100 pixels along the horizontal axis and 80 along the vertical axis. For video applications, this border is undesirable—viewers want their desktop videos to fill the entire screen, just as broadcast programming does on ordinary TV—so programs that don't offer overscan are not really suitable for DTV.

An increasing number of DTV programs provide a way around this by offering an overscan mode. Essentially, overscan makes the border pixels available for imaging. Not all programs offer the same degree of overscan, however. Table 2-2 lists the popular overscan formats used by several programs. The optimal dimensions are 384×240 pixels for the lo-res mode, 384×480 pixels for the interlace mode, 768×240 pixels for med-res, and 768×480 pixels for hi-res. Make sure the animation and paint programs you use supply the most "extreme" overscan; otherwise black borders will appear in your videos. Note that using extreme overscan will slow down animation programs, and graphics in general will take up more memory and storage space (because there's more pixel information per picture to store).

Amiga Color

The Amiga, and every other personal computer, generates color graphics using a digital RGB (Red-Green-Blue) component color video system incompatible with analog composite video. The Amiga can generate 16 levels of red, 16 levels of green, and 16 levels of blue; these can be mixed in any combination to create a maximum palette of 4096 ($16 \times 16 \times 16$) colors. That seems like a lot of colors (and it is), but it doesn't begin to compare with the millions of colors possible on an ordinary television screen. Moreover, in most screen formats you can't display the full range of Amiga colors onscreen at the same time, as you can see from Table 2-1. Only the HAM mode allows all available colors to be on the screen at once, but, as mentioned above, HAM has a number of rendering limitations that make it difficult to use for some applications, like painting. (When you plan your DTV production,

**Table 2-2. NTSC Overscan Screen Dimensions
(in Pixels)**

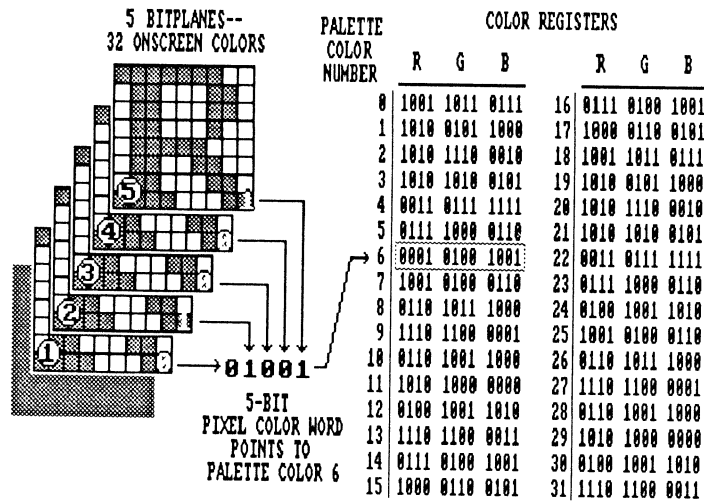
	Medium Overscan	Extreme Overscan
Lo-Res	352 × 200	384 × 240
Interlace	352 × 440	384 × 480
Med-Res	704 × 220	768 × 240
Hi-Res	704 × 440	768 × 480

keep in mind that the Amiga graphics part of it will not look as realistic as the composite video part. That's not a problem for most applications, such as titling, which require only a few colors.)

Bitplanes. The Amiga uses the *bitplane* system of creating colors on the screen. Think of the Amiga display as being composed of layers, with each layer doubling the number of colors available onscreen. Using one bitplane, just 2 colors are available from the 4096-color Amiga palette. Using 2 bitplanes makes 4 colors available; 5 bitplanes yields 32 colors (2 to the fifth power). The pattern breaks when you get to the sixth and final bitplane, which is used for HAM and extra-halfbright images, making it possible to show more of the Amiga palette onscreen. Figure 2-20 illustrates the concept of bitplanes.

Another way to approach the concept of a bitplane is to consider that each bitplane adds one additional bit to the length of the digital "word" that specifies the color of any pixel. For example, in a one-bitplane display, the pixel color word can only be one bit long, so it can have only two possible states, 0 or 1, black or white. A two-bitplane display offers four possible states (2 to the second power), each of which can be assigned a color—00 for black, 01 for white, 10 for red, 11 for blue. The typical five-bitplane, lo-res Amiga display has a five-bit-long word, yielding 32 (2 to the fifth power) colors. Some Amiga DTV components are capable of boosting the Amiga's color capabilities beyond those built into the machine, making it possible to display images with as many as 24 bitplanes, color words as long as 24 bits, and up to 16.7 million colors (2 to the twenty-fourth) onscreen (assuming you've got a display with enough pixels—4096 × 4096—to show that many colors).

In most cases, you don't need to know (or care) how many bitplanes are being used for the display. The only time you need to be concerned is when you're running low on memory. In gen-

Figure 2-20. Bitplanes


eral, the more bitplanes the display is using, and the more bits required to specify the color of each pixel, the more memory is required. Some DTV programs allow you to choose fewer bitplanes (fewer colors) to free up memory for other things, such as animation.

Color Registers. One more thing you'll need to know about Amiga color is the concept of *color registers*. Basically, these are places in memory where color information is stored. In the Workbench's four-color display, for example, there are four color registers, one for each of the available onscreen colors. For convenience these are given numbers, from color 0, the first register, to color 3, the last. Color 0 is the background Workbench blue, and it's usually the default background color in any graphics program. Color 0 is particularly important in DTV post-production; see Chapters 3 and 5.

Chapter 6 has more on video and computer color, including tips on the best colors to use for graphics.

Interfacing the Amiga with Video

All Amigas output a video signal through the RGB port in the rear, where the monitor is usually connected. The Amiga creates an RGB signal of the analog type (there's a D/A converter in there transforming the digital information to analog) that drives an analog RGB monitor (a type similar to that used by the Mac II but

unlike the digital RGB monitors used by IBM-compatible machines). This analog RGB signal, it cannot be emphasized too often, is not compatible with composite video, so it is unusable by any normal video equipment—but that’s the only signal where the really high-quality Amiga image information is available. So for DTV, the essential trick is to get composite video into and out of the computer.

Getting video out of an Amiga 1000 isn’t hard—the machine has a composite video out jack right in the back. (A2000s, A2500s, and A500s do not.) You can use that output to record directly to a VCR. But the video that comes through isn’t of very high quality. A1000s produce a signal with a severe horizontal shift. Display an A1000 picture on a composite monitor, and you’ll see what that means. The picture will be off center, and no adjustment you can make will completely move it to the center. This is especially annoying in overscan mode, where you’ll see a black band along one side of the picture, and some of the picture will be pushed off the viewable area along the opposite side. A broadcast-quality proc amp (see Chapter 9) is the only thing that can really fix that horizontal shift. The direct A1000 video signal is also out of phase in relation to RS-170A specs, so you’ll be unable to record the color you see on the RGB monitor with real accuracy. (Actually, that is a general problem with converting RGB to video, just worse in the case of the A1000.) A proc amp, among other devices, (see Chapters 3 and 9) can fix this problem.

Another Amiga 1000 composite output problem is the signal’s chrominance level, which is set too high. This makes Amiga colors transferred to video look oversaturated (too intense), especially reds and magentas. The colors are noisy and wiggle at the edges. Running the Amiga signal through a proc amp and lowering the proc amp’s chroma adjustment helps this problem. But really, you’re better off bypassing that low-quality composite output altogether.

To get composite video out of the RGB port, you must purchase additional hardware that plugs into the port and outputs video that can be transferred to tape. This calls for a *composite encoder*, a device central to DTV. Similarly, you need other external devices to get composite video into the Amiga so you can mix video and graphics. No Amiga, or any other computer for that matter, offers a video-in jack. For that you need an *RGB encoder*, to convert composite video to analog RGB; a *genlock*, a device that

synchronizes one video source with another; and a *digitizer*, a device that captures video images and converts them to digital format.

The next chapter covers these and other devices in more depth, as well as showing how to acquire and set up a highly capable DTV studio.

Chapter 3

The DTV Studio

When you start exploring the idea of setting up your own desktop video studio, you'll find it's a jungle out there. Competing tape formats, incompatible software, computer peripherals galore—it's hard to find your way through the underbrush to the system you need, especially if your experience with either video or computers is limited. This chapter will describe the major types of hardware and software available and give you some tips on how to put a system together. For information on the audio side of video, see Chapter 8. For manufacturers and product descriptions of video and Amiga products, see Appendix A.

Ask These Questions

What do you want out of your DTV system? Will you be creating titles for existing video programming? Assembling original programs from footage you shoot on location? Making animations? Will sound be an important part of your programs? Does your system need to be compatible with any other system, either video or computer? What level of quality are you willing or able to purchase? Questions like these will help you define what your goals are, and thus what kind of DTV system you need. The more questions you ask beforehand, the less likely you'll be stuck later with a system that doesn't really meet your needs.

Amiga Hardware

The center of your DTV system is the Amiga. You can use any current Amiga for DTV, since they're all software compatible and, to some extent, hardware compatible. The Amiga 2000, and A2500, while more expensive than other models, offer internal ex-

pansion slots that make them more easily configured for higher-level systems. Many of the more sophisticated video components for the Amiga are only available as plug-in boards for the A2000/2500.

The standard Amiga analog RGB monitors—the 1080, 1084, 1084S, and other models, one of which you probably have bought or will buy with your computer—are excellent for DTV applications because they can be converted to composite operation with a flick of a switch. Thus they can do double duty as displays for the Amiga and as video monitors, though not at the same time. For a simple system, your Amiga monitor may be all the display you need. There's more on video monitors below.

To the basic Amiga setup you may want to add additional memory, mass storage, a faster processor, a drawing tablet, and a printer. Nearly all DTV software, especially animation software, works better with more than 512K of RAM in your computer. Additional RAM also makes it easier to run several programs at once, such as a paint program, an animation program, and a DTV production program, which really can speed production. While the cost of memory has risen sharply in recent years, it's still a good idea to buy as much memory as your budget will allow, since software memory requirements are on the increase as well. Consider 1MB of RAM as the absolute minimum requirement, and 2MB as the minimum for professional applications.

For file storage, you need at least two floppy drives; most DTV programs will not run with only one disk drive in your system. A Winchester hard disk or a "megafloppy" removable mass storage device is highly recommended. For elaborate animations, which can take up a lot of disk space, a hard disk is a necessity. It's amazing how much time you can save when you don't have to switch disks and wait ages for your programs and files to load. Running the Amiga operating system version 1.3 or greater will also speed file access.

Another piece of equipment you'll want to consider for your Amiga is an *accelerator board*. This contains a faster CPU chip—a 68020, 68030, or a 68000 running at higher speed than the 68000 or 68020 that comes with the computer—and may also have a math coprocessor chip that speeds repetitive calculations. An accelerator board is something of a luxury unless you plan to create a lot of 3-D graphics, where a board may speed rendering 200 to 400 percent over a standard Amiga. Definitely get an accelerator if you'll be doing a lot of ray-tracing (see Chapter 7).

Drawing tablets (also called graphics or digitizer tablets) are supplementary data entry devices designed for freehand drawing. The tablet is a large rectangle with embedded sensors that register the position of a stylus or puck (a kind of mouse) moved over it. Software running on the Amiga reads the signal from the tablet and moves the screen pointer accordingly. If you are an artist or animator, you may prefer a tablet over the mouse for drawing because you can make the same kind of sketching motions you'd use with a pencil, pen, or brush (although a mouse is perfectly fine for drawing and painting). You can also trace over existing drawings with a tablet, something that's impossible with a mouse.

A printer isn't really an integral part of most DTV operations, except for printing scripts, contracts, budgets, and storyboards produced with word processors and paint programs. If you have to hand a lot of professional-looking paper documentation to clients, a laser printer is probably worth the investment.

Finally, be sure you're running the latest version of the Amiga system software and have upgraded to the latest ROM and graphics chips offered by Commodore. These will significantly increase the performance of your Amiga over the older versions.

DTV Hardware

DTV hardware comes in two categories—general video equipment that can be used with or without a computer, and Amiga-specific devices that connect directly to the machine and mediate between the analog and digital worlds. We'll cover basic video equipment first, and then look at specialized Amiga devices.

When evaluating video equipment, keep in mind that the industry classifies components into three levels:

- *Broadcast*. Professional video equipment that yields top-notch imagery, with prices to match. For pros only.
- *Industrial*. Ruggedly built units with good image quality, but not as good as broadcast. Prices are correspondingly lower. Good for serious individuals and small companies.
- *Consumer*. Video equipment built with price rather than image-quality in mind. At the high-end of the consumer market, however, you may find components that match industrial quality.

VCRs

After the Amiga in system importance comes the video cassette recorder. A VCR can store immense amounts of image and sound information, far more than is possible even on the largest Amiga hard disk, and lets you easily distribute your work for viewing wherever there is a compatible VCR. This is the component on which you'll probably be spending the bulk of your system budget.

In the beginning there was only one kind of VTR (Video Tape Recorder)—*quad*, with 2-inch-wide recording tape, transport and signal components that occupied the space of a washer-dryer combo, and a vacuum system to keep the heavy, wide tape tight on the recording heads. You can still find quad machines tucked away in the corners of network editing rooms, gathering dust. They've been superseded by the many current VCR formats, differentiated primarily by the width of the recording tape—1-inch, $\frac{3}{4}$ -inch, and so on. Each major format is electronically compatible with the others. As long as they all adhere to the same television standard, such as NTSC, you can record from one format to any other by running a cable from the video-out jack of one machine to the video-in jack of another. However, the formats are mechanically incompatible—you can't play a $\frac{1}{2}$ -inch cassette in a $\frac{3}{4}$ -inch VCR, for example, or vice-versa. Within each format there are an increasing number of subdivisions and choices, some of which are also incompatible with the others. Here's a guide to the current formats.

1-inch

This is what the big boys and girls play with—the VTR format used by the networks and big production houses. One-inch VTRs are strictly *broadcast-quality*, offering the highest available horizontal resolution and the best available color purity. There are two subformats: Type B and Type C, with Type C the dominant format in the U.S. Nearly all big-budget work is edited on open-reel, 1-inch, Type C equipment because it offers the best video quality and interfaces with the widest range of computer controllers and digital effects machines.

With 1-inch decks costing several tens of thousands of dollars (not to mention all the support equipment and technicians

needed to run them), it's unlikely you'll be buying one for your DTV productions. However, should you ever land a professional project with a budget to match, 1-inch is the currently the best way to go. Note that time in editing rooms equipped with 1-inch equipment costs several hundred dollars an hour (see Chapter 9 for more on stepping up to broadcast).

$\frac{3}{4}$ -inch

The $\frac{3}{4}$ -inch cassette format (or U-Matic, as its inventor, Sony, calls it), is the format of choice for field recording and lower-cost professional editing. Professional-end $\frac{3}{4}$ -inch recorders offer true broadcast quality and can be operated by broadcast computer edit controllers. Three-quarter-inch decks also come in an industrial grade, which may be within your budget. Industrial $\frac{3}{4}$ is widely used by small production companies, corporate video studios, and video artists, and it's still a popular format for distributing programming, especially news, technical, medical, and scientific programs. If you have professional plans, and a moderate budget for equipment, look into $\frac{3}{4}$ -inch. It's possible to purchase good-quality used or reconditioned machines at significant discounts. You won't be missing much in technical innovation by buying an older deck, since the U-Matic technology hasn't changed significantly in the last five years.

The standard $\frac{3}{4}$ -inch cassette is about the size of a hardcover book and records 30 or 60 minutes. Portable $\frac{3}{4}$ -inch VCRs use smaller 5-, 10-, or 20-minute cassettes that can be played on tabletop machines as well. Look for the letters KCS, KCA, UCS, or UCA (for example, KCA-60) in the tape name to identify it as a $\frac{3}{4}$ -inch tape; MBR or XBR in the name means the tape is of extra-high quality and meant to be used as a broadcast master.

Three-quarter-inch offers 260 or 270 lines of horizontal resolution, good color fidelity, and two channels of audio. The recently introduced U-Matic SP component format offers improved resolution—300 lines—while remaining compatible with all older $\frac{3}{4}$ -inch equipment. The letters SP appear in the name of SP tapes. Standard or SP, portable $\frac{3}{4}$ -inch equipment is big and heavy, requiring a separate deck operator and carrier on location productions (see Chapter 4).

$\frac{1}{2}$ -inch

The $\frac{1}{2}$ -inch market is divided into two camps, Beta and VHS. These use different size cassettes and different tape-transport configurations, so VHS tapes cannot be played in Beta machines and vice versa.

VHS. By far the most popular $\frac{1}{2}$ -inch consumer format is VHS. The VHS cassette is about the size of a paperback book; the typical T-120 tape lasts two hours at the fastest VHS speed (SP) and six hours at the slowest speed (EP). Although VHS VCRs and camcorders are relatively cheap and easily obtainable, VHS picture quality is relatively poor, with 240 lines of horizontal resolution, fuzzy color, and low-fidelity sound. Decks with VHS-HQ (high-quality) and hi-fi yield somewhat improved video and much better audio, and are worth the additional investment. Industrial-quality VHS systems are also available with heavy-duty tape transport systems and slightly better video specifications; these can be used for offline editing (see Chapter 5). VHS is now the most-used format for distributing video programming.

Most VHS camcorders use a variant format called VHS-C. The VHS-C cassette is smaller and records only 20 minutes. It can be played in standard VHS decks with a cassette adapter.

Super-VHS (S-VHS). This is an enhanced version of VHS, with better color purity and over 400 lines of horizontal resolution—not quite broadcast quality, but a lot closer than ordinary VHS. The higher resolution is achieved by splitting the chrominance part of the video signal from the luminance part so each can be processed optimally. This requires a split connector called a *Y/C connector* on any equipment used in an S-VHS system, if the full resolution of the S-VHS picture is to be maintained. If you choose S-VHS, you'll need to purchase an S-VHS camcorder and/or an S-VHS VCR, an S-VHS compatible monitor, and specially formulated S-VHS tapes. S-VHS is downward-compatible with ordinary VHS—that means you can play VHS tapes on an S-VHS machine, but not vice versa.

S-VHS is overtaking $\frac{3}{4}$ -inch as the preferred format for small producers and dedicated videophiles. Although it's more pricey than regular VHS, it is much less expensive than $\frac{3}{4}$ -inch and yields better-looking pictures.

M-II. This is the broadcast VHS format, using component video to gain superior image quality. Because it's smaller and

more convenient than U-Matic SP or 1-inch while offering comparable quality, it may ultimately replace the big formats for professional field recording. At least one network has already adopted M-II as its preferred in-house format. MII camcorders are beginning to appear for the broadcast market as well.

Betamax. Betamax was the first consumer $\frac{1}{2}$ -inch cassette format and enjoyed several years of popularity before being hammered in the market by the competing $\frac{1}{2}$ -inch format, VHS, which is mechanically incompatible with Beta. Currently, Betamax machines are manufactured only by Sony. Because standard Beta machines are getting very hard to find, as are blank Beta tapes, you should think carefully before buying a Beta deck. You can find good deals on discontinued models, though.

Standard Betamax machines offer a picture resolution slightly better than VHS (240–50 lines) and much smoother tape transport. There are three Beta speeds, Beta 1 (which most consumer decks can play but not record), Beta 2, and Beta 3. The Beta Hi-Fi and SuperBeta versions offer better sound and video quality; there is also an industrial Beta line that can record in the high-quality Beta 1 speed.

ED (Extended Definition) Beta. This is Sony's bid to recapture some of the consumer $\frac{1}{2}$ -inch VCR market. ED-Beta offers higher resolution—500 lines of horizontal resolution—and sharper color than S-VHS. Like S-VHS, ED-Beta is a component format that requires compatible equipment with a special Y/C connector. It is downward-compatible with older Beta equipment and tapes. ED-Beta equipment is pricey, but still cheaper than $\frac{3}{4}$ -inch, and it yields video of near-broadcast quality.

Betacam. Betacam, the Betamax broadcast-quality format, is used in broadcast camcorders manufactured by Sony. It came out several years earlier than MII and has a solid foothold in the broadcast market. Like MII, it's a component format. Lightweight Betacam camcorders have been around a while and are favored for ENG (Electronic News Gathering).

8mm

8mm, the newest tape format, offers $\frac{1}{2}$ -inch video quality in a compact package. 8mm tape is about half the width of $\frac{1}{2}$ -inch, and 8mm cassettes are only a little larger than audio cassettes. This makes for small VCRs and camcorders, an important consideration for field production. On the other hand, 8mm cassettes last

only two hours, so they're not much used for recording off a TV or distributing movies and other programming. Since 8mm is supported by a number of manufacturers, including Sony, Sanyo, and the major Japanese camera manufacturers, it's likely to be more successful than Betamax.

8mm sound quality is far better than that of most $\frac{1}{2}$ -inch decks—in fact, an 8mm VCR makes an excellent audio cassette recorder with audio quality near that of CDs or DAT (Digital Audio Tape). Most 8mm decks also sport flying erase heads (see below), which aid in creating smooth edits. The latest wrinkle in industrial 8mm is a compact videotape editing system consisting of a single unit with two built-in VCRs, a monitor, a keyboard, and an on-board edit controller computer. Sony has introduced a hand-held 8mm VCR-color monitor combo that would be handy for location production (see Chapter 4).

8mm Hi-band. This new 8mm format, also called Hi8, is roughly equivalent in quality to S-VHS and ED Beta. It features an expanded high-frequency band for the luminance part of the signal, offering a theoretical 400-plus lines of horizontal resolution if recorded and viewed with the proper equipment. 8mm Hi-band is downward-compatible with earlier 8mm equipment.

Camcorders

Camcorders, combination video cameras and VCRs, are available in all the above formats except 1-inch and $\frac{3}{4}$ -inch. Camcorders are discussed in their own section, below.

Table 3-1 gives the tape types, lengths, recording speeds, and running times for the $\frac{3}{4}$ -inch, $\frac{1}{2}$ -inch, and 8mm VCR formats.

Choosing a VCR

Choosing the right VCR is crucial for obtaining the level of video quality you need for your programming. While any VCR can record your work, a high-end VCR can be a creative tool in itself. If you already own a VCR or camcorder, use what you have, at least until you're no longer satisfied with what it can do. If you're planning to purchase one especially for DTV work, get the very best machine you can afford—if possible, an industrial-quality or even broadcast-quality deck. Here are some things to consider:

- Buy the format appropriate to the task. If you'll be making tapes primarily for your own enjoyment, and you don't have a

Table 3-1. Formats, Tape Speeds, and Recording Times

Format	Tape Speed (in inches per second)		
U-Matic	3.75		
Cassette	Recording Times		
KCS-5	:05		
KCS-10	:10		
KCS-20	:20		
KCA-30	:30		
KCA-60	:60		
Format	Tape Speed (in inches per second)		
VHS	SP	LP	EP
	1.32	.66	.45
Cassette	Recording Times		
T-20	:20	:40	1:00
T-25	:25	1:00	1:25
T-40	:40	1:20	2:00
T-60	1:00	2:00	3:00
T-80	1:20	2:40	4:00
T-100	1:40	3:20	5:00
T-120	2:00	4:00	6:00
T-160	2:40	5:20	8:00
Format	Tape Speed (in inches per second)		
Betamax	Beta I	Beta II	Beta III
	1.54	.79	.45
Cassette	Recording Times		
L-125	:15	:25	:45
L-250	:25	1:00	1:25
L-370	:45	1:25	2:15
L-500	1:00	2:00	3:00
L-750	1:25	3:20	4:25
L-830	1:40	3:20	5:00
Format	Tape Speed (in inches per second)		
8mm	SP	LP	(playback only)
	.56	.28	
Cassette	Recording Time		
Standard 8mm	2:00	3:00	

lot of money to spend, buy a good $\frac{1}{2}$ -inch consumer machine. If you'll be trading tapes with your friends or associates, buy what they have—probably VHS. The 8mm camcorders are the smallest and lightest, so if you'll be doing a lot of field work, consider getting one of those. If you plan to do semiprofessional work, S-VHS, ED-Beta, or $\frac{3}{4}$ -inch are the formats to



Plate 1. Neon with custom type styles and fonts.



Plate 2. A station ID graphic made with Deluxe Paint III KaraFont.

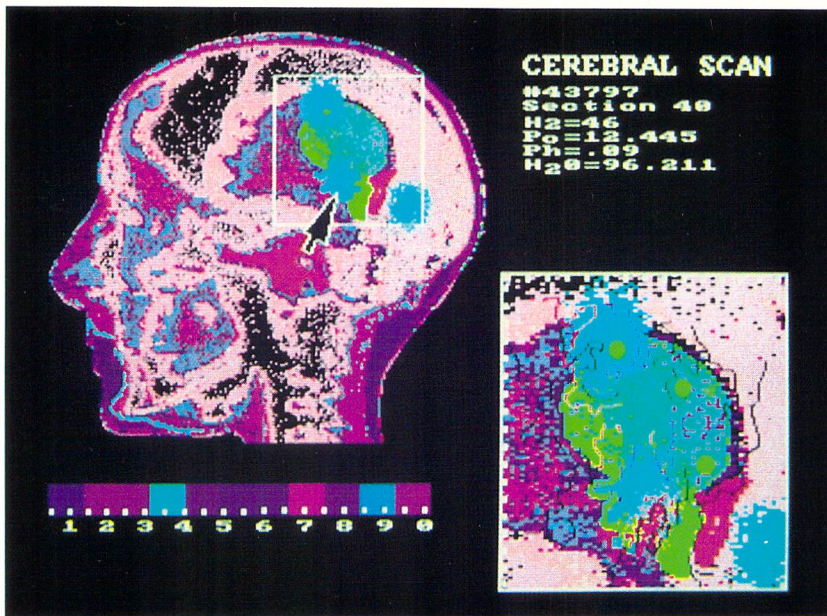


Plate 3. An MRI scan digitized with Digi-View and animated with a custom pointer, created in a paint program.



Plate 4. A Digi-View scan processed in false color with Butcher 2.0.

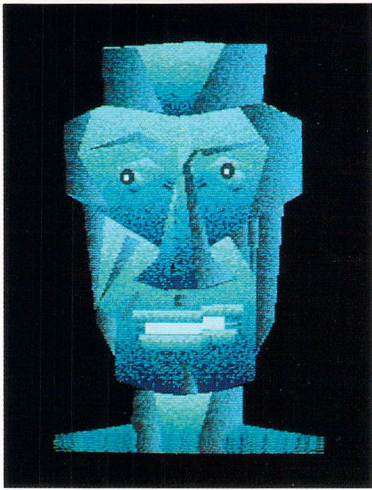


Plate 5. *An Amiga graphic with a background of color 0.*



Plate 6. *The same graphic genlocked onto a video feed-back pattern, which appears in the color 0 pattern.*

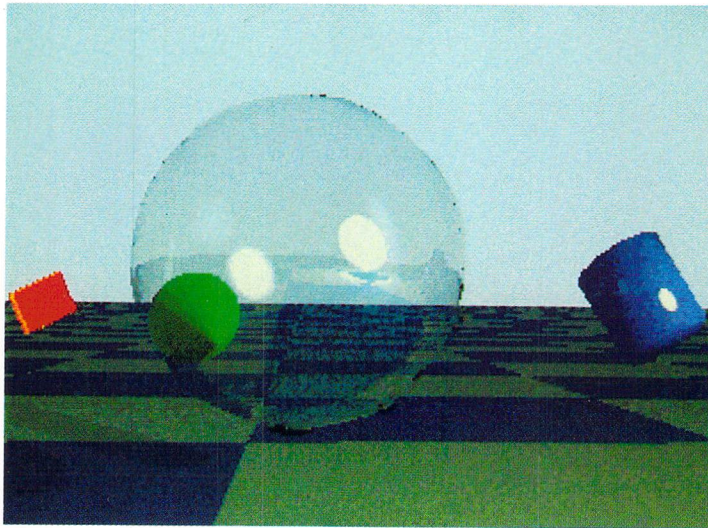


Plate 7. *Ray-traced scene created with Sculpt-Animate 3D.*



Plate 8. *Title and graphics genlocked over taped video.*

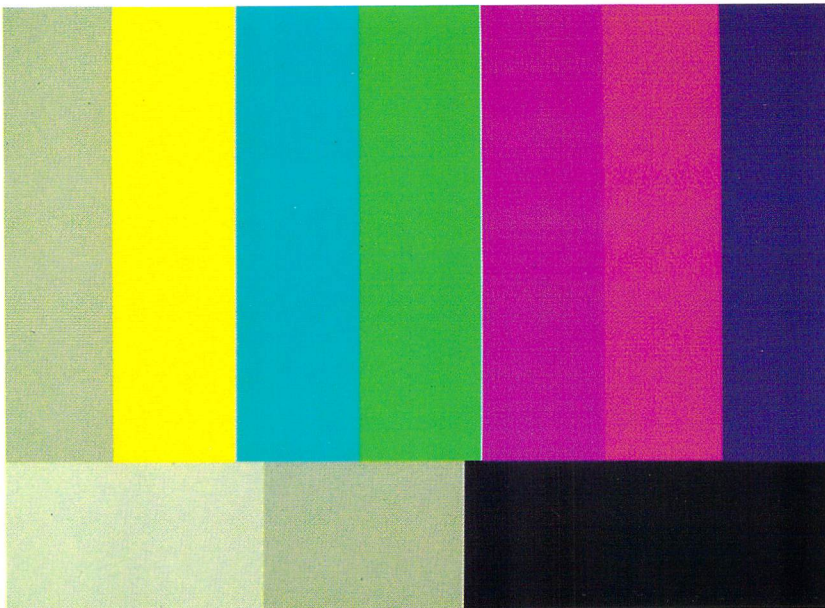


Plate 9. *A close approximation of NTSC color bars created with Deluxe Paint III.*



Plate 10. A bar chart for a business presentation.

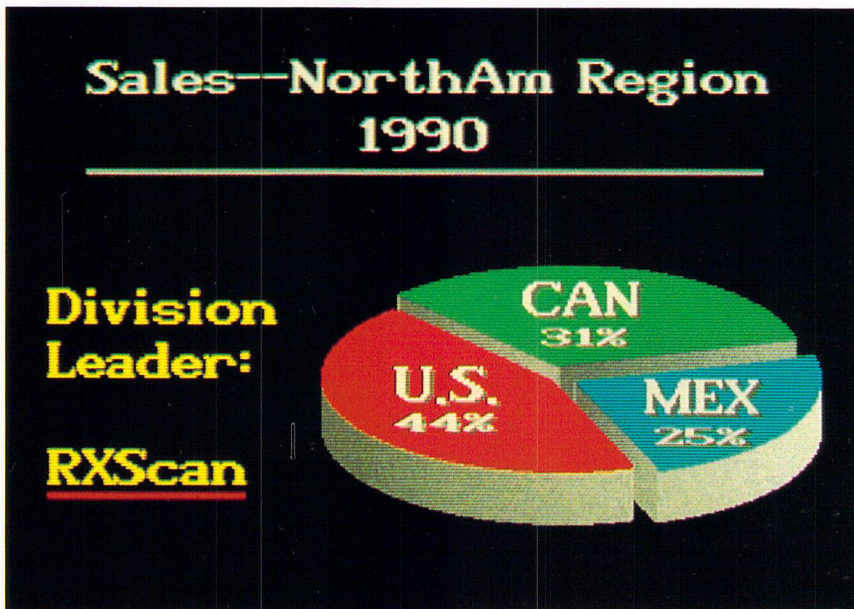


Plate 11. Another business graphic created with a paint program.



Plate 12. A portrait digitized with Digi-View, with text added; pictures like these can be accessed with a picture database program like MicroFiche Filer.

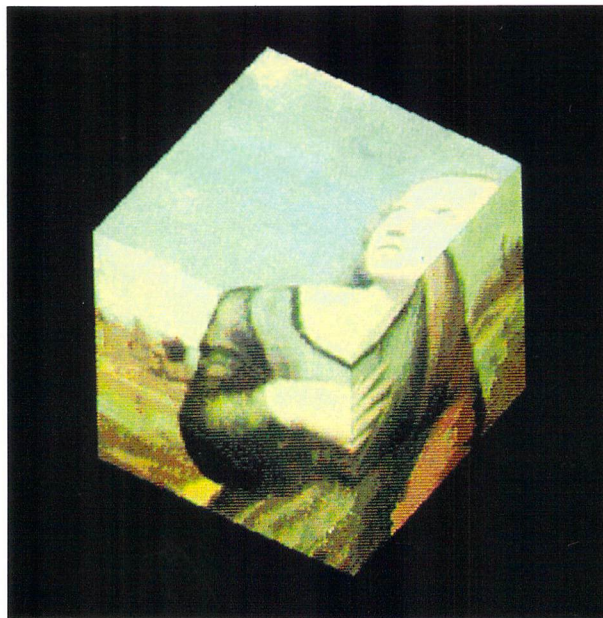


Plate 13. A digitized image mapped onto the visible faces of a cube. Similar to the effects possible with a digital video effects device.

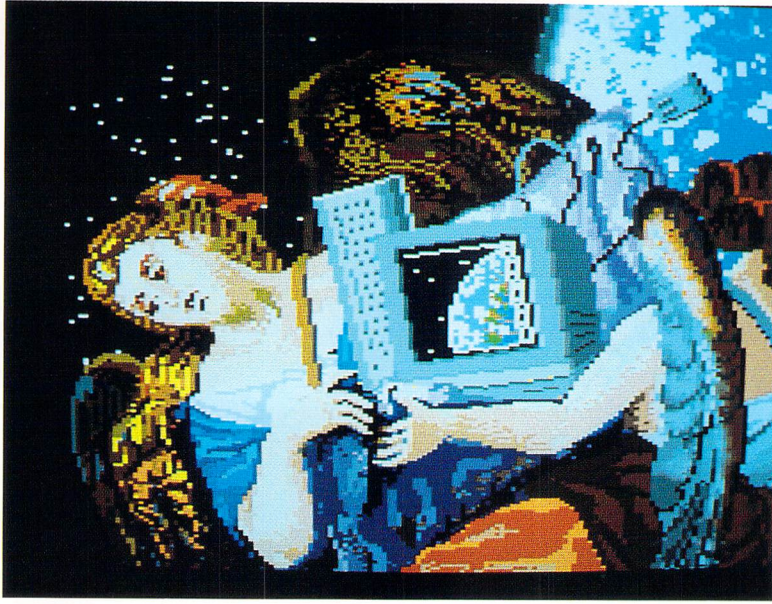


Plate 14. Part of a painting created in extra halfbrite mode.



Plate 15. A product graphic, created with Photon Paint, a HAM program, to be included in an animatic.

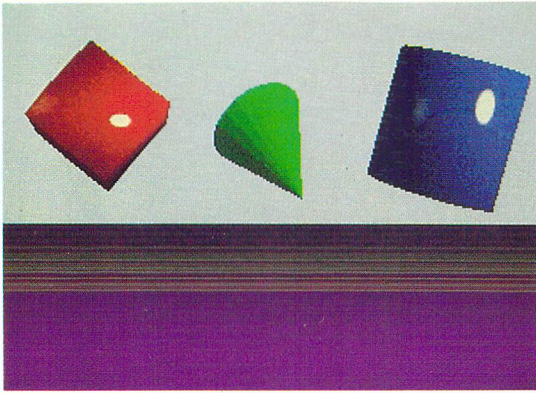


Plate 16. One frame in a 3-D animation.

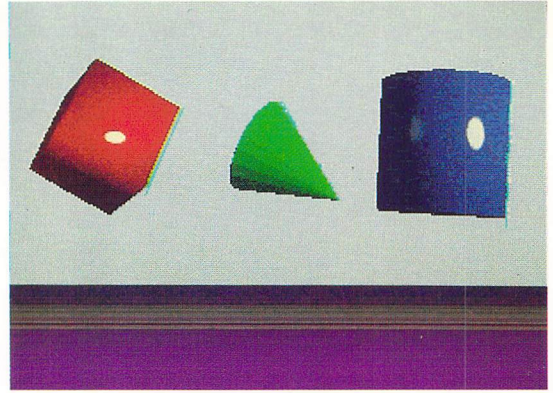


Plate 17. Another frame in the same series. The objects are rotating around their centers of gravity, while the observer's viewpoint moves up.

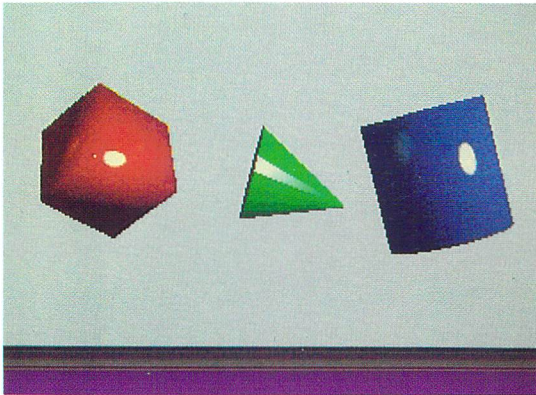


Plate 18. More rotation and vertical movement.

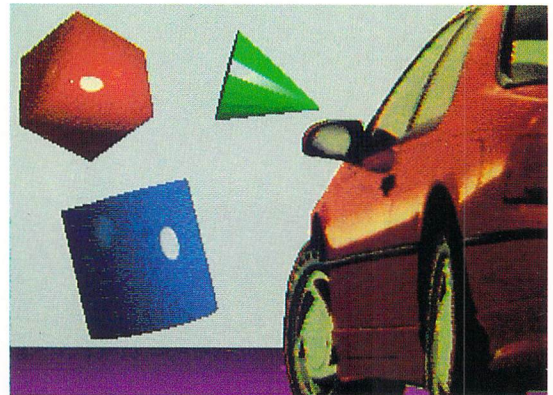


Plate 19. Objects move left and a HAM car (not a 3-D object) enters from right.

choose, with $\frac{3}{4}$ -inch the semipro format of choice. There are no $\frac{3}{4}$ -inch camcorders, but there are many S-VHS and ED-Beta models to choose from. Portable VCRs (still available for $\frac{3}{4}$ -inch and the other professional formats, but rapidly being replaced by camcorders in the consumer realm) may be a good bet for field use, especially if you already own or have access to a video camera.

EDITING
V.C.R.

- Buy an editing VCR. These high-end machines have a wealth of additional features, including the ability to perform frame-accurate insert edits (see Chapter 5), edit marking and random-access searches, digital special effects, and more. Check that the VCR has flying erase heads. These are tape heads in a VCR that erase tape with frame accuracy, yielding perfectly clean edits. Nearly all 8mm machines are now equipped with flying erase heads, as are the better $\frac{1}{2}$ -inch editing VCRs. Editing VCRs can often be slaved to an edit controller (see below) for more convenient editing. Although many camcorders now include editing features, tabletop decks are best for regular editing use—their tape transport subsystems are sturdier and will last longer under the stop-and-start rigors of editing.
- VCRs with high-fidelity stereo sound can record a far greater audio range. You'll want two audio channels on your VCR in case you ever want to add time code (see Chapter 9). An *audio dub* feature allows you to record new audio over one audio track without disturbing the video tracks—convenient for quickly adding narration or music to a tape.
- The back panel should be fully equipped with RF in and out (probably called TV or ANT in and out), composite video in and out (called LINE in and out), stereo audio in and out (two channels), five-pin remote, mike jacks, and possibly a camera jack. Industrial decks should use BNC connectors (see the end of this chapter for more on connectors).
- The front panel should have easy-to-understand and logically arranged controls. A jog-shuttle wheel gives better control of tape viewing speed. Look for a digital counter that shows seconds and frames, not a mechanical counter that displays arbitrary numbers on little wheels. Also look for VU or LED meters for audio and video levels.

- Special effects, such as freeze-frame and slow-motion, should yield a noise-free image. You'll find these most often in decks that offer "digital" special effects.
- VCRs with direct drive motors rather than belts and pulleys are more reliable and offer smoother and more accurate tape transport. When a direct-drive motor breaks, however, it usually has to be replaced, which is a lot more expensive than replacing a drive belt.
- A good remote control will make it easier to operate your Amiga and your VCR at the same time. A universal remote can control the remote functions of several different pieces of equipment—a VCR, TV, stereo receiver, and so on.
- A top-loading VCR will give you greater access to the inside of the machine should you want to clean the video heads or untangle a tape snarl. That's why the professional portables still load from the top. If your tape is jammed inside a front-loader, you can forget about getting it out unless you disassemble the VCR or get it to a service center. The downside of top-loaders is that they require a few inches of clearance above for the tape door to pop up. Consumer top loaders are getting hard to find as the industry shifts to front-loaders.

Tape Stock

In a field prone to alphabet-soup terminology, tape stock manufacturers are among the worst offenders. HD, HS, EG, SR, HGX, EXG, XL, HD-X and STD all designate "grades" of videotape produced by the major manufacturers. And only the manufacturers could be expected to remember what these acronyms mean. Once you've identified what format of tape you need (VHS or $\frac{3}{4}$ -inch, hi-fi or not, and so on), shopping for videotape is a matter of ignoring the ABC's and looking for these words on the box:

- The name of a well-known manufacturer, such as Ampex, Fuji, Maxell, Scotch, Sony, or TDK. These companies charge more for their tape, but it doesn't pay to risk your production with the cheaper Brand-X varieties.
- "Professional-quality" or "pro-grade," which usually means an improved magnetic coating, stronger tape backing, and more rugged cassette housing.

- “Broadcast” or “broadcast-quality” for tape at the top of the quality heap.

Avoid the tapes with the longest playing time, such as the T-160 (see Table 3-1). These have a thinner backing (so more tape can fit in the housing) and may be more fragile.

Tape quality is to some extent a subjective judgment, so it might pay to buy several roughly comparable tapes from different manufacturers and test each for color accuracy, picture clarity, dropouts (“snow” in the picture), and so on. Price is also a good indicator of tape quality—expensive tape tends to be superior to cheap tape, and similar tapes tend to be priced similarly. Always get the best stock you can afford. The cost of tape stock is usually a minor part of the total expense of a production. If you can, buy in bulk to save on the unit cost of cassettes.

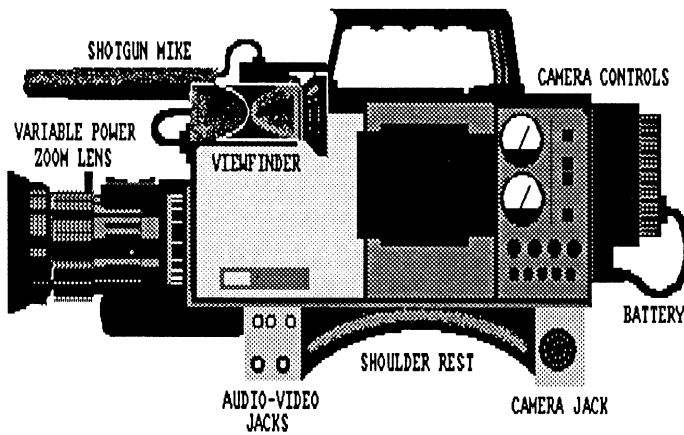
Cassettes are rugged, but not indestructible. Keep your fingers off the tape; don’t store them in hot cars, underwater, or near magnetic fields, such as those emitted by speakers, VCRs, and TVs; and store them upright, fully rewound, and in their dust jackets. Make a few copies of your finished tapes and store them in separate places. In fact, you should treat tape just like you treat your floppy disks—with respect for your irreplaceable programming.

Cameras and Camcorders

A video camera or camcorder is another essential piece of DTV equipment. With a camera, you can grab scenes from your world and incorporate them into your DTV productions.

Cameras come in two basic types: *standalone cameras*, and cameras incorporated into *camcorders*.

A standalone camera is a good choice when you need high-quality camera output—up to broadcast quality—and system flexibility. The higher-priced cameras yield better images than most camcorders do and can be teamed with any VCR, so you’re not limited to one VCR format or level of quality, as you are with some camcorders. Low-end industrial black-and-white cameras can be used with any VCR for digitizing (see below) and cost far less than camcorders. Standalones generally come with better lenses and can accept a variety of other lenses, microphones, and accessories. More expensive models can be converted from field use to studio use, and even controlled from a remote. The down

Figure 3-1. Color Camera

side is that a separate camera and VCR arrangement is more expensive than a camcorder, heavier and more awkward to transport, and may require two persons to operate. Figure 3-1 shows a typical industrial color camera.

Camcorders are small, convenient, and available. For field use, you can't beat a unit that weighs two pounds, can be held in one hand, and needs no setting up to roll tape. The better camcorders are laden with features, including all the usual camera and VCR functions plus titling, special effects, electronic camera stabilizers, high-speed shutters (see below for more on these), and more. Better camcorders also offer *video-out*, so you can use the camcorder as a camera connected to a separate VCR. And camcorders can be bought just about anywhere. Consumer camcorders are relatively fragile, however, and not rugged enough for daily professional or semiprofessional use. Broadcast-quality camcorders are also available (in the Betacam and MII formats) but are very expensive.

Choosing a Camera

If you're considering a standalone camera, decide what you need it to do. Will you be using it in a studio? In field productions? Do you need a camera to scan flat art for digitizing? What level of quality do you need, and what can you afford? Does the camera have to interface with existing equipment?

Here are some features to look for:

Color or black-and-white. Consider a black-and-white camera *Closed-Circuit Television (CCTV)* camera, such as the Panasonic WV-1410, for use when digitizing or capturing images that will later be color-enhanced on the Amiga. CCTV cameras are small, light, and rugged, but need an AC power supply. For field work, use a portable color camera.

CCD versus tubes. Many broadcast and industrial cameras still use camera tubes instead of charge-coupled devices (see the previous chapter for more on CCDs) to pick up the image. Usually there are three tubes, one for each color, although some less-expensive cameras have only one tube. Tubes yield better images, but they are fragile, need to be periodically aligned, and can be “burned” by too much light (for example, if you point the camera at the sun or a floodlight). A CCD camera is recommended—they are rugged, lighter, need less maintenance, can’t be burnt, and make for smaller cameras. Look for a CCD pixel count of at least 250,000.

High resolution. Broadcast cameras yield 525 lines of horizontal resolution or better. Four hundred lines is still good quality, and suitable for DTV. A standalone camera that yields under 300 lines is probably not worth getting.

Light sensitivity. Video cameras don’t record well in poor light. The minimum illumination for a camera is usually given in *lux*, with some cameras claiming to provide decent images down to ten lux or under. This is very little light, and the images won’t be very good even with a top-quality camera. You may be able to adjust the *gain*, or light sensitivity, of the camera, but the higher the gain, the noisier the image.

A good lens. Zoom lenses are standard on video cameras (except CCTV cameras), and, at the high end, can cost 20 percent or more of the entire camera cost. Look for a brand-name lens (Canon, Vivitar, Zeiss, and so on) with a zoom ratio of 6:1 or better; 12:1 zooms are available. (The higher the left number in the zoom ratio, the more range between the wide angle and the telephoto ends of the zoom.) Lens *speed* (the amount of light a lens allows into the camera) is also important. An *f*/1.2 lens is “faster” than an *f*/2.0 lens, and to be preferred for low-light shooting. Make sure the camera has a standard *c-mount* so you can change to other lenses (such as lenses for 16mm film cameras). Look for a *variable zoom* that will zoom in faster when you want to and

slower when you don't. A *macro* feature lets you focus up close to small objects to get magnified images, useful for digitizing.

Auto-aperture. This feature automatically adjusts the iris of the lens to allow the optimum amount of light into the camera, saving you the trouble of setting the iris yourself. A manual iris adjustment gives you greater control in odd lighting situations.

Auto-focusing. An auto-focus lens uses a sonic or infrared rangefinder to determine the distance to the subject, usually the object in the center of the viewfinder. A chip tells the lens motor how far to twist the lens so the subject will be in focus. Auto-focus is very convenient, making it possible to just point and shoot in a wide variety of conditions, but most auto-focus mechanisms can't cope well with quick changes in lighting when you're shooting fast-moving objects (as might be encountered when shooting sports events) or with two objects at different distances that must both be in focus. Most higher-priced standalones do not come with auto-focusing lenses; nearly all consumer camcorders do. Make sure the camera has a manual focus override.

Full color controls. These include a *white balance* adjustment, to set the white level for each lighting condition you encounter; a *lighting type* adjustment, for setting the camera to work with tungsten (incandescent) light, fluorescent light, or daylight; and a *color temperature control*, to set the amount of red or blue in the image. Newer cameras and most consumer camcorders take care of color adjustments automatically, but you may want the ability to set them manually. Colors set by the camera's auto color controls should look clear, bright, and natural, even down to relatively low light levels.

An electronic viewfinder. This is the type that's actually a small video monitor, letting you see exactly what the camera sees (in black-and-white, anyway). All standalone cameras have them, but many less-expensive camcorders use optical viewfinders that are merely tubes with plastic lenses at each end that give you an approximate frame for the scene you're shooting.

A complete range of audio and video connections. This includes composite video out; a camera cable connection (for remote control of the camera from a matching portable VCR); two microphone-in jacks; one or two audio-out jacks; a headphone jack; a battery connection; and AC power. Some of these may be part of an AC power box separate from the camera itself.

A comfortable camera. The camera should be comfortable to handle, light in weight, and easy to operate, with conveniently placed controls.

Choosing a Camcorder

Most desktop videographers start with a good-quality camcorder rather than a standalone. When choosing a camcorder, you'll want to keep in mind the points raised in the sections on choosing a VCR and a video camera. But camcorders have additional aspects to consider:

- Match the camcorder to the intended use. Small, no-frills camcorders are best for traveling and occasional use; top-rated camcorders are best for semiprofessional applications. Add-ons like waterproof casings help the camcorder adapt to specialized uses.
- Don't feel that you must buy a camcorder that uses the same format as VCRs you may already have. The new super-formats (S-VHS, ED-Beta, 8mm Hi-Band) are well worth considering for their superior image quality. You can always copy tapes from one format to another.
- Don't pay for bells and whistles you don't need, like in-camera titling, digital effects, and so on. The Amiga is capable of better effects. A fade-to-black feature can be useful, however.
- Make sure the camcorder has a *flying erase head*. This means the camcorder creates glitch-free transitions between scenes as you shoot, making it possible to edit in the camcorder (see Chapter 4). You'll find flying erase heads in Beta and 8mm camcorders, less often in VHS units. Industrial and professional units always have flying erase heads.
- Camcorders with a *high-speed shutter* take better footage of fast-moving events, such as sports and action scenes. Otherwise this feature is not very useful.
- *Image stabilization* is available on some recent camcorders, notably those marketed by Panasonic. The stabilizer is a snout that

fits over the front end of the camcorder and smooths out jerky or inadvertent camera motion by moving the lens in a compensating motion. This can be a real help when you must move the camcorder as you shoot but don't have a steady hand or a Steadicam.

- Make sure the camcorder has video-in and video-out jacks—some don't. If you plan to use the camcorder as part of an editing system (see below), choose one that has the proper remote control jack for the edit controller. In that case, you'll probably want to stick to one brand for all your components—Sony, JVC, or Panasonic, for example.

Video Displays

You may also wish to purchase one or more video displays to supplement your Amiga monitor. The ideal setup is to have displays for every piece of equipment—the camera, computer, and VCR(s)—so you can see what's happening with each. This doesn't mean you must purchase expensive color monitors for every DTV component you own; a cheap black-and-white monitor can be quite adequate when all you want to do is position an object in the field of view of your CCTV camera. You can use any TV to monitor your VCR, just as you play tapes on the TV now. But to see the output of a camcorder, camera, or pro VCR, you'll want a color monitor with a composite video input. If you're planning to present your video to an audience, you want the best, biggest display you can find.

Video displays come in several types:

TVs. The traditional TV, still to be found at the low end of the video market, has a television tuner and amplifier but no provision for direct display of composite video. Video has to be converted (*modulated* is the technical term) to an RF signal for input through the TV's antenna terminals, then demodulated inside the TV for display on the screen. The set contains a minimum of controls, has a tiny monaural speaker, and requires AC power.

TV monitors. These are basically TVs with provision for accepting a composite video signal. Most higher-priced consumer TVs fall into this category. You may also find sets in this price range that offer stereo sound, high-quality picture tubes, full remote controls, and digital picture enhancements, such as displaying pictures from two sources at once. Some TV monitors have

Y/C-split connector jacks for connection to the new super format equipment. The current picture tube size limit for TV monitors (and any device using a CRT) is about 35 inches diagonal. Small battery-powered units with 5-inch screens are popular for monitoring field production.

Video monitors. These accept only composite input and are generally used by professionals. They're likely to provide the best picture and cost the most. Some monitors display RGB signals as well. Racks of two, three, or four black-and-white monitors can be purchased for use in a studio with many video sources.

Projection TVs. Instead of using a standard picture tube, projection TVs project the image through a lens or lenses onto a screen either in front or in back of the projector. The projected image can be quite large, up to 100 inches across or larger, and thus suitable for viewing by large audiences. But the picture is correspondingly dim, best seen from directly in front in a darkened room. Projection TVs tend to sport all the latest features and contain a full range of input and output options. They cost three to five times as much as a top-rated 26-inch CRT TV monitor.

LCD TVs. These tiny displays use liquid crystal technology to make possible flat screens 1½ to 4 inches in size. Display quality is poor, and only one person can watch the set at one time. If the set has composite video-in, and few do, it may be useful as a field monitor because of its small size and low weight.

Monitor VCRs. These combine a monitor and a VCR in one compact, portable package, useful when you need to make quick presentations. Sizes range from a handheld model with an 8mm deck to portable projection units with a built-in, full-sized VHS deck.

Computer displays. These generally accept digital signals only and can't be used directly with video equipment. The Amiga monitors are unusual in that they can be switched from displaying analog RGB to composite video, but it's possible to find other computer monitors that look better than the Amiga monitors and still offer composite input.

By the way, the Amiga 1080 and 10845 can be used as SVHS monitors. If you have a 1080, plug the luminance part of the Y/C cable into the video RCA jack on the back of the monitor, and the Chroma cable into the Chroma jack. Then set the video mode switch on the front to SEP. If you have a 10845, use the same jacks, but set the video mode switch to CVBS.

Choosing a Color Display

Picture, sound, connectivity, and controls are the most important aspects to evaluate when choosing a color display.

Monitor picture quality depends on several factors. Among them are the type of display technology—CRT, projection, or color LCD; the number of lines of resolution produced by the display; the size and number of phosphor dots on the screen and the precision of the holes in the shadow mask behind them; the existence of picture-enhancing circuitry; the size of the display; and the flatness, squareness, and reflectivity of the screen. The best-looking displays have a high number of lines of resolution (400 or better); a small *dot pitch* (the distance between phosphor dots of the same color) of .34 mm or less; a comb filter or digital circuits to reduce color noise in the picture; a picture no bigger than 27-inches; and a flat, black, glare-free, square-cornered screen. These general principles apply to computer monitors as well.

Sets with hi-fidelity stereo speakers designed for proper operation within the magnetic fields generated by CRTs provide the best sound and are worth the extra expense.

Good connectivity means that you can hook the set up to any other component you have. The display should include composite video (LINE) in and out, RF in (for use with VCRs and antennas), stereo audio in and out, and standard antenna screws.

A full set of display controls includes brightness, contrast, hue, vertical and horizontal hold, audio levels (for both channels if it's a stereo set), channel, power, and a knob to switch among video sources. A full-function remote control is worth having. Controls should be easy to reach and unambiguous in function.

Other Video Components

A VCR, camera, and display are the most important pieces of video equipment you'll need. But there are other types of components that you may want to know about, especially if you plan to pursue DTV professionally.

Videodisc Players. These playback-only units read video information from a videodisc, where the video is stored in digital form as laser-etched pits. Because the video is digital, videodisc image quality is far better than from any but broadcast-quality VCRs, and there are the additional advantages of perfect still frames and special effects, random access to the program material, and CD-quality sound.

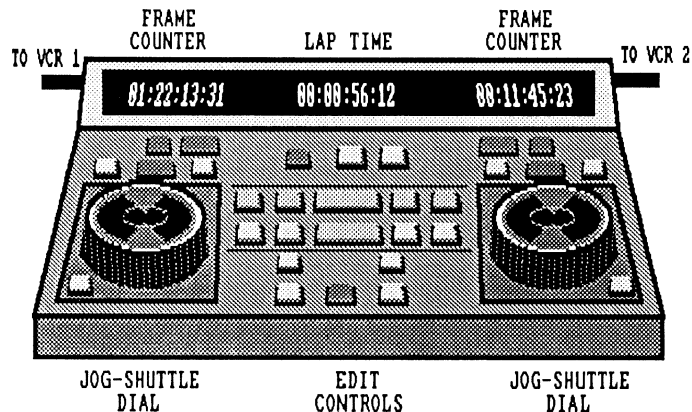
Most videodisc players are aimed at the consumer market, but industrial models can be controlled by a computer, assuming you have the right interface (such interfaces are available; see Appendix A). An educational program on the Amiga could, for example, command the videodisc player to go to a particular piece of video, then wait for the student to answer a question posed by the program about the video sequence. Depending on the answer given, the program could call up a new sequence or replay the last sequence for review.

For now, such interactive systems are currently the only DTV use for videodiscs (though any DTV program can be transferred to disc for interactive use). In a few years, videodisc recorders should become available, bringing video completely into the digital age.

Edit Controllers. An *edit controller* is basically a type of remote that lets you precisely control the actions of two or more compatible VCRs for editing videotape—that is, assembling footage into a coherent narrative. The controller, which displays the current frame for each VCR and has buttons for searching tape, marking editing points, and automatically executing edits, makes the process fast and easy. Figure 3-2 shows the layout of a typical edit controller. Generally these must be used with editing VCRs that have flying erase heads and the proper remote-control jack; the best bet is to buy editing VCRs and an edit controller in one package. Chapters 5 and 9 have more on editing.

Single-Frame Controllers. This is a box that takes over the transport functions of a high-end VCR, usually under software

Figure 3-2. Edit Controller



control from the Amiga, so you can record images on one frame at a time. The sole use for single-frame controllers is to produce frame-by-frame computer graphics animations. (See Chapter 7 for more on animation.) Single-frame controllers are expensive and require expensive VCRs and support equipment, so they are suitable primarily for TV studio use only. Lower-cost units are beginning to appear, however; see Appendix A.

Character Generators (CG). These are video typewriters for putting text on the screen (called *titles*). The Amiga makes an excellent character generator, giving you much of the functionality of a \$10,000 CG for one-fifth to one-tenth of the price. Chapters 5 and 6 cover titling in more detail.

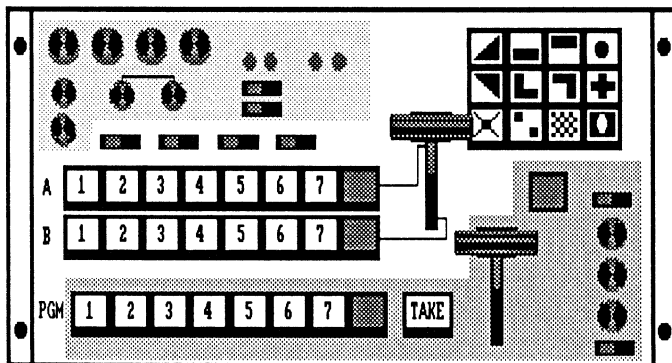
Special Effects Devices. Several different types of video equipment have been developed to create those video special effects we all know and love.

A *switcher* is a device for instantly cutting between several live or taped video sources. A switcher is what makes it possible to cut between the input from various video cameras in a live news show, for example.

A switcher is usually part of a *Special Effects Generator*, or *SEG*. This is a device for creating and controlling transitions and other effects during video production and editing. It's the SEG that makes the fancy wipes and dissolves between scenes that you see used regularly in sports and game shows. Figure 3-3 shows an SEG.

A *keyer*, often included in the SEG unit as well, is hardware that makes it possible to replace part of the image from one video source with the image from a second video source. Keying can be

Figure 3-3. SEG



over a specified gray level in the video (*luminance keying*) or over a specified color (chrominance keying, or *chromakeying*). An example of keying is the insertion of video of a weather map over the blue screen behind a TV weatherperson.

Digital Video Effects (DVE) machines are computers dedicated to creating flying, twisting, turning, and perspective effects. When you see the screen image turn on its side and fly away into the distance, you're seeing DVE in action.

Usually, switchers, SEGs, keyers, and DVE computers are found only in professional video studios. With your Amiga, however, you can create many of the same effects.

Processing amplifiers. A *processing amplifier*, or *proc amp*, takes a weak and/or substandard composite signal and boosts it to proper voltage levels while tweaking all the little signal details to get them just right. Broadcast edit rooms and studios have proc amps that cost several thousand dollars and are invaluable when you need to bump your Amiga DTV efforts up to broadcast quality.

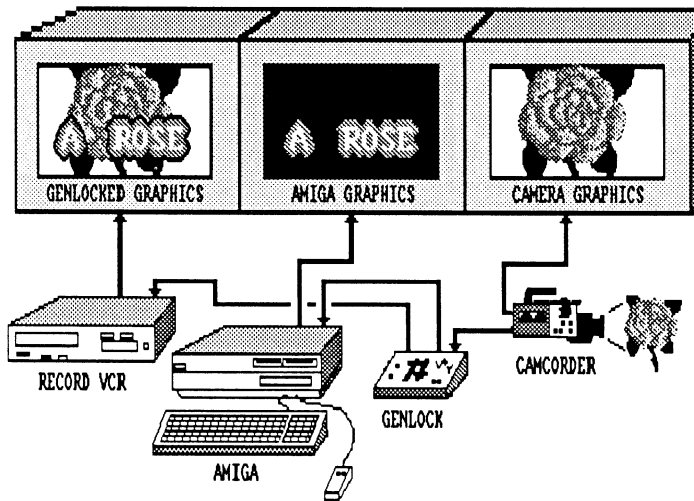
Inexpensive consumer proc amps (\$100–\$300) are marketed by a number of firms, including Vidicraft. Despite their low cost, these little units can be helpful in improving the kind of second-rate composite signal output by low-end Amiga genlocks (see below), although they won't give you the video quality possible with their bigger siblings. Simply route the genlock (or Amiga 1000) composite output through the proc amp before recording, and twiddle the knobs until you get a picture with clearer color, sharper edges, and more *luminance range* (the difference between the brightest white and the darkest black). Having a waveform and vectorscope handy will let you measure the improvement.

Amiga-Specific DTV Hardware

The main purpose of Amiga-specific DTV hardware is to bring video into the Amiga and get it out again. Here are the principal types:

Composite and RGB Encoders. These are boxes for converting video into the RGB format the Amiga understands, and then taking the Amiga RGB output and converting it to composite video usable by video devices. Generally these encoders plug into the Amiga's RGB port. Encoders can be inexpensive and adequate for consumer and home use, or broadcast-quality, costing thousands. It all depends on the quality of the video desired.

Genlocks. As mentioned in Chapter 2, a *genlock* is a device

Figure 3-4. Genlocking

that synchronizes one video source with another—in this case, computer graphics with live video—for recording to a VCR. For example, with a composite signal from one VCR routed through a genlock and into the computer, you can display a live video picture in place of a selected color in an Amiga computer graphic—usually color 0, the background color of the graphic (see Chapter 2). But some genlocks allow you to overlay video on any color or combination of colors you specify. (In other words, all Amiga genlocks incorporate a keyer as well.) You can't modify the incoming video from your computer, but you can mix together the Amiga graphics and composite video and output the mixture for recording on tape. Figure 3-4 shows how this works.

As an example of how a genlock is used, say you want to lay a chart over taped footage of your organization's headquarters. First, set up your equipment as in Figure 3-4. Then create the chart on your Amiga with a graphics program, with black as the background color (color 0). Pop the taped footage of the headquarters into the player VCR and route the VCR output to the Amiga through the genlock. On the Amiga monitor, the video footage appears only over color 0, black. The combined image is output back out of the Amiga through the genlock to the record VCR. When you play back the recording, you see the chart superimposed over the video. Another example, an Amiga-generated

cartoon character genlocked over an abstract video background, is shown in color plates 5 and 6.

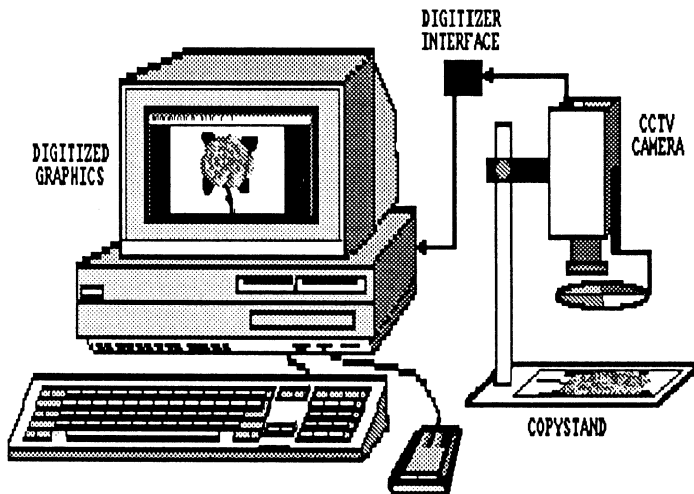
A genlock is virtually a necessity for DTV; genlocks incorporate encoders to provide a good-quality composite output for your Amiga, as well providing a video-in jack, so they're useful even if you don't need to superimpose graphics on video.

As with most components, it pays to buy the best genlock you can afford. Low-end genlocks (\$300 and under) provide basic mixing and composite in and out, but the signal is not likely to be completely up to NTSC snuff, so you may have trouble later when you try to edit tape that's been recorded with these units. Better genlocks (\$500 and over) generate better video output and may have manual slider controls, for fading the live video in and out or changing the background color used to superimpose the video. Genlocks at the very high end of the price scale (\$1000 to \$2000) virtually assure broadcast-quality, RS-170A output.

Most genlocks are self-contained boxes that plug into the Amiga's RGB port, but more expensive units may be plug-in boards tailored for use with the Amiga 2000/2500 only (or an expansion chassis for the A500). All genlocks come with software to adapt the Amiga for genlock use and to provide some software control over genlocking operations.

A note on genlocking: Most genlocks halve the clock speed of your Amiga as a byproduct of creating a composite signal. You may need to run a public-domain utility program called SetLace before you start genlocking. SetLace is available on BBSs and from user groups; many genlocks provide a similar program as part of the genlock software. Workbench 1.2 and later versions provide an interlacing utility as well.

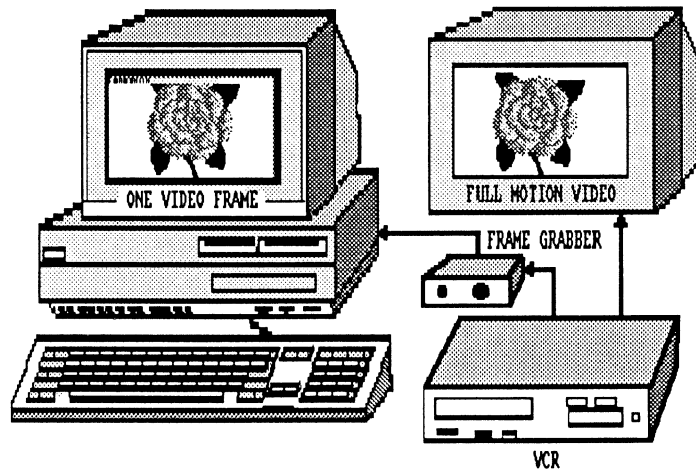
Digitizers and Frame Grabbers. Another method for getting images into your computer is by using a device called a *digitizer*, hardware for taking a video camera signal and converting it to the RGB format and picture file type the Amiga uses. Most digitizers, including the popular Digi-View manufactured by NewTek, work best with the type of black-and-white CCTV cameras discussed above. The camera feeds a signal to the digitizer itself, which is basically an RGB encoder with software to reconstitute the incoming image information into an Amiga picture format. Figure 3-5 is a diagram of a standard digitizer setup. Current digitizers work best with monochrome cameras; color images are created by scanning the image three times with red-, green-, and blue-colored fil-

Figure 3-5. Digitizer

ters in front of the camera lens, then merging and reconstituting the three images into one full-color picture.

A *frame grabber*, also called a *frame buffer* or *stillstore*, can capture a single video frame from a live or taped source by storing the entire picture in RAM. An encoder in the frame grabber converts the image to Amiga RGB; software then converts the stored image to a picture file format. Using a frame grabber, you can grab a still right off a tape playing on a VCR and feed it into your Amiga for graphical embellishment. Or the frame grabber can be hooked to a camera and grab a still at specified intervals—one every second, for example—for time-lapse video. Some frame grabbers/buffers can store more picture information (more screen pixels or onscreen colors) than the Amiga can use on its own. The concept of frame grabbing is illustrated in Figure 3-6.

Some manufacturers claim that their products work in “real time,” that is, the grabber supposedly can digitize and display full video at the standard frame of 30 frames per second. No Amiga video digitizer is actually capable of this; some are faster than others, but none process the full video frame instantly. Since the various frame grabbers are quite different in capability, try each out before you purchase one. Be sure it can accept both live and taped video, and that the machine co-resides well with other Amiga hardware. Also check that the digitizer software handles

Figure 3-6. Frame Grabbing

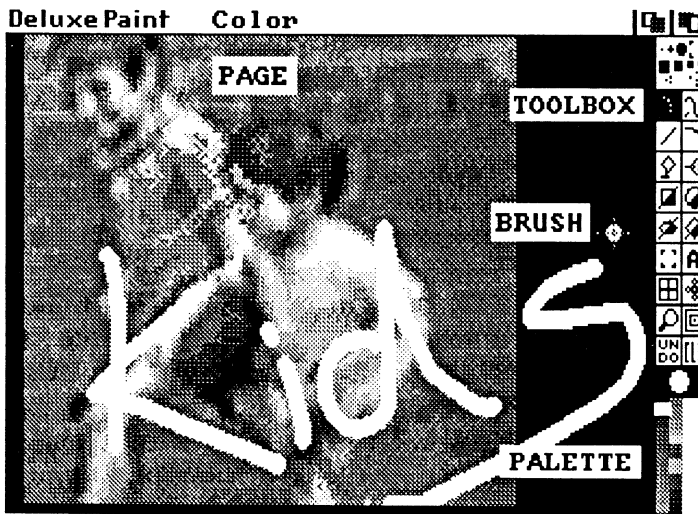
the effects you're looking for and multitasks properly with other Amiga applications.

If you plan to digitize photos or prerecorded video, especially for use in a for-profit DTV production, keep in mind that this material is probably protected by the copyright laws. It's illegal to use copyrighted material without the permission of the copyright owner.

DTV Software

All that fancy DTV equipment isn't worth much without software to run on your Amiga. With the right software, you can create spectacular color graphics; add plain or fancy text over your videos; modify digitized images to sharpen details or add false colors; craft two- or three-dimensional animations; and directly control the functions of video hardware with the Amiga mouse and keyboard. Following are descriptions of the most common categories of DTV software.

Paint Programs. *Paintbox* is the video term for a paint program, software for creating computer pictures. The typical paint program contains tools that are computer analogies to standard artists' tools, like pencils, brushes, and rulers. Figure 3-7 shows the workspace of a popular Amiga paint program, *Deluxe Paint III* (Electronic Arts). Note the icons running down the right side of the screen; each one corresponds to a different artist's tool. Some

Figure 3-7. Deluxe Paint III Workspace

paint programs, such as *Digi-Paint* (NewTek) and *Photon Paint* (Microillusions) work in the Amiga's HAM mode, making it possible to create pictures with thousands of colors onscreen that look especially good on video.

Paint programs are among the most adaptable and easiest-to-use DTV software—with any paint program, you can create

Figure 3-8. Video Titler Workspace

graphic designs, titles, backgrounds for animation and genlocked live video, and more. Overall, a paint program is probably the most basic and necessary software tool for the desktop videographer, and the one that should be purchased first. See more on using paint programs in Chapter 6.

Titling Programs. One of the most common tasks in DTV is putting text over video, and there is software to help you do this. Most paint programs offer access to the built-in Amiga fonts (typefaces), but dedicated titling software will give you more fonts and let you create your own. More advanced titling software allows the storage of many pages of text in memory, and will scroll or wipe through the pages according to your instructions. Figure 3-8 shows the workspace of *Aegis Video Titler*, a popular titling program. Chapter 6 also covers the esthetics and use of text on video.

Slideshow programs. Slideshow programs provide a way of displaying a series of computer pictures, in effect creating an Amiga slideshow. The program usually requires that you write a script telling the program which pictures you want to display, how long they should be on the screen, and the type of transitions you want between them—dissolves, wipes, and so on. The program then displays the pictures from disk according to the

Figure 3-9. Animator Workspace

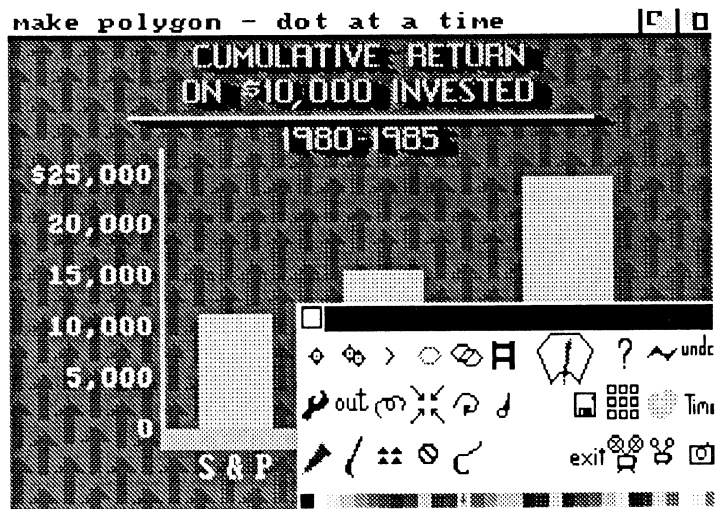
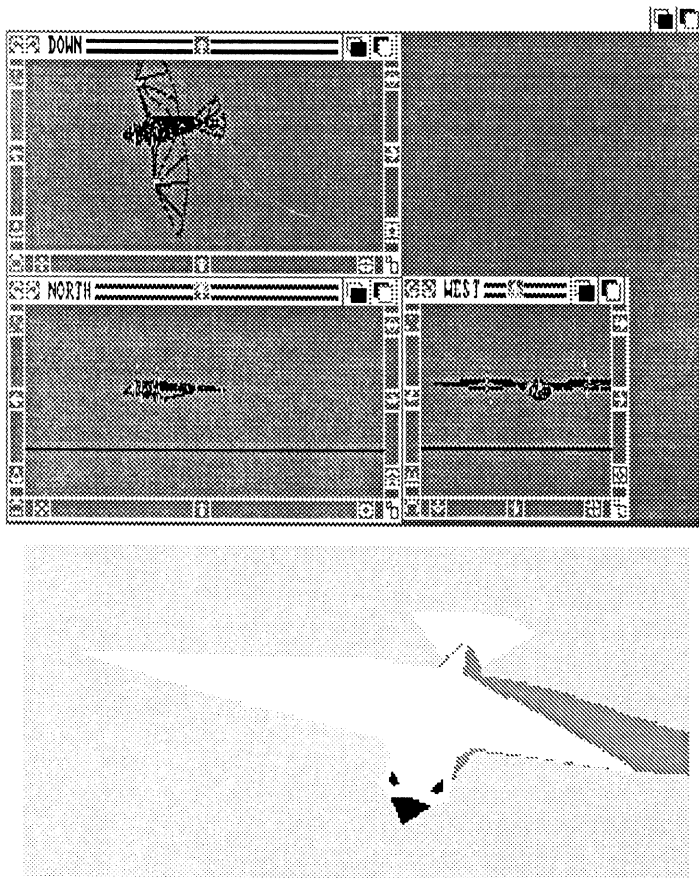


Figure 3-10. Sculpt-Animate 3D Workspace

script instructions. Most animation programs offer slideshow capabilities as a basic feature.

Animation programs. Animation, a series of pictures shown quickly in sequence to create the illusion of movement, can add excitement to your DTV productions. Animation programs for the Amiga, of which there are a growing number, come in two basic categories: two-dimensional and three-dimensional. The difference is plain to the eye: Two-dimensional animation deals with images that are resolutely flat, while three-dimensional animation moves objects that appear to have full height, width, and depth.

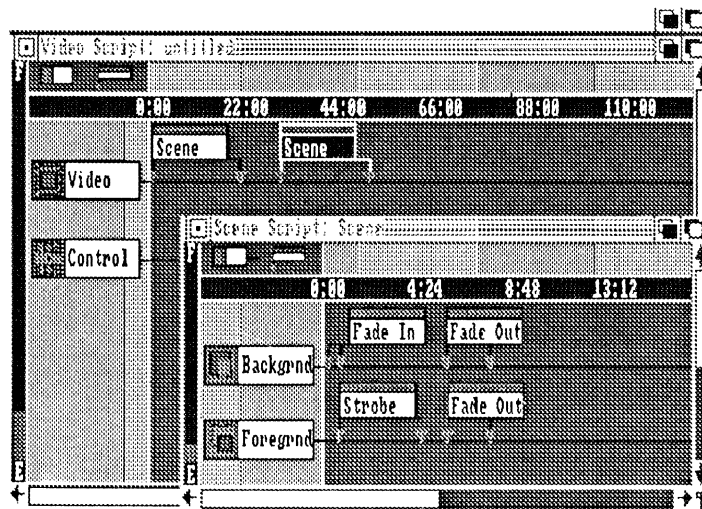
Two-dimensional animation programs usually first require art to be drawn with a paint program or fed in through a digitizer before you can begin animation. Some paint programs, such as

Deluxe Paint III, offer animation capabilities of their own. With three-dimensional animation software, you need a three-dimensional modeling program to first create the objects you'll move in the animation. Figures 3-9 and 3-10 show two animation program workspaces: a two-dimensional program, *Aegis Animator*, the first Amiga animation program to appear on the market; and a three-dimensional animation program, *Sculpt-Animation 3D*. For more on animation, see Chapter 7.

Production Programs. Some Amiga DTV software tries to do it all—production outlining and planning, pictures, animation, titles, and sound. The idea with these full-featured production programs is to provide you with a single source for all (or nearly all) the tools you need to create DTV programming in the Amiga. One of the better known is *Deluxe Video* (Electronic Arts), shown in Figure 3-11. *Deluxe Video* provides an easy method of assembling multiple tracks of graphics, animation, and sound by moving icons along timelines. Such programs are great for pulling together short sequences in little time and with a minimum of resources.

Image Processing Programs. Video images can carry valuable information that's not easy to pick out with the unaided eye. *Image processing* software gives you the tools to analyze and alter a scanned computer graphics image with your Amiga; for example,

Figure 3-11. *Deluxe Video* Workspace



to add false colors, increase the contrast, sharpen the boundaries between shapes, and so on. These tools are especially valuable for researchers and others who need to squeeze the last drop of information from real-world video imagery.

Setting Up the Studio

Now you've reviewed the basic components and software. How do you put them together to create a working DTV studio? It helps to draw up a plan and scout for the proper location.

First, decide what tools you need to make your programming. Make a list of desired abilities and match them to the available components, keeping in mind the level of video quality your budget can support. Remember you can always start small, with an Amiga, a camcorder, an inexpensive genlock, and a paint program; you can build your system from there.

Then, find the best site for the studio. Since DTV production is concentration intensive, you'll probably want a separate room, or at least a secure, quiet area away from traffic; your kitchen is not a good spot. Components take up room, so give yourself more than enough space to spread out. Even glare-free lighting is important, as is air conditioning in the summer; computers and video equipment need a temperature-controlled climate to operate properly. You should also be sure of a steady, uninterrupted source of adequate, grounded electrical power. Don't place a studio near a freight elevator or heavy machinery that might cause dips and surges in power or unusual magnetic fields.

Furnishings can be minimal. Tables to hold equipment should be away from the walls so you can easily get to the back panels of components to switch wires around. Better yet, mount equipment on rollable racks or tables so they can be rearranged easily. One or two comfortable swivel chairs are a must (and you might want to get yourself a director's chair with your name on it). Make sure you have a secure storage area for tapes and disks away from speakers and monitors.

For bigger productions—a regular talk show with the president of the firm, for example—consider installing a real television studio with a control room, a sound stage, lights, backdrops, and so on. Advanced stage and studio design is really beyond the scope of this book, but several sources in Appendix A can give you more information. Chapter 4 has more on studio production techniques.

The following figures diagram studio arrangements for different kinds of DTV productions—an entry-level studio for simple graphics and titling; a more elaborate setup for mid-level productions; and a full-blown studio with graphics, sound, and editing capabilities.

Maximizing Your Signal. Gremlins, in the form of external electronic noise and interference, are in every studio, waiting to ambush a defenseless video signal as it travels from one component to another. You can minimize interference and maximize your signal by taking these steps:

- Don't stack components one atop the next—separate them by a foot or two on a table or rack. Put the Amiga on another table at least four feet away—it puts out stray radio frequency signals that can interfere with the operation of other equipment.
- Make all connections carrying a video or audio signal with 75-ohm shielded coaxial cable. Gold-plated connectors work best.
- Keep wires straight and untangled. Don't wrap one wire around another, or bundle them all together with a wire tie. Keep power cables from crossing or twisting around signal cables.
- Run all equipment, especially the computer, from surge- and spike-protected outlets. Power protection boxes are available from computer supply stores.

Figure 3-12. Studio 1

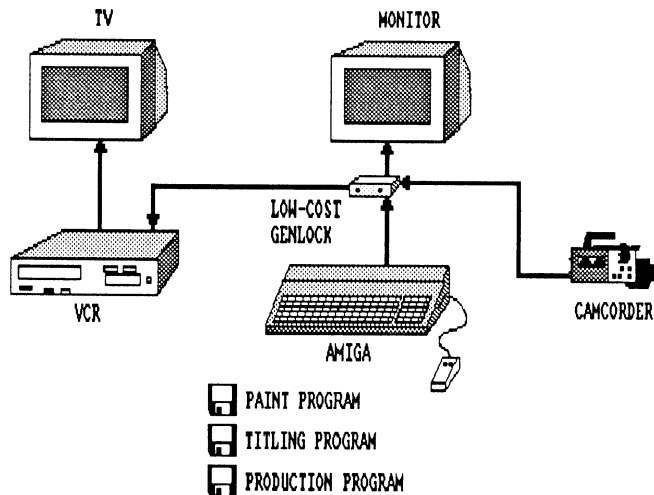


Figure 3-13. Studio 2

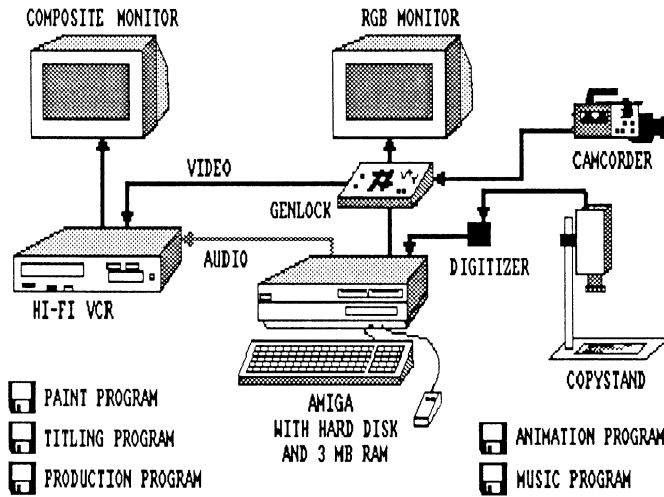
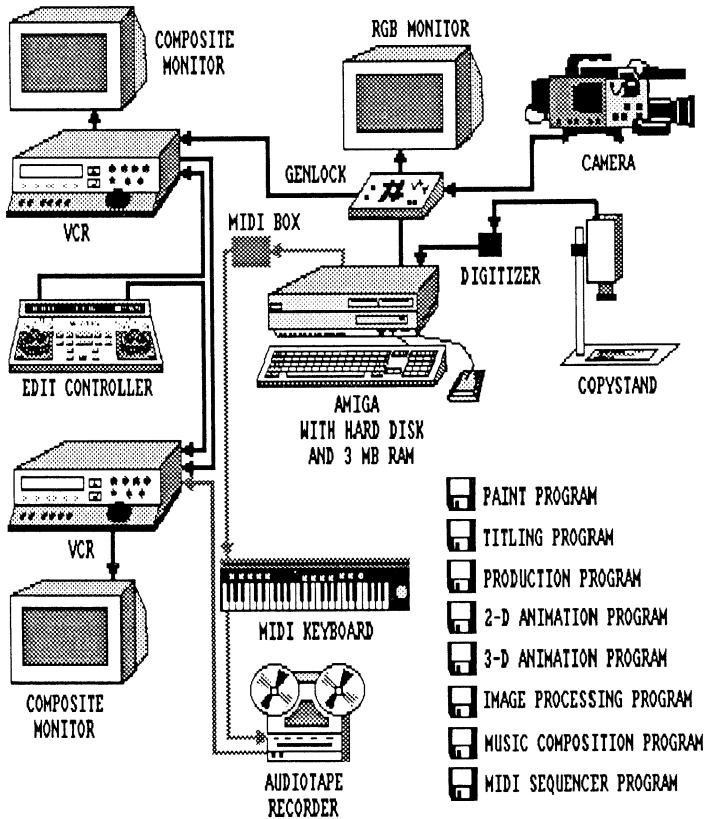


Figure 3-14. Studio 3



- Don't start or stop electrical machinery, such as an air conditioner or household appliance, while recording or saving data to a disk.

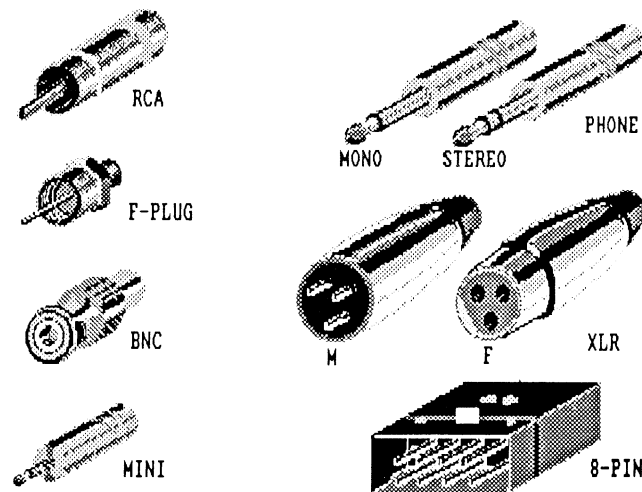
Connectors and Cables. Anyone who has tried to connect one piece of electronic equipment to another has discovered the wonderful world of connectors, those little plugs that never seem to fit into the holes where you think they go. Compared with the computer industry, which uses scores of incompatible, fragile, and difficult-to-use connectors ("Is that a DB23 or a DB25 plug?"), the world of audio and video connectors is relatively easy to understand. The well-equipped DTV producer needs to be familiar with the eight basic varieties. Following is a brief description of each; a picture is shown in Figure 3-15.

RCA (Phono) Plug. The standard plug for consumer audio and video. This is the plug used on most VCRs, camcorders, and audio equipment for carrying a line signal from one unit to another.

F-Plug (Coax Connector). This is the plug used for coaxial cable carrying RF signals from cable boxes to VCRs and from VCRs to TVs. It comes in two varieties—the older screw-on type, and the newer push-on type. Both must be fitted carefully onto the F-jack, making sure not to bend the fragile center cable.

BNC Plug. The broadcast standard for carrying video signals.

Figure 3-15. DTV Connectors



It goes on with a push and comes off with a twist, but can't be pulled off. Better-quality equipment uses BNC connectors.

8-Pin. A boxy connector for hooking up older monitors to industrial or broadcast VCRs. Not seen in consumer equipment.

Phone Plug. The standard headphone, microphone, and patch cord plug for audio equipment. Mono phone plugs have one dark band; stereo phone plugs have two. Rarely seen on video equipment.

Mini Plug. A miniature version of the phone plug. Commonly used for headphone and mike jacks on camcorders and walkperson-type recorders. Easy to pull out by accident.

XLR (Cannon) Plug. Used on professional audio and video equipment that requires balanced audio lines. Comes in male (XLRP) and female (XLRJ) versions.

In addition there are standard connectors for hooking standalone cameras to VCRs (10- and 14-pin camera connectors) and for slaving consumer VCRs to remotes (5-pin DIN). Industrial and broadcast equipment use various multi-pin parallel or serial connectors to slave VCRs to edit controllers.

With mastery of DTV theory, equipment, software, and studio setup, you're ready to tackle a real production. The next chapters show how to put your DTV knowledge to good use in creating a video program.

Chapter 4

DTV Production

Desktop video can be a spontaneous business. You get some equipment together, recruit a friend or two to help, and play around with the materials at hand until you've made something interesting. In fact, that's a good way for beginners to learn the basics of operating hardware and software without feeling the pressure of a definite goal. But that is not how most video productions happen. Instead, everything is planned to a T, then everyone involved scrambles to make the real world conform to the plan (even though the world often refuses to do so). Why? Simply because video production is usually so expensive and difficult to pull off that careful planning is the only way to ensure results.

Most DTV programming is less expensive to produce, and so more amenable to experimentation and spontaneity, but it still is good practice to plan ahead and know the right techniques for getting the job done. This chapter covers the basics of setting up a DTV production and getting good video down on tape.

As a framework for this chapter and elsewhere in the book, we'll look at production techniques used in the making of a promotional tape on a new medical scanner, the RxScan. The tape is called "Introducing RxScan," the client is a small high-tech firm called ScanTech, and the producer/videographer/director is Jane, who runs MediVideo, a DTV production company that specializes in medical and scientific promotional programming.

The Stages of Production

Videographers recognize three major stages any video production must go through:

- *Pre-production*, the paper and planning stage in which the basic form of the video is worked out and materials and manpower are assembled.
- *Production*, the actual taping of the program material.
- *Post-production* (often just called *post*), in which the raw tape is edited to create a narrative, and sound and special effects may be added. Much of desktop video, such as titling and graphics overlays, falls into what most videographers consider post-production. DTV post-production is covered in Chapter 5.

A simple DTV program flows imperceptibly from one stage to the next. You'll think up the concept, jot down a few ideas, turn on your Amiga and VCR, and get to work. This is the sort of thing that happens when you're asked to create some titles for a program under someone else's direction, or when you're just creating some graphics to embellish a family video. In this case, DTV is truly desktop-bound, since there is no need to go beyond the basic setup of camera, Amiga, and VCR.

Productions become more complex, and require greater definition between stages, when there's a lot of video footage to shoot, many resources to manage, and other people's money to spend. For our example production on the medical scanner, Jane at MediVideo must pay considerable attention to each stage. In pre-production, she must write a script and prepare an animatic for approval by the client; draw up a budget, schedule, and contract; secure permissions and releases; hire personnel; and rent or purchase the necessary equipment. In the production stage, she must get her equipment and personnel to each location and make sure that all necessary scenes are captured on tape, while dealing diplomatically with the client and any unexpected problems that crop up. In post-production, she must log each shot, add special effects and titles, create a short animated sequence, work on the soundtrack, and edit the entire thing into a seamless whole.

Pre-Production

When ScanTech contacts Jane about doing a promotional video on the RxScan, the company provides basic information on the product and outlines the main ideas it wants to communicate—that the scanner is new, inexpensive for hospitals and doctors to purchase and operate, and able to provide more accurate information than other types of scanners. Jane takes this material and turns it

into a concept, a storyboard, and a script, expressing her own vision of the information she's been given.

Concept or Premise. This is the unifying idea behind the program. The *concept* outlines the goals of the program, describes the audience, sets the tone the piece will take, and details the resources needed to complete it. For larger productions, the concept is usually worked up into a formal proposal of a page or so. Once the concept is settled upon by the videographer and client, it should be stuck to; nothing will doom a production faster than losing sight of the concept.

The main part of Jane's concept for "Introducing RxScan" looks like this:

"Introducing RxScan" Proposal for A Promotional Video

The RxScan is a revolutionary magnetic resonance imaging system looking for a market. Because ScanTech is a small company with limited resources for advertising and marketing, it needs to bring the message about RxScan to doctors, hospital administrators, and institutional researchers in the most efficient manner. The best way to do this is by producing a promotional videotape that will show off the many strengths of RxScan to potential buyers at conferences, trade shows, and sales contacts.

The video will begin with a walk through the ScanTech plant with Dr. Beverly Gold, ScanTech's CEO, as she introduces the company and its newest product. Dr. Henry Damian, chief scientist, will describe the features of RxScan that make it superior to offerings from competitors. As Dr. Damian talks, videotaped and computer-animated segments will illustrate the technical concepts. Finally, location footage will show the RxScan in actual operation at the Valley Hospital installation. Dr. Palmer, head of radiology at Valley, has agreed to an interview. Beverly Gold will close the tape by inviting prospects to attend a technology demonstration.

The Script. Once the concept is approved, it's time to write a *script*. The script fleshes out the concept by:

- creating a narrative about the subject of the program that engages the audience's imagination
- giving the audience all the important information about the subject

- defining the length of the program
- breaking the production into manageable parts, or *scenes*, based on location or time of day
- specifying the *shots* or *camera setups* for each scene
- providing general directions to the production staff
- providing words for the narrator and/or actors to say

Scriptwriting is an art, like any other creative endeavor, and a full discussion of that art is beyond the scope of this book. If you've never written or seen a script before, you may want to consult some of the books that teach scriptwriting form and that discuss methods for building narrative (see the bibliography in Appendix A).

In our example production, Jane has a much easier job than the writer of a movie-length drama. It is already clear what the program has to say, and the script is largely a practical matter of showing how to say it. She has to decide on the total length of the program (about 10 minutes), the number of scenes, the location of each scene, approximately how many individual shots should be in each scene, and the action that will take place in each shot. She also has to draft words for the actors (called the *talent* in video and film parlance) to say, but here she can use the practiced pitches already developed by ScanTech's president and chief engineer, who know exactly what they want to communicate to the audience and can ad-lib if necessary. Jane has to make sure that the progress of shots and scenes adds up to a coherent whole; that no shot or scene is out of place; and above all that the message about ScanTech and its product comes through loud and clear, without distraction. At the same time, Jane tries to keep the number of shots, scenes, and effects to an efficient minimum to save production time and money.

Part of Jane's finished script looks like this:

INTRODUCING RXSCAN
—SCRIPT—

SCENE 3—INTERIOR, SCANTECH RESEARCH LAB

We begin in Dr. Damian's office. He is looking at some scanned prints with an assistant, signs off on them, and looks up as the assistant exits.

As Dr. Damian begins to talk, we precede him out of the office into the adjoining lab, where an RxScan unit can be seen in the background.

DR. DAMIAN

I'm Dr. Henry Damian, chief scientist at ScanTech, and this is our research lab. Let me take a few moments to show you what the RxScan can do and what makes it different from other MRI systems on the market.

Some of you may not be familiar with MRI imaging. In brief, magnetic resonance imaging is based on the principle that the atoms of certain substances resonate with a characteristic radio frequency, or RF, when immersed in a powerful magnetic field and bombarded with an external source of radio waves.

INSERT AN ANIMATION SHOWING THE BEHAVIOR OF ATOMS DURING MAGNETIC RESONANCE.

DR. DAMIAN

Atoms of hydrogen, potassium, and other elements in the patient's body emit a readable RF signal inside the RxScan's imaging module. A matrix of sensors in the module transmit the RF signal data to a computer, which converts it to a three-dimensional computer image of the location of each element in the scanned area. Not only does MRI provide a highly detailed picture of the patient's interior anatomy, it also creates an accurate, real-time portrait of patient physiology—without invasive measures of any kind.

Dr. Damian walks us through the various parts of the RxScan, pointing or gesturing to each part as he describes it.

DR. DAMIAN

Here is the RxScan main imaging unit, where scanning takes place. Those of you familiar with other MRI scanners will notice right away that RxScan is much less bulky than others. This is because RxScan uses permanent ceramic magnets, rather than superconducting magnets. This means no liquid helium to cool the superconducting coil, no refrigeration systems, and radically reduced capital and operating costs. But the magnetic field is still quite strong—10,000 gauss.

Dr. Damian places a monkey wrench in the “tunnel” of the imaging unit. The wrench jumps out of his hand and stays suspended in midair.

DR. DAMIAN

In addition, the extreme sensitivity of our RF sensing matrix makes it unnecessary to build an RF-shielded room for the imaging unit, one of the most expensive aspects of previous MRI installations. . . .

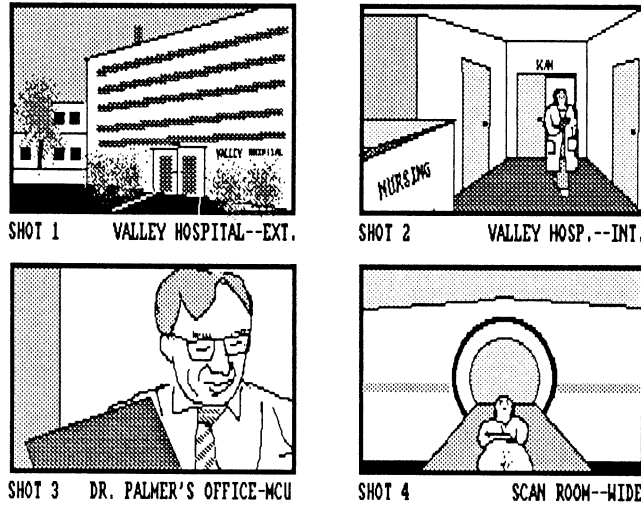
Stopwatch in hand, Jane reads aloud the draft of her script and jots down how long it takes to read each page. This lets her know approximately how long each scene will be, as well as the total length of the program. She reworks the script as necessary to bring it to the needed length of ten minutes.

Storyboard and Animatics. A script is a narrative in words. But video is a visual medium. Videomakers, taking their cue from filmmakers, often use a *storyboard*, a visual outline of the narrative of a film or video production, to provide the client with an idea of what the program will look like, as well as what it will say.

Storyboards are made up a many panels, usually one per shot. (You might think of a storyboard as a comic-strip version of your program.) The art in the panels doesn't have to be of illustration quality (although clients are always impressed if it is), but it should show the subject and camera angle of each shot, together with a brief text description of what's happening in the shot. Figure 4-1 illustrates several panels from a possible storyboard for “Introducing RxScan.”

But let's face it—storyboards are passé, and they go against the philosophy of desktop video. The DTV way to do it is to create an *animatic*—a video storyboard that incorporates sound and motion. What an animatic can do that a storyboard cannot is give clients an understanding of the length and pace of the piece, as well as a sense of how it really will look.

Jane uses some basic DTV tools to create an animatic for “Introducing RxScan.” When she visits ScanTech's headquarters and Valley Hospital, the two locations for the production, to make arrangements for the actual shoot, she takes some camcorder footage and instant photos of the locations of each scene, trying to match her shots with the shots she'll use later in the actual production. (This material will also come in handy later as she and

Figure 4-1. Storyboard

her production crew try to anticipate lighting needs and set up times.) ScanTech also provides her with color glossies of the Rx-Scan and Drs. Gold and Damian, as well as a promotional audio tape Dr. Gold has made about the product.

Back at her office, she uses a digitizer and copy stand to digitize the photos into her Amiga, then adds text or graphics to the pictures with a paint program. At the same time she works up some preliminary sketches of the animation sequences. All the Amiga material is then transferred to tape through a genlock. Using her editing system, and following the events in her script, she cuts together the Amiga tape with portions of the camcorder footage she shot on location and narration from Dr. Gold's audio tape to create the finished animatic. (See the next chapter for more on editing, and Chapter 8 for tips on audio.)

It might seem like a lot of work to create an animatic, and it can be. For a small production, the effort isn't justified. But for bigger jobs, an animatic can be a very useful aid to conceptualizing the actual production. Problems with pacing, location, graphics, and animation, not to mention in relations between videomaker and client, will often show up at this stage, before any serious money or time has been spent. From ScanTech's point of view, the animatic, together with the script, provide real assurance that the company will get the production it wants, and that MediVideo is competent to get the job done.

Scheduling. Once the script and storyboard or animatic are complete, they become the basis for the *shooting schedule* and *post plan*. The schedule takes each scene in the script and assigns it a date and location. The schedule also shows what talent, props, and effects are needed to accomplish each scene.

For example, this is how Jane’s shooting schedule looks:

Table 4-1. “Introducing RxScan” Shooting Schedule

Date	Scene	Location	Talent	Props	Effects
9/10/89	1	ScanTech HQ—ext			
9/10	2	ST int.—	Dr. Gold		Wireless mike, window scrim
9/10	5	Dr. Gold’s office ST int.—	Dr. Gold		Wireless mike, window scrim
9/10	3	Dr. Gold’s office ST int.—Dr. Damian’s office, lab	Dr. Damian	Scanprints, monkey wrench	Wireless mike, window scrim
9/17	4	Valley H. int.	Dr. Palmer	Patient, scanprints	Wireless mike

Note that the shooting schedule groups scenes by location rather than scene number. That’s because Jane will shoot all scenes that take place in one location before she moves to the next location.

The post plan lists all post-production effects (often abbreviated *EFX* or *F/X*, and *SFX* for sound effects or special effects) for each scene. These may include still graphics, animation, sound effects, and music. Jane needs the following post effects for “Introducing RxScan”:

Table 4-2. “Introducing RxScan” Post Plan

Scene	Title and/or Graphics	Anim	SFX	Music
1	“Introducing Electronic RxScan—An MRI Scanner from ScanTech”	logo	ScanTech	theme
2	“Dr. Beverly Gold, Founder of ScanTech”			
3	“Dr. Henry Damian, Chief Scientist”	NMR effect, T1 and T2 charts	NMR sfx	
4	“Valley Hospital” “Dr. Paul Palmer”			

Table 4-2 con't.

Scene	Title and/or Graphics	Anim	SFX	Music
5	"Dr. Gold"			
Closing	"For a daylong technology demonstration, please contact your ScanTech representative, or call 1-800-333-3333"		Narration	Electronic theme

Budgeting. In part, all this preliminary work—scripting, storyboarding, timing, shooting schedules, and post planning—is simply preparation for making a *budget*, the anticipated total cost of producing the DTV program. No budget is needed for low-cost productions you're making for yourself, of course, but when you're spending other people's money, a solid budget is a necessity.

Realistic budgetmaking requires a thorough understanding of what a production requires. Usually, this understanding comes with experience—you know how long it takes to create a certain effect because you've done it before, so the charge for that element of the production is a matter of multiplying the anticipated hours by the hourly charge. Still, video production budgeting is one of the blackest of the black arts, and even experienced producers sweat over budgets to make them appealing to clients while preserving some profit at the end for the producer. It gets worse when you're one among several bidders—then the temptation is great to offer a rock-bottom price, which usually ends up meaning no profit for you. When you're just getting started, however, you may find that underbidding is the only way to get work. Usually, things are made easier because the client will already have a price in mind, and your job is to figure out how to deliver the production at or below that price.

If you lack experience, a read through one of the many books on video and film production budgeting is a must. Then call around to production, post-production, and rental houses to learn the going rates for various services. You can get various pre-printed budget forms from video supply houses. The AICP (Association of Independent Commercial Producers) standard video production budget form is generally considered one of the most comprehensive; it budgets for estimated and actual expenses for every possible category of production expense. AICP forms are readily available—ask around.

For "piecework," such as creating a single graphic, anima-

tion, or sound, you can charge the client a flat rate based on the number of hours the effect takes to produce. More elaborate productions, such as “Introducing RxScan,” involve both fixed costs (such as for planning, tape stock, and a director’s fee) and variable costs (such as rentals, payment to crew, and most post-production costs, all of which may increase if the production is delayed). There’s no limit to the amount of detail your budget can include. All the little budget items are summarized on one page, called the *top sheet*, which is the part of the budget shown to the client.

Jane’s budget for the production is relatively simple. Her top sheet contains the following categories:

Table 4-3. “Introducing RxScan” Budget Proposal

Consultation/Research	\$200
Planning	1,500
Animatic	600
Direction	3,000
Site Fee	150
Tape Stock	260
Miscellaneous	250
Video Rental	500
Light Rental	450
Sound Rental	100
Transportation Rental	150
Crew	1,475
Editing	1,800
Graphics/Animation	850
Music/Sound Mix	400
Duplications (20)	120
Insurance	200
Miscellaneous	250
Subtotal	\$12,255
10% Contingency	\$1,225
Total	\$13,480

One item on this budget merits additional explanation. The *site fee* is an amount charged by Valley Hospital for taping in the building. Organizations, institutions, and municipalities may require you to get written permission—called a *location release*—and pay a fee before you can tape on their premises or within their boundaries. You’ll probably also have to show proof of liability and hazard insurance (which you buy just for the days of the shoot), and obtain permission to freely use the image and voice of any persons who will appear on tape (these are called *model re-*

leases). Jane obtains model releases from everyone involved, and a location release from Valley Hospital.

Pre-Production Wrap. The next logical step, if it hasn't happened already, is signing a contract with the client. Sample contracts are widely available, and it's a good idea to study a few carefully before working up and signing one. Payment is often divided by thirds: one-third at signing of the contract; one-third upon production wrap; and one-third when the finished program is delivered.

Once that's out of the way, it's time to hire the crew, set up any equipment and transportation rentals, and launch any post-production activities (such as animations) that may take a long time to finish. Jane plans to use a four-person crew—a camcorder operator, a lighting person, a sound person, and herself as director. She rents two S-VHS camcorders, two color monitors, two tripods and a dolly, a lighting kit, a high-quality audio cassette recorder and several microphones, miscellaneous cables, and a van. She also brings along an Amiga 500, a monitor, an inexpensive genlock, a printer, a word processor, and a titling program, in case she needs to create documents or titles on the spot.

The pre-production stage (*ends*, in film and video lingo) the night before the first day of shooting, when you sit around looking at all the stuff you've assembled and making sure it's all in working order.

Production

All the planning and preparation of pre-production begins to bear fruit in the production stage. Here's where the images and sound are recorded, later to be assembled into a finished product during the post stage.

DTV productions tend to fall into three categories:

- *Field or location productions*, shot at the subject's site. You must bring all production equipment and personnel with you to the location.
- *Studio productions*, shot in a space specifically designed for video production. The studio is quiet and has a flat floor, high ceiling, built-in lighting system, and a control room for observing and directing the action.
- *Home productions*, created in your own living room with a minimum of resources and fuss.

In this section we'll look at basic techniques for both field and studio production. All of these can be applied in some form to DTV programs you create at home. For example, techniques for handling a camcorder in the field apply whether the location is a jungle in South America or your own backyard. Lighting in your garage follows much the same principles as lighting in the studio. Sound recording techniques are the same as, well—see Chapter 8 for more on recording and creating sounds for DTV.

It can't be stressed enough that planning is everything when you begin field production. As mentioned, you should have already scouted your location and obtained any necessary permits and releases. If you'll be shooting a narrative rather than just covering an event, your shooting schedule and shot list should be in final (or nearly final) form. While many simple DTV shoots will require nothing more than a camcorder, elaborate productions may use multiple VCRs, cameras, switchers and SEGs, tripods, a dolly or crane, mikes and sound equipment, lights, cables, generators, props, makeup and costumes, tools, transportation, talent, production personnel, food, and even portable toilets. Lay out the equipment the night before and test everything before you go. Carry backups for as many components as you can—and don't forget the gaffer's tape (a strong, sticky fabric tape).

If you want to do studio productions, first you need a studio. Most high schools and colleges have television studios, or a space that can be temporarily outfitted as one; perhaps you can arrange time at one of these in exchange for allowing students to help you in the production. Local cable stations are usually required by law to maintain a public facility for video production; you may be able to book time in one of these also. Major cities usually have at least one place where production facilities can be rented at rock-bottom rates.

If none of these options is available, you can try to set up a studio in your home or office. Look for an open space that has a high ceiling and few windows—garages work fairly well, as do conference rooms. Mask off the windows, hang a neutral background, add lights, and you're set to go.

Preparing the Tape. The production stage begins when the tape rolls. To get the tape rolling, you need to prepare the tape properly.

If you shoot video in the field to be incorporated into your DTV production later, you can use new tapes right out of the box. (That field video is called *raw footage*.) But it's better to record

all footage on cassettes that have been *blacked*. Blacked tapes have been recorded on once already, so that they're "broken in."

The essential thing is to lay down a solid *control track* on the blank tape before recording. The control track is a recorded signal impressed on the tape by the VCR in sync with an incoming video source (see Chapter 2). The control track contains frame pulses that provide information about frame timing to control-track edit controllers and VCRs with insert editing capability (see Chapter 5 for more on editing).

A blank tape has no control track, so raw footage recorded on blank tape is not guaranteed to have a solid control track. Anywhere you paused the VCR or switched the camcorder off, then on, will result in a gap in the control track. Thus, raw footage is often unstable in playback; the transitions between shots show *glitches*—jumps and wavers in the image and sound caused by cutting between frames in which control pulses don't match. This makes it hard to achieve professional-looking edits in the post-production stage. But a control track laid down on the tape before it's used will remain there to provide a stable pulse when you insert-edit from raw footage.

Recording that control track is simple. Just pop a fresh, blank tape into your camcorder, put it into record, point it at the wall or close the iris, and let the entire tape run through. Or, hook up a video source to your VCR, put it into record, and run the tape through. That's all. You might want to buy a case of pro-quality tape and lay black over every one, just to have a good supply.

For "Introducing RxScan," Jane blacks 10 tapes, one for each scene plus a backup. She expects to shoot perhaps ten times as much footage in the field as she will end up using in the final program, but it never hurts to have more tape than you really need.

While you're preparing the blacked tapes, you may want to prepare what's called a *blacked master*, the tape onto which you'll be editing the final version of the program. Prepare it the same way as any blacked tape, but you might try recording the face of a clock or stopwatch to give you a handy indicator of how long your master is when you record on it later, or using a paint program to create color bars and tape those (see Chapter 6). The master should be recorded on the best tape stock available.

For a truly professional-looking master tape, the kind that convinces clients you really know what you're doing, you should start your blacked master with the following sequence. Use an ov-

erscan paint program to create the necessary graphics, then feed your Amiga's video output through a good quality genlock to a VCR or camcorder.

1. Record 10 seconds of black.
2. Record 10 seconds of color bars. Add a 1,000Hz, 0 VU-volume tone if you have audio equipment capable of generating one.
3. Record 15 seconds of a title screen showing production name, creator, and date, as well as the name and address of the production company. You can also read this information onto the tape via a mike attached to the VCR or camcorder.
4. Record a 7-second countdown sequence showing slides of numbers at 1-second intervals—10, 9, 8, 7, 6, 5, 4, 3. If you can, add a beep at the beginning of each second.
5. Record black over the rest of the tape (leave black on the Amiga screen for the length of the tape). Your DTV program should start two seconds after the number 3 disappears.

Basic Camera

In video, the camera is the surrogate for the director's and the viewer's eye. So it follows that the meaning and impact of any program is determined in large part by where the video camera looks and how it's moved. An ineptly handled camera is like a storyteller who constantly stumbles over his words; a well-handled camera is like a storyteller who is so adept you don't just hear a voice, you enter into the tale and hear it in your own voice. Luckily, it's easy to learn the basics of film and video camera handling, since you see the work of professional video camera operators in every movie or TV program you watch. You need only to step back from the program and watch it analytically. What is the camera doing now, and why? Whose point of view does the camera show? How does the camera move? Does that movement further the narrative? This kind of analysis applies equally to animation, where there's an imaginary camera showing you the animated scene.

Probably the most fundamental thing to learn when first handling a camera for DTV production is to keep it level, steady, in focus, and pointed straight at the subject. (In this discussion, camera stands for camcorder, too.) All of you have seen home videos in which the camera wanders aimlessly about, sometimes on the subject, sometimes off it, sometimes in focus, sometimes out

of focus. They're hard to watch, aren't they? Lackadaisical camera is barely tolerable for home video, where people don't expect much, but it just won't do for more formal productions. Even in the typical home video, effective communication requires straight-on, no-nonsense camera. Always be sure the camera shows just what the viewer ought to see—and that means, as the DTV director, you have to take the viewer's part above all.

With today's lightweight camcorders, you can shoot a lot of the production from your shoulder. A handheld camera yields footage with spontaneity and immediacy, good for fast-moving events, but not so well-suited to static setups or long scenes. A video tripod keeps the camera steady and adds a professional look to your footage. Use a tripod for scenes that run a long time, or when you'll be holding close-ups (see below) for more than a moment or two. The best tripods have a *fluid head*, which means the moving parts of the tripod head are hydraulically damped to make camera motions very smooth. Fluid head tripods are expensive; lower-cost, fluid-effect heads that use gears of friction rather than hydraulics don't work as well, but are still preferable to an undamped tripod head. Some tripods come equipped with wheels, so you can move the camera smoothly through the scene.

A shoulder brace, while not as steady as a tripod, does keep the camera more stable than just holding it in your hands and gives you a lot more portability than a tripod. If you have access to the necessary equipment, consider using more than one camcorder (make sure they're the same type and brand); mount one on a tripod and use the other for handheld or shoulder-braced shots.

Composition. The video screen is relatively small and square, and that affects how you'll set up a composition for the camera. Wide, movie-like panoramas are out; tight, intimate compositions are best. Keep video compositions down to one, two, or at most three main elements. Move your elements together so they fit in a small space, or move your camera to view them from a different angle—for example, when a group of people are talking, shoot over one person's shoulder.

It's tempting to make all compositions balanced and symmetrical. Too much symmetry, however, leads to visual boredom. Try unbalancing some shots. Leaving space to one side of an actor, for example, leads the viewer to expect that the actor will move in that direction. If the actor moves, you will have created a dra-

matic expectation with composition that leads to a payoff in action.

Shots and Angles. The camera can show the subject or scene from various distances and angles. Each has its own significance to the program narrative. These are the basic shots, as illustrated in Figure 4-2.

Long Shot. This is a view taken far away from the subject. It places the subject within a larger environment. The long shot is more objective, and neutral.

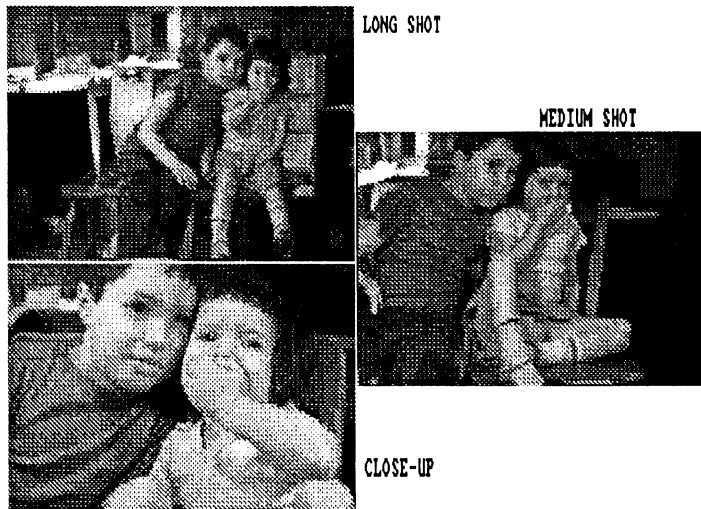
Medium Shot. The subject dominates the screen. If you're shooting a figure, you'd see from the head down to the waist.

Close-Up. The subject fills the screen—there's no room for anything else. For a figure, the close-up shows the head and shoulders. This is the typical "talking head" shot. It's more intimate and personal.

There are shades and degrees of in-between shots. Extreme long shots are popular in film but not too popular on video, as tiny details in a large panorama tend to get lost on the small screen. Extreme close-ups, on the other hand, are very popular and very effective on video; the majority of TV shows contain many shots where someone's face completely fills the screen.

Almost all video cameras come equipped with zoom lenses, giving you the capability to shoot both wide shots and telephoto

Figure 4-2. Camera Shots



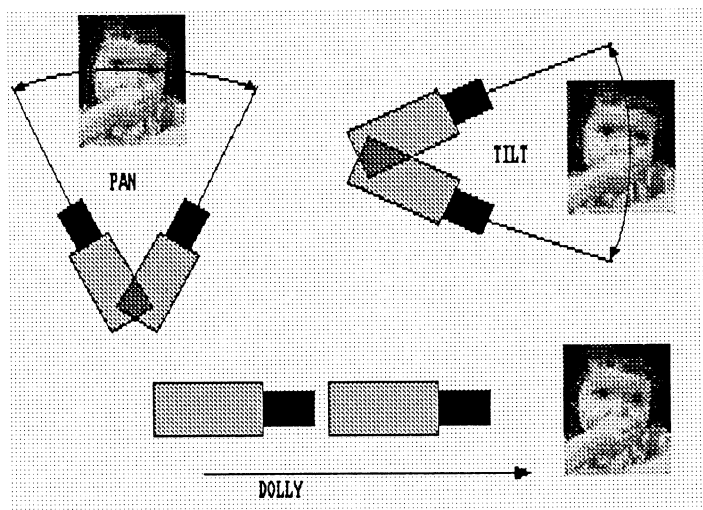
shots. With the lens set wide, the camera sees more of the total scene, and more of the scene remains in focus. A wide shot is appropriate for panoramas and scenes in which both foreground and background elements must be in focus. In a telephoto shot, the camera sees a small part of the scene and shows that part up close; the rest of the scene is not in focus. The area the lens sees looks compressed and flattened. A classic telephoto shot, often used in westerns, is of horsemen on a ridge framed by a huge setting sun that appears to be right behind them. The telephoto exaggerates the size of the sun relative to the figures, and flattens the space so all elements seem to be in the same plane. Use telephoto shots primarily to capture far away events.

The angle of the camera is of great psychological importance. A *low angle*, with the camera looking up at the subject, makes the subject appear bigger and more important. Candidates in campaign spots are inevitably shot from a moderately low angle, to give them a aura of power and authority. A *straight* or *normal angle*, with the camera at the same level as the subject, is neutral in effect. This is the angle most often chosen for talk shows. A *high angle*, with the camera looking down at the subject, makes the subject appear smaller and less important, even puny. High angles also put the subject in the context of its environment. The classic example, which appears in innumerable action shows, is a shot from a helicopter looking down at a car chase through city streets.

Angles can also be subjective and objective. A subjective angle shows the scene from the viewpoint of one of the actors in the scene. Subjective angles are used constantly in thrillers, where the camera shows the view of the criminal stalking his victim. The objective angle is most popular, though; it shows the scenes as they would appear to a neutral observer who is not involved in the action.

Camera Moves. Video would be a dull visual medium indeed if the camera always stayed in one place. Instead, the camera should be free to move whenever and wherever the action calls for it. The standard camera moves are shown in Figure 4-3.

Pan. The *pan* is a rotation of the camera parallel to the ground. Typically, the pan is used to follow a moving subject or to slowly reveal details in the environment. To execute a pan successfully, you should pick the beginning and end points of the pan, set your feet facing the end point, and then twist around to

Figure 4-3. Camera Moves

face the beginning point. This will give you maximum control at the end of the pan, where you'll need it most. A *whip pan* is a rapid pan movement, which can be disconcerting and blurry and should be used sparingly, if at all. Most pans should be slow enough to avoid disorienting the viewer.

Tilt. The *tilt* is a camera rotation perpendicular to the horizon. It's used to reveal the height of the subject or to follow actions that move vertically.

Dolly. The *dolly shot* moves the camera laterally to follow along with a movement in the scene—an actor running, for example. The standard dolly is the *walking dolly*, so called because you simply walk along with camera following the subject, trying to keep the camera as level and steady as possible. (This isn't easy, because a dolly often requires that you walk backwards to precede the subject, who is walking forwards.)

Dolly shots taken with a wheeled tripod pose some special problems because you may not have a smooth, even surface to roll over. Film production companies build tracks to roll on; you can get away with laying some plywood or Masonite along the dolly path and taping the edges together with gaffer's tape. An old trick is to use a wheelchair as the dollying vehicle; the chair's big wheels provide a smooth ride. For fast dolly shots where the camera is close to the ground, dispense with the wheelchair and

tape the camera to a skateboard or tricycle. If the terrain is right, you can shoot the scene from a moving car driving at slow speed. This works well for lengthy dolly shots of actors walking down the street.

Zoom. The *zoom* shot uses the camera's zoom lens to get closer to or farther away from the subject in one smooth "movement." A zoom is not really a camera move per se, but it does give the effect of a changing viewpoint.

The best thing about zooms is that they allow you to get close without moving the camera. The worst thing is that they are very obtrusive and easy to do wrong. Zooms should be used sparingly, and the zooming action should move slowly, not fast (unless you're taping a kung fu adventure, where fast zooms are part of the accepted pulp style). You can often hide a zoom by moving the camera in another way at the same time, such as panning while you zoom.

Jane combines a number of these camera effects in the first shot of Dr. Damian in Scene 3 of "Introducing RxScan." This is the most difficult shot in the production. She sets up the camcorder on a wheeled tripod in front of Dr. Damian's desk, with a dolly path laid out behind the camera, through the open door, and into the development lab. The camera is set at a slight low angle, so Dr. Damian looks imposing, and also so the plywood boards along the dolly path won't appear in the shot. The shot begins with the camera stationary, pointed at Dr. Damian, in a medium shot. As he moves around his desk and into the corridor, the camera gently zooms out a little to widen the shot, pans to follow him, and at the same time begins a backward dolly movement, always staying in front of Dr. Damian as he walks. In the shot, it appears the Dr. Damian is walking toward the viewer. Viewers can also see the bustle of activity through doors in the corridor.

The camera then moves into the lab, stops on a mark, and zooms out to widen the shot further while panning smoothly to follow Dr. Damian as he walks past the camera and stands next to the scanning unit. Now the camera sees the entire scanner in a wide shot, and the angle is nearly level. When Dr. Damian puts the monkey wrench into the magnetic field of the scanner, the camera zooms in to see the wrench more closely. The intent of this fairly elaborate shot, which Jane rehearses a few times with the crew, is to allow Dr. Damian to give his pitch without inter-

ruption, while also giving him freedom of movement through his domain, the lab. Figure 4-4 shows the entire sequence.

Multiple Cameras. The intricate choreography of multiple cameras in a big TV studio or on location is a subject beyond the scope of this book, but there are a few aspects of studio camera handling worth noting for DTV production. It makes sense to have several cameras covering once-in-a-lifetime events, so there will be backup footage from several angles for editing later, but the cameras or camcorders must be closely matched (that is, of the same make and model) so all the footage looks the same in terms of color, resolution, and so on. It won't do to have the talent appear to be wearing a red tie in one shot, and a magenta one in the next.

The typical studio production uses three cameras, positioned as in Figure 4-5. One camera is stationed well back in a fixed position and gets the wide angle shot, so there will always be a wide shot to cut away to if something happens to the other cameras. Another camera is up close at an angle, and gets medium shots and close-ups. The third camera can get medium shots and close-ups from the opposite angle, or can be handheld anywhere on the stage if the program calls for a cinema verite look. Music videos may call for other camera angles, such as the up-from-the-

Figure 4-4. Shooting Dr. Damian

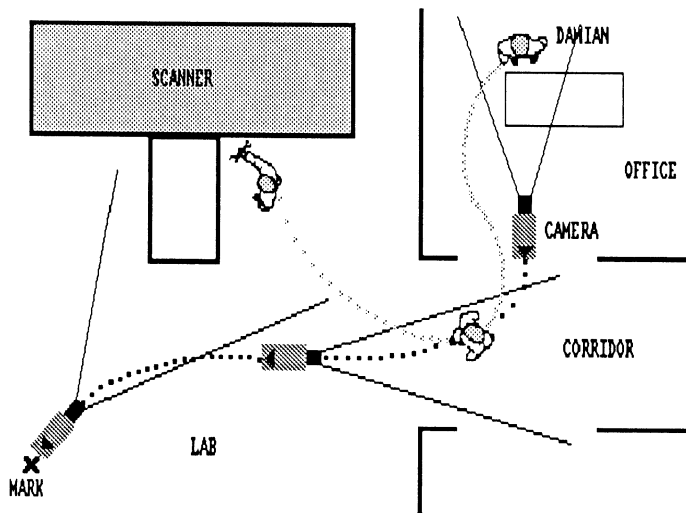
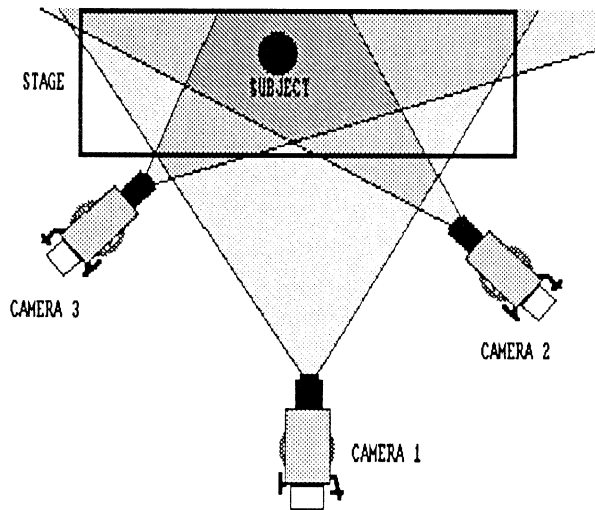


Figure 4-5. Studio Cameras

floor angle, the flying-overhead angle, and the extreme close-up or “in-your-face” shot.

When you have multiple cameras to deal with, a switcher comes in handy. As noted in Chapter 3, this device accepts video from several sources (usually cameras, but they can be any synchronizable device).

Shooting for Continuity and Narrative

The cleanest and most economical way to shoot is to tape scenes and events as far as possible in the sequence determined by the script and to do as much editing as possible in the camera. A camcorder or VCR with flying erase heads makes it possible to achieve clean edits in the camera just by pausing the tape between setups.

With practice, you’ll learn to create short programs entirely within the camera without post-production editing, ready for graphic enhancement with your Amiga. If editing is required, having the raw footage in its approximate final order makes post-production much easier. Old hands also believe that if you shoot expecting to edit all the bad parts, you’ll lose your edge and possibly miss that perfect shot. This is especially true when you shoot important one-time-only happenings, such as weddings or news events. You’ve got to get it all down, and the best attitude to take is to assume that you only have one chance to put the

tape together. No amount of editing can make up for crucial shots missed.

The natural flow of events in a narrative is called *continuity*. When editing in camera, you have to have a vision of each shot and how it will match with the next. The action should flow smoothly, without a disturbing break in continuity that looks awkward or confusing to the viewer. For example, a typical continuity mistake is to shoot an actor walking toward the left of the screen, then cut to a shot of the actor moving in the same direction but seen from the other side, so it looks like the actor is suddenly walking in the opposite direction. Movements should seem to match throughout a sequence; each change in viewpoint and angle has to serve the narrative, not call attention to itself. As continuity bears closely on editing, the subject is covered in more detail in the next chapter.

However, you can't edit every production in the camera. So when you can't, you must compensate by making sure you have all the footage you need for later editing. Besides taking all the shots called for in the script, you may find it necessary to get additional material, both to take advantage of opportunities not covered in the script and to provide alternative footage in case of mistakes.

It's especially important when shooting on location to get an *establishing shot*, a shot that sets the scene for the viewer. Have the camcorder running as soon as you get out of the car to capture the exterior of the building, the doorway, a sign, the landscape, a street corner. Hold each shot for a few seconds so there will be enough to work with in the editing stage. Get one or more wide shots of the subject(s). When you're inside a building, shoot the corridor, the office, the machinery, whatever is necessary to fully tell the story on tape. You may not use most of these shots later, but tape is cheap, and you don't want to have to return to the location to get a missing shot.

When you shoot from a script, consider shooting key scenes more than once and from more than one angle. The additional versions supply *cutaways*, alternative views of a scene that can be intercut in post production to provide visual interest. *Reaction shots* (the facial expressions of viewers to an event) are also ideal for cutaways. When taping a sports event, for example, make sure to get reaction shots from the crowd—but don't miss the main action while you're doing it.

Jane's program will be put together in post, so she doesn't worry too much about editing in the camera. She does use her second camera to get establishing shots of the ScanTech and Valley Hospital exteriors, and she also tapes cutaways for each scene, just in case.

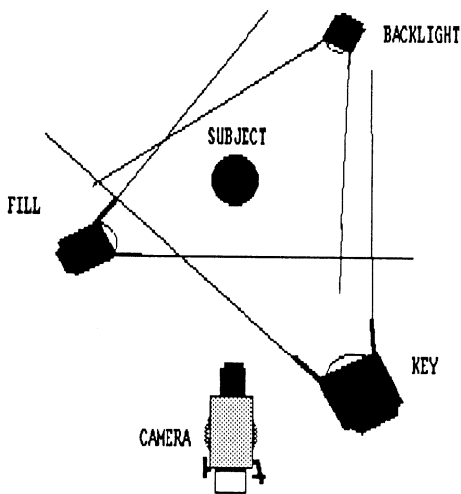
Lighting

The purpose of lighting your production is, first and foremost, to ensure that you have adequate illumination to capture the scene with good fidelity on tape. Recall from Chapter 3 that most video cameras are not very light sensitive, and need as much additional illumination as you can give them. So professional DTV producers always take lights with them in the field, where lighting conditions are rarely perfect for video.

For handheld taping of daytime exteriors, you can shoot without the benefit of additional lighting. While you have no control over the illumination, you will get footage with a completely natural look. When you move indoors, though, lighting becomes much more important. A simple solution that involves minimal expense is to mount a single bright light on top of the camera or camcorder that points in the same direction as the lens. A wide variety of such camera lights are available from video accessory manufacturers. Camera lights give flat, rather harsh illumination, but that's expected in many cases, such as in footage of news and sports events.

Light Types and Colors. Lights comes in several lamp types and light colors. In video and film, the two common lamp types are the *floodlight*, which gives a broad illumination, and the *spotlight*, which lights a small area with a high-intensity beam. Combinations of the two types, plus reflectors, masks, filters, and so on to modulate the light, generate all the different kinds of artificial illumination you see on tape.

The higher the wattage of a bulb, the more light it emits, as you know, but also the whiter the light. So try to use higher wattage bulbs whenever possible. You'll most often use *tungsten* or incandescent lights (color temperature 3200 degrees K), since that's what most video and film cameras are balanced for—they are engineered to see the light as pure white. Make sure you set the camera color adjustment to the "lightbulb" setting before rolling tape. Other light colors are created by daylight and fluorescent light.

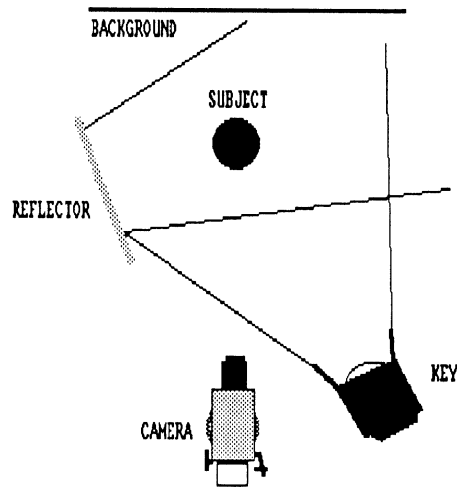
Figure 4-6. Three-Light System

Key, Fill, and Backlight. For more elaborate productions, taking the time to set up a basic lighting system can result in a much more professional product. In general, video should be brightly lit, but that doesn't mean you need a lot of lights. The standard setup to light a single subject is to use just three lights: a *key light*, the primary source of illumination; a *fill light*, which fills and softens the shadow cast by the key light; and a *backlight*, which shines on the subject from behind, separating it from the background. The key light should be about twice as bright as the fill light, with the backlight softer still. Figure 4-6 shows how these lights should be arranged.

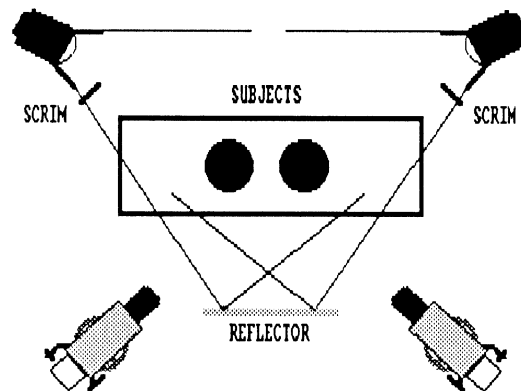
You may not have three lights, but don't despair—you can get by with just a key light and a large reflector—a piece of white posterboard or foamcore works well—positioned as in Figure 4-7. Be sure the background is dimmer than the subject, and position the subject several feet from the background.

Things become more complicated if you light two or more subjects, as when you shoot an interview or talk show, but the same basic rules apply. Figure 4-8 shows one two-light method for illuminating two subjects sitting face to face. Make sure no shadows are cast on the other subject.

Take a look at how people are positioned on the sets of talk shows—you'll soon figure out that seating arrangements are

Figure 4-7. One Light and Reflector

mostly to aid lighting and camerawork, and that it's a good idea to copy what the pros do. Try close-ups and medium shots to see whether the lighting works at various angles and distances. A *set light* directed at the background can help mask any shadows cast there. Colored gels can be fixed over lights to add color. Shining the set light through a patterned *scrim* (a paper, cloth, or plastic sheet) can add texture to a plain background. Experiment with each lighting element until you achieve the effect you want; check the camcorder viewfinder or run some test tape and play it back to check the results.

Figure 4-8. Lighting Two Subjects

There are no hard and fast rules for lighting action, especially if the subject is moving through a complicated space. You might need many lights to illuminate a wide area. Often a dramatic effect can be achieved by creating zones of light and darkness that the subject can move through; for instance, lighting a doorway but leaving the hall behind it dark, so the subject appears to be bursting into the room. Drama can be created by using very bright backlighting or having the lights move.

Every location offers its own mix of artificial and natural light. Settle on one type of light—for example, fluorescent in an office—and try to eliminate all the others. Mixing light types will result in odd colors on tape, especially noticeable in flesh tones. In an interior, natural light is the hardest to control. For example, Jane has to tape Dr. Gold, the ScanTech CEO, in an office with a big picture window behind the desk. The window faces south, so the sunlight streams in, but there's also a good view of the ScanTech building through the window. Jane brings along a plastic gel she bought at a local photo and film supply stores. She cuts it to shape and applies to the windows; the gel changes the daylight color to match the color of the lights she is using, and also cuts down on troublesome reflections. She lights Dr. Gold with a soft key and fill, but uses the window illumination as a backlight.

Lighting Tips. If you do a lot of lighting, buy or rent a lighting kit. These include three or more lights with bulbs, clamps and barn doors; reflectors, umbrellas, and scrims to filter and direct light; poles, tripods, and other mounting hardware; and a case to hold it all. For occasional use, a floodlight, a spotlight, a sheet or two of white posterboard or foamcore, a couple of step ladders, some C-clamps, and several rolls of gaffer's tape will do the job.

Since video lights draw a lot of juice, you may have to cope with inadequate power on location. Check this out in advance; no one will thank you if you blow the fuses in someone's home and you have to make a ten-mile trip to the hardware store to get new ones. Only run one 1000 watt light on any fuse or circuit breaker line, and don't run any 1000 watt lights at all on a home system with 60 amp service. Bring plenty of long, heavy-duty (15-amp) extension cords and multiple outlet boxes with circuit breakers.

In Jane's case, she has access to ample electricity at ScanTech and the hospital (having notified both places that she will be drawing lots of juice for the day), but on other jobs she hasn't

been so lucky. In the past she's rented a small gas generator and used that to power two or three lights. She positions the generator as far away from the shooting location as possible so the noise won't overwhelm the ambient sound—that's where those long extension cords come in handy.

Working with Talent

Your DTV production is very likely to involve the onscreen actions of people—moving, talking, telling stories, teaching lessons, pitching products, communicating in every way. As the DTV director, you should have some sense of how to get the best performance from the people in your video.

The management of professional actors is a subject of great subtlety, and not within the scope of this book. There are many books written by theater, film, and video directors that can give you more insight into professional directing than can be encapsulated here. It's worthwhile to use professionals when the material (and your budget) calls for it (especially for narration, where a professional speaking voice is *de rigeur*). More often, you'll be using amateurs—people who may never have been in front of the camera before but who have some connection with the project. Your task is to be sensitive to their needs and fears while coaxing from them the best performance they're capable of giving.

For "Introducing RxScan," Jane is lucky that the main actors in the production, Drs. Gold, Damian, and Palmer, are all professionals speaking about their areas of expertise. They don't have to be coached on the basic information. As the chief representative of her company, Dr. Gold is fairly experienced with media in general and will be delivering a practiced speech, a variation on one she has given many times before.

Dr. Damian is not so experienced, so Jane rehearses his scene with him several times so he feels comfortable with his movements and the pace of his speech. She advises him to speak slowly and clearly, to pause between sentences, and to look directly at the camera at all times. She tapes one of his rehearsals and analyzes it with him. She also talks to the other personnel in the area, who will be working while the scene is being shot. They are instructed to act completely normally, to avoid looking at the cameras and production people, to talk softly and not make loud noises, and to keep away from the immediate area of the shoot. In general, Jane's attitude is patient and reassuring, and it pays

off; Dr. Damian gives a natural, confident performance that clearly conveys the necessary information.

Looking Good on Video. Video performances can be ruined by things that have nothing to do with the actor's behavior—the wrong suit, for example. Here are some tips for getting your actors to look their best on tape:

Clothing. Avoid loud, contrasting patterns (especially herringbones and stripes), glossy white shirts and blouses, and white, navy, and black suits. For men, solid medium blue or gray suits, light blue, tan, or gray shirts, and dark red ties work well (all the politicians wear them). A conservative dress or business suit is good for women, with a minimum of shiny jewelry. (None of this applies if you tape real actors or rock musicians, who can wear any bizarre thing they think will catch the audience's eye.) Check that little clothing details are in order before the tape rolls—your boss won't thank you if his fly happens to be open through the entire interview.

Body language. Audiences are extremely alert to body language and tend to judge what's said on the basis of what's seen. Actors should remember to sit forward in their chairs and look alert. In a talk show, guests should never look at the camera (leave that for the interviewer), but should look at the host or other guests instead. In a promotional or instructional video, however, the performer should always look directly at the camera when explaining important points. The eye contact brings home the information to the viewer. Keep hands relaxed and free to gesture. In interviews, a pitcher of water and a glass can be a useful outlet for impulses that would otherwise lead to fidgeting, handwringing, foottapping, headscratching, and so on. For extremely nervous interviewees, a rehearsal or two can ease their fears.

Speech. Clear speech and a confident voice make words credible. Mumbling is completely incomprehensible on TV—remember those tiny little speakers that most sets have. Do a sound check before rolling tape to let the guest know how he or she will sound, and adjust the guest's mike-level accordingly. (See Chapter 8 for sound in DTV.)

Expect the Unexpected

No matter how well you've planned and how experienced you are, every production has its own little surprises. Just keep your

cool and use your wits, as Jane did when she discovered that the magnetic field and radio signals from the scanner made her cameras and wireless mikes go haywire. She simply reblocked her shots of the scanner so the cameras were outside the influence of the magnetic field, wrapped some components in aluminum foil to shield from the RF, and substituted wired mikes for wireless ones.

Once your production is wrapped, you're ready to go into post-production. That's the subject of the next chapter.

Chapter 5

DTV Post-Production

Your raw footage is “in the can,” as they say in the film world. But all the raw footage in the world isn’t worth much without organization. The post-production stage is when you turn that great footage into a meaningful, polished DTV program.

Some DTV directors love post, because that’s when you get to play with the Amiga itself, creating the fantastic effects that only a computer can create. DTV directors with a bent for editing feel comfortable putting together a program from disparate parts in post, especially if they haven’t been able to plan the pre-production and production stages in much detail, as happens in shooting documentaries, for example. Some desktop video programming, notably pure animation, may never go through a production stage at all, but instead moves directly from pre-production to post-production.

Some DTV directors hate post. Post is when you have to make up for the bad footage, shortsightedness, and other problems you introduced in the pre-production and production stages—if you can. Of course, a botched editing job can make great raw footage look bad, as can second-rate animation or graphics. When post is finished, your program has to stand or fall on its own.

The heart of post-production is editing, assembling the raw footage into a finished program, and coverage of the editing process forms the centerpiece of this chapter. But before you can edit, you usually have additional effects to create that couldn’t be done in the production stage. In Amiga DTV, these usually involve using a genlock, titling, and digitizing.

Using a Genlock for Post

As mentioned in Chapters 2 and 3, a genlock is indispensable for DTV production, especially post-production. Not only does it provide a route for the video signal in and out of the Amiga, but it also makes possible the most basic special effects, such as titling over video.

There are at least half a dozen genlocks available for the Amiga, each with its own niche. Genlocks range from Magni's 4004 Video Graphics System (list \$1999), which consists of two Zorro plug-in cards and an external controller; to the mid-priced (list \$749.95) SuperGen (Digital Creations); to the Amigen genlock from Mimetics, the only low-price (list \$179) genlock on the market that works with any Amiga.

The Magni, aimed at professional DTV producers, represents one typical genlock configuration. One card interfaces with the Amiga RGB graphics system; the other contains a broadcast encoder with internal blackburst and sync generators, the genlock, and its own system clock. A controller box has sliders for fading video in and out, as well as other controls. While convenient and powerful, the Magni approach is limited to Amiga 2000s and 2500s and can't easily be moved from one computer to another.

At the other end of the scale is the Amigen, which is shaped something like a very big printer connector. It plugs onto the Amiga RGB port and has composite video in and out jacks (RCA), plus a passthrough for the RGB signal so you can hook up your monitor and run the genlock at the same time. There are no external adjustments, knobs, or sliders, but that's why the Amigen is so inexpensive—it just does three things: it allows composite input into the Amiga; puts video over color 0, the default background color of your Amiga graphic; and provides a composite output to a VCR. The Amigen is the obvious choice for bargain basement DTV—it doesn't break the bank, and you can still do good work with it.

A middle approach is the one taken by most genlocks, such as the popular SuperGen, which we'll look at in more detail. The SuperGen is a standalone unit that attaches to the Amiga with a cable to the RGB port. On the back of the unit are BNC jacks for

- composite video in, which you connect to the play VCR
- overlay 1, the primary genlocked composite video output, which you connect to the record VCR

- overlay 2, a second genlocked output, identical to overlay 1, which can be routed to another VCR
- video thru, for passing through the video input before it's genlocked with Amiga graphics
- key out, for use with a downstream SEG in a professional studio

On the top of the SuperGen box are two slider controls and two switches. One switch turns on a notch filter, for sharpening the outgoing signal. The sliders control the mix of graphics and video. The background slider controls the amount of video that replaces the background color, color 0. At the top position, no video shows in the color 0 areas. As you pull the slider down, video gradually appears, fully replacing the background when the slider is at the bottom position. The graphics slider is for mixing video and all the foreground colors in your Amiga graphic. The graphics slider allows you to fade the foreground colors evenly into video, or stop at any intermediate point for transparent effects.

With the graphics slider, you can also choose an *interpretive dissolve* option, in which the graphics slider removes the foreground colors by register—color 1, then color 2, then color 3, and so on—as you pull it down, rather than all at once. (Color registers are discussed in Chapter 2.) To make best use of this feature, you have to design your graphics so the order of colors is in some way meaningful. As a simple example, suppose you want to create an effect in which the words “Now,” “Hear,” and “This!” appear in that sequence over video. Here's how:

1. Create a graphic in which “This” is painted in color 1; “Hear” in color 2, and “Now” in color 3.
2. Set the SuperGen to interpretive dissolve and pull the graphics slider all the way down.
3. Load the graphic and display the video.
4. Gradually pull the graphics slider up. The graphic colors appear in reverse order—color 3 (“Now”), color 2 (“Hear”), and color 1 (“This!”).

SuperGen also comes with multitasking controller software that makes it possible to perform background and graphics dissolves from the keyboard.

Here's a typical example of genlocking in action. For "Introducing RxScan," Jane wants to use her SuperGen to run video of the exterior of the ScanTech headquarters under a title animation she has created. Here's how she does it:

1. She creates the animation with *Deluxe Paint III* (see Chapter 7 for more on animation), making sure to leave the entire screen in color 0 (the genlock color) except for the animated title.
2. Jane hooks up her genlock to her Amiga in the standard genlock configuration.
3. She loads the *Deluxe Paint III* animation into her Amiga and gets it ready to play.
4. She puts the tape containing the field footage of the ScanTech exterior in the playback VCR. She cues up the tape to the beginning of the desired sequence and puts the VCR in pause. She puts a blacked tape into the record VCR.
5. Jane now does a dry runthrough. She makes sure the SuperGen has locked the Amiga to the external video signal from the VCR (a green light on the SuperGen tells her the lock is on). She takes the playback VCR off pause and starts the tape rolling. At the same time, she sets the animation to loop over and over again. Pulling down on the background slider, she watches video fade dissolve into the title animation background. The animated text appears to be flying over the video.
6. Satisfied with the results, she rewinds the playback tape to the cue-in point and gets the record VCR rolling. She records the genlocked sequence a few times, running the animation at slightly different speeds. She can choose the one that works best in the editing stage.

Titles and Character Generation

Titling—the process of adding text to video—is probably the most common video "special effect." Use titles to

- Identify and introduce the production
- Label events and people
- Mark transitions between scenes
- Provide textual information
- List the credits and end the production

The most basic form of titling is to print on a piece of paper and shoot it with a camera at the time of production. This is the method still used by most home videographers. Newer VCR and camcorder models provide more sophisticated electronic titling capabilities right in the deck, including being able to insert title text over video as it's being shot. However, these models offer only one typeface and limited ability to place the title in different parts of the screen. Video studios use character generators with titles, drops shadows, moving text, and more. Your Amiga, with the right software, can do all that, with more colors and greater flexibility than all but the highest-priced character generators; in fact, the Amiga makes a truly superior titler.

DTV titles are generally added in post-production. You create the title with titling software, run video through the Amiga with a genlock, and superimpose the title over the video at the proper point. (See the discussion of genlocking below for an example of how to do this.) Figure 3-4 shows a typical titling setup using a genlock. The esthetics of titling—fonts, text colors, placing type, and special titling effects—are covered in Chapter 6.

The Amiga can also be used as a titler during a live production. The setup is similar: send live video from a camera through a genlock to the Amiga which is running a titling program, type in the proper title at the right moment, and record the video on a VCR or send the video to a closed circuit system. This takes good timing, good typing skills, and a titling program that allows you to type without showing a cursor or menu bar. Another approach, useful if you know in advance what titles you'll need, is to create the titles and save them as separate pages in the order you'll need them, then summon each page with a keystroke at the proper moment. Even if your titling software can't do this, you can save your titles as pictures and load them into a slide-show program that can.

Using a Digitizer

NewTek's Digi-View color video digitizer, first introduced in 1986, opened the eyes of many people to the Amiga's stunning graphic abilities. It was the first high-quality desktop video product for the Amiga, and remains one of the required tools for any Amiga DTV or graphic artist.

Digi-View's latest incarnation is Digi-View Gold, for the Amiga 500 and 2000/2500. Like previous versions, Digi-View Gold

takes the image from a video camera and turns it into a color Amiga picture in any of the Amiga's display formats, including Hold-And-Modify (HAM), which allows 4096 colors on the screen at the same time. Several examples of Digi-View output can be seen in the color plates, notably in plates 12 and 13.

How It Works. Like all digitizers, Digi-View is a combination of hardware and software. The hardware part is a composite video-to-RGB encoder interface box about the size of a Chunky bar that plugs into the Amiga's parallel port. Digi-View's image processing software controls the encoder functions and lets you do some amazing things with the Digi-View scans.

To use Digi-View, you must first have a source of monochrome or color composite video. NewTek recommends (and sells) an industrial monochrome CCTV camera, Panasonic's WV-1410, for its greater resolution and clearer picture. How does Digi-View create color pictures from a black-and-white camera? It scans the image three times, once for each of the video primary colors, red, green, and blue, using the plastic color filter wheel provided. The filter wheel hooks onto the camera's tripod mount hole (or you can use tape or velcro for this purpose) so the lens looks through the appropriate color filter.

You can also use the video output of a standard color camera or camcorder, but these yield poorer pictures. Still, if you're reluctant to pay the approximately \$240 for the Panasonic or a similar model, you can get started with your own camcorder and trade up later. If you do plan to use another monochrome camera, make sure it outputs 2:1 interlace video (that's NTSC standard, with the lines from each field neatly intertwined), not the random (every-which-way) interlace offered by some cheap security cameras. Digi-View can't handle random interlace. The WV-1410 has an internal switch that lets you flip back and forth between the two types of interlace.

First, hook up the camera to any composite monitor and use the monitor image to aim and focus the camera on the subject. You can use your Amiga monitor for this; just switch the monitor to *composite* and hook the camera into the video-in jack in the back of the monitor. Once the image is positioned, load the Digi-View software, switch your monitor to *RGB*, and hook the camera to the Amiga through the Digi-View interface box.

NewTek sells a copy stand to support the camera in a downward-pointing position, for scanning flat art and photographs.

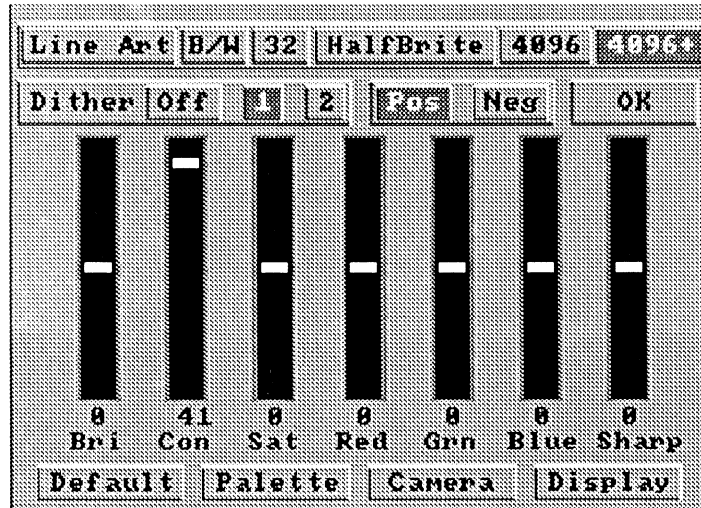
You can use the beefier copy stands used by photographers, or screw the camera onto a video tripod. The WV-1410 has a standard c-mount that accepts many film-camera lenses, so you can put a zoom or closeup lens on your camera for digitizing small objects or distant scenes. For clear scans, the camera and the subject should remain stationary until the scanning process is complete. Note, though, that some interesting distortions can be created by moving the subject or the camera during the scan—in fact, it's strongly recommended that you try some experiments in this vein once you've mastered the basic scanning techniques.

On loading, the Digi-View software asks you what kind of scan and screen format you plan to use. You can choose any screen format, plus two levels of overscan and whether you'll be digitizing in gray scales or color. When the menu bar appears, choose *Digitize*. If you're scanning in color, you'll take three scans, turning the filter wheel each time so the camera takes a picture through the correct color filter. A motorized color wheel turner is offered by NewTek for unattended scanning.

Once the scans are complete, the Digi-View software combines the three images into one full-color image, then dithers the colors together to smooth out any banding, fringing, and other funny scanning artifacts. In interlace HAM mode, the picture looks just like regular TV—sharp, clear, and with thousands of colors. For best color fidelity, illuminate the subject with fluorescent lighting, rather than incandescent. You can pop the new fluorescent bulbs into cheap clip-on floodlights for quite respectable results.

Digi-View's image processing capabilities are limited but powerful. With the easy-to-use scanning, palette, and color controls, you can change the brightness, contrast, and sharpness of the scan, adjust the RGB setting of any color or all of them, and use the complements of all the scanned colors to create color negative images. For desktop publishing, you can choose to digitize in only a few colors, or adjust the scanning process for line art. Figure 5-1 shows some of the image-processing tools available.

Scans can be printed and saved as IFF files (compatible with Amiga paint and titling programs) or with the complete raw RGB information for later processing. The raw RGB files contain 21 bits per pixel, or enough information to display more than 2 million colors on the screen. The Amiga currently doesn't have a display mode that can handle that many colors, but upcoming image processing boards for the Amiga may.

Figure 5-1. Digi-View Image Processing

You'll find the Digi-View useful in several post-production situations. For example, "Introducing RxScan" contains a sequence in which an animated pointer moves over a printout of an MRI scan. Jane found that the easiest way to create this sequence was to digitize the printout using the Digi-View in HAM interlace overscan format. She then moved the Digi-View pointer around on the screen as called for in the script while taping the whole thing through a genlock to a VCR. You can see the result in color plate 3.

Editing

It wasn't so long ago that video editing was done with a knife and tape, just like film editing. Things have gotten a little more advanced since then. Now video is always edited electronically, by transferring selected material from raw footage on a playback VCR (or *source*) to a master tape in a recording VCR (or *slave*). Only a signal passes from the source to the slave.

It's the quality of that signal, and how it's manipulated, that determines the technical quality of the finished edits, or *cuts* (after the old razor-blade editing process). As you might guess, there's a right way and a wrong way to edit.

Punch and Crunch. Anyone with two VCRs can cut tape. Here's how:

- Hook up the output of the source VCR to the input of the slave VCR.
- Put your raw footage into the source VCR and a blank tape into the slave VCR.
- Search the raw footage for the beginning of the first shot in your program, and put the source VCR in play-pause. Put the slave VCR into record-pause.
- Hit both pause buttons at the same time.
- When the first shot has finished, put both machines into pause again.
- Look through your raw footage for the next shot in your program, and repeat the process until the program is completely edited.

This is called *assemble editing*, or *punch and crunch editing*. Why is it called punch and crunch? The “punch” part is from the necessity of punching the two pause buttons at exactly the same moment, but the “crunch” part is not readily apparent until you play back the edited tape. With this method, you’ll discover, edits aren’t smooth but cause a jump in the video that interrupts both sound and picture.

There’s a couple of reasons for this. For one thing, the slave VCR tape transport system can’t get up to speed fast enough to record the first frame that’s coming over from the source VCR, so you get broken-up video. The other reason is that assemble edits record over the slave tape’s control track, erasing some of the track after each edit. That makes it hard for the slave to sync up with the signal from the source.

There are other shortcomings with assembly editing as well. The main one is, you can’t easily go back and fix mistakes or add additional material. Suppose you’ve made a program with ten edits, and you want to go back and put in a graphic in shot 3, while leaving the audio part of shot 3 intact. If you were to try that by assembly editing, you’d record over the audio as well, plus ruin a few seconds of footage after the edit. All in all, you can see that assembly editing is the wrong way to go if you have any choice in the matter.

Insert Editing. The right way to edit is to *insert edit*. Insert editing doesn’t disturb the control track of the master tape, so you can record new video over existing footage without ruining the video on either side. VCRs capable of insert editing have

flying erase heads (see Chapter 3) that allow clean, glitch-free transitions.

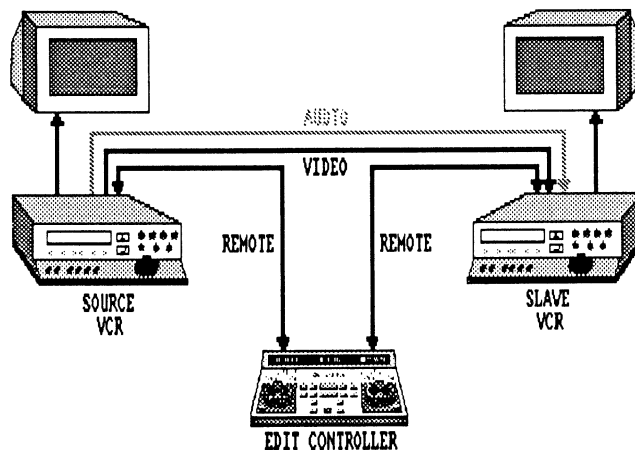
Figure 5-2 illustrates a typical insert editing system. Among the many features a good insert editing system should offer are

- Centralized control over the transport and recording functions of the VCRs with the edit controller.
- Control of VCR pre-roll, so VCR transports are up to speed before the edit begins.
- Digital readouts of the time of edit-in and edit-out points, and the total duration of your cuts so far.
- Preview of an edit before anything is actually recorded.
- Memory that can hold the edit-in and edit-out points of many edits and then execute them in a batch.
- The ability to edit video and audio tracks separately.

Using an edit controller, the insert editing process for one edit typically works like this:

1. The raw footage is loaded into the source VCR, and the master tape into the slave VCR. Both tapes are rewound to the beginning, and the VCR counters are set to 0, as are the timer readouts on the controller. You choose whether you want to transfer just video, just audio, or audio and video.

Figure 5-2. Insert Editing System



2. Using the shuttle controls, search the raw footage for the beginning of the first shot you want to use. Mark that point with the controller. The controller remembers the timer setting you've marked. Then roll forward to the end of the shot; mark that point also.
3. Then roll the master tape forward until you reach the first edit-in point (usually at the end of the countdown you laid down on the tape during blacking; see Chapter 4). Now you've set up the basic situation for the edit.
4. To see a dry run of the edit, hit the Preview button. The controller rolls each VCR back a few frames before the edit-in point on both VCRs. (This is called *pre-roll*.) Both VCRs roll forward, and at the precise spot where you marked the edit-in point, you see the raw footage substituted for the master footage. Actually, no recording has been done; the controller only sends the raw footage video to the monitor. At the end of the edit, the decks rewind back to the starting point.
5. If you're not satisfied with the way the edit looks, you can adjust the edit-in and edit-out anyway you want. Once you've settled on the right edit, pressing the Edit button actually does the edit. The controller leaves the slave VCR paused at the last frame of the edit, ready for the next.

Frankly, insert editing with an edit controller and compatible decks is so much faster and more flexible than assembly editing, and the results are technically so superior, that no one who has a choice would ever use "punch and crunch."

But do you have a choice? Until recently, insert editing equipment was restricted to the industrial and professional realms. For example, in 1989 a three-quarter-inch insert editing system consisting of two Sony VO-5850 VCRs (\$8,350 each), a Sony RM-450 Editing Console (\$2,300), and two Sony PVM 1271Q twelve-inch Video Monitors (\$1,095 each) would run you a cool \$21,190. However, the DTV revolution has even invaded the editing suite. Now it's possible to find decks with insert editing capabilities at the consumer level. Sony, Panasonic, and JVC all offer complete systems, including compatible VCRs and edit controllers, in 8mm, standard VHS, or S-VHS. You may be able to find a complete VHS insert editing system for under \$3,000.

Also keep in mind that it may be possible to edit your material with editing equipment at a school, local-access cable facility,

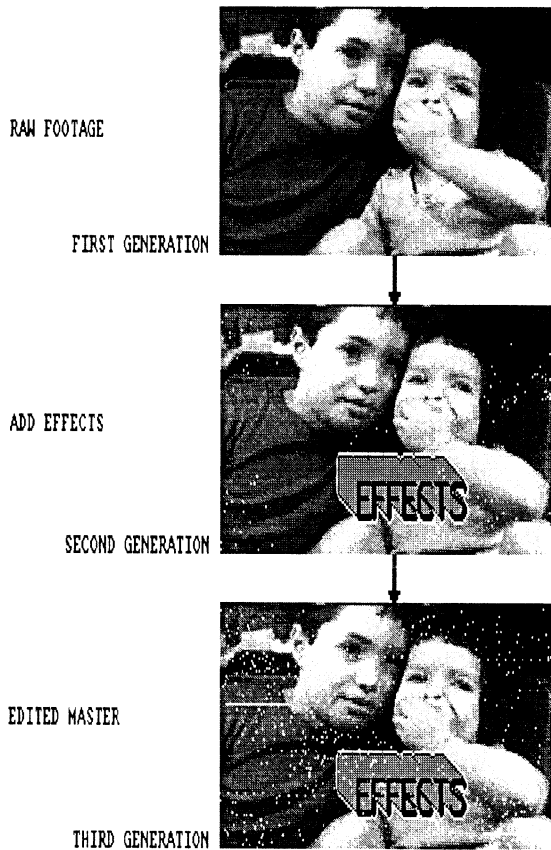
or publicly funded video facility. You can even do the job at a professional editing house, many of which maintain a low-end (and relatively low-cost) edit room for insert editing only. There's more about working with editing professionals in Chapter 9.

Something that several manufacturers have been promising is hardware and software that makes it possible to use the Amiga itself as an edit controller. There's nothing, in principle, that makes the Amiga any less suited to the task than the dedicated computers used in professional editing suites. At least one company, RGB Creations, is installing Amiga 2000-controlled editing systems. These systems are aimed at professional users, but they're an indication of what is to come for the amateur desktop video producer as well.

Another company, Software Visions, has demonstrated a setup that uses their *Microfiche Filer Plus* database and a macro language (ARexx) to control a videodisk player. With a single keystroke, the viewer can make any selected segment from the video disk pop up on the Amiga monitor (routed through the Amiga via a genlock). This is another obvious precursor to an Amiga-controlled editing system, but it also opens interesting possibilities for using an Amiga to control other A/V devices as well, including audio equipment, lighting systems, slideshows, and even other computers.

Generations. Whether you're cutting by assembling or inserting, present editing systems all require that you record down at least one generation from the raw footage to the finished master. Sometimes you'll need at least three generations, usually for effects that involve laying graphics over raw footage and sending the mix through a genlock to a VCR, then cutting that footage into a master. Figure 5-3 illustrates how this can work.

As you learned in Chapter 2, each time the video signal is recorded down another generation, it loses quality. You've all seen programs that have been rerecorded many times—they're painful to watch. So, when editing, you first of all have to strive to record down as few generations as possible. This is something you can achieve by good planning. The other thing you can do is invest in or use equipment that incorporates circuits for minimizing signal loss over generations. Some industrial-quality VCRs can do this, as can all professional editing VCRs. Signal amplifying and processing equipment can also be a help in maintaining video quality during the editing process.

Figure 5-3. Editing Generations

The Editing Process

The process of editing generally breaks down into several stages, or levels of approximation. The first and roughest stage is *logging*; here you record the beginning, ending, and duration of all your raw footage and start to make evaluations about what to keep and what to discard. In the *rough cut* stage, you take shots selected from the raw footage and piece them together into a smooth narrative. The final stage, or *fine cut*, is when you refine the rough cut, adjusting pacing and adding the final touches, including additional audio and graphics.

Logging. The logging stage is invaluable for seeing what you have, finding where the good shots are, culling the unusable

shots, and deciding whether additional footage is needed before it's no longer possible to shoot anymore.

Cautious editors log from exact copies of the raw footage (called *workprints*, after their film counterparts), rather than the originals themselves. The less the raw footage is handled, the better. It's always possible to log footage by hand on legal pads, but you'll find it worthwhile to do your logging directly on the Amiga, using a text editor or word processor. This gives you the basic advantages of a readable log and the ability to search, replace, cut, and paste the text. Set up the Amiga alongside the VCR and enter edit-in and edit-out points as you determine them.

Part of a log list might look like this:

“Introducing RxScan”—Tape #6

Date: 10/6/89

Logged by: J

Shot	Start Time	End Time	Duration	Notes
1	00:00:00:00	00:00:45:13	00:00:45:13	Good bldg ext.
2	00:00:45:14	00:01:20:30	00:00:35:16	Hallway; poor light
3	00:01:20:31	00:09:20:40	00:08:00:09	Gold on goals of ScanTech

The numbers refer to hours, minutes, seconds, and frames. Obviously, if you're using SMPTE time code (see Chapter 9), you can be more exact than you can by logging by counter numbers on an inexpensive VCR. If you're using time code and are handy with AmigaBASIC, you can create a program that will automate much of the logging tedium. An example of such a program can be found in “The Portable A.D.,” an article by Mike Wilson in *AV Video Magazine*, November 1988, beginning on page 56.

You can also enter log information in a database manager such as *MicroFiche Filer Plus*, mentioned above. The advantages of using a database manager instead of a text editor is that the database manager can do a lot of the work for you, including calculating the duration of shots and sorting shots by any criteria you set up in advance, such as length, location, quality, and so on. All that's required is that you know enough about the functions of the database management software to set up your own calculating and sorting criteria. Once you've entered the log information, you may find it useful to rearrange it with the database sorting and extracting functions to create a preliminary edit list.

The Rough Cut. This is the first real editing stage, when the rough outline of the program is blocked together into a continuous narrative. It is this stage where most important decisions are made about how the tape should be put together—the pacing, the order of shots within each scene, and so on. You sit back and look at the rough cut to finally get a sense of what the piece will really look like, and tinker with parts of the whole until it begins to match your vision. The decision-making becomes easier, of course, if you've written a solid script and held to it during the production stage.

At this point careful editors are still working closely with the log list, the storyboard or animatic, and the script, and are still using the workprint tapes, rather than the raw footage.

The Final Cut. This is the final edit stage, where the master tape is assembled from the original raw footage. During the final cut, the DTV editor (and perhaps the director and producer, if they are not the same person) hone the rough cut, perhaps substituting better shots for the ones chosen in the rough cut and making small adjustments in pacing. This is also when final effects are added, including special transitions and audio effects.

Of course, the stages of editing are not always so cut and dried. DTV producers who are pressed for time may just do a rough cut right from the raw footage and call it final. Even when time is ample, the work of rough cutting inevitably shades over into final cutting.

Offline and Online Editing. When the final cut is to be done using a computer-controlled editing system, the editing process also breaks down into *offline* and *online editing stages*. The offline stage corresponds to the rough cut described above. Additionally, however, the editor prepares an *Edit Decision List* (or EDL) that specifies the in and out points of all the edits in the piece (usually in SMPTE time code; see Chapter 9). Computer-controlled editing systems prepare and update such lists automatically.

In the online editing stage corresponding to the final cut, the EDL is fed in electronic form to a computerized edit controller, which auto-assembles the master tape from the original raw footage. This process is covered in more detail in Chapter 9. Should you plan to do your final edit at a professional editing studio, you will want to organize the editing process the same way—preparing an offline edit and an EDL yourself with whatever equipment you have handy (even a paper edit decision list is better than nothing) before you go to the studio for editing online.

Cutting for Continuity

Creating continuity with editing is much the same as doing it in the camera during production (see Chapter 4). The most important aim is to tell the story effectively and clearly, without glaring disjunctions.

We'll discuss some specific aspects of cutting for continuity below. But there's one thing that has to be taken care of in the production stage, and that's making sure that certain small details are the same throughout a sequence. This can be hard when parts of a scene have to be shot at different times, even though the scene is supposedly taking place all at once. There's not much you can do in post-production to fix a scene in which the actor is wearing a green sweater in one shot, a blue suit in the next, then the green sweater again.

Matching Action and Position. As with in-camera editing, you must maintain the proper screen position and movement for a subject through a sequence of shots. A person walking in one direction should not suddenly seem to be walking in the opposite direction without some event to justify the change. When a motion across the screen does need to reverse, insert a neutral-angle shot between. Cutaways or reaction shots can be used for the same purpose. The key is to imagine yourself as the audience, and make sure there is nothing to confuse or distract them.

There should be enough variety in the angle of consecutive shots that the audience doesn't get bored, but not so much that viewers become disoriented. Note that very small increments of change in the angle of consecutive shots can be just as disorienting as large changes.

One thing that should never happen (except in avant-garde efforts) is to allow the point of view of the scene to shift from neutral to subjective, or from one actor to another, in adjacent shots. The audience is much more comfortable with a consistently neutral point of view, or the point of view of just one subject.

Many experienced editors feel that the best time for cutting on action is just after the initiation of the act. Here's how Jane cuts a sequence from "Introducing RxScan" that shows Dr. Palmer in Valley Hospital working with a patient.

1. Shot 1 is a medium close-up of Dr. Palmer looking at scan-prints in the scanning lab. There's a sound of a door opening and Dr. Palmer begins to look up.

2. Shot 2 is medium wide, showing Dr. Palmer smiling and walking to greet the patient, who has just entered. They talk; then Dr. Palmer gestures to the scanner. The patient begins to walk over to it.
3. Shot 3 is another medium shot from a slightly different angle on the same side of the room. The patient is still moving toward the scanner in approximately the same direction as in the previous shot. As the patient is getting onto the bed . . .
4. Shot 4 switches to a high overhead shot above the patient but still on the same side as the other shots, showing how Dr. Palmer operates the scanner's laser positioning device.

The aim in cutting this way is to create a smooth flow from one shot to the next, with the movements of the actors naturally motivating each transition. The last shot has a practical purpose, to show an action that can't be seen from another angle, but the center of attention is still the patient, and there is not an abrupt change in viewer position.

Obviously, shooting and cutting have to work together here; if you don't keep action continuity in mind when you shoot, you won't have the proper footage to make smooth cuts. As stated before, no amount of editing can make up for crucial shots missed.

Audio. Another important way to create continuity is with sound. Music and ambient sound used across an entire sequence or scene can really help to pull together material that otherwise may not hang together well. Narration and dialog can overlap from one shot to the next, smoothing transitions. Audio should be properly equalized and at a constant level across a scene; see Chapter 8 for more on this.

Matching by Shape and Sound. One trick bold editors use is to match a cut on a shape or a sound. For example, you could start with a picture of the earth spinning and cut to a closeup of a baby's face. Here you're matching the round shapes of the world and the face (and making a comparison between the two, as well). To match by sound, find two sounds that are alike, and use them as the bridge between shots—a cut from a wide shot of a whistling train to a close-up of a whistling tea kettle is a classic example.

Pacing

The proper pacing of sequences and scenes is one of the hardest things to learn; there are few rules for how long any particular

action should take. When in doubt, though, you'll probably be kinder to your audience if you make your sequences shorter, rather than longer, as long as all the necessary information is still there. Check your own reactions—do you want to make that love scene go on longer, or would that turn it from intense to laughable? Get the reactions of others as well.

Sometimes quickening the pace serves the plot as well. Chase scenes, as you've surely noticed, always speed up toward the end, to create tension. Romantic interludes move slowly, with few cuts. The pace of the material itself may impose stringent requirements on the editor; you shouldn't speed up a basketball game, or slow down the act of a standup comic. Music videos are invariably cut to follow the beat of the music; since that beat is much more regular than the natural pace of a drama, music video directors fall back on the *montage* technique. They use quick cuts from one striking image to another, rather than build a strong, connected narrative.

In other cases, however, you have to acquire a feel for the rhythm of the narrative. Small adjustments in edit-in and edit-out points can make a big difference in the smoothness of a story. Just remember that viewers have been conditioned to expect things to move fast on the small screen.

Study the work of other editors to get a feel for where and how to cut. But don't look at TV programs for examples of great editing—you'll see only competent or functional editing on the small screen at best, even on MTV, where you can pick up a lot of wrong ideas about editing for continuity. Look at the work of the great filmmakers instead—you can probably learn all you'll ever need to know by studying the films of Eisenstein, Hitchcock, and Kurosawa.

Transitions

A unique aspect of video and film storytelling is the visual transition. Consistently using the right transition can further your narrative by providing important visual clues to the audience. Here are the major kinds of transitions.

Cut. The *cut* is an instantaneous transition from one shot to the next. It is simple, direct, and honest. Whenever you're tempted to use a fancier transition, try the edit with a cut instead first.

A *jump cut* is created by cutting to create a discontinuity between shots—for example, cutting before the shot has quite

ended, or cutting to an entirely unrelated shot. Jump cuts can add shock or excitement to a DTV program (music videos use them all the time), but they're also a good way to irritate viewers and hamper your narrative. Use them judiciously.

Dissolve. A *dissolve* gradually replaces one image with another. A video dissolve substitutes one video source for another. This can be accomplished using a switcher or an SEG between video from a VCR and a camera that accepts external sync, but not between two VCRs. (That is, without broadcast-level equipment that we'll discuss in Chapter 9).

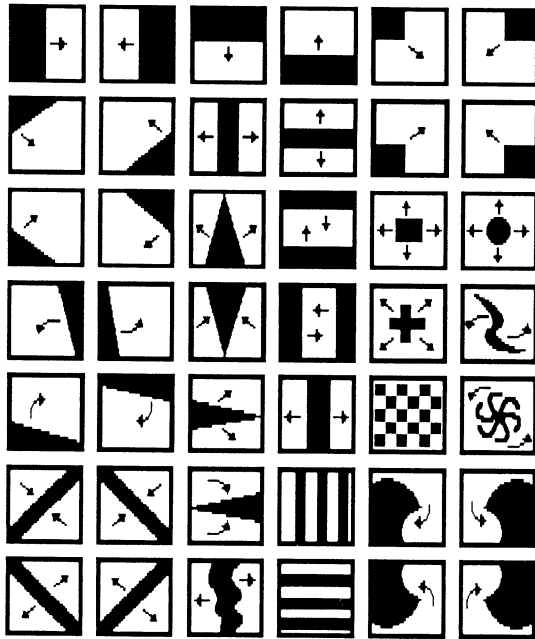
A dissolve between two Amiga pictures (using a slideshow program, for example) just randomly substitutes the pixel information from the second picture for that of the previous picture. The dissolve can be fast or slow, fine-grained or "chunky." Using a genlock/keyer, you can always dissolve to and from Amiga graphics and video.

Use dissolves for moving between shots that occur at different locations or at different times. An interesting effect can be achieved by maintaining a partial dissolve between shots—try it.

Fade. The *fade* dissolves the video or graphics from or to any solid color, usually black. Fades are a good way to start and end your program—they are gentle transitions—and to mark the beginning and ending of major scenes in the program. You can easily create fades in the camera while you're shooting (by opening or closing the iris or using the camera's fader option), and in fact it's a good practice to fade in and out of shots when you can.

Wipe. The *wipe* is a generic term for hundreds of different transitions in which one image replaces another along a border that moves across the screen. Like dissolves, wipes can't be accomplished between two VCRs without special equipment, but all Amiga special effects programs offer them for use with camera or genlocked input.

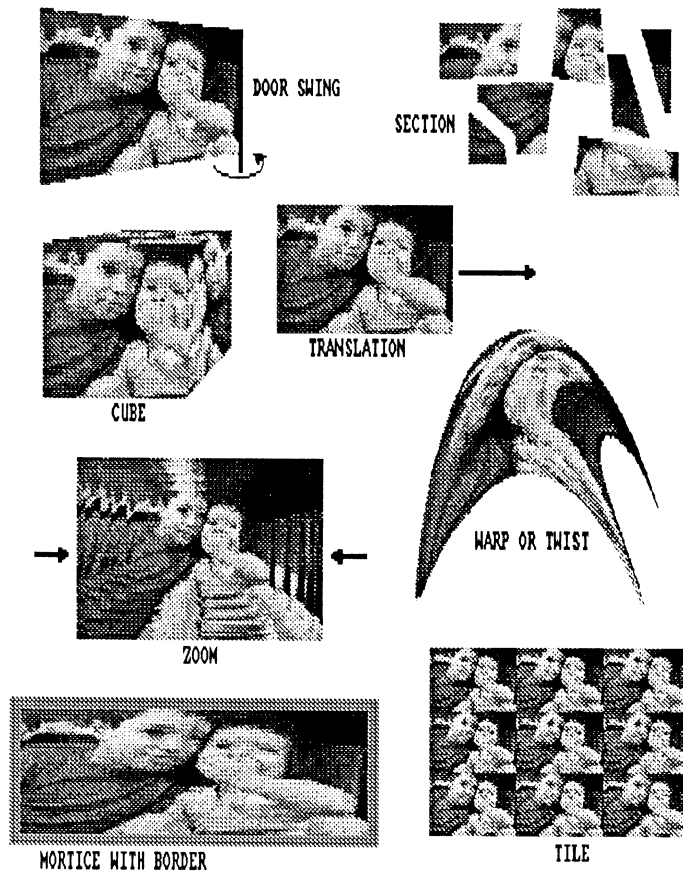
Wipes are used much like dissolves, except they have a directional emphasis. A wipe left, for example, gives you the impression you're about to see something that's happening just to the right of the screen. Wipes can be slow or fast, simple or complex, hard-edged or soft-edged, borderless or with a colored border, and more. The typical SEG or Amiga special effects program offers more ways to wipe between one shot and another than you're ever likely to use. Figure 5-4 shows a selection of wipes, but these are by no means all of them.

Figure 5-4. Wipes

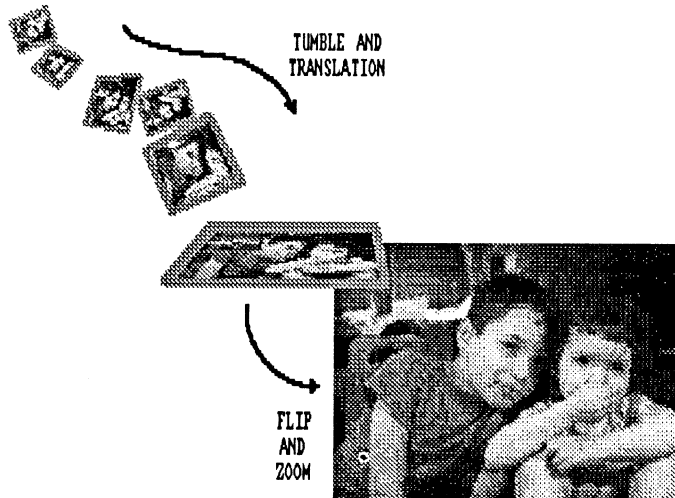
Wipes were the first transitions really invented for video rather than being borrowed from film, and they have always been popular for their flash and lack of subtlety. (Some filmmakers have borrowed back, like George Lucas in the Star Wars films). For documentaries and educational programming, you should probably keep the kinds of wipes you use to the sober left, right, and checkerboard wipes. For music videos, game shows, and video art, where fancy visual business may be all that's going on, the more esoteric wipes can definitely add style to the proceedings.

Digital Transitions. The most recent transition vocabulary comes from digital video. *Digital Video Effects* (DVE) computers like the Quantel, Mirage, and ADO have added new transition effects such as the following (several are illustrated in Figure 5-5)

- *cubing*, putting video or animation on the surface of a 3-D representation of a cube (see color plate 13)
- the *door swing*, rotating an image along the vertical axis
- the *mortice*, squeezing a video picture and surrounding it with a border

Figure 5-5. Digital Video Effects

- *perspective rotation*, rotating the plane of the image along any axis in what appears to be 3-D space
- the *translation, push, or scroll*, moving the image smoothly around on the screen or off the screen altogether
- the *rubberband*, stretching or squashing the image
- the *section*, splitting the image into parts that can be put back together again; often used for exploding effects
- the *split or multiple screen*, combining images from two or more different video sources, each on one part of the screen.
- *tiling*, repeating the image in a tile pattern on the screen
- the *twist*, warping one part of the image one way, the other part another way
- the *zoom*, moving the image into or out of apparent screen space

Figure 5-6. A DVE Move

Usually DVE effects are combined into one choreographed move. For example, a common DVE transition is to have the new shot, perhaps with a colored border, fly in from the corner of the screen as if from a distance. The shot, first seen at an angle, turns itself upright and expands to fill the entire screen, replacing the previous shot (see Figure 5-6). An effect like this uses perspective rotation, translation, zooming, and morticing.

While you can create purely Amiga-based DVE effects with animation programs (see Chapter 7 for an example), doing it with video currently requires some heavy hardware, including two or more synchronized video sources (usually VCRs with time-base correctors—see Chapter 9) and a dedicated DVE computer. But just over the horizon are Amiga products that will be able to accomplish some of the same effects at a tenth or less of the cost. NewTek's Video Toaster, announced but not yet available as this is being written, is the most eagerly anticipated of the second generation of Amiga special effects hardware. The LIVE! video digitizer and Elan's *Invision* effects software, which are available now, also offer DVE-style effects. Be aware, however, that you will not actually be working in "real time." No current Amiga digitizer is capable of continuously taking analog video input, converting it to a stream of bitmaps, and displaying them instantly in sequence on the screen. There is always a measurable delay between the video input and the digitized result; some digi-

tizers can't even process 30 frames per second, yielding a digitized sequence that looks fragmented and jerky. Right now, though, the combination of LIVE! and *Invision* seems to offer the nearest Amiga DTV comes to real DVE effects.

Keep in mind that you'll probably have to dump your Amiga DVE effect directly to tape, not save it to disk, unless the effect is very brief. At 30 digitized frames per second, you would fill up an entire floppy in less than a second. Even using frame compression, you might only get a second or two of digitized video onto a disk. Even a 20MB hard disk would fill up in half a minute or so. See Chapter 7 for an extension of this discussion as it applies to DTV animation.

In the last three chapters we've looked at video production and post-production basics. The next three chapters cover several important topics in more detail: video graphic design; Amiga animation; and sound and music.

Chapter 6

DTV Graphic Design

One important reason for building a desktop video system centered on the Amiga is to take advantage of the computer's graphics power. Yet the medium of video has a graphic logic of its own that isn't immediately obvious. Some kinds of graphics work well on TV; others don't. This chapter will help you develop an understanding of design principles for practical communication, data graphics, video text, and creative design.

Elements of Video Design

The best video graphics are *simple*, *direct*, and *bold*. Only simple designs will get your message across on the small, low-resolution television screen. Video imagery usually moves so fast that viewers simply won't be able to see complex designs well enough or long enough to make sense of them. Functional designs give all the necessary information to the viewer in compact fashion, so the most message gets through with the minimum of confusion. And dull, lifeless graphics won't even garner the attention paid to a soap commercial. Keep in mind that everyone in your audience is well-practiced in tuning out dull TV. To be successful, graphics must be bold and direct, and work within the limitations of video, not against them.

There are a variety of means to achieve these three desirable qualities. Simplicity is achieved by paring the number of elements in a graphic to the minimum, keeping them large and obvious, and unifying all with a central or master idea. Directness is inherent in graphics that possess only the elements necessary to tell the tale and no others, with each element chosen carefully and arranged in a straightforward fashion. Boldness is harder to

achieve; it may require a mixture of bright, eye-catching colors and shapes, the juxtaposition of appropriate but unexpected images, and the expert choreography of movement. Beyond that, a truly penetrating graphic derives from the designer's thorough understanding of the subject's emotional impact on the intended audience.

The following figures illustrate a few effective designs for different types of desktop video graphics. Figure 6-1 is a title card meant to introduce a home video. The large letters and simple graphics were created with a paint program and inexpensive titling program, then recorded directly to video through a low-cost genlock. Color plate 8 is the full-color version.

Figure 6-2 shows a more elaborate graphic for a news program. Note that the emphasis is on the graphic part of the message; text, in large, blocky letters, is held to a minimum. In some cases, graphics like these can stand in for video footage of actual events. In designing video graphics, it's best to use graphic symbols that anyone can grasp—spilling steel drums to symbolize toxic waste, for example. For an example of a TV-station logo that also incorporates large letters and simple graphics, see color plate 2.

Figure 6-1. DTV Graphic 1



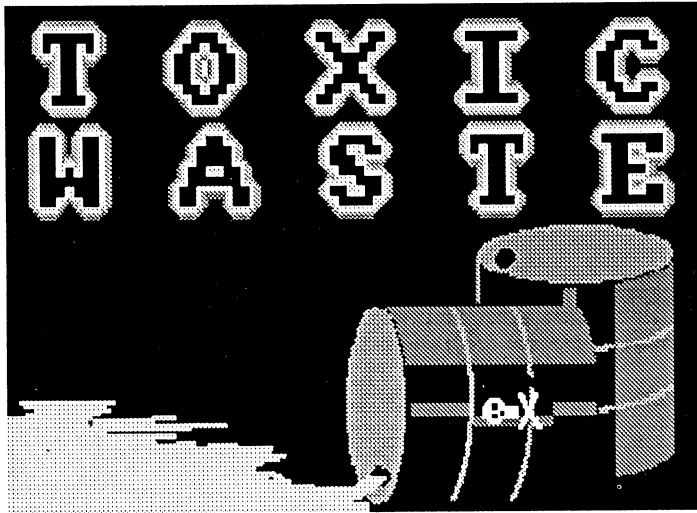
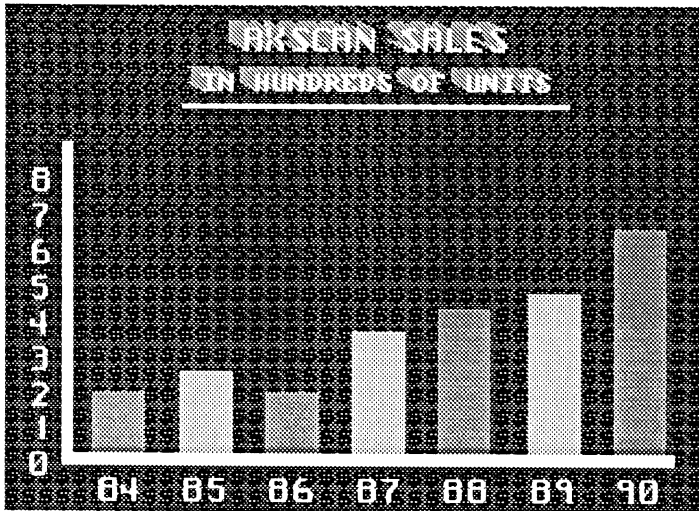
Figure 6-2. DTV Graphic 2

Figure 6-3 integrates scanned images with highly realistic graphics for a commercial. The attempt here is to create as “print-like” an effect as possible. Color plate 15 takes a similar approach.

Data graphics (charts and graphs that illustrate numerical information and relationships) are also seen often in DTV produc-

Figure 6-3. DTV Graphic 3

Figure 6-4. DTV Graphic 4—RxScan

tions. A graphic created for the “Introducing RxScan” tape discussed in previous chapters is shown in Figure 6-4; see also color plates 10 and 11. There’s more on data graphic design later in this chapter.

Digitized images can also be used to catalog personnel and materials for video databases, as in color plate 12.

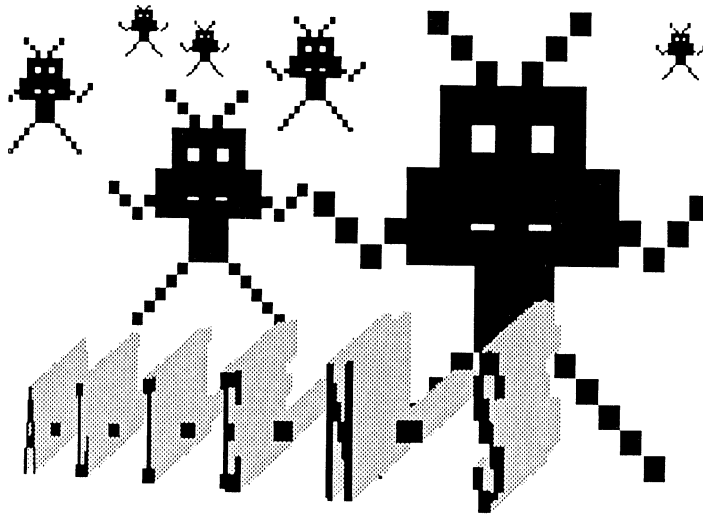
Figure 6-5. The Bitmap Look

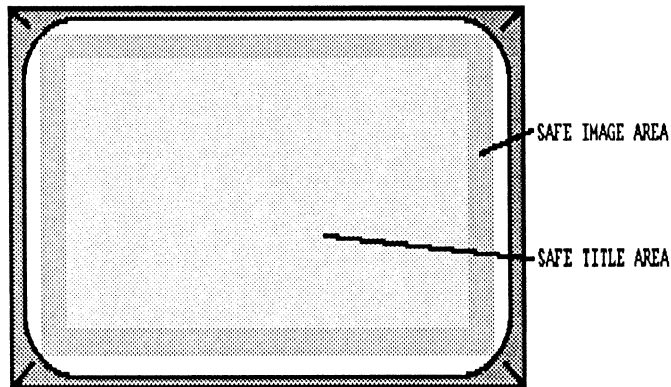
Figure 6-6. Pixelization

Specialized abstractions have become part of the vocabulary of video graphics. The low resolution imagery created by computers has become an accepted graphic style in its own right, like the use of blown-up, grainy photos in desktop publishing. Some DTV designers call this “the bitmap look.” An example is shown in Figure 6-5. Don’t be afraid to use big, blocky letters and simple images when it’s appropriate to do so; not all DTV graphics should strive to look photographic.

A related style is *pixelization*, sometimes called *pixelation*. In pixelization, a continuous image is broken up into rectangular blocks to give it a “digitized” look. You can see the effect in Figure 6-6. Pixelized images have become something of a graphic cliché in DTV design, so they should be used sparingly, only to draw attention to the fact that a particular image is “computer generated.”

Composition

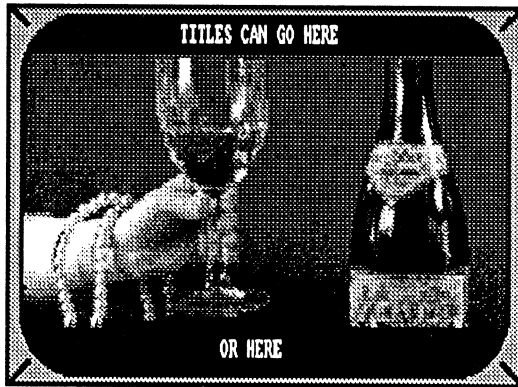
The arrangement of graphic elements on a flat plane is called *composition*. Probably the most basic part of video composition is making sure that all the picture is visible on the screen. Given the slightly different shapes and curvatures of CRTs made by various manufacturers, you need to place the important part of an image in the central part of the screen. Video producers talk of the *safe image area*, comprising the central 90 percent of the screen. Text and other graphic symbols should be placed in the *safe title area*, the central 80 percent of the screen (see Figure 6-7).

Figure 6-7. Safe Image and Title Area

The video screen can be small or large but always has the same ratio of width to height, 3×4 units. That makes a bland rectangle that allows for little compositional drama. Wide landscapes or tall figurative compositions don't translate well to video, but that 3 to 4 aspect ratio is proportioned just right for talking heads. That's one reason why video imagery is so face obsessed. You'll rarely see great vistas and shots with real depth of field in programming made expressly for video.

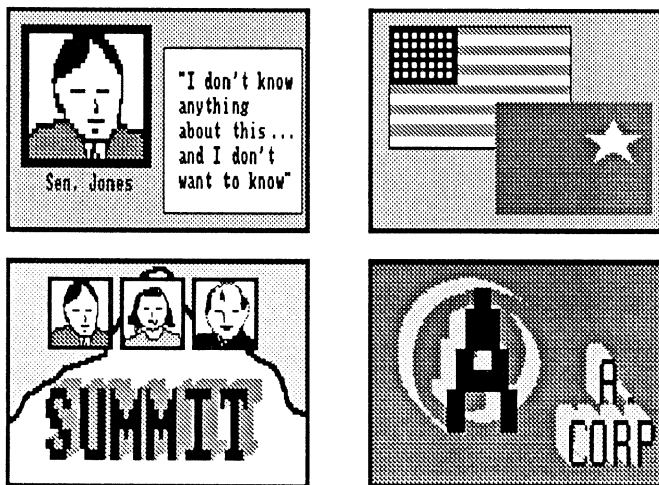
If you're willing to use less than the total available screen area, you can simulate the film aspect ratio (about 1 to 3) by masking off the top and bottom of the screen and placing graphics only in the middle strip, as in Figure 6-8. Although this won't look exactly like the TV most people are familiar with, your audience will ignore it if the production is interesting enough. A wider screen allows more flexibility in composing wide angle shots, landscapes, chases, and any scenes that involve lateral motion. You can use the blank strips above and below to add titles and graphics, without interfering with the main image. If you're planning to genlock video and graphics, don't use color 0 for the masked areas or the genlocked video will show through.

There's no rule, by the way, that says your monitor has to sit on its base. Tip it over on its side, and suddenly your picture is taller than it is wide, good for images of entire bodies, as in fashion videos. The only tricks are to make sure the video imagery is also oriented the same way (that is, tipped over 90 degrees) and to get your audience to accept looking at a tipped-over TV. (This

Figure 6-8. Changing the Aspect Ratio

may not work with monitors that have speakers or controls on the sides of the monitor casing.)

Two-Shots. By far the most popular way of arranging graphic elements on the small screen is the two-shot, a composition with two major elements. (The assumption by broadcast video designers has always been that the general viewing public can't keep more than two things in mind at the same time. As members of the viewing public, we know that's not true, but the compositions work well anyway.) The typical two-shot is a large picture with smaller text caption—a logo with a slogan, a map and a label, a

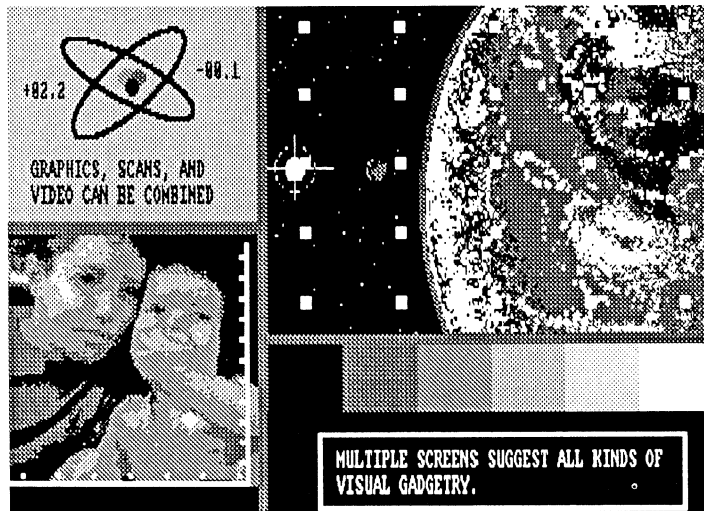
Figure 6-9. Two-Shot Compositions

face with a short quote. Sometimes one of the two elements can be a tightly related, easily recognized group of smaller elements—for example, grouped portraits of co-stars in a popular show or co-conspirators in a national scandal. Some two-shot compositions are shown in Figure 6-9. See also color plate 12, for example.

Compositions can get more complex as necessary, with three, four, or more important elements. But, given the confines of the video screen and the necessity of getting the visual message across in a relatively short time, it's best to keep compositions as simple as possible. Better to break a complex concept down into several different frames and show them in sequence (or change them through animation) than to cram too much into one frame.

Split Screens. A compositional device widely used in films of the late 1960s (for example, *Easy Rider* and *The Trip*) and in sports programming and music videos today is the *split* or *multiple screen*. In a split screen composition, one image occupies half of the screen, and a different image occupies the other half. Multiple screens involve several different image areas in “windows” surrounded by black or a neutral color. A main image window is often surrounded by smaller windows showing close-ups or different angles of the main action (see Figure 6-10). This effect works well when you are simulating the look of control panels or scientific displays.

Figure 6-10. Multiple Screens



You can make good use of split or multiple screens in DTV productions. For animations, divide the screen up into areas when you plan the animation, and draw each sequence in its own area. For a mixture of graphics and live video, create graphics in some areas and leave a window in color 0 for the genlocked video to show through. You'll need to make sure the window is in the proper area of the screen to reveal the part of the video image you want to see. With current Amiga DTV hardware, it's not possible to have more than one genlocked video image visible on the screen at the same time, though this effect can be achieved with broadcast digital effects equipment. Chapter 7 has some suggestions for creating a moving split screen effect.

Color

When we looked at how the Amiga creates color in Chapter 2, no mention was made of how to *use* color. First you should know more about the general theory of computer and video color.

Just what color is and how we perceive it is a matter of continuing scientific debate, but it's generally accepted that color is made up of three elements:

- *Hue*, the actual color, such as red, green, blue, or yellow; the spectral wavelength of the color
- *Saturation*, the purity of the color; how much white is mixed into it
- *Value*, the lightness or darkness of the color; how much black is mixed into it

Figure 6-11. Red-Yellow-Blue Color Wheel

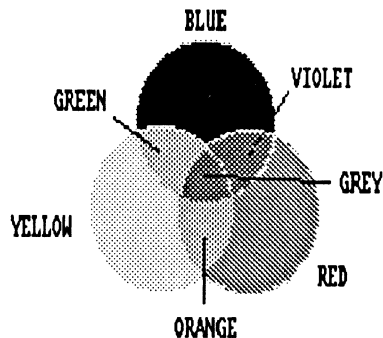
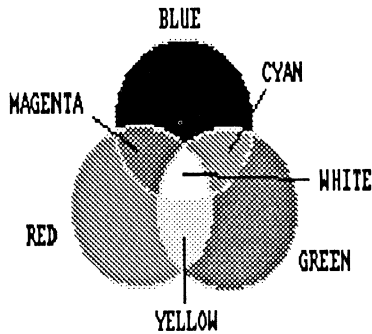


Figure 6-12. Red-Green-Blue Color Wheel

Any color the Amiga can create—4096, a fair number of colors to choose from—can be specified as some combination of hue, saturation, and value. But colors can also be specified by their proportions of red, green, and blue, the primary colors of video and computer graphics.

Figures 6-11 and 6-12 will help you understand how the RGB system of color mixing works. Figure 6-11 shows the color-mixing system everyone learned in grammar school, the one used when mixing paint. In this system, red, yellow, and blue are the primary colors from which all other colors are made. To make medium green, for instance, you mix yellow and blue in equal proportions. But in the RGB color system, mixing green and blue yields yellow. That sounds wrong, but a little experimentation with any paint program will verify it.

Figure 6-13 is a color mixing requester from *Deluxe Paint III*. You can see the sliding controls that give you the ability to mix colors either by RGB or by HSV, hue, saturation, and value. Both

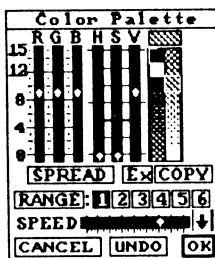
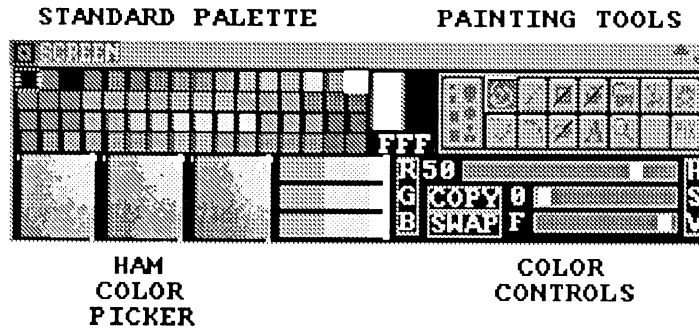
Figure 6-13. Deluxe Paint III Palette Requester

Figure 6-14. HAM Color Controls

systems work equally well, and most programs that allow color mixing give you the option of using the one you're most comfortable with.

A HAM graphics program has a somewhat different color palette arrangement, as shown in Figure 6-14, the palette controls for *Photon Paint* (Microillusions). You can mix colors just as in standard paint programs, but you can also choose from hundreds of related colors shown onscreen. See below for more on using HAM paint programs.

Using Color

As a desktop video designer, you can use color to set the psychological tone of your production, making it eye-catching or subtle, intimate or aloof, soothing or angry. The adroit use of color can give the appearance of great depth to a flat screen; can make shapes seem to jump, vibrate, and swim; or can create an image that hits the viewer with the force of a blow.

Video tends to look flat, at least compared to film or print images, but you can use color to give apparent depth to your graphics. Psychologically, we expect deep colors to be nearer and faded colors to be farther away because the atmosphere tends to filter and soften distant objects. The illusion is enhanced if the nearer colors are warm—shades of red, orange, yellow—and the farther colors are cool—pale pastels of blue, brown, gray, and green. These color expectations can be also be turned on their heads by making the foreground pale and cool, the background dark and warm; the ultimate use of this scheme is white symbols or letters on a near-black background.

Colors have other psychological meanings as well. For example, in most western cultures, red means stop, danger, hot; green means go, safe, cool, on. Weather and financial graphics each have their own set of meaningful colors—the colors of maps and clouds, or the red and black of financial performance. The DTV designer should be alert to these color connotations. Here are some additional tips for effective color use:

- Colors are seen most clearly when displayed against a neutral field. Gray makes an appropriate background color.
- Small objects should be colored boldly. The low-resolution video screen makes it harder than normal for the eye to resolve small areas.
- Don't use blue for small objects, lines, and letters. The human eye has the most trouble focusing on blue, and won't easily be able to see small blue shapes, especially on the low-resolution video screen. For the same reason, it's difficult to see edges between colors that differ only in their proportion of blue. However, blue makes an excellent background color. And blue is perfect for graphic elements that should be unobtrusive, like gridlines.
- Don't use thin vertical lines that contrast against the background, such as black lines on white. Thin, contrasting horizontal lines jump very noticeably in the interlaced modes on the Amiga screen, but not so badly on video. Avoid them anyway, as thin lines tend to disappear when seen from typical TV viewing distances.
- Fine patterns of contrasting colors flicker badly when seen on video. Patterns to avoid are checkerboards, herringbones, crosshatches, dot patterns, and fine stripes.
- Avoid juxtaposing complementary colors. For example, highly saturated red against highly saturated cyan will create a vibrating border between the colors. This is a distracting irritation, unless you want a psychedelic effect. Other offending combinations are green and magenta and blue and yellow. Try using a line of neutral gray between complementary colors; this will eliminate the vibration.
- Also avoid heavy use of red, magenta, orange, hot pink, and brown. Video displays have the most difficulty rendering these colors with fidelity and clarity. Red and magenta are particularly unstable, and red areas almost always exhibit *crawling* (a

shimmering border effect) along their edges. You can avoid this to some extent by always using colors that are less saturated—for example, not setting the red, green, or blue of any color above 13 in *Deluxe Paint III*. Black, white, blue, green, and gray are the most stable colors—and, you'll notice, the most used in broadcast video graphics.

- Keep in mind that the colors you see on your Amiga (analog RGB) monitor won't look quite the same when seen on a composite monitor. The better your encoder, the truer the colors will translate from Amiga to video. Reds and blues seem to suffer the most in translation.
- Use the fewest colors that will do the job. People have difficulty keeping track of the meanings of seven or more colors.

Titling

As you've seen, most video graphics incorporate text as part of the image, but the use of text in video is different than the use of text in print media. Here are some basic principles of video text design to keep in mind:

- Short words and messages work best. It's hard to read text on TV at typical viewing distances and angles. Use narration instead to convey large amounts of verbal information.
- Keep text in the center part of the screen. The curved corners and edges of TV screens distort text and make it hard to read.
- Use large letters (18 points in size or larger; see below). Most television sets are not nearly as sharp and clear as the Amiga monitor you're using. Video text has to be large to be readable.
- Don't mix many different styles and sizes of text in one graphic unless you're after a cluttered, eclectic look. One or two fonts and sizes are adequate for most graphics.
- Separate text from the background through the use of color, shape, and graphic design tricks like drop shadows and block letters (Figure 6-15).

Fonts and Styles. A *font*, also called a *typeface*, is a complete set of letters and other characters in one typestyle and size. Ten-point Times Roman, for example, is a font often used in newspapers and books. There are many fonts, ranging from the utilitar-

Figure 6-15. Drop Shadows and Block Letters

D R O P
S H A D O W S

B L O C K
L E T T E R S

ian to the exclusively decorative. The Amiga provides a selection of built-in (system) fonts. These are illustrated in Figure 6-16.

Fonts come in various sizes, measured by *points* (there are 72 points in an inch). The numbers after each font name in the figures above indicate the font's size in points. As you can see, a smaller point number means a smaller font, and a larger number means a larger font. The Amiga has only a few sizes for each font, but note that the larger fonts are not blown-up copies of the

Figure 6-16. Amiga Fonts

Topaz 8	Opal 9
Topaz 9	Opal 12
Topaz 11	emerald 17
Ruby 8	emerald 20
Ruby 12	Garnet 9
Ruby 15	Garnet 16
Diamond 12	Sapphire 14
Diamond 20	Sapphire 20

Figure 6-17. Font Styles

Plain
Bold
Italic
Bold Italic
Underline
All Styles

smaller versions; the larger letters are actually redrawn with more detail.

In addition to choosing a font size, you can specify whether letters will be plain, bold, italic, underlined, or any combination of these, as shown in Figure 6-17.

Most fonts fall into two general categories, *serif* and *sans-serif*. Serif fonts, such as Times Roman, have short bases, caps, and tails on the letters. The little caps and tails add to the legibility of sans-serif fonts on the printed page but tend to get lost in the lower resolution world of video. Sans-serif fonts, such as the popular Helvetica, look clean, modern, and are generally better for video use. Fancy type styles, such as Broadway and Neon, don't really fall into either category. They are *display* fonts, used mainly to catch the eye with a bold typographical statement. Blocks of text should not be in a display font, but in a more sober, traditional style that's easier to read. Figure 6-18 illustrates serif, sans-serif, and display fonts.

Titling programs offer a wonderland of fancy fonts—more than you're likely to use. Aegis's *Video Titler* software can produce a large number of different fonts and styles, some of which are illustrated in Figure 6-19. Among the special font effects are neon, block, brick, camouflage, and letters made of glittering banks of lights.

In *Video Titler*, text size can be changed simply by dragging one of the "handles" at the corners and centers of each line of text. Letters can be reproporioned to be long and thin or wide and high, tilted and slanted, moved anywhere on the screen, painted with all available colors, and exported to a paint program

Figure 6-18. Font Types

for additional embellishment. In short, titling programs give you almost unlimited versatility for designing the text you need. Several companies also sell disks of display fonts in wood, marble, and metal textures.

Moving Titles. Most titling programs also offer you a number of ways to move text. You can dissolve from one page of text to

Figure 6-19. Video Titler Fonts and Styles

the next, scroll text up from the bottom of the screen, move text sideways, and so on. *ProVideo CGI* from JDK (see Appendix A) seems to have the edge here; it can hold scores of pages in memory and show them in any order and with any movement you require. Some of the same effects can be achieved with a paint program and a slideshow program.

Text, Data, and Graphics. One of the most common uses for video text is in maps, charts, graphs, and other kinds of *data graphics* for desktop presentations. For example, you can prepare charts with a paint program and show them to your audience directly on the Amiga screen or recorded on video for display with a VCR. Data graphics can make the complex relationships among data easier to understand—but only if the graphic itself is easy to understand. There are a few guidelines to follow when designing data graphics:

- Get the data right, and make sure you understand the relationship between data sets; if you don't, neither will the viewer.
- Make sure data always takes precedence over design. Let the data guide your choice of design.
- Avoid cluttering your graphic with extraneous patterns (especially patterns that vibrate), lines, and dingbats. The fewer marks to distract from the message of the data, the clearer that message will be.
- Use labels whenever necessary; spell out words and place them near what they describe. But use as few words as possible.
- Once you've designed your data graphic, look at it critically to see what should be removed and what should be added for clarity.

The best book yet written on designing data graphics is *The Visual Display of Quantitative Information* by Edward R. Tufte (Graphics Press, Box 430, Cheshire, Connecticut 06410). No video designer should be without it.

Titles and Credits. Another standard use for titling programs is to produce subtitles and credits that are genlocked over live or taped video. The aim in subtitling is to position the text in just the right place, so it clearly labels the subject or action but doesn't obscure it. Subtitles also must be very legible; a strong sans-serif font in white or yellow with a dark blue or black border will show

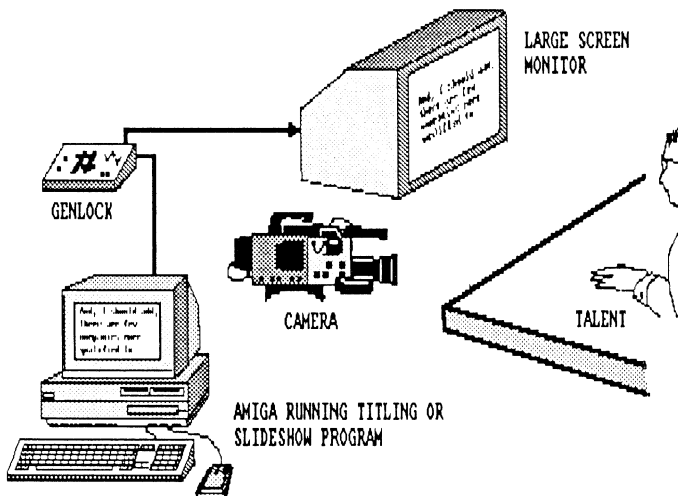
up well against most kinds of backgrounds. Or the text can appear in a block of solid color.

Leave the subtitle or credit onscreen long enough for the viewer to read it; nothing will frustrate viewers faster than flashing information more quickly than it can be absorbed. On the other hand, titles should leave when they're no longer needed. An interesting exercise is to study the use of video text names under the guests on a Sunday news program. When do the names appear? What font and what color is the text? How long do the names stay? How many times are the names shown before the TV director decides viewers already know who the guests are? You can be sure that the directors of these programs have the use of subtitles down to a fine art.

It's even more complicated when the titles are being used with a live show. For a professional look, each piece of text that will be needed for the show must be prepared in advance and held in readiness for immediate use.

The Amiga as Teleprompter. A *teleprompter* is a video device to display the text of a speech to an actor so it can be read on camera. Text in large letters are displayed on a video screen next to the camera for the actor to read, with a new block of text appearing just as the actor finishes reading the previous block. A skilled actor or news anchor can make this look as though he is

Figure 6-20. Amiga Teleprompter



speaking extemporaneously, rather than reading a speech—it just looks more natural on camera.

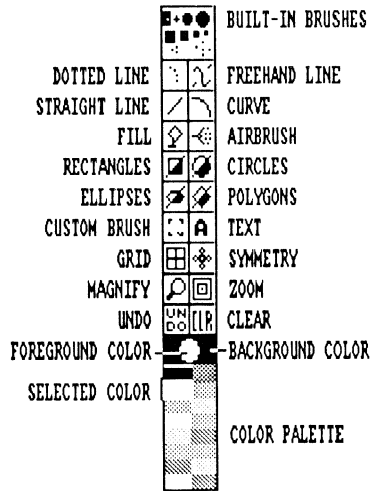
Jane at MediVideo uses her Amiga, two monitors, a genlock, and a titling program as an impromptu teleprompter for field or studio production. Before the shoot, she types up the text of the actor's speech in the titler, using large, easy-to-read letters and as many screen pages as necessary. At the shoot, she sets up the Amiga RGB monitor so she can see it, and a composite monitor facing out toward the actor. (See Figure 6-20.). Using the titler's built-in scrolling or slideshow function, she shows the pages of text to the actor, putting up a new screen as he finishes the old one. In a pinch, she has even used an ordinary Amiga word processor as a teleprompter, typing in text in the biggest available Amiga font and using the cursor keys or mouse to scroll down the document she has created.

Graphics Software

Paint programs offer the easiest access to the Amiga's graphic capabilities. A paintbox does nothing more than allow you to change the color of any pixel at will. What distinguishes one paint program from another is the design and range of tools provided to help you in that basic task. A good paint program should provide digital counterparts to an artist's traditional tools: pencils, brushes, rulers, a palette for mixing colors, and a canvas or page to work on. These basic functions include

- a simple pencil or freehand drawing tool for sketching
- an eraser and screen-clearing function
- a selection of brushes for painting
- shape tools for drawing geometric forms—rectangles, polygons, circles, and curves
- a fill tool for filling areas with colors and patterns
- palettes for color selection and mixing
- cut-and-paste for moving and copying any area of the picture
- a magnifying glass for close-up work
- a grid to help you align parts of your painting
- full access to all Amiga screen formats and all available memory
- speed and ease of use

Deluxe Paint III, the best-known Amiga paint program, keeps its basic tools in an iconic toolbox (Figure 6-21).

Figure 6-21. Deluxe Paint III Toolbox

A good paint program should also go beyond tradition to give you new tools that make painting faster, easier, and more successful. The latest generation of paint programs do just that, offering the kinds of advanced functions that two or three years ago could be found only in high-end graphics software costing thousands of dollars. These advanced features include

- flip, rotate, distort, and bend options for changing the orientation of selected areas
- dithering and smoothing tools that blend colors to create smears, blends, and other painterly effects
- stenciling or masking tools that prevent you from painting over selected colors or areas of the screen
- a perspective feature to make paintings appear to recede into space
- the ability to create washes and overlays of translucent color
- *antialiasing*, a technique that reduces the stairstepped appearance of Amiga graphic images, making edges appear smoother and more natural (especially useful for text)

You may not need every bell and whistle in the top paint programs, but it's nice to know they are there if you ever do.

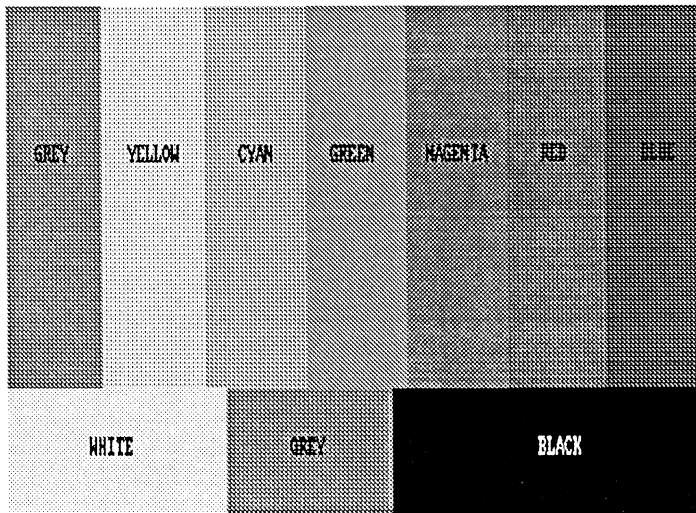
Since graphics creation is a time-consuming, painstaking process, even using a computer, any tool that may cut your time is worth having. For example, color plate 9, a magnified part of a larger image, used smoothing and blending brushes, automatic curve-drawing tools, an airbrush tool, and a feature that resizes any selected part of the picture.

Making Color Bars. One thing you can do with a paint program is make yourself some test screens to use at the beginning of your productions. NTSC color bars are used most often for checking the color accuracy of the signal and adjusting monitors. Here's how to make an Amiga version of color bars that adheres pretty closely to NTSC standards:

- Load any paint program that allows you to set colors by the amount of red, green, and blue. *Deluxe Paint III* is used for this exercise. Use the 32-color, interlace, overscan screen format.
- Set the color palette as follows, starting from the top left:

Color Number	Color	RGB Settings
0	Black	1,1,1
1	White	13,13,13
2	Yellow	13,12,1
3	Cyan	0,10,13
4	Green	2,12,0
5	Magenta	13,0,15
6	Red	14,0,5
7	Blue	1,1,12
8	Gray	8,8,8

- Divide the screen into an upper and lower section, with seven equal vertical bars on top and three horizontal bars on the bottom, as shown in Figure 6-22.
- Color the bars on top from left to right as follows: gray, yellow, cyan, green, magenta, red, blue. Color the lower blocks from left to right as follows: white, gray, black. The color in each bar should touch the colors in the adjacent bars; there should be no lines between them.
- You can also put text information, such as your name or the name of your production company, at the bottom of the lower section.

Figure 6-22. Color Bars

See plate 9 for the full-color version.

HAM Painting. Several Amiga paint programs operate in the Amiga's Hold-And-Modify (HAM) mode, which allows all 4,096 colors in the Amiga palette to be on screen at the same time (but restricts you to the lo-res and medium-res formats). This makes possible images of near-photographic quality—far more lifelike than those you can create in the Amiga's 64-, 32-, or 16-color modes. As mentioned, most of the color plates are HAM images.

The tradeoff for this increase in realism is threefold. Drawing and filling operations tend to be slower in HAM because the processor has many more calculations to perform. HAM pictures also take up a lot of room on disk—you can fit only a dozen or so onto an 880K floppy—and in memory. To get the most from a HAM paint program, you really should use an Amiga with more than one megabyte of RAM and a hard disk to store all those huge pictures.

The other tradeoff is that HAM pictures tend to have "fringes" or look blurry at color transitions because of the way they're calculated. The program may take up to three pixels to get from one color to an unrelated one—from pure blue to pure red, for example—painting the transitional pixels with intermediate colors. For hard edged drawing, therefore, HAM programs are not always the best choice. But for the realism that more than

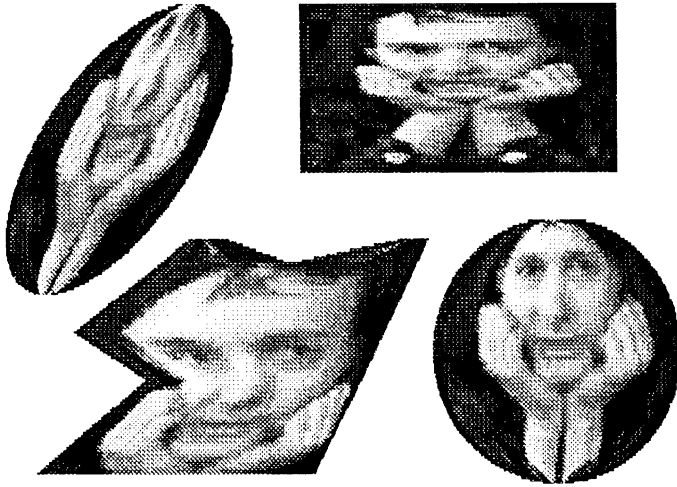
4,000 onscreen colors can provide, HAM programs are currently the graphic champs of the personal computer world. They're ideal for painting over and touching up digitized images.

Paint Effects. There are an infinite number of different pictorial effects possible with paint programs. Here are a few that recall the digital effects often seen on broadcast TV:

- **Tiling.** In computer graphics, a *tile* is a rectangular image repeated in a pattern all over the screen, like tiles on a floor. Figure 6-23 shows a screen covered in tiles.
- **Image Mapping.** Some paint programs have the capability of taking any image and warping it to look like it's wrapped (*mapped* is the computer graphics term) around a shape, as a drawing on paper could be wrapped around a ball. (This looks like, but is not really the same as, the *surface mapping* used by 3-D object editing programs discussed in the next chapter.) Some examples of image mapping are shown in Figure 6-24 and color plate 13.
- **Perspective.** Paint programs can take part or all of the flat picture plane and make it appear to recede into the distance, an effect called *perspective*. An example of the use of perspective is illustrated in Figure 6-25, in which the box design was first created as a flat, square image, then tilted to appear three-dimensional. Keep in mind that paint programs only work with flat

Figure 6-23. Tiles



Figure 6-24. Image Mapping

planes, so your images will always look like tilted flat planes. For real manipulations in computer space, you'll need a three-dimensional object editor and animation program.

- **Zoom Effect.** This simple effect (Figure 6-26) looks like the infinite regression created by two mirrors facing each other, or a frozen camera zoom, or video feedback. It is accomplished by repeatedly shrinking an image by increments and pasting it on the screen. Variations can be achieved by making certain colors in the image transparent, or pasting the image down so it ap-

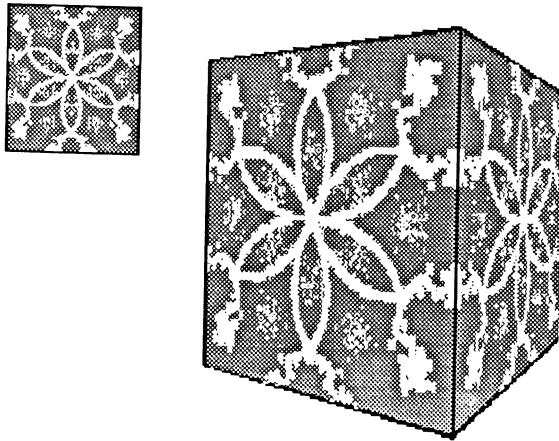
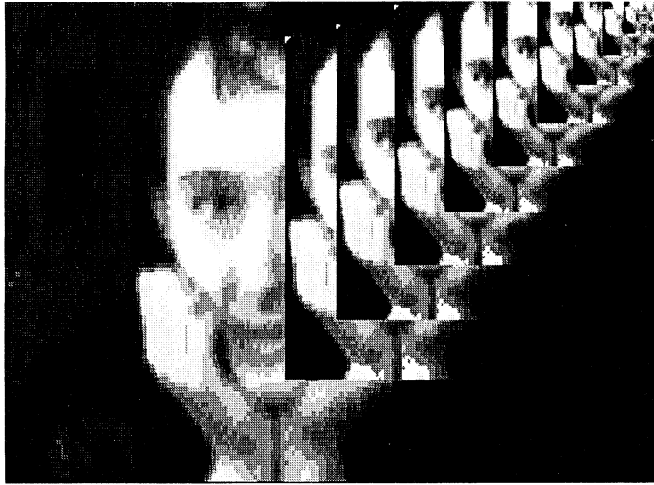
Figure 6-25. Perspective

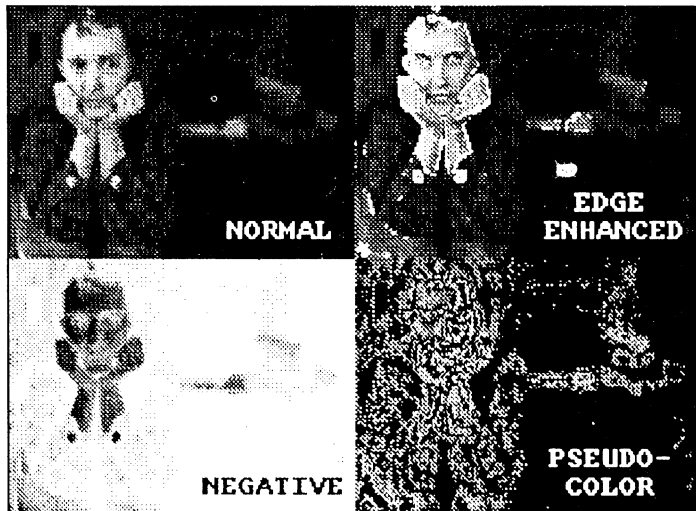
Figure 6-26. Zoom Effect

appears to be coming from a corner. *Deluxe Paint III* allows you to program this effect automatically using the program's built-in animation tools (see Chapter 7).

Image Processing. Image processing software makes it possible to create additional graphic effects on existing images that are not easily achieved with paint programs alone. Among the possible effects are edge enhancement; comparison and merging of two or more pictures; changing a number of selected colors to one color; negative images (with values or colors reversed as in a photographic negative); color to monochrome images; false color or solarized images; and elimination of noise or graininess in digitized pictures. Figure 6-27 shows some of the effects possible with *Butcher* (Eagle Tree Software), an entry-level image processor. Color plate 4 is a false-color image of the same picture.

Higher-level programs such as *Photosynthesis* (Escape Sequence, Inc.) let you devise your own image processing algorithms based on Boolean logical operators, such as AND, OR, XOR, and NOR.

Unless you are of a mathematical bent, and most graphic artists are not, you won't need many of the higher image processing functions. If analyzing satellite video is your business, however, image processing can give you access to valuable information you can't get otherwise. For example, high-level image processors can

Figure 6-27. Image Processing

eliminate image noise from a digitized picture, making fuzzy pictures sharper. Or the software can tell you what percent of an image is a certain color, handy knowledge if you're using digitized images taken with a thermographic camera in which colors correspond to heat emissions from the object being videotaped. (Keep in mind that no commercial image processor for the Amiga will analyze live video; you must capture a still image first, then analyze that.)

IFF. One of the things that has aided the rapid development of sophisticated graphics software on the Amiga is the establishment of a standard format for picture files. All current paint and titling programs will create, load, and save files in the ILBM (InterLeaved BitMap) version of the Interchange File Format (IFF) developed by Electronic Arts. Thus, you can swap pictures among various programs, using the features on each you like best. Many animation, CAD (Computer Aided Design), titling, database, and image processing programs accept IFF images as well. You may have to add a suffix to the filename of the picture file (such as ".pic" for use in some Aegis applications) so the program will recognize the file, but otherwise transporting pictures from one application to another is easy, which is a real boon. HAM picture files use a different version of IFF, but are also transferable from one HAM application to another. You cannot

load a HAM picture into a standard paint program (such as *Deluxe Paint III*) without a file conversion utility, but all HAM programs will accept IFF ILBM files. Animation and music also have standard file formats; these are discussed in the following chapters.

Graphics Multitasking. The Amiga can do one thing other personal computers can't quite manage yet, and that is true multitasking, the running of several programs simultaneously. Think of multitasking as layers of windows, each with its own program that can perform tasks in the background while you work on another program in the foreground. For example, you could have genlock software running in a background window, 3-D rendering software creating a highly detailed image in a middle window, an animation program that you're using right now in the foreground window, and a paint program in a window up in the corner for quick touchups to any animation frame.

Multitasking really speeds up graphics creation, giving you access to the powers of several programs at once. To run a number of programs, however, especially big ones like animation programs, you'll need lots of memory—two megabytes at least. But if you're really serious about DTV graphics you'll probably want to have additional memory anyway.

A paint or titling program can create the graphics and text you need for subtitles or desktop presentations, but they can't handle every aspect of video graphics. Most importantly, you need to have a method of moving from one image to another—of creating motion, the heart of video's appeal. On broadcast TV, text and graphics scroll up from the bottom of the screen, are wiped off the screen and replaced by another image, or spin off into apparent three-dimensional space. For those effects, you need animation programs, software for making graphics move, and a sense of how to create narrative through movement. The theory and practice of DTV animation is discussed in the next chapter.

Chapter 7

Animation

High over the lowlands of prehistoric Texas soars a lone Quetzalcoatlus. Effortlessly catching the shimmering thermals with its 25-foot wings, the pterosaur passes over herds of triceratops grazing on thorny scrub. Below, a pack of tyrannosaurs surrounds a triceratops calf that has wandered from its family group. As the lead tyrannosaur moves to sink its teeth into the bleating calf, its mother charges, her three sharp horns slamming into the predator's side at more than 30 miles per hour. Above, the Quetzalcoatlus circles, waiting to feed.

This is not a scene from a Hollywood remake of Conan Doyle's *The Lost World*. It's a scene from a computer-animated video on current theories of dinosaur behavior that one DTV artist is producing on the Amiga. With the tools and techniques discussed in this chapter, you can make your own animated DTV programs, create dynamic business presentations, devise instructional tapes that engage your students, and design sophisticated moving graphics for logos, commercials, promotional tapes, and animatics.

The great Disney animated films were intended to entertain, as are most animations today. But DTV animation has its practical uses as well, to illuminate actions, events, and processes that cannot be taped directly. The dinosaur animation described above is a good example of a program that requires animation of some kind, there being no dinosaurs left to go out and shoot with your camcorder. Network newscasts increasingly use computer animation as a stand-in when live action footage isn't available—for example, to diagram action in a war zone where no reporters are

allowed. Such animation was used to effect in coverage of the Falklands War in the mid 1980s. Animation can be genlocked over live or taped action to emphasize an idea or process that isn't obvious from the tape itself, as when animated detergent enzymes are shown gobbling up the grime while scurrying over footage of real dirty clothes in a washing machine.

Traditionally, quality animation has been a craft that requires a long apprenticeship to master and deep pockets to fund. The Amiga and low-cost video equipment make the technical parts of animation easier to learn. Even if you've never tried your hand at animation before, you'll be able to create useful animations with several of the programs discussed below. As you progress, you can concentrate on learning the really hard parts—rendering objects and environments, choreographing movement, developing rounded and believable characters, pacing sequences and scenes, and structuring complete narratives.

If you're an experienced film animator who has hesitated to enter the highly technical world of video and computer animation, you will find an Amiga animation system the right place to begin. A suitably equipped Amiga and VCR can substitute directly for the animation stand, allowing you to produce animations without the expense—and drudgery—of traditional techniques. While you may not be able to match the realism of drawing, smoothness of movement, and richness of characterization in the classic Disney cartoons of the later 1930s to mid-1950s, the high quality of Amiga-produced animations may surprise you. Keep in mind, though, that even the power of the most advanced computer can't replace the accumulated knowledge and experience of an entire animation studio, and you shouldn't expect it to.

Animation Basics

Whatever you can set in motion in your mind's eye can be expressed through animation, the process of stringing together individual pictures to create the illusion of movement. The images themselves don't really move; instead, a sequence of related but incrementally changing images called *cels* or *frames* are displayed in succession so rapidly that, to the human eye, they give the appearance of smooth motion. All animation—and for that matter, all video and film imagery—takes advantage of this physiological effect, which is called *persistence of vision*.

For animation to appear smooth and fluid, the animation frames must be shown at a *frame rate* of at least 15 frames per second (fps); for DTV the preferred rate is 30 fps, the video frame rate (see Chapter 2). Frame rates slower than 15 fps result in animation that appears to hesitate or jerk between movements, which is usually not the effect you want to achieve.

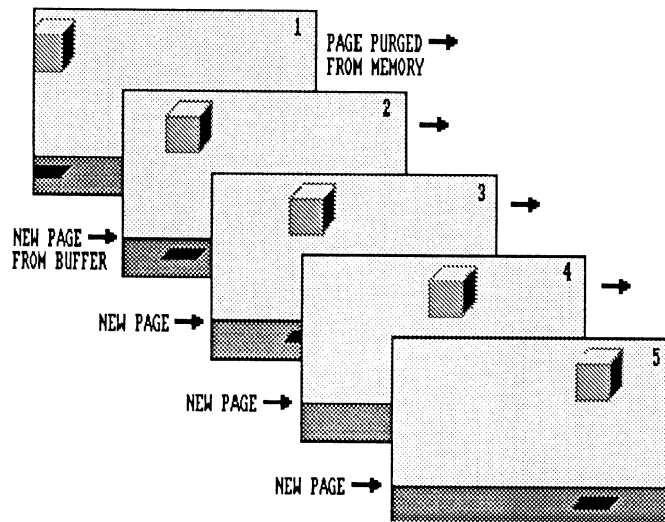
However, note that 30 frames per second means a lot of pictures—1800 per minute, 162,000 for a 90-minute, feature-length program. “Snow White,” Disney’s first feature-length animation (but not, as most people think, the first feature-length animation made by anyone—that distinction belongs to Lotte Reiniger’s 1926 film “The Adventures of Prince Achmed”) required more than a million test and finished drawings. Luckily, your Amiga can take over some of the tedium for you, freeing you to concentrate on the creative aspects.

Amiga Animation

Amiga animation comes in several varieties. Animation software may combine several of these features:

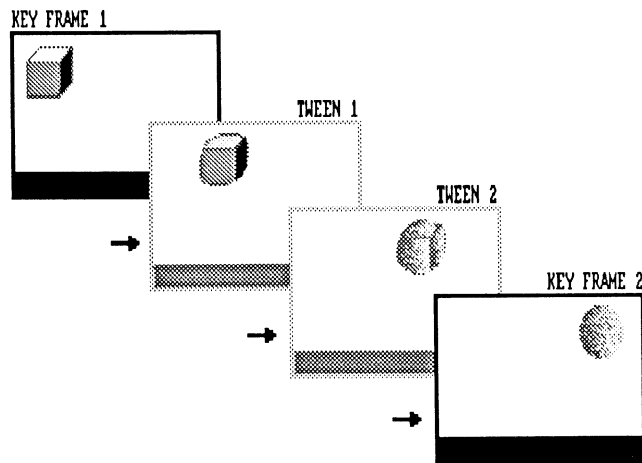
Page-flipping. Page-flipping is analogous to cel animation as practiced by filmmakers. A series of frames is created by the DTV animator with a paint or other image creation program. Each picture is incrementally different from the previous one; for example, a square could move from the left of the screen to the right in equal increments spread across 30 frames. When the sequence is finished, it’s stored in memory or on disk as a series of frames, often referred to as pages. To run the animation, the animator instructs the program to load all the frames into memory (or as many as will fit) and display them in sequence at a predetermined frame rate. When you look at the animation, the square will look like it’s sailing across the screen. If you’ve ever buzzed through the pages of an animation flip book, you’ll understand the concept behind page-flipping. Figure 7-1 shows how it works.

Page-flipping animation programs provide rich-looking results and are closest in concept to traditional animation, so experienced animators may take to them faster than the other types. But they do make more demands on your artistic abilities; the program won’t do much more than provide an easy way to show images in succession—you’ve got to create the images and figure out how to move them.

Figure 7-1. Page-Flipping

Metamorphic and Key Frame Animation. A few Amiga animation programs take a different approach. Rather than page-flipping, these programs work with animation objects called *polygons* that are manipulated as a mathematical database (for example, a list of the screen coordinates of every vertex and side of the polygon), rather than as bitmaps. Polygons are not as detailed as bit-mapped images, but they require less memory and the computer can do more things with them.

For example, with a metamorphic program, you can draw a polygon on one frame, define a path for it to move around on the screen, and then drag the vertices of the polygon to create a new shape on a second frame. The program will then animate the entire sequence, including figuring out the intermediate shape the polygon should take to transform from its original shape to the new shape. This process is called *key frame animation*: the program figures out and shapes the images you draw, which are called *key frames*. The in-between images are called *tweens*, and key frame animation is sometimes referred to as *tweening*. See Figure 7-2 for a graphic depiction of how key frame animation works. Obviously, having the program accomplish the movement for you saves a lot of work.

Figure 7-2. Key Frame Animation

The best-known Amiga program of this type is Aegis Development's *Animator*, which was also the first Amiga animation program. Some other programs, such as *Deluxe Paint III* and *Zoetrope*, have limited metamorphic animation capabilities. A key frame animation program is ideal for learning animation basics, and it's also appropriate for creating simple animations, like moving bar charts and such.

Enhanced Slideshow Programs. Certain programs build upon the basic slideshow metaphor for creating simple animations. In addition to providing fancy transitions from one picture to another, these applications let you efficiently program the movement of smaller images across larger ones, a process called *compositing*. For example, with *Deluxe Productions* (Electronic Arts), you can float small pictures of clouds and rain (these are actually brushes created with *Deluxe Paint*) left to right across a map background, and then dissolve all into a new picture of the five-day forecast. As you might expect, *Deluxe Productions* and similar applications are aimed primarily at the news and business graphics user. One inexplicable shortcoming of *Deluxe Productions*, and of some other Electronic Arts programs, is that it does not offer full overscan, so the animation doesn't extend all the way to the edge of the video screen; this limits its appeal to professional users.

Two- and Three-Dimensional. Another distinction between animation programs on the Amiga is whether they handle two- or

three-dimensional images. What's the difference? As noted in Chapter 3, two-dimensional animation deals with images that are resolutely flat, while three-dimensional animation moves objects that appear to have full height, width, depth, texture, reflectivity, and shadows in an imaginary three-dimensional computer "space." A page-flipping two-dimensional animator manipulates bitmaps created with a paint program or digitizer; three-dimensional animators work more like metamorphic programs, in that they manipulate databases that define the three-dimensional mathematical characteristics of objects. These objects are created with three-dimensional object editing software, which is usually, but not always, integrated into the animation software.

Three-dimensional animation is more difficult to learn than two-dimensional, partly because working in three dimensions requires an extra dimension to your thinking as well as demanding more from your Amiga. Two-dimensional is sufficient for many routine DTV animation tasks, such as those associated with educational or business programming. But with three-dimensional programs you can create incredible (and impressive) animations not possible with two-dimensional programs; and three-dimensional animation is a fascinating subject in its own right, at the cutting edge of computer and animation technology. We'll look at three-dimensional animation in more detail later in this chapter.

Using a Page-Flipper Program

Most animators get started with a two-dimensional page-flipping program, such as *PageFlipper Plus F/X*, *Zoetrope*, or *Deluxe Paint III* which has animation capabilities built in. Because most Amiga owners are familiar with *Deluxe Paint III* and because it's one of the simplest animation programs to use, we'll look at it more closely.

Deluxe Paint III's animation tools are integrated with its paint tools. Options from the program's Anim menu allow you to set the number of frames and playing speed of your animation; navigate backwards and forwards from one frame to the next; add and delete individual frames; copy the background of one frame to all frames; and set up automatic moves using anim and perspective tools. Restrictions include the necessity of having all frames share the same palette, background color, and screen format, and the inability to have animation frames that are bigger than the screen. It's also not possible to link short animations to-

gether in a longer sequence; for that you have to use another program that will, or edit together animation segments on videotape in post.

Efficient Animation Design. Before starting your *Deluxe Paint III* animation, you need to do a bit of planning as to what the animation will show, how long it needs to be, how many colors you need, whether it will be shown on the computer display or on a standard TV, and so on. The more planning you do, the less likely you are to need to make changes in each frame of the animation after you've created 30 or 40 frames.

With page-flipping, memory is usually the biggest constraint on the length and resolution of animations you can create. Most page-flipping animation programs stored work in compressed form so more pages will fit in memory, making possible longer animations. Basically, the program compares each frame to the one before it and stores only the changes between frames.

It follows that the number of frames you can store is a function of the complexity of your animation. If most of the picture changes from frame to frame, there is more information to store, and fewer frames will fit in memory. For example, if your animation shows a landscape as it is seen by a fighter pilot swooping past at low altitude, virtually every pixel in every frame will change, and fewer frames will fit in memory. A bouncing ball against a plain background entails fewer changes from frame to frame, and so you'll be able to fit more frames in memory.

You'll want to design your animations with this in mind. One efficient method is to have animated shapes move across an unchanging background. Only the changes in the shapes will need to be stored, yielding more available frames. This approach is quite satisfactory for animated business graphics, moving text, simple cartoon characters, and any animation in which the background is merely a setting for foreground action that carries the "message" of the piece. For more elaborate animations, you may want to change all or part of the background as well. The trick is to paint a background that incorporates everything you think won't change, and leaves out what will.

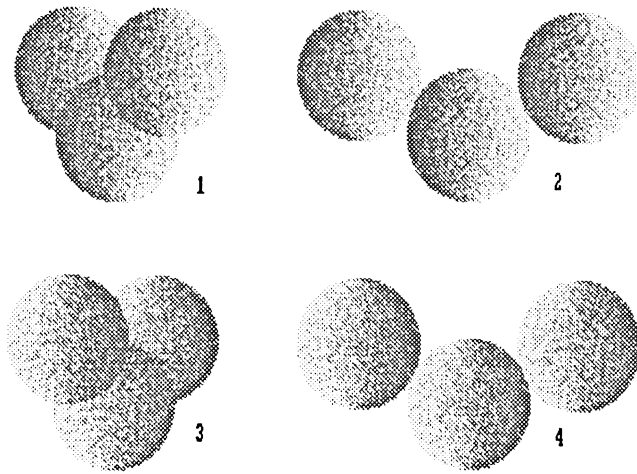
There are two additional ways to reduce the amount of storage required per frame. One is to use a lower resolution screen format, the other is to use fewer colors (that is, fewer bitplanes). The two-color lo-res (320 × 200) screen format lets you fit the most frames into memory—up to ten seconds worth at 30 fps—

and can be perfectly adequate for animated text or *pencil tests*, rough sketches of animations to be fleshed out later in color. Use *Deluxe Paint III*'s overscan interlace format for recording animations to tape.

You can reduce the amount of work needed to create an animation by keeping some basic rules in mind. For example, you need to redraw only the parts of a brush or background that move. If you think about it, most cyclical processes, such as a figure walking, need only a few states for each movement—the swinging back and forth of each arm and leg. You can draw the arm and leg positions as separate *Deluxe Paint III* brushes and tack them onto a brush of the body. After you've created the various stages of the walking figure, you can pick up the entire animated figure as an *animbrush*—a feature unique to *Deluxe Paint III*—and save it for compositing onto another animation.

Animating an Atom. Jane's "Introducing RxScan" video includes an animation of a vibrating, rotating atom, which she has created with *Deluxe Paint III*. Here's the general procedure she uses to create such a brief animation.

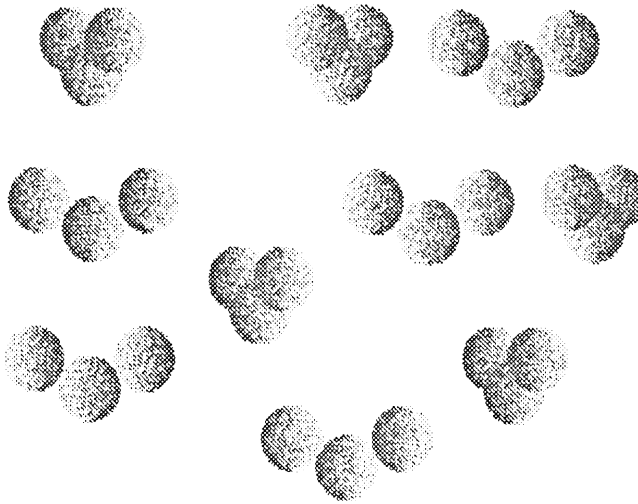
- Jane enters *Deluxe Paint III* and sets the screen format for interlace and overscan. Since she only needs a few colors, she sets the color count to 8; this will not use as much memory as the full 64-colors possible in halfbrite mode, meaning she'll have more memory for animation frames.
- The next step in creating this animation is to draw four views of the rotating atom. Jane draws position one, picks it up as a custom brush (*Deluxe Paint*'s term for a part of the screen that you can specify with the brush tool and then paint with), and flips it to create position 3. She then draws position 2 and flips it to make position 4. (See Figure 7-3.) When the four are put together in the animation, the atom will look like it's spinning.
- Now Jane makes four animation frames with an option in the Anim menu. Jane picks up each position of the atom as a brush and pastes it on its own frame, but in the same location on the screen. She plays the frames to check the positioning and effect.

Figure 7-3. Atoms 1

Minor adjustments can be made easily by working on any individual frame with any paint tool.

- Using the Animbrush option in the Anim menu, she picks up the entire animated sequence as an animbrush. She saves it in case she needs it again later.
- Jane clears the current animation frames and starts a new animation, this time with 60 frames (two seconds long at 30 fpi). She also turns on the grid, a tool that allows the artist to paste brushes at precise intervals. Holding down the Amiga key, which allows her to paint automatically on each successive frame, she paints with the atom animbrush at every grid intersection. Checking the result, she now has a two-second animation of rotating atoms filling the screen (Figure 7-4). Total time to create the animation: ten minutes.

Perspective Animation. One of the most useful features of any animation program is the ability to accomplish many difficult moves for you automatically. *Deluxe Paint III* can take a brush and move it smoothly across the background in the plane of the screen; zoom it in and out; and do complicated turns, swoops, spins, and orbits. The key to these tricks is the integration of *De-*

Figure 7-4. Atoms 2

Deluxe Paint III's perspective and animation tools through the Move box in the Anim menu (see Figure 7-5).

Here's how Jane uses the Move box to make a moving title:

- First she renders a title with a titling program (such as *Video-Titler*). She saves the title art as an IFF file.
- She enters *Deluxe Paint III*, loads the title art, and picks it up as a custom brush. She creates 30 animation frames, and then makes sure she's at the first frame.

Figure 7-5. Deluxe Paint III Move Box

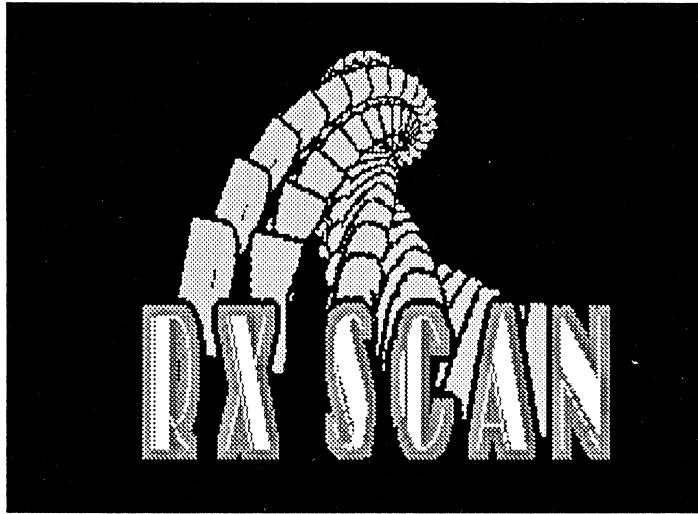
Move			
Dist:	X	Y	Z
0	500	1000	BRUSH
Angle:	0	0	360
			BRUSH
Clear		Go Back	CYCLE
Ease-Out:	0	Direction:	
Ease-In:	0	Move	Record
Count:	30	← →	» «
Preview		Trails	Fill Draw
Cancel		Exit	

- Now Jane turns on *Deluxe Paint III's* perspective mode (you have to be in both animation and perspective modes to use the Move capabilities) and stamps down the brush in the center of the page. She calls up the Move box.
- The settings in the upper part of the Move box refer to the direction and angle of motion of the brush. Jane can enter an amount in pixels in the Dist (Distance) row to make the brush move horizontally (X-axis), vertically (Y-axis), or into and out of the screen (Z-axis). She wants the brush to zoom along the z-axis, so she enters 500 in the Z Dist box. Jane also enters 500 in the Y column to make the brush move down from the upper part of the screen. Brushes can also be rotated along the axis of the brush handle by entering degree values in the Angle column. In this case, Jane enters 360 (a complete turn) in the Z Angle box. The other settings are left at their default values. She also chooses the Reverse recording option to make the brush zoom out toward the viewer as the sequence progresses.
- Jane clicks on Preview to see a *wireframe* (outline only) rendition of the move she has programmed. This lets her check the motion path and make changes before the animation is actually rendered. To do the animation, she clicks on Trails, and the sequence is automatically painted, showing the position of the brush on each frame. On playback, the text swoops smoothly in toward the center of the screen while making a full turn, as shown in Figure 7-6.

The animation resembles the kind of flying text that costs thousands of dollars to produce at video special effects studios. This feature alone makes *Deluxe Paint III* invaluable for generating animated titles and logos for desktop video.

Moving Windows. A slick effect is to have genlocked video from a taped source appear in an image window that moves around on the screen. This requires planning and some simple animation, which can be accomplished with *Deluxe Paint III* or most other page-flipping or metamorphic animation programs. Here's one method:

- Review the taped sequence and select the subject you want to follow. For example, suppose you're creating a music video and

Figure 7-6. Moving Text

your tape shows the lead singer dancing across the stage. You decide to put the singer in a moving window that follows his motion path, with graphics in other parts of the screen. Generally, it's best to use short sequences of no more than a few seconds for this technique. Time the entire sequence with a stopwatch or with your VCR's counter, making sure to note the counter number of the start of the sequence.

- Chart the motion path of the subject. To do this, you need to know exactly where the figure of the singer is on the screen so you can create a window in the proper place. One way to chart the path is to use a sheet of acetate and a piece of tinted plastic cut to the size of the moving window. Tape the acetate over the Amiga monitor, which you'll use to view composite video from your VCR and to create the graphics later. Step through the sequence frame by frame using the VCR's slow-motion capability. (You can identify the beginning or end of a frame by the bar of static that moves through the picture area.) On every third frame, center the plastic template over the figure of the singer, trace the template onto the acetate with a marker pen, and number the outline. (You can create a tracing at any frame interval you choose, but every third frame is a reasonable compromise.) After a few frames, you'll begin to see the motion

path of the singer as defined by the sequence of tracings. When you're finished, leave the acetate sheet in place for the next step.

- Create an animated window. There are a couple of ways to do this. You can use *Deluxe Paint III* to make a series of frames with a window in color 0 that corresponds to each outline you drew on the acetate, and then animate the frames. To make the frames, first draw a shape in color 0 that's the same size as the window template and pick it up as a brush. Paint a background using any color but color 0. Align the window shape within the template outline you drew for the first frame of the sequence, stamp the shape down, and save the picture. That's the first picture in the sequence. Now step to the next frame, pick up the window shape, and move it to correspond to the second outline you drew. Continue until you've created a frame for every outline. When the sequence of pictures is animated, the window should appear to move across the screen on exactly the path that the singer travelled in the original video. Each picture should be displayed for the duration of three frames, or one-tenth of a second (or for the duration corresponding to any other frame interval you may have chosen).
- Record the sequence. Get the VCR up to speed and load the animation. The trick is getting animation and video in sync. If you start both at the right moment, the singer should appear centered in the window throughout the sequence. If video and animation are not in sync, the singer may disappear from the window altogether. A few test runthroughs should show you where you need to start.

You can also use dedicated animation programs, like *Aegis Animator* or *Deluxe Productions*, to make the window move over a background. Both programs have a path feature that lets you preset the motion of any object across the screen. Create a window-sized object in color 0 and chart a path for it through the centers of the outlines on the acetate. Make sure the window takes the same amount of time to travel the path as the duration of the video sequence; your stopwatch reading will tell you how long that is. Replay the animation to test how it looks against the outlines.

Three-Dimensional Animation

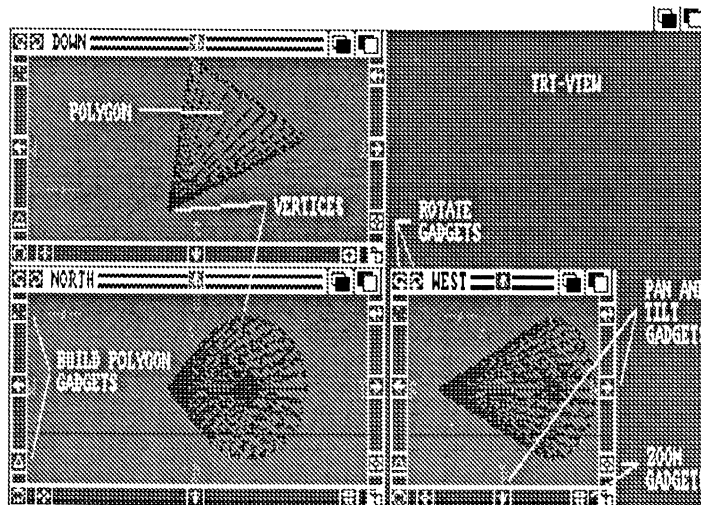
Animation in three dimensions really requires two separate processes: (1) designing and editing 3-D objects, and (2) moving them in space. We'll look at editing and movement in the context of a full-featured 3-D package, *Sculpt-Animate 3D*. Other programs, such as *Turbo Silver* and *VideoScape 3-D/Modeler 3-D*, offer similar tools.

Object Building

In *Sculpt-Animate 3D*, you build objects in three windows that show you the top, front, and side of the object (Figure 7-7). Any readers who have done some mechanical drafting, or who took metal shop back in high school, will recognize the SA3D "tri-view" as a standard orthographic projection. Most Amiga 3-D programs take a similar approach to representing objects, with the exception of *Caligari* (Octree Software), which attempts to give a single-window view in perspective.

SA3D objects are made of *polygons*—flat planes that form the object's surfaces. As you can see from Figure 7-7, the cone is made up of small triangles, the only kind of polygon SA3D can use. (Other programs allow you to use polygons with any number of sides, which can make it easier to build certain kinds of shapes.) To draw a polygon, click and drag the mouse in two of

Figure 7-7. *Sculpt-Animate Tri-View*



the windows to position the vertices; then draw the sides, using tool gadgets located around the edge of the tri-view windows. The polygon can then be treated as a plane, colored, warped, glued to another polygon, made bigger and smaller, and so on, all with menu options or gadgets in the tri-view windows. With practice, you can build any kind of 3-D object from SA3D's triangles.

Object Primitives. Along with objects you create yourself, SA3D provides *object primitives*, ready-made Platonic solids. These include a sphere, cube, cone, cylinder, and hemisphere. Since many objects are built out of these basic forms, using primitives can save a lot of design time. Color plates 7, and 16 through 19 use a selection of *Sculpt-Animate 3D* object primitives.

Lathing. Another method of creating objects in SA3D is to draw an outline, then rotate it around a central axis. This is somewhat like drawing a template for a table leg, and then turning a piece of wood on a wood lathe until it has the same profile as the template. To take a simple example, a sphere can be created by revolving a circle around its diameter. A lathed object is also called a *surface of revolution*.

Extrusion. *Extrusion* builds three-dimensional objects by stretching a two-dimensional outline along a third axis. This is like squeezing a plastic block through a shaped nozzle. If you've used a pasta-making machine or watched kids squeeze Play-Doh through their fingers, you know how extrusion works. Extrusion is particularly useful in creating three-dimensional fonts; you draw the letters in outline, and then extrude them to create the sides.

Object Surfaces. Three-dimensional computer objects can have a variety of surface characteristics, just like objects in real life. These include:

- *Color*, up to 4096 in HAM mode.
- *Transparency*, the amount of light that can pass through the object. SA3D and other programs can create objects with the transparency of air, water, glass, and so on.
- *Luster*, or the reflectivity (sometimes called *albedo*) of the surface. Objects can be dull, glossy, or mirrorlike, or imitate the luster of metals or plastic.
- *Luminescence*, the amount of light the object surface emits. SA3D

has one surface option for objects that give off their own light in any color.

- *Texture*, a pattern wrapped onto the object surface to give it the characteristic appearance of a familiar material, such as an orange rind. Usually this is accomplished by wrapping the object with a two-dimensional picture created with a paint program. This is also called *surface mapping*.

The objects in color plate 7, for example, have surfaces that are dull, shiny, luminous, and transparent.

Scene Editing

Objects generally don't exist in a void—they exist in a *scene*, or 3-D computer space. Scenes can have the following characteristics:

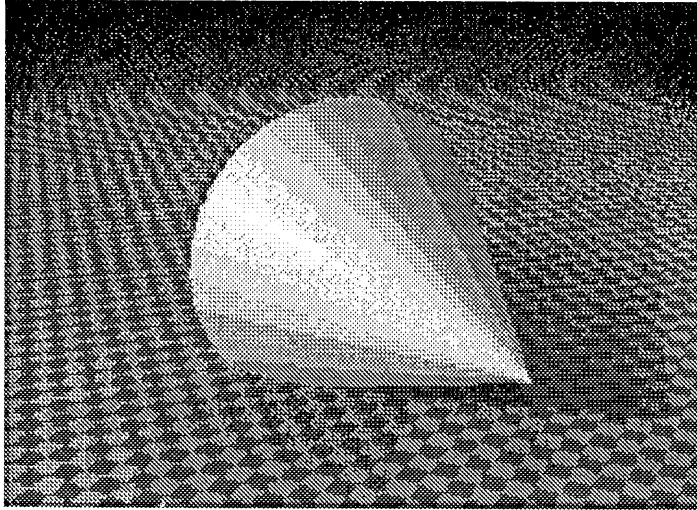
- *A sky and ground plane*. SA3D lets you define an infinite ground plane in a single color or two-color tile pattern. (as in color plate 7). The sky is nothing more than a dithered two-color background extending up from the ground. Other programs allow the use of any IFF picture as sky or ground plane. (These are optional; the scene can be completely featureless except for the objects you put in it.) You can also create additional objects to put in the background—for example, flat planes to act as the walls of buildings, a sphere far away to pose as a moon. *Turbo Silver*, another 3-D package, offers an option that makes it possible to create irregular, lifelike 3-D landscapes with simple mathematical entities called *fractals*. Fractals are forms that are similar in structure at any level of magnification. A typical example of a fractal in nature is a coastline, which has much the same kind of ragged, seemingly random edge whether seen from space, from an airplane, or from six feet above the ground. Landscape generators that use fractals are responsible for the moon-like scenes that IBM used in a series of recent TV commercials, and they can be used to advantage in your 3-D desktop video art as well.
- *Light sources, or lamps*. Think of these as the lighting kit of your scene. With *Sculpt 3D*, you can position scores of lights in any color, at any distance—even inside objects—and with any intensity. Just as with real lights, you'll need to experiment to achieve the effects you want to see.

- *The observer.* That's the viewpoint from which you see the scene. With SA3D you can move the observer point anywhere in the scene, even inside objects. The observer is also like a camera, so you can use wide-angle and telephoto "lenses" to gain a wide or close-up view of the scene. Essentially, you have the ability to do anything with the observer you can do with a real camera.

Rendering Techniques

Once you've defined all the properties of your objects and the scene they inhabit, it's time to *render* it—that is, create a fully detailed picture out of it. Three-dimensional packages generally offer several levels of rendering realism, including:

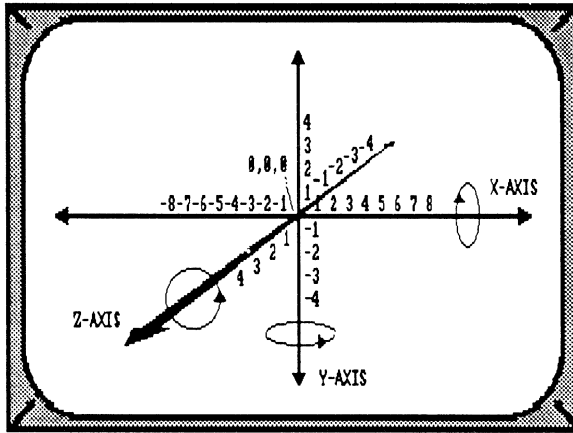
- *Wire-frame*, a representation of the scene as a hollow structure of wires showing shapes but no interiors or shading. It provides a sense of the scene with minimal computation. Wire-frame can be an appropriate rendering strategy when your animation should look like it was done on a computer.
- *Solid model*, where the scene is rendered with realistic shading and hidden areas removed, but without shadows, reflections, transparency, and texture. This is an intermediate rendering strategy that does the job for most animations in which you require some realism but don't want to spend the time computing surface details. Solid model scenes generally render in a few seconds.
- *Ray-traced*, a highly realistic method of rendering that traces the path of a ray of light from the observer's point of view to every element in the scene. With ray-tracing, you get accurately rendered shadows, reflections, and textures, but at a cost—it may take hours or even days to fully render a scene because of the many calculations needed to compute the color of each pixel. But the breathtaking realism of a HAM, interlaced ray-traced scene has to be seen to be believed. Figure 7-8 is a relatively simple ray-traced scene showing a shiny object with shadow. Color plate 7 is also a fully ray-traced scene.

Figure 7-8. Ray-Traced Scene

Object Movement

Objects, light sources, and the observer/camera have movement properties as well as surfaces and volumes. They can move anywhere in the scene, at any velocity. But how do you move a 3-D object in a 3-D space when you can only see a flat representation of it on the computer screen? Luckily, there's already an accepted framework for describing location and movement in space—the three-axis Cartesian coordinate system diagrammed in Figure 7-9. As you can see from the figure, movement of an object along the x -axis is movement from side to side of the computer screen; an object rotated along the x -axis flips head over heels. Y -axis movement is along the vertical dimension of the screen; an object rotating on its y -axis spins like a top. Movement in depth—from close to the viewer to far away—is measured along the z -axis. Z -axis rotation is like that of a windmill seen from the front.

One way to position any object in a scene is by specifying its x , y , and z coordinates. *VideoScape 3-D* is one program that makes extensive use of the Cartesian coordinate system for creating and positioning objects. To animate the movement of an object, set the coordinates of the beginning position; then set the coordinates of the end position (each coordinate number along an axis corresponds to an arbitrary length, such as a meter), and *VideoScape*

Figure 7-9. Spatial Axes

moves it from beginning to end over a number of frames. Other 3-D programs at least provide the coordinates of the position of any object, if you need that kind of precision.

A more intuitive method, and the one that SA3D and most other 3-D programs use, is to attach a special kind of object, called a *path* or *spline*, to an object (or light source or observer), and have the program automatically move the object along the path over a set number of frames. Each vertex on the path corresponds to the position of the object in one frame. Paths can contain curves, sharp angles, and closed loops; paths also change the object's speed and rotation.

In SA3D, light sources and the observer can also travel along paths. Moving the observer gives the effect of dollying or flying through the scene. Moving a light source can be a useful effect in special cases; for example, you can create the illusion of a swinging lamp by having a light source travel back and forth along a short arc directly over your scene.

Color plates 16 through 19 show an animation sequence using several types of movement. In the first three frames, the objects are rotating in space in two dimensions while the observer moves straight up. In plate 19, the objects move over to one side of the frame. This animation was exported from SA3D as individual IFF files to a HAM program and an animation utility. In the final step, a HAM image of a car was composited over each frame

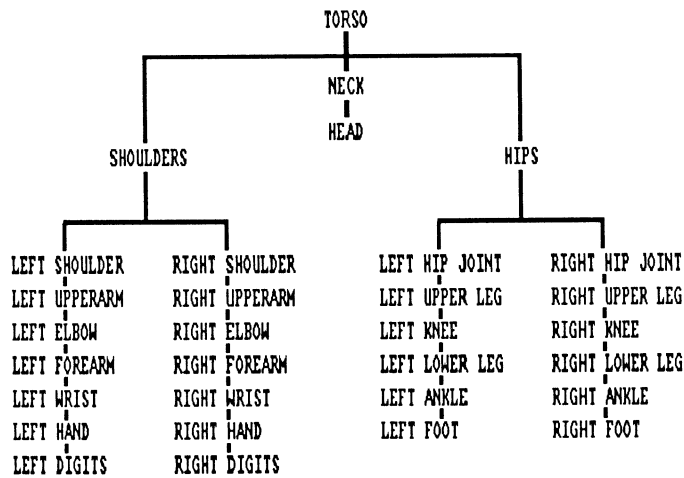
so the car appears to move across and past the objects as they fly around.

Metamorphosis. SA3D can change the shape of an object, as well as move it in space. In principle, this is the same as the key-frame and tweening process performed by two-dimensional metamorphic programs. In its simplest form, you set a number of frames and two key frames at the beginning and end of the sequence by entering information in requester boxes. You create the object for the first key frame, and then change its shape and other properties for the second key frame. The program then takes care of the in-between transformations through the number of frames you've specified between the two key frames. In this way, for example, you can make an alligator turn smoothly into a polo player. This method is more difficult to manage than the movement path type of animation described above, but it yields transformations not possible any other way. You can also combine techniques within one animation, having one object metamorphose while another moves along a path, and even having the same object exhibiting both kinds of changes.

Object Hierarchies. Perhaps the most powerful, and certainly the most complex, aspect of SA3D is its ability to link objects and their movements together in a *hierarchy*. The motion of objects in an object hierarchy is linked to the motion of other objects according to levels of influence; for example, an arm may be made up of a hand object, a forearm object, and an upper arm object, with the upper arm motions determining the forearm motions, and the forearm determining the hand motion, but not vice versa. Figure 7-10 diagrams a simple hierarchy of a entire human body.

To set up a hierarchy, first create and name the various objects—"leftthumb," "lefthand," "leftforearm," and so on—then link each one with its parent and offspring objects. The naming and linking is accomplished with SA3D requesters. When the whole object is created out of all the various levels of subobjects, you can then define paths for each part. Assuming that all parts have been named, linked, and pathed correctly, the object can exhibit extremely complex movements.

If you look at your own body objectively, you can see that it's no trivial task to design and move a 3-D human body simulation. Before you tackle it yourself, you should be aware that there are clip object disks that contain complete, if generic, 3-D human bodies, already linked and ready for you to customize and ani-

Figure 7-10. Object Hierarchy

mate. If that sounds like science fiction, well, doing 3-D animation on a personal computer was science fiction just a few years ago. Perhaps more useful to the DTV producer, there are also clip object disks of 3-D fonts that make the generation of slick animated logos a snap.

A complete tutorial on 3-D animation would require a book all to itself. If you're really interested in the world of 3-D, the best and only way to learn is to get a package and plunge in. *Sculpt-Animate 4D*, the somewhat more powerful (and more expensive) version of SA3D, is perhaps the most sophisticated, flexible program (and one of the most expensive), but you can do well with several of the others, such as *Turbo Silver 3.0*. A unique, cartoon-character-oriented approach is taken by the Hash Enterprises products, such as *Animator:Apprentice 3.2*; this program specifically aims to give you the power to create "Disney-style" animations in 3-D, using a complex object creation and linking system. (Of course, Disney-quality animation is entirely a matter of the animator's artistic and narrative skills.) Other Hash programs provide digital analogs to traditional animation tools such as rotoscoping and the multiplane animation stand.

Sharing Objects and Animations Among Programs

One problem with Amiga 3-D animation software is that each program creates its own type of object file format. SA3D objects

can't be loaded directly into *VideoScape 3-D* or *Turbo Silver*, and vice versa. This is frustrating to animators who, for example, like SA3D's animation controls, but prefer *Turbo Silver*'s more powerful tools for setting object surface properties and would like to be able to move objects between the two programs. Synthesis, a third-party developer, has jumped into the breach with a translation utility program called *Interchange* (see Appendix A). Using *Interchange*, you can convert the object file format of one program to another with little or no loss of information.

The ANIM Format. Animation files (the file containing all the rendered animation frames) don't have a standard format either, although this situation may be changing. In the last year, the Aegis/Sparta ANIM animation file format has emerged as a standard for many Amiga animation programs. The ANIM format uses file compression techniques (described above in the discussion of *Deluxe Paint III*) to squeeze a lot of animation into a relatively small file, so relatively lengthy animations can fit into the relatively small RAM available on most Amigas. Any animation created in the ANIM format can be loaded and saved in an ANIM compatible program; for example, you can play *Deluxe Paint III* animations with Aegis's *ShowANIM* utility program.

Unfortunately, a number of Amiga animation programs still use incompatible animation file formats, such as the RIFF files created by Antic's *Zoetrope* and the format used by Gold Disk's *MovieSetter*. If you want to swap animations among these programs, you need to find a file conversion utility. *Elan Performer* from Elan Design (P.O. Box 31725, San Francisco, California 94131. Telephone: (415) 621-8673) can convert between ANIM and RIFF, and other utilities are available on bulletin boards and from user groups. Your best bet may be to stick with ANIM-compatible programs for the greatest flexibility.

Getting Animation on Tape

Normally, you'd record an Amiga animation to tape in the same way you'd record any other Amiga graphics—through a genlock to a VCR—and then edit it into a larger work in post-production. That works in some cases. But animation, especially 3-D animation, presents some special problems as well.

We've blithely been talking about 3-D programs creating frames of ray-traced, interlaced, HAM animation of all kinds of fantastic scenes. But the fact is, it may take your Amiga a whole day to render just one of these frames. Even an Amiga with a

68020 or 68030 accelerator board and floating-point coprocessor, or one of the new 68020-based Amiga 2500s, seems painfully slow at generating detailed 3-D scenes. There's just no such thing as "real-time" ray-tracing. It's quite possible to design an animation that would tie up your Amiga for a year; assuming that each frame took 12 hours to render, you could only generate about 24 seconds of animation in 365 days. (In that case, it would probably pay to buy a few Amiga 500s just to do the rendering.)

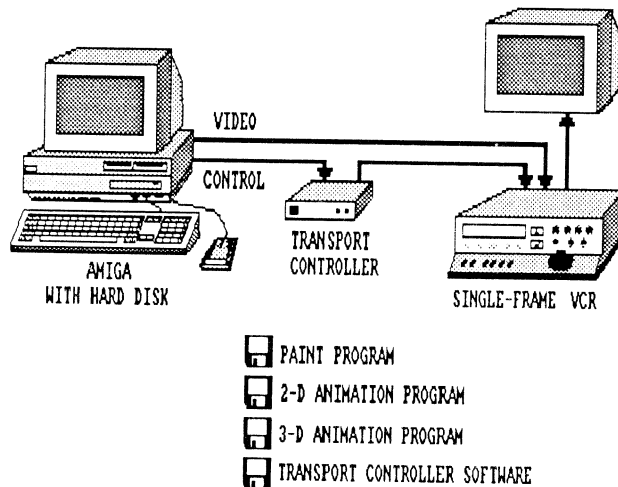
And where would you store the rendered frames? Twenty-four seconds of ray-traced HAM animation frames would require about a hundred floppies, or a 100MB hard disk. Even when the frames are compressed, only a few seconds of animation are likely to fit in memory for playback to a VCR—remember, HAM images use a lot of bytes.

Single-Frame Recording. When you've got long, complex animations in mind, and you're dead-set on the superrealism of ray-tracing, the way to go is to record the animation frames directly to videotape. That's how most professional video animation is done. As it happens, tape has a far greater storage capacity than memory or disks, and at far less cost. The trick is to get each frame of animation onto a single frame of video, which requires specialized equipment, including a VCR that can record one frame at a time.

With the current state of the art, that's neither easy nor inexpensive. Consumer and industrial VCRs just aren't accurate enough to let you record on a single frame. A broadcast VCR using time code can do it, and certain VCRs, such as the Sony $\frac{3}{4}$ -inch V0-5850, have attracted third-party hardware that takes over control of the VCR transport, also making frame-accurate recording possible. Amiga-specific software exists to interface with the better-known transport controllers, such as the Lyon Lamb MiniVAS series (see Appendix A). The minimum required system is diagrammed in Figure 7-11.

If this is the route you want to go, expect to lay out money for a VCR with frame-accurate capability, a transport controller box, a high-quality genlock, transport controller interface software, animation software, and probably time code equipment as well (see Chapter 9). In other words, you should already be a video professional, have access to professional equipment, or be willing to pay for professional services, before you consider it.

The next generation of "digital" consumer VCRs may offer single-frame recording capability, as the market for advanced

Figure 7-11. Frame-Accurate Animation System

DTV equipment matures. At least one company (MediaPhile, see Appendix A) is offering a controller system that will run some current S-VHS and 8mm VCRs at about two frames accuracy, which may be good enough (you don't get broadcast-quality results, of course). But you may not have to go that route. As more and more DTV animators get into Amiga 3-D, it's likely that service bureaus will spring up to render animations and record them on tape. You'll be able to drop off your disk with the animation all programmed and come back later (perhaps much later) for the finished product.

Something that will help the process along is the appearance of Amiga software on dedicated animation computers. At least one Amiga animation program, *Sculpt-Animate 4D*, is in the process of being ported to a high-end graphics workstation (Silicon Graphics' Iris machines). The Iris version of SA4D will use the same kernel (written by astrophysicist Eric Graham of "Juggler" fame) as the Amiga and the Macintosh versions, and will be file-compatible as well. Byte by Byte, the publisher of SA4D, envisions a cost-effective animation environment in which lots of artists are using SA4D to create objects and scenes on inexpensive Amiga 500s, then moving files over to an Iris for fast, high-resolution rendering. Since SA4D can create ray-traced scenes with up to 24 bitplanes of color information, an Iris rendering of a scene originated on an Amiga could have millions of colors onscreen, assuming there were enough pixels to show them all. The Disney

studio, whose first Amiga—an A1000—did not live up to expectations and was tossed in the trash by disillusioned animators, is reportedly interested in such a system. Maybe the revolution in low-cost animation sparked by the Amiga will reach to the very top of the field.

Sound is a vital element in video design, integral to telling a video story and focusing the viewer's attention on key aspects of a narrative. Without sound, TV is no more interesting than a fuzzy silent picture. With a driving, creative soundtrack, video is uniquely expressive. The orchestration of video sound is the subject of the next chapter.

Chapter 8

Audio for DTV

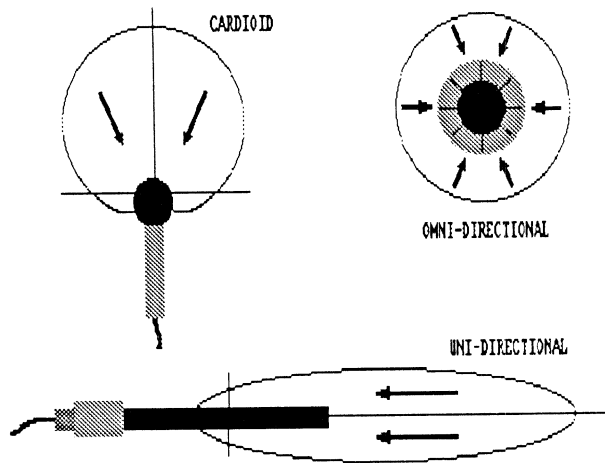
So far in this book we've barely mentioned video sound. But sound is, in fact, a crucial element of any DTV production. Sound designers will tell you that most of the emotional impact of video is in what you hear, not in what you see. You can easily test this for yourself by turning on any TV action drama and then turning down the sound. You can still tell what's happening—you've seen every TV action plot a hundred times already, so no surprises—but it isn't nearly as engaging. Now switch to a comedy. Without the laugh track, music, and pratfall sound effects, Bill Cosby isn't that funny, even if you can read his lips. (Charlie Chaplin and Buster Keaton *are* funny without sound, though—we've just been conditioned to expect sound to help us connect with video).

Probably worse than no sound is bad sound—sound that is muddy, unpleasant, or unintelligible. A DTV training tape won't have much effect if the audience can't hear what the instructors are saying. Unfortunately, audio is often neglected by the DTV director in search of stunning visuals, and that's a shame, because getting effective sound on tape is not that difficult.

This chapter covers the basics of audio for DTV video. Later in this chapter we'll look at how to create custom sounds with your Amiga—effects, music, and complete scores—and add them to your DTV production.

Basic Audio Equipment

Before you add those wonderful sounds to your tape, you've got to capture them. As with video, there are standard pieces of audio for the job.

Figure 8-1. Mike Pickup Patterns

Microphones. A microphone, as you know, is a device for turning sound into an electrical signal. There are various types, with different levels of directional sensitivity (see Figure 8-1).

Many amateur DTV directors take mikes for granted and use whichever one is handy, such as the small mike that comes built into every camcorder. But all microphones are not created equal. Most camcorder microphones, for example, are the inexpensive *omnidirectional* kind, which means they pick up sound in every direction. That includes the sound of the camcorder's autofocus device, the zoom motor, your breathing, and jet planes flying overhead. If you don't really care about the quality of the sound in your DTV production, use the camcorder mike.

You'll get far better sound with a modest investment in a better mike. For field production, a *shotgun mike* works best. This is the long, aggressive-looking microphone you see on top of news cameras. A shotgun mike picks up sound in a narrow cone in front of the mike and very little to the side or behind, so you only record the sounds coming from the subject where the camera is pointing. The shotgun can be mounted on the top or side of the camcorder and plugged into the external mike jack.

For studio production, especially for talk shows and the like, *lavalier mikes* are a necessity. These tiny devices clip onto ties, behind lapels, and under collars. Lavaliers are relatively weak microphones, but this is an advantage—they pick up only their

wearer's voice. A general-purpose mike, useful for interviewing, on-camera work, and ambient sound recording, is the *cardioid* (so-called because of its heart-shaped pickup pattern), which has good recording characteristics and is fairly directional. Variations in tone quality can be achieved by simply pointing a cardioid mike at a slight angle to the subject.

If you're going to plug an external mike directly into your camcorder, make sure it has a matching *impedance*, measured in ohms. Most mikes have a low impedance (under 600 ohms), and should match the impedance of most camcorders, but check both the mike and your camcorder manual before assuming that just any microphone will work.

Audio Tape Recorders. Your VCR may or may not make a good audio tape recorder (ATR). The typical inexpensive VHS VCR or camcorder is not high-fidelity and doesn't record any more sound than the typical three-inch television speaker can put out. Ask any audiophile; standard TV audio is about the worst there is. So if sound quality is important to you, you may want to invest in a good ATR. Marantz and Sony, among other manufacturers, make high-quality, moderately priced portable stereo cassette recorders that are expressly designed for field production. Expect to pay \$150 to \$400 for one of these. For studio use, consider a open-reel ATR, which costs more (\$750 and up) but yields much higher fidelity recordings. But even an inexpensive stereo walkman-type recorder will make better-sounding tapes than an inexpensive VCR.

But hi-fi, one-half-inch, and 8mm VCRs make excellent, cost-effective ATRs. This is one of the best-kept secrets in the audio industry. In fact, some DTV producers buy hi-fi VCRs to use solely as ATRs. (Forget digital audio tape—the much-heralded DAT—which is currently very expensive and may never catch on in this country.) The advantages of using a good VCR as an ATR are obvious; you get several hours of sound on each tape, and the sound is already in a format that is easy to edit with other video. Just plug microphones or other audio sources (including your Amiga) into the mike or line inputs of the VCR, and roll tape. For the best audio, record at the fastest available speed—in VHS, the two-hour SP speed, for example.

Audio tape recorders may be able to record one, two, or multiple *tracks* of sound. (A track is a separate strip of recorded sound on a tape.) For example, a stereo ATR can record two

tracks, Left and Right; a mike plugged into the left track will record sound only onto that track if the right track recording level is set to 0. By plugging microphones into both mike inputs and adjusting the recording levels on each track, you can perform basic audio mixing (see below). More sophisticated ATRs provide four or more tracks, one track for each sound source. Generally, these are open-reel machines, although you can find four-track cassette recorders. Recording each sound on a separate track lets you do more with them in post-production.

Hi-fi VCRs offer two audio tracks, but lower-quality ones don't provide controls for setting audio levels. Something new in VCR audio is *pulse code modulation* (PCM), a digital recording method that yields recording quality close to that of compact disks. You'll find PCM mainly on Sony 8mm decks, and some high-end 8mm camcorders, which may offer two channels of PCM and one FM monaural channel.

Headphones. These are indispensable for any audio work and should be part of the kit on every location shoot. Wear headphones connected to your camcorder as you shoot, and you'll hear the action as the camcorder is hearing it. The rare earth-magnet types provide the greatest audio range and are lightweight as well.

Recording Sound in Production

Getting good sound on tape during the production stage is mainly a matter of proper mike selection, placement, and testing—and common sense. For example, what kind of mike should you choose to record the conversation of a group of people sitting around a table? An omnidirectional mike is the type to choose, placed in the center of the table. In fact, there are mikes designed especially for that situation, and practically any other you can think of recording.

As mentioned above, even if you're out there shooting alone with an inexpensive camcorder, your DTV audio will really improve by replacing the camcorder mike with a good (\$50–\$100) cardioid or shotgun mike. For newsgathering, documentaries, special events, and such, that and a pair of headphones are all you'll need. More elaborate productions call for more variety in mikes. Interviews should be shot with a good cardioid mike held by the interviewer, or perhaps lavaliers on the interviewer and subject. A live music performance might call for a shotgun on the

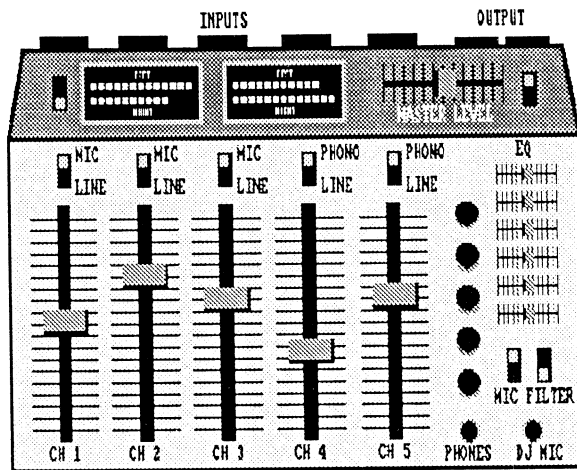
camera, cardioids placed near the instruments, and a wireless mike on the singer. This kind of multiple-microphone situation calls for audio mixing, discussed below.

The distance you position a mike from the sound source is a matter of judgement and experience. In general, the mike has to work in conjunction with the camera. A mike placed close to a speaker, for example, gives a tight, close sound presence (as well as possibly picking up any sibilance in the speaker's voice), which won't work with a long or wide shot. Miking the speaker from a distance cuts sibilance but adds more room noise and won't match a close-up. The mike should point directly at the speaker, not at an angle (unless you're looking for an oblique sound effect), and the angle shouldn't change during the recording session. Try not to point mikes directly at nearby walls, so as not to record unpleasant sound reflections. And caution speakers not to fiddle with the mike, rub their fingers on the top, or put their mouths right up close to it.

Even harder to mike is a shot in which the subject is moving. The mike has to move in tandem with the camera and keep a constant distance from and angle to the subject—tricky in the case of dolly shots. Moving shots will probably require putting the mike on top of the camera, or assigning one person the task of following the subject while maneuvering the mike, perhaps on the end of a long pole or *boom*. Audio stores sell a variety of booms for extending mikes over an actor or scene, but a broom handle and some gaffer's tape works just as well. In any case, test the miking to see if it matches the shot you've planned.

Audio Mixing. If you want to incorporate many layers of sound in your production, you need an *audio mixer*. Audio mixing can be done on location or in the studio using a *mike mixer* (Figure 8-2), a device for setting the levels and combining the input of several microphones or monaural audio sources. Disco mixers accept stereo inputs rather than monaural inputs but are essentially the same beast. Many mixers accept both mono and stereo inputs, as well as mike level (low-strength audio signal) and line level (high-strength audio signal) inputs. (If you plan to send the mixer output directly to a camcorder and the camcorder only has a mike input, make sure your mixer can output a mike level signal.)

In a typical recording setup, you'll place microphones at each source of sound—for example, a lavalier on each actor, and per-

Figure 8-2. Audio Mixer

haps another mike to catch background sounds. Each mike is connected to the mike mixer, and the monaural mixer output is sent to the VCR's audio input. (Or, if you're planning to sample the sound, you can send the mike mixer output directly to an audio digitizer connected to your Amiga.) The output of any stereo hi-fi device can also be sent to the mixer, with each stereo channel requiring its own input; for example, the left and right channels of your receiver are plugged into separate inputs on the mixer. A typical moderately priced mixer may offer 8 inputs, which can be mixed down into four channels for a four-track ATR, or two channels for stereo recording. Better mixers may have 16 or 32 inputs, and the ability to send partial mixes to a variety of special sound processing devices (see below).

Most mixers provide equalization (tone control) for each input channel. Test and set each mike and audio component recording level with the Volume Unit (VU) meters on the mixer. The VU meters give you visual feedback on the strength of the incoming signal. Do a test recording on a monaural VCR or camcorder with the mixer output set to different levels and choose the strongest one that yields the least distortion. Hi-fi VCRs with VU meters make it much easier to adjust the levels. You may need to recalibrate the VU meters on your mixer so the 0 VU on VCR and mixer are the same. Many mixers can generate a 0 VU test tone that provides a standard level for recalibrating the VCR's

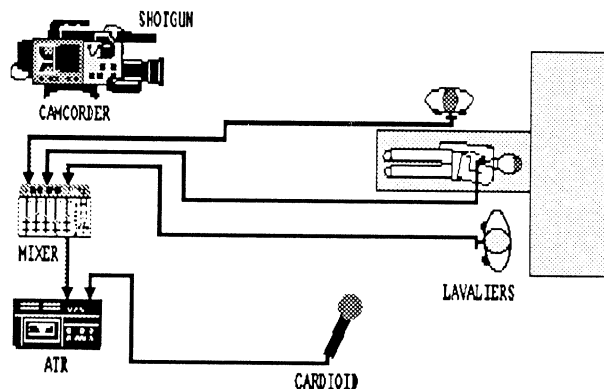
VU level. A 0 VU tone is also useful for making the blacked master described in Chapter 5.

Understand that VU levels are somewhat arbitrary; do test recordings and trust your ears rather than a number on a meter. As you work, always monitor your audio mix on a standard TV. What you hear is what the viewers of your video will hear; what sounds tinny to you will sound tinny to them.

Figure 8-3 shows how Jane uses a mike mixer on location for “Introducing RxScan.” She uses lavaliers on the patient, Dr. Palmer, and his assistant; a cardioid placed well away from the scanner but pointing at it to catch the scanner sounds and other room noises; and a shotgun on the camcorder to cover herself if the other audio goes wrong (for example, if the magnetic field of the scanner overpowers the lavaliers). The shotgun output goes to one track on the camcorder; the three lavaliers are mixed onto one track of an ATR with the mike mixer; and the cardioid output is recorded to the second ATR track. Later, she’ll mix the sounds together in post.

Using a mike mixer during the production stage saves a lot of post-production audio mixing, but, since you may not be able to correct any mistakes you make on already mixed audio, it may be better in critical situations to record the output of each microphone with a separate ATR or on a separate track of a multi-track ATR. (This may not be practical for a music video, where there may be a dozen or more microphones and other audio sources onstage; you’ll have to do some on-the-spot mixing.) You can

Figure 8-3. Mixing on Location



then check each tape or track before you mix them all down to one or two tracks in post.

Audio in Post-Production

If you listen closely to the soundtrack of any television program or film, you'll hear not one but many layers of sound going on all at once. For example, in a party scene you might hear music, dialog, and several different sound effects at once—ice tinkling in glasses, champagne corks popping, the hum of background conversation, and so on. In nearly all cases, these sounds weren't recorded on videotape during the production but were added to the video during post-production. In fact, post is where most of the audio work on video gets done.

The handling of audio in post-production involves adding sounds that were not recorded on the videotape during production (these are called *wild sounds* because they're not synched to any visual) and improving or *sweetening* sounds. You can tackle these tasks at various levels of complexity.

Audio Dub. The simplest way to add wild sound to your DTV program in post-production is by using the *audio dub* function on your VCR. This records new audio over the linear audio track on the tape without disturbing the video; the tradeoff is you record over whatever audio was there before. On hi-fi or two-track VCRs, the audio dub may be recorded over one of the tracks (usually track 1); so you may be able to keep one track of original audio while dubbing new audio, say narration or a musical score, over the second track.

To audio dub a sound effect onto your tape, all you have to do is plug a mike into the VCR or camcorder, cue up the tape, put the recorder into audio dub mode, and make the sound at the right moment. Punch-and-crunch audio dubbing from an ATR to a VCR is only a little more complicated:

1. Set up your ATR and VCR with the ATR line output plugged into the VCR audio line input.
2. On the ATR, cue up a second or two before the beginning of the piece of audio you want to dub onto the videotape and put the ATR in play-pause. (The second is to allow the ATR to get up to speed.) Cue up a second or two before the beginning of the piece of video you want dub over, and put the VCR in audio dub-pause.

3. Punch both pause buttons at the same time. If you've timed the cues just right, the ATR audio should start to dub over the VCR audio at the proper moment.
4. Punch the pause buttons again when the dub is finished. Play back the dub on the VCR to test the result. If the timing or sound level is off, you can try again.

If you're generating wild sound with your Amiga (see below), use the above method, treating the Amiga as the ATR. One thing to note is that the Amiga doesn't need pre-roll time—just hit the play key or click the mouse to start the sound at the right moment.

Insert Audio. As with punch and crunch video editing (see Chapter 5), a standard audio dub is simple to do but haphazard in results. If you have access to an insert editing system (also discussed in Chapter 5), you have more flexibility and can produce a smoother program with more precisely timed audio. The insert edit controller may allow you to do inserts on one or both of the VCR audio tracks only. Even if the controller doesn't specifically control audio, you can probably do audio inserts anyway. Try this with a test tape: When you're ready to dub the audio in, manually press the audio dub button on the slave VCR (and release the record button, if necessary). Perform a standard insert edit. The audio should go on the test tape without disturbing the video.

The real skill in editing audio into video is matching the sound with the visuals. In punch and crunch, you depend on your own sense of timing—and the speed of your index fingers—to make sure audio and video are in sync. With insert editing, you can use the edit controller's frame counter to insert sound with near-frame accuracy, which is usually good enough for the ears of your viewers. The one time when you must be right on the mark is when you have to sync wild dialog to video. Your viewers can inevitably tell if the dialog is even a frame or two out of sync with the lip movements of the speaker, so you may have to perform the audio insert several times to get it exact. If frame precision is necessary for sound effects or dialog, consider organizing your audio effects using a detailed edit or cue sheet, just as you might for video effects. The sheet should contain the shot number, frame in and frame out, duration, and desired sound effects.

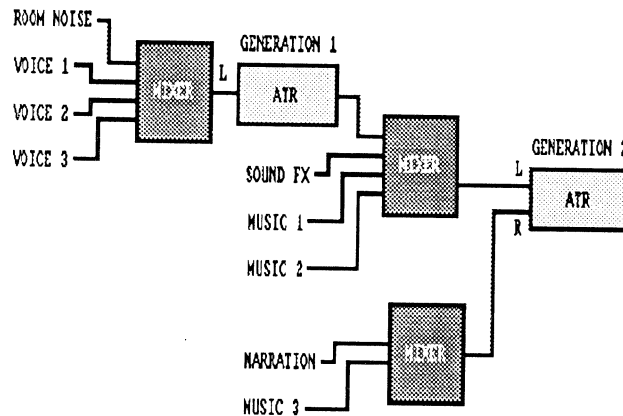
Audio can provide a useful way to pull together adjacent scenes. When you do an audio insert, let the audio from the previous scene bleed over into the next, past the cut in video. Or start the audio for the next scene a few moments early, before the cut. If your video is short, laying a single piece of music over the entire piece can bind it together effectively even if the video cuts are choppy. (Video and film directors depend on the score composer to do that for them all the time.) Use audio fades, which you can easily do with a mixer or the audio level controls on the ATR or VCR, to gently bring the viewer into or out of a scene. Try bringing up the audio at the beginning of the program before you show any video to create a feeling of expectation in your audience.

You can go the other way as well. Instead of audio dubbing sound over edited video, you can take a piece of prerecorded music and edit the video to fit. That's the way music videos are usually done—every edit is on a beat, and, in extreme cases, every beat has an edit. Most commercials are edited the same way. If the sound already has a structure, then it only makes sense to use that structure. Just record the audio onto the master tape before you start to add video; then do inserts as you normally would.

Mixing in Post. Conceptually, mixing in post-production is not much different than mixing in production. The aim is the same—to combine many audio sources into one or two for recording onto videotape.

If you're willing to mix down two or more generations, you can layer dozens of sound sources together before adding them to the video. Figure 8-4 shows how. This is particularly useful when you have many sound effects to add to a tape and only a few inputs on your mixer. Audio doesn't lose as much signal quality as video does when it's recorded down a generation, so you don't need to be so concerned about rerecording the audio several times before laying it onto the edited master videotape.

Audio Sweetening. The term *sweetening* is often applied to any manipulation of audio done in post, but here we'll refer to it as the process of cleaning and improving inadequate audio. Probably the simplest form of sweetening is adjusting the volume of a sound to bring it up or down to the level of the rest of the audio, but you can do more than that. For example, you may have re-

Figure 8-4. Layering Sounds

corded the sound of a car door closing in the field, but when you get back home you find that you've also recorded the sound of a horn that partly masks the sound of the door. To some extent, you can fix the problem with an audio mixer and an *equalizer* (or *EQ*), a device for adjusting the pitch or tone quality of a sound. The main use for an EQ is to clean up existing sounds or tailor them to suit a particular use. Using an EQ, you may be able to block the sound of the horn by filtering that portion of the recording with the pitch controls, which adjust the level of set ranges in the audio spectrum (bass, midrange, and treble, measured in kilohertz). Equalizers may take several inputs, with separate controls to set the pitch of each input; they may be built into amplifiers and audio mixers or stand alone.

Another device called a *reverb* can add apparent depth to sounds; you can make a tinny recording of conversation sound deeper and more natural by rerecording the sound through a reverb, which is used in conjunction with the mixer. *Digital delays* and *echo boxes* change the timing of sound effects and make them sound as though they were recorded within a large space. Other devices can create and modify sounds in all kinds of unusual ways, but these are used mainly by professional audio technicians and aren't likely to find their way into a DTV studio. In any case, you can use your Amiga as a very effective audio sweetener, as you'll see on the following pages.

Making Amiga Music

The Amiga is an amazing music machine. With it you can record and modify sounds, create unheard-of sound effects, compose your own music—even if you aren't a musician—and add them all to your DTV productions.

The Amiga offers four hardware sound channels, or *voices*, which are mixed down to stereo, converted to analog form, and sent out of the machine through two RCA jacks on the back panel. (In other words, the Amiga can play up to four instruments or sound effects at a time.) Channels 0 and 3 are connected to the Left stereo jack; channels 1 and 2 to the Right jack. To play or record sounds directly from the Amiga, simply run two standard audio cables from the back panel of your computer to any amplifier or audio tape recorder. Don't expect true high-fidelity sound, though; a low-pass audio filter in Amiga 500s and 2000s cuts off the high end of the audio signal at about 13 kHz, well below the 20 kHz frequencies audible to the human ear. Some music programs can bypass the filter to increase the Amiga's musical range.

In addition to being able to create sounds and music, the Amiga is equipped with a speech synthesizer, accessible from the CLI. Using the CLI's *say* command, you can coax your machine to talk in a robotic voice that sounds slightly Scandinavian. This may be useful if you happen to have a robot, computer, or alien character in your video.

Audio In. You'll want a way to get external sounds into your Amiga for creating custom sound effects. A *sampler*, or sound digitizer, is a device for converting live or recorded audio to a form the Amiga can understand. Standard audio, like standard video, is analog, and thus incomprehensible to your computer, which can only process digital information. When an analog audio signal is fed into the sampler (from a microphone or other audio source), the sampler divides the continuous analog signal into discrete parts and assigns them digital values. Each part is called a sample, as is the digitized sound as a whole. The more samples per unit of time the analog signal is divided into, the more accurate the digital version of the sound. For example, suppose you were to sample Beethoven's Fifth Symphony for 1/60 of a second, once every second. The sample wouldn't sound much like the Fifth Symphony on playback—59/60 of the music would be lost. Sampling the music at a much higher rate—say for 1/250 of a second, 128 times a second—would give you a much better approxi-

mation of the real symphony. So one of the most important things to look for in a sampler is the highest possible sampling rate.

One problem is that high-quality samples tend to make big files that take up a lot of memory and disk space. (In fact, all sound and music files are quite large.) Software that comes with many samplers allows you to compress the sample into a smaller size by a process similar to the one used for animation in the ANIM compressed file format. Just make sure your sampler creates files in a format your sound software can understand. Sampler software also lets you play with the sound after it has been sampled—adjusting duration, frequency (pitch), amplitude (volume), and harmonics (timbre)—by using the mouse to redraw a waveform of the sound. Here's where you can turn a sample into a sound that seems to have come from outer space. Aegis's *Audio Master II* is one example of such software.

The possibilities for tailoring sound effects are limitless. One of the simple tricks you can accomplish with a sampler is to sample your own voice saying a word—"Amiga," for instance. When you play back the sound in the Amiga at different pitches, you'll hear your voice saying "Amiga" going up and down the scale.

If your video is for commercial purposes or broadcast, be cautious when you use sampled music. Music, like books, art, film, and photographs, can be and usually is copyrighted. Recent music is very likely to be copyrighted in the name of the composer or performer. Even if it's too old to be copyrighted outright (classical music, for example), music may be copyrighted in the form of a particular performance. Since using a copyrighted piece of music in your video without permission is a crime, as well as bad form, you are safer sampling music placed expressly in the public domain by the performer and/or composer, or creating your own.

Using Music Software

To coax complex audio from your Amiga, you'll need sound software. A wide range is available, from programs for the nonmusician to applications that give you all the musical power a professional could want. Let's look at two popular programs that can be used to create DTV scores.

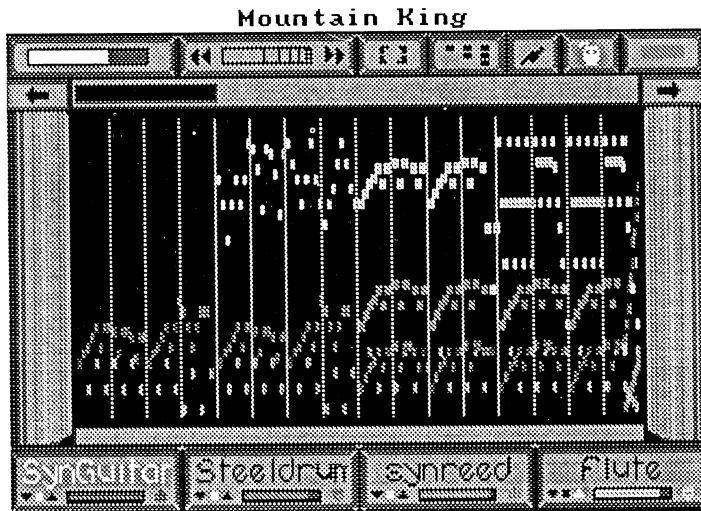
Instant Music. For the musical novice, the easiest way to compose Amiga music for video is with *Instant Music* from Electronic Arts. This non-traditional music composing tool lets you draw rhythms, melodies, and harmonies on the screen with the

mouse, while artificial intelligence routines keep you from making a musical mistake.

Instant Music doesn't use standard music notation—you won't see a staff or a note anywhere. The colorful musical patterns you draw, as illustrated in Figure 8-5 (that's *Instant Music's* version of "Hall of the Mountain King" by Edvard Grieg), are kept within musical bounds set by the kind of music you choose. You can choose from several dozen songs in a variety of musical styles on the *Instant Music* disk or create your own from scratch. With the program in control, you can play along with the song on the mouse (a process called "mousejamming") in any of four instruments, without getting out of tempo or key. Chords (limited to four notes or less) are set automatically according to the position of the mouse on the screen; you can also create short phrases and cut and paste them anywhere on the screen. Quick drawing tools are provided for extending a musical line across the screen or for creating short, repetitive phrases. The score automatically plays over and over again as long as you want it to, with each repetition lasting no more than 16 measures. You can endlessly alter each instrument, however, while the others continue chugging on underneath.

Instant Music also functions as a good introduction to the way samples and scores are handled on the Amiga. For example, you

Figure 8-5. *Instant Music*



can easily see that the Amiga has only four voices available (the instrument names at the bottom of the screen) and that each voice can be altered in pitch and volume. You can also see that instrument sounds (samples) are stored separately from score files, and that different samples can be used to play the same musical line.

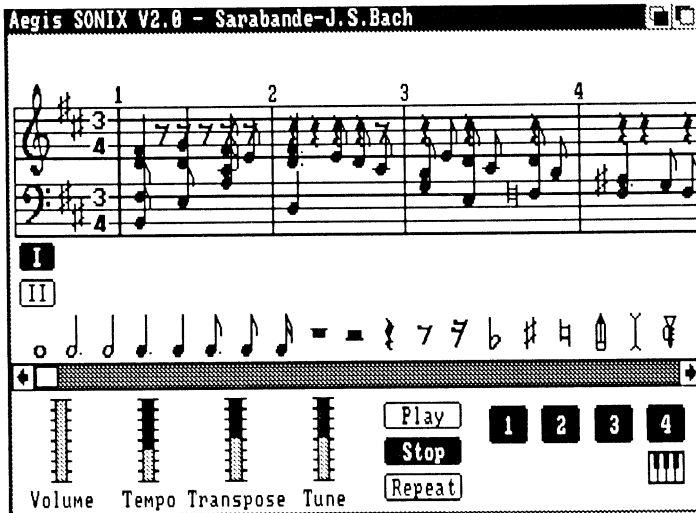
Scoring a video with *Instant Music* is really pretty easy. Play your video on a VCR while playing along on *Instant Music*, using the mouse to tailor the music to important points in the narrative of the video. *Instant Music* saves you from making too many mistakes. Put the score you've created on disk, then sync up the beginning of the video with the *Instant Music* score and simply audio dub it from the Amiga to your VCR while the video is playing. Or, if the score is too long to save on a disk, record it straight to an ATR and dub from that to the VCR as described under audio dubbing, above. Electronic Arts sells a variety of *Instant Music* templates—rock, jazz, and so on—with which you can craft your own musical creations.

Sonix. *Instant Music* is easy and fun to use, but it has obvious limitations that make it unsuitable for more capable musicians. Aegis's *Sonix* is a higher-level music program that doesn't create complete music instantly, but does offer far greater flexibility in a musically familiar format. While it takes some musical skill to operate (the *Sonix* manual acknowledges this by beginning with an entire section on music theory), you can really write and play musical scores in the traditional manner while still having digital music tools at your command.

Sonix is really three interlinked programs, one to compose scores by editing notes on a staff (Figure 8-6; that's Bach's "Sarabande"); one to modify the characteristics of instruments or create new ones (Figure 8-7); and one that allows you to play the Amiga keyboard like a piano or synthesizer keyboard (Figure 8-8).

When you load a song into the Score screen, it appears in standard musical notation, unlike *Instant Music*'s rhythm graphs. To edit or compose a new score, simply paste notes from the note menu onto the staff; you can easily change signatures, move to another octave, and do transpositions with other menu and gadget options. As with other Amiga music programs, up to four voices or instruments are available at once (this puts an obvious limit on the complexity of orchestrations you can create—no symphonic scores, for example).

Figure 8-6. Sonix Score Screen



The Keyboard screen can be played by hitting the labeled keys on the Amiga keyboard. Unlabeled keys can be given pitch names by selecting the key and then choosing a key from the piano keyboard at the bottom of the screen. In the same way, you can completely rearrange the pitch assignments, or assign entirely new ones to every key. Touch typists who also play the piano are

Figure 8-7. Sonix Instruments Screen

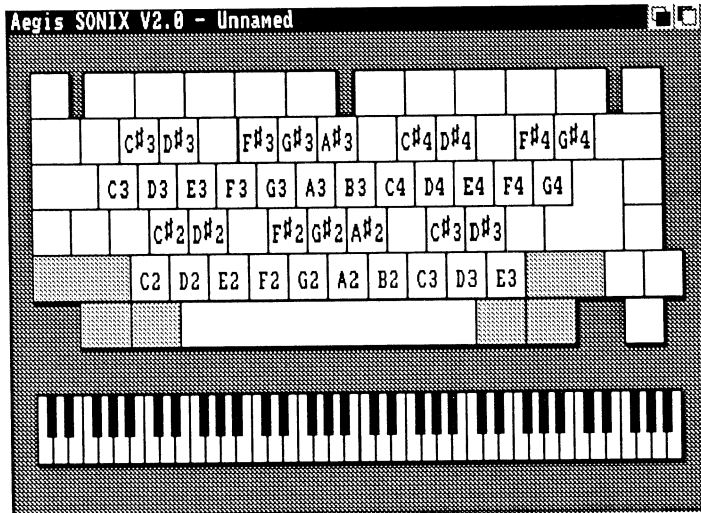
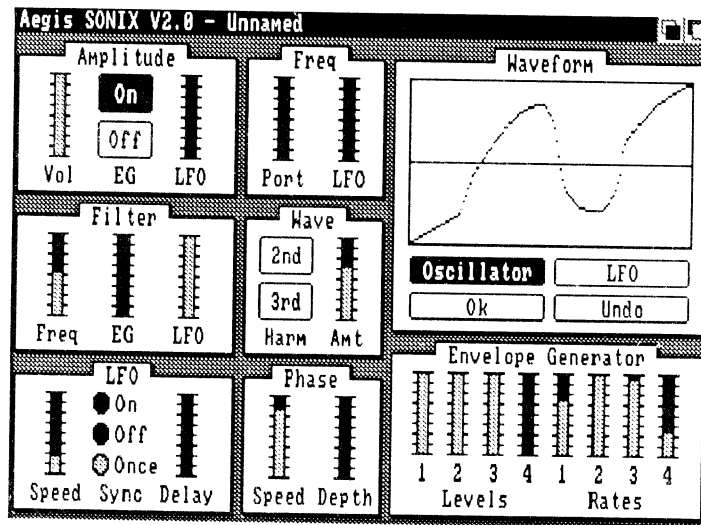


Figure 8-8. Sonix Keyboard Screen

especially likely to get confused with this arrangement, but it is workable. The keyboard is always active, so you can play it in any screen, even if a score is already playing (so you can jam with J. B. S. Bach, if you want). You may have to turn off one of the voices in the score to give the keyboard a voice to play with. One shortcoming of the program is that it won't automatically put notes up on the screen that correspond with the notes you're playing on the keyboard. Other music programs, such as *Deluxe Music Construction Set* (Electronic Arts), do offer that capability.

The Instrument screen provides several tools for tailoring sounds and constitutes an education in digital sound construction all by itself. *Sonix* distinguishes among synthesized sounds created with the Amiga sound chip; sampled sounds; and imported IFF samples. Synthesized sounds are represented as analog waveforms—sine waves, square waves, and so on—that can be redrawn with the mouse or modified with sliders to control the amplitude, frequency, phase, and other wave characteristics. Samples have fewer parameters to set, because their characteristics are determined by the sample. Imported IFF samples can't be modified at all.

Using the instrument tools, an infinite number of original instruments and sound effects can be created and played on the Amiga's keyboard. Among the instruments included in *Sonix* are

several synth and electric piano samples and a snare drum sample that can be used to create everything from explosions, firecrackers, and gunshots to faceslaps, knucklecracks, and fingersnaps (good for kung fu videos and Three Stooges knockoffs). Special synth routines give *Sonix*'s instruments particular depth; they sound more like real instruments than the ones in *Instant Music*.

Sonix can be used to score a video in much the same way as the *Instant Music* method described above; just run the video and watch it as you play the *Sonix* keyboard. Unless you're an experienced musician, you'll find it hard to create effective scores with *Sonix* this way, although it works fine for sound effects. If you make a mistake, you have to go back and edit, or even start all over again. Instead, you're more likely to use a program like *Sonix* to compose musical themes in the traditional way and put them on audiotape for mixing in audio post.

Sound File Formats. Amiga sound programs do not all share a common file format, as is the case among Amiga graphics programs. Electronic Arts uses an IFF sound file called SMUS (*simple music*), which contains a complete musical score but not samples or instruments. The IFF INS1 (*instrument 1*) format is for synthesized instruments, and IFF 8SVX (*8-bit sampled voice*) files are for sound samples, which can also be used as instrument sounds. Other programs may not use these formats. *Sonix*, for example, prefers the RFF sample file format (Riley File Format, an extension of IFF developed by Mark Riley, the programmer of *Sonix*) samples not 8SVX. These can't be read in their entirety by Electronic Arts products.

Aegis and Electronic Arts offer integrated lines of products that make it easy to integrate video with a variety of sound files. The Aegis production program *Lights, Camera, Action!*, for example, accepts *Sonix* scores and will play them in conjunction with ANIMs and slideshows. Electronic Arts's *Deluxe Video* reads SMUS, INS1, and 8SVX files from *Deluxe Music Construction Set* and *Instant Music*. In both cases, you can use tools within the production programs to time the playing of scores down to the frame; the *Deluxe Video* interface is particularly elegant. If you are willing to accept the limitations of these programs, you at least can be sure of having a complete environment for linking audio and video.

A wide variety of scores and instruments are available for these and other programs in the public domain and from the developers themselves, so with a little searching you probably can find the music, instrument, or sound you want, readymade, in the right file format, waiting for you to use it.

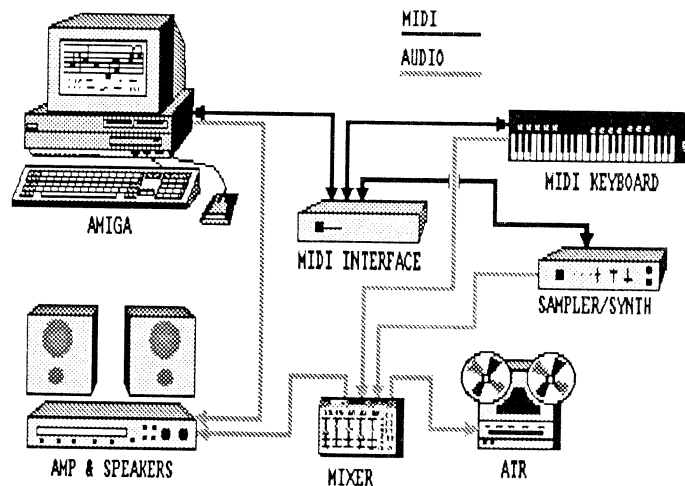
Amazing MIDI

For the ultimate in DTV audio sophistication, consider investing in a *MIDI* music system for your Amiga. MIDI, the Musical Instrument Digital Interface, is a language and set of protocols that allow MIDI-compatible instruments to talk to one another.

Your Amiga can easily become the center of a MIDI system by attaching a MIDI interface to the serial port, then linking other MIDI devices to the interface, as in Figure 8-9. Once your Amiga has been MIDI-ized, you can play MIDI music on a MIDI instrument and see the notes appear on the Amiga screen, with the proper software. Or you can create a sound with the Amiga and play that sound on a MIDI keyboard. Any MIDI interface offering multiple MIDI channels and MIDI in, out, and through should meet your needs for some time to come.

After the Amiga and a MIDI interface, a MIDI keyboard is the most important element in a MIDI system. Some programs allow you to play the computer keyboard like a music keyboard,

Figure 8-9. Amiga MIDI System



but this is definitely not recommended, even for nonmusicians. Casio's CZ-101 (available from Casio, 57 Mt. Pleasant Avenue, Denver, New Jersey 07801; telephone (201) 361-5400; list price \$499) is one of the least-expensive MIDI keyboards; you can move up from there with keyboards from Casio, Roland, Yamaha, Korg, Ensoniq, Kawai, and other manufacturers.

Keyboards may also contain their own samplers and synthesizers; the more capable the keyboard, the more it will contribute to your music. Of course, you can play any MIDI instrument, not just a keyboard; it's now possible to outfit nearly any brass, string, percussion, and wind instrument as a MIDI device—possibly even your voice!

MIDI Software. There are several types of software for making MIDI music:

- *Sequencers*, for controlling the sound coming from other MIDI devices.
- *Synthesizers*, usually called synths, for creating original sounds and music.
- *Drum synthesizers*, for automated percussive effects.
- *Note editors*, for composing, editing, transcribing, and playing musical scores.
- *Patch editor/librarians*, for linking together compatible audio equipment (a *patch* is a connection between two or more tracks or sources of audio). A patch editor is specific to the particular MIDI instrument linked with it.

Most Amiga music software is MIDI-compatible—*Sonix* is, for example. But if you're really serious about MIDI, and you already have some MIDI components, you need a MIDI sequencer. While there are several excellent sequencers for the Amiga, such as *ProMIDI Studio* (Mimetics) and *Dynamic Studio* (New Wave), the KCS (Keyboard Controlled Sequencer) sequencer/master editor from Dr. T's is considered by many musicians to be one of the most comprehensive and professional. (Dr. T's software is also the most complex and expensive, but power has its price.) KCS can handle up to 48 tracks, 16 simultaneous songs, and virtually unlimited sequences. It does not conform closely to the standard Amiga interface, however—no pull-down menus, for example—so KCS may be too forbidding for you. However, there is an entry-level version, *MIDI Recording Studio*, that is less expensive,

easier to learn, and fully compatible with KCS. In addition, Dr. T's offers other parts of a modular MIDI music software system, including a patch editor-librarian for your keyboard; *The Copyist III*, a note editor-printing utility for sheet music and the only current Amiga software that gives you PostScript-formatted scores (using Adobe's Sonata font); a drum synth; and disks of additional sounds and voices for a variety of keyboards.

New Wave's *Dynamic Drums* is the best drum synthesizer for the Amiga, offering 100 drum and percussion samples, onscreen pattern editing, and full MIDI compatibility. A neat little utility is *MidiVU*, a desk accessory that records one real-time track from any MIDI source, so you can cook whenever the inspiration hits.

Tips on DTV Scoring

Music adds emotional impact to any production—if the music is appropriate and correctly handled. Whether you are creating your own score or getting music from somewhere else, make sure it fits the program material; the wrong musical ambience can cripple an otherwise effective program. It doesn't make much sense to use a delicate piano sonata to score a video about aliens attacking Miami (unless you're as sure of yourself as the film director Stanley Kubrick, who could put the "Blue Danube Waltz" in outer space and make it sound right). Appropriate music, on the other hand, can instantly establish the location, period, and mood of a scene or entire program. An alien-invaders video scored with electronic thriller music, or the soundtrack of a 1950s sci-fi film, or a parody of the "Miami Vice" score, would press the right buttons with certain segments of your audience, but perhaps not with others—be aware of what your prospective audience is likely to expect and how they'll respond. Even animation sparks viewer expectations when it comes to sound and music—most of us have the entire musical library of the Warner Brothers' cartoons stashed somewhere in memory. Choosing music is not an issue for music videos, of course, where the visuals function primarily as illustrations for the song.

Knowing when to use music is as important as knowing what music to use. Traditionally, music is added to a program at the beginning, end, and at dramatic points in-between. Music can lead you into a situation, foreshadow an event, recall an event that happened earlier in the narrative, or shock you, as directors of thrillers often try to do. Characters and locations in the pro-

gram can have their own themes, which can be used to add layers of interpretation to dramatic events. One thing the music should not do is overpower or contradict the video. In a training tape, a powerful theme played while the instructor is explaining the workings of an automatic milling machine would work counter to the purpose of the scene, and invite laughter rather than learning. The same cautions apply to the use of sound effects, especially laugh and applause tracks. If you must use these, add them sparingly and consistently, with sensitivity to the context of each scene.

Matching Sound and Music. One of the main advantages to synthesizing music on the Amiga is you can stretch or squash it to fit a particular length of video. If the video is 11.5 seconds long but your Amiga music is 13 seconds long, it is simplicity itself to use your sequencer to change the tempo of the piece to run slightly faster, with or without changing the pitch. You can also loop a short piece of music to play over and over again during a program, or chop up a long piece and use only parts of it.

Things get more complicated when you want to compose music and sound to match video events exactly—for example, if you want to place thriller music and tire squeals in just the right places during a car chase scene. For sound effects, you can laboriously audio dub in the effects on your VCR, finding the right video frame in your edited version and inserting the matching audio. Musical scoring can't be done that way, because the music has to flow as a whole as well as hit a beat on the right events. Some composers just write an appropriate piece to the correct length without worrying about matching the beat with events on the screen. This approach is adequate for documentaries, instructional videos, and other programs where music with a strong beat isn't necessary or appropriate, but results in lackluster scoring for drama, love scenes, and action sequences. Others write music that is heavily percussive, so at least some events will hit on a beat. Low budget action dramas are often scored that way. A skillful musician can watch the video and play along with it on the Amiga or keyboard, hitting beats as needed and adding more tracks and effects once the main framework of the score has been laid out. When you use *Instant Music* or another program to play along with your video, you're following the same procedure.

Professional film and video composers can't take shortcuts, however; they need to know just what video frames contain what

action, so they can compose the soundtrack to match those frames. For that, you really need SMPTE time code—a subject we'll get into in the next chapter. For now, keep in mind that both video and audio tape can be imprinted with time code, that MIDI and SMPTE can be synchronized, and a SMPTE-MIDI music system will let you score video easier and in less time than any other method.

Scoring Animation. Traditionally, synching sound with animation has been one of the animator's biggest headaches, especially for animated characters who speak on screen. The main problem is figuring out what the character's mouth should be doing in any frame to give a believable impression of speech. The speech is usually recorded first, and then broken down by phonemes into frame-length segments $1/30$ or $1/15$ of a second long. The animator draws the mouth making the proper shape for the phoneme associated with each frame. You can tell this is hard work, because many cheap Saturday morning cartoons hardly bother to make speech look realistic; mouth movements of the characters are generic and could be saying almost anything. Also note that characters rarely talk and move at the same time; it's even harder to get speech and realistic body movement to work together.

With the Amiga, you can do better. Some DTV animation programs make it easy to sync sound. Broderbund's *Fantavision* and Electronic Arts' *Deluxe Video*, for example, come with built-in sounds that you can add frame by frame to animations. *Fantavision*, which as you'll recall from Chapter 7 is a low-cost tweening animation program, contains a sound effects library that includes a variety of animal noises, bug squeaks, laser blasts, and directional sounds—"up," "down," "squash," and so on; you can customize any sound with the help of mouse-alterable controls for volume, balance, echo, frequency, duration, and looping. Sounds can be attached easily to any key frame, and then tweened to the next key frame. Here's an example of how *Fantavision* handles sound:

1. Create an object—we'll use a bug shape—with the object editing tools.
2. Place the bug to the left side of the screen in the current frame, which is key frame 1.
3. Create a new key frame (key frame 2) and move the bug all

the way to the right of the screen. Set the number of tweens between the two key frames. Play the animation to see if the bug will crawl smoothly across the screen as the program automatically creates all the tweens.

4. Now go back to key frame 1 and select one of the bug sounds from the sound menu. Set the balance all the way to the left. Go to frame 2 and set the balance all the way to the right.
5. When you play the animation through a stereo monitor or amplifier, the sound will follow the bug as it crawls from left to right.

Photon Video *Cel Animator* from Microillusions takes another approach, closer to the traditional method. *Cel Animator* basically does all the spadework of analyzing sounds and assigning them to frames.

1. First, create a blank animation sequence in *Cel Animator's* pencil test mode that is at least as long as the prerecorded speech. A short phrase such as "Time for animation!" might take about two seconds to say—that's 60 frames at 30 fps.
2. Create an Amiga sound sample file with a sound digitizer.
3. Load the sample file into *Cel Animator*. Use the sound-sync tools to begin the sound at a specified frame.
4. Play each frame to hear the portion of the sample "attached" to that frame. Type the phoneme for each frame somewhere on the frame, then print out the frames in a *Cel Animator* "exposure sheet" (a small representation of each frame arranged in storyboard form).
5. Now for the actual animation: Draw the character's mouth in each frame so that it appears to make the proper sound. Use the phoneme on each frame for reference, or look at the exposure sheet.
6. When you play back the animation, the mouth should move in perfect synchronization with the sound.

If you've worked through the book this far, you have the skills to plan, shoot, edit, embellish, animate, and score a dynamite desktop video. What will you do with it now? The ultimate aspiration is to get it on TV—and that's what the next chapter is all about.

Chapter 9

Stepping Up to Broadcast

Every serious Amiga DTV producer harbors the ambition, perhaps secret and unexpressed, to see his or her work splashed across the screens of a hundred million homes. Well, it can and has been done. Amiga artists have created special effects for “Max Headroom,” “Amazing Stories,” and “TV 101,” among other TV series. MTV has been running at least one flashy animated spot that is entirely Amiga-generated; Amiga animation (including the famous “Juggler” by Eric Graham, originator of *Sculpt 3D*) appears in several music videos. Making it to the big time, however, means stepping up to the arena of broadcast video and meeting the broadcast requirements of high video quality and awesomely deep pockets.

This chapter is not meant as an exhaustive discussion of big-time video production and post-production; that would take several books to cover (some useful guides are listed in Appendix A). It will introduce you to some of the methods and equipment currently used in broadcast video, and give you some tips on how to proceed when you’re ready to take the big step.

What Broadcast-Quality Really Means

What’s meant by broadcast video? In Chapter 2, you learned about the NTSC standard for color video, RS-170A. The narrowest definition of broadcast video is that it meets every NTSC and RS-170A parameter. The only way you can really tell if a video signal meets RS-170A is by running the signal through a waveform monitor and a vectorscope while referring to the published specifications. That, of course, is what broadcast professionals do.

A more general definition of broadcast video has to include less technical, more visible criteria, such as

- a stable, jitter-free picture
- sharp-edged, clear colors without excessive noise or crawl
- a strong signal suitable for genlocking and control track or time code editing

Practically speaking, if you can run your video through broadcast equipment without the need for amplification or processing, and get something that looks just like regular broadcast TV, your signal is broadcast quality.

Beyond signal quality, the production values of broadcast video are also high. Scenes are properly framed and lit; colors are consistent throughout the program; edits are clean and noise-free; sound is not just audible, but clear, strong, and perfectly in sync; narrative continuity is unbroken. To achieve this level of quality takes good equipment and the skills to use it.

When to Go Broadcast—and When Not To. Why go broadcast at all? It's really a matter of professionalism. If you don't plan to ever show your work on TV or to video professionals, it would be a waste of time, money, and resources to attempt to meet broadcast standards. All the typical video hobbyist, educator, business DTV producer, or video artist needs is a few DTV programs and a decent genlock to get watchable video out of the Amiga and onto a consumer VCR. You may even prefer the somewhat funky look of consumer or industrial video; many DTV artists do, making a silk purse out of a sow's ear.

The look and feel of broadcast only becomes important when your program will be on TV; when you want to impress video pros or others who demand professional-level quality; or when you absolutely need an effect, such as a dissolve between tapes played on two VCRs, that can't be obtained with current Amiga DTV technology. It's worth thinking twice before setting your cap for broadcast, because it can be difficult and expensive to satisfy real video snobs who may only accept the video coming out of the networks as being truly up to broadcast specs.

The Amiga and Broadcast

It's a basic fact of life in the Amiga DTV world: the video you can create with most DTV products doesn't measure up to the techni-

cal specs that professional broadcast programming requires. This applies not only to inexpensive consumer video equipment, but to the output of the Amiga itself.

As one observer of the DTV scene has put it, computer manufacturers have been rowing away from NTSC for several years, searching for the clear, clean land of RGB display. Now, looking back, they see the island of video and realize that they have to go there. That means a lot of painful reevaluation of what computer graphics should be like and to what standards they should adhere. Meanwhile, the broadcast video community is intrigued by the power and cost-effectiveness of personal computers such as the Amiga, but it looks rather scornfully at the machines themselves, waiting for computer makers to come to them.

The funny thing is, NTSC composite video as a standard for the display of visual images is generally inferior to the RGB method used in displaying computer graphics—try to use your TV as a monitor for word processing, and you'll immediately see the truth of that for yourself. NTSC (an acronym that insiders jokingly claim means "Never The Same Color") is a jerrybuilt system that suffers from overcomplexity and lack of stability. Nonetheless, it has the weight of history (and hundreds of millions of color TV sets and VCRs) behind it, so computer makers, including Commodore, have to make accommodations.

Commodore had the right idea when it brought out the original Amiga 1000. The A1000 had a built-in composite video out jack; the video that came out wasn't great, certainly not RS-170A, but at least you could play Amiga graphics on your TV. Also, a first in a mass-market computer, the Amiga was easily genlockable. Even though Commodore's own genlocks, the A1300 and A2300, are hardly broadcast quality, they did convincingly demonstrate that the Amiga and video belonged together. Instead of improving the video output of later Amigas, however, Commodore has inexplicably removed composite-out capability from the A500, A2000, and A2500, hampering the fledgling DTV industry just as it was ready to come out of the nest.

As for third-party developers, most of them still have not grasped the possibility that a low-end computer really can be used in a professional setting, and so aren't making products that measure up to professional requirements. To take just one example, several graphics products from Electronic Arts, a company that otherwise is firmly committed to the development of the

desktop video market, still don't offer an overscan mode extreme enough to fill the entire visible screen on a standard TV. This makes it impossible to genlock a full screen graphic from, say, the current version of *Deluxe Productions* over live video without seeing slivers of video peeking out around the edges of the graphic.

This doesn't mean it's impossible to use your Amiga to create broadcast video, just that at this stage in the game it definitely requires a sizeable investment in hardware, and being picky about the right software, to get truly broadcastable results. Let's take a look at what's involved.

Amiga Graphics for Broadcast

There are a few important steps to take when designing Amiga graphics to make sure they're the best they can be before you put them on tape:

- Use an interlaced mode with extreme overscan. HAM overscan interlace provides graphics that give the closest match to the look of video, but for simple charts and other graphics that don't require a lot of colors, you can equally well use hi-res overscan. Use antialiasing or smoothing, if available, to cut the apparent jaggedness of diagonals and curves in graphics created with paint programs.
- As mentioned in Chapter 6, don't use highly saturated colors that overstress NTSC's color handling method. Even the best processing amplifier can't completely eliminate color noise from a pure Amiga red or purple. Upcoming Amiga DTV programs will provide special palettes specially adapted to the limitations of NTSC. You can even design such a palette yourself using *Deluxe Paint III* or one of the other paint programs.
- Use the best available genlock/encoder. Graphics recorded through an inexpensive genlock just won't look that good. Genlock/encoders that claim broadcast output include the Magni, the Neriki, the RM-2, the GEN/ONE, the GenKey, and the SuperGen (see Appendix A). If you can't afford one of the \$2,000 genlocks, perhaps you can find someone who has one and borrow or rent it. User groups often have such equipment for rental or can put you in touch with someone who does. Or

your post-production facility may have an Amiga already equipped with a top-notch genlock (see below).

- Record your graphics directly to a quality tape format. That means S-VHS or ED-Beta at a minimum; better to use one of the broadcast one-half-inch formats (MII or Betacam) or three-quarter-inch, since many post-production facilities still don't have the capability to handle the one-half-inch superformats. A cost-effective practice is to use your own consumer VCR to work out the bugs in your desktop production, then use a three-quarter-inch VCR to record the final product. You can rent a three-quarter-inch machine for \$150–\$200 per diem (don't forget the proper cables and tape stock), or bring your Amiga to a local access or not-for-profit production facility. If you'll be genlocking Amiga graphics over another video source, make sure the incoming video is high-quality—from a broadcast camera, a good superformat, or a three-quarter-inch VCR.

Broadcast Production

If your DTV production is not simply coming out of the Amiga but will involve field or studio production, you'll need to dramatically increase your hardware requirements. Cameras and decks should be up to broadcast specs, and that means higher rental costs—more money up front from your client or yourself. You'll want to establish a relationship with a video rental company, many of which offer stage and post-production facilities as well. For first-time renters, many companies require an equipment insurance policy and/or a deposit equal to the cost of the equipment (which might amount to tens of thousands of dollars). It helps to establish a record with the company by renting small items first.

A broadcast camera, such as a high-end Sony or Ikegami, is likely to be the most expensive single item on a shoot. A Betacam camcorder outfitted for ENG (Electronic News Gathering) may cost up to \$30,000, with standalone ENG cameras running in the neighborhood of \$10,000 to \$20,000. Fully loaded studio cams can cost \$50,000 or more. (The ones used by the networks are worth in excess of \$100,000, not counting the hydraulic pedestals!) Rental costs are around \$500–\$750 per diem for an ENG camera, \$750–\$1000 for a camcorder.

Portable broadcast VCRs are less expensive, but hardly cheap. Sony's top-of-the-line, portable three-quarter-inch ma-

chine, the BVU-150SP, costs about \$7,000, or perhaps \$250–300 per diem rental. Of course, you may need to rent all kinds of other equipment, from color monitors to lights, from ATRs and mikes to switchers and SEGs.

All this price-quoting is meant to suggest that you may be better off hiring someone to do the shooting for you. As mentioned, broadcast production values are exacting. Camera movement, lighting, and audio recording must be professional; so should set design, makeup, and costuming. Whenever possible, professional talent should be behind and in front of the cameras. A DTV producer without previous broadcast experience should hand the actual taping over to a small production company while you kibbitz from the sidelines. Here are a few suggestions for working with a production company:

- Choose a production company carefully. Don't investigate just one, try several. Get recommendations from the company's other clients, and call at least one client. Look at the company's demo tape to see what they consider good work, and whether they've worked on projects similar to yours.
- Make sure the production company understands the level of quality you're looking for. Companies will take technical shortcuts if you let them, so set up several review times during the production stage when you can monitor how things are being done. Get it in writing.
- You don't have to take the first budget the company submits to you—negotiation is everything—but don't expect high production values to come cheap.
- Draw up a detailed contract that defines exactly what the production company is and is not responsible for, and who will pay for what. Make sure the company is bonded and properly insured.
- Be prepared. Provide a script, storyboard, and prop/effects list well in advance of the production dates. Listen to the recommendations of the production director, but remember, it's your show.

- It's worthwhile to try to instill some of your own enthusiasm for the program into the people working with you. A "special" project will get a little more attention than "just another commercial."
- Finally, make sure the production director understands that you'll be visiting the production site. You won't interfere with the director (unless you see something really bad going on), but you will be watching to see that the production is going as planned. Almost always, the director wants and needs you there, because you're the one with the contacts, and with the vision that's driving the whole endeavor.

If you're willing to do more work yourself but still want help with your production, you may get more mileage from your budget by using a not-for-profit production facility. Often such facilities can offer a sound stage with broadcast cameras and decks, audio and video rentals, and student interns to help you set up, all at much less than the cost of a professional production house. The equipment might not be brand new, but it's still likely to be better than anything you can afford on your own. Also, you may meet other Amiga DTV producers there.

SMPTE Time Code

One thing you should do is put *time code* on all your raw footage, so you can use broadcast post-production methods. Time code has already been mentioned several times in this book; here's the promised explanation of time code's nature and use.

In Chapters 3 and 5 we talked about the control track on a tape, the series of pulses that tag each frame. Most lower-cost insert editing systems read the control track as a way of locating a specific frame for editing. But there is a better way of tagging and locating frames for editing, and that's *time code*, or *TC*. In essence, time code is a digital signal recorded on a tape that identifies every frame with its own number. The Society of Motion Picture and Television Engineers (SMPTE, pronounced "Semp-tee") has set the technical specifications for time code, so you'll often hear it referred to as "SMPTE time code," or even just "SMPTE."

How Time Code Works. The frames on a time-coded tape are numbered sequentially from the first to the last frame on the tape

(to a limit of 12 or 24 hours) by hour, minute, second, and frame. The first frame is usually numbered 01:00:00:00, or one hour, zero minutes, zero seconds, and zero frames. (Although you can start the tape at zero hours, it causes problems when backspacing for the first edit. The hour you start on has no other practical effect.)

Drop frame time code is a variant time coding method in which the occasional frame number is dropped to make the time code exactly match the real time as measured by an external clock. (To be precise, drop-frame TC skips two frames a minute except for every tenth minute.) Non-drop-frame time code gradually gets out of synch with an external clock because NTSC actually runs slightly faster than the clock time of 60 cycles/fields per second. Actually, NTSC runs at 59.94 hertz, which means there are slightly more than 60 fields in a second, although the time code counts only 60 fields. (Why does NTSC run at 59.94 hertz, and not 60? Don't ask, but it's true.) A non-drop-frame program will end up being four seconds longer for each hour than is indicated by the time code. The upshot is, having the time code match external clock time is a big convenience, so choose drop-frame for computerized editing if you have a choice.

A *time code generator* is needed to impress the code onto a track on the tape. (The process of recording time code is called *striping*.) During the broadcast production stage, time code can and should be added to each tape with a portable time code generator attached to each VCR, with each time code generator in sync and sending the same number to each VCR. The time code can be recorded onto the vertical blanking interval between fields (this is *Vertical Interval Time Code*, or VITC) or on a spare track, usually one of the audio tracks of the tape; this type is called longitudinal time code, or LTC. If BVU-type three-quarter-inch VCRs are used, time code is recorded on a special *address track*. Since both VITC and LTC have their drawbacks, many editors like to have both kinds on a tape.

Time code should also be striped onto the master editing tape as it's being blacked, and on any ATRs being used to record wild sound. Nagra ATRs, among others, are set up to record time code. You can always add time code to raw footage or wild audio in post, but it's more efficient and cheaper to do it in the production stage.

A *time code reader* makes it possible to see the time code, which otherwise is invisible. Usually, time code generators and

readers are built into the same machine. It's also possible to "burn" the time code on a working copy of the raw footage so it's always visible. Tapes with visible time code are called *window dupes*. Window dupes are very useful during the logging stage, making it possible to log by time code without having to use a time code reader.

Advantages of Time Code. The advantages of time code in post-production are many. It's possible to skip a control track pulse and make a sloppy edit with a control track editing system, but time code makes for totally accurate insert editing, since the number on the frame never changes. You can always see just where you are in the tape by checking the time code number, which is very convenient for handling the raw footage during off-line editing. Just use the time code number to identify the precise location of each shot in the edit log, as shown in the discussion on logging in Chapter 5.

With computerized time-code editing systems, you can go directly to any frame on any tape by simply entering the right code. And you can go to the same frame, or perform the same edit, as many times as you like with perfect accuracy. The system logs scenes with just a few keystrokes and keeps track of the time code of all offline edits. An *Edit Decision List* (EDL) is prepared that specifies each edit by time code number; an online editing computer then auto-assembles the entire production from the EDL. Audio as well as video recorders can use time code, meaning you can easily sync an audio tape to video for precise audio mastering.

Until recently, the only place you'd find time code was on a pro shoot or in a professional facility. Now consumer video equipment manufacturers are starting to offer low-cost (under \$500) time code generators and readers, so time code can be used in at-home DTV production as well. Striping time code onto work tapes with one of these units enables you to do much off-line editing work at your convenience. This can save hundreds or thousands of dollars in edit room charges, and make the time you spend in the edit room more productive. Several companies are planning to introduce time code readers and EDL software for the Amiga, so you can use your own equipment to do basic offline editing.

MTC. For the last two years or so, SMPTE and MIDI have been going steady. A new time code standard, MTC (MIDI Time

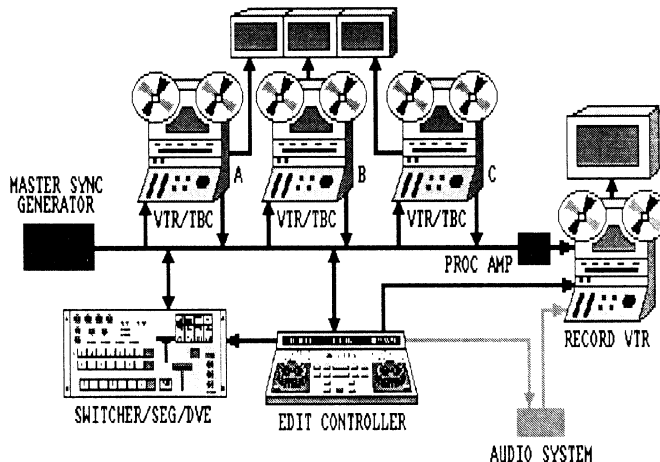
Code) combines features of SMPTE and MIDI into one coding system. An MTC reader reads SMPTE time code off your video, converts it to MTC, and sends to the Amiga via a MIDI interface. MTC-compatible applications can then direct MIDI devices to create music and sounds exactly in sync with video. For example, you could jot down the SMPTE numbers of frames you want to coincide with sound effects (the frames or events are called *hits*, and the list is a *hit list*). An MTC-compatible sequencer can watch for the frames in the hit list as the video plays and, when a hit comes up, command a synthesizer to play just the right sound.

Professional film and video composers already know that MTC is the wave of the future. As time goes on, Amiga music programs should begin to support MTC, providing one more link from Amiga DTV to the world of professional video. Among Amiga sequencers, *Music-X* (Microillusions) is one that already supports SMPTE with an optional time code reader.

Broadcast Post-Production

Broadcast post-production, like broadcast production, involves an entirely higher level of hardware, and operating skills to go with it. In almost all cases, you'll be doing post in a professional facility, with the aid of a videotape editor and sound engineer.

Figure 9-1. Broadcast Editing Bay



The layout of a typical broadcast editing bay is shown in Figure 9-1. As you can see, several specialized pieces of video gear are used in broadcast-level editing. These include:

Master Sync Generator. This box just supplies a steady horizontal and vertical sync to all the video-processing components in the bay, so every component uses the same sync.

Switcher and DVE. All video in the system flows through the switcher, which is used to program wipes, keys, and other effects. Along with the switcher, and used in conjunction with it, is the DVE computer, which, unlike the Amiga, can accept multiple channels of video.

Edit Controller. A computerized edit controller does not actually handle video and audio, but it controls the components that do: the VTRs, VCRs, and ATRs, and often the switcher and DVE as well.

Proc Amp. A *proc amp* (processing amplifier) is the most valuable tool for reconditioning bad video. The proc amp allows precise adjustment of signal levels; brightness and color phase can be corrected at the same time. A good proc amp can help turn video recorded directly from an Amiga with a less-than-broadcast genlock/encoder into video that can be handled by broadcast equipment.

Time Base Corrector. The *time base* of a video signal is the timing of each cyclical signal event—the horizontal and vertical sync pulses, for example. Unfortunately, all VCRs are imperfect mechanical devices that introduce *time base errors*, instabilities and irregularities in the tape's sync pulses, onto recorded material. The time base of one recorded tape is always slightly different than the time base of another recording, even a tape recorded with the same VCR, and that makes it impossible to sync the signal from one VCR with the signal from another—something you need to do if you want to create an effect that involves two taped sources.

A *Time Base Corrector* (TBC) is a device that corrects time-base signal instabilities caused by VCRs during videotape playback, making it possible for two or more VCRs to be in sync. The TBC strips the old sync pulses from the recorded signal and inserts nice, clean, stable sync pulses instead. Most TBCs also include proc amps for sprucing up other parts of the signal, such as the black, video, and chrominance levels.

Each VCR in a multi-deck editing system needs its own TBC; most broadcast VCRs or VTRs have TBCs built in. Figure 9-2 shows the setup for a typical transition effect that requires 2 VTRs with TBCs—an *A/B roll* that involves a superimposition between VTR A and VTR B.

The signal from an Amiga, if it's part of the system, has no time base error and only needs to be sent through a TBC if the TBC incorporates a proc amp. Otherwise, the Amiga output should go through a separate proc amp.

Multitrack Mixer/ATR. A multitrack audio mixer and ATR, time-code compatible, are always part of the editing bay arsenal.

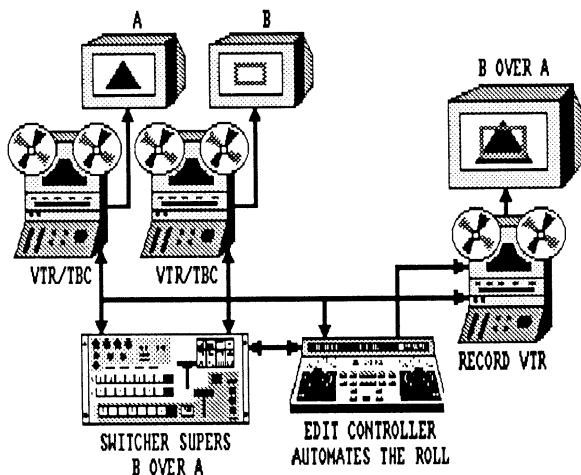
Working with a Post-Production Facility

The system just described should give you a good feel for the complexity of a broadcast editing system. Now that you know you have to hire one, rather than create one yourself, you need to think about what facility to use.

When it comes to working with a post-production facility, preparation is all-important. Lack of foresight will invariably result in unpleasant problems and bad feelings—not to mention a more expensive product.

- First, you should know how much you can spend. Fully equipped edit rooms are very expensive, running several hundred dollars an hour for the room plus the services of an

Figure 9-2. A/B Roll



editor and a technician. Budget for 30 percent more time than you actually think it will take to edit your production.

- Shop around. Edit room charges can vary greatly. In larger cities, you may find cut-rate, publicly funded facilities that will do the job.
- Make sure the facility has the equipment to handle your production needs—online computerized editing, the right tape formats, the right digital effects machines, the capacity to handle film-to-tape transfers and copy stand work, a 24-track audio mixer, an Amiga, whatever. Draw up a complete post-production outline, then visit the facility before you commit yourself and talk to the facility manager. The better you know your own needs, the more likely you'll find a facility that meets them. Post facilities that use Amigas in-house should be first on your list, since they will have already encountered and solved the signal problems inherent in Amiga graphics. You may be able to just bring in a disk and let the facility transfer your graphics directly to broadcast tape through a high-quality genlock/encoder. At least, they can give you suggestions for revising your video to bring it closer to broadcast specifications.
- Find an editor you can work with comfortably. Remember, you're going to be cooped up with this person in a dark room for many hours at a time. In the edit bay, at least, most editors are easygoing and professional; these are the only personality types who can survive daily contact with anxious, abrasive video producers. A good editor can really improve your project with suggestions based on his or her previous experience. If you don't trust the editor, you probably won't get the benefit of that experience. On the other hand, the final form of the production is ultimately your responsibility, so evaluate your editor's suggestions carefully, especially if they seem to go against your original vision of the piece.
- Do as much as you can before you enter the facility. Put time code on your raw footage during production to save the time and expense of doing it in post. Use copies of the raw footage for logging, or have window dupes made by the production facility; in either case, log the footage thoroughly. Know your ma-

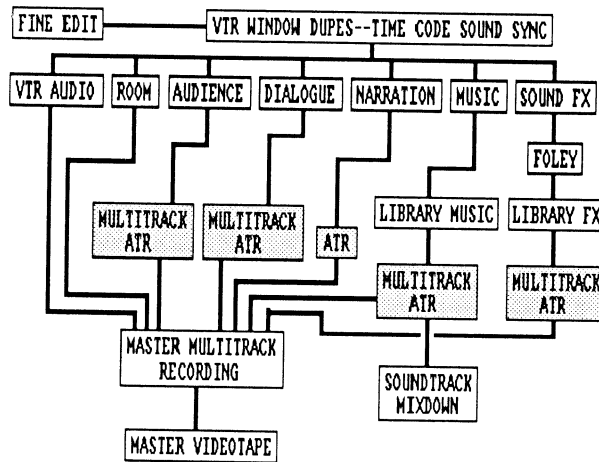
terial backwards and forwards. Consider using or renting an off-line editing system and putting together a rough cut yourself from the window dupes—a control-track editing setup can be rented for \$750–\$1000 a week, against the \$300 to \$500 an hour for online editing. Bring an edit decision list and your entire supply of raw footage and wild sound on audiotape (neatly labeled) to the edit session. Let the facility know in advance what you need in terms of time-coded tape stock, audiotape, and so on; the format(s) you want for the master tape; and whether you need a separate audio master (for distribution as a sound recording, for example—a definite possibility for a music video).

- Work out digital special effects in advance. The Amiga can do a lot of magical things, but DTV effects still can't quite match those possible with dedicated DVE machines like the Quantel, ADO, and Mirage, notably manipulating multiple channels of video in real time. If you decide you need an advanced effect, go over your plan with your editor before the start of editing. You may be able to do a dry run to see how the effect will look. Because digital effects are expensive, review your needs to see if you can't use the Amiga instead—that's the whole point of DTV, after all. Even if the Amiga can't handle it, perhaps you can use Amiga software to create an outline or simpler version of the effect that will give the editor a clear idea of what you're shooting to get.
- Bring one or more associates to the edit session. Your partner will notice continuity or other problems that escape you, and you can spell each other when the edit room gets claustrophobic.

Broadcast Audio Post-Production. All those minor audio imperfections you would normally ignore in the low-budget DTV program—room ambience noise that varies from shot to shot, a low rumble in a street scene, the loss of clear high tones in rerecording, the slight hiss added by the cassette player—can and should be fixed for a broadcast program.

Producing truly high-quality audio for broadcast video can be a complex business, involving several steps and many personnel.

As you might imagine, exact synchronization of the various audio sources is a necessity, and that's only possible with the use

Figure 9-3. Broadcast Audio Post-Production

of SMPTE time code. Broadcast audio production uses multitrack ATRs that accept time code and can be slaved to sophisticated audio edit controllers, some of which can be controlled in turn by video editing equipment. A host of exotic audio processing devices, such as noise gates, expanders, parametric equalizers, limiters, exciters, and filters are employed to tailor each sound to the requirements of the production. Any audio that does not meet exacting standards is entirely replaced with equivalent audio created fresh in post.

The very complexity of the broadcast audio post process definitely requires that you secure the services of a professional sound engineer, who is as much an artist as the video editor. You may also need such specialists as foley artists (who recreate and enhance sound effects for the tape), narrators (usually professional actors), composers and arrangers (to create original music), a conductor and orchestra, and a music librarian (to locate and obtain permission for the use of prerecorded music and other audio). Big audio plans can cost big dollars, so be absolutely sure you really can afford that John Williams-style score for your commercial before you start the ball rolling. At this level, you should have a detailed audio post budget. Discuss your audio needs with your editor at the post facility; he can describe the audio services the facility offers and direct you to sources of additional services, if you need them. Again, it's important to carefully log and label

any audio you've recorded in the production stage, and come to the post sessions with a clear idea of what audio you want.

Breaking into the Big Time

If the road from your desktop to a multimillion-dollar editing bay just seems too long, take heart. Maybe you can convince someone else—say, one of the networks—to bump your masterpiece up to broadcast without your spending a dime and show your program to millions of viewers.

It really all comes down to getting your work before the people who have the power to put it on the air. One of the tried and true ways of doing that is making and cultivating contacts in the business. That may mean joining computer graphics and video organizations; going to video and computer conventions (you can meet helpful contacts at Amiga events, where many people are focused on DTV); taking courses in pro-level video production and/or computer graphics; entering your work in video contests; and even taking a job in a production company or a computer graphics firm. Some places, notably MTV and HBO, have been known to review and use original animations and promotional spots received “over the transom,” that is, unsolicited. So do local cable and PBS stations. But the networks never take the work of lowly unknowns. It makes sense to work your way up the video hierarchy, getting your work shown in local venues, entering competitions (see the list of video competitions in Appendix A), building a base of contacts, and gaining experience and a rep before hitting the big time.

Beyond career building, however, it's the quality of your work that counts. DTV programs that are exciting, engaging, imaginative, and informative will attract attention wherever they are shown. Ironically, fresh and original work may meet as much resistance from broadcast programmers as work that's inept and amateurish—the networks are obviously most interested in the familiar, comfortable, and profitable—but you may find your audience elsewhere. Good work will win out.

Conclusion

This book hardly begins to touch on the possibilities inherent in the Amiga desktop video revolution. DTV technology is moving so fast it's hard to keep up with the latest developments. No

doubt by the time you are finished with this book, there will be new products and new techniques that will change the direction of the field, matching and then exceeding the tools of broadcast TV. Nor have all the possible applications for desktop video been thought of, let alone explored. You and your Amiga can make a major contribution to the field, if you so choose. Good luck!

Appendix A

Desktop Video Resources

Collected here are some of the more important resources for Amiga desktop video. This is not a comprehensive list of all organizations, products, vendors, services, and publications, but merely a selection of useful materials to get you started in your own explorations. Every effort has been made to include the latest information on products, prices, addresses, and phone numbers, but these things change daily, so there may be some discrepancies between the information here and what you find out in the real world.

Associations

Association for Computing Machinery-ACM Siggraph
11 West 42 St.
New York, NY 10036

Association of Independent Video and Filmmakers
625 Broadway, 9th Floor
New York, NY 10012
Dues: \$35.00 per year

Interactive Video Association
P.O. Box 1491
Evanston, IL 60204
(312) 364-5888

National Computer Graphics Association (NCGA)
8401 Arlington Blvd.
Fairfax, VA 22031

Professional Photographers of America
Electronic Creative Imagery Group
1090 Executive Way
Des Plaines, IL 60018

Society of Motion Picture and Television Engineers (SMPTE)
862 Scarsdale Ave.
Scarsdale, NY 10583

Books and Periodicals

Books

- Alton, Stanley R. *Audio in Media*. 2nd ed. Belmont, CA: Wadsworth Publishing, 1986.
- Anderson, Gary H. *Video Editing and Post-Production: A Professional Guide*. 2nd ed. White Plains, NY: Knowledge Industry Publications, 1988.
- Anzovin, Steven. *Using Deluxe Paint, Second Edition*. Greensboro, NC: COMPUTE!, 1989.
- Berryman, Gregg. *Notes on Graphic Design and Visual Communications*. Los Altos, CA: William Kaufmann, 1984.
- Blank, Ben, and Mario R. Garcia. *Professional Video Graphic Design*. New York: Knowledge Industry/Prentice-Hall, 1986.
- Bloom, Mike. *The Amiga*. Microsoft Press, 1987.
- Born, Robert, ed. *Designing for Television: The New Tools*. Tequesta, FL: Broadcast Designers' Association, 1983.
- Dreyfuss, Henry. *Symbol Sourcebook*. New York: Van Nostrand Reinhold, 1984.
- Ennis, Harold E. *Television Broadcasting: Equipment, Systems, Operating Fundamentals*. Indianapolis: Howard W. Sams, 1979.
- Field, Syd. *Screenplay: The Foundations of Screenwriting*. New York: Dell, 1979.
- Finch, Christopher. *Special Effects*. New York: Van Nostrand Reinhold, 1984.
- Fox, David and Michael Waite. *Computer Animation Primer*. New York: McGraw-Hill, 1983.
- Gaskill, Arthur L., and David A. Englande. *How to Shoot a Movie and Video Story: The Technique of Pictorial Continuity*. rev. ed. New York: Morgan and Morgan, 1985.
- Galluzzo, Tony. *Home Video Movies: How to Get the Most from Your Camcorder and VCR*. Greensboro, NC: COMPUTE!, 1987.
- Green, William B. *Digital Image Processing*. New York: Van Nostrand Reinhold, 1983.

- Holden, Alan. *Shapes, Space, and Symmetry*. New York: Columbia University Press, 1971.
- Hubatka, Milton, Fredrick Hull, and Richard W. Sanders. *Audio Sweetening for Film and TV*. Blue Ridge Summit, PA: TAB Books, 1985.
- Itten, Johannes. *The Elements of Color*. Edited by F. Birren. New York: Van Nostrand Reinhold, 1970.
- Jankel, Annabel, and Rocky Morton. *Creative Computer Graphics*. Cambridge, England: Cambridge University Press, 1984.
- Kerlow, Isaac V. and Judson Rosebush. *Computer Graphics for Designers and Artists*. New York: Van Nostrand Reinhold, 1986.
- Kodak Pocket Guide to Video*. New York: Simon and Schuster, 1987.
- Leemon, Sheldon. *Inside Amiga Graphics*. Greensboro, NC: COMPUTE!, 1986.
- LeTourneau, Tom. *Lighting Techniques for Video Production: The Art of Casting Shadows*. White Plains, NY: Knowledge Industry Publications.
- Levitan, Arlan, and Sheldon Leemon. *The AmigaDOS Reference Guide*. Greensboro, NC: COMPUTE!, 1986.
- McNeill, Dan. *COMPUTE!'s Beginner's Guide to the Amiga*. Greensboro, NC: COMPUTE!, 1986.
- Milano, Dominic, ed. *Mind Over MIDI*. Milwaukee: Hal Leonard Books, 1987.
- Peck, Rob. *The Amiga Companion*. Peterborough, NH: IDG Communications, 1988.
- Robinson, Richard. *The Video Primer*. 3rd ed. New York: Putnam, 1983.
- Root, Wells. *Writing the Script: A Practical Guide for Films and Television*. New York: Holt, Rinehart and Winston, 1980.
- Tufte, Edward R. *The Visual Display of Quantitative Information*. Cheshire, CT: Graphics Press, 1983.

Periodicals

Amazing Computing
PiM Publications, Inc.
P.O. Box 869
Fall River, MA 02722
\$24.00 per year

AmigaWorld
IDG Communications/Peterborough, Inc.
80 Elm St.
Peterborough, NH 03458
\$29.97 per year

Annual Official Video Directory & Buyers' Guide

P.O. Box 2740
Palm Springs, CA 92263
(619) 322-3050
\$100.00 per copy
The home video "black book."

Audio-Visual Communications

50 West 23rd St.
New York, NY 10010
\$13.50 per year

AV Video

25550 Hawthorne Blvd.
Suite 314
Torrance, CA 90505
\$18.00 per year

Cinefex

P.O. Box 20027
Riverside, CA 92516
All about special effects for film; has relevance to video as well.

COMPUTE! Magazine

COMPUTE!'s Amiga Resource

324 West Wendover Ave.
Suite 200
Greensboro, NC 27408
Both \$24.00 per year

Computer Graphics World

119 Russell St.
P.O. Box 1112
Littleton, MA 01460
\$42.00 per year

Computer Pictures

2 Village Square West
Clifton, NJ 07011
\$24.00 per year

Electronic Musician

2608 Ninth St.
Berkeley, CA 94710
\$22.00 per year

Studio Systems Journal
P.O. Box 13859
San Luis Obispo, CA 93406
\$12.00 per year

Videography
50 West 23rd St.
New York, NY 10010
\$25.00 per year

Videomaker
381 East 4th St.
Chico, CA 95928
\$15.00 per year

Video Systems
P.O. Box 12912
Overland Park, KS 66212
\$25.00 per year

Video Times
514 West 57th St.
New York, NY 10019
\$10.00 per year

DTV Hardware

Amiga Systems

Amiga 500	\$799.00
Amiga 2000	\$1699.00
Amiga 2500	\$4695.00
1084S Monitor	\$399.95
A501 RAM Expansion Card (for A500)	\$199.95
A1010 External Disk Drive	\$299.95
A2052 2MB Ram Expansion Card (for A2000, A2500)	\$549.95
A2058 8MB Ram Expansion Card (for A2000, A2500)	\$799.95
A2088 MS-DOS Bridgeboard (for A2000, A2500)	\$699.95
A2090A Hard Disk/SCSI Controller (for A2000, A2500)	\$399.00

A2620 68020 Accelerator (for A2000) \$ N/A
 Commodore Business Machines
 1200 Wilson Dr.
 West Chester, PA 19380
 (215) 431-9100
 Additional Amiga peripherals available and forthcoming.

Audio Digitizers

FutureSound (for A1000)	\$179.00
FutureSound (for A500, A2000)	\$119.95
Applied Visions 1 Kendall Square Suite 2200 Cambridge, MA 02139 (617) 494-5417 Parallel-port (with passthrough) digitizer with good software; stereo for A500, A2000.	
Perfect Sound SunRize Industries 3801 Old College Rd. Bryan, TX 77801 (409) 846-1311 Parallel-port (no pass-through) sampler.	\$89.95
Pro Sampler Studio Datel Computers 3430 E. Tropicana Ave., Unit 67 Las Vegas, NV 89121 (702) 454-7700 Sampler and software.	\$119.99
Pro*Sound Designer Precision Incorporated 8404 Sterling St. Suite A Irving, TX 75063 (214) 929-4888 Versatile unit that handles four sounds simultaneously, with a 1–32 kHz frequency response.	\$159.95

SoundScape Sound Sampler \$99.95
Mimetics Corp.
P.O. Box 1560
Cupertino, CA 95015
(408) 741-0117
Mouse-port sampler; mic requires preamp.

Composite Interfaces

A-Video \$49.95
Akron System Development
P.O. Box 6408
Beaumont, TX 77705
(409) 833-2686
RGB to composite for A500 and A2000

C-View I, C-View II \$39.95
C Ltd.
723 East Skinner
Wichita, KS 67211
(316) 276-6322
RGB to composite for monitors and VCRs; C-View II drives CBM 1700
and 1800 monitors and VCRs with separate chroma-luminance in-
puts; NTSC and PAL versions.

520 Video/RF Modulator \$49.00
Commodore Business Machines
1200 Wilson Dr.
West Chester, PA 19380
(215) 431-9100
Composite encoder-RF out for A500.

V-I 500, V-I 2000 \$79.95
Creative Microsystems, Inc.
10110 S.W. Nimbus, #B-1
Portland, OR 97223
(503) 684-9300
Composite, chroma, and luma out for A500 and A2000; \$99.95 each with
RF modulator (for TVs).

Edit/VCR Controllers

AmiLink RGB Video Creations 3944 Florida Blvd. Palm Beach Gardens, FL 33410 (407) 622-0138 Amiga SMPTE edit controller system.	\$1995.00
MediaPhile 8mm Video Production System (with components)	\$5948.00
MediaPhile Super-VHS Video Production System (with components)	\$7191.00
MediaPhile System 1-B (with components)	\$903.00
MediaPhile System II (with components)	\$2828.00
MediaPhile VHS (with components)	\$5592.00
MediaPhile 1.3 System	\$275.00
Interactive Microsystems P.O. Box 1446 Haverhill, MA 01831 (617) 372-0400 Complete 8mm, Super-VHS, or VHS Amiga video systems, with editing.	
Photo Video Transport Controller Microillusions 17408 Chatsworth St. Granada Hills, CA 91344 (800) 522-2041 CA: (818) 360-3715 Interface software for Lyon Lamb MiniVAS and other single-frame controllers.	

Genlock/Encoders

Amigen Mimetics Corp. P.O. Box 1560 Cupertino, CA 95015 (408) 741-0117 Basic genlocker with RCA composite out and RGB passthrough.	\$179.00
---	----------

APPENDIX A

A1300 Genlock	\$299.95
A2300 Genlock	\$399.95
Commodore Business Machines 1200 Wilson Dr. West Chester, PA 19380 (215) 431-9100 Basic genlocks for A1000 and A2000.	
4003RCU	\$499.00
Video Bus/Slot Expansion	\$TBA
Amicore International 154 Grove St. Chicopee, MA 10120 (413) 592-9122 Zorro controller board for Magni genlock; expand A2000 video slot for using Magni and other video boards.	
GEN/ONE	\$895.00
Communications Specialties, Inc. 6090 Jericho Turnpike Commack, NY 11725 (516) 499-0907 Broadcast genlock; Super-VHS compatible.	
GenKey	\$760.00
SciTech Corp. 1450 Northwest 78th Ave. Miami, FL 33126 (305) 591-1620 Broadcast genlock with proc amp, TBC, vertical interval switcher, and keyer.	
Image Master Pro Genlock	\$2195.00
Neriki Computer Graphics PTY Ltd. Distributed by: Compu__Art P.O. Box 712, Victoria Station Montreal, Canada H3Z 2V8 (514) 483-2080 Pro-quality rack-mountable unit with luminance keyer, chroma phase control, and clipper.	

Desktop Video Resources

Magni 4004 Video Graphics System \$1995.00
Magni Systems
9500 S. W. Gemini Dr.
Beaverton, OR 97005
(800) 237-5964
Broadcast genlock/encoder on two Zorro boards for the A2000/A2500;
external controller.

ProGEN \$399.95
Progressive Peripherals and Software, Inc.
464 Kalamath St.
Denver, CO 80204
(303) 825-4144
RS-170A genlocker for all Amigas.

RM-2 \$2995.00
Wollner Associates
3306 Horseman Lane
Falls Church, VA 22042
(703) 533-1236
Top-of-the-line sync-generator and genlock.

SuperGen \$749.95
Digital Creations
1333 Howe Ave.
Suite 208
Sacramento, CA 95825
(916) 344-4825
Broadcast-quality genlock with faders, notch filter, RGB encoder, and
BNC connectors.

MIDI Interfaces

Deluxe MIDI Interface
HyperTek/Silicon Springs
120-1140 Austin Ave.
Coquitlam, British Columbia
Canada V3K 3P5
MIDI in, out, and thru for Amiga 500/1000.

Micro MIDI
Microillusions
17408 Chatsworth St.
Granada Hills, CA 91344
(800) 522-2041
CA: (818) 360-3715
Full-featured MIDI in, out, thru, with serial port pass-through.

MIDI-1	\$79.95
Creative Microsystems, Inc. 10110 S.W. Nimbus, # B-1 Portland, OR 97223 (503) 684-9300 Three selectable out/through ports, MIDI in, sync out, pass through, and software; internal version for A2000.	
MIDI Gold Insider (for A2000, A2500)	\$89.95
MIDI Gold 500 (for A500)	\$79.00
Golden Hawk Technology 427-3 Amherst St. Suite 389 Nashua, NH 03063 (603) 424-0269 Popular MIDI interfaces; MIDI Gold 500 has no MIDI thru.	
MIDI Interface	\$49.95
Mimetics Corp. P.O. Box 1560 Cupertino, CA 95015 (408) 741-0117 Sound digitizer and MIDI interface.	
MIDI-STAR MS-2X6	\$262.50
Spirit Technology Corp. 220 West 2950 South Salt Lake City, UT 84115 (801) 485-4233 (800) 433-7572 High-end interface; multiple MIDI in, thru, out, RS-232, LEDs.	

Time Code

Time Code Generators and Readers

Horita

P.O. Box 3993

Mission Viejo, CA 92690

(714) 364-1143

Low-cost (\$300-\$400) series of time code readers and generators, plus
other components.

Micro SMPTE \$N/A
 Microillusions
 17408 Chatsworth St.
 Granada Hills, CA 91344
 (800) 522-2041
 CA: (818) 360-3715
 Time code reader for *Music X*.

Video Digitizers and Frame Grabbers

Digi-View Gold \$199.95
 Digi-Droid \$69.95
 CS-1 Copy Stand \$74.95
 NewTek

115 West Crane St.
 Topeka, KS 66603
 (800) 843-8934

Digi-View is a color video digitizer with image processing software; Digi-Droid moves the color wheel for Digi-View.

FlickerFixer \$595.00

Microway
 P.O. Box 79
 Kingston, MA 02364
 (617) 746-7341

Amiga 2000 driver for high-resolution noninterlaced displays; not for video recording, but good for hi-res presentations with the Amiga itself.

Frame Buffer \$549.95

Mimetics Corp.
 P.O. Box 1560
 Cupertino, CA 95015
 (408) 741-0117

Frame buffer/grabber for Amiga 2000; captures 4 overscanned hi-res fields.

Frame Grabber \$499.95

Progressive Peripherals and Software, Inc.
 464 Kalamath St.
 Denver, CO 80204
 (303) 825-4144

Real-time color digitizer.

APPENDIX A

LIVE! for A500	\$399.00
LIVE! for A1000	\$295.00
LIVE! for A2000	\$450.00
A-Squared Distributions Inc. 6114 La Salle Ave. Suite 326 Oakland, CA 94611 (415) 339-0339 Video digitizer and image processing software.	
Perfect Vision	\$219.95
SunRize Industries 3801 Old College Rd. Bryan, TX 77801 (409) 846-1311 Color, real-time digitizer.	
VD-1	\$1000.95
Impulse, Inc. 6870 Shingle Creek Parkway #1112 Minneapolis, MN 55430 (612) 372-0400 Capture frames from any NTSC source in real time with 24-bit frame buffer.	
Video Toaster	\$1299.95
NewTek 115 West Crane St. Topeka, KS 66603 (800) 843-8934 Digital genlocker, frame grabber, and SEG with two-channel ADO-like effects.	

Video Production/Post-Production Equipment

(Camcorders, VCRs, Monitors, Edit Controllers, and so on).

Canon USA Inc.
Video Division
One Canon Plaza
Lake Success, NY 11042
(516) 488-6700

Comprehensive Video Supply Corp.
148 Veterans Dr.
Northvale, NJ 07647
Wide variety of video production supplies, cables, etc.

JVC
41 Slater Dr.
Elmwood Park, NJ 07407

Panasonic
One Panasonic Way
Secaucus, NJ 07094
(201) 348-7183

Sony Video Communications
Sony Dr.
Park Ridge, NJ 07656
(201) 930-1000

Sanyo Corporation
1200 W. Artesia Blvd.
Compton, CA 90220
(213) 605-6526

DTV Software

Animation and 3-D Design

<i>Animation: Apprentice 3.2</i>	\$295.00
<i>Animation: Editor</i>	\$59.95
<i>Animation: Effects</i>	\$49.95
<i>Animation: Flipper</i>	\$15.95
<i>Animation: Multiplane</i>	\$89.95
<i>Animation: Rotoscope</i>	\$79.95
<i>Animation: Libraries</i>	\$24.95 each
<i>Animation: Stand</i>	\$49.95

Hash Enterprises
2800 E. Evergreen
Vancouver, WA 98661
(206) 693-7443

A complete set of two- and three-dimensional animation applications.
Unique character-animation oriented interface; inexpensive add-on
utilities and clip object disks.

<i>Animator/Images</i>	\$89.95
------------------------	---------

Aegis Development
2210 Wilshire Blvd.
Suite 277
Santa Monica, CA 90403
(213) 392-9972

Easy-to-use first-generation two-dimensional metamorphic animator,
plus paintbox.

APPENDIX A

<i>C-Light</i>	\$49.00
Ronald Peterson P.O. Box 614 Milford, NH 03055 Budget 3-D modeler; easy to learn and use.	
<i>Design 3D</i>	\$99.95
Gold Disk 2179 Dunwin Dr., #6 Mississauga, Ontario Canada L5L 1X2 (416) 828-0913 Low-cost 3-D modeler.	
<i>Fantavision</i>	\$69.95
Broderbund Software, Inc. 17 Paul Dr. San Rafael, CA 94903 (800) 527-6263 Tweening two-dimensional animator with sync sound editor; ILBM compatible.	
<i>Forms in Flight II</i>	\$119.00
Micro Magic 261 Hamilton Ave., #320C Palo Alto, CA 94301 (415) 327-9107 3-D object editor and animator	
<i>InterChange</i>	\$49.95
Syndesis 20 West St. Wilmington, MA 01887 (617) 657-5585 Share 3-D object files among <i>Sculpt 3-D</i> , <i>VideoScape 3-D</i> , and <i>Forms in Flight</i>	
<i>Modeler 3-D</i>	\$99.95
Aegis Development 2210 Wilshire Blvd. Suite 277 Santa Monica, CA 90405 (800) 345-9871 CA: (213) 392-9972 Object generator for use with <i>VideoScape 3-D</i> , <i>Aegis Draw Plus</i> , and <i>Sculpt-Animate 3-D</i> ; lathing, extrusions, mirroring, and arrays.	

- MovieSetter* \$99.95
Gold Disk
2179 Dunwin Dr., #6
Mississauga, Ontario
Canada L5L 1X2
(416) 828-0913
Complete animation system with onscreen storyboards.
- Pagerender 3-D* \$149.95
Mindware International
110 Dunlop St. West
Box 22158
Ontario, Canada L4M 5R3
(800) 461-5441
(705) 737-5998
Three-dimensional modeler and animator; includes object library and support for stereo imaging.
- PageFlipper Plus F/X* \$159.00
Mindware International
110 Dunlop St. West
Box 22158
Barrie, Ontario
Canada L4M 5R3
(705) 737-5998
Orders: (800) 461-5441
Frame-by-frame animations; supports ANIM format.
- Photon Video: Cel Animator* \$149.95
Microillusions
17408 Chatsworth St.
Granada Hills, CA 91344
(800) 522-2041
CA: (818) 360-3715
Cel animation program with sound synch, available transport controller hardware.
- Sculpt 3D* \$99.95
Animate 3D \$149.95
Sculpt-Animate 4D \$499.95
Gallery 3D—Space Station-Orbiter \$69.95
Gallery 3D—Tate Fonts \$69.95
Byte-by-Byte Corp.
Arboretum Plaza II
Suite 150
9442 Capital of Texas Highway N.
Austin, TX 78759
(512) 343-4357

Full-featured three-dimensional ray-tracing object editor and hierarchical animator. SA4D has faster rendering, smoother interface, and a better manual. The Gallery disks contain compatible three-dimensional clip art and fonts.

3-D Design Disks \$34.95 each

Antic Software
544 Second St.
San Francisco, CA 94107
(415) 957-0886

Readymade three-dimensional objects—architectural elements, futuristic machines, robots, and the human body—in a four disk set; object files compatible with *Videoscape 3-D*, *Modeler 3-D*, *SA3D*, and *SA4D*.

3-Demon \$99.95

Mimetics Corp.
P.O. Box 1560
Cupertino, CA 95015
(408) 741-0117

Flexible hierarchical object editor, compatible with most other 3-D programs.

Turbo Silver 3.0 \$199.00

Impulse Inc.
6860 Shingle Creek Pkwy. #110
Minneapolis, MN 55430
(800) 328-0184
(612) 556-0221
Improved ray-tracing animation program.

Videoscape 3-D 2.0 \$199.95

Aegis Development
2210 Wilshire Blvd.
Suite 277
Santa Monica, CA 90405
(800) 345-9871
CA: (213) 392-9972
Script-based 3-D animation system.

Zoetrope \$139.95

Cyber Graphics/Antic Software
544 Second St.
San Francisco, CA 94107
(800) 234-7001
(415) 957-0886

Jim Kent's second-generation 2½-D cel animator with compositing, some professional features.

Character Generation

- AmigaMETAFONT* \$75.00
 Radical Eye Software
 P.O.Box 2081
 Stanford, CA 94309
 (415) 32-AMIGA
 Font design and generation software.
- Broadcast Titler* \$299.95
 Innovision Technology
 P.O. Box 743
 Hayward, CA 94543
 (415) 538-8355
 Colorfonts character generator.
- InterFont* \$119.95
 Syndesis
 20 West St.
 Wilmington, MA 01887
 (508) 657-5585
 Three-dimensional font design tool, also converts two-dimensional fonts to three-dimensional works with all three-dimensional design and animation programs supported by *InterChange*.
- Kara Fonts* \$79.95 for
InterChange add-on
 version
 Kara Computer Graphics
 6365 Green Valley Circle
 Suite 317
 Culver City, CA 90230
 (213) 670-0493
 Two-dimensional fonts made of chrome, marble, brick, wood, metal, and so on.
- Masterpiece Professional Font Collection* \$199.00
 AROCK Computer Software
 1306 E. Sunshine
 Springfield, MO 65804
 (800) 288-AROK
 Scores of fonts on 20 disks.

<i>Pro Video CGI</i>	\$199.95
<i>Pro Video Plus</i>	\$299.95
<i>Pro Video CGI Font Disks</i>	\$99.95 each
<i>Pro Video Plus Fonts Library</i>	\$129.95
JDK Images 15075 S.W. Koll Pkwy. Suite G Beaverton, OR 97006 (503) 626-2022 Professional titles and effects; 100-plus pages.	
<i>TV*Text</i>	\$99.95
<i>TV*Show</i>	\$99.95
Brown-Waugh Publishing 16795 Lark Ave. #210 Los Gatos, CA 95030 (800) 451-0900 CA: (408) 395-3838 Basic character generation and title effects.	
<i>Video Titler</i>	\$149.95
Aegis Development 2210 Wilshire Blvd. Suite 277 Santa Monica, CA 90405 (800) 345-9871 CA: (213) 392-9972 Titler with slick special fonts.	
Image Processing and Special Effects	
<i>Butcher 2.0</i>	\$37.00
Eagle Tree Software P.O. Box 164 Hopewell, VA 23860 (804) 452-0623 Edge-detection, bit-plane slicing, color sorting, false-color images, and other image processing exotica.	
<i>Invision</i>	\$129.00
Elan Design P.O. Box 31725 San Francisco, CA 94131 (415) 621-8673 Image mixer: keying, colorizing, and so on. Works with LIVE! digitizer.	

PIXmate \$69.95
 Progressive Peripherals and Software, Inc.
 464 Kalamath St.
 Denver, CO 80204
 (303) 825-4144
 Image processing.

Photosynthesis \$149.95
 Escape Sequence, Inc.
 P.O. Box 1101
 Troy, NY 12180
 Image processor with interpreter for designing your own algorithms;
 works in lo-res only.

Paint Programs

Deluxe Paint II \$129.95
Deluxe Paint III \$149.95
Deluxe Photo Lab \$199.95
 Electronic Arts
 1820 Gateway Dr.
 San Mateo, CA 94404
 (415) 571-7171
Deluxe Paint II is the best paint program for the Amiga; *Deluxe Paint III*
 adds cel animation capabilities; *Deluxe Photo Lab* is a HAM paint pro-
 gram, image analyzer, and poster printer.

Digi-Paint II \$79.95
 NewTek
 115 West Crane St.
 Topeka, KS 66603
 (800) 843-8934
 Second-generation HAM paint program.

Express Paint 3.0 \$139.95
 Brown-Waugh Publishing
 16795 Lark Ave. #210
 Los Gatos, CA 95030
 (800) 451-0900
 CA: (408) 395-3838
 Paint program with PostScript support.

Photon Paint \$99.95
Microillusions
17408 Chatsworth St.
Granada Hills, CA 91344
(800) 522-2041
CA: (818) 360-3715
HAM paint program.

Prism Plus \$69.95
Impulse Inc.
6860 Shingle Creek Pkwy, #110
Minneapolis, MN 55430
(800) 328-0184
(612) 556-0221
HAM paint program; requires 1 megabyte RAM.

Sound and Music Software

AudioMaster II \$59.95
Aegis Development
2210 Wilshire Blvd.
Suite 277
Santa Monica, CA 90403
(213) 392-9972
Edit IFF, *Sonix*, and *Mimetics* samples.

Deluxe Music Construction Set \$99.95

Instant Music \$49.95

Electronic Arts
1820 Gateway Dr.
San Mateo, CA 94404
(415) 571-7171
DMCS is a MIDI note editor; *Instant Music* lets you create listenable music with little or no musical knowledge. Several IFF music data disks available.

Dynamic Drums \$79.95

Dynamic Studio \$199.95

New Wave Software
P.O. Box 438
St. Clair Shores, MI 48080
(313) 771-4465
Drum machine synthesizer; *Dynamic Studio* is a sequencer built around *Dynamic Drums*.

Desktop Video Resources

<i>KCS</i>	\$249.00
<i>The Copyist III</i>	\$399.95
<i>Editor-Librarian</i>	\$149.95 each
<i>MIDI Recording Studio</i>	\$49.00
<i>Fingers</i>	\$79.00
Dr. T's 220 Boylston St. Suite 206 Chestnut Hill, MA 02167 (617) 244-6954 Professional music sequencing, patching, composition, and copying system.	
<i>MIDI Magic</i>	\$149.95
Brown-Waugh Publishing 16795 Lark Ave. #210 Los Gatos, CA 95030 (800) 451-0900 CA: (408) 395-3838 Entry-level MIDI sequencer; 16 tracks with up to 26 sequences.	
<i>MidiVU</i>	\$29.00
Diemer Development 12814 Landale St. Studio City, CA 91604 (818) 762-0804 Desk accessory program for recording one MIDI track.	
<i>Music-X</i>	\$299.95
Microillusions 17408 Chatsworth St. Granada Hills, CA 91344 (800) 522-2041 CA: (818) 360-3715 Full-featured MIDI sequencer, note editor, and patch librarian; supports SMPTE time code.	
<i>Sonix</i>	\$79.95
Aegis Development 2210 Wilshire Blvd. Suite 277 Santa Monica, CA 90403 (213) 392-9972 Interactive note editor with good sound.	

Soundscape ProMIDI Studio \$179.95
Mimetics Corp.
P.O. Box 1560
Cupertino, CA 95015
(408) 741-0117
Sequencer with add-on modules for special effects, sample editing, and composition.

StudioMagic \$99.95
SunRize Industries
3801 Old College Rd.
Bryan, TX 77801
(409) 846-1311
Versatile IFF sample editor; use with PerfectSound audio digitizer.

Synthia \$99.99
The Other Guys
55 North Main St.
Suite 301-D
P.O. Box H
Logan, UT 84321
(800) 942-9402
IFF digital synthesizer

Texture II \$199.00
Magnetic Music.
RD #5
P.O. Box 227A
Myrtle Dr.
Mahopac, NY 10541
(914) 248-8208
Twenty-four track sequencer with full editing features; requires two MIDI interfaces.

Video Production

Deluxe Video \$129.95

Deluxe Productions \$199.95

Electronic Arts
1820 Gateway Dr.
San Mateo, CA 94404
(415) 571-7171

Deluxe Video and *Deluxe Productions* are complete DTV production systems; innovative and easy-to-learn scripting tools.

<p><i>The Director</i> The Right Answers Group Dept C P.O. Box 3699 Torrance, CA 90510 (213) 325-1311</p> <p>A complete display and animation language, controls page-flipping, transitions, and so on. Requires text editor.</p>	<p>\$69.95</p>
<p><i>Lights, Camera, Action!</i> ANIMagic Aegis Development 2210 Wilshire Blvd. Suite 277 Santa Monica, CA 90405 (800) 345-9871 CA: (213) 392-9972</p> <p>Combine IFF pictures, ANIM animations, <i>Sonix</i> scores, and IFF sounds with transitions and effects.</p>	<p>\$79.95 \$99.95</p>
<p><i>Station Manager/Character Generator</i> <i>Station Manager/Teleprompter</i> <i>Station Manager/Weather Graphics</i> <i>Tape Library Management</i> <i>Weather Graphics Map Generator</i> <i>Weather Graphics WeatherLink</i> Associated Computer Services 1306 East Sunshine Springfield, MI 65804 (417) 887-7373</p> <p>Integrated video graphics and management packages for small television stations.</p>	<p>\$295.00 \$295.00 \$295.00 \$295.00 \$149.95 \$295.00</p>
<p><i>Video Visions Art Disks</i> Charles Voner Designs 61 Clewey Rd. Medford, MA 02155 (617) 396-8354</p> <p>Video clip art collection on seven disks.</p>	<p>\$24.95 each</p>

Other

- The Mandala* \$395.00
Very Vivid, Inc.
1499 Queen St. W. #302
Toronto, Ontario
Canada M6R 1A3
(416) 537-7222
Interactive, MIDI-based audio-video software that links onscreen live digitized graphics with sound and music; primarily performance and dance applications.
- Microfiche Filer Plus* \$179.95
Software Visions
P.O. Box 33119
Framingham, MA 01701
(800) 527-7014
A useful database for DTV recordkeeping and logging; also can be programmed to control external devices using the ARexx macro language.
- Mind Light* \$198.00
Visual Aural Animation
P.O. Box 4898
Arcata, CA 95521
(707) 822-4800
Fantastically versatile light and music show; 1960s meets 1990s.

Services

- Alan Gordon Enterprises
1430 Cahuenga Blvd.
Hollywood, CA 90078
(213) 466-3561
Film, video, and DTV books and technical manuals.
- Infotronics
Woodbury Hamlet
P.O. Box 935
Woodbury, CT 06798
(203) 263-5350
Complete Amiga titling and animation systems for video production.

Interactive Microsystems, Inc.
Landmark, Suite 20
P.O. Box 1446
Haverhill, MA 01831
(617) 372-0400
Amiga-based DTV and A/V systems and training.

Omni International Trading
3826 Woodland Park Ave. N.
Seattle, WA 98103
(206) 547-6664
Complete Amiga DTV systems.

Pixelvision
125 White Spruce Blvd.
Rochester, NY 14623
(716) 424-5041
Graphics for DTV; custom logos and presentations.

Redmond Cable
East Coast: (615) 478-5760
West Coast: (206) 882-2009
Custom Amiga cables of all kinds.

RGB Computer and Video Creations
3944 Florida Blvd.
Suite 102
Palm Beach Gardens, FL 33410
(407) 622-0138
Custom Amiga editing systems; graphic services and instruction.

Soundware
200 Menlo Oaks Dr.
Menlo Park, CA 94025
(800) 333-4554
Complete MIDI and sound studio services.

Competitions

AmiEXPO Graphics Contest
211 E. 43rd. St.
Suite 301
New York, NY 10017
1-(800) 32-Amiga
The only Amiga-specific competition; includes two- and three-dimensional art, animation, and DTV; held in conjunction with AmiEXPO conventions.

Chicago International Film Festival
415 N. Dearborn St.
Chicago, IL 60610
(312) 644-3400
Video and film; deadline early September.

Global Village Documentary Festival
445 Broome St.
New York, NY 10013
(212) 741-8903
Documentaries only; deadline December 9.

Hometown USA Video Festival
c/o National Federation of Local Cable Programmers
906 PA Ave. S.E.
Washington, D.C. 20003
(202) 829-7186
For community programming; deadline mid-March.

Vision of U.S. Video Contest
P.O. Box 200
Hollywood, CA 90078
(213) 856-7622
Half-inch and 8mm formats only; deadline May 31.

Appendix B

Desktop Video Glossary

This glossary gives short definitions for most of the computer and video terms used in *Amiga Desktop Video*, as well as some terms commonly used in the video and computer graphics industries that are not mentioned in this book. This is by no means a complete dictionary of all desktop video terminology; like all technical dialects, the language of desktop video is constantly expanding to include new terms as new technologies and effects are incorporated into the field. With a few exceptions, general computer terms and terms specific to the Amiga operating system are not covered here; see your Amiga operating manual for information on Workbench and CLI terminology.

A/B Roll Switching between two synchronized and time-base-corrected VCRs for special effects like dissolves, wipes, and other transitions.

ADO (Ampex Digital Optics) A popular broadcast device, manufactured by Ampex, for creating digital video effects in real-time—squashes, flips, twists, and so on. Some DTV programs offer ADO-like effects.

Aliasing The jagged, stairstepped effect along the edges of computer graphics; also called “the jaggies.” *See* antialiasing.

AmigaDOS The Amiga’s disk operating system, used for accessing and managing files and some other operations.

Analog Video Video information carried on a continuously varying electric signal.

Animatic The visual outline of a video program presented in videotape form or on the computer screen; *see also* storyboard.

Animation A series of pictures shown quickly in sequence to create the illusion of movement.

Anim File An animation stored in the Aegis/Sparta "Anim" file format, read by several Amiga animation programs.

Antialiasing Image processing technique that reduces the appearance of aliasing, or jaggies, in a computer picture. Makes edges appear smoother and more natural, if less sharp.

ASCII (American Standard Code for Information Interchange) A widely used coding system and file format for computer text.

Aspect Ratio The ratio of screen height to screen width; in video, the ratio is 3 to 4.

Assemble Editing Piecing together sequences of video directly from a playback VCR to a record VCR without benefit of an edit controller, pre-roll, or other features to ensure smooth edits; also called "punch-and-crunch" editing.

Audio The audible part of a video production; it may be sounds, music, dialog, narration, or all of these.

Audio Dub Recording new audio on a tape after the video has been shot using the "audio dub" feature on most VCRs. The dubbed audio records directly over one track of the original audio.

Audio Mixing Creating a custom audio track from several different sources using a mic mixer or other sound mixing device.

A/V Short for audio-video or audiovisual.

Available Light Ambient or natural light; shooting in available light means not using artificial light in a location production.

Autofocus Rangefinder mechanism that automatically focuses the lens of a camera/camcorder on the object seen in the center of the viewfinder.

Backlight Light placed behind the subject in a scene to create a separation between the subject and the scene background.

Backspacing See pre-roll.

Bandwidth The maximum frequency range of a transmitted signal, measured in hertz.

Betacam Broadcast version of Sony's ½-inch Betamax tape format.

Betamax First of the ½-inch consumer tape formats; invented by Sony. An enhanced consumer version is ED-Beta.

Bitmap The plan in a computer's memory that contains information about the field of pixels on its screen. Bitmapped graphics are computer pictures made up of tiny dots called *pixels*.

Bitplane A layer of color information about the bitmap. The Amiga can use from 1 to 6 bitplanes; the more bitplanes, the more colors.

Black A video signal without picture information; also called color black.

Boot Switching on a computer and loading the operating system; from "bootstrap."

Breakup Disruptions or breaks in a signal due to tape damage or loss of sync.

Broadcast Video Video that meets RS-170A signal standards with at least 525 lines of resolution; video good enough to be broadcast, sent over cable, and so on.

Business TV Video produced in an in-house studio by a corporation for creating records of meetings, orientation, training, product evangelism, demonstrations, and presentations; usually distributed live or on tape to other branches of the company.

Buffer Area in computer memory reserved for a computer graphic or other body of information.

Bumping Up Transferring recorded video to a higher-quality tape format, as from $\frac{1}{2}$ -inch VHS to $\frac{3}{4}$ -inch broadcast.

Camcorder Consumer device that combines a video camera and a VCR in one lightweight unit.

Cardioid A type of microphone sensitive to sound in a heart-shaped pickup pattern in front of the mike.

CCD (Charge-Coupled Device) A light-sensitive electronic plate replacing video tubes in most camcorders.

Cel A single drawing or frame in an animation.

C-Format 1-inch VTR

CGI Computer-Generated Imagery.

Channel The frequency bandwidth necessary to carry a complete television signal; about 6 MHz wide in the U.S.

Character Generator, Titler Hardware device, or similarly capable software for a computer, for creating video text and titles.

Chip Memory The internal memory accessible to the Amiga's graphics chips for picture information and operations.

Chroma Color in video.

Chromakey Inserting video imagery over a chosen color in a second video source using a special effects generator or computer. Used every day in TV news for putting weather maps behind the weatherperson.

Chrominance The color portion of the video signal; hue and saturation information.

CLI The Amiga's Command Line Interface, a way of controlling the computer with typed instructions using the command language of AmigaDOS.

Coax Coaxial cable, the standard type of shielded cable for carrying video signals.

Color 0 The color in the Amiga's first color register; the color that will show genlocked video.

Color Bars Standard color chart for adjusting the color balance in any video device.

Color Burst Reference wave of the video signal for measuring hue and saturation.

Color Cycling Repeatedly flashing a series of colors on the screen; can be used to create simple animations.

Color Registers Areas in computer memory where color information is kept.

Colorization Adding color to a black-and-white image, or changing the colors in a color image.

Component Video A video signal with picture information broken down into red, blue, and green components. *See* RGB.

Composite Encoder A device that converts RGB video to composite video.

Composite Video Standard TV video with a signal containing sync and picture information.

Control Track Recorded signal on a tape that controls tape motion in playback. The control track contains frame pulses that provide information about frame timing to control-track edit controllers. Tapes without a solid control track are unstable in playback and often can't be edited.

Copy Stand Device for holding and adjusting a video camera used to shoot flat art or still items.

Crawl Annoying shimmer on the borders of bright colors in a poorly recorded tape; more generally, the movement of titles or graphics across the video image.

CRT (Cathode Ray Tube) The standard TV or computer display device.

Cut An abrupt, instantaneous transition between two scenes in a production; also, slang for a video edit.

Desktop Video (DTV) Video production using low-cost video equipment and desktop computers.

Digital Video Video information contained in a sequence of discrete binary numbers.

Digitizer Device for converting an analog video image into a digital computer graphic.

Dissolve Scene transition that gradually replaces one image for another.

Dithering Using a paint or image processing program to blur the transition from one color to another in a computer picture.

Dolly Rolling the camera along a path to follow the action in a scene; often used for chase sequences.

Door Swing Rotation of a video image along any axis with a digital effects generator.

Dot Pitch On a color display, the distance between phosphor dots of the same color. A measure of display resolution.

Double Buffering In computer animation, displaying an image in a sequence while keeping the next to be displayed in memory (employing two memory buffers for image information)

Dropout Loss of a recording's playback quality due to wear and tear on the tape.

Dub To copy a tape; also called *dupe*.

DVE (Digital Video Effects) The use of computers to create unique video special effects.

8mm A diminutive consumer tape format invented by Sony; offers superior sound recording.

8SVX IFF sampled sound file format used in some popular music programs.

Editing Arranging video sequences to create a finished program.

Edit Controller Device that controls two or more VCRs to accomplish smooth, accurate video editing.

Edit Decision List (EDL) A time code list of edit points in a production; fed to a computerized edit controller, the EDL allows the system to auto-assemble the master tape from time-coded original raw footage.

EFP (Electronic Field Production) Basic one-camera location shooting.

ENG (Electronic News Gathering) EFP with easily portable equipment.

Extra-Halfbright An Amiga screen mode that allows up to 64 on-screen colors, with half of the colors 50-percent intensity duplicates of the other half.

Extrusion In computer graphics, the process of creating a three-dimensional shape by stretching a two-dimensional shape along a third axis; like squeezing a plastic block through a shaped nozzle.

Fade A dissolve from video to black or any color; also, decreasing audio from full volume to zero volume.

Fast Memory Amiga memory available for programs and operations, but not for image information. *See* chip memory.

Feedback Endless looping signal of audio or video; a standard method of creating infinite regress images in video.

Field Half a video frame; 262.5 horizontal lines written in 1/60 of a second.

Fill Light Light positioned to illuminate the shadows cast by the key or main light in a scene.

Film Printer Device for creating slides or film prints of a video or computer graphics image.

Flying Erase Heads Tape erasing heads in a VCR that erase tape with frame accuracy, making perfect insert editing possible.

Font Typeface for titles or computer graphics.

Footcandle A measurement of light emission: lumens per square foot.

Fractals In computer graphics, method for producing irregular, lifelike landscapes and branching forms with simple mathematical formulas.

Frame A complete still video image containing two interlaced video fields; 525 horizontal lines written in 1/30 of a second.

Frame Buffer Device for temporarily storing one video frame.

Frame Grabber Device for capturing and storing a video frame from an external video source, such as a VCR, for display in a computer.

Gadget An Amiga screen object that responds to a click of the mouse or enables you to enter text in a box.

Gain Amplitude or strength of an analog signal.

Generation Number of times a videotape has been copied. The original tape is first generation, a copy of it is second generation, a copy of the copy is third generation, and so on. Information stored in analog form is degraded with each generation.

Genlock Device that synchronizes one video source with another (for example, computer graphics with live video) for mixing and recording.

Graphic Equalizer Audio device for adjusting sound quality within set frequency ranges.

Gray-Scale Even range of gray tones between black and white; easily created with paint programs.

HAM (Hold-And-Modify) An Amiga screen mode that allows all 4096 Amiga colors to be onscreen at the same time.

Hertz (Hz) Electronic measure of cycles per second; the number of times an electrical event is repeated in a second.

Hierarchical Objects In 3-D imaging, objects whose motion is linked to the motion of other objects according to levels of influence; for example, an arm may be made up of a hand object, a forearm object, and an upper arm object, with the upper arm motions determining the forearm motions, and the forearm determining the hand motion, but not vice versa.

HDTV (High-Definition Television) Any of several proposed standards for higher-resolution color television approaching 35mm film image quality.

Horizontal Blanking Interval Part of the video signal that contains the pulses that control the transition from the end of one horizontal scanline to the beginning of the next.

Hue Color, such as red or blue.

IFF (Interchange File Format) Any of several standard file formats developed for Amiga graphics, text, and music by Electronic Arts. All paint programs save images in IFF, for example.

INS1 IFF instrument file format used in some Amiga music programs.

Image Processing Using software to manipulate a scanned computer graphics image—for example, to add false colors, increase the contrast of shapes boundaries, eliminate moire patterns, and so on.

In-Betweening Drawing intermediate positions of an animated object between the key frames. The in-between frames are called *tweens*. See key frame.

Insert Edit Video editing technique in which audio or video is slipped seamlessly into already recorded material. Requires a control track or time code on both source and master videotape.

Interlace Amiga screen mode with 32 colors and 400 horizontal lines; half the lines are refreshed every 1/15 of a second, causing flicker on the computer monitor. Interlace is the preferred screen mode for video production, since NTSC video is also interlaced.

Iris A spiral wipe that imitates the opening and closing action of a camera iris.

Jaggies The ragged edges of shapes in computer graphics. See aliasing.

Jiffy One sixtieth of a second.

Jitter Instability due to sync or tracking problems.

Jump Cut Jarring edit that creates a visual non sequitur, out of touch with the original.

Key Method of replacing part of the image from one video source with the image from a second video source. Keying can be over a specified gray level in the video (luminance keying) or over a specified color (chromakeying). For example, keying video of a weather map over the blue screen behind a TV weatherperson.

Key Light The main light source for a scene.

Key Frame In cel animation, a picture defining the beginning or end of an animated sequence.

Lavalier A small microphone meant to be worn on the lapel; also called a lapel mike.

Light Source Shading In computer graphics, simulating the effects of one or more lights shining on a 3-D object.

Logo Distinctive design for a corporate name and/or symbol.

Lumen A measurement of light emitted by a lightsource at the point of emission.

Luminance Strength of the gray-scale portion of the video signal.

Lux A measurement of light reflection: .1076 footcandles.

Macro A magnifying camera lens that can focus down to a few inches.

Matte Method of creating composite pictures by placing a multi-colored image from one video source over a background from a second source; a form of keying.

Mike Mixer Device for combining and manipulating input from several microphones or other audio sources for recording in mono or stereo.

MIDI (Musical Instrument Digital Interface) The standard method of controlling musical instruments by computers.

Moire A vibrating pattern of intersecting lines caused by video signal distortion.

Monitor In video, a television with composite video inputs. A computer monitor usually accepts RGB rather than composite input.

Mortice Technique of squeezing a video picture and surrounding it with a black or other border.

Neon Popular font style that imitates the look of neon signs.

Note Editor Software for writing, editing, and playing music notation.

NTSC (National Television Standards Committee) Professional body of the Federal Communications Commission that sets standards for video hardware and broadcasting.

Object Editor Software for creating and editing 3-D computer objects.

Offline Editing First editing stage, where tape is reviewed from workprints, rough edits prepared, and an edit decision list compiled.

Online Editing Final edit stage, where the master tape is assembled from the original production footage. The edit decision list also may be fed to a computer editing system that auto-assembles the master tape.

Overscan Amiga screen mode in which the computer graphics image extends to the limits of the visible TV screen.

Page The computer graphics workspace; may be bigger than the visible part of the screen, but not bigger than can fit in RAM.

Page Flipping Holding two or more pages in buffers and showing them in a defined sequence; used for cel-type animation.

Paintbox, Paint Program Software for creating bitmapped computer graphics pictures.

PAL (Phase Alternating Line) A video standard used in Europe, Latin America, and elsewhere; not compatible with NTSC.

Palette The selection of colors available in a computer graphics system.

Pan Camera move swinging along the horizontal *x*-axis.

Patch Connecting video and audio equipment with cables or through a central *patch panel*.

Path The trail along which a computer-graphics object travels.

Phase The timing of an electronic signal; two signals which occur simultaneously are in phase; if they occur at different times, they're out of phase.

Pixel The basic picture element of a computer screen or graphics sensing array, such as a CCD; the smallest dot a computer can create.

Pixelization Using image processing software to break up a continuous image into rectangular blocks to give it a “digitized” look.

Polygon A flat geometric shape; one of the components of the surfaces of objects in 3-D modeling programs.

Polyhedron A many-faceted solid object.

Post Short for *post-production*, all elements of TV or film production occurring after the original stock is shot. Most DTV work would be considered post by TV and film professionals.

Posterization Using image processing software to divide a continuous image into flat areas of heightened color.

POV (Point Of View) The viewing angle and apparent position of the camera.

Pre-roll Rewinding tape in an editing VCR to a cue point, so the tape is up to speed when rolled forward to the editing point.

Proc Amp Processing amplifier, electronic device that massages a video signal to produce stable sync and good-quality signal levels.

Quad From quadruplex, the original broadcast VTR system, using 2-inch-wide tape; now outdated.

Quantel Broadcast digital video effects system manufactured by MCI/Quantel.

RAM-Animation A computer-animated sequence that’s compressed so it can be stored entirely in random-access memory.

Raster The scanned area of the video screen; where the video image is displayed.

Ray Tracing Highly realistic method of 3-D computer graphics rendering that traces the path of a ray of light from the camera POV to every element in the scene; can accurately render shadows, reflections, and translucent substances.

Real-Time The actual time it takes events to occur; action on the computer screen that corresponds in a one-to-one ratio to real clock time.

Reference Black Level (Pedestal) Part of the video signal that provides a reference level for total picture brightness.

Render Creation of a realistic two-dimensional scene from three-dimensional object information.

Requester An Amiga screen box that alerts you to an event or asks for a typed response.

Resolution The clarity or graininess of a video or computer image as measured by lines or pixels; the smallest resolvable detail in the image.

RF (Radio Frequency) Used for transmitting video signals.

RGB (Red, Green, Blue) The video display system used by most computers and some broadcast video equipment.

RGB Encoder Device for converting composite video to RGB video.

RS-170A Set of technical specifications for “legal” video as defined by the National Television Standards Committee.

Safe Title Area Area of the screen, about 80 percent as measured from the center, that is always visible and available for placing credits, even in a poorly adjusted monitor.

Sample Digitized version of a sound as processed by a sampler.

Sampler Audio device that converts sound into digital information that can be manipulated by a computer.

Screen Shot A photograph of the screen of a computer or video monitor.

Scroll Moving pages of video text up or down on the screen. *See* crawl.

SECAM (Sequential Colour à Memoire) A video standard developed and used mainly in France, also in the USSR and several African countries; not compatible with NTSC video.

SEG (Special Effects Generator) Video device for creating and controlling transitions and other effects during video production and editing.

Sequencer Software for controlling other MIDI musical devices.

Shotgun A type of cardioid microphone that picks up sound only in a narrow cone in front of the mike; usually camera mounted, it’s good for recording sounds only in the direction the camera is pointing.

Single-Frame Recorder A VCR capable of recording a single video frame at a time.

SMPTE (Society of Motion Picture and Television Engineers) A professional organization that sets technical standards for film and video.

SMUS IFF musical score file format used in some Amiga music programs.

Solid Model A computer-generated 3-D object with realistic shading and hidden areas removed.

Spline A curve defined by a mathematical formula; used to specify smooth paths for 3-D object motion.

Split Screen Video effect that shows images from two different video sources, each on one half of the screen. Multiple split screens shows images from several sources or different actions taking place in several windows in the screen area.

Stencil Paintbox feature that allows the artist to create a mask that prevents painting over selected areas or colors.

Still-store *See* frame grabber.

Storyboard A visual outline of the narrative of a film or video production.

Subcarrier Frequency carrying the video color information.

Super Superimposition, laying titles or graphics over a video image.

Surface of Revolution A three-dimensional computer graphics shape created by revolving a two-dimensional shape around a central axis; for example, a sphere can be created by revolving a circle around its diameter.

Sweetening Audio post-production, with an emphasis on adjusting audio for the best quality.

Switcher Electronic device for instantly cutting between several live or taped video sources.

Sync Short for synchronization; the horizontal and vertical timing pulses that control the operation of video equipment.

Sync Generator Device that generates stable sync pulses for use by all the video components in a video system.

Synthesizer, Synth An electronic device for creating artificial sounds and sound effects. Also, software for creating similar effects through a computer.

Talking Head Video slang for the typical head-and-shoulders shot of actors seen on talk shows and newscasts.

Tape Format Any of several tape widths and recording methods, such as $\frac{1}{2}$ -inch VHS and $\frac{3}{4}$ -inch U-Matic, used in video recording systems.

Texture or Surface Mapping In computer graphics, wrapping a two-dimensional picture around a three-dimensional object to give that object a simulated surface texture or pattern.

Tile A rectangular computer image that's repeated in a pattern all over the screen, like tiles on a floor.

Tilt A camera move swinging up and down along the vertical y -axis.

Time Base The timing of a portion of the video signal, particularly the horizontal and vertical sync pulses.

Time Base Corrector (TBC) Device that corrects time-base signal instabilities caused by VCRs during videotape playback; makes it possible for two or more VCRs can be in sync.

Time Code An electronic counter or index of videotape duration; the hours, minutes, seconds, and frames that a tape lasts that is usually visible only with a special time code reader. Usually "burned-in" on the tape as the tape is logged during offline editing.

Transport Controller An computer device that controls the operations of a VCR with frame accuracy.

U-Matic Trade name for the $\frac{3}{4}$ -inch tape format invented by Sony.

VCR (Video Cassette Recorder) Device for recording the video signal. A video recorder using open reels (such as a 1-inch or quad machine) is referred to as a VTR, or video tape recorder.

Vectorscope Video test equipment that displays information about the color part of the video signal.

Vertical Blanking Interval Part of the video signal that contains pulses that move the scanspot from the bottom of the screen at the end of one field to the top of the screen to begin the next field.

VHS (Video Home System) Most popular $\frac{1}{2}$ -inch consumer tape format, invented by JVC. An enhanced version is Super-VHS.

Video Signal A waveform carrying video information.

Waveform Monitor Video test equipment that measures and displays the parameters of the video signal.

Window An Amiga screen object that defines an area of activity; it can contain pictures, documents, and other objects and be opened, moved, resized, stacked, and closed.

Window Dupe A workprint with visible time code displayed in a small window on the image.

Wipe Film or video transition in which one image replaces another along a border that moves across the screen.

Wire-Frame Representation of a computer-generated 3-D object as a hollow structure of wires with the shape of the object but no interior or shading; provides a sense of the object while cutting down on the computation needed to represent it.

Workbench The Amiga's operating system graphic interface.

Workprint A copy of the raw footage of a production; used in off-line editing.

Zoom Using a camera's zoom lens to get closer to or farther away from the subject without moving the camera; in computer animation, changing the focal length of the "camera lens" or "observer viewpoint" along the screen's z-axis.

Zorro The technical specifications and form factor for Amiga expansion boards.

Appendix C

Countries That Use NTSC Video

The world of DTV is an increasingly cosmopolitan one, especially with sales of Amigas continuing to be very strong in Europe and Canada. If you wish to show or distribute your DTV production to other countries, you'll need to know what TV standards each uses. (See the section in Chapter 2 on television standards.) Following is a list of countries that have adopted NTSC video as the standard; you can freely distribute your tapes to these countries without worrying about standards compatibility. (Note that these countries may not use the same voltage in the national grid as the U.S. does, so DTV equipment may not work in those countries without a power converter.) It is possible to obtain Amigas with PAL compatibility for creating DTV that can be shown in PAL countries, but the rest of your DTV setup—the camera, VCR, and so on—must be PAL-compatible as well.

Country	Voltage
Barbados	120
Bermuda	120
Canada	110–240
Chile	220
Colombia	150–240
Costa Rica	110
Curacao	120
Dominican Republic	110
Ecuador	120
El Salvador	110
Guam	110
Guatemala	110–220

Country	Voltage
Honduras	110-220
Japan	100-200
Mexico	127-220
Nicaragua	117
Panama	110
Peru	220
Philippines	115
St. Kitts	220
South Korea	100
Surinam	115-127
Taiwan	100
Trinidad & Tobago	117
U.S.A. and Protectorates	110-120

Index

- A/D device 26
- accelerator board 41
- Aegis Animator* program 166
- algorithms, image processing 151
- Amiga
 - advantages of for DTV 3
 - animation 156–78
 - as character generator 60
 - as DTV standard 1
 - as edit controller 115
 - as teleprompter 144–45
 - audio and 190–97
 - color 35–37
 - color registers 37
 - colors, limitations of 32
 - composite out jack, limitations of 38
 - fonts 140
 - genlock 11, 38–39, 61–63, 175
 - graphics, basic 30–35
 - graphics, broadcast tips for 206–7
 - graphics software 6
 - hardware 40–42
 - interfacing with video 37–39
 - memory 30
 - monitors 41
 - NTSC and 205
 - overview 28–39
 - picture information in 30
 - pixels in 30
 - resolution, limitations of 32
 - RGB format, converting to 61
 - screen formats 33–35
 - specifications 28
 - systems list 224–25
 - titling and 108
 - typical configuration of 29
 - video resolution 30–32
 - voices 193
- Amigen genlock 105
- analog device quality, measuring 26
- analog signal, degradation of 26
- analog-to-digital encoder.
 - See* A/D device
- ANIM format 175
- animatic 80–81
- animation 9, 68–69, 154–78, 177
 - Amiga 156–78
 - design, efficient 160–61
 - example of 161–62
 - exporting 174–75
 - files, incompatibility of 175
 - frame rate and 156
 - fundamentals of 155–56
 - metamorphic and key-frame 157–58
 - perspective 162–64
 - scene editing and 169–70
 - scoring 201–2
 - software 68–69, 233–37
 - transferring to tape 175–77
- architecture and engineering,
 - DTV and 8
- aspect ratio 17, 132
 - modifying 132
- assemble editing 112
- associations, DTV 220–21
- attention, how to hold 127–8
- audio 10
- audio digitizers 184
 - list 225–26
- audio dub, VCR 186–87
- audio
 - Amiga and 190–97
 - DTV and 179–202

- equipment, basic 179–82
- importance of 179
- mixing 183–86, 188
- post-production and 186–89
- sampling 190–91
- sweetening 188–89
- backlight 98
- bandwidth 23–24
- Betamax 46
- big time, breaking into 218
- bitmap look 131
- bitmaps 30
- bitplanes 36–37
- blacked tape 87
- black-and-white cameras, when to use 53, 63
- blacked master tape 87–88, 109
- body language 102
- books 221–22
- borders, Amiga graphics and 35
- broadcast production 207–9
- broadcast quality, defined 204
- broadcast video, Amiga and 203–19
- budgeting 83–85
- budget top sheet 84
- business video, DTV and 7–8
- Butcher* image processor program 151

- cables, types of 73–74
- camcorder 4, 51, 52, 180
 - choosing 55–56
 - described 14–18
 - resolution of 15
- camera
 - basic techniques with 88–97
 - black-and-white cameras, when to use 53, 63
 - choosing 52–55
 - features needed in 53–55
 - moves 91–94
 - tube 53
- cameras 51–55
 - multiple 94–95
- cardiac fibrillation, nonlinear 8
- cardioid microphone 181
- Cartesian coordinates 171
- CAT scanner 9
- CCTV. *See* black-and-white
- cel animation 154, 156
- character generation software 237–38
- character generator (CG) 60
 - Amiga as 60
- charge-coupled device (CCD) 14, 53
- chip RAM 30
- chrominance 21, 25
- CLI (Command-Line Interface) 28
- clothing 102
- color bars, NTSC, making 147–48
- color
 - Amiga 35–37
 - Amiga, limitations of 32
 - how to use 135–39
 - reference burst 21
 - registers, Amiga 37
 - saturation 21, 135
 - suggesting depth with 137
 - temperature 97
 - use, tips for 138–39
- colors
 - mixing 136–37
 - psychological meaning of 138
 - saturated 206
 - which to avoid 138
- competitions 245–46
- component video 25, 45
- composite and RGB encoders 38, 61
- composite interfaces list 226
- composite video 24–25
 - alternatives to 25
- compositing 158
- composition 88–91, 131–35
- concept 77
- connectors, types of 73–74
- continuity 96
 - cutting for 119–20
- contract 85
- control track 87
- copyright, music 191
- C part of video signal 21
- cut 121–22
- cutaway shot 96

- D/A device 26, 37
- data graphics, guidelines for 143
- degradation
 - analog signal 26
 - digital signals and 27
- Deluxe Paint III* program 65, 68–69, 107, 145–46, 159, 160, 162–66
- Deluxe Productions* program 158, 166
- Deluxe Video* program 8, 69
- depth, suggesting with color 137
- desktop video. *See* DTV
- Digi-Paint* program 66
- Digi-View digitizer 63, 108–11
- digital, from analog to 25–28
- digital signals, degradation and 27
- digital-to-analog encoder. *See* D/A device
- digitizer 39, 63–65, 108–11
- dissolve 122
- dolly 92–93
- drawing tablet 42
- drop frame time code 209
- DTV
 - advantages of 3–4
 - advantages of Amiga for 3
 - architecture and engineering and 8

- associations 220–21
- audio and 179–202
- basic concepts of 4–6
- business video and 7–8
- current use of 2–3
- glossary 247–58
- graphic design 127–53
- hardware 42–65
- hardware, Amiga-specific 61–65
- hardware, grades of 42
- home video and 6
- production 75–103
- professional 10–11
- relative cost of 10–11
- scoring 199–202
- software 65–70, 233–44
- studio, setting up 40–74
- uses for 6–11
- video art and 9
- DVE (Digital Video Effects) 123–26
- Dynamic Studio* program 198
- echo box 189
- edit controller 59, 227
 - Amiga as 115
- edit decision list 118, 211
- editing 49, 111–26
 - offline and online 118
 - shooting without 95–96
 - time code and 211
 - VCR 49
- education, DTV and 7–8
- 8mm tape format 46–47
- enhanced slideshow programs 158
- equalization 184, 189
- equipment needed, extra 38–39
- establishing shot 96
- extra-halfbright colors 24
- extrusion 168
- faces, why effective on video 132
- fade 122
- fast RAM 30
- FCC regulations 26–27
- file storage, recommended 41
- fill light 98
- final cut 116, 118
- flicker, interlace and 34
- fluid head tripod 89
- flying erase heads 49, 95, 112–13
- focussing 54
- font styles 141
- fonts 139–42
 - Amiga 140
- frame grabbers 63, 64–65
 - list 231–33
- frame, assigning sound to 202
- frame rate, animation and 156
- frames, time-coding 209–12
- generations, tape 115
- genlock
 - Amiga 11, 38–39, 61–63, 175
 - post-production and 105–7
- genlock/encoders, list 227–29
- genlocking, example of 107
- graphics
 - Amiga, basic 30–35
 - Amiga, broadcast tips for 206–7
 - multitasking 153
 - software 145–53
 - software, Amiga 6
- HAM (Hold-and-Modify) 34–35, 36, 109
 - files 152–53
 - paint colors 137
 - painting 148–49, 176
- hardware
 - Amiga 40–42
 - DTV 42–65
 - DTV, Amiga-specific 61–65
- headphones 182
- home video, DTV and 6
- horizontal blanking interval 21
- hue 21, 135
- IFF (Interchange File Format) files
 - 110, 152–53, 196
- ILBM (Interleaved Bitmap) format 152
- image mapping 149
- image processing 151–52
 - algorithms 151
 - software 8, 69–70, 238–39
- insert audio 187–88
- insert editing 112–15
 - cost of equipment 114–15
 - system, desirable features of 113
- Instant Music* program 191–93, 196
- insurance 84
- Interchange* program 175
- interlacing 16, 33–34, 109
 - preferable for DTV 33–34
- interpretive dissolve 106
- intuition operating system 28
- keyer 60–61
- key light 98
- lathing 168
- lavalier microphone 180–81
- lighting 97–101
- light types 97
- location release 84
- log list 117
- logging 116–17
- luminance 21, 25
- M-II format 45–46
- Magni genlock 105

- memory, Amiga 30
- memory requirements 41
- metamorphosis 173
- Microfiche Filer Plus*
 - program 115, 117
- microphone 180–81
 - cardioid 181
 - impedance of 181
 - lavalier 180–81
 - omnidirectional 180
 - positioning 183
 - shotgun 180
- MIDI (Musical Instrument Digital Interface) 197–99
 - list 229–30
 - software 198–99
- MIDI Recording Studio* program 198–99
- monitors, Amiga 41
- montage 121
- MRI scanner 9
- MTC (MIDI Time Code) 211–12
- multiple cameras 94–95
- multitasking 28
- music copyright 191
- music software 191–97, 240–42

- nanosecond measurement 32–33
- NTSC 26. *See also* composite video
 - Amiga and 205
 - color bars, making 147–48
 - countries that use 259–60
 - limitations of 205
 - standards 63, 203

- object
 - building 167–69
 - hierarchies 173–74
 - movement 171–74
 - primitives 168
 - surfaces 168–69
- omnidirectional microphone 180
- 1/2-inch tape format 45–46
- 1-inch 43–44
- overscan 35, 206
 - screen dimensions 36

- pacing 120–21
- page-flipping 156, 159–61
- PageFlipper Plus F/X* program 159
- paint
 - effects 149–51
 - program, advanced features of 146
 - program, desirable features of 145
 - programs 65–67, 239–40
- paintbox. *See* paint program
- PAL video standard 24
- pan 91–92
- PC, evolution of 1–2
- pedestal 21

- periodicals 222–24
- persistence of vision 155
- personal appearance 102
- perspective 149–50
- perspective animation 162–64
- Photon* paint program 66
- Photosynthesis* image processing program 151
- picture information, in Amiga 30
- pixelization 131
- pixels
 - in Amiga 30
 - in camcorder 14–15
- pixel shape, optimum 33
- playback, VCR 20
- polygons 157, 167
- post-production 75, 104–26
 - audio and 186–89
 - broadcast 212–18
 - broadcast audio 216–18
 - commercial facility, working with 214–16
 - equipment, broadcast 213–14
- pre-production 76–85
- pre-roll 113, 114
- proc amp (processing amplifier) 38, 61, 213
- production 75, 85–103
 - programs 69
 - stages of 76
- ProMIDI Studio* program 198
- ProVideo CGI* program 143
- punch and crunch editing 112

- raster 16
- ray-traced rendering 170
- ray-tracing 41
- reaction shot 96
- reference black level 21
- rendering 170–71
 - time spent in 175
- research, DTV and 8–9
- resolution, Amiga, limitations of 32
- resolution lines 26
- reverb 189
- RGB
 - component color monitors 35
 - encoder 38
 - format, Amiga, converting to 61
- RIFF files 175
- rough cut 116, 118
- RS-170A video. *See* composite video

- safe image area 131
- safe title area 131
- sans-serif 141
- saturation, color 135
- Say command, CLI 190
- scene editing, animated 169–70
- scheduling shoot 82
- screen formats, Amiga 33–35

- script 77–82
- Sculpt-Animate* 3D program 167–70
- SECAM video standard 24
- serif 141
- service organizations, list 244–45
- shadow mask 17
- shotgun microphone 180
- shots, types of 90–91
- sidebands 25
- signal, tips for maximizing 71–73
- single-frame controllers 59–60
- single-frame recording 176–78
- site fee 84–85
- slideshow programs 67–68
- SMPTTE time code 117, 209–12, 217
- SMUS sound files 196
- software
 - animation 233–37
 - character generation 237–38
 - DTV 65–70, 233–44
 - graphics 145–53
 - image processing 8, 69–70, 238–39
 - music 191–97, 240–42
 - solid model rendering 170
- Sonix* program 193–96
- sound
 - and music, matching 200–201
 - assigning to frames 202
 - file formats 196–97
 - recording in production 182–86
 - software 240–42
 - tracks 181–82
- special effects generators (SEG) 60–61
- specifications, Amiga 28
- speech 102
- spline 172
- split screens 134–35
- storyboard 80
- studio, setting up 70–74
- Super-VHS tape format 25, 45
- SuperGen genlock 105–7
- switcher 60
- synchronization, video signal 21–22
- system requirements 40–42
- systems list, Amiga 224–25

- talent 101–2
 - broadcast production and 207–9
- tape
 - blacked master 87–88, 109
 - care of 51
 - copying 27
 - format summary 47
 - format, Super-VHS 25, 45
 - 1/2-inch format 45–46
 - 1-inch format 43–44
 - preparing 86–88
 - speed 19
 - 3/4-inch format 44
- tracks 20
- transferring animation to 175–77
 - which to buy 50–51
- teleprompter, Amiga as 144–45
- text
 - design, principals of 139
 - over live video 143–44
 - size, changing 141
- 3-D design software 233–37
- three-dimensional animation 68–69, 158–59, 167–78
- tiling 149
- tilt 92
- time base corrector 213–14
- time-code 209–12
 - advantages of 211
 - equipment, list 230–31
- titles, moving 142–43
- titling 107–8, 139–45
 - Amiga and 108
 - programs 67
- transitions
 - digital 123–26
 - visual 121–26
- tripod 89, 92–93
- tube, camera 53
- Turbo Silver* program 167
- tweening 157
- two-shot 133–34
- two-dimensional animation 68–69, 158–66
- typeface. *See* font

- value, color 135
- VCR
 - choosing 48–51
 - consumer 2
 - described 18–20
 - features needed in 48–51
 - types of 43–48
- vectors 22–23
- vertical blanking interval 21–22
- VHS 45–46
- video
 - an analog operation 12
 - art, DTV and 9
 - as a business presentation tool 7
 - democratization of 4
 - design, elements of 127–45
 - digitizers 231–33
 - displays, features needed in 56–58
 - displays, types of 56–57
 - editing, historical 1
 - heads 19
 - how it works 13–25
 - production software 242–43
 - resolution, Amiga 30–32
 - signal, described 20–25
 - sources, multiple, synchronizing 39
 - storyboard. *See* animatic

Index

Video Titler program 67, 141–42
videodisc players 58–59
 controlling with Amiga 115
VideoScape 3-D program 167, 171–72
videotape, structure of 18
viewfinder 15–16, 54
voices, Amiga 193

warping. *See* image mapping
waveforms 22–23
windows, moving 164–66

wipe 122–23
wipes, diagram 123
wire-frame rendering 170
workbench, Amiga 28

Y part of video signal 21

Zoetrope program 159, 175
zoom 93–94
zoom effects, paint 150–51





Since its introduction to the computer marketplace, the Amiga has been the machine of choice for many commercial artists, designers, and architects. Recent advances in hardware and software have enlarged its user base to include video professionals and hobbyists. Even in video shops filled with sophisticated and expensive high-end systems, the Amiga is often chosen first when an outstanding product is required.

Not only is the machine marvelously adapted to video creation, there are more programs for 3-D and cel animation, character generation, ray-tracing, and storyboarding for the Amiga than for any other computer — including the Mac II.

Until now, there has been no manual that does full justice to the Amiga's video capabilities. Steven Anzovin fills a real need with this comprehensive guide and reference. The author covers literally *everything*. He begins with the basics of choosing hardware and software, and developing a complete DTV (Desktop Video) system. He covers production planning and development, scoring, and suggested applications in business, the graphic arts and education. He gives special attention to consumer applications like titling. Other topics include:

- Composing and using color
- Creating animation
- Combining audio and video
- Composing Amiga music
- Creating 3-D Graphics

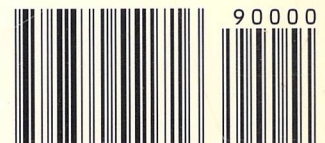
Steven Anzovin owns his own video production company and uses his Amiga to create animated graphics for industrial video productions. He has written a number of computer books, the most recent of which is the second edition of *Using Deluxe Paint* (COMPUTE! Books, 1989), which is generally acknowledged to be the premier book in its field.

COMPUTE! Books
Radnor, Pennsylvania

\$19.95

Higher in Canada

ISBN 0-87455-171-4



9 780874 551716