

This book is a collection of ready-made machine language routines that show how to achieve spectacular effects on the Spectrum.

Most of the routines are aimed at creating visual displays that are at the frontiers of Spectrum's capabilities. The routines include features that have never been published before, such as:

- Full Screen Horizon!  
Lets you change the colour of the border and screen at any point, and move this horizon at will!
- Interrupt Driven Sprite Animation!  
Animate objects with perfectly flicker-free movement by pixels!
- High Resolution Colour!  
Create an area on the Spectrum with eight times the normal Spectrum's Colour Resolution!
- Full Screen Images!  
Create images over all of the screen area, including all regions of the border!

This book is for programmers with some experience in machine language programming. All the routines are listed in labelled assembly language and the techniques and principles involved are fully explained.

Other routines included in this book are PRINT, PLOTTING, DRAWING and KEYBOARD SCAN. The routines are all of professional quality and do not involve any calls to the ROM. This means that the speed of your machine language programs can be dramatically increased using these routines.

This book gives a unique insight into the Spectrum and into a professional's machine language programs. All the routines are designed with maximum flexibility for inclusion into your own programs, and in addition, the listings contain exhaustive explanatory comments, so that you can 'learn by example'.



ISBN 0 86161 160 8

ISBN 0-86161-160-8



9 780861 611607

ADVANCED SPECTRUM MACHINE LANGUAGE DAVID WEBB

# ADVANCED SPECTRUM MACHINE LANGUAGE

Extend your Spectrum with ready-made machine language routines



# **ADVANCED SPECTRUM MACHINE LANGUAGE**

**DAVID WEBB**



Melbourne House

Published in the United Kingdom by:  
Melbourne House (Publishers) Ltd.,  
Church Yard,  
Tring, Hertfordshire HP23 5LU.

Published in Australia by:  
Melbourne House (Australia) Pty. Ltd.,  
Suite 4, 75 Palmerston Crescent,  
South Melbourne, Victoria, 3205.

ISBN 0 86161 160 8

Copyright © 1984 by David Webb.

All rights reserved. This book is copyright. No part of this book may be copied or stored by any means whatsoever whether mechanical or electronic, except for private or study use as defined in the Copyright Act. All enquiries should be addressed to the publishers.

Printed in Hong Kong by Colorcraft Ltd.

The terms Sinclair, ZX, ZX80, ZX81, ZX Spectrum, ZX Microdrive, ZX Interface, ZX Net Microdrive, Microdrive Cartridge, ZX Printer and ZX Power Supply are all Trade marks of Sinclair Research Limited.

DCBA9876543210

# Contents

<b>Preface</b>	.....	1
<b>Introduction</b>	Assumptions made for the use of this book .....	2
<b>Chapter 1</b>	Screen Addressing .....	4
<b>Chapter 2</b>	Developing a PRINT Routine .....	13
<b>Chapter 3</b>	Plotting and Drawing .....	19
<b>Chapter 4</b>	Producing Animated Loading Screens .....	29
<b>Chapter 5</b>	Scanning the Keyboard .....	33
<b>Chapter 6</b>	Player-Selectable Control Keys .....	41
<b>Chapter 7</b>	Everything you should know about Interrupts .....	46
<b>Chapter 8</b>	A Discussion of Pixel Animation Techniques .....	53
<b>Chapter 9</b>	An Interrupt-Driven Print-Processor with Full-Screen Horizon Generator .....	57
<b>Chapter 10</b>	Moving the Full-Screen Horizon by Pixels .....	79
<b>Chapter 11</b>	A Suite of Routines to Complement the Print-Processor .....	93
<b>Chapter 12</b>	Perfectly Flickerless Sprite Pixel-Animation .....	112
<b>Chapter 13</b>	High-Resolution Colour .....	162
<b>Chapter 14</b>	Producing Full-Screen Images with the Border .....	173
<b>Appendix A</b>	A List of All Principle Routines .....	197
<b>Appendix B</b>	Recommended Reading .....	199
<b>Appendix C</b>	Recommended Assemblers and Monitor/Disassemblers .....	200

# Preface

Practically the only branch of Spectrum programming not extensively and comprehensively covered by a plethora of books is that of advanced Spectrum machine language programming. With this book I hope to remedy the situation.

By 'advanced' programming I mean the type of top-level machine language behind many of the most successful Spectrum games. Indeed, some of the techniques produced in this book are completely original and beyond anything seen in Spectrum games at the time of writing. As an example, I cite the high-resolution colour routines, and the suite of routines which allows you to produce full screen pictures over the border. Neither of these special effects has ever been seen in public before.

It is only fair to warn you that this book is not intended for beginners — there are plenty of good publications already available for newcomers to Spectrum machine language — and this book assumes a full understanding of Z-80 instruction code right from the start. This makes it possible for me to take you to the very frontiers of state-of-the-art Spectrum programming, extending them as we go. I hope you will enjoy and benefit from the experience.

I would like to acknowledge the contributions of the following people:

- Mum and Dad, for eighteen years of immeasurable patience.
- My publisher, Fred Milgrom, and all those at Melbourne House involved in the production work for this book.
- John, Deb, Brian, Dermot and Nobby for their support and encouragement.

Finally, I dedicate this book to the six of clubs; and that's known as dropping a good clanker.

DAVID M. WEBB  
Exeter College,  
Oxford.  
February, 1984.



# Introduction

## Assumptions Made for the Use of This Book

The very title of this book indicates that it does not set out to teach elementary machine language. I am assuming that the reader at least has a grasp of the fundamentals of, and preferably a proficiency in, Z-80 Programming. It is not, however, essential to have learnt or practised machine language on the Spectrum to any great extent; all the peculiarities specific to the Spectrum will be described in detail, without assuming any previous knowledge of them.

To write anything but the shortest of machine language programs one should be using an assembler, and I am therefore presuming that you either already have one or are prepared to make the very worthwhile investment in one. All of the listings in this book are in assembly language, but I have deliberately restricted the use of 'pseudo-instructions', (i.e. those not in the standard Z-80 instruction set) to the ORG, DEFB, DEFW and EQU operations, which any assembler worth its tape should be capable of handling.

Your assembler should be capable of calculating forward and backward relative jumps, and of handling labels, which should preferably be six or more characters in length.

At the head of each listing will be a set of comments informing you of any parameters that the registers should hold on entry to the routine. Also listed will be any significant values held in the registers on exit, and a comment on which registers are preserved in value. Unless stated otherwise, you can assume that the alternate registers AF', BC', DE', HL', the stack pointer SP, the index registers IX and IY, and the interrupt vector register I are all preserved by the routine.

Similarly, unless stated otherwise, you should assume that the registers A, F, B, C, D, E, H and L are all destroyed by calling the routine. The program counter is, of course, preserved on the stack by a CALL.

The multitude of explanatory comments that are integrated into all but the simplest of routines in this book are provided for your own benefit, in the hope that you might gain the enlightenment of learning by example. They are, of course, entirely non-functional to the routines, and may be omitted when you enter the listings into your computer, just as one would omit BASIC REM statements to conserve memory.

Any numeric values printed herein will, by default, be in decimal, unless followed by an 'H' or the abbreviation 'Hex.' for hexadecimal, or by the word 'binary' when using base two.

You are now equipped with the knowledge necessary to use the rest of this book. One word of advice, though; it is intended that the user read in the general direction 'front to back', since many of the latter programs contain references to material printed earlier on in the book.

# CHAPTER 1

## Screen Addressing

I start this chapter by clarifying what is otherwise a frequent source of confusion. Throughout this book I shall refer to the Spectrum display as having twenty-four LINES, each line having eight ROWS of pixels, rather than twenty-four rows of eight pixel lines. Thus we see that the text area of the screen has  $24 \times 8 = 192$  rows on it.

That technicality out of the way, let me continue with a discussion of how to calculate the text address of any of the 768 ( $24 \times 32$ ) CELLS on the screen.

It cannot have escaped your notice that the display file is laid out in a somewhat unusual way in memory. A quick POKE around with this program will show you what I mean.

```

10 REM TO DEMONSTRATE MEMORY LAY-OUT
   OF TEXT
20 FOR A=0 TO 6143
30 POKE 16384+A,255
40 NEXT A
50 PAUSE 0

```

In fact, the display file resides at addresses 4000H to 57FFH in the following manner. Each row has 32 columns in it and each column is 8 pixels wide. Since there are 8 bits in a byte, each column of each row is represented by one byte. The 32 bytes of each row are, as you would expect, stored consecutively in memory, reading from left to right. First to be stored (from address 4000H) is row 0 of line 0. Next comes row 0 of line 1, and so on down to row 0 of line 7. Then, instead of finding row 0 of line 8, we have row 1 of line 0, down to row 1 of line 7. The pattern

continues down to row 7 of line 6, then row 7 of line 7. At this stage, 2K of memory has been allocated, and we find that the entire top third of the screen is mapped.

The pattern described above is then repeated for the middle and bottom thirds of the screen, each consuming 2K of RAM. A rather happy consequence of having the three thirds of the screen in separate blocks of memory is that we can perform partial SAVE...SCREEN\$ commands. The numbers required for this are as follows:

	START ADDRESS	LENGTHS
TOP THIRD	16384	2k=2048 BYTES
MIDDLE	18432	4k=4096 BYTES
BOTTOM	20480	6k=6144 BYTES

So to SAVE the bottom two thirds of the screen (of length 4K),

```
SAVE "(NAME)"CODE 18432,4096
```

Since the display file is contained within 8K of RAM from 4000H, the left-most three bits of any address in it are always 010. The complete pattern is composed as seen in this diagram:

Display File Address

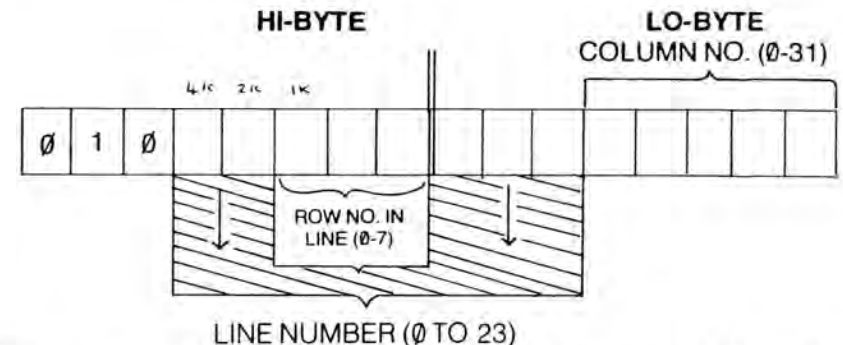

The advantage of this layout is that we can step through the addresses of the eight rows of any screen cell simply by incrementing the hi-byte of the original address, rather than adding 32 to the whole address, as would be required in a 'normal' layout. This allows for that extra touch of speed in one-cell printing routines.

Now, I hear you ask, 'What's the easiest way to calculate the address of a cell?' Well, you could do a lot worse than this routine, called DF-LOC for Display File LOCation. It is worth noting that the routine will produce a

logical address for any line number entered in the B register, whether or not it is in the range of 0-23. This can be useful if, for example, you want to work down from the logical start of a 2x2 character block, the top line of which is off the top of the screen. Simply enter B=255 (for -1, the number of the line above the screen) and call DF-LOC as usual.

```

;ENTRY : B=LINE,C=COLUMN
;PRESERVED : BC,DE
;EXIT: HL=ADDRESS IN DISPLAY FILE, A=L
78 DF-LOC LD A,B
E6F8 AND 0F8H
C640 ADD A,40H
67 LD H,A
78 LD A,B
E607 AND 7
0F RRCA
0F RRCA
0F RRCA
81 ADD A,C
6F LD L,A
C9 RET

```

To turn the routine into a kind of PRINT AT, you could add the line

```
LD (5C84H),HL
```

before the RET statement, to load the system variable DF-CC with the address to be next used by some printing routine.

Before moving on to a discussion of the attribute file, I ought to provide a routine to clear the display file, DF-CLS. It works by filling the first byte with a zero, and then using the powerful LDIR instruction to 'copy' the contents of that byte to the one above it, repeating Hex. 17FF times to fill the entire display file with zeroes. This technique should always be used whenever one needs to fill a block of memory with one particular byte.

Notice the use of the instruction

```
LD (HL),L (Since L = 0)
```

which is faster and occupies less memory than

```
LD (HL),0
```

```

;PRESERVED : A
;EXIT : BC=0, DE=5800H, HL=57FFH
;

```

```

210040 CLS-DF LD HL,4000H
01FF17 LD BC,17FFH
75 LD (HL),L
54 LD D,H
1E01 LD E,1
EDB0 LDIR
C9 RET

```

Obviously and in a similar way to the partial SAVE SCREEN\$ command described earlier in this chapter, you could adapt the routine to clear only part of the screen. Some useful numbers are these Hex. start addresses and lengths:

	ADDRESS		VALUE FOR BC
TOP THIRD	4000H	ONE THIRD	07FFH
MIDDLE	4800H	TWO THIRDS	0FFFH
BOTTOM	5000H	WHOLE SCREEN	17FFH

So to clear the bottom two thirds of the screen, use the lines

```
LD HL,4800H
LD BC,0FFFH
```

The attributes of the Spectrum display file are those bytes which are responsible for the colours of the INK and PAPER and the state of BRIGHT and FLASH in each character cell of the screen. Consequently there are 768 bytes in the attribute file, and they are laid out logically as 24 groups of 32 bytes, one for each column, reading from left to right across the screen.

The following routine will find the address of the attributes of any cell on the screen and is called ATTLOC for ATTRibute LOCator.

```

;ENTRY : B=LINE, C=COLUMN
;PRESERVED: BC,DE
;EXIT : HL=ADDRESS IN ATTRIBUTE FILE, A=L
78 ATTLOC LD A,B
CB2F SRA A
CB2F SRA A
CB2F SRA A

```

```

C658      ADD     A,58H
67        LD      H,A
78        LD      A,B
E607      AND     7
0F        RRCA
0F        RRCA
0F        RRCA
81        ADD     A,C
6F        LD      L,A
C9        RET

```

Notice the use of SRA A to sign-extend the value in A as it is shifted rightwards. This allows the routine to produce, as in DF-LOC, a logical address given any line number in B (range -128 to +127).

The logical extension of the routine to produce the ATTR (Y, X) function is to add the instruction

```
LD      A, (HL)
```

before the RET, returning the attribute in the A register.

I have included a couple of routines to convert between display file and attribute file addresses, which may be useful if you have one but not the other. The first routine, DF-ATT will find the address of the attribute covering any byte in the display file, regardless of whether it is on row zero of a line.

```

;ENTRY: HL=D.F. ADDRESS
;PRESERVED: HL,BC
;EXIT: DE=ATTR. ADDRESS, A=D
DF-ATT LD      A,H
0F        RRCA  -8 to create
0F        RRCA  256 blocks for
0F        RRCA  each 1/3 of screen
E603      AND     3  allows 256 block
F658      OR      58H to be added to
57        LD      D,A base of ATTR
5D        LD      E,L DE set to
C9        RET      individual cell
                address. D = base,
                E cell within 256.

```

The opposite routine is ATT-DF, which finds the address of the first row of a cell in the display file, given the address of its attributes.

```

;ENTRY: HL=ATTR. ADDRESS
;PRESERVED: HL, BC
;EXIT: DE=D.F. ADDRESS, A=D
ATTDF LD      A,H
E603      AND     3  Preserve Lsb of H
07        RLCA  which are then shift of H
07        RLCA  3 times before being added
07        RLCA  to 40H to give base for
F640      OR      40H each 1/3 of screen.
57        LD      D,A DE set to individual
5D        LD      E,L display file address.
C9        RET      D = base, E = character
                within 256.

```

To complete the set of 'Locator' routines, I have included a multi-purpose piece that returns the address of a cell in the display file, stores it in a variable labelled DFCC, returns the address of its attributes, and finally the actual attributes, in the accumulator. I have called the routine LOCATE.

```

;ENTRY: B=LINE, C=COLUMN
;PRESERVED: BC
;EXIT: HL=D.F. ADDRESS, DE=ATTR.
ADDRESS, A=ATTR(B,C)
;DF-CC IS ALTERED
;
DFCC EQU     5C84H
;
LOCATE LD      A,B Set A to line number
E618      AND     18H Set A, then 18 to 40H
67        LD      H,A to reflect top
CBF4      SET     6,H middle or bottom 1/3 of
0F        RRCA  line
0F        RRCA  Convert to 1/3 of
0F        RRCA  line number. Set H to
F658      OR      58H or 58H
57        LD      D,A Debounce ATTR base
78        LD      A,B Set A to line number
E607      AND     7  Converts line number
0F        RRCA  within individual 1/3
0F        RRCA  of screen and adds
0F        RRCA  column value to
81        ADD     A,C give L
6F        LD      L,A HL = DF address

```



```

5F      LD      E,A      DE = A TOP address
1A      LD      A,(DE)   A = current attribute
22845C  LD      (DFCC),HL  DE = A pointer
C9      RET

```

As I mentioned, the attributes of each cell tell you its INK and PAPER colours and its state of BRIGHT and FLASH. The bit pattern associated with this is shown in the diagram.

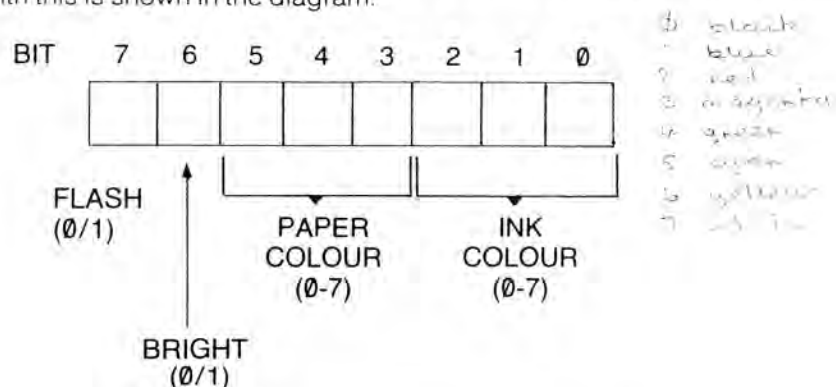

Hence the pattern for FLASH 1, BRIGHT 0, INK 3, PAPER 6 would be 10110011, or Hex B3.

We can 'clear' the attribute file by filling it with any bit-pattern using the following routine, CLSATT, which works in a very similar way to CLS-DF.

```

;ENTRY: A=SCREEN ATTRIBUTE
;PRESERVED: A
;EXIT: BC=0, DE=5B00H, HL, 5AFFH
;
210058  CLSATT LD      HL,5800H  Start address of attribute file
01FF02  LD      BC,02FFH  No of attributes to be filled
77      LD      (HL),A  Content of first attribute filled
54      LD      D,H  address filled
1E01    LD      E,1  DE save to 5B01H
EDB0    LDIR   (DE)←(HL), DE=DE+1, HL=HL+1, BC=BC-1
C9      RET

```

Hence to reset the attributes to their initial condition (FLASH 0, BRIGHT 0, PAPER 7, INK 0),

```

LD      A,38H  3E 38
CALL   CLSATT  CD - -

```

I have also included a combination of CLS—DF and CLSATT which clears the display file and sets the attributes to a given value. The routine is called CLS, for obvious reasons.

```

;ENTRY: A=SCREEN ATTRIBUTE
;PRESERVED: A
;EXIT: BC=0, DE=5B00H, HL=5AFFH
;
210040  CLS   LD      HL,4000H  Start address of display file
010018  LD      BC,1800H  No of attributes to be cleared + 1
75      LD      (HL),1  All cleared + 1
54      LD      D,H  Memory address
1E01    LD      E,1  Start of memory
EDB0    LDIR   to give start address of attribute file
77      LD      (HL),A  Content of attribute combination
01FF02  LD      BC,02FFH
EDB0    LDIR   combination of attribute file
C9      RET

```

My final point about screen addressing is the control of the border colour. The current border colour on the Spectrum screen is usually held as bits 3, 4 and 5 of the system variable BORDCR, address 5C48H.

However, altering this address from machine language has no effect on the border colour, it simply changes the value held at 5C48H. To change the border, we must reset bit 0 of the address bus and then output the new colour number on the data bus. In order not to affect any other devices attached to the user port, we SET the other seven bits of the lo-byte of the data bus, giving us the pattern 1111 1110 in binary, or FE in Hex.

Hence to change the border colour to red (value 2) we use the sequence

```

LD A,2
OUT (0FEH),A

```

I should point out that the border colour only consumes bits 0, 1 and 2 of the data bus. In fact, bit 3 controls the MIC and EAR outputs, and bit 4 the loudspeaker. Altering the state of these (COMPLEMENTING them) causes a 'click' to be sent to the MIC and EAR sockets or heard on the speaker.

It is good programming practice to 'mask off' those bits not needed to alter the border colour, so that their state is maintained and no extraneous clicks are heard on the loudspeaker. If we store the last value sent to port 0FEH in the variable BORD, then to change the border colour, this program segment is applicable:

```

LD      A, (BORD)  Load border value
AND     0F8H      Mask out all but the
OR      <NEW BORDER VALUE>  Replace border
OUT     (0FEH), A  Write new border value
LD      (BORD), A  Store new border value

```

If you have a spare register pair such as HL then it is slightly faster and more economical to use

```

LD      HL, (BORD)
LD      A, (HL)
AND     0F8H
OR      (NEW BORDER VALUE)
OUT     (0FEH), A
LD      (HL), A

```

While on the subject, an interesting quirk of Z-80 machine language is that, unlike most other instructions, it is actually quicker to use immediate data rather than a register as the port number when outputting from the accumulator. That is to say.

```

OUT     (0FEH), A    TAKES 11 T-STATES , while
OUT     (C), A       TAKES 12 T-STATES

```

This can make quite a difference when very high speed output is required, as will be seen later in this book.

## CHAPTER 2

# Developing a PRINT Routine

The printing routines in the Spectrum ROM are decidedly slow and tedious to use. This is a consequence of the RST 10H instruction being used for so many different printing functions. Once called, the routine has to decide, amongst other things, whether you are printing in the INPUT area, the top part of the screen or on the printer, whether you are trying to change the INK or PAPER colour or to execute some other control such as a TAB or AT function; and whether you are printing a 'normal' character, a 'chunky graphic' character or a user-defined graphic character. On top of all this, by the nature of BASIC, the routine also spends time carrying out a series of error-checks that we can do without in a machine-code program.

It is thus imperative that we develop our own, customised printing routine, and that is what I shall be doing in this chapter.

The process of printing a character can be broken down into three stages. First we locate the address of the character data (the eight bytes whose bit patterns define the character), then we copy this data to the required screen cell, and finally we change the attributes of that cell as required.

You are no doubt familiar with the concept of leaving certain attributes of a cell as they are by the use of INK 8, PAPER 8, FLASH 8 and BRIGHT 8 when printing a new character in that cell. These BASIC functions are easily performed in machine language by what is known as MASKING off individual bits of the 'old' attribute byte when printing a 'new' character.



We shall use a one-byte variable, ATT, to hold the new attributes for the character to be printed, and a second byte, MASK, to hold the mask for the old attributes. For each bit of the old attributes that we want preserved, we set the corresponding bit of MASK to 1. Suppose that we just want the BRIGHT bit to be masked (i.e. BRIGHT 8). Then referring to the attribute bit-pattern in chapter one, we see that BRIGHT occupies bit 6. So we set bit 6 of our mask, and have the pattern 0100 0000, or Hex. 40 so we equate the variable MASK to Hex. 40.

If we examine the 8 values that represent the set of INK and PAPER colours more closely, we find that they are allocated to the colours in an extremely logical way. All colours are combinations of the three primary colours, blue, red and green, and each of these colours has been allocated one of the three bits in each of the INK and PAPER patterns. This makes life easier for the celebrated ULA chip, which crudely speaking has to forward these bits to the blue, red and green electron guns which then fire pixels onto your colour telly screen.

Blue is allocated to the lower of the three bits (value 1), then red (value 2) then green (value 4). Thus the INK and PAPER bit patterns look like this:



and the complete attribute (and mask) pattern is as given:

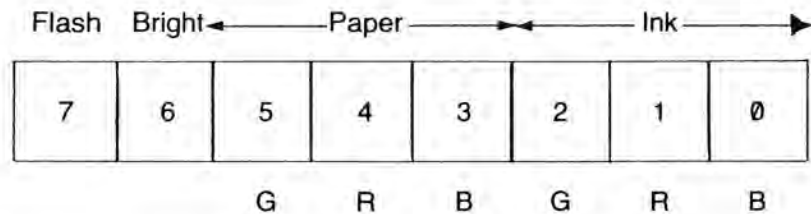

Whenever a primary colour is required to make up another colour, then its bit is set. Thus cyan, which is a mixture of green and blue, has the binary pattern

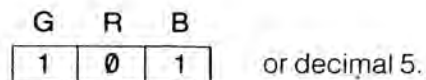

White is the combination of all three primary colours, and so has the pattern

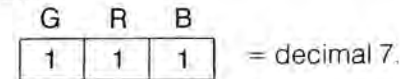

while black is a total absence of colour, and is thus represented by:

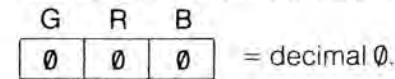

Incidentally, there is no difference between bright black (with BRIGHT 1) and dark black (BRIGHT 0). You can check that this is the case by doing

```
BORDER 0: PAPER 0: BRIGHT 1: CLS
```

On entering this line the border and text area will become indistinguishable in colour.

An advantage of having the colour values allocated so logically is that you can mask off individual primary colours or combinations of them, rather than being restricted to masking all three bits, which is all that INK 8 and PAPER 8 offer from BASIC.

Having obtained values for ATT and MASK, we are ready to create the new attribute byte for a cell. Loading the old attributes into the accumulator, the quickest way to perform the operation is:

```
XOR    ATT
AND    MASK
XOR    ATT
```

The new attribute byte is now ready to be placed in the attribute file. You will see such a program fragment appearing in the following print routine.

We shall store the base address of the character data to be used in the two-byte variable BASE. This should point at row zero of the first character in your set. I have made provision for up to 256 characters, and since each requires 8 bytes, a full set will need 2K of memory. In the unlikely event that more than 256 characters are required, you will need two bytes to represent each character, and you could use the hi-byte to indicate which value of BASE is required, then call the same print routine.

The Spectrum has the bit-patterns for 96 of its characters in ROM, ranging from SPACE to the copyright symbol. This data occupies the last 768 bytes of the ROM, from address 3D00H.

The system variable CHARS on page 173 of the Spectrum manual is quoted as holding '256 less than address of character set'. This may seem a little odd, until you realize that the first character, a space, is represented numerically by 20H, or 32 decimal. Now  $32 \times 8 = 256$ , so by setting CHARS TO 256 less than the address of the character set, the Spectrum can find the address of a character just by multiplying its code by 8 (rows) and adding it to CHARS.

In the PRINT 1 routine you will notice that I have initialized our variable BASE to 3C00H, so normal CODE values for the Spectrum character set are applicable. I have also placed ATT immediately before MASK, so that the two can be accessed with one LD instruction.

Lookup Table

```

;ENTRY: A=CHAR. CODE
;PRESERVED: C
;EXIT: B=0, DE=ATTRIBUTE ADDRESS
;
003C    BASE    DEFW    3C00H  ; CHARS = 3C00H
0040    DFCC    DEFW    4000H
38      ATT     DEFB    38H
00      MASK    DEFB    0
;
;CONSTRUCT CHARACTER DATA ADDRESS
6F      PRINT1  LD      L,A      ; Character code
2600    LD      H,0      ; code base
29      ADD     HL,HL    ; multiplied by 8
29      ADD     HL,HL    ; added 7 * 003C
29      ADD     HL,HL    ; to give us
ED5B0000 LD     DE,(BASE) ; character data address in ROM.
19      ADD     HL,DE
;TAKE DISPLAY FILE ADDRESS
ED5B0200 LD     DE,(DFCC) ; DE set to DFCC
0608    LD      B,8      ; B set for 8 rows
;PRINT CHARACTER ROW BY ROW
7E      NXTROW  LD      A,(HL) ; 1st byte in ROM
12      LD      (DE),A ; row jumped to display file ROM address
23      INC     HL      ; increment Display file
14      INC     D       ; incremented by 256.
10FA    DJNZ   NXTROW ; Relative jump backwards
;CONSTRUCT ATTRIBUTE ADDRESS until all 8 bytes
7A      LD      A,D     ; of character displayed.
0F      RRCA    ; Usually same routine as
; 38-ATT on page 7

```

```

0F      RRCA
0F      RRCA
3D      DEC     A
E603    AND     3
F658    OR      58H
57      LD      D,A
2A0400  LD      HL,(ATT)
;H=MASK, L=ATTRIBUTE
;TAKE OLD ATTRIBUTE
1A      LD      A,(DE)
;CONSTRUCT NEW ONE
AD      XOR     L
A4      AND     H
AD      XOR     L
;REPLACE ATTRIBUTE
12      LD      (DE),A
;FINALLY SET DFCC TO NEXT PRINT POSITION
210200  LD      HL,DFCC
34      INC     (HL)
C0      RET     NZ
23      INC     HL
7E      LD      A,(HL)
C608    ADD     A,8
77      LD      (HL),A
C9      RET

```

I made the assumption in the above routine that DF-CC had already been set to the correct address in the display file, by use of the LOCATE routine in Chapter 1 or otherwise. You will notice that it is updated to the next print position every time a character is printed.

As an example to show PRINT 1 in action, here is a routine to print out the character set from the ROM (codes 20H to 7FH). You will need the LOCATE routine of Chapter One.

```

;PRINT1 DEMO
;SET DFCC TO (0,0)
010000  LD      BC,0
CD0000  CALL   LOCATE
;SET BASE TO POINT AT ROM CHARACTER SET
21003C  LD      HL,3C00H
220000  LD      (BASE),HL
;NOW PRINT FROM CODE 20H TO 7FH

```

```

;REMEMBER PRINT1 PRESERVES THE C REGISTER
0E20          LD      C,20H
79          LOOP   LD      A,C
CD0000      CALL   PRINT1
0C          INC    C
;WHEN C BECOMES NEGATIVE (>7FH) THEN
;ALL IS DONE
F20E00      JP     P,LOOP
C9          RET

```

## CHAPTER 3 Plotting and Drawing

Many are the times when you may need to plot stars and positions on maps or draw laser rays. Here I shall develop a routine to let you plot anywhere on the screen, and one to draw, using absolute coordinates, a line between any two points on the screen. The routines are slightly faster than those in the BASIC ROM, since I have removed a lot of cumbersome error-checks.

The procedure needed to plot a point on the screen can be broken down into four stages. First, we find the address of the byte in the display file which holds the bit representing our 'target' pixel on the screen. Then we find the address of the attributes of the cell which the target pixel is in. We then change the attributes according to our standard variables ATT and MASK, and finally we make the actual plot, taking careful note of whether INVERSE 1 or OVER 1 is required.

I should remark at this point that given a byte in the display file, which represents one row of a cell, the left-most bit (BIT 7) represents the left-most pixel, while the right-most bit (BIT 0) represents the right-most pixel. A frequent programming error is to think that bit 0 represents the first (left-most) pixel. The easiest way to remember this is by visualizing this diagram:

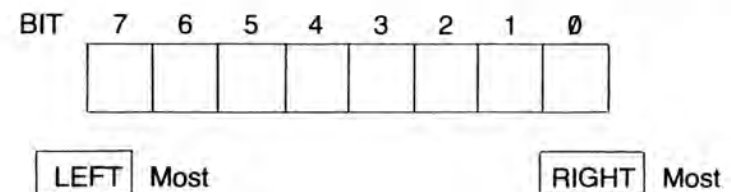

You will see that in the PLOT routine I find the attribute address by converting the display file address. This is much easier and quicker than going back to our original coordinates and calculating the address from them.

The routine decides whether to use OVER or INVERSE by referring to two flags in a one-byte variable called PFLAG. This is equivalent to the BASIC system variable of the same name at address 23697 (5C91 Hex.) We signify OVER 1 by setting bit 1 of PFLAG, and INVERSE 1 by setting bit 3.

Notice that I am employing a new coordinate system on the screen, which makes it easier and faster to calculate addresses. The top left-hand corner is (0, 0) while the bottom right-hand corner (including the INPUT lines) is (255, 191). Here, then, is the routine.

```

;ENTRY: H=X, L=Y
;PRESERVED: HL
;EXIT: DE=ADDRESS OF PIXEL IN DISPLAY FILE
;A=(DE), C=(PFLAG)
;TOP LEFT-HAND CORNER = (0,0)
;
;BIT 1 (PFLAG)=OVER
;BIT 3 (PFLAG)=INVERSE
;
38  ATT  DEFB  38H
00  MASK  DEFB  0
00  PFLAG  DEFB  0
;
;FIND ADDRESS OF REQUIRED BYTE IN D.F.
7D  PLOT  LD  A,L
E6C0  AND  0C0H
1F  RRA
37  SCF
1F  RRA
0F  RRCA
AD  XOR  L
E6F8  AND  0F8H
AD  XOR  L
57  LD  D,A
7C  LD  A,H
07  RLCA

```

```

07  RLCA
07  RLCA
AD  XOR  L
E6C7  AND  0C7H
AD  XOR  L
07  RLCA
07  RLCA
5F  LD  E,A
;ADDRESS IS STORED IN DE
D5  PUSH  DE
;FIND ATTRIBUTE ADDRESS
7A  LD  A,D
0F  RRCA
0F  RRCA
0F  RRCA
E603  AND  3
F658  OR  58H
57  LD  D,A
ED4B0000  LD  BC,(ATT)
;CHANGE ATTRIBUTE
1A  LD  A,(DE)
A9  XOR  C
A0  AND  B
A9  XOR  C
12  LD  (DE),A
;RETRIEVE D.F. ADDRESS
D1  POP  DE
7C  LD  A,H
E607  AND  7
47  LD  B,A
04  INC  B
;B HOLDS (TARGET BIT NUMBER)+1
3EFE  LD  A,0FEH
;ROTATE A WINDOW TO THE TARGET BIT
PLOOP  RRCA
10FD  DJNZ  PLOOP
47  LD  B,A
3A0200  LD  A,(PFLAG)
4F  LD  C,A
;TAKE BYTE FROM D.F.
1A  LD  A,(DE)
;CHECK FOR OVER 1

```



```

CB49          BIT      1,C
2001          JR       NZ,OVER1
A0           AND      B
              ;CHECK FOR INVERSE 1
CB59          OVER1   BIT      3,C
2002          JR       NZ,INV1
A8           XOR      B
2F           CPL
12          INV1   LD       (DE),A
C9           RET

```

The final portion of the routine, that does the actual 'plotting', merits a more detailed explanation. Ignoring what happens to the other seven bits in our byte, since they are always unchanged in the end, let us examine the behaviour of the 'target' bit.

```
AND      B
```

makes the target zero if OVER 0 is selected. OVER 1 causes the instruction to be skipped.

```
BIT      3,C
JR       NZ,INV1
```

causes a jump to the end if INVERSE 1 was selected, leaving the bit as it was if OVER 1 was selected, or zero (PAPER) if OVER 0 was selected.

Finally, having 'narrowed down' our selections to INVERSE 0,

```
XOR      B
CPL
```

which may be thought of more clearly as

```
XOR      B
XOR      0FFH
```

leaves the bit complemented in the case of OVER 1, or set in the case of OVER 0. The byte is now replaced in the display file.

★★★★

Following on from the PLOT routine, I decided it would be a worthwhile exercise to develop our own machine-code DRAW routine. Although it uses the same algorithm as that in the Spectrum ROM, the routine will run somewhat faster due to the use of 'optimized' code and fewer error traps.

I shall be using absolute coordinates as the parameters for the routine, rather than the relative ones used in Spectrum BASIC. This is largely a matter of personal preference, and the routine is easily altered to provide relative drawing. As for the PLOT routine, the coordinates are assigned thus:

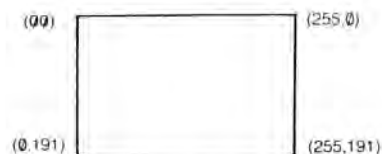

In order to discuss the drawing algorithm, let us assume that the line is from (X1, Y1) to (X2, Y2), both inclusive. Before going any further, the routine plots the first point on the line. Now some preparation is needed to decide which direction to draw in.

If (X2 - X1) is positive, we will be drawing to the right. If it is negative, then to the left. Similarly, if (Y2 - Y1) is positive, we will be drawing downwards, otherwise the direction will be upwards.

The routine loads the D and E registers with the unit changes in X and Y (respectively) related to the direction along each axis. For example, if we were drawing upwards and to the right, then the change in X would be positive (D = 1) and that in Y would be negative (E = -1). So the routine produces:

```
DE=01FFH
```

We now need to consider exactly how a line can be formed by making unit steps either horizontally, vertically or diagonally between points on a grid. A moment's thought reveals that, unless the two points at either end of the line are on a diagonal of pixels, we will need to combine a mixture of 'straight' steps and diagonal steps to draw the line. The routine allocates the BC pair as follows:

```
B=ABS(X2-X1)    C=ABS(Y2-Y1)
```

If B is greater than C, then we will need a mixture of horizontal and diagonal steps, thus:

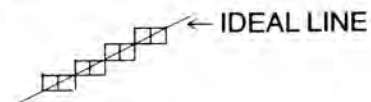

While if B is less than C, a mixture of VERTICAL and diagonal steps is required, such as this:

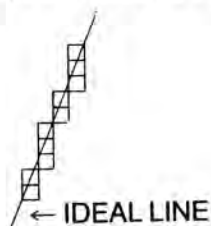

The routine decides whether we need vertical or horizontal steps, and stores the required value of DE, as explained earlier, in the variable VHSTP. The direction of the diagonal steps is stored in DIASTP.

The values in B and C are stored so that B is greater than or equal to C. We are now just about ready to begin plotting the line, which will have (B-C) straight steps, and C diagonal steps. In order to ensure that the straight and diagonal steps are evenly distributed, the following procedure is used.

B is copied to H, and then halved and copied to L. Now, entering the loop, C is added to L, and if the result equals or exceeds B, then it is reduced by B and a diagonal step is taken. Otherwise, a straight step is taken. A point is plotted, the counter in H is decremented and the loop is repeated until the line is complete.

What this loop can be thought of as, is continually adding C to itself and taking a diagonal step every time the result passes a new multiple of B. The reason L is initialized to  $\frac{1}{2} B$  is simply to ensure that the line is straight at the beginning.

Here at last is the DRAW routine; the most useful exit values are the coordinates of the last point plotted, in HL. Since HL also holds the coordinates of the first point of a line on entry to the routine, we see that it can be used without alteration between calls to the DRAW routine, to draw lines to, and then from, the same point. This facility will be heavily utilized in the demonstration program following the routine.

```

;ENTRY: H=X1, L=Y1, B=X2, C=Y2
;SO DRAWS FROM (H,L) TO (B,C) INCLUSIVE
;PRESERVED: NONE
;EXIT: DE IS THE ADDRESS OF THE LAST
;      PIXEL PLOTTED WHICH IS AT (H,L).
;      B IS THE GREATER, AND C IS THE
;      LESSER OF ABS(X2-X1) AND ABS(Y2-Y1).
;
;

```

*working Table*

```

0100 DIASTP DEFW 1
0100 VHSTP DEFW 1
;

```

```

C5 DRAW PUSH BC
;PLOT (X1,Y1)
CD0000 DRAW CALL PLOT
C1 POP BC
110101 LD DE,0101H
;DE HOLDS THE DIRECTION OF THE
;X AND Y STEPS
78 LD A,B
;GOING LEFT (-1), OR RIGHT (+1)?
94 SUB H
3004 JR NC,X2X1
15 DEC D
15 DEC D
ED44 NEG
47 X2X1 LD B,A
;B HOLDS NO. OF STEPS IN X
79 LD A,C
95 SUB L
;GOING UP (-1), OR DOWN (+1)?
3004 JR NC,Y2Y1
1D DEC E
1D DEC E
ED44 NEG
4F Y2Y1 LD C,A
;C HOLDS NO. OF STEPS IN Y
;CHECK THAT LINE ISN'T A POINT
B0 OR B
C8 RET Z
79 LD A,C
B8 CP B
E5 PUSH HL
;STORE THE DIRECTION OF A DIAGONAL STEP
62 LD H,D
6B LD L,E
220000 LD (DIASTP),HL
;DECIDE BETWEEN VERTICAL AND
;HORIZONTAL STEPS DEPENDING ON
;WHICH IS THE BIGGER OF B AND C
2E00 LD L,0
3804 JR C,BBC
65 LD H,L

```



```

6B      LD      L,E
48      LD      C,B
47      LD      B,A
;STORE THE V/H STEP
;
220200  BBC     LD      (VHSTP),HL
;
;B IS NOW )=C. THE ROUTINE TAKES B-C
;STRAIGHT STEPS AND C DIAGONAL ONES
60      LD      H,B
78      LD      A,B
CB3F   SRL     A
6F      LD      L,A
7D      NXTSTP LD      A,L
81      ADD     A,C
;DECIDE ON A DIAGONAL OR A STRAIGHT STEP
;THIS TIME
3803   JR      C,DIAG
B8      CP      B
3808   JR      C,VERHOR
90      DIAG   SUB     B
6F      LD      L,A
ED5B0000 LD     DE,(DIASTP)
1805   JR      STEP
6F      VERHOR LD     L,A
ED5B0200 LD     DE,(VHSTP)
E3      STEP   EX     (SP),HL
;MAKE THE STEP ALONG X
7C      LD      A,H
82      ADD     A,D
67      LD      H,A
;MAKE THE STEP ALONG Y
7D      LD      A,L
83      ADD     A,E
6F      LD      L,A
;THE ACTUAL PLOT!!!!!!
C5      PUSH   BC
CD0000  CALL   PLOT
C1      POP    BC
;RETRIEVE COUNTER
E3      EX     (SP),HL
25      DEC    H

```

```

20DC   JR      NZ,NXTSTP
E1      POP    HL
C9      RET

```

In the following machine language demonstration program, I have combined the use of CLS (see Chapter one) with PLOT and DRAW to produce a 24-line interference pattern, which I am reliably informed looks like a heavy paperweight on a soft cushion, from above.

If you are calling the routine with USR under direct command from BASIC, then it would be a good idea to follow the USR function with a PAUSE 0 statement, so that the bottom two lines of the pattern are not destroyed on return. The comments in the listing should provide adequate explanation of the program's operation.

```

;DEMO ROUTINE FOR CLS, PLOT AND DRAW
;
3E0E   MOIRE  LD      A,0EH
;BLUE PAPER, YELLOW INK
CD0000  CALL   CLS
;OVER 1
3E02   LD      A,2
320000  LD      (PFLAG),A
;BORDER 6
3E06   LD      A,6
D3FE   OUT     (0FEH),A
;SET ATTRIBUTES & MASK
210E00  LD      HL,000EH
220000  LD      (ATT),HL
;DRAW TOP BORDER (BC=0)
2100FF  LD      HL,0FFF00H
CD0000  CALL   DRAW
;DRAW LEFT BORDER
2C      INC    L
01BF00  LD      BC,00BFH
CD0000  CALL   DRAW
24      INC    H
;NOW CREATE PATTERN IN THE REMAINING
;(255*191) PIXELS
E5      NXTDR1 PUSH   HL
;DRAW EROM LEFT SIDE TO CENTRE
016080  LD      BC,8060H
CD0000  CALL   DRAW

```

```

;NOW FROM CENTRE TO RIGHT
C1          POP      BC
C5          PUSH     BC
06FF       LD       B,0FFH
CD0000     CALL     DRAW
;DECREASE COUNTER TO NEXT ROW
;UP THE SCREEN
E1          POP      HL
2D         DEC      L
20EE       JR       NZ,NXTDR1
2C         INC      L
E5          NXTDR2  PUSH  HL
;DRAW FROM TOP EDGE TO CENTRE
016080     LD       BC,8060H
CD0000     CALL     DRAW
;NOW FROM THE CENTRE TO THE
;BOTTOM EDGE
C1          POP      BC
C5          PUSH     BC
0EBF       LD       C,0BFH
CD0000     CALL     DRAW
;INCREMENT COUNTER TO THE NEXT PIXEL
;COLUMN (RIGHTWARDS)
E1          POP      HL
24         INC      H
20EE       JR       NZ,NXTDR2
C9         RET

```

If speed is of the essence then I should warn you that the DRAW routine should only be used if 'general' lines from non-specific points are required. It is almost always quicker to use a customized routine, perhaps employing a look-up table of plotting coordinates, if specific lines are being drawn.

For example, if you frequently needed to draw a line right across row 0 of the screen, then it is far quicker to load the first 32 bytes of the display file with FFH than it is to DRAW from (0, 0) to (255, 0).

## CHAPTER 4 Producing Animated Loading Screens

It cannot have escaped your notice that almost every self-respecting games program for the Spectrum presents you with a pretty picture to look at, to help you pass the time while the machine code makes its slow and ponderous way along the black lead between your tape player and your computer. The aesthetic appeal of this 'loading screen' is usually proportional to the amount of hard graft and graph paper that went into designing and coding the picture, both of which can be considerable, even with the use of a good 'screen graphics designer' utility program.

In this chapter I will provide you with a pair of short utility routines to produce a spectacularly eye-catching but easily implemented alternative style of loading screen.

Ask yourself the question 'What does the ULA do while the Z-80 is busy loading a program from tape to RAM?' The answer is the same as always; it copes with all input, output and generation of the screen display. The last function includes FLASHING the INK and PAPER colours of any cell whose attribute has bit 7 set. We can use this property to produce a screen which flashes between two images, perhaps showing a figure in two different positions thus 'animating' it whilst loading, or as an alternative, showing two separate words of the title of the game.

The concepts involved with this technique are very simple. We will take a blank screen, and then print different coloured spaces on it, controlling the colour of these spaces with PAPER commands. The resulting coloured cells will form our first image, and hence we have a 32 column

× 24 line grid to design the image in, each cell being one of eight colours. When the first image is complete, we will use a short machine language routine to copy the attributes into 768 bytes of reserved memory for later use.

We then use another BASIC sequence to print a second image of coloured, blank cells on the screen, and we 'pair off' the attributes of the second image with those of the first one. The PAPER attributes of the second image are shifted three bit to the right (into the INK position) and are then blended with the PAPER and BRIGHT bits of the first image.

The FLASH bit is then set, and the completed byte is replaced in the attribute file, whereupon the cell concerned starts FLASHing between the two colours provided by the images (these may, of course, be the same).

A composition diagram of the new attribute byte may be of assistance:

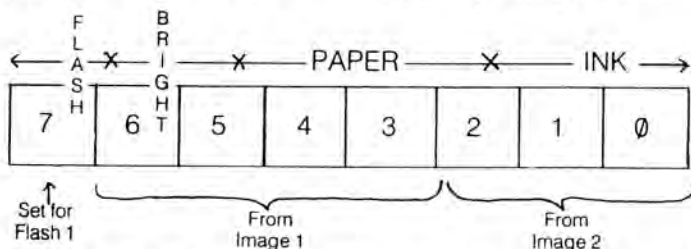

This technique has the advantage over conventional loading screens that only the attribute file of 768 bytes is required, as against the 6.75K (6912 bytes) of memory occupied by the standard loading screen. Thus the screen may be loaded in one ninth of the time normally required, or about five seconds, before moving swiftly on to load the game itself.

An 'animated' loading screen was first used commercially in *Bug Byte's* highly successful *Manic Miner*, now published by *Software Projects*. The two images used were colourful manifestations of the words 'Manic' and 'Miner'.

Well that's about all the theory, so how about some machine language? First we need a mega-simple block shift routine to copy the attribute file into 'safe' memory, which I have reserved as the 768 bytes from the label IMAGE1.

```

;MOVE IMAGE 1 FROM ATTRIBUTE FILE TO
;STORAGE AREA
;
;PRESERVED: A
;EXIT: HL=5B00H, BC=0

```

```

;
210058 ATTSTR LD HL,5800H
110C00 LD DE,IMAGE1
010003 LD BC,300H
EDB0 LDIR
C9 RET
IMAGE1 DEFS 768

```

The routine to 'blend' the stored image with that in the attribute file is almost as simple. BLEND places the new image back in the attribute file, and that's about all the explanation this listing needs!

```

;MIX IMAGE 1 FROM STORAGE WITH CURRENT
;ATTRIBUTES
;
;EXIT: DE=5B00H, BC=0, A=0
;
110058 BLEND LD DE,5800H
210000 LD HL,IMAGE1
010003 LD BC,300H
;
;TAKE BYTE OF IMAGE 1
;
7E NXTATT LD A,(HL)
;
;MASK OFF ITS PAPER AND BRIGHT VALUES
;
E678 AND 78H
;
;STORE IT AGAIN
;
77 LD (HL),A
;
;TAKE CURRENT ATTRIBUTES
;
1A LD A,(DE)
;
;SHIFT THE PAPER BITS INTO THE INK BITS
;AND MASK THEM
;
0F RRCA
0F RRCA
0F RRCA

```

```

E607      AND      7
;
; BLEND THESE BITS WITH THE PAPER AND BRIGHT BITS
; OF IMAGE 1
;
B6        OR      (HL)
;
; SET FLASH 1
;
F680     OR      80H
;
; STORE COMPLETED BYTE IN ATTRIBUTE FILE
;
12       LD      (DE),A
;
; REPEAT FOR THE NEXT CELL
;
13       INC     DE
23       INC     HL
0B       DEC     BC
78       LD     A,B
B1       OR     C
20EB    JR     NZ,NXTATT
C9       RET

```

Once the final image has been created in the attribute file, you can either SAVE the bytes direct to tape, using:

```
SAVE (NAME) CODE 22528,768
```

or, if you have been using the bottom two lines and don't want them to be corrupted by the tape messages, then use ATTSTR again to shift the attributes to 'safe' memory unaffected by the screen, and SAVE them from there.

## CHAPTER 5

# Scanning the Keyboard

In this chapter I shall explain how the keyboard is mapped and how to read keys or groups of keys in machine language.

The more numerate among you will have noticed that the Spectrum has in fact got 40 keys. These appear as four rows of 10, but the computer finds it easier to consider them as eight half-rows of five keys, on account of there being less than 10 bits in a byte.

If you have ever dared to remove the lid from your Spectrum (not an option to be recommended, as this technically invalidates your guarantee), you will have found that the keyboard is connected to the printed circuit board with two rather flimsy-looking ribbon cables. Closer examination reveals that one of these has eight tracks, and the other has five. In fact, each of the tracks on the larger cable is connected to one of bits 8 to 15 (the HI-byte) of the address bus, while the smaller cable is connected to the lowest five bits (0 to 4) of the data bus.

When the Spectrum makes a complete scan of the keyboard (every fiftieth of a second), the procedure it adopts is as follows. To each of the address lines in turn, it applies a 'current'. Now each of the five keys in the corresponding half-row can be considered as a switch, connected between one of the five data lines and the address line, and allowing a current to flow when depressed. The computer reads the five data lines, and if a current comes through on a line then it knows that the corresponding key is depressed, and acts accordingly.

We label the address lines (by convention) A8 to A15, and the data lines D0 to D4. The address lines are allocated to the half-rows in the following way:



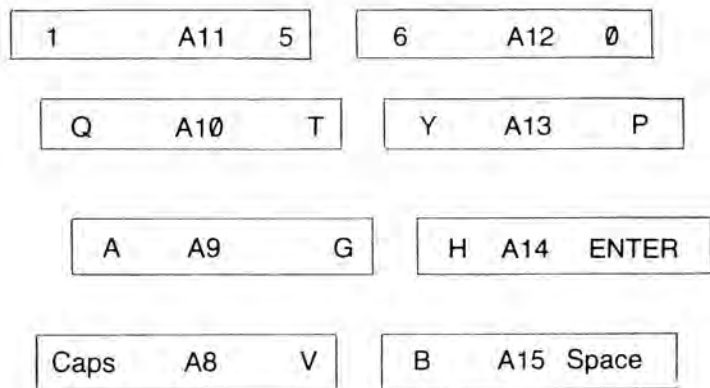

Whenever we want to read a particular half-row, we send its address line low (zero). Similarly, whenever a key on that half-row is depressed, its data line goes low (zero). Otherwise it is high (one).

The data lines are attached to any half-row with the lowest bit (D0) on the outside, counting inwards. Hence the mapping for the second row (for example) is as follows:

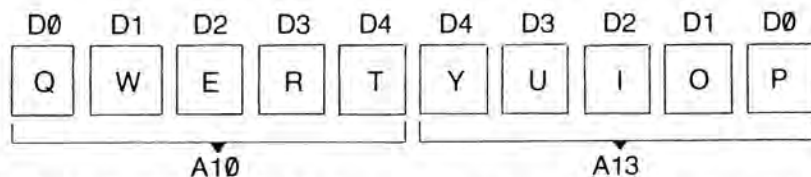

Well that's the theory out of the way, so now down to the actual practice. The keyboard itself is selected (rather than some other peripheral such as a microdrive or printer) by sending address line A0 low. Hence the low byte of our input port address is FEH, and we either use the instruction

```
IN A, (0FEH)
```

or we load the C register with FEH and use

```
IN r, (C)
```

where r is a single register. First, however, we must load the hi-byte of the address into A or B (depending on which instruction we are using). For example, suppose we want to read the half-row A to G. This has line A9 (bit 1 of the hi-byte), so we load our register with the binary pattern 1111 1101 = 0FDH

Hence a suitable fragment to read the half-row would be

```
LD A, 0FDH
IN A, (0FEH)
```

For your convenience, here is a table of hi-bytes to read each half-row.

HALF-ROW	LINE	BIT	HI-BYTE	BIT-PATTERN
CAPS SHIFT — V	A8	0	FE	= 1 1 1 1 1 1 1 0
A — G	A9	1	FD	= 1 1 1 1 1 1 0 1
Q — T	A10	2	FB	= 1 1 1 1 1 0 1 1
1 — 5	A11	3	F7	= 1 1 1 1 0 1 1 1
6 — 0	A12	4	EF	= 1 1 1 0 1 1 1 1
Y — P	A13	5	DF	= 1 1 0 1 1 1 1 1
H — ENTER	A14	6	BF	= 1 0 1 1 1 1 1 1
B — SPACE	A15	7	7F	= 0 1 1 1 1 1 1 1

We are now able to produce a program fragment to test the BREAK key (SPACE). To test it on its own, rather than with CAPS SHIFT, we use

```
LD A, 7FH
IN A, (0FEH)
RRA ; MOVE D0 INTO CARRY
JP NC, BREAK ; BREAK IF D0=0
```

Whilst on the subject of BREAK, it may interest you to know that due to a fluke of hardware design on the Spectrum, it is possible to BREAK a Spectrum in BASIC without actually pressing the BREAK key. For some reason, pressing CAPS SHIFT with any of the following pairs of keys causes D0 to go low whenever A15 is sent low, making the Spectrum think that BREAK is being pressed.

Here are the four magic combinations:

- CAPS SHIFT with Z and SYMBOL SHIFT
- CAPS SHIFT with X and M
- CAPS SHIFT with C and N
- CAPS SHIFT with V and B

So you know what to do next time your BREAK key breaks! In fact, you will find that if you take any whole row of keys, then press any pair of them attached to the same data line, then press any other key on that row, it will appear to the Spectrum that the other key of that row on the same data line is also being pressed. That may sound a little complicated, so let me give you an example. Press T and Y together (both on data line D4 on the second row). Now press W (on D1). The computer will think that O is also being pressed, since this is also on line D1. This is of little practical use, but fascinating none-the-less.

It is possible to read more than one half-row in one go, simply by resetting more than one bit in the hi-byte of the input address. For example, to read the entire bottom row (lines A8 and A15), the value would be binary

$$0111 1110 = 7EH$$

The value returned is determined as follows. If any of the keys attached to one particular data line are depressed, then the corresponding bit is zero. Otherwise it is set. Hence if we are scanning the bottom two rows of the keyboard, then D1 will be reset if any of the keys Z, S, L and SYMBOL SHIFT are depressed.

This leads us to an easy way of testing to see if any key on the entire keyboard is pressed, as might be required before the start of a new game.

```

XOR  A           ;A=0, SO SCAN ALL HALF ROWS
WAIT IN A, (0FEH) ;READ BOARD
CPL           ;MASK OFF REQUIRED BITS AND
AND  1FH       ;CHECK FOR ALL 1'S
JP   NZ, GO    ;JUMP IF KEY PRESSED
JR   WAIT     5 lines with ...

```

If a key is being pressed, then the zero flag will be reset, and a jump made to start the game, or whatever you were waiting for. Otherwise the routine will jump back to WAIT with the A register holding zero again.

We now have all the information necessary to design a complete keyboard-scanning routine. As an example, I shall describe the development of a games routine, providing 8-directional control and a 'fire' bar

I shall be using the keys 1 for up, A for down, I for left, P for right, and any key on the entire bottom row for 'fire', thus:

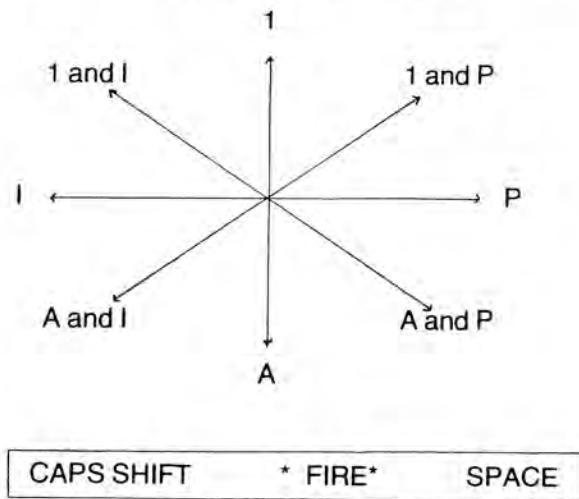

The routine will return a 'control code' which will depend on which of the control keys are pressed. Allocating one bit of the code to each of the four main directions up, down, left and right, and one bit to our 'fire bar', we can denote all other directions by setting combinations of these five bits. I have allocated the bits as follows:

BIT	CONTROL
0	RIGHT
1	LEFT
2	DOWN
3	UP
4	FIRE

Thus the values returned will be as illustrated:

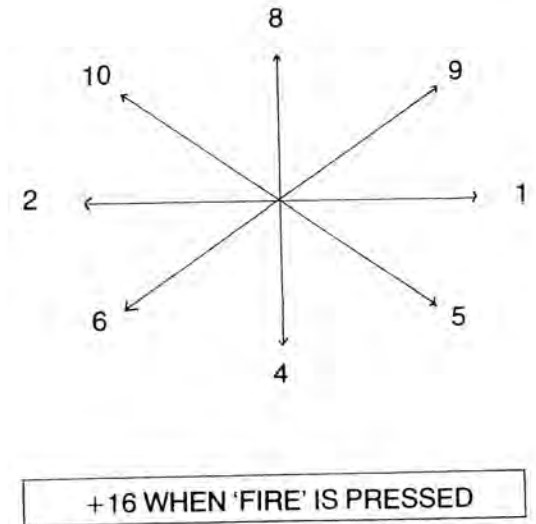

The three spare bits in the code will, of course, be zeros. Note that since 'North-East' is a combination of upwards and to the right, the corresponding control code is 8+1=9. Similarly for the other three diagonal directions.

Now obviously there are some control values that just wouldn't make sense, for example the value 3 (= 1+2) would indicate a desire to go both right and left. The user has pressed too many keys, and instead of



being 'biased', by always choosing one of the two directions in favour of the other, it would be fairer if our routine were to ignore both key presses. This it does, by calling the sub-routine CHECK twice in succession; once for left-right, and once for up-down. On entry to CHECK, the B register holds a 'mask' for the two bits we wish to examine. We are testing for the 'illegal' binary code of 11, and for this we use the fragment

```

CHECK  LD    A,C    ;C HOLDS THE CONTROL CODE
      CPL
      AND    B
      RET    NZ

```

which returns if the code is found to be legal. Otherwise we have found the illegal code 11 in C, and the routine completes its task by resetting the offending bits. with

```

LD    A,B
XOR   C
LD    C,A
RET

```

The rest of the routine listing is self-explanatory and highly demonstrative, so here it is!

```

;ENTRY: NONE
;PRESERVED: DE,HL
;EXIT:C=CONTROL CODE, B=12
;
;READ HALF-ROW Y-P
;
3EDF  SCAN1  LD    A,0DFH
DBFE  IN     A,(0FEH)
;
;MASK I AND P KEYS
;
2F    CPL
E605  AND    5
;
;PUT I IN BIT 1, AND P IN THE CARRY
;
1F    RRA
;
;MOVE P FROM THE CARRY TO BIT 0
;
CE00  ADC    A,0
;

```

```

;STORE THE LEFT-RIGHT CONTROL IN C
;
4F    LD    C,A
;
;READ THE A KEY
;
3EFD  LD    A,0FDH
DBFE  IN     A,(0FEH)
1F    RRA
;
;JUMP IF A NOT PRESSED
;
3802  JR    C,NDOWN
CBD1  SET    2,C
;
;READ THE 1 KEY
;
3EF7  NDOWN  LD    A,0F7H
DBFE  IN     A,(0FEH)
1F    RRA
;
;JUMP IF 1 NOT PRESSED
;
3802  JR    C,NUP
CBD9  SET    3,C
;
;CHECK FOR LEFT AND RIGHT BOTH
;BEING PRESSED
;
0603  NUP    LD    B,3
CBD300 CALL  CHECK
;CHECK FOR UP AND DOWN BOTH
;BEING PRESSED
;
060C  LD    B,12
CBD300 CALL  CHECK
;
;READ THE BOTTOM ROW
;
3E7E  LD    A,07EH
DBFE  IN     A,(0FEH)
2F    CPL
E61F  AND    1FH
;

```

```

;
;RETURN UNLESS "FIRE"
;
C8      RET      Z
CBE1    SET      4,C
C9      RET
;
;CHECK FOR "IMPOSSIBLE" DIRECTIONS
;
79      CHECK    LD      A,C
2F      CPL
A0      AND      B
C0      RET      NZ
78      LD      A,B
A9      XOR      C
4F      LD      C,A
C9      RET

```

0000 0000 0000 0000  
 0000 0000 0000 0000

\* back procedure re-used with 00 set to 02 (line 11)  
 for detection of simultaneous key depressions  
 routine omitted & continue with FIRE detection

## CHAPTER 6 Player-Selectable Control Keys

In the last chapter I concluded with an example of how to develop a typical games keyboard control routine, using a predetermined choice of keys. It can often be an advantage in terms of user-friendliness, however, if the user is allowed to select her or his choice of control keys, to suit personal preference and number or shape and size of fingers, thumbs and hands. I shall provide the fundamental routines to allow you to do this in this chapter.

Picture, if you will, our typical player, poised over the keyboard and awaiting our every command, as the game finishes its long and tortuous journey from tape to memory. He is told to press any key (as is invariably the case). He is now asked to select a key to control (say) the upwards movement of his spaceship. Now first we must wait for him to stop pressing 'any key'. The following fragment will do, and is equivalent to the BASIC line.

```

10 IF INKEY$ <> " " THEN GO TO 10
WAIT - XOR      A
IN      A, (0FEH) ;READ ENTIRE KEYBOARD
CPL
AND     1FH      ;IF ANY KEY PRESSED
JR      NZ, WAIT ;THEN WAIT

```

Now we are ready to select the 'upwards' control. What is required is a routine that will return a unique value for each key pressed, and that tells us when no key or more than one key is being pressed. The key value will then be stored away for use during the game, when a separate routine will tell us if the key associated with that value is depressed.

The following routine, KFOUND1, returns a key value in the D register with the zero flag set, if exactly one key is depressed. If no key is held, then D will hold FFH, while if more than one key is held, then the zero flag will be reset, indicating an error. The key values, ranging from 0 to 27H, are allocated as follows (all values in hexadecimal).

24	1C	14	C	4	3	B	13	1B	23
25	1D	15	D	5	2	A	12	1A	22
26	1E	16	E	6	1	9	11	19	21
27	1F	17	F	7	0	8	10	18	20

To the human eye that layout may seem somewhat crazy, until you realize that it will make life easier for the later game control routine. Looking at the hex values closely, we see that the lowest three bits tell us which half-row the key is in (and so which port to address) while bits 3, 4 and 5 tell us what position in that half-row the key holds. Here is KFOUND1.

```

;ENTRY: NONE
;PRESERVED: L
;EXIT: D=KEY CODE, D=FFH IF NO KEY PRESSED.
;ZERO FLAG RESET IF MORE THAN ONE KEY PRESSED.
;OTHERWISE, ZERO SET AND A=D
;
;
112FFF KFOUND1 LD DE,0FF2FH
01FEFE LD BC,0FEFEH
;
;D STARTS AT "NO-KEY" E HOLDS INITIAL KEY VALUE
;FOR EACH HALF-ROW
;BC HOLDS PORT ADDRESS
;
;READ A HALF-ROW
;
ED78 NXHALF IN A,(C)
2F CPL
E61F AND 1FH
;
;JUMP IF NO KEY PRESSED
;
280C JR Z,NPRESS

```

```

;
;TEST FOR MULTI-KEYPRESS
;
14 INC D
;
;RETURN WITH Z RESET IF SO
;
C0 RET NZ
;
;CALCULATE KEY VALUE
;
67 LD H,A
7B LD A,E
D608 KLOOP SUB 8
CB3C SRL H
30FA JR NC,KLOOP
;
;TEST FOR MULTI-KEY PRESS
;
C0 RET NZ
;
;STORE KEY VALUE IN D
;
57 LD D,A
;
;TEST THE OTHER 7 HALF-ROWS
;
1D NPRESS DEC E
CB00 RLC B
38E8 JR C,NXHALF
;
;SET ZERO FLAG
;
BF CP A
C8 RET Z

```

A typical fragment to wait for a legal keypress in response to our 'please choose a key for upwards' prompt, would be:

```

REPT CALL KFOUND1 ;SCAN KEYBOARD
JR NZ,REPT ;REPEAT IF ILLEGAL ENTRY
INC D ;REPEAT IF NO KEY WAS
JR NZ,REPT ;PRESSED
DEC D

```

I have named the complementary routine to KFIND1, KTEST1. Every time the Spectrum needs keyboard control during a game, we must call KTEST1 once for each selected control key. The routine will read that key, and return with the carry flag reset if it is depressed, and set otherwise. The only parameter required by KTEST1 is the value of the key we are testing, entered in the accumulator. Here is the listing, followed by a worked example.

```

;ENTRY: A=KEY TEST VALUE
;PRESERVED: HL, DE
;EXIT: CARRY RESET IF KEY DEPRESSED, SET
;OTHERWISE BC=0
;
;
4F      KTEST1 LD      C,A loads key value into C
;
;LET B=16-(ADDRESS LINE NO.)
;
E607   AND      7 Subs B to 16 (data line) - address line number (A8-F) for the address - A to 16-5, B = 5 to 10, 11, 12, 13, 14, 15
3C     INC      A
47     LD      B,A
;
;LET C=(DATA LINE NO.)+1
;I.E. LET C=5-INT(C/8)
;
CB39   SRL      C Subs C to data line number + 1
CB39   SRL      C number + 1
CB39   SRL      C position - half row
3E05   LD      A,5
91     SUB      C
4F     LD      C,A
;CALCULATE HI-BYTE OF PORT ADDRESS
;
3EFE   LD      A,0FEH Subs A to port address row A8 to 16-1 = 15
0F     HIFIND RRCA for A8 to 16-1 = 15
10FD   DJNZ   HIFIND then A8 to 16-1 = 15
; decrement B to 0 to give the appropriate high-byte of the port address
;READ HALF-ROW for the half row (see Page 35 table)
;
DBFE   IN      A,(0FEH) reads the half row pointed at by A; resets bit 0 to 0 if 0 accordingly
;
;PUT REQUIRED KEY BIT INTO CARRY

```

```

;
1F     NXKEY   RRA
0D     DEC     C
20FC   JR      NZ,NXKEY
C9     RET

```

As an example, let's suppose our game involves movement in eight compass directions and a fire button. For this our user will have chosen five control keys, for up, down, left, right and fire. Let the associated five key values be stored in a table pointed at by HL, in the order fire, up, down, left, right. We will use the same 'control values' as in the previous chapter, namely:

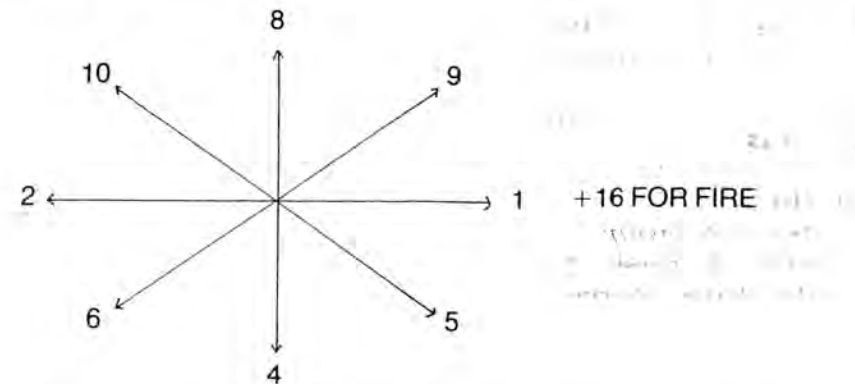

A suitable routine to build up the control value in the E register is as follows.

```

NXTKEY LD      E,8      ;E IS ALSO A COUNTER
LD      A,(HL)        ;TAKE KEY VALUE
INC     HL
CALL   KTEST1        ;LOOK FOR A KEY-PRESS
CCF    ;1=PRESS, 0=NOT
RL     E             ;MOVE KEY-BIT INTO E
JR     NC,NXTKEY     ;REPEAT FOR THE OTHER
RET    ;4 KEYS

```

Note that I have made the E register 'double' as a counter for the loop. The initial bit 3 is the highest set bit, and this is shifted to the left once in every pass around the loop, until after five passes it falls into the carry, causing the routine to return with the completed control value in the E register. The usual checks for 'impossible' directions such as left AND right may then be performed.



# CHAPTER 7

## Everything You Should Know About Interrupts

As you are probably aware, the Z-80 microprocessor offers us a choice of three maskable interrupt modes, named by the instructions which select them, IM0, IM1 and IM2.

The instruction IM0 on the Spectrum is pretty much redundant. In this mode, the Z-80 expects an instruction from some peripheral to begin making its way along the data bus during the interrupt acknowledge cycle. In the case of the Spectrum, however, the data bus usually holds FFH during an interrupt, and this is the one-byte Hex. code for RST 38H, which the Z-80 duly executes. The reason I said IM0 is redundant is that IM1 performs exactly the same function of RST 38H when an interrupt occurs, whatever the data bus holds at the time.

The Spectrum normally operates in interrupt mode one, and whenever an interrupt occurs the routine at 0038H proceeds to increment the television frame counter and scan the keyboard, updating all the various system variables associated with it. The number of interrupts accepted since the computer was turned on is held in the three-byte system variable FRAMES, at 5C78H, 23672 decimal. The use of this counter is well documented both in the Spectrum manual and other books such as 'Super Charge Your Spectrum', also published by Melbourne House. For this reason I shall not comment further on it.

Unless you particularly wish to use the frame counter or keyboard scan while running your machine language program, you should use the instruction DI to disable the interrupts, which would otherwise slow you down. This is especially relevant when you are producing sound or are

involved in some other piece of programming that requires precision timing; otherwise you will hear a 50 Hz 'hum' caused by gaps in the sound while interrupts are being processed.

The final maskable interrupt mode, IM2, is the most complex and powerful. When an interrupt occurs, the Z-80 takes the byte currently on the data bus as the low order of an address, and the contents of the I register, or 'interrupt vector register' as the hi-byte.

This address points to a second address stored (lo-byte first) in memory, which is then loaded into the program counter. Execution of the subroutine at that address then commences. As an example, suppose the I register held FEH, the data bus had 40H, and the address stored at FE40H was 0038H. Then the Z-80 would construct the address FE40H from the interrupt vector register and the data bus. It would take the address stored at FE40H and jump to 0038H, which just happens to be the normal interrupt routine.

In actual fact, since the data bus usually holds FFH during an interrupt, all our 'vector addresses' will end in FFH. A little experimentation will show you that to avoid picture 'break-up' or 'snow' on the Spectrum display, the I register must either form the hi-byte of an address in ROM or in the top 32K of RAM.

This restricts us to the ranges 00 to 3FH and 80H to FFH for I. Now if you have a 48K machine, it should not be too difficult to find an unoccupied vector address amongst the 127 possible options in the top 32K of RAM (note that we cannot practically use I=FFH, since the address stored from FFFFH would have its hi-byte in location 0, which is in ROM). If, however you only have a 16K machine, or there is no room in the top 32K of RAM, then we must resort to vector addresses in the ROM.

Of the 63 such vector addresses (again 3FH is not really usable, since the hi-byte of the address would be the first byte of screen RAM), only thirteen point at addresses in the bottom 16K of RAM. Four of these thirteen are in the screen memory, leaving a choice of the following nine addresses.

	I=(Hex)	Vector Address (Hex)	Holding (Hex)	Address (Decimal)
(i)	2B	2BFF	5C65	23653
(ii)	29	29FF	5C76	23670
(iii)	2E	2EFF	5CA1	23713
(iv)	19	19FF	5D22	23842
	14	14FF	6469	25705
	1E	1EFF	67CD	26573
	0F	0FFF	6D18	27928
	06	06FF	71DD	29149
	28	28FF	7E5C	32348

### Notes:

- (i) The three bytes necessary for a jump instruction to be stored at 5C65H are normally occupied by the system variables STKEND and BREG, and as such should not be altered if you plan on using the calculator stack or returning to BASIC after your machine language program.
- (ii) If your program is a hybrid BASIC/machine language one, then note that the first two bytes from address 5C76H hold the variable SEED for the BASIC pseudo-random number generator, and will be altered by RANDOMIZE or the use of the RND function. The third byte after 5C76H is the low order of FRAMES, so you must ensure that no IM1 interrupts are allowed to occur once the interrupt intercept from 5C76H onwards has been set up. Otherwise the address in any jump instruction inserted at 5C76H would increase by 256 every 20 ms!
- (iii) The fourth five-byte register in the calculator's memory area starts at 5CA1H, so again, do not use this address if you are planning to use any of the calculator routines in the ROM from your machine language program.
- (iv) If you wish to return to and use BASIC, then address 5D22H is out, too. It is simply too low: try the command CLEAR 23841 and you'll see what I mean!

The other type of interrupt not implemented on the ZX Spectrum is the NMI, or Non-Maskable Interrupt. If a Z-80 receives an NMI, then it completes the instruction it is dealing with and calls the routine at 0066H.

On the Spectrum this routine (in ROM) is the source of rather a sore point among manufacturers of hardware add-ons. The routine is as follows:

```
0066H  PUSH    AF
        PUSH    HL
        LD     HL, (5CB0H)
        LD     A, H
        OR     L
        *JR    NZ, 0070H
        JP     (HL)
0070H  POP     HL
        POP     AF
        RETN
```

The instruction labelled \* should have been

```
JR     Z, 0070H
```

... and would then have caused a jump to the address held in 5CB0H (which, incidentally, is quoted in the Spectrum manual as 'unused') unless the address was zero, in which case a return would have been made. Instead, as it stands, the only possible use of an NMI on the Spectrum is to cause a complete system reset if the address at 5CB0H is zero, which it usually is.

Inside the Z-80 are two special bits called interrupt flip-flops, and named IFF1 and IFF2. They are normally handled together under the collective name IFF, except during an NMI, when IFF2 stores the previous value of IFF1, while IFF1 is reset for the duration of the NMI. The function of IFF is to tell the Z-80 whether maskable interrupts are currently permitted. If they are set (value 1), then interrupts are authorized. If they are reset (masked) then the maskable interrupts will not be detected. So obviously EI sets them while DI resets them. To be absolutely accurate, the flip-flops are always reset while DI or EI is being processed, and the interrupts are not enabled until the instruction AFTER the EI has been executed. The reason for this is worth mentioning.

Whenever an interrupt is accepted, the IFF are reset automatically. It is, however, the programmer's responsibility to re-enable the interrupts before returning from the interrupt routine with RETI. It could cause untold problems if an interrupt were to occur between enabling them and returning from the last one, and hence the 'delayed action' of EI to allow a safe return to be made, as in

```
EI
RETI
```

... the standard end to an interrupt routine.

An instruction often overlooked in books on Spectrum machine language is

```
LD     A, R
```

This may not at first sight appear to serve any useful purpose, but an examination of its effect on the flags will prove otherwise. When the instruction is executed, the parity/overflow (P/V) flag is set to the contents of IFF2. Hence we can use the instruction to tell us whether or not the maskable interrupts have been enabled. When the P/V flag is set it normally indicates even parity (PE), while when it is reset we have odd parity (PO).

Suppose that we want to preserve the contents of the IFF while we disable the interrupts to produce some 'pure' sound, and then restore the IFF. A suitable method would be:



```

LD      A,R          ;SET P/V TO 1FF
PUSH   AF           ;STORE P/V
DI      ;DISABLE INTERRUPTS
(PRODUCE SOUND)
POP    AF           ;RETRIEVE P/V
JP     PO,NOT-ON    ;IF PE THEN P/V=1, SO
EI      ;SET 1FF

```

NOT-ON

This way, if we enter the routine with the interrupts masked, then they will not be enabled at the end of it. The instruction LD A, I affects the P/V flag in the same way as LD A, R.

I stated earlier that the data bus 'usually' holds FFH during an interrupt. For an isolated Spectrum I have never known this not to be the case. There are, however, certain hardware 'add-ons' that do not decode signals on the IOREQ and READ lines of the Z-80 correctly, and as a result cause variable numbers to be on the data bus during the interrupt acknowledge cycle. These add-ons do not, incidentally, include the ZX printer or the ZX Interface 1.

Now obviously if the value on the data bus changes then we will have to set up a whole table of interrupt vectors in memory for IM2, so that any of the possible values on the bus will still cause a jump to the correct address.

If we know that the value will be even, then we simply require a table of 128 vector addresses ending in 00,02, . . . , FEH, each entry containing the address of our interrupt routine. Similarly, if the data bus will hold an odd value, then we have a table one byte higher in memory, so that the vector addresses end in 01, 03, . . . FFH.

If, however, the data bus holds any of the 256 possible values, as, for example, is the case when a Kempston Microelectronics joystick is attached to the user port, then we have to use a slightly different technique. Each of the 257 bytes in the vector table must hold the same value, so that whether the vector address is odd or even, the interrupt address will still be the same. Thus the high and low order address bytes of the interrupt routine must be the same. In case this is not clear, let us suppose for contradiction that the interrupt address is 89ABH. If we build up a table by inserting this address 128 times from (say) FE00H, then an even value on the data bus would cause a correct jump, but an odd value would cause a jump to AB89H; obviously not what we want!

Note that the table is 257 bytes long, not 256, since we must account for the vector address ending in FFH, causing an entry to 'spill over' into the next page of memory.

Probably the most convenient value to set the I register to is FEH, using the highest possible page of RAM for the vector table. If we then fill the table with FDH, an interrupt will cause a jump to FDFDH, which is just three bytes before the start of the table. Now three bytes, as it happens, are just enough to place a jump instruction to our 'real' interrupt routine. This way, we have confined the memory needed for a fool-proof IM2 interrupt to a continuous block of 250 bytes, without affecting the versatility of the interrupt in any way (except to add on the 10T— states of the JP instruction to the processing time!).

Here is a suitable routine to initialise the IM2 system described above.

```

INT LD      HL,0FE00H    ;LOAD TABLE AT 0FE00H
LD      BC,00FDH      ;WITH 256 OF FDH
LP1 LD      (HL),C
INC     HL
DJNZ   LP1
LD      (HL),C        ;THE 257TH ENTRY
LD      A,0FEH        ;LET I=FEH
LD      I,A
IM      2              ;SELECT IM2
RET

ORG     0DFDFDH
JP      0038H          ;INSERT YOUR OWN ADDRESS

```

The above technique is all very well if you have 48K of RAM, but will not work on a 16K machine. As I mentioned before, pointing the interrupt vector register at any page of the lower 16K of RAM will cause 'snow' on the screen. All is not lost, however, for in the case of at least one 'rogue' peripheral, the Kempston joystick, there is a way, although somewhat messy and restrictive, of using interrupt mode 2.

The joystick is normally 'read' in BASIC by a command of the form

```
LET A= IN 31
```

. . . but in fact all that is required for the interface to deposit a value on the data bus is to send address line A5 low (holding zero), so that the command

```
LET A= IN (31+64+128+256+512+1024)
```

for example, would do just as well. When A5 is high, however, the

joystick will not affect the contents of the data bus, and the normal value of FFH should result during interrupt acknowledge.

Well that's the theory done. Now how do we ensure that A5 is high whenever an interrupt occurs under IM2? This can be done by ensuring that the program counter holds an address containing bit 5 set before an interrupt, and this is why I called the technique 'somewhat messy and restrictive.'

We principally have two options once the program counter is in a 32-byte block that has bit 5 set for its addresses; we can either come to a HALT instruction while we wait for an interrupt, or we can spend the time doing something useful like generating sound. If the latter option is chosen, there are two main points to remember.

Firstly, we must not allow bit 5 of PC to go low, so the routine must either exist in a 32-byte block, or call other subroutines that are also in locations where A5 is high. Secondly (and assuming that we do not wish to waste time in this routine once an interrupt has been taken), we must continually test some kind of flag that is set by the interrupt routine, so that we know when an interrupt has been taken.

After the interrupt has been dealt with we have up to about 20ms, which is an awfully long time in machine language, to do as much 'normal' processing as we want before getting back to wait for the next interrupt.

At first sight all the effort required to use IM2 interrupts on the Spectrum may not seem worthwhile, but they do in fact have a wide range of uses. They are the fundamental concept behind many of the commercially available utilities such as real-time clocks, TRACE routines, extensions to BASIC, user-definable function keys and so on.

In addition to this, interrupts have the special property that they are generated at precisely the same frequency as the frames which go to make up your TV display. They always occur when the beam is at the high-point of its 'fly-back' from the bottom to the top line of the display; and consequently we can use interrupts to produce full-screen (BORDER included) horizons, flickerless pixel-by-pixel animation of sprites, and higher resolution colour, to name but a few of the possibilities afforded by TV-Synchronized processing.

## CHAPTER 8

# A Discussion of Pixel-Animation Techniques

Since the launch of the ZX Spectrum, the quality of games software for it has steadily increased, and with it the technical quality of animation. The emphasis has shifted away from movement by one character at a time, and towards movement by a few pixels at a time. At the same time, the spectrum has been pushed closer and closer to its design limits, with programmers squeezing every last gramme of speed out of the Z-80 microprocessor in an effort to achieve more spectacular special effects than the last game.

In the next few chapters I shall be developing a very powerful set of routines that will let you achieve totally flickerless animation and special effects never before seen on the Spectrum.

Before we go any further, let us remind ourselves how the television display is generated. Although when we watch TV, we see a continuous picture, it is in fact only one (in the case of black and white) or three (in the case of most colour sets) electron beams scanning across and down the screen at great speed. If it were not for the human phenomenon of persistence of vision, which 'preserves' on the retina of the eye the image generated by the beam long enough for it to complete one 'frame' of the TV (20 milliseconds), then all we would see is a brightly coloured dot moving at high speed, and television displays as we know them would not exist.

In the U.K., televisions are quoted as having a '625-line' display. That is to say that the television pictures are transmitted as signals for 625 scan-lines of the TV. An average TV set only displays about 540 of these scan-lines:— the rest are off the top and bottom of your screen, and some of the resulting 'spare' time is consumed by a period known as 'flyback', when the electron beams are being moved back from the bottom of the screen to the top, ready to produce the next frame.

Some of the spare scan-lines, incidentally, are used to transmit the data for the BBC's 'Ceefax' and ITV's 'Oracle' teletext services. A decoder in your teletext TV then converts the binary data into a full-screen TV picture and displays it. It is the number of scan-lines available for this feature that limits the resolution and choice of colours on teletext graphics:— there just isn't enough room to transmit high-resolution teletext at an acceptable baud-rate.

Well before I digress any further, back to our discussion of picture-generation. The chip that is responsible for TV handling in the Spectrum is called the ULA (Uncommitted Logic Array) and what it does is to use two scan-lines for each row of the Spectrum display. Hence the text area occupies  $2 \times 192 = 384$  scan lines; about 70% of the screen height and takes about 61% of each frame-time, or 12.288 ms, to generate.

Now why, I hear you ask, am I going into so much detail about the TV display? Well, in the course of 'normal' animation by one cell at a time, none of this would be necessary. The characters are moved fairly 'rarely', typically about five times a second, or once in every ten frames or so. Consequently no significant interference by the TV display generation is noticed.

However, every time we move a character, we must in some way 'blank out' its old image and 'print in' the new one in the display file. If the television happens to be producing the scan lines on which we are printing and deleting, then it will take the image from memory, whatever state it is in, and display it on the screen. The consequence is that for the current frame an incomplete image will be displayed.

As I said, this interference is not noticeable for low-frequency movement. However, animation by pixels requires up to eight times the frequency of movement to move a character at the same speed as by cells, and this results in unacceptable ghosting and flickering using standard techniques.

One partial solution to the problem is to deal with the movement in terms of TV scan-lines. You take each row that would be occupied by either the 'new' or the 'old' image in turn. Then blank out any part of the 'old' image

on that row, and print in any part of the new image on that same row. This produces reasonably smooth animation, since we will never have completely blank cells on the screen where there shouldn't be. A similar technique to this has been used by Ashby Computers and Graphics Limited in their highly successful 'Ultimate, Play The Game' series for the Spectrum.

There is, however, a drawback to the technique described above. All interference has not been eliminated, and we are left with two principle effects. Firstly, there is a reduced form of flickering, where a blank row is displayed while we are switching between deleting the old image and printing the new one on that row. The result is that the character is continually 'dissected' in different places as it moves. This effect can be minimised by moving our character from its bottom row upwards, rather than in the traditional top-downwards manner. This way we ensure that the printing routine can only 'clash' with the TV once during each frame, when the two processes 'cross over', working in opposite directions. I still find the remaining interference frequent enough to be annoying, however.

The second effect of interference between the display generation and printing routine is that the character becomes either 'stretched' or 'shrunken' vertically, or disjointed horizontally, depending on the direction of movement.

Imagine that the character is being moved (from the bottom row upwards) in the North-East direction, that is upwards and to the right. For the sake of argument we will assume it to be a  $10 \times 10$  pixel square moving two pixels at a time along each axis. In the usual case, when there is no interference, the images observed would be as shown.

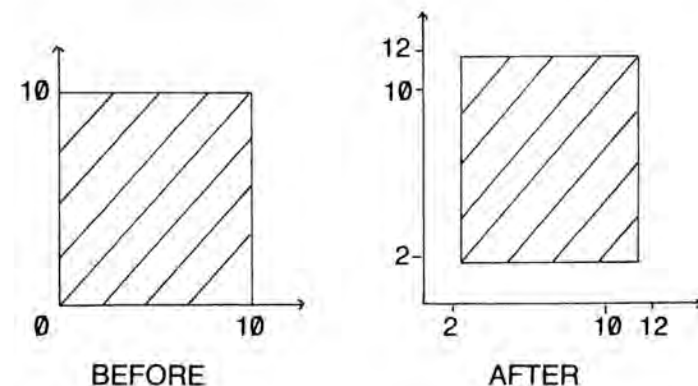



However, if the TV scan passes over the area in which we are printing whilst we are doing so, then we will end up with a disjointed figure, now shrunken to an overall eight pixels in length. If the 'clash' occurs after the fourth row up has been moved, for example, then we will have the following images:

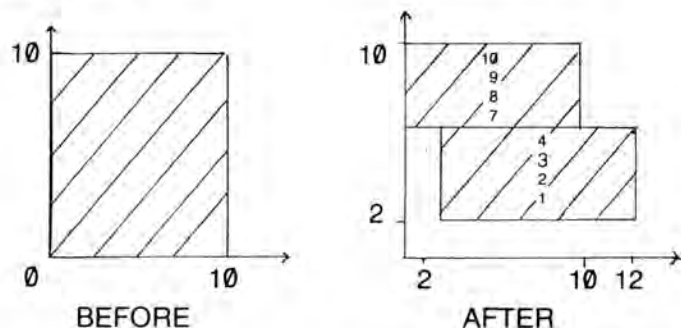

As you see, we would have lost rows 5 and 6 of our mutilated character for one frame.

The only sure-fire way to obtain totally flickerless animation is to ensure that the TV scan NEVER passes over the area which is currently being printed in. There are a variety of different ways in which to do this, and they all involve keeping track of the interrupts that the Spectrum receives every fiftieth of a second. This is the same frequency as your TV display, and consequently the electron beam is always in the same place, during flyback, when an interrupt signal is sent.

As long as we can confine our printing to times when the TV is not generating the 384 scan-lines of the text area, we can be sure that there will be no flickering during animation, no matter where on the screen our shape is being printed. Hence the 'safe' times are while the bottom and top borders are being generated, and during flyback.

Now unfortunately, unless all our games routines are 'time-constant', that is they always take the same time to execute, we will have no way of knowing when the text area has been just generated, and are thus unable to use the 'bottom border' time for printing. This leaves us with the time between an interrupt and the TV scan reaching the text area, which is about 14,200 T-states, or 4.06 ms. Now incredible as it may seem, this is, in fact, enough time to print forty characters on the screen, using a special 'print processing' interrupt handler, which I shall be developing in the next chapter.

## CHAPTER 9 An Interrupt-Driven Print-Processor with Full-Screen Horizon Generator

I shall now begin development of the interrupt-driven 'print processor' routine mentioned at the end of the last chapter. This, together with a comprehensive suite of routines in the following chapters, will enable you to produce the much-sought-after flickerless pixel animation of any 'sprite' (a shape consisting of a block of characters) up to 5x5 or 7x4 cells in area.

In addition to its main function as a print-processor, the interrupt handler, together with a complementary set of routines, will also be capable of generating a full-screen (border included) horizon. At the time of writing, the first and only game to have a full-screen horizon was Quicksilva's 'Aquaplane', by John Hollis. Unlike the stationary horizon of 'Aquaplane', the horizon generated by my routines will be movable at between one and eight 'pixels' per frame within a region bounded by the top of the text area and the very bottom of the screen.

This is only made possible by a special technique that 'fools' the computer into producing three or four colours in the attributes covering the horizon, so that we have something left to print with after two colours have been used up by the background.

I should state now that these routines have been designed to run in the top 32K of RAM on a 48K machine, based on the assumption that if you are a serious machine language programmer, working with an assembler, then you probably have 48K of RAM in order to have room for anything but a small text file once the assembler has loaded.

At the risk of repetition, let me explain that machine code placed in the lowest 16K of RAM will run about 20% slower whenever the TV is generating the text area, as the ULA and Z-80 will both be trying to access the same eight memory chips, and the ULA takes priority. As a consequence, the 'print-processor' part of the interrupt handler would not need modification to run in the lower 16K (it only runs while the top border is being generated), but the horizon generator would require extensive modification in order to compensate for the loss of speed and general changes in timing.

In this case it would probably be better for you to settle for a stationary horizon on a boundary between two of the twenty-four lines. That way, no special work is required on the attributes, and the border horizon is generated simply by going through a suitable delay loop and then changing the colour from that above the horizon to that below it, using an OUT instruction.

The print-processor system works in the following manner. Every time some animation routine feels the urge to print something on the screen, instead of doing so directly, it does as much preparation as possible and then deposits the resulting data for each character to be printed in an area of memory which shall be called the 'print buffer'. Then, on every interrupt, the print-processor 'empties' the buffer, one entry at a time, and puts the corresponding character and its attributes in the correct place in the display and attribute files respectively.

We shall label the start of the buffer as BUFFER. Each entry in the buffer is six bytes long; and the data is formatted as follows.

- 1) ATTRIBUTE BYTE
- 2) ATTRIBUTE ADDRESS (LO)
- 3) ATTRIBUTE ADDRESS (HI)
- 4) DISPLAY FILE ADDRESS (HI)
- 5) CHARACTER DATA ADDRESS (LO)
- 6) CHARACTER DATA ADDRESS (HI)

Note that we do not need to store the low order of the display file address, since it is identical to that of the attribute file (byte 2).

I have never known it to be useful or necessary to use FLASH 1 when animating sprites by pixels, and thus decided to sacrifice its attribute

bit, leaving us with room for a flag. The attribute is stored in a form shifted one bit to the left in the buffer, leaving bit 0 as a flag. It is often useful when two sprites overlap to be able to 'merge' one on top of the other using an OR operation, rather than the usual 'blotting out' of the first image by the second. I have named these two types of printing operation 'OR-print' and 'OVER-print' respectively. When bit 0 of the attribute byte is set, it will tell the print-processor to merge this particular character with the current contents of the cell, by OR-printing.

The routine may be easily modified if you wish to use it for your own purposes to print using the XOR (exclusive OR) operation, simply by changing all the relevant OR instructions to XOR ones. Setting the flag would then, of course, indicate 'XOR-printing required.'

In order to generate a stable horizon, it is imperative that any routine executed between the interrupt and the horizon generation is time-constant. Thus I have carefully balanced the print-processor routine so that whatever is in the buffer, it still takes the same time to execute.

Various tricks have been used to make the routine as fast as is practically possible. It emerged that there was time to print exactly 40 characters, and hence our buffer needs to be  $40 \times 6 = 240$  bytes long. If we ensure that the low order of BUFFER is 10 Hex, then we can use single-register increment instructions such as

```
INC L
as opposed to INC HL
```

to step through the buffer. This saves two T-states every time we use it, and has the added advantage that we can tell after processing an entry whether the end of the buffer has been reached, simply by using

```
INC L
```

and then testing the zero flag.

If you are not using the top few lines of the text area for animation, or if you don't mind flickering in that area, then you may at some stage in your life find it desirable to increase the number of characters that the print-processor can handle. Up to a limit of 42 characters (the hitchhikers answer to everything) this poses no problems, as the buffer would still be contained within one 'page' (256 bytes with the same high order address) of memory. However, beyond this limit, some alteration will be required so that the routine steps across the page-boundary correctly.



Since each buffer entry is six bytes long, there are six INC L instructions in each loop of the routine, as you will see when I eventually produce the listing. The first one is after the attribute byte has been fetched, the second after its low-order address has been fetched, and so on. A quick bit of maths shows us that a buffer ending at FCFFH and 43 entries long, would start at FBFEH. Hence for buffers over 42 entries, change the second INC L to INC HL.

Similarly, for an 86-entry buffer the start address would be FAFCH, so for buffers longer than 85 entries, change the fourth INC L to INC HL. The maximum buffer length by this method is a more-than adequate 128 entries (768 bytes) at which point it would start on a page boundary, FA00H. As a guide to the extra processing time for a longer buffer, each entry takes about 1.6 rows or 3.2 scan-lines to be printed.

Now obviously there will be times when we do not actually use all forty entries in the buffer. However, we must ensure that the print-processor still takes the same time to execute for a null entry, and probably the easiest way to do this is to make the routine THINK it is printing a character, without actually affecting the screen.

To signify a null entry in the buffer we will set the attribute byte to zero. The following fragment will be executed at the start of each loop, with HL pointing at the start of a buffer entry.

```
NXTCH LD    A,(HL)
      AND    A
      JR     Z,FAKE
```

At FAKE we will update the buffer pointer in HL and set up the registers necessary to OR-print a space (no net effect) in the bottom right-hand corner of the screen. There will then be a short pause in order to perfectly equalise the timing with the normal printing routine path, followed by a jump into the main section of the OR-printing procedure. The attributes will not be affected, and the fragment at FAKE goes like this:

```
FAKE LD    A,5           ;ADJUST BUFFER POINTER
      ADD   A,L           adjusts HL so that inc L after
      LD    L,A           OR-print prints HL to next
      LD    DE,50FFH     ;D.F. ADDRESS OF (23,31)
      LD    A,(DE)       ;TIMING EQUALIZER
      LD    BC,3D00H     ;ADDRESS OF 'SPACE' DATA
      EX   DE,HL         ;IN ROM
      NOP                ;WAIT 14 T-STATES
```

```
JP    $+3           ;NOTE: $=PROGRAM COUNTER
JR    OR            ;JUMP INTO MAIN ROUTINE
```

The main substance of the instructions from label OR is the fragment

```
LD    A,(BC)       ;TAKE DATA
OR    (HL)         ;'OR' WITH DISPLAY ROW
LD    (HL),A       ;INSERT IN DISPLAY FILE
INC   BC           ;NEXT BYTE OF DATA
INC   H            ;NEXT ROW OF DISPLAY FILE
```

... which is repeated six times, followed by

```
LD    A,(BC)       ;PRINT LAST ROW OF CHAR
OR    (HL)
LD    (HL),A
EX   DE,HL
INC   L            ;TEST FOR END OF BUFFER
JP    NZ,NXTCH
```

On first sight the listing for this may appear clumsy, but we must remember that time is of the essence, and a conventional loop repeated seven times would take a lot longer to execute. For the same reason, an absolute JP instruction (10 T-states) has been employed rather than a relative jump (12 T-states, the extra time being used to add the displacement to the program counter).

While all this is fresh in your mind, and before proceeding to develop the horizon-generating part of the interrupt handler, I shall list the first part of the routine for your contemplation. A word or two of explanation for the first few lines of the routine is required. The first priority in any interrupt handler should be to preserve any registers used by the handler. Having done that, we must output the border colour for the 'sky' above the horizon. This also provides an opportunity to send a 'click' to the loudspeaker, by adding 10 hex. to the argument of the XOR instruction at label TOPBRD. We shall always store the last value sent OUT to port FEH in the variable BORD, so preserving the speaker status (bit 4).

The variables CHSTRE and BUFFPT store the number of 'real' entries and the address of the next free entry in the buffer respectively. These variables will be greatly utilised later on. Now for the first part of the interrupt handler; please read at least to the end of this chapter before attempting to use it, as running it on its own would cause an almighty crash. Note also that the \$ sign in jump instructions means 'program counter', so

JR \$+2 and  
JP \$+3

simply mean 'advance to the next instruction' and are used as timing delays.

```

BUFFER EQU 0FF10H
10FF BUFFPT DEFW BUFFER
00 CHSTRE DEFB 0
00 BORD DEFB 0
;
;
; INTERRUPT HANDLER *****
; SAVE REGISTERS
;
F5 INTERP PUSH AF
C5          PUSH BC
D5          PUSH DE
E5          PUSH HL
;
; SET TOP BORDER
;
210300          LD HL, BORD
7E          LD A, (HL)
E610          AND 16
EE05 TOPBRD XOR 5
D3FE          OUT (0FEH), A
77          LD (HL), A
;
; START WORKING THROUGH BUFFER ENTRIES
;
2110FF          LD HL, BUFFER
;
; A ZERO ATTRIBUTE="NO ENTRY" SO PRINT A FAKE
; CHARACTER
;
7E NXTCH LD A, (HL)
A7          AND A
2871          JR Z, FAKE
2C          INC L
;
; TAKE ATTRIBUTE ADDRESS

```

```

;
5E          LD E, (HL)
2C          INC L
56          LD D, (HL)
2C          INC L
1F          RRA
;
; STORE NEW ATTRIBUTE
;
12          LD (DE), A
;
; FORM D.F. ADDRESS
;
56          LD D, (HL)
2C          INC L
; TAKE CHARACTER DATA ADDRESS
;
4E          LD C, (HL)
2C          INC L
46          LD B, (HL)
;
; DECIDE WHETHER TO MERGE OLD CHARACTER
;
302F          JR NC, NTOR
EB          EX DE, HL
;
; PRINT NEW CHARACTER USING "OR"
;
0A          OR LD A, (BC)
B6          OR (HL)
77          LD (HL), A
03          INC BC
24          INC H
0A          LD A, (BC)
B6          OR (HL)
77          LD (HL), A
03          INC BC
24          INC H
0A          LD A, (BC)
B6          OR (HL)
77          LD (HL), A
03          INC BC

```



```

;A SPACE WITH "OR" IN THE BOTTOM-RIGHT
;CORNER
;
3E05  FAKE  LD      A,5
85      ADD  A,L
6F      LD   L,A
11FF50  LD   DE,50FFH
1A      LD   A,(DE)
01003D  LD   BC,3D00H
EB      EX  DE,HL
00      NOP
C39B00  JP   $+3
188C    JR   OR

```

Incidentally, the label ROWS will be on the first line of the next part of the routine.

I shall now begin a discussion of the principles involved in generating a moving full-screen horizon. For the sake of convenience, I shall refer to the area of the screen above the horizon as 'sky', and that below it as 'sea'. The routines will produce a cyan sky and blue sea initially, but these colours are very easily changed and I shall indeed be including a routine to do this at a later stage.

You may well be asking yourself 'What use is a full-screen horizon' or 'is it worth all the effort and careful timing involved?'

The answer is that it IS worth the effort, because although extending the horizon doesn't allow you to print in any greater area of the screen, it does increase the effective 'playing area' of a game and is far more aesthetically pleasing. Suppose, for example, that your game involved controlling an aircraft as it flew along above the sea, and that the current position of the 'plane was as far to the left in the text area as is possible, without 'spilling' off the screen. With a conventional text-only horizon, we would see something like this:

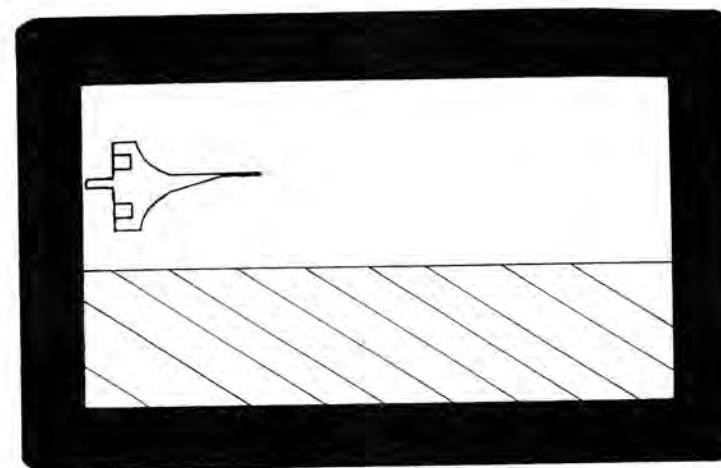

As you see, our aircraft looks extremely 'out of place' since it is cramped right up against the left border. Compare this with the 'spacious' look of a full-screen horizon, where the 'plane does not look at all unnatural, even though it is being printed in exactly the same place on the screen:

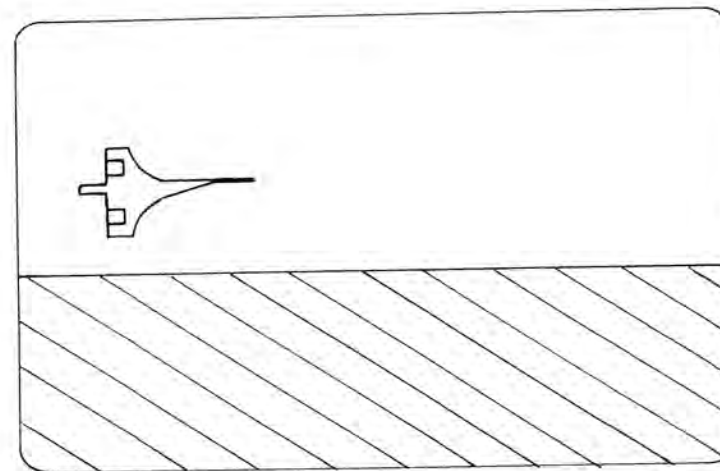

The principle behind all programming 'tricks' with the border is very simple. The ULA continually reads port 254 and sends the corresponding colour to the TV, which is building up the display line by line. Hence to obtain a steady boundary between two border colours, we just wait an exact time after each interrupt signal before sending out the 'sea' colour to port 254.



Now the Z-80 in the Spectrum runs at a clock speed of 3.5 MHz, that is to say there are 3,500,000 T-states per second. Television frames are generated at 50 Hz, and each with 625 scan lines. Hence we have

$$\begin{aligned} \text{Time taken for one scan-line} &= \frac{3\,500\,000}{625 \times 50} \\ &= 112 \text{ T-states} \end{aligned}$$

Not forgetting that the Spectrum uses two scan-lines for each row of the display, we have that each row takes  $2 \times 112 = 224$  T-states to generate, and this is how long we have to wait for each row of the display above the horizon, before changing the border colour. A suitable delay loop, where the number of rows is in the accumulator, would be as follows:

```

SCAN1 LD B,15 ;7 T-STATES
LN DJNZ LN ;14*13+8=190
AND 0FFH ;7 T-STATES
INC HL ;6 T-STATES
DEC A ;4 T-STATES
JP NZ,SCAN1 ;10 T-STATES, LOOP BACK
;FOR NEXT ROW

```

You will find the above fragment in the second part of the interrupt handler.

Well that's the border control taken care of. Now what about the attributes? If the horizon is on a boundary between two lines of the display, then we have no problem. We simply use cyan paper in the line above the horizon and blue paper in the line below it. If, however, the number of text rows above the horizon is not divisible by eight, then we will need to produce both cyan and blue paper in one line of attributes. It is not sufficient just to use cyan INK and blue PAPER, since this would leave us with no colours to print our sprites in over the horizon.

To produce these 'two-paper' attributes, we need to fill the line containing the horizon with cyan paper (and whatever coloured ink we happen to be using) then wait for the TV-scan to reach the horizon level, then hurriedly refill the line with blue-papered attributes. The ULA tests the attributes every time it generates one row of the text area, so the result should be cyan paper above the horizon and blue paper below it, together with our choice of ink and brightness for each region.

Unfortunately, due to the great speed at which the electron beam hurtles from left to right across the screen, we simply do not have enough time to replace a whole line of attributes before the ULA needs

them again. A quick calculation shows that to change 32 attributes in 224 T-states would require an average rate of one attribute in 7 T-states, which is only enough time to do a basic LD (HL), A, without incrementing any pointers.

There are two other factors to consider. On the plus side, we do in fact have slightly longer than 224 T-states. Suppose, for example, that we had managed to refill half of one TV-row, starting at the left-hand edge of the text area. The time we have had to do this would be that taken for 1.5 rows (336 T-states), since we would have started the moment the beam had left the first attribute, and finished when it 'lapped us' half way across the screen.

On the minus side, we must remember that changing the attributes will require access to the lowest 16K of RAM, and the resulting interruptions by the ULA will mean a slight overall speed decrease.

After experimentation, I found that the best we could hope for is a continuous level 'horizon' of 22 attributes. In most arcade games the action always tends towards the centre of the playing area, so I have positioned these 22 bytes in the centre of the text area, leaving 'steps' of 5 columns in width on either side. As it stands, the resulting malformed horizon would appear as follows:

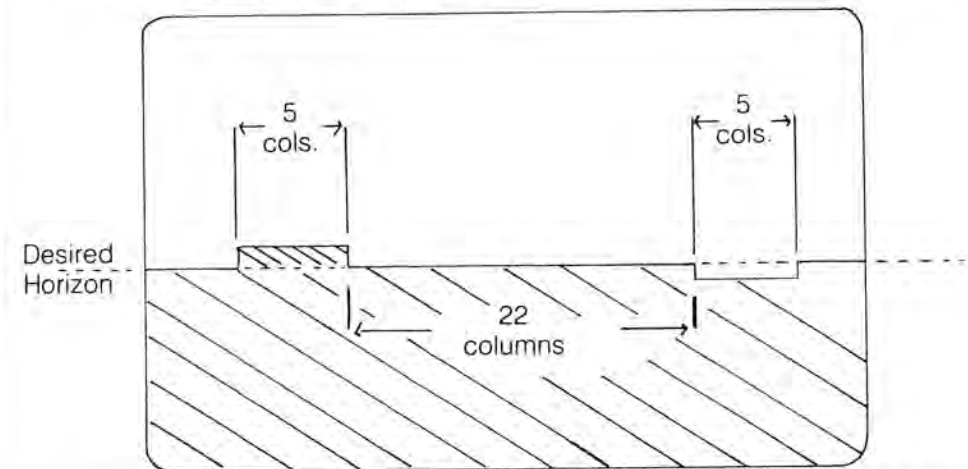

Now this jagged appearance is, unless you want a rectangular 'hill' and 'valley' on your screen, quite intolerable. The best solution to the problem is to fill the five columns on the left with one row of ink immediately above the horizon, and the five columns on the right with one row of ink just below the horizon. We will then use cyan ink on the left and blue ink on the right to create a continuous, level horizon.

At the beginning of each interrupt, all the attributes concerned will be cyan paper and (say) white ink. The sequence in which we will change the attributes is as follows (after an exact delay).

- 1) Fill rightmost 5 attributes with cyan paper, blue ink.
- 2) Fill leftmost 5 attributes with blue paper, cyan ink.
- 3) Fill middle 22 attributes with blue paper, white ink.
- 4) Fill leftmost 5 attributes with blue paper, white ink.
- 5) Fill rightmost 5 attributes with blue paper, white ink.
- 6) We must now wait 'till the TV has completely finished generating this line of the display. Part of this time will be spent preparing the print buffer for the next interrupt.
- 7) Fill all 32 attributes with cyan paper, white ink, ready for the next interrupt.

At a certain critical point during Stage (3), the beam will reach the right-hand side of the screen having generated the cyan row immediately above the horizon. While the beam is in 'flyback' to the left-hand side of the screen, we must take a break from filling attributes and output the new border value. We store the new value at (BOTBRD+1), and add 16 to it if a click is to be sent to the speaker. This combined with the value in (TOPBRD+1) allows us a choice between no sound, a 50 Hz or 100 Hz sound. In the last case, you will find that when we move the horizon up and down in the next chapter, the waveform of the sound changes due to the varying time between the 'top' click and the 'bottom' click.

Going back to our procedure for changing the attributes, the only slight side effect of using this technique will be that up to 2 rows of any sprite printed on the horizon in the left or right five columns will be cyan and blue respectively. This is hardly noticeable and a small price to pay for the overall effect of a full-screen display.

The technique will work for anything down to 2 text rows above the horizon, and the number of these rows is stored in (ROWS+1). Zero text rows poses no problem, as the whole screen will be sea, and we just jump straight to label NOWAIT where the border colour is changed. However, in the very unlikely event that you require just one text row above the horizon, then you will have to revert to the old technique of filling it with ink and using cyan ink and blue paper. This is because there is not enough time to manipulate the attributes in the manner required by the new technique. In this case, the interrupt handler jumps to label WT1.LN and waits for the TV to reach row one before changing the border.

Scattered through the listing you will find labels HCOL1 to HCOL4; these will be used in the next chapter to change the sky and sea colours. HRZN3 will be used by the horizon movement routines. It holds the

address of the 28th horizon attribute, and will be set to point at 001BH (in the ROM) whenever no attribute work is required. This is indeed the case in the routine as it stands, as I have set (ROWS+1) to 96, or half-way down the screen.

After the horizon has been generated, the interrupt handler has two more tasks. Firstly, it must 'tidy up' the print buffer by deleting all the entries just printed, inserting zero attribute bytes to signify forty null entries. It resets BUFFPT to the first free entry, which is now at BUFFER, and sets the number of entries, CHSTRE, to zero. Finally it retrieves all the registers stored at the beginning of the interrupt, and terminates.

Here then is the second part of the interrupt handler, followed by an initialization routine.

```

3E60    ROWS    LD      A,96
;
;A HOLDS NO. OF ROWS ABOVE HORIZON
;IF A=0 THEN DON'T WAIT TO CHANGE BORDER
;
D601    SUB     1
DAC800  JP      C,NOWAIT
;
;IF A=1 THEN WAIT FOR ONE SCAN LINE
;
CABE00  JP      Z,WT1LN
3D      DEC    A
;
;IF A=2 THEN SKIP THIS DELAY
CA1900  JP      Z,GO4IT
;
;THIS LOOP TAKES 224 T-STATES OR ONE
;SCAN-LINE PER PASS
060F    SCAN1  LD      B,15
10FE    LN     DJNZ   LN
E6FF    AND    0FFH
23      INC    HL
3D      DEC    A
C20E00  JP      NZ,SCAN1
;
;TIMING BALANCER
;
060A    GO4IT  LD      B,10
10FE    SELFS  DJNZ   SELFS

```

```

E6FF          AND      ØFFH
;
211BØØ      HRZN3  LD      HL,1BH
;HL=ADDRESS OF 26TH ATTRIBUTE IN THE LINE
;
7D           LD      A,L
E6EØ        AND      ØEØH
47          LD      B,A
;
;FIND BOTTOM BORDER COLOUR
;
11ØØØØ      LD      DE,BORD
1A          LD      A,(DE)
E61Ø        AND      16
EEØ1        BOTBRD XOR    1
12          LD      (DE),A
1E29        HCOL1  LD      E,41
ØEØD        HCOL2  LD      C,13
;
;FILL RIGHT 5 ATTS WITH CYAN PAPER,BLUE INK
73          LD      (HL),E
2C          INC    L
73          LD      (HL),E
2C          INC    L
73          LD      (HL),E
2C          INC    L
73          LD      (HL),E
2C          INC    L
73          LD      (HL),E
2C          INC    L
68          LD      L,B
1EØF        HCOL3  LD      E,15
;
;FILL LEFT 5 ATTS WITH BLUE PAPER, CYAN INK
;
71          LD      (HL),C
2C          INC    L
71          LD      (HL),C
2C          INC    L
71          LD      (HL),C
2C          INC    L
71          LD      (HL),C
2C          INC    L

```

```

71          LD      (HL),C
2C          INC    L
;
;FILL MIDDLE 22 ATTS WITH BLUE PAPER,WHITE INK
;
73          LD      (HL),E
2C          INC    L
73          LD      (HL),E
2C          INC    L
73          LD      (HL),E
2C          INC    L
73          LD      (HL),E
2C          INC    L
73          LD      (HL),E
2C          INC    L
73          LD      (HL),E
2C          INC    L
73          LD      (HL),E
2C          INC    L
73          LD      (HL),E
2C          INC    L
73          LD      (HL),E
2C          INC    L
73          LD      (HL),E
2C          INC    L
;MEANWHILE THE TV SCAN HAS REACHED THE RIGHT-HAND
;EDGE, SO CHANGE BORDER COLOUR NOW.
;
D3FE        OUT    (ØFEH),A
73          LD      (HL),E
2C          INC    L
73          LD      (HL),E
2C          INC    L
73          LD      (HL),E
2C          INC    L
73          LD      (HL),E
2C          INC    L

```

```

2C      INC      L
73      LD       (HL),E
2C      INC      L
73      LD       (HL),E
2C      INC      L
73      LD       (HL),E
2C      INC      L
73      LD       (HL),E
2C      INC      L
73      LD       (HL),E
7D      LD       A,L
68      LD       L,B

```

```

;
;NOW FILL LEFT 5 ATTS WITH BLUE PAPER, WHITE INK
;

```

```

73      LD       (HL),E
2C      INC      L
73      LD       (HL),E
2C      INC      L
73      LD       (HL),E
2C      INC      L
73      LD       (HL),E
2C      INC      L
73      LD       (HL),E
6F      LD       L,A
2C      INC      L

```

```

;FINALLY FILL RIGHT 5 ATTS WITH BLUE PAPER,
;WHITE INK
;

```

```

73      LD       (HL),E
2C      INC      L
73      LD       (HL),E
2C      INC      L
73      LD       (HL),E
2C      INC      L
73      LD       (HL),E
2C      INC      L
73      LD       (HL),E
68      LD       L,B

```

```

;
;STORE START OF ATT LINE
E5      INIT3   PUSH   HL

```

```

;ENSURE THAT THE BUFFER IS FILLED WITH FAKE
;CHARACTERS
;
2100000 LD       HL,CHSTRE
7E      LD       A,(HL)
A7      AND      A
280F    JR       Z,END
1106000 INIT2   LD       DE,6
;
;NOTE   D=0
72      LD       (HL),D
2100000 LD       HL,BUFFER
2200000 LD       (BUFFPT),HL
47      LD       B,A
72      NXTFL   LD       (HL),D
19      ADD     HL,DE
10FC    DJNZ    NXTFL
;
;RETRIEVE ATT ADDRESS
;
E1      END     POP     HL
;
;H=0 MEANS NO ATTS TO FILL
;
7C      LD       A,H
A7      AND      A
CAB7000 JP       Z,NOPLG
;
;WAIT TILL TV HAS FINISHED WITH THIS
;ATTRIBUTE LINE
;N.B. IF FLICKERING OCCURS THEN
;INCREASE THIS DELAY
;
064D    LD       B,4DH
10FE    SELF4   DJNZ    SELF4
;
;FILL THE LINE WITH CYAN PAPER, WHITE INK
;
0E1F    LD       C,31
54      LD       D,H
5D      LD       E,L
1C      INC     E

```



```

362F      HCOL4   LD      (HL),47
EDB0      LDIR
;
;RETRIEVE REGISTERS
;
E1        NOPLG   POP      HL
D1        POP     DE
C1        POP     BC
F1        POP     AF
;
;END INTERRUPT
;
FB        EI
ED4D      RETI
;
;
;DELAY FOR HORIZON AT ROW1
;
060F      WT1LN   LD      B,15
10FE      SELF11  DJNZ    SELF11
E6FF      AND     0FFH
23        INC     HL
3D        DEC     A
2B        DEC     HL
3C        INC     A
;
;ENTERS HERE FOR ROW ZERO HORIZON
;
;FIND NEW BORDER COLOUR
;
2A2C00    NOWAIT  LD      HL,(BOTBRD)
110000    LD      DE,BORD
1A        LD      A,(DE)
E610     AND     16
AC        XOR     H
;
;STORE IT AND OUTPUT IT
;
12        LD      (DE),A
D3FE     OUT     (0FEH),A
;
;SET FLAG FOR NO ATTS TO FILL

```

```

2600      LD      H,0
;
;JUMP BACK TO MAIN ROUTINE
;
C38D00    JP      INIT3

```

We will, of course, be using interrupt mode 2, and as you will see, I have elected to use a 257 byte vector table pointing to a jump instruction at FDFDH to the interrupt handler. This technique was described more fully in Chapter 7. By putting the table at FE00H and the buffer at FF10H (remember, the low byte must be 10H) I have neatly used up the last 1/2K of RAM, wasting only fifteen bytes. The following initialization routine sets up the vector table, selects IM2 and then jumps into the interrupt handler in order to ensure that the buffer is clear. I have called the routine INT1, and its counterpart for reselecting IM1 (should you wish to return to BASIC) DISINT.

The last three lines of the listing set up the all-important JP at FDFDH.

```

;INITIALIZE INTERRUPT PROCESSOR
;PRESERVE REGISTERS AS WE EXIT VIA THE
;INTERRUPT HANDLER
;
F3        INT1    DI
F5        PUSH   AF
C5        PUSH   BC
D5        PUSH   DE
E5        PUSH   HL
3EFE     LD      A,0FEH
ED47     LD      I,A
;
;SET UP VECTOR TABLE FOR IM 2 BY FILLING
;257 BYTES FROM 0FE00H WITH 0FDH
;
2100FE    LD      HL,0FE00H
45        LD      B,L
3D        DEC     A
77        TBLP   LD      (HL),A
23        INC     HL
10FC     DJNZ    TBLP
77        LD      (HL),A
;
ED5E     SELECT IM 2 AND PREPARE FOR....

```

```

3E28          LD      A,40
ED5E          IM      2
2600          LD      H,0
E5            PUSH   HL
210000        LD      HL,CHSTRE
;
;A JUMP INTO THE INTERRUPT HANDLER TO CLEAR
;THE PRINT BUFFER
C30000        JP      INIT2
;
;
;USE THIS ROUTINE TO RESELECT IM 1
3E3E          DISINT LD      A,3EH
ED56          IM      1
ED47          LD      I,A
C9            RET
;
;POSITION THE JUMP INSTRUCTIONS TO THE
;INTERRUPT HANDLER

          LABEL  ORG      0FDFDH
C30000        JP      INTERP
          ORG      LABEL

```

In the next chapter I shall produce a suite of routines to deal with every aspect of horizon generation and movement. Following that will be a powerful set of sprite animation routines to make full use of the (as yet unused) print-processor.

If you do not wish to use the full-screen horizon generator in the interrupt handler, then you can 'turn it off' with the following sequence.

```

LD      A,<BORDER COLOUR>
LD      (TOPBRD+1),A
LD      (BOTBRD+1),A
XOR    A
LD      (ROWS+1),A

```

This sets the horizon to its maximum level with the same coloured sea and sky, and causes the routine to skip any work on the attributes. You may then safely ignore the next chapter!

## CHAPTER 10

# Moving the Full-Screen Horizon by Pixels

Before I supply the horizon control routines, a word or two of caution about the use of the interrupt processor is required.

Although the Z-80 always receives an interrupt signal at exactly the same stage of the TV frame, it will never react to it until it has finished processing the current instruction. This can lead to a variation of as much as 23 T-states (as in the case of one of the longest instructions, EX(SP),IX) in the time at which the interrupt is processed.

In human terms this does not seem very long, but it is long enough for the TV to progress about one tenth of the way through a row, thereby affecting our 'artificial' horizon, shifting the central, level portion momentarily to the left or right. In fact, the horizon generator can tolerate a time displacement of about  $\pm 4$  T-states with no ill effect, so as long as we get back to a HALT instruction (which makes the processor continuously execute NOPs at 4 T-states each) before an interrupt occurs then there will be no problem.

If, however, you wish to execute some other routine while expecting an interrupt, then you will probably find that flickering occurs. In this case the solution is to extend our 'ink rows', which as you recall are normally five columns in width, either side of the central horizon, until they completely cover the flickering area. You should not need to make them wider than seven columns on each side, leaving eighteen untouched columns in the centre of the screen. Naturally you will then need to make slight modifications to all of the horizon routines so that they calculate the correct addresses for, and correctly manipulate, the new attributes

and ink rows. The same goes for the horizon generator in the interrupt handler.

I shall now begin development of the first horizon routine, HRZST1. Its function will be to delete the last ink rows inserted on the screen, and calculate the addresses of the new ones, after we have moved the horizon. We will store the address of the left five ink rows in HRZN1, and that of the right five in HRZN2. When no ink rows are required (if the horizon is not in the text or is between two lines) then we will set the high order of HRZN1 and HRZN2 to zero, as flags.

The address of the current attribute line will always be stored in HRZN4, and also inserted in the interrupt handler itself at (HRZN3+1). The high order of the latter will be set to zero when no attribute manipulation is necessary, thereby pointing the horizon generator in the interrupt handler at the ROM. This is the easiest way to ensure that the generator still gets the timing right for the border change.

We will thus need to define the variables at the start of the program:

```

                ORG      (YOUR ADDRESS)
HRZN1  DEFW      0
HRZN2  DEFW      0
HRZN4  DEFW      0

```

Now for the listing of HRZST1, followed by notes on its use.

```

                ;DELETE OLD INK ROWS AND SET UP
                ;NEW VALUES FOR LOCATIONS OF INK ROWS
                ;AND ATTRIBUTES
                ;ENTRY: C=NO. OF TEXT ROWS ABOVE THE
                ;HORIZON
                ;PRESERVED: DE,C
2A0000  HRZST1  LD      HL,(HRZN1)
                ;
                ;CLEAR THE LEFT FIVE INK ROWS
                ;
AF                XOR      A
77                LD      (HL),A
2C                INC      L
77                LD      (HL),A
2C                INC      L
77                LD      (HL),A
2C                INC      L

```

```

77                LD      (HL),A
2C                INC      L
77                LD      (HL),A
                ;
                ;NOW THE RIGHT FIVE
                ;
2A0000          LD      HL,(HRZN2)
77                LD      (HL),A
2C                INC      L
77                LD      (HL),A
2C                INC      L
77                LD      (HL),A
2C                INC      L
77                LD      (HL),A
2C                INC      L
77                LD      (HL),A
79                HRZST2  LD      A,C
320000          LD      (ROWS+1),A
                ;IS THE HORIZON STILL IN THE TEXT AREA?
                ;
FEC1           CP      0C1H
                ;
                ;IF NOT THEN NO INK ROWS ARE NEEDED
3031           JR      NC,NOWRK
                ;
                ;LOCATE ATTRIBUTE LINE
                ;
07                RLCA
07                RLCA
E603           AND      3
F658           OR      58H
67                LD      H,A
79                LD      A,C
87                ADD      A,A
87                ADD      A,A
E6E0           AND      0E0H
6F                LD      L,A
                ;STORE IT
220000          LD      (HRZN4),HL
79                LD      A,C
                ;
                ;IF HORIZON IS BETWEEN TWO LINES THEN NO

```

```

;INK ROWS NEEDED
;
E607          AND      7
281C          JR        Z,NOWRK
;
;LOCATE 28TH ATTRIBUTE
;
7D            LD        A,L
F61B          OR        1BH
45            LD        B,L
6F            LD        L,A
;
;INSERT IT IN INTERRUPT HANDLER
220000        LD        (HRZN3+1),HL
;LOCATE 28TH BYTE OF D.F. ROW BELOW HORIZON
;
79            LD        A,C
1F            RRA
37            SCF
1F            RRA
A7            AND        A
1F            RRA
A9            XOR        C
E6F8          AND        0F8H
A9            XOR        C
67            LD        H,A
220000        LD        (HRZN2),HL
;NOW FIRST BYTE OF ROW ABOVE HORIZON
;
25            DEC        H
68            LD        L,B
220000        LD        (HRZN1),HL
C9            RET
AF            NOWRK    XOR        A
;WHEN NO INK ROWS ARE NEEDED,POINT
THE VARIABLES ;AT THE ROM
320000        LD        (HRZN1+1),A
320000        LD        (HRZN2+1),A
320000        LD        (HRZN3+2),A
C9            RET

```

HRZST1 will be called by the next routine, HRZMV1, whenever it moves the horizon (ST for SeT, MV for MoVe). You may also call it directly to move the horizon to any level on the screen in one go, from any 'old' level. Just

```

LD        C,(NO. OF ROWS ABOVE HORIZON)
CALL     HRZST1

```

... then fill in the ink rows and attributes as required. If the horizon level is being set for the first time, then you should skip the section that 'blanks out' the old ink rows by entering at HRZST2.

To develop a routine to move the horizon, HRZMV1, we shall first define two variables. HRZSPD will hold the number of rows moved by the horizon every time the routine is called. This will vary between one and eight. The direction of the horizon will be stored in CNTRL, which may be set (for example) by a keyboard scanning routine. Bit 2 of CNTRL will be set (value 4) for downwards movement, and bit 3 (value 8) for upwards. So we start with the lines

```

                ORG        (YOUR ADDRESS)
HRZSPD    DEFB        0
CNTRL     DEFB        0

```

Due to the problem of a horizon on row one, described in the previous chapter, I have limited movement to levels below this. On my TV there are about 236 rows from the top of the text area to the bottom of the screen, so I have set the lower limit at  $(ROWS+1)=236$ . You will probably want to alter this for your own TV, and in any case you must remember that the lower the horizon, the longer it takes to generate it and thus the less time you have to do anything else before the next interrupt (like animating sprites, for example!).

The main function of HRZMV1 is to take care of the attributes as the horizon moves. If, for example, we have just moved the horizon up to row 0 of the current line, or into the line above it, then we will need to change a line of attributes from sky to sea. Similarly, if we have just moved down onto a new line then we must fill its attributes with sky, ready for the next interrupt. HRZMV1 will be called by the forthcoming master horizon routine, HRZNMK. When the routine HRZMV1 is completely satisfied with the attributes, it makes a jump to HRZST1 in order to set up the new values for HRZN1 to HRZN4 and blank out any old ink rows.

You may notice two unused labels in the listing, HCOL5 and HCOL6. These will be used by a later routine which will set up new sky and sea colours. Here comes the listing ...



```

;ROUTINE TO CHANGE HORIZON LEVEL
;BY AMOUNT (HRZSPD) IN DIRECTION
;(CNTRL) NOTE 4=DOWN, 8=UP
;
;
3A0000 HRZMV1 LD      A,(HRZSPD)
47      LD      B,A
3A0000      LD      A,(CNTRL)
110000      LD      DE,0
;
;TEST FOR UPWARDS
;
CB5F      BIT      3,A
C23C00      JP      NZ,UP2
;
;TEST FOR DOWNWARDS
;
CB57      BIT      2,A
C8        RET      Z
;
;INCREASE ROWS ABOVE HORIZON BY HRZSPD
;
3A0000      LD      A,(ROWS+1)
80        ADD     A,B
;
;SAFETY CHECK FOR MINIMUM HORIZON LEVEL 1
;
FEEC      CP      236
D0        RET     NC
;
;IF ROWS>192 THEN SKIP TO HRZST1
;
FEC1      CP      0C1H
4F        LD      C,A
D20000      JP      NC,HRZST1
;
;ARE WE ON ROW ZERO OF A LINE?
;
E607      AND     7
2008      JR      NZ,NROWZ1
;
;IF SO, THEN IS HRZSPD AT 8 ROWS PER MOVE?

```

```

;
;          BIT      3,B
CB58
;
;IF NO, THEN SKIP TO HRZST1
;
;          JP      Z,HRZST1
CA0000      JR      ROWZ1
1808      NROWZ1 CP      B
B8
;
;ARE WE MOVING FROM ROW 0 OF A LINE?
;
2805      JR      Z,ROWZ1
;
;OTHERWISE, IF WE ARE STILL ON THE SAME
;LINE THEN JUMP
;
D20000      JP      NC,HRZST1
1E20      LD      E,20H
;
;DELAY TO ENSURE TV HAS FINISHED THE NEW LINE
;
064D      ROWZ1 LD      B,77
10FE      SELF42 DJNZ   SELF42
;
;FILL THE NEW LINE WITH CYAN PAPER, WHITE INK
;
062F      HCOL5 LD      B,47
C36000      JP      UPINIT
;
3A0000      UP2   LD      A,(ROWS+1)
;
;DECREASE ROWS ABOVE HORIZON BY HRZSPD
;
90        SUB     B
;
;RETURN IF NEGATIVE
;
D8        RET     C
;
;RETURN IF LESS THAN 2
;
FE02      CP      2

```

```

D8          RET      C
;
; IF ROWS > 184 THEN SKIP TO HRZST1
;
FEB9       CP       0B9H
4F         LD       C,A
D20000    JP       NC,HRZST1
ED44      NEG
E607      AND      7
110000    LD       DE,0
;
; JUMP IF NOT ON ROW 0 OF A LINE
;
2007      JR       NZ,NROWZ2
;
; OTHERWISE FILL IN THE CURRENT LINE
; WITH BLUE PAPER, WHITE INK
;
CB58      BIT      3,B
2807      JR       Z,HCOL6
11E0FF    LD       DE,0FFE0H
B8        NROWZ2 CP   B
;
; IF WE ARE STILL ON THE SAME LINE THEN JUMP
;
D20000    JP       NC,HRZST1
;
; OTHERWISE FILL THE OLD ONE WITH BLUE PAPER
; WHITE INK
060F     HCOL6  LD   B,15
2A0000    UPINIT LD   HL,(HRZN4)
19        ADD   HL,DE
;
; THE ALL-PURPOSE FILLER
;
54        LD   D,H
5D        LD   E,L
1C        INC  E
70        LD   (HL),B
79        LD   A,C
011F00    LD   BC,31
EDB0     LDIR

```

```

4F         LD       C,A
;
; FINALLY JUMP TO HRZST1
;
C30000    JP       HRZST1

```

We now have all the code necessary to set and move the horizon level. HRZMV1 copes with all work on the attributes as the horizon moves, while HRZST1 makes sure that we know where those attributes are, deletes the old ink rows and calculates the addresses of the new ones. All that remains is to actually insert those ink rows into the display file before every interrupt (they may have been overprinted by sprites since the last one). The master routine HRZNMK (MK for MaKe) will do this after having called HRZMV1, which makes any necessary changes to the attributes and variables. Thus HRZNMK is the only routine that we have to call directly after each interrupt, as will be seen in the demonstration routine following its listing.

```

; THE MAIN HORIZON ROUTINE
; JUST CALL THIS AFTER EACH
; INTERRUPT, HAVING SET THE VARIABLES
; CNTRL AND HRZSPD
;
CD0000    HRZNMK CALL HRZMV1
;
; RETURN IF NO INK ROWS ARE NEEDED
;
2A0000    LD       HL,(HRZN1)
24        INC     H
25        DEC     H
C8        RET     Z
;
; INSERT THE INK ROWS FOR THE HORIZON
;
3E0F     LD       A,0FFH
;
; FIRST THE LEFT FIVE
;
77        LD       (HL),A
2C        INC     L
77        LD       (HL),A
2C        INC     L
77        LD       (HL),A

```

```

2C          INC     L
77          LD      (HL),A
2C          INC     L
77          LD      (HL),A
;
;NOW THE RIGHT FIVE
;
2A0000     LD      HL,(HRZN2)
77          LD      (HL),A
2C          INC     L
77          LD      (HL),A
2C          INC     L
77          LD      (HL),A
2C          INC     L
77          LD      (HL),A
2C          INC     L
77          LD      (HL),A
C9          RET

```

To illustrate your new-found power over the Spectrum, here is a demonstration routine that employs INT1, HRZST2, HRZNMK, DISINT and indirectly, HRZST1, HRZMV1 and the interrupt handler.

The routine gives you direct control over the horizon. Pressing any of keys 1 to 5 moves it upwards, while keys CAPS SHIFT to V move it downwards. Keys 8,9 and 0 are used to control the speed of the horizon. Think of them as a three bit number, each bit being set when its key is depressed, then add one to obtain HRZSPD. Thus presing keys 8 and 0 (101 binary=5 decimal) gives a speed of 6 rows per TV frame. Here then is the routine, DEMO.

```

CD0000     DEMO    CALL    INT1
;
;SET INITIAL HORIZON
;
0E54          LD      C,84
CD0000     CALL    HRZST2
;
;WAIT FOR INTERRUPT
;
76          DMLP    HALT
;
;C WILL HOLD DIRECTION

```

```

0E00          ;          LD      C,0
;
;TEST BOTTOM-LEFT HALF-ROW
;
3EFE          LD      A,0FEH
DBFE          IN      A,(0FEH)
2F           CPL
E61F          AND     1FH
2802          JR      Z,ND1
;
;IF PRESSED, THEN SET BIT 2 FOR "DOWN"
;
CBD1          SET     2,C
;
;TEST TOP-LEFT HALF-ROW
;
ND1          LD      A,0F7H
3EF7          IN      A,(0FEH)
DBFE          IN      A,(0FEH)
2F           CPL
E61F          AND     1FH
2802          JR      Z,NU1
;
;IF PRESSED, THEN SET BIT 3 FOR "UP"
;
CBD9          SET     3,C
;
;STORE DIRECTION
;
NU1          LD      A,C
320000     LD      (CNTRL),A
;
;TEST TOP-RIGHT HALF-ROW
;
3EEF          LD      A,0EFH
DBFE          IN      A,(0FEH)
;
;USE RIGHT 3 KEY-BITS FOR HORIZON SPEED
;
2F           CPL
E607          AND     7
3C          INC     A

```

```

320000      LD      (HRZSPD),A
;
;CALL THE MASTER HORIZON ROUTINE
;
CD0000      CALL    HRZNMK
;
;TEST BREAK KEY
;
3E7F        LD      A,7FH
DBFE        IN      A,(0FEH)
1F          RRA
38CE        JR      C,DMLP
;
;IF PRESSED, THEN BACK TO BASIC
;
CD0000      CALL    DISINT
C9          RET

```

For the final routine in this 'horizon suite' I have produced HRZCOL, which allows you to set up the other routines for any combination of sea and sky colours. It also sets the ink colours for above and below the horizon (if you are moving shapes over the horizon, then you will probably want these two to be the same). You have the option of causing the interrupt handler to generate a background 'motor' sound, either at 50 Hz or 100 Hz, by adding 16 to one or both of the paper values respectively. The registers should then be prepared as follows:

H = sea paper value (+16 for sound)  
L = sky paper value (+16 for 100 Hz sound)

B = sea ink value  
C = sky ink value.

For example, to produce green ground and a white sky, with black ink in both,

```

LD      HL,0407H
LD      BC,0000H
CALL    HRZCOL

```

The routine simply inserts the correct attributes at the labels HCOL1 to HCOL6, which are to be found in the interrupt handler (HCOL1 to HCOL4) and HRZMV1 (HCOL5 and HCOL6).

```

;ROUTINE TO SET COLOURS OF SEA AND SKY
;ENTRY: H=SEA PAPER, L=SKY PAPER
;B=SEA INK, C=SKY INK
;ADD 16 TO H OR L OR BOTH FOR SOUND
;
;
7C          HRZCOL LD      A,H
320000      LD      (BOTBRD+1),A
;
;LEAVE SEA PAPER IN H
;
E607        AND      7
67          LD      H,A
7D          LD      A,L
320000      LD      (TOPBRD+1),A
;
;LEAVE SKY PAPER IN L
;
E607        AND      7
6F          LD      L,A
;
;HCOL1 NEEDS SKY-PAPER PAPER AND SEA PAPER INK
;
07          RLCA
07          RLCA
07          RLCA
5F          LD      E,A
B4          OR      H
320000      LD      (HCOL1+1),A
;
;HCOL2 NEEDS SEA-PAPER PAPER AND SKY-PAPER INK
;
7C          LD      A,H
07          RLCA
07          RLCA
07          RLCA
57          LD      D,A
B5          OR      L
320000      LD      (HCOL2+1),A
;HCOL3 NEEDS SEA-PAPER PAPER AND SEA-INK INK
;
7A          LD      A,D

```



```

B0          OR      B
320000     LD      (HCOL3+1),A
;
;...AS DOES HCOL6
;
320000     LD      (HCOL6+1),A
;
;HCOL4 NEEDS SKY-PAPER PAPER AND SKY-INK INK
;
7B         LD      A,E
B1         OR      C
320000     LD      (HCOL4+1),A
;
;....AS DOES HCOL5
;
320000     LD      (HCOL5+1),A
C9         RET

```

## CHAPTER 11

# A Suite of Routines to Complement the Print-Processor

In this chapter I shall be developing a complete set of printing routines, to take full advantage of the interrupt-driven print-processor produced in Chapter 9. In the following chapter will come the sprite animation routines.

To start with, it would be useful to have a simple routine with which to send any character to the buffer. Rather than using the address of the current cell in the display file, as does Spectrum BASIC with the system variable DF-CC, I find it more convenient to keep track of the print position using the attributes file. Thus we will define a variable ATCC to hold the attribute address of the current cell, and start with the lines

```

                ORG      (YOUR ADDRESS)
ATCC    DEFW    5800H

```

... thereby initialising our marker to the top-left corner of the text area. The base of the table holding the character data will be stored in CHARS, and we may as well start by pointing it at the Spectrum BASIC character set, using the line

```

CHARS    DEFW    3C00H

```

Remember that CHSTRE holds the number of used entries in the print buffer, and BUFFPT points at the next free entry. Both variables are altered accordingly. The rest of the routine is self-explanatory, so without further ado, I hereby present HIPRINT to you.

```

;SEND A CHARACTER TO THE BUFFER
;ENTRY: A=CHARACTER CODE
;EXIT: BC=ADDRESS OF CHARACTER DATA
;DE=ATCC (SEE TEXT)
;HL=NEXT BUFFER ENTRY
;A=HI BYTE OF D.F. ADDRESS
;
;MULTIPLY CODE BY 8
;
6F      HIPRNT  LD      L,A
2600    LD      H,0
29      ADD     HL,HL
29      ADD     HL,HL
29      ADD     HL,HL
;
;ADD BASE ADDRESS OF TABLE
;
ED5B0000 LD     DE,(CHARS)
19      ADD     HL,DE
;
;LET BC = DATA ADDRESS
;
44      LD      B,H
4D      LD      C,L
210000  PLACE  LD     HL,CHSTRE
7E      PWAIT  LD     A,(HL)
;
;IF THE BUFFER IS FULL THEN WAIT FOR AN
;INTERRUPT
;
FE28    CP      40
DA1900  JP      C,GO
FB      EI
18F7    JR      PWAIT
F3      GO     DI
;
;UPDATE BUFFER CHARACTER COUNT
;
34      INC     (HL)
ED5B0000 LD     DE,(ATCC)
;
;DE=ADDRESS OF ATTRIBUTE

```

```

2A0000  ;      LD      HL,(ATT)
;
;H=MASK, L=ATT
;CONSTRUCT NEW ATTRIBUTE
;
1A      LD      A,(DE)
AD      XOR     L
A4      AND     H
AD      XOR     L
2A0000  LD      HL,(BUFFPT)
;
;HL=FIRST FREE BUFFER LOCATION
;ROTATE AND STORE ATTR
;
07      RLCA
77      LD      (HL),A
;
;STORE ATTR. ADDRESS
;
2C      INC     L
73      LD      (HL),E
23      INC     HL
72      LD      (HL),D
2C      INC     L
;
;FIND AND STORE HI BYTE OF D.F. ADDRESS
;
7A      LD      A,D
E603    AND     3
07      RLCA
07      RLCA
07      RLCA
F640    OR      64
77      LD      (HL),A
23      INC     HL
;
;STORE CHARACTER DATA ADDRESS
;
71      LD      (HL),C
2C      INC     L
70      LD      (HL),B

```

```

23          INC    HL
           ;
           ;SET BUFFPT TO NEXT FREE BUFFER ENTRY
           ;
220000     LD      (BUFFPT),HL
C9          RET

```

There will be times during some programs when you want the interrupt handler to continually print a particular character or set of characters in the same place on the screen. For example, you may wish to superimpose 'laser target sights' on the centre of the screen, and these would need continual OR-printing on every interrupt, as the enemy spaceship (or whatever) moves behind them. Since time is so short between two interrupts (especially if you are using the horizon generator, at low level), it would be highly preferable not to have to load all the data for the target sights into the print buffer after every interrupt.

In order to enable this, I have devised a system of routines which use a subsection of the print buffer, which shall be called 'RO-buffer' for 'Read-Only buffer'. Unlike normal entries in the print buffer, those in the RO-buffer will not be erased by the interrupt handler when they have been printed. Thus all that we need to do before each interrupt is to make sure the correct attributes for each cell concerned have been inserted in the RO-buffer. If the attribute mask is the zero byte, then we will not even need to do this, since the characters will always be printed with the same attributes, regardless of the 'old' attributes for that cell.

Consecutive entries normally 'grow' upwards from the start of the print buffer: so to keep them separate, we will make the RO-buffer grow downwards from the end of the print buffer. The two regions should never overlap. We will store the number of entries in the RO-buffer in the variable ROLNTH, and the start (lowest address) of the RO-buffer in the variable ROBFPT. Thus we initialise them (for a zero-length RO-buffer) with the lines.

```

           ORG    (YOUR ADDRESS)
ROLNTH    DEFB    0
ROBFPT    DEFW    0

```

Before we go any further we need a routine to set up a RO-buffer. What, in fact, the following routine will do is to ALTER the length of the RO-buffer by the value in C, which may be positive or negative. Having adjusted ROLNTH, the routine fills all the entries between the end of the 'normal' entries (i.e. BUFFPT) and the beginning of the RO-buffer, with 'null' characters, to prevent any garbage being printed. For this reason

the routine, called ALTRBF, should always be called with the interrupts disabled. ALTRBF then sets ROBFPT to the new start address of the RO-buffer, and returns it in HL, which will be used later.

```

           ;ROUTINE TO ALTER LENGTH OF RO-BUFFER
           ;ENTRY: C=ALTERATION TO LENGTH
           ;PRESERVED: C
           ;EXIT: HL=START OF RO-BUFFER, B=0, A=NO. OF
           ;UNUSED ENTRIES IN PRINT BUFFER
           ;
           ;
210000     ALTRBF LD      HL,ROLNTH
           ;
           ;ALTER ROLNTH BY C
           ;
7E          LD      A,(HL)
81          ADD     A,C
77          LD      (HL),A
           ;
           ;FIND NO. OF UNUSED ENTRIES IN PRINT BUFFER
           ;(>=0)
           ;
3A0000     LD      A,(CHSTRE)
47          LD      B,A
3E28       LD      A,40
90         SUB     B
96         SUB     (HL)
47         LD      B,A
           ;
           ;FILL THEM WITH "NULL" ENTRIES
           ;
2A0000     LD      HL,(BUFFPT)
           ;
           ;BUT JUMP IF THERE ARE NO ENTRIES TO BE FILLED
           ;
2807       JR      Z,HOPFL
110600     LD      DE,6
           ;
           ;NOTE: D=0
           ;
72         BLNK   LD      (HL),D
19         ADD     HL,DE

```

```

10FC          DJNZ  BLNK
              ;
              ; RESET ROBFPT TO START OF RO-BUFFER
              ;
220000 HOPFL  LD      (ROBFPT),HL
C9          RET

```

Obviously any routine written to output characters to the print buffer is easily adapted to use the RO-buffer, which is indeed a subsection of the former. You could modify HIPRNT or any of your own printing routines. I shall be supplying a routine to dump pre-defined shapes such as our target-sight into the RO-buffer, but first let me get the simple routine needed to refresh the attribute bytes of each entry out of the way.

The routine is called SRVR1 (for it is a SeRVice Routine). It takes the attribute address from an entry, finds the attribute from the file, then masks it with our standard variable MASK, which as usual is placed directly after ATT, the attributes for our characters. The completed attribute byte is then rotated left by one bit (to counter the rightwards rotation by the interrupt handler) and inserted in the RO-buffer. Note that if we wish to select OR-printing then we set bit 7 of ATT (bit 7 of MASK should always be zero), which will then be rotated to bit 0 before insertion in the buffer. This also applies to HIPRNT.

Here, then, is the listing for SRVR1. Note the use of the zero flag to detect the end of the buffer, when the lo-byte of its address becomes zero.

```

              ;SERVICE ROUTINE TO UPDATE ATTRIBUTES
              ;IN THE RO-BUFFER
              ;EXIT: B=MASK, C=ATTRIBUTE, A=0
              ;HL=BYTE AFTER PRINT BUFFER
              ;
2A0000 SRVR1  LD      HL,(ROBFPT)
              ;
              ;LET B=MASK, C=ATTRIBUTE
              ;
ED4B0000          LD      BC,(ATT)
              ;
              ;TAKE ATTRIBUTE ADDRESS
              ;
2C          NXSrv1  INC      L
5E          LD      E,(HL)
2C          INC      L
56          LD      D,(HL)

```

```

2D          DEC      L
2D          DEC      L
              ;
              ;TAKE CURRENT ATTRIBUTE
              ;
1A          LD      A,(DE)
              ;
              ;CREATE NEW ONE
              ;
A9          XOR      C
A0          AND      B
A9          XOR      C
              ;
              ;ROTATE LEFT, PRESERVING THE OR-FLAG
              ;
07          RLCA
              ;
              ;STORE NEW ATTRIBUTE IN BUFFER
              ;
77          LD      (HL),A
              ;
              ;MOVE ON TO NEXT ENTRY
              ;
7D          LD      A,L
C606        ADD      A,6
6F          LD      L,A
20EE        JR      NZ,NXSrv1
              ;
              ;UNTIL RO-BUFFER HAS BEEN SERVICED
C9          RET

```

SRVR1 should be called whenever there is a chance that the attributes of the cells used by our RO-buff entries have been changed, for example, by moving a sprite into them, or a horizon down one line. The routine also gives you the opportunity to vary the colour of the 'permanent' characters on your screen, by altering ATT. Since it deals with the entire RO-buffer, every entry will use the same ATT value. If this is not desired, then the easiest modification is to change the fragment

```

XOR      C
AND      B
XOR      C

```



```

ro LD C, (HL)
   RRC C
   XOR C
   AND B
   XOR C

```

thereby effectively using the original value of ATT with which the entry was inserted (by a modified HIPRNT, for example).

Now for that rather specialised routine I mentioned earlier, to send specific 'shapes' to the RO-buffer. A shape will consist of a number of separate characters that together form an image to be printed on the screen. As an example, I shall be taking the previously-discussed laser target sight, which will be made up of thirteen characters as shown.

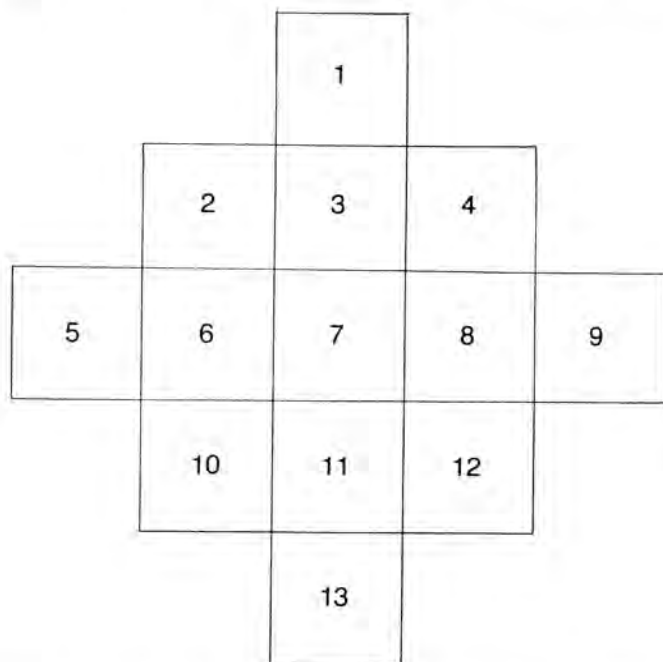

The routine, called SRVR2, will need two data tables. One will hold the desired position of each character on the screen, while the other will be a table of character data, stored, as usual, in eight bytes per character. The position data and character data must, of course, be stored in the same order, with no gaps in the tables!

To represent the position of each character, I have decided to number the cells 0 to 02FFH, in the order of their attributes. This has the

advantage that the lo-byte of the position will be identical to that of the attribute and display file addresses for the cell. If you prefer to use a co-ordinate system, then it is a simple task to write a routine to convert from one system to the other. Alternatively, you could modify SRVR2.

As an aid to easy calculation of position data, here is a labelled screen grid — just read the line value and add the column value (both in hex.).

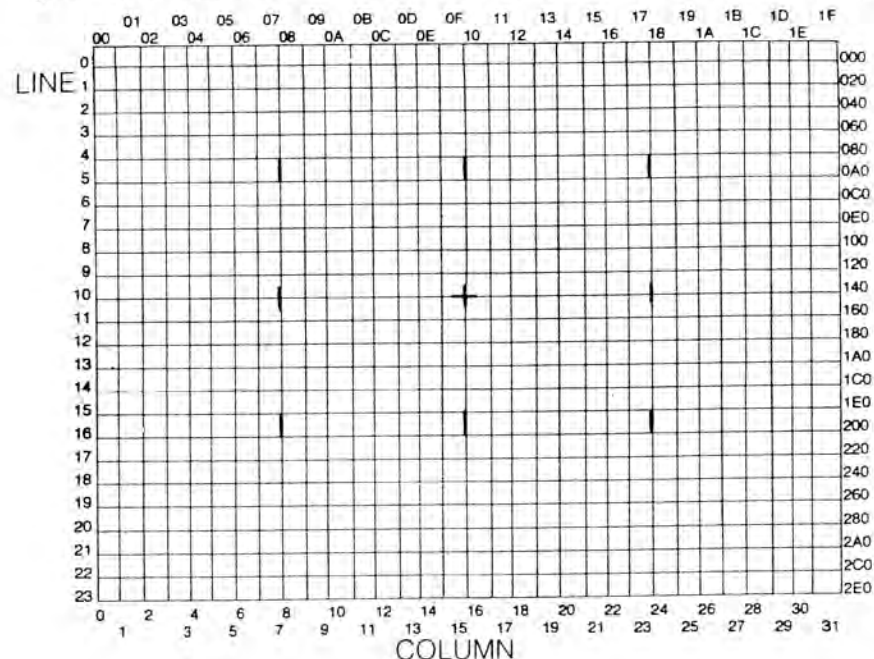

The tasks of SRVR2 are to take the position of a character, calculate the attribute address, display file address, and character data address, and store them all in the correct order in the RO-buffer. I will list the routine before demonstrating its use.

```

;ROUTINE TO SEND DATA TO RO-BUFFER
;ENTRY: HL=START OF POSITION DATA
;DE=START OF RESERVED RO-BUFFER AREA
;BC=ADDRESS OF CHARACTER DATA
;A=NO. OF CHARACTERS
;EXIT: A=0, BC=8
;N.B. AF IS DESTROYED
;
C5 SRVR2 PUSH BC
;

```

```

;USE BC AS A CONSTANT
;
010800      LD      BC,8
;
;A BECOMES A COUNTER
;
08          NXCHR9 EX    AF,AF'
1C          INC     E
;
;TRANSFER LO-BYTE OF ATTRIBUTE ADDRESS
;
7E          LD      A,(HL)
12          LD      (DE),A
1C          INC     E
23          INC     HL
;
;FORM HI-BYTE OF ATTRIBUTE ADDRESS
;
7E          LD      A,(HL)
F658       OR      58H
12          LD      (DE),A
1C          INC     E
;
;FORM HI-BYTE OF D.F. ADDRESS
;
E603       AND     3
07         RLCA
07         RLCA
07         RLCA
F640       OR      40H
;
;STORE IT
;
12          LD      (DE),A
1C          INC     E
23          INC     HL
;
;RETRIEVE CHAR. DATA ADDRESS, SAVE POSITION DATA
;ADDRESS
;
E3         EX      (SP),HL
EB         EX      DE,HL

```

```

;
;STORE CHAR. DATA ADDRESS IN BUFFER
;
73         LD      (HL),E
2C         INC     L
72         LD      (HL),D
2C         INC     L
;
;ADD EIGHT TO IT
;
EB         EX      DE,HL
09         ADD     HL,BC
;
;SAVE NEW CHAR. DATA ADDRESS, RETRIEVE
;POSITION DATA ADDRESS
;
E3         EX      (SP),HL
08         EX      AF,AF'
;
;NEXT CHARACTER
;
3D         DEC     A
20DE       JR      NZ,NXCHR9
E1         POP     HL
C9         RET

```

Referring to the previous block-diagram of the laser target, I shall be printing character 1 at (10, 15), so we have

$$\begin{aligned} \text{position} &= 140 + 0F \\ &= 14FH \end{aligned}$$

By inspection we see that character 2 is one line down (+20H) and one column to the left (-1) so its position is 16EH, character 3 is at 16FH and so on. I will label the start of the position data TRGPOS and that of the character data TRGDAT (the 'donkey work' of creating the character data has been done for you, and you will find it listed in the routine).

The first task in TARGET is to call INT1 to set up the interrupt handler. This must be done before anything else, since, as you recall, INT1 clears the print buffer. We then disable the interrupts, which are not desirable while we are loading the print buffer. To reserve 13 characters in the RO-buff we use

```

LD      C,13
CALL    ALTRBF

```

... which returns the start address of the RO-buffer in HL. We need to put this in DE, with

```
EX      DE,HL
```

... then prepare the other registers for SRVR2.

```
LD      HL,TRGPOS
LD      BC,TRGDAT
LD      A,13
CALL   SRVR2
```

Now choose a full mask (7FH, since bit 7 should always be reset) and OR—print (set bit 7 of ATT, giving ATT=80H). Finally, initialize the 'attribute' entries in the RO-buffer with SRVR1.

```
LD      HL,7F80H
LD      (ATT),HL
CALL   SRVR1
```

For demonstration purposes I have put the last instruction in the main loop so that SRVR1 is called after every interrupt, but in this case it is not imperative, since the attribute file is not altered within the loop. It WOULD be necessary, however, if you were to incorporate the horizon demonstration routine of the previous chapter.

When the BREAK key is pressed, TARGET terminates by clearing the RO-buffer (setting ROLNTH to zero) and reselecting IM1.

```
CALL   DISINT
LD      A,(ROLNTH)      ;ADD (-ROLNTH) TO ROLNTH
NEG
LD      C,A
CALL   ALTRBF
RET
```

The rest of the listing is sufficiently explained by the comments, so here is TARGET.

```
      ;THIS DEMO OR-PRINTS A HIGH RESOLUTION
      ;RIFLE SIGHT ON THE CENTRE OF THE SCREEN
      ;
      ;CALL INT FIRST, SINCE IT CLEARS THE BUFFER, AS
      ;WELL AS INITIALIZING THE INTERRUPT HANDLER
      ;
CD0000 TARGET CALL INT1
```

```
      ;
      ;NO INTERRUPTS WHILE WE ARE ALTERING THE BUFFER
      ;
F3      DI
      ;
      ;SET UP ROBUFF FOR 13 ENTRIES
      ;
0E0D      LD      C,13
CD0000      CALL   ALTRBF
      ;
      ;PREPARE TO DUMP DATA FOR 13 CHARACTERS IN THE
      ;BUFFER
      ;
EB      EX      DE,HL
213400      LD      HL,TRGPOS
014E00      LD      BC,TRGDAT
3E0D      LD      A,13
      ;
      ;FILL RO-BUFFER
      ;
CD0000      CALL   SRVR2
      ;
      ;SELECT FULL MASK, AND OR-PRINT OPERATION BY
      ;SETTING BIT 7 OF ATT
      ;
21807F      LD      HL,7F80H
220000      LD      (ATT),HL
FB      EI
      ;
      ;CALCULATE ATTRIBUTES
      ;
CD0000      TSLP   CALL   SRVR1
      ;
      ;WAIT FOR INTERRUPT
      ;
76      HALT
      ;
      ;TEST BREAK KEY
      ;
3E7F      LD      A,7FH
DBFE      IN      A,(0FEH)
1F      RRA
```

```

38F5          JR      C,TSLP
;
;IF PRESSED THEN SELECT IM 1,
CLEAR THE RO-BUFFER AND END

```

```

CD0000      CALL    DISINT
3A0000      LD      A,(ROLNTH)
ED44        NEG
4F          LD      C,A
CD0000      CALL    ALTRBF
C9          RET

```

```

;THE POSITION DATA

```

```

4F01      TRGPOS  DEFW   014FH
6E01      DEFW   016EH
6F01      DEFW   016FH
7001      DEFW   0170H
8D01      DEFW   018DH
8E01      DEFW   018EH
8F01      DEFW   018FH

```

```

9001      DEFW   0190H
9101      DEFW   0191H
AE01      DEFW   01AEH
AF01      DEFW   01AFH
B001      DEFW   01B0H
CF01      DEFW   01CFH

```

```

;THE CHARACTER DATA

```

```

00      TRGDAT  DEFB   0
18      DEFB   24
10      DEFB   16
10      DEFB   16
18      DEFB   24
10      DEFB   16
10      DEFB   16
18      DEFB   24

00      DEFB   0
00      DEFB   0

```

```

00      DEFB   0
03      DEFB   3
0E      DEFB   14
18      DEFB   24
10      DEFB   16
30      DEFB   48

```

```

10      DEFB   16
10      DEFB   16
FE      DEFB   254
93      DEFB   147
10      DEFB   16
18      DEFB   24
10      DEFB   16
7C      DEFB   124

```

```

00      DEFB   0
00      DEFB   0
00      DEFB   0
80      DEFB   128
E0      DEFB   224
30      DEFB   48
10      DEFB   16
18      DEFB   24

```

```

00      DEFB   0
00      DEFB   0
00      DEFB   0
92      DEFB   146
FF      DEFB   255
00      DEFB   0
00      DEFB   0
00      DEFB   0

```

```

21      DEFB   33
61      DEFB   97
43      DEFB   67
4A      DEFB   74
FF      DEFB   255
42      DEFB   66
43      DEFB   67
61      DEFB   97

```



```

D7      DEFB      215
11      DEFB      17
11      DEFB      17
00      DEFB      0
D7      DEFB      215
00      DEFB      0
11      DEFB      17
11      DEFB      17
;
08      DEFB      8
0C      DEFB      12
84      DEFB      132
A4      DEFB      164
FF      DEFB      255
84      DEFB      132
84      DEFB      132
0C      DEFB      12
;
00      DEFB      0
00      DEFB      0
00      DEFB      0
92      DEFB      146
FE      DEFB      254
00      DEFB      0
00      DEFB      0
00      DEFB      0
;
21      DEFB      33
30      DEFB      48
10      DEFB      16
18      DEFB      24
0E      DEFB      14
03      DEFB      3
00      DEFB      0
00      DEFB      0
;
D7      DEFB      215
7C      DEFB      124
10      DEFB      16
18      DEFB      24
10      DEFB      16
93      DEFB      147

```

```

FE      DEFB      254
10      DEFB      16
;
08      DEFB      8
18      DEFB      24
10      DEFB      16
30      DEFB      48

```

As you will recall, we have made provision in the print-processor part of the interrupt handler for an 'OR printing' function that merges a new character with the current contents of a screen cell in the display file. I will now provide the support routines for this function.

Whenever we come to print a character on the screen, we will need to know whether the contents of the destination cell are to be preserved by OR-printing, or destroyed by over-printing. For example, when two characters in a game move into the same cell, we will probably want to merge them together, while if we are moving a character from one cell to the next, trailing a blank behind it to delete the old image, then we certainly won't want to OR-print the space with the old image.

To this end we need a map in memory, which I shall call the OR-map, to keep track of which cells are 'occupied'. Only one bit per cell is required, a 1 indicating 'cell occupied' and a zero indicating 'empty cell'.

Thus we have four bytes for each of the twenty-four screen lines, making a 96 byte OR-map. Not surprisingly, I have labelled the start of this as ORMAP. To reserve the required space we need the line:

```
ORMAP DEFS 96
```

The OR-map will need clearing regularly, so before we go any further, let's have a routine to fill it with zeroes, CLOR.

```

;ROUTINE TO CLEAR THE OR-MAP
;
210000 CLOR LD HL,ORMAP
015F00 LD BC,95
70 LD (HL),B
54 LD D,H
5D LD E,L
13 INC DE
EDB0 LDIR
C9 RET

```

Every time we are preparing to send a character to the print buffer and wish it to be considered for OR-printing with existing and future characters, we should access the bit corresponding to the destination cell in the OR-map.

If that bit is set, then there is already something in that cell, and we select OR-print by setting bit 7 of the attribute byte, ATT. If the bit is zero, then as far as we are concerned the cell is 'empty', and having set the OR-map bit to signify that it is now occupied, we reset bit 7 of ATT to select over-printing. The character is then sent to the print-buffer using HIPRINT (or your own routine) in the usual manner.

The following routine, ORCHK, carries out the process described above, using the pointer ATCC, which holds the location of the current attribute byte, as a means of locating the correct OR-map bit. No entry values are required, and the comments in the listing provide adequate explanation.

```

;ROUTINE TO DECIDE WHETHER TO OR-PRINT ON THE
;CURRENT CHARACTER CELL
2A00000 ORCHK LD HL,(ATCC)
;
;TAKE ATTR. ADDRESS DIVIDE ITS LOWEST 10 BITS
;BY 8
7D LD A,L
CB1C RR H
1F RRA
CB1C RR H
1F RRA
CB3F SRL A
;
;PUT RESULT IN DE
5F LD E,A
1600 LD D,0
7D LD A,L
;
;ADD BASE ADDRESS OF TABLE
210000 LD HL,ORMAP
19 ADD HL,DE
;

```

;ROTATE A MASK UNTIL THE '1' IS OVER THE  
REQUIRED BIT

```

E607 AND 7
47 LD B,A
04 INC B
3E01 LD A,1
0F NXTROT RRCA
10FD DJNZ NXTROT
;
;PUT THE MASK IN C
;
4F LD C,A
;
;TEST IS THIS CELL ALREADY OCCUPIED
;
A6 AND (HL)
110000 LD DE,ATT
1A LD A,(DE)
;
;IF NOT THEN SELECT OVER-PRINT
;
CBBF RES 7,A
2802 JR Z,NOTOR
;
;OTHERWISE SELECT OR-PRINT
;
CBFF SET 7,A
12 NOTOR LD (DE),A
;
;NOW SET THE BIT IN THE OR-MAP
;TO SIGNIFY "CELL USED"
;
79 LD A,C
B6 OR (HL)
77 LD (HL),A
C9 RET

```

## CHAPTER 12

# Perfectly Flickerless Sprite Pixel-Animation

We are now ready, at last, to begin development of the sprite generation, printing and control routines for the production of flickerless pixel graphics in conjunction with the interrupt-driven print processor.

As you will recall, we define a sprite to be some image contained in a movable object block (hence their other name, MOB) of adjacent characters on the screen. This block will always be rectangular, and the image may be anything from  $1 \times 1$  character upwards in size.

The most obvious approach to moving a sprite from one position to another is to 'blank out' the 'old' image, by printing spaces over it, and then to print the new image in the new position. If the two images are mutually exclusive (i.e. they do not overlap), then this is a perfectly acceptable technique.

If, however, as is more usually the case, we have only moved the sprite by a few pixels, then there seems little point in printing a space in a cell common to both images, only to replace it with part of the new image almost instantly.

To avoid this time wasting, we will use a more subtle approach to sprite animation. Each shape will be surrounded by a narrow region of blank pixels, so that as we move from one position to the next, these trailing blanks will wipe out any part of the old image not already obliterated by the printing of the new image.

This way, animation will be achieved in just one print operation rather than the two required by the former technique, and the number of characters we need to print will be halved. This is a distinct advantage when you bear in mind that the standard print-processor can only print 40 characters per TV frame.

For the purposes of the rest of this discussion I shall be referring to a one character shape being moved in steps of one pixel.

If our shape is containable within  $(m)$  columns (i.e. is less than or equal to  $(m \times 8)$  pixels wide) then we see that it can, at most, occupy  $(m + 1)$  separate columns. Hence the sprite must be at least  $(m + 1)$  columns in width. For example, our  $1 \times 1$  shape may occupy columns 14 and 15 in the following way:

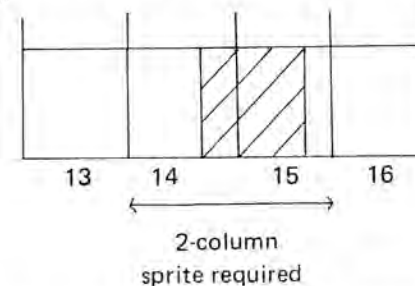

If, in addition, we place the restriction that the shape can never occupy more than  $(m + 1)$  different columns in moving from one position to the next, then we see that both the 'old' and 'new' images can be contained in an area  $(m + 1)$  columns wide.

For example, we must restrict the motion of our  $1 \times 1$  shape so that if the old image occupies column 14, the new one doesn't occupy column 16. Hence if our shape in columns 14 and 15 has two blank pixel columns to its right in column 15, then we must not allow it to move more than two pixels to the right:

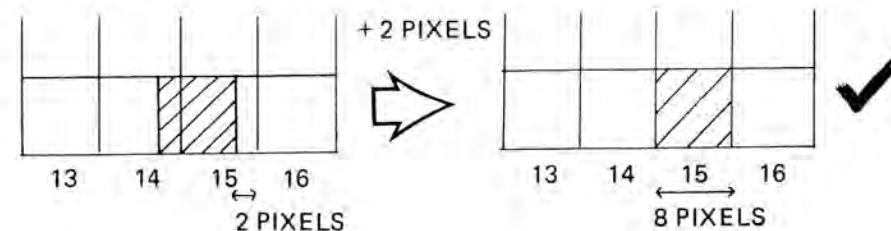

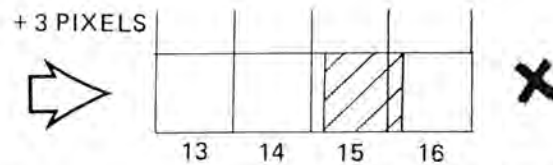

This restriction is, in practice, easy to apply, and leads to the result that we can animate a shape contained in  $(m \times n)$  characters by continually printing a set of sprite images of fixed dimensions  $(m + 1)$  by  $(n + 1)$ . Thus to move our  $1 \times 1$  shape about the screen we will need a  $2 \times 2$  cell sprite.

Now if you can imagine our  $m \times n$  shape floating around within its  $(m + 1) \times (n + 1)$  sprite, you will see that by virtue of the eight different horizontal positions and eight different vertical positions the shape can take, the resulting sprite will be any one of  $8 \times 8 = 64$  possible images.

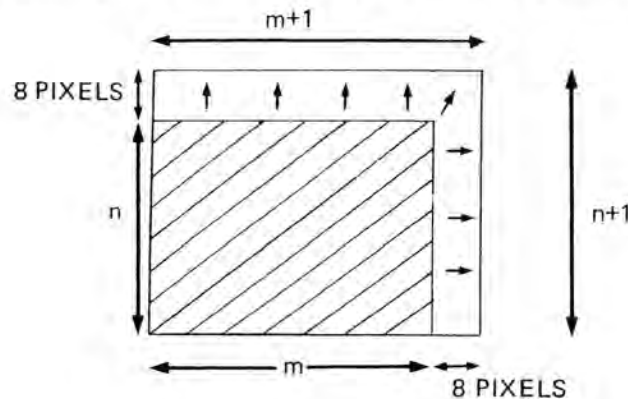

If the shape is movable at one pixel at a time in each of the X and Y directions, then each of these 64 patterns would at some time need to be printed. Before proceeding any further with this discussion, it would be prudent to define some variables. We will call the horizontal distance (in pixels) of the shape from the left hand edge of its sprite XP, and the vertical distance of the shape from the bottom edge of the sprite YP, thus:

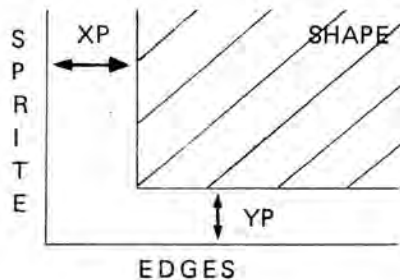

We now have a direct choice over the method of generation of the sprite patterns. We may either store just one of the sprite 'images' in memory, and manipulate the shape within it bit-wise to obtain the required image for printing, or we may store the images in a somewhat larger table in RAM, using an indexing technique to 'pluck out' the required image without further manipulation.

Experience has shown that, while the former technique uses as little as one eighth of the amount of memory to store the image, and is thus useful if RAM is at a premium, it is very time consuming to perform the XP bit-shifting operations required on each of the  $(M + 1) \times N \times 8$  bytes affected, and it is thus preferable, wherever possible, to employ the latter technique.

Although the sprite may be one of 64 possible patterns, the situation is not as grave as it seems. We do not need to store 64 different images in memory, as it is possible to produce the eight images corresponding to the different values of YP from the one image corresponding to a given XP. Thus we only need to store (at most) eight images, one for each value of XP.

We will store the images one at a time, and each image will be stored one column at a time, working from top to bottom and left to right. Thus the order of storage for an image of our  $1 \times 1$  shape in its  $2 \times 2$  sprite will be:

0	2
1	3

Each image will be stored as though YP = 0, that is to say the shape will be against the bottom edge of the sprite and the top line of the image will be blank. The images are stored in increasing order of XP, so for our  $1 \times 1$  shape the first image will be:

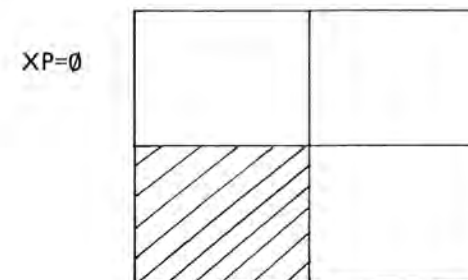



... and the last will be:

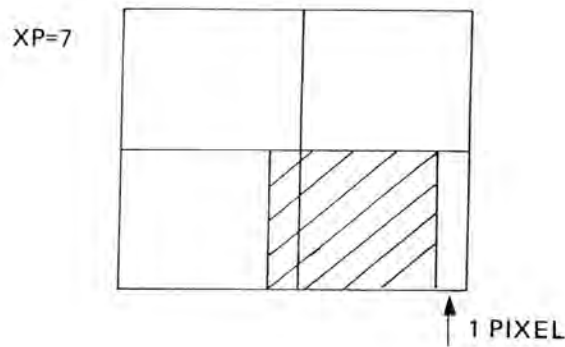

As our shape glides across the screen, the animation routines will simply be cycling through the sequence of images as XP cycles through 0 to 7. I will now define the screen position of the sprite in terms of the position of the top left hand corner of the image, (XC, YC), where XC is measured rightwards from zero, YC is measured downwards from zero, and the C stands for cell co-ordinates rather than the P for pixels. Thus we have:

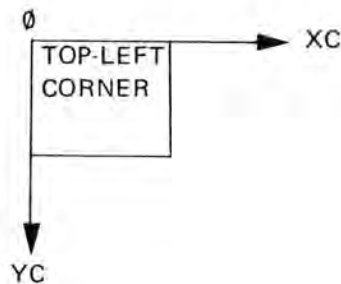

If the shape is moving leftwards, then we will be cycling backwards through the images. When XP reaches 0, the rightmost column will be completely blank and we will be able to decrement XC and change XP to 7 without leaving any trace of the old image in its rightmost column, which is outside the new sprite area. If however, we are moving rightwards, then it will not be sufficient just to switch from image 7 to image 0, incrementing XC, as this would leave a pixel-column of the old image in the column immediately to the left of the new one, thus:

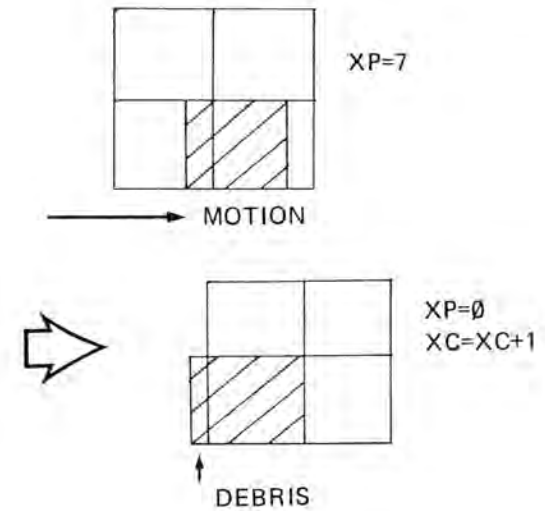

To get around this problem we need to simulate a 'ninth' image, and this will be done by including an extra column of blank cells immediately BEFORE image 0. We will then move from XP = 7, by pointing the sprite generator at this column of blanks and pretending that XP = 8. As far as the rest of the routines are concerned, XP will be 0 and XC will be incremented. We will then have:

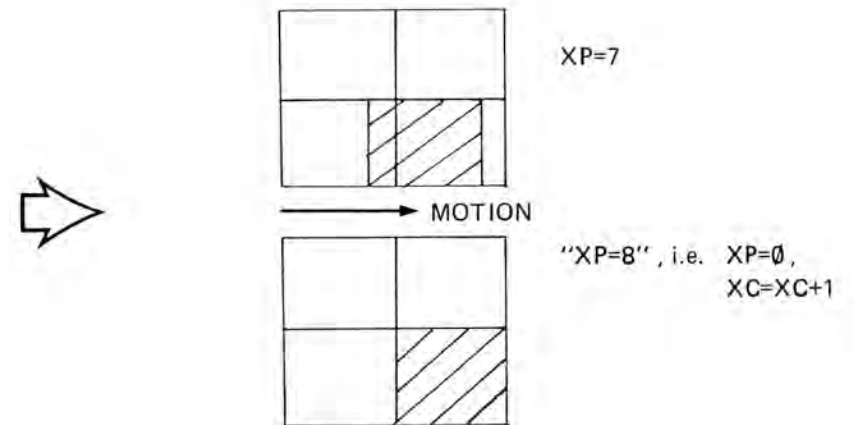

The various images corresponding to each value of YP will be produced by pointing the sprite generator at the YPth row of the XPth image, counting downwards from row zero. The reason for storing the images column by column can now be seen. Let us look at the memory layout of (say) image 4 of our 1 x 1 shape. We find that after the bottom left corner of this image comes the top right corner, then the bottom right corner, and then the top left corner of the next image. Thus:

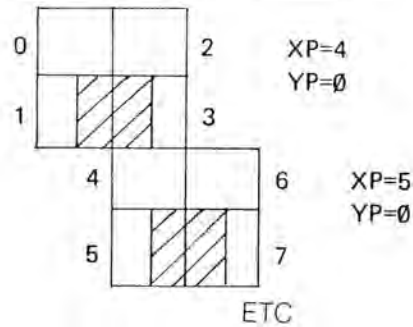

By pointing at row 4 of cell 0, we effectively shift up all the bytes in the image by four rows, and the result is a centralised shape with XP = 4, YP = 4:

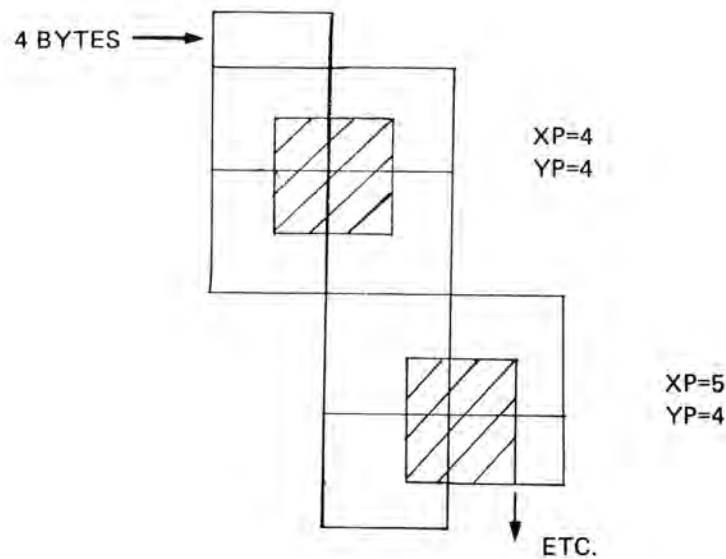

In a similar fashion to XP = 8, we will simulate YP = 8 by pointing the sprite generator at row 0 of cell 1 when moving upwards from YP = 7. Notice that YP and YC are increasing in opposite directions, so when YP reaches 7 we then let YP = 0 and DECREMENT YC.

I should point out at this stage that it is by no means essential to store eight separate images if we do not require movement in the X direction at one pixel per cycle. After all, there is little point in storing eight images if we are only moving in two-pixel steps, since there would only be four attainable values of XP, and hence only four of the images would ever be used. It emerges that we have a choice between storing 8, 4, 2 and 1 separate images.

With eight images, any horizontal speed up to eight pixels per movement is possible. With four images, we have a step of two pixels between images and thus speeds of 0, 2, 4, 6 and 8 pixels are allowed, but XP must always be even. With two images, we have a step of four pixels between images, and thus a speed of 0, 4 or 8 pixels per movement is possible, with XP being a multiple of four.

For example, if we represent our 1 x 1 shape in two separate images (bearing in mind that the shape is always at the bottom left corner of image 0), then we have the sequence:

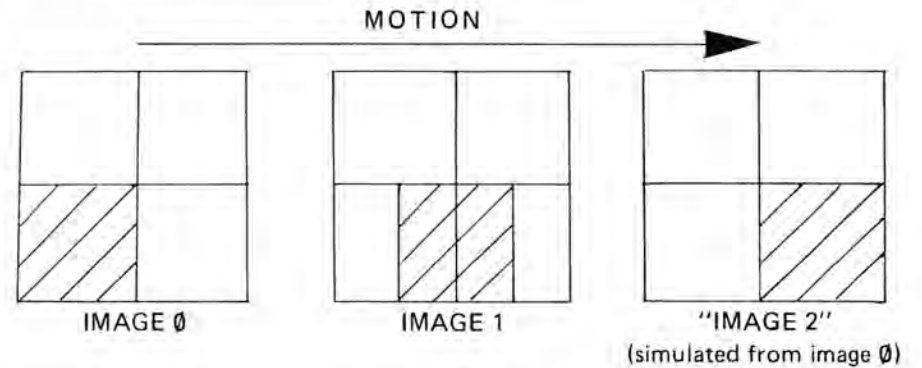

Obviously with one image we just have the simple case of movement by one character at a time.

It is now possible to calculate the amount of memory needed to store the images of any one sprite. Take an (m x n) character shape, and enclose it in an (m + 1) x (n + 1) character sprite. Producing (a) images of this sprite, and bearing in mind that each cell requires eight bytes and each set of images requires a preceding blank column, we have:

$$\begin{aligned} \text{memory needed} &= 8 \times a \times (m + 1) \times (n + 1) + 8 \times (n + 1) \\ &= 8 (a (m + 1) + 1) (n + 1) \text{ bytes} \end{aligned}$$

Thus for a shape three columns wide by two lines deep, defined in four images, we have  $m = 3$ ,  $n = 2$ ,  $a = 4$  and:

$$\begin{aligned} \text{memory needed} &= 8 (4 (3 + 1) + 1) (2 + 1) \\ &= 408 \text{ bytes.} \end{aligned}$$

In addition to this, and assuming that all the images for the sprites currently in use are stored consecutively in memory, we must include eight zero bytes after the last image of the last sprite, to allow for the memory 'take-up' when  $YP = 8$  and the last image is being used. In this case, those eight bytes will represent the bottom right corner of the sprite.

As an example, suppose we have two sprites in use, both of the  $3 \times 2$  shape in the previous memory calculation. If one is a plane, the other a train, then a suitable memory-reserving sequence might be:

```
PLNSPC  DEFS    408
TRNSPC  DEFS    408
        DEFW    0,0,0,0          ; 8 BYTES
```

(Using labels suffixed SPC for SPaCe).

Let us now discuss the method of controlling and keeping track of the position of the sprites. For each sprite we will use a seventeen-byte table of information which we shall call the 'sprite motion data'. This table will tell our animation routine at what speed to move the sprite along X and Y, the whereabouts of the sprite at any time, the location of the image data, the dimensions of the sprite, the colour it is to be printed in and so on. Whenever we want to move a sprite, we will point the IY index register at the start of its motion data and then call the animation routine, which will do all of the rest of the work for us, referring to the table of motion data.

Before proceeding to a complete breakdown of this table, let us first redefine XP to be the number of the image currently being used by the sprite generator. Thus if there are four images, XP will now cycle continuously through the values (0, 1, 2, 3) as the sprite moves across the screen. That is to say, that XP is continually incremented and then reduced modulo < number of different images >.

When there are eight images, then XP will have the same value as before, that is the number of pixels from the shape to the left hand edge

of the sprite. Otherwise, you will need to multiply XP by the step between images (2, 4 or 8 pixels) to find this distance. This conversion is worth bearing in mind when you are writing collision-detection routines and such like.

Here then is a list of the seventeen bytes of motion data for each sprite, followed by some elaboratory notes.

Address	Contents
IY	XP = Current image number (< 8)
IY+1	VX = Rate of change of XP (positive or negative)
IY+2	N = Number of images = (max. value of XP)+1
IY+3	XC = position of leftmost sprite column
IY+4	YP (0-7)
IY+5	VY = Rate of change of YP (positive or negative)
IY+6	YC = position of uppermost sprite line
IY+7	LO } Address of row 0, cell 0 of image 0
IY+8	HI }
IY+9	Cycle count (see notes)
IY+10	Cycle period (see notes)
IY+11	Width of expanded sprite
IY+12	Depth of expanded sprite
IY+13	LO } Length of one image = width x depth x 8
IY+14	HI }
IY+15	Attribute byte and flag for OR-printing
IY+16	Attribute mask

The 'cycle count' and 'cycle period' of (IY + 9) and (IY + 10) will be used to increase the versatility of our sprite control routine. Whenever the routine is called, the cycle count will be decremented. If the count is not zero then an immediate return will be made. Otherwise, the cycle count will be reloaded with the constant 'cycle period', which controls indirectly the frequency of movement of the sprite, and the sprite will be moved and printed. More about this later.

In view of the amount of memory needed to store the images of a fully operational sprite, it would be wise of us to store the bit-patterns of the various shapes a program requires in as compact a form as possible,

and then to expand them to the full blown sprite images as and when required. We will need some utility routines to do this, and I have chosen to provide a two-stage sprite expansion system.

The first routine, called PADOUT, will copy the dormant shape from its storage area to the 'sprite image area', adding a column of blanks to the right, a line of blanks above it, and the statutory preceding blank column to image  $\emptyset$ . The second routine, SPREX, will manipulate a copy of image  $\emptyset$ , row by row, using shifting and rotating operations to generate the other images.

The 'bare' sprite data should be stored one column at a time, one row at a time, working from left to right and top to bottom, in the same manner in which the images are stored.

Referring to the earlier part of this chapter, you will recall that the motion of the ( $m$ ) column wide shape must be restricted so that it does not occupy more than ( $m + 1$ ) columns in moving from one position to the next. At the time, I dismissed such a restriction as 'easy to apply'. Now is the time to explain how to do so.

The shape must include as its top and right hand edges an L-shaped region of blanking between  $\emptyset$  and 7 pixels in width. The width of this safety region is determined as follows.

Suppose that the highest valued image used by the sprite is that corresponding to  $XP_{max}$ , and that the absolute rate of change of  $XP$  is  $VX$  per movement. Let the step in pixels between the shape's positions in successive sprite images be  $D$ . Then the number of pixels moved each time is  $D \times VX$ . We see that the distance of the shape from the left hand edge of the sprite is  $(XP \times D)$ , and hence at minimum there are  $(8 - (XP_{max} \times D))$  pixels of the shape in the leftmost column.

If the right hand safety margin in sprite is  $P_x$  pixels wide, then at minimum there will be  $(8 - (XP_{max} \times D) + P_x)$  blank pixels in the rightmost column of the sprite. Some diagrams may help:

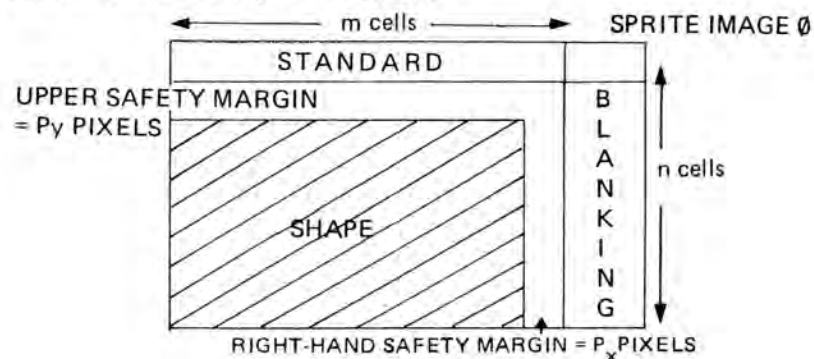

Above we see how the shape must 'shrink' to allow a blank margin to fit around it. When the  $XP_{max}$  image is being used we have

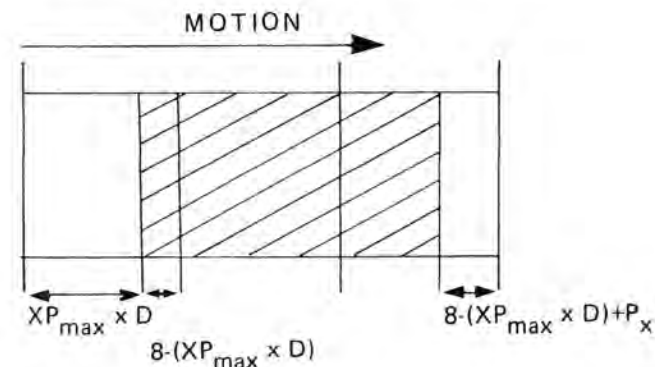

... and we see that, if our rule that the  $m$ -column shape does not occupy more than  $m + 1$  columns during motion is to be obeyed, then we can only allow  $(8 - (XP_{max} \times D) + P_x)$  pixels of movement to the right. Now the distance moved to the right is  $D \times VX$ , hence

$$8 - (XP_{max} \times D) + P_x = D \times VX$$

$$\Rightarrow P_x + 8 = D (VX + XP_{max})$$

and finally:

$$P_x = D (VX + XP_{max}) - 8.$$

After all that theoretical strain I think a practical example would help to clarify the situation.

Suppose that we are animating a car, which at one time or other will be moving in one pixel steps, but at present is moving two pixels at a time. We will thus need a full set of eight images, which means the 'step between images' is one pixel, i.e.

$$D=1$$

to move the car in two pixel steps, we have

$$VX = \frac{2}{1} = \frac{2}{1} = 2.$$

Now at this constant speed we will be cycling either through the 'odd' images, where



$XP = \{1, 3, 5, 7\}$  giving  $XP_{max} = 7$

or through the 'even' images, where

$XP = \{\emptyset, 2, 4, 6\}$  giving  $XP_{max} = 6$

Thus we have for the 'odd' cycle,

$P_x = 1(2 + 7) - 8 = 1$  pixel

and for the even cycle,

$P_x = 1(2 + 6) - 8 = \emptyset$  pixels

This gives us the significant result that if we can restrict  $XP$  to multiples of  $VX$  then no right hand margin is required, but if we are forced to use the images for odd values of  $XP$  then the right most pixel column of the shape must be blank. Hence the car shape must include a blank right hand safety margin of one pixel in width.

A similar analysis is applicable to determine the necessary width of the upper safety margin; I shall not therefor repeat all the gory detail. Taking the absolute vertical speed  $VY$  ( $\emptyset-8$  pixels per movement), and the maximum value of  $YP$ ,  $YP_{max}$  (always less than eight), we find that the thickness of the upper margin,  $P_y$  pixels, is given by

$$P_y = VY + YP_{max} - 8$$

Suppose, as a further example, that we wish to design, within a  $4 \times 3$  sprite and hence a  $3 \times 2$  shape, a fighter plane capable of moving at up to four pixels per movement in the  $X$  direction and up to three pixels in the  $Y$  direction. How much of the  $3 \times 2$  shape are we free to design in?

Since speeds may be as low as one pixel per frame, we'll need eight images again, so step  $D = 1$  pixel. At maximum, we have  $VX = 4$  and  $VY = 3$ . It is quite possible that at some time or other we may reach  $XP = 7$  and  $YP = 7$ , the maximum possible values. Hence  $XP_{max} = 7$ , and  $YP_{max} = 7$  (if you are ever in any doubt, then use the maximum available values in calculations, that is  $YP = 7$  and  $XP = [\text{number of images}] - 1$ ). This gives us

$P_x = D(VX + XP_{max}) - 8 = 1(4 + 7) - 8 = 3$

and

$P_y = VY + YP_{max} - 8 = 3 + 7 - 8 = 2$ .

So we need a two-pixel upper margin and a three-pixel right hand margin. Hence the area we have left to design in is  $(3 \times 8) - 3 = 21$  pixels wide, and  $(2 \times 8) - 2 = 14$  pixels deep, thus:

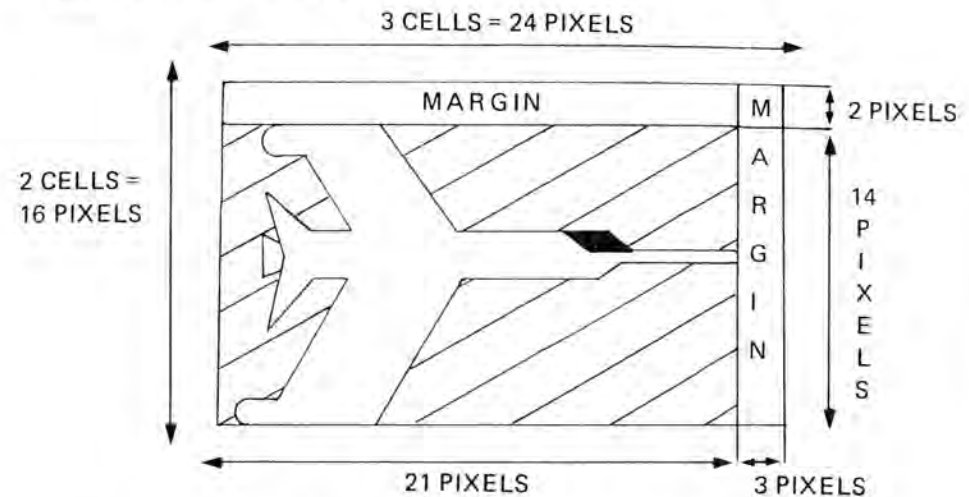

I will now provide the previously mentioned PADOUT routine which expands the 'standard sprite' or 'shape' data, stored in its compact form, to an 'expanded sprite', which is formed as image  $\emptyset$  in our previously reserved sprite image area.

Taking note of the entry requirements from the assembly listing, we see that for the  $3 \times 2$  shape in the above example, a suitable 'run-up' to calling PADOUT would be as follows:

```

PLNSPC DEFS 408 ;IMAGE AREA
        DEFW 0,0,0,0
PLNDAT DEF B (SPRITE DATA);(3*2)*8=48 BYTES OF DATA
PLNMTN DEFS 17 ;SEE LATER FOR DETAILS
        ;ON HOW TO INITIALIZE THE
        ;MOTION DATA
        LD BC,0302H ;WIDTH, DEPTH
        LD DE,PLNDAT
        LD HL,PLNSPC
        LD IY,PLNMTN
        CALL PADOUT
    
```

Notice that we call PADOUT with  $IY$  pointing at the motion data for our shape. This is because the routine initialises the values  $(IY + 7)$ ,  $(IY + 8)$ ,  $(IY + 11)$ ,  $(IY + 12)$ ,  $(IY + 13)$  and  $(IY + 14)$  (see previous table for details of these). O.K: get typing!

```

;TO "PAD OUT" BARE SPRITE DATA AND PRODUCE ENTRIES
;IN THE SPRITE MOTION DATA
;
;
;ENTRY: DE=SPRITE DATA ADDRESS
;       HL=IMAGE STORAGE AREA
;       B=COLUMN WIDTH OF STANDARD SPRITE
;       C=LINE DEPTH OF STANDARD SPRITE
;       IY=SPRITE MOTION DATA ADDRESS
;EXIT:  HL=ADDRESS OF IMAGE 0
;       B=COLUMN WIDTH OF EXPANDED SPRITE
;       C=ROW DEPTH OF EXPANDED SPRITE
;NOTE! HL AND BC WILL BE USED BY "SPREX"
;NOTE AF' DESTROYED
;
;CALCULATE NO. OF ROWS IN EXPANDED SPRITE
;
0C      PADOUT  INC    C
FD710C      LD      (IY+12),C
CB21        SLA    C
CB21        SLA    C
CB21        SLA    C
;
;STORE BC FOR SPREX
;
78         LD      A,B
04         INC    B
FD700B     LD      (IY+11),B
C5         PUSH   BC
;
;A COUNTS THE COLUMNS
;
08         EX     AF,AF'
;
;STORE DATA ADDRESS
;
D5         PUSH   DE
;
;START WITH A COLUMN OF BLANKS
;
0600      LD      B,0
C5         PUSH   BC

```

```

70         LD      (HL),B
0D         DEC    C
CD5800     CALL   CL
C1         POP    BC
79         LD      A,C
D608      SUB    8
4F         LD      C,A
;
;BC=NO. OF ROWS IN STANDARD COLUMN
;
E1         POP    HL
;
;STORE START OF IMAGE 0
;
D5         PUSH   DE
C5         PUSH   BC
08         EX     AF,AF'
;
;INSERT A SPACE ON THE TOP LINE
;
E5         NXSCOL PUSH  HL
EB         EX     DE,HL
3600      LD      (HL),0
0E07      LD      C,7
CD5800     CALL   CL
E1         POP    HL
;
;FILL THE REST OF THE COLUMN WITH SPRITE DATA
;
C1         POP    BC
C5         PUSH   BC
EDB0      LDIR
;
;DO NEXT STANDARD COLUMN
;
3D         DEC    A
20EF      JR     NZ,NXSCOL
;
;EXPAND WITH A RIGHTMOST BLANK COLUMN
;
C1         POP    BC
79         LD      A,C

```

```

C607      ADD     A,7
4F        LD     C,A
EB        EX     DE,HL
70        LD     (HL),B
CD5800    CALL    CL
;
;RETRIEVE ADDRESS OF IMAGE 0
;
E1        POP     HL
;
;AND VALUE IN DE, FOR SPREX
;
DI        POP     DE
D5        PUSH    DE
E5        PUSH    HL
;
;CALCULATE # OF BYTES IN ONE IMAGE AND STORE
;IT IN SPRITE MOTION DATA
;
60        LD     H,B
68        LD     L,B
42        LD     B,D
54        LD     D,H
19        MUL1   ADD     HL,DE
10FD     DJNZ   MUL1
FD750D    LD     (IY+13),L
FD740E    LD     (IY+14),H
E1        POP     HL
C1        POP     BC
;PUT IMAGE 0 LOCATION IN SPRITE MOTION DATA
;
FD7507    LD     (IY+7),L
FD7408    LD     (IY+8),H
C9        RET
;
;CLEARING SUBROUTINE
;
54        CL     LD     D,H
5D        LD     E,L
13        INC    DE
EDB0     LDIR
C9        RET

```

Now that we have taken our bare, unexpanded sprite data from memory and created image 0 from it, we need to generate the other images. Each successive image is formed by shifting the rows of the previous one by one or more bits to the right. The routine SPREX does this by taking each row of image 0 in turn, copying it into an area of 'workspace' and then repeatedly shifting it and copying it into the appropriate position for each of the other images. We will label the start of the workspace as WKSPC and note that since we only need to place one row of a sprite in it at a time, twenty bytes should be ample. Hence you should start your program with a line like:

```
WKSPC  DEFS  20
```

Notice that SPREX needs to be called with IY pointing at the motion data for your sprite, since it sets the number of images in (IY + 2). The entry values of HL and BC are already set up for you by calling PADOUT, so the only parameter you have to set after calling PADOUT is the step (in pixels) between images, stored in D. We therefore append to our previous fragment for setting up the aeroplane sprites, the lines:

```
LD     D,1           ;FORM 8 IMAGES
CALL   SPREX
```

Beware that nearly all of the alternate register set is used by the routine, so if you are intending to come back to BASIC after using SPREX, be sure to preserve HL' with

```

EXX
PUSH  HL
EXX
AND
EXX
POP   HL
EXX

```

at the beginning and end of your program respectively.

```

;ROUTINE TO FORM THE "SHIFTED" IMAGES OF EXPANDE
;SPRITE DATA AS PRODUCED BY "PADOUT"
;
;ENTRY: HL=ADDRESS OF IMAGE 0
;       D=STEP BETWEEN IMAGES
;       B=WIDTH OF EXPANDED SPRITE
;       C=DEPTH OF EXPANDED SPRITE IN ROWS
;PRESERVED: BC
;N.B.! B'C'D'E'H'L' ARE DESTROYED

```

```

;EXIT: DE'=ENTRY VALUE OF DE,BC'=0,L'=0
;
3E08 SPREX LD A,8
1EFF LD E,0FFH
92 SUBDIV SUB D
1C INC E
30FC JR NC,SUBDIV
FD7302 LD (IY+2),E
1D DEC E
D5 PUSH DE
C5 PUSH BC
0600 LD B,0
;
;BC NOWS HOLDS LENGTH OF 1 COLUMN IN BYTES
;
110000 LD DE,WKSPC
D9 EXX
E1 POP HL
D1 POP DE
;
;H'=WIDTH,L'=# OF ROWS
;D'=IMAGE STEP,E'=# OF IMAGES-1
;GENERATE ONE ROW OF EACH IMAGE
;
D5 NXROW9 PUSH DE
44 LD B,H
D9 EXX
;
;STORE ADDRESS OF ROW 0 OF IMAGE 0
;
E5 PUSH HL
110000 LD DE,WKSPC
;
;BUILD THAT ROW OF SPRITE IN WORK SPACE
;
D9 EXX
D9 NXBYT3 EXX
7E LD A,(HL)
09 ADD HL,BC
12 LD (DE),A
13 INC DE
D9 EXX

```

```

10F8 DJNZ NXBYT3
;
;STORE ADDRESS OF CURRENT ROW OF NEXT IMAGE IN DE
;
D9 NXPOS EXX
EB EX DE,HL
D9 EXX
;
;SHIFT ROW BY D' PIXELS
;
D5 PUSH DE
4A LD C,D
;
;ONE PIXEL AT A TIME
;
7C NXSHF LD A,H
D9 EXX
210000 LD HL,WKSPC
A7 AND A
CB1E NXBYT RR (HL)
2C INC L
3D DEC A
20FA JR NZ,NXBYT
;
;NEXT SHIFT
;
D9 EXX
0D DEC C
20F0 JR NZ,NXSHF
;
;RETRIEVE ADDRESS OF NEXT IMAGE ROW TO HL
;
D9 EXX
EB EX DE,HL
110000 LD DE,WKSPC
D9 EXX
;
;TRANSFER THE ROW OF H' COLUMNS TO IMAGE AREA
;
44 LD B,H
D9 NXBYT2 EXX
1A LD A,(DE)

```



```

77          LD      (HL),A
09          ADD     HL,BC
13          INC     DE
D9          EXX
10F8       DJNZ    NXBYT2
          ;
          ;LOOP BACK TO GENERATE THE SAME ROW OF
          THE OTHER IMAGES
D1          POP     DE
1D          DEC     E
20D8       JR      NZ,NXPOS
D9          EXX
          ;
          ;FIND NEXT ROW OF IMAGE 0
          ;
E1          POP     HL
23          INC     HL
          ;
          ;RETRIEVE DE' AND REPEAT FOR NEXT ROW
          ;
D9          EXX
D1          POP     DE
2D          DEC     L
20C0       JR      NZ,NXROW9
          ;
          ;RETURN WITH THE CORRECT REGISTER SET
          ;
D9          EXX
C9          RET

```

So far, so good. By now you should have a reasonable understanding of the principles involved in this sprite animation technique, together with a pair of routines that do nearly all the preparation work for such animation. The only real task that you now need to perform whenever you wish to define a sprite, is the unavoidably tedious one of designing the shape and converting it into the original sprite data. Many people find 'character designer' programs useful, and indeed there are a number available, including the somewhat limited one-character version on the introductory 'Horizons' cassette that came with your machine.

You could invest in one of these programs, or better still, write your own. Personally, I prefer the more traditional method of a pencil, an eraser, a pile of graph paper and a good supply of coffee and patience.

If you take any one row of a character and break it up into two groups of four pixels each, then each group will correspond to one digit in the hexadecimal representation of that row-byte. It is then easily seen that the four pixels will be one of only sixteen patterns, and with a little practice you will find it very easy to attach the correct digit to any given pattern. The most obvious ones are probably:

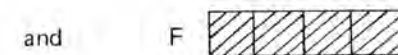
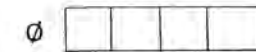

... Followed closely by the one-bit-set patterns.

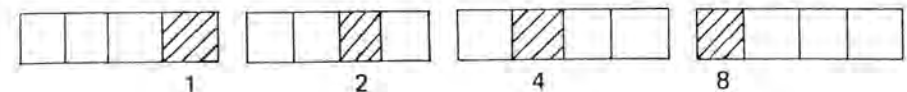

Then we have the patterns with two consecutive set bits:

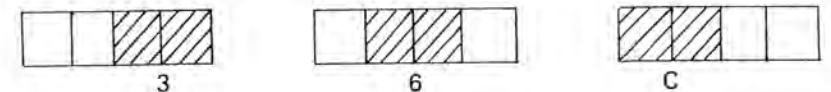

... and those with just one reset bit.

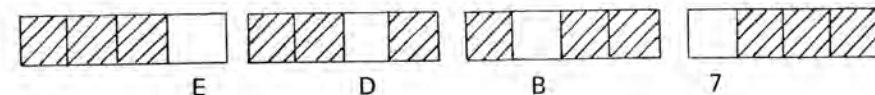

There are two possible patterns with alternate set and reset pixels. Distinguish them by remembering that 5 is odd and thus has the rightmost pixel-bit set:



and this just leaves the pattern for 9, which has a certain unmistakable symmetry about it:

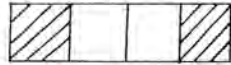

9

If you are not already familiar with the patterns, then I hope that the above categorisation will provide you with a useful mnemonic.

I shall now provide the actual sprite 'printing' routine, SPRINT, which assimilates the correct information for each sprite and sends it to the print buffer for the print-processor.

SPRINT has been written with speed and versatility as the top priorities. If we are moving sprites once in every TV frame, in addition, perhaps, to producing sound and a low-level full screen horizon, then time is of the essence and should take priority over compactness of code and so on. You will not normally call SPRINT directly, as it will be subsidiary to a more general routine called SPRMV, which will perform various manipulations of the motion data before jumping to SPRINT.

SPRINT allows us to check for OR-printing using the OR-map system described at the end of the last chapter. A slightly modified version of ORCHK has been built into SPRINT for speed, and the option of checking for OR-printing is selected by setting bit 7 of the sprite's attribute byte, stored in (IY + 15).

Resetting this bit causes the OR-map to be ignored, and in this case over-printing will always occur. The state of this flag causes an early branch in the routine between two distinct sections, one incorporating ORCHK, the other not. It was found that this arrangement is far quicker than running a combined routine involving repeated flag tests and jumps would be.

Notice that the routine calls ATTLOC, which was listed in Chapter 1 and is used to provide the attribute address of the top left corner of the sprite.

Since the routine destroys the contents of all alternate registers, you must once again preserve HL if you wish to return to BASIC. SPRINT makes the assumption that there is actually room for your sprite in the print buffer, and as such should not be called if there is not room, in which case you should wait for an interrupt to clear the buffer. You will notice that the sections involved in sending data to the buffer use single-register increment instructions to step through it. If you have extended the buffer beyond 42 entries in length, as described in chapter 9, then you will need to change the instructions to dual-register increments, i.e. change INC L to INC HL. Recall that the one-byte

variable CHSTRE holds the number of used entries in the buffer, and that BUFFPT points at the next free entry. Both are adjusted accordingly by the routine.

It is not desirable to receive an interrupt when only half a sprite has been sent to the buffer, so unless you are using the interrupt intercept for something other than the print processor, you should disable the interrupts before calling SPRINT, and enable them on return.

SPRINT will cope admirably with sprites that 'spill off' the edges of the screen, or even those that are not on the screen at all. For example, we may have just the right hand column of a 3 x 3 sprite on the screen by sending SPRINT the value XC = -2, or FE Hex.

As the routine stands, any part of the sprite that is in the text area will be printed. However, we can, if we wish, alter the width of this 'sprite window' by changing the operands of the instructions labelled LFTLM1, LFTLM2, RGTLM1 and RGTLM2, where LFTLM stands for 'LeFT LiMit' and RGTLM for 'RiGht LiMit'. The left limit is the value of the leftmost column in the sprite window, while the right limit is the value of the column immediately to the right of the window (32 in the case of a maximum window).

For example, suppose that we want the sprite window to be over the central 20 columns of the screen (we may be using the outer ones for scoring, say). Then the left limit will be column 6, and the right limit will be column 6 + 20 = 26. So we use:

```
LD      A,6
LD      (LFTLM1+1),A
LD      (LFTLM2+1),A
LD      A,26
LD      (RGTLM1+1),A
LD      (RGTLM2+1),A
```

That's about all there is to say regarding this formidable listing, so I'll leave you to type it in and peruse the coding.

```

;THIS ROUTINE SENDS SPRITE DATA TO THE PRINT BUFFER
;ENTRY: B=XP,C=YP,D=YC,E=XC
;      HL=ADDRESS OF IMAGE 0
;ALL AS SET UP BY SPRMV
;EXIT: DE=0
;DESTROYS: A'F'B'C'D'E'H'L'
;
D5 SPRINT PUSH DE
```

```

;
;IF XP=0 THEN LEAVE HL POINTING AT IMAGE 0
;
78          LD      A,B
A7          AND     A
2809       JR      Z,POS0
;
;FIND CORRECT IMAGE
;
FD5E0D     LD      E,(IY+13)
FD560E     LD      D,(IY+14)
19        NXA     ADD     HL,DE
10FD      DJNZ    NXA
;
;FIND CORRECT VERTICAL POSITION
;
09        POS0   ADD     HL,BC
;
;FIND LOCATION OF TOP-LEFT ATTRIBUTE OF SPRITE
;
C1         POP     BC
E5         PUSH    HL
CD0000    CALL    ATTLOC
;
;E COUNTS THE COLUMNS REMAINING
;
FD5E0B     LD      E,(IY+11)
;
;DECIDE BETWEEN OR-PRINT AND OVER-PRINT MODES
;BY TESTING BIT 7 OF THE SPRITE ATTRIBUTES
;
D9         EXX
FD6E0F     LD      L,(IY+15)
FD6610     LD      H,(IY+16)
CB7D      BIT     7,L
CBBD      RES     7,L
D9         EXX
CAD800    JP      Z,SPRTNO
;
;OR-PRINT IS SELECTED. FIND APPROPRIATE ADDRESS IN
;OR-MAP
;

```

```

78          LD      A,B
87          ADD     A,A
87          ADD     A,A
47          LD      B,A
79          LD      A,C
CB2F      SRA     A
CB2F      SRA     A
CB2F      SRA     A
80          ADD     A,B
;
;ADD BASE ADDRESS OF OR-MAP
;

```

```

D9         EXX
EB         EX      DE,HL
4F         ADD     C,A
0600      LD      B,0
210000    LD      HL,ORMAP
09         LD      HL,BC
3A0000    LD      A,(CHSTRE)
47         LD      B,A
D9         EXX
;
;HL' HOLDS LOCATION IN OR-MAP ROTATE MASK OVER
;CORRECT CELL-BIT IN THE OR-MAP
;

```

```

79          LD      A,C
E607      AND     7
47         LD      B,A
3E80      LD      A,80H
2803      JR      Z,NROT1
0F        NXTRT  RRCA
10FD     DJNZ    NXTRT
;
;STORE MASK IN C'
;
D9         NROT1  EXX
4F         LD      C,A
D9         EXX
79         LD      A,C
;

```

```

;POINT BC AT IMAGE DATA
;
C1      POP      BC
E5      NXTX1   PUSH   HL
;
;STORE OR-MAP ADDRESS
;
D9      EXX
E5      PUSH    HL
D9      EXX
;
;LET D=DEPTH IN LINES
;
FD560C      LD      D,(IY+12)
;
;IF PRINT POSN IS OUT OF X-RANGE THEN SKIP COLUMN
;
FE20      RGLM1   CP      32
3071      JR      NC,HOPCL1
FE00      LFTLM1  CP      0
386D      JR      C,HOPCL1
;
;STORE COLUMN POSN IN A'
;
08      EX      AF,AF'
;
;IF PRINT POSN IS BELOW TEXT AREA THEN END
;
7C      NXTY1   LD      A,H
FE5B      CP      91
3068      JR      NC,OUT81
;
;IF PRINT POSN IS ABOVE TEXT AREA THEN MISS THIS
;LINE OF SPRITE
;
FE58      CP      88
D5      PUSH   DE
EB      EX      DE,HL
382F      JR      C,NPR1
;
;DECIDE WHETHER OR-PRINT ON THIS CELL IS NEEDED
;

```

```

D9      EXX
79      LD      A,C
A6      AND     (HL)
CBBB    RES     7,E
2802    JR      Z,NOTOR3
;
;IF CELL IS OCCUPIED THEN SET FLAG FOR OR-PRINT
;
CBFB    SET     7,E
;
;SIGNIFY CELL OCCUPIED
;
79      NOTOR3  LD      A,C
B6      OR      (HL)
77      LD      (HL),A
D9      EXX
;
;SEND CHARACTER TO BUFFER
;
1A      LD      A,(DE)
D9      EXX
AB      XOR     E
A2      AND     D
AB      XOR     E
04      INC     B
D9      EXX
2A0000  LD      HL,(BUFFPT)
07      RLCA
77      LD      (HL),A
2C      INC     L
73      LD      (HL),E
2C      INC     L
72      LD      (HL),D
2C      INC     L
7A      LD      A,D
E603    AND     3
07      RLCA
07      RLCA
07      RLCA
F640    OR      64
77      LD      (HL),A
2C      INC     L

```



```

71          LD      (HL),C
2C          INC     L
70          LD      (HL),B
2C          INC     L
220000     LD      (BUFFPT),HL
;
; INCREASE DATA POINTER TO NEXT CELL OF IMAGE
;
210800     NPR1    LD      HL,8
09          ADD     HL,BC
44          LD      B,H
4D          LD      C,L
EB          EX      DE,HL
D1          POP     DE
;
; IF LINE-COUNT IS ZERO THEN NEXT COLUMN
;
15          DEC     D
2810       JR      Z,IN16
;
; OTHERWISE MOVE OR-MAP POINTER TO NEXT LINE
;
D9          EXX
7D          LD      A,L
C604       ADD     A,4
6F          LD      L,A
D9          EXX
;
; AND MOVE ATTRIBUTE POINTER TO NEXT LINE
;
7D          LD      A,L
C620       ADD     A,32
6F          LD      L,A
30AF       JR      NC,NXTY1
24          INC     H
;
; LOOP BACK FOR NEXT LINE OF SPRITE
;
C35E00     JP      NXTY1
;
; INCREASE COLUMN POSITION
;

```

```

08          IN16   EX      AF,AF'
3C          INC     A
;
; FETCH OR-MAP ADDRESS AND MOVE MASK TO
; INCREMENTING THE POINTER IF NECESSARY
;
D9          EXX
E1          POP     HL
CB09       RRC     C
3001       JR      NC,NINC2
2C          INC     L
D9          NINC2  EXX
;
; POINT HL AT FIRST ATTRIBUTE OF NEXT COLUMN
;
E1          POP     HL
2C          INC     L
;
; LOOP BACK FOR NEXT COLUMN
;
1D          DEC     E
C24E00     JP      NZ,NXTX1
;
; SET NEW VALUE OF CHSTRE
;
D9          EXX
78          LD      A,B
320000     LD      (CHSTRE),A
D9          EXX
C9          RET
;
; JUMPS TO HERE TO OMIT ALL OR PART OF A COLUMN
;
08          HOPCL1 EX      AF,AF'
;
; MOVE IMAGE POINTER TO THE NEXT SPRITE COLUMN
;
60          OUT81  LD      H,B
69          LD      L,C
010800     LD      BC,8
09          NXT81  ADD     HL,BC
15          DEC     D

```

```

20FC      JR      NZ,NXT81
44        LD      B,H
4D        LD      C,L
;
;JUMP BACK INTO MAIN ROUTINE
;
18DB      JR      IN16
;
;THE MUCH SHORTER AND FASTER OVER-PRINTING SECTION
;
79        SPRTNO LD      A,C
C1        POP     BC
;
;HOLD CHSTRE IN E
;
D9        EXX
ED5B0000 LD      DE,(CHSTRE)
D9        EXX
E5        NPTX2  PUSH   HL
;
;LET D=DEPTH IN LINES
;
FD560C    LD      D,(IY+12)
;
;IF PRINT POSN IS OUT OF X-RANGE THEN SKIP COLUMN
;
FE20      RGTLM2 CP      32
3056      JR      NC,HOPCL2
FE00      LFTLM2 CP      0
3852      JR      C,HOPCL2
;
;STORE COLUMN POSN IN A
;
08        EX      AF,AF'
;
;IF PRINT POSN IS BELOW TEXT AREA THEN END
;
7C        NPTY2  LD      A,H
FE5B      CP      91
304D      JR      NC,OUT82
;
;IF PRINT POSN IS ABOVE TEXT AREA THEN MISS THIS

```

```

;LINE OF SPRITE
;
FE58      CP      88
D5        PUSH   DE
EB        EX      DE,HL
3822      JR      C,NPR2
;
;SEND CHARACTER TO BUFFER
;
1A        LD      A,(DE)
D9        EXX
AD        XOR     L
A4        AND     H
AD        XOR     L
1C        INC     E
D9        EXX
2A0000    LD      HL,(BUFFPT)
07        RLCA
77        LD      (HL),A
2C        INC     L
73        LD      (HL),E
2C        INC     L
72        LD      (HL),D
2C        INC     L
7A        LD      A,D
E603      AND     3
07        RLCA
07        RLCA
07        RLCA
F640      OR      64
77        LD      (HL),A
2C        INC     L
71        LD      (HL),C
2C        INC     L
70        LD      (HL),B
2C        INC     L
220000    LD      (BUFFPT),HL
;
;INCREASE DATA POINTER TO NEXT CELL OF IMAGE
;
210800    NPR2   LD      HL,8
09        ADD     HL,BC

```

```

44          LD      B,H
4D          LD      C,L
EB          EX      DE,HL
D1          POP     DE
;
; IF LINE-COUNT IS ZERO THEN NEXT COLUMN
;
15          DEC     D
280A        JR      Z,IN17
;
; OTHERWISE MOVE ATTRIBUTE POINTER TO NEXT LINE
;
7D          LD      A,L
C620        ADD     A,32
6F          LD      L,A
30C2        JR      NC,NXTY2
24          INC     H
;
; LOOP BACK FOR NEXT LINE OF SPRITE
;
C3ED00     JP      NXTY2
;
; INCREASE COLUMN POSITION
;
08          IN17   EX      AF,AF'
3C          INC     A
;
; POINT HL AT FIRST ATTRIBUTE OF NEXT COLUMN
;
E1          POP     HL
2C          INC     L
;
; LOOP BACK FOR NEXT COLUMN
;
1D          DEC     E
C2E000     JP      NZ,NXTX2
D9          EXX
7B          LD      A,E
320000     LD      (CHSTRE),A
D9          EXX
C9          RET
;

```

```

; JUMPS HERE TO OMIT ALL OR PART OF COLUMN
;
08          HOPCL2  EX      AF,AF'
;
; MOVE IMAGE POINTER TO THE NEXT SPRITE COLUMN
;
60          OUT82   LD      H,B
69          LD      L,C
010800     LD      BC,8
09          NXT82   ADD     HL,BC
15          DEC     D
20FC        JR      NZ,NXT82
44          LD      B,H
4D          LD      C,L
;
; JUMP BACK INTO THE MAIN ROUTINE
;
18E3        JR      IN17

```

We now have the three routines necessary to prepare the data for, and actually print, our sprites on the screen. To complete the set of sprite generation routines I shall supply a master sprite controlling routine. The function of SPRMV will be to update the values of XP, XC, YP and YC according to VX and VY (all stored in the motion data, indexed by the IY register) and then to set up the correct parameters in the registers and jump to SPRINT the sprite. The only parameter required by SPRMV is the address of the motion data, in IY. Once SPRMV has been called, no further work is required to move and print your sprite.

Before explaining how to initialise and manipulate the motion data, together with providing a spectacular demonstration routine, allow me to present the listing for SPRMV.

```

;
; GENERAL PURPOSE SPRITE CONTROLLER
;
; ENTRY: IY POINTS AT MOTION DATA SEE TEXT
; FOR DETAILS
; NOTE: B'C'D'E'H'L'A'F' DESTROYED
; NOTE: IY IS PRESERVED
;
;
; DECREMENT CYCLE COUNT
;

```

```

FD3509   SPRMV   DEC   (IY+9)
C0       RET    NZ
;
;IF ZERO THEN REFILL CYCLE COUNT
;
FD7E0A   LD      A,(IY+10)
FD7709   LD      (IY+9),A
;
;LET HL=ADDRESS OF IMAGE 0
;
FD6608   LD      H,(IY+8)
FD6E07   LD      L,(IY+7)
;
;ADD STEP TO XP
;
FD7E00   LD      A,(IY+0)
FD8601   ADD     A,(IY+1)
F22500   JP      P,NNEG1
;
;IF RESULT NEGATIVE THEN LET XP=XP+XMAX
;AND LET XC=XC-1
;
FD8602   ADD     A,(IY+2)
FD3503   DEC     (IY+3)
FD5E03   LD      E,(IY+3)
;
;JUMP TO DEAL WITH Y
;
C33F00   JP      XDN
FD4602   NNEG1  LD      B,(IY+2)
;
;IF XP<XMAX THEN GO FOR Y
;
B8       CP      B
FD5E03   LD      E,(IY+3)
3811    JR      C,XDN
;
;ELSE INCREMENT XC, LET XP=XP-XMAX
;
FD3403   INC     (IY+3)
90      SUB     B
;

```

```

;AND DECREASE HL BY ONE COLUMN TO
ALLOW FOR A BLANK
;LEFT COLUMN
;
08       EX      AF,AF'
FD7E0C   LD      A,(IY+12)
01F8FF   LD      BC,0FFF8H
09       NXUB   ADD     HL,BC
3D       DEC     A
C23900   JP      NZ,NXUB
08       EX      AF,AF'
;
;STORE NEW VALUE OF XP
;
FD7700   XDN    LD      (IY+0),A
47       LD      B,A
;
;ADD STEP TO YP
;
FD7E04   LD      A,(IY+4)
FD8605   ADD     A,(IY+5)
F25800   JP      P,NNEG2
;
;IF RESULT NEGATIVE THEN LET YP=YP MOD 8
;
E607    AND     7
4F      LD      C,A
;
;AND INCREMENT YC
;
FD3406   INC     (IY+6)
FD5606   LD      D,(IY+6)
C36500   JP      YDN
;
;IF YP>7 THEN LET YP=YP-8
;AND DECREMENT YC
;
FE08    NNEG2  CP      8
FD5606   LD      D,(IY+6)
4F      LD      C,A
3805    JR      C,YDN
E607    AND     7

```



```

FD3506      DEC      (IY+6)
FD7704      YDN      LD      (IY+4),A
            ;
            ;JUMP TO THE SPRITE PRINTING ROUTINE
            ;
C30000      JP      SPRINT

```

With reference to the table of motion data contents found earlier in this chapter, we recall that seven bytes of the seventeen allotted to each sprite are initialised by the routines PADOUT and SPREX.

Thus we need only reserve space for them with DEFB 0 in the assembly listing. The variables we have to initialise ourselves include the obvious position values XP, XC, YP and YC. Remember that XP is measured to the right and YP upwards from, the bottom left corner of the sprite, while XC is measured to the right of and YC downwards from, the top left corner of the screen. Recall also that (XC, YC) are the co-ordinates of the top left corner of the sprite.

The speeds VX and VY are measured in the same directions as XP and YP, and may be greater than, less than or equal to zero. If  $VX > 0$  then movement is to the right, while if  $VX < 0$  then it is to the left. Similarly  $VY > 0$  signifies upward movement, while  $VY < 0$  sends the sprite downwards. This arrangement allows high versatility in the direction of movement. For example, we could cause a sprite to make a gentle 'dive' with horizontal speed three pixels and vertical speed one pixel per movement, by setting:

$VX = 03H$   $VY = 0FFH$  (minus one)

As I explained earlier, the 'cycle count' is provided as a means for regulating the frequency at which the sprites move, and also whether two or more sprites move in phase with each other.

This is best shown by means of an example. Suppose that we have two sprites, with motion data at labels MDAT1 and MDAT2, and that we want one sprite to move every five TV frames, and the second to move once in every three frames. We set the respective 'cycle periods' to values five and three, and, as usual, initialise the 'cycle counts' to one, so that both sprites will move on the first call to SPRMV. All that we then have to do is:

```

LD      IY,MDAT1
CALL    SPRMV
LD      IY,MDAT2
CALL    SPRMV

```

after each interrupt.

If we have (say) two sprites moving at the same frequency, and we wish to keep them 'out of phase', perhaps because there isn't enough room in the print buffer to animate them both in the same TV frame, then we use different initialisations of the cycle count. For example, suppose that two sprites are given cycle periods of two calls.

Then we can make them move on alternate TV frames by setting the first cycle count to one, and the second to value two. Whatever happens, the cycle period and cycle count must always be non-zero. Since otherwise a movement frequency of once in every 256 calls to SPRMV would result.

Using the concepts of cycle count and cycle period, we can animate all the sprites involved in a program in one block. If we place all their motion data consecutively in memory, then a suitable fragment after each interrupt (detected by a HALT instruction) might be as follows:

```

MDAT      EQU      (ADDRESS OF MOTION DATA)
           LD      IY,MDAT
           LD      B,(NUMBER OF SPRITES)
NXTSPRT   PUSH    BC
           CALL    SPRMV
           POP     BC
           LD      DE,17
           ADD     IY,DE
           DJNZ    NXSPT

```

Referring again to the earlier table of motion data contents, you will notice that the address of the first byte of image 0 (immediately after the preceding blank column) is stored at (IY + 7). This value is also returned in HL after the call to PADOUT to set up the sprite data.

We can use this entry in the motion data as a means of switching or cycling through different sets of images for any one sprite. For example, you may wish to make your character 'walk' instead of glide, or perhaps make your spacecraft gradually disintergrate in flight, after being hit by a particularly nasty plasma bolt.

To realise this function, set up as many different sets of sprite data as you need, storing the values returned by PADOUT in your own look-up table. IY should be kept pointing at one set of motion data, which will obviously then be set up with the last set of sprite data generated.

Then when you are running your program, use an 'animation count' and 'animation period' analogous to the 'cycle count' and 'cycle period' system to step through the different sets of images, retrieving the appropriate address from your look-up table and inserting it at (IY + 7) every time you want to switch data.

There are various other manipulations of the motion data that you could try; for example, you could make the sprite move in a preprogrammed pattern by running through a table of values for VX and VY, or you could make the sprite do a 'chameleon' act by manipulating the attribute byte at (IY + 15) (remember to preserve bit 7, the OR-printing flag, though!). I'll leave further variations on this theme to your imagination, and begin development of a demonstration routine.

After a great deal of thought I elected to show you how to move two sprites in opposite directions along the horizontal centre line of the screen. One sprite will be of a special playing card, the six of clubs, known traditionally in Oxfordshire as 'Gordon's Card', while the other, to preserve variety, will be of a red telephone.

It would be a pity not to use the smoothest possible animation, so we will move both sprites by one pixel in every TV frame. Now the print buffer can take forty characters, so let's use twenty on each sprite. We know that  $5 \times 4 = 20$ , so we can use a  $3 \times 4$  cell shape for the card, and a  $4 \times 3$  cell shape for the telephone.

Recall the formula for the image area for (a) images of an (m x n) shape, namely:

Memory needed =  $8(a(m + 1) + 1)(n + 1)$  bytes.

For the telephone, m = 4, n = 3, a = 8 and

Memory needed =  $8(8(4 + 1) + 1)(3 + 1)$   
= 1312 bytes.

For the card, m = 3, n = 4, a = 8 and

Memory needed =  $8(8(3 + 1) + 1)(4 + 1)$   
= 1320 bytes.

Not forgetting the eight zero bytes at the end of the combined image area, we reserve space with

```

TELSPC  DEFS    1312
CARSPC  DEFS    1320
        DEFW    0,0,0,0

```

The horizontal speed will be  $VX = 1$ , the maximum value of XP will be  $XP_{max} = 7$ , and the distance between two successive images will be  $D = 1$  pixel. Hence the width of the safety margin to the right of our shapes will be:

$$\begin{aligned}
 P_x &= D(VX + XP_{max}) - 8 \\
 &= 1(1 + 7) - 8 \\
 &= 0 \text{ pixels,}
 \end{aligned}$$

that is to say that we may design our shapes in the full three or four columns! Since the sprites will not be moved vertically, no upper safety margin is necessary anyway. The phone and card have been designed in the full area allowed, and I have encoded the data for you, the results of which will be found at labels TELDAT and CARDAT respectively. Casting your mind back to the procedure for employing PADOUT and SPREX, you will see that we can generate the images of our telephone by the fragment:

```

LD      HL, TELSPC      ; IMAGE AREA
LD      DE, TELDAT      ; SPRITE DATA
LD      BC, 0403H       ; B=WIDTH, C=HEIGHT
LD      IY, TELMTN      ; MOTION DATA
CALL    PADOUT
LD      D, 1             ; STEP BETWEEN IMAGES OF
CALL    SPREX           ; ONE PIXEL

```

A similar fragment will generate the images of the playing card; where TELMTN and CARMTN are the start addresses of the motion data tables for the phone and card respectively.

We will initialise the position of the telephone to just off the left hand edge of the screen, with the base of the phone in line eleven. Hence the top left corner of the sprite is at (-4, 9) and the shape is at the bottom left corner of the sprite, i.e.

$XP = 0, XC = 0FCH, YP = 0, YC = 9.$

We shall be moving the sprites once in every TV frame, so set the cycle count and cycle period to one, I have elected to use OR-printing in this demonstration, so that the two sprites merge as they cross over each other. The telephone will be red (value 2) and we'll mask the paper from the current attribute (i.e. PAPER 8), hence we have attribute byte 82H and mask byte 38H. Plugging zero into the gaps in our table that will be filled by PADOUT and SPREX, we have the initial motion data:

```

TELMTN  DEFB    0,1,0,0FCH,0,0,9,0,0,1,1,
           0,0,0,0,82H,38H

```

The card will start just off the right hand screen edge with its base in line twelve. Hence we start with

XP = 0, XC = 32, YP = 0, YC = 9.

Remembering that VX = -1 = 0FFH since the card is moving leftwards, and using cyan INK, PAPER 8 and OR-printing (bit 7 of the attribute set) we have the initial card motion data

```
CARDAT  DEFB  0,0FFH,0,32,0,0,9,0,0,1,1,
             0,0,0,0,85H,38H
```

To operate the OR-printing function, we must make sure that the OR-map is cleared (using the CLOR routine in the last chapter) before each complete set of sprite movements is started. Otherwise, we would end up OR-printing the new image of a sprite on top of its old one, causing an undesirable trail over the screen as the sprite moves. Thus the main loop of the demonstration will include the lines

```
CALL  CLOR
LD    IY, TELMTN
CALL  SPRMV
LD    IY, CARMTN
CALL  SPRMV
```

before a HALT instruction, to get the sprites actually printed.

The rest of the demonstration listing is self explanatory. Notice that the routines INT1 and DISINT are called from Chapter 9.

Here then is the 'spectacular demonstration' routine. Study the listing carefully, and feel free to try altering the speed of the sprites, the number of images and so on.

```

;
;
; DEMO ROUTINE FOR PADOUT, SPREX, SPRINT
AND SPRMV
;
; PRESERVE HL' FOR RETURN TO BASIC
;
D9  TEST  EXX
E5          PUSH  HL
D9          EXX
;
; SET ZERO-HORIZON, BLACK SKY AND SEA
```

```

;
AF      XOR  A
320000  LD   (ROWS+1),A
320000  LD   (TOPBRD+1),A
320000  LD   (BOTBRD+1),A
;
; GENERATE SPRITE DATA FOR TELEPHONE
;
214D01  LD   HL, TELSPC
118C00  LD   DE, TELDAT
;
; PHONE IS 4 COLUMNS BY 3 LINES
;
010304  LD   BC, 0403H
FD216A00 LD  IY, TELMTN
CD0000  CALL PADOUT
1601    LD   D, 1
CD0000  CALL SPREX
;
; GENERATE SPRITE DATA FOR PLAYING CARD
;
216D06  LD   HL, CARSPC
11ED00  LD   DE, CARDAT
;
; CARD IS 3 COLUMNS BY 4 LINES
;
010403  LD   BC, 0304H
FD217B00 LD  IY, CARMTN
CD0000  CALL PADOUT
1601    LD   D, 1
CD0000  CALL SPREX
;
; INITIALIZE INTERRUPT-DRIVEN PRINT-
PROCESSOR
;
CD0000  CALL INT1
76      HALT
;
; MOVE THE SPRITES ACROSS THE SCREEN
4 TIMES AT ONE
; PIXEL PER TV FRAME IN OPPOSITE DIRECTIONS
;
```

```

0E02          LD      C,2
0600    NXAM2    LD      B,0
C5          NXAM    PUSH   BC
;
;CLEAR THE OR-MAP BEFORE EACH SET OF
MOVEMENTS
;
CD0000          CALL    CLOR
;
;MOVE AND PRINT PHONE
;
FD216A00        LD      IY,TELMTN
CD0000          CALL    SPRMV
;
;MOVE AND PRINT CARD
;
FD217B00        LD      IY,CARMTN
CD0000          CALL    SPRMV
C1              POP     BC
76              HALT
;
;NEXT FRAME
;
10EA          DJNZ    NXAM
;
;REVERSE DIRECTIONS ALONG X
;
FD7E01          LD      A,(IY+1)
FD77F0          LD      (IY-16),A
ED44           NEG
FD7701          LD      (IY+1),A
;
;NEXT PASS
;
0D              DEC     C
20DA           JR      NZ,NXAM2
;
;RESELECT IM 1 AND RETRIEVE HL
;
CD0000          CALL    DISINT
D9              EXX
E1              POP     HL

```

```

D9              EXX
C9              RET
;
;SPRITE MOTION DATA
;
00      TELMTN  DEFB    0
01      DEFB    1
00      DEFB    0
FC      DEFB    0FCH
00      DEFB    0
00      DEFB    0
09      DEFB    9
00      DEFB    0
00      DEFB    0
01      DEFB    1
01      DEFB    1
00      DEFB    0
00      DEFB    0
00      DEFB    0
00      DEFB    0
82      DEFB    82H
38      DEFB    38H
00      CARMTN  DEFB    0
FF      DEFB    0FFH
00      DEFB    0
20      DEFB    32
00      DEFB    0
00      DEFB    0
09      DEFB    9
00      DEFB    0
00      DEFB    0
01      DEFB    1
01      DEFB    1
00      DEFB    0
00      DEFB    0
00      DEFB    0
85      DEFB    85H
38      DEFB    38H
;
;UNEXPANDED SPRITE DATA
;

```



0F	TELDAT	DEFB	15
1F		DEFB	31
3F		DEFB	63
7F		DEFB	127
FF		DEFB	255
FE		DEFB	254
FE		DEFB	254
FC		DEFB	252
78		DEFB	120
30		DEFB	48
01		DEFB	1
03		DEFB	3
03		DEFB	3
07		DEFB	7
07		DEFB	7
;			
0F		DEFB	15
1F		DEFB	31
3F		DEFB	63
7F		DEFB	127
7F		DEFB	127
7F		DEFB	127
3F		DEFB	63
3F		DEFB	63
0F		DEFB	15
FF		DEFB	255
FF		DEFB	255
FF		DEFB	255
FF		DEFB	255
F0		DEFB	240
60		DEFB	96
;			
60		DEFB	96
60		DEFB	96
FF		DEFB	255
FF		DEFB	255
F8		DEFB	0F8H
F3		DEFB	0F3H
E7		DEFB	0E7H
CF		DEFB	0CFH
DE		DEFB	0DEH
9C		DEFB	9CH

9C	;	DEFB	9CH
DE		DEFB	0DEH
CF		DEFB	0CFH
E7		DEFB	0E7H
F3		DEFB	243
F8		DEFB	248
FF		DEFB	255
FF		DEFB	255
FF		DEFB	255
FF		DEFB	255
FF		DEFB	255
FF		DEFB	255
;			
FF		DEFB	255
0F		DEFB	15
06		DEFB	6
06		DEFB	6
06		DEFB	6
FF		DEFB	255
FF		DEFB	255
1F		DEFB	31
CF		DEFB	0CFH
E7		DEFB	0E7H
F3		DEFB	243
7B		DEFB	7BH
39		DEFB	39H
39		DEFB	39H
7B		DEFB	7BH
;			
F3		DEFB	243
E1		DEFB	0E1H
CE		DEFB	0CEH
1F		DEFB	31
FF		DEFB	255
FF		DEFB	255
F0		DEFB	240
F8		DEFB	248
FC		DEFB	252
FE		DEFB	254
FF		DEFB	255
7F		DEFB	127
7F		DEFB	127

3F	;	DEFB	63
1E		DEFB	30
0C		DEFB	12
80		DEFB	128
C0		DEFB	192
C0		DEFB	192
E0		DEFB	0E0H
E0		DEFB	0E0H
F0		DEFB	240
F8		DEFB	0F8H
FC		DEFB	0FCH
FE		DEFB	0FEH
FE		DEFB	0FEH
FE		DEFB	0FEH
FC	;	DEFB	0FCH
FC		DEFB	0FCH
F0		DEFB	0F0H
3F	;	DEFB	63
60	CARDAT	DEFB	96
D8		DEFB	0D8H
A0		DEFB	0A0H
B9		DEFB	0B9H
AB		DEFB	0ABH
B9		DEFB	0B9H
85		DEFB	85H
8F		DEFB	8FH
85		DEFB	85H
81		DEFB	81H
80		DEFB	80H
81	;	DEFB	81H
83		DEFB	83H
81		DEFB	81H
85		DEFB	85H
8F		DEFB	8FH
85		DEFB	85H
81		DEFB	81H
80		DEFB	80H

81		DEFB	81H
85		DEFB	85H
8F		DEFB	8FH
85		DEFB	85H
81		DEFB	81H
83	;	DEFB	83H
81		DEFB	81H
80		DEFB	80H
80		DEFB	80H
C0		DEFB	0C0H
60		DEFB	96
3F		DEFB	63
FF		DEFB	255
00		DEFB	0
00		DEFB	0
00		DEFB	0
00		DEFB	0
00		DEFB	0
81		DEFB	81H
00		DEFB	0
42		DEFB	66
E7		DEFB	0E7H
42	;	DEFB	66
00		DEFB	0
00		DEFB	0
00		DEFB	0
81		DEFB	81H
00		DEFB	0
42		DEFB	66
E7		DEFB	0E7H
42		DEFB	66
00		DEFB	0
00		DEFB	0
00		DEFB	0
42		DEFB	66
E7		DEFB	0E7H
42		DEFB	66
00		DEFB	0
81		DEFB	81H
00		DEFB	0
00		DEFB	0

```

00      DEFB  0
;
00      DEFB  0
00      DEFB  0
FF      DEFB  0FFH
FC      DEFB  0FCH
06      DEFB  6
03      DEFB  3
01      DEFB  1
81      DEFB  81H
C1      DEFB  0C1H
81      DEFB  81H
A1      DEFB  0A1H
F1      DEFB  0F1H
A1      DEFB  0A1H
81      DEFB  81H
01      DEFB  1
81      DEFB  81H
;
C1      DEFB  0C1H
81      DEFB  81H
A1      DEFB  0A1H
F1      DEFB  0F1H
A1      DEFB  0A1H
81      DEFB  081H
01      DEFB  1
81      DEFB  81H
A1      DEFB  0A1H
F1      DEFB  0F1H
A1      DEFB  0A1H
81      DEFB  081H
DD      DEFB  0DDH
;
95      DEFB  095H
1D      DEFB  29
05      DEFB  5
1B      DEFB  27
06      DEFB  6
FC      DEFB  0FCH
;
; IMAGE AREA FOR EXPANDED SPRITE DATA
; LENGTH=4*5*64+(4*8)

```

```

;
TELSPC DEFS  1312
;
; LENGTH=5*4*64+(5*8)
;
CARSPC DEFS  1320
0000    DEFW  0
0000    DEFW  0
0000    DEFW  0
0000    DEFW  0

```

If you have followed the last few chapters accurately, the images which should appear on your screen look like this:



## CHAPTER 13

# High-Resolution Colour

Hands up all those of you who have ever had the need for more than the two colours normally available in each character cell. Well behold, your wishes are about to be granted. With the routines in this chapter you will be able to cover an area of the screen eight columns wide and up to twenty four lines deep with colour attributes at eight times normal resolution; that is, one attribute byte for each row of each cell in the high-resolution area.

The routine works using our tried and trusted technique of interrupts vectored under interrupt mode 2 (IM 2) to our own interrupt handler, as described in Chapter 7.

On receiving an interrupt, the Spectrum will execute a suitable delay routine while it waits for the TV beam to approach the high-resolution area. From then on we have exactly 224 T-states to send as long a row as possible of our 'high-resolution' attributes to the normal attribute file. Experimentation proves that, under the usual restriction that the routine is placed in the top 32K of RAM to avoid delays due to ULA interference, it is possible to replace the attributes of just 8 cells if we are to have time to adjust our pointers and counters ready for the next row of attributes.

The new attributes will be stored in a special high-resolution attribute file, the start of which we shall label with the two-byte variable HIATT. For maximum flexibility, the high-resolution area will be of variable length and variable vertical position. Labelling the top line of the screen as zero

and counting downwards, the first line in the high-resolution area will be STRTLN and the number of lines in the area will be specified by the one-byte variable DEPTH.

The interrupt handler, which I have christened HIRES, includes two stack operations inside its main loop. In order to ensure that these do not run the risk of ULA interference by access to the lowest 16K of RAM, the routine stores away the value of SP in VALSP and then uses its own two-byte machine stack, placed immediately before the routine and thus in the top 32K of RAM.

Central to the routine is a sequence of eight consecutive LDI instructions to load the attributes from the high-resolution file to the normal file. This is the fastest possible method of data transference, each operation taking a nominal 16 T-states. This compares with a usual 21 T-states per repetition of the LDIR instruction (this only takes 16 T-states on its final execution, when BC = 0).

High resolution attributes are, of course, mapped out in exactly the same manner as the standard attribute bytes. Bits 0 to 2 are for INK, bits 3 to 5 are for PAPER, bit 6 for BRIGHTness, and setting bit 7 denotes FLASH 1.

Here then is the listing for HIRES, the interrupt handler, followed shortly after by an initialisation routine. Remember the restrictions; the interrupt handler, its preceding variables, and the high-resolution attribute file must all be in the top 32K of RAM.

```

;HIGH RESOLUTION COLOUR
;N.B! POSITION ABOVE 32K BOUNDARY
;VARIABLES AND ROOM FOR A TWO-BYTE
;MACHINE STACK:- USED BY INTERRUPT
;HANDLER
;
00 STRTLN  DEFB  0
18 DEPTH  DEFB  24
0000 HIATT  DEFW  0
0000 VALSP DEFW  0
0000      DEFW  0
;
;PRESERVE REGISTERS
;
C5 HIRES  PUSH  BC
D5      PUSH  DE
E5      PUSH  HL

```



```

F5          PUSH   AF
           ;
           ;STORE SP AND USE THE TWO BYTES PRECEDING
           ;THIS ROUTINE AS A STACK
           ;
ED730400    LD      (VALSP),SP
310800      LD      SP,HIRES
           ;
           ;PRODUCE AN EXACT DELAY
           ;
011802      LD      BC,0218H
0B          DELAY  DEC   BC
78          LD      A,B
B1          OR      C
20FB       JR      NZ,DELAY
           ;
           ;CALCULATE # OF TEXT ROWS ABOVE HI-RES AREA
           ;
3A0000      LD      A,(STRTLN)
87          ADD     A,A
87          ADD     A,A
87          ADD     A,A
CA2F00      JP      Z,GO4IT2
           ;
           ;WAIT UNTIL BEAM REACHES HI-RES AREA
           ;EACH LOOP TAKES 224 T-STATES, OR ONE TV-ROW
           ;
060F       SCANL  LD      B,15
10FE       LN2    DJNZ   LN2
00         NOP
00         NOP
C8         RET    Z
3D         DEC   A
C22400     JP      NZ,SCANL
           ;
           ;CALCULATE ATTRIBUTE ADDRESS FOR (STRTLN,12)
           ;
6F         GO4IT2 LD     L,A
3A0000     LD     A,(STRTLN)
67         LD     H,A
CB3C       SRL    H
CB1D       RR     L

```

```

CB3C       SRL    H
CB1D       RR     L
CB3C       SRL    H
CB1D       RR     L
110C58     LD     DE,580CH
19         ADD    HL,DE
           ;
           ;PUT ATT. ADDRESS IN DE
           ;
EB         EX     DE,HL
           ;
           ;TAKE START OF HI-RES ATTRIBUTE FILE
           ;
2A0200     LD     HL,(HIATT)
           ;
           ;A COUNTS THE NUMBER OF LINES LEFT
           ;
3A0100     LD     A,(DEPTH)
           ;
           ;BC COUNTS THE HI-RES COLOUR BYTES
           ;FOR THIS LINE
           ;
014000     NXLINE LD    BC,64
           ;
           ;SAVE ADDRESS OF LEFT-HAND ATTRIBUTE ON THIS LINE
           ;
D5         NXTROW PUSH  DE
           ;
           ;TRANSFER THE EIGHT ATTRIBUTES FOR THIS ROW
           ;
EDA0      LDI
EDA0      LDI
EDA0      LDI
EDA0      LDI
EDA0      LDI
EDA0      LDI
EDA0      LDI
EDA0      LDI
           ;
           ;RETRIEVE ADDRESS OF LEFT-HAND ATTRIBUTE
           ;
D1         POP    DE

```

```

;
; IF BC=0 THEN ROW 7 IS COMPLETE
;
E26A00      JP      PO,LSTROW
;
; 23 T-STATE TIMING EQUALIZER
;
1800      JR      $+2
00      NOP
E6FF      AND     0FFH
18E4      JR      NXTROW
;
; ADD 32 TO ATTR. ADDRESS AND MOVE
; ON TO NEXT LINE
;
EB      LSTROW  EX     DE,HL
0E20      LD     C,32
09      ADD     HL,BC
EB      EX     DE,HL
3D      DEC     A
C20000    JP     NZ,NXLINE
;
; RETRIEVE SP, THEN UNSTACK THE OTHER REGISTERS
;
ED7B0400   LD     SP,(VALSP)
F1      POP    AF
E1      POP    HL
D1      POP    DE
C1      POP    BC
;
; RETURN FROM INTERRUPT
; NOTE: YOU COULD INSERT A JUMP TO THE ROM
; INTERRUPT ROUTINE HERE (TO 0038H)
FB      EI
ED4D      RETI

```

The interrupts will be intercepted by means of a 257 byte vector table, starting at an arbitrary page boundary which I have chosen to be FE00H. This technique was detailed in Chapter 7. We need a routine to set up the vector table and select interrupt mode 2, and it shall be called HIRON for High Resolution ON. Following the routine is a short fragment to set up the jump instruction to HIRES at FDFDH, to which all interrupts are vectored.

```

; INITIALIZE INTERRUPT INTERCEPTION
; WITH A 257 BYTE VECTOR TABLE AT 0FE00H
;
; EXIT: BC=0, DE=0FF01, HL=0FF01
;
3EFE      HIRON  LD     A,0FEH
ED47      LD     I,A
010001    LD     BC,0100H
67      LD     H,A
69      LD     L,C
57      LD     D,A
58      LD     E,B
36FD      LD     (HL),0FDH
EDB0      LDIR
ED5E      IM     2
C9      RET
;
; PRODUCE THE JUMP TO HIRES
; AFTER AN INTERRUPT
;
;
; LABEL   ORG     0FDFDH
C30000    JP     HIRES
; ORG     LABEL

```

Now that you have the interrupt handler and initialisation routine, you have all the means to produce high resolution colour, and its nearly time for some examples.

The maximum high-resolution area is  $8 \times 24 = 192$  cells, and hence at most  $192 \times 8 = 1536$  attribute bytes are required, or 1.5K of memory. As it stands, the routine HIRES positions this area in the centre of the screen, starting at column twelve. Some variation in this is possible by altering the base address of the attribute area held in the instruction:

```
LD     DE,580CH
```

shortly after label GO4IT2. Some timing adjustment may be necessary, but on my Spectrum I found that the leftmost column of the high-resolution area could quite happily be varied between column 0 and column 13. Thus to cover the area from column 5 to column 12 inclusive, change the instruction to:

```
LD     DE,5805H
```

Unlike the full screen horizon generator in the interrupt handler of Chapter 9, HIRES does not depend on returning to a HALT instruction before each interrupt to maintain stability and prevent flickering attributes. Once we have 'turned on' the high resolution colour, therefore, we are free to do any processing we like without worrying about when the interrupts occur, just as long as we don't disable them.

By substituting the instruction:

```
JP      0038H
```

for the pair

```
EI
RETI
```

at the end of HIRES, we would cause a jump to the standard ROM interrupt handler after every high-resolution frame had been generated. It would then be safe to return to BASIC, which would run normally, apart from the fact that the deeper and lower the high-resolution area, the slower BASIC would get!

For the first example, I have simply pointed HIRES at the start of the ROM and told it to display the first 1.5K in the full-blown high-resolution area, for 256 TV frames (5.12 seconds). The routine is called DEMO1 (points for imagination . . . ?).

```
AF      DEMO1  XOR    A
320000      LD    (STRTLN),A
;
;USE FIRST 1.5K OF ROM AS
;HI-RES COLOUR FILE
;
6F          LD    L,A
67          LD    H,A
3E18       LD    A,24
320000      LD    (DEPTH),A
220000      LD    (HIATT),HL
CD0000      CALL  HIRON
;
;NOTE L=0 FROM HIRON
;
45          LD    B,L
;
```

```
;PRODUCE HI-RES COLOUR FOR
;5.12 SECONDS
;
76         TSLP3  HALT
10FD          DJNZ  TSLP3
;
;RESELECT IM 1 FOR RETURN TO BASIC
;
ED56          IM    1
3E3F          LD    A,3FH
ED47          LD    I,A
C9           RET
```

The second demonstration is slightly more exotic, and involves the use of a subroutine DATPRP to generate a 25 line attribute file. Obviously not all of these lines can be used at any one time, but by cycling the label pointing at the 'start' of the file, HIATT, backwards or forwards in steps of eight bytes, we can make the high-resolution attributes 'scroll' up or down the screen.

DATPRP, for DATa PReParer, generates a 25 line attribute file, each line the same, and each row of a line having just one paper colour and white ink. In an effort to provide some colour separation, I have used the sequence black, magenta, yellow, blue, green, white, red, cyan for the paper colours of successive rows. However, whether it is possible to distinguish these separate colours (or shades, for those of you reading in black and white) will depend on the resolution of your TV sets, over which I regrettably have no control.

Here comes DATPRP, followed closely by DEMO2.

```
;DEMO ROUTINE TO SET UP A 25 LINE
;HI-RES COLOUR FILE
;SPACE NEEDED=25*64=1984
;
TSTDAT  DEFS  1984
;
210000  DATPRP LD    HL,TSTDAT
;
;FOR 25 LINES
;
0E19          LD    C,25
;
;USE BLACK PAPER ON ROW 0
```

```

AF          ;          XOR      A
          ;
          ; ALWAYS USING WHITE INK
          ;
F607       NXCOLR  OR      7
          ;
          ; CREATE A ROW OF 8 HI-RES ATTRIBUTES
          ;
0608       LD      B,8
77         FL9     LD      (HL),A
23         INC     HL
10FC      DJNZ    FL9
          ;
          ; NEXT PAPER COLOUR
          ;
C618       ADD     A,24
E638       AND     38H
20F2       JR     NZ,NXCOLR
          ;
          ; NEXT LINE
          ;
0D         DEC     C
20EF      JR     NZ,NXCOLR
C9         RET

```

DEMO2 will make a multicoloured pile shrink into the 'ground', with the colours scrolling downwards as it goes. The routine is best run with a global black paper and border.

```

          ; SET-UP 25-LINE ATT. FILE AND TURN ON HI-RES
          ;
CD0000     DEMO2   CALL    DATPRP
CD0000     CALL    HIRON
          ;
          ; CYCLE (HIATT) BACKWARDS THROUGH THE FIRST
          ; EIGHT ROWS, MAKING THE COLOUR FLOW DOWN THE
          ; SCREEN. NOTE: THIS IS WHY WE NEED 25-LINES,
          ; NOT 24
          ;
11F8FF     LD      DE,0FFF8H
          ;
          ; AFTER EVERY CYCLE DECREMENT (DEPTH)

```

```

          AND INCREMENT
          ; (STRTLN), MAKING THE HIRES AREA SHRINK
          ; DOWNWARDS
          ;
0E18       LD      C,24
79         TSLP   LD      A,C
320000     LD      (DEPTH),A
3E18       LD      A,24
91         SUB    C
320000     LD      (STRTLN),A
0608       LD      B,8
210000     LD      HL,TSTDAT+64
220000     NXRUN  LD      (HIATT),HL
76         HALT
19         ADD    HL,DE
10F9       DJNZ   NXRUN
0D         DEC    C
20E7       JR     NZ,TSLP
          ;
          ; RESELECT IM 1 FOR RETURN TO BASIC
          ;
ED56       IM     1
3E3F       LD      A,3FH
ED47       LD      I,A
C9         RET

```

The final demonstration routine for HIRES is a rather spectacular piece called (you guessed it) DEMO3. Again, it uses the ROM to provide a fairly random attribute file, but this time it spend 30.72 seconds or so running HIATT backwards from 0600H to zero. The result is a very captivating pattern. Try following its movement from left to right, and then look from right to left across it. Do you notice any difference in its apparent speed?

```

          ; SET UP FULL LENGTH HI-RES AREA
AF         DEMO3   XOR      A
320000     LD      (STRTLN),A
3E18       LD      A,24
320000     LD      (DEPTH),A
          ;
          ; TURN ON THE HI-RES COLOUR
          ;
CD0000     CALL    HIRON
          ;

```

```

;USE ROM AS HI-RES COLOUR FILE, STEPPING HIATT
;BACKWARDS FROM 0600H TO ZERO. NOTE
  THAT THERE ARE 0600H HI-RES ATTRIBUTES
;
2606      LD      H,6
;
;NOTE L=0 FROM HIRON
;
220000    TSLP2   LD      (HIATT),HL
76        HALT
2D        DEC     L
20F9      JR      NZ,TSLP2
25        DEC     H
20F6      JR      NZ,TSLP2
;
;RESELECT IM 1 FOR RETURN TO BASIC
;
3E3F      LD      A,3FH
ED56      IM     1
ED47      LD      I,A
C9        RET

```

In closing this chapter I ought to point out that the above format is not the only possible layout for high-resolution colour. For a start, if you were willing to have just one attribute byte per scan line, then you wouldn't need to 'dump' a high-resolution colour file on a one-to-one basis, and could dispense with the 16 T-state:

```
LDI
```

in favour of a pair of instructions like:

```
LD      (DE),A
INC     E
```

Where the accumulator would hold the current row attribute, and each pair would take 11 T-states. This way you could probably increase the width of the high-resolution area by three or four columns.

## CHAPTER 14

# Producing Full-Screen Images with the Border

Spectacular though it was, the full-screen horizon generated in Chapter 9 by switching the border colour one hundred times a second (at 100 Hz) was merely scratching the surface of the potential effects of direct border colour control. In this chapter, I shall realise the full potential of high-speed border switching with a set of routines that will allow you to produce ten distinct columns on the border, with each row of each column taking any one of the eight colours. The switching speeds involved will stretch the Z-80 processor to its limits, with a 12 T-state gap between colour changes and an average frequency over one TV row of 156250 Hz.

The principles involved in the 'picture generator' are very similar to those of our full-screen horizon. We use interrupts vectored under interrupt mode 2 to our own customised interrupt handler, which after executing appropriate delays for the TV beam to descend to the screen, hurtles through a table of border values like a bat out of hell, always changing the border colour at exactly the same stages in the generation of each TV frame.

To go into more detail, recall that the time taken for the TV to generate one row of the display is exactly 224 T-states. Now the fastest way of transferring data from a table to port 254 is by using a sequence of OUTI instructions, each of which takes 16 T-states. As this instruction is so rarely used, I shall take the trouble to detail its action for you.

The HL pair holds the address of the data byte, the C register holds the lo-byte of the port address, and the B register supplies the hi-byte of that



address. In every execution, the B register is decremented, the port address is formed, the data byte at HL is sent out to the port, and HL is incremented. If B reaches zero then the zero flag is set, if not, then it is reset.

Theory would dictate that we can produce  $\text{INT}(224/16) = 14$  'border columns' on the screen, but we must remember that the TV beam spends a certain amount of time in 'horizontal flyback' from the right hand edge to the left hand edge of the screen. Experimentation reveals that this traversal occupies the beam for around 64 T-states, or 2/7 or about 29% of its time.

We consequently have just enough time to change the border colour ten times as the beam crosses the screen from left to right, and this results in each 'border column' being four text columns in width.

I name this interrupt handler BORPIC for obvious reasons. The border data for BORPIC will be stored anywhere you like in the top 32K of RAM, and must be pointed to by the two-byte variable PICDAT. We shall format the border data as follows:

FIRST BYTE: NUMBER OF BORDER LINES

then the data for each 'border line':

FIRST BYTE: NUMBER OF TV ROWS IN THIS BORDER LINE

TEN BYTES: The border values for each of the 10 border columns.

The concept of border lines is analogous to that of text lines, except that border lines have a variable number of rows in them (up to 256), and the rows continue above and below the text area. It is easily seen that the storage area needed for a picture with n border lines is given by:

Memory needed =  $(11 * n) + 1$

In the listing of BORPIC you will see that I have reserved room for ten lines of border data and labelled it BORSTR. This area will be used later, but for now here is the listing. Please don't try to run it until I've explained how to!

```

0000 PICDAT DEFW 0
;
;PICDAT HOLDS ADDRESS OF BORDER DATA
;SPACE NEEDED=1+11*(NO. OF BORDER LINES)
;

```

```

BORSTR DEFS 111
;
;BORDER PICTURE GENERATOR PRESERVE REGISTERS
;
C5 BORPIC PUSH BC
D5 PUSH DE
E5 PUSH HL
F5 PUSH AF
08 EX AF,AF'
F5 PUSH AF
;
;WAIT 38 T-STATES
;
E3 EX (SP),HL
E3 EX (SP),HL
;
;WAIT FOR (FLYBAK+1) TV ROWS WHILE BEAM REACHES
;TOP OF SCREEN.
;
3E1F FLYBAK LD A,31
060F SCANM LD B,15
10FE LN4 DJNZ LN4
00 NOP
A7 AND A
C8 RET Z
3D DEC A
C27B00 JP NZ,SCANM
;
;5 T-STATE TIMING TRIMMER
;
C0 RET NZ
;
;POINT HL AT PICTURE DATA
;
2A0000 LD HL,(PICDAT)
;
;C HOLDS PORT VALUE
;
0EFE LD C,0FEH
;
;A COUNTS THE LINES OF BORDER DATA
;

```

```

7E          LD      A,(HL)
23          INC     HL
08          NXTLN2 EX     AF,AF'
;
;A COUNTS ROWS FOR THIS BORDER LINE
;
7E          LD      A,(HL)
23          INC     HL
;
;STORE START OF THIS ROW OF DATA IN DE
;
54          LD      D,H
5D          LD      E,L
;
;THE CORE OF 10 SUCCESSIVE BORDER CHANGES
;
EDA3       NXTRW  OUTI
EDA3       OUTI
EDA3       OUTI
EDA3       OUTI
EDA3       OUTI
EDA3       OUTI
EDA3       OUTI
EDA3       OUTI
EDA3       OUTI
EDA3       OUTI
EDA3       OUTI
;
;GENERATE NEXT ROW OF DISPLAY
;
3D          DEC     A
CAB600     JP      Z,NXTLN
62          LD      H,D
6B          LD      L,E
;
;FIRST WAIT 30 T-STATES
;
0600     LD      B,0
0600     LD      B,0
1800     JR      $+2
00       NOP
18DD     JR      NXTRW
;

```

```

;NEXT LINE OF BORDER DATA
;
08          NXTLN  EX     AF,AF'
3D          DEC     A
;
;7 T-STATES EQUALIZER
;
E6FF     AND     0FFH
C28E00   JP      NZ,NXTLN2
;
;RETRIEVE REGISTERS AND RETURN FROM INTERRUPT
;
F1          POP     AF
08          EX     AF,AF'
F1          POP     AF
E1          POP     HL
D1          POP     DE
C1          POP     BC
FB          EI
ED4D     RETI

```

As I said, BORPIC will be run as an interrupt handler using IM2. We shall use the usual 257-byte table of vectors to a jump instruction to BORPIC, a technique described in detail in Chapter 7. As usual, which page boundary you place the table at and where you put the jump instruction are entirely up to you. If you are undecided, however, then why not put the vector table at FE00H and the jump instruction at FDFD H. The latter may be achieved by adding the lines:

```

          LABEL  ORG     0FDFDH
C30000   JP      BORPIC
          ORG     LABEL

```

The routine HIRON from Chapter 13 may then be used to set up the vector table and select interrupt mode two (it was used previously to set up the same table for the high-resolution colour routine HIRRES).

Right then, now we have the routines necessary to make the border picture a reality. The generator is extremely sensitive to timing variations, and so, as in the case of the full-screen horizon generator in Chapter 9, we must always return to a HALT instruction before an interrupt. This way we have a maximum variation in timing of 4 T-states, the time taken for the processor to execute a NOP, which is what it repeatedly does when the HALT instruction is reached.

Referring to the listing of BORPIC, you will see a mysterious label on the line:

```
FLYBAK LD A,31
```

We will use this to make adjustments to the height at which the border picture starts on the screen. The value loaded into A is the number of TV rows the routine should wait before commencing the border data processing. If you want a picture to start right at the top of the screen, then adjust (FLYBAK + 1) until it does. The resulting value will depend on your particular television set as well as your Spectrum.

In the case of my colour portable I found that loading (FLYBAK + 1) with 31 brought the beam down to the top of the screen. There were then 32 rows of top border left before the text area, and indeed it is the general case that the depth of this 'top margin' plus the value in (FLYBAK + 1) should be 63. There are, of course, 192 rows in the text area. Below this is the 'bottom margin', the visible depth of which varies with different TVs and Spectrums, but on my system is about 44 rows deep, giving a total of  $32 + 192 + 44 = 268$  rows on the screen.

Although we can now produce a stable image on the screen border, the picture will be somewhat incomplete unless we can show the parts of the 'border columns' and 'border lines' which are, if you like, 'behind' the text area. What we need is a routine which examines the data for the 'invisible' part of the border and sets the paper attributes of all text cells appropriately, so that after 'switching on' the picture generator we appear to have a full-screen image, and the boundary between the text area and the border cannot be detected. I shall now develop just such a routine, and call it ATTSET.

Nine of the border columns overlap the text area as shown:

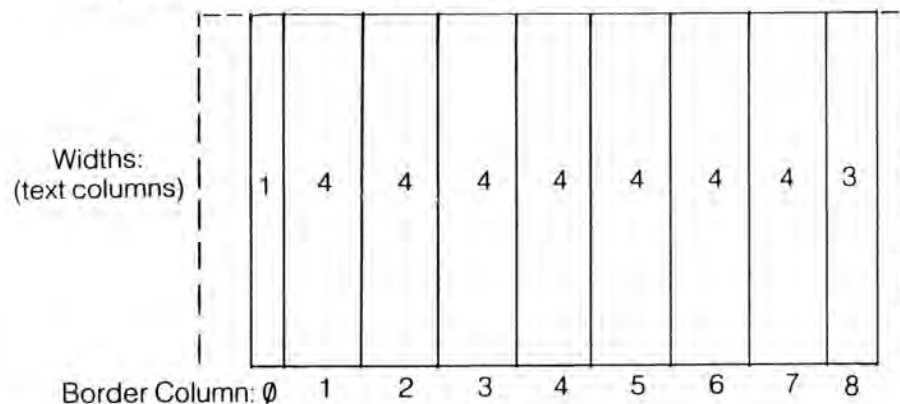

For the purposes of this routine we will assume that the text area has been divided into exactly six border lines, each of 32 rows in depth. If you prefer to have narrower border lines or possibly border lines of variable depth, then ATTSET is easily adjusted. It will not have escaped your notice that 32 rows = 4 text lines in depth, so with this format we end up producing 'border cells' that are four text cells square.

The principles involved in ATTSET are really very simple; we enter the routine with HL pointing at the border data for the first column of the first border line in the text area. ATTSET takes this byte, multiplies it by eight to obtain a PAPER value, ORs it with the INK value of the first cell and then places the lot in the first byte of the attribute file. The next border value is taken and used for the next four text columns of line 0, and this procedure is repeated for the next six border columns. The value of border column eight is used for the final three text columns, and this line of border data is then reprocessed three times for the remaining text lines of this border line.

The whole of the above procedure is then repeated for each of the five remaining border lines in the text area, and the listing of ATTSET evolves, followed by a demonstration.

```

;ROUTINE TO SET THE PAPER ATTRIBUTES
GIVEN BORDER DATA
;ENTRY :HL=ADDRESS OF FIRST BYTE OF BORDER
DATA IN TEXT AREA AS PRODUCED BY "EXPAND"
;EXIT:BC=0, HL=5B00H
;
;POINT HL AT START OF ATTRIBUTES
110058 ATTSET LD DE,5B00H
EB EX DE,HL
;
;B COUNTS THE BORDER LINES
;
0606 LD B,6
;
;C COUNTS THE ATTRIBUTE LINES (4 PER BORDER LINE)
;
0E04 NXTLN3 LD C,4
;
;STORE BORDER DATA ADDRESS
;
D5 NXT14 PUSH DE
C5 PUSH BC

```

```

;C HOLDS MASK FOR PAPER
;
0E38          LD      C,38H
;
;TAKE BORDER BYTE MULT BY 8 TO GET PAPER BITS
;
1A          LD      A,(DE)
07          RLCA
07          RLCA
07          RLCA
;
;USE THE INK OF THE CELL WITH OUR PAPER TO FORM
;NEW ATTRIBUTE BYTE
;
AE          XOR      (HL)
A1          AND      C
AE          XOR      (HL)
77          LD      (HL),A
;
;DO THE SAME FOR THE NEXT SEVEN BORDER COLUMNNS
;EACH OF WHICH IS FOUR TEXT COLUMNS WIDE
;
13          INC      DE
2C          INC      L
0607        LD      B,7
1A          NXT12  LD      A,(DE)
07          RLCA
07          RLCA
07          RLCA
AE          XOR      (HL)
A1          AND      C
AE          XOR      (HL)
77          LD      (HL),A
2C          INC      L
AE          XOR      (HL)
A1          AND      C
AE          XOR      (HL)
77          LD      (HL),A
2C          INC      L
AE          XOR      (HL)
A1          AND      C
AE          XOR      (HL)

```

```

77          LD      (HL),A
2C          INC      L
AE          XOR      (HL)
A1          AND      C
AE          XOR      (HL)
77          LD      (HL),A
2C          INC      L
13          INC      DE
;
;NEXT BORDER COLUMN
;
10E5        DJNZ    NXT12
;
;NOW DO THE THREE RIGHT-MOST ATTRIBUTE COLUMNS
;
1A          LD      A,(DE)
07          RLCA
07          RLCA
07          RLCA
AE          XOR      (HL)
A1          AND      C
AE          XOR      (HL)
77          LD      (HL),A
2C          INC      L
AE          XOR      (HL)
A1          AND      C
AE          XOR      (HL)
77          LD      (HL),A
2C          INC      L
AE          XOR      (HL)
A1          AND      C
AE          XOR      (HL)
77          LD      (HL),A
23          INC      HL
;
;HL NOW POINTS AT THE NXT LINE OF ATTRIBUTES
;
C1          POP      BC
;
;REPEAT FOR THE NEXT THREE ATTRIBUTE LINES
;
0D          DEC      C

```

```

2803      JR      Z,OUT1
D1        POP    DE
18BB      JR      NXT14
;
;DISCARD LAST STACK ENTRY
;
F1        OUT1   POP    AF
;INCREASE POINTER TO NEXT LINE OF BORDER DATA
;
13        INC    DE
13        INC    DE
13        INC    DE
;
;REPEAT FOR FIVE BORDER LINES
;
10B3      DJNZ   NXTLN3
C9        RET

```

As a demonstration for BORPIC and ATTSET, we shall produce a multi-coloured 'quilt' pattern of eight border lines by eight border columns, each line being 32 rows deep, as indeed is required by ATTSET. The first 32 rows above the text area are needed for the first line, so we must set (FLYBAK + 1) to  $63 - 32 = 31$  in order to start generating the image in the right place. The border data will be built up at BORSTR, and the space needed will be  $1 + (8 \times 11) = 89$  bytes, which is within the 111 bytes we reserved in BORPIC.

Since we have one byte for the number of lines, eleven bytes for the first border line and one byte for the depth of the second, the first border value of the second border line will be at  $(BORSTR + 1 + 11 + 1) = (BORSTR + 13)$ , hence we set the PAPER attributes with:

```

LD      HL, BORSTR+13
CALL   ATTSET

```

The comments in the assembly listing should provide adequate explanation of the rest of the routine, named BPDEMO.

```

;DEMONSTRATION FOR BORPIC AND ATTSET
;
3E1F    BPDEMO LD      A,31
320000  LD      (FLYBAK+1),A
;
;BUILD BORDER DATA AT BORSTR

```

```

;
210000  LD      HL, BORSTR
220000  LD      (PICDAT),HL
;
;START WITH BLACK BORDER
;
AF      XOR    A
;
;DENOTE "8 BORDER LINES"
;
3608    LD      (HL),8
23      INC    HL
;
;LOOP TO GENERATE DATA FOR EACH BORDER LINE
;DENOTE "32 ROWS IN THIS LINE"
3620    NXBLIN LD      (HL),32
23      INC    HL
;MAKE FIRST BORDER COLUMN BLACK
;
3600    LD      (HL),0
23      INC    HL
;
;RUN THROUGH THE 8 COLOURS FOR THE
MIDDLE 8 COLUMNS
0608    LD      B,8
77      NXBCLM LD      (HL),A
C603    ADD    A,3
E607    AND    7
23      INC    HL
10F8    DJNZ   NXBCLM
;
;MAKE LAST COLUMN BLACK
;
70      LD      (HL),B
23      INC    HL
;
;CHANGE COLOUR OF SECOND COLUMN TO
NEXT IN SERIES
C603    ADD    A,3
E607    AND    7
20E8    JR     NZ,NXBLIN
;

```



```

;SET PAPER ATTRIBUTES TO MATCH BORDER
;DATA
;
210D00      LD      HL,BORSTR+13
CD0000      CALL    ATTSET
;
;TURN ON BORDER PICTURE
;
CD0000      CALL    HIRON
;
;GENERATE IT FOR 5.12 SECONDS
;NOTE B=0 FROM ATTSET
76          TSLP9   HALT
10FD        DJNZ    TSLP9
;
;RESELECT IM 1 FOR BASIC
;
ED56        IM      1
3E3F        LD      A,3FH
ED47        LD      I,A
C9          RET

```

As a final utility routine for BORPIC I thought it would be rather useful to have one which generates the border data for us, given a set of bit-patterns and colour values, which I shall call collectively 'compact border data'.

The routine EXPAND will allow us to specify any number of border lines, each of any depth (up to 256 in each case), and use two colours for each border line, which will then be defined by the leftmost ten bits of two 'compact data bytes'. Each of these ten bits corresponds to one border column on a border line. Using a system analogous to the Spectrum BASIC's INK and PAPER values, let the two colours available on each border line be BINK and BAPER, denoting a BINK border cell by a 1, and a BAPER cell by a 0.

To minimise the amount of data required for an image, we will only specify the BINK and BAPER values at the start of the data and whenever we wish to change their values as we work down the screen. We need some way of telling EXPAND to start using new colours, and probably the easiest way to do that is by using the spare six rightmost bits of the data for a line. We will set them to 3FH for a change of colours, then follow that byte with two bytes containing the BINK and BAPER values respectively. Setting the same bits to 3EH will denote 'end of data'. This procedure will become clearer with the examples following the listing of EXPAND.

```

;ROUTINE TO EXPAND BORDER DATA FOR BORPIC
;
;ENTRY: HL=START OF COMPACT BORDER DATA
;EXIT:  HL=ADDRESS OF FIRST BORDER VALUE OF
;FIRST BORDER LINE IN TEXT AREA
;A=0, B=BAPER COLOUR, C=BINK COLOUR
;DE=NEXT BYTE AFTER COMPACTED DATA
;BUILD UP THE DATA IN THE SPACE AT BORSTR
;
110000      EXPAND  LD      DE,BORSTR
;
;TRANSFER "# OF LINES"
;
EDA0        LDI
;
;A REG. WILL COUNT ROWS OF T.V. DISPLAY ALLOTTED
;TO DATE
;
AF          XOR      A
08          EX      AF,AF'
;
;C=BINK COLOUR
;
4E          NEWCOL  LD      C,(HL)
23          INC     HL
;
;B=BAPER COLOUR
;
46          LD      B,(HL)
23          INC     HL
;
;IF WE'RE AT THE TEXT AREA THEN STORE ADDRESS OF
;EXPANDED DATA
;
08          NXTWD   EX      AF,AF'
;
;THE NEXT VALUE MAY BE ALTERED TO CHANGE
;THE DEPTH OF THE TOP MARGIN
;
FE21        TPMRGN  CP      33
C21200      JP      NZ,NYET
D5          PUSH    DE

```

```

;
; INCREASE ROW COUNT
;
86 NYET ADD A, (HL)
08 EX AF, AF'
;
; TRANSFER DEPTH OF THIS LINE (IN ROWS)
;
EDA0 LDI
03 INC BC
;
; TAKE FIRST COMPACT DATA BYTE
;
7E LD A, (HL)
EB EX DE, HL
D5 PUSH DE
;
; FOR EACH OF EIGHT BITS...
;
1E08 LD E, 8
;
; PLACE A BAPER BYTE IN BORDER DATA IF BIT IS SET
;
17 ABC RLA
70 LD (HL), B
D22200 JP NC, PAPER
;
; OTHERWISE INSERT A BINK BYTE
;
71 LD (HL), C
;
; MOVE ON TO NEXT BIT
;
23 PAPER INC HL
1D DEC E
C21C00 JP NZ, ABC
;
; TAKE SECOND COMPACT BYTE
;
D1 POP DE
13 INC DE
1A LD A, (DE)

```

```

;
; CHOOSE BAPER OR BINK FOR EACH OF
LEFT-MOST 2 BITS
17 RLA
70 LD (HL), B
D23000 JP NC, PAPER2
71 LD (HL), C
17 PAPER2 RLA
23 INC HL
70 LD (HL), B
D23700 JP NC, PAPER3
71 LD (HL), C
23 PAPER3 INC HL
;
; TEST BITS 0-5 OF SECOND COMPACT DATA BYTE
;
1A LD A, (DE)
13 INC DE
EB EX DE, HL
;
; 3FH INDICATES NEW COLOURS REQUIRED
;
F6C0 OR 0C0H
3C INC A
28C7 JR Z, NEWCOL
;
; 3EH INDICATES END OF DATA
;
3C INC A
C20B00 JP NZ, NXTWD
;
; IN WHICH CASE, RETRIEVE ADDRESS FOR ATTSET
;
E1 POP HL
23 INC HL
C9 RET

```

Notice the line

TPMRGN CP 32

The value in this instruction is the number of rows of the border picture which are above the text area, and should always be equal to 63 - (FLYBAK + 1), that is to say the sum of the two values at labels FLYBAK in BORPIC and TPMRGN in expand should be 63:

$$(FLYBAK + 1) + (TPMRGN + 1) = 63$$

TPMRGN in case you hadn't guessed, stands for 'top margin'. EXPAND uses this value to find the correct address in the border data for use as an entry value to ATTSET, where such a use is applicable. It then stores this value away and returns it in HL ready for immediate use, if so desired, with ATTSET.

As a simple demonstration for EXPAND, I have written a routine to display a crude but large manifestation of the Melbourne House logo, as seen on the spine of this book. We will be using a grid of  $10 \times 8$  square border cells, so we need the top margin to be 32 rows deep. This is set by:

```
LD    A, 32
LD    (TPMRGN+1), A
LD    A, 31
LD    (FLYBAK+1), A
```

EXPAND builds the data in the previously reserved space at BORSTR, so we must point PICDAT at it:

```
LD    HL, BORSTR
LD    (PICDAT), HL.
```

The desired image is as shown:

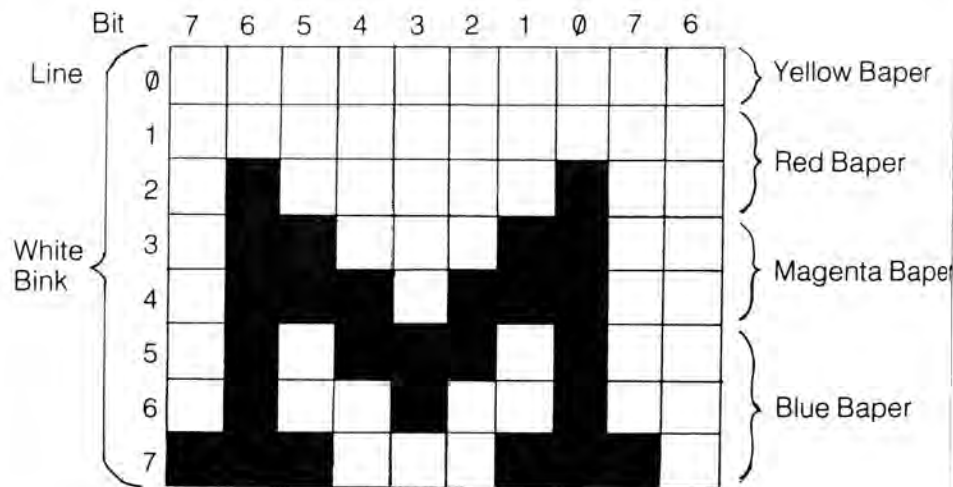

On first sight, the bit pattern for this is given by the hex values:

```
00    00
00    00
41    00
63    00
77    00
5D    00
49    00
E3    80
```

We must now incorporate the other information. The first byte must be the number of border lines (8) followed by the first BINK and BAPER values (7 and 6 respectively). We require a new BAPER after line 0, so we denote this by changing the data

from 00 00 to 00 3F

and then include the new value of BAPER after the BINK value, which remains the same. The first seven bytes are now:

```
08 — BORDER LINES
07 06 — BINK, BAPER
00 3F — DATA FOR LINE 0
07 02 — BINK, BAPER.
```

The rest of the data is treated in the same fashion, adding 3EH to the last value to signify 'end of data', thus the last two bytes change

from E3 80 to E3 BE.

The final list of compact border data is found at label MELDAT in the assembly listing, so we set up the image with the simple, rapid-fire sequence:

```
LD    HL, MELDAT
CALL  EXPAND
CALL  ATTSET
CALL  HIRON
```

Here is the complete listing, called EXDEMO.

```
; DEMO ROUTINE FOR EXPAND ATTSET AND BORPIC
; GENERATES THE MELBOURNE HOUSE LOGO
;
; 32 LINES OF THE PICTURE WILL BE ABOVE TEXT
```

```

;
3E20  EXDEMO LD      A,32
320000 LD      (TPMRGN+1),A
;
;NOTE 63-32=31 FOR FLYBAK
;
3E1F  LD      A,31
320000 LD      (FLYBAK+1),A
;
;BUILD UP BORDER DATA AT BORSTR...
;
210000 LD      HL,BORSTR
220000 LD      (TICDAT),HL
;
;BY USING "EXPAND" ON COMPACT BORDER DATA
;
212600 LD      HL,MELDAT
CD0000 CALL    EXPAND
;
;NOW SET PAPER ATTRIBUTES APPROPRIATELY
;
CD0000 CALL    ATTSET
;
;TURN ON BORDER PICTURE GENERATOR
;
CD0000 CALL    HIRON
;
;GENERATE PICTURE FOR 5.12 SECONDS
;NOTE B=0 FROM HIRON
;
76    XLP     HALT
10FD  DJNZ    XLP
;
;RESELECT IM 1 FOR BASIC
;
ED56  IM      1
3E3F  LD      A,3FH
ED47  LD      I,A
C9    RET
;
;COMPACT BORDER DATA 8 BORDER LINES
;WITH WHITE BINK;

```

```

08    MELDAT DEFB  8
;
;ONE WITH YELLOW BAPER
;
07    DEFB  7
06    DEFB  6
20    DEFB  32
00    DEFB  0
3F    DEFB  03FH
;
;TWO WITH RED BAPER
;
07    DEFB  7
02    DEFB  2
20    DEFB  32
00    DEFB  0
00    DEFB  0
20    DEFB  32
41    DEFB  41H
3F    DEFB  3FH
;
;TWO WITH MAGENTA BAPER
;
07    DEFB  7
03    DEFB  3
20    DEFB  32
63    DEFB  63H
00    DEFB  0
20    DEFB  32
77    DEFB  77H
3F    DEFB  3FH
;
;AND THREE WITH BLUE PAPER
;
07    DEFB  7
01    DEFB  1
20    DEFB  32
5D    DEFB  5DH
00    DEFB  0
20    DEFB  32
49    DEFB  49H
00    DEFB  0

```

```

20      DEFB  32
E3      DEFB  0E3H
BE      DEFB  0BEH

```

The routines provided in this chapter have a great many possible uses. You could use BORPIC on its own to provide some very fancy graphics in the top and/or bottom margin (remember you may use border lines as little as one row deep), using a border line 192 rows deep of one colour in between. Alternatively, and remembering that the routines do not affect the display file or INK attributes, you could use BORPIC, ATTSET and EXPAND to provide a spectacular background when, say, an arcade game has been frozen or you have just been exterminated.

I will conclude this chapter with one such example, producing a sequence of four images of the numbers 3, 2, 1 and 0, in that order. This countdown may be used, for example, as the background to a text image of a submarine about to launch one of its Polaris missiles, in spectacular 3-D, of course.

```

      ;3-2-1-0 COUNTDOWN
      ;
      ;COMPACT BORDER DATA
      ;
      ;IMAGE "3"
      ;
08      DAT3  DEFB  8
05      DEFB  5
02      DEFB  2
20      DEFB  32
FF      DEFB  0FFH
80      DEFB  80H
20      DEFB  32
01      DEFB  1
80      DEFB  80H
20      DEFB  32
01      DEFB  1
80      DEFB  80H
20      DEFB  32
FF      DEFB  0FFH
80      DEFB  80H

      ;
20      DEFB  32
FF      DEFB  0FFH

```

```

80      DEFB  80H
20      DEFB  32
01      DEFB  1
80      DEFB  80H
20      DEFB  32
01      DEFB  1
80      DEFB  80H
20      DEFB  32
FF      DEFB  0FFH
BE      DEFB  0BEH

```

```

;
;IMAGE "2"
;
DAT 2  DEFB  8
      DEFB  2
      DEFB  4
      DEFB  32
      DEFB  0FFH
      DEFB  80H
      DEFB  32
      DEFB  1
      DEFB  80H
      DEFB  32
      DEFB  1
      DEFB  80H
      DEFB  32
      DEFB  0FFH
      DEFB  80H
      DEFB  32
      DEFB  0FFH
      DEFB  80H
      DEFB  32
      DEFB  0C0H
      DEFB  0
      DEFB  32
      DEFB  0C0H
      DEFB  0
      DEFB  32
      DEFB  0FFH
      DEFB  0BEH

```



```

;IMAGE "1"
08 DAT1 DEFB 8
07 DEFB 7
02 DEFB 2
20 DEFB 32
1C DEFB 1CH
00 DEFB 0
20 DEFB 32
7C DEFB 7CH
00 DEFB 0
20 DEFB 32
0C DEFB 12
00 DEFB 0
20 DEFB 32
0C DEFB 12
00 DEFB 0
20 DEFB 32
0C DEFB 12
;
00 DEFB 0
20 DEFB 32
0C DEFB 12
00 DEFB 0
20 DEFB 32
7F DEFB 7FH
80 DEFB 80H
20 DEFB 32
7F DEFB 7FH
BE DEFB 0BEH
;
;IMAGE "0"
;
08 DAT0 DEFB 8
01 DEFB 1
05 DEFB 5
20 DEFB 32
7F DEFB 7FH
00 DEFB 0
20 DEFB 32
FF DEFB 0FFH
80 DEFB 80H
20 DEFB 32

```

```

C7 DEFB 0C7H
80 DEFB 80H
20 DEFB 32
CD DEFB 0CDH
;
80 DEFB 80H
20 DEFB 32
D9 DEFB 0D9H
80 DEFB 80H
20 DEFB 32
F1 DEFB 0F1H
80 DEFB 80H
20 DEFB 32
FF DEFB 0FFH
80 DEFB 80H
20 DEFB 32
7F DEFB 7FH
3E DEFB 3EH
;
;TABLE OF COMPACT BORDER DATA ADDRESSES
;
0000 BORTAB DEFW DAT3
1B00 DEFW DAT2
3600 DEFW DAT1
5100 DEFW DAT0
;
;THE COUNTDOWN ROUTINE*****
;USE 32 TV-ROWS ABOVE TEXT AREA
;
3E20 CNTDWN LD A,32
320000 LD (TPMRGN+1),A
3E1F LD A,31
320000 LD (FLYBAK+1),A
210000 LD HL,BORSTR
220000 LD (PICDAT),HL
;
;SET UP VECTOR TABLE, BUT DON'T TURN ON
;PICTURE GENERATOR UNTIL BORDER DATA IS SET UP
;
F3 DI
CD0000 CALL HIRON
216C00 LD HL,BORTAB

```

```

0604          LD      B,4
;
;TAKE ADDRESS OF COMPACT BORDER DATA
;
5E  NXTNUM  LD      E,(HL)
23          INC     HL
56          LD      D,(HL)
23          INC     HL
C5          PUSH   BC
E5          PUSH   HL
;
;SET UP BORDER DATA AND PAPER ATTRIBUTES
;
EB          EX      DE,HL
CD0000     CALL   EXPAND
CD0000     CALL   ATTSET
;
;PRODUCE THE PICTURE FOR 1 SECOND
;
FB          EI
0632       LD      B,50
76  PSE    HALT
10FD       DJNZ   PSE
F3         DI
;
;NEXT PICTURE
;
E1          POP     HL
C1          POP     BC
10E8       DJNZ   NXTNUM
;
;RESELECT IM 1 FOR BASIC
;
3E3F       LD      A,3FH
ED47       LD      I,A
ED56       IM     1
FB         EI
C9         RET

```

## APPENDIX A: A List of all Principal Routines

Name	Function/Discription	Page
DF-LOC	Finds cell location in display file. ....	6
CLS-DF	Clears the display file. ....	7
ATTLOC	Finds cell location in attribute file. ....	7
DF-ATT	Converts display file address to attribute file address. ....	8
ATT-DF	Converse of DF-ATT. ....	9
LOCATE	Combination of DF-LOC and ATTLOC, also finds attribute value. ....	9
CLSATT	Clears the attribute file with one byte. ....	10
CLS	Combination of CLS-DF and CLSATT. ....	11
PRINT1	General-purpose PRINT routine. ....	16
PLOT	Plots a point anywhere. ....	20
DRAW	Draws a straight line between any two points. ....	24
ATTSTR	Copies attribute file into higher memory. ....	30
BLEND	Mixes two attribute files together. ....	31
KFIND1	Returns value of key being pressed. ....	42
KTEST1	Tests one key, given its value. ....	44
INT	Initialises IM2 and its vector table. ....	51
INTERP	Interrupt-driven print-processor with full-screen horizon generator. ....	62
INT1	Sets up vector table for IM2 and initialises INTERP. ....	77
HRZST1	Sets full-screen horizon level. ....	80
HRZMV1	Moves the full-screen horizon up or down by pixels. ....	84
HRZNMK	Main horizon control routine. ....	87
HRZCOL	Sets colours above and below the horizon. ....	91
HIPRNT	Sends a character to the print-processor buffer. ....	94
ALTRBF	Alters length of the 'read-only' part of the print-processor buffer (the RO-buffer). ....	97
SRVR1	Services the attribute values of entries in the RO-buffer. ....	98
SRVR2	Sends data to the RO-buffer. ....	101
CLOP	Clears the OR-map. ....	109
ORCHK	Checks whether we should OR-print on a cell. ....	110

PADOUT	Creates first image from bare sprite data, by adding blanks. ....	126
SPREX	Forms multiple 'shifted' images of sprite data, as expanded by PADOUT. ....	129
SPRINT	Sprite printing routine. ....	135
SPRMV	Master sprite control routine. ....	145
HIRES	High-resolution colour generator. ....	163
HIRON	Sets up vector table, IM2, and jump to HIRES. ....	167
BORPIC	Interrupt-driven border picture generator. ....	174
ATTSET	Sets attributes according to data for BORPIC. ....	179
EXPAND	Expands compacted data for the picture generated by ATTSET and BORPIC. ....	185

## APPENDIX B: Recommended Reading

Throughout this book you will have seen references to 'T-states' and the various times taken for different instructions to be executed. A complete breakdown of the timing for each Z-80 instruction, its op-code and its affect on the flags can be found in what is considered by many to be the authoritative guide to Z-80 programming, 'Programming The Z-80 by Rodney Zaks, published by Sybex.

This book is undoubtedly worth having as a reference guide, although it is somewhat pricey.

The other book no good Spectrum machine language programmer should be without is, 'The Complete Spectrum ROM Disassembly' by Dr. Ian Logan and Dr. Frank O'Hara, published by Melbourne House.

A complete, fully-commented ROM assembly listing almost entirely fills the 236 pages of the book, which should be on hand whenever you need to study how a particular ROM routine has been programmed, or what entry values are necessary to its utilisation.

## APPENDIX C:

# Recommended Assemblers and Monitor/Disassemblers

### Hisoft 'DEVPAK 3'

... is comprised of 'GENS3' assembler and 'MON3' monitor/disassembler. The routines in this book were developed on 'GENS3'. A microdrive-compatible version is available. 'GENS3' is 7K long and hence only practical to use on a 48K Spectrum.

Hisoft  
13 Gooseacre  
Cheddington  
Leighton Buzzard  
Beds.  
LU7 0SR

### Oxford Computer Publishing (OCP)

... supply two separate programs for the 16K/48K Spectrum: 'Full Screen Editor/Assembler' and 'Machine Code Test Tool' — a tutor and debugging monitor.

Oxford Computer Publishing Ltd,  
4 High Street  
Chalfont St. Peter  
Bucks  
SL9 9QB

### Picturesque

... do a very powerful pair of utilities called 'Editor Assembler' and 'Spectrum Monitor', the latter also being a disassembler, and both being for the 16K or 48K Spectrum.

Picturesque  
6 Corkscrew Hill  
West Wickham  
Kent  
BR4 9BB

### Sinclair Research

... a company with which you should now be familiar, publishes 'ZEUS Assembler' and 'Monitor/Disassembler', both for the 48K Spectrum and originally written by Crystal Computing Limited.

Sinclair Research  
Stanhope Road  
Camberley  
Surrey  
GU15 3BR.

**ADVANCED SPECTRUM MACHINE LANGUAGE  
MELBOURNE HOUSE REGISTRATION CARD**

Please fill out this page and return it promptly in order that we may keep you informed of new software and special offers that arise. Simply fill in and send to the correct address on the reverse side.

Name .....

Address .....

..... Code .....

What product did you purchase? .....

Which computer do you own? .....

Where did you learn of this product?

Magazine. If so, which one? .....

Through a friend

Saw it in a Retail Shop

Other. Please specify .....

Which magazines do you purchase?

Regularly: .....

Occasionally: .....

What Age are you?

10-15       16-19       20-24       Over 25

We are continually writing new material and would appreciate receiving your comments on our product.

How would you rate this book?

Excellent       Value for money

Good       Priced right

Poor       Overpriced

Please tell us what books you would like to see produced for your SPECTRUM.

\_\_\_\_\_  
\_\_\_\_\_  
\_\_\_\_\_



**PUT THIS IN A STAMPED ENVELOPE AND SEND TO:**

**In the United Kingdom return page to:**

Melbourne House (Publishers) Ltd., Melbourne House, Church Yard,  
Tring, Hertfordshire, HP23 5LU

**In Australia & New Zealand return page to:**

Melbourne House (Australia) Pty. Ltd., Suite 4, 75 Palmerston Crescent,  
South Melbourne, Victoria, 3205.