

2756

1001 THINGS TO DO WITH YOUR COMMODORE 128™

BUSINESS
AND FINANCIAL
APPLICATIONS

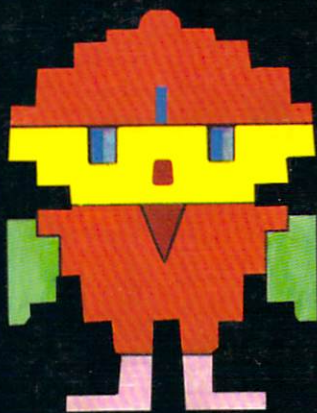
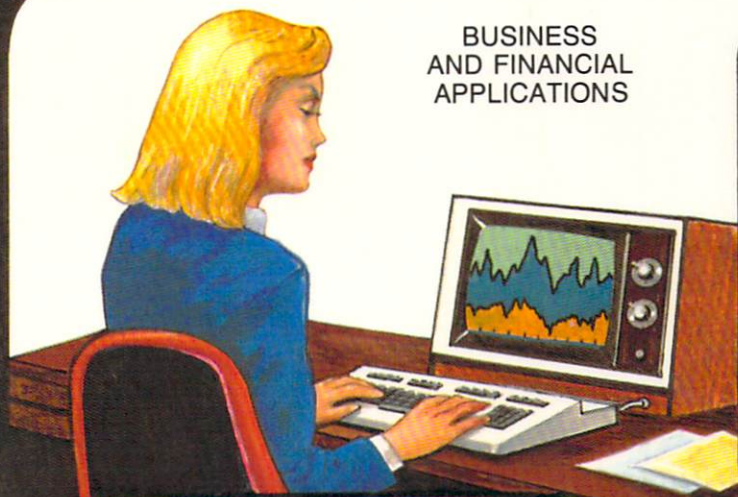

GAMES

SCIENTIFIC
APPLICATIONS

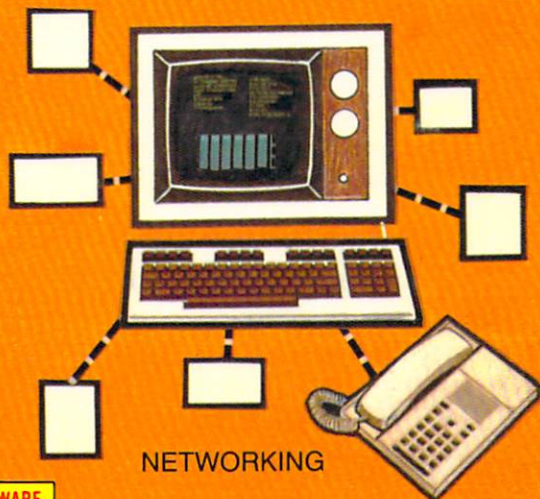

NETWORKING

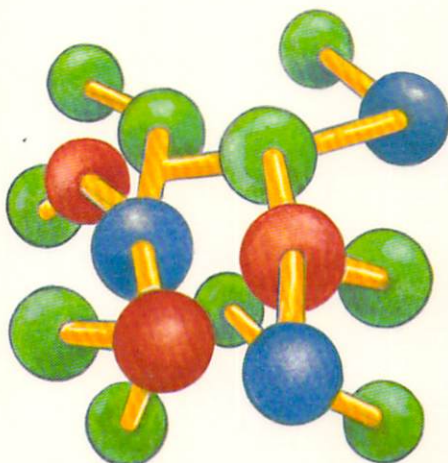

SOFTWARE
AVAILABLE



INFO
INSIDE

MARK SAWUSCH AND DAVE PROCHNOW

1001 THINGS TO DO WITH YOUR COMMODORE 128™

MARK SAWUSCH AND DAVE PROCHNOW



TAB BOOKS Inc.

Blue Ridge Summit, PA 17214

**FIRST EDITION
FIRST PRINTING**

**Copyright © 1986 by TAB BOOKS Inc.
Printed in the United States of America**

**Reproduction or publication of the content in any manner, without express
permission of the publisher, is prohibited. No liability is assumed with respect to
the use of the information herein.**

Library of Congress Cataloging in Publication Data

**Sawusch, Mark.
1001 things to do with your Commodore 128.**

Includes index.

**1. Commodore 128 (Computer)—Programming.
I. Prochnow, Dave. II. Title. III. Title: One thousand
one things to do with your Commodore 128.**

QA76.8.C645S28 1986 005.265 86-5735

ISBN 0-8306-0456-1

ISBN 0-8306-2756-1 (pbk.)

Contents

Preface	vii
Acknowledgments	viii
Introduction	ix
1 Commodore 128 Applications for Everyone	1
Personal Reference Source	1
An Index to Your Library	3
Word Processing	3
Letter Writing	4
A Recipe Index and Calculator	5
Itinerary Assistant	6
Telephone Time	6
Telephone File, Dialer, and Answering Machine	7
Greeting Card/Invitation List	7
Personal Time Management System	7
Decision Maker	7
Health	7
Shorthand Translator	7
Kitchen Inventory	7
Rating Calculations	11
Inventory of Possessions	11
Index to Important Literature	12
Day of the Week Calculation	12
Food Store Shopping Aid	12

Coupon File 12
Home Planning 13
 Group Activities—Social Activities—Work Activities—Private Areas—Storage Requirements
Private Information Storehouse 13
General Purpose Clock or Timer 13
Carpenters' and Mechanics' Helper 14
Car Maintenance Calculations and Record Keeping 15
Raffle Ticket Producer and Drawer 15
Database Use 15

2 Business and Financial Applications

19

Finances and Investments 19
 Stocks, Bonds, and Securities—Portfolio Management—Technical and Fundamental Analysis—
 Moving Averages—Price/Volume Trace—Rate of Change—Change Distribution—Price Indexes—
 Ratio Relationships—Trend Line Analysis—Database Searching—Financial Ratio Analysis—
 Additional Investment Applications—Mortgages—Depreciation Calculations—Annuities—Bonds and
 Warrants
Personal Accounting 37
 Personal Accounts Receivable/Payable—Daily Interest Passbook Savings Account—Income Tax—
 Home Banking
Money-Making Applications 41
 Stock Market—Services—Real Estate
Business Decision Making 44
 Spreadsheets—Other Decision-Making Computer Applications
General Business Calculations and Business Accounting Systems 46
 Writing a Small Business Accounting System—Additional Applications for the Small Business Per-
 son or the Professional—Professional Practice Management—Business Letters—Sales Device—
 Time Calculations—The Calculation of Reference Tables
The Computer and the Professions 57

3 Commodore 128 Number Crunching: Mathematical and Statistical Applications

57

The Commodore 128 As a Sophisticated Calculator 57
 RPN Calculator
Statistics 61
 Statistical Analysis
Mathematics 62
 The Solution of Simultaneous Equations—Integral Evaluation—Determining the Equation of a Line—
 Solving for Corresponding Values—Computer Calculus
Mathematical Recreations and Programming Challenges 67

4 Technical and Scientific Applications

73

Weather Forecasting 73
Energy Efficiency Computation 75
Technical and Scientific Calculations 76
 Aviation—Marine Navigation—Medical Calculations—Surveying Calculations—Chemistry—
 Physics—General Purpose Experimental Applications
Engineering Applications 78
 Electrical Engineering—Civil Engineering—Chemical Engineering—Machine Design

5 Commodore 128 Goes to School: Educational Applications

91

Application Ideas 92
Computer-Assisted Instruction 93
Computer Tutor 93
Educational Simulations 95
 Large-Scale Simulations
Additional CAI Ideas 98

6	Hobby Applications	99
	The Arts 99	
	The Visual Arts—The Verbal Arts—The Musical Arts	
	Hobbies 109	
	Photography—Amateur Radio—Collections—Astronomy—Gardening—Sports—Fishing—Biorhythms and Extrasensory Perception—Additional Hobby Applications	
7	Commodore 128 Games and Recreational Applications	117
	Board and Strategy Games That You Can Program 118	
	Computer Quizzes 122	
	Games That Use Words 122	
	Magic 123	
	Programs for Young Children 123	
	Simulation and Adventure Games 124	
	Video Games 125	
	Recreations Involving the Commodore Itself 127	
	Computers and Chess 124	
	The Reference Arrays Used by Chess	
8	Connecting Commodore 128's Peripherals	133
	Household Control Devices 135	
	Commodore 128 System—Dedicated Systems—The Use of Home Control Systems	
	Music 136	
	An External Device Controller for Your Computer 137	
	An A/D Converter for Your Computer 139	
	Personal Robots 140	
9	Artificial Intelligence and Networking	143
	Futuristic Applications That Are Feasible Now 143	
	Networking 145	
	Modems—Terminal Programs—Available Networks	
	Databases 149	
	A Sampler of Information Networks	
10	Useful Utility Programs	153
	Multipurpose Programs 153	
	Utility Subroutines 154	
11	Miscellaneous Applications	155
	Computers and the Humanities 155	
	History—Language—Literature and Writing	
	Aid to the Handicapped 157	
	Test Your Typing Speed 158	
	Maintenance of Organization Records 158	
	Co-op Scheduling and Finances 158	
	Tailor's Calculations 158	
	Phone Code 158	
	Brainstormer 158	
	Brainstorm Chart for Products, Processes, and Services—Inventor's Idea Simulator	
	Source Index 159	
	People Matching 159	
	Greeting Card Producer 160	
	Contests 160	
	Handwriting Analysis 160	
	Fifty Miscellaneous Applications 160	
	Appendix A: Commodore 128 Software Guide	163

Appendix B: Commodore 128 Peripheral Guide	167
Appendix C: Commodore 128 BASIC Command Summary	169
Appendix D: A Brief Tour of the Commodore 128 Environment	171
The C64 Mode	171
The C128 Mode	172
The CP/M Mode	172
Appendix E: C64 Mode Summary	179
Appendix F: C128 Mode Summary	181
Appendix G: CP/M Mode Summary	183
Appendix H: For Further Reading . . .	185
Glossary	189
Index	192

Preface

1001 Things To Do With Your Commodore 128 represents an important step in an evolutionary line of computer books. The phenomenal success of this line of books has been demonstrated by its original volume, *1001 Things To Do With Your Personal Computer*, which has sold over 130,000 copies. While *1001 Things To Do With Your Personal Computer* has succeeded in meeting the needs of the novice computer community, the needs of an increasingly computer literate public have necessitated specialized information regarding particular computer types. The result is the production of this book, which is especially designed for Commodore 128 users.

In order to best serve Commodore 128 personal computer users, *1001 Things To Do With Your Commodore 128* contains new, updated information. The most important facet of this book, however, is that it includes all new line illustrations, photographs, and Commodore 128-specific programs, which have been created exclusively by Julie Knott and Dave Prochnow. These new programs take full advantage of the Commodore 128's remarkable programming capabilities, including sound, graphics, and sprite animation. We hope that this book is a useful step in your continuing evolution as a Commodore 128 user.

Acknowledgments

There are several people that deserve acknowledgment for their participation in this book's preparation. First of all, we would like to thank Mr. Bill Stewart of Heath/Zenith Corporation, for his helpful assistance in arranging the loan of a HEROjr robot for discussion in this book. Second, we would like to express our appreciation of Ms.

Mary Beth Klein of Shimer vonCantz, for her information regarding the Okimate 10 dot matrix printer and Plug 'N Print interface for the Commodore computer. Finally, we extend our thanks to our editor, Mr. Brint Rutherford, for giving us the opportunity to participate in this book's creation.

Introduction

If you are holding this book, reading these words, you probably either own, or are planning to purchase, a Commodore 128 personal computer. If you already own a Commodore 128, you undoubtedly have a few applications in mind for your computer to perform. If, however, you haven't yet purchased the computer, you're probably at the stage where you're intrigued by the hardware but unsure of the computer's possible applications. This is why you should continue holding this book, carry it up to the cash register with a fist full of dollars, and take it home for further study.

Within this book are 1001 fascinating, utilitarian, educational, entertaining, and helpful applications for your Commodore 128. Suggested possibilities, as well as full-fledged programs, fill this book's pages. Furthermore, these proposed applications are aimed at all types of Commodore 128 users, including personal, professional, domestic, hobby, and business users. There's something in here for everyone.

This book is a unique browser's catalog of potential applications for your Commodore 128.

You can make the best use of this book if you allow it help you to spawn, identify, and tailor new uses for your Commodore system. *1001 Things To Do With Your Commodore 128* provides the background that you need to become more adept, versatile, and creative in using your Commodore's problem solving capabilities. As an idea book, it will stimulate your own creativity, helping you stretch your own limits and those of your Commodore system.

This book will appeal to current or potential Commodore 128 owners on three levels. Skeptical buyers may use it in deciding whether the possible applications will justify the cost of the C-128. Those interested in using the computer, but not in designing their own programs for it, can type in and utilize the complete Commodore BASIC programs provided within this book. The advanced personal computer user has the opportunity to sharpen her or his programming skills by implementing the book's interesting and challenging program suggestions in self-created programs.

Use your C-128 to do complex calculations that

were previously too troublesome to perform manually (for example, the photographer can calculate more precise values for camera settings to achieve a certain effect). Examples of simple formulas are presented within the text and are intended to be part of larger, more complex programs to be written for your own applications.

The Commodore BASIC program listings that are provided, however, are complete in every regard. These programs are ready for you to type in and enjoy immediately. With your Commodore 128 in its C128 mode, be sure to type the program lines exactly as they are listed in the text. Unusual look-

ing spaces, character arrangements, and punctuation are all part of the plan to make the program's output look good on the screen and to make the program function correctly. If a listed program fails to run correctly after you have typed it in, be sure to verify each character that you have entered against the listing in the book for possible errors in your entry. If you would like to avoid the exacting task of entering these programs yourself, be sure to examine the program disk offer at the back of this book. A Commodore 128 disk containing all of these programs is available from TAB BOOKS, Inc. (See the back of the book.)

Chapter 1

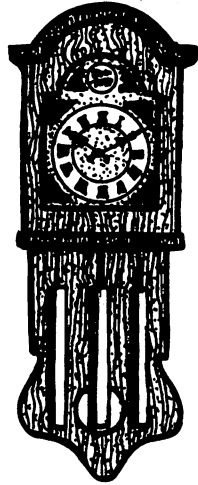

Commodore 128 Applications for Everyone

As life on earth becomes increasingly more complex, personal computers continue to demonstrate their indispensable ability to organize and simplify the minutia of everyday life. Within this chapter you will find a broad collection of Commodore 128 computer applications for everyone, each designed to streamline daily life.

PERSONAL REFERENCE SOURCE

Personal reference information often takes the form of paper scraps or dog-eared book pages. Unfortunately, bits of paper are quickly lost and dog-eared books are easily misplaced. Your Commodore 128 (see Fig. 1-1), however, makes an ideal storage place for the information contained on such paper scraps and book pages. When used in conjunction with the appropriate software, your C-128 can organize this information so that it is available for instant retrieval. The possibilities for such data storage are endless, but a few examples of charts, tables, and lists that can be stored in your C-128 include the following:

1. Caloric and nutritional content of selected foods.
2. Appointment itinerary.
3. Important article and book references (stored by author, title, topic, and date).
4. Sports statistics, amateur or professional.
5. Buyer's comparison guide statistics, such as product sources, specifications, and prices from various suppliers.
6. Names, addresses, and telephone numbers.
7. Stock market portfolio data including name, symbol, shares, price, and historical data.
8. Recipes and shopping lists.
9. Postal and shipping rates, requirements, and regulations.
10. Metric conversions and information.
11. Time differences and phone rates between cities.
12. Words commonly misspelled or misused (as a quick reference for writers).
13. Ham radio log of contacts, locations, and times.
14. Collection inventory (e.g. for coins or stamps), including name of item, age, values, and identifying information.

1001 Things to Do With Your Commodore 128

15. Private pilot flight planning data.
16. Household inventory for insurance and financial purposes.
17. Astronomical data.
18. Planning lists for activities including schedules and deadlines.
19. Fishing log.
20. Quotations by topic and source.
21. References from literature.
22. Dates of birthdays, anniversaries, and other special occasions.
23. Automotive service information.
24. Patient laboratory data over time, differential diagnoses, or drugs for physicians.
25. Credit card list, with telephone numbers to call in the event of loss or theft.
26. Safety deposit box contents.
27. Physical constants, chemical data, formulas.
28. Emergency telephone numbers.
29. Common household poison antidotes.
30. Computer software and hardware comparisons.
31. Cumulative weather data.
32. Abbreviations.
33. Record of valuable household possessions.
34. Horse racing statistics.
35. Log of wine cellar contents, including years and quantities.
36. Insurance policy inventory including coverage, cost, account numbers, and deductibles for house, car, and health.

This list is not exhaustive, and perhaps only a

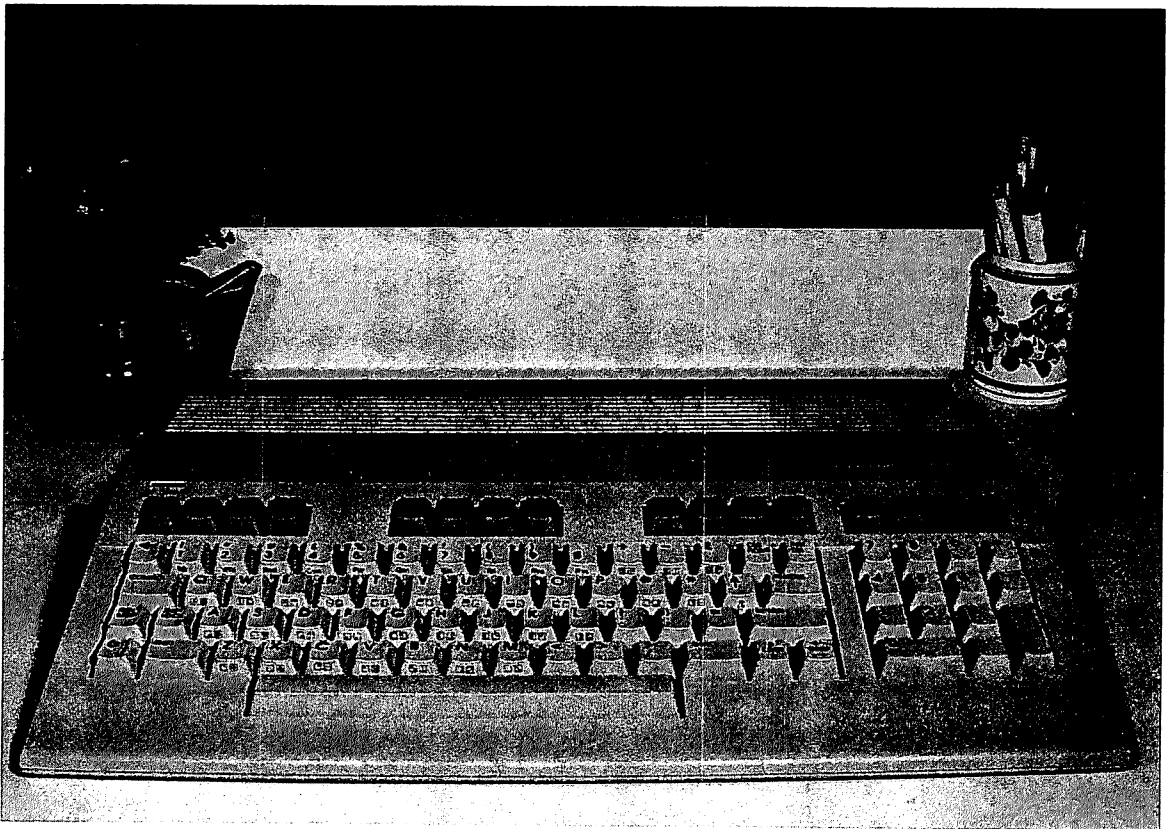

Fig. 1-1. The Commodore 128 is an extremely powerful home personal computer that blends harmoniously with its surroundings.

few of these applications will be of use to you. This list does, however, serve to illustrate the variety of possibilities involving the storage of information with the assistance of your Commodore 128. Sophisticated software is available commercially for data storage and retrieval on the C-128. Appendix A lists several pieces of commercial software that can be used for these purposes.

AN INDEX TO YOUR LIBRARY

How often do you remember reading an important article or book chapter only to forget the name of the magazine or book? Your Commodore 128 can easily be used to help you organize and cross-reference your books and articles for instant retrieval using only the title, subject, or author to locate the pertinent entries. With the wealth of computer-related books and magazines that are available, an index to relevant subjects will ease the difficulty of finding a special tutorial or program.

One programming method that accomplishes this type of indexing stores information as a number of continuous strings of data. Each string of data is composed of several "fields," and each field is separated by a comma. An example of a string with fields describing a magazine article is as follows:

The Stock Market,		Business Today,	
name of article/book		name of magazine/book	
5,	6/84,	I,	S,
volume	date	category	category
no.		#1	#2
1,	Smith		
storage	author		
location			

Data is formatted on a disk in a manner similar to this example. Random access disk commands

allow the Commodore 128 to search for all entries with a given field. For example, you could specify a search for all entries having an author named "Smith." The C-128 would then search through the entire disk file examining all the fields containing the author names (the last field in the above example). All fields having "Smith" as the author would then be printed out.

In order to limit the search to more specific entries, the C-128 could examine more than one field. As an example, you could request a list of all articles published after 1980 concerning the stock market. The Commodore 128 would search both the category and date fields for data meeting both of these requirements. Narrowing the requirements down in this manner results in a more accurate listing at the conclusion of the search.

WORD PROCESSING

Writers have long been subjected to the limitations of using pen and paper as the tools for composition. Paper refuses to accept instant changes at the whim of the writer. Instead, the writer must resort to laboriously deleting, inserting, cutting, and pasting the text into its final form.

Fortunately, we are no longer restricted to using pen and paper to express our thoughts. Word processing programs permit the arrangement of words at the touch of a finger, making erasures obsolete. Similarly, correction fluid has been replaced by the delete key. Word processors give you the ability to write spontaneously. Whereas most people try to mentally edit their words before committing them to paper, the advent of word processing frees you to type as you think, and later modify your document painlessly. The writer enjoys the flexibility of the computer's monitor on which to correct grammatical and typographical errors before actually printing a document. Many writers feel that this ability enhances their creativity while also making writing easier and more enjoyable.

After your manuscripts, letters, or documents are corrected on the monitor, you can set printing parameters within your word processing program

1001 Things to Do With Your Commodore 128

to control margins, page lengths, and page numbering. These parameters tell the printer how to reproduce the document exactly to your specifications. Finally, any errors missed during the on-screen editing process that are noted on the printed page can be quickly modified by correcting the word processed file. This means that there is never any need to retype the entire document.

Anyone who writes professionally or composes a letter or two each day should investigate the use of a word processor. Most commercial word processors are very easy to use and they can save tremendous amounts of time, labor, and money (Appendix A lists several word processors for the C-128). As a matter of fact, word processing is considered one of the most useful applications for Commodore 128 owners.

With most word processors you can do the following:

- **Block Move.** This feature lets you move pieces of your text—from a word to several paragraphs—around like blocks. You can also delete a block at whatever point you designate, and the rest of the text will fill in the “hole.” Or, conversely, you can add new blocks at any point. Think of a word processor as a food processor of writing, capable of slicing, chopping, and dicing the language with ease.
- **Word Wrap.** As you type on a word processor you can forget hitting the carriage return key at the end of each line, as the computer automatically puts as many words as possible on one line and then starts a new one. This, in computerese, is called *word wrap*.
- **Search and Replace.** You can instruct the word-processor program to search the entire text or a portion of it for the occurrence of a particular word or phrase. Suppose you would like to correct a misspelled name throughout a six page letter: just type in the name as you misspelled it and again as spelled correctly; the program will automatically correct this error throughout the text. The search command may also be used to

rapidly locate a section in a large manuscript.

- **Typeover.** When you want to substitute one word or phrase for another, you can type your change right over the existing text, and the unwanted letters will vanish as the new ones appear to fill their places.
- **Justify.** Some programs will automatically adjust the spacing between words or letters so that each line can be printed out at the same length. This process is called *right justification*. Left justification simply means that the lines are aligned at the left margin as usual, although some programs can create special effects by aligning text only at the right margin or by centering all text.

These are the most basic features found on word processing programs. Many other special features come with certain word processing packages. For example, a mouse can be used to position the cursor at any point on the screen to facilitate editing. A spelling checker program can automatically verify the spelling of each word you write against its vocabulary and make corrections. Similarly, a thesaurus program can, at your command, display several synonyms for thousands of common English words. Other programs are designed to correct faulty grammar—for those people who don't mind having a computerized English teacher. Still other software packages allow you to design type fonts and integrate graphs and pictures with your text. Several typesetting firms will also accept word processor output directly via a modem or floppy disk for instant, money-saving typesetting jobs.

LETTER WRITING

A word processing program expedites the creation of form letters. For example, if you are writing a business letter for several recipients, the body of the letter could be stored in the C-128 as a form letter. Then, you need to type only the addresses and other personalized information to be integrated within the text to form each complete letter. A mailing list program can be integrated with such a pro-

gram to automatically produce personalized letters.

A RECIPE INDEX AND CALCULATOR

A collection of your favorite recipes can be stored on your Commodore 128 for rapid and selective retrieval. A list of the characteristics of each recipe could be included, such as the time required for preparation, whether the dish is hot or cold, the number of people served, the meal type, the cost, and the number of calories per serving. Using these characteristics, the Commodore 128 could index recipes and print lists of recipes with a selected

characteristic for a special occasion.

A recipe calculator could change the amounts of each ingredient so that the proper amount of the recipe will be made for a given number of people. A simple recipe calculator subroutine is presented in Listing 1-1. It can be used alone or it can be incorporated into a recipe database program.

If the costs for the various ingredients were stored in your Commodore, the cost of a given recipe could be quickly computed. This calculation could, of course, also include the number of people served as a factor in the final cost calculation.

Listing 1-1: The Recipe Calculator Routine

```

10 REM COOK OF THE HOUSE
20 SCNCLR 0
30 GRAPHIC 0
40 COLOR 0,1:COLOR 1,2:COLOR 4,1
50 PRINT TAB(12) "IT'S DINNERTIME"
60 PRINT:PRINT:INPUT "HOW MANY GUESTS WILL THERE BE TONIGHT?";G
70 INPUT "HOW MANY SERVINGS COULD THE ORIGINAL      RECIPE
   MAKE?";S
80 I=G/S
90 X=1:SCNCLR 0
100 PRINT:PRINT:PRINT:PRINT"WHAT ARE THE INGREDIENTS?"
110 PRINT "USE THE FOLLOWING FORMAT: NAME, AMOUNT,  UNITS."
120 PRINT "FOR EXAMPLE, EGGS,1,DOZEN"
130 PRINT "WHEN YOU HAVE ENTERED ALL OF YOUR      INGREDIENTS,
   TYPE DONE,0,OK"
140 PRINT "O.K., I'M READY...ENTER"
150 INPUT A$(X),B(X),C$(X)
160 IF A$(X)="DONE" THEN 180
170 X=X+1:GOTO 150
180 SCNCLR 0
190 PRINT:PRINT "PRESS ANY KEY TO CONTINUE"
200 FOR Y=1 TO X-1
210 PRINT A$(Y),I*B(Y),C$(Y)
220 GETKEY Z$
230 NEXT Y
240 PRINT:PRINT TAB(17)"ENJOY"
250 SLEEP 2
260 SCNCLR 0
270 COLOR 0,1:COLOR 1,2:COLOR 4,6

```

1001 Things to Do With Your Commodore 128

This type of program would be especially useful to those with a sideline or full-time bakery or catering service, because the costs for any recipe for any number of people can be quickly estimated.

A sample field of information for one recipe is shown below:

MEATLOAF,	6,	1.5 lb.gr.beef*1cup milk*.
	no.	5 cup onion*1 egg,
name of item	servings.	abbreviated ingredients
350	1.5 hr.,	Bill's favorite
oven temp.	bake time	comments

ITINERARY ASSISTANT

A list of appointments, deadlines, and various tasks can be stored in a Commodore 128 and displayed in a specified format to assist you with your itinerary. Another format can be that of a calendar—each day's block would be filled with things to do. Is there some periodic task that you often forget to perform? Then program the C-128 to automatically remind you.

A program could also print out a customized

daily appointment calendar. This program can include beginning and ending times, time intervals, and provisions for recording expenses and comments. It might also be helpful to incorporate a feature that calculates the day of the week that a particular day falls on.

The professional can use a more sophisticated program for the purposes of time billing for clients. The Commodore 128 can also be used as a dedicated reminder, using an audible alarm as a signaling method for those on complex therapeutic regimens.

TELEPHONE TIMER

When you are making long distance telephone calls, whether for conversations or telecommunications, keeping track of elapsed time can save you a considerable amount of money (see Listing 1-2). A computerized timer can display the amount of time spent on each call. Also, a record of the number called and the cost for the call could also be kept, for use with income tax deductions or for comparison with your telephone bill.

Listing 1-2: The Timer Routine

```
10 REM TIMER
20 GRAPHIC 0
30 SCNCLR 0
40 COLOR 0,2:COLOR 1,1:COLOR 4,3
50 PRINT:PRINT:PRINT TAB(17)"TIMER"
60 PRINT:PRINT "AT THE PRESS OF ANY KEY YOUR C-128 WILL BECOME A
  VERY HEAVY STOP WATCH."
70 PRINT:PRINT:PRINT "WHEN YOU ARE READY...JUST PRESS A KEY."
80 GETKEY Z$:SOUND 2,32000,20
90 GRAPHIC 1,1
100 CHAR 1,16,4,"ACTIVE"
110 CHAR 1,16,6,"TIMER"
120 CHAR 1,12,21,"X/60TH SECONDS"
130 BOX 1,90,100,210,150
140 TI$="000000"
150 GET X$
160 CHAR 1,15,15,STR$(TI)
170 IF X$="" THEN 150
```

```

180 SOUND 2,32000,20
190 CHAR 1,16,23,"TIME"
200 GETKEY Z#:SOUND 2,32000,20
210 GRAPHIC CLR
220 GRAPHIC 0
230 SCNCLR 0:COLOR 0,1:COLOR 1,2:COLOR 4,6

```

TELEPHONE FILE, DIALER, AND ANSWERING MACHINE

Listings of emergency and frequently used telephone numbers can be stored on your Commodore 128, providing that the list is sufficiently long to warrant computer search capabilities.

The data strings used to store this information could be formatted as follows:

<u>HOSPITAL,</u>	<u>AMBULANCE,</u>
identifier	additional related identifier (to cross-reference)
<u>643-1998 * 643-1997</u>	
tel. numbers	

For those who enjoy hardware construction, the addition of a pulse or tone dialing circuit for a modem with an automatic dialing capability would allow a Commodore 128 to search and then automatically dial a desired number. If this circuit is used in connection with a burglar/security alarm system, the C-128 can be instructed to dial the police or fire department and deliver a tape-recorded message. You can also construct a computer-controlled, programmable telephone answering machine with capabilities far exceeding those of commercially available models.

GREETING CARD/INVITATION LIST

A mailing list program could be used to address your holiday greeting cards. If your list is large enough, your Commodore 128 could sort zip codes, allowing you to send your cards under the bulk mail rate. (This would be most practical for businesses with large customer files.) Additionally, the C-128

could print a short "hello" note on the back of each card. The same idea could be applied to producing an invitation list for a party or meeting.

Similarly, a list of dates of birthdays and anniversaries could be stored, and each month the C-128 could remind you of the important dates for the upcoming month.

PERSONAL TIME MANAGEMENT SYSTEM

A personal time management system would assist you in planning the most effective schedule for completing a list of tasks. Input might include the description of each goal, the priority of that goal (using A, B, or C to represent categories of importance), and the deadline date. The program could use *PERT* (program evaluation and review technique) or *critical path analysis* to plan and output a schedule most evenly distributing the work load. Many people have found that they can accomplish much more if they make schedules and deadlines for themselves. PERT analysis will make that scheduling even more simple.

DECISION MAKER

Complex decision making can be facilitated through the use of the Commodore 128 (see Listing 1-3).

HEALTH

Your Commodore 128 can help you maintain your health. A listing of the caloric or nutrient content of various foods could be stored and subsequently referenced for determining the nutritive value of the food you eat. Additionally, data on the sugar or the salt content of foods could be stored for the diabetic or the person on a salt-free diet.

Listing 1-3: The Decision Maker Program

```

10 REM DECISION MAKER
20 GRAPHIC 0
30 SCNCLR 0
40 COLOR 0,16:COLOR 1,3:COLOR 4,12
50 PRINT:PRINT:PRINT TAB(12)"DECISION MAKER"
60 PLAY "V203T0U8X0CDCDEFF":SLEEP 1
70 SCNCLR 0
80 COLOR 0,7:COLOR 1,1:COLOR 4,13
90 PRINT:PRINT:PRINT "ASK ME ANY QUESTION AND I WILL ANSWER"
100 PRINT:PRINT "JUST SPEAK THE QUESTION AND PRESS ANY KEY..."
110 PRINT:PRINT:PRINT"AND I'LL DO THE REST."
120 GETKEY Z$
130 X=INT(RND(1)*6+1)
140 IF X=2 OR X=3 OR X=6 THEN SOUND 1,3500,80,1,200,10,1,800
150 IF X=1 OR X=4 OR X=5 THEN SOUND 2,9500,80,0,3500,10,2,900
160 PRINT:PRINT
170 SLEEP 2
180 IF X=1 THEN PRINT TAB(18)"YES"
190 IF X=2 THEN PRINT TAB(19)"NO"
200 IF X=3 THEN PRINT TAB(5)"I WOULDN'T IF I WERE YOU"
210 IF X=4 THEN PRINT "100% GO!"
220 IF X=5 THEN PRINT "REPHRASE THE QUESTION,PLEASE."
230 IF X=6 THEN PRINT "I DON'T KNOW."
240 PRINT:PRINT "DO YOU HAVE ANY MORE QUESTIONS (Y/N)?"
250 GETKEY A$
260 IF A$="Y" THEN 70
270 COLOR 0,1:COLOR 1,16:COLOR 4,6
280 SCNCLR 0

```

Such a program also lends itself well to diet planning.

A low-calorie diet-planning program would compute the number of calories you use per day (on the basis of weight, sex, height, and activities). If you consume more calories than you use up in energy, you build up reserves in the form of fat. Therefore, weight control is primarily based on calorie balance. The amount of weight you could lose by either reducing intake or increasing activities would be mathematically calculated. The following data should be helpful in writing a program to help you lose weight or maintain health through exercise.

A complete nutritional analysis program would

allow you to input the types and amounts of food you have eaten during the day, would compute the total intake of proteins, carbohydrates, fats, fiber, vitamins, and minerals, and would determine your average intake of each per day. Similarly, it would compute your average energy expenditure (see Table 1-1) and then subtract this figure from your average daily nutrient intake to determine your calorie balance and to compare your intake with the recommended daily allowances for your age, sex, and weight (see Table 1-2). Therefore, areas for improvement could be easily identified. A diet plan could then be determined to achieve these improvements.

One hobbyist uses a C-128 to determine his

Commodore 128 Applications for Everyone

Table 1-1. Energy Consumption Table.

Intensity of Exercise	Heart (Beats Minute)	Respiration (Breaths/Minute)	Energy Consumption (Calories/Hour)
maximum	200	50	1440
very heavy	150	30	1008
heavy	140	25	864
fairly heavy	130	20	720
moderate	120	18	576
light	110	16	432
very light	100	14	288
resting	70	10	100

pulse rate and lead him through an exercise session, acting as the coach and timer. Along similar lines, another hobbyist computes the aerobic points that he earns in bicycling.

A general purpose data plotting subroutine

could graph morning resting pulse versus minutes run on the previous day, or miles run versus subjective feeling at the end of the day to allow you to see where you've been and where you are going.

Listing 1-4 is a simple program that will help

Table 1-2. Recommended Caloric Intake Table.

Mean heights and weights and recommended energy intake							
Category	Age (years)	Weight (kg) (lb)	Height (cm) (in)		Energy needs (with range) (kcall) (MJ)		
Infants	0.0-0.5	6 13	60	24	kg × 115 (95-145) kg × .48		
	0.5-1.0	9 20	71	28	kg × 105 (80-135) kg × .44		
Children	1-3	13 29	90	35	1300	(900-1800) 5.5	
	4-6	20 44	112	44	1700	(1300-2300) 7.1	
	7-10	28 62	132	52	2400	(1650-3300) 10.1	
Males	11-14	45 99	157	62	2700 (2000-3700) 11.3		
	15-18	66 145	176	69	2800 (2100-3900) 11.8		
	19-22	70 154	177	70	2900 (2500-3300) 12.2		
	23-50	70 154	178	70	2700 (2300-3100) 11.3		
	51-75	70 70	178	154	2400 (2000-2800) 10.1		
	76+	70 154	178	70	2050 (1650-2450) 8.6		
Females	11-14	46 101	157	62	2200 (1500-3000) 9.2		
	15-18	55 120	163	64	2100 (1200-3000) 8.8		
	19-22	55 120	163	64	2100 (1700-2500) 8.8		
	23-50	55 120	163	64	2000 (1600-2400) 8.4		
	51-75	55 120	163	64	1800 (1400-2200) 7.6		
	76+	55 120	163	64	1600 (1200-2000) 6.7		
Pregnancy					+ 300		
Lactation					+ 500		

One gram of Carbohydrate = 4 calories
 One gram of Fat = 9 calories
 One gram of Protein = 4 calories

Listing 1-4: The Pulse Rate Calculator Program

```

10 REM PULSE-CALC
20 GRAPHIC 0
30 COLOR 0,11:COLOR 5,3:COLOR 4,3
40 SCNCLR 0
50 FOR X=1 TO 120:PRINT CHR$(115);:NEXT X
60 PRINT TAB(15)"PULSE RATE"
70 PRINT TAB(15)"CALCULATOR"
80 IF X=7 THEN 150
90 SOUND 1,200,10
100 FOR X=1 TO 7
110 SOUND 1,550,15:SLEEP 1
120 IF X=7 THEN 150
130 SOUND 1,200,10
140 NEXT X
150 SCNCLR 0
160 FOR X=1 TO 200:PRINT CHR$(115);:NEXT X
170 PRINT "COUNT YOUR NUMBER OF PULSES OVER A 15 SECOND TIME
PERIOD."
180 PRINT:PRINT "I WILL TIME YOU.":SLEEP 1
190 PRINT:PRINT "READY...BEGIN COUNTING BY PRESSING ANY KEY.":
GETKEY Z$:PRINT:PRINT "GO!"
200 SLEEP 14
210 PRINT:INPUT "STOP, HOW MANY PULSES DID YOU COUNT";P
220 P=P*4
230 PRINT:PRINT "YOUR PULSE RATE IS";P;"BEATS PER MINUTE."
240 SLEEP 1
250 PRINT:PRINT "TRY ANOTHER (Y/N)?"
260 GETKEY Z$
270 IF Z$="Y" THEN 150
280 SCNCLR 0
290 COLOR 0,1:COLOR 5,16:COLOR 4,6

```

you calculate your pulse rate. The beginning runner is often unsure of how fast he should run. Pulse taking can be helpful to assure beginners that they're doing the right amount of work—not too much or too little. First, determine your base training pulse using the formula $(220 - (\text{your age})) * .65$. Anyone who makes sure that his pulse does not rise above this value is in the safety zone where the heart is being strengthened rather than overtaxed.

SHORTHAND TRANSLATOR

You could develop a shorthand system that

your Commodore 128 could be programmed to understand and translate. The system could be similar to that used by court reporters, in which a single key represents a word or part of a word. In this manner, you could quickly type your thoughts in shorthand form, and the C-128 could analyze your notes and print the English equivalent. The basic stenographer's character and word assignment list is given in Table 1-3.

KITCHEN INVENTORY

A file of all food items on hand, a pantry inven-

Character	Word	Suffix	Character	Word	Suffix
A	and	able	V	very	ver
B	been	bility	W	with	ward
C	can	cial	X	experience	
D	down	day	Y	you	
E	even	ent	Z	the	zation
F	from	ful	0	zero	
G	good	ght	1	one	
H	have	hood	2	two	
I	into	ing	3	three	
J	just		4	four	
K	know		5	five	
L	like	less	6	six	
M	more	ment	7	seven	
N	not	ness	8	eight	
O	other	ous	9	nine	
P	people		!	hundred	
Q	quite		@	thousand	
R	right	rent	#	million	
S	said	self	\$	dollar	
T	that	tion	%	percent	
U	united	ugh	¢	cent	

Table 1-3. Basic Steno Character Assignment Chart.

tory, would be useful in determining whether or not a given recipe can be prepared. As each food item is added or subtracted from the pantry, the transaction would be entered into the C-128. If a desired level of inventory is specified, the computer could automatically print out a shopping list of items that are below desired quantity levels. An inventory program of this type would be best suited for the gourmet cook who must have a wide variety of seasonings and other ingredients on hand. The inventory of a wine collection or food in the deep freezer could also be maintained.

RATING CALCULATIONS

An equation to determine a rating for a particular stock, car, horse, or home could be computerized if it is referred to often or if it's complex. For example, the horse racing fan could use the following empirically derived equation to determine an objective rating for a particular horse:

$$\text{Rating} = (W + P/3 + S/6) \times 100/R + E/850$$

where W = the number of wins

- P = the number of places
- S = the number of shows
- R = the number of races
- E = the amount of earnings in dollars

Rating equations are empirically derived or are determined by finding the statistical correlation between a set of factors and the outcomes that the factors influence.

INVENTORY OF POSSESSIONS

A file of your personal property could be stored with the C-128 for insurance purposes or for determining your net worth. A database program could record the date of purchase, the place of purchase, length of warranty, description of item, price, serial number, and model number. For instance, you could set up a simple database for tracking possessions by using these four fields: date, store, item, and price. This information could be entered from sales receipts or from your checkbook. At the end of the year, the database could be printed and a backup disk stored for safe keeping. This could

1001 Things to Do With Your Commodore 128

save you thousands of dollars in the event of a major disaster, because you will have excellent documentation of what you've owned.

The advantage of using a C-128 for inventory keeping is that items are easily added, deleted, or categorized, and a disk copy of the inventory can be stored in a safe-deposit box. If you own a business, use this type of program to inventory your business equipment.

The C-128 may also be useful in comparing various insurance policies to determine which plan offers what you need at the lowest cost. Professionally prepared insurance planning programs are available for the Commodore 128.

INDEX TO IMPORTANT LITERATURE

Your favorite lines and passages of literature, quotations, scientific and business journal references, anecdotes, and other literary miscellanies could be collected, categorized, cross-referenced, and indexed for rapid retrieval. A specialized database program could be used for this purpose.

DAY OF THE WEEK CALCULATION

Calculation of the day of the week corresponding to a given date is useful to businessmen, vacation planners, and historians. For the sake of curiosity, some people have found amazing congruencies between the days on which U. S. Presidents were born and other significant events in history.

In order to calculate the day of the week for a specific date in the twentieth century, use the following formula:

$$N = D + M + Y[(0.8(2M + 1))] + [Y/4]$$

where D = day of the month

M = Month, where March is considered the first month, April the second, and February the twelfth

Y = Last two digits of the year

[] = The integer part of the result

Next, divide the sum N by 7. The remainder from the division gives the day of the week. Count 0 as Sunday, 1 as Monday, and so on.

Programs that calculate the date of Easter for forthcoming years have been written, and this remains an interesting programming challenge (hint—incorporate the above formula).

A simpler program could calculate the day of the year for a given date. Businessmen might find the results of such calculations useful.

FOOD STORE SHOPPING AID

The Commodore 128 can be programmed to add and categorize prices and types of items as they are found in weekly supermarket sale fliers. Provisions could be made for categorizing items into meat, groceries, produce, and taxable subdivisions. Additionally, there may be provisions for multiple entries, unit price calculations and comparisons, error correction, and a warning if a preset cash limit has been exceeded. Outputs could include total cost, tax, item count, and subtotals in each category. This type of program would help you decide where to shop and what specific items to look for.

COUPON FILE

For those who possess the money-saving habit of collecting food coupons, a computerized list of your coupons would be helpful. Enter each coupon by its amount, brand name, product name, and location in your coupon folders or envelopes. Next, enter your shopping list. A C-128 search between your shopping list and the available coupon list should yield a roster of coupons that may be used and where each one is located.

Alternatively, the Commodore 128 could store coupons by type of product, using, for instance, these categories: restaurants, pasta products, drinks, cereals, snacks, meat, poultry, fish, vegetables, condiments, dairy products, baking items, pet food, cosmetics, paper goods, cleaning products, medicine, and miscellaneous. You can call up the list of coupons within a specific category to select

the coupons that you are interested in and pick one for a particular brand name product.

HOME PLANNING

A useful program could be written to help a family design a house to fit its needs. The expense of a house certainly justifies an in-depth analysis of the design before construction is started. You could use a commercially available computer-aided design (CAD) program, to draw and transform basic house plans.

In regards to area planning, square footage could be calculated with the following guidelines in mind: the minimum square footage should equal the number of family members times 200, and the desirable square footage should equal the number of family members times 300. An activity list such as the one below could be included to ensure that the family's activities will not conflict and that there will be provisions for all activities. The program could request the user to enter the activities that are to be done in each room and the times involved. Conflicts could, therefore, be analyzed, and the plans could be altered accordingly. The following activities could be included in the program:

Group Activities

1. Lounging—indoors and outdoors
2. Television watching
3. Listening to stereo, tapes, or radio
4. Playing a musical instrument
5. Meals
6. Children's play areas

Social Activities

1. Holding a meeting in the home
2. Children's/adult's games
3. Viewing movies/slides
4. Visiting with guests

Work Activities

1. Meal preparation and clean-up

2. Household business
3. Laundry
4. Ironing, sewing, or drying clothes
5. Workshop area

Private Areas

1. Study or reading areas
2. Grooming or dressing facilities

Traffic patterns and storage requirements could also be analyzed.

Storage Requirements

Bedrooms: minimum of 4' by 6' by 2' closet space per person

Kitchen: approximately 10 linear feet of base and wall cabinets

PRIVATE INFORMATION STOREHOUSE

Almost everyone has some private informational items—financial information, diaries, or important numbers—that they would like to keep more securely than in a filing cabinet. A program could be written to store this information in coded form so that it could only be retrieved by someone with the proper password. Copies of such data could be stored in a safe-deposit box.

GENERAL PURPOSE CLOCK OR TIMER

Your Commodore 128, with its internal clock, can be used as an electronic timer or time controller for scientific research, sporting events, or other applications requiring a stopwatch. The capabilities that your C-128 has, but a stopwatch doesn't, are the automatic storage and printout of selected times and the automatic control of instruments or other devices that must be turned on or off at given times.

Your C-128 can even use its timing capabilities to act as a simple timer for applications in which accuracy is not a major factor (see Listing 1-5). When they are not using their Commodores for more practical tasks, some hobbyists have trans-

Listing 1-5: The Tick Tock Program

```

10 REM TICK-TOCK
20 SCNCLR 0
30 PRINT:PRINT:PRINT"    PRESS ANY KEY TO STOP TICK-TOCK"
40 SLEEP 3
50 COLOR 0,2:COLOR 1,1:COLOR 4,2
60 GRAPHIC 1,1
70 CIRCLE 1,160,100,95,80
80 GET Z$:X=160:Y=20
90 DRAW 1,160,100 TO X,Y
100 SLEEP 1
110 SOUND 1,1000,25
120 DRAW 0,160,100 TO X,Y
130 Y=Y+50
140 IF Y=70 THEN X=X+85
150 IF Y=120 THEN X=X+5
160 IF Y=170 THEN X=X-45
170 IF Y<200 THEN 90
180 IF Y>200 THEN 190
190 X=160:Y=180
200 DRAW 1,160,100 TO X,Y
210 SLEEP 1
220 SOUND 1,1000,25
230 DRAW 0,160,100 TO X,Y
240 Y=Y-50
250 IF Y=130 THEN X=X-85
260 IF Y=80 THEN X=X-5
270 IF Y=30 THEN X=X+50
280 IF Y>0 THEN 200
290 IF Z$="" THEN 80
300 GRAPHIC CLR
310 COLOR 0,1:COLOR 1,16:COLOR 4,6
320 GRAPHIC 0
330 SCNCLR 0

```

formed their computers into very elegant clocks, with graphic displays of hour and minute hands, digital displays, simulated sundials, or even sand timers (see Fig. 1-2).

CARPENTERS' AND MECHANICS' HELPER

The Commodore 128 can expedite the numerous calculations required by carpenters and mechanics when they perform tasks such as changing the dimensions of a set of plans, converting be-

tween anglo and metric measurements, and estimating the amount of building materials needed. Some useful formulas include:

Anglo/metric Conversions

1 meter = 39.37 inches
 = 3.281 feet
 = 1.0936 yards
 1 inch = 2.54 cm

1 foot = 30.48 cm
= .3048 m
1 yard = .9144 m
1 mile = 1609 m
= 1.609 km

Wall Paper Estimator

$$N = \frac{8640}{W \cdot (H + R)} \quad P = \frac{S}{W \cdot N}$$

where N = the number of strips in one roll
W = the width of the paper
H = the height of the wall
R = the repeat length of the pattern
P = the number of double rolls needed
S = the width of the wall to be covered

Concrete Block Estimator

$$N = \frac{H \cdot L \cdot 1.25}{125}$$

where N = the number of blocks
H = the height of the wall
L = the length of the wall

Concrete Yardage Estimator

$$Y = \frac{L \cdot W \cdot T}{324}$$

where Y = the volume of concrete in cubic yards
L = the length (ft.)
W = the width (ft.)
T = the thickness (in.)

**CAR MAINTENANCE
CALCULATIONS AND RECORD KEEPING**

In addition to calculating and recording your car's miles per gallon, your C-128 could keep track

of mileage statistics and signal you when a periodic check-up, overhaul, or oil change is necessary. For business people having the privilege of deducting automotive expenses, the C-128 could keep tabs on amounts spent.

RAFFLE TICKET PRODUCER AND DRAWER

If your organization is sponsoring a raffle drawing, your C-128 could print out serialized raffle tickets and then draw the winning ticket based on a random number generator.

DATABASE USE

Many of the program ideas described in this chapter can be implemented with a general purpose database program. This type of program should be able to store information pertaining to many items on a disk and then retrieve selected information.

The usual method of storing data involves the use of one string of information containing several fields of separate data. A field is an item of data.

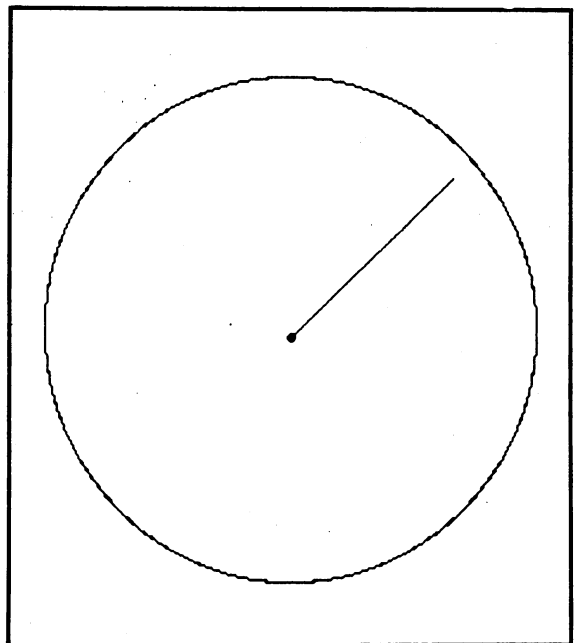

Fig. 1-2. A screen dump of Listing 1-3 in operation.

1001 Things to Do With Your Commodore 128

For example, a string containing five fields might look like this:

Boolean Algebra*Byte Magazine*25*Schwartz*
Feb 1978

The first field signifies the title of the item (in this case, a magazine article). All of the strings to be stored would be formatted in the same way, with the title of the item in the first field. Also, a limit is usually set on the length of any field. If the information in one field does not contain enough characters to fill the allocated space, extra spaces are added. The longer the field, the fewer records the disk can hold. You'll learn to make fields as short as possible when you are dealing with a large database.

The second field in the example above contains

the name of the source of the item. The third, fourth, and fifth fields contain the page number, author, and issue date respectively. An adequate database program should be able to search through many such strings and output those that contain items that you want. For example, you can store an index to your library on a database system and subsequently obtain a listing of all of the references pertaining to the stock market and written after a specific date. You would simply instruct the computer to search for all items that contain "stock market" in a certain field and a date later than the date specified in another field. Because the position of each field in all strings is fixed, the computer can search through a string to the beginning of the proper field. Specific information can easily be accessed in this manner.

Table 1-4. Uses for Database Management Systems.

BUSINESS USES		EDUCATIONAL USES		HOME & HOBBY USES
Customer filing	Workshop data	Student records	Field trips	Personal records
Prospect lists	Assets lists	Grade records	Vehicle records	Check lists
Master files for . . .	Marketing data	Teacher lists	Tenure records	Club rosters
Gen. Ledger	Insurance data	School lists	Parking assignment	Telephone directories
Accts. Receiv.	Pricing schedules	Program design	Violation records	Recipes files
Accts. Payable	Formulas	Tuition data	Meeting schedules	Medical information
Payroll Records	Production data	Enrollment data	Facility schedules	Property records
Personal data	Processes	Property/equipment		Appliance warranties
Telephone logs	Cross referencing	Athletic schedules		Insurance records
Telephone lists	Commission records	Player assignment		Christmas lists/gifts
Hotel/travel data	General filing	Games schedules		Appointments
Reservations		Player statistics		Articles indexes
Property control		Mailing lists		Tax records/data
Library catalogues		Test scores		Expenses
Inventory		Menus		Book ownership
Key Employee data		Diet selections		Utility records
Advertising data		Inventory		Deposit files
Source files		Seating charts		Due dates
Sales leads		Cataloguing		Travel records
Mail lists		Laboratory data		Meal planning
Private records		Inspection data		Mortgage data
Corp. records		Experimental data		Auto records
Directories		Attendance data		Crop yields
Billing information		Course description		Source files
Delivery schedules		Purchase orders		Magazine Article index
Routes		Requisitions		Estimate files
Territories		Vacation records		Investments
Quotations		Budgets		Plus all the Business &
Applintments		Maintenance data		Educational overlaps
Conventions		Locker assignment		

Commodore 128 Applications for Everyone

Database programs are extremely useful Commodore 128 tools because of their wide applications. In what applications could you use a database? The list in Table 1-4 names a number of the thousands

of types of information that can be stored, indexed, organized, or cross-referenced by a database program. Many of these applications are discussed in more detail throughout this book.

Chapter 2

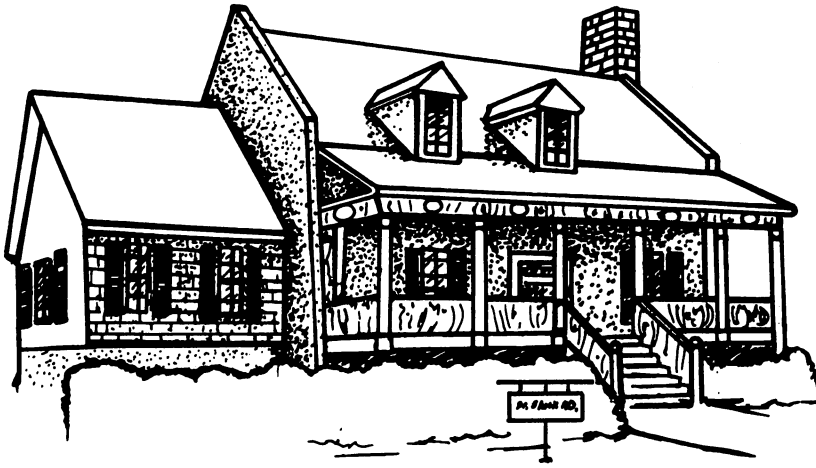

Business and Financial Applications

Personal computers have greatly altered the business world by permitting rapid calculation of numerous "What if . . . ?" questions involving both complicated financial formulas and the more traditional accounting functions. Likewise, the home owner will find the Commodore 128 useful in analyzing loans, budgets, and investments. Calculations that were previously time-consuming and open to error can now be accomplished with ease, which permits better decision making.

FINANCES AND INVESTMENTS

A growing number of investors are using their Commodore 128 to help them manage their stock and bond portfolios, analyze trends in the financial markets, investigate individual stocks, and decide when to buy or sell. A C-128 connected to a database can sort out enormous quantities of market and company statistics for an investor; within seconds the results may be projected on the screen as charts, tables, or graphs. This quick access to data enables an investor to evaluate a buying

opportunity—or a must-sell situation—quickly and probably more accurately than if the calculations were done by hand. Therefore, the Commodore can sometimes make your life as an investor more rewarding and often much easier. Additionally, the cost of investment programs, through proper use, may be counted as a business expense for tax purposes, as can part or all of the cost of your Commodore. Be sure to consult your tax guides to determine the exact qualifications.

Stocks, Bonds, and Securities

The C-128 has come to the aid of the individual investor in three areas: portfolio management, technical and fundamental analysis, and database access. Making investment decisions or recommendations requires accurate technical analysis of large amounts of data on a timely basis. Compiling information in standard formats concerning stock performance or company finances, doing statistical computations to update individual stock files, tracking moving averages, and maintaining com-

plete records of one or a number of portfolios are all tasks ideally suited to the Commodore. Professional brokers, as well as individuals, have witnessed the significant impact that the Commodore 128 can have on the analytical functions on which they base their recommendations. With the advent of the bull market of the early 1980s and the rise of the discount broker, professional software packages have become available to help investors at home make the investment decisions that used to be made by their full-service brokerages.

Portfolio Management

Portfolio management programs are really just electronic notebooks. They keep a complete record of the stocks you own and show how well you're doing at the game. They are especially useful at tax time; their compilations of your losses, gains, dividends, and brokerage commissions make it easy to account to the IRS (Internal Revenue Service) for your Wall Street activity.

The limitations on most packages involve the number of stock characteristics maintained or computed for each stock. Most packages will allow for a virtually unlimited number of stock records (letting you track your own portfolio, as well as that of several financial advisors), as long as you are willing to maintain them on a number of separate floppy disks.

The simplest individual portfolio management programs provide a means of recording the basic information on stocks in your own portfolio or on any other stocks that you wish to track for comparison. When you choose to update—on a daily, weekly, or other periodic basis—the program will automatically perform certain calculations, such as the present value of the issues, or long- and short-term gains and losses (as if you sold the stock on that date). It can automatically remind you of a stock that will go long-term within 30 days or maintain other information such as dates and number of shares purchased, total number of shares owned, dividends, growth rate, and percentage appreciation or depreciation. The following analysis factors

may be computed for the entire portfolio: sum of cost prices, sum of current value, sum and percentage difference between cost and current price, percentage return on a cost basis, and percentage return on the current value. A report may be automatically prepared for attachment to IRS forms, and the portfolio information may be printed in a variety of formats for ready reference.

More advanced portfolio management packages allow hundreds of open tax lots in a system that matches your transactions against open positions to let you make investment decisions that minimize your tax liability. You can track stocks, options, bonds, treasuries, and mutual funds; the system can accommodate buy, sell, short sell, and buy-to-cover transactions. Return on investment for each stock and the entire portfolio can be computed, as well as the total net earnings. Sophisticated programmers could make use of Sharpe's method (or another method) in determining the proportion of funds that should be allocated to each security in a portfolio to maximize returns.

Technical and Fundamental Analysis

Fundamental analysis assumes that the price fluctuations of stocks are based on the basic financial health of the economy and the performance of the individual company. Therefore, fundamental analysts look at such factors as earnings, sales, assets, and liabilities and use these factors to predict future price movements.

Technical analysts argue that these factors affect stock prices only over a long period. Short-term fluctuations, they maintain, are governed by psychological conditions in the market itself, not external factors. Therefore, they believe that the study of the past market behavior can determine the way to profits in the future. There are many different theories that promote various indicators as being the key to future price movement. Some of the major indicators are the relationship between price and volume, market averages, and new highs versus former lows.

Both fundamental and technical analyses call

for extensive number crunching and are well suited for being handled by computers, although fundamental analysis stretches the memory capacity of the Commodore 128. In fact, almost all of the analysis programs available on the Commodore market do technical analysis. In technical analysis, computers can be especially useful in charting various relationships between individual stock prices and trading volumes. A C-128 can turn a pile of statistics that might take several hours to plot by hand into a chart within seconds. The remainder of this chapter discusses some popular means of technical and fundamental analysis. Interested readers are referred to popular manuals on investment analysis, statistics, and the following publications on computer-assisted stock analysis for further information:

- * Milner, W. L., *Personal Money Management with Your Micro*, TAB Books, Inc., Blue Ridge Summit, PA 17214.
- * Schmeltz, L. R., *Playing the Stock and Bond Markets with Your Personal Computer*, TAB Books, Inc., Blue Ridge Summit, PA 17214.
- * Sparks, L. E., *Investment Analysis with Your Microcomputer*, TAB Books, Inc., Blue Ridge Summit, PA 17214.
- * Zonderman, J., *The Personal Computer Investment Handbook*, TAB Books, Inc., Blue Ridge Summit, PA 17214.

With a Commodore 128 at your disposal, you can now develop and test a market theory without countless, error-prone manual calculations. A "paper portfolio," or a collection of stocks to track that are not actually owned, was once too time and effort consuming for the individual investor to experiment with. Now, when you experiment, each "buy and sell" decision can be based on actual market performance and serve as a "lesson learned" in developing your own trading strategies.

Moving Averages

Moving averages provide a measure of the

movement of a stock relative to itself (in price, dividend, or volume), a composite summary of a key factor (for example, the average price of a stock group), and a ratio of two or more key factors (for example, price/earnings ratios). The moving average is often most useful in predicting the buy versus sell position of a stock in regard to its past trend. If the current stock price drops below the moving average, a sell position would be taken and vice-versa for a buy position.

Price/Volume Trace

In this analysis technique, the daily stock price and volume data are considered as (x,y) data points. Probability rules may be developed as clues to the immediate future performance of the stock price as it relates to volume.

Rate of Change

The rate of change is a measure that involves price fluctuations of a stock to itself and may be used to compare stocks in terms of price, sales, or earnings. On this basis you can find the stock with the best potential to increase in price in the immediate future, barring any information or indication that the current stock trend will change or reverse. It is computed as follows:

$$\% \text{ Rate of Change} = \frac{\text{Ending-Starting Price}}{\text{Starting Price}} \div \frac{\text{No. of trading days}}{1} * 100$$

This value may be determined for daily, weekly, monthly, or yearly periods of time by altering the denominator.

Change Distribution

This analysis technique compares the distributional change of individual stocks within a group to the average change of the group for a given time period. This provides a probabilistic measure of the rate of change in either relative or absolute terms.

The stock distribution, like a normal distribution, is described by the factors of price average and standard deviation; the standard deviation usually increases as the length of time considered increases and as the market rate of change increases. By knowing the typical stock price distributions for different market index rates of change, the probability of success in short-term trading is increased; the investor is equipped with the probability distribution of the price change.

Price Indexes

Price indexes are indicators of the central drift of a set of stocks or the market as a whole. These indexes include the Dow-Jones, New York Stock Exchange, American Stock Exchange, and Standard & Poor. They can be best applied to determine a consensus of individual stock trends within a given stock category. An indicator that is well suited for computation on your Commodore uses the formula:

$$\text{INDEX} = \frac{\sum_{\text{all stocks}} \frac{x_n y_n}{y}}$$

where x_n = stock price
 y_n = number of shares traded at x_n
 y = total shares traded

The moving average and indexing concepts may be used as powerful decision-making tools in determining whether the investor should be anticipating a trading decision, trading, or investigating other investments.

Ratio Relationships

The use of ratios is popular in business and finance because they afford a means of comparison of two or more factors that influence investment decisions. A well-known example is the price/earnings (P/E) ratio used in measuring the potential of a stock. Others include the ratio of sales growth,

the ratio of consecutive period earnings, the yearly high stock price versus the yearly low price, and the relative strength of a stock versus the market index. The C-128 may be used in automatically calculating many of these popular ratios and in forecasting changes of ratios through the use of statistical regression. For instance, the future price of a stock may be computed given current value per share, projected earnings, and projected percent change in the P/E ratio using this simple formula:

$$V_p = \frac{V_c E_p^2}{E_c^2}$$

where V_c = current value per share
 E_c = projected earnings
 C_p = projected percent change of P/E ratio
 E = current earnings
 V_p = projected value per share

Note that all projected values must be for the same length of time.

Trend Line Analysis

Trend line analysis (see Fig. 2-1) is a major statistical computation in financial analysis and is accomplished by using the method of linear least squares fitting of data. Suppose that you obtained a set of data listing the value of one stock over a period of time and that these values were plotted versus the Dow-Jones Index. A trend line analysis would determine the equation of the line that best fits or describes the data, telling you how one variable is related to the other. This equation, in the form of $y = a + bx$, provides a means to estimate the value of a variable (y) given the value of the other variable (x). The other values (a and b) are determined using these regression equations:

$$b = \frac{n\sum XY - \sum X \sum Y}{n \sum X^2 - (\sum X)^2}$$

$$a = \frac{1}{n} (\Sigma Y - b \Sigma X)$$

- where n = no. of (x,y) pairs
- X = individual x values
- Y = individual y values
- b = slope of line
- a = y axis intercept

As described in Chapter 3, the standard error may be calculated for a regression line to determine how well it describes the data.

The technique of multiple linear regression is used by investors in determining the influence of more than one variable (x . . .) on another variable (y). The total variation in y may often be better explained through the use of multiple x variables

(y = . . .), allowing a more precise prediction than is possible through the simple linear regression discussed above. For instance, one investor using Commodore techniques has developed a four-variable regression equation describing the stock market average:

$$\log V = a + b \log E + c \log G - d \log R$$

- where V = Value of the average
- E = Earnings of the average
- G = Growth rate of the average's earning
- R = Yield of quality long-term bonds

In this example, the variables (E, G, R) are regressed on V. The constants (a, b, c, d) are determined and used in predicting future values of V

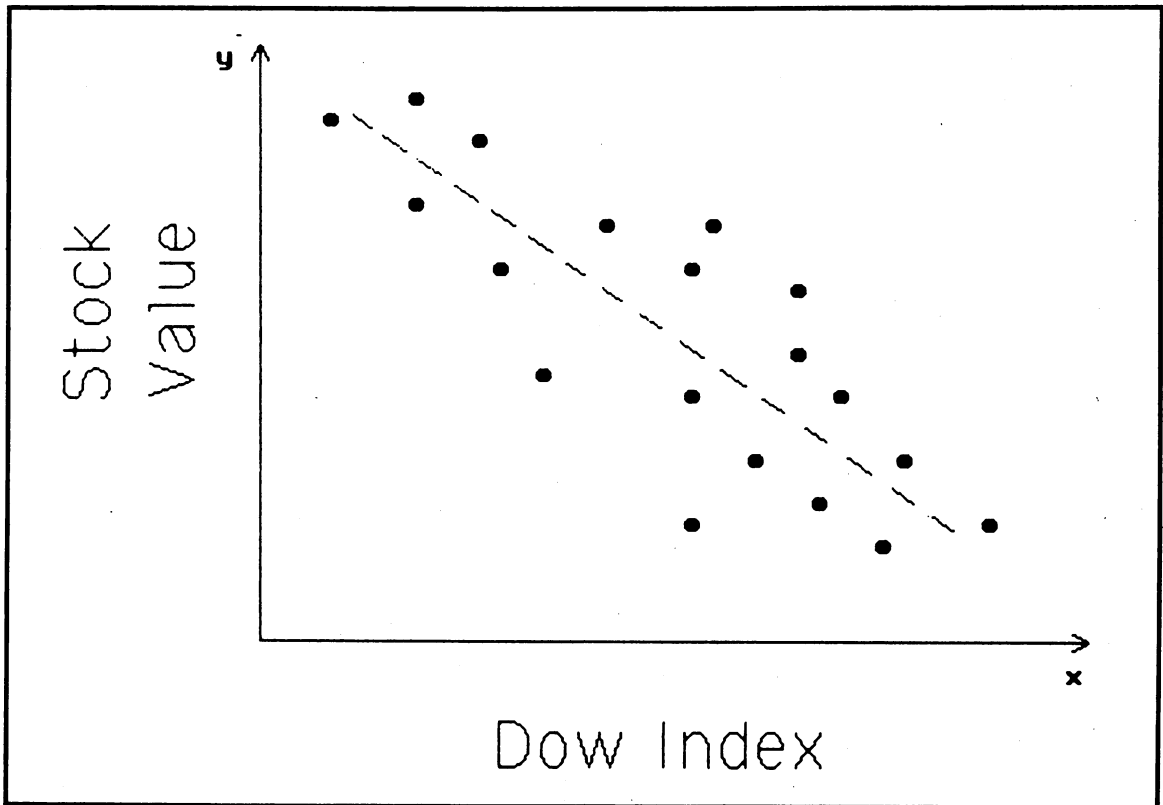

Fig. 2-1. A generic trend line graph.

based on past relationships to E, G, and R. Multiple linear regression is also computed using the least squares method. For more information on the least squares method, please consult a textbook on statistics.

Investors using multiple linear regression techniques have developed modeling equations that reflect the influence of a wide variety of factors, with high correlations, on stock and security prices, earnings, and P/E ratios. These include:

- The current month's interest yield of the Moody's AAA Bond Index.
- The ratio of pretax corporate profits for the preceding twelve months to pretax corporate profits adjusted for inventory profits for the same period.
- The ratio of current dollar gross national product for the preceding twelve months to current dollar gross national product for twelve months ending one quarter into the future.
- The average yield on taxable U.S. Government 3-5 year issues for the preceding six months.
- The average year-to-year percentage gain of the Consumer Price Index.
- The equity of the S&P 400 one year previous divided by the earnings of the S&P 400 for the latest twelve months.
- The relative consistency of dividend growth for ten years, in terms of the ratio of the correlation of the stock's dividend growth with time to that of the S&P Industrial Stock Average's dividend growth.
- The relative consistency of earnings growth for ten years, computed as above.
- The relative profit margin for the latest report twelve months.
- The relative rate of earnings growth for the previous ten years on a per-share basis.
- The relative size measured by net income for the latest twelve months.
- The relative return on equity, as earnings less dividends divided by equity at the beginning of the twelve-month period.
- The relative five-year earnings-per-share least-squares growth rate.
- The relative prospective return on equity in the year for which earnings are being estimated.
- The relative prospective earnings growth for the next quarter.
- The relative reinvestment rate in the latest year.
- The relative prospective earnings growth for the next two quarters.
- The relative dividend payout ratio for the latest twelve months.
- The relative earnings growth for the latest twelve months.

Many other variables could be used at the investors discretion, including DJIA (Dow-Jones Industrial Average), specific industrial indicators, gross national product (GNP), employment statistics, disposable personal income statistics, indexes of industrial production, bank deposits, money supply, interest rates, inventory levels, accounts receivable/payable, and railroad freight usage. With a large selection of apparently useful variables to employ, you can now build a multiple regression equation on your Commodore, seeking both the highest possible correlation and confidence level and the least interaction among the variables chosen. The variables may be regressed against individual stock performance, group stock performance, and market indexes or other securities. Those variables that are generally most useful include measures of preceding and following interest rates, inflation, economic activity (e.g., GNP), industrial health, and rates of change.

Database Searching

With the advent of databases that are available to the individual investor at low rates, a Commodore computer can be instructed to search for stocks fulfilling any combination of investment criteria. If, for example, you are a conservative investor, you could have a program hunt for companies whose shares have a P/E ratio of 5 or less and

annual yields of 10% or more—both of which can signify under-valued companies.

Return on assets
Return on net worth

Financial Ratio Analysis

Financial ratio analysis is an ideal, simple method of determining how well a particular company has performed, in relation to other companies in its industry or in relation to its own past performance, and of predicting future performance. Described below are several popular financial ratios that can be determined using figures from corporate annual reports and a simple Commodore BASIC program that does the necessary calculations or comparisons with figures concerning other corporations. Over the years, security analysts, brokers, and investors have found that financial statements become more meaningful when ratios between various values on the income and balance sheets are computed. These ratios may be divided into four categories:

Liquidity Ratios

Current ratio
Quick ratio
Inventory to working capital

Leverage Ratios

Debt to total assets
Times interest earned
Current liabilities to net worth
Fixed assets to net worth
Debt to equity

Activity Ratios

Cash velocity
Inventory turnover
Fixed assets turnover
Average collection period
Total assets turnover

Profitability Ratios

Net operating margin
Net income margin

Liquidity Ratios are designed to measure a firm's ability to meet its obligations as they mature and relate to the amount of cash in the near future.

Leverage Ratios measure the financing provided by owners as compared with the financing provided by the firm's creditors. Creditors look at the owner-supplied funds to provide them with a margin of safety, but by raising funds through debt, the owners are able to maintain control of the firm with a small investment. The return for the owners is magnified when the firm earns more on the borrowed funds than it pays in interest.

Activity Ratios determine how effectively the firm utilizes the resources that are available.

Profitability Ratios demonstrate the result of the policies and decisions of the firm's management. Both operating margins and new profits are calculated to distinguish between the results of operating policies and the results of financial policies.

The input data needed for computation of these ratios is usually found in the financial statements of a company and includes:

Cash—all cash on hand plus cash in the company's bank accounts. Any cash in certificates of deposit or other short-term deposits should be included.

Marketable securities—investments in obligations that are readily marketable and can be converted into cash on short notice.

Receivables (beginning)—receivables should be net of any reserve for doubtful accounts, and they should also be fully collectible within one year. Beginning receivables are those that were due to the company at the beginning of the operating year.

Receivables (ending)—those receivables due to the company at the end of the operating year.

Inventory (beginning)—inventory that is on hand at the beginning of the operating year.

Inventory (ending)—inventory that is on hand at

1001 Things to Do With Your Commodore 128

the end of the operating year.

Current assets—the total cash, marketable securities, receivables, inventories, and other assets of the company that are expected to be converted into cash in the normal course of business within the current operating year.

Fixed assets—assets such as land, buildings, leasehold improvements, equipment, fixtures, furnishings, vehicles, and other assets with lives longer than one year that are used in the operations of the company.

Total assets—the total of all assets of the company, including current assets, fixed assets, and other assets.

Current liabilities—debts of the company that must be paid within one year, usually consisting of trade accounts payable, payroll taxes withheld, accrued expenses, and that portion of long-term debt coming due within one year.

Total liabilities—the total of all debt of the company, including current, as well as noncurrent, liabilities.

Net worth—(also called owner's equity or stockholder's equity) the difference between total assets and total liabilities.

Sales—the total revenues earned by the company during the year, net of all sales discounts and returns.

Gross operating profit—found by subtracting the cost of sales from the sales. This final value represents the difference between the sales price of all items sold and the cost of the items sold.

Interest charges—the total amount of interest that has been paid by the company on its indebtedness.

Profit before income taxes—the net income of the company for the year after all of the expenses have been considered. This figure is commonly referred to as the "bottom line."

Current Ratio. This ratio is computed by dividing current liabilities into current assets. This ratio is the generally accepted measure of the ability to satisfy short-term obligations. Current ratio also indicates the extent to which claims of short-

term creditors can be covered by assets that can be converted to cash in a period corresponding to the time when the obligations become due.

Quick Ratio. This ratio is computed by deducting inventories from current assets and dividing the remainder by current liabilities. This is a measure of the ability to pay short-term obligations without relying on the sale of inventories and is a better guide to short-term liquidity than is the current ratio.

Inventory to Working Capital. This ratio demonstrates the proportion of working capital tied up in inventory and is used to find the possible loss to the company resulting from a decline in inventory values. In this situation, a low ratio is desirable.

Debt to Total Assets. This ratio measures the company's obligations to creditors in relation to all the funds provided to the company; the lower the ratio, the greater the protection from losses being incurred by the creditors in the event of a liquidation. Generally speaking, the maximum debt ratio should be 50 percent.

Times Interest Earned. This ratio is determined by dividing earnings before interest and taxes by interest expense. This measures the extent to which earnings could fall before the company is unable to pay the annual interest costs; the lower the ratio, the more difficulty the company will have in raising additional funds. A manufacturing company should cover interest more than four times and public utilities should cover interest about three times.

Current Liabilities to Net Worth. This ratio indicates the amount of funds supplied by owners compared to funds provided by current debt; if the owners have not put enough funds into the company, long-term creditors will be less likely to provide funds, and the company will have to utilize short-term financing to a greater extent, lengthening the time before current bills are paid. Therefore, lower ratios are favorable.

Fixed Assets to Net Worth. This ratio indicates the extent to which owner's funds are invested in assets with little turnover. Higher ratios

will result for industries that are capital intensive versus companies that are labor intensive.

Debt to Equity. This ratio demonstrates the relation between the total debt of the firm and the funds provided by the owners; the lower the ratio, the greater the protection against creditors' losses in the event of liquidation. Owners may desire a high ratio because this will magnify earnings and prevent possible dilution of control of the company if additional equity must be raised.

Cash Velocity Ratio. This ratio is computed by dividing cash and cash equivalents into sales. This ratio indicates the number of times cash has turned over within the year; a high cash velocity indicates that cash is being used effectively.

Inventory Turnover. This ratio is computed by dividing the cost of sales by inventory. This ratio indicates the liquidity of inventory; a high inventory turnover shows that inventories are being held to a minimum, and a low ratio may indicate obsolete or slow-moving stock.

Fixed Assets Turnover. This ratio is computed by dividing sales by fixed assets. This measures the utilization of fixed assets; a low ratio may indicate that the plant isn't being utilized as effectively as possible, unless the company is labor intensive.

Average Collection Period. This ratio is computed by dividing accounts receivable by average daily sales. This represents the average time period after making a sale before the cash is actually received. The result indicates the effectiveness of credit and collection policies; these may need to be strengthened if this ratio is on the increase.

Total Assets Turnover. This ratio is computed by dividing sales by total assets. This shows the effectiveness of the firm in utilizing resources to generate sales; a high ratio may indicate over utilization of assets, and a low ratio may indicate an excessive investment or idle assets.

Gross Operating Margins. This ratio is computed by dividing the gross operating profit by sales. This ratio determines how far unit selling prices may decline before resulting in a loss from

the sale of units and how products are priced in relation to their cost.

Net Operating Margin. This ratio is computed by dividing profit before taxes by sales. This shows the amount each sales dollar provides to the continuing operation of the firm before consideration of income taxes.

Net Income Margins. This ratio is determined by dividing net profits after taxes by sales. A lower ratio indicates that selling prices are relatively low and that the total costs are relatively high; therefore, a small percentage drop in sales may result in losses. This ratio indicates the profitability after taking into account all income taxes and expenses and measures the return on sales.

Return on Assets Ratio. This ratio is computed by dividing net profits after taxes by total assets. This measures the rate of return on total resources.

Return on Net Worth Ratio. This ratio is computed by dividing net profit after taxes by net worth. This ratio is indicative of the company's earning on the investment of shareholders. A high or increasing value is favorable, although a very high value may indicate intense competition. Additionally, temporary inventory profits may be the result on increasing commodity prices. A high value could also be caused by general prosperity or a declining position.

Combined Coverage. Combined coverage is computed by dividing annual interest and debt costs plus preferred dividends into the adjusted operating profit after taxes and before interest. A combined coverage of four is considered acceptable for an industrial company; a coverage of three times the combined requirements would make a utility stock high-grade.

Dividend Payout. The dividend payout is the percentage of earnings on common stock that are paid out as dividends. Industrial companies average about 55 percent, utilities average 70 percent, and growth companies reach less than 55 percent.

Book Value Per Share. The book value per share is determined by adding the stated or par

1001 Things to Do With Your Commodore 128

value of the common stock to the additional paid-in capital and retained earnings accounts and dividing by the number of common shares. The book value would be lower for companies in which preferred stock is entitled to share in additional paid-in capital. The book value is not as important an indicator as earnings and prospects for industrial companies. The book value of stock for financial institutions and utilities, however, is important in analysis.

Additional Investment Applications

On the following pages you will find a dozen

more ways in which you can use your C-128 as a tool for making profitable financial decisions.

The Intrinsic Value of a Stock. The program in Listing 2-1 calculates this value with this formula:

$$I = \frac{TC \cdot AMT}{CS}$$

Where I = intrinsic value
TC = total corporation capital
AMT = price per share
CS = amount in dollars of capital stock

Listing 2-1: The Stock Value Calculation Program

```
10 REM INTRINSIC STOCK VAL CALC
20 GRAPHIC 0
30 SCNCLR 0
40 COLOR 0,1:COLOR 5,2:COLOR 4,1
50 FOR X=1 TO 15
60 SOUND 1,790,2
70 NEXT X
80 PRINT:FOR X=1 TO 32:READ A#:PRINT TAB(5) A#;
90 SOUND 1,790,2
100 NEXT X
110 PRINT:PRINT:FOR X=1 TO 10:READ A#:PRINT TAB(15) A#;
120 SOUND 1,790,2
130 NEXT X
140 PRINT:PRINT:FOR X=1 TO 80:PRINT CHR$(113);
150 SOUND 1,790,2
160 NEXT X
170 PRINT:PRINT:PRINT "I WILL CALCULATE THE INTRINSIC VALUE OF
    A STOCK BASED ON FOUR INPUTS."
180 SLEEP 6
190 SCNCLR 0
200 I=0
210 PRINT:INPUT "WHAT IS THE STOCK'S NAME";N#
220 PRINT:INPUT "WHAT IS THE STOCK'S PRICE PER SHARE";S
230 PRINT:INPUT "WHAT IS THE CORPORATION'S TOTAL CAPITAL";C
240 PRINT:INPUT "WHAT IS THE DOLLAR AMOUNT OF CAPITAL STOCK";D
250 I=(S*C)/D
260 PRINT:PRINT "THE INTRINSIC VALUE OF ";N#;" IS $";I
270 PRINT:PRINT "CALCULATE ANOTHER (Y/N)?:":GETKEY Z#
280 IF Z#="Y" THEN 190
290 SCNCLR 0
```

```

300 COLOR 0,1:COLOR 5,16:COLOR 4,6
310 DATA T,H,I,S," ",I,S," ",A,N," ",I,N,T,R,I,N,S,I,C," ",
    S,T,O,C,K," ",V,A,L,U,E
320 DATA C,A,L,C,U,L,A,T,O,R
    
```

A Stock Valuation Program. A program of this type could find current and future values of a stock and the rate of return before and after taxes. Commissions would be considered in all calculations.

Brokerage Commissions. Commissions could be calculated on standard and odd lots, as well as for stocks selling below one dollar per share.

Earnings Per Share Estimation. A historical balance sheet and income data could be used to estimate future earnings for a given stock; future estimations may be made with trend line analysis.

An Options Valuation Program. Using the Black-Scholes or another economic model, an options valuation program could determine the optimum hedge ratio and the spread of any options. When selling partially covered calls or when selling puts and shortening stock, an options writing program could be used to find the maximum profit and upper and lower break-even points.

The purpose of this type of program would be to assist the investor in planning the most profitable stock-option buy and sell strategy. The strategy used by the program would involve the selling of options against stock bought; this is usually considered the least risky strategy and it is often the most profitable one. For example, you could buy 100 shares of stock to use as collateral for each call option sold. A call option, which is sold at a premium, allows the purchaser the rights to buy the stock at a certain price (called the strike point), no matter what the true stock price becomes. The option, however, is valid only for a certain length of time, known as the life of the option.

Such a program would request information pertaining to the stock and would calculate the value of the stock and return on investment (ROI) over

a range of 40 to 160 percent of the current value. Using this data, the investor should be able to decide the probability that a certain buy and sell strategy will be profitable. In the final analysis, the program would use a set of financial formulas to recommend a specific buy-sell strategy and then print an itemized listing of all costs, brokerage fees, proceeds, and returns. To make the best use of such a program, you should study references concerning stock-option strategies.

Computation of Short-Term Insolvency. In this "Z-Score" computation based on an American Institute of Certified Public Accountants timesharing program (see Listing 2-2), the short-term liquidity trend score indicates whether a company is likely to face financial difficulties in the near future.

$$Z = .012*((G-L)/I) + .014*(W/I) + .033*((P+E)/I) + .006*(W/M) + .999*(S/I)$$

where G = current
 L = current liabilities
 I = total assets
 W = net worth
 P = profit before income taxes
 E = interest changes
 M = total liabilities
 S = sales
 Z = "Z score"

Stock Alpha and Beta. In this approach to analysis, the investor compares the movement of a stock over a period of time with the movement of a market average. This can be best measured by comparing the percent change in a given stock's price with the percent change in the market as a whole over several large recent market fluctuations

Listing 2-2: The Short Term Insolvency Calculation Program

```

10 REM SHORT-TERM INSOLVENCY CALC
20 GRAPHIC 0
30 SCNCLR 0
40 COLOR 0,2:COLOR 5,3:COLOR 4,2
50 PLAY "V102T7U8X0HCQDEW$DWD"
60 PRINT:PRINT TAB(10) "SHORT-TERM INSOLVENCY"
70 PRINT:PRINT TAB(15) "CALCULATOR"
80 PRINT:PRINT "I WILL CALCULATE SHORT-TERM INSOLVENCY BY
    COMPUTING A COMPANY'S Z-SCORE."
90 SLEEP 8
100 SCNCLR 0
110 PRINT:INPUT "WHAT IS THE COMPANY'S NAME";N$
120 INPUT "WHAT ARE THE COMPANY'S CURRENT ASSETS";G
130 INPUT "WHAT ARE ITS CURRENT LIABILITIES";L
140 INPUT "WHAT ARE ITS TOTAL ASSETS";I
150 INPUT "WHAT IS ITS NET WORTH";W
160 INPUT "WHAT IS ITS PROFIT BEFORE INCOME TAXES";P
170 INPUT "WHAT ARE ITS INTEREST CHANGES";E
180 INPUT "WHAT ARE ITS TOTAL LIABILITIES";M
190 INPUT "WHAT ARE ITS SALES";S
200 Z=.012*((G-L)/I)+.014*(W/I)+.033*((P+E)/I)+.006*(W/M)
    +.999*(S/I)
210 PRINT:PRINT "THE Z-SCORE FOR ";N$;" IS";Z
220 PRINT:PRINT "WANT TO FIGURE ANOTHER (Y/N)?:GETKEY Z$
230 IF Z$="Y" THEN 100
240 COLOR 0,1:COLOR 5,16:COLOR 4,6
250 SCNCLR 0

```

and deriving a result in the form $y = a + bx$, where y equals percent change in a stock's price given by x as the percent change in the market level. The constant (a) is called alpha and is a measure of the stock's absolute continuing movement; high positive alphas are always attractive in stocks. The coefficient (b) is called the stock's beta and is a measure of the riskiness of a given stock. High betas should produce good relative performance in a bull market, but relatively poor performance in a declining market. Betas may be calculated separately as a function of such factors as size of the company involved, its capital structure (for ex-

ample, its debt/equity ratio), return on equity, and earnings consistency. You may experiment with multiple linear regression in determining the relationship between betas and these or other variables. In general, the greater the beta, the cheaper the stock should be and the greater the appreciation potential. A risk versus benefit analysis may be conducted, with, for example, betas charted versus potential appreciation based on present discounted value of the price of the stock.

Equations used to independently determine stock betas are as follows and are well suited for incorporation into a portfolio analysis program:

Stock Beta

$$\text{Beta} = \frac{\left(\text{Covariance of market and stock risk premiums} \right)}{\text{Variance of market risk premium}}$$

$$\text{Variance} = \sum_{\text{time}} \left(\frac{\text{market risk premium} - \text{ave. market risk premium}}{\text{market risk premium}} \right)^2$$

$$\text{Covariance} = \sum_{\text{time}} \left(\frac{(\text{SRP} - \text{ave. SRP}) \cdot (\text{MRP} - \text{ave. MRP})}{(\text{MRP} - \text{ave. MRP})} \right)$$

SRP = stock risk premium

MRP = market risk premium

$$\text{risk premium} = (\text{rate of return}) - (\text{risk free rate of return})$$

$$\text{risk free rate of return} = \frac{1}{12 \cdot (\text{annual rate of a 3 month T-bill})}$$

$$\text{rate of return} = \frac{(\text{price at month end} + \text{dividend}) - (\text{price at month start})}{\text{price at month start}}$$

Portfolio Beta

$$\text{Beta} = \sum_{\text{portfolio}} \left(\frac{(\text{stock beta}) \cdot (\% \text{ of market value})}{(\% \text{ of market value})} \right)$$

$$\% \text{ market value} = \frac{\text{market value of a stock}}{\text{total market value}}$$

$$\text{market value of a stock} = \text{current price} \times \text{no. of shares}$$

Inflation Rate Effect. An oversimplified, but often useful, method of forecasting the effect of a given inflation rate on the stock market obeys

the following structure. First, assume that the cost of money is constant at three percent. Add to this value a one percent constant that will be assumed to be the risk factor for owning stocks instead of bonds. To this sum, add the current inflation rate. Divide this final sum into 100; the result is the average stock market multiple of earnings. Now, multiply this result by the sum of the estimated yearly earnings of the thirty Dow-Jones Industrial stocks. If the sum of the estimated earnings is not known, a simple Commodore program could determine earnings for the industrial stocks from the newspaper listings of price and price/earnings ratios (earnings = price/P/E ratio); a method of determining future earnings growth would have to be employed. The final product calculated is a projected Dow-Jones industrial stock average.

Here is an example of the use of these calculations, assuming an inflation rate of five percent and estimated Dow-Jones Industrial stock earnings of \$110:

$$\frac{100}{(3\% + 1\% + 5\%)} \cdot 110 = 1222.$$

Investment Analysis Using Interest Rate Formulas. The set of interest rate formulas outlined below may be used to assess and compare the values of investments with respect to time and money, considering that money today is inherently worth more than the same money tomorrow. In an investment, money passes from and to the investor in the form of borrowed money, loaned money, dividends received, and installment loan payments made; these are called cash flows. The resulting profit or loss can be measured as an interest rate, the rate being absolute throughout the whole period of investment or applying only to a specific time interval. A \$30 profit on a \$100 investment four years ago is a 30 percent profit in absolute terms, but when it is measured at an annual rate (using the equations in Table 2-1), the profit comes to 6.8 percent.

1001 Things to Do With Your Commodore 128

This table shows the appropriate formulae to use given three input parameters and a required output parameter.

GIVEN

no. of uniform periods	(n)	x	x	x	x	x	x
interest rate per period	(i)	x	x	x		x	x
present value	(P)	x		x	x		x
future value	(F)	x		x	x		x
uniform payments	(R)		x	x	x		x

REQUIRED	n			1	2	3
	i			4	5	6
	P	7	8			
	F	9	10			
	R	11	12			

1. $n = \frac{\log \frac{F}{P}}{\log (1+i)}$	5. $i = \frac{R}{P} (1-i)^{-n}$	9. $F = P(1+i)^n$
2. $n = \frac{\log \frac{1}{1-iP:R}}{\log (1+i)}$	6. $i = \frac{R}{F} ((1+i)^n - 1)$	10. $F = R \frac{(1+i)^n - 1}{i}$
3. $n = \frac{\log 1 + \frac{iF}{R}}{\log (1+i)}$	7. $P = \frac{F}{(1+i)^n}$	11. $R = P \frac{i}{1 - (1+i)^{-n}}$
4. $i = \frac{F}{P} - 1$	8. $P = R \frac{1 + (1+i)^{-n}}{i}$	12. $R = F \frac{i}{(1+i)^n - 1}$

Table 2-1. Look-up Table of Financial Formulae.

The interest equations in the table may be divided into two sets: equations 1, 4, 7, and 9 are used to measure investments in which transactions occur only twice—once at the beginning and once at the end of the investment period. The other eight equations apply to problems in which constant dollar transactions occur at regular intervals. An installment loan is a good example of this kind of problem. If you borrow \$4000 to buy a car and pay off the loan over 36 months at 12 percent interest, equation 11 may be used to compute the amount for each payment (\$132.86).

It is important to note that there is no formula for solving for interest rates directly in the second set of equations, because the interest rate per period

(i) cannot be isolated on one side of the equation. The only method to solve for interest rates in this situation is to use a “brute force” approach in which the Commodore tries values for i and solves for F or P until the right answer is found. The value for i would be successively approximated.

The formulas in Table 2-1 will be used throughout this chapter in discussing loans, mortgages, annuities, and real estate evaluation. There uses are as varied as the diversity of investments. The C-128 becomes useful in answering “what if . . . ?” questions involving changes in interest rates, time periods, and other variables with these equations; it can also be useful in solving equations 5 and 6 in Table 2-1, which require an iterative approach.

Financial Databases. The easiest way to enter information into stock market programs is over the telephone. Various database services supply detailed financial information—both current and historical—which can be retrieved by any Commodore through a modem. On-line services offer most, if not all, of the securities you are likely to be interested in. For instance, one of the popular networks (CompuServe) offers the following financial information for instant retrieval:

- Figures on more than 9,000 securities, updated throughout each trading day—no need to wait for day-old stock values in the newspaper.
- Detailed descriptive and financial information on thousands of major publicly-held companies.
- Current and historical information on more than 40,000 stocks, bonds, and options.
- Continually updated information on prices and basic news stories incorporating market commentary and statistics.
- Specialized reports on commodities, today's economy, and implications for the future.
- Financial commentary from the nation's leading news publications.

Other databases specializing in business information can supply the text of leading industry newsletters, with extensive search and indexing capabilities. The NewsNet Network, for instance, provides the full text of over 125 business newsletters in the following areas:

- advertising and marketing
- aerospace
- automobile industry
- behavioral sciences and social services
- corporate communications
- education
- electronics and computers
- energy
- entertainment and leisure
- environment
- farming and food

- finance, accounting, and taxes
- general business management
- government regulations and law
- international affairs
- investments
- labor
- metals and mining
- office automation
- politics
- publishing and broadcasting
- real estate
- politics
- telecommunications
- transportation

Interest Calculations. The Commodore 128 can be used to calculate simple, compound, and true interest. A program could be written to calculate the exact number of days between two dates, and the number of months, days, and years in the interest period; leap years would be accounted for. The following formula would be the basis:

$$i = \frac{\text{cpd}}{100 \ 360}$$

- where i = interest on the capital
- c = capital, invested or borrowed
- p = rate of interest
- d = number of days

Compound interest can also be calculated. Given three of the four variables (F , P , i , and n), the fourth may be solved for using equations 1, 4, 7, or 9 in Table 2-1.

The true interest is calculated as follows:

$$R = \frac{24F_c}{m I_m (m + 1)}$$

- where R = the true interest rate
- F_c = finance charge
- m = number of months
- I_m = monthly installment

Minimum Investment for Withdrawals.

This formula may be used to determine the minimum investment required to allow regular withdrawals of a given amount over a given time period, assuming compounded interest with each withdrawal and an ending balance of \$0. A retiree might use this formula to compute the amount to invest in a savings account at 6 percent interest to provide monthly withdrawals of \$100 for 10 years.

$$P = \frac{R \cdot N}{i} \left(1 - \frac{1}{(1 + i/N)^{NY}} \right)$$

- where P = initial investment
- R = amount of regular withdrawal
- i = nominal interest rate
- N = number of withdrawals per year
- Y = number of years

Mortgages

The C-128 can be very useful to the home buyer in simplifying the many financial options that are available. You can use your Commodore to determine mortgage payments based on the interest rates available, the length of the life of the mortgage, and the amount. With recent swings in interest rates, knowing what you will be paying at any given interest can be very important; a difference of a half or one percent can be substantial. This information is also important in budget planning—in determining how much of the family income must be allocated to mortgage or loan payments. You can do a “What if . . . ?” analysis; that is, if interest rates are predicted to decline by 3 percent next year, is it best to buy or wait? With your C-128 and the financial formulas outlined in Table 2-1, the financial ramifications of home buying or other investments can be easily determined.

It may be worth your while to analyze a mortgage agreement on your Commodore 128 before signing any contracts. A yearly amortization program could calculate a schedule of payments, the annual debt service, the mortgage constant, the re-

maining balance, the payment to principal, the payment to interest, the accumulated principal, and the accumulated interest for each year. A general amortization program could solve for the following additional factors: the number of payments to reach a certain balance, the payment amount, the annual percentage rate, and the principal amount.

Special programs could calculate the above values for wraparound mortgages and determine the price and yield of discounted mortgages.

Loan with Points. Points are a percentage of the value of a loan that is paid at the start of the loan period. Theoretically, the seller pays the points, but in practice it does not matter who pays—the price of the house increases with the addition of points.

One point represents one percent of the mortgage value. It must be paid at the beginning of the loan. The important question to consider is how does the addition of points affect the annual percentage rate actually being paid for the loan? A C-128 program could calculate this value given the number of points, amount of the loan, years, and annual percentage rate of the loan. It would then output the value for monthly payments and true annual percentage rate.

Direct Reduction Loan. The payment, present value, or number of time periods for a reduction loan may be calculated by using the equations 2, 8, and 11 in Table 2-1.

Additional Loan Formulas. Here are some more formulas that you will find useful when you are dealing with loans.

- Principal on a loan

$$P = \frac{R \cdot N}{i} \cdot \left(1 - \frac{1}{(1 + i/N)^{N \cdot Y}} \right)$$

- where P = principal
- R = regular payment
- i = annual interest rate
- N = number of payments per year
- Y = number of years

- Regular payment on a loan

$$R = \frac{i \cdot P/N}{1 - \left(\frac{i}{N} + 1\right)^{-N \cdot Y}}$$

where R = regular payment
 i = annual interest rate
 P = principal
 N = number of payments per year
 Y = number of years

- Term of a loan

$$Y = - \frac{\log \left(1 - \frac{P \cdot i}{N \cdot R}\right)}{\log \left(1 + \frac{i}{N}\right)} \cdot \frac{1}{N}$$

where Y = term of payment in years
 P = principal
 i = annual interest rate
 N = number of payments per year
 R = amount of payments

Depreciation Calculations

Standard, composite, and excess depreciations may be calculated with the following methods:

- 1) Straight line depreciation

$$D = PV/n$$

$$B_k = PV - kD$$

- 2) Sum-of-the-years-digits depreciation

$$B_k = \frac{S + (n-k) D_k}{2} \quad D_k = \frac{2 (n-k + 1) PV}{n (n + 1)}$$

- 3) Variable rate declining balance depreciation

$$D_k = PV \frac{R}{n} (1 - R/n)^{k-1}$$

$$B_k = PV (1 - R/n)^k$$

In each of the above depreciation formulas,

PV = original value of asset (less salvage value)
 n = lifetime number of periods of asset
 B_k = book value at time period K
 D = each year's depreciation
 k = the number of the time period (that is, 1, 2, 3, . . . n)
 S = salvage value
 R = depreciation rate
 D_k = depreciation at time period k

The actual depreciation rate for an investment is computed with the formula (see Listing 2-3):

$$\text{depreciation rate} = 1 - \left(\frac{\text{resale price}}{\text{original price}}\right)^{1/\text{age}}$$

This depreciation rate formula may be used to answer queries such as "If a car was bought for \$9000 and sold three years later for \$5100, what is the depreciation rate?"

The *salvage value* of an item at the end of a given year may be calculated with the formula:

$$S = P(1 - i)^Y$$

where S = salvage value
 P = original price
 i = depreciation rate
 Y = age in years

Annuities

Given the values of the required variables as input data, an annuity program could calculate the

Listing 2-3: The Depreciation Rate Calculation Program

```

10 REM DEPRECIATION RATE CALC
20 GRAPHIC 0
30 SCNCLR 0
40 COLOR 0,7:COLOR 5,3:COLOR 4,7
50 PRINT:PRINT TAB(11) "DEPRECIATION RATE"
60 PRINT:PRINT TAB(15) "CALCULATOR"
70 PRINT:PRINT "I WILL CALCULATE THE DEPRECIATION RATE ON ANY
  ITEM FOR YOU."
80 SLEEP 5
90 SCNCLR 0
100 PRINT:INPUT "WHAT IS THE ITEM'S NAME";N$
110 PRINT:INPUT "WHAT IS THE ITEM'S ORIGINAL PRICE";O
120 PRINT:INPUT "WHAT IS THE ITEM'S RESALE PRICE";R
130 PRINT:INPUT "WHAT WILL THE ITEM'S AGE BE, IN YEARS, WHEN IT
  IS SOLD";A
140 D=1-(R/O)^(1/A)
150 PRINT:PRINT "THE DEPRECIATION RATE FOR ";N$;" IS ";D
160 PRINT:PRINT "SHOULD I ALSO CALCULATE THE SALVAGE VALUE?
  (Y/N)":GETKEY Z$
170 IF Z$="Y" THEN GOSUB 230
180 PRINT:PRINT "DO ANOTHER (Y/N)":GETKEY Z$
190 IF Z$="Y" THEN 90
200 COLOR 0,1:COLOR 5,16:COLOR 4,6
210 SCNCLR 0
220 END
230 S=INT(O*(1-D)^A)
240 PRINT:PRINT "THE SALVAGE VALUE OF ";N$;" , AFTER ";A;"
  YEARS, IS ";S
250 RETURN

```

remaining variable in any of the following situations:

- Sinking funds—a sinking fund is an annuity in which a future value is accumulated by making equal payments at equal intervals at a certain interest rate. The value can be computed using equation 10 in Table 2-1.
- Annuity due—the future or present value can be calculated using equations 8 and 10 in Table 2-1.
- Ordinary annuity—This value may or may not include a balloon payment. Again, use equations

2, 8, and 11 in Table 2-1.

Bonds and Warrants

A simple, useful program could be written to determine the value of both short- and long-term warrants. Given present value, coupon interest, yield to maturity, and maturity value for the number of periods (three values out of the four), a Commodore program can compute the remaining term. Taxes, commissions, and current yield could also be determined. The formula used to calculate the present value (cost) of a bond with annual coupons is as follows:

$$\text{Price} = \left[\left(\frac{1 - (1 + i/c)^{-n}}{i/c} \right)^{(1000 \text{ Cr}/2)} + [(1+i/c)^{-n} (1000)] \right]$$

where i = discount rate as %
 n = number of years to maturity multiplied by 2
 Cr = coupon rate of bond
 c = number of compounding periods per year

The formula used to calculate the bond yield of an annual coupon is as follows:

$$j = \frac{Fg - \frac{(B.V.)_1 - (B.V.)_n}{n}}{\frac{(B.V.)_1 + (B.V.)_n}{2}}$$

where j = nominal yield rate
 $(B.V.)_1$ = original bond value
 $(B.V.)_n$ = bond at n years
 F = face value
 g = nominal dividend rate
 n = number of years

PERSONAL ACCOUNTING

There are a number of ways in which your C-128 can help you manage your personal finances more effectively. The Commodore can help you deal with everything from credit card payments to income tax calculations.

Personal Accounts Receivable/Payable

A personal accounts receivable/payable (AR/AP) program similar to a business AR/AP program could manage a large portion of your financial affairs. The program could include these features:

1. A checking and savings account management program to enable you to maintain the current

balance of your checking and savings accounts. Interest credits could be calculated and added. A file of each check (with its number, purpose, notes, amount, and payee) could be stored for later income tax preparation. Specialized reports could be generated from this check file including a check register for a specified time period, the distribution of expenditures, and statements of selected accounts. The ideal program would request all information concerning each check written, store this information, and print the check itself.

2. A budgeting program to keep you up to date on expenditures in various areas so that income can be allocated appropriately. A plan for family spending could take the following format:

Set-asides

Emergencies and future goals	_____
Seasonal expenses	_____
Debt payments	_____
Regular monthly expenses	_____
Rent or mortgage payment	_____
Utilities	_____
Installment payments	_____
Other	_____
Total	_____

Day to day expenses

Food and beverages	_____
Household maintenance	_____
Furnishings, equipment	_____
Clothing	_____
Personal	_____
Transportation	_____
Medical care	_____
Recreation, education	_____
Gifts, contributions	_____
Total	_____

Total of all expenses

_____	_____
-------	-------

Alternatively, you could take realistic estimates for the upcoming year and enter these figures. A program could then use this information in comput-

1001 Things to Do With Your Commodore 128

ing the percentage of gross income that each item requires. As a rule of thumb, housing should cost no more than one fourth of your gross income. This is an example of one of the budgeting principles discussed in most references concerning family budget preparation. The C-128 removes the drudgery of manual calculations for those determined to stick to a well-planned budget.

On command, a budget program could print month-to-date figures and an end-of-month comparison of budget versus actual expenses. It can also show the amount of cash needed to meet budgeted expenses for the rest of the month. It could also maintain tax records, keep a running balance of cash on hand, keep an inventory of your possessions, and even help in planning weekly menus.

Table 2-2 shows a portion of a personal budget report that indicates where the money has been and where it will be spent in a spreadsheet fashion. Such spreadsheets, besides being a personal planning benefit, are often useful when securing a personal loan.

3. A financial behavior determination program to help you analyze your expenditures and sum-

marize your spending in various areas (the same categories from the above budget) that would be useful in preparing a budget plan.

According to the experts at the United States Department of Labor, a family of four should typically allocate its spending as follows:

Housing	24%
Food	24%
Transportation	15%
Clothing, personal care	13%
Taxes	13%
Medical	7%
All other	4%

Families differ, but how do your own expenses correspond to these percentages?

4. A file of unfulfilled contracts, mail orders, and so on for which you have sent checks and have not received a reply. As replies are received, the appropriate accounts are removed from the file.

Table 2-2. A Portion of a Personal Budget Sheet in Spreadsheet Form.

EXPENSE	ACTUAL FOR JOE SMITH OCT. 8, 1982							
	JAN	FEB	MAR	APR	MAY	JUN	JUL	AUG
RENT	650	0	0	0	0	0	0	0
FOOD	323	361	357	371	290	251	410	356
CLOTHES	154	0	54	0	0	0	0	68
UTILITIES	57	56	50	59	62	51	53	59
CREDIT CARD INTEREST	0	0	0	0	0	0	0	0
ENTERTAINMENT	143	100	58	13	24	45	125	54
GASOLINE	100	110	90	100	100	100	95	90
MORTGAGE INTEREST	0	0	0	0	0	0	0	0
MISCELLANEOUS EXPENSE	28	0	44	0	98	0	0	48
CAR EXPENSES	990	0	0	0	0	0	0	0
TOTAL EXPENSE	2445	627	653	543	574	447	683	675
NET INCOME	105	1623	1597	2091	1676	1803	1863	1825

Daily Interest Passbook Savings Account

You can create a Commodore BASIC program to maintain a savings account. The program should have provisions for interest, withdrawals, and deposits.

Income Tax

Preparation of income tax forms is a task that lends itself very well to the Commodore 128 because computers are great organizers and calcula-

tors (see Fig. 2-2), and they can save you both time and money. Tax preparation programs range from the simple arithmetic calculators to the complete personal accounting programs. In the most popular approach, the computer requests answers to such questions as, "What are your federal withholding taxes?" You proceed to answer all of the possible questions necessary to prepare a 1040 tax form (approximately 50), but unfortunately, you must first do considerable accounting and calculating to answer some of the questions. The program would

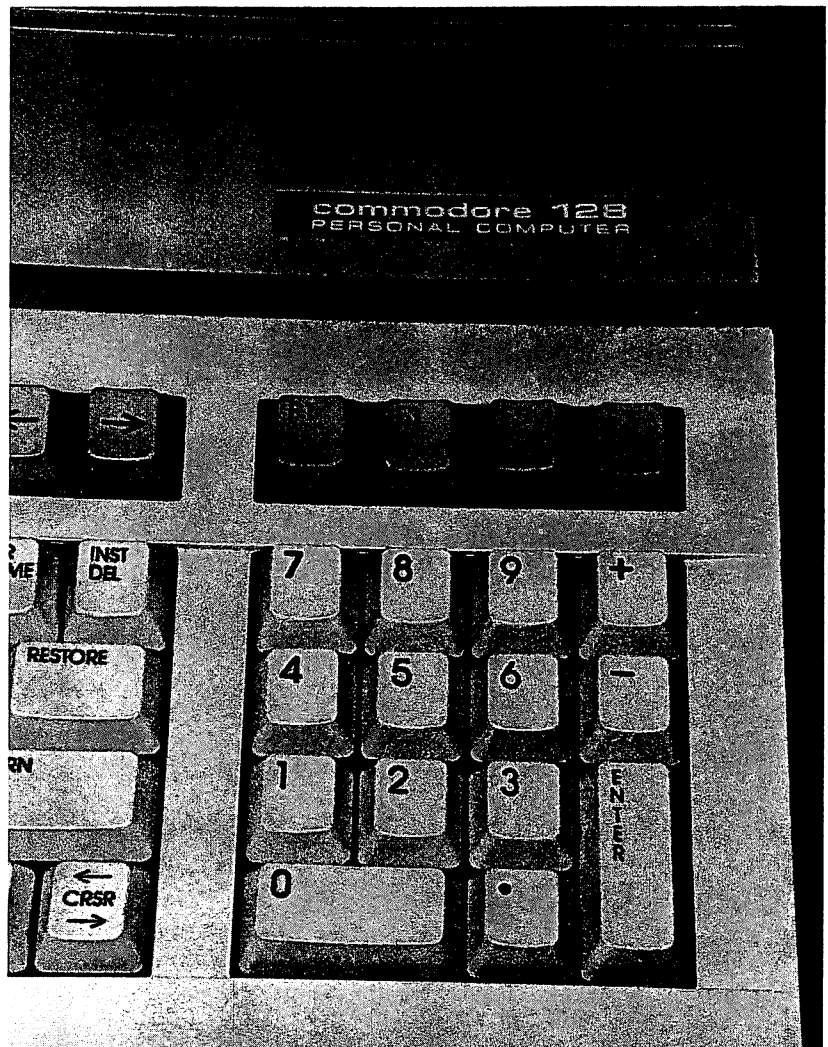

Fig. 2-2. Financial and statistical programming is enhanced with this 14-key keypad that is located to the right of the main C-128 keyboard.

1001 Things to Do With Your Commodore 128

complete the simple arithmetic which is necessary for filling in the 1040 form and then print the proper values in the appropriate boxes on the form.

A more complex approach would involve the periodic storage of all of your financial data on a floppy disk. For example, each week you could store the names, addresses, purposes, numbers, and amounts of all checks written or cashed. At year's end, the Commodore would search and group all relevant data and do all of the necessary calculations. In this latter approach, a complete summary of all deductions and income could be printed categorically. References to the filed location of the original checks, bills, and receipts could be included for proof of the transactions. A warning could also be issued in the event that your deductions exceed ten percent of your income (a tax audit would be likely). Provisions could be made to compare the taxes that you would pay if you filed jointly with your spouse to what you would pay if you filed as an individual.

A tax planning program can help cut your tax liability in the years to come. Investment decisions, personal financial decisions, and business decisions with tax consequences can all be analyzed in planning a tax strategy. In a divorce, for example, the arrangement of a settlement can result in substantially less tax depending upon how the money is allocated between property settlement, alimony, and child support. A tax planning program can be used to quickly answer "What if . . . ?" questions during the negotiation of a settlement. The ease of changing inputs and having the program recalculate the entire return can be a tremendous time-saver.

Additionally, complex calculations such as income averaging on Form G can be done automatically, perhaps yielding a bigger refund for those who previously would not have attempted the calculations manually. A tax planning program in the form of a spreadsheet allows the simultaneous consideration of multiple cases covering different facts and years. The spreadsheet can include graphics showing the impact of adding or subtracting in-

come, deductions, or credits, and varying tax computations over a period of several years—including regular tax, alternative minimum tax, add-on minimum tax, income averaging, and the consideration of limitations on the use of credits. For instance, you could consider the possibility of a second income versus staying at home by having your Commodore 128 program figure the after-tax results of that extra income, which is often discouraging. As another example, assume that you own a business and want to know if you should pay your spouse a salary. Depending upon your income level, this may or may not be advantageous; a tax planning program could determine the best option for your income bracket.

A recurring question among investors is "What are the sources of tax-free income whose yields are equal to or greater than the yields provided by taxable investments?" Should you invest in tax-free bonds and other tax-free securities or place your money in a fully taxable bond, savings account, or treasury bill? Remember that you may wish to consider other factors, such as liquidity of assets. The two formulas necessary to compute taxable and tax-free yields are given below. A simple Commodore BASIC program could compute these for a given situation and determine which alternative offers the better investment.

taxable yield = tax-free yield / (1 - federal tax bracket)

tax-free yield = taxable yield * (1 - federal tax bracket)

For instance, if you are in the 35 percent federal income bracket, have invested in a money-market account at 8 percent, and are offered the opportunity to invest in a tax-free fund yielding 6.2 percent, which is the better investment? Using the second equation above, you find that the tax-free fund would be a better investment at 6.2 percent versus the 5.2 percent after taxes for the money-market account. A more sophisticated program could print a table of yields given the known tax-

free or taxable yield starting value and the increment and the starting value of the tax bracket and the increment. Investors in some states are allowed tax exemptions for qualifying tax-free investments. In this situation, simply add the exempted state tax rate to the federal tax rate when entering your tax bracket value.

Home Banking

You may soon be able to do your banking from home with a Commodore 128. Many banks are conducting pilot home-banking studies and are beginning to sell such services to depositors. With most of these services, a customer dials the bank's central computer or uses one of the timesharing networks, such as CompuServe, through a modem. After providing a secret password, the customer can, for instance, ask for a list of recent deposits and pay bills directly by transferring money from the customer's account to the accounts of the creditors. Banks charge from \$5 to \$15 per month for this service.

MONEY-MAKING APPLICATIONS

There are many ways to use your Commodore 128 to make money; you might consider starting a part-time or full-time business based on one of the following ideas.

Stock Market

One Commodore 128 user is deriving his income from his stock prediction newsletter that is composed of market predictions determined by using "twelve confidential indicators" on his Commodore. In a similar fashion, you could experiment with mathematical analysis of the stock market using the statistical methods outlined earlier in this chapter. A Commodore 128 could also serve to maintain stock portfolios and organize or correlate market predictions and stock recommendations to ease decision making. With the proliferation of financial databases available through the use of a modem, information on stock prices, market per-

formance, and so on could be entered automatically to a stock analysis program designed to scan the entire market, stocks of a given industry group, or solitary stocks. Financial databases may also be scanned to provide historical data or the latest news reports on selected corporations.

The Commodore is certainly useful in mathematical analysis and data storage for other forms of financial investment, including stock options and commodities. Again, the use of financial databases accessible via modems permits the automatic input of data to your analysis program. The commodities trader will probably find the Commodore 128 to be a real boon in organizing and obtaining information in the fast moving and volatile commodities market and in allowing trading from the home for the first time.

Services

The Commodore owner is in the position to offer the following services.

Mailing Lists. A mailing list of people in your area could be used by local firms with direct mail campaigns. The mailing list could be compiled from area phone books and association directories, entered into your C-128, and stored permanently on floppy disks. The list can then be printed on adhesive labels and sold to local businesses. The advantage of being a local business serves to eliminate competition from large mailing list brokers in other cities.

Resumes. People in all areas can use a resume preparation service to write, type, and mail resumes to potential employers. A word processing system could automate this business entirely.

Typesetting, Indexing, and Editing. All businesses and organizations can use a printing preparation enterprise for typesetting and editing promotional material. A Commodore 128 interfaced to a letter-quality printer (e.g., Diablo, Qume, Epson, NEC), laser printer (e.g., Apple LaserWriter, Hewlett-Packard LaserJet), or conventional typesetting equipment can produce excellent justified and camera-ready artwork for printing. The cost

savings of using a Commodore will allow the entrepreneur to offer lower prices for such services and ensure greater accuracy. Furthermore, an indexing service using a C-128 program to create book and magazine indexes could provide a valuable service to small publishing firms.

Home Swap and Rental Locator Services. The practice of swapping one's home with other people during vacation time is quite popular. A service that used a Commodore to categorize homes available and homes wanted could profit by publishing a newsletter of listings.

A rental locator service categorizes homes and apartments for rent from classified newspaper ads or other sources. In metropolitan areas, where finding an ideal home to rent is a difficult task, a service to match people with the right living conditions at the right price would be useful. In a similar manner, a service company could match people with cars for sale by the owners.

One entrepreneur has developed a computerized bartering service for matching the needs to the services of those in high income tax brackets for the purpose of mutual tax write-offs. He charges a small fee for successful bartering arrangements.

Finder Fees. A finder's fee is a sum of money paid to someone who finds something wanted by another person who is willing to offer an award for it, be it business opportunities, products, or rare items. Usually, finder's fees are expressed as a percentage of the amount of money involved in purchasing the item when it is found. A few organizations publish newsletters listing finder's fee opportunities. A person could computerize hundreds of listings for future reference and could correlate the need of buyers with the offerings of sellers.

Telephone Answering Message Service and Newspaper Clippings Service. Telephone answering services of sufficient size can use a Commodore to increase efficiency and lower costs. A newspaper clipping service, which clips articles of interest to paying clients, could use a C-128 to keep track of the varied categories to search for.

Computer Dating Service. Popular a few years ago, computer dating services could make a return appearance, especially in metropolitan areas.

Sports Predictions and Gambling. An enterprising hobbyist uses his Commodore to predict college football scores. The information produced is sold as "CLYDE the computer" sports forecasts to television stations for use on local news broadcasts. Other entrepreneurs have used Commodore predictions of sporting events to publish flyers that are sold at legal dog and horse races.

Employment Agency. The C-128 could be useful to an employment agency in matching the right people with the right jobs. The use of the Commodore may also serve to increase business in itself.

Small Business Systems and Software. Many hobbyists have turned Commodores into a profitable sideline business by selling packaged computer systems with accounting, word processing, and spreadsheet software to small businesses and offering technical support and training. You could also create personalized programs including databases and mailing lists on a freelance basis for firms with Commodores.

Collection Service. A word processing system could automatically output personalized collection letters, which theoretically generate a greater response. Therefore, a low-cost collection service charging a flat rate or a percentage of the money collected would be an excellent sideline business for the C-128 hobbyist.

Word Processing. A word processing service can be employed by businesses to prepare typewritten personalized sales letters. Such a business would be almost totally automated by a Commodore 128.

Bowling League Bookkeeping. A few hobbyists have sideline businesses that calculate bowling league scores and handicaps for ten to thirty cents per player per week. This cost is usually less than the costs for hiring a person to do the bookkeeping.

Supermarket Comparison Service. A

hobbyist turned businessman uses his Commodore to collect and compare price data for popular foods at local supermarkets and sells a listing of the most economical stores to shoppers.

Personalized Books. Children's books containing a child's name, address, and other personal information can be printed by a C-128 and printer economically. Studies show that children prefer reading personalized books over any other type of book and that there is a considerable demand for them. An enterprising hobbyist could develop a large-scale business along these lines. Perhaps a humorous personalized book could be sold for adults as well.

Educational Programs. You could form a distributorship to bring educational Commodore materials to schools, bookstores, and other institutions. The market for educational computer programs is also growing. You could develop popular tutorials concerning electronics, higher mathematics, business and investments, and computers.

Real Estate

Possible applications for Commodores in real estate include the following:

Residential Purchase Analysis. A useful program could calculate the total monthly payment, income tax deductions, and equity build-up resulting from the purchase of a home. An own versus rent analysis could also be useful.

General Real Estate Investment Analysis. Mortgages, cash flow in percent growth return, taxable income (tax shelter), and financial feasibility can be calculated by considering such factors as inflation and interest rates. Income property reports and closing statements may also be generated.

Rental Property Management. A program designed for management of rental properties could store the following types of information for each property or client: receipts, disbursements, gross income, calculated profit and loss, calculated return on investment, and calculated net income.

Appraisal Tabulator Program. A pro-

gram designed for an appraiser could organize and tabulate variables and could determine an appraisal.

Real Estate Evaluation. A program could be designed for use by a potential investor in evaluating a piece of real estate, such as an apartment building. The program would estimate the total monthly income, annual rate of return, and tax deductions based on such input data as cost, down payment on mortgage, estimated overhead costs, and income.

Here's a sample run that will show you what information this kind of program might request and what kind of results it might produce:

Enter the purchase price of the real estate? 75000
Enter the mortgage interest (%) ? 9.75
Enter the mortgage down payment as a % of purchase cost? 10
Enter the number of years in the loan term? 25
Enter the closing cost (% of purchase price)? 2
Enter miscellaneous initial expenses as one sum?
100
Enter the estimated income per month from the property? 1125
Enter the real estate tax for one year? 1300
Enter the estimated overhead costs (maint., utilities, insur., etc.)? 525
For tax deduction purposes, enter the est. property value? 15000
Enter your tax bracket as a % of your income? 40
Is the building on the property new or used ("N" or "U")? N

Tax and Cash Flow Analysis

Monthly expenses \$525.00
Monthly taxes \$108.33
Monthly mortgage \$601.52
Monthly income \$1125.00
Monthly cash flow \$109.85

Tax hedge:

Expenses (yr. #1) \$7650.00

Depreciation (yr. #1) \$6000.00
 Deductible interest \$6581.25
 Real estate tax (yearly) \$1300.00

Total: (yr. #) \$21531.30
 Total income (yr. #1) \$13500.00
 Net deduction (yr. #1) \$8031.25
 Tax advantage (yr. #1) \$3212.50

Return on investment 18%

Curve Fit. A program to fit such data as land prices or construction cost per square foot to a curve may be used to make more accurate forecasts, bids, and estimates.

Internal Rate of Return and Cash Flows. One purpose of an internal rate of return and cash flow program would be to calculate the net present value of a series of cash flows. In general, an investment, V_o , is made in some enterprise that is expected to bring periodic cash flows C_1, C_2, \dots, C_n . Given a discount rate (i), the program would compute the net present value at period k , NPV_k for each cash flow. A negative value for NPV_k indicates that the NPV_k enterprise has not been profitable. A positive value for NPV_k indicates that the enterprise has been profitable to the extent that a rate of return (i) on the original investment has been exceeded.

$$NPV_k = -V_o + \sum_{j=1}^k \frac{C_j}{(1+i)^j}$$

BUSINESS DECISION MAKING

The following Commodore applications can help you make the decisions that will optimize the way that you run your business.

Spreadsheets

Most people have seen or worked with the

traditional accounting ledger spreadsheet or worksheet. Typically, there are descriptions along the left edge, month designations across the top of each column, and room for a totals column on the right. For budget preparation, each line could represent a budget category and have budgeted monthly amounts across the page. Each line and each month's column are totaled. A change to a single number involves replacing a figure with a new one, and readjusting the affected column and row. This is a tedious procedure and one that is prone to error. Therefore, you can appreciate the tremendous benefits of a totally electronic spreadsheet.

A spreadsheet program is a super calculator that provides you with a giant electronic grid that functions analogously to the traditional spreadsheet, as described above. When you change the values of numbers in the grid, the program automatically calculates what effect, if any, there is on all of the other numbers. The spreadsheet can provide answers within seconds to all sorts of financial "What if . . . ?" questions. For example, to qualify for the mortgage that you want, how much income must you have? Or, how would your portfolio value change with a half-point advance in a stock?

A typical electronic spreadsheet may be 2,048 rows long by 256 columns high, depending on the program, floppy disk space, and available Commodore memory. Formulas, equations, and algorithms may be input to provide comparisons, ratios, and totals.

Who uses spreadsheet programs? Anyone who works with numbers might find a use for such a program. Obviously, accounting is a primary area of application, but scientists, engineers, managers, and executives use spreadsheets. How useful a spreadsheet is in a particular situation depends on the degree to which it increases productivity. Frequently, a spreadsheet user will get important answers that previously were not cost effective to obtain. Anyone who needs more accurate and faster calculations is a potential spreadsheet user.

Spreadsheet programs are being used in an

endless variety of applications. Some use it for solving simple or complex equations, others for normal calculator functions, and still others as a complete decision-support tool. Specific uses include financial modeling, budgeting, doing cash flow analysis, planning, making projections, making business plans, creating sales reports, doing "What if . . . ?" analysis, pricing, making cost estimates, tax planning, improving time management, performing chemical formulation, doing regression analysis, and analyzing structural design. Anything that can be done using a calculator can be done more easily and more extensively through the use of a spreadsheet program.

Other Decision-Making Computer Applications

In addition to making the electronic spread-

sheet available as a decision-making tool, the Commodore 128 enables you to use programs to guide you in making decisions in the following areas:

Long- and Short-Term Financing Requirements. A commercially available long-term financing requirement calculation program could compute the cost of capital for various forms of funding (e.g., common stocks, preferred stocks, and bonds), select the cheapest form, and determine the amount needed to support operating plans. A short-term financing requirement calculation program could compute the amount and timing of short-term financing based on sales forecasts, inventory purchases, and collection and payment policies.

Breakeven Analysis. Programs can be used to compute the breakeven points for projects or products based on fixed and variable costs and selling prices; learning curves may also be applied (see Listing 2-4).

Listing 2-4: The Breakeven Calculation Program

```

10 REM BREAKEVEN CALC
20 GRAPHIC 0
30 SCNCLR 0
40 COLOR 0,8:COLOR 5,10:COLOR 4,8
50 PRINT:PRINT TAB(15) "BREAKEVEN"
60 PRINT:PRINT TAB(15) "CALCULATOR"
70 PRINT:PRINT "I WILL CALCULATE THE BREAKEVEN POINT OF A
   PRODUCT FOR YOU."
80 SLEEP 5
90 SCNCLR 0
100 PRINT:INPUT "WHAT IS THE ITEM'S NAME";N$
110 PRINT:INPUT "WHAT IS THE ITEM'S SALES PRICE";P
120 PRINT:INPUT "HOW MANY HAVE BEEN SOLD";K
130 PRINT:INPUT "WHAT ARE THE FIXED COSTS";F
140 PRINT:INPUT "WHAT ARE THE VARIABLE COSTS";V
150 PRINT:INPUT "HOW MANY ITEMS HAVE BEEN PRODUCED";Q
160 IF P*K=F+(V*Q) THEN PRINT:PRINT N$;" IS A BREAKEVEN
   PRODUCT.":GOTO 180

170 PRINT:PRINT N$;" IS NOT A BREAKEVEN PRODUCT"
180 PRINT:PRINT "DO ANOTHER (Y/N)":GETKEY Z$
190 IF Z$="Y" THEN 90
200 COLOR 0,1:COLOR 5,16:COLOR 4,6
210 SCNCLR 0

```

1001 Things to Do With Your Commodore 128

The following must be true, in order to breakeven:

$$P \cdot K = FC + (VC \cdot Q)$$

where P = sales price of each unit

K = quantity of units sold

FC = fixed costs over the period in question

VC = variable costs per unit produced

Q = no. of units produced

Inventory Control. The generalized inventory model known as the economic order quantity (EOQ) is an important part of the management of inventory. The formulas below may be used to compute the EOQ, the minimum inventory costs for a specified time period, and the number of times to order replacement stock during a given time period.

$$EOQ = \frac{\sqrt{2KL}}{M} + S$$

$$C_{\min} = \sqrt{2KLM}$$

$$N = \frac{L}{EOQ}$$

where EOQ = the economic order quantity in units.

C_{\min} = the minimum inventory costs for the time period

N = the number of times replacement stock should be ordered during the period

K = the cost of placing and receiving each order

L = the total number of units used during the period

M = the cost of carrying one unit in inventory for the time period

S = the "safety" quantity of stock to be held in inventory, to minimize the risks or losses involved in running out of a crucial part or item.

Reorder Timing. Programs can be used to compute the reorder point based on inventory carrying costs, stockout costs, and demand variation.

Facility Scheduling. Programs can be used to compute job shop performance (average turn-around time and percent late) based on a variety of scheduling rules (e.g., first-in-first-out or most overdue items first) and on job processing times.

Demand Forecasting. Programs can be used to compute a forecast of future demand by exponentially smoothing past demand.

Market and Media Research. Programs can perform many aspects of this kind of research, including questionnaire analysis.

Purchasing. Programs can analyze vendors (e.g., order-filling speed and previous complaints record) to select the best overall vendors.

Bid Preparation and Job Pricing. The salesman or contractor would find a bid preparation program useful in calculating variable sales prices, keeping running totals, and figuring markups or markdowns. Preparation on the Commodore typically requires one fifth to one tenth the time required by manual methods and frees up more time that can be spent on profit-making.

GENERAL BUSINESS CALCULATIONS AND BUSINESS ACCOUNTING SYSTEMS

The Commodore 128 can be used to keep track of accounts receivable, to prepare aged trial balances, monthly statements, follow-up sales letters and collection letters, and to provide on-line account status inquiry handling.

Writing a Small Business Accounting System

The following is an outline of a small business accounting system designed for use on a Commodore 128 a printer and an optional second floppy disk drive. The program is intended for use by an individual proprietorship or a small partnership. For such a business, tax returns are prepared (either Form 1040 Schedule C or Form 1065), bookkeeping is done, and balance sheets are produced by the

Business and Financial Applications

system described, for management and banking purposes. Advantages of computerizing this information include savings in time and improved error detection.

The most desirable bookkeeping system is called the double entry system; each transaction is entered into two different accounts, and therefore, the system is self-checking. With the double entry system, each transaction is first recorded as money coming from some account and then recorded as money going to some account. Debits, abbreviated as DR for Commodore use, represent an addition to your account or to an expense; credits, abbreviated CR, represent a subtraction from an account or from an expense. In order to determine whether or not the bookkeeping has been done correctly, find out whether or not the debits always equal the credits. For example, if you paid a bill for \$50 and received a check for \$100 for services performed, the bookkeeping entries would be as follows:

- a. Debit (subtract from what you owe) accounts payable for \$50.
- b. Credit (subtract from what you have) cash on hand for \$50.
- c. Debit (add to what you have) cash on hand for \$100.
- d. Credit (add to revenue) income or revenue for \$100.

The continual upkeep of the status of each account for a business is the purpose of the bookkeeping program. An example of the account files along with a suggested Commodore abbreviation for each is listed below:

EXPENSES (debit to add, credit to subtract)

Return and allowances	RTN (goods returned for refund)
Depreciation	DEP (for equipment owned)
Business taxes	TAX

Rent	RNT
Repairs	RPR
Bad debts	BDB (for the charge-off accounting method)
Professional fees	PRF
Amortization	AMT (charge partial costs of organization expense, research/development, etc.)
Fuel	FUL
Telephone	PON
Electricity	PWR
Salaries and wages	SAL (does not include wages included in cost of goods sold)
Interest	INT (interest paid, only)
Labor/production costs	LAB
Purchases	PUR
Insurance	INS
Pension/profit sharing	PEN
Depletion	DPL (used for such assets as mines/oil fields)
Materials/supplies	MAT
Cost of goods sold	CGS (includes: purchases, materials/supplies, labor/production costs, other costs)

ASSETS (debit to add, credit to subtract)

Cash	CSH (usually checking acct. balances)
Receivable	RBL (amounts owed by customers on accounts)
Inventory	INV
Prepaid expenses	PPD
Supplies	SUP
Equipment	EQT

1001 Things to Do With Your Commodore 128

Investments IVS
Miscellaneous ETC

LIABILITIES AND EQUITY

Payables PBL (amounts owed on an account)
Notes NOT (borrowed money)
Long term payables LTP
Proprietor PRP (amount invested in business and net income)
Drawing DRW (amount from which owner may use money for personal expenses)

REVENUES (credit to add, debit to subtract)

Gross receipts RCP
Other revenue REV

The IRS requires reports in the following areas: depreciation, business taxes, repairs, and amortization.

The various reports that may be generated by the system include the balance sheet; a sample balance sheet is listed below:

ASSETS		LIABILITIES	
Equipment	5000.	Notes	2000.
Receivables	500.	Payables	3500.
Cash	3000.	Total	5500.
Total	8500.		
		EQUITY	
		Proprietor	3000
		Total (Liabilities + Equity) =	
			8500.

Assets represent what the businessman has, liabilities represent the amounts owed, and equities

are amounts contributed or earned by the owners.

Another report that is a necessary part of a small business accounting system is termed the income statement. It displays the income and expense of the business during a certain period of time; it may be used to fill out tax forms 1040C or 1065. In order to generate this report, total income is computed and total expenses are subtracted from this figure. Income for accounts may be stated on an accrual basis, which is to say that future expenses or revenues are included if the exact amount is known and certain (e.g., the amounts customers owe may be stated on an accrual basis). Business owners may prefer to prepare a tax return report on a cash basis, in which the only revenue considered is to be cash in and the only expenses considered are cash out. To prepare such a report, you must eliminate payables, receivables, prepaid expenses, and supplies that are not yet part of the cost of the goods sold; the revenue and expense accounts should be adjusted to reflect this change.

Another necessary report is the ledger, which may be of two types: summary and detailed. The detailed ledger is a complete listing of each account transaction (name and amount) that has been input within a certain period of time (usually done on a weekly or monthly basis). The balances up to the time of the beginning of the report have been stored from prior ledgers and are read into the Commodore. A report listing each transaction and the remaining balance in each account is generated. The summary ledger report only lists the remaining balances after adding and subtracting all transactions for a given period of time.

The balance sheet is the final report necessary on a small accounting system. The sum of the liabilities is subtracted from the sum of the assets to determine the balance or net profit for the business owner. This balance is credited to the proprietor (PRP) account, and therefore, the assets plus the net income will balance (remain equal) with the liabilities.

Additional functions of the accounting system could include forecasting income using trend line

analysis of previous balance sheets, forecasting other accounts using previous records, preparing amortization schedules, determining depreciation amounts, and budgeting cash based on forecasting cash on hand and cash payable.

Additional Applications for the Small Business Person or the Professional

The small business person or professional could use his or her Commodore for the following additional purposes.

Order Processing. The Commodore 128 could be used for order editing, freight cost computation, credit card checks, stock availability checks, and order status checks. A billing/invoicing calculation program could provide the following information: net total, total tax, total tax plus freight, total profit, percent of net profit, total value of back-ordered items, total discount amount, total gross amount, and total cost amount.

Sales. The Commodore could prepare a breakdown of sales volume and profitability by product, customer, or salesman. Sales order processing software could print packing slips, deduct sold merchandise from inventory, verify orders, process returned goods, accumulate back orders, enter cash receipts, print invoices, print sales and credit journals, and maintain a customer master file.

General Accounting. General accounting functions include cost record keeping, budgeting, daily exception record keeping, and the issuing of profit and loss statements.

Mailing List. One of the prime assets of a small business is its mailing list, representing customers who are likely to be repeat purchasers. The Commodore 128 simplifies mailing list maintenance and is capable of sorting names according to a variety of characteristics, depending upon how much information is stored by the program in addition to names and addresses. Consider the following promotional or money-saving activities that can easily be accomplished through the use of a full-featured mailing list program:

- Sort list by zip for bulk mail savings.
- Sort list alphabetically and printout as a customer reference.
- Mail pieces to residents of a certain town or zip for a special local promotion.
- Mailings to customers having an upcoming birthday.
- Mailings to all women announcing a special sale on dresses.
- Mailings to only the most active customers for a special "favored customer promotion."

The ability of a mailing list program to sort customers by these and other criteria requires that special codes be input along with the names and addresses. The coding used and its extent are at the user's discretion.

Customer File Management. By functioning in a manner similar to the way that a mailing list programs functions, a customer file management program could keep track of customers in a way that is useful to the business. The data stored could include customer name, address, phone number, occupation, credit limit, current balance, brand preference, total purchases, sales representative, and date of last order. The business manager could then obtain lists of customers according to:

- Outstanding balance of 30+ days, for collection purposes.
- Brand preference, for research and promotional purposes.
- Sales representatives.
- Those who have not ordered within the last year, for consideration of removal from the active list or for a followup campaign.

A mailing list program could be combined with a customer maintenance program to provide a powerful tool—an accurate profile of your customer base, useful reports for the sales staff, and a means for select mail promotion.

Payroll. A complete payroll calculation pro-

1001 Things to Do With Your Commodore 128

gram would include the following features: time card hours computation, check writing, and provisions for commissions, bonuses, piecework salaries, and incentives. Additionally, W-2 forms and payroll summaries could also be generated.

Inventory. A complete inventory management program should be able to output the following reports: detailed inventory, inventory status, on-order, order exception, analysis by cost, list for use in physical inventory, period to date, year to date, minimum quantity search, and inventory projections. The following file update functions should also be provided: place an order, cancel an order, add a new inventory item, and initialize a new period or year. The inventory program could also print purchase orders or reminders.

Contract Preparation. A word processing system could print personalized contract forms. Cost estimation functions could also be integrated into the contract preparation program.

General Business Calculations. Consider the use of your Commodore in performing the following general business computations, which may previously have been too awkward or time consuming when done by manual methods: cash flow, breakeven point, government withholding calculations, selling price from cost and gross profit prorating, unit price comparisons, order quantity for optimum price break, moving average, seasonal average, cyclical analysis, histogram generation, worse-case analysis, universal rate of return, summation of ledger columns, optimum markup or markdown, net present value, choice between debt and equity, lease versus buy determinations, funds statement preparation, perpetual sales quantity, and gross sales revenue.

Professional Practice Management

Professionals with large practices should consider using a Commodore 128 system to do the following:

- Maintaining appointments
- Billing and collection

- Generating appointment reminders
- Accessing reference libraries and data resources for journal articles, diagnoses, case laws, standards, rules and regulations, codes, and drug information.
- Correspondence and document preparation
- Telecommunication with laboratories for diagnostic tests.
- Insurance form preparation or transmission.

Business Letters

Professionally prepared files of business letters are available for Commodore computers to save you time from having to create your own letters. There are typically over 1000 letters for review, modification, and output through the use of a word processing program.

Sales Device

The Commodore 128 can be used as a sales device in several ways. Now that telephone dialing interfaces are available, you can use the Commodore to call every possible telephone number in an exchange or from a customer file and deliver a taped retail sales message to anyone who answers. At expositions or retail sales outlets, a Commodore with a video display can continually list sales information. Crude question-and-answer capabilities could also be provided.

Use of the Commodore as a customer advisor can increase sales traffic, as well. For example, a garden supply shop could provide customers with access to a Commodore 128 programmed to answer gardening questions about specific plants (e.g., questions about growing seasons and nutrient requirements), amount and type of fertilizer for a certain size lawn and type of grass, and possibly output a complete garden plan. A wine shop Commodore could recommend a type of wine to accompany a given meal, the glass and temperature to use, and the comparative prices of wines. The cosmetics department of a store could use the Commodore 128 to suggest brand name cosmetics to use in

achieving a certain complexion. A swimming pool maintenance company advertises that it offers a free computer analysis of anyone's swimming pool water. From water samples, the computer determines the type and amount of chemicals necessary to maintain a specific pool; these chemicals are then sold to the pool owner.

Time Calculations

Calculation of the difference in hours or days between two given times is an important business application. The results can be used in determining hours worked for payroll purposes or in figuring accumulated interest.

Time differences between major cities or time zones could be calculated by a program. A world map could also be displayed on a video screen with the appropriate times in major cities continuously updated. This application may be useful to those making long distance calls or flying into other time zones.

The Calculation of Reference Tables

Any mathematical function may be expressed as a table of values corresponding to the factors in the equation. Businesses that need to calculate the value of a particular function could produce a table listing values at specified intervals for easy reference. For example, a portion of a chart used in converting British pounds to American dollars is reproduced here. Note that the dollar equivalents are found in the interior of the chart.

	pence										
	.00	.10	.20	.30	.40	.50	.60	.70	.80	.90	
pounds	1	1.90	2.09	2.28	2.47	2.66	2.85	3.04	3.23	3.42	3.61
	2	3.80	3.99	4.18	4.37	4.56	4.75	4.94	5.13	5.32	5.51
	3	5.70	5.89	6.08	6.27	6.46	6.65	6.84	7.03	7.22	7.41
	4	7.60	7.79	7.98	8.17	8.36	8.55	8.74	8.93	9.12	9.31

The conversion rate for this chart is 1.90 dollars per British pound. As an example of its use, the number of dollars that are equivalent to 4.90 pounds is given by the chart as 9.31.

Your Commodore 128 can be a time saver by computing and outputting tables concerning areas such as:

- Stock commissions.
- Values of an investment or savings account over periods of time.
- Unit prices after certain quantity purchases.
- Break-even values for various prices and sales of a product.
- UPS/USPS rates to various cities for various weights.

THE COMPUTER AND THE PROFESSIONS

In this section a variety of ways in which the C-128 can be used in the professions and in many blue collar occupations are listed. This short listing is far from complete; uses of Commodores are so diverse that these descriptions can only be suggestive of a few of the many applications.

Accountants and tax specialists:	All aspects of work
Advertising:	Client fees Composition and printing costs Production (film and TV) costs Space and time buying Statistics in market research
Agriculture:	Yields per acre Livestock growth and feeding Livestock food supplements Crop mix and rotation Fertilizer ratios
Appraisers:	Comparative values Quantities Summations
Architects:	Strength of materials Loads, stresses, and strains

1001 Things to Do With Your Commodore 128

	Geometrical configurations		Foreign size conversions
Artists and designers:	Supplies and materials		Cost relative to markup at retail
	Scale reductions and expansions		Profit potential
Attorneys:	Client fees by hours worked	Chemists and lab technicians:	Quantitative measurements
	Terms of contracts		Composition of solutions and compounds
	Tax calculations		Rates of reactions
Auto salesmen:	Bankruptcy dispositions		Volumetric and gravimetric analysis.
	Optional equipment costs	Construction trades:	Calculations of materials, labor time, charges, and so on by bricklayers, masons, carpenters, plasterers, plumbers, etc.
Auto service and repair:	Discounts and prices		
	Used car allowances	Dieticians:	Food quantities and costs
	Towing and road service costs		Nutritional and caloric values
	Costs of materials and labor	Educators—teachers:	Grading homework and examination papers
Banking:	Estimates		Classroom games and instructions in arithmetic, English, etc.
	Interest, assets, annuities, insurance	Employment counselors:	Working conditions, wages, and salaries
	Foreign exchange		Fringe benefits
	Collateral	Engineers:	Labor supply and openings
Broadcasting:	Trust and pensions		All phases of construction, including plant location studies, tax rates, labor and transportation charges, loads, amounts and costs of raw materials, excavation needs, fill, wood, wire and cement forms, steel reinforcement,
	Program scheduling		
	Advertising rates		
Building contractor:	Station logs		
	Measuring land sites		
	Amounts and costs of roofing, flooring, siding, etc.		
	Electrical loads and needs		
	Figuring gutters, windows, screen sizes		
	Water pressures, plumbing		
	Work schedules and transportation		
Building maintenance:	Supplies and power		
Buyer:	Waste disposal		
	Comparative costs among suppliers		
	Shipping charges		

Business and Financial Applications

Geologists:	<p>strength of materials, electrical loads, chemical reactions, etc.</p> <p>Land measurements</p> <p>Chemical analysis and assays</p> <p>Mineral depletion rates</p>	Landscape architects and contractors:	<p>Land areas, planting and fertilization schedules</p> <p>Land fill</p>
Hotel and inn keepers:	<p>Supplies and labor</p> <p>Occupancy rates</p> <p>Concession profits and activity</p> <p>Group discounts and catering</p>	Manufacturer's representative:	<p>Cost of items less discounts</p> <p>Shipping and insurance costs</p> <p>Invoices prepared for suppliers and clients</p>
Independent businesses:	<p>Balance sheet, profit and loss statements</p> <p>Purchases, returns, and allowances</p> <p>Cost of materials, labor, services, loans</p> <p>Figuring profit on investment and costs of expansion</p> <p>Itemizing for tax deductions</p> <p>Depreciation schedules</p>	Market research:	<p>Statistics of opinion and field testing</p> <p>Extent and nature of competition</p> <p>Prescribing or utilizing medications, anesthetics, prosthetic devices, etc.</p> <p>Operational costs of services</p> <p>Supplies inventories and costs</p>
Insurance salesman:	<p>Premiums, dividends on policies</p> <p>Annuities</p> <p>Alternative insurance packages</p> <p>Proper levels of coverage</p>	Medical, dental, and other health services:	<p>Geometric configurations</p> <p>Measurements and conversions</p> <p>Alternative designs</p> <p>Absenteeism rates, efficiency</p> <p>Vacations, illness rates</p> <p>Wage rate compliances and comparisons</p> <p>Employee benefits</p> <p>Hirings and severances</p>
Interior decorating:	<p>Amounts and costs of fabrics, rugs, carpeting, drapes, wallpaper, etc.</p> <p>Discounts for quantity</p> <p>Shipping times and charges</p>	Pattern makers:	<p>Pharmaceutical measurements</p> <p>Supplies inventory and costs</p> <p>Pricing</p> <p>Composition of solutions</p> <p>Supplies comparisons</p> <p>Pricing</p> <p>Exposure times and shutter speeds</p>
Jewelers:	<p>Pricing and costs</p> <p>Composition of precious metals</p> <p>Gem weights and sizes</p>	Pharmacists:	
		Photographers:	
		Personnel administration:	

1001 Things to Do With Your Commodore 128

Pilots:	Passenger and freight loads Fuel consumption and capacities Navigation		Employer's personal finances Correspondence and memo verification
Printers:	Paper stocks Scheduling printing runs	Security analysts:	Profits, expenses, P/E ratios working capital, depreciation, growth rates, dividends, etc.
Psychologists:	Psychological testing Statistics of experiments		Technical and fundamental analyses
Publishing:	Composition and printing costs Postage and shipping costs Inventory control Distribution costs Discounts	Securities salesmen:	Margin costs and availability Dividend and interest yields Commissions earned Growth rates, price changes, balanced portfolios
Real estate:	Market and appraised value Development costs Taxes, insurance, water, and heating costs, Closing fees	Social services:	Welfare availability versus family needs Family budgeting Land measurements
Restaurants:	Commissions Food and liquor costs and prices Tips	Surveyors: Travel agents:	Discounts on fares, tours, hotels Commissions earned Distances and costs per distance Converting foreign currencies, kilometer distances, etc.
Renting and leasing:	Interest charges and cash flow Inventory and usage rates		Billing airlines, steamship lines, bus companies, tours, hotels, etc.
Sales, door to door:	Travel and other expenses Statements to suppliers Commissions	Trucking and shipping:	Load capacities by weight and volume Distances, time schedules, costs Equipment inventory and maintenance License fees and taxes
Sales, retail:	Taxes and commissions Inventory and turnover Pricing—markups and markdowns	Typographers:	Printers' measurements Plates and etchings
Secretaries:	Petty cash, travel expenses Postage costs Budget, production, sales reports		

Waiters and waitresses:	Tips
	Totaling checks
Wholesalers and manufacturers	Labor and overhead
	Loss on discounting customers' interest- bearing notes
	Interest on account bal- ances
	Recording payments, promissory notes, partial payments
	Consignments and re- turns
	Shipping costs and taxes

Chapter 3



Commodore 128 Number Crunching: Mathematical and Statistical Applications

One of the biggest assets of the Commodore 128 is its ability to perform complicated and tedious mathematical calculations with unerring diligence. Your C-128 can be programmed to emulate a simple adding machine or a complex scientific business calculator. It can perform statistical computations of use to those involved with businesses, investments, questionnaire analysis, and the sciences.

THE COMMODORE 128 AS A SOPHISTICATED CALCULATOR

A program could be written to emulate the functions of an ordinary calculator (see Listing 3-1) or an RPN calculator. The computer could be used as a simple business or scientific calculator for a variety of purposes (see Fig. 3-1). Additionally, functions not provided on an ordinary calculator

Listing 3-1: The Desktop Calculator Program

```
10 REM DESKTOP CALCULATOR
20 COLOR 0,2:COLOR 1,1:COLOR 4,2
30 X=14:Y=0:C#="":D#="":E#=""
40 GRAPHIC 1,1
50 BOX 1,100,0,200,125
60 DRAW 1,100,20 TO 200,20
70 CHAR 1,15,3,"7 8 9 +"
80 CHAR 1,15,5,"4 5 6 -"
90 CHAR 1,15,7,"1 2 3 ="
100 CHAR 1,15,8,"    "
110 CHAR 1,15,9,"    0    "
120 CHAR 1,15,10,"    "
130 CHAR 1,15,11,"    END    "
```

1001 Things to Do With Your Commodore 128

```

140 CHAR 1,12,20,"PRESS E TO END"
150 GETKEY N$
160 SOUND 1,500,8
170 X=X+1
180 IF X=24 THEN X=14:CHAR 1,X,1,"          ":Y=0
190 CHAR 1,X,1,N$
200 IF N$=CHR$(43) THEN Z=Y:FOR W=0 TO Y:C#=C#+STR$(A(W)):
    NEXT W:M=0
210 IF N$=CHR$(45) THEN Z=Y:FOR W=0 TO Y:C#=C#+STR$(A(W)):
    NEXT W:M=1
220 IF N$=CHR$(69) THEN 370
230 A(Y)=VAL(N$)
240 IF N$=CHR$(61) THEN 260
250 Y=Y+1:GOTO 150
260 FOR W=Z+1 TO Y:D#=D#+STR$(A(W)):NEXT W
270 C=VAL(C#):D=VAL(D#)
280 IF M=1 THEN E=C-D
290 IF M=0 THEN E=C+D
300 E#=STR$(E)
310 L=LEN(E#)
320 E#=LEFT$(E#,L-1)
330 IF E#=" " THEN E#=""
340 CHAR 1,14,1,"          ":CHAR 1,14,1,E#
350 Y=0:Z=0:X=14:E=0:C=0:D=0:M=0:C#="":D#="":E#=""
360 GOTO 150
370 GRAPHIC 0:COLOR 0,1:COLOR 5,16:COLOR 4,6:SCNCLR 0

```

Fig. 3-1. Listing 3-1 generates a functional desktop calculator. In this example, the addition of 12 and 37 awaits the pressing of the equals key (=). All calculations in this program are entered in conventional fashion. In other words, you would press the following keys in this demonstration: 1, 2, +, 3, 7, and =.

12+37			
7	8	9	+
4	5	6	-
1	2	3	=
0			
END			

Commodore 128 Number Crunching: Mathematical and Statistical Applications

could easily be included (e.g., the ability to solve quadratic equations).

RPN Calculator

RPN, which stands for Reverse Polish Notation, is a system of representing mathematical equations. Some of the advanced scientific calculators use the RPN system because fewer keystrokes are required to do complex calculations with an RPN system than with the regular system. The RPN system is often easier to use after you have gained familiarity with it. You could program the C-128 to emulate an RPN calculator, providing many mathematical functions.

In the RPN system there are no parentheses and no = (equals) key. Only two numbers are worked with at one time. A sample calculation would proceed as follows:

Step	Input	Display	Comments
①	2.5	2.5 0 0 0	Enter first number These are the four registers
②	4	4 2.5 0 0	Enter second number as new numbers are input, preceding inputs are shifted through the registers.
③	*	10 4 2.5 0	* stands for multiplication. The answer to 2.5×4 was calculated and put in the first position in the display.
④	10	10 10 4 2.5	enter third number

Step	Input	Display	Comments
⑤	5	5 10 10 4	enter fourth number
⑥	/	2 5 10 10	/ stands for division. The following calculation was performed, and the answer was stored in the first display position: $10/5 = 2$
⑦	+	12 2 5 10	The + sign instructed that the two preceding results were to be added: $10+2=12$; the answer was stored in the first position. The two preceding results were added because no new numbers were input for the computation.

The functions that should be available in such an RPN program are described below:

function	description
*	multiplication
+	addition
/	division
-	subtraction
↑	powers (e.g., $x + y$ stands for x^y and $x + .5$)
√	stands for \sqrt{x}
INV	inverse (e.g., $1/x$)
C	clear display/registers
SIN	compute the sine of x
ASIN	compute the arcsine of x
COS	compute the cosine of x

1001 Things to Do With Your Commodore 128

function	description	function	description
ACOS	compute the arccosine of x		lates given rectangular coordinates
TAN	compute the tangent of x	RECT	compute rectangular coordinates given polar coordinates
ATAN	compute the arctangent of x		
SEC	compute the secant of x		
ASEC	compute the arcsecant of x	MET	compute metric conversions—a subprogram
COT	compute the cotangent of x	HSIN	compute the hyperbolic sine of x
ACOT	compute the arccotangent of x	HCOS	compute the hyperbolic cosine of x
CSC	compute the cosecant of x	HTAN	compute the hyperbolic tangent of x
ACSC	compute the arccosecant of x	HSEC	compute the hyperbolic secant of x
PI	place the value of π in the register	HCSC	compute the hyperbolic cosecant of x
E	compute the exponential of x (i.e., e^x)	HCOT	compute the hyperbolic cotangent of x
LOG	compute the logarithm of x	#SIN	inverse hyperbolic sine of x
MEM+	add a number to the memory register	#COS	inverse hyperbolic cosine of x
MEM-	delete a number from the memory register	#TAN	inverse hyperbolic tangent of x
%	change x to a percentage value	#SEC	inverse hyperbolic cosecant of x
N!	compute the factorial of x	#CSC	inverse hyperbolic cotangent of x
SD	compute the standard deviation for a set of scores	#COT	inverse hyperbolic secant of x
HYP	compute the value for the hypotenuse of a triangle given the two sides	SZ	switch the z registers
SIDE	compute the value for a side of a triangle given the hypotenuse and another side	RZ	rotate the z registers
DEG	change x from radians to degrees	QUAD	compute solutions to quadratic equations with the quadratic equation
RAD	change x from degrees to radians	?	put computer in monitor mode so that ordinary calculations may be made in the form PRINT 5*1.6. Type
POLR	compute polar coordi-		

description

CONT in some BASICs to continue with the program

STATISTICS

The Commodore 128 is well suited for dealing with statistics. Basic statistics for one or two variables (e.g., mean, variance, and standard deviation) can be found for a set of observations on one variable. For paired variable sets, the above statistics could be determined for each, and the covariance and correlation coefficient calculated.

$$\text{Mean } \bar{x} = \frac{\sum x}{n}$$

$$\begin{aligned} \text{Variance } \sigma_x^2 &= \frac{\sum(\text{deviation from true mean})^2}{n} \\ &= \frac{\sum(x - \mu)^2}{n} \end{aligned}$$

$$\text{Standard deviation } \sigma_x \sqrt{\text{variance}}$$

$$r = \frac{\sum XY - n\bar{X}\bar{Y}}{\sqrt{(\sum X^2 - n\bar{X}^2)(\sum Y^2 - n\bar{Y}^2)}}$$

Means and Moments. For grouped or ungrouped data, the arithmetic, geometric, and harmonic means can be determined. The second, third, and fourth moments about the mean and the coefficients of skewness and kurtosis can also be calculated.

One and Two Way Analysis of Variance. The mean and variance for two treatment groups and for the entire sample can be calculated, and an F statistic can be applied to the differences between populations.

Contingency Table Analysis. The chi-square statistic may be used to test independence between row and column classifications of a con-

tingency table.

Linear Regression. A set of observations can be fit to a straight line by linear regression. The coefficient of determination, the standard error of y on x, and the standard error for the coefficients can also be computed. Multiple linear regression fits and polynomial regression could also be performed.

For the linear equation $y = a + bx$.

$$\begin{aligned} b &= \frac{\sum XY - n\bar{X}\bar{Y}}{\sum X^2 - n\bar{X}^2} \\ a &= \bar{Y} - b\bar{X} \end{aligned}$$

where $\bar{X} = (\sum X)/n$, $\bar{Y} = (\sum Y)/n$

Survey Analysis. The following statistical parameters could be calculated by a complete survey analysis program: multivariate analysis, regression analysis, time-series analysis, variance determination, factor analysis, descriptions, and tabulations.

Generation of Frequency Tables. For a large sample, a sorting program could output a standard or relative frequency table.

Hypothesis Testing. A useful program could determine confidence intervals for a given sample, which can then be used in testing hypotheses. Statistical hypothesis testing is used to answer such questions as, "A businessman claimed that 20 percent of the public prefers his product. If 100 people were asked their opinion, what percentage would have to respond negatively for this claim to be refutable?"

Statistical Distribution. The approximations for normal and student's t-distributions given below are designed for easy translation into Commodore BASIC program statements and have wide applications in statistical analysis.

Similar approximations, available in statistical handbooks and the U. S. Bureau of standards manuals of computer approximations, can be used to compute chi-square and F distributions.

• Normal Distribution

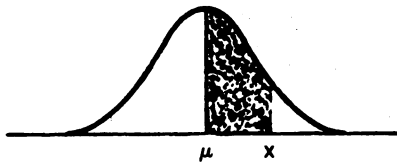

Standard Normal Distribution

$$u = \frac{(x - \mu)}{\sigma x}$$

probability of x falling in the shaded area above = $1 - r(a_1 t + a_2 t^2 + a_3 t^3) + \epsilon(x)$

where: $a_1 = 0.4361836$
 $a_2 = -0.1201676$
 $a_3 = 0.9372980$
 $r = (e^{-x/2})(2\pi)^{-1/2}$
 $t = (1 + 0.3326x)^{-1}$
 $|\epsilon(x)| < 10^{-5}$

• Student's t-distribution

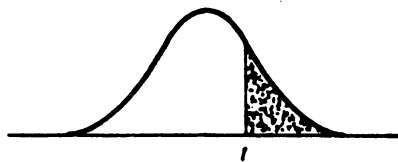

Student's t-distribution

area of right-tail = $\frac{1}{4}(1 + a_1 x + a_2 x^2 + a_3 x^3 + a_4 x^4)^{-4} + \epsilon(x)$

where: $a_1 = 0.196854$
 $a_2 = 0.115194$
 $a_3 = 0.000344$
 $a_4 = 0.019527$

t = t-value

d = no. degrees of freedom

$$x = (t^{2/3} (1 - 2/9d) - 7/9) (2/9 + t^{2/3} \cdot 2/9d)^{-3/2}$$

$$|\epsilon(x)| < 2.5 \cdot 10^{-4}$$

Statistical Analysis

Statistical analysis programs have a wide range of applications in business, stock analysis, and the sciences.

A program dealing with statistics with one variable can be used to find basic descriptions for a set of data—that is the mean and the standard deviation. Another program could determine the linear regression for a set of (x,y) pairs. For example, the relationship between the price of a stock (x) to the Dow-Jones Industrial Average (y) could be determined by inputting corresponding pairs of values. A program could be created that computes the area under a normal curve between two points. A normal curve is used to describe many phenomena; it is pictured and mathematically described above. The area under the curve is equal to one. The average of a set of data (x) is the point at which the curve peaks. If two values on the x axis are picked, the area under the curve between these two points is equal to the probability of a value being between those points.

You could program your Commodore 128 to compute the cumulative binomial probability for the occurrence of a given value or to plot data in simple bargraph format. This program could be made to plot data on an x,y axis or to create a labeled histogram. A C-128 program could even be written to exponentially smooth a set of data. Data values would be entered, and an exponential function used to predict future values. This smoothing constant should be adjusted so that the output error is minimized.

MATHEMATICS

Your Commodore 128 can be called upon to perform all of the following:

Commodore 128 Number Crunching: Mathematical and Statistical Applications

- Solution of quadratic and cubic equations: given the coefficients of either a quadratic or cubic equation, a program could solve for both real and complex roots; equations of degrees could also be solved for.
 - Roots of f(x): a program could find the roots of a user-defined function using the bisection method or Newton's method.
 - Vector operations: given two vectors in two dimensions, a program could calculate their magnitudes, the angle between them, and their dot and cross products.
 - Triangle solution: for a triangle with three known "variables," the lengths of the sides, the angles between sides, and the area could be computed.
 - Curve solution: the arc length, central angle, radius, chord length, and tangent length for a curve could be calculated given two known parts; the area enclosed by these parts could also be calculated.
 - Arithmetic, geometric, and harmonic progressions: a table of elements for the above three progressions could be generated. The element and the sum of the first n elements could also be determined.
 - Factors of integers, GCD, LCM: the prime factors of an integer, the greatest common divisor (GCD), and the least common multiple (LCM) of two integers could be determined.
 - Function value table: a useful program could print the values for a user-defined function over a specified interval.
 - Prime number table: a table of prime numbers or a test for primes in a specified interval could be generated.
 - Partial sums and products: the partial sum or product of a user-defined function could be computed.
 - Interpolation between known values: Lagrange polynomial interpolation, or the Newton divided difference method may be performed to interpolate values of a function.
 - Gaussian integration: the integral of a user-defined function can be determined by Gaussian quadrature.
 - Solutions of differential equations: first-order differential equations may be solved by a program using the Runge Kutta method; a step size may be determined to yield results within a specific error tolerance.
 - Polynomial arithmetic: addition, subtraction, multiplication, and division of polynomials may be accomplished.
 - Polynomial evaluation: a polynomial $(P_x) = a_0 + a_1x + a_2x^2 + \dots + a_nx^n$ may be evaluated at a point x with complex coefficients.
 - Polynomial root finding: Barstow's method is well suited for computer evaluation of quadric factors for polynomials of degree n.
 - Complex arithmetic: addition, subtraction, multiplication, division, squares, inverses, and so on may be performed using complex numbers.
 - Complex trigonometric functions: common trigonometric functions may be evaluated using complex numbers.
 - Base conversions: a useful program could transform numbers of any real base to another base.
 - Graphing calculations: the intervals to use for proportional axes given the minimum/maximum values and number of major divisions could be calculated and used for plotting data manually or with a plotter/printer. Additionally, conversion routines between radians, quadrants, revolutions, and degrees could be provided.
 - Coordinate conversion between rectangular and polar equivalents may be computed with these formulae:

$$r = \sqrt{x^2 + y^2}$$

$$A = \arctangent(y/x)$$

$$x = r \cdot \cosine(A)$$

$$y = r \cdot \sine(A)$$
- where: $x = \text{abscissa}$ } Cartesian coordinates
 $y = \text{ordinate}$ }
 $r = \text{magnitude of ray}$ } Polar coordinates
 $A = \text{angle (in degrees)}$ }

See Listings 3-2 and 3-3 and Fig. 3-2.

Listing 3-2: The Trigonometric Calculator Program

```

10 REM TRIG CALCULATOR
20 COLOR 0,2:COLOR 1,1:COLOR 4,2
30 X=14:Y=0:C$="":D$="":E$=""
40 GRAPHIC 1,1
50 BOX 1,100,0,200,125
60 DRAW 1,100,20 TO 200,20
70 CHAR 1,15,3,"7 8 9 A"
80 CHAR 1,15,5,"4 5 6 C"
90 CHAR 1,15,7,"1 2 3 L"
100 CHAR 1,15,8,"      "
110 CHAR 1,15,9,"S  0  Q"
120 CHAR 1,15,10,"      "
130 CHAR 1,15,11," E   =  "
140 CHAR 1,12,17,"PRESS A TO ATN"
150 CHAR 1,12,18,"PRESS C TO COS"
160 CHAR 1,12,19,"PRESS L TO LOG"
170 CHAR 1,12,20,"PRESS S TO SIN"
180 CHAR 1,12,21,"PRESS Q TO SQR"
190 CHAR 1,12,22,"PRESS E TO END"
200 CHAR 1,6,24,"ENTER FUNCTION, THEN VALUE"
205 CHAR 1, 1, 24, "(ANGLES SHOULD BE ENTERED IN RADJANS)"
210 GETKEY N$
220 SOUND 1,500,8
230 X=X+1
240 IF X=24 THEN X=14:CHAR 1,X,1,"      ":Y=0
250 CHAR 1,X,1,N$
260 IF N$=CHR$(65) THEN Z=Y:M=0
270 IF N$=CHR$(67) THEN Z=Y:M=1
280 IF N$=CHR$(76) THEN Z=Y:M=2
290 IF N$=CHR$(83) THEN Z=Y:M=3
300 IF N$=CHR$(81) THEN Z=Y:M=4
310 IF N$=CHR$(69) THEN 480
320 A(Y)=VAL(N$)
330 IF N$=CHR$(61) THEN 350
340 Y=Y+1:GOTO 210
350 FOR W=Z+1 TO Y-1:D$=D$+STR$(A(W)):NEXT W
360 D=VAL(D$)
370 IF M=0 THEN E=ATN(D)
380 IF M=1 THEN E=COS(D)
390 IF M=2 THEN E=LOG(D)
400 IF M=3 THEN E=SIN(D)
410 IF M=4 THEN E=SQR(D)
420 E$=STR$(E)
430 E$=LEFT$(E$,9)

```

```

440 IF E$=" " THEN E$="0"
450 CHAR 1,14,1,"          ":CHAR 1,14,1,E$
460 Y=0:Z=0:X=14:E=0:C=0:D=0:M=0:C$="":D$="":E$=""
470 GOTO 210
480 GRAPHIC 0:COLOR 0,1:COLOR 5,16:COLOR 4,6:SCNCLR 0
    
```

Listing 3-3: The Trigonometric Plotter Program

```

10 REM TRIG PLOTTER
20 GRAPHIC 0:SCNCLR 0
30 PRINT:PRINT "I AM A TRIGONOMETRIC PLOTTER."
40 PRINT:PRINT "TO USE ME, FOLLOW THE MENU INSTRUCTIONS"
50 PRINT:PRINT "PRESS ANY KEY TO GO TO THE MENU":GETKEY Z$:
   SCNCLR 0
60 PRINT:PRINT TAB(12)"TRIG PLOTTER MENU"
70 PRINT:INPUT "CHOOSE ONE: S)SIN  C)COS":C$
80 PRINT:INPUT "ENTER AMPLITUDE: (1-80)":A
90 PRINT:INPUT "ENTER PERIOD: (.1-4.5)":P
100 PRINT:PRINT "YOU WILL SOON SEE THE FOLLOWING PLOT-"
110 IF C$="S" THEN PRINT:PRINT "A SIN PLOT OF X FROM 0 TO 310
   WITH A PERIOD OF":P;"AND AN AMPLITUDE OF":A
120 IF C$="C" THEN PRINT:PRINT "A COS PLOT OF X FROM 0 TO 310
   WITH A PERIOD OF":P;"AND AN AMPLITUDE OF":A
130 PRINT:PRINT "PRESS ANY KEY TO SEE THIS PLOT":GETKEY Z$
140 COLOR 0,8:COLOR 1,12:COLOR 4,8
150 GRAPHIC 1,1
160 IF C$="S" THEN 180
170 IF C$="C" THEN 230
180 FOR X=0 TO 310 STEP P
190 Y=(SIN(X))*A
200 DRAW 1,X,Y+90
210 NEXT X
220 GOTO 270
230 FOR X=0 TO 310 STEP P
240 Y=(COS(X))*A
250 DRAW 1,X,Y+90
260 NEXT X
270 SLEEP 4:COLOR 0,1:COLOR 5,13:COLOR 4,6
280 GRAPHIC 0
290 SCNCLR 0
300 PRINT:PRINT "DO ANOTHER (Y/N)?:GETKEY Z$
310 IF Z$="Y" THEN 20
320 SCNCLR 0
    
```

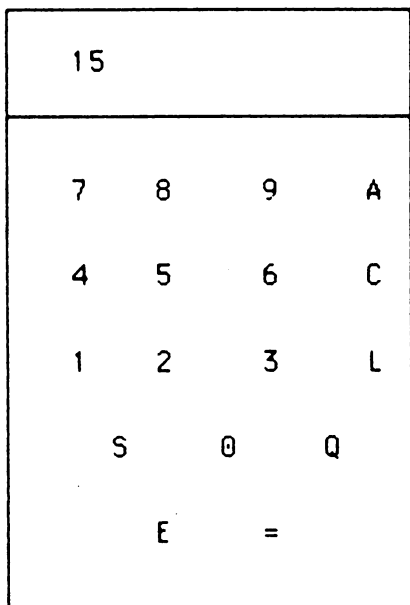

Fig. 3-2. This trigonometric calculator is from Listing 3-2. The displayed result, 15, was obtained by finding the square root of 225. These keys were pressed to find this answer: Q, 2, 2, 5, and =. When using this program, always enter the function followed by the value.

The Solution of Simultaneous Equations

The C-128 can be used to find the solution to a set of simultaneous equations. This mathematical operation has applications in many areas including business and science. An example of two equations to be solved simultaneously follows:

$$\begin{aligned} 5X &= 4Y + 24 \\ 2.5Y &= 6X - 4 \end{aligned}$$

If the equations are solved simultaneously, a value will be found for X and Y such that both equations will be correct.

Integral Evaluation

Among the many methods used for computer evaluation of integrals is Simpson's Rule:

$$\int_a^b f(x)dx \approx h/3[f(a)+4f(a+h)+2f(a+2h)+4f(a+3h)+\dots+2f(a+(n-2)h)+4f(a+(n-1)h)+f(b)]$$

where $h = \frac{b-a}{n}$ and $n =$ number of iterations
(as n increases, accuracy increases)

The trapezoidal approximation is another algorithm used with computers.

The trapezoidal approximation is another algorithm used with computers.

Determining the Equation of a Line

One useful Commodore 128 program is one that would accept (x,y) data points and use linear regression to determine the equation of the line that best fits, or describes, the data. Applications are numerous. For instance, if you were on a weight-loss plan and input values for your weight versus your amount of exercise or calorie intake, the program could find the equation of a line that best fits this data. Therefore, you could input a value for one variable (e.g., calorie intake) and receive a corresponding value (e.g., weight) for the other variable. Other areas that could be analyzed include

stock price versus Dow-Jones Index, miles traveled versus gallons used, distance versus time, and heating costs versus outside temperature. Such a program would use the least squares method of linear regression.

Solving for Corresponding Values

Given two points of a line, linear interpolation can be used to solve for y values corresponding to a given x value. Although this method is not as accurate as the least squares linear regression method, it can be used in situations in which the correlation coefficient is high.

$$y = y_1 + \frac{(y_2 - y_1) \cdot (x - x_1)}{(x_2 - x_1)}$$

where: x_1, y_1 = coordinates of first point on the line
 x_2, y_2 = coordinates of second point on the line
 x = abscissa of point to be interpolated
 y = ordinate of the point on the line with x

Computer Calculus

Long perceived as merely number crunchers, computers are now moving into the realm of elegant mathematics. Computer algebra programs are now available for the Commodore 128. These programs can manipulate abstract symbolic mathematical expressions and have the ability to do virtually everything taught in the first two years of university mathematics. They can factor polynomials, simplify expressions, differentiate functions, solve equations, expand functions into a Taylor series, invert matrices, and even integrate functions. Before you invest in your next college level calculus course, you might want to try one of the commercial calculus teaching programs for the C-128.

MATHEMATICAL RECREATIONS AND PROGRAMMING CHALLENGES

Interesting mathematical problems and ideas to implement on your computer include the following.

Using Probability to Forecast the Outcome of a Sporting Event. For example, an equation expressing the probability that a stronger team will win in a seven game series is:

$$p^4 + 4p^4q + 10p^3q^2x + 10p^2q^2(1-x)p$$

where

- p = probability that stronger team will win ($\geq .5$)
- q = probability that weaker team will win ($= 1-p$)
- x = conditional probability particular to a sport for example, for basketball this value has been calculated to be = .408)

For further information, see *Mathematics Magazine* (Sept.-Oct. 1975, pp. 187-192).

Solving Mathematical Puzzles. Puzzles such as the following can probably be solved only with the use of brute force, trial and error computer techniques—that is, if they can be solved at all:

- Find three distinct right triangles with the following properties:
 - A. Are pythagorean (all three sides are integers)
 - B. The perimeters of the three triangles are equivalent
 - C. The areas of the triangles are in arithmetic progression
- Find the smallest solution in positive integers x and y of $x^2 - n \cdot y^2 = 1$ where $n = 61$
- Find how many ways the integer 10,000 can be expressed as a sum of distinct positive integers (ignoring permutations).
- Find the minimum value of the gamma function. $\text{gamma}(n) = (n-1)!$

for an integer n in the range $1 < n < 2$.

Puzzles that are simpler to solve include such popular logic games as

- Instant Insanity™ blocks: five blocks with different colors on each side must be arranged so that all five blocks in a row have the same colors on each side. The computer could determine all possible solutions. (7,962,624 possible combinations exist and there are 192 solutions.)
- The High I.Q. Game consists of a board in the shape of a cross with markers in every hole except the center hole. The player jumps markers with adjacent markers as in checkers and then removes the one jumped over. Markers may not be moved unless a jump is possible. The object of the game is to jump all the markers on the board, leaving only one final marker; this is difficult to accomplish. The computer could determine the strategy for winning the game and the number of different ways possible to win (is there only one method?). A mathematical analysis of this game appeared in *The Journal of Recreational Mathematics*, Vol. 5, No. 2, 1972 pp. 133-. The triangular version was discussed in *The Mathematics Teacher*, January 1979, pp. 53-.

Computing for Pi, e, Solutions for High-Degree Equations, and Mathematical Oddities.

Many mathematicians take delight in computing values for irrational expressions, determining equations for special mathematical circumstances, and discovering unusual properties of specific numbers. The Commodore 128 is useful in such computations.

Pi can be calculated using this successive approximation:

$$\pi = 4 - 4/3 + 4/5 - 4/7 + 4/9 - 4/11 + \dots$$

Similarly, the value of the natural log e can be calculated using this successive approximation:

$$e^x = 1 + x + \frac{x^2}{2!} + \frac{x^3}{3!} + \frac{x^4}{4!} + \dots$$

Programs to compute a Fibonacci Sequence are also popular. The sequence is created by adding each previous term to the term before that:

1, 1, 2, 3, 5, 8, 13 . . .

Sunflower and daisy florets, pinecones, pineapples, the shells of some mollusks, and even patterns of paving stones and the mating habits of bees and rabbits exhibit properties given by the Fibonacci Sequence. For example, the seeds of sunflowers and daisies form a pattern of two sets of spirals, one clockwise and the other counterclockwise. The numbers of spirals in the two sets are usually consecutive Fibonacci numbers (e.g., 34 and 55).

Playing Games. Interesting mathematical games for your C-128 include the following:

- The four color map problem: a recreation that has interested mathematicians for many years is to prove that only four colors are needed to copy any map in such a manner that no bordering countries are of the same color. The proof was accomplished by a large-scale, brute-force computer program.

A game based on this fact could involve two players who attempt to force each other to color two bordering countries the same color. In each turn, a player would choose any color to apply to any country on a map with random boundaries. Proper logic will ensure that one player will lose. The computer could serve as one of the opponents.

- Magic squares game: the magic squares game pits the computer against a human in an attempt to complete a magic square while blocking an opponent. A magic square is composed of smaller squares, each with a separate number inside. The numbers in the smaller squares in horizontal, vertical, and diagonal rows sum to the same amount. Opposing players could attempt to complete a magic square in opposing directions.
- Maze games: maze games involve a randomly generated maze and a computer controlled mouse

Commodore 128 Number Crunching: Mathematical and Statistical Applications

- that learns to find its way through the maze.
- **Exacto:** this game for young people involves two five-digit numbers that have been randomly selected by the computer. Players are instructed to transform the first number into the second through multiplication, division, addition, or subtraction of any other number within a specified range. The computer would keep track of all computations at each stage. The players are scored according to speed or number of operations required to finish.
 - **Euclid:** in this game (p,q) represents a pair of positive numbers such that p is greater than q ; A and B signify the two players. Players alternate turns. Each turn consists of replacing the larger of the two numbers given to a player by any positive number obtained by subtracting a positive multiple of the smaller number from the larger number. (All numbers are integers). The first player to obtain zero for the (new) smaller number is declared the winner.

A sample game is shown below; $(51,30)$ is the starting pair of numbers.

A:(30,21) B:(21,9) A:(9,3) B:(3,0) B wins

or the game could have been

A:(30,21) B:(21,9) A:(12, 9) B:(9,3)
A:(3,9) A wins

- **The Two Move Game:** in the first half of this game, the two players secretly enter four non-negative numbers totaling the same number into the cells of a 2 by 2 matrix:

x1	x2	y1	y2
x3	x4	y3	y4

The entries are then exposed and a third 2 by 2 matrix is developed in which the entries are $x_i y_i$. This final matrix is then analyzed by the first player who chooses a column and tries to maximize. The second player then chooses a row and tries to maximize. The player with the greatest variation wins. A mathematical strategy exists to win this game; can you find it?

- **Sim:** the game of Sim involves a gameboard like this:

	x		x
x			x
	x		x

The players take alternate turns drawing lines between two points. The first player to draw an equilateral triangle or square loses. A mathematical strategy exists to win this game.

See Listing 3-4 and Fig. 3-3.

Listing 3-4: The Sim Game Program

```
10 REM THE SIM GAME
20 GRAPHIC 0
30 SCNCLR 0
40 PRINT:PRINT "HERE IS A SIMPLE GAME THAT HUMANS LOVE TO PLAY"
50 PRINT:PRINT TAB(9)"THE GAME IS CALLED SIM."
60 PRINT:PRINT "HERE ARE THE INSTRUCTIONS FOR SIM":SLEEP 1
70 PRINT:PRINT "EACH PLAYER TAKES A TURN DRAWING A LINE BETWEEN
    TWO DIFFERENT POINTS."
80 PRINT:PRINT "THE FIRST PLAYER THAT COMPLETES AN EQUI-LATERAL
    TRIANGLE OR A SQUARE--LOSES.":SLEEP 2
90 PRINT:PRINT "SOUNDS SIMPLE DOESN'T IT":SLEEP 1
100 PRINT:PRINT "LET ME DRAW THE GAME BOARD--THEN WE'LL BEGIN."
```



1001 Things to Do With Your Commodore 128

```

: SLEEP 1
110 PRINT:PRINT "PRESS ANY KEY TO BEGIN":GETKEY Z#
120 COLOR 0,1:COLOR 1,2:COLOR 5,3:COLOR 4,1
130 GRAPHIC 2,1,15
140 CHAR 1,10,0,"1      2"
150 CHAR 1,8,2,"3      4"
160 CHAR 1,10,4,"5      6"
170 INPUT "OK, PLAYER 1, MOVE FROM":A#
180 INPUT "AND MOVE TO":B#
190 GOSUB 350
200 DRAW 1,A,B TO C,D
210 INPUT "OK, PLAYER 2, MOVE FROM":A#
220 INPUT "AND MOVE TO":B#
230 GOSUB 350
240 DRAW 1,A,B TO C,D
250 PRINT:PRINT "DID ANYONE LOSE YET? (Y/N)":GETKEY Z#
260 IF Z#="N" THEN PRINT:PRINT:GOTO 170
270 COLOR 0,1:COLOR 5,13:COLOR 4,6
280 GRAPHIC 0
290 SCNCLR 0
300 PRINT:PRINT "CONGRATULATIONS"
310 PRINT:PRINT "PLAY ANOTHER (Y/N)?:GETKEY Z#
320 IF Z#="Y" THEN 120
330 SCNCLR 0
340 END
350 IF A#="1" THEN A=83:B=4
360 IF A#="2" THEN A=140:B=4
370 IF A#="3" THEN A=68:B=19
380 IF A#="4" THEN A=156:B=19
390 IF A#="5" THEN A=83:B=35
400 IF A#="6" THEN A=140:B=35
410 IF B#="1" THEN C=83:D=4
420 IF B#="2" THEN C=140:D=4
430 IF B#="3" THEN C=68:D=19
440 IF B#="4" THEN C=156:D=19
450 IF B#="5" THEN C=83:D=35
460 IF B#="6" THEN C=140:D=35
470 RETURN

```

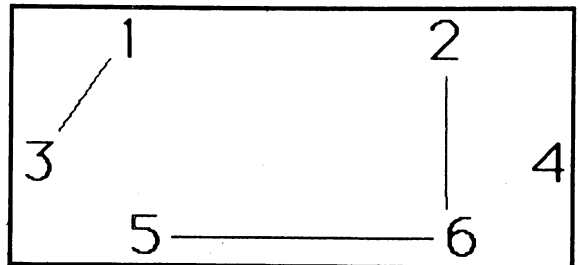
Fig. 3-3. Is this a winning or losing strategy for Sim? The Sim game is found in Listing 3-4. The object is to make the other player form an equilateral triangle or a square. In order to achieve this goal, each player takes turns connecting lines between two different points.



Commodore 128 Number Crunching: Mathematical and Statistical Applications

Computing Probabilities. You could use your Commodore 128 to calculate the following probabilities:

- **Life:** this popular computer recreation was devised by John Conway, a mathematician at Cambridge University. It simulates an ecological system and illustrates the rise, fall, and changes of a society of living organisms as they interact with their environment and each other. The game begins with a small population of organisms; as time progresses (measured in terms of generations), the population experiences one of three fates: it dies out due to over or underpopulation, it becomes stable, or it oscillates in a repeating pattern. Each member of the population has one of three fates during each generation. It can die from "starvation," give birth to another organism, or survive in a stable form.

The game board is a grid of arbitrary size, often larger than 20×20 . Each square on the grid may be occupied by one organism or empty. Thus, each organism always has eight surrounding squares. It will die if it touches fewer than two or more than three occupied squares. If three occupied squares touch an empty square, a new occupant is born to fill that square. Births and deaths are evaluated simultaneously.

- **Poker Probabilities:** you could compute the probability that $m \cdot n$ cards held by a defender in a bridge hand will be split m and n , or the probabilities for obtaining a certain hand in poker after certain cards have been played.
- **Birthdays:** in a classroom of 24 students, how many would you estimate have the same birthday? The chances are slightly better than even that 2 or more students will have birthdays on the same date, counter to our intuition! For a given number of people, x , the percent chance that 2 or more will have the same birthday is given by

$$\% \text{ chance} = 100 - 100 \cdot \left(\frac{365-x}{365} \right)$$

Write a BASIC program to calculate the percent chance of coincident birthdays for any input of x , the number of people in the group considered.

- **An Apocalyptic Possibility:** an equation expressing the probability of an accidental nuclear missile launch by the United States or the Soviet Union falsely triggering World War III is as follows:

$$PA = 1 - (1 - P)^{N(U+S)}$$

where PA=Probability of the Apocalypse (for percent chance, multiply PA•100)

U=total number of strategic missiles in the U.S. arsenal (2000 est.)

S=Total number of strategic missiles in the Soviet arsenal (2300 est.)

P=Probability of accidental launching of a nuclear missile by either side during a 24-hr. period (1F-8 estimated)

N=Number of days under consideration (20 years=7,300 days)

Write a BASIC program to consider different values for U, S, P, and N.

Calculating Useful Information. You can use your C-128 to figure out practical information such as the following:

- **Easter:** a program to calculate the date of Easter for any year would make use of the fact that Easter falls on the first Sunday following the arbitrary Paschal Full Moon, which does not necessarily coincide with a real or astronomical moon. The Paschal Full Moon is calculated by adding 1 to the remainder obtained by dividing the year by 19 and applying the information given in Table 3-1.

Table 3-1. The Paschal Full Moon Date.

1-Apr 14	6-Apr 18	11-Mar 25	16-Mar 30
2-Apr 3	7-Apr 8	12-Apr 13	17-Apr 17
3-Mar 23	8-Mar 28	13-Apr 2	18-Apr 7
4-Apr 11	9-Apr 16	14-Mar 22	19-Mar 27
5-Mar 31	10-Apr 5	15-Apr 10	

1001 Things to Do With Your Commodore 128

Thus, for the year 2000, the key is 6, or April 18. A program to calculate the day of the week (see the Business and Financial Applications chapter) could then indicate that April 18, 2000 is a Tuesday. Note: If the Paschal Full Moon falls on a Sunday, Easter is the following Sunday. The earliest Easter can fall is March 23rd and the latest is April 25th.

- **Horizons:** the distance to the horizon in miles is approximately $= \sqrt{1.5h}$, where h = elevation above sea level in feet. Write a BASIC program to draw a mountain and print the miles to the horizon for viewers located at 100 foot intervals.

Creating Artistic Patterns. You can use your Commodore 128 to generate interesting, artistic patterns such as Pascal's art. As described in the December 1966 issue of *Scientific American*, Pascal's triangle can be used to generate artistic

geometric patterns. A sample Pascal triangle is shown below. Each number in the successive rows is generated by adding the two numbers above and to the immediate left and right of the number in question.

```
      1
     1 1
    1 2 1
   1 3 3 1
  1 4 6 4 1
 1 5 10 10 5 1
```

In order to write a Commodore BASIC program to generate patterns using the triangle, you could, for example, represent all odd numbers by an X and all even numbers by a space. Then, print the results on a dot matrix printer. A variety of interesting geometrical patterns involving triangles will be formed.

Chapter 4

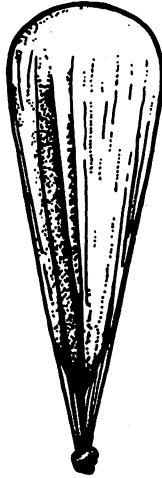

Technical and Scientific Applications

Personal computers, rather than their large-scale mainframe counterparts, are being increasingly used by technicians and scientists for problem solving. They offer the advantages of ease of use, low cost, and greater portability. Although many large-scale scientific problems are best left to supercomputers, the Commodore has become an asset in its own right in all types of laboratories.

In this chapter, we will examine the ways Commodores have been put to scientific and technical use. The C-128 can help to rid the professional or amateur scientist of the mathematical drudgery that is so much a part of the discovery process. It can rapidly and accurately solve problems, many of which would not have previously been undertaken because of their sheer magnitude.

Many of these applications are specialized. The purpose of this chapter is to touch upon just a few of the most commonly used scientific applications, provide sources for further information, and demonstrate some solutions in Commodore BASIC. Due to space restrictions, formulas and in-depth coverage of each application are impossible, but this infor-

mation should be readily available in standard reference volumes.

WEATHER FORECASTING

Forecasting the weather is usually thought to be a task that is limited to large computers. Local weather forecasting, however, can be accomplished with surprising accuracy by just taking note of wind direction and barometric changes. A chart in use by local weather bureaus has been based upon these two parameters and could easily be computerized. This data could be input automatically by the use of electronic barometers and wind direction instruments.

Wind change		Barometric condition	Forecast code
<i>From</i>	<i>To</i>		
S	SW	7	L
S	SE	3	E
		4	F
		9	M

1001 Things to Do With Your Commodore 128

Wind change		Barometric condition	Forecast code
From	To		
NE	SE	3	G
		4	H
		5	J
		6	K
		9	M
N	E	3	I
		4	A
		9	N
to the West		8	O
NW	SW	1	C
		2	B
		3	D
		7	L

If a forecast is not listed for the proper barometric condition, enumerated below, other factors must be used to provide the forecast.

Barometric Conditions (IN INCHES Hg)

1. 30.1 or more and steady
2. 30.1-30.2 rising rapidly
3. 30.1 or more falling slowly
4. 30.1 or more falling rapidly
5. 30.0 or less falling slowly
6. 30.0 or less falling rapidly
7. 30.0 or less rising slowly
8. 29.8 or less rising rapidly
9. 29.8 or less falling rapidly

A rapid change is considered to be over .06 inches per hour. 30 inches of mercury equals 760 mm mercury.

Forecasts

- A. Summer: rain probable within 12-24 hours. Winter: rain or snow, increasing wind; bad weather often sets when barometer begins to

- fall and winds set in from the northeast.
- B. Fair, followed within two days by rain.
- C. Continued fair, no decided temperature change.
- D. Fair for two days with slowly rising temperatures.
- E. Rain within 24 hours.
- F. Wind increasing, rain within 24 hours.
- G. Rain within 12-18 hours.
- H. Wind increasing, rain within 12 hours.
- I. Summer: light winds, rain may not fall for several days. Winter: rain within 24 hours.
- J. Rain will continue for 1 to 2 days.
- K. Rain, with high wind, followed within 36 hours by clearing, and in winter by colder temperatures.
- L. Clearing within a few hours, fair for several days.
- M. Severe storm imminent, followed within 24 hours by clearing, and in winter by colder temperatures.
- N. Severe northeast gale and heavy precipitation; in winter, heavy snow followed by a cold wave.
- O. Clearing and colder.

A cloud chart with forecasts included is also useful. The forecast data for the various types of clouds could be stored and a comparison made between this forecast and a forecast from the above chart.

Other suggestions for applying a Commodore 128 to weather calculations include the following:

1. Pressure/height conversions to allow an aneroid barometer to serve as an altimeter.
2. Dew point temperature and relative humidity from wet and dry bulb readings.
3. Normal maximum, mean, and minimum temperature degree days for a given date and location.
4. Estimates of cloud base heights from dew point and surface temperature observation.
5. Almanac data for a given time and date (e.g., declination of the sun, distance of the sun

from the earth, phase of the moon, and positions of the planets) stored for ready access.

6. Analysis and display of hourly weather data derived from a phone line connected with a weather data channel.

7. Temperature humidity index and relative humidity calculations.

8. Wind chill factor calculations. To calculate the wind chill factor, use the following formula:

$$H = (.14 + .47 * V) * (36.5 - T)$$

where,

H = chill in calories lost per square centimeter of skin per second

V = wind velocity (m/sec)

T = temperature (Centigrade)

Create a program that converts dry bulb temperature in °F. and wind speed in miles per hour into the apparent wind chill temperature. The only problem with using such a program is that now you will really know how cold you feel.

ENERGY EFFICIENCY COMPUTATION

You can use your C-128 to make the following studies:

- A computerized statistical comparison between the water temperature in a solar energy system and the outside temperature, the angle of the sun, and so on could serve to evaluate the efficiency of a home solar energy system. Analog to digital converters could be used to gather the information automatically.
- Those of you considering the installation of a solar system might want to do another statistical analysis of the heating requirements for your home based on Btu/hr times the number of hours that your furnace operates during the heating season. The size of a solar system necessary to

heat your house can then be calculated using this data and the manufacturer's efficiency data.

In the central United States on June 21, the maximum solar energy striking the earth is 290 Btu/square foot (approximately 15 hours in the day). Conversely, on December 21, the solar energy is a maximum of 220 Btu/square foot (approximately 9 hours in the day). Therefore, you can compute the average values for the variables in the formula below:

$$\text{Solar collector Btu output} = \frac{B \cdot h \cdot s \cdot m}{2}$$

where B = Btu/sq ft

h = hrs/day

s = sq. ft of collector

m = max. efficiency

Keep in mind that it takes 500 Btus to heat water at ground temperature (40° F.) to 100° F. and that the desired water temperature for home use is 120° F.

- The answer to "How much fuel can be saved by turning the thermostat down from 70°F to 60°F at night?" may be determined using this equation:

$$A = \frac{.0625 (n-1)W}{z}$$

where A = amount of heat (Btu)

W = the normal heat loss/hr. (Btu)

n = the number of hours of discontinued heating

z = the number of hours from the beginning of reheating until the house is at an acceptable temperature

- To find the heat loss of your home, use the formula

$$H = \frac{kA(t-t^1)T}{d}$$

where H = heat transmission (Btu)

K = coefficient of thermal conduction
(Values for the type of construction used in your home may be found in builder's manuals)

A = exposed area

(t-t') = temperature difference between inside and outside (°F)

T = duration of exposure (hours)

d = thickness of walls (inches)

- To calculate fuel requirements use the formula

$$C = \frac{H(t_a - t_b)N \times S \times q}{100,000 \times (t_i - t_o)}$$

where C = fuel cost

H = heat loss/hr.

t_o = outside temperature

t_i = inside temperature

t_a = average inside temperature

t_b = average outside temperature

N = number of hours of heating required

S = number of units of fuel

q = cost per unit of fuel

TECHNICAL AND SCIENTIFIC CALCULATIONS

The C-128 can be used to perform calculations needed by those involved in many fields, from navigation to chemistry.

Aviation

The private or business pilot will find the following calculations useful. Additional information on aviation calculations may be found in: *The Pilot's Complete Computer Book* by John L. Nelson, TAB Books, Inc., Blue Ridge Summit, PA 17214.

1. Flight plan with wind allowances: calculation of the heading, speed, fuel, and ETA for a trip of multiple legs could be done.
2. Long-range flight plan: calculations could be done for great circle routes and could include distance, time, fuel, and source.

3. Atmosphere, speed, temperature, and altitude: from pressure altitude, a program could calculate the speed of sound, temperature, pressure, and density relative to standard sea level.

4. Prediction of freezing level and lowest usable flight level.

5. Wind components and average vector: crosswind and tail or head wind components of a single wind vector could be calculated.

6. Dead reckoning of position.

7. Great circle flying navigation.

8. Course correction to fly correct path.

9. Rhumb line navigation.

10. Unit conversions: length, volume, weight, U. S. equivalents and metric temperature conversions:

$$^{\circ}\text{F.} = (9/5) * (^{\circ}\text{C.} + 32^{\circ})$$

$$^{\circ}\text{C.} = (5/9) * (^{\circ}\text{F.} - 32^{\circ})$$

Marine Navigation

Some of the following applications are designed for use on board a small vessel.

1. Time-speed-distance with current sailing: a useful program could solve time-speed-distance equations and could consider the current in determining the proper course to steer and the speed through the water that is necessary to reach a given destination in a specified amount of time.
2. Distance short of, beyond, or to a horizon: a program could calculate the distance to the apparent horizon, as well as the distance to and visibility of an object of known height.
3. Velocity, VMG, and current vectors: given two of the following, 1) drift and set of the current, 2) speed and course through the water, and 3) speed and course made good, a program could calculate the unknown value.
4. Running fix from two objects: a program could calculate a fix of a vessel from bearings of two objects.

Technical and Scientific Applications

5. Planet location. A program could estimate the altitude and azimuth of the four navigational planets. The GMT (Greenwich mean time) of twilight could also be calculated or manually input.

6. Rhumb line and great circle navigation calculation.

7. Sight reduction calculation.

8. Length conversions. For example, nautical miles converted to statute miles.

9. Vector addition.

10. Estimated time of arrival.

11. Conversion of compass points to degrees.

12. Area navigation by VOR (very-high-frequency omnirange).

13. Rhumb line navigation.

14. Dead reckoning of position.

15. Great circle computations.

16. Distance from VOR/OMNI.

17. Course correction.

18. Distance by two bearings.

19. Conversions between knots, miles, statute miles, and kilometers.

20. Speed computation given distance covered and time.

Medical Calculations

Doctors, nurses, technicians, and other medical personnel may find the following calculations useful:

1. Conversions of weight, length, and volume to other units, or conversion of U. S. measurements to their metric equivalents.

2. Lung diffusion calculations.

3. Blood acid-base status determination.

4. Beer's law calculation.

5. Protein electrophoresis: given integration counts of a number of protein fractions, the percentage of each may be found.

6. Body surface area estimation.

7. Oxygen saturation and content. Oxygen content and saturation in the blood may be

found given: pO_2 , pCO_2 , pH, and body temperature.

Publications containing computer programs and applications of use to the health professional include:

Computers in Biology and Medicine

Computers in Medicine

Medical Computer Journal

Physicians Microcomputer Report

Surveying Calculations

Those involved in surveying could utilize the following calculations:

1. Azimuth/bearing traverse: given reference coordinates, leg length, azimuth or bearing, and quadrant, the endpoint coordinates, departure, latitude, and total distance may be computed.

2. Slope reduction determinations.

3. Point of intersection calculation.

Chemistry

Chemists and chemistry students may find the following calculations useful:

1. Calculation of the requirements to produce a given solution.

2. Calculations of the following parameters, given adequate inputs: pH, molality, total atomic weights, gas density and pressure, electron energies, gravimetric factors, liquid pressure, degree of saturation, gram equivalent weight, normality, percent composition, mole fraction, mole percent, and ionic strength dilution factor.

3. Plotting/simulation of reaction rates and electron distribution.

Physics

Those involved with physics will also find the

1001 Things to Do With Your Commodore 128

Commodore's capacity for performing calculations useful. Potential uses include:

1. The plotting of potential energy functions and lab data.
2. Conversions of units.
3. Solutions to elementary equations: velocity, acceleration, momentum, work, and power.
4. Statistical analysis and data compilation.

An article discussing the use of personal computers by physicists appeared in *Physics Today* (December 1983, pp. 25-28). The author states, '... it is very likely that most calculations in physics will be performed by the home computer in the future,' because of the benefit of independence from large computer organizations, bureaucracies, and economic constraints.

General Purpose Experimental Applications

Scientists in many fields can use their Commodores to perform the following types of calculations:

1. Statistical analysis of data: useful statistical applications include curve fitting and plotting, chi-square tests, analysis of variance and standard deviation, solutions to equations, and correlation coefficients.
2. Calculation of tables for a specific application: functions that are commonly referred to, yet do not have reference tables, could be calculated for a number of different values and the results displayed in a table form for easy reference.

In addition to using Commodores for calculations, scientists can interface these same microcomputers to lab instrumentation and develop automatic data log and acquisition systems. They can also develop voice input interfaces that could accept data called out by a lab technician who is too busy to manually record the data.

ENGINEERING APPLICATIONS

Professionals and hobbyists will have several uses for C-128 programs in the following engineering fields.

Electrical Engineering

Commodores can help those who deal with electricity by performing calculations and analyses and by facilitating design work.

Active High- and Low-Pass Filter Design. High- and low-pass filters may be designed for a given center frequency, gain, and Q values for the resistors and capacitors in the infinite-gain multiple-feedback circuit. A Commodore 128 program may be created for use in designing simple filters through the use of schematics and formulas.

Active Bandpass Filter Design. Second-order active bandpass filters may be designed using a multiple-feedback network. Both high-Q and low-Q circuits could be designed. Standard values may be selected for easy implementation.

Chebyshev and Butterworth Filter Design. Chebyshev and Butterworth low-pass filters may be designed for specified filter order, termination resistance, and corner frequency.

Resonant Circuits. The impedance and resonant frequency could be calculated by a program for a series or parallel resonant circuits whose component values are specified.

Attenuators. Component values for T and Pi impedance matching circuits may be found for specified input/output impedances and desired loss. Minimum-loss pad matching may be performed for given impedances.

T to Pi Transformations. T(Pi) networks may be transformed to Pi(T) networks having the same characteristics.

Ladder Network Analysis. The input impedance for a ladder network could be calculated; the network may be composed of any combination of resistors, capacitors, and inductors.

Coil Properties. The inductance or number of turns for a single or multilayer coil may be found

when given the wire diameter and the dimensions of the coil. The inductance of two parallel, round wires, one forming a return circuit is given by:

$$L = .0041 [2.303 \log_{10} (2 * D / d - D / c)]$$

where,

- L = inductance (μ H)
- D = distance in cm between the centers of wires
- d = diameter of wire (cm)
- c = conductor length (cm)

Power Transformer Design. Core weight may be calculated for a specified power requirement. For a specified core, area flux density and frequency, the number of primary and secondary turns is found. A program for designing power transformers may be found in *Electronic Design News* (October 27, 1983, p. 346).

Rectifier Circuits. Full-wave or half-wave rectifier circuits may be evaluated for a given component value, input voltage, and frequency. The dc (direct current) output voltage and peak-to-peak ripple may also be calculated.

S and Y Parameter Transformations. A set of S(Y) parameters expressed as magnitudes and angles may be transformed to a set of Y(S) parameters.

Phase-Locked Loops. Natural frequency, damping factor, and loop noise bandwidth may be found for either passive or active phase-locked loops. Loop gain and component values for the circuits are required for input.

Transistor Amplifier Design. Collector current and sensitivity factors can be computed for transistor circuits for specified current gain, supply voltage, and resistor values.

Fourier Series. Fourier coefficients may be computed for discrete values for a periodic function. Sine and cosine coefficients may be found and could be used to calculate new values of the function.

Reactive L-Network Impedance Matching. Networks that will match any two complex impedances may be determined.

Bilateral Design, Stability Factor, Maximum Gain, and Optimum Matching. A program could compute the maximum gain available and the load and source reflection coefficients that yield the maximum gain.

Frequency Conversion Program. A Commodore BASIC program to interconvert velocity, period, wavelength, and frequency values could make use of these commonly used formulas:

$$\begin{aligned} T &= 1/f \\ \omega &= 2\pi f \\ \lambda &= v/f \\ f &= 1/T \\ f &= \omega/2\pi \\ f &= v/\lambda \end{aligned}$$

- where T = period
- f = frequency
- ω = radian frequency
- λ = wavelength
- V = propagation velocity

Similarly, frequency and reactance conversions may be accomplished with these formulas:

$$\begin{aligned} X_c &= \frac{1}{2\pi f C} = \frac{1}{\omega C} \\ X_L &= 2\pi f L = \omega L \\ C &= \frac{1}{2\pi f X_c} = \frac{1}{\omega X_c} \\ L &= \frac{X_L}{2\pi f} = \frac{X_L}{\omega} \\ f &= \frac{1}{2\pi C X_c} \end{aligned}$$

$$f = \frac{X_L}{2\pi L}$$

555 Timer Circuit Design. Given the frequency duty cycle and either the timing capacitor or resistor, a program could calculate the other timing component, charge time, discharge time, and period of the commonly used 555 stable multivibrator circuit.

Resonance Calculations. Resonant frequency of inductance-capacitance circuit is given by:

$$f_r = \frac{L - R_L^2 C}{2\pi \sqrt{LC} (L - R_C^2 C)}$$

where $L = 1/(4\pi^2 f^2 C)$

$C = 1/(4\pi^2 f^2 L)$

R_L = series resistance of inductor

R_C = effective series resistance of capacitor

f_r = resonant frequency

Antenna Design. A given frequency could be input to a program that would calculate the antenna dimensions for a dipole, Yagi, or cubical quad antenna. A special program can be created to calculate the dimensions for a Yagi antenna to receive television, radio, or amateur radio broadcasts. When an antenna is designed for a specific frequency, it can often receive signals from distances not previously approached. If the mathematical specifications of the antenna design are unclear, refer to an electronic manual for a picture. Construction of the antenna is not difficult and should cost no more than twenty dollars.

Decibel Conversion and Voltage to dBm Conversion. Voltage ratio in decibels is given by:

$$N_{dB} = 20 \log_{10} (E_{OUT}/E_{IN})$$

where E_{OUT} = output voltage

E_{IN} = input voltage

Such computations would be helpful to the serious audiophile. Also of interest to the audiophile would be a formula used to compute the inductance of a straight wound speaker wire:

$$L = .021 * [2.303 * \log_{10}(41/d) - .75]$$

where,

L = inductance (μH)

d = diameter of wire (cm)

Evaluation Routine for a Program of Boolean Functions. AND, OR, NOT, and other logical statements could be evaluated in a program; the circuit status at each step would be output.

Ohm's Law Calculation. A C-128 can be used to determine the unknown value, as shown in Listing 4-1 and Fig. 4-1.

$$E = I * R$$

where

R = resistance (ohms)

E = voltage

I = current

Resistor Color Codes. An ideal program for the novice in electronics is one that outputs the value for a resistor given the color from the component (see Listing 4-2 and Fig. 4-2).

Inductance Bridge Calculation. Given this design:

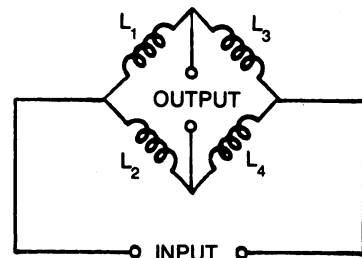

Listing 4-1: The Ohm's Law Calculation Program

```

10 REM OHM'S LAW CALC
20 GRAPHIC 0
30 COLOR 0,15:COLOR 5,1:COLOR 4,15
40 SCNCLR 0
50 PRINT:PRINT TAB(10)"OHM'S LAW CALCULATOR"
60 PRINT:PRINT TAB(13)"FOR DC CIRCUITS"
70 SLEEP 3
80 SCNCLR 0
90 PRINT:PRINT "WHICH VALUE DO YOU WISH TO SOLVE FOR:"
100 PRINT:INPUT "1)VOLTAGE 2)CURRENT 3)POWER 4)RESISTANCE
    5)HELP";A$
110 IF A$="1" THEN 210
120 IF A$="2" THEN 290
130 IF A$="3" THEN 370
140 IF A$="4" THEN 450
150 IF A$="5" THEN 530
160 SCNCLR 0
170 PRINT:PRINT "DO ANOTHER (Y/N)?":GETKEY Z$
180 IF Z$="Y" THEN 80
190 COLOR 0,1:COLOR 5,13:COLOR 4,6
200 END
210 REM VOLTAGE
220 SCNCLR 0
230 PRINT:INPUT "WHICH EQUATION DO YOU WISH TO USE:      1)E=IR
    2)E=P/I 3)E=SQR(PR)";A$
240 IF A$="1" THEN PRINT:INPUT "HOW MANY AMPS";I:PRINT:INPUT
    "HOW MANY OHMS";R:E =I*R
250 IF A$="2" THEN PRINT:INPUT "HOW MANY WATTS";P:PRINT:INPUT
    "HOW MANY AMPS";I: E=P/I
260 IF A$="3" THEN PRINT:INPUT "HOW MANY WATTS";P:PRINT:INPUT
    "HOW MANY OHMS";R: E=SQR(P*R)
270 PRINT:PRINT "THE VOLTAGE EQUALS";E;"VOLTS":PRINT:PRINT
    "PRESS ANY KEY":GETKE Y Z$
280 GOTO 160
290 REM CURRENT
300 SCNCLR 0
310 PRINT:INPUT "WHICH EQUATION DO YOU WISH TO USE:      1)I=E/R
    2)I=P/E 3)I=SQR (P/R)";A$
320 IF A$="1" THEN PRINT:INPUT "HOW MANY VOLTS";E:PRINT:INPUT
    "HOW MANY OHMS";R: I=E/R
330 IF A$="2" THEN PRINT:INPUT "HOW MANY WATTS";P:PRINT:INPUT
    "HOW MANY VOLTS";E : I=P/E
340 IF A$="3" THEN PRINT:INPUT "HOW MANY WATTS";P:PRINT:INPUT
    "HOW MANY OHMS";R: I=SQR(P/R)

```

1001 Things to Do With Your Commodore 128

```
350 PRINT:PRINT "THE CURRENT EQUALS";I;"AMPS":PRINT:PRINT
    "PRESS ANY KEY":GETKEY Z#
360 GOTO 160
370 REM POWER
380 SCNCLR 0
390 PRINT:INPUT "WHICH EQUATION DO YOU WISH TO USE:      1)P=EI
    2)P=E^2/R 3)P=I^ 2R";A#
400 IF A#="1" THEN PRINT:INPUT "HOW MANY VOLTS";E:PRINT:INPUT
    "HOW MANY AMPS";I:P=E*I
410 IF A#="2" THEN PRINT:INPUT "HOW MANY VOLTS";E:PRINT:INPUT
    "HOW MANY OHMS";R:P=(E^2)/R
420 IF A#="3" THEN PRINT:INPUT "HOW MANY AMPS";I:PRINT:INPUT
    "HOW MANY OHMS";R:P =(I^2)*R
430 PRINT:PRINT "THE POWER EQUALS";P;"WATTS":PRINT:PRINT
    "PRESS ANY KEY":GETKEY Z#
440 GOTO 160
450 REM RESISTANCE
460 SCNCLR 0
470 PRINT:INPUT "WHICH EQUATION DO YOU WISH TO USE:      1)R=E/I
    2)R=E^2/P 3)R=P /I^2";A#
480 IF A#="1" THEN PRINT:INPUT "HOW MANY VOLTS";E:PRINT:INPUT
    "HOW MANY AMPS";I:R=E/I
490 IF A#="2" THEN PRINT:INPUT "HOW MANY VOLTS";E:PRINT:INPUT
    "HOW MANY WATTS";P:R=(E^2)/P
500 IF A#="3" THEN PRINT:INPUT "HOW MANY WATTS";P:PRINT:INPUT
    "HOW MANY AMPS";I:R=P/(I^2)
510 PRINT:PRINT "THE RESISTANCE EQUALS";R;"OHMS":PRINT:PRINT
    "PRESS ANY KEY":GET KEY Z#
520 GOTO 160
530 REM HELP
540 SCNCLR 0
550 PRINT:PRINT "IN EACH MENU CATEGORY, YOU WILL BE PRE- SENTED
    WITH A CHOICE OFDIFFERENT EQUA- TIONS."
560 PRINT:PRINT "SELECT THE EQUATION THAT CONTAINS THE
    VARIABLES FOR WHICH YOU HAVE VALUES."
570 PRINT:PRINT "IN THIS PROGRAM, VOLTAGE IS IN VOLTS,
    CURRENT IS IN AMPS, POWER IS IN WATTS, AND RESISTANCE IS
    IN OHMS."
580 PRINT:PRINT "PRESS ANY KEY TO BEGIN.":GETKEY Z#
590 GOTO 80
```

Ohm's Law Formulas

DC Circuits:

E = Voltage in Volts

I = Current in Amps

P = Power in Watts

R = Resistance in Ohms

$$E = I * R$$

$$E = P / I$$

$$E = \text{SQR}(P * R)$$

$$I = E / R$$

$$I = P / E$$

$$I = \text{SQR}(P / R)$$

$$P = E * I$$

$$P = (E^2) / R$$

$$P = (I^2) * R$$

$$R = E / I$$

$$R = (E^2) / P$$

$$R = P / (I^2)$$

Fig. 4-1. These are the formulas used in the Ohm's Law calculator from Listing 4-2.

Listing 4-2: The Resistor Color Coder Program

```

10 REM RESISTOR COLOR CODER
20 COLOR 0,2:COLOR 1,1:COLOR 5,12:COLOR 4,2
30 GRAPHIC 0
40 SCNCLR 0
50 PRINT:PRINT TAB(11)"THE HANDY RESISTOR"
60 PRINT:PRINT TAB(15)"COLOR CODER"
70 PRINT:PRINT "I WILL HELP YOU DETERMINE THE COLOR      CODES
   FOR ANY RESISTOR."
80 PRINT:PRINT "PRESS ANY KEY TO BEGIN.":GETKEY Z#
90 COLOR 0,2:COLOR 1,12:COLOR 4,2:COLOR 5,12
100 GRAPHIC 0:SCNCLR 0
110 PRINT:INPUT "WHICH DO YOU WISH TO SOLVE FOR:  1)COLOR
   2)VALUE  3)HELP":A$
120 IF A#="1" THEN 160

```

1001 Things to Do With Your Commodore 128

```
130 IF A#="2" THEN 800
140 IF A#="3" THEN 1640
150 IF A#<CHR$(49) OR A#>CHR$(51) THEN 90
160 GRAPHIC 2,1,15
170 BOX 1,100,40,220,0
180 DRAW 1,100,20 TO 50,20:DRAW 1,220,20 TO 270,20
190 DRAW 1,110,0 TO 110,40:DRAW 1,120,0 TO 120,40
200 DRAW 1,135,0 TO 135,40:DRAW 1,145,0 TO 145,40
210 DRAW 1,160,0 TO 160,40:DRAW 1,170,0 TO 170,40
220 PRINT:INPUT "CHOOSE THE COLOR OF THE FIRST BAND:      1)BLACK
      2)WHITE 3)RED 4)GRAY   5)VIOLET 6)GREEN 7)BLUE 8)YELLOW
      9)ORANGE 0)BROWN";F
230 IF F=4 THEN F=13
240 IF F=0 THEN F=10
250 COLOR 1,F
260 PAINT 1,115,5,1
270 PRINT:PRINT:PRINT:PRINT:PRINT
280 PRINT:INPUT "CHOOSE THE COLOR OF THE SECOND BAND:      1)BLACK
      2)WHITE 3)RED 4)GRAY   5)VIOLET 6)GREEN 7)BLUE 8)YELLOW
      9)ORANGE 0)BROWN";S
290 IF S=4 THEN S=13
300 IF S=0 THEN S=10
310 COLOR 1,S
320 PAINT 1,140,5,1
330 PRINT:PRINT:PRINT:PRINT:PRINT
340 PRINT:INPUT "CHOOSE THE COLOR OF THE THIRD BAND:      1)BLACK
      2)WHITE 3)RED 4)GRAY   5)VIOLET 6)GREEN 7)BLUE 8)YELLOW
      9)ORANGE 0)BROWN";T
350 IF T=4 THEN T=13
360 IF T=0 THEN T=10
370 COLOR 1,T
380 PAINT 1,165,5,1
390 PRINT:PRINT:PRINT:PRINT:PRINT
400 IF F=1 THEN F=0:GOTO 500
410 IF F=2 THEN F=9:GOTO 500
420 IF F=3 THEN F=2:GOTO 500
430 IF F=13 THEN F=8:GOTO 500
440 IF F=5 THEN F=7:GOTO 500
450 IF F=6 THEN F=5:GOTO 500
460 IF F=7 THEN F=6:GOTO 500
470 IF F=8 THEN F=4:GOTO 500
480 IF F=9 THEN F=3:GOTO 500
490 IF F=10 THEN F=1:GOTO 500
500 IF S=1 THEN S=0:GOTO 600
510 IF S=2 THEN S=9:GOTO 600
520 IF S=3 THEN S=2:GOTO 600
530 IF S=13 THEN S=8:GOTO 600
540 IF S=5 THEN S=7:GOTO 600
550 IF S=6 THEN S=5:GOTO 600
```

```

560 IF S=7 THEN S=6:GOTO 600
570 IF S=8 THEN S=4:GOTO 600
580 IF S=9 THEN S=3:GOTO 600
590 IF S=10 THEN S=1:GOTO 600
600 IF T=1 THEN I=1:GOTO 690
610 IF T=2 THEN I=1000000000:GOTO 690
620 IF T=3 THEN I=100:GOTO 690
630 IF T=13 THEN T=1000000000:GOTO 690
640 IF T=5 THEN T=100000000:GOTO 690
650 IF T=6 THEN I=100000:GOTO 690
660 IF T=7 THEN I=1000000:GOTO 690
670 IF T=8 THEN I=10000:GOTO 690
680 IF T=9 THEN I=1000:GOTO 690
690 V=((F*10)+S)*T
700 V$=STR$(V)
710 L=LEN(V$)
720 IF RIGHT$(V$,6)="000000" THEN V$=LEFT$(V$,L-6)+" M"
730 IF RIGHT$(V$,3)="000" THEN V$=LEFT$(V$,L-3)+" K"
740 PRINT:PRINT:PRINT:PRINT:PRINT
750 PRINT:PRINT "YOUR RESISTOR HAS A VALUE OF:"
760 PRINT:PRINT V$;:PRINT " OHMS"
770 PRINT:PRINT "DO ANOTHER (Y/N)?":GETKEY Z$
780 IF Z$="Y" THEN 90
790 GOTO 1020
800 GRAPHIC 2,1,15
810 BOX 1,100,40,220,0
820 DRAW 1,100,20 TO 50,20:DRAW 1,220,20 TO 270,20
830 DRAW 1,110,0 TO 110,40:DRAW 1,120,0 TO 120,40
840 DRAW 1,135,0 TO 135,40:DRAW 1,145,0 TO 145,40
850 DRAW 1,160,0 TO 160,40:DRAW 1,170,0 TO 170,40
860 PRINT:INPUT "WHAT IS THE FIRST DIGIT";F
870 IF F=0 THEN F=1:GOTO 970
880 IF F=1 THEN F=10:GOTO 970
890 IF F=2 THEN F=3:GOTO 970
900 IF F=3 THEN F=9:GOTO 970
910 IF F=4 THEN F=8:GOTO 970
920 IF F=5 THEN F=6:GOTO 970
930 IF F=6 THEN F=7:GOTO 970
940 IF F=7 THEN F=5:GOTO 970
950 IF F=8 THEN F=13:GOTO 970
960 IF F=9 THEN F=2
970 COLOR 1,F
980 PAINT 1,115,5,1
990 PRINT:PRINT:PRINT:PRINT:PRINT
1000 PRINT:INPUT "WHAT IS THE SECOND DIGIT";S
1010 IF S=0 THEN S=1:GOTO 1110
1020 IF S=1 THEN S=10:GOTO 1110
1030 IF S=2 THEN S=3:GOTO 1110
1040 IF S=3 THEN S=9:GOTO 1110

```

1001 Things to Do With Your Commodore 128

```
1050 IF S=4 THEN S=8:GOTO 1110
1060 IF S=5 THEN S=6:GOTO 1110
1070 IF S=6 THEN S=7:GOTO 1110
1080 IF S=7 THEN S=5:GOTO 1110
1090 IF S=8 THEN S=13:GOTO 1110
1100 IF S=9 THEN S=2
1110 COLOR 1,S
1120 PAINT 1,140,5,1
1130 PRINT:PRINT:PRINT:PRINT:PRINT
1140 PRINT:INPUT "HOW MANY ZEROS ARE THERE";T
1150 IF T=0 THEN T=1:GOTO 1250
1160 IF T=1 THEN T=10:GOTO 1250
1170 IF T=2 THEN T=3:GOTO 1250
1180 IF T=3 THEN T=9:GOTO 1250
1190 IF T=4 THEN T=8:GOTO 1250
1200 IF T=5 THEN T=6:GOTO 1250
1210 IF T=6 THEN T=7:GOTO 1250
1220 IF T=7 THEN T=5:GOTO 1250
1230 IF T=8 THEN T=13:GOTO 1250
1240 IF T=9 THEN T=2
1250 COLOR 1,T
1260 PAINT 1,165,5,1
1270 PRINT:PRINT:PRINT:PRINT:PRINT
1280 IF F=1 THEN F$="BLACK":GOTO 1380
1290 IF F=2 THEN F$="WHITE":GOTO 1380
1300 IF F=3 THEN F$="RED":GOTO 1380
1310 IF F=13 THEN F$="GRAY":GOTO 1380
1320 IF F=5 THEN F$="VIOLET":GOTO 1380
1330 IF F=6 THEN F$="GREEN":GOTO 1380
1340 IF F=7 THEN F$="BLUE":GOTO 1380
1350 IF F=8 THEN F$="YELLOW":GOTO 1380
1360 IF F=9 THEN F$="ORANGE":GOTO 1380
1370 IF F=10 THEN F$="BROWN":GOTO 1380
1380 IF S=1 THEN S$="BLACK":GOTO 1480
1390 IF S=2 THEN S$="WHITE":GOTO 1480
1400 IF S=3 THEN S$="RED":GOTO 1480
1410 IF S=13 THEN S$="GRAY":GOTO 1480
1420 IF S=5 THEN S$="VIOLET":GOTO 1480
1430 IF S=6 THEN S$="GREEN":GOTO 1480
1440 IF S=7 THEN S$="BLUE":GOTO 1480
1450 IF S=8 THEN S$="YELLOW":GOTO 1480
1460 IF S=9 THEN S$="ORANGE":GOTO 1480
1470 IF S=10 THEN S$="BROWN":GOTO 1480
1480 IF T=1 THEN T$="BLACK":GOTO 1580
1490 IF T=2 THEN T$="WHITE":GOTO 1580
1500 IF T=3 THEN T$="RED":GOTO 1580
1510 IF T=13 THEN T$="GRAY":GOTO 1580
1520 IF T=5 THEN T$="VIOLET":GOTO 1580
1530 IF T=6 THEN T$="GREEN":GOTO 1580
```

```

1540 IF T=7 THEN T$="BLUE":GOTO 1580
1550 IF T=8 THEN T$="YELLOW":GOTO 1580
1560 IF T=9 THEN T$="ORANGE":GOTO 1580
1570 IF T=10 THEN T$="BROWN":GOTO 1580
1580 PRINT:PRINT:PRINT:PRINT:PRINT
1590 PRINT:PRINT "YOUR RESISTOR HAS THE FOLLOWING COLOR CODE:"
1600 PRINT:PRINT F$;"-";S$;"-";T$
1610 PRINT:PRINT "DO ANOTHER (Y/N)?:":GETKEY Z$
1620 IF Z$="Y" THEN 90
1630 GOTO 1820
1640 GRAPHIC 2,1,15
1650 BOX 1,100,40,220,0
1660 DRAW 1,100,20 TO 50,20:DRAW 1,220,20 TO 270,20
1670 DRAW 1,110,0 TO 110,40:DRAW 1,120,0 TO 120,40
1680 DRAW 1,135,0 TO 135,40:DRAW 1,145,0 TO 145,40
1690 DRAW 1,160,0 TO 160,40:DRAW 1,170,0 TO 170,40
1700 PRINT:PRINT "IN THIS RESISTOR COLOR CODER, YOU WILL BE
GIVEN A CHOICE BETWEEN TWO METHODS: A)COLOR B)VALUE"
1710 PRINT:PRINT "USING THE COLOR METHOD YOU WILL BE ASKED THE
COLOR OF THREE BANDS"
1720 PRINT "BAND 1, BAND 2, AND BAND 3"
1730 CHAR 1,14,6,"1 2 3"
1740 PRINT:PRINT "PRESS ANY KEY TO CONTINUE.":GETKEY Z$
1750 PRINT:PRINT:PRINT:PRINT "AFTER YOU HAVE ENTERED THE THREE
COLORS, YOU WILL RECEIVE THE FINAL VALUE."
1760 PRINT:PRINT:PRINT:PRINT "PRESS ANY KEY":GETKEY Z$
1770 PRINT:PRINT:PRINT:PRINT "IN THE VALUE METHOD, YOU WILL ENTER
THE VALUE FOR EACH DIGIT."
1780 PRINT:PRINT "ON THE THIRD DIGIT, YOU WILL ENTER THE NUMBER
OF ZEROS."
1790 PRINT:PRINT "REMEMBER, K=000 AND M=000000"
1800 PRINT:PRINT "PRESS ANY KEY TO BEGIN":GETKEYZ$
1810 GOTO 90
1820 COLOR 0,1:COLOR 1,13:COLOR 5,13:COLOR 4,6
1830 GRAPHIC 0
1840 SCNCLR 0

```

if any of the three values are known, the fourth may be calculated:

$$\begin{aligned}
 L_1 &= L_2 L_3 / L_2 \\
 L_2 &= L_1 L_4 / L_3 \\
 L_3 &= L_1 L_4 / L_2 \\
 L_4 &= L_2 L_3 / L_1
 \end{aligned}$$

Logic Circuit Analysis. It is possible to

simulate the operation of a simple logic circuit with a C-128 program. The circuitry (gates and connecting lines or nodes) is described to the Commodore along with the input states to the circuit (on and off are represented as 1 and 0, respectively). Next, the program could determine what the resultant states of the nodes will be throughout the circuit following all of the logic 'decisions.' Essentially, this program would allow you to design and test a logic

Resistor Color Codes

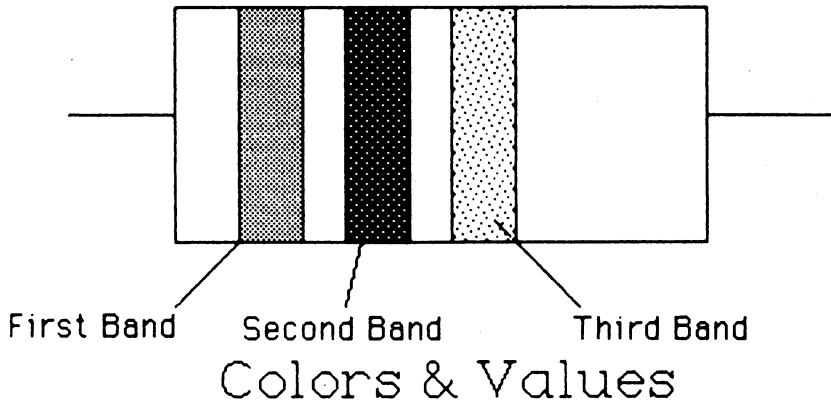

	First Band	Second Band	Third Band
Black	0	0	1
Brown	1	1	10
Red	2	2	100
Orange	3	3	1000
Yellow	4	4	10000
Green	5	5	100000
Blue	6	6	1000000
Violet	7	7	10000000
Gray	8	8	100000000
White	9	9	NA

Fig. 4-2. Listing 4-3 is a resistor color coder. This program will enable you to correctly identify any resistor based on either its color or its value. The speed and execution of this program make it educational, as well as enjoyable—even if you don't like resistors.

circuit without all of the problems associated with breadboarding.

Additional Applications for Electrical Engineers. The following list includes a number of other areas in which the Commodore 128 can make an EE's life much easier.

- Transistor configuration conversion
- Resistive attenuator design
- Smith chart conversions
- Phase shift oscillator design
- Dc bias analysis
- Waveform limits determination
- Plotting of waveforms
- Plate resistance/transconductance calculations
- Gauss calculations
- Reactance chart calculations
- Design of controlled rectifier circuits
- Integrated circuit current-source design
- Solution of resistive networks
- Rf amplifier analysis
- Bipolar junction transistor analysis
- Complex matrix calculations as used in electrical engineering
- Wheatstone bridge design

Civil Engineering

Civil engineers will find Commodores useful for performing the following functions:

- Moment of inertia calculation
- Vector statics
- Section properties
- Stress on an element or beam
- Static equilibrium about a point

Chemical Engineering

Chemical engineers can use Commodores for the following:

- Ideal gas equation of state
- Conservation of energy calculations
- Heat exchanger analysis
- Curve fitting
- Hydrocarbon combustion calculations

Machine Design

Machine designers can use Commodores to do the following:

- Constant acceleration calculations, relation to time and velocity.
- Kinetic energy determination
- Critical shaft speed calculation
- Cam design functions
- Gear and spring calculations/design
- RPM/torque/power computation
- Tachometer/dwell meter calculation: your oscilloscope can be converted into a tachometer and dwell meter in conjunction with your computer. The following information must be input to the computer to determine engine RPM and dwell angle:
 - a. Number of cylinders in the engine
 - b. Interval in milliseconds for open ignition points
 - c. Interval in milliseconds for closed ignition points

Factors a and b are determined using the oscilloscope. (RPM may also be calculated using the factors of tire diameter, gear ratio, and vehicle speed.)

$$\text{ignition pulse frequency} = \frac{\text{RPM} \times \text{No. Cylinders}}{120}$$

Chapter 5

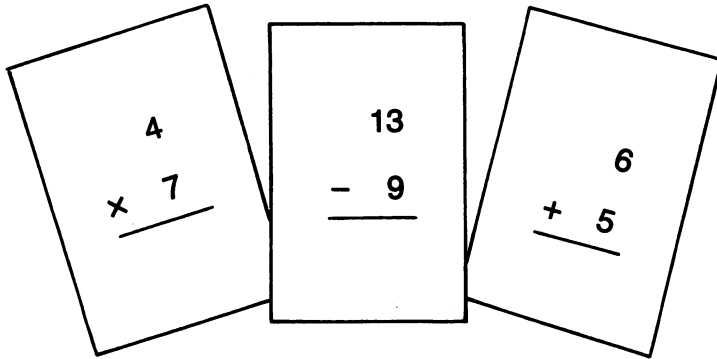

Commodore 128 Goes to School: Educational Applications

One of the most important uses for a Commodore 128 is most certainly education. The acronym CAI, which stands for Computer-assisted Instruction, is often used to represent the application of computers in the field of education. Not only can the Commodore serve as a drill and practice machine for teaching a wide variety of different subjects, but it can also teach the fundamentals of computer programming and prepare the learner for a career in the computerized future. Likewise, the C-128 can be used as a tool, much like a pencil and a piece of paper can be, by the student.

We all have memories of learning addition and subtraction, repeating spelling words, and memorizing the dates of important events. Most of us considered this to be one of the boring essentials of elementary education, and our attention span was accordingly short.

The addition of the Commodore 128 to education reduces the tendency towards this mind-wandering habit. Although the subject matter has not changed, the method of "drill-till-you-drop" practice has become much more entertaining with

the insertion of the C-128. Countless studies have shown that computerized education makes learning more interesting and more effective. The task of learning school subjects has become colorful, individualized, and in some cases, exciting. The students have instant feedback from the Commodore 128 so that they know whether their answers are right or wrong and they can continue to build from that point.

Commodore programs designed for drill and practice are usually capable of providing questions at various levels of difficulty. For example, simple multiplication problems with single digit, double digit, or triple digit multiplication can be provided. In this way, the student learns his basic multiplication tables before tackling 472×952 . The C-128 can either randomly generate these problems or choose them from a large collection stored in memory. As the student masters a certain number of problems at the beginning level, he can advance at his own pace to succeeding levels. If he encounters any difficulty at a particular level, the Commodore 128 will provide more of the same kinds of prob-

lems or offer help. The C-128 can even be programmed to remember what level a student has achieved and can begin from that point the next time that he uses the program.

Each time the student answers a question, the C-128 informs him whether the answer is right or wrong. If the answer is correct, the student can be rewarded with a picture of a smiling face, a colorful, animated display, or an encouraging message. If the student responds incorrectly, the Commodore 128 offers a gentle correction, which may be humorous, in order to keep the learning experience enjoyable rather than painful.

Commodore drill and practice systems have been applied to every educational area, from preschool to college level. Some programs make use of computer graphics for those situations in which "a picture is worth a thousand words." Newer systems make use of random-access video disk players, in which short video segments can be selected by the Commodore.

Certainly, one of the best ways to learn about computer operation and programming is to purchase a Commodore 128. Not only can a child learn how to program computers, but she can also learn how to think logically and how to draw conclusions based on fact analysis. The ability to define and analyze a problem during the creation of a program requires many human thought factors that can be applied in situations devoid of computers. Children and adults both need to become familiar with computer operation, capabilities, and programming as preparation for life in an increasingly computerized world.

Software publishers have discovered that there's no faster way to a parent's wallet than to sell the notion that using a Commodore 128 will improve a child's mind. If you intend to purchase a commercially available software package, ask for a demonstration prior to presenting your hard-earned cash. Your best bet is to consult the local magazine stand before you make the final purchase decision. Look for competent reviews of the products that you feel are worthy of your attention. Af-

ter you have completed your research, then and only then should you lay down your cash.

APPLICATION IDEAS

The educational uses for Commodores are unlimited. A few of the possible ways of using a C-128 for instructing yourself, your children, or your friends, include the following. If you are excited by the prospect of marketing your own software, you might wish to incorporate these ideas into the programs that you sell:

- Create a program describing how to program computers in BASIC or another language such as assembly language or FORTRAN, etc. with step-by-step examples.
- Create a story building program for youngsters in which the computer randomly selects individual story parts and combines them to produce a different story each time. Questions could be asked to test reading comprehension, grammar, and writing skills. For example, the program could produce a personalized story for a child using his or her name. Occasionally, questions such as this should be displayed:

Johnny, should I write the next sentence as

1. "Johnny and I went to the park."

or

2. "I and Johnny went to the park."

If the child answers correctly, the computer reply could be "O.K., that's correct," and a wrong answer could be explained—"No that's wrong. The person who is talking should place the "I" last, after the names of other people."

- Create an I.Q. builder program to familiarize people with the types of questions and problem solving methods used on tests such as the Scholastic Aptitude test, Civil Service tests, and the American College Assessment test. Research has shown that familiarization with the tests can improve performance considerably. Sample questions are readily available in test-preparation books.

Commodore 128 Games and Recreational Applications

- Create a future-potential evaluation program designed to quiz high school or college students about their talents, interests, and abilities. The program could direct them toward promising careers based upon this information.
- Computerize psychological questionnaires, which are often found in popular magazines and books for recreational and education use. Tests particularly suited for computerization are those requiring tedious calculation to analyze. For instance, this quiz is designed to test your "happiness quotient" and could be easily computerized:
Answer each question as true or false.

1. My work is usually fulfilling or interesting.
2. I have a good ability to relax.
3. I can enjoy happiness in little things easily.
4. I seldom envy other people.
5. My moods have great fluctuation.
6. I have a great desire to change either my location, family situation, or job.
7. I usually sleep well and don't feel tired in the morning.
8. I periodically "blow my top" without knowing the real reason.
9. I am usually a pessimistic person.
10. I cannot have happiness without others being around me.

Scoring:

Start with zero, add one point for each true answer to questions 1, 2, 3, 4, 7 and add one point for each false answer to questions 5, 6, 8, 9, 10. Multiply the total by 10 to determine percentage happiness (average score is approximately 50).

An ambitious programmer could program the computer to print out an analysis of the subject based on his answers. Such a program would make use of stock phrases to be used for many possible combinations of answers and could read like this:

If you don't derive much pleasure from little things or if you regularly lose your temper (3 and 8), you should give some attention to your attitudes. Is your social situation the cause of the trouble (6) or is it your job situation (1)? Often, the simple recognition of this difficulty will serve to clear up the situation. The person who is truly happy can find happiness while alone (10) and isn't envious (4). The moody person (5 and 9) can often benefit from the advice of a counselor.

- Create a spelling program that would allow you to input and store words. Words would be randomly selected and flash on the screen from .1 to 10 seconds. The player must then type in the word from memory.

COMPUTER-ASSISTED INSTRUCTION

Computer-assisted instruction (CAI) refers to the use of a computer as a teaching device. Graphics, text, and questions can all be presented on the screen. A simple CAI program is designed to ask a question, wait for a response, determine whether or not the answer is correct, and keep track of your progress (see Listing 5-1). One incorrect answer is allowed for each question before the correct answer is given.

In this program, you may create your own questions by making a Commodore BASIC DATA statement. Each DATA statement contains two elements that are separated by a comma. The first element is the actual question, while the second element represents the correct answer. Finally, remember to replace the last number in the FOR statement of line 110 with the total number of questions.

COMPUTER TUTOR

You can use your Commodore 128 to assist you in the memorization of lists, names, and vocabulary words. For instance, the Commodore 128 could quiz you in a flashcard fashion from a vocabulary list, displaying each randomly selected word individually on the screen. Once you have studied the

Listing 5-1: The CAI Tutor Program

```

10 REM CAI TUTOR
20 GRAPHIC 0
30 SCNCLR 0
40 COLOR 0,1:COLOR 5,8:COLOR 4,1
50 PRINT:PRINT TAB(12)"I AM YOUR TUTOR"
60 PRINT:PRINT "TODAY WE WILL LEARN ABOUT COMPUTERS"
70 PRINT:PRINT "YOU WILL BE GIVEN TEN QUESTIONS"
80 PRINT:PRINT "PRESS ANY KEY TO BEGIN.":GETKEY Z$
90 SCNCLR 0
100 X=0
110 FOR Q=1 TO 10
120 READ Q$,A$
130 PRINT Q$
140 INPUT R$
150 IF R$=A$ THEN PRINT "CORRECT":PLAY "V203T6UBX0AB":X=X+1:
    NEXT Q
160 IF R$<>A$ THEN PRINT "SORRY, THE ANSWER IS ";A$:NEXT Q
163 FOR Z=1 TO 1500:NEXT Z
170 SCNCLR 0
180 PRINT:PRINT "YOU ANSWERED";X;"QUESTIONS CORRECT":
    PLAY "V203T6UBX0ABABD"
190 PRINT:PRINT "WANT TO TRY AGAIN (Y/N)?:GETKEY Z$
200 IF Z$="Y" THEN RESTORE:GOTO 90
210 COLOR 0,1:COLOR 5,13:COLOR 4,6
220 SCNCLR 0
230 END
240 DATA WHAT DOES CPU MEAN, CENTRAL PROCESSING UNIT, HOW MANY
    BYTES ARE IN 1 KB YTE, 1024, WHAT IS THE NAME OF YOUR
    COMPUTER, C-128
250 DATA HOW MANY MODES ARE IN THE C-128, 3, HOW MANY THINGS CAN
    YOU DO WITH THE C-128, 1001, WHAT TYPE OF DISKS DOES THE
    C-128 USE, FLOPPY
260 DATA WHAT BUTTON RESTARTS THE C-128, RESET, HOW MUCH RAM DOES
    THE C-128 HAVE , 128K, WHICH KEYS CONTROL SCREEN MOVEMENT,
    CURSOR KEYS
270 DATA WHAT IS THE NAME OF A MOVABLE SCREEN OBJECT, SPRITE

```

word and attempted to recite its definition, press the return key. The definition could be automatically displayed, and if you made an error, you would be able to correct yourself. When the test concludes, a percentage of correct versus incorrect answers could be printed on the monitor's screen.

The high school or college student should find computerized quizzes helpful in memorizing such information as:

1. Historical names, dates, and places—presidents, authors, inventors, etc.

Commodore 128 Games and Recreational Applications

2. Parts and functions of the anatomy
3. Mathematical or chemical formulas
4. Verses in literature
5. Spellings or definitions of difficult words
6. Trigonometric identities
7. Geography—states, capitals, countries
8. Technical and scientific terminology
9. Anglo/metric unit conversions
10. Constellation recognition (see Listing 5-2 and Fig. 5-1)

Listing 5-2: The Astronomy Quiz Program

```
10 REM ASTRONOMY QUIZ
20 COLOR 0,1:COLOR 1,2:COLOR 5,13:COLOR 4,1
30 GRAPHIC 0
40 SCNCLR 0
50 PRINT:PRINT TAB(13)"ASTRONOMY FLASH"
60 PRINT:PRINT TAB(17)"CARDS"
70 PRINT:PRINT "YOU WILL BE SHOWN FIVE CONSTELLATIONS.
  YOUR GOAL IS TO CORRECTLY IDENTIFY EACH OF THEM."
80 PRINT:PRINT "PRESS ANY KEY TO BEGIN.":GETKEY Z#
90 GRAPHIC 2,1,15
100 X=0
110 FOR Q=1 TO 5
120 GRAPHIC 2,1,15
130 FOR P=1 TO 7
140 READ A,B
150 DRAW 1,A,B
160 NEXT P
170 READ A#
180 INPUT R#
190 IF R#=A# THEN PRINT:PRINT "CORRECT":PLAY "V203T8U8X0AB":
  X=X+1:NEXT Q
200 IF R#<>A# THEN PRINT:PRINT "SORRY, THE ANSWER IS ";A#:
  PRINT:PRINT "PRESS ANY KEY":GETKEY Z#:NEXT Q
210 GRAPHIC 0
220 SCNCLR 0
230 PRINT:PRINT "YOU IDENTIFIED";X;"CONSTELLATIONS RIGHT":PLAY
  "V203T8U8X0ABABCD"
240 PRINT:PRINT "DO YOU WANT TO TRY AGAIN (Y/N)?:GETKEY Z#
250 IF Z#="Y" THEN RESTORE:GOTO 20
260 COLOR 0,1:COLOR 5,13:COLOR 4,6
270 GRAPHIC 0
280 SCNCLR 0
290 END
300 DATA 50,25,75,18,100,30,100,45,140,45,140,30,50,25, THE BIG
  DIPPER
310 DATA 50,18,100,30,80,52,75,55,70,58,50,85,100,80, ORION
320 DATA 75,20,50,35,158,73,150,75,125,90,120,95,75,20, GEMINI
330 DATA 115,15,50,30,105,40,25,50,100,60,25,50,50,30, VIRGO
340 DATA 115,15,120,28,115,38,105,55,98,40,95,25,98,40, BOOTES
```

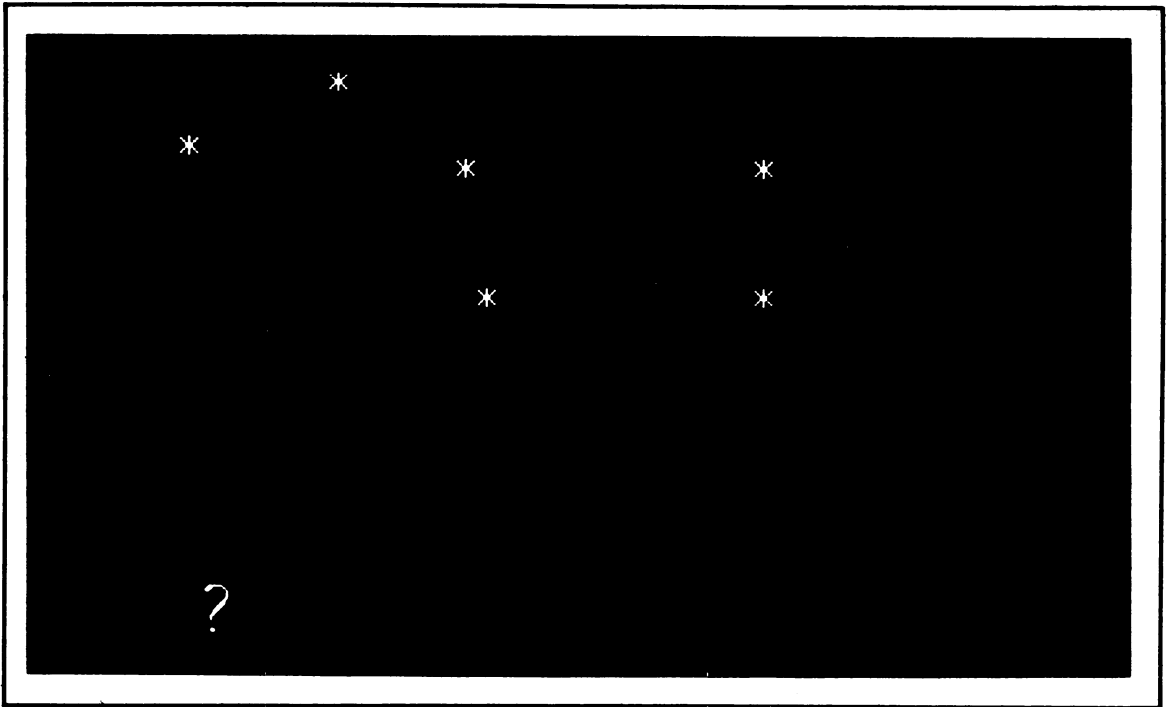

Fig. 5-1. What is the name of this constellation? Run the program in Listing 5-2 and you will find out.

EDUCATIONAL SIMULATIONS

Because of the ability of the Commodore 128 to perform calculations rapidly, it is well suited to be used for educational and mathematical simulations. Simulations for educating grade school individuals include the following:

The Manhattan Indian Problem. This simulation teaches the principle of compounded interest. As the story goes, the New World settlers paid the Indians \$24 for the entire island of Manhattan in 1626. Today, this property is worth millions of dollars. The main question is, what would have happened if these same settlers had deposited the \$24 in a savings account at 6 percent interest compounded daily? How much would that account be worth today? A Commodore 128 generated chart listing the value of the account after each decade of interest gathering would serve as an illustration of the geometric growth rate involved with the an-

swer to the Manhattan Indian Problem.

Use the formula $A_1 = A(1+r)^n$ where A_1 = value acquired (capital + interest), A = original investment, v = interest rate, and n = number of years.

The Growth of an Amoeba Colony. This simulation represents the growth of a colony of amoebas (microscopic, unicellular protozoans) in a jar with a limited food supply. The reproduction rate will cause the colony's population to double per unit of time. The formula for geometric progressions is:

$$S = a \times \frac{q^n - 1}{q - 1}$$

where S = sum, a = the first term (in this case = 1), q = the ratio for successive values (in this case = 2 because the colony doubles with each generation).

Pollution and a limited food supply, however, will decrease the colony's size at an increasing rate. Otherwise, within one month's time, a single amoeba dividing at a rate of five times per day would produce a volume of organisms equal to one million times the volume of the sun, provided that the food and space were available in a controlled environment. A numerical listing or plot of the colony's population versus time could be generated by the Commodore 128. Will the colony ever reach a state of equilibrium? Along similar lines, simulations on a larger scale, such as the ecology of a forest, could be undertaken.

The Laws of Physics. A demonstration of some of the laws of physics could take the form of a graphical illustration of planetary orbits, acceleration due to gravity, and the motion of a pendulum.

Large-Scale Simulations

Simulations on a large scale that require extensive preparation have also been accomplished on the Commodore 128. These include the following:

The Acoustics of a Room. The acoustics of a room could be mathematically simulated, if such parameters as the dampening effects of the walls, the shape of the room and its contents, and the location of the sound source were provided. This could be useful to the architect or audiophile. For example, in designing a small stereo listening room or studio, concentrations of standing waves cause unequal resonances in different spots within the room. In order to reduce the nonuniformity of standing waves at lower frequencies, room proportions must be carefully controlled to ensure optimum diffusion of sound. Standing waves in a rectangular room are governed by a simple equation that could be modeled on your C-128:

$$f(n_1, n_w, n_h) = (c/2) [(n_1/l)^2 + (n_w/w)^2 + (n_h/h)^2]^{1/2}$$

where c = velocity of sound, and l = length, w = width, h = height of the room; the n 's are the mode

numbers—the lowest mode number ($n = 1$) represents the lowest frequency resonance appearing, governed by the dimension, and the higher n 's represent higher frequency resonances. In order to calculate the frequency of a standing wave along one axis of the room, you must set the n values for the two other axes equal to zero. For example, if $n_1 = 1$ and the others equal zero, the formula will give the lowest frequency standing wave along the length of the room. When two terms are non-zero, the standing waves are tangential. In order to obtain uniformity, the tangential waves are the most desirable, the oblique waves are next, and the axial waves are the least desirable. Therefore, by using this equation you can adjust a room's dimensions to provide the most even spacing of axial standing waves together with a preference for tangential waves. This allows the greatest degree of uniformity in frequency.

A Simulation of World Dynamics. This simulation, which is similar to Jay Forrester's "Limits to Growth" computer simulation, could be accomplished on a smaller scale. World dynamics involves the interaction of population, pollution, and resources to predict future outcomes.

A Simulation of Astronomical and Physical Theories. This kind of simulation could possibly be accomplished with a Commodore 128, although the memory requirements would be very large and the simulation could run for hundreds of hours. See the article, "Doing Physics with Microcomputers," in *Physics Today* (Dec 1983, pp.25-28). The author describes a Monte Carlo simulation of the three-dimensional Ising model for the study of phase transitions.

A Simulation of Automotive Fuel Economy. This simulation could include such factors as fuel injection, fuel additives, and pollution monitors.

A Simulation that Stages Your Own World Series or Super Bowl. You could use statistical techniques to simulate a game or series of games using star athletes whose simulation performance would be based on their career averages.

ADDITIONAL CAI IDEAS

Examples of teaching programs for a variety of different levels are listed below:

Elementary Math Flashcards. Programs designed to increase both speed and efficiency in basic mathematical skills.

Word Problems. A program designed to output "random" mathematical word problems for practice.

Rhymes and Riddles. In this learning game, young children could try to unscramble words to form a line from a nursery rhyme or an answer to a riddle.

Fractions. A program that drills students in recognizing common denominators and adding and multiplying fractions.

Spelling. A program that teaches the student how to recognize commonly misspelled words.

Roots. A guessing/learning game in which the student must guess the square or cube root of a random number.

Ballistic. A program in physics that helps the student learn how to calculate the path of a projectile.

Gasvol. A plotting/calculating program that draws pressure/volume diagrams of a gas.

Logic Reasoning. This program tests the student on conditional statements, hypotheses, conclusions, deduction, fallacies, and definitions.

Balance. A drill program on balancing chemical equations.

Metric. An exercise in converting units between United States measurements and their equivalents in the metric system.

Bases. A demonstration program for teaching how to do conversions from one numerical base system to another.

Multiplication Drill. A random generation of single digit multiplication problems for practice in memorizing the multiplication tables.

Speed Reading/Tachistoscope. A program that helps you learn to read faster. Lines from a piece of literature could be stored in DATA statements in a Commodore BASIC program and flashed singly on the screen. The amount of time that you are given to read each line should be gradually decreased until a speed of several hundred words per minute is obtained.

A tachistoscope can be used to improve your perception and short-term memory. Psychologist G. Miller reports that anyone should be able to see from five to nine letters in any given brief exposure, whether 1/100 of a second long or 1/2 of a second long, which shows the limitation in our ability to perceive visual information in brief exposures. In addition, we are able to comprehend many more letters displayed by the tachistoscope if they form a familiar word instead of an unfamiliar or foreign word. A tachistoscope program could be written for a science fair project. The program should offer adjustable speeds, familiar and unfamiliar words, and a final display of the words for confirmation.

can be obtained. A more sophisticated program could combine different graphics characters within the line in symmetric fashion. Similarly, new quilting patterns could be designed mathematically.

Perspective Drawing Aid. Given a set of points describing the (x,y,z) dimensions of objects in a picture, the Commodore 128 could use matrix manipulations to produce a new set of points describing the picture from another perspective or viewpoint. Additionally, if video graphics or plotting capabilities are available, the new picture could be plotted. Perspective transformations are useful in technical illustration and other art forms as well.

As an example of the perspective transformations that can be accomplished using a large array of points, let (x,y) be a coordinate pair under the "old" coordinate system. Let (x_0,y_0) be the center coordinates of the new system rotated through angle θ in relation to the old system. The new coordinates (x',y') can be calculated with these equations:

$$\begin{aligned}x' &= (x - x_0) \cos \theta + (y - y_0) \sin \theta \\y' &= -(x - x_0) \sin \theta + (y - y_0) \cos \theta\end{aligned}$$

A dimension scaling program would request the largest dimension of the object and the largest dimension of the drawing of the object. The scaling factor is the ratio of these values. The program would eliminate the headaches of creating a scale drawing by multiplying the input dimensions of the object by the scaling factor to arrive at the scaled down dimensions for the drawing.

Computer as Sculptor. One hobbyist has created a computer-controlled router that can sculpt material in accordance with a set of programmed points (x,y,z) . The C-128 controls the rotation of the sculpturing material (y axis) and the horizontal/vertical (x and y axes) motion of the router by means of servomechanisms. Eliminating one axis, the computer could also control a lathe to produce sculptured furniture legs of exacting proportions.

Computer Painting. A commercial computer-controlled airbrush system is being used

to create murals from photos or other graphic images. The image is digitized through the use of a TV camera and A/D converter. Then, the image is painted in much larger proportions by the use of a special x,y plotting system that uses an airbrush in lieu of a pen. An enterprising hobbyist could construct such a system.

Computer Posters. Everyone has seen the "computer portraits" popular at carnivals and shopping malls, in which a television picture of a subject is digitized and output on a printer. One hobbyist has circumvented the expense of a television digitizer by taking an ordinary photograph and placing a fine grid over it. He assigns each square in the grid a brightness level and manually inputs this information. The C-128 prints dark characters or blocks for the squares with a low brightness level and vice versa for squares with a high brightness level. Through this tedious process, he creates computer-generated posters and portraits without the expense of a television camera and video image digitizer.

The Verbal Arts

What usefulness could there be in creating poems with the Commodore 128? Unlike humans, computers have the capability of being "completely" random. They are free from the "inspirational" selection of words when composing a poem. Completely is in quotation marks because there will always be some bias introduced by the programmer. A computer-generated poem can serve as a stimulus for the human poet. He can elaborate on the poem and extract inspirational clues in composing his own poetic works.

One crude method for generating computer poetry makes use of the following format in randomly selecting words from large lists of nouns, verbs, adjectives, definite articles, prepositions, conjunctions, and adverbs:

Title:	Adjective + Noun (singular)
First Line:	Adjective + Noun (plural) + Adverb + Verb (plural, pres-

	ent tense) + Adjective + Noun (plural)
Second Line:	Adjective + Noun (plural) + Verb (plural, present tense) + Adverb + Adjective + Noun (plural)
Third Line:	Article (definite, such as the) + Noun (singular) + Verb (singular, present tense) + Preposition + Article (definite) + Adjective + Noun (singular)
Fourth Line:	Noun (plural) + Verb (plural, present tense) + Preposition + Article (definite) + Noun (singular)

In order to ensure some continuity, the second adjective and second noun of the first line may be repeated as the first adjective and first noun of the second line.

Granted, some computer-generated poems make more sense than others. If you select words related to the same subject matter for your lists of the different parts of speech, the resulting poem might seem almost human-generated. It is sometimes more fun, however, to list completely unrelated terms for the creation of computer-generated nonsense verses.

Along similar lines, an aphorism generator could create aphorisms (short, pithy sayings) using the form, “_____ is the _____ of _____.” Each blank would be replaced with a randomly selected noun.

The Musical Arts

Within the field of music, the Commodore 128 can be used in a number of different areas. Some of these areas are listed below.

Music Education. Possible music education applications include the following:

1. A graphic, flashcard style quiz that could dis-

play notes and other musical notation on the scale for identification and practice in reading music.

2. A quiz on pronunciations and definitions of musical terms (e.g., *andante*, *diatonic*, and *staccato*).
3. A musical staff drill. A graphic keyboard and staff could be presented, and the C-128 could select the note on the staff corresponding to the key that is pressed. Key signature drills could be done in a similar manner.
4. A basic ear-training skills program. The Commodore 128 could quiz students on recognition of pitches, intervals, chords (major, augmented, diminished, and minor), and scales (major, natural minor, harmonic minor, and melodic minor, whole tone, and chromatic).
5. A name the tune game. A tune produced by the C-128 can teach identification by sound of the degrees of the scale, using *solfeggio* syllables or scale degree numbers.
6. A wrong note program. Pitch error detection can be practiced within various combinations of four-voiced chord types. Following the selection of a chord type, the C-128 can visually represent the chord and play the sound with one incorrect note. The student must identify the wrong voice and its corresponding pitch.
7. Harmony drills. Commodore 128-produced aural diatonic chord progressions can be taught on various levels of difficulty.
8. Write that tune game. The C-128 plays a random or preprogrammed series of notes that the student must then reproduce on a video staff or on an interfaced musical keyboard.
9. Chord progression practice. Students can predict chord progressions and receive feedback from the C-128 in the form of subsequent visual and aural output.
10. Guitar chords practice. Students can practice finger placement required to produce guitar chords, with visual and aural feedback.
11. Famous composers and their music quiz. A quiz-style program could teach famous composers' names, pronunciations, and composi-

1001 Things to Do With Your Commodore 128

tions with the aural output of excerpts from those works reproduced by the Commodore 128.

12. Transposition practice. The student is presented with a short melody to transpose to a randomly selected key. The C-128 verifies the correct transposition.
13. Tuner program. Two tones, which are separated by less than one half-step, are produced by the Commodore 128. The student tunes these tones to match each other by selecting an increase or decrease in one of the tones.
14. Rhythm practice. The student could practice playing rhythm patterns on a keyboard. The C-128 can analyze these patterns for accuracy, play the passage the way it should be played, and even demonstrate how the student's response differed from the expected response.
15. Composition package. This type of program, given the notes of a composition, can display the piece in standard musical notation and actually play it. The student can experiment with tempo, timbre, and musical envelopes. Having control of timbre and musical envelopes permits composition of a piece performed by three voices resembling the clarinet, flute, and oboe and demonstrates the interaction between voices.

Music Composition. In the past, programs designed to compose music were based more on random numbers than on true musical principles. Therefore, the tunes that were produced could, at best, be compared to a child randomly banging on piano keys. Lately, however, progress has been made in developing more complex programs that adhere to the "rules of thumb" for composing particular types of music. One program, which used the following rules, was somewhat successful in composing "pop" music.

Basic melody requirements:

1. The first note must be one that is not a fourth,

a flatted fifth, a minor second, or a ninth.

2. An ascending minor second progresses to a second, and a descending minor second progresses to the tonic. An ascending flatted fifth progresses to a fifth, and a descending fifth progresses to a fourth.
3. Not more than five notes in descension or ascension are permitted without a complementary movement.
4. The melody should consist of 35 to 60 notes.
5. The release begins on a subdominant major note.
6. Melodic leaps must not be larger than a major tenth.
7. A melodic leap may not be followed by another melodic leap larger than a major sixth.
8. No more than three consecutive melodic leaps are allowed.
9. No ascending or descending passage may contain more than one melodic leap.

Rather than subjecting purely random notes to these compositional rules, a probability distribution used in conjunction with a random number generator could help to produce notes that would more likely fit these rules. Table 6-1 illustrates how this might be accomplished. The name for each interval is given along with the corresponding keyboard distance a note is from the last note. The next column gives a probability for selection of that particular interval. This probability of selection value can be changed according to the composer's wishes. The next two columns give the range of numbers, generated by a random number generator, that corresponds to the probability of selecting a given + or - interval. In this way, a random number generator selecting numbers from 1-100 can provide a given probability distribution of notes.

In order to further ensure the choice of "good" notes, second or third order probability distributions could be specified. In other words, for each possible preceding interval (10), a probability distribution would exist for the purpose of choosing a particular value for the next interval. For instance,

Table 6-1. The Probability Distribution for the Random Selection of Notes.

INTERVAL	NO. OF NOTES AWAY FROM LAST NOTE	PROBABILITY OF SELECTION	RANDOM NUMBER RANGE	
			IN + DIRECTION	IN - DIRECTION
Unison	0	4%	49-52	49-52
Half Step	±1	14%	53-59	42-48
Whole Step	±2	12%	60-65	36-41
Minor Third	±3	10%	66-70	31-35
Major Third	±4	8%	71-74	27-30
Perfect Fourth	±5	12%	75-80	21-26
Tritone	±6	2%	81	20
Perfect Fifth	±7	14%	82-88	13-19
Minor Sixth	±8	6%	89-91	10-12
Major Sixth	±9	6%	92-94	7-9
Minor Seventh	±10	4%	95-96	5-6
Major Seventh	±11	2%	97	4
Octave	±12	6%	98-100	1-3

in traditional music, a tritone is usually followed by a stepwise interval (e.g., a whole or half step). Therefore, the second order probability distribution for a tritone would be heavily weighted toward a

stepwise interval in selecting the next note of the composition.

The program in Listing 6-2 simulates a fully-functional organ (see Fig. 6-2).

Listing 6-2: The Happy Organ Program

```

10 REM HAPPY ORGAN
20 COLOR 0,7:COLOR 5,8:COLOR 4,7
30 GRAPHIC 0
40 SCNCLR 0
50 V=1:O=0:T=0:G$=""
60 PRINT:PRINT TAB(8)"THIS IS THE HAPPY ORGAN"
70 PRINT:PRINT "WITH THE HAPPY ORGAN, YOU WILL SELECT:  1)VOICE
  2)OCTAVE 3)INSTRUMENT 4)NOTES"
80 PRINT:PRINT "PRESS ANY KEY TO BEGIN.":GETKEY Z$
90 SCNCLR 0
100 PRINT TAB(8)"THIS IS THE HAPPY ORGAN"
110 PRINT:PRINT TAB(6) CHR$(170);:FOR X=1 TO 25:PRINT CHR$(183);:
  NEXT X:PRINT CHR$(180)
120 PRINT TAB(6) CHR$(170);:PRINT TAB(32) CHR$(180)
130 PRINT TAB(6) CHR$(170);:FOR X=1 TO 3:PRINT TAB(8)
  CHR$(117)CHR$(105) " ";:NEXT X:PRINT CHR$(180)
140 PRINT TAB(6) CHR$(170);:FOR X=1 TO 3:PRINT TAB(8)
  CHR$(106)CHR$(107) " ";:NEXT X:PRINT CHR$(180)
150 PRINT TAB(6) CHR$(170);:PRINT TAB(32) CHR$(180)

```

1001 Things to Do With Your Commodore 128

```
160 PRINT TAB(6) CHR$(170);" V(1) O(2) I(3) ";CHR$(180)
170 PRINT TAB(6) CHR$(170);:PRINT TAB(32) CHR$(180)
180 PRINT TAB(6) CHR$(170);:FOR X=1 TO 25:PRINT CHR$(175);:
NEXT X:PRINT CHR$(180)
190 PRINT TAB(6) CHR$(170);:FOR X=1 TO 5:PRINT " ";CHR$(161);
" ";:NEXT X:PRINT CHR$(180)
200 PRINT TAB(6) CHR$(170);:FOR X=1 TO 5:PRINT " ";CHR$(161);
" ";:NEXT X:PRINT CHR$(180)
210 PRINT TAB(6) CHR$(170);:PRINT TAB(32) CHR$(180)
220 PRINT TAB(6) CHR$(170);:PRINT TAB(32) CHR$(180)
230 PRINT TAB(6) CHR$(170);:FOR X=1 TO 25:PRINT CHR$(175);:
NEXT X:PRINT CHR$(180)
240 PRINT:PRINT "SELECTION MENU:"
250 PRINT "PRESS THE FOLLOWING KEY FOR THE SELEC- TION-
260 PRINT "1-VOICE 2-OCTAVE 3-INSTRUMENT A,B,C,D,
E,F,G-NOTES S-STOP"
270 GETKEY G$
280 IF G$="1" THEN V=V+1:G$="":IF V=4 THEN V=1
290 IF G$="2" THEN O=O+1:G$="":IF O=7 THEN O=0
300 IF G$="3" THEN T=T+1:G$="":IF T=10 THEN T=0
310 IF G$="S" THEN 360
320 V$=STR$(V):O$=STR$(O):T$=STR$(T)
330 A$="V"+V$+"O"+O$+"T"+T$+"U8X0"+G$
340 PLAY A$
350 GOTO 270
360 COLOR 0,1:COLOR 5,13:COLOR 4,6
370 GRAPHIC 0
380 SCNCLR 0
```

Additional possibilities for using your Commodore 128 in music composition include the following:

1. Produce a stricter set of rules for composition than those given above; rely less on randomness.
2. Develop programs to compose in assorted musical styles including classical, rock and roll, and children's music. Computer musicians have applied statistical analysis to various styles and composers to determine characteristic probability distributions. Random numbers subjected to these probability criteria can produce music reminiscent of the original style.
3. Develop programs to compose tunes for given lyrics by using the timing of each syllable to time the duration of the notes accordingly. The ambitious programmer might try to link a lyric producing program with a music composing program. Some unusual results would, undoubtedly, be produced.
4. A popular melody could be mathematically transformed to produce a new melody, and this new melody would likely be more tuneful than compositions based on random number generators or probability distributions. The original melody would be numerically encoded such that each note and note duration has a unique number. With the melody so encoded, an algorithm could be applied to each note, translating that note into another. The simplest such

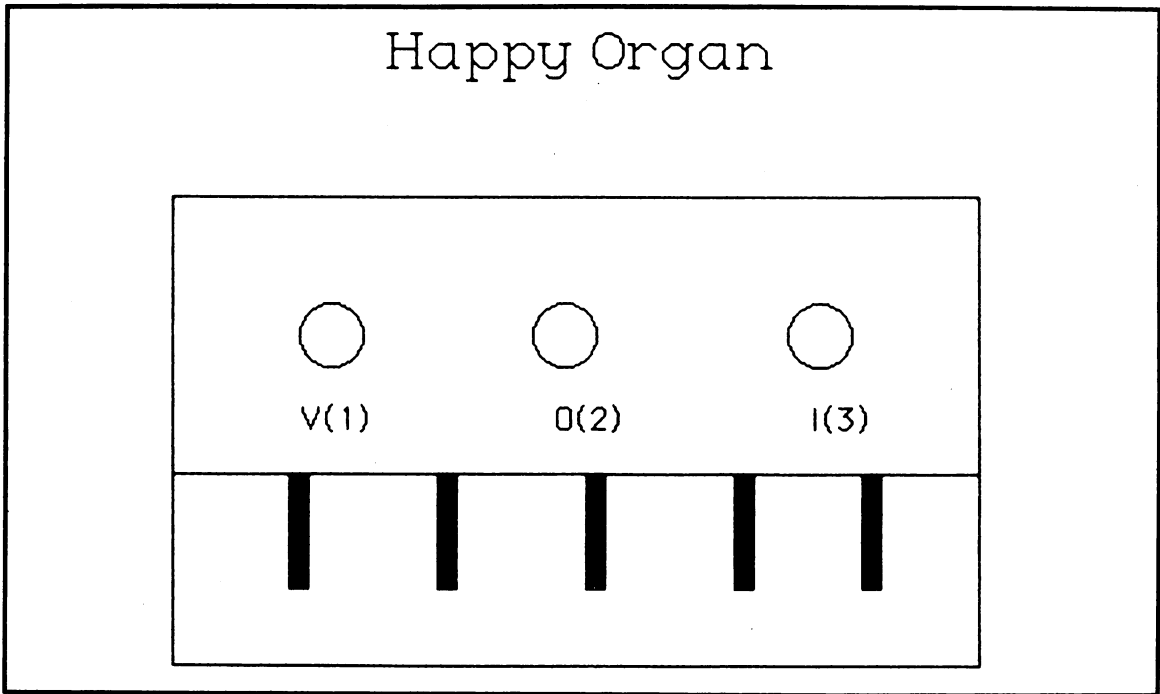

Fig. 6-2. Even if you can't play a note, the Happy Organ will make you sound like a professional "keyboardist." Four parameters are controlled through Listing 6-2: the organ's voice (press 1 to alter your choice; they all sound alike, however), the organ's octave (press 2 for raising the octaves), the organ's instrument sound (press 3 for selecting one of 10 different musical instruments), and the musical notes (press A, B, C, D, E, F, or G for the corresponding musical note).

algorithm could reflect each note around a central value, transforming high notes into low ones and vice versa. The program could also use a mathematical formula, but extensive experimentation would be necessary.

The following formula is useful as a part of a musical tone generating program based on the numbering of notes according to octave (V), where middle C is in the fourth octave, and according to position within the octave where $C = 1, C\# = 2 \dots B = 12$.

$$\log_2 \frac{f}{55} = V + \frac{P-22}{12}$$

where,

f = frequency in Hz (hertz)

5. Given the score of a music piece written for a solo instrument (e.g., the piano), the Commodore 128 could transpose and analyze melodies, bass, and counter rhythms to produce sheet music versions for other instruments.
6. A Commodore 128 connected to a player piano via a solenoid interface could digitally record songs that you play or song notes that you input. The song could be stored on a disk and recalled to be played at normal speed, faster, slower, with staccato, or even backward.
7. A C-128 can be programmed to produce a polyphonic synthesizer effect along with continuous beat patterns. The C-128 can also be used to perform mixing functions.
8. From a given composition, a simplified version could be extracted by the C-128 (the melody is usually carried by the highest notes and the

1001 Things to Do With Your Commodore 128

bass by the lowest) and printed in standard musical notation. Also, a given piece of music could be arranged so that all chords are broken up into varying arpeggios.

9. Given a melody, the Commodore 128 could be programmed to compose a bass counter-melody.

Computer Controlled Synthesizers. In 1982, a group of synthesizer manufacturers developed a standardized interface, called MIDI (musical instrument digital interface), to enable communications between synthesizers and computers. Each synthesizer key is encoded in a fashion similar to an ASCII (American standard code for information interchange) computer keyboard. For each synthesizer key struck, a series of codes is transmitted including a NOTE ON signal, a PITCH signal, a VELOCITY signal, and other sig-

nals specifying pitch blends, key release, and front panel changes. This information can be sent to any other MIDI synthesizer so that two or more keyboards can perform in exact synchronization, although the ADSR (attack, decay, sustain, release) envelopes are different on each machine.

Special codes can indicate that only specified synthesizers are to respond to an incoming code. This information can also be sent to the Commodore 128, which can be used as a polyphonic sequencer or imitator of a multitrack tape recorder. The C-128 may record, edit, store, and play back your music or play music entered through the keyboard. A composer can quickly change tempo pitch, instruments, and accents with the aid of such a system, which is capable of producing a flawless rendition.

Listing 6-3 turns the C-128 into a powerful polyphonic synthesizer (see Fig. 6-3).

Listing 6-3: The Polyphonic Synthesizer Program

```
10 REM POLY-C SYNTHESIZER
20 COLOR 0,10:COLOR 1,14:COLOR 5,14:COLOR 4,10
30 GRAPHIC 0
40 SCNCLR 0
50 PRINT:PRINT "WELCOME TO THE WORLD OF THE POLY-C"
60 PRINT:PRINT "THE POLY-C IS A SOPHISTICATED MUSIC      SYNTHESIZ
   ER THAT IS NOW CONTAINED INSIDE YOUR C-128."
70 PRINT:PRINT "THE POLY-C IS EASY TO OPERATE AND FUN    TO USE.
   JUST PRESS ANY KEY TO BEGIN    PLAYING ON THE POLY-C."
80 GETKEY Z$
90 F=1000:D=60:U=0:M=0:S=0:W=0:P=100:V1=0:V2=0:V3=0
100 GRAPHIC 2,1,18
110 BOX 1,25,5,75,95
120 BOX 1,135,5,190,95
130 BOX 1,260,5,310,95
140 CHAR 1,3,13,"VOICE 1"
150 CHAR 1,17,13,"VOICE 2"
160 CHAR 1,32,13,"VOICE 3"
170 CHAR 1,4,2,"F=":CHAR 1,18,2,"F=":CHAR 1,33,2,"F="
180 CHAR 1,4,3,"D=":CHAR 1,18,3,"D=":CHAR 1,33,3,"D="
190 CHAR 1,4,4,"U=":CHAR 1,18,4,"U=":CHAR 1,33,4,"U="
200 CHAR 1,4,5,"M=":CHAR 1,18,5,"M=":CHAR 1,33,5,"M="
210 CHAR 1,4,6,"S=":CHAR 1,18,6,"S=":CHAR 1,33,6,"S="
220 CHAR 1,4,7,"W=":CHAR 1,18,7,"W=":CHAR 1,33,7,"W="
```

```

230 CHAR 1,4,8,"P=":CHAR 1,18,8,"P=":CHAR 1,33,8,"P="
240 PRINT "IN ORDER TO USE POLY-C, PRESS THESE KEYS:
1,2,3)VOICE 4)FREQ. 5) DURATION 6)DIRECTION 7)MIN. FREQ.";
250 PRINT " 8)SWEEP 9)WAVE 0)PULSE WIDTH SPACE) SOUND E)END"
260 GETKEY K#
270 IF K#="1" THEN V1=V1+1:CHAR 1,2,13,"*":IF V1=2 THEN V1=0:
CHAR 1,2,13," "
280 IF K#="2" THEN V2=V2+2:CHAR 1,16,13,"*":IF V2=4 THEN V2=0:
CHAR 1,16,13," "
290 IF K#="3" THEN V3=V3+3:CHAR 1,31,13,"*":IF V3=6 THEN V3=0:
CHAR 1,31,13," "
300 IF K#="4" THEN F=F+1000:F#=STR$(F):F#=LEFT$(F#,2):
CHAR 1,6,2,F#:CHAR 1,20,2,F#:CHAR 1,35,2,F#:IF F=66000 THEN
F=1000
310 IF K#="5" THEN D=D+60:D#=STR$(D):D#=LEFT$(D#,2):
CHAR 1,6,3,D#:CHAR 1,20,3,D#:CHAR 1,35,3,D#:IF D=30000 THEN
D=60
320 IF K#="6" THEN R=R+1:R#=STR$(R):CHAR 1,6,4,R#:
CHAR 1,20,4,R#:CHAR 1,35,4,R#:IF R=3 THEN R=0
330 IF K#="7" THEN M=M+1000:M#=STR$(M):M#=LEFT$(M#,2):
CHAR 1,6,5,M#:CHAR 1,20,5,M#:CHAR 1,35,5,M#:IF M=65000 THEN
M=0
340 IF K#="8" THEN S=S+1000:S#=STR$(S):S#=LEFT$(S#,2):
CHAR 1,6,6,S#:CHAR 1,20,6,S#:CHAR 1,35,6,S#:IF S=32000 THEN
S=0
350 IF K#="9" THEN W=W+1:W#=STR$(W):CHAR 1,6,7,W#:CHAR 1,20,7,W#:
CHAR 1,35,7,W#:IF W=4 THEN W=0
360 IF K#="0" THEN P=P+100:P#=STR$(P):P#=LEFT$(P#,2):
CHAR 1,6,8,P#:CHAR 1,20,8,P #:CHAR 1,35,8,P#:IF P=4000
THEN P=100
370 IF K#=CHR$(32) THEN 400
380 IF K#="E" THEN 440
390 GOTO 260
400 IF V1>0 THEN SOUND V1,F,D,R,M,S,W,P
410 IF V2>0 THEN SOUND V2,F,D,R,M,S,W,P
420 IF V3>0 THEN SOUND V3,F,D,R,M,S,W,P
430 GOTO 260
440 COLOR 0,1:COLOR 5,13:COLOR 4,6
450 GRAPHIC 0
460 SCNCLR 0

```

HOBBIES

The Commodore 128 can perform invaluable services for those involved in all hobbies.

Photography

The serious photographer should investigate the use of the Commodore 128 to obtain more pre-

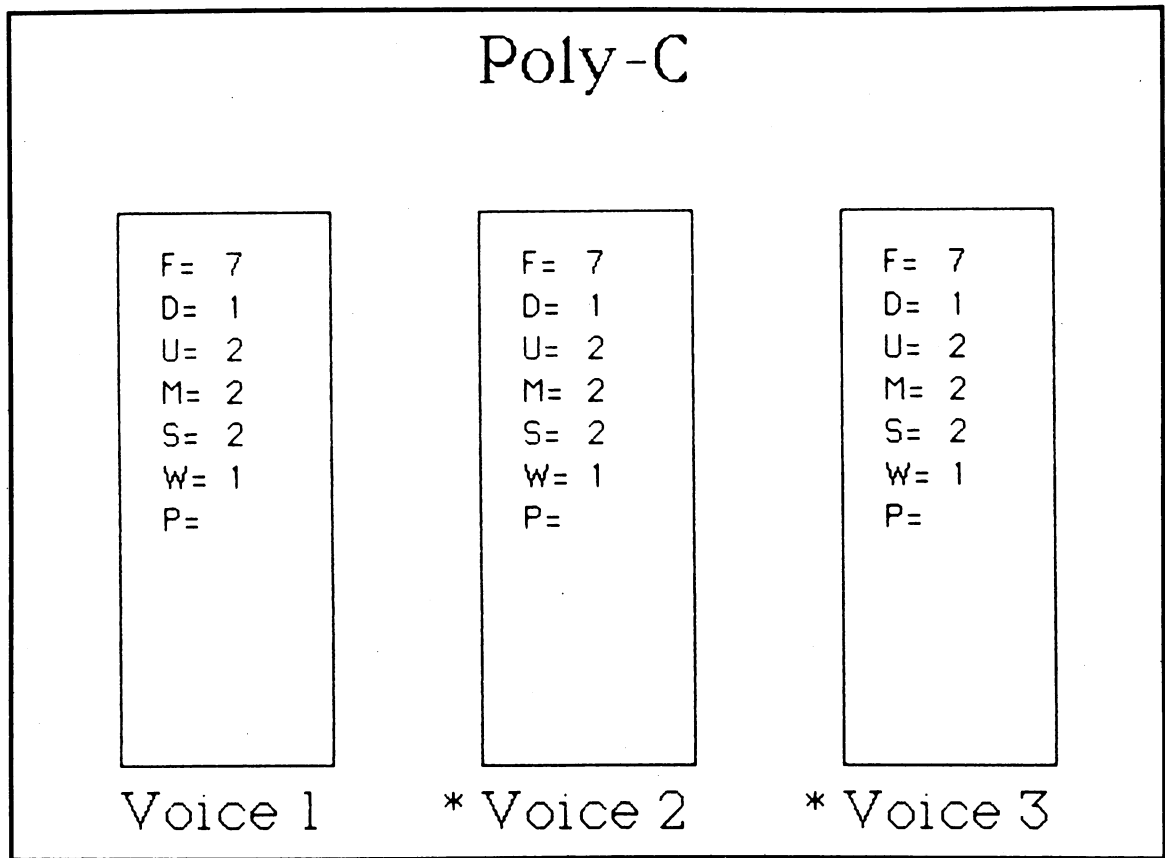

Fig. 6-3. Poly-C is a synthesizer program found in Listing 6-3. Seven different controls are available to the would-be Poly-C player: voice (press 1, 2, and 3), frequency (press 4), duration (press 5), direction (press 6), minimum frequency (press 7), sweep (press 8), waveform (press 9), pulse width (press 0), and sound production (press the space bar).

cise values for such things as development times, light exposures, and filters through the use of mathematical formulas. For example, the standard exposure meter assumes that: 1) for any emulsion, the curve of the density versus the log of the exposure yields a straight line and is characterized by a single factor—speed, and 2) time and intensity of light are interchangeable to provide a certain exposure (reciprocity). Actually, these assumptions are only approximations of true values. In extreme cases, reciprocity does not work; the density versus log of the exposure curve is not linear, and emulsions have differing contrasts and latitudes. A reference manual describing the mathematical

calculations of photography should describe the formulas used to take these factors into account.

Other ways in which photographers can use the Commodore 128 include the following areas:

1. Exposure compensation is useful in the dark-room to calculate the exposure required to compensate for a change in photo enlargement magnification. Using the inverse square law, if you have data on a "perfect" print expressed as enlarger head height above the easel (H_0) and time of exposure (T_0), the formula for computing the new time of exposure (T_N) at the new height (H_N) with the same aperture is:

$$T_N = \left(\frac{H_N}{H_0} \right)^2 \times T_0$$

A useful program could calculate exposure times for a range of specified heights at all available f-stops to permit easy enlargement of a negative to a given size.

2. Fill-in flash computation is used to determine the correct lens f-stop when a flash is used in the presence of strong ambient light to fill in undesired shadows.
3. If you intend to do specialized photography requiring home-built equipment, the C-128 could be useful in optical and dimensional calculations.
4. Automated control of darkroom equipment, including such features as temperature correction for chemicals, timer, and development calculator, could expedite the development process. Alternatively, the computer could serve as a timer and a reminder for steps to be taken in the development process.
5. An inventory of slides or photographs could be stored on disks, and topics could be indexed and cross-referenced. In order to create a slide show on a particular topic, you can use the C-128 to determine all relevant slides and output a listing of each slide along with its location.
6. A simple switching interface to a cassette recorder and slide projector could automate a complete audiovisual slide presentation. An exotic audiovisual light show could also be controlled in a similar manner.
7. Focal length conversions from one camera to another, based on the diagonal or horizontal angle of view, could be programmed.
8. A program could be written to calculate film speed (ASA), flash ECPS value, or flash guide number, given the other two values. Once the flash guide number is known, the maximum f-stop setting for the distance from the flash to the subject can be calculated, using the formula:

$$\text{f-stop} = \frac{\text{Guide number}}{\text{distance}}$$

The published flash guide number is for one speed of film only. If you use a different film with a different speed, the new guide number can be obtained by using the following formula:

$$NG = OG \cdot \sqrt{\frac{NF}{PF}}$$

where NG = new guide no.
 OG = old guide no.
 NF = new film speed.
 PF = published film speed.

9. Close-up photography values for subject distance, required lens focus setting, or depth of field could be calculated given the other two values.
10. The depth of field indicates the distance from some point in front of the subject to some point in back of the subject for which a given photograph will be acceptably in focus. A Commodore 128 program could mathematically determine how the desired near and far distances can be obtained, in terms of the f-stop setting and distance setting to use. The hyperfocal distance, or the nearest distance for which a lens can be focused to give satisfactory definition of infinity, is given by:

$$H = \frac{F^2}{f \cdot d}$$

where,

H = hyperfocal distance
 F = focal length of lens
 f = f-stop
 d = diameter of circle of confusion

11. A photograph of your Commodore's monitor

1001 Things to Do With Your Commodore 128

displaying text or graphics could be used to title home slide shows or movies. A recommended procedure is to darken the room completely, use a tripod, and shoot with a film such as KODAK Professional Film Ektachrome 50 Tungsten EPY.

BASIC programs that aid computing many photographic values can be found in contemporary photography magazines, such as *Popular Photography* and *Modern Photography*.

Animated Films. Although the Commodore 128 is capable of displaying high-resolution real-time animation on its own, an animated film could be made using screen or printed graphics. A three dimensional rotation of an object is a popular film subject that can be programmed with relative ease. A plotter can be used for drawing the figures you design on your C-128. These figures form the individual images that must be photographed to create your final animated film.

Amateur Radio

The ham radio or citizen's band radio enthusiast could use a Commodore 128 to assist with his hobby in these ways:

Morse Code Tutor. Commodore 128 users interested in passing the Morse code test to become amateur radio operators could use their Commodores to quiz themselves both visually and audibly. The visual representation of Morse code is a series of dots and dashes (e.g., . . . - - - . . .). The standard method of learning Morse code is to first study the visual representations and then to transcribe an audio transmission at a gradually increasing rate. Your Commodore 128 could be programmed to aid you in this tutorial procedure. Likewise, a program similar to the general CAI program described in Chapter 5 could be used to requiz you on the codes you have missed.

Message Displayer. By using a Morse code decoder/sender interface between the radio and your Commodore 128, messages that are received and sent could be displayed on the monitor as Eng-

lish text, by programming the C-128 to perform the translation between Morse code signals and the English language.

Message Monitor. The Commodore 128 could monitor a specified frequency for a particular audio signal or coded message. Transmissions immediately following this signal would be recorded digitally. Therefore, it is unnecessary to attend to the radio constantly to receive a message. Received messages could also be forwarded automatically on another frequency to another station in a network.

Message Relay. A stored message could be sent at the proper time if the station operator was unable to send it personally.

Controller. Add intelligence to your test equipment or radio with a controlling microprocessor. Test sequences could be performed automatically.

Station Log Maintainer. Maintain your station log automatically. All entries could be stored and classified and special reports could be generated (e.g., the number of countries contacted and the number of repeat contacts). As an example of the usefulness of a station log maintainer, if you hear someone and you would like to verify the last date of contact, you could type in his name or call letters and find this information from a database of log entries.

Error Correcting Code Senders. Error correcting codes could be automatically generated to improve communications.

Contest Record Keeper. Several ham radio contests have utilized Commodores to keep track of all contacts.

Collections

Some people make a hobby of collecting items such as coins, books, magazines, stamps, or antiques. The Commodore 128 can help you both organize and present your collection.

Collection Inventory. If your collection consists of many items, such as hundreds or even thousands of stamps, it is certainly a good idea to catalog each item. A database program, as described in

Chapter 1, is ideal for maintaining large collections of any kind.

In addition to storing an individual record specifying all pertinent information on each item, the C-128 would also be able to categorize, cross-index, and generate special lists of items. A special list could include all items that have a particular characteristic (e.g., a list of all British stamps or all stamps issued in 1986).

The fields to use in setting up a stamp collection database might look like this:

1. Catalog number
2. Name or identifying title
3. Denomination
4. Subject
5. Original Cost
6. Condition
7. Date issued
8. Quality
9. Current value
10. Country of origin
11. Descriptive information and history
12. Where purchased
13. Miscellaneous comments

Using a database program, you could request the sum of all records in a field, such as field 5 or field 9, to determine the original cost or the current value for the entire collection.

Collection management on your Commodore 128 gives you more time to enjoy the fun of collecting without the bother of record keeping. Additionally, a copy of your inventory disk could be stored in a safe location in the event that an insured collection is destroyed.

Collection Narrator. Hobbyists with collections will find that their Commodore 128 makes an excellent visual narrator for a collection. For example, a stamp collector created a file of his entire collection and made the information concerning each item randomly accessible. Interested persons can be instructed how to obtain information on a particular item, or else the C-128 can present a continuous display of each item in sequence. This tech-

nique can save you from monotonous repetition of information to visitors at an exhibition. Similarly, businessmen at expositions could put their Commodores to use explaining products.

Astronomy

Potential applications for your Commodore 128 in amateur astronomy include the following:

1. Locate and identify stars by the calculation of declination, sidereal hour angle from observed altitude, azimuth, and time.
2. Record observations efficiently on the Commodore 128 for quick retrieval.
3. Interface the telescope's drive mechanism to a microprocessor controller for automatic photographic observations. For more information, see *InfoWorld*, Volume 5, Number 47, pp. 45-46, *Sky and Telescope*, January 1981, p. 71, and *Build Your Own Telescope* by Richard F. and Sally Daley, TAB BOOKS Inc.
4. Convert between astronomical units, kilometers, light years, and parsecs.
5. Calculate and plot orbits of satellites and planets.

Gardening

Writing a garden analysis program for one time use would not be a good idea, but your friends and neighbors might also be able to use such a program. Who knows? You might even be able to sell your completed software to a local garden supply store. A complete garden analysis program is more complicated than it appears, however. These are some of the factors to consider:

1. pH, water, soil density, and sunshine levels of the plot.
2. Desired pH, water, soil density, and sunshine levels for the plants to be planted.
3. Nitrogen, phosphorus, and potassium contents in the soil compared to plant requirements.
4. The size of the garden.

1001 Things to Do With Your Commodore 128

Proper planning will allow you to position certain vegetables that ward off insects next to others that need this protection. The space needed between adjacent plants should also be considered. Specific plant requirements and the harvest times of the vegetables could be printed, along with a graphic presentation of the garden plot.

Additional outputs could explain how to form a compost heap and how to use fertilizer. One gardener uses his Commodore 128 to track precipitation dates and amounts, temperatures, and garden chores to be done. Tables of times to plant, spray, and prune can also be stored for ready reference and to simplify planning.

Sports

A file of team and player statistics, players names and numbers, and play-off results could be stored on the Commodore 128 for quick retrieval by the sports fan. Sports statistics could be compiled, graphed, and analyzed. Probability forecasting of score and point spreads, based on the past performance of opposing teams, could be accomplished. The C-128 could also "learn" from its mistakes, by retaining the outcomes of many games in a programmed database.

At local sporting events, a Commodore 128 could be useful in maintaining scores, team records, and player statistics as the game progresses. This information could then be used by an announcer or for permanent records.

Sports, such as bowling and golf, that involve tedious calculations of averages and other statistics for a league are well suited for Commodore 128 bookkeeping. Sell such a computation service to your local bowling alley or golf course.

Fishing

Potential applications for serious fishermen include the following:

1. The analysis of weather patterns and times in order to forecast the ideal time to fish.

2. The recording of weight and species of catch, locations fished, weather, tides, depth, and temperature. Use this statistically correlated data for future reference.
3. The computation of high and low tide times.
4. The computation of sunrise and sunset times.

The Computation of the Times of Sunrise and Sunset and High and Low Tides.

Pilots, as well as fishermen will find a sunrise and sunset calculating program useful. In order to keep such a program as simple as possible, sunrise data, from previous days should be entered, thereby, eliminating the need for complex calculations. The same would be true for a high- and low-tide program. The times for future sunrises, sunsets, and high and low tides may then be projected by linear regression or moving average calculation.

For those inclined to astronomical calculations, the time of sunrise, sunset, and high and low tide may be more accurately calculated by the consideration of the changing inclination of the earth to the sun and the time of rotation for the earth.

Biorhythms and Extrasensory Perception

Those involved in exploring the more speculative aspects of human existence will find the C-128 useful in the pursuit of these pastimes.

Biorhythms. Biorhythms are purported to be the cycles in the emotional, physical, and intellectual states that govern a person's behavior. Dozens of Commodore programs have been written to generate personalized biorhythm charts, but interesting variations are still possible. These potential innovations include:

1. Plotting or numerically comparing the biorhythms of two or more friends.
2. Computing the average of the three biorhythm cycles.
3. Generating a biorhythm chart in the form of a standard calendar.
4. Judging the reliability of biorhythms by objec-

tively analyzing your three cycles at the end of each day and then making a statistical comparison and plotting these data versus your biorhythm.

5. Investigating the use of histograms and other means of presenting data to output biorhythms.

Extrasensory Perception. Those interested in ESP have written testing programs by using random number generators. In these programs, you are asked to predict the number or other value that the Commodore will choose next.

Additional Hobby Applications

Hobbyists will find Commodores useful in all of the following areas:

Designing Recreational Vehicles. A hang glider or ultralight aircraft enthusiast who is considering the design of a new airfoil could find a detailed computer-simulated wind tunnel test beneficial. The proposed design could be mathematically described to the C-128. Similar simulations could be applied to boats, as well as other motorized vehicles.

Model Building. A simple, time-saving program could calculate the scaling factors for model builders by dividing the length of the model by the length of the object that is to be modeled. Next, each dimension of the object would be input and the corresponding dimension for the model would

be calculated by multiplying the original dimension by the scaling factor.

Model Railroading. Model railroading enthusiasts with a large train layout may wish to automate the trains, lights, and switches with a controlling microprocessor. One hobbyist went so far as to print train schedules, print tickets, and analyze a model freight business on his Commodore 128.

Scuba Diving Plan. A simple program could calculate one of these four diving parameters, given the other three.

1. Time underwater, in minutes.
2. Surface air consumption rate in cubic ft/min.
3. Depth in feet.
4. Total air volume of your diving tank in cubic feet.

Geneological Storehouse. A few hobbyists have obtained a sufficient amount of geneological information that these data can only be handled efficiently with a C-128. Additionally, having specified characteristics for each family member instantly available eases the task of further geneological research.

Aquarium Maintenance. One hobbyist uses his Commodore 128 to compute the amounts of chemicals that are necessary for maintaining a seawater aquarium environment. In order to obtain the exact values over a range of temperatures and conditions, several calculations are required.

Chapter 7

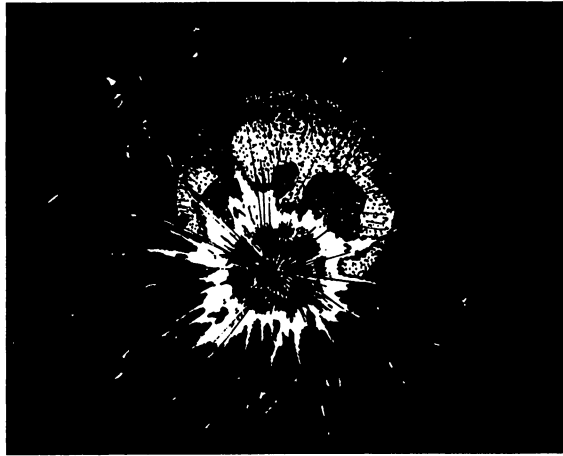

Commodore 128 Games and Recreational Applications

According to various polls, the most popular applications for Commodore 128 computers are entertainment and games. Some C-128 owners even proclaim game playing to be their primary application for their computers. Despite the advent of inexpensive and easy to use productivity software, games will continue to be popular fare for most Commodore 128 owners.

Games are not only fun, but they often have the added benefit of being educational. Sure, there are the standard games that simply teach hand-eye coordination, but there are also commercially available games that develop abilities to react creatively, solve problems logically, and make decisions. There are even a few games that aid in teaching computer programming.

Learning to program games of their own, however, is one of the best educational challenges for Commodore 128 owners. Games encourage imaginative and constructive programming and responses.

There are at least eight major categories of games that have been successfully adapted to the C-128:

Fantasy and Adventure Games. Fantasy and adventure games lead the player step by step through an imaginary world to find a special treasure, solve a mystery, or outfox an evil wizard. The player must learn how to overcome the many obstacles that the game throws at him to prevent his success at solving the game's elaborate puzzle. These adventure games are usually text-based and depend on imagination instead of screen graphics to carry the story, although more elaborate adventure games use vivid graphics to support their stories. In response to text that appears on the screen, the player must type in English commands, such as "go east," to control the action of a character within the game. It is this heavy dependence on text within these games that make them relatively easy to program. The only programming obstacles are controlling the many possible outcomes of game situations and recognizing a variety of player responses to the game's text and questions.

"Video" Games. This is an extremely popular genre of C-128 games. Video games, which are exciting and challenging to the player's hand-eye coordination, place the player against continually

increasing enemy hoards. The player's only option is to learn to shoot more quickly and accurately than the enemy.

Strategy and Battle Games. For those who prefer a more enlightened approach to gaming, strategy games offer complex rules and tactics to employ in fighting battles against a human or computer controlled opponent. Many strategy and battle games make extensive use of graphics to display battlefields and tokens representing each side, while some still rely on physical game boards.

Card Games. If you occasionally have difficulty rounding up enough people for a game of cards, you can find plenty of opponents within your Commodore 128. Programs are available that allow your C-128 to play against you at bridge, poker, black jack, and gin.

Board and Word Games. Among the popular board games that have been converted to run on the Commodore 128 are chess, backgammon, and checkers. Crossword-like games, some of which have up to 50,000 word vocabularies, have also been made available for C-128 users.

Gambling Games. Las Vegas type gambling games, from roulette to one-armed bandits, have been adapted to the C-128. These games offer the thrill of "gambling" without the risk of emptying your bank account.

Sports Games. Football, basketball, baseball, car racing, and skiing are among the sports that have been successfully simulated on the Commodore 128. These high resolution games provide both excellent animation and playing times that rival the real sports.

Party Games. Popular party games, from charades to spin the bottle, have been programmed for the C-128.

BOARD AND STRATEGY GAMES THAT YOU CAN PROGRAM

Although most of the popular live-action or real-time commercial games currently on the market required extensive time and effort to develop, many entertaining games can be written for the C-128 by

the beginning programmer. A sampling of game ideas to tackle in Commodore BASIC follows.

Many popular board and logic games take on an added dimension when computerized, especially if the Commodore is programmed to be the opponent. Some of the many possibilities include the following games:

Tricolor. Tricolor is a game played on a hex "board" with hexagonal cells colored red, white, and blue displayed on the Commodore's screen (see Fig. 7-1). Each of the two players begin with 18 playing pieces, called stacks, with one player using white stacks, and the other, black. At the start of the game, white places his stacks on hex places 1-18 and black places his stacks on hex places 44-61.

The playing pieces are called stacks because, throughout the game, stacks are merged to create piles of multiple pieces. The maximum number of cells that a stack can traverse in a particular direction in a single move is determined by the number of pieces in a stack (e.g., one cell for a stack with one piece, two cells for a stack with two pieces, and three cells for any larger stack).

The combat strength of a stack depends on both the number of pieces in the stack and the color of the cell on which it rests. Taking the strength of a single white stack on a white cell as the unit, the strength of a two cell stack on a white cell is two units, and the strength of any larger stack on a white cell is three units. The strength of a stack on a blue cell is twice what it would be on a white cell, and a stack on a red cell is worth three times as much as it would be on a white cell.

Players take alternate turns, each moving a single stack along a diagonal or horizontal line as far as he wishes, within the range of the stack. The player can move either an entire stack or only a portion of a stack. Occupied cells may not be jumped, but a player may move his stack onto a cell occupied by another stack owned by himself or by an opponent. If the stack is his own, the stacks are merged. If, however, the opponent owns the other stack, an "attack" has been initiated. A stack may attack an

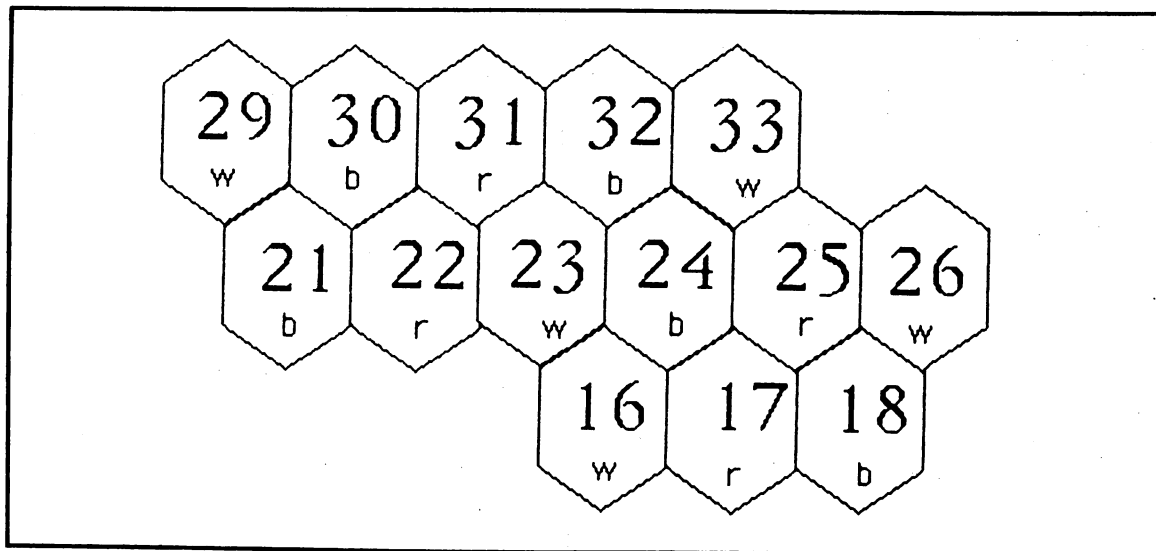

Fig. 7-1. A partial Tricolor game board.

opposing stack only if the attacking stack is stronger. If it is more than twice as strong, the opposing stack is "killed" and all hostile pieces in the stack are removed from play; friendly pieces are added to the winning stack. If the attacking stack is not more than twice as strong, it "captures" the opposing stack by combining it with itself. If a capture or kill can be made during a player's turn, it must be made. The game ends with the capture or killing of all of one player's pieces.

Black Sheep. Black sheep is a two-player game (one white and one black) that is played on a graphic chessboard. White begins the game with four white checkers that are placed on the four black squares on one side of the chessboard. Black uses one black checker and places it on either of the middle black squares on the opposite side of the board. The white pieces may only move forward to the opposite side; black may move forward or backward. Both colors may only move one square at a time and only on the diagonal.

Players take alternate turns with black moving first. The object for black is to reach the opposite side of the board without being "trapped." The object of white is to trap black before it reaches the

other side of the board. Black is trapped when it is surrounded with white pieces in such a way that there is no adjacent diagonal unoccupied square for black to move to. It would be challenging to develop a strategy that would allow the computer to play either side.

Bridge-It. In the game of Bridge-it, the first player is designated as O and the second player as X. Using the grid shown in Figure 7-2, the players take turns putting a connecting line between two horizontally or vertically adjacent markers of the player's symbol. The O player attempts to build a connected "bridge" from the bottom to the top of the board, while the X player simultaneously attempts to build a bridge from the left to the right side of the board. The first player that successfully builds a bridge wins the game.

Hex. Hex is a game similar to Bridge-it, but Hex is played on a board composed of hexagons, with eleven hexagons on each side. Two opposite sides of the board are named black, while the other two sides are named white. The hexes at the four junctions between the sides are neutral. One player has black pieces and the other player has white pieces. Alternate turns are taken, with each player

	1	2	3	4	5	6	7	8	9	10	11
1		O		O		O		O		O	
2	X		X		X		X		X		X
3		O		O		O		O		O	
4	X		X		X		X		X		X
5		O		O		O		O		O	
6	X		X		X		X		X		X
7		O		O		O		O		O	
8	X		X		X		X		X		X
9		O		O		O		O		O	
10	X		X		X		X		X		X
11		O		O		O		O		O	

Fig. 7-2. A complete Bridge-it game board.

placing one of his pieces on any unoccupied hexagon. The object for both players is to complete a continuous chain of his pieces between the two sides labeled with his color.

Cross Capture. Cross Capture is played on a chessboard. At the start of the game, a set of randomly distributed letters is put on the board, with no more than one character per square. Most of the board remains empty. Players take turns choosing one of the letters and all other letters on the board that fall into a given category become the property

of that player. One category may be defined as all of the letters in the same horizontal, diagonal, or vertical row as the chosen letter or as all of the letters within a certain proximity of the chosen letter (e.g., one space away). The player who possesses the most letters at the end of the game is declared the winner.

Ticktacktoe Variation. An interesting ticktacktoe variation is played as follows. Each player puts his three pieces on a ticktacktoe board such that piece ownership alternates around the periph-

ery of the board. Following this setup, each player is allowed to move one of his pieces to an adjacent square. The winner of the game is the first to align three pieces in a row.

Tuknanavuhpi. Tuknanavuhpi is a Hopi Indian chase game played on a 4×4 board with diagonals drawn in each of the 16 squares. Pieces should be moved on the points where lines meet on the board, not on the squares. Each of the two players has twenty playing pieces placed on their side of the board. The middle of the board is initially empty.

Players take alternate turns moving their pieces in any direction along the lines on the board, from one intersection to another adjacent intersection. As in checkers, pieces are captured by jumping over any of the opponent's pieces. The winner is the player who has captured all of his opponent's pieces.

Nim. The rules of Nim are simple; from a pile of any number of items (13 is the usual number), players take turns picking one, two, or three items. The player forced to pick up the last item loses the game. A winning strategy for the second player is to ensure that with every move you leave the pile with the number of objects equal to nine, five, or one.

Nim Variations. Here are a few games that can be mathematically analyzed in a manner similar to the way Nim has been analyzed:

- **Rectangular dominoes:** players take turns placing dominoes on a chess-type board or a board of arbitrary size (8×8 is fine). The board is of a size such that a domino placed horizontally or vertically on it will cover up exactly two squares. The first player places his dominoes horizontally, the second player places his vertically; dominoes may not overlap. The winner of the game is the player who makes the last possible move.
- **Welter:** the board for this game consists of an arbitrary number of squares in one line (usually about twenty). An arbitrary number of tokens are randomly placed in the squares, with only one

token in each square (there are usually about five tokens). Players take turns moving a single token to any unoccupied square to the left, jumping over other tokens if desired. The player who makes the last move wins the game.

- **Traffic Jam:** represents one-way roads between towns. An arbitrary number of vehicles are placed on the board to set-up the game. Players take turns moving one of the vehicles in the proper direction from one town to an adjacent town. The game continues until a traffic jam develops, in which no further moves are possible; the player who makes the final move is declared the winner.
- **Tsyanshidzi:** this is the Chinese national game in which players may select from two piles of objects either an arbitrary number of objects from one pile or the same number of objects from each pile, but no fewer than one object from each pile. As always, the player taking all remaining objects wins. This game requires a more complex analysis than the simple game of Nim does.
- **Acey-ducey:** in this game the computer "shuffles" a card deck and deals two cards. The player then bets against the computer, wagering that the next card dealt will fall in between the first two cards in rank. Can you determine the mathematical strategy behind a winning program?

Neutron. Neutron is a two-player game played on a 5×5 grid. At the start of the game, white owns the five pawns at the top and black owns the five pawns at the bottom. The neutron (n) begins at the center and is neutral. Each player's turn has two parts. First, the player must move the neutron in any direction, and then the player must move one of his pawns in any direction. The winner is the first player to maneuver the neutron to his own back row, whether by moving it by himself or by forcing the opponent to do so. You can also win by stalemating an opponent—that is by trapping him so that he cannot complete his turn. For example, if the neutron is completely surrounded with black pieces, then the white player

1001 Things to Do With Your Commodore 128

cannot complete his turn and black wins. One further point to remember is that any time that a pawn or neutron is moved, it must be moved as far as it can go in a straight line, within the confines of the represented board. Furthermore, as a handicapping feature, the white player moves first, but is not permitted to move the neutron on his first move.

Hexpawn. This game is played on a 3×3 grid, similar to the one used in ticktacktoe. The two players place their three playing pieces on opposite sides of the board. The pieces are moved in a manner similar to the way pawns are moved in chess. By moving a pawn one space diagonally, it is possible to capture and remove an opponent's playing piece. Players alternate turns, and the winner is the first player to reach the opponent's side of the board, or the remaining player when the opponent has no legal moves available.

COMPUTER QUIZZES

Computer quiz games can be instructive as well as fun, if clever programming techniques are employed. Examples of these techniques include the following:

- Having a large data base of questions from which a few are randomly selected to produce a new set of questions for each quiz
- Automatically recording the score and rewarding the player with graphic or musical interludes for good scores; new scores may be compared with old scores or with those of other players
- Providing explanations of missed answers
- Allowing for the selection of questions according to the player's level of ability or providing for an automatically-adjusting level of difficulty based upon performance

Assorted suggestions concerning topics for quiz games include the following:

- Names and capitols of states or countries, possibly using computer graphics to draw maps

- Vocabulary words
- I.Q. tests
- Personality and aptitude tests
- Foreign language vocabulary or grammar
- Preschool skills including comparing and counting random shapes, words, and numbers, and copying letters, words, and numbers
- Practice questions for examinations such as the SAT, GMAT, MCAT, LSAT, and ACT.
- Analogies
- Spelling bees
- Verses from literature or the Bible
- Trivia questions for trivia lovers, on science fiction, movies, and history
- Basic math skills
- Chemical equation balancing
- English grammar
- History of the United States, the Renaissance period, or World War I

GAMES THAT USE WORDS

You can program a wide variety of games and activities that are based on words, including the following:

- *Cryptograms*, or coded messages, could be displayed for you to decode; simple clues could be provided.
- Word search puzzles ad infinitum may be computer generated, either from a word list or as a random matrix similar to the popular Boggle™ game. A program to determine the locations of all words in the puzzle could also be implemented. You could also have the computer assist in creation of a crossword puzzle. Choose a topic and enter words; the computer will automatically fit the common letters together to form a crossword grid. Next, enter an obscure or humorous clue for each word. The completed crossword can be saved for later use or printed and sent to friends.
- Word guessing games, similar to twenty questions, can be computerized. In these games, the

player asks the computer questions to determine what word has been randomly selected. Replies for the many possible questions a human could pose must be stored; thus there are difficult programming challenges. The dialogue with one such program went like this:

(c=computer, h=human)

h: Does it grow?

c: To answer that question might be misleading.

h: Can I eat it?

c: Only as food for thought.

h: Do computers have it?

c: Strictly speaking, no.

c: The word is "Knowledge."

- A word game similar to the popular Mastermind™ game would involve the computer's selecting a three-letter word from a large list. The player would guess by entering a three-letter word and would be told whether or not the computer's word contained any of the letters in the word the player guessed and whether or not those letters were in the correct position. The object is to guess the computer's word in the least number of tries.
- In the game of Confound, the computer outputs 15 letters (consonants and vowels). The players must form the longest word possible using these letters. The computer serves to keep score and check to ensure that no letters were used improperly, that is, used more often than they appear in the list.

MAGIC

Although computers are almost magic in themselves, real magic tricks performed by the Commodore 128 are quite entertaining for youngsters or party guests. Here are some suggested C-128 magic tricks:

Micro Mentalist. The C-128 becomes a mind reader in this magic trick. As the magician, you must ask your audience to provide you with a common personal item, such as a watch or key chain.

Then, you ask the Commodore 128 to identify the item, which it does with alarming accuracy. The secret of this trick lies in the manner in which this question is asked. You, in fact, identify the item for the C-128 by typing in a question that will match the correct answer—different questions represent different answers. For example, the question "What item am I holding," could indicate a watch. The C-128 simply matches the question that you enter with an identical programmed question and, consequently, the name of the desired object.

The Break in the Chain. This trick is performed with a complete, 28 piece set of dominoes. Before the trick is performed, the magician removes one of the dominoes (it cannot be a double) from the set and enters the two domino numbers into the program. The audience members are given the remaining pieces of the set and are asked to complete a single domino chain, as in regular play. Once the chain is completed, the numbers on the two ends of the chain are noted. The magician enters a question, such as "What are the two domino numbers," into the C-128. The Commodore then responds by correctly displaying the two previously stored numbers.

PROGRAMS FOR YOUNG CHILDREN

Programs that make liberal use of graphics and that are designed to be foolproof against accidental inputs are excellent learning tools for young children. These programs can be made to teach not only a particular subject matter, but also to familiarize children with using the Commodore's keyboard and cursor controls. Suggestions for educational children's games include the following:

- **Matching Games:** children can match letters, words, and shapes.
- **Drawing Machine:** a joystick controller or arrow keys permit drawing on a video screen. A library of shapes including squares, triangles, and circles can also be used to construct pictures.
- **Face Maker:** children can create their own funny

face on a video screen by selecting eyes, ears, a nose, hair, and a mouth from a collection of possibilities.

- **Storybook:** using the keyboard, children can write their own stories, which the computer then interprets and animates on the screen. Stories can involve stored images such as houses, trees, people, and cars, which may then be animated to illustrate a sentence such as "The girls walked from home to school."

SIMULATION AND ADVENTURE GAMES

Simulations of real-world situations can be represented on the Commodore 128 in high resolution and with realistic animation. Some of the many programming possibilities include the following:

Pool Table. A graphically animated pool playing game would serve to teach the principles of elastic collisions and angular geometry.

Motorcycle Jump. A simulation in which a motorcycle must leap a certain distance in order to land safely would illustrate projectile motion.

Navigation. A simulation in which the participant must find the way to an island, using a radio direction finder in a sailboat, would teach the principles of navigation.

Detective. The participant would assume the role of a detective in this simulation. A valuable gem has been stolen from a museum and five persons are suspected of the crime. The use of deductive reasoning is the only way in which the detective can solve this crime.

Wall Street. A stock market simulation would allow players to buy and sell stocks according to market conditions. The C-128 is programmed to determine the price for each stock while also acting as broker and bookkeeper.

World Conflict. This simulation would place each player as the head of a nation. Players must decide whether they should go to war, form cartels, or make concessions and compromises. The C-128 could select the conflicting situations (e.g., oil embargoes, assassinations, nuclear threats).

Decision. A simulation of corporate management and big business could place each player as a top executive. Each executive has the authority to produce the product of his choice and sell the product at the best market price. Throughout the game, prices fluctuate according to the law of supply and demand.

Fire. The object of this simulation is to subdue a raging forest fire with chemicals, backfires, and other firefighting techniques. The success of the player depends on quick decisions concerning how to control a geometrically increasing fire.

Adventure. The object of this simulation is survival during a desperate attempt to locate buried treasure on an island.

Careers. This simulation game places the player in a new occupation in order to enable him or her to experience decision making, conflicts, opportunities, and financial stress from different viewpoints in a variety of careers.

Grid Search. A search game that pits a destroyer against a submarine, for example, could be programmed. The game would use a 10 × 10 grid that must be selectively searched by the ship or the submarine in its efforts to locate and attack the other vessel. Similarly, a game in which a spy searches for hidden documents while avoiding hidden enemy agents could also employ this same grid searching technique.

Laser Tank. The player and a computer-controlled opponent each has a laser-firing tank and a base. The object of the game is to be the first one to destroy the opponent's base while avoiding the opponent's fire. Obstacles litter the battlefield and laser fire is destructive only at a limited range.

Robotwar. The purpose of this simulation is to teach computer programming. Two opposing players are instructed to secretly design programs, written in a custom language, that would create and control destructive robots. The programs would be entered, and the video display of the combat field would be constantly refreshed. The object could be to hit the opposing robot five times to win.

Robotwar II. In this game, you must avoid

your opponent, the C-128, which controls annihilating robots. An electrified, lethal fence defines the playing field.

The Commodore's robots will destroy you if they come close. These robots will destroy themselves, however, if they run into the fence. Your objective is to evade the robots until they have all been destroyed by the fence.

VIDEO GAMES

Because of the Commodore's high resolution graphics (see Fig. 7-3), sprites (see Fig. 7-4), and excellent sound capabilities, this computer is well suited to the creation of action-packed video games. Although games written in Commodore BASIC do not execute as fast as the real, assembly language arcade versions, they do counteract the speed limitation with an easily implemented final product. Here are some ideas that you might want to write Commodore BASIC versions of:

Maxwell's Demon. Two chambers are connected through a passage and a gate. Bouncing molecules fill one of the chambers. Your challenge is to move all of the molecules into the other chamber.

Hockey and Tennis Type Games. These Commodore 128 games could be controlled with joysticks and act just like their arcade cousins.

Tanks. This game tests your ability to launch projectiles and strike another object.

Pinball. Once again, joysticks are used to move the flippers on this recreation of the analog pinball machine.

Lunar Lander. This game involves a lunar landing spacecraft that is governed by rocket thrust, a limited fuel supply, and the moon's gravitational pull.

Football, Baseball, and Basketball. An animated display of players, ball positions, and the playing field would be used to duplicate the action of these sports.

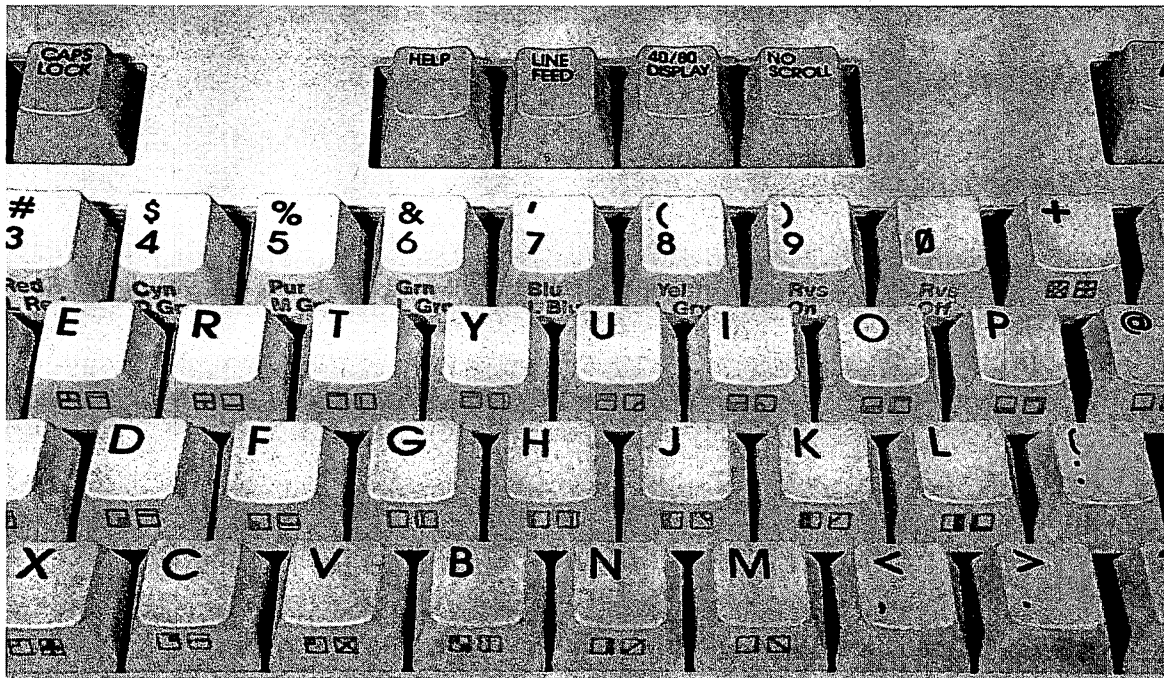

Fig. 7-3. Low resolution graphics characters are directly accessible from the C-128 keyboard. Each key's representative character is illustrated on the key's front face.

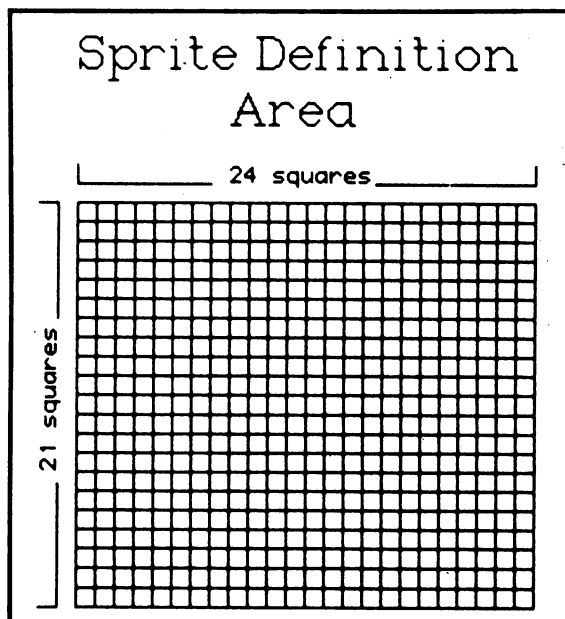

Fig. 7-4. A sprite is made up of pixels that have been arranged inside a 21 × 24 grid. Copies of this figure are ideal for planning your sprite creations.

Racetrack. The object of this automobile racing game is to finish the race in the least amount of time.

Skydiver. The player in this game must control the jump time and the opening of the chute for a perfect landing.

Robot Bowl. This bowling game carries a twist in that the Commodore player is really a robot. Therefore, the robot must be given instructions as to the weight of the ball, time of release, and angle of approach.

Shooting Gallery. Several moving targets of different point values are placed in front of a Commodore-controlled gun.

Golf. A golf game with a complete set of graphical holes would let the players choose the clubs that they will use, the power of the swing, and the angle at which the ball will be hit.

Verti-Bird. Land the maneuverable helicopter onto its landing pad. You must exactly land on the spot 240 × 187 to win (see Listing 7-1 and Fig. 7-5).

Listing 7-1: The Verti-Bird Program

```

10 REM VERTI-BIRD
20 COLOR 0,1:COLOR 1,8:COLOR 5,3:COLOR 4,1
30 GRAPHIC 0
40 SCNCLR 0
50 PRINT:PRINT TAB(15)"VERTI-BIRD"
60 PRINT:PRINT "IN THIS GAME, YOUR JOB IS TO LAND THE
   HELICOPTER ON THE LANDING PAD."
70 PRINT:PRINT "YOU ARE FIGHTING THE CLOCK...SO HURRY."
80 PRINT:PRINT "USE THE CURSOR KEYS TO CONTROL THE VERTI-BIRD."
90 PRINT:PRINT "PRESS ANY KEY TO BEGIN.":GETKEY Z#
100 COLOR 0,1:COLOR 4,1:COLOR 1,1
110 GRAPHIC 1,1
120 CIRCLE 1,75,150,4,2
130 DRAW 1,80,150 TO 83,150
140 DRAW 1,80,151 TO 83,151
150 DRAW 1,75,147 TO 75,145
160 DRAW 1,67,145 TO 82,145
170 DRAW 1,73,152 TO 73,154
180 DRAW 1,75,152 TO 75,154
190 DRAW 1,70,154 TO 77,154

```

Commodore 128 Games and Recreational Applications

```
200 PAINT 1,75,150,1
210 SSHAPE A#,65,142,88,162
220 SPRSAV A#,1
230 SPRITE 1,1,8,0,0,0,0
240 COLOR 1,6
250 DRAW 1,0,175 TO 319,175
260 PAINT 1,5,178,1
270 COLOR 1,5
280 DRAW 1,200,150 TO 250,150 TO 225,168 TO 200,150
290 PAINT 1,225,155,1
300 COLOR 1,3
310 CHAR 1,31,20,"_ THE PAD"
320 CHAR 1,15,2,"VERTI-BIRD"
330 MOVSPR 1,100,210
340 GETKEY Z#
350 TI#="000000"
360 SOUND 1,5500,10,2,1100,100,3
370 IF RSPPOS (1,0)=240 AND RSPPOS (1,1)=187 THEN 440
380 GET K#
390 IF K#=CHR$(145) THEN MOVSPR 1,0 #3
400 IF K#=CHR$(17) THEN MOVSPR 1,180 #3
410 IF K#=CHR$(157) THEN MOVSPR 1,270 #4
420 IF K#=CHR$(29) THEN MOVSPR 1,90 #2
430 GOTO 360
440 SPRITE 1,1,3,0,1,1
450 MOVSPR 1,0 #0
460 CHAR 1,5,10,"YOUR TOTAL TIME:"
470 CHAR 1,22,10,TI#
480 CHAR 1,5,15,"DO ANOTHER (Y/N)?"
490 GETKEY Z#
500 IF Z#>CHR$(89) THEN 490
510 IF Z#<CHR$(78) THEN 490
520 IF Z#="Y" THEN 100
530 COLOR 0,1:COLOR 1,13:COLOR 5,13:COLOR 4,6
540 SPRITE 1,0,1
550 GRAPHIC 0
560 SCNCLR 0
```

RECREATIONS INVOLVING THE COMMODORE ITSELF

There are many exciting programming challenges that can be directed at the C-128. Your goal in each program is roughly the same: write as simple a Commodore BASIC program as you can that solves a given problem. In order to start you off on the right foot, here are several programming

challenges that are only for the strong of heart and mind:

1. Calculate Pi to in excess of 500,000 decimal places.
2. Create a program that can only be stopped by turning off the Commodore.
3. Find the largest prime number.

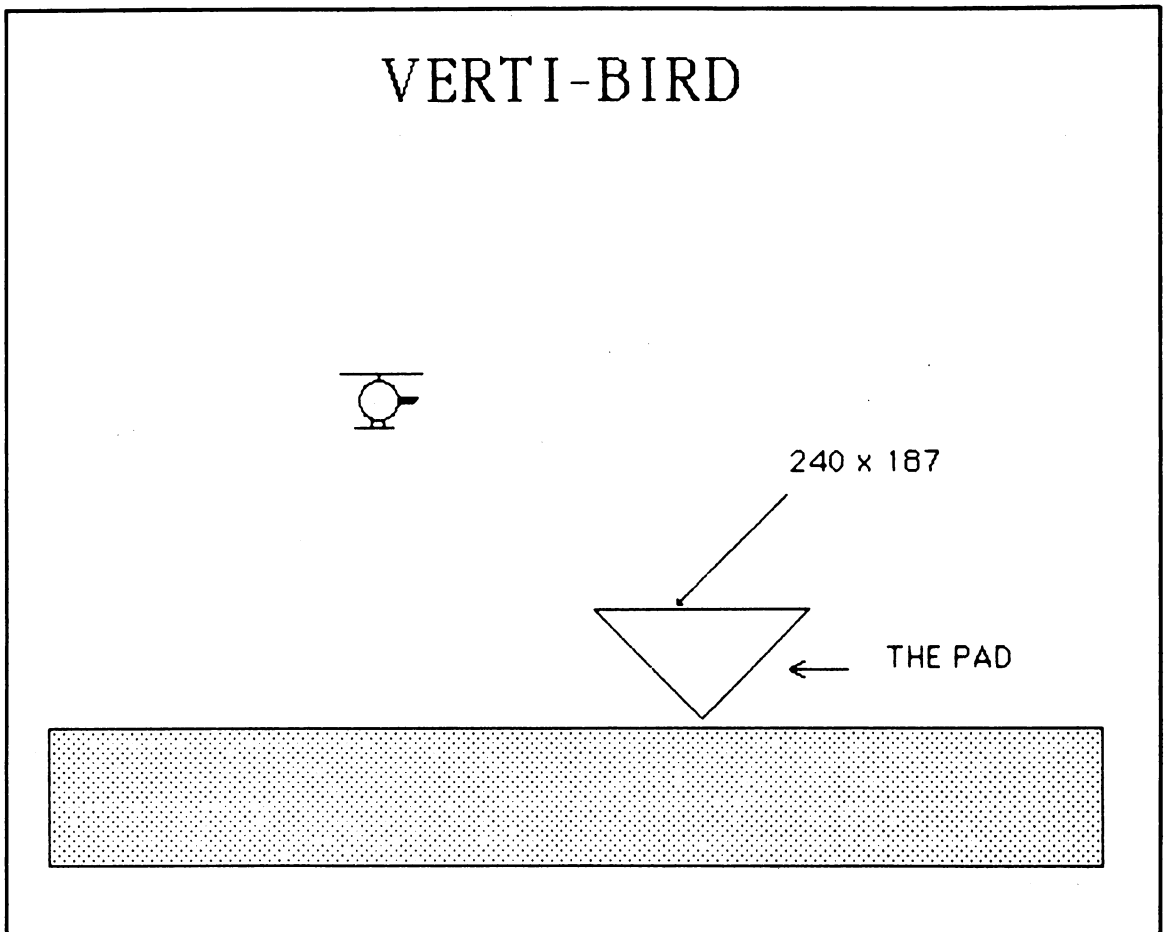

Fig. 7-5. Verti-Bird is an arcade-type game that utilizes the C-128's color, graphics, sound, and sprite capabilities. In order to win at Verti-Bird, you must land the helicopter on its landing pad. You will only receive the proper credit when you have touched the exact pixel spot of 240×187 . This is a delicate maneuver that very few pilots will get exactly right. If you find that you lack this "right stuff," you can rearrange lines 370 and 380 in Listing 7-1. This will help you, but it still won't be easy. By the way, one of our fastest times is 47. See if you can top it.

4. Create a modem re-dialer that can't be interrupted.
5. Compact ASCII data files into the smallest possible amount of disk space.
6. Make a copy-protection scheme that can be used to protect your files.

COMPUTERS AND CHESS

Chess is one of the most popular computer recreations for several reasons. First, it requires an advanced level of computer programming, de-

scribed by some as "artificial intelligence," that enables a computer to emulate human thought. Second, it may be difficult to find chess opponents at your level of ability. The computer, as your opponent, solves that problem by having adjustable skill levels, making it possible to find an opponent of your own strength. Third, many chess programs can serve as chess tutors by suggesting moves, demonstrating piece movements, allowing the rearrangement of boards, and even stepping you through a collection of games from masters-level

tournaments. Many of today's chess programs are rated in the middle 1200s or above and can serve as a formidable opponent for novice to intermediate level players.

Chess playing programs are almost always written in assembly language for the purpose of speed; they may analyze from a few thousand to over one million possibilities before making a move. A large scale computer chess program is described below for those interested in the inner workings of the game. The discussion can, perhaps, provide added insights for your game and can assist those who are interested in writing their own chess programs. A warning, however: most credible chess programs have required thousands of man-hours in development time and are truly a programmer's ultimate challenge.

The program described here is named OSTRICH; it competed in the First World Computer Chess Tournament. The OSTRICH program is composed of three modules: BOOK, which provides standard book opening moves for up to the first five moves, CHESS, which is the main program used during most of the game, and END GAME, which takes over in rook/king or queen and king/king end games. CHESS, the main module, is comprised of approximately 9000 instructions, which are divided into five subprograms:

1. A subroutine for the control of input and output and for the control of the size of the search tree. The *search tree* refers to the branching search for all move possibilities that the computer performs before making each move. The size of the tree indicates the depth or number of moves ahead that will be considered for each move.
2. A subprogram to generate all move possibilities or search the tree.
3. A subprogram to arrange each possible move on a hierarchy scale according to its plausibility (each move is given a plausibility score). Following this initial ordering, another set of routines is called upon to improve the ordering.
4. A subprogram to calculate a terminal score or to evaluate the chess board at each terminal or branching point in the tree.
5. A subroutine to update all arrays, lists, and pointers used by the remainder of the program.

The Reference Arrays Used by Chess

1. The lists of the locations of each chess piece: an 8×8 array holds an identification number for each of the pieces on the board, in a corresponding memory location. The white pieces are identified as follows: King = 6, Queen = 5, Rook = 4, Bishop = 3, Knight = 2, and Pawn = 1. The black pieces are identified as the negative of the corresponding white piece number. The boards position array is updated after each move.
2. The piece location arrays: two separate arrays are generated at the beginning of each tree search. The list contains the names and corresponding locations of the white pieces; the other does the same for the black pieces.
3. The possible moves list: a list of possible moves for *ply* 1 (*ply* refers to the depth searched), *ply* 2, and *ply* 3, corresponding to each initial move, is generated. Additionally, memory is reserved to indicate which moves will result in a capture.
4. The control piece array: this array stores the squares that each piece "controls" as well as the pieces that control a particular square. Thus, it is possible to determine the power of each piece along with what pieces are in control of the specific square in question.
5. The change array: all changes made at a node in the search tree are stored in this array when control advances to a new node. The purpose of the list is to expedite the restoring of positions.
6. The pinned pieces list: a listing of all pinned pieces is maintained in this array.
7. The en prise pieces list: a separate list of en prise pieces at each search node is maintained.
8. The Alpha and Beta cut-offs lists: two lists, one

1001 Things to Do With Your Commodore 128

- of the last eight moves resulting in alpha refutations and the other of beta refutations, are maintained.
9. The ply 3 plausibility list: CHESS maintains a list of the best ply 3 move for each possible ply 2 opponent's move for each ply 1 move investigated.
 10. The principal variations list: each principal variation originating in the tree search is stored in this list.
 11. The position records list: this listing of all moves since a recent capture or pawn move is used to determine whether a draw should be made because of repetition.
- A short chess game board construction program is given in Listing 7-2 (see Fig. 7-6).

Listing 7-2: The Game Board Routine

```
10 REM GAME BOARD
20 COLOR 0,3:COLOR 4,3
30 GRAPHIC 1,1
40 COLOR 1,1
50 BOX 1,65,4,255,188
60 FOR R=1 TO 14
70 READ A,B,X,Y
80 DRAW 1,A,B TO X,Y
90 NEXT R
100 FOR Z=1 TO 32
110 READ T,S
120 PAINT 1,T,S,1
130 NEXT Z
140 DATA 88,4,88,188,111,4,111,188,134,4,134,188,157,4,157,188,
180,4,180,188,203,4,203,188,226,4,226,188,65,27,255,27,65,50,
255,50,65,73,255,73,65,96,255,96,65
150 DATA 119,255,119,65,142,255,142,65,165,255,165
160 DATA 90,15,140,15,190,15,240,15
170 DATA 70,30,120,30,170,30,210,30
180 DATA 90,60,140,60,190,60,240,60
190 DATA 70,80,120,80,170,80,210,80
200 DATA 90,100,140,100,190,100,240,100
210 DATA 70,130,120,130,170,130,210,130
220 DATA 90,150,140,150,190,150,240,150
230 DATA 70,170,120,170,170,170,210,170
```

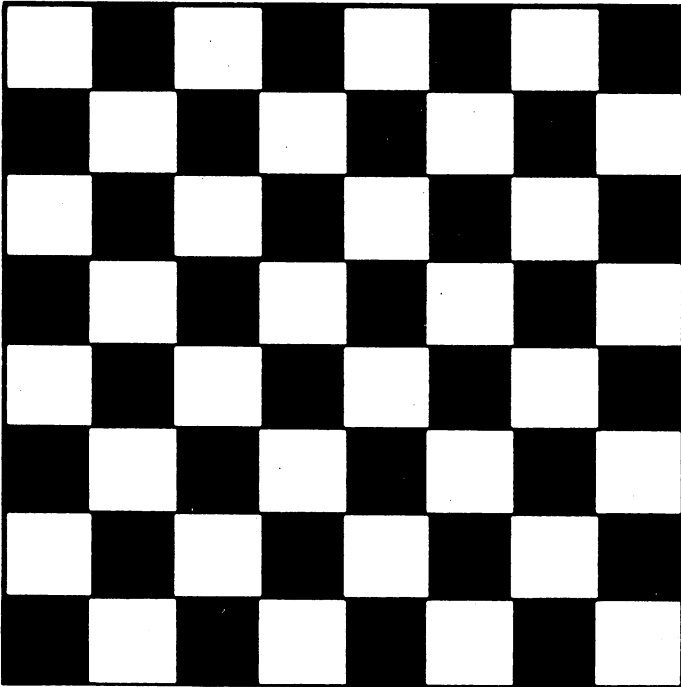
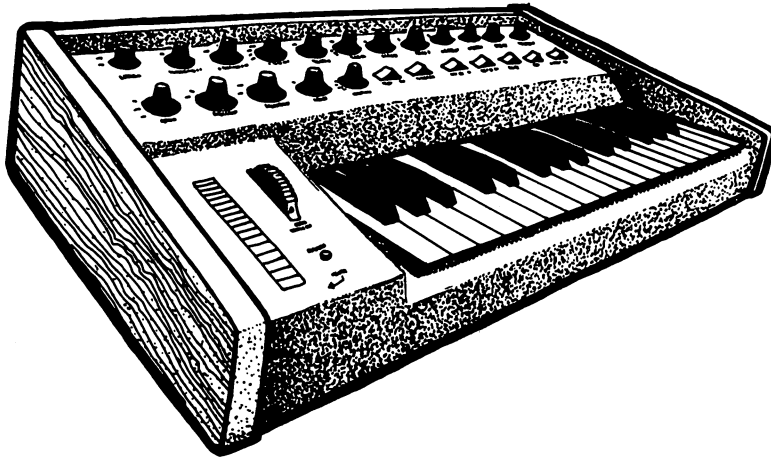

Fig. 7-6. A chess game board that was drawn with the program in Listing 7-2.

Chapter 8



Connecting Commodore 128's Peripherals

The potentials for computer control and monitoring of the home are nearly endless. Only a few of the possible applications have been put into practice with the incorporation of microprocessors into household appliances. Several industry demonstration homes have been built to exhibit this household microprocessor control. The following suggestions have been included in these homes or have been suggested by leading industry forecasters and futurists:

- Climate control is just one of the many functions provided by the home computer system. The rate of temperature change and humidity is noted, and the air conditioner or heater is turned off before the house is at a preset level; the temperature will "coast" to the desired level. The system also times the thermostat. In winter it turns down the temperature at night, turns it up again in the morning, and then turns it back down while you go off to work; in the summer it controls the air conditioner in the same manner. To conserve energy, the hot water heater is also turned down during certain hours when hot water isn't needed.
- A vocal input interface to the home computer is continuously active, waiting for a command by one of the occupants. All appliances and lights controlled by the system can be switched on and off by voice command or can be programmed to start and stop at selected times.
- An intelligent alarm system will turn off all electricity and gas and call the fire department in case of fire. A burglar detection system calls the police if an intruder is detected ultrasonically or by other sensors.
- Interfaces to stereo, televisions, and telephones are also interesting. The telephone controller acts as a phone message recorder with additional features. If a message is taken, the unit can be instructed to call someone at another number and deliver the message. A telephone call to the machine itself can allow you to change the recorded message, play back messages, or control any of the devices connected with the home computer. A telephone file of commonly used numbers is stored in the computer. Additionally, you

1001 Things to Do With Your Commodore 128

can dial numbers by simply calling them out vocally; if a busy signal is encountered the computer continually redials the number until the line is free.

- The stereo interface transforms an ordinary stereo into a "jukebox" from which recordings may be selected and played at the touch of a button. A special device can monitor radio broadcasts and record all music; commercials and news are not recorded (voice patterns can be distinguished from music). You can preprogram the volume level and the type of music you want to have recorded for special purposes such as musical interludes and background music for dinner. A given song can be played a selected number of times, or the computer may be programmed to skip to the next song on a record or cassette.
- The television interface will turn on the set at selected times or record shows on video tape; a directional antenna or satellite dish is automatically turned for the best reception.
- You can use a voice synthesizer to audibly awake you in the morning with "Good Morning Mr. T. It's 8 A.M.," and then summarize your itinerary for the day.
- An automatic system can release fresh food and water for pets left at home for a long period, can sense when the animal has not eaten the food, and can notify the veterinarian to check the home.

Some other applications currently being used by hobbyists include the following:

- Voice or sound synthesizers are incorporated into games to provide dialogue or sound effects.
- Voice input computers are used for recording information called out by an operator. One hobbyist uses such a system to make simple calculations in his home workshop while his hands are full. Although such systems are usually limited to a vocabulary of about thirty words, some hobbyists have managed to develop automatic "dictation-taking" typewriters for limited pur-

poses (a word capacity of 100 is considered maximum).

- A hobbyist has used his small computer to replace over 7000 mechanical relays necessary to control a pipe organ in his home. Similarly, computers could be used to light the keys on an organ to help you learn to play a song. Although a commercial piano player has been developed to digitally record music played and play it back later, the cost is high. If you were to implement such a system with your computer, additional features could be added; speed, sustain, attack, and other features could all be varied.
- One hobbyist is using a microprocessor to create intelligent test equipment that can automatically perform a set of test routines on a given circuit. This is an interesting application for amateur radio operators. A calculating oscilloscope is able to compute exact items for rises, perform integrals, and differentials, compute peak areas, RMS values, and peak to peak distances, and do n-point averaging; all data can be stored.
- With the addition of silver contacts and a small amplifier, your computer could serve as a biofeedback monitor or lie detector. Galvanic skin resistance, temperature, or heartbeat could all be measured with the use of the proper instruments.

The capabilities of a Commodore 128 allow sophisticated analysis and conversion of waveforms not obtainable with standard biofeedback equipment. An assembly language program could be written to convert alpha brain wave signals, which are in the range of 8-12 Hz, into audible sound by raising all of the frequency components of the brain wave signal to the audible range, while preserving the ratios between the frequencies. Such a program could then be used for a variety of unique applications; for example, for converting your voice from a very deep level into a high-pitched level or for dealing with any situation requiring the conversion of analog signals. You can envision future digital music players that have the added capability of al-

Connecting the Commodore 128's Household Control Devices

tering songs through the use of hardwired computer circuits.

- A New Hampshire resident uses his home computer to control his wood stove; he reports a 10 to 30 percent improvement in efficiency.
- A digital/audio file in which a standard cassette interface is used to record digital information between songs (audio) could be used to index songs, prompt a vocal announcement by a voice synthesizer, or control volumes, speakers, times, or mixing.
- Hobbyists have connected computers to exercise equipment, such as jogging pads or exercise bikes, to keep track of energy expended, speed, or time. These special input devices could also be used as controllers for special video games.
- Special software and hardware configurations could permit two or more opposing players to use separate but interconnected computers in such a manner that they cannot see each other's gamefield. Games of the type (*multiplayer games*) are gaining in popularity on computer networks.
- Chess fanatics who also happen to be gadget fanatics would take delight in a computer-interfaced chessboard capable of sensing the movement of pieces. A robotic arm, of course, would move pieces for the computer.
- Personal computers can be used to generate titles for home video or film movies that can involve animated color graphics. Titles for slide shows could also be made by photographing the screen.
- Along similar lines, your computer could flash subliminal messages over television programs for behavior modification. These would last 1/30 of a second and assail your subconscious with messages to help you control your weight, deal with stress, smoking, or alcoholism, or become motivated toward success. Messages such as "I exercise" and "I am successful" could be repeated every minute.
- Radio scanner buffs can interface their computer

to a scanner via CompuScan™, a Bearcat product, allowing them to monitor up to 200 channels. The computer can display the frequency and the description of the channel received on a video monitor.

- Weather sensors such as electronic anemometers, thermometers and barometers can be interfaced with a computer to provide automatic weather monitoring.

HOUSEHOLD CONTROL DEVICES

There are interfaces that allow a C-128 to help you out around the house commercially available from the firms listed below. For those readers with a hardware bent and solder for blood, there are schematics for a simple control latch system and A/D (analog/digital) converter included at the end of this chapter.

These firms have been divided into two groups, depending on the type of products that they offer: the one listed under "Commodore 128 System," offers a product that is designed to work specifically with the C-128, and those in the "Dedicated Systems" category offer products that are made for home control applications, but they lack a direct C-128 interface. These dedicated systems can be interfaced, however, to Commodores through some elaborate electronic restructuring.

Commodore 128 System

X-10, 185A Legrand Avenue, Northvale, NJ 07647; (800) 526-0027. The X-10 Powerhouse, offered by X-10, is a combination home security/home control system that interfaces directly with your Commodore 128. The X-10 Powerhouse uses your standard 110V outlet to send digitally encoded signals to remote X-10 Modules that control household appliances. Once programmed by your C-128, the X-10 Powerhouse can be disconnected from the computer and function in a stand-alone fashion with a battery back-up.

Dedicated Systems

Anova Electronics, Three Waters Park

1001 Things to Do With Your Commodore 128

Drive, San Mateo, CA 94403; (415) 572-9686. Anova sells three dedicated, microprocessor-based systems for home control. These systems can be used to remotely control, via the telephone, appliances and protection systems.

Audio Command Systems, 46 Merrick Road, Rockville Center, New York, NY 11570; (516) 766-2627. This firm offers remote control devices including low-voltage lighting control systems, motorized drapery controllers, stereo components, and robots.

BSR, Route 303, Blauvelt, NY 10913; (914) 358-6060. This firm is the founder of home control system market. The BSR System is used by a variety of different manufacturers as an OEM (original equipment manufacturer) component of their system. The BSR controller encodes a signal on the 60-cycle alternating current of the house's electrical system. This eliminates the need for special wiring throughout the house. Each controlled appliance is plugged into a remote unit that may be turned on and off by the main control box of the BSR system.

Leviton, 59-25 Little Neck Parkway, Little Neck, NY 11362; (212) 229-4040. Leviton manufactures electronic control devices that enable computer control of lighting and appliances.

Technicom International, 23 Old Kings Highway South, Darien, CT 06820; (202) 655-1299. This firm offers the Energy Control System (ECS) which can control up to eight devices in the home using BSR remote modules.

The Use of Home Control Systems

Users of these control systems report actual applications as diverse as energy conservation, keeping various rooms at desired temperatures for different times of the day, sprinkling the lawn according to a predetermined ground moisture level, securing doors, signaling a baby's movements in a crib, making and logging telephone calls, detecting the seepage of water into a basement, opening and shutting drapes, and starting a roast for dinner through a remote telephone signal.

The control system can be arranged in such a manner that one Commodore controls the entire house or with a network of Commodores interconnected via RS-232C interfaces.

MUSIC

There are numerous music and speech synthesizers available for the C-128. Possible uses for these include:

- Use them with games for special sound effects.
- Use them with a music composing program to generate and play original music continuously.
- Use a music synthesizer as programmable drummer to accompany other instruments. Various drum sounds, speeds, and patterns including Latin, swing, jazz, waltz, and march, could be programmed. The metronome, cymbals, and other percussion devices could also be imitated.
- Use a voice synthesizer to "sing" the vocals of a music piece, producing a unique composition.
- Use the standardized MIDI (Musical Instrument Digital Interface) to connect a home computer to one or more electronic musical synthesizers to play or digitally record your compositions on a standard electronic keyboard. Comprehensive reformation on MIDI is available from: MIDI Users Group, P.O. Box 593, Los Altos, CA 94022, phone (408) 253-4684.

Additional applications in the area of music include the following:

- If you have a plotter or a graphic printer or terminal, your musical compositions or those of the computer could be displayed in standard musical notation.
- Loops of the proper speed and duration will generate a specific audible frequency on an AM radio placed next to a CPU. A machine language or BASIC program to make use of this effect could produce sounds that resemble music.
- If music is digitized with the use of an A/D con-

Connecting the Commodore 128's Household Control Devices

verter, it can be altered in various ways. Here are some examples:

- selected voices or instruments could be removed/added after an analysis of frequency content.
- The music could be played at any selected rate without a change in pitch, or could be played backwards or special effect. You could transform a given composition into another style of your choice.
- Today's color organs, which produce a pulsating light in response to music, rely upon analog circuits and often do not produce good results. A dedicated microprocessor could be used to control the lights instead, resulting in a more favorable response.

AN EXTERNAL DEVICE CONTROLLER FOR YOUR COMPUTER

The project described below will enable the electronic enthusiast to construct an economical interface for the C-128. For those who lack the desire or ability to make this circuit, commercially available boards for the Commodore can be purchased for under \$200.

This interface can connect your Commodore with up to sixteen external devices. Once these connections have been made, your C-128 can control all sixteen devices simultaneously.

This interface switches on and off a small amount of current which controls the relays that in turn can control larger electrical loads (see Fig. 8-1). The powerful C-128 will have no problem driving this interface.

The interface consists of three modules: a 16-channel demultiplexer, a 16-bit memory, and 16-transistor amplifier drivers. The final construction cost will be in the neighborhood of \$30. The final interface is designed to connect directly to a parallel Centronics port. This port will have to be added to the C-128 prior to the connection of the constructed interface.

The four low-order bits of data coming from the parallel output port are input to the demultiplexer.

In turn, the demultiplexer selects the appropriate output pin and pulls it low. For example, if the four bits are 0000, then channel zero will be selected and pin one will be pulled low. Since only 16 individual signals are possible with four bits per signal, 16 is the maximum number of channels that can be selected.

Each output signal switches the state of one of the sixteen flip-flop chips. Therefore, the flip-flops act as a 16-bit memory that continuously maintains the status of each channel. Signals sent to one flip-flop will alternatively toggle the corresponding channel on and off. The fifth bit of the data byte is first buffered, and then it is connected to the reset pin of each flip-flop. Consequently, all channels may be reset (turned off) simultaneously through the use of the fifth bit.

The software must output the signal corresponding to the correct channel to control the devices that are connected to this interface. The channel cannot be switched on and off continuously, however, by selecting that channel over and over again. This restriction is due to the flip-flop's switching structure. Flip-flops can only switch on the rising edges from the demultiplexer, which occurs only if the multiplexer has been changed to select a different channel. Therefore, to switch a given flip-flop on and then off, follow these steps: 1) select the channel with the proper data byte, 2) select any other channel, including an unused channel, 3) wait for the first channel to toggle on, and 4) reselect the first channel to turn that channel off.

AN A/D CONVERTER FOR YOUR COMPUTER

This analog-to-digital converter has many applications for use with a Commodore 128, including the automation of test equipment and the control of robots.

The eight channel interface described here is designed for use in converting signals in the range of .1 Hz to 100 Hz which is sufficient for the applications listed here (see Fig. 8-2). The "sample-and-hold" principle is used in this design to store an analog signal as a capacitor charge until it is processed.

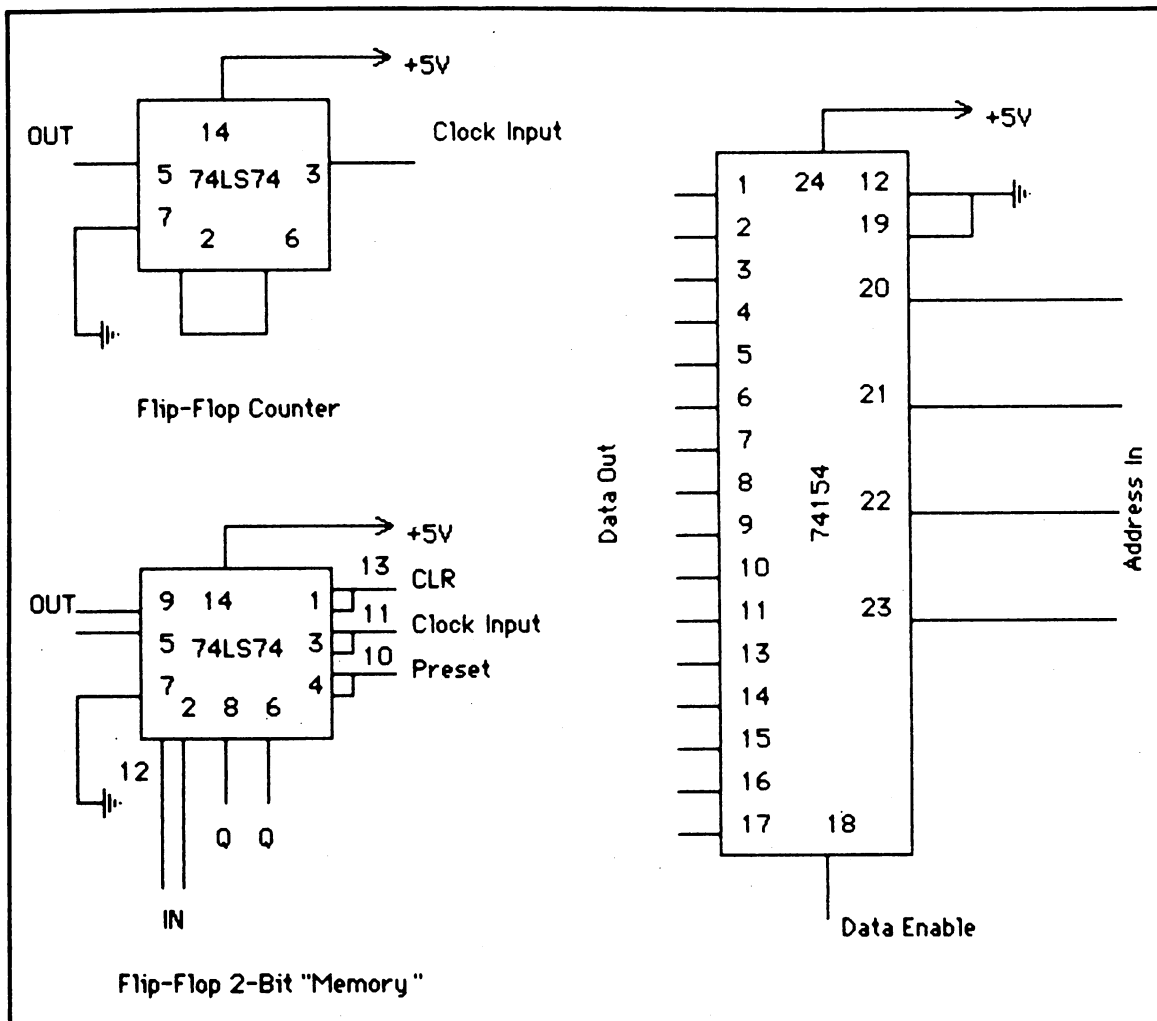

Fig. 8-1. The schematic parts necessary for constructing a control latch.

The two power supplies that are necessary for this circuit should fall between 4.5V to 6.5V and 12V to 15V, respectively.

An assembly language software description is provided below:

1. Initialize the pointer.
2. Load the next byte for output.
3. Output the byte.
4. Set the accumulator equal to the pointer.
5. Select the next channel and enable the sample-and-hold process.
6. Turn off the sample-and-hold strobe.
7. Turn off the selected sample-and-hold.
8. Decrement the value of the pointer.
9. If the pointer is greater than or equal to zero, then loop back to Step 2. Otherwise, return to the main program.

As you can see, the program sequentially ad-

Connecting the Commodore 128's Household Control Devices

addresses a channel, outputs the voltage that is to be held, disables that channel, repeats the process for the other channels, and then returns to the main program. You can arrange the program to act as an interrupt handler signaled by a clock strobe on

an interrupt line.

Similar to the A/D converter, a D/A (digital-to-analog) converter can also be built or purchased for producing speech, music, sound effects, and control the speed of a motor.

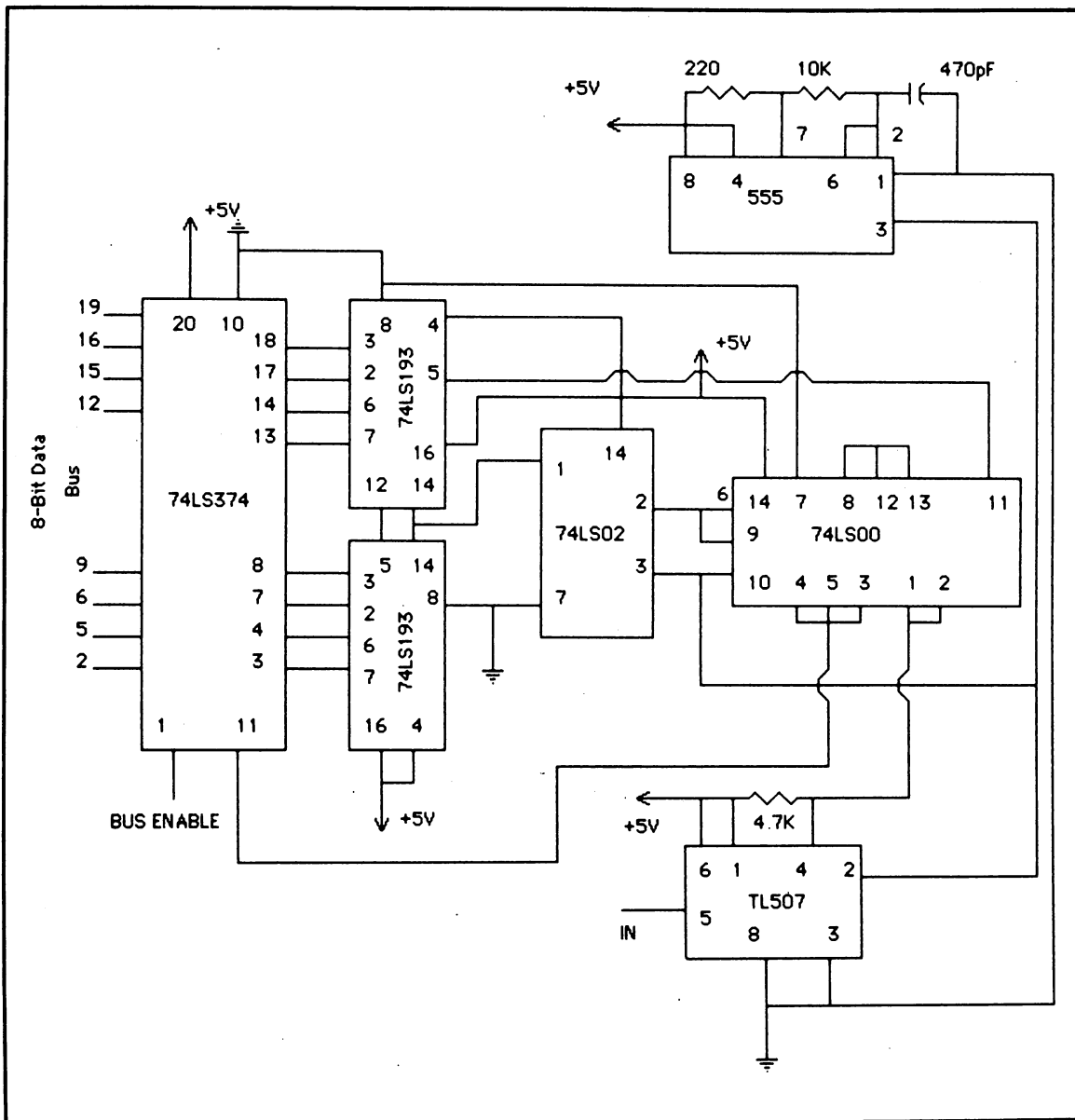

Fig. 8-2. A complete schematic for an A/D converter using a 74LS374 Decoder IC.

PERSONAL ROBOTS

Today the development of personal robots is at a stage that duplicates the position of personal home computers in the early 1970s. Robotics is a young field with great potential and open for exploring. Personal robotics is discussed here as a control application for your C-128, considering that many robots are available on the market that rely on external microprocessors for at least partial control over their actions.

State of the art robots can locomote, talk, and perform crude manipulator functions. Capabilities such as setting the table, mowing the lawn, and making meals are impractical actions for a personal

robot. A personal home robot is ideally suited for the tasks of home security, companionship, and mobile computing. While science fiction crowds our imagination with thoughts of robotic slaves, the reality is fixed firmly on the robot being placed in the home as a tool or appliance, and nothing more. Even the massive robots operating on Detroit assembly lines execute only a single, preprogrammed, designated task. Human servitude was abolished in the late 1800s and shouldn't be electronically reinstated in the 21st Century.

HEROjr, manufactured by Heath/Zenith Corporation (see Fig. 8-3), has demonstrated its stamina by being the sole survivor of the brief boom in

Fig. 8-3. An on guard Heath HEROjr personal robot. A 17-key keypad is located on the top of HEROjr's head. This keypad is used for direct robot programming. An RS-232C port on HERO's back, however, provides Commodore 128 access to all levels of personality programming that are possible with this robot.

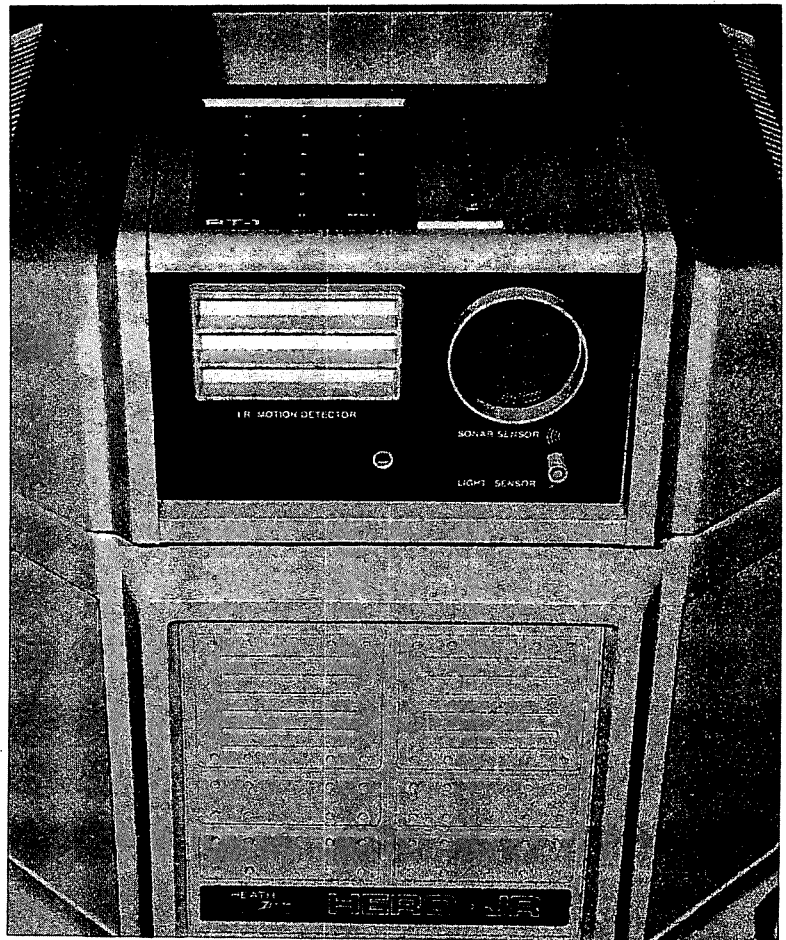

Connecting the Commodore 128's Household Control Devices

home robotics that occurred during the early 1980's. Advertised as a friend, companion, and security guard, HEROjr uses its built-in sensors to seek out human companionship or to recognize intruders. Plug-in cartridges add new personalities to this robot by teaching it how to perform such activities as singing or asking riddles. The HEROjr cartridge of most interest to the Commodore 128 owner, however, is the HEROjr BASIC cartridge. If

you have installed a standard RS-232C serial port on your C-128 and you have a terminal program handy, then you can interface your Commodore to your robot for simplified programming of the robot's capabilities. In this way, your C-128 becomes a sophisticated tool that eliminates the tedium of programming the HEROjr via a primitive (that is, compared to your C-128's keyboard) hex keypad on the robot's head.

Chapter 9

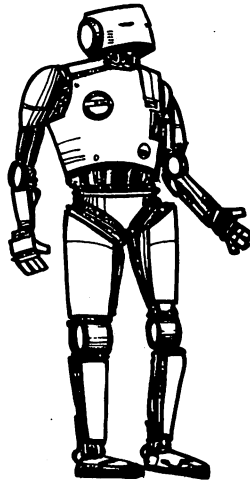

Artificial Intelligence and Networking

In his book, *Future Shock*, Alvin Toffler describes a future home computer system named OLIVER. OLIVER's primary purpose is to help the owner deal with decision overload. In a suggested scenario, OLIVER functions exactly like its contemporary C-128 cousin of today does. The suggestions continue, however, and OLIVER is able to perform speech recognition functions coupled to a rudimentary expert system ability. Actually, none of Toffler's OLIVER attributes are beyond the capabilities of your Commodore 128. The only barrier in obtaining an OLIVER quality with the C-128 is constructing the proper hardware and purchasing the necessary software.

FUTURISTIC APPLICATIONS THAT ARE FEASIBLE NOW

While *Future Shock* contains many startling predictions about the human condition in the future, most of its computer-related speculations are now possible. The following list describes applications that the C-128 is currently capable of handling with the proper hardware and software:

Medical Monitoring. A specially designed microcomputer constantly checks your body functions. Information such as nutritional and caloric intake, pulse rate, blood pressure, and weight loss or gain are entered into a program that monitors your metabolism. The program is then able to dictate visits to the doctor when certain programmed conditions are met.

Furthermore, telecommunications with larger medical databases gives this computer a vast source of expert medical opinion. Therefore, answers to virtually any medical questions or crisis can be handled quickly and at the on-site facility.

Information Research. Your C-128 can easily "hook-up" to hundreds of different computerized information systems. For example, news agencies, stock market brokerage firms, and international libraries are all within reach of your Commodore. By using a modem, full-service companies like CompuServe provide vital links with many of these enormous databases. Additionally, your C-128/modem combination can tap the Library of Congress's computerized card catalog system

1001 Things to Do With Your Commodore 128

and receive information concerning thousands of references.

Personalized News Service. A Commodore 128 online with a news service is able to select news items by category and store them for review at a later time. The United Press International wire service provides all of the major national and international news. These news items are coded by category and they are, therefore, easier to locate by the telecomputing Commodore user.

Travel Information. A travel service database, filled with information regarding flights, schedules, prices, availability, and reservations, is able to supply all of the information that is necessary for you to plan your next vacation via your C-128.

Stock Market Quotes. A continual Dow-Jones listing service supplies stock market quotes to the Commodore 128 through a modem. This service is a strong ally in the pursuit of a profitable stock market venture.

Educational Programs. Many comprehensive educational programs that utilize video playback systems for the presentation of television images are being developed for the C-128. These video images are then combined with educational programming to provide a unique learning experience.

Business Extensions. The advent of the C-128 has made travel to the office virtually unnecessary for certain individuals. All of the business work is handled through the computer and the modem.

Computer Networks. Just like the popular "analog" bulletin boards found in college dormitories and grocery stores, the computer variety is filled with hundreds of "digital" pieces of paper. As with any telecommunications, your C-128 will require both a modem and telecommunications software prior to accessing these computerized bulletin boards.

Conversely, you can start your own computer bulletin board system (BBS). You will need your C-128, special bulletin board software, and an auto-

answer modem. As your BBS grows you will need vast amounts of computer storage. A hard disk is the best method for achieving both the required storage room and the needed speed for accessing these data.

Intelligent Devices. A C-128 interfaced with household devices is the basis for a complete home management system. Climate control, solar energy system control, video cassette recorder timing, and cooking control are all done simultaneously with the properly equipped C-128.

Artificial Intelligence. Artificial intelligence (AI) is a greatly misused term that carries a variety of different meanings. The first rudimentary chess playing programs were created as substitute human players possessing enormous move options. These programs spawned the artificial intelligence movement, which ranges from elementary psychologist programs to diagnostic expert systems. While many of the more sophisticated AI programs are restricted to the larger, industrial computers, there are several small AI pieces of software that are available for the C-128.

For further information concerning the growing AI field, please consult the following references:

Burulé, J., *Artificial Intelligence: Theory, Logic, and Application*, TAB Books, Inc., Blue Ridge Summit, PA 17214.

Holtz, F., *LISP—The Language of Artificial Intelligence*, TAB Books, Inc., Blue Ridge Summit, PA 17214.

Jenkins, R., *Supercomputers of Today and Tomorrow: The Parallel Processing Revolution*, TAB Books, Inc., Blue Ridge Summit, PA 17214.

O'Malley, T., *Artificial Intelligence Projects for the Commodore 64*, TAB Books, Inc., Blue Ridge Summit, PA 17214.

Townsend, C. and D. Feucht., *Designing and Programming Personal Expert Systems*, TAB Books,

Inc., Blue Ridge Summit, PA 17214.

Tracton, K., *Programmer's Guide to LISP*, TAB Books, Inc., Blue Ridge Summit, PA 17214.

NETWORKING

The world is your neighbor via your C-128. Within the past few years there has been a tremendous growth in networking. *Networking* is the connecting of computers to other computers through the use of modems and the telephone system. Based on the present increase in modem traffic, networking is a Commodore application that is increasing explosively.

What services are currently available from networks for the Commodore? One of the more important applications is the creation of a home banking system. This system will enable you to conduct all of your banking duties through your Commodore 128. The only roadblock preventing the widespread acceptance of this computerized, home banking system is the banking industry's reluctance to adopt this method.

Another, more readily available, networking activity is in the area of information processing. Data about everything from sport scores to encyclopedia articles can be quickly obtained through a modem. You are able to exchange information, unique C-128 programs, and even electronic mail with any of the thousands of Commodore network users. Very little in the way of extra equipment is necessary for tapping a network's potential. The most important piece of hardware that you will need is a modem.

Modems

Modems (modulation/demodulation) are electronic devices that allow communications between computers using a serial transmission protocol. They translate the electronic voltage signals from the computer into audio tones that may be sent through an ordinary telephone system. Likewise, the modem is able to take modem-converted audio

tone and translate them into the 1 and 0 voltage levels of the computer.

Modems designed for the Commodore 128 range in cost from \$50 to \$695. This enormous difference is due to the modems features and construction. Therefore, when selecting your modem find one that offers the features that you need, instead of buying a modem based solely on price.

A direct-connect modem interfaces directly with your household telephone system, usually through a modular jack. Alternatively, an acoustic-coupled modem physically holds your household telephone's handset in a special cradle. In terms of their reliability, the direct-connect modem is superior in receiving and transmitting signals virtually error-free.

The other consideration when purchasing your modem is the speed of data handling. Data handling speed is discussed in terms of bits per second (bps). This bps rate is also known as the *baud* rate. Baud rates for Commodore modems are available in three speeds: 300 bps, 1200 bps, and 2400 bps. Choose a speed that matches both your software and your patience. For example, the transmission of a 5K byte file would take roughly 2.5 minutes at 300 bps, 1/2 minute at 1200 bps, and 1/4 minute at 2400 bps.

Terminal Programs

In order to make your modem function properly with your Commodore, you will need to purchase a terminal or communications program. Many manufacturers pack the appropriate software with their modems. Terminal software enables you to send and receive messages and programs between your C-128 and the network. Additionally, this software has provisions for storing all of the data that you receive in a memory buffer for subsequent saving onto a floppy disk.

Available Networks

There are two major networks of broad interest—CompuServe and The Source. Both of these services offer a variety of informational sub-

1001 Things to Do With Your Commodore 128

CompuServe
 5000 Arlington Center Blvd.
 P.O. Box 20212
 Columbus, OH 43220
 (800) 848-8199

<p>AAMSI Medical Forum AID calculations AMEX prices (NQUOTE) ASCMD SIG ASI Monitor AVSIG. Academic American Ency Access Access phone numbers Adult education Adventure game Advertisers, TODAY Advertising: For sale Notices TODAY Magazine Want ads Advertising, classified: St. Louis Post-Dispatch Advice: Aunt Nettie African weather Agribusiness Agricultural news Air travel: Firstworld travel: Firstworld Travel Club Official Airline Guide Pan Am Travel Fax Air travel delays Aircraft Airline guide Airport delay guide Amateur Radio Analogies test Annual reports Apple, programs for Apple User's Group Appliances for sale Arcade (SIG) Art Gallery Articles, computer Asian weather Assoc. Press Access Assoc. Viewdate Wire Astrology Game Astronautics Atari Forum Athletic equipment Athletic's Outfitter Atlas, shopping service Attorneys Author's (SIG) Auto information: Gov't publications Investors Diversified</p>	<p>Popular Science AutoNet Autos, buying AutoNet St. Louis Post-Dispatch Aviation: ASI Monitor EMI Flight Planning NSW Aviation Weather Official Airline Guide Peak Delay Guide Aviation Rules & Reg Aviation Safety Inst Aviation (SIG) Aviation weather Bacchua Data Services Banking, electronic Banks: Central Trade Bank First Tennessee Bank Huntington National Bank Shawmut Bank of Boston Benshi game Baseball (AP wire) Basic CompuServe Beef prices Belmont Golf Association Belmont's golf (SIG) Billing, reviewing Biorhythms Blackjack game Biles language Book, ordering: Fifth Avenue Shopper Howard Sams Books Book, reviews AAMSI, medical journals Rainbo's Review Boston, Shawmut Bank Bridge game Brokerage Budgeting, home: CompuServe Gov't publication Bulletin Board Business, farming Business Information Wire Business news: AP Viewdata Wire Business Wire Canadian, U.S. Int'l CompuServe Middlesex Daily St. Louis Post-Dispatch Washington Post CB Interest Group CB Radio simulation:</p>	<p>Access to Instructions Introduction CB Society CEMSIG CP/M user's group Cameras for sale Canadian: Business news Currency exchange Stocks Canning, home Car care Care, comparison Cattle prices Central Trade Bank Changing password Changing terminal type Charges, monthly Checking, banking Child care Children, education Children's games Cinema news Clarke School for Deaf Classified Ads: St. Louis Post-Dispatch Clothing, fashion Clothing, sport Cocoa news Coffee news College cost program Color computer (SIG) Color graphics Columbus area: Banks Chamber of Commerce Education SIG Command level Commentaries: Investment Video Commodities calendar Commodities future Commodities glossary Commodity News Service: Agricultural news Commodity prices Economic news Futures industry news Futures market prices General news Metals news Weather Commodore newsletter Commodore VIC (SIG)</p>	<p>Comm. Industry Forum CompuServe command Comp-U-Store Computer, books Computer club news: Computers & Electronics The Micro Advisor Computer Magazine Index Computers & Electronics Concentration game Consumer items for sale Consumer news: Software Continuing education Cooking (SIG) Corporate news release Copper futures prices Copper news Cotton futures prices Cotton news Court cases, aircraft Cross Assemblers Cruise line Current rates Database, how to use Database searches dataFamiliae Decwars game Decwars (SIG) DEFAULTS, setting Department of State Disk area Document delivery Document retrieval Documentation ordering Dress Drugs Drugs, medicine EMI Flight Plans Earnings forecasts Economic news Editorials: Washington Post Education: Academic Encyclopedia Clarke School for Deaf The College Board The Multiple Choice Education, family Educational games: Super Brain Challenge Witty Write-Ins Educator's (SIG) Electronic banking Electronic Bounce Back. Electronic Heath Catalog Electronic mail</p>
--	--	--	--

Fig. 9-1. The subject matter offered by CompuServe. Continued to page 149.

Electronic shopping
 Eliza program
 EMAIL
 Emergencies, auto
 Emergencies, health
 Employee benefits
 Encyclopedia
 Energy conservation:
 Gov't publication
 Popular Science
 Energy news
 Entertainment:
 AP Viewdata Wire
 CompuServe
 Hollywood Hotline
 Environmental Forum
 Equipment, mining
 European weather
 Executive, terminal
 Expert, music
 FAA reports
 FAA rule changes
 FOI Newsline
 Facts, general
 Family budget
 Family life
 Family Matters Forum
 Fantasy game
 Farming
 Fashions
 Federal gov't news:
 Associated Press News
 Washington Post
 Federal publications
 Fedwatch newsletter
 Feedback, CompuServe
 Fifth Avenue Shopper
 FILGE Instructions
 Finance
 Financial advice
 Financial aid, college
 Financial forecasts
 Financial information
 Financial insurance
 Financial news (AP)
 Financial planning
 Financial services
 Fire Fighters' (SIG)
 Fire prevention
 Fireplaces, firewood
 First Aid
 First Tennessee Bank
 Firstworld Travel Club
 Fitness
 Flight operations
 Flight plans
 Flowers, ordering
 Focal
 Food & Drug Admin
 Food Buyline (SIG)
 Food information:
 FDA
 Food storage
 For fitness
 Freezing

Menus
 Football (AP wire)
 Football game
 For Sale:
 Bulletin Board
 Clothing, sport
 Consumer goods
 Fortran (XF4)
 Funds Management
 Fur Trader game
 Futures Industry news
 Futures prices
 Games, computer:
 Adventure
 Astrology
 Backgammon
 Banshi
 Biorhythms
 Blackjack
 Bridge
 Chess
 Civil War
 Concentration
 Decwars
 Dica
 Eliza
 Fantasy
 Fastermind
 Football
 Fur Trader
 Golf
 Gomoku
 Hammurabi
 Hangman
 Kesmai
 Lunar Lander
 Magic Cube solution
 Maze
 Megawars
 Mugwump
 New Adventure
 Othello
 Real-Time Star Trek
 Roulette
 Scott Adams
 Scramble
 Space War
 Star Trek
 Trivia test
 Wumpus
 Games (SIG)
 Gandolf's Reports
 Gardening
 Gasoline, saving
 General banking
 Godive chocolate
 Gold:
 Future prices
 News
 Golf, Belmont Golf Assn
 Golf, Official PGA Tour:
 Biographies
 Players
 Statistics
 Golf (SIG)

Gomoku game
 Good Earth (SIG)
 Grain prices
 Grains futures
 Groller's Encyclopedia
 Ground water
 Hammurabi game
 HamNet (SIG)
 Handelman's Athletic Sup
 Handicapped, deaf
 Hardware reviews
 Health
 Health and fitness
 Health Care
 Health Resources
 Health-Tex
 Health Users' Group
 Heathkit Catalog
 Heihold Commodities
 Help
 Help (documentation)
 Hi-Tech Forum
 Hockey (AP wire)
 Hollywood Hotline
 Home banking
 Home finance
 Home management programs:
 Amortize a loan
 Calculate a raise
 Checkbook balancer
 Net worth
 Home services
 Horticulture
 House plants
 Howard Sams Books
 Humor, satire
 Huntington, bank
 Husbandry
 IBM-PC (SIG)
 IDS
 IRA
 Immigration
 Index:
 AAMSI Journals
 CompuServe
 Computer Periodical
 Stock Market
 Industries, farming
 Information, music
 Information on Demand
 Information Retrieval Ser
 Insurance:
 Dental
 Disability
 Employee Benefits
 Health
 Life
 Miscellaneous
 Insurance, aircraft
 Intelligence test
 Interest rate
 Investment news
 Investment News & Views
 Investments:
 MicroQuote

Investors Diversified
 Job, in the home
 Jobs:
 St. Louis Post-Dispatch
 Jumbled words test
 Kesmai
 Kitbuilding
 LDOS (SIG)
 Languages on CompuServe:
 Bliss
 Focal
 Fortran
 Macro
 Pascal
 Snobol
 Legal Forum
 Legal issues
 Library, electronic
 Lineprinter art
 Liquid Green
 Literary (SIG)
 Livestock futures
 Livestock prices
 Lobby Letters
 MMS Financial Analysis
 MNET-11 (SIG)
 Macro
 Magazine, advertisers
 Magic Cube solution
 Mainstreaming
 Maintenance equip
 Manuals, documentation
 Manufacturer's newsletters:
 Commodore
 RCA
 Tandy
 Maps, road travel
 Marine weather
 Market prices
 Market research
 Massachusetts, banking
 Medical:
 AAMSI Forum
 ASCMD Forum
 FOI Newsline
 Medical newsletter
 Medical Records
 Medicine, consumer
 Metals future prices
 Metals prices
 Micro Advisor, The
 Microcomputers:
 Advice
 Financial news
 General
 RCA
 Tandy
 What's new in
 MicroQuote
 Microsoft (SIG)
 Middlesex Daily News
 Mine-Equip
 Money market
 Money supply
 Monthly charges

1001 Things to Do With Your Commodore 128

- Mortgage budgeting
- Movie reviews
- CompuServe
- Hollywood Hotline
- Multiple Choice, the
- Music
- Music Forum
- Music Information Service
- Musue-Pascal (SIG)
- Mutual Funds
- NASA
- NIPSIG
- NOAA weather
- NTSB cases (aviation)
- NWS aviation (weather)
- NYSE prices (MQQUOTE)
- Names of users
- National Issues (SIG)
- National Water Well Assn
- National Weather Service
- Netwits
- Netwits (SIG)
- New product news
- Popular Science
- The Micro Advisor
- News services
- News, CB
- Newsletters:
- AAMSI Communications
- Commodore
- RCA
- Tandy
- Newspapers
- Node locations
- North American weather
- Norwegian Am. Cruises
- Notices (Bulletin)
- Nutritional analysis
- OK level
- OTC drugs
- OTC prices (MQQUOTE)
- Official Airline Guide
- Ohio, banking
- Ohio regional news
- Ohio Scientific (SIG)
- Options, stock
- Orch-90 music (SIG)
- PGA Official Tour Guide
- PUG (Panasonic SIG)
- Pan Am
- Panasonic (SIG)
- Parenting & Family Life
- Pascal (SIG)
- Password, changes
- Peak Delay Guide
- Periodical Guide
- Personal computing
- Personal finance:
- Gov't publications
- Home Management
- Investors Diversified
- Personality profile
- Pets
- Pilot weather
- Plants
- Politics:
- AP Viewdata Wire
- Middlesex Daily
- Washington Post
- Popular Science Magazine:
- Automotive News
- New products
- Science & Technology
- Software reviews
- Pork prices
- Portfolio valuation
- PowerSoft's XTRA-80
- Precious metals
- Precious metals news
- Prescriptions
- Prime Interest Rates
- Primetime Radio Classics
- Professional:
- Agribusiness database
- Eng Technical database
- Environmental database
- Programmer's SIG
- Programming area
- Programming languages
- Programs for sale
- Programs from users
- Programs, medical
- Public access
- Quick Quote
- RCA Newsletter
- RCA (SIG)
- Radio:
- Amateur
- Old radio shows
- Radio Shack computers
- Rainbo's Reviews
- Rates, CompuServe
- Real estate, ads
- St. Louis Post-Dispatch
- Recipes (SIG)
- Recordkeeping, home
- Reference guide
- Referral Service, law
- Regulatory Affairs Prof
- Reservations, airline
- Firstworld Travel
- Resource, water
- Reviews, hardware
- Reviews, movie
- CompuServe
- Reviews, software:
- Popular Science
- The Micro Advisor
- SAT test information
- SIGS:
- AAMSI
- ASCMD
- AVSIG
- Arcade
- Atari
- Author's
- CBIG
- CEMSIG
- Commodore
- Commodore Pet
- Commodore 64
- Commodore VIC 20
- Communications
- Cooks' Underground
- CP/M Group
- Decwars
- Educators'
- Environmental
- Family Matters
- FireNet
- Food Buyline
- Games
- Golf
- Good Earth
- HamNet
- Hi-Tech
- HUG (Health)
- IBM-PC
- LDOS TRS-80
- Legal
- Literary
- MAUG (Apple)
- Microsoft
- MNET-11
- MNET80 TRS-80
- Music
- Musue-Pascal
- Netwits
- NIPSIG
- Orch-90
- OSI
- PowerSoft's XTRA-80
- Programmer's PUG (Panasonic)
- RCA Group
- Space
- Sports
- Telecomm
- Travel
- TRS-80 color
- TRS-80 Model 100
- Veterinarians
- Work-at-Home
- St. Louis Post-Dispatch
- Sams, Howard Books
- Satire
- Saving Accounts
- Scott Adams' games
- Scramble game
- Securities:
- Information
- Self-employment
- Self-Health
- Services for the Deaf
- Shawmut, bank
- Shop-at-home
- Shopping:
- Cars
- Musical
- Radio Shows
- Shuttle, space
- Silly fill-ins
- Silver-futures prices
- Silver news
- Ski conditions
- Small business reports
- Smoking and health
- Snobol
- SOFTEX
- Software Authors' SIG
- Software Exchange
- Software reviews:
- Popular Science
- The Micro Advisor
- South America weather
- Space (SIG)
- Special Interest Groups:
- Access to
- Commercial
- Descriptions of
- General
- Hardware related
- Instructions
- Software related
- Sport, clothes
- Sports news:
- Golf
- St. Louis Post-Dispatch
- Scores (AP)
- Sports quiz
- Sports (SIG)
- Spotlight, CBers
- Standard & Poors
- Star Trek game
- State capital games
- Stereos for sale
- Stevens Business Reports
- Stocks, bonds:
- MicroQuote
- Quick Quote
- Sugar futures prices
- TMC for kids
- TRS-80 color (SIG)
- TRS-80 computers
- TRS-80, MNET80 (SIG)
- TRS-80 Model 100 (SIG)
- TRS-80, programs for
- Tandy Corp. news
- Technical books
- Technical research
- TeleComm (SIG)
- Telephone access
- Tennessee, banking
- Terminal parameters
- Terminal software
- Terminal types
- Tests, children
- Tests, interactive
- Tests, SAT
- Text editors
- The College Board:
- Adult education
- Choosing a college
- Financial aid
- Publications of
- SAT test information
- The National Satirist

Time used	Movie	War games:	Work-at-Home (SIG)
TODAY, advertisers	Radio	Decwars	World news:
Trading, commodities	Unlimited test	Megawars	AP Viewdata Wire
Travel:	UCSD Pascal Group	Space War	Associated Press
Department of State	USDA Grades	Washington, D.C. area:	Washington Post
Firstworld Travel Club	USDA standards:	Middlesex Daily	Worldwide Exchanges
Norwegian Am. Cruises	Meat	St. Louis Post-Dispatch	Yachts
Official Airline Guide	Poultry	Washington Post	Associated Press News Access
Pan Am	U.S. Department of State	Washington Post	Financial wire:
Travel Fax	U.S. News:	Water, ground	Middlesex Daily News
TravelVision	Middlesex Daily	WaterLine	St. Louis Post-Dispatch
Worldwide Exchanges	St. Louis Post-Dispatch	Weather:	Washington Post
Travel, abroad:	Washington Post	AP Viewdata Wire	Sports:
Department of State	Used cars, buying	African weather	Middlesex Daily News
Firstworld Travel Club	User directory	Asian weather	St. Louis Post-Dispatch
Norwegian Am. Cruises	User information	Aviation weather	Washington Post
Official Airline Guide	User's programs	European weather	U.S. News:
Pan Am	VIC 20 (SIG);	Extended forecasts	Middlesex Daily News
Travel Fax	Vacationing	N. American weather	St. Louis Post-Dispatch
Travel, advisories	Value Line Database	S. American weather	Washington Post
Travel, airline guide	Vegetables	Sports forecasts	Washington News:
Travel fax	Veterinarians Forum	State forecasts	Middlesex Daily News
Travel (SIG)	Victory Garden	What's New	St. Louis Post-Dispatch
Traveler, airport guide	Video Information	Wheat prices	Washington Post
TravelVision	Videotex, views on	Wine guide	World News:
Treasury bills, yields	VIDTEX executive	Wire service news:	Middlesex Daily News
Trivia:	Viewpoint, CompuServe	(see Associated Press Access)	St. Louis Post-Dispatch
Kids	Want ads (Bullet)	Word processors	Washington Post

ject matter, which are outlined in Figs. 9-1 and 9-2.

Local Networks. A listing of several Commodore-oriented bulletin board systems is provided below. Each BBS follows a standard communication protocol (usually, 300 or 1200 bps, 1 stop bit, 7 or 8 bit word length, and even or no parity, unless otherwise stated):

Quantum Computer	
Services	(800)833-9400
Daly City, CA	(415)755-2030
San Francisco, CA	(415)567-5046
Colorado Springs, CO	(303)578-5405
Chicago, IL	(312)475-4884
Urbana, IL	(217)344-4032
Davenport, IA	(319)326-3904
Boston, MA (300 bps only)	(617)288-4667
Oklahoma City, OK	(405)848-5317
Harrisburg, PA	(717)657-8699
Nashville, TN	(615)321-0669
Houston, TX	(713)488-2003
Edmunds, WA	(206)743-6021

DATABASES

Vast information is available to every Commodore owner through computerized databases and their modem. Just about everything that is available in print is available on a database. There are in excess of 1300 public databases, which operate on a fee basis. Additionally, there are over 6000 private databases maintained by colleges, trade associations, and businesses.

Most databases provide abstracts of materials that have already been published in journals, magazines, and newspapers. A few provide only citations of the author's name, title, and publication. There are many databases, however, that do provide the full text of each article.

The greatest advantage to the use of databases is in their comprehensive indexing and cross-referencing features. These features enable you to conduct a rapid search of thousands of periodicals, journals, and textbooks. Conversely, you can often search through every word of an article in order to determine if the article is on the subject that you requested. These features provide information-gathering capabilities that transcend many of those

1001 Things to Do With Your Commodore 128

The Source
 1616 Anderson Road
 McLean, VA 22102
 (800) 336-3366

ADVANCED APPLICATIONS & PROGRAMS

ADVICE COLUMN

AIRSCHEDULES

- Domestic
- International
- Inter-City

ASTROLOGY LIBRARY

AWARE FINANCIAL SERVICE GLOSSARY

BARTER-TRADE NETWORK

BUSINESS & FINANCE

- Analysis Programming
- Annuities Analysis
- Aware Financial Service
- Spreadsheet

PURCHASE VS. PRODUCTION COMPARISON

BUSINESS PROGRAMS

- Complete Listing
- Amortization of Loans
- Amortization of Loan UNK Term
- Annuity Debt Payment
- Balancing Checkbook
- Capital, Cost of Equity
- Cashflow, Present Value
- Commission, Sales Report
- Depreciation Schedule
- Equipment, Lease vs. Purchase
- Equity Capital, Cost of
- Inter-Industry Flow of Goods & Services
- Interest, Bonds
- Interest, Loans
- Sales Commission Report

CALCULATOR

CAREER NETWORK

CLASSIFIED ADS

COMMODORE BUSINESS MACHINES

COMMUNICATIONS

CHAT

- Chat (live conversation with other subscribers)

TELECONFERENCING

SOURCEMAIL

- To Check Mailbox
- To Read Letters
- To Scan Correspondence
- To Send a Letter
- General Information
- Commands in Mail
- Cross-Referenced Names
- Operation of SourceMail
- Timed-Mail Delivery
- To Send a MAILGRAM

MISCELLANEOUS COMMUNICATION SERVICES

- Contents of THE SOURCE
- Personal Appointment Schedule
- THE SOURCE Announcements
- THE SOURCE Toll Charges
- Suggestions for THE SOURCE

- Subscribers Currently On-Line
- TYMNET/TELENET Access Numbers
- Subscriber Directory Services
- The Common-Interest Directory
- To Add Your Name and Number

CONSUMER INFORMATION

DINING OUT; WASHINGTON, D.C.

NEW YORK CITY

CONTINENTAL U.S. & CANADA

DISCOUNT SHOPPING SERVICE (COMP-U-STORE)

- Instructions
- Overview
- Bargains (the monthly listing)
- Auction
- Product and Manufacturer List
- Begin Shopping

Covering the following product categories:

- | | | |
|------------|-----------------|-------------|
| Appliances | Fine China | Sterling |
| Cameras | Furniture | Televisions |
| Cars | Pianos and | Video |
| Crystal | Organs | Recorders |
| Figurines | Specialty Items | Watches |
| | Stereo & Audio | |

EDUCATION

ENERGY SAVING NEWS & TIPS

FINANCIAL MARKETS

UNISTOX REPORT INDEXES

- Alphabetically
- By Time
- Dividends, Earnings
- Earnings Reports
- Exchange Rate
- Federal Land Bank Bonds
- Futures, Treasury Bills
- Futures & Options
- Glossary of Stock Investment Terms
- Indexes, Stock Market Daily Avgs
- Moody's Index
- Standard & Poor's Index

AMERICAN STOCK EXCHANGE

- Bonds
- Closings (All Stock Exchanges)
- Ten Most Active
- Weekly Composite Prices
- Weekend Bond Prices

BONDS

- AMEX Daily Listing
- Bond Yield Computations
- Bond Price, Accrued Interest Computations
- Federal Land Bank, Daily
- NYSE Daily Listing
- Treasury OTC, Daily
- World Bank, OTC, Daily

- Treasury OTC, Weekend
- Weekend Listings
- Commodities

METALS

- Metals News
- Gold News
- Gold Spot Prices
- NY/Chicago Mkt Prices
- NY/London Mkt Prices
- Platinum
- Silver Coins
- Silver Prices
- Silver News

MONEY MARKET NEWS AND COMMENTS

- Afternoon Lead
- Futures
- Markets at a Glance
- Night Lead
- Noon Lead
- NYSE Trends
- Opening Lead
- Stock Pulse
- What the Market Did

FINANCIAL MODELING

FOR BUSINESS PLANNING

FINANCIAL NEWS

GAMES

- Adventure
- Backgammon
- Blackdragon
- Cards
- Blackjack
- Super Blackjack
- Bridge
- Poker
- Tricks
- Checkers
- Chess
- Children's Programs
- Civil War
- Craps
- Draw
- Farmer
- Fill in Letters
- Football
- Golf
- Govern Sumeria
- Guess Computer's Number
- Hangman
- Horse Race
- I-Ching
- IQ Test
- Life
- Lunar Landing
- Market A Product
- Mastermind

Fig. 9-2. The subject matter offered by the Source.

1001 Things to Do With Your Commodore 128

service provides financial information, including current and historical quotations from major stock exchanges, commodities, media general reports, and financial disclosures on thousands of American corporations.

ITT Dialcom

ITT Dialcom, Inc., 1109 Spring St., Silver Spring, MD 20910; (301) 588-1572. This service offers a variety of databases with information about medicine, government, energy, and travel.

The Knowledge Index

Dialog Information Services, Inc., 3460 Hillview Ave., Palo Alto, CA 94304; (800) 528-6050. This service offers a subset of Dialog's more consumer-oriented databases, including business, engineering, psychology, education, magazines, and computer information.

NewsNet

NewsNet, 945 Haverford Rd., Bryn Mawr, PA 19010; (800) 345-1301. This service offers the full text of over 100 newsletters on a variety of subjects and electronic mail connections with the newsletter's publishers.

Nite-Line

National Computer Network, 1929 Harlem Ave., Chicago, IL 60635; (312) 622-6666. This service offers financial and business databases.

Orbit Informational Retrieval System

SDC Information Services, 2500 Colorado Ave., Santa Monica, CA 90406; (800) 412-7229. This service offers reference databases covering business, chemistry, engineering, and electronics.

The Source

Source Telecomputing Corp., 1616 Anderson Road, McLean, VA 22102; (800) 336-3366. This service is a large general-interest utility offering consumer information, electronic mail, conferencing, and programming languages.

The Definitive Source

Link-Up, 143 Old Marlton Pike, Medford, NJ 08055. This is the definitive telecommunications publication currently available. A one year subscription to this online *vade mecum* consists of 11 issues covering new bulletin board services, hardware, software, books, and databases.

Chapter 10

Askey Louis

Auman Glen

Avey Mana

Baer Egar

Bard Ellis

Barlup Helen

Basorea Edwina

Cosey Sid

Covalt Mark

Freena Merla

Gsel Tim

Hamilton Angela

Kerman Ed

Loche Ron

Lundio P. Ron

Useful Utility Programs

Although your C-128 may not offer many of the useful features found on larger, more expensive systems, programs can be written to simulate many of these absent features. Such software is often referred to as utility programs. The category of utility programs also includes commonly used routines or subprograms that can be incorporated into a larger program. Through the use of utility programs, your Commodore 128 can emulate its immense cousins.

MULTIPURPOSE PROGRAMS

Many of the following suggestions are already available as commercial products for your C-128. Therefore, you have two options: write your own program or buy the ready-made product.

- **Diagnostic programs:** programs that test all of the statements and commands found in given BASIC are useful in determining whether or not BASIC has loaded properly for execution. Programs to test memory by filling and reading all

locations are also helpful.

- **Base conversion programs:** this kind of program is useful in assembly language programming.
- **Multiple-precision routines:** the scientific user of small computers (and some business users) needs multiple-precision capability.
- **Memory-map programs:** a machine-language program to output a memory map would be valuable.
- **Menu selection programs:** a machine-language routine to automatically find and execute any programs that are on line would make life easier for some operators.
- **Routines for handling fractions instead of decimals for greater precision in certain applications** could be created.
- **Vector graphic assembly language routines** could be useful.

Additionally, the useful reference manual that accompanied your C-128 will also provide you with other utility program ideas.

1001 Things to Do With Your Commodore 128

UTILITY SUBROUTINES

Below are some practical routines that deal with screen manipulation and matrices:

Listing 10-1: The Window Command Routine

```
10 REM WINDOW COMMAND
20 GRAPHIC 0
30 SCNCLR 0
40 WINDOW 1,1,10,10,1
50 PRINT CHR$(18)CHR$(129);
60 LIST
70 WINDOW 8,8,22,12,1
80 PRINT CHR$(18)CHR$(150);
90 LIST
100 WINDOW 25,1,38,18,1
110 PRINT CHR$(18)CHR$(153);
120 LIST
```

Listing 10-2: The Formatted Output Routine

```
10 REM FORMATTED OUTPUT
20 X=128
30 PRINT USING "### " ; X;
40 X=X-4
50 IF X>3 THEN 30
```

Listing 10-3: The Matrix Arrays Routine

```
10 REM MATRIX ARRAYS
20 DIM M(4,5)
30 FOR X=1 TO 4
40 FOR Y=1 TO 5
50 INPUT N
60 M(X,Y)=N
70 NEXT Y
80 NEXT X
90 INPUT "ROW";X
100 INPUT "COLUMN";Y
110 PRINT M(X,Y)
120 GOTO 90
```

Listing 10-4: The Screen Pokes Routine

```
10 REM SCREEN POKES
20 FOR X=1 TO 17
30 READ Y
40 POKE 1115+X,Y
50 NEXT X
60 DATA 49,48,48,49,32,20,8,9,
14,7,19,32,20,15,32,4,15
```

File Handling Routines

The listings below are sequential file handling routines.

Listing 10-5: The Sequential File Creation Routine

```
10 REM CREATE SEQUENTIAL FILE
15 REM REMEMBER YOU CAN'T REUSE
THE FILENAME 'DATAFILE'
20 OPEN 8,8,12,"DATAFILE,SEQ,
WRITE"
30 INPUT "DATA";D#
40 PRINT#8,D#
50 IF D#="END" THEN CLOSE 8:END
60 GOTO 30
```

Listing 10-6: The Sequential File Reading Routine

```
10 REM READ SEQUENTIAL FILE
20 OPEN 8,8,12,"DATAFILE,SEQ,
READ"
30 INPUT#8,D#
35 IF D#="END" THEN CLOSE 8:END
40 PRINT D#
50 GOTO 30
```

Chapter 11

M
MERRY
MERRYCHRI
MERRYCHRISTMA
MERRYCHRISTMASMER
MERRYCHRISTMASMERRYCH
MERRYCHRISTMA
MERRYCHRISTMASMER
MERRYCHRISTMASMERRYCH
MERRYCHRISTMASMERRYCHRIST
MERRYCHRISTMASMERRYCHRISTMASM
MERRYCHRISTMASMERRYCHRISTMASMERRY
MERRYCHRISTMASMER
MERRYCHRISTMASMERRCH
MERRYCHRISTMASMERRYCHRIST
MERRYCHRISTMASMERRYCHRISTMASM
MERRYCHRISTMASMERRYCHRISTMASMERRY
MERRYCHRISTMASMERRYCHRISTMASMERRYCHRIS
MERRYCHRISTMASMERRYCHRISTMASMERRYCHRISTMA
MERRYCHRISTMASMERRYCHRISTMASMERRYCHRISTMASMER
MERRY
MERRY
MERRY
MERRY

Miscellaneous Applications

There are a number of different applications that don't fit into any of the previously discussed chapters. These applications have been grouped under the potpourri heading of this final chapter.

COMPUTERS AND THE HUMANITIES

Professional scholars of history, language, literature, anthropology, and archeology will find the C-128 useful in storing, organizing, analyzing, and indexing data.

History

The historian can encode information of the following types on a Commodore 128:

1. Census records
2. Congressional voting records
3. Election statistics
4. Court records and decisions
5. Ship sailing records—these records have historical, geneological, and economic
6. Diplomatic records

7. Journalism statistics

Language

The C-128 can be used to deal with languages in at least two different ways.

Translations. It is possible to program a Commodore 128 to act as a crude translating machine, capable of recognizing foreign vocabulary words and providing the English equivalent. Sentence structure and overall meaning are much more difficult to program, however. Pocket translating machines and spelling checker programs serve as models for such a program. The ultimate goal is to provide the interpretable English equivalent for a given foreign phrase. An even more sophisticated program would check for idiomatic expressions and provide a correct translation, as opposed to a literal translation. The translating program in Listing 11-1 may prove to be educational to those with a minimal familiarity with the language involved.

Compilation of Dictionaries. The dialects and languages of a speech community can be en-

Listing 11-1: The English-German Translator Routine

```

10 REM ENGLISH--GERMAN TRANSLATOR
20 COLOR 0,11:COLOR 4,11:COLOR 5,7
30 GRAPHIC 0
40 SCNCLR 0
50 DIM G$(10)
60 PRINT:PRINT TAB(6)"AN ENGLISH--GERMAN TRANSLATOR"
70 FOR X=1 TO 10
80 READ G$(X)
90 NEXT X
100 PRINT:INPUT "ENTER AN ENGLISH WORD";E$
110 FOR X=1 TO 10 STEP 2
120 IF E$<>G$(X) THEN NEXT X:GOTO 100
130 PRINT:PRINT "THE GERMAN EQUIVALENT IS ";G$(X+1)
140 GOTO 100
150 DATA HELLO, GUTEN TAG, GOOD-BYE, AUF WIEDERSEHEN, MONDAY,
    MONTAG, BIRD, VOGEL, COMPUTE, ERRECHNEN

```

tered into a computer database for ease in compiling a dictionary.

Literature and Writing

There are a number of ways in which you can use your C-128 to help you in your writing and analyzing of literature.

Grammar Checker. Commodore 128 programs are available for scanning your word processed files in search of grammatical inconsistencies. These errors cover punctuation, split infinitives, and synonym misuse. A word of caution should be exercised in blindly following the suggestions from this program.

Thesaurus. An online thesaurus can provide rapid, timesaving access to alternative word choices. The limited dictionaries of a computer thesaurus, however, can handicap its thorough integration with a word processor.

Automatic Table of Contents/Index Generator. In preparing text on a word processor, the author must flag each keyword with a special code for subsequent indexing and table of contents construction. After this chore has been performed, this program will search for each oc-

currence of the keyword and log its page number; its alphabetical place in an index, its place in the and table of contents.

Writer's outline utility. This specialized word processor has a database ability. The writer begins by entering all of the relevant ideas pertaining to the writing assignment into the outline program. Specific categories are formed as the outline's structure starts to take shape. Finally, the writer finishes the assignment by elaborating on the categories developed by the outline program.

Spelling Checker. Numerous spelling checker programs are available for the C-128. These are capable of inspecting documents for errors with a special dictionary consisting of 30,000-200,000 words. The user has the option of adding or deleting words. Additionally, specialty dictionaries for word-intensive professions (e.g., medical, law, and scientific) can be created.

Analysis of Literature. Computers can be used to prepare statistical analyses of literature that you have typed using your word processor. Such a program would calculate the number of lines, number of sentences, number of words, number of syllables, average word length, average sentence length, and the reading level based upon any of the

standard formulas developed by Flesch, Fry, Raygor, Dale Chall, or Spache. For instance, the Fog index (FI) is given by

$$FI = \left[\frac{\text{total no. words}}{\text{total no. sentences}} + \frac{\text{no. "hard" words} \times 100}{\text{total no. words}} \right] \times 4$$

where "hard" words are considered to be those words with three or more syllables, except proper names, compounds of short words (for example, down-and-out), and words in which the third syllable ends in es or ed (for example, arrested). Those who use the Fog index suggest that an FI value of 20 or more indicates an advanced or difficult reading level and that an FI of 10 or less is best for dealing with the masses.

The use of computers for the analysis of literature in this manner is controversial. Teachers sometimes find that these statistics provide useful guidelines when they are creating material they plan to use in reading classes and when they are writing specialized subject-matter text that must be understood by students whose reading skills are not highly developed; however, misuse of these statistics can occur when publishers demand that authors use them to "clean up their text" as a condition of publication.

A Commodore 128 can also be used to construct a concordance table, listing all words used in a piece of text and their absolute or relative frequency of use; the list can be sorted alphabetically or by frequency. See *Microcomputing*, page 60, June 1981 for a sample BASIC program. Word-class distribution statistics, measures of redundancy of vocabulary (averages, medians, and so on), numbers of modifiers, adverb/verb and auxiliary verb/verb ratios, clause length statistics, distribution of clause types (simple, compound subject, and so on), distribution of sentence openers (prepositional phrase, subordinated clause, and so on), and style of sentence structure could also be analyzed by a more complex program. This information can be used to statistically determine whether works of indefinite authorship are typical of a given writer

(for example, works by Bacon and Shakespeare are compared) since these parameters tend to remain constant for a given author.

Literature Database. A specialized database could store important manuscripts and be used to index, cross-reference, and search for keywords quickly and efficiently.

AID TO THE HANDICAPPED

The use of Commodores as aids to the handicapped is an appropriate application; only the leading edge has been explored, but the potential is tremendous. Examples of these applications include the following areas.

The C-128 can act as an intelligent typewriter for the handicapped. One system was used by a paraplegic to communicate with others; the computer scanned the alphabet and once the particular letter was reached, the patient made a movement to acknowledge the correct letter, and a printout was made. In this manner, words and sentences were produced.

Along similar lines, voice synthesizers and decoders are especially helpful for those who cannot interact with a computer through a video terminal.

A computer with a dot matrix printer can be used to convert input text into braille text. Each line of text would be reversed in the computer's memory and the braille equivalent would be printed in its mirror image. By turning the output over, the impressions left by the printer will form the braille text.

Other areas in which the Commodore 128 can help the handicapped, include the following:

- Sensory enhancement or translation: clarification of audio or visual information or translation of video information to and from audio information.
- Manipulator controls: powered prostheses or robots for individuals with severe motor impairment.
- Information amplification for the motion impaired: increase the amount of information that can be relayed with a given number of key-

1001 Things to Do With Your Commodore 128

strokes, for example, a shorthand translator, as described in the first chapter.

- Recreation and development aids: games and educational programs allowing handicapped persons a reliable means to control, explore, and manipulate objects or learn about them.
- Communication aids: telephone dialers, computer-aided writing and filing systems, and phone communication through the use of speech synthesizers, for example.
- Security/monitoring systems: mechanisms for controlling locks and windows, emergency call systems, medication reminders, and monitoring systems that will periodically demand a response and signal if the individual fails to answer its queries.
- Information resource/management: inability to quickly manipulate and scan materials may prevent the handicapped from making effective use of dictionaries, phone lists, calendars, filing systems, and books. These functions can be paralleled through the use of specifically designed microcomputer-based interfaces that work with residual physical and sensory capabilities.

TEST YOUR TYPING SPEED

Those learning to type will appreciate a measurement of their lightning-fast digits.

MAINTENANCE OF ORGANIZATION RECORDS

Clubs and other organizations may find it worthwhile to purchase a C-128 to ease the paperwork crunch. Anyone who develops software for this application may be able to sell it to other organizations or charge for his or her computing services.

CO-OP SCHEDULING AND FINANCES

A Commodore 128 analysis of costs and duties can help divide these responsibilities more fairly between members of communal residences or cooperative organizations. A duty roster in calendar form, as well as a financial summary of the amounts owed could then be printed out.

TAILOR'S CALCULATIONS

Alterations to dress and suit patterns can be mathematically determined by your C-128. If you have a dot matrix printer, the altered pattern could be printed.

PHONE CODE

A relatively simple program could be written to produce a listing of all of the possible letter combinations on the phone dial for a given phone number. Businesses may then use this listing to produce an appropriate, easy-to-remember word that represents their phone number. In fact, an interesting word may appear for you to use with your own telephone number.

BRAINSTORMER

A few years ago, a large sphere, containing thousands of plastic squares with a different word printed on each, was sold as a "brainstormer." The idea behind this device was to rotate the sphere, mix up the words, and then peek through a window at whatever words appeared. From this combination of adjectives and nouns, the user was supposed to come up with a new invention or idea. The "brainstormer" was said to be useful in stimulating ideas. For instance, if the words "television" and "game" appeared, a properly prepared mind could have made the intuitive leap to invent video games. Tracing this line from history, you could create your own computerized "brainstormer" by programming a large array of randomly-accessed nouns and adjectives to appear on the Commodore's monitor.

A similar program could be called an "idea stimulator." Instead of miscellaneous words randomly appearing, a special set of adjectives or phrases, describing possible improvements to an invention, would be displayed on the screen. The following list of brainstorming questions could be arranged by your C-128 and individually called to the screen.

Brainstormer programs needn't be limited to

products and inventions. One cartoonist reports the use of a computer program that randomly mixes clichés, locations, props, and various character types for possible cartoon ideas.

Brainstorm Chart for Products, Processes, and Services

- In what other way can it be made more effective?
- Is there a surer way to do it?
- Is there a cleaner way to do it?
- Is there a safer way to do it?
- Is there a more durable form?
- Is there an easier way to do it?
- In what other way can it be improved?
- Can the distribution be improved?
- Can it be made portable?
- Can something be added to enhance its value?
- Can it be adapted to some other use?
- Can it be made more attractive?
- Is there a cheaper way to do it?

Inventor's Idea Simulator

An inventor's idea stimulator program, which would be very useful to those who have a creative mind, could be written. A large listing of "idea words" would be shuffled and displayed three at a time. The object is to apply your thinking to these words in relation to another idea.

SOURCE INDEX

Addresses of manufacturers, institutions, or organizations, and other sources of information or products can be stored in computer form and indexed for future reference. Any source of information or materials that you don't have use for at present, but might need in the future, should be stored with this system. These sources can later be indexed under the material they can provide.

PEOPLE MATCHING

Computers have prepared seating charts for

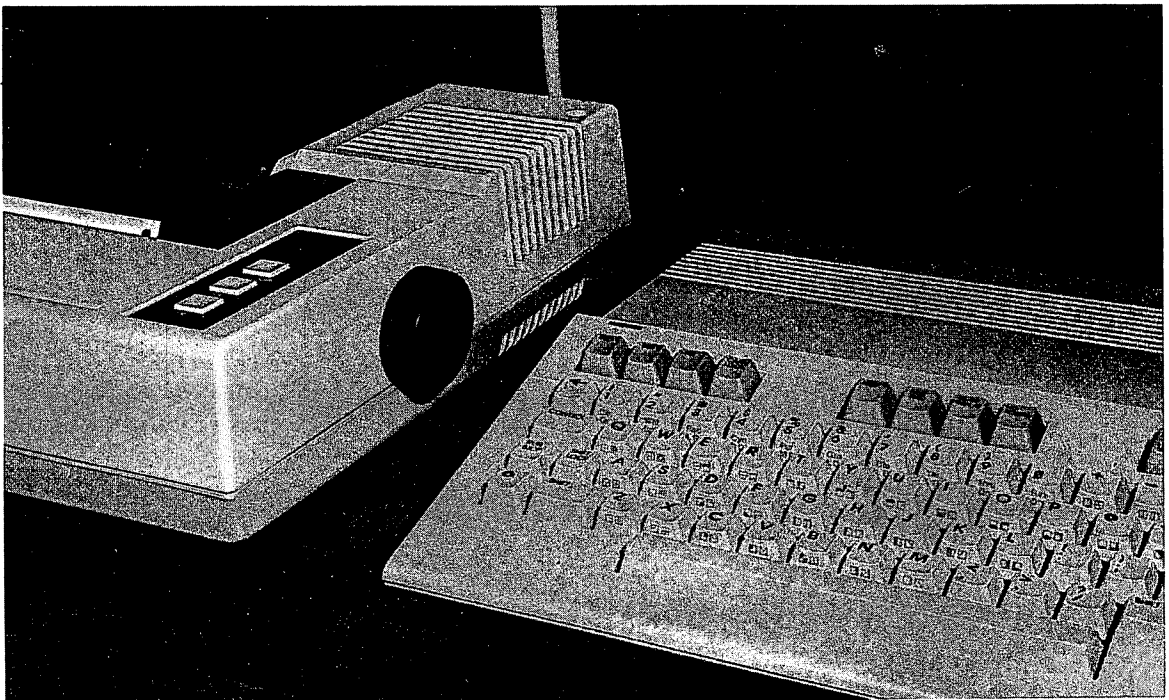

Fig. 11-1. The C-128 and an Epson FX-80 can be easily connected with a Card?/+ G parallel connector (see Appendix B).

1001 Things to Do With Your Commodore 128

dinners, arranged blind dates, matched carpools, and paired athletes according to individual characteristics. Digital cupid playing, however, is best taken tongue-in-cheek and relegated to an entertainment status.

GREETING CARD PRODUCER

Some clever hobbyists have written programs to produce assorted types of greeting cards, announcements, and invitations on their dot matrix printers (see Fig. 11-1). These cards can be personalized and incorporate computer art into their final composition. Another hobbyist uses her Commodore 128 to produce Christmas gift wrapping paper by printing designs of Christmas artifacts on colored tractor paper.

CONTESTS

For those who actively pursue sweepstakes, a C-128 can be used to fill out multiple contest entry forms with your name and address. This technique would only be applicable where an unlimited number of similar entries were legal.

HANDWRITING ANALYSIS

A few major corporations are now using handwriting analysis as one instrument for evaluating prospective employees. The humorous shopping mall handwriting analysis "computers" do little more than print out a random evaluation from a database of stock personality traits. You could write a program that would print out the standard interpretations for handwriting characteristics. Unfortunately, the characteristics would themselves have to be encoded for your Commodore to handle properly. Unless you have the time for a lengthy study of handwriting, this matter will have to be left to the handwriting experts.

FIFTY MISCELLANEOUS APPLICATIONS

In order to further exemplify the scope of applications that are available to Commodore users

in all walks of life, the following reader contributed list contains fifty of the more unusual computer-related activities:

- Design and animation of marching band patterns.
- Maintenance and inventory of equipment and instruments in small laboratories.
- Membership tracking for small organizations with the addition of dues accounting, questionnaire analysis, and mailing list capabilities.
- TV pattern generator for electronic technicians.
- Artistic pacifier for toddlers based on random graphical patterns, as a form of the stimulation necessary for the development of a normal IQ.
- Banner and sign generator to prominently display your message, created on ordinary lineprinters.
- Posters and calendars from lineprinter output.
- Translations of foreign words done by portable computers for travelers (or for educational purposes).
- Analysis of the cost-saving benefits of various solar collector designs.
- Calculation of home improvement costs by determining gallons of paint, rolls of wallpaper, or square yards of carpeting for a given job.
- Car maintenance reminder for routine tuneups and parts replacement according to miles driven.
- Car pool record keeping program which records car usage by driver, destination, and date with the ability to print schedules for each member.
- Bendo Kagawa, a Zen priest in Japan, uses his personal computer to help people meditate.
- Bob Waltz's personal computer at Smithers-Oasis can tell you all you ever wanted to know about germanium growing.
- Three Harvard professors writing a physiology text use their personal computers to exchange chapters by phone.
- Edward Adler arranged for his computer to rock his baby's cradle every time she cried.
- Architects can sketch new designs on personal computers that rival design systems formerly costing in the millions.

Miscellaneous Applications

- For training purposes, companies are now using personal computers to instruct employees in everything from advanced optics to photocopier repair.
- A psychologist is using his computer to teach people self-relaxation techniques and self-hypnosis.
- Earth, Wind, and Fire use a computer to set off flash pots and explode small bombs on stage during their pyrotechnic rock performances.
- A German firm is using a personal computer to create new sweater patterns.
- Daryl Faud's personal computer sifts through hundreds of bacterial strains to assist in recombinant DNA experiments.
- Dr. Terry Pundiak uses a voice interface with his computer to give antismoking lectures.
- Experimental systems that are being developed to read ordinary text to the blind are based on personal computers.
- Boy Scouts across the nation are using personal computers for help in earning the Computer merit badge.
- Dr. Michael Lamb has adapted his personal computer for anesthesia monitoring during surgery.
- Colossal Pictures Corporation used a personal computer to create the title sequences for *The Black Stallion* and *One From The Heart*.
- Psychologist John McPhee developed a program to analyze Rorschach Inkblot Tests on his personal computer.
- The Sports Car Club of America, San Francisco office uses a PC personal computer to track race results instantly.
- David Curtis turned his personal computer into a lie-detector and analysis machine.
- One hobbyist creates personalized Christmas letters by using a word processor, cutting the time required in half.
- A bar-code reader allows a hobbyist to rapidly input information concerning supermarket items purchased. A pantry inventory can easily be created.
- One thrifty personal computer owner devised a program to randomly match each person in his extended family for exchange of gifts.
- One family uses their system as a message board to store, word-process, and display messages to other family members.
- Traveling salesmen use their portable computers to maintain expense accounts.
- One hobbyist created a "drunkometer" program to evaluate residual cognitive function in those smashed by alcohol.
- A nighttime and vacation check-off program to remind the hobbyist that nights and vacations exist for a purpose and to ensure that all necessary duties have been taken care of could be a godsend to obsessive programmers.
- A citrus grower uses his personal computer to continuously monitor temperature and soil conditions to alert him of changes and automatically control heaters and sprinklers.
- An instrumentalist uses his personal computer to accompany him on the flute.
- A wrestling coach no longer tussles with the problem of pairing 500 boys by age and weight; he uses his personal computer.
- A personal computer owner about to marry created a database to map out chapel seating for 100 wedding guests and table arrangements for 220 lunch guests and to do tabulations on no-shows. He is also keeping a record of those who give gifts and what they send.
- A new minister was given information concerning the personal and familial problems of his flock stored in a database created by the retiring minister.
- Chicago Alderman Lawrence Bloom keeps a database of 6,000 voters on his computer. Precinct workers can make personalized calls and say "Alderman Bloom helped you get rid of that abandoned car. Now he needs your help."
- Carter Scholz used his personal computer to compute the lengths of a set of tuned wind chimes.
- The Osvoz family of New York use their personal

1001 Things to Do With Your Commodore 128

computer to maintain database of family medical information, including blood types, allergies, dates of checkups, poison antidotes, eyeglass prescriptions, insurance policies, checkup reminders, height, and weight.

- Professionally-prepared programs are available to plan a vacation trip for you, given the starting point and the destination; miles, costs, routes, and itinerary can be computed automatically.
- Dave Adams, a businessman, uses his personal computer with a modem to access on-line airline schedules and make reservations. The Source and CompuServe, among other networks, offer this service.
- Automotive expense records, including the following information, may be tracked using your personal computer: loan or lease payment records, accumulated gasoline costs, MPG average, maintenance and repair records, insurance records, depreciation, automotive tax deductibles, and accumulated cost per mile to operate.
- Bill Strozier uses his personal computer to operate a passive solar heating system in his home. The computer controls the opening and closing of movable partitions and shades and an air circulation system. Other personal computer owners have controlled active solar heating collectors, directed air or liquid to areas where it was needed, and analyzed the performance of the system.
- One hobbyist uses a program to organize his elaborate home workshop; he maintains a tool and equipment inventory and lists of parts and supplies, projects completed, and future projects (with tentative starting dates).
- Bird watcher Edward Mair uses a personal computer to store his lifetime, year, state, property, and feeder lists and for exchanging information with other birdwatchers across the nation via a network.
- Several executives, computer programmers, and writers can now do their work at home, rather than traveling to the office, thanks to personal computers linked with their company's computer via modems.

Appendix A

Commodore 128 Software Guide

Abacus Software

CHARTPAK
BASIC 128 Compiler
SUPER Pascal
SUPER C

Abacus Software offers this line of business and language software for the C-128.

P.O. Box 7211
Grand Rapids, MI 49510
(616) 241-5510

Activision Home Computer Software

GameMaker: The Computer Game Design Kit
Space Shuttle—A Journey Into Space
Activision produces a line of entertainment and game software, including GameMaker, a utility for designing C-128 games.

Batteries Included

PaperClip

PaperClip is a word processing program.

17875 Sky Park North, Suite P
Irvine, CA 92714
(416) 881-9816

Broderbund

Captain Goodnight
Karateka
Lode Runner
Sky Blazer

Broderbund is noted for its exciting and highly graphically appealing game software.

17 Paul Drive
San Rafael, CA 94903

Electronic Arts

Seven Cities of Gold
Heart of Africa

1001 Things to Do With Your Commodore 128

Electronic Arts is a manufacturer of many popular C-128 entertainment programs.

2755 Campus Dr.
San Mateo, CA 94403

EPYX Computer Software

Winter Games
Temple of Apshai Trilogy
Rescue On Fractalus!
Ballblazer

EPYX produces many pieces of entertainment software.

1043 Kiel Court
Sunnyvale, CA 94089

Hayden Software

Sargon II
Sargon III

Hayden publishes a variety of entertainment software packages for the C-128, including these two popular chess games.

Lionheart

Business Statistics
PERT & Critical Path Techniques
Sales & Marketing Forecasting

Lionheart markets a line of ten useful business and statistical software packages.

P.O. Box 379
Alburg, VT 05440
(514) 933-4918
(Note that this is a Quebec, Canada area code)

Mastertronic International, Inc.

Hero of the Golden Talisman
The Last V8

Mastertronic is unique among entertainment software manufacturers in its production of cheap game software (usually \$9.99 each).

7311B Grove Road
Frederick, MD 21701
(301) 695-8877

Oasis Software

BASIC Lightning
White Lightning
Machine Lightning

These graphic development systems aid software design by adding such features as sprite, sound, and screen commands and functions to Commodore BASIC.

377 Oyster Pt. Blvd., Unit 15
South San Francisco, CA 94080
(415) 588-1587

Professional Software, Inc.

Fleet System 2

This software is an inexpensive word processing program that also contains a 90,000 word spelling checker.

51 Fremont Street
Needham, MA 02194
(617) 444-5224

Solid State Software

Vizastar 128
Vizawrite Classic

These machine language programs offer an integrated spreadsheet, database, and graphics package (Vizastar 128), and a word processor (Vizawrite Classic) for the C-128.

1125 E. Hillsdale Blvd., Suite 104
Foster City, CA 94404
(415) 341-5606

subLOGIC Corporation

Flight Simulator II
Jet

These entertaining programs are the first and last word on flight simulation. Flight Simulator II is the classic flight simulator, while Jet advances your piloting skills into the jet age.

713 Edgebrook Drive
Champaign, IL 61820
(217) 359-8482

Appendix B

Commodore 128 Peripheral Guide

Cardco, Inc.

Card?/+G

A Centronics parallel printer interface that will print text and graphics on your Epson or compatible dot matrix printer.

300 S. Topeka
Wichita, KS 67202

Epson America, Inc.

FX-85+

A workhorse dot matrix printer for your C-128.

3415 Kashiwa Street
Torrance, CA 90505

MegaSoft Ltd.

Magnum Load, versions D

Magnum Load is a replacement ROM chip for the Commodore 128 that speeds up operation of Commodore's 1541 disk drive.

P.O. Box 1080
Battle Ground, WA 98604
(800) 541-1541

Okidata Corporation

Okimate 10 Printer
Plug 'N Print Interface for Commodore 128

This is an exceptional color, thermal transfer dot matrix printer with an interface that allows full color screen dumps from the C-128.

Mt. Laurel, NJ 08054

Star Micronics, Inc.

SG-10C

A completely Commodore compatible dot matrix printer.

1001 Things to Do With Your Commodore 128

#3 Oldfield
Irvine, CA 92714

Welwyn/Currah

VOICE MESSENGER

When accompanied by Welwyn/Currah's EASY SPEECH software, the VOICE MESSENGER gives the C-128 speech synthesis capabilities, including text-to-speech, for a low price.

104 West Fourth Street
Suite 208-9
Royal Oak, MI 48067

X-10 (USA)

X-10 Powerhouse
X-10 Modules

The X-10 Powerhouse and Modules combine to form a home control and security system that is integrated with the C-128.

185A Legrand Avenue
Northvale, NJ 07647
(800) 526-0027

Appendix C

Commodore 128

BASIC Command Summary

ABS	CONCAT	ENVELOPE	IF
AND	CONT	ER	INPUT
APPEND	COPY	ERR\$	INPUT#
ASC	COS	EXIT	INSTR
ATN	DATA	EXP	INT
AUTO	DCLEAR	FAST	JOY
BACKUP	DCLOSE	FETCH	KEY
BANK	DEC	FILTER	LEFT\$
BEGIN	DEF FN	FN	LEN
BEND	DELETE	FOR	LET
BLOAD	DIM	FRE	LIST
BOOT	DIRECTORY	GET	LOAD
BOX	DLOAD	GETKEY	LOCATE
BSAVE	DO	GET#	LOG
BUMP	DOPEN	GO64	LOOP
CHAR	DRAW	GOSUB	MID\$
CHR\$	DS\$	GOTO	MONITOR
CIRCLE	DSAVE	GO TO	MOVSPR
CLOSE	DS	GRAPHIC	NEW
CLR	DVERIFY	GSHAPE	NEXT
CMD	EL	HEADER	NOT
COLLECT	ELSE	HELP	OFF
COLOR	END	HEX\$	ON

Commodore 128 BASIC Command Summary

OPEN
OR
PAINT
PEN
PEEK
PLAY
POKE
POS
POT
PRINT
PRINT USING
PRINT#
PRINT# USING
PUDEF
QUIT
RCLR
RDOT
READ
RECORD

RENAME
RENUMBER
RESTORE
RESUME
RETURN
RGR
RIGHT\$
RND
RSPCOLOR
RSPPOS
RSPRITE
RUN
RWINDOW
SAVE
SCALE
SCNCLR
SCRATCH
SGN
SIN

SLEEP
SLOW
SOUND
SPC
SPRCOLOR
SPRDEF
SPRITE
SPRSAV
SQR
ST
STASH
STEP
STOP
STR\$
SWAP
SYS
TAB
TAN

TEMPO
THEN
TI
TI\$
TO
TRAP
TRON
TROFF
UNTIL
USR
VAL
VERIFY
VOL
WAIT
WHILE
WIDTH
WINDOW
XOR

Appendix D

A Brief Tour of the Commodore 128 Environment

The owner of a Commodore 128 actually possesses three powerful computers within one single chassis. That's right, the C-128 has a "split personality" that allows it to function as a popular Commodore 64 computer, as a unique Commodore 128 computer, and as a CP/M computer with access to the hundreds of universal software packages available for CP/M machines. Fortunately, instead of being a psychological handicap, the C-128's split personality offers its owners the best of all three computer worlds.

The Commodore 128 environment, therefore, consists of three modes of operation: the C64 mode (which emulates the Commodore 64 computer), the C128 mode (the computer's unique mode), and the CP/M mode (the popular operating environment of Z80 microprocessor-based computers, such as the Kaypro II and the Osborne). By examining these three modes, you can better understand the full use of your Commodore 128.

THE C64 MODE

Because the Commodore 64 has been one of the

all time best selling computers, Commodore 64 owners reap the reward of a vast assortment of software packages that have been created specifically for this machine. When the C-128 is made to run in C64 mode, C-128 users are also able to take advantage of this wide variety of Commodore 64 software.

Programmers who are familiar with the Commodore 64's built-in Commodore BASIC 2.0 programming language will find this same, familiar language available on their Commodore 128s when they are operated in C64 mode. All of the C-64's graphics, sprite animation, and sound commands remain the same. Similarly, the values for the Commodore 64 memory map locations that permit the necessary Commodore BASIC PEEKing and POKEing required by many of the graphics and sound commands are also present in C64 mode. Therefore, software written for the Commodore 64's BASIC 2.0 will run on the Commodore 128 operating in C64 mode. Commodore BASIC 2.0 is, in fact, a subset of the Commodore BASIC 7.0 language, which is present in the C128 mode.

1001 Things to Do With Your Commodore 128

The C64 mode is accessed by turning the Commodore 128 on while holding the Commodore key (the key with the Commodore symbol on it) or by entering the Commodore BASIC 7.0 command G064 from within C128 mode. Alternatively, the Commodore 128 will automatically enter the C64 mode if it senses that a Commodore 64 software cartridge is located in the cartridge slot when the computer's power is turned on.

THE C128 MODE

The C128 mode is the default mode for the Commodore 128 computer. This means that as soon as you turn on your Commodore 128, you have access to the advanced sound, sprite animation, and graphics commands that are inherent in the C128 mode's Commodore BASIC 7.0. The Commodore 128 does retain, however, all of the Commodore BASIC commands resident in the C64 mode's BASIC 2.0. Because Commodore has added enhanced features to Commodore BASIC 7.0, sound and graphics programming operations that required a battery of POKE statements when programmed in C64 mode require only the use of a single new command in C128 mode.

The only way to enter the C128 mode from the C64 mode is with a fresh start. If you have been working in the C64 mode, you must first turn off the computer before you can restart it in the default C128 mode (be sure to save any programs or data you have been working on, or they will be lost in the transition between modes). In order to enter the C128 mode from the CP/M mode, the CP/M disk must be removed from the attached disk drive and the computer's RESET button must be pressed.

THE CP/M MODE

Unlike the Commodore 128's other two modes, the CP/M mode does not offer a programming language. Instead, CP/M is an operating system. An operating system, such as CP/M, is a type of univer-

sal equalizer for computer software. CP/M simply provides a familiar environment under which a variety of programs, created for a variety of computer brands, can run. This environment includes commands for controlling disk operations such as copying files or printing a directory of all of the files on a disk.

The two common traits of all computers operating under the CP/M environment are the inclusion of a Z80 microprocessor in their design and the need for a software disk containing the CP/M operating system. The Commodore 128, with its on board Z80 microprocessor, also comes with the necessary CP/M Plus Version 3.0 (developed by Digital Research Incorporated) software disk.

In order to enter the CP/M mode, the disk drive must be turned on and the CP/M disk inserted into the drive before the computer is turned on. Once the computer is turned on, CP/M is loaded automatically.

When operating under the CP/M environment, the Commodore 128 can run programs created for other CP/M based computers such as the Kaypro II, Kaypro IV, Osborne, and Epson QX10. Programs and data can be transferred from one CP/M computer to another via a serial port connection. A better method of program and data transfer is available, however, to owners of Commodore's 1571 disk drive. Although each computer has its own unique method of formatting the data that is placed on its floppy disks, some CP/M computers, including the Commodore 128 in the CP/M mode, are able to read the formats of other computer's disks. When a CP/M disk formatted for the Kaypro II, for example, is placed into the 1571 disk drive, the Commodore 128 senses that a CP/M disk is present and asks you to verify that particular disk type. Thereafter, the 1571 drive is able to read the information on this Kaypro II disk.

Considering the large number of CP/M computer types available, the CP/M mode makes your Commodore 128's personalities outdo even the three basic modes discussed here.



Fig. D-1. The main Commodore 128 housing. Of special note, on the right, eight function keys are horizontally located above the 14-key keypad.

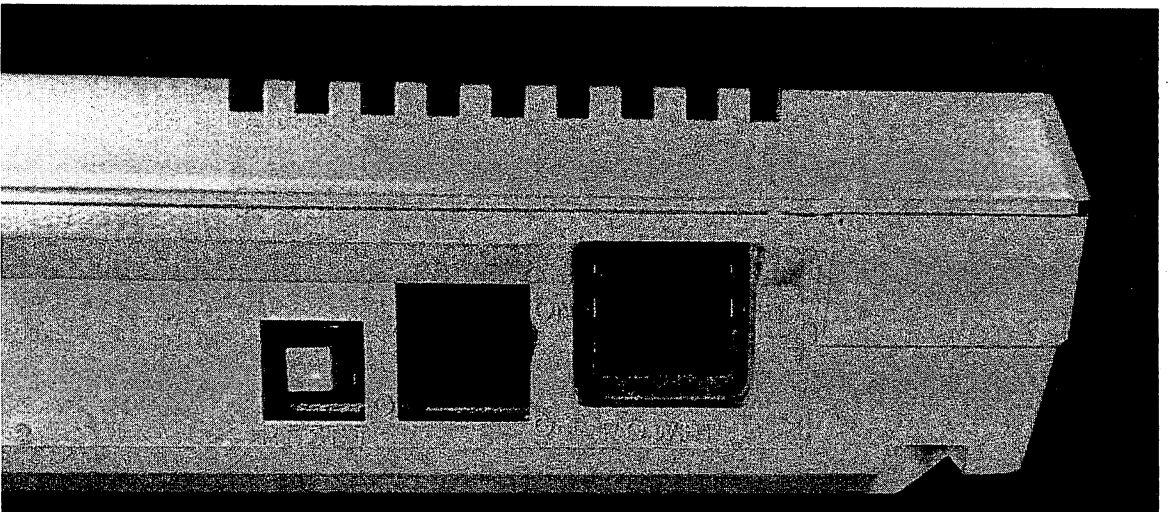

Fig. D-2. Starting on the right side panel, you can see the power connection socket, the on/off switch, and the reset button. The reset button is particularly handy for switching modes without turning the C-128 off and then on again.

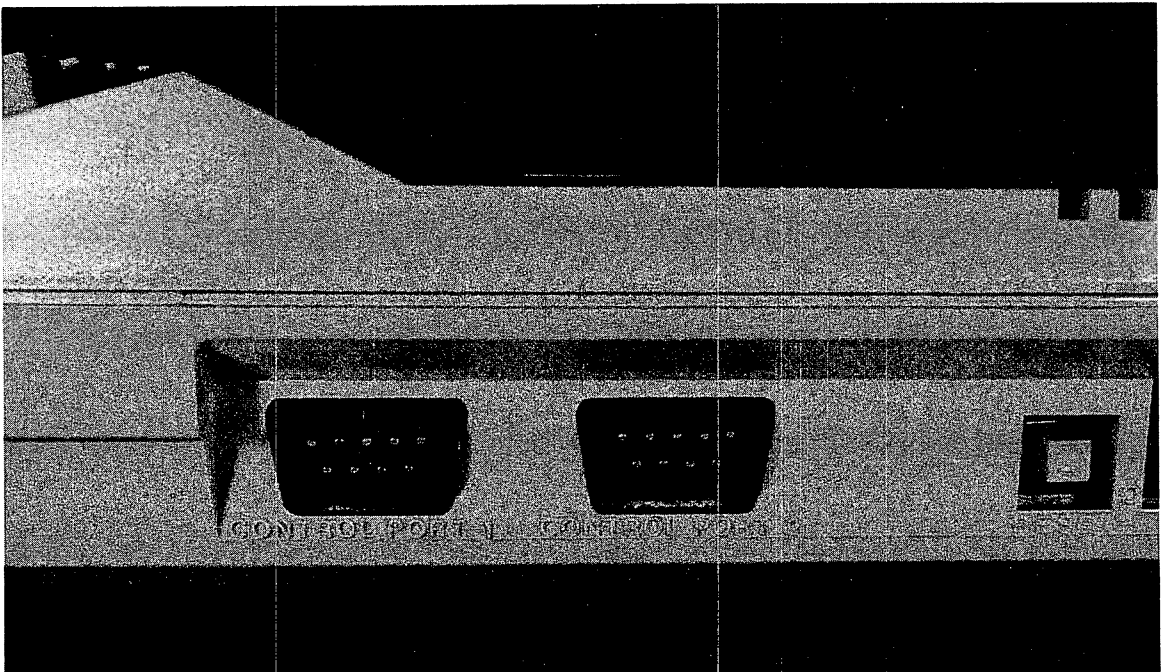

Fig. D-3. Also on the right side panel are two control ports. These ports are used for attaching joysticks, graphics tablets, and other peripheral devices.

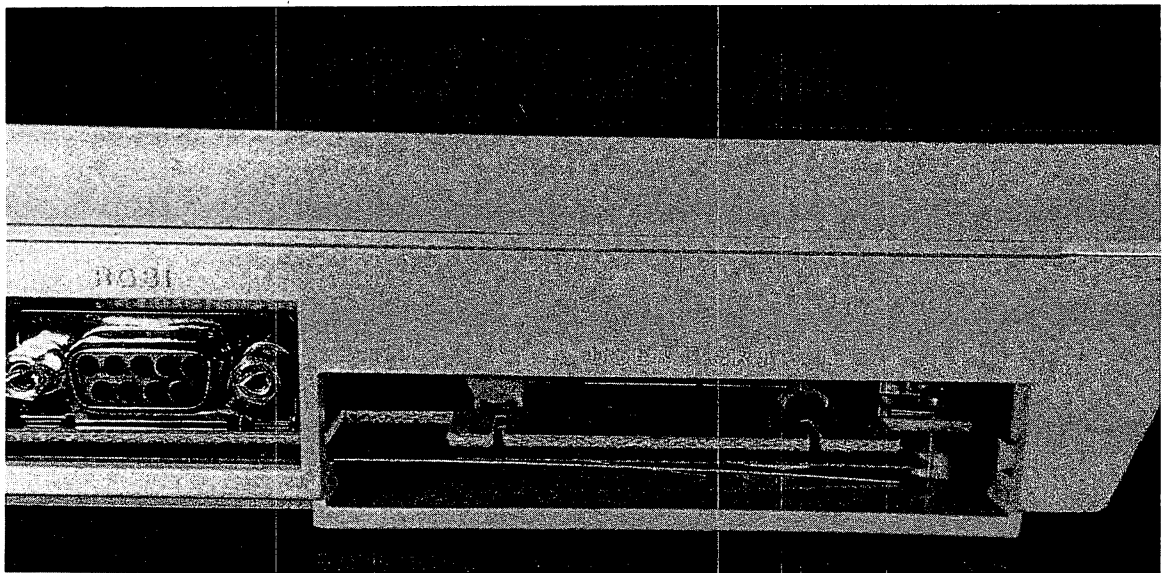

Fig. D-4. Starting on the far right side of the rear panel are the user port and the RGBI socket. The user port is for plugging in hardware devices like a modem, while the RGBI socket is the connection point for an 80-column red-green-blue (RGB) monitor.

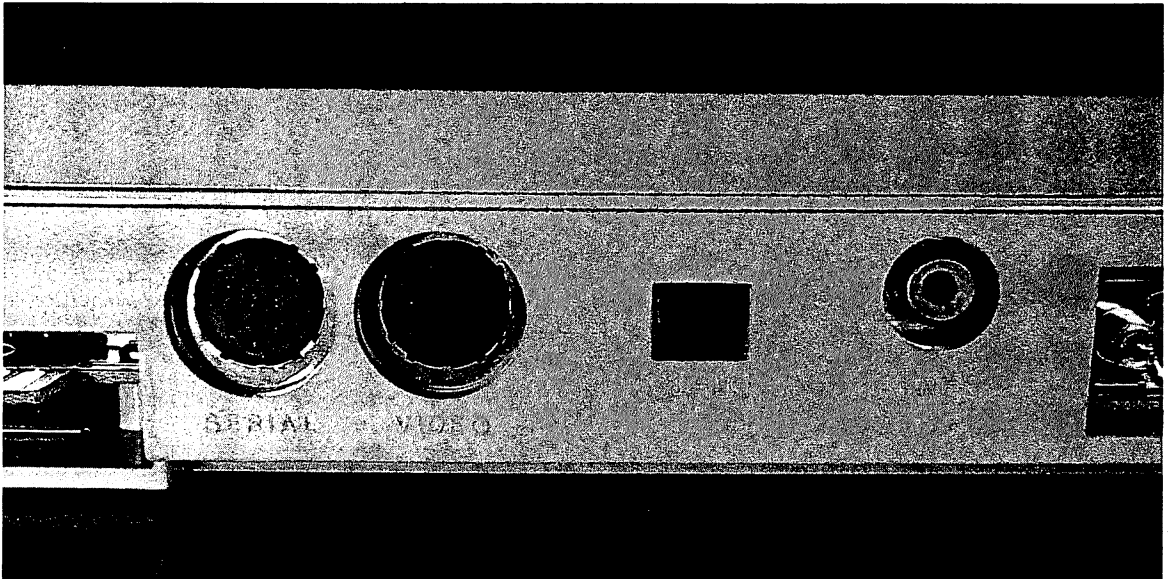

Fig. D-5. Continuing along the rear panel are the RF socket, channel selector switch, video socket, and serial socket. The RF socket is for the direct connection of an ordinary television set to the C-128. Once this TV set is attached, the channel selector switch chooses whether channel 3 or 4 will receive the computer's signal. Alternatively, a 40-column composite monitor can be plugged into the video socket. Even though the serial socket is a sister look-alike of the video socket, only printers and disk drives (e.g., the 1541 and 1571) can be joined through this serial socket.

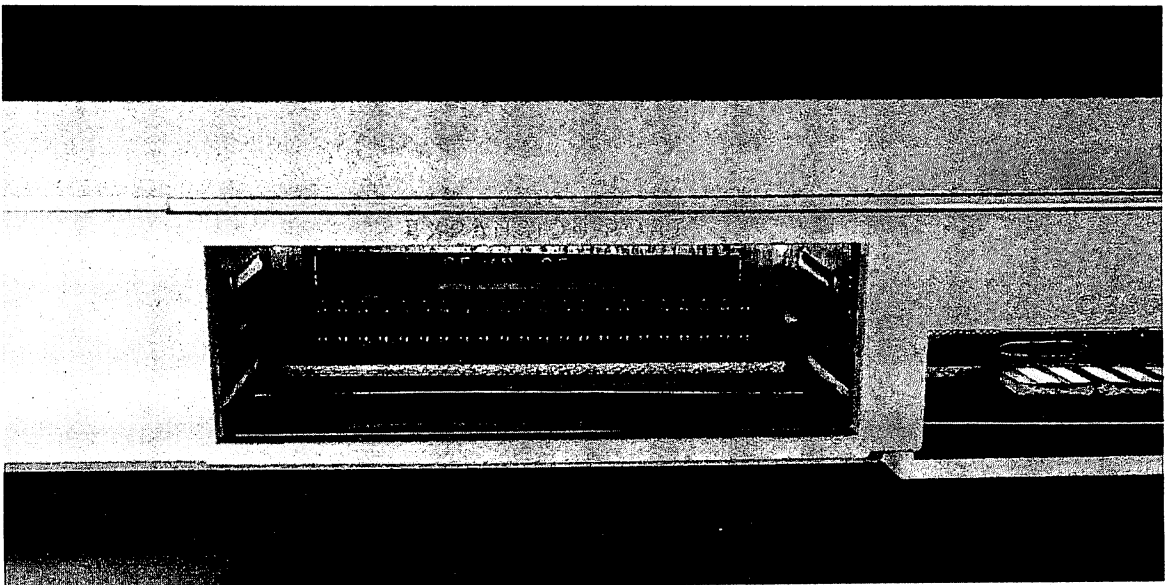

Fig. D-6. Finally, the cassette port and the expansion port round out the rear panel. Only cassette tape recorders can be connected on the cassette port. The more versatile expansion port, however, accepts software cartridges.

1001 Things to Do With Your Commodore 128

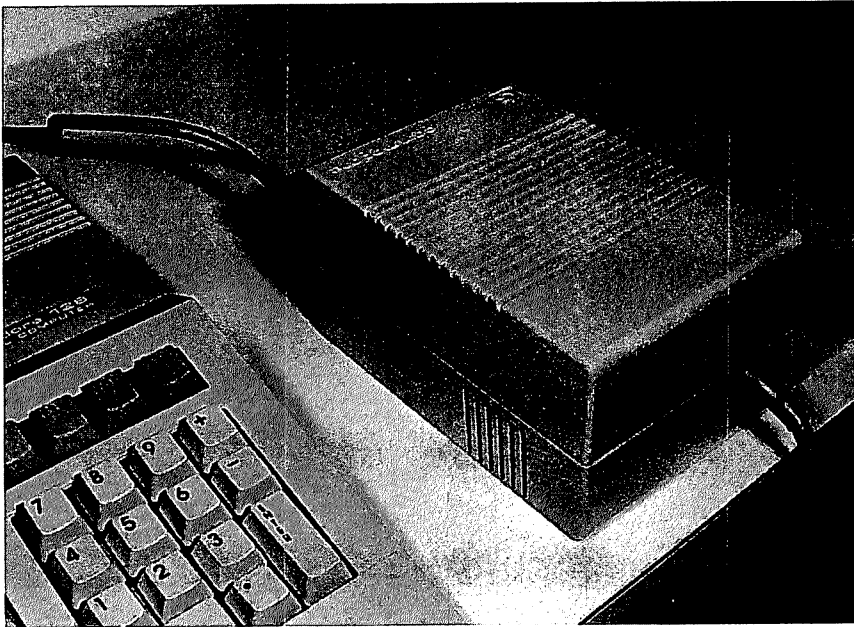
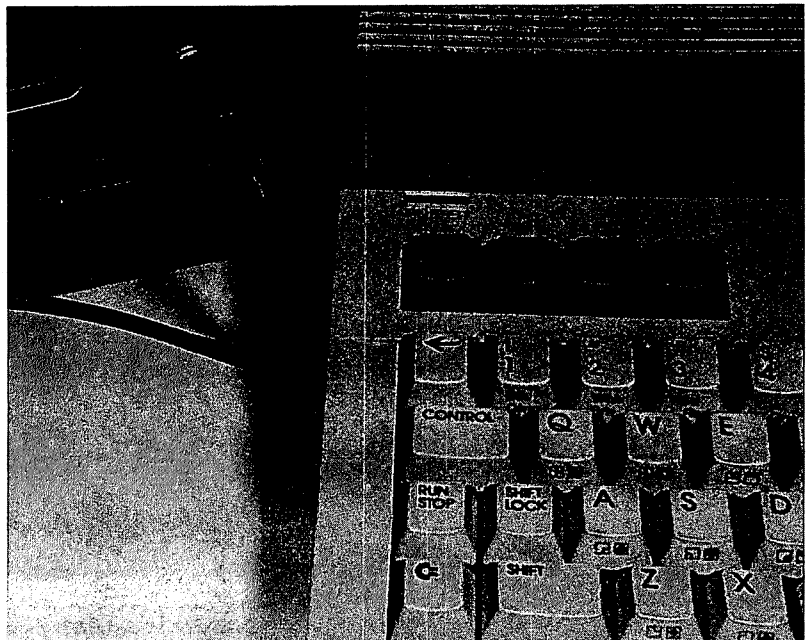

Fig. D-7. The "brick." An external power supply plugs into the right side panel of the Commodore 128.

Fig. D-8. This C-128 is hooked up to a TV as its monitor.



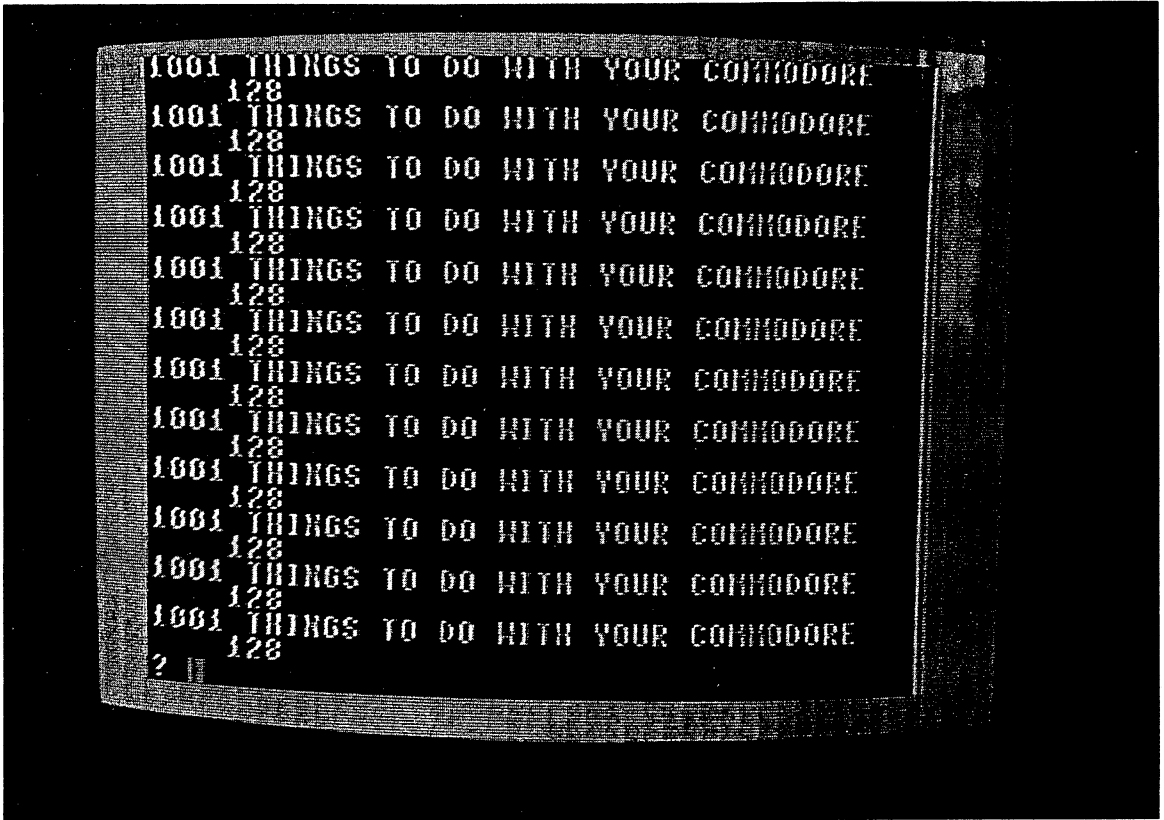

Fig. D-9. Using a TV as a monitor is ideal for 40-column usage. In fact, throughout this book only 40-column programs are provided.

Appendix E

C64 Mode Summary

Within the C64 mode, disk commands are performed in the following manner.

Loading a program from a disk into the computer's memory:

```
LOAD "name",8
```

Formatting a disk so that it can receive programs and data:

```
OPEN 15,8,15:PRINT# 15,"N0:name,ab"
```

then,

```
CLOSE 15
```

Saving a program onto a formatted disk:

```
SAVE "name",8
```

Verifying that a program has been correctly saved onto a disk:

```
VERIFY "name",8
```

Obtaining a directory of the programs on the disk currently in the disk drive:

```
LOAD "$",8
```

then,

```
LIST
```

Initializing the disk drive after a disk error has occurred:

```
OPEN 15,8,15,"T":CLOSE 15
```

Appendix F

C128 Mode Summary

Within the C128 mode, disk commands are performed in the following manner:

Loading a program from a disk into the computer's memory:

DLOAD "name"

Formatting a disk so that it can receive programs and data:

HEADER "name", I (two character I.D.),D(0 or 1),U8

Saving a program onto a formatted disk:

DSAVE "name"

Verifying that a program has been correctly saved onto a disk:

DVERIFY "name"

Obtaining a directory of the programs on the disk currently in the disk drive:

DIRECTORY

Initializing the disk drive after a disk error has occurred:

OPEN 15,8,15,"I":CLOSE 15

Appendix G

CP/M Mode Summary

Within the CP/M mode, disk commands are performed in the following manner.

Selecting a file:

at the A> prompt, type:

filename

Formatting a disk so that it can receive programs and data:

at the A> prompt, type:

FORMAT

follow the on-screen instructions and then, at the A> prompt, type:

PIP E:=A: CPM + .SYS

then, at the A> prompt, type:

PIP E:=A: CCP.COM

Saving a program in the computer's memory onto a formatted disk:

SAVE

Obtaining a directory of the programs on the disk currently in the disk drive:

at the A> prompt, type:

DIR

Appendix H

For Further Reading . . .

Addison-Wesley Publishing Company, Inc.
Reading, MA 01867

-a discussion of applications software for the
Commodore 64

Dwyer, T. and M. Critchfield, *CP/M and the Personal Computer*

-a general tutorial on the CP/M operating system

COMPUTE! Books

P.O. Box 5058

Greensboro, NC 27403

Foster, D., *The Addison-Wesley Book of Commodore Software 1985*

-a comprehensive guidebook to popular software for the Commodore computers

Knott, J. and D. Prochnow, *Commodore Peripherals: A User's Guide*

-a thorough guide to choosing and connecting peripherals for your Commodore computer

Knott, J. and D. Prochnow, *Epson, Epson, Read All About It!*

-demonstrates the connection of Epson dot matrix printers with a variety of computers

Osborne/McGraw-Hill

2600 Tenth Street

Berkeley, CA 94710

Lyons, L., *The Commodore 64 Connection*

-the use of Commodore's modem hardware for telecommunications is discussed

Erickson, J., *C-64 Telecommunications*

-an introduction to telecommunications along with hardware and software descriptions

Lyons, L., J. Campbell, and H. Moore, *Using the Commodore 64*

Heilborn, J. and R. Talbott, *Your Commodore 64: A Guide to the Commodore 64 Computer*

1001 Things to Do With Your Commodore 128

-a user's guide to the Commodore 64's hardware and software

Hogan, T., *The Osborne/McGraw-Hill CP/M User Guide (3rd Edition)*

-an instructional guide to using CP/M commands and utilities

Jeffries, R., G. Fisher, and B. Sawyer, *Commodore 64 Fun & Games*

-provides program listings for several Commodore 64 games featuring sound and graphics

Johnson-Laird, A., *The Programmer's CP/M Handbook*

-a tutorial of CP/M functions, along with examples and explanations

Leventhal, L., *6502 Assembly Language Programming*

-includes examples of assembly language programming for the 6502 (Commodore's) microprocessor

Leventhal, L. and W. Saville, *6502 Assembly Language Subroutines*

-a programmer's book of subroutines for the Commodore's main microprocessor

Shaffer & Shaffer, Applied Research and Development, Inc., *Special Effects Library*

-this book/software disk combination demonstrates BASIC programming of animation, sound, and graphics for special effects

Skier, K., *Top-Down Assembly Language Programming for Your VIC 20 and Commodore 64*

-a tutorial of assembly language programming

Scott, Foresman and Company

1900 East Lake Avenue

Glenview, IL 60025

Daley, R. and S. Daley, *The Commodore 64 Family*

Helper: Super Software for Home Management

-includes home management programs, such as a word processor

Knott, J. and D. Prochnow, *Commodore 64 Tutor for Home and School*

-a comprehensive tutorial for learning the Logo, PILOT, and BASIC programming languages

Lane, J., *Programming Commodore Graphics with your 64 or 128*

-a tutorial on graphics programming, including the creation of sprites and bit mapped graphics

Wood, R., *Connections: Telecommunicating on a Budget*

-offers advice for low cost telecommunications

TAB Books, Inc.

P.O. Box 40

Blue Ridge Summit, PA 17214

Bress, S., *Commodore 64 Assembly Language Arcade Game Programming*

-teaches assembly language programming techniques necessary for writing arcade type games

Haas, L., *Going On-Line With Your Micro*

-an overview of the hardware and software required for telecommunications, as well as the use of bulletin board systems

Prochnow, D., *Chip Talk: A Handbook to Speech Synthesis*

-includes hardware projects for the Commodore 128 that give your computer a voice

Prochnow, D., *101 Projects, Plans and Ideas for the High-Tech Household*

-shows how to use a computer for designing your home's high-tech environment

Krute, S., *Advanced Commodore 128 Graphics and Sound Programming*

For Further Reading

-provides in-depth explanations and demonstrations of the Commodore 128's three modes of operation

Krute, S., *Commodore 64/128 Graphics and Sound Programming—2nd Edition*

-includes BASIC programming examples for performing advanced sound and graphics routines

Luetzow, R., *Practical Interfacing Projects with the Commodore Computers*

-includes projects for interfacing the Commodore to external inputs

Myers, L. *How to Create Your Own Computer Bulletin Board*

-provides instructions for forming your own computer bulletin board

Nickell, D., *Forecasting On Your Microcomputer*

-provides forecasting techniques and subroutines that you can use with your computer

Phillips, G., *Commodore 64 Expansion Guide*

-provides reviews and interfacing advice for various peripherals, such as printers and modems

Schwenk, G., and N. Schwenk, *Commodore 64 Advanced Game Design*

-a tutorial of game design techniques, using three, complete Commodore 64 games as examples

Simpson, H., *Serious Programming for the Commodore 64*

-suggests programming routines for performing practical applications

Smith, M., *6502 Machine and Assembly Language Programming*

-a tutorial for BASIC programmers to learn machine and assembly language programming

Glossary

address—The location in memory where a given binary bit or word of information is stored.

alphanumeric—The set of alphabetic, numeric, and punctuation characters used for computer input.

analog/digital (A/D) conversion—A device that measures incoming voltages and outputs a corresponding digital number for each voltage.

ASCII—American Standard Code for Information Interchange.

assembly language—A low level symbolic programming language that comes close to programming a computer in its internal machine language.

binary—The base two number system, in which 1 and 0 represent the on and off states of a circuit.

bit—One binary digit.

byte—A group of eight bits.

chip—An integrated circuit.

compiler—A program that converts all the state-

ments in a program in a high-level language into machine codes at one time for fast execution.

CPU—Central Processing Unit; the major operations center of the computer where decisions and calculations are made.

data—Information that the computer operates on.

data rate—The amount of data transmitted through a communications line per unit of time.

debug—To remove program errors, or bugs, from a program.

digital—A circuit that has only two states, on and off, which are usually represented by the binary number system.

disk—The magnetic media on which computer programs and data are stored.

DOS—Disk operating system; a control system that allows the use of general commands to manipulate the data stored on a disk.

firmware—Software instructions permanently stored within a computer using a read only memory (ROM) device.

floppy disk—See disk.

1001 Things to Do With Your Commodore 128

flowchart—A diagram of the various steps to be taken by a computer in running a program.

hardware—The computer and its associated peripherals, as opposed to the software programs that the computer runs.

hexadecimal—A base sixteen number system often used in programming in assembly language.

input—To send data into a computer.

input/output (I/O) devices—Peripheral hardware devices that exchange information with a computer.

interface—A device that converts electronic signals to enable communications between two

devices; also called a port.

interpreter—A program that accepts one statement of a high level language at a time, converts that statement into its machine language equivalent, and then proceeds to the next statement. As implemented on your C-128, Commodore BASIC is a high-level language that is interpreted rather than compiled (see Figure I-1).

keyboard—A series of switches, usually in the form of a typewriter keyboard, that the computer operator uses to communicate with the computer itself.

languages—The set of words and commands that

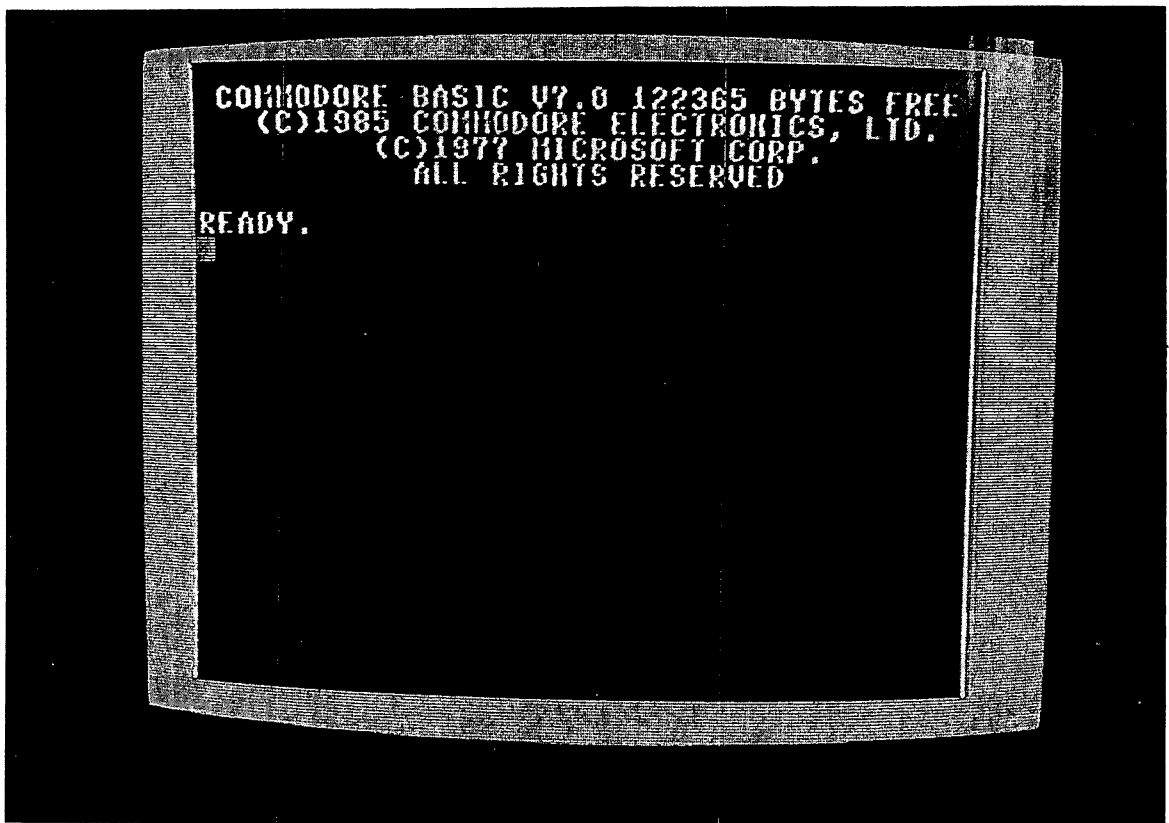

Fig. I-1. The opening screen in C-128 mode operation. The installed Commodore BASIC version 7.0 interpreter language is now ready for use.

- are understood by the computer and used in writing a program.
- loop**—A programming technique that allows a portion of a program to be repeated several times.
- machine language**—The internal, low level language of the computer.
- memory**—An area within a computer reserved for storing data and programs that the computer can operate on.
- microcomputer**—A small computer, such as the Commodore 128, that contains all of the circuitry it needs to operate on a few internal integrated circuits.
- mnemonic**—An abbreviation or word that represents another word or phrase but is easier to remember.
- modem**—A peripheral device that converts digital signals to audio signals, and vice versa; used for telecommunications.
- octal**—A base eight number system often used in machine language programming.
- opcode**—An operation code signifying a particular task to be performed by the computer.
- parallel port**—A data communications channel that sends data out along several wires, so that entire bytes can be transmitted simultaneously, rather than one bit at a time.
- peripheral**—An external device that communicates with a computer, such as a printer, a modem, or a disk drive.
- program**—A set of instructions for the computer to perform.
- RAM**—Random Access Memory; integrated circuits within the computer where data and programs can be stored and recalled. Data stored within RAM is lost when the computer's power is turned off.
- ROM**—Read Only Memory; integrated circuits that permanently store data or programs. The information contained on a ROM chip cannot be changed and is not lost when the computer's power is turned off.
- RS-232C**—A standard form for serial computer interfaces.
- serial communications**—A method of data communication in which bits of information are sent consecutively through one wire.
- software**—A set of programmed instructions that the computer must execute.
- statement**—A single computer instruction.
- subroutine**—A small program or routine contained within a larger program.
- terminal**—An input/output device that uses a keyboard and a video display.
- word**—A basic unit of computer memory usually expressed in terms of bytes.

Index

A

A/D converter, 137
A/D converters, 100
account
 savings, 39
accounting
 business, 46
 personal, 37
accounts payable, 37
accounts receivable, 37
acoustics of a room, 97
activity ratios, 25
adventure games, 117, 124
alarm system, 133
alpha
 stock, 29
amateur radio, 112
amoeba colony
 growth of, 96
amplifier, 79
analysis
 financial ratio, 25
 fundamental, 20
 ladder network, 78
 statistical, 62
 technical, 20
 trend line, 22
anamorphic art, 100
AND, 80
Anglo/metric conversions, 14
animated films, 112
annuities, 35
answering machine, 7
antenna design, 80
applications miscellaneous, 159
appointment calendar, 6
aquarium maintenance, 114
art
 anamorphic, 100
artificial intelligence, 144
artistic patterns, 72
arts, 99
 musical, 103
 verbal, 102
assets, 47
assistant
 itinerary, 6
astronomy, 113
Astronomy Quiz program, 95

attenuators, 78
average collection period ratio, 27
averages
 moving, 21

B

balance, 98
ballistics, 98
banking
 home, 41
bases, 98
BASIC commands, 169
battles games, 118
Beta
 portfolio, 31
 stock, 29, 31
billing
 time, 6
biofeedback, 134
biorhythms, 114
birthdays, 71
Black Sheep game, 119
board games, 118
bonds, 19, 36
book value per share ratio, 27
books on stock analysis, 21
Boolean functions, 80
bowling league bookkeeping, 42
brain stormer, 158
break in the chain game, 123
breakeven analysis, 45
Breakeven calculation program, 45
Bridge-It game, 119
brokerage commissions, 29
budget
 personal, 38
business accounting systems, 46
business calculations, 46, 50
business decision making, 44
business extensions, 144
business letters, 50
business software, 42
button
 reset, 173

C

C128 mode, 172, 181
C64 mode, 171, 179
CAI, 91
CAI Tutor program, 94

calculations
 business, 46
 depreciation, 35
 interest, 33
 medical, 77
 rating, 11
 surveying, 77
calculator, 5, 57
 RPN, 59
calculus
 computer, 67
calendar
 appointment, 6
 car maintenance, 15
 car record keeping, 15
card games, 118
card list, 7
carpenters' helper, 14
cash velocity ratio, 27
change
 rate of, 21
change distribution, 21
chemical engineering, 89
chemistry, 77
chess, 128
children
 young, 123
circuit
 analysis, 87
circuits, 78
civil engineering, 89
climate control, 133
clock, 13
co-op scheduling, 158
code
 Morse, 112
coil properties, 78
collection service, 42
collections, 112
combined coverage ratio, 27
commands
 BASIC, 169
 disk, 179, 181, 183
commissions
 brokerage, 29
companies
 peripheral, 167
 software, 163
compilation of dictionaries, 155

composition
 music, 104
 Compuserve, 146
 computation
 energy efficiency, 75
 computer and professions, 51
 computer dating service, 42
 computer networks, 144
 computer quizzes, 122
 computer recreations, 127
 computer-aided instruction, 91
 computers and chess, 128
 concrete block estimator, 15
 connectors, 173
 contests, 159
 contract preparation, 50
 control, 133
 inventory, 46
 control devices, 135
 conversion
 frequency, 79
 conversions
 Anglo/metric, 14
 converter
 A/D, 137
 converters
 AD, 100
 corresponding values, 67
 crossword poetry, 101
 coupon file, 12
 CP/M mode, 172, 183
 Cross Capture game, 120
 current ratio, 26
 current liabilities to net ratio, 26
 current ratio, 26
 customer file management, 49

D

D/A converter, 139
 database searching, 24
 database use, 15
 databases, 149
 financial, 33
 day of week calculation, 12
 debt to equity ratio, 27
 debt to total assets ratio, 26
 debt to working capital ratio, 26
 decibel conversion, 80
 decision maker, 7
 Decision Maker program, 8
 decision making
 business, 44
 dedicated systems, 135
 depreciation calculations, 35
 Depreciation Rate Calculation program, 36
 design
 house, 13
 designs, 99
 design, 79
 Desktop Calculator program, 57
 device controller, 137

dialer
 telephone, 7
 dictionaries, 155
 diet planning, 8
 direct reduction loan, 34
 disk commands
 C128 mode, 181
 C64 mode, 179
 CP/M mode, 183
 random access, 3
 distribution
 change, 21
 dividend payout ratio, 27
 drawing
 perspective, 102

E

e, 68
 earnings per share estimation, 29
 Easter, 71
 editing, 41
 education, 91
 music, 103
 educational programs, 43
 educational simulations, 96
 educational programs, 144
 efficiency
 energy, 75
 electrical engineering, 78
 employment agency, 42
 energy efficiency computation, 75
 engineering, 78
 civil, 89
 equation of a line, 66
 equity, 48
 estate
 real, 43
 Euclid game, 69
 Exacto, 69
 expenses, 47
 experimental applications, 78
 external device controller, 137
 extrasensory perception, 114

F

fantasy games, 117
 fields, 3
 file
 coupon, 12
 telephone, 7
 File Handling routines, 154
 films
 animated, 112
 filter design, 78
 finances, 19
 financial databases, 33
 financial ratio analysis, 25
 financing requirements, 45
 finder fees, 42
 fishing, 114
 fixed assets to net worth ratio, 26
 fixed assets turnover ratio, 27

food shopping aid, 12
 forecasting weather, 73
 form letters, 4
 Formatted Output routine, 154
 Fourier series, 79
 fractions, 98
 frequency conversion, 79
 function keys, 173
 fundamental analysis, 20
 further reading, 185
 Future Shock, 143
 futuristic applications, 143

G

gambling, 42
 gambling games, 118
 Game Board routine, 130
 games, 117
 mathematical, 68
 video, 125
 games for children, 123
 gardening, 113
 gas volume, 98
 genealogical store house, 114
 general accounting, 49
 grammar, 156
 greeting card list, 7
 greeting card producer, 159
 gross operating margin ratio, 27
 guide
 peripheral, 167
 software, 163

H

handicapped
 aid to, 157
 handwriting analysis, 159
 Happy Organ program, 105
 health, 7
 helper
 carpenters', 14
 mechanics', 14
 HEROjr, 140
 Hex game, 119
 Hexpawn game, 121
 high-degree equations, 68
 history, 155
 hobbies, 109
 hobby applications, 99
 home banking, 41
 home control systems, 136
 home planning, 13
 home swap service, 42
 house design, 13
 household control devices, 135
 humanities
 computer and, 155

I

impedance, 79
 income tax, 39
 index

- recipe, 5
- index generator, 156
- index to library, 3
- index to literature, 12
- indexes
 - price, 22
- indexing, 41
- inductance bridge calculations, 80
- inflation rate, 31
- information
 - private, 13
- information networks, 151
- information on stock analysis, 21
- information research, 143
- insolvency
 - short term, 29
- integral evaluation, 66
- intelligent devices, 144
- interest calculations, 33
- interest rate, 31
- interfaces, 133
- intrinsic value of a stock, 28
- inventors idea simulator, 158
- inventory, 50
 - collection, 112
 - kitchen, 10
- inventory control, 46
- inventory of possessions, 11
- inventory to working capital ratio, 26
- inventory turnover ratio, 27
- investments, 19
- investments for withdrawals, 34
- invitation list, 7
- itinerary assistant, 6

K

- kaleidoscope, 99
- keyboard, 173
- keys
 - function, 173
- keywords
 - BASIC, 169
- kitchen inventory, 10

L

- language, 155
- laws of physics, 97
- letter writing, 4
- leverage ratios, 25
- liabilities, 48
- library index, 3
- Life, 71
- line
 - equation of, 66
- liquidity ratios, 25
- lists
 - mailing, 4
- literature, 156
 - analysis of, 156
 - index to, 12
- loan formulas, 34
- loan with points, 34

- local networks, 149
- logic circuit analysis, 87
- logical reasoning, 98
- loops
 - phase-locked, 79

M

- machine
 - answering, 7
- machine design, 89
- magic, 123
- magic squares game, 68
- mailing list, 49
- mailing lists, 4, 41
- maintenance
 - car, 15
- maker
 - decision, 7
- making money, 41
- management
 - portfolio, 20
- management system
 - time, 7
- Manhattan Indian problem, 96
- marine navigation, 76
- math flash cars, 98
- mathematical calculations, 67
- mathematical games, 68
- mathematical puzzles, 67
- mathematics, 62
- Matrix Arrays routine, 154
- maze games, 68
- mechanics' helper, 14
- medical calculations, 77
- medical monitoring, 143
- mathematical functions, 99
- metric, 98
- mode
 - C128, 172, 181
 - C64, 171, 179
 - CP/M, 172, 183
- model building, 114
- model railroading, 114
- modems, 145
- money making applications, 41
- monitoring, 133
- Morse code, 112
- mortgages, 34
- moving averages, 21
- multiple linear regression, 23
- multiplication drill, 98
- multipurpose programs, 153
- music, 136
- music composition, 104
- music education, 103
- musical arts, 103

N

- narrator
 - collection, 113
- navigation
 - marine, 76

- net income margins ratio, 27
- net operating margin ratio, 27
- networking, 145
- networks
 - available, 145
 - informations, 151
- networks
 - local, 149
- Neutron game, 121
- new service, 144
- newspaper clipping service, 42
- Nim game, 121
- Nim variations, 121
- NOT, 80
- notes
 - random selection of, 105
- nutritional analysis, 8

O

- oddities
 - mathematical, 68
- OE, 80
- Ohm's law, 80
- Ohm's Law Calculation program, 81
- options valuation program, 29
- order processing, 49
- organization records, 158
- outline utility, 156

P

- paintings
 - computer, 102
- party games, 118
- Paschal full moon, 71
- Pattern Generator program, 100
- patterns
 - artistic, 72
 - textile, 101
- payroll, 49
- people matching, 158
- perception
 - extrasensory, 114
- peripheral guide, 167
- personal accounting, 37
- personal reference source, 1
- personal robots, 140
- personalized books, 43
- phone code, 158
- photography, 109
- physics, 77
 - laws of, 97
- pi, 68
- planning
 - tax, 40
- planning a home, 13
- poetry
 - crossword, 101
- points
 - loan with, 34
- poker, 71
- Polyphonic Synthesizer program, 108

- portfolio Beta, 31
 - portfolio management, 20
 - ports, 174
 - possessions
 - inventory of, 11
 - posters
 - computer, 102
 - price indexes, 22
 - price trace, 21
 - private information, 13
 - probabilities, 71
 - probability, 67
 - problem
 - Manhattan Indian, 96
 - processing
 - word, 3
 - professional practice management, 50
 - professions
 - computer and, 51
 - program
 - Astronomy Quiz, 95
 - Breakeven Calculation, 45
 - CAI Tutor, 94
 - Decision Maker, 8
 - Depreciation Rate Calculation, 36
 - Desktop Calculator, 57
 - Game Board, 130
 - Happy Organ, 105
 - Ohm's Law calculation, 81
 - Pattern Generator, 100
 - Polyphonic Synthesizer, 108
 - Pulse Rate Calculator, 10
 - Recipe Calculator, 5
 - Resistor Color Coder, 83
 - Short Term Insolvency Calculation, 30
 - Sim Game, 69
 - Stock Value Calculation, 28
 - Tick Tock, 14
 - Timer Routine, 6
 - Trigonometric Calculator, 64
 - Trigonometric Plotter, 65
 - Verti-Bird, 126
 - programming challenges, 67
 - programming games, 117
 - programs
 - utility, 153
 - pulse rate, 9
 - Pulse Rate Calculator program, 10
 - puzzles
 - mathematical, 67
- Q**
- quick ratio, 26
 - quizzes
 - creating, 93
- R**
- radio
 - amateur, 112
 - raffle tickets, 15
 - railroading
 - model, 114
 - random access disk commands, 3
 - random patterns, 99
 - random selection of notes, 105
 - rate
 - interest, 31
 - pulse, 9
 - rate of change, 21
 - rating calculations, 11
 - ratio
 - average collection period, 27
 - book value per share, 27
 - cash velocity, 27
 - current liabilities to net worth, 26
 - debt to equity, 27
 - debt to total assets, 26
 - debt to working capital, 26
 - dividend payout, 27
 - fixed assets to net worth, 26
 - fixed assets turnover, 27
 - gross operating margins, 27
 - inventory to working capital, 26
 - inventory turnover, 27
 - net operating margin, 27
 - quick, 26
 - return on net worth, 27
 - return on assets, 27
 - times interest earned, 26
 - total assets turnover, 27
 - ratio
 - net income margins, 27
 - ratio current, 26
 - ration
 - combined coverage, 27
 - ration relationships, 22
 - ratios
 - activity, 25
 - financial, 25
 - leverage, 25
 - liquidity, 25
 - profitability, 25
 - profitability, 25
 - reading
 - further, 185
 - real estate, 43
 - Recipe Calculator Routine, 5
 - recipe index, 5
 - record keeping
 - car, 15
 - recreational vehicles, 114
 - recreations
 - computer, 127
 - mathematical, 67
 - rectifier circuits, 79
 - reference
 - personal, 1
 - reference tables, 51
 - regression line, 23
 - relationships
 - ratio, 22
 - rental locator service, 42
 - reserved words
 - BASIC, 169
 - reset button, 173
 - Resistor Color Coder program, 83
 - resistor color codes, 80
 - resonance calculations, 80
 - resumes, 41
 - return on net worth ratio, 27
 - return on assets ratio, 27
 - revenues, 48
 - RGBI socket, 174
 - rhymes, 98
 - riddles, 98
 - robots
 - personal, 140
 - roots, 98
 - RPN calculator, 59
- S**
- sales, 49
 - sales device, 50
 - savings account, 39
 - scheduling
 - coop, 158
 - Screen Pokes routine, 154
 - scuba diving, 114
 - sculptor, 102
 - searching
 - database, 24
 - securities, 19
 - Sequential File Creation routine, 154
 - Sequential File Reading routine, 154
 - services, 41
 - shopping aid
 - food, 12
 - Short Term Insolvency Calculation
 - program, 30
 - short-term insolvency, 29
 - shorthand translator, 10
 - Sim Game program, 69
 - simulation games, 124
 - simulations
 - educational, 96
 - large-scale, 97
 - simultaneous equations, 66
 - sock market quotes, 144
 - software
 - business, 42
 - software guide, 163
 - Source, 150
 - personal reference, 1
 - source index, 158
 - speed reading, 98
 - spelling, 98
 - spelling checker, 156
 - sports, 114
 - sports games, 118
 - sports predictions, 42
 - spreadsheets, 44

standard error, 23
 statistical analysis, 62
 statistics, 61
 stock
 intrinsic value of, 28
 stock alpha and beta, 29
 stock analysis
 information on, 21
 stock Beta, 31
 stock market, 41
 stock valuation program, 29
 Stock Value Calculation program, 28
 stocks, 19
 strategy games, 118
 sunrise time, 114
 sunset time, 114
 supermarket comparison service, 42
 surveying calculations, 77
 synthesizers, 133
 computer controlled, 108
 system
 Commodore 128, 135
 systems
 business, 42

T

table of contents, 156
 tachistoscope, 98
 tailor's calculations, 158
 tax
 income, 39
 tax planning, 40
 technical analysis, 20
 telephone answering machine, 7
 telephone answering service, 42
 telephone dialer, 7
 telephone file, 7

telephone timer, 6
 terminal programs, 145
 textile patterns, 101
 thesaurus, 156
 Tick Tock program, 14
 tickets
 raffle, 15
 Ticktacktoe variations, 120
 tides, 114
 time
 sunrise and sunset, 114
 time billing, 6
 time calculations, 51
 time management system
 personal, 7
 timer, 13
 telephone, 6
 timer circuit, 80
 Timer routine, 6
 times interest earned ratio, 26
 Toffler
 Alvin, 143
 total assets turnover ratio, 27
 trace
 price, 21
 volume, 21
 transformer design, 79
 transformations, 78
 translations, 155
 translator
 shorthand, 10
 travel information, 144
 trend line analysis, 22
 Tricolor game, 118
 Trigonometric Calculator program,
 64
 Trigonometric Plotter program, 65

Tuknanavuhpi game, 121
 tutor
 computer, 93
 Two Move game, 69
 typesetting, 41
 typing speed, 158

U

utility programs, 153

V

values
 corresponding, 67
 vehicles
 recreational, 114
 verbal arts, 102
 Verti-Bird program, 126
 video games, 117, 125
 visual arts, 99
 vocal input, 133
 voltage conversion, 80
 volume trace, 21

W

wall paper estimator, 15
 warrants, 36
 waveforms, 134
 weather forecasting, 73
 Window Command routine, 154
 withdrawals
 minimum investment for, 34
 word games, 118, 122
 word problems, 98
 word processing, 3, 42
 World War III, 71
 writing, 156
 letter, 4

1001 Things to Do with Your Commodore 128™

If you are intrigued with the possibilities of the programs included in *1001 Things to Do with Your Commodore 128™* (TAB Book No. 2756), you should definitely consider having the ready-to-run disk containing the software applications. This software is guaranteed free of manufacturer's defects. (If you have any problems, return the disk within 30 days, and we'll send you a new one.) Not only will you save the time and effort of typing the programs, the disk eliminates the possibility of errors that can prevent the programs from functioning. Interested?

Available on disk for Commodore 128 at \$24.95 for each disk plus \$1.00 shipping and handling.

I'm interested. Send me:

_____ disk for the Commodore 128 (6426S)

_____ TAB BOOKS catalog

_____ Check/Money Order enclosed for \$24.95 plus \$1.00 shipping and handling for each disk ordered.

_____ VISA _____ MasterCard

Account No. _____ Expires _____

Name _____

Address _____

City _____ State _____ Zip _____

Signature _____

Mail To: **TAB BOOKS Inc.**
P.O. Box 40
Blue Ridge Summit, PA 17214

(Pa. add 6% sales tax. Orders outside U.S. must be prepaid with international money orders in U.S. dollars.)

TAB 2756

1001 Things to Do with Your Commodore 128™

Mark Sawusch and Dave Prochnow

**TAB's all-time bestselling computer idea book . . .
now in a brand new, revised edition for the Commodore 128™!**

"An amazing collection of practical ideas and programs . . . the book is really overwhelming . . . enough ideas to keep you and your computer busy for 01100100 binary years!"

80 Microcomputing

" . . . a marvelous guide to personal computer use . . . an indispensable reference that will open up new horizons for you and your computer."

Mother Earth News

" . . . a good source of material for programmers who write games, or who like variety, or who run out of ideas."

Creative Computing

Here's a gold mine of exciting ideas . . . more than 1000 ways you can use your Commodore 64 for applications ranging from household record keeping and budgeting to investment analysis and business management—from game playing and hobby use to scientific and educational applications.

This well-illustrated guide shows how to use numerous techniques for using your computer in both practical and just-for-fun ways . . . to forecast weather . . . to help your youngsters make better grades . . . to calculate camera settings . . . to put your business on the road to better profits . . . technical applications . . . and more!

Packed with ingenious and innovative ideas for putting your computer to work—including lots of ways to save time and money, even ways to use your computer to make money—it's a book that's sure to inspire you to come up with still more ideas of your own. And that's only the tip of the iceberg! The authors have provided all-new, commercial-quality programs for sound and graphics; financial, business, educational, and high-tech applications; plus unique games and puzzles as well as an invaluable library of computer specific utilities and subroutines. Printouts, flowcharts, diagrams, step-by-step instructions, and a wealth of new illustrations are all featured in this new version of a programming book that has always been ahead of its time!

Mark Sawusch is an experienced microcomputer programmer, writer, and a pioneer in the personal computing field. Dave Prochnow is co-author of TAB's *101 Projects, Plans and Ideas for the High-Tech Household*.

TAB TAB BOOKS Inc.

Blue Ridge Summit, Pa. 17214

Send for FREE TAB Catalog describing over 1200 current titles in print.

FPT > \$12.95

ISBN 0-8306-2756-1

PRICES HIGHER IN CANADA

1245-0686